

# 2024 FORD SUPER DUTY Owner's Manual

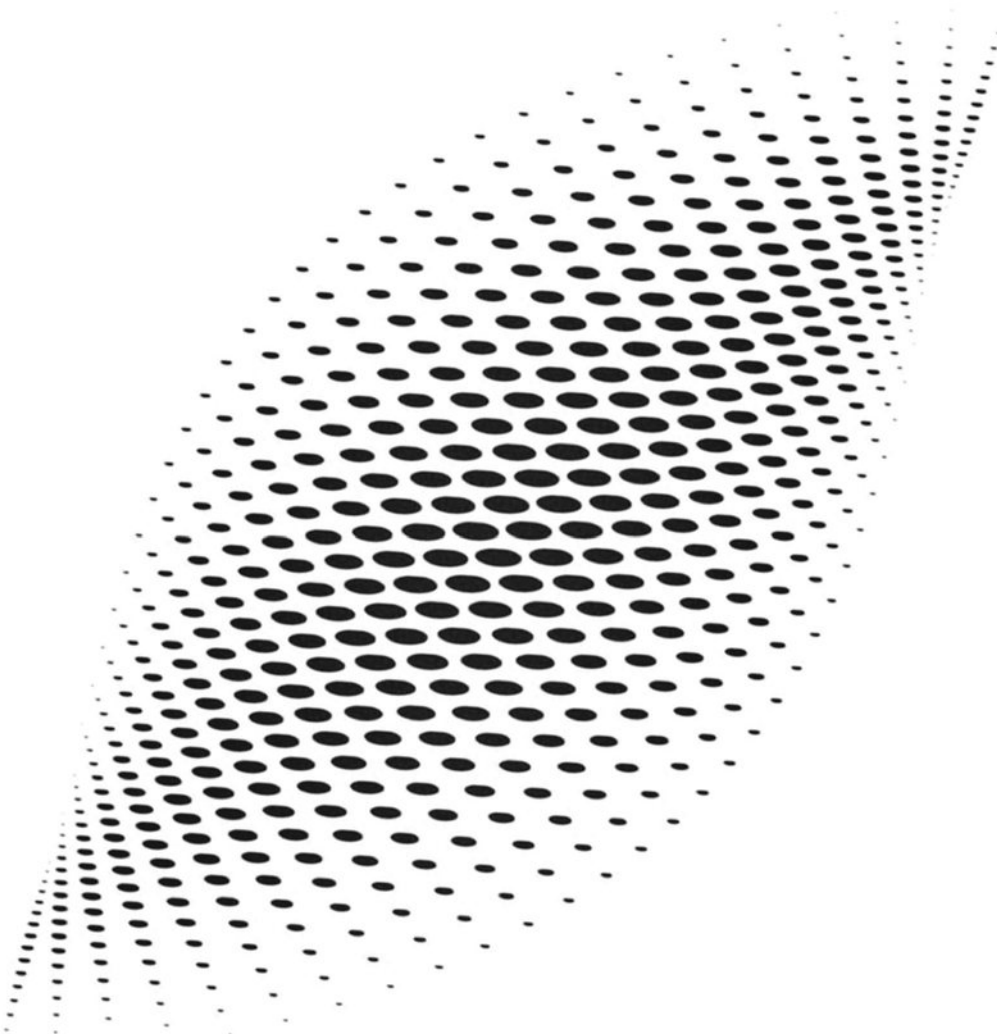



The information contained in this publication was correct at the time of release. In the interest of continuous development, we reserve the right to change specifications, design or equipment at any time without notice or obligation. No part of this publication may be reproduced, transmitted, stored in a retrieval system or translated into any language in any form by any means without our written permission. Errors and omissions excepted.

© Ford Motor Company 2023

All rights reserved.

Part Number: -202307-20230712175524

## California Proposition 65



**WARNING:** Operating, servicing and maintaining a passenger vehicle or off-highway motor vehicle can expose you to chemicals including engine exhaust, carbon monoxide, phthalates, and lead, which are known to the State of California to cause cancer and birth defects or other reproductive harm. To minimize exposure, avoid breathing exhaust, do not idle the engine except as necessary, service your vehicle in a well-ventilated area and wear gloves or wash your hands frequently when servicing your vehicle. For more information go to [www.P65Warnings.ca.gov/passenger-vehicle](http://www.P65Warnings.ca.gov/passenger-vehicle).



**WARNING:** Battery posts, terminals and related accessories contain lead and lead compounds, chemicals known to the State of California to cause cancer and reproductive harm.  
**Wash your hands after handling.**





# Table of Contents

---

## Contacting Us

Contacting Us .....	19
---------------------	----

## Introduction

About This Publication .....	21
Using This Publication .....	22

## Symbols Glossary

Symbols Used on Your Vehicle .....	23
------------------------------------	----

## Data Privacy

Data Privacy .....	26
Service Data .....	27
Event Data .....	27
Settings Data .....	28
Connected Vehicle Data .....	28
Mobile Device Data .....	29
Emergency Call System Data .....	29

## Environment

Protecting the Environment .....	30
----------------------------------	----

## Visual Search

Steering Wheel .....	31
Instrument Panel .....	32
Vehicle Interior .....	33
Front Exterior .....	34
Rear Exterior .....	35

## Child Safety

Child Safety Precautions .....	36
Child Restraint Anchor Points .....	37
Child Restraints .....	39
Installing Child Restraints .....	40
Booster Seats .....	47
Child Safety Locks - Crew Cab/ SuperCab .....	49

## Seatbelts

Seatbelt Precautions .....	50
Fastening and Unfastening the Seatbelts .....	51
Sensitive Locking Mode .....	52
Automatic Locking Mode .....	52
Adjusting the Seatbelts During Pregnancy .....	53
Adjusting the Seatbelt Height .....	53
Adjusting the Seatbelt Length .....	54
Seatbelt Reminder .....	54
Checking the Seatbelts .....	56
Seatbelt Extensions .....	56

## Airbags

How Do the Front Airbags Work .....	57
How Do the Side Airbags Work .....	57
How Does the Safety Canopy™ Work .....	58
Airbag Precautions .....	59
Switching the Passenger Airbag On and Off .....	60
Properly Adjusting the Driver and Front Passenger Seats .....	64
Children and Airbags .....	64
Crash Sensors and Airbag Indicator .....	65
Disposing of Airbags .....	66

## 911 Assist

What Is 911 Assist .....	67
How Does 911 Assist Work .....	67
Emergency Call Requirements .....	67
Emergency Call Limitations .....	68
911 Assist Videos .....	68

## Keys and Remote Controls

Remote Control Limitations .....	69
Using the Remote Control .....	69
Opening and Closing the Flip Key .....	70
Removing the Key Blade - Vehicles With: Push Button Start .....	70

# Table of Contents

---

Sounding the Panic Alarm .....	71	Locating the Keyless Entry Keypad .....	83
Locating Your Vehicle .....	71	Keyless Entry Keypad Master Access Code .....	83
Changing the Remote Control Battery - Vehicles With: Flip Key .....	71	Keyless Entry Keypad Personal Access Codes .....	84
Changing the Remote Control Battery - Vehicles With: Push Button Start .....	72	Using the Keyless Entry Keypad .....	84
Replacing a Lost Key or Remote Control .....	73	Keyless Entry Keypad – Troubleshooting .....	85
Programming the Remote Control - Vehicles With: Flip Key .....	74	Keyless Entry Keypad Videos .....	85
Programming the Remote Control - Vehicles With: Push Button Start .....	75	<b>Easy Entry and Exit</b>	
Keys and Remote Controls Audible Warnings - Vehicles With: Push Button Start .....	76	How Does Easy Entry and Exit Work .....	86
Keys and Remote Controls Audible Warnings - Vehicles With: Flip Key .....	76	Switching Easy Entry and Exit On and Off .....	86
Keys and Remote Controls – Troubleshooting .....	76	<b>Tailgate - Vehicles With: Manual Tailgate</b>	
<b>Doors and Locks</b>		Tailgate Precautions .....	87
Operating the Doors From Outside Your Vehicle .....	77	Opening the Tailgate .....	87
Operating the Doors From Inside Your Vehicle .....	77	Removing and Installing the Tailgate .....	87
Autounlock .....	78	Tailgate Step .....	88
Autolock .....	78	Tailgate Videos .....	89
Mislock .....	78	<b>Tailgate - Vehicles With: Power Tailgate</b>	
Doors and Locks Audible Warnings .....	78	Tailgate Precautions .....	90
Doors and Locks – Troubleshooting .....	79	Opening the Tailgate .....	90
		Closing the Tailgate .....	90
		Removing and Installing the Tailgate .....	91
		Tailgate Step .....	92
		Tailgate – Troubleshooting .....	94
		Tailgate Videos .....	95
<b>Keyless Entry</b>		<b>Tailgate - Vehicles With: Remote Power Tailgate Release</b>	
Keyless Entry Limitations .....	81	Tailgate Precautions .....	96
Keyless Entry Settings .....	81	Opening the Tailgate .....	96
Using Keyless Entry .....	81		
Keyless Entry – Troubleshooting .....	82		
Keyless Entry Videos .....	82		
<b>Keyless Entry Keypad</b>			
What Is the Keyless Entry Keypad .....	83		
Keyless Entry Keypad Limitations .....	83		

# Table of Contents

Removing and Installing the Tailgate .....	96	Wipers and Washers Videos .....	112
Tailgate Step .....	97	Wipers and Washers – Troubleshooting .....	113
Tailgate – Troubleshooting .....	98		
Tailgate Videos .....	99		
<b>Security</b>		<b>Exterior Lighting</b>	
Passive Anti-Theft System .....	100	Exterior Lighting Control .....	114
Anti-Theft Alarm System .....	100	Headlamps .....	114
Anti-Theft Alarm System Settings .....	101	Headlamps – Troubleshooting .....	114
Security – Troubleshooting .....	102	Autolamps .....	115
		Exterior Lamps .....	115
<b>Power Running Boards</b>		Exterior Zone Lighting .....	118
Power Running Board Precautions .....	104	Automatic High Beam Control .....	119
Power Running Board Settings .....	104	Automatic High Beam Control – Troubleshooting .....	121
Power Running Boards – Troubleshooting .....	105	Adaptive Front Lighting .....	122
		Exterior Lighting Videos .....	122
<b>Steering Wheel</b>			
Adjusting the Steering Wheel - Vehicles With: Manual Adjustable Steering Column .....	106	<b>Interior Lighting</b>	
Adjusting the Steering Wheel - Vehicles With: Power Adjustable Steering Column .....	106	Switching All of the Interior Lamps On and Off .....	123
Resetting the Stopping Position - Vehicles With: Power Adjustable Steering Column .....	107	Switching the Front Interior Lamps On and Off .....	123
Horn .....	107	Switching the Rear Interior Lamps On and Off .....	123
Switching the Heated Steering Wheel On and Off - Vehicles With: Heated Steering Wheel .....	108	Interior Lamp Function .....	123
		Adjusting the Instrument Panel Lighting Brightness .....	124
<b>Adjustable Pedals</b>		Ambient Lighting .....	124
Adjusting the Pedals .....	109	Interior Lighting – Troubleshooting .....	124
<b>Wipers and Washers</b>		<b>Windows</b>	
Wipers .....	110	Opening and Closing the Windows .....	125
Autowipers .....	110	Global Opening .....	125
Checking the Wiper Blades .....	111	Window Bounce-Back .....	126
Replacing the Front Wiper Blades .....	111	Locking the Rear Window Controls - Crew Cab/SuperCab .....	126
Washers .....	112	Opening and Closing the Sliding Windows - Vehicles With: Power Sliding Rear Window .....	126
		Windows Videos .....	127

# Table of Contents

---

## Interior Mirror

Interior Mirror Precautions .....	128
Manually Dimming the Interior Mirror .....	128
Auto-Dimming Interior Mirror .....	128

## Exterior Mirrors

Adjusting the Exterior Mirrors .....	129
Folding the Exterior Mirrors - Vehicles With: Manual Folding Mirrors .....	129
Folding the Exterior Mirrors - Vehicles With: Power Folding Mirrors .....	129
Extending the Exterior Mirrors .....	130

## Moonroof

Opening and Closing the Sunshade .....	131
Opening and Closing the Moonroof .....	131
Venting the Moonroof .....	132
Moonroof Bounce-Back .....	132
Moonroof Videos .....	132

## Instrument Cluster

Instrument Cluster Overview - Vehicles With: 4.2 Inch Screen .....	133
Instrument Cluster Overview - Vehicles With: 12 Inch Screen .....	134
Tachometer .....	134
Speedometer .....	134
Fuel Gauge .....	134
Engine Coolant Temperature Gauge .....	135
Engine Oil Pressure Gauge .....	135
Engine Oil Temperature Gauge .....	135
Transmission Fluid Temperature Gauge .....	135
Turbo Boost Gauge .....	135
Diesel Exhaust Fluid Gauge .....	135
What Are the Instrument Cluster Warning Lamps .....	135
Instrument Cluster Warning Lamps .....	136

What Are the Instrument Cluster Indicators .....	137
Instrument Cluster Indicators .....	137

## Instrument Cluster Display

Using the Instrument Cluster Display Controls .....	140
Instrument Cluster Display Main Menu - Vehicles With: 4.2 Inch Screen .....	140
Instrument Cluster Display Main Menu - Vehicles With: 12 Inch Screen .....	141
Customizing the Instrument Cluster Display - Vehicles With: 4.2 Inch Screen .....	141
Customizing the Instrument Cluster Display - Vehicles With: 12 Inch Screen .....	141

## Personalized Settings

Changing the Language .....	142
Changing the Measurement Unit .....	142
Changing the Temperature Unit .....	142
Changing the Tire Pressure Unit .....	142

## Trip Computer

Accessing the Trip Computer - Vehicles With: 4.2 Inch Screen .....	143
Accessing the Trip Computer - Vehicles With: 12 Inch Screen .....	143
Resetting the Trip Computer .....	143
Trip Data .....	143

## Head Up Display

What Is the Head Up Display .....	144
Switching the Head Up Display On and Off .....	144
Head Up Display Settings .....	144
Head Up Display – Troubleshooting .....	145

## Remote Start

What Is Remote Start .....	146
----------------------------	-----

# Table of Contents

---

Remote Start Precautions .....	146
Remote Start Limitations .....	146
Enabling Remote Start .....	146
Remotely Starting and Stopping the Vehicle .....	146
Extending the Remote Start Duration .....	147
Remote Start Settings .....	147

## **Climate Control - Vehicles With: Automatic Temperature Control**

Identifying the Climate Control Unit .....	148
Switching Climate Control On and Off .....	148
Switching Recirculated Air On and Off .....	148
Switching Air Conditioning On and Off .....	148
Switching Defrost On and Off .....	148
Switching Maximum Defrost On and Off .....	148
Switching Maximum Cooling On and Off .....	149
Switching the Heated Rear Window On and Off .....	149
Setting the Blower Motor Speed .....	149
Switching the Heated Mirrors On and Off .....	149
Setting the Temperature .....	149
Directing the Flow of Air .....	150
Auto Mode .....	150
Climate Control Hints .....	150
Climate Control Videos .....	151

## **Climate Control - Vehicles With: Manual Temperature Control**

Identifying the Climate Control Unit .....	152
Switching Climate Control On and Off .....	152

Switching Recirculated Air On and Off .....	152
Switching Air Conditioning On and Off .....	152
Switching Defrost On and Off .....	152
Switching Maximum Defrost On and Off .....	152
Switching Maximum Cooling On and Off .....	153
Switching the Heated Rear Window On and Off .....	153
Setting the Blower Motor Speed .....	153
Switching the Heated Mirrors On and Off .....	153
Setting the Temperature .....	154
Directing the Flow of Air .....	154
Climate Control Hints .....	154
Climate Control Videos .....	155

## **Interior Air Quality**

What Is the Cabin Air Filter .....	156
Replacing the Cabin Air Filter .....	156

## **Front Seats**

Front Seat Precautions .....	157
Sitting in the Correct Position .....	157
Manual Seats .....	158
Power Seats .....	160
Massage Seats .....	163
Heated Seats .....	164
Ventilated Seats .....	165
Front Seats Videos .....	165

## **Rear Seats - Crew Cab/ SuperCab**

Manual Seats .....	166
Heated Seats .....	168

# Table of Contents

---

## Rear Occupant Alert System

What is the Rear Occupant Alert System .....	170
How Does the Rear Occupant Alert System Work .....	170
Rear Occupant Alert System Precautions .....	170
Rear Occupant Alert System Limitations .....	170
Rear Occupant Alert System Settings .....	171
Rear Occupant Alert System Indicators .....	171
Rear Occupant Alert System Audible Warnings .....	172

## Memory Function

What Is the Memory Function .....	173
Memory Function Precautions .....	173
Locating the Memory Function Buttons .....	173
Saving a Preset Position .....	173
Recalling a Preset Position .....	173

## Garage Door Opener

Garage Door Opener Introduction .....	174
Garage Door Opener Precautions and Frequencies .....	174
Programming the Garage Door Opener .....	175
Garage Door Opener Additional Assistance .....	177

## USB Ports

Locating the USB Ports .....	178
Playing Media Using the USB Port .....	178
Charging a Device .....	178

## Power Outlet - Vehicles With: 110V Power Outlet

What Is the Power Outlet .....	180
--------------------------------	-----

Power Outlet Precautions .....	180
Power Outlet Limitations .....	180
Locating the Power Outlets .....	180
Power Outlet Indicators .....	181
Power Outlet Videos .....	181

## Onboard Generator

What Is the Onboard Generator .....	182
Onboard Generator Precautions .....	182
Locating the Outlets .....	183
Onboard Generator Indicators .....	183
Switching the Outlets On and Off .....	184
What Is Utility Idle Mode .....	185
Switching Utility Idle Mode On and Off .....	185
What Is Generator Mode .....	185
Switching Generator Mode On and Off .....	185
Resetting Ground Fault Detection .....	185
Onboard Generator – Troubleshooting .....	186

## Center Console Work Surface

Using the Center Console Work Surface .....	188
Center Console Work Surface – Troubleshooting .....	189

## Wireless Accessory Charger

What Is the Wireless Accessory Charger .....	190
Wireless Accessory Charger Precautions .....	190
Locating the Wireless Accessory Charger .....	190
Charging a Wireless Device .....	190
Wireless Accessory Charger Videos .....	191

## Storage

Cup Holders .....	192
-------------------	-----

# Table of Contents

Glove Compartment .....	192	Diesel Particulate Filter Manual Regeneration .....	218
Center Console .....	193	Diesel Particulate Filter – Troubleshooting .....	220
Under Seat Storage .....	193		
Glasses Holder .....	196		
<b>Starting and Stopping the Engine</b>		<b>Selective Catalytic Reduction System - Diesel</b>	
Starting and Stopping the Engine – Precautions .....	197	What Is the Selective Catalytic Reduction System .....	222
Ignition Switch .....	197	How Does the Selective Catalytic Reduction System Work .....	222
Push Button Ignition Switch .....	198	Selective Catalytic Reduction System Precautions .....	222
Starting the Engine .....	198	Selective Catalytic Reduction System Requirements .....	224
Engine Block Heater .....	200	Selective Catalytic Reduction System Guidelines .....	224
Stopping the Engine .....	201	Filling the Selective Catalytic Reduction System Tank .....	224
Idle Timer .....	202	Checking the Selective Catalytic Reduction System Status .....	226
Automatic Engine Stop .....	203	Diesel Exhaust Fluid Capacity and Specification .....	226
Accessing the Passive Key Backup Position .....	204	Selective Catalytic Reduction System – Troubleshooting .....	227
Starting and Stopping the Engine – Troubleshooting .....	204		
Starting and Stopping the Engine Videos .....	208		
<b>Fuel and Refueling</b>		<b>Catalytic Converter</b>	
Fuel and Refueling Precautions .....	209	What Is the Catalytic Converter .....	229
Fuel Quality .....	209	Catalytic Converter Precautions .....	229
Running Out of Fuel .....	214	Catalytic Converter – Troubleshooting .....	229
Refueling .....	214		
Fuel Tank Capacity .....	216	<b>Automatic Transmission</b>	
Fuel and Refueling – Troubleshooting .....	216	Automatic Transmission Precautions .....	230
<b>Diesel Particulate Filter - Diesel</b>		Automatic Transmission Positions .....	230
What Is the Diesel Particulate Filter .....	217	Shifting Your Vehicle Into Gear .....	231
How Does the Diesel Particulate Filter Work .....	217	Automatic Transmission Position Indicators .....	231
Diesel Particulate Filter Precautions .....	217	Automatic Transmission Audible Warnings .....	231
Diesel Particulate Filter Requirements .....	218	Using Progressive Range Selection .....	231
		Manually Shifting Gears .....	232

# Table of Contents

Power Take-Off .....	232	Checking the Brake Fluid .....	246
<b>Four-Wheel Drive</b>		Brake Fluid Specification .....	247
How Does Four-Wheel Drive Work .....	234	Brakes – Troubleshooting .....	247
Four-Wheel Drive Precautions .....	235	<b>Electric Parking Brake</b>	
Four-Wheel Drive Limitations .....	235	What Is the Electric Parking Brake .....	250
Switching Four-Wheel Drive On and Off .....	236	Applying the Electric Parking Brake .....	250
Selecting a Four-Wheel Drive Mode .....	237	Applying the Electric Parking Brake in an Emergency .....	250
Four-Wheel Drive Modes .....	238	Manually Releasing the Electric Parking Brake .....	250
Four-Wheel Drive Indicators .....	238	Automatically Releasing the Electric Parking Brake .....	251
Transfer Case Fluid Capacity and Specification .....	238	Electric Parking Brake Audible Warning .....	251
Four-Wheel Drive – Troubleshooting .....	239	Releasing the Electric Parking Brake if the Vehicle Battery Has Run Out of Charge .....	251
Four-Wheel Drive Videos .....	240	Electric Parking Brake – Troubleshooting .....	251
<b>Rear Axle</b>		<b>Diesel Engine Exhaust Brake</b>	
Limited Slip Differential .....	241	Diesel Engine Exhaust Brake – Precautions .....	253
<b>Electronic Locking Differential</b>		Using the Diesel Engine Exhaust Brake .....	253
What Is the Electronic Locking Differential .....	242	Diesel Engine Exhaust Brake Indicators .....	254
How Does the Electronic Locking Differential Work .....	242	Diesel Engine Exhaust Brake Gauge .....	254
Electronic Locking Differential Precautions .....	242	Diesel Engine Exhaust Brake – Troubleshooting .....	254
Switching the Electronic Locking Differential On and Off - 4x4 .....	242	<b>Reverse Brake Assist</b>	
Switching the Electronic Locking Differential On and Off - 4x2 .....	244	What Is Reverse Brake Assist .....	255
Electronic Locking Differential Indicators .....	244	How Does Reverse Brake Assist Work .....	255
Electronic Locking Differential – Troubleshooting .....	245	Reverse Brake Assist Precautions .....	255
<b>Brakes</b>		Switching Reverse Brake Assist On and Off .....	256
Brake Precautions .....	246	Overriding Reverse Brake Assist .....	256
Anti-Lock Braking System .....	246	Reverse Brake Assist Indicators .....	256
Brake Over Accelerator .....	246		
Locating the Brake Fluid Reservoir .....	246		



# Table of Contents

---

Reverse Brake Assist – Troubleshooting .....257

## **Cross Traffic Braking**

What Is Cross Traffic Braking .....259  
How Does Cross Traffic Braking Work .....259  
Cross Traffic Braking Precautions .....259  
Switching Cross Traffic Braking On and Off .....260  
Overriding Cross Traffic Braking .....260  
Cross Traffic Braking Indicators .....260  
Cross Traffic Braking – Troubleshooting .....260

## **Hill Start Assist**

What Is Hill Start Assist .....262  
How Does Hill Start Assist Work .....262  
Hill Start Assist Precautions .....262  
Switching Hill Start Assist On and Off .....262  
Hill Start Assist – Troubleshooting .....262  
Hill Start Assist Videos .....262

## **Auto Hold**

How Does Auto Hold Work .....263  
Switching Auto Hold On and Off .....263  
Using Auto Hold .....263  
Auto Hold Indicators .....263

## **Traction Control**

What Is Traction Control .....265  
How Does Traction Control Work .....265  
Switching Traction Control On and Off .....265  
Traction Control Indicator .....265  
Traction Control – Troubleshooting .....266

## **Stability Control**

How Does Stability Control Work .....267

Switching Stability Control On and Off .....268  
Stability Control Indicator .....269

## **Trail Control**

What Is Trail Control .....270  
Trail Control Limitations .....270  
Switching Trail Control On and Off .....270  
Setting the Trail Control Speed .....270  
Canceling the Set Speed .....271  
Trail Control Indicators .....271  
Trail Control – Troubleshooting .....272

## **Trail Turn Assist**

What Is Trail Turn Assist .....273  
Trail Turn Assist Precautions .....273  
Trail Turn Assist Limitations .....273  
Switching Trail Turn Assist On and Off .....273  
Trail Turn Assist Indicators .....273  
Trail Turn Assist – Troubleshooting .....274

## **Hill Descent Control**

What Is Hill Descent Control .....275  
How Does Hill Descent Control Work .....275  
Hill Descent Control Precautions .....275  
Switching Hill Descent Control On and Off .....275  
Setting the Hill Descent Speed .....275  
Hill Descent Control Indicator .....275  
Hill Descent Control – Troubleshooting .....276  
Hill Descent Control Videos .....276

## **Steering**

Hydraulic Power Steering .....277  
Steering – Troubleshooting .....279

# Table of Contents

---

## Parking Aids

Parking Aid Precautions .....	280
Switching Parking Aid On and Off - Vehicles With: Front Parking Aid .....	280
Switching Parking Aid On and Off - Vehicles With: Rear Parking Aid .....	281
Rear Parking Aid .....	281
Front Parking Aid .....	282
Parking Aid Indicators .....	283
Parking Aids – Troubleshooting .....	284
Parking Aids Videos .....	284

## Rear View Camera

What Is the Rear View Camera .....	285
Rear View Camera Precautions .....	285
Locating the Rear View Camera .....	285
Rear View Camera Guide Lines .....	286
Rear View Camera Settings .....	286

## 360 Degree Camera

What Is the 360 Degree Camera .....	288
How Does the 360 Degree Camera Work .....	288
360 Degree Camera Precautions .....	288
Locating the 360 Degree Cameras .....	288
360 Degree Camera Guide Lines .....	289
360 Degree Camera Settings .....	290

## Cruise Control

What Is Cruise Control .....	292
Switching Cruise Control On and Off .....	292
Setting the Cruise Control Speed .....	292
Canceling the Set Speed .....	293
Resuming the Set Speed .....	293
Cruise Control Indicators .....	293

## Adaptive Cruise Control

How Does Adaptive Cruise Control With Stop and Go Work .....	294
---	-----

Adaptive Cruise Control Precautions .....	294
Adaptive Cruise Control Limitations .....	295
Switching Adaptive Cruise Control On and Off .....	297
Adaptive Cruise Control Automatic Cancellation .....	297
Setting the Adaptive Cruise Control Speed .....	297
Setting the Adaptive Cruise Control Gap .....	298
Canceling the Set Speed .....	299
Resuming the Set Speed .....	299
Overriding the Set Speed .....	300
Adaptive Cruise Control Indicators .....	301
Switching From Adaptive Cruise Control to Cruise Control .....	301
Lane Centering .....	301
Lane Centering – Troubleshooting .....	304
Predictive Speed Assist .....	305
Predictive Speed Assist – Troubleshooting .....	307
Adaptive Cruise Control – Troubleshooting .....	308
Adaptive Cruise Control Videos .....	308

## Drive Mode Control

What Is Drive Mode Control .....	309
How Does Drive Mode Control Work .....	309
Selecting a Drive Mode .....	309
Drive Modes .....	309
Drive Mode Control – Troubleshooting .....	312

## Lane Keeping System

What Is the Lane Keeping System .....	315
How Does the Lane Keeping System Work .....	315
Lane Keeping System Precautions .....	315
Lane Keeping System Limitations .....	315

# Table of Contents

Switching the Lane Keeping System On and Off .....	316	Exit Warning Limitations .....	329
Switching the Lane Keeping System Mode .....	316	Exit Warning Indicators .....	330
Alert Mode .....	316	Switching Exit Warning On and Off .....	330
Aid Mode .....	317	Locating the Exit Warning Sensors .....	330
Alert and Aid Mode .....	317	Exit Warning – Troubleshooting .....	331
Lane Keeping System Indicators .....	318	<b>Cross Traffic Alert</b>	
Blind Spot Assist .....	319	What Is Cross Traffic Alert .....	332
Blind Spot Assist with Trailer Coverage .....	319	How Does Cross Traffic Alert Work .....	332
Lane Keeping System – Troubleshooting .....	321	Cross Traffic Alert Precautions .....	332
		Cross Traffic Alert Limitations .....	332
		Switching Cross Traffic Alert On and Off .....	333
		Locating the Cross Traffic Alert Sensors .....	333
		Cross Traffic Alert Indicators .....	333
		Cross Traffic Alert – Troubleshooting .....	334
<b>Blind Spot Information System</b>		<b>Pre-Collision Assist</b>	
What Is Blind Spot Information System .....	324	What Is Pre-Collision Assist .....	335
How Does Blind Spot Information System Work .....	324	How Does Pre-Collision Assist Work .....	335
Blind Spot Information System Precautions .....	324	Pre-Collision Assist Precautions .....	335
Blind Spot Information System Limitations .....	324	Pre-Collision Assist Limitations .....	336
Blind Spot Information System Requirements .....	324	Switching Pre-Collision Assist On and Off .....	337
Switching Blind Spot Information System On and Off .....	324	Locating the Pre-Collision Assist Sensors .....	338
Locating the Blind Spot Information System Sensors .....	325	Distance Indication .....	338
Blind Spot Information System With Trailer Coverage .....	325	Distance Alert .....	339
Blind Spot Information System Indicators .....	327	Automatic Emergency Braking .....	339
Blind Spot Information System – Troubleshooting .....	328	Evasive Steering Assist .....	340
Blind Spot Information System Videos .....	328	Pre-Collision Assist – Troubleshooting .....	341
		Pre-Collision Assist Videos .....	342
<b>Exit Warning</b>		<b>Speed Sign Recognition</b>	
What is Exit Warning .....	329	What Is Speed Sign Recognition .....	343
How Does Exit Warning Work .....	329	How Does Speed Sign Recognition Work .....	343
Exit Warning Precautions .....	329		

# Table of Contents

---

Speed Sign Recognition Precautions .....	343
Speed Sign Recognition Limitations .....	343
Speed Sign Recognition Indicators .....	343
Setting the Speed Sign Recognition Speed Warning .....	344
Setting the Speed Sign Recognition Speed Tolerance .....	344
Speed Sign Recognition – Troubleshooting .....	344

## Driver Alert

What Is Driver Alert .....	346
How Does Driver Alert Work .....	346
Driver Alert Precautions .....	346
Driver Alert Limitations .....	346
Switching Driver Alert On and Off .....	346
Driver Alert – Troubleshooting .....	347

## Load Carrying

Load Carrying Precautions .....	348
Using a Slide-In Camper .....	349
Locating the Safety Compliance Certification Labels .....	349
What Is the Gross Axle Weight Rating .....	349
What Is the Gross Vehicle Weight Rating .....	349
What Is the Gross Combined Weight Rating .....	349
Calculating Payload .....	350
Calculating the Load Limit .....	350

## Pickup Bed

Pickup Bed Precautions .....	353
Pickup Bed Anchor Points .....	353
Tailgate Anchor Points .....	355
Pickup Bed Videos .....	355

## Connecting a Trailer

Connecting a Trailer Precautions .....	356
--	-----

Hitches .....	356
Connecting a Trailer .....	358
Trailer Lighting Check .....	360
Connecting a Trailer – Troubleshooting .....	361

## Towing a Trailer

Towing a Trailer Precautions .....	362
Trailer Brake Precautions .....	362
Towing a Trailer Limitations .....	363
Loading Your Trailer .....	363
Trailer Towing Hints .....	364
Launching or Retrieving a Boat or Personal Watercraft .....	364
Towing Weights and Dimensions .....	365
Towing a Trailer – Troubleshooting .....	367
Towing a Trailer Videos .....	368

## Integrated Trailer Brake Controller

What Is the Integrated Trailer Brake Controller .....	369
Integrated Trailer Brake Controller Precautions .....	369
Using the Integrated Trailer Brake Controller .....	369
Adjusting the Integrated Trailer Brake Controller Mode .....	371
Integrated Trailer Brake Controller – Troubleshooting .....	372

## Trailer Sway Control

How Does Trailer Sway Control Work .....	374
Trailer Sway Control Precautions .....	374
Switching Trailer Sway Control On and Off .....	374
Trailer Sway Control Videos .....	374

## Trailer Hitching Assistance

What Is Trailer Hitching Assistance .....	375
---	-----

# Table of Contents

How Does Trailer Hitching Assistance Work .....	375
Trailer Hitching Assistance Precautions .....	375
Trailer Hitching Assistance Limitations .....	376
Switching Trailer Hitching Assistance On and Off .....	376
Using Trailer Hitching Assistance .....	376
Trailer Hitching Assistance Indicators .....	377

## Smart Hitch

What Is Smart Hitch .....	379
How Does Smart Hitch Work .....	379
Smart Hitch Limitations .....	379
Using Smart Hitch .....	379

## Onboard Scales

What Is Onboard Scales .....	381
How Does Onboard Scales Work .....	381
Onboard Scales Limitations .....	381
Using Onboard Scales .....	381

## Trailer Backup Assistance

What is Trailer Backup Assistance .....	383
How Does Trailer Backup Assistance Work .....	383
Trailer Backup Assistance Precautions .....	383
Setting Up the Trailer Backup Assistance for a Conventional Trailer .....	383
Setting Up the Trailer Backup Assistance for a Fifth-Wheel or Gooseneck Trailer .....	386
Switching Trailer Backup Assistance On and Off .....	389
Using the Trailer Backup Assistance Controller .....	389
Using the Trailer Backup Assistance Views .....	390
Trailer Backup Assistance – Troubleshooting .....	392

## Trailer Reverse Guidance

What Is Trailer Reverse Guidance .....	398
How Does Trailer Reverse Guidance Work .....	398
Trailer Reverse Guidance Precautions .....	398
Setting Up Trailer Reverse Guidance for a Conventional Trailer .....	398
Switching Trailer Reverse Guidance On and Off .....	401
Using Trailer Reverse Guidance Views .....	402
Trailer Reverse Guidance – Troubleshooting .....	404

## Off-Road Driving

Basic Off-Road Driving Techniques .....	409
Driving Through Water Limitations .....	410
Water Wading .....	411
After Driving Your Vehicle Off-Road .....	412

## Driving Hints

Cold Weather Precautions - 6.7L Diesel .....	413
Cold Weather Precautions - 6.8L/7.3L .....	413
Driving on Snow and Ice .....	413
Breaking-In .....	414
Driving Economically .....	414
Driving Through Mud and Water .....	414
Floor Mats .....	415

## Snow Plowing - Vehicles With: Snow Plow Mode

Snow Plowing Precautions .....	416
Operating Your Vehicle With a Snowplow .....	416

## Crash and Breakdown Information

Roadside Assistance .....	418
---------------------------	-----

# Table of Contents

Switching the Hazard Flashers On and Off .....	419	Changing the Fuel Filter - Gasoline .....	452
Jump Starting the Vehicle .....	419	Drive Belt Routing Overview - 6.7L Diesel, Vehicles With: 110-120V 2kW Pickup Bed Power Outlet/Dual Generators .....	452
Post-Crash Alert System .....	421	Drive Belt Routing Overview - 6.7L Diesel, Vehicles With: Dual Generators .....	453
Post-Collision Braking .....	421	Drive Belt Routing Overview - 6.7L Diesel, Vehicles With: Single Generator .....	453
Automatic Crash Shutoff .....	422	Drive Belt Routing Overview - 6.8L, Gasoline, Vehicles With: Dual Generators .....	453
Recovery Towing .....	422	Drive Belt Routing Overview - 6.8L, Gasoline, Vehicles With: Single Generator .....	454
Transporting the Vehicle .....	423	Drive Belt Routing Overview - 7.3L, Gasoline, Vehicles With: Dual Generators .....	454
Fail-Safe Cooling .....	424	Drive Belt Routing Overview - 7.3L, Gasoline, Vehicles With: Single Generator .....	455
<b>Towing Your Vehicle</b>		12V Battery .....	455
Towing Your Vehicle Precautions .....	426	12V Battery – Troubleshooting .....	458
Recreationally Towing Your Vehicle - 4x4 .....	426	Adjusting the Headlamps .....	458
Recreationally Towing Your Vehicle - 4x2 .....	427	Exterior Bulbs .....	460
Emergency Towing .....	428	Interior Bulbs .....	467
Towing Your Vehicle – Troubleshooting .....	428	<b>Vehicle Care</b>	
<b>Fuses</b>		Cleaning Products .....	468
Fuse Precautions .....	429	Cleaning the Exterior .....	469
Under Hood Fuse Box .....	429	Cleaning the Interior .....	471
Interior Fuse Box .....	434	Repairing Minor Paint Damage .....	473
Identifying Fuse Types .....	438	Waxing Your Vehicle .....	474
Fuses – Troubleshooting .....	438	Vehicle Care Videos .....	474
<b>Maintenance</b>		<b>Storing Your Vehicle</b>	
Maintenance Precautions .....	439	Preparing Your Vehicle for Storage .....	475
Opening and Closing the Hood .....	439	Removing Your Vehicle From Storage .....	476
Under Hood Overview - 6.7L Diesel .....	440	<b>Wheel and Tire Information</b>	
Under Hood Overview - 6.8L, Gasoline .....	441	Locating the Tire label .....	477
Under Hood Overview - 7.3L, Gasoline .....	442		
Engine Oil .....	443		
Engine Air Filter .....	444		
Draining the Fuel Filter Water Trap - Diesel .....	446		
Coolant .....	449		
Changing the Fuel Filter - Diesel .....	452		

# Table of Contents

Department of Transportation Uniform Tire Quality Grades .....	477	Motorcraft Parts - 6.7L Diesel .....	523
Information on the Tire Sidewall .....	478	Motorcraft Parts - 6.8L, Gasoline .....	524
Glossary of Tire Terminology .....	483	Motorcraft Parts - 7.3L, Gasoline .....	525
Tire Replacement Requirements .....	484	Engine Oil Capacity and Specification - 6.7L Diesel .....	526
Using Snow Chains .....	486	Engine Oil Capacity and Specification - 6.8L, Gasoline .....	528
<b>Tire Care</b>		Engine Oil Capacity and Specification - 7.3L, Gasoline .....	530
Checking the Tire Pressures .....	489	Cooling System Capacity and Specification - 6.7L Diesel .....	532
Inflating the Tires .....	489	Cooling System Capacity and Specification - 6.8L, Gasoline .....	533
Inspecting the Tire for Wear .....	493	Cooling System Capacity and Specification - 7.3L, Gasoline .....	534
Inspecting the Tire for Damage .....	493	Fuel Tank Capacity - Diesel .....	534
Inspecting the Wheel Valve Stems .....	497	Fuel Tank Capacity - Gasoline .....	535
Tire Rotation .....	497	Air Conditioning System Capacity and Specification .....	536
<b>Tire Pressure Monitoring System</b>		Washer Fluid Specification .....	536
What Is the Tire Pressure Monitoring System .....	500	Diesel Exhaust Fluid Capacity and Specification .....	537
Tire Pressure Monitoring System Overview .....	500	Automatic Transmission Fluid Capacity and Specification .....	538
Tire Pressure Monitoring System Precautions .....	501	Brake Fluid Specification .....	538
Tire Pressure Monitoring System Limitations .....	501	Transfer Case Fluid Capacity and Specification .....	539
Viewing the Tire Pressures .....	502	Front Axle Fluid Capacity and Specification .....	539
Resetting Tire Pressure Monitoring System .....	502	Rear Axle Fluid Capacity and Specification .....	541
Tire Pressure Monitoring System – Troubleshooting .....	505	Hydraulic Power Steering Fluid Capacity and Specification .....	545
<b>Changing a Road Wheel</b>		<b>Vehicle Identification</b>	
Changing a Flat Tire .....	508	Vehicle Identification Number .....	546
Wheel Nuts .....	518	<b>Connected Vehicle</b>	
<b>Capacities and Specifications</b>		What Is a Connected Vehicle .....	547
Engine Specifications - 6.7L Diesel .....	520	Connected Vehicle Requirements .....	547
Engine Specifications - 6.8L, Gasoline .....	521	Connected Vehicle Limitations .....	547
Engine Specifications - 7.3L, Gasoline .....	522	Connecting the Vehicle to a Mobile Network .....	547

# Table of Contents

Connecting the Vehicle to a Wi-Fi Network .....	547
Connected Vehicle Settings .....	548
Connected Vehicle – Troubleshooting .....	548

## Vehicle Wi-Fi Hotspot

Creating a Vehicle Wi-Fi Hotspot .....	550
Changing the Vehicle Wi-Fi Hotspot Name or Password .....	550
Vehicle Wi-Fi Hotspot – Troubleshooting .....	551

## Audio System

Audio System Precautions .....	552
Identifying the Audio Unit .....	552
Switching the Audio Unit On and Off .....	552
Selecting the Audio Source .....	552
Playing or Pausing the Audio Source .....	552
Adjusting the Volume .....	553
Switching Shuffle Mode On and Off .....	553
Switching Repeat Mode On and Off .....	553
Setting a Memory Preset .....	553
Muting the Audio .....	553
Adjusting the Sound Settings .....	553
Setting the Clock and Date .....	553
FM Radio .....	554
Switching the Display On and Off .....	554
Digital Radio .....	554
Satellite Radio .....	556
Audio System – Troubleshooting .....	558

## Center Display

Center Display Overview .....	562
Status Bar .....	562
Information On Demand Screen .....	563
Feature Bar .....	563

Settings .....	564
Rebooting the Center Display .....	564

## Voice Interaction

Ford Assistant .....	565
----------------------	-----

## Alexa Built-In

What is Alexa Built-In .....	567
Alexa Built-In Requirements .....	567
Signing In to Your Account .....	567
Using Alexa Built-In .....	567
Alexa Built-In Settings .....	567

## Phone

Phone Precautions .....	569
Connecting Your Phone .....	569
Phone Menu .....	569
Making and Receiving a Phone Call .....	571
Sending and Receiving a Text Message .....	572
Switching Text Message Notification On and Off .....	573

## Bluetooth®

Connecting a Bluetooth® Device .....	574
Playing Media Using Bluetooth® .....	574

## Apps

App Precautions .....	575
App Requirements .....	575
Accessing Apps .....	575
Enabling Apps on an iOS Device .....	575
Enabling Apps on an Android Device .....	575
Switching Apple CarPlay On and Off .....	576
Switching Android Auto On and Off .....	576

## Personal Profiles

How Do Personal Profiles Work .....	577
-------------------------------------	-----



# Table of Contents

---

Enabling or Disabling Personal Profiles .....	577
Creating a Personal Profile .....	577
Linking or Unlinking a Personal Profile .....	577
Selecting a Personal Profile .....	578
Deleting a Personal Profile .....	578

## Navigation

Connected Navigation .....	579
Accessing Navigation .....	579
Navigation Map Updates .....	579
Adjusting the Map .....	579
Live Traffic .....	579
Setting a Destination .....	579
Waypoints .....	580
Route Guidance .....	580
Trailer Towing Navigation .....	581

## Vehicle Software Updates

Vehicle Software Updates .....	582
Software Update Settings .....	582
Software Update Indicators .....	583

## Vehicle System Reset

Performing a System Reset .....	584
---------------------------------	-----

## Accessories

Accessories .....	585
-------------------	-----

## Auxiliary Switches

What Are the Auxiliary Switches .....	586
Locating the Auxiliary Switches .....	586

## Ford Protect

What Is Ford Protect .....	587
----------------------------	-----

## Scheduled Maintenance

General Maintenance Information .....	589
---------------------------------------	-----

## Customer Information

Rollover Warning .....	594
The Better Business Bureau Auto Line Program .....	594
The Mediation and Arbitration Program .....	595
Ordering a Canadian French Owner's Manual .....	595
Reporting Safety Defects in the United States .....	596
Reporting Safety Defects in Canada .....	596
Third Party Software Copyright Acknowledgment .....	597
Radio Frequency Certification Labels .....	597
Perchlorate .....	647
Replacement Parts Recommendation .....	647
Mobile Communications Equipment .....	648
Federal Highway Administration Regulation .....	648
End User License Agreement .....	649
Emission Law .....	674
Export Unique Options .....	675
Warranty Information .....	675

## Appendices

Electromagnetic Compatibility .....	677
-------------------------------------	-----



# Contacting Us

---

If you require assistance or clarification on policies or procedures, please contact the customer relationship center.

## United States

Ford Motor Company  
Customer Relationship Center  
PO Box 6248  
Dearborn, MI 48126  
1-800-392-3673 (FORD)  
TDD for the hearing impaired:  
7-1-1 (where offered by your telephone  
service provider)  
[www.ford.com/help/contact/](http://www.ford.com/help/contact/)

## Ford Credit - US Only

Ford Credit offers a full range of financing and lease plans to help you acquire your vehicle. If you have financed or leased your vehicle through Ford Credit, thank you for your business.

For assistance call 1-800-727-7000, or for more information about Ford Credit and access to an account manager, visit [www.ford.com/finance](http://www.ford.com/finance).

## Canada

Customer Relationship Centre  
Ford Motor Company of Canada Limited  
P.O. Box 2000  
Oakville, Ontario L6J 5E4  
1-800-565-3673 (FORD)  
TDD for the hearing impaired:  
7-1-1 (where offered by your telephone  
service provider)  
[www.ford.ca](http://www.ford.ca)

## Australia

Ford Motor Company of Australia Pty Ltd.  
Customer Relationship Centre  
Private Mail Bag 5  
Campbellfield, Victoria, 3061  
Telephone: (13 FORD) 13 3673  
E-mail: [foacust1@ford.com](mailto:foacust1@ford.com)

## New Zealand

Ford Motor Company  
Attention: Customer Relationship Centre  
Private Bag 76912  
Manukau City 2241  
Telephone: 0800 367 369 (FORDNZ)  
E-mail: [fnzcust@ford.com](mailto:fnzcust@ford.com)

## China - Imported Vehicle

Customer Relationship Center  
Telephone: 400-690-1886  
Website: <https://www.ford.com.cn/>

## China - Chang'An Ford

Customer Relationship Center  
Telephone: 800-810-8168  
Mobile: 400-887-7766  
Website: <https://www.ford.com.cn/>

## Asia Pacific Direct Markets (APDM)

E-mail: [apemcrc@ford.com](mailto:apemcrc@ford.com)

## Caribbean, Central America and Israel

Ford Motor Company  
Ford Export Operations  
Attention: Owner Relations  
1555 Fairlane Drive  
Fairlane Business Park #3  
Allen Park, MI 48101  
Fax: (313) 390-0804  
Telephone: (313) 594-4857  
E-mail: [expcac@ford.com](mailto:expcac@ford.com)

## U.S. Virgin Islands and Puerto Rico

Ford Motor Company  
Ford Export Operations  
Attention: Owner Relations  
1555 Fairlane Drive  
Fairlane Business Park #3  
Allen Park, MI 48101  
Telephone: (800) 841-3673  
E-mail: [prcac@ford.com](mailto:prcac@ford.com)

# Contacting Us

---

## Argentina

Telephone: 0800-888-3673

## Brazil

Website: [www.ford.com.br](http://www.ford.com.br)  
Telephone: 0800-703-3673  
E-mail: [central@ford.com](mailto:central@ford.com)

## North Africa

E-mail: [nafcrc@ford.com](mailto:nafcrc@ford.com)

## South Africa

Telephone: 0860011022  
Email: [fordcrc2@ford.com](mailto:fordcrc2@ford.com)

## Sub-Saharan Africa

E-mail: [ssacrc@ford.com](mailto:ssacrc@ford.com)

## Puerto Rico

Ford International Business Development,  
Inc.  
P.O. Box 11957  
Caparra Heights Station  
San Juan, PR 00922-1957  
1-800-392-3673 (FORD)  
Fax: (313) 390-0804  
E-mail: [prcac@ford.com](mailto:prcac@ford.com)  
[www.ford.com.pr](http://www.ford.com.pr)

## Middle East

Ford Middle East Customer Relationship  
Center  
P.O. Box 21740  
Dubai, United Arab Emirates  
Telephone: 80004441066  
Toll-free number for the Kingdom of Saudi  
Arabia: 8008443673  
Mobily and Zain cell phone users in Saudi  
Arabia: 800850078  
Kuwait: 22280384  
Local telephone number for Kuwait: +965  
1 898900  
Fax: +971 4 3327266  
E-mail: [menacac@ford.com](mailto:menacac@ford.com)  
[www.me.ford.com](http://www.me.ford.com)

## South Korea

Customer Relationship Center  
Telephone: +82-02-1600-6003  
E-mail: [infokr1@ford.com](mailto:infokr1@ford.com)  
Emergency Dispatch Service call:  
080-300-3673

## Philippines

Telephone: 02-88669408  
Email: [emailus@ford.com](mailto:emailus@ford.com)

## Taiwan

Telephone: 0800-032100  
705 Zhonghua Rd., Sec. 1  
Zhongli District, Taoyuan, Taiwan, 32068

## Thailand

Telephone: 1383  
E-mail: [fordthai@ford.com](mailto:fordthai@ford.com)

## Vietnam

Telephone: 1800588888  
E-mail: [fordvn@ford.com](mailto:fordvn@ford.com)

# Introduction

## ABOUT THIS PUBLICATION



**WARNING:** Driving while distracted can result in loss of vehicle control, crash and injury. We strongly recommend that you use extreme caution when using any device that may take your focus off the road. Your primary responsibility is the safe operation of your vehicle. We recommend against the use of any hand-held device while driving and encourage the use of voice-operated systems when possible. Make sure you are aware of all applicable local laws that may affect the use of electronic devices while driving.



**WARNING:** You risk death, fire, or serious injury to yourself and others if you do not follow the instruction highlighted by the warning symbol.

Thank you for choosing Ford. We recommend that you take some time to get to know your vehicle in order to benefit from greater safety and pleasure from driving it. Use this publication, whether in-vehicle, print, in FordPass app or online, to familiarize yourself with the features on your vehicle.

**Note:** Use and operate your vehicle in line with all applicable laws and regulations.

**Note:** Pass on all printed owner's information when selling this vehicle.

## Features and Options

This publication describes product features and options available throughout the range of available models, sometimes even before they are generally available. It could describe options that are not available on the vehicle you have purchased.

## Providing Feedback

If you would like to provide feedback to the Owner's Manual team, please email us at [OWNERMANUALFEEDBACK@ford.com](mailto:OWNERMANUALFEEDBACK@ford.com).

You will not receive a direct email response. Your submission will be investigated and necessary changes will be made to the Owner's Manual content.

To help investigate your submission, please include the following information:

- Your vehicle model
- The country in which your vehicle was purchased
- The Owner's Manual section needing investigation

## Illustrations

**Note:** Some of the illustrations in this publication could show features as used in different models, so could appear different to you on your vehicle.

## Location of Components

This manual may qualify the location of a component as left-hand side or right-hand side. The side is determined when facing forward in the seat.

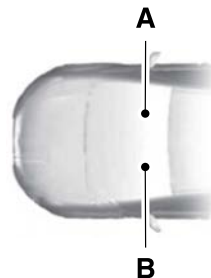

A Right-hand side.

B Left-hand side.

# Introduction

---

## Accessing the Digital Owner's Manual

### Vehicles with a Portrait Center Display Screen

The Owner's Manual application is located in the Apps list.

1.  Press the button on the touchscreen to see a list of apps.
2. Select the Owner's Manual application.

### Vehicles with a Landscape Center Display Screen

Depending on your vehicle, the Owner's Manual application is located in either the Apps list or the Features list.

1. Press Apps or Features on the touchscreen.

**Note:** *Some vehicles have the Apps or Features buttons on the home screen. Not all vehicles have a Features button.*

2. Select the Owner's Manual application.

## Accessing the Online and Printed Owner's Manual

### Online Owner's Manual

- Through your device's app store, you can download the FordPass app.
- You can visit the local Ford Website.

**Note:** *To find the local Ford website, visit <https://corporate.ford.com/operations/locations/global-links.html>.*

**Note:** *We strongly recommend downloading a copy of the Owner's Manual and having it with you whenever you drive, and to view the information if you are unable to be inside the vehicle.*

## Printed Owner' Manual

In U.S. and Canada, visit [www.helminc.com](http://www.helminc.com) or see an authorized dealer.

In Europe, visit [www.z-order.de](http://www.z-order.de) or see an authorized dealer.

All other Countries, see your authorized dealer.





## USING THIS PUBLICATION

To quickly locate information about your vehicle, use the word search within the Owner's Manual application.

# Symbols Glossary

## SYMBOLS USED ON YOUR VEHICLE

These are some of the symbols you may see on your vehicle.

	Airbag		Child safety door lock or unlock
	Air conditioning system		Child seat lower anchor
	Air conditioning system lubricant type		Child seat tether anchor
	Anti-lock braking system		Cruise control
	Avoid smoking, flames or sparks		Do not open when hot
	Battery		Electric Parking brake
	Battery acid		Engine air filter
	Blower motor		Engine coolant
	Brake fluid - non petroleum based		Engine coolant temperature
	Brake system		Engine oil
	Brake system		Explosive gas
	Cabin air filter		Fan warning
	Check fuel cap		Fasten seatbelt
			Flammable
			Front fog lamps

# Symbols Glossary



Fuel pump reset



Fuse compartment



Hazard flashers



Headlamp high beams



Headlamps on



Heated rear window



Hill descent control



Horn control



Interior luggage compartment release



Jack



Keep out of reach of children



Lighting control



Low fuel level



Low tire pressure warning



Maintain correct fluid level



Malfunction Indicator Lamp (MIL)



Note operating instructions



Panic alarm



Parking aid



Parking lamps



Passenger airbag activated



Passenger airbag deactivated



Power steering fluid



Power windows front/rear



Power window lockout



Requires registered technician



Safety alert



See Owner's Manual



See Service Manual



Side airbag



# Symbols Glossary

---



Shield the eyes



Stability control



Stability control off



Trail control



Turn Signal



Windshield defrosting system



Windshield wiping system



Windshield wash and wipe

# Data Privacy



**WARNING:** Do not connect wireless plug-in devices to the data link connector. Unauthorized third parties could gain access to vehicle data and impair the performance of safety related systems. Only allow repair facilities that follow our service and repair instructions to connect their equipment to the data link connector.

We respect your privacy and are committed to protecting it. The information contained in this publication was correct at the time of release, but as technology rapidly changes, we recommend that you visit the local Ford website for the latest information.

Your vehicle has electronic control units that have data recording functionality and the ability to permanently or temporarily store data. This data could include information on the condition and status of your vehicle, vehicle maintenance requirements, events and malfunctions. The types of data that can be recorded are described in this section. Some of the data recorded is stored in event logs or error logs.

**Note:** *Error logs are reset following a service or repair.*

**Note:** *We may provide information in response to requests from law enforcement, other government authorities and third parties acting with lawful authority or through a legal process. Such information could be used by them in legal proceedings.*

Data recorded includes, for example:

- Operating states of system components, for example fuel level, tire pressure and battery charge level.
- Vehicle and component status, for example wheel speed, deceleration, lateral acceleration and seatbelt status.

- Events or errors in essential systems, for example headlamps and brakes.
- System responses to driving situations, for example airbag deployment and stability control.
- Environmental conditions, for example temperature.

Some of this data, when used in combination with other information, for example an accident report, damage to a vehicle or eyewitness statements, could be associated with a specific person.

## Services That We Provide

If you use our services, we collect and use data, for example account information, vehicle location and driving characteristics, that could identify you. We transmit this data through a dedicated, protected connection. We only collect and use data to enable your use of our services to which you have subscribed, with your consent or where permitted by law. For additional information, see the terms and conditions of the services to which you have subscribed.

For additional information about our privacy policy, refer to the local Ford website.

## Services That Third Parties Provide

We recommend that you review the terms and conditions and data privacy information for any services equipped with your vehicle or to which you subscribe. We take no responsibility for services that third parties provide.

Where equipped, SiriusXM with 360L could use the modem. To disable, turn off the SiriusXM with 360L or Vehicle Connectivity setting. See **Enabling and Disabling the Modem** (page 547).

# Data Privacy

---

## SERVICE DATA

Service data recorders in your vehicle are capable of collecting and storing diagnostic information about your vehicle. This potentially includes information about the performance or status of various systems and modules in the vehicle, such as engine, throttle, steering or brake systems. In order to properly diagnose and service your vehicle, Ford Motor Company (Ford of Canada in Canada), and service and repair facilities may access or share among them vehicle diagnostic information received through a direct connection to your vehicle when diagnosing or servicing your vehicle. Additionally, Ford Motor Company (Ford of Canada, in Canada) may, where permitted by law, use vehicle diagnostic information for vehicle improvement or with other information we may have about you, for example, your contact information, to offer you products or services that may interest you. Data may be provided to our service providers such as part suppliers that may help diagnose malfunctions, and who are similarly obligated to protect data. We retain this data only as long as necessary to perform these functions or to comply with law. We may provide information where required in response to official requests to law enforcement or other government authorities or third parties acting with lawful authority or court order, and such information may be used in legal proceedings. For U.S. only (if equipped), if you choose to use connected apps and services, you consent that certain diagnostic information may also be accessed electronically by Ford Motor Company and Ford authorized service facilities, and that the diagnostic information may be used to provide services to you, personalizing your experience, troubleshoot, and to improve products and services and offer you products and services that may interest

you, where permitted by law. For Canada only, for more information, please review the Ford of Canada privacy policy at [www.ford.ca](http://www.ford.ca), including our U.S. data storage and use of service providers in other jurisdictions who may be subject to legal requirements in Canada, the United States and other countries applicable to them, for example, lawful requirements to disclose personal information to governmental authorities in those countries.

## EVENT DATA

This vehicle is equipped with an event data recorder. The main purpose of an event data recorder is to record, in certain crash or near crash-like situations, such as an airbag deployment or hitting a road obstacle; this data will assist in understanding how a vehicle's systems performed. The event data recorder is designed to record data related to vehicle dynamics and safety systems for a short period of time, typically 30 seconds or less.

The event data recorder in this vehicle is designed to record such data as:

- How various systems in your vehicle were operating.
- Whether or not the driver and passenger seatbelts were buckled/fastened.
- How far (if at all) the driver was depressing the accelerator and/or the brake pedal.
- How fast the vehicle was traveling.
- Where the driver was positioning the steering wheel.

This data can help provide a better understanding of the circumstances in which crashes and injuries occur.

# Data Privacy

---

**Note:** *Event data recorder data is recorded by your vehicle only if a non-trivial crash situation occurs; no data is recorded by the event data recorder under normal driving conditions and no personal data or information (for example name, gender, age, and crash location) is recorded. However, parties, such as law enforcement, could combine the event data recorder data with the type of personally identifying data routinely acquired during a crash investigation.*

To read data recorded by an event data recorder, special equipment is required, and access to the vehicle or the event data recorder is needed. In addition to the vehicle manufacturer, other parties, such as law enforcement, that have such special equipment, can read the information if they have access to the vehicle or the event data recorder.

## SETTINGS DATA

Your vehicle has electronic control units that have the ability to store data based on your personalized settings. The data is stored locally in the vehicle or on devices that you connect to it, for example, a USB drive or digital music player. You can delete some of this data and also choose whether to share it through the services to which you subscribe.

## Comfort and Convenience Data

Data recorded includes, for example:

- Seat and steering wheel position.
- Climate control settings.
- Radio presets.

## Entertainment Data

Data recorded includes, for example:

- Music, videos or album art.
- Contacts and corresponding address book entries.
- Navigation destinations.

## CONNECTED VEHICLE DATA



The modem has a SIM. The modem was enabled when your vehicle was built and periodically sends messages to stay connected to the cell phone network, receive automatic software updates and send vehicle-related information to us, for example diagnostic information. These messages could include information that identifies your vehicle, the SIM and the electronic serial number of the modem. Cell phone network service providers could have access to additional information, for example cell phone network tower identification. For additional information about our privacy policy, visit [www.FordConnected.com](http://www.FordConnected.com) or refer to your local Ford website.

**Note:** *The modem continues to send this information unless you disable the modem or stop the modem from sharing vehicle data by changing the modem settings. See **Connected Vehicle** (page 547).*

**Note:** *The service can be unavailable or interrupted for a number of reasons, for example environmental or topographical conditions and data plan coverage.*

**Note:** *To find out if your vehicle has a modem, visit [www.FordConnected.com](http://www.FordConnected.com).*

# Data Privacy

---

## MOBILE DEVICE DATA

If you connect a mobile device to your vehicle, you can display data from your device on the touchscreen for example, music and album art. You can share your vehicle data with mobile apps on your device through the system. See **App Requirements** (page 575).

The mobile apps function operates by your connected device sending data to us in the United States. The data is encrypted and includes, for example, the vehicle identification number of your vehicle, the SYNC module serial number, odometer, enabled apps, usage statistics and debugging information. We retain it only as long as necessary to provide the service, to troubleshoot, for continuous improvement and to offer you products and services that may be of interest to you according to your preferences and where allowed by law.

If you connect a cell phone to the system, the system creates a profile that links to that cell phone. The cell phone profile enables more mobile features and efficient operation. The profile contains, for example data from your phonebook, read and unread text messages and call history, including history of calls when your cell phone was not connected to the system.

If you connect a media device, the system creates and retains a media device index of supported media content. The system also records a short diagnostic log of approximately 10 minutes of all recent system activity.

The cell phone profile, media device index and diagnostic log remain in your vehicle unless you delete them and are generally accessible only in your vehicle when you connect your cell phone or media device. If you no longer plan to use the system or your vehicle, we recommend you use the system reset function to erase the stored information. See **Performing a System Reset** (page 584).

System data cannot be accessed without special equipment and access to your vehicle's module.

For additional information about our privacy policy, refer to the local Ford website.

**Note:** *To find out if your vehicle has connectivity technology, visit [www.FordConnected.com](http://www.FordConnected.com).*

## EMERGENCY CALL SYSTEM DATA

When the emergency call system is active, it may disclose to emergency services that your vehicle has been in a crash involving the deployment of an airbag or activation of the fuel pump shut-off. Certain versions or updates to the emergency call system may also be capable of electronically or verbally disclosing to emergency services operators your vehicle location or other details about your vehicle or crash to assist emergency services operators to provide the most appropriate emergency services. If you do not want to disclose this information, do not activate the emergency call system.

**Note:** *You cannot deactivate emergency call systems that are required by law.*

# Environment

---

## **PROTECTING THE ENVIRONMENT**

Sustainability is a priority at Ford. We are constantly looking for ways to reduce our impact on the planet while providing customers with great products and delivering a strong business. You should play your part in protecting the environment. Correct vehicle usage and the authorized disposal of waste, cleaning and lubrication materials are significant steps toward this aim.

For additional information about our sustainability progress and initiatives, visit [www.sustainability.ford.com](http://www.sustainability.ford.com).

# Visual Search

---

## STEERING WHEEL



- A See **Setting the Cruise Control Speed** (page 292). See **Setting the Adaptive Cruise Control Speed** (page 297).
- B See **Using the Instrument Cluster Display Controls** (page 140).
- C See **Making and Receiving a Phone Call** (page 571).
- D See **Adjusting the Volume** (page 553).

# Visual Search

## INSTRUMENT PANEL

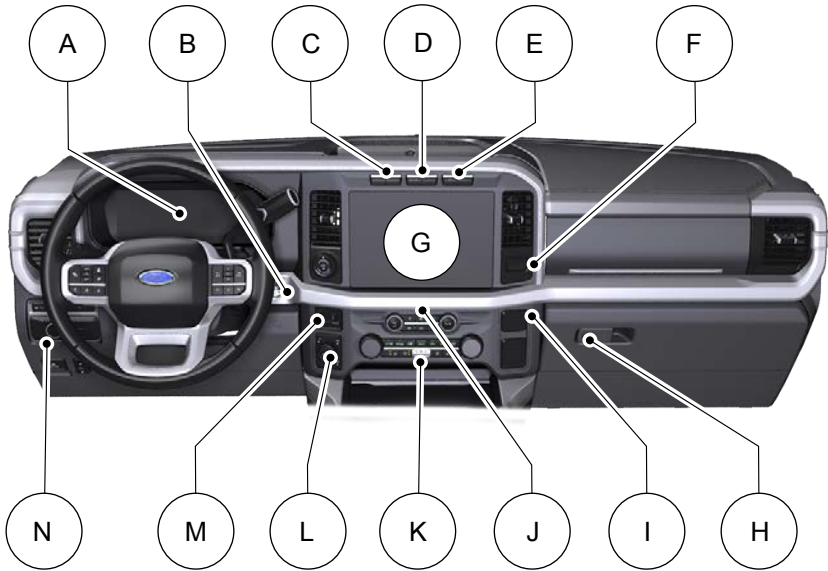

- A See **Instrument Cluster Overview** (page 133). See **Instrument Cluster Overview** (page 134).
- B See **Ignition Switch** (page 197). See **Push Button Ignition Switch** (page 198).
- C See **Switching the 360 Degree Camera On and Off** (page 290).
- D See **Switching the Hazard Flashers On and Off** (page 419).
- E See **Switching Stability Control On and Off** (page 268).
- F See **Opening the Glove Compartment** (page 192).
- G See **Status Bar** (page 562).
- H See **Opening the Glove Compartment** (page 192).
- I See **Locating the Power Outlets** (page 180).
- J See **Switching the Audio Unit On and Off** (page 552).
- K See **Identifying the Climate Control Unit** (page 148). See **Identifying the Climate Control Unit** (page 152).



# Visual Search

- L See **Selecting a Four-Wheel Drive Mode** (page 237).
- M See **Using the Integrated Trailer Brake Controller** (page 369).
- N See **Exterior Lighting Control** (page 114).

## VEHICLE INTERIOR

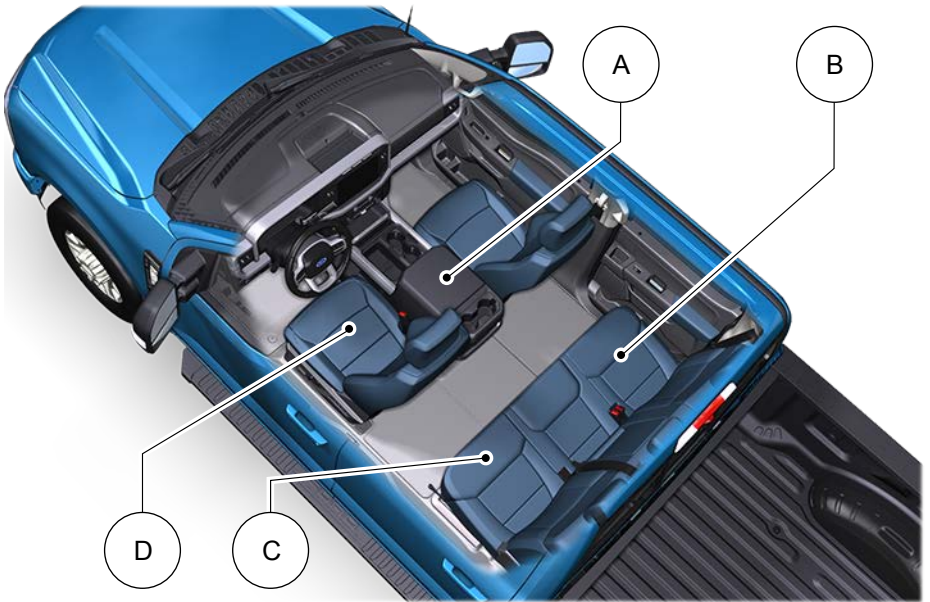

- A See **Opening the Center Console** (page 193).
- B See **Unfolding the Seats** (page 167).
- C See **Folding the Seats** (page 167).
- D See **Sitting in the Correct Position** (page 157).

# Visual Search

## FRONT EXTERIOR

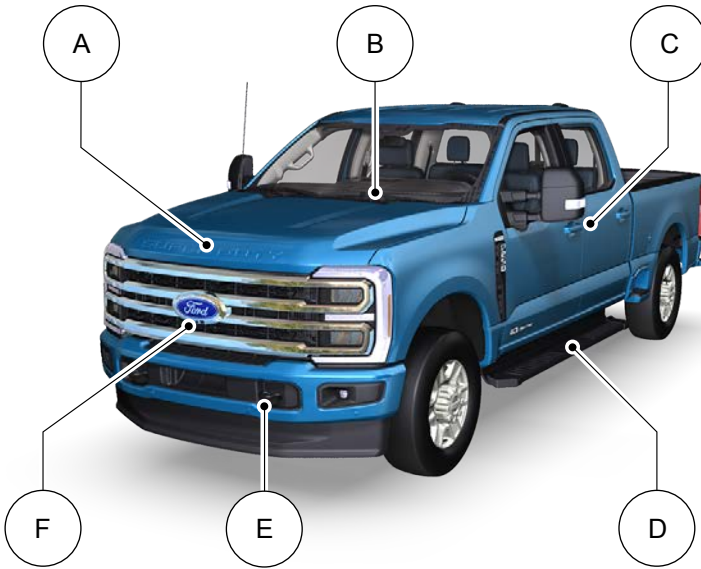

- A See **Opening and Closing the Hood** (page 439).
- B See **Replacing the Front Wiper Blades** (page 111).
- C See **Unlocking and Locking the Doors Using the Key Blade** (page 77).
- D See **Power Running Board Settings** (page 104).
- E See **Accessing the Front Towing Point** (page 422).
- F See **Locating the 360 Degree Cameras** (page 288).

# Visual Search

## REAR EXTERIOR

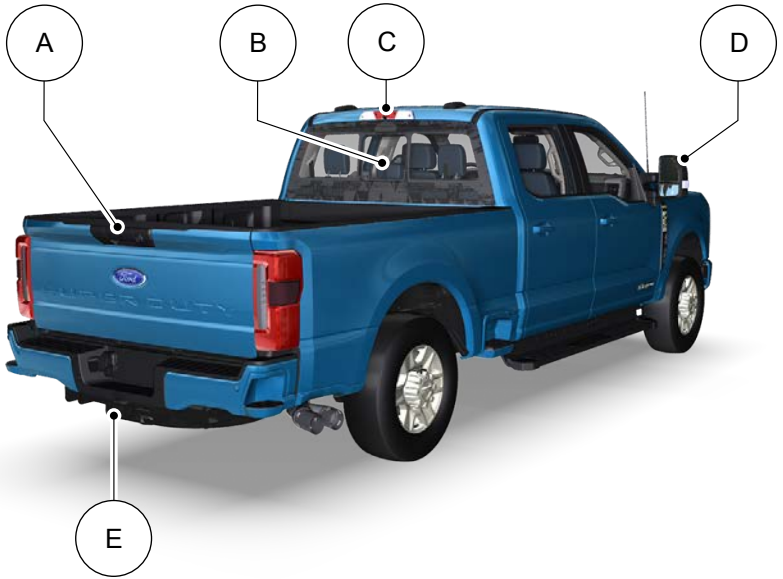

- A See **Opening the Tailgate From Outside Your Vehicle** (page 87).
- B See **Opening and Closing the Sliding Windows** (page 126).
- C See **Locating the 360 Degree Cameras** (page 288).
- D See **Folding the Exterior Mirrors** (page 129). See **Folding the Exterior Mirrors** (page 129).
- E See **Connecting a Trailer** (page 358).

# Child Safety

## CHILD SAFETY PRECAUTIONS



**WARNING:** Always make sure your child is secured properly in a device that is appropriate for their height, age and weight. Child safety restraints must be bought separately from your vehicle. Failure to follow these instructions and guidelines may result in an increased risk of serious injury or death to your child.



**WARNING:** All children are shaped differently. The National Highway Traffic Safety Administration and other safety organizations, base their recommendations for child restraints on probable child height, age and weight thresholds, or on the minimum requirements of the law. We recommend that you check with a NHTSA Certified Child Passenger Safety Technician (CPST) to make sure that you properly install the child restraint in your vehicle and that you consult your pediatrician to make sure you have a child restraint appropriate for your child. To locate a child restraint fitting station and CPST, contact NHTSA toll free at 1-888-327-4236 or go to [www.nhtsa.dot.gov](http://www.nhtsa.dot.gov). In Canada, contact Transport Canada toll free at 1-800-333-0371 or go to [www.tc.gc.ca](http://www.tc.gc.ca) to find a Child Car Seat Clinic in your area. Failure to properly restrain children in child restraints made especially for their height, age and weight, may result in an increased risk of serious injury or death to your child.



**WARNING:** On hot days, the temperature inside the vehicle can rise very quickly. Exposure of people or animals to these high temperatures for even a short time can cause death or serious heat related injuries, including brain damage. Small children are particularly at risk.



**WARNING:** Do not place a rearward facing child restraint in front of an active airbag. Failure to follow this instruction could result in personal injury or death.



**WARNING:** Properly secure children 12 years old and under in a rear seating position whenever possible. If you are unable to properly secure all children in a rear seating position, properly secure the largest child on the front seat. If you must use a forward facing child restraint on the front seat, move the seat as far back as possible. Failure to follow these instructions could result in personal injury or death.



**WARNING:** Always carefully follow the instructions and warnings provided by the manufacturer of any child restraint to determine if the restraint device is appropriate for your child's size, height, weight, or age. Follow the child restraint manufacturer's instructions and warnings provided for installation and use in conjunction with the instructions and warnings provided by your vehicle manufacturer. A safety seat that is improperly installed or utilized, is inappropriate for your child's height, age, or weight or does not properly fit the child may increase the risk of serious injury or death.

# Child Safety

**WARNING:** Do not allow a passenger to hold a child on their lap when your vehicle is moving. Failure to follow this instruction could result in personal injury or death in the event of a sudden stop or crash.

**WARNING:** Do not use pillows, books or towels to boost your child's height. Failure to follow this instruction could result in personal injury or death.

**WARNING:** Properly secure child restraints or booster seats when they are not in use. They could become projectiles in a sudden stop or crash. Failure to follow this instruction could result in personal injury or death.

**WARNING:** Do not put the shoulder section of the seatbelt or allow the child to put the shoulder section of the seatbelt under their arm or behind their back. Failure to follow this instruction could reduce the effectiveness of the seatbelt and increase the risk of injury or death in a crash.

**WARNING:** Do not leave children or pets unattended in your vehicle. Failure to follow this instruction could result in personal injury or death.

When installing a child restraint with seatbelts:

- Place the vehicle seat in the upright position before you install the child restraint.
- Use the correct seatbelt buckle for that seating position.
- Insert the belt tongue into the buckle. Make sure the tongue is securely fastened in the buckle.

- Keep the buckle release button pointing up and away from the child restraint, with the tongue between the child restraint and the release button, to prevent accidental unbuckling.
- Put the seatbelt in the automatic locking mode.

## CHILD RESTRAINT ANCHOR POINTS

### WHAT ARE THE CHILD RESTRAINT ANCHOR POINTS

Anchor points allow you to quickly and safely install a child restraint.

### LOCATING THE CHILD RESTRAINT LOWER ANCHOR POINTS

Crew Cab

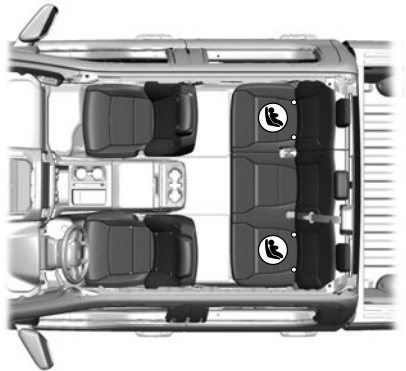

Super Cab

# Child Safety

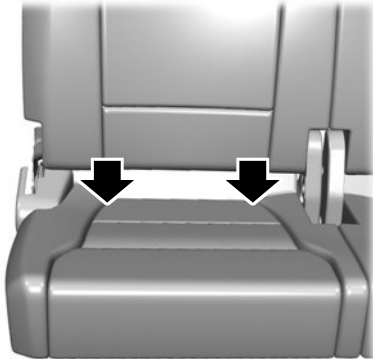
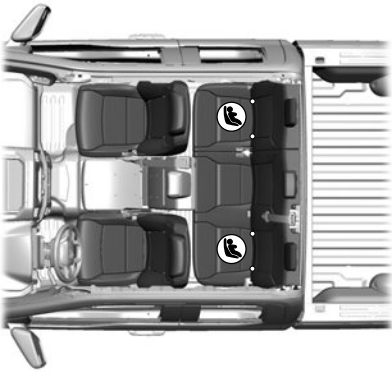

The lower child restraint anchors are at the rear section of the rear seat between the cushion and seat backrest.

**Note:** *Regular Cab* vehicles do not have lower anchors.

## LOCATING THE CHILD RESTRAINT TOP TETHER ANCHOR POINTS

Regular Cab

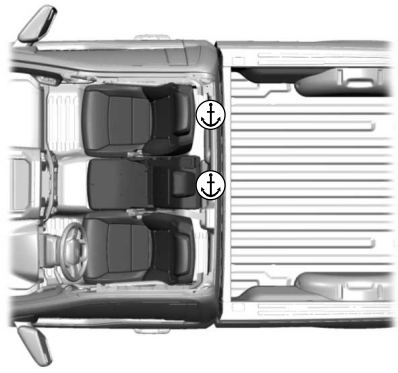

Crew Cab

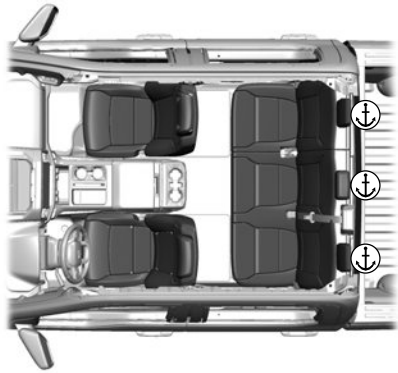

Super Cab

# Child Safety

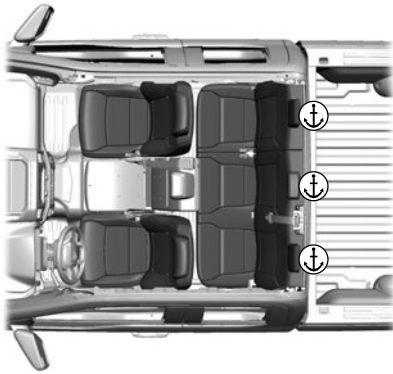

## CHILD RESTRAINTS

### CHILD RESTRAINT POSITION INFORMATION

Install the child restraint tightly against the vehicle seat. It may be necessary to lift or remove the head restraint.

#### Rear Facing Child Restraints

Combined Weight of Child and Child Restraint	LATCH (Lower Anchors Only)	Seatbelt Only
Up to 65 lb (29 kg)	X	X
Over 65 lb (29 kg)		X

#### Forward Facing Child Restraints

Combined Weight of Child and Child Restraint	LATCH (Lower Anchors and Top Tether Anchor)	Seatbelt and Top Tether Anchor	Seatbelt and LATCH (Lower Anchors and Top Tether Anchor)
Up to 65 lb (29 kg)	X	X	X
Over 65 lb (29 kg)		X	X

# Child Safety

## CHILD RESTRAINTS RECOMMENDATION

Child Size, Height, Weight, or Age	Recommended Restraint Type
Children weighing 40 lb (18 kg) or less (generally age four or younger).	Use a child restraint (sometimes called an infant carrier, convertible seat, or toddler seat).
Children who have outgrown or no longer properly fit in a child restraint (generally children who are less than 57 in (1.45 m) tall, are greater than age four and less than age 12, and between 40 lb (18 kg) and 80 lb (36 kg) and upward to 100 lb (45 kg) if recommended by your child restraint manufacturer).	Use a belt-positioning booster seat.
Children who have outgrown or no longer properly fit in a belt-positioning booster seat (generally children who are at least 57 in (1.45 m) tall or greater than 80 lb (36 kg) or 100 lb (45 kg) if recommended by child restraint manufacturer).	Use a vehicle seatbelt having the lap belt snug and low across the hips, shoulder belt centered across the shoulder and chest, and seat backrest upright.

You are required by law to properly use child restraints for infants and toddlers in the United States, Canada and Mexico.

Many states and provinces require that small children use approved booster seats until they reach age eight, a height of 57 in (1.45 m) tall, or 80 lb (36 kg). Check your local and state or provincial laws for specific requirements about the safety of children in your vehicle.

When possible, properly restrain children 12 years of age and under in a rear seating position of your vehicle. Accident statistics suggest that children are safer when properly restrained in the rear seating positions than in a front seating position.

When installing a rear facing child restraint, adjust the vehicle seats to avoid interference between the child restraint and the vehicle seat in front of the child restraint.

## INSTALLING CHILD RESTRAINTS

### USING SEATBELTS



**WARNING:** Depending on where you secure a child restraint, and depending on the child restraint design, you may block access to certain seatbelt buckle assemblies and LATCH lower anchors, rendering those features potentially unusable. To avoid risk of injury, make sure occupants only use seating positions where they are able to be properly restrained.

**Note:** *The following does not apply to the front center position of Super Cab and Crew Cab vehicles.*

**Note:** *Although the child restraint illustrated is a forward facing child restraint, the steps are the same for installing a rear facing child restraint.*



# Child Safety

Perform the following steps when installing a child restraint with seatbelts.

1. Position the child restraint in a seat with a seatbelt.



2. Pull down on the shoulder belt and then grasp the shoulder belt and lap belt together.



3. While holding the shoulder and lap belt portions together, route the tongue through the child restraint according to the child restraint manufacturer's instructions. Make sure you did not twist the belt webbing.

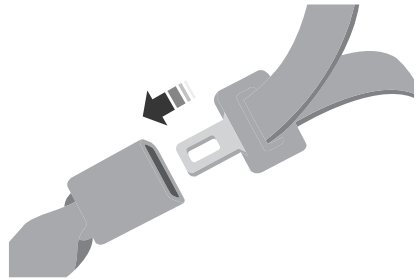

4. Insert the belt tongue into the proper buckle for that seating position until the latch engages. Make sure the tongue is latched securely by pulling on it.



5. To put the retractor in the automatic locking mode, grasp the shoulder portion of the belt and pull downward until you pull all of the seatbelt out.

**Note:** *The automatic locking mode is available on the front passenger and rear seats. This mode is also available on the center seat of a Regular Cab. This vehicle does not require the use of a locking clip.*

6. Allow the belt to retract to remove slack. The seatbelt clicks as it retracts to indicate it is in the automatic locking mode.

# Child Safety

7. Pull the seatbelt out of the retractor to make sure the retractor is in the automatic locking mode. You should not be able to pull more belt out. If the retractor is not locked, unbuckle the belt and repeat Steps 5 and 6.



8. Remove remaining slack from the belt. Force the seat down with extra weight, for example, by pressing down or kneeling on the child restraint while pulling up on the shoulder belt in order to force slack from the belt. This is necessary to remove the remaining slack that exists once you add the extra weight of the child to the child restraint. It also helps to achieve the proper snugness of the child restraint to your vehicle. Sometimes, a slight lean toward the buckle helps to remove remaining slack from the belt.
9. If the child restraint has a tether strap, attach it.

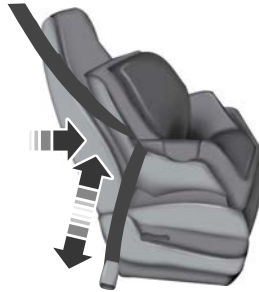

10. Before placing the child in the seat, forcibly move the seat forward and back to make sure the seat is securely held in place.

To check this, grab the seat at the belt path and attempt to move it side to side and forward and back. There should be no more than 1 in (2.5 cm) of movement.

We recommend checking with a NHTSA Certified Child Passenger Safety Technician to make certain the child restraint is properly installed. In Canada, check with Transport Canada for referral to a Child Car Seat Clinic.

## Using Seatbelts



**WARNING:** Always use both the lap and shoulder portion of the seatbelt in the center seating position.

**Note:** *The following applies to the front center position of Super Cab and Crew Cab vehicles.*

The seatbelt webbing below the tongue is the lap portion of the seatbelt. The webbing above the tongue is the shoulder belt portion of the seatbelt.

1. Position the child restraint in the front center seat.

# Child Safety



2. Slide the tongue up the webbing.

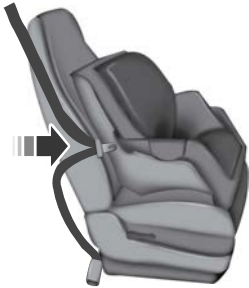

3. While holding both shoulder and lap portions next to the tongue, route the tongue and webbing through the child restraint according to the child restraint manufacturer's instructions. Make sure you did not twist the belt webbing.

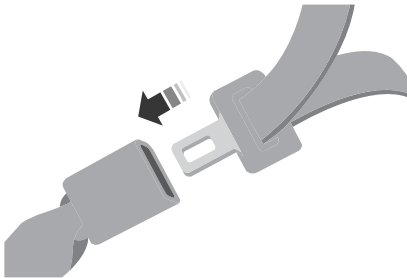

4. Insert the belt tongue into the proper buckle for that seating position until the latch engages. Make sure the tongue is latched securely by pulling on it.



5. When pushing down with your knee on the child restraint, pull up on the shoulder belt portion to tighten the lap belt portion of the seatbelt.
6. Allow the seatbelt to retract and remove any slack in the belt to securely tighten the child restraint in the vehicle.
7. If the child restraint has a tether strap, attach it.

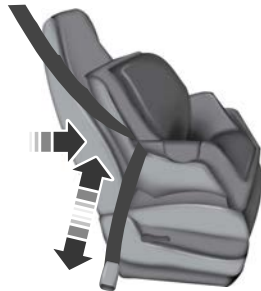

# Child Safety

- Before placing the child in the seat, forcibly move the seat forward and back to make sure the seat is securely held in place. To check this, grab the seat at the belt path and attempt to move it side to side and forward and back. There should be no more than 1 in (2.5 cm) of movement.
- Check from time to time to be sure that there is no slack in the lap and shoulder belt. The shoulder belt must be snug to keep the lap belt tight during a crash.

We recommend checking with a NHTSA Certified Child Passenger Safety Technician to make certain the child restraint is properly installed. In Canada, check with Transport Canada for referral to a Child Car Seat Clinic.

## USING LOWER ANCHORS AND TETHERS FOR CHILDREN



**WARNING:** Do not attach two child safety restraints to the same anchor. In a crash, one anchor may not be strong enough to hold two child safety restraint attachments and may break, causing serious injury or death.



**WARNING:** Depending on where you secure a child restraint, and depending on the child restraint design, you may block access to certain seatbelt buckle assemblies and LATCH lower anchors, rendering those features potentially unusable. To avoid risk of injury, make sure occupants only use seating positions where they are able to be properly restrained.

The Lower Anchors and Tethers for Children (LATCH) system has three vehicle anchor points:

- Two lower anchors where the vehicle seat backrest and seat cushion meet, called the seat bight.
- One top tether anchor behind that seating position.

LATCH compatible child restraints have two rigid or webbing mounted attachments. These attachments connect to the two lower anchors at the LATCH equipped seating positions in your vehicle. This type of attachment method eliminates the need to use seatbelts to attach the child restraint.

However, you can still use the seatbelt to attach the child restraint if the lower anchors are not used. For forward-facing child restraints, you must also attach the top tether strap to the proper top tether anchor if a top tether strap has been provided with your child restraint.

Follow the instructions later in this chapter on attaching child restraints with tether straps.

## INSTALLING A CHILD RESTRAINT IN A CENTER SEAT



**WARNING:** The standardized spacing for LATCH lower anchors is 11 in (280 mm) center to center. Do not use LATCH lower anchors for the center seating position unless the child restraint manufacturer's instructions permit and specify using anchors spaced at least as far apart as those in this vehicle.

The lower anchors at the center of the second row rear seat are spaced 25.7 in (652 mm) apart. The standardized spacing for LATCH lower anchors is 11 in (280 mm) center to center.

# Child Safety

You cannot install a child restraint with rigid LATCH attachments at the center seating position. You can only use LATCH compatible child restraints with attachments on belt webbing at this seating position provided that the child restraint manufacturer's instructions permit use with the anchor spacing stated. Do not attach a child restraint to any lower anchor if another child restraint is attached to that anchor.

Each time you use the child restraint, check that the seat is properly attached to the lower anchors and tether anchor, if applicable. Tug the child restraint from side to side and forward and back where it is secured to the vehicle. The seat should move less than 1 in (2.5 cm).

If you did not properly anchor the child restraint, the risk of a child being injured in a crash greatly increases.

## COMBINING THE SEATBELT AND LOWER ANCHORS FOR ATTACHING CHILD RESTRAINTS

When used in combination, you may attach either the seatbelt or the LATCH lower anchors first, provided a proper installation is achieved. Attach the tether strap afterward, if it is included with the child restraint.

## USING TETHER STRAPS

Many forward-facing child restraints include a tether strap which extends from the back of the child restraint and hooks to an anchoring point called the top tether anchor. Tether straps are available as an accessory for many older child restraints.

Contact the manufacturer of your child restraint for information about ordering a tether strap, or to obtain a longer tether strap if the tether strap on your child restraint does not reach the appropriate top tether anchor in the vehicle.

Attach the tether strap only to the appropriate tether anchor. The tether strap may not work properly if attached somewhere other than the correct tether anchor.

If you install a child restraint with rigid LATCH attachments, do not tighten the tether strap enough to lift the child restraint off the vehicle seat cushion when the child is seated in it. Keep the tether strap just snug without lifting the front of the child restraint. Keeping the child restraint just touching the vehicle seat gives the best protection in a severe crash.

Once you have installed the child restraint using either the seatbelt, the lower anchors of the LATCH system, or both, you can attach the top tether strap.

## ATTACHING THE FRONT SEAT TETHER STRAP

Regular Cab

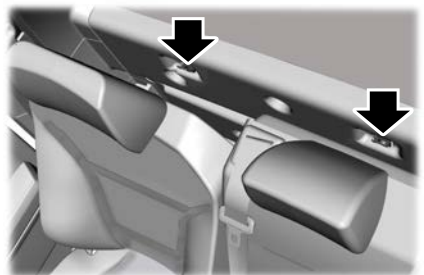

1. Route the child restraint tether strap over the back of the seat and under the head restraint.

# Child Safety

**Note:** For vehicles with adjustable head restraints, route the tether strap under the head restraint and between the head restraint posts. Otherwise, route the tether strap over the top of the seat backrest.

2. Locate the correct anchor for the selected seating position. You may need to pull the seat backrest forward to access the tether anchors. Make sure the seat is locked in the upright position before installing the child restraint.
3. Clip the tether strap to the anchor.
4. Tighten the child restraint tether strap according to the manufacturer's instructions.

If you incorrectly clip the tether strap, the child restraint may not be retained properly in the event of a crash.

If you did not properly anchor the child restraint, the risk of a child being injured in a crash greatly increases.

If your child restraint system has a tether strap, and the child restraint manufacturer recommends its use, we also recommend its use.

## ATTACHING THE REAR SEAT TETHER STRAP

Crew Cab and Super Cab

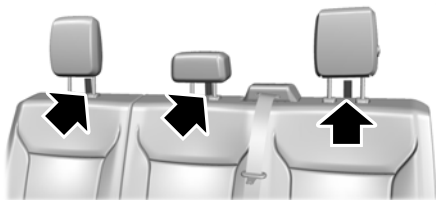

There are three loops of webbing above the back of the rear seat. Use these loops as routing loops and anchor loops for up to three child restraint tether straps.

For example, you can use the center loop as a routing loop for a child restraint in the center rear seat and as an anchoring loop for child restraints installed in the outermost rear seats.

Many tether straps cannot be tightened if the tether strap is hooked to the loop directly behind the child restraint.

To provide a tight tether strap:

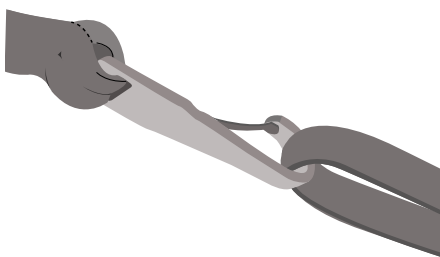

1. Route the vehicle tether loop between the head restraint posts, then route the child restraint tether strap through the loop, forward of the head restraint.
2. Hook the strap to the vehicle tether anchor loop in the adjacent seating position. If using the driver side, pass the strap behind the shoulder belt for the center seat. Put the tether strap through the routing loop. The head restraint support post holds the child restraint tightly, but the head restraint post is not strong enough to hold the child restraint during a crash.
3. Tighten the tether strap according to the child restraint manufacturer's instructions.

# Child Safety

If you did not properly anchor the child restraint, the risk of a child being injured in a crash greatly increases.

If your child restraint system has a tether strap, and the child restraint manufacturer recommends its use, we also recommend its use.

## BOOSTER SEATS

Use a belt-positioning booster seat for children who have outgrown or no longer properly fit in a child restraint and meet the following criteria.

- Generally children who are less than 57 in (1.45 m) tall.
- Are greater than age four (4) and less than age twelve (12).
- Are between 40 lb (18 kg) and 80 lb (36 kg) and upward to 100 lb (45 kg).

Many state and provincial laws require that children use approved booster seats until they reach age eight, a height of 57 in (1.45 m) tall, or 80 lb (36 kg).

Booster seats should be used until you can answer yes to all of these questions when seated without a booster seat:

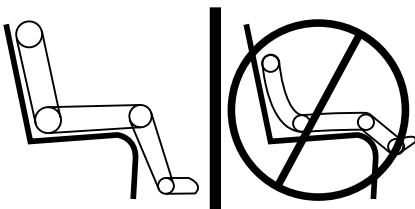

- Can the child sit all the way back against their vehicle seat backrest with knees bent comfortably at the edge of the seat cushion?
- Can the child sit without slouching?
- Does the lap belt rest low across the hips?
- Is the shoulder belt centered on the shoulder and chest?
- Can the child stay seated like this for the whole trip?

Always use booster seats in conjunction with your vehicle lap and shoulder belt.

## Types of Booster Seats



- Backless booster seats  
If your backless booster seat has a removable shield, remove the shield.

If a vehicle seating position has a low seat backrest or no head restraint, a backless booster seat may place your child's head, as measured at the tops of the ears, above the top of the seat. In this case, move the backless booster to another seating position with a higher seat backrest or head restraint and lap and shoulder belts, or consider using a high-back booster seat.

# Child Safety



If, with a backless booster seat, you cannot find a seating position that adequately supports your child's head, a high-back booster seat would be a better choice.

Children and booster seats vary in size and shape. Choose a booster that keeps the lap belt low and snug across the hips, never up across the stomach, and lets you adjust the shoulder belt to cross the chest and rest snugly near the center of the shoulder.

The following drawings compare the ideal fit to a shoulder belt uncomfortably close to the neck and a shoulder belt that could slip off the shoulder. The drawings also show how the lap belt should be low and snug across the child's hips.

- High-back booster seats





# Child Safety

If the booster seat slides on the vehicle seat upon which it is being used, placing a rubberized mesh sold as shelf or carpet liner under the booster seat may improve this condition. Do not use any item thicker than this under the booster seat. Check with the booster seat manufacturer's instructions.

## CHILD SAFETY LOCKS - CREW CAB/SUPERCAB



**WARNING:** You cannot open the rear doors from inside if you have put the child safety locks on.



A child safety lock is on the rear edge of each rear door. You must switch the child safety lock separately on each door.

### Left-Hand Side

Turn the key clockwise to switch the child lock on and counterclockwise to switch it off.

### Right-Hand Side

Turn the key counterclockwise to switch the child lock on and clockwise to switch it off.

**Note:** To make sure the child safety lock is on, pull the inside door handle twice to verify the door does not open.

**Note:** To open the rear doors from inside the vehicle when the child lock is engaged, roll down the rear window and use the outside door handle. Or have someone outside the vehicle open the door.

# Seatbelts

## SEATBELT PRECAUTIONS



**WARNING:** Always drive and ride with your seatback upright and the lap belt snug and low across the hips.



**WARNING:** Children must always be properly restrained.



**WARNING:** Do not allow a passenger to hold a child on their lap when your vehicle is moving. Failure to follow this instruction could result in personal injury or death in the event of a sudden stop or crash.



**WARNING:** All occupants of your vehicle, including the driver, should always properly wear their seatbelts, even when an airbag supplemental restraint system is provided. Failure to properly wear your seatbelt could seriously increase the risk of injury or death.



**WARNING:** It is extremely dangerous to ride in a cargo area, inside or outside of a vehicle. In a crash, people riding in these areas are more likely to be seriously injured or killed. Do not allow people to ride in any area of your vehicle that is not equipped with seats and seatbelts. Make sure everyone in your vehicle is in a seat and properly using a seatbelt. Failure to follow this warning could result in serious personal injury or death.



**WARNING:** In a rollover crash, an unbelted person is significantly more likely to die than a person wearing a seatbelt.



**WARNING:** Each seating position in your vehicle has a specific seatbelt assembly made up of one buckle and one tongue designed to be used as a pair. Use the shoulder belt on the outside shoulder only. Never wear the shoulder belt under the arm. Never use a single seatbelt for more than one person.



**WARNING:** Even with advanced restraints systems, properly restrain children 12 and under in a rear seating position. Failure to follow this could seriously increase the risk of injury or death.



**WARNING:** Seatbelts and seats may be hot in a vehicle that is in the sunshine. The hot seatbelts or seats may burn a small child. Check seat covers and buckles before you place a child anywhere near them.



**WARNING:** If your vehicle is involved in a crash, have the seatbelts and associated components inspected as soon as possible. Failure to follow this instruction could result in personal injury or death.

All seating positions in this vehicle have seatbelts. All occupants of the vehicle should properly wear their seatbelts, even when an airbag supplemental restraint system is provided.

The seatbelt system consists of:

- Lap and shoulder seatbelts.
- A shoulder seatbelt with automatic locking mode, except driver seatbelt.
- Height adjusters at the front outermost seating positions.
- Seatbelt pretensioners at the front outermost and rear outermost seating positions.

# Seatbelts



A seatbelt warning light and chime.



Crash sensors and monitoring system with readiness indicator.

The seatbelt pretensioners are designed to tighten the seatbelts when activated. In frontal and near-frontal crashes, the seatbelt pretensioners may be activated alone or, if the crash is of sufficient severity, together with the front airbags. In side crashes and rollovers, the pretensioners will be activated when the Safety Canopy is activated.

## FASTENING AND UNFASTENING THE SEATBELTS



**WARNING:** Always drive and ride with your seatback upright and the lap belt snug and low across the hips.

All seatbelts in your vehicle are a three-point combination lap and shoulder seatbelt.

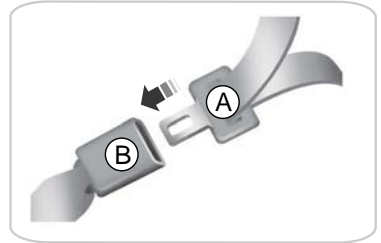

A Seatbelt tongue.

B Seatbelt buckle.

1. Pull the seatbelt out steadily.

**Note:** *It may lock if you pull it sharply or if the vehicle is on a slope.*

2. Insert the tongue into the buckle.
3. Pull the seatbelt tight to remove any slack.

### Unfastening the Seatbelts

1. Press the red button on the buckle to release the seatbelt.
2. Hold the seatbelt tongue and let it retract completely and smoothly to its stowed position.

### Using the Seatbelt With Cinch Tongue

This applies to the front center seating position of Super Cab and Crew Cab.

# Seatbelts

The cinch tongue slides up and down the seatbelt webbing when you stow the seatbelt or when you put the seatbelts on. When you buckle the seatbelt, the cinch tongue allows you to shorten the lap portion, but pinches the webbing to keep the lap portion from getting longer. The cinch tongue is designed to slip during a crash, so wear the shoulder belt properly and do not allow any slack in either the lap or shoulder portions.

While you are fastened in the seatbelt, the seatbelt with a cinch tongue adjusts to your movement. However, if you brake hard, turn hard, or if your vehicle receives an impact of 5 mph (8 km/h) or more, the seatbelt locks and helps reduce your forward movement.

## SENSITIVE LOCKING MODE

### WHAT IS SENSITIVE LOCKING MODE

Sensitive locking mode is a seatbelt retractor feature that allows shoulder belt length adjustment according to your movements and locking in response to vehicle movement.

### HOW DOES SENSITIVE LOCKING MODE WORK

If the driver suddenly brakes, turns a corner sharply, or the vehicle receives an impact of about 5 mph (8 km/h) or more, the seatbelts lock to help reduce forward movement of the driver and passengers.

In addition, the seatbelt retractor locks if you pull the seatbelt webbing out too quickly. If the retractor locks, slowly lower the height adjuster to allow the seatbelt to retract.

If the retractor does not unlock, pull the seatbelt out slowly then feed a small length of webbing back toward the stowed position.

## AUTOMATIC LOCKING MODE

### WHAT IS AUTOMATIC LOCKING MODE

This feature keeps the seatbelts pre-locked. The belt still retracts to remove any slack in the shoulder belt.

### WHEN TO USE AUTOMATIC LOCKING MODE

Use this mode any time you install a child restraint in a front or rear seating position. Properly restrain children 12 years old and under in a rear seat whenever possible. See **Child Safety** (page 36).

**Note:** *Automatic locking mode is not available on the driver seatbelt.*

**Note:** *Vehicles with optional front seat center may not have this function.*

### ENGAGING AUTOMATIC LOCKING MODE



1. Fasten the combination lap and shoulder belt.

# Seatbelts

2. Grasp the shoulder portion and pull downward until you pull the entire belt out.
3. Allow the belt to retract. As the belt retracts, you will hear a clicking sound. This indicates the seatbelt is now in the automatic locking mode.

## DISENGAGING AUTOMATIC LOCKING MODE

Unbuckle the combination lap and shoulder belt and allow it to retract completely to disengage the automatic locking mode and activate the vehicle sensitive locking mode.

## ADJUSTING THE SEATBELTS DURING PREGNANCY



**WARNING:** Always ride and drive with your seatback upright and properly fasten your seatbelt. Fit the lap portion of the seatbelt snugly and low across the hips. Position the shoulder portion of the seatbelt across your chest. Pregnant women must follow this practice. See the following figure.

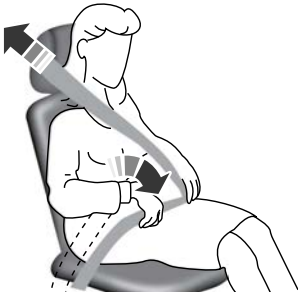

Pregnant women should always wear their seatbelt. Position the lap belt portion of a combination lap and shoulder belt low across the hips below the belly and worn as tight as comfort allows. Position the shoulder belt to cross the middle of the shoulder and the center of the chest.

## ADJUSTING THE SEATBELT HEIGHT



**WARNING:** Position the seatbelt height adjuster so that the seatbelt rests across the middle of your shoulder. Failure to adjust the seatbelt correctly could reduce its effectiveness and increase the risk of injury in a crash.

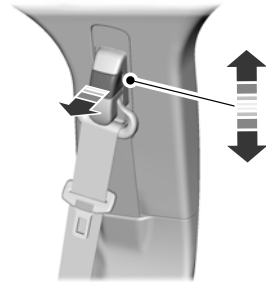

1. Pull the button and slide the height adjuster up or down.
2. Release the button and pull down on the height adjuster to make sure it is locked in place.

# Seatbelts

## ADJUSTING THE SEATBELT LENGTH



1. Pull some seatbelt webbing out of the shoulder belt retractor.

2. While holding the webbing below the tongue, grasp the metal tip of the tongue so that it is parallel to the webbing and slide the tongue up.
3. Provide enough lap belt length so that the tongue can reach the buckle.

## SEATBELT REMINDER

### HOW DOES THE SEATBELT REMINDER WORK

This feature supplements the seatbelt warning function. It provides additional reminders by sounding a tone and illuminating the seatbelt warning light when you are in the driver seat and an occupant unfastens their seatbelt.

<b>If</b>	<b>Then</b>
You switch your vehicle on and do not fasten one of the front occupant seatbelts...	The seatbelt reminder activates.
You do not fasten your seatbelt before your vehicle reaches at least 6 mph (9 km/h) ...	The seatbelt reminder activates, the seatbelt warning light illuminates and a warning tone sounds until you fasten your seatbelt.
Rear seats becomes occupied...	The seatbelt reminder becomes active when a rear seat passenger fastens a seatbelt.

This feature also informs the driver that an occupant unfastened their seatbelt.



# Seatbelts

- When the ignition is on, a warning informs the driver about the status of each seat, following each seat buckle or unbuckle. You can acknowledge this, or the system will time out after 60 seconds.
- If a seatbelt is unfastened, a second warning informs the driver about which seatbelt was unfastened. A warning remains until all occupied seatbelts are fastened.

## SEATBELT REMINDER INDICATORS

A warning lamp illuminates if the ignition is on, a front seat is occupied and the seatbelt has not been fastened.



The warning lamp illuminates until you fasten your seatbelt.

## SEATBELT REMINDER AUDIBLE WARNINGS

A warning tone sounds and the warning lamp illuminates if you are not wearing your seatbelt when your vehicle exceeds a relatively low speed.

The warning tone sounds for a short period of time or until you fasten your seatbelt.

## SWITCHING THE SEATBELT REMINDER ON AND OFF



**WARNING:** While the system allows you to deactivate it, this system is designed to improve your chances of being safely belted and surviving an accident. We recommend you leave the system activated for yourself and others who may use the vehicle.

**Note:** *The driver and front passenger warnings switch off independently. When you perform this procedure for one seating position, do not buckle the other position as this cancels the process.*

Read Steps 1 - 4 before proceeding with the programming procedure.

Make sure that:

- You set the parking brake.
  - The transmission is in park (P).
  - The ignition is off.
  - You close all vehicle doors.
  - You unfasten the driver and front passenger seatbelts.
1. Switch the ignition on. Do not start the engine.
  2. Wait for a short period of time until the seatbelt warning light switches off. After Step 2, wait an additional five seconds before proceeding with Step 3. Once you start Step 3, you must complete the procedure within 30 seconds.
  3. For the seating position you are switching off, fasten then unfasten the seatbelt four times at a moderate speed, ending in the unfastened state. After Step 3, the seatbelt warning light switches on.
  4. When the seatbelt warning light is on, fasten then unfasten the seatbelt. After Step 4, the seatbelt warning light flashes for confirmation.

This switches the feature off for that seating position if it is currently on.

This switches the feature on for that seating position if it is currently off.

# Seatbelts

## CHECKING THE SEATBELTS

Check the seatbelts and child restraints periodically to make sure they work properly and are not damaged. Make sure there are no nicks, tears or cuts. Replace if necessary.

Check the following seatbelt assemblies after a crash.

- Retractors.
- Buckles.
- Front seatbelt buckle assemblies.
- Shoulder belt height adjusters.
- Shoulder belt guide on seat backrest.
- Child restraint LATCH and tether anchors.
- Attaching hardware.

Read the child restraint manufacturer's instructions for additional inspection and maintenance information specific to the child restraint.

We recommend that all seatbelt assemblies in use in vehicles involved in a crash be replaced. However, if the crash was minor and an authorized dealer finds that the belts do not show damage and continue to operate properly, they do not need to be replaced. Seatbelt assemblies not in use during a crash should also be checked and replaced if either damage or improper operation is noted.

Properly care for seatbelts. See **Cleaning Seatbelts** (page 473).

## SEATBELT EXTENSIONS



**WARNING:** Persons who fit into the vehicle's seatbelt should not use an extension. Unnecessary use could result in serious personal injury in the event of a crash.



**WARNING:** Only use extensions provided free of charge by our dealers. The dealer will provide an extension designed specifically for this vehicle, model year and seating position. The use of an extension intended for another vehicle, model year or seating position may not offer you the full protection of your vehicle's seatbelt restraint system.



**WARNING:** Never use seatbelt extensions to install child restraints.



**WARNING:** Do not use extensions to change the way the seatbelt fits across the torso, over the lap or to make the seatbelt buckle easier to reach.

If, because of body size or driving position, it is not possible to properly fasten the seatbelt over your lap and shoulder, an extension that is compatible with the seatbelts is available free of charge from our dealers. Only use our seatbelt extensions made by the original equipment seatbelt manufacturer with our seatbelts. Ask your authorized dealer if your extension is compatible with your vehicle restraint system.



# Airbags

## HOW DO THE FRONT AIRBAGS WORK

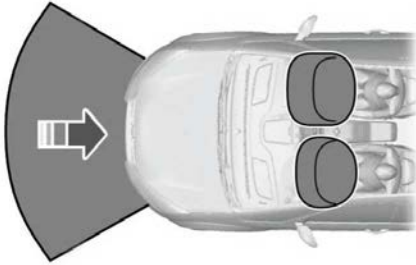

The driver and front passenger airbags deploy during significant frontal and near frontal crashes.

The driver and passenger front airbag system consists of:

- Driver and passenger airbag modules.
- Crash sensors and monitoring system with a readiness indicator. See **Crash Sensors and Airbag Indicator** (page 65).

The airbags are a supplemental restraint system and are designed to work with the seatbelts to help protect the driver and right front passenger from certain upper body injuries. Airbags do not inflate slowly. There is a risk of injury from a deploying airbag.

**Note:** *You will hear a loud bang and see a cloud of harmless powdery residue if an airbag deploys. This is normal.*

The airbags inflate and deflate rapidly upon activation. After airbag deployment, it is normal to notice a smoke-like, powdery residue or smell the burnt propellant. This may consist of cornstarch, talcum powder, to lubricate the bag, or sodium compounds

(for example, baking soda) that result from the combustion process that inflates the airbag. Small amounts of sodium hydroxide may be present which may irritate the skin and eyes, but none of the residue is toxic.

Contact with a deploying airbag may cause abrasions or swelling. Temporary hearing loss is also a possibility as a result of the noise associated with a deploying airbag.

Because airbags must inflate rapidly and with considerable force, there is the risk of death or serious injuries such as fractures, facial and eye injuries or internal injuries, particularly to occupants who are not properly restrained or are otherwise out of position at the time of airbag deployment. Thus, it is extremely important that occupants be properly restrained as far away from the airbag module as possible while maintaining vehicle control.

The airbag does not require routine maintenance.

## HOW DO THE SIDE AIRBAGS WORK



**WARNING:** Do not place objects or mount equipment on or near the airbag cover, on the side of the front or rear seatbacks, or in areas that may come into contact with a deploying airbag. Failure to follow these instructions may increase the risk of personal injury in the event of a crash.



**WARNING:** Accessory seat covers not released by Ford Motor Company could prevent the deployment of the airbags and increase the risk of injuries in a crash.

# Airbags



**WARNING:** Do not lean your head on the door. The side airbag could injure you as it deploys from the side of the seatback.

The side airbags are on the outermost side of the seat backrests of the front seats. In certain sideways crashes or rollovers, the airbags will be inflated. The airbag was designed to inflate between the door panel and occupant to further enhance the protection provided to occupants in side impact crashes.



The system consists of the following:

- A label or embossed side panel indicating that side airbags are fitted to your vehicle.
- Side airbags inside the driver and front passenger seat backrests.
- Crash sensors and monitoring system with readiness indicator. See **Crash Sensors and Airbag Indicator** (page 65).

## HOW DOES THE SAFETY CANOPY™ WORK



**WARNING:** Do not place objects or mount equipment on or near the headliner at the siderail that may come into contact with a deploying curtain airbag. Failure to follow these instructions may increase the risk of personal injury in the event of a crash.



**WARNING:** Do not lean your head on the door. The curtain airbag could injure you as it deploys from the headliner.



**WARNING:** To reduce risk of injury, do not obstruct or place objects in the deployment path of the airbag.

The Safety Canopy deploys during significant side crashes or when a certain likelihood of a rollover event is detected by the rollover sensor. The Safety Canopy is mounted to the roof side-rail sheet metal, behind the headliner, above each row of seats. In certain sideways crashes or rollover events, the Safety Canopy will be activated, regardless of which seats are occupied. The Safety Canopy inflates between the side window area and occupants to further enhance protection provided in side impact crashes and rollover events.

# Airbags

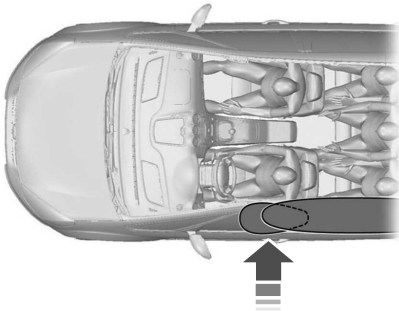

The system consists of the following:

- Safety Canopy curtain airbags above the trim panels over the front and rear side windows identified by a label or wording on the headliner or roof-pillar trim.
- A flexible headliner which opens above the side doors to allow air curtain deployment



• Crash sensors and monitoring system with a readiness indicator. See **Crash Sensors and Airbag Indicator** (page 65).

Properly restrain children 12 years old and under in the rear seats. The Safety Canopy will not interfere with children restrained using a properly installed child or booster seat because it is designed to inflate downward from the headliner above the doors along the side window opening.

## AIRBAG PRECAUTIONS



**WARNING:** Airbags do not inflate slowly or gently, and the risk of injury from a deploying airbag is the greatest close to the trim covering the airbag module.



**WARNING:** All occupants of your vehicle, including the driver, should always properly wear their seatbelts, even when an airbag supplemental restraint system is provided. Failure to properly wear your seatbelt could seriously increase the risk of injury or death.



**WARNING:** Properly secure children 12 years old and under in a rear seating position whenever possible. If you are unable to properly secure all children in a rear seating position, properly secure the largest child on the front seat. If you must use a forward facing child restraint on the front seat, move the seat as far back as possible. Failure to follow these instructions could result in personal injury or death.



**WARNING:** Do not place your arms on the airbag cover or through the steering wheel. Failure to follow this instruction could result in personal injury.



**WARNING:** Keep the areas in front of the airbags free from obstruction. Do not affix anything to or over the airbag covers. Objects could become projectiles during airbag deployment. Failure to follow this instruction could result in personal injury or death.



**WARNING:** To reduce risk of injury, do not obstruct or place objects in the deployment path of the airbag.



**WARNING:** Do not place a rearward facing child restraint in front of an active airbag. Failure to follow this instruction could result in personal injury or death.

# Airbags

**WARNING:** Do not attempt to service, repair, or modify the supplementary restraint system or associated components. Failure to follow this instruction could result in personal injury or death.

**WARNING:** Several airbag system components get hot after inflation. To reduce the risk of injury, do not touch them after inflation.

**WARNING:** If a supplementary restraint system component has deployed, it will not function again. Have the system and associated components inspected as soon as possible. Failure to follow this instruction could result in personal injury or death.

**WARNING:** The front passenger airbag is not designed to offer protection to an occupant in the center seating position.

**WARNING:** Your vehicle may have an airbag deactivation switch. Before driving, always look at the switch to make sure it is in the appropriate position. Failure to put the switch in the proper position can increase the risk of serious injury or death in a crash.



## SWITCHING THE PASSENGER AIRBAG ON AND OFF

**WARNING:** Even with advanced restraints systems, properly restrain children 12 and under in a rear seating position. Failure to follow this could seriously increase the risk of injury or death.

The front passenger airbag on and off switch has indicators that illuminate, indicating that the front passenger frontal airbag is either on or off. The indicators are near the center of the instrument panel.

**Note:** *The indicators illuminate for a short period of time when you switch the ignition on to confirm it is functional.*

Switch Position	Passenger Airbag Status Indicator	Passenger Airbag
Off	OFF: Illuminated	Disabled
	ON: Not Illuminated	
On	OFF: Not Illuminated	Enabled
	ON: Illuminated	

# Airbags

## Switching the Passenger Airbag Off

**WARNING:** If the light does not illuminate when the passenger airbag switch is off and you switch the ignition on, have the passenger airbag switch serviced immediately by a qualified technician.

**WARNING:** To avoid switching on the airbag, always remove the ignition key with the switch in the off position.

**WARNING:** If your vehicle has rear seats, always transport children who are 12 and younger in the rear seat. Always use seatbelts and child restraints properly. Do not place a child in a rear facing infant seat in the front seat unless your vehicle is equipped with an airbag on and off switch and the passenger airbag is turned off. This is because the back of the infant seat is too close to the inflating airbag and the risk of a fatal injury to the infant when the airbag inflates is substantial.

The passenger airbag on and off switch is in the glovebox.



1. Insert the ignition key, turn the switch to OFF and hold in OFF while removing the key.
2. When you switch the ignition on, the passenger airbag off light illuminates briefly, momentarily shuts off and then switches back on. This indicates that the passenger airbag is deactivated.

## Switching the Passenger Airbag On

**WARNING:** The seatbelts for the driver and right front passenger seating positions are specifically designed to operate together with the airbags in certain types of crashes. When you switch off your airbag, you not only lose the protection of the airbag, you also may reduce the effectiveness of your seatbelt system. If the passenger does not meet the requirements stated in the National Highway Traffic Safety Administration or Transport Canada deactivation criteria, switching off the airbag can increase the risk of serious injury or death in a crash.

**WARNING:** If your vehicle has rear seats, always transport children who are 12 and younger in the rear seat. Always use seatbelts and child restraints properly. Do not place a child in a rear facing infant seat in the front seat unless your vehicle is equipped with an airbag on and off switch and the passenger airbag is turned off. This is because the back of the infant seat is too close to the inflating airbag and the risk of a fatal injury to the infant when the airbag inflates is substantial.

# Airbags



**WARNING:** If the passenger airbag off light is illuminated when the passenger airbag switch is on and the ignition is on, have the passenger airbag switch serviced immediately by a qualified technician.

The passenger airbag remains off until you switch it back on.



1. Insert the ignition key and turn the switch to ON.
2. The passenger airbag off light briefly illuminates when you switch the ignition on. This indicates that the passenger airbag is operational.

The passenger side airbag should always be on, and the passenger airbag off light should not be illuminated, unless the passenger is a person who meets the requirements stated either in Category 1, 2 or 3 of the National Highway Traffic Safety Administration or Transport Canada deactivation criteria which follows.

The vast majority of drivers and passengers are much safer with an airbag than without. To do their job and reduce the risk of life threatening injuries, airbags must open with great force, and this force can pose a potentially deadly risk in some situations, particularly when a front seat occupant is not properly buckled up. The most effective way to reduce the risk of unnecessary airbag injuries without reducing the overall safety of the vehicle is to make sure all occupants are properly restrained in the vehicle, especially in the front seat. This provides the protection of seatbelts and permits the airbags to provide the additional protection they were designed to provide. If you choose to deactivate your airbag, you are losing the very significant risk reducing benefits of the airbag and you are also reducing the effectiveness of the seatbelts. Seatbelts in modern vehicles are designed to work as a safety system with the airbags.

## National Highway Traffic Safety Administration Deactivation Criteria-Excluding Canada



**WARNING:** This vehicle has special energy management seatbelts for the driver and right front passenger. These particular seatbelts are specifically designed to work with airbags to help reduce the risk of injury in a crash. The energy management seatbelt gives or releases additional seatbelt webbing in some accidents to reduce the concentration of force on an occupant's chest and to reduce the risk of certain bone fractures and injuries to underlying organs. In a crash, if the airbag is off, this energy management seatbelt might permit the passenger wearing the seatbelt to move forward enough to have a serious or fatal injury. The more

# Airbags

severe the crash, and the heavier the occupant, the greater the risk. Make sure the airbag is on for any passenger who does not qualify under the National Highway Traffic Safety Administration deactivation criteria.

1. **Infant.** An infant, less than 1 year old, must ride in the front seat because:

- The vehicle has no rear seat.
- The vehicle has a rear seat too small to accommodate a rear-facing infant seat.
- The infant has a medical condition which, according to the infant's physician, makes it necessary for the infant to ride in the front so that the driver can constantly monitor the child's condition.

2. **Children age 1 to 12.** Children age 1 to 12 must ride in the front seat because:

- The vehicle has no rear seat.
- Although children ages 1 to 12 ride in the rear seat(s) whenever possible, children ages 1 to 12 sometimes must ride in the front because no space is available in the rear seat(s) of your vehicle.
- The child has a medical condition which, according to the child's physician, makes it necessary for the child to ride in the front seat so that the driver can constantly monitor the child's condition.

3. **Medical condition.** A passenger has a medical condition which, according to his or her physician:

- Causes the passenger airbag to pose a special risk for the passenger.
- Makes the potential harm from the passenger airbag in a crash greater than the potential harm from turning off the airbag and allowing the passenger, even if belted, to hit the dashboard or windshield in a crash.

## Transport Canada Deactivation Criteria-Canada Only



**WARNING:** This vehicle has special energy management seatbelts for the driver and right front passenger. These particular seatbelts are specifically designed to work with airbags to help reduce the risk of injury in a crash. The energy management seatbelt gives or releases additional seatbelt webbing in some accidents to reduce the concentration of force on an occupant's chest and to reduce the risk of certain bone fractures and injuries to underlying organs. In a crash, if the airbag is off, this energy management seatbelt might permit the passenger wearing the seatbelt to move forward enough to have a serious or fatal injury. The more severe the crash, and the heavier the occupant, the greater the risk. Make sure the airbag is on for any passenger who does not qualify under the Transport Canada deactivation criteria.

1. **Infant:** An infant, less than 1 year old, must ride in the front seat because:

# Airbags

- The vehicle has no rear seat.
- The rear seat in my vehicle cannot accommodate a rear-facing infant seat.
- The infant has a medical condition which, according to the infant's physician, makes it necessary for the infant to ride in the front seat so that the driver can monitor the infant's condition.

2. **Children age 12 or under:** Children age 12 or under must ride in the front seat because:

- The vehicle has no rear seat.
- Although children age 12 and under ride in the rear seat whenever possible, children age 12 and under have no option but to sometimes ride in the front seat because rear seat space is insufficient.
- The child has a medical condition that, according to the child's physician, makes it necessary for the child to ride in the front seat so that the driver can monitor the child's condition.

3. **Medical condition:** A passenger has a medical condition that, according to his or her physician:

- Poses a special risk for the passenger if the airbag deploys.
- Makes the potential harm from the passenger airbag deployment greater than the potential harm from turning off the airbag and experiencing a crash without the protection offered by the airbag.

## PROPERLY ADJUSTING THE DRIVER AND FRONT PASSENGER SEATS



**WARNING:** National Highway Traffic Safety Administration (NHTSA) recommends a minimum distance of at least 10 in (25 cm) between an occupant's chest and the driver airbag module.

To properly position yourself away from the airbag:

- Move your seat to the rear as far as you can while still reaching the pedals comfortably.
- Recline the seat slightly one or two degrees from the upright position.

After all occupants have adjusted their seats and put on seatbelts, it is very important that they continue to sit properly. Properly seated occupants sit upright, lean against the seat backrest, and center themselves on the seat cushion, with their feet comfortably extended on the floor. Sitting improperly can increase the chance of injury in a crash event. For example, if an occupant slouches, lies down, turns sideways, sits forward, leans forward or sideways, or puts one or both feet up, the chance of injury during a crash greatly increases.

## CHILDREN AND AIRBAGS



**WARNING:** Do not place a rearward facing child restraint in front of an active airbag. Failure to follow this instruction could result in personal injury or death.



# Airbags



Children must always be properly restrained. Accident statistics suggest that children are safer when properly restrained in the rear seating positions than in the front seating position. Failure to follow these instructions may increase the risk of injury in a crash.

If two adults and a child occupy a vehicle without rear seats, properly restrain the child in the center front seat unless doing so would interfere with driving your vehicle. This provides lap and shoulder belt protection for all occupants, and airbag protection for the adults. A child or infant properly restrained in the center front seat should have a reduced risk to serious injury from the airbags.

## CRASH SENSORS AND AIRBAG INDICATOR



**WARNING:** Modifying or adding equipment to the front of your vehicle could affect the performance of the airbag system, increasing the risk of injury. This includes the hood, bumper system, frame, front body structure, tow hooks, hood pins, push bar and snowplows.

Your vehicle has a collection of crash and occupant sensors. These sensors provide information to the restraints control module which activates the following:

- Seatbelt pretensioners.
- Adaptive steering column.
- Driver airbag.
- Passenger airbag.
- Seat mounted side airbags.
- Safety Canopy.

Based on the type of crash, the restraints control module deploys the appropriate safety devices.

The restraints control module also monitors the readiness of the above safety devices plus the crash and occupant sensors. The readiness of the safety system is indicated by a warning indicator light in the instrument cluster or by a backup tone if the warning light is not working. The airbag does not require routine maintenance.

A difficulty with the system is indicated by one or more of the following:



The readiness light will not illuminate immediately after you switch the ignition on.

- The readiness light either flashes or stays on.
- You hear a series of five tones. The tone pattern repeats periodically until the problem, the light or both are repaired.

If any of these things happen, even intermittently, have the supplemental restraint system serviced immediately. Unless serviced, the system may not function properly in the event of a crash.

# Airbags

---

The fact that the seatbelt pretensioners or front airbags did not activate for both front seat occupants in a crash does not mean that something is wrong with the system. Rather, it means the restraints control module determined the accident conditions (crash severity, seatbelt usage) were not appropriate to activate these safety devices.

- The front airbags activate only in frontal and near-frontal crashes. Front airbags may activate in rollovers, side impacts or rear impacts if the crash causes sufficient frontal deceleration.
- The adaptive steering column activates only in frontal and near-frontal crashes. It may activate in rollovers, side impacts or rear impacts if the crash causes sufficient frontal deceleration.
- The seatbelt pretensioners activate in frontal, near-frontal and side crashes, and in rollovers.
- The side airbags inflate in certain side impact crashes or rollover events. Side airbags may activate in other types of crashes if the vehicle experiences sufficient sideways motion or deformation.
- The Safety Canopy inflates in certain side impact crashes or rollover events. The Safety Canopy may activate in other types of crashes if the vehicle experiences sufficient sideways motion or deformation, or a certain likelihood of rollover.

## **DISPOSING OF AIRBAGS**

Contact your authorized dealer as soon as possible. Airbags must be disposed of by qualified personnel.

# 911 Assist

## WHAT IS 911 ASSIST

911 Assist is a SYNC system feature that can call for help.

For more information, visit [www.owner.ford.com](http://www.owner.ford.com).

## HOW DOES 911 ASSIST WORK

If a crash deploys an airbag, excluding knee airbags and rear inflatable seatbelts, or activates the fuel pump shut-off, your vehicle may be able to contact emergency services by dialing 911 through a paired and connected **Bluetooth**® enabled phone.

Not all crashes deploy an airbag or activate the fuel pump shut-off. If a connected cell phone sustains damage or loses its connection to SYNC during a crash, SYNC searches for and tries to connect to a previously paired cell phone. SYNC then attempts to call the emergency services.

Before making the call:

- SYNC provides about 10 seconds to cancel the call. If you fail to cancel the call, SYNC attempts to dial 911.
- SYNC says the following, or a similar message: SYNC will attempt to call 911, to cancel the call, press Cancel on your screen or press and hold the phone button on your steering wheel.

If you do not cancel the call and SYNC makes a successful call a pre-recorded message plays for the 911 operator. The occupants in your vehicle are able to talk with the operator. Be prepared to provide your name, phone number and location immediately because not all 911 systems are capable of receiving this information electronically.

During an emergency call the system transmits vehicle data to the emergency service.

## EMERGENCY CALL REQUIREMENTS



**WARNING:** Do not wait for 911 Assist to make an emergency call if you can do it yourself. Dial emergency services immediately to avoid delayed response time which could increase the risk of serious injury or death after a crash. If you do not hear 911 Assist within five seconds of the crash, the system or phone may be damaged or non-functional.



**WARNING:** Always place your phone in a secure location in your vehicle so it does not become a projectile or get damaged in a crash. Failure to do so may cause serious injury to someone or damage the phone which could prevent 911 Assist from working properly.



**WARNING:** Unless the 911 Assist setting is set on before a crash, the system will not dial for help which could delay response time, potentially increasing the risk of serious injury or death after a crash.

- SYNC is powered and working properly at the time of the incident and throughout feature activation and use.
- The 911 Assist feature must be set on before the incident.
- You must pair and connect a **Bluetooth**® enabled and compatible cell phone to SYNC.
- A connected **Bluetooth**® enabled phone must have the ability to make and maintain an outgoing call at the time of the incident.

# 911 Assist

---

- A connected **Bluetooth**® enabled phone must have adequate network coverage, battery power and signal strength.
- The vehicle must have battery power and be located in the U.S., Canada or in a territory in which 911 is the emergency number.

**Note:** *If any user sets 911 Assist to on or off, that setting applies for all paired phones. If 911 Assist is off and the phone connected to SYNC, an icon displays on the status bar.*

**Note:** *Every phone operates differently. While SYNC 911 Assist works with most cellular phones, some may have trouble using this feature.*

## EMERGENCY CALL LIMITATIONS

The SYNC 911 Assist feature only operates in the U.S., Canada or in a territory in which 911 is the emergency number. The following are limitations of this feature:

- Your cellular phone or 911 Assist hardware sustains damage in a crash.
- The vehicle's battery or the SYNC system has no power.
- The phone(s) thrown from your vehicle are the ones paired and connected to the system.

## 911 ASSIST VIDEOS

[911 Assist Video Link](#)

# Keys and Remote Controls

## REMOTE CONTROL LIMITATIONS



**WARNING:** Changes or modifications not expressly approved by the party responsible for compliance could void the user's authority to operate the equipment. The term "IC:" before the radio certification number only signifies that Industry Canada technical specifications were met.

This device complies with Part 15 of the FCC Rules and with Industry Canada license-exempt RSS standard(s). Operation is subject to the following two conditions: (1) This device may not cause harmful interference, and (2) This device must accept any interference received, including interference that may cause undesired operation.

Make sure a valid remote control is within 3 ft (1 m) from the front door handles and rear of vehicle.

The system may not function if:

- The remote control remains stationary for about a minute.
- The vehicle battery has no charge.
- The remote control battery has no charge.
- There is interference causing issues with the remote control frequencies.
- The remote control is too close to metal objects or electronic devices, for example keys or a cell phone.

## USING THE REMOTE CONTROL



**WARNING:** Do not leave a key or remote control unattended in the vehicle. Children or pets could operate the power windows, moonroof or other controls. Failure to follow this instruction could result in personal injury or death.

Use your remote control to access various vehicle systems.

**Note:** *The buttons on your remote may vary depending on the vehicle region or options.*

### Unlock



Press the button to unlock all doors. See **Unlocking and Locking the Doors Using the Remote Control** (page 77).

### Lock



Press the button to lock all doors. See **Unlocking and Locking the Doors Using the Remote Control** (page 77).

### Remote Start (If Equipped)



Press the button twice within three seconds to remote start. See **What Is Remote Start** (page 146).

### Tailgate (If Equipped)



Press the button twice within three seconds to open the tailgate. See **Opening the Tailgate Using the Remote Control** (page 96).

# Keys and Remote Controls

## Panic Alarm (if Equipped)



Press the button to sound the panic alarm. See **Sounding the Panic Alarm** (page 71).

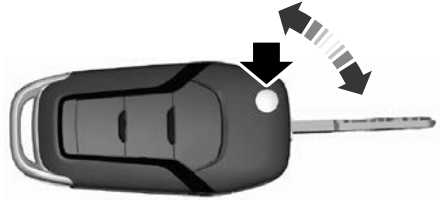

## OPENING AND CLOSING THE FLIP KEY

### Opening Your Flip Key

Press the round button on the remote control to extend the flip key.

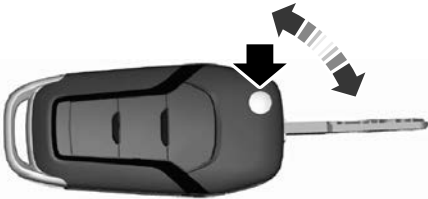

**Note:** *Inspect the key blade for debris. Periodically clean with a brush.*

### Closing Your Flip Key

Press and hold the round button on the remote control to fold the key blade when not in use.

## REMOVING THE KEY BLADE - VEHICLES WITH: PUSH BUTTON START



Push the release button on your passive key and pull the key blade out.

# Keys and Remote Controls

## SOUNDING THE PANIC ALARM



Press the button to sound the panic alarm. Press the button again, or switch the ignition on to turn it off.

**Note:** *The panic alarm only operates when the ignition is off.*

## LOCATING YOUR VEHICLE



Press the lock button twice within three seconds. The turn signal lamps flash.

**Note:** *We recommend you use this method to locate your vehicle.*

## CHANGING THE REMOTE CONTROL BATTERY - VEHICLES WITH: FLIP KEY



**WARNING:** Keep batteries away from children to prevent ingestion. Failure to follow this instruction could result in personal injury or death. If ingested, immediately seek medical attention.



**WARNING:** If the battery compartment does not securely close, stop using the remote control and replace it as soon as possible. In the meantime, keep the remote control away from children. Failure to follow this instruction could result in personal injury or death.

### Battery Replacement Procedure

The remote control uses one coin-type 3-volt lithium battery CR2032 or equivalent.

Press the button to release the key blade before beginning the procedure.

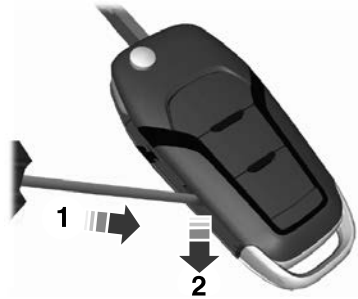

1. Insert a screwdriver, in the position shown and gently push the clip.
2. Press the clip down to release the battery cover.

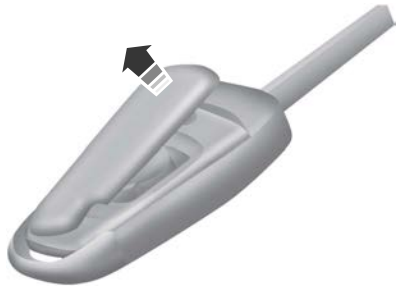

3. Carefully remove the cover.



## Keys and Remote Controls

4. Insert a screwdriver as shown to release the battery.



**Note:** Do not touch the battery contacts or the printed circuit board with the screwdriver.

5. Remove the battery.
6. Install a new battery with the + facing up.
7. Replace the battery cover.



Dispose of old batteries in an environmentally friendly way. Seek advice from your local authority about recycling old batteries.

**Note:** Do not wipe off any grease on the battery terminals or on the back surface of the circuit board.

**Note:** Replacing the battery does not erase the programmed key from your vehicle. The remote control should operate normally.

### CHANGING THE REMOTE CONTROL BATTERY - VEHICLES WITH: PUSH BUTTON START

**WARNING:** Keep batteries away from children to prevent ingestion. Failure to follow this instruction could result in personal injury or death. If ingested, immediately seek medical attention.

**WARNING:** If the battery compartment does not securely close, stop using the remote control and replace it as soon as possible. In the meantime, keep the remote control away from children. Failure to follow this instruction could result in personal injury or death.

The remote control uses one coin-type 3-volt lithium battery CR2450 or equivalent.





## Keys and Remote Controls

1. Push the release button and pull the key blade out.

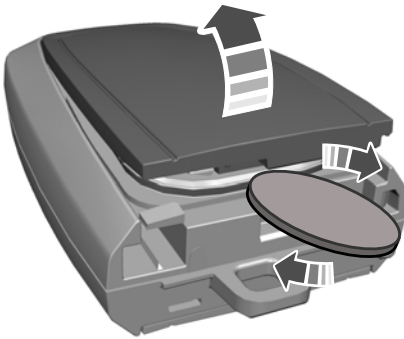
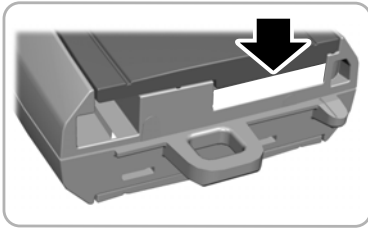

2. Twist a thin coin under the tab hidden behind the key blade head to remove the battery cover.

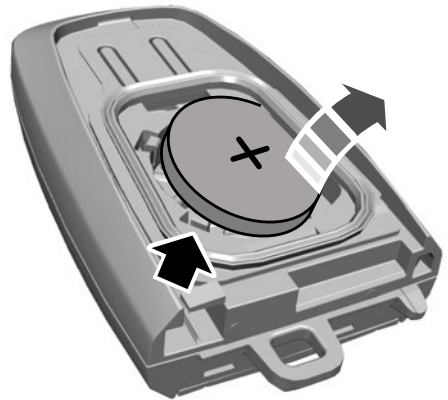

3. Insert a screwdriver, and carefully remove the battery.
4. Install a new battery with the + facing upward.
5. Reinstall the battery housing cover onto the transmitter and install the key blade.



Dispose of old batteries in an environmentally friendly way. Seek advice from your local authority about recycling old batteries.

**Note:** Do not wipe off any grease on the battery terminals or on the back surface of the circuit board.

**Note:** Replacing the battery does not erase the programmed key from your vehicle. The remote control should operate normally.

## REPLACING A LOST KEY OR REMOTE CONTROL

You can purchase replacement keys or remote controls from an authorized dealer. Authorized dealers can program remote controls for your vehicle.

# Keys and Remote Controls



**Note:** *Your vehicle keys came with a security label that provides important key cut information. Keep the label in a safe place for future reference.*

## PROGRAMMING THE REMOTE CONTROL - VEHICLES WITH: FLIP KEY

### General Information

You can program your own remote control to your vehicle. This procedure programs both the engine immobilizer keycode and the remote entry portion of the remote control to your vehicle.

Only use remote controls with an integrated mechanical key.

You must have two previously programmed coded remote controls and the new un-programmed remote readily accessible. Contact an authorized dealer to have the spare remote control programmed if the two previously programmed coded remote controls are not available.

Read and understand the entire procedure before you begin.

### Steps for Programming Your Spare Remote Control

1. Insert the first previously programmed coded key into the ignition.

2. Switch the ignition from off to on. Keep the ignition on for at least three seconds, but no more than 10 seconds.
3. Switch the ignition off and remove the first coded key from the ignition.
4. After three seconds but within 10 seconds of switching the ignition off, insert the second previously coded key into the ignition.
5. Switch the ignition from off to on. Keep the ignition on for at least three seconds, but no more than 10 seconds.
6. Switch the ignition off and remove the second previously programmed coded key from the ignition.
7. After three seconds but within 10 seconds of switching the ignition off and removing the previously programmed coded key, insert the new un-programmed key into the ignition.
8. Switch the ignition from off to on. Keep the ignition on for at least six seconds until you hear the door locks cycle.
9. Remove the newly programmed coded key from the ignition.

The key starts the engine if programming is successful. You can operate the keyless remote entry system with the new remote control with integrated key.

If programming was not successful, wait 20 seconds and repeat Steps 1 through 8. If you are still unsuccessful, take your vehicle to an authorized dealer.

**Note:** *You can program a maximum of six coded remote controls to your vehicle.*

# Keys and Remote Controls

## PROGRAMMING THE REMOTE CONTROL - VEHICLES WITH: PUSH BUTTON START

### General Information

You must have two previously programmed remote controls inside your vehicle and the new unprogrammed remote controls readily accessible. Contact an authorized dealer to have the spare remote control programmed if two previously programmed remotes are not available. Make sure that your vehicle is off before beginning this procedure. Make sure that you close all the doors before beginning and that they remain closed throughout the procedure. Perform all steps within 30 seconds of starting the sequence. Stop and wait for at least one minute before starting again if you perform any steps out of sequence.

Read and understand the entire procedure before you begin.

**Note:** You can program a maximum of four remote controls to your vehicle.

**Note:** If your programmed remote controls are lost or stolen and you do not have an extra coded remote, you need to have your vehicle towed to an authorized dealer. Store an extra programmed remote away from your vehicle in a safe place to help prevent any inconvenience. Contact an authorized dealer to purchase additional spare or replacement remotes.

### Steps for Programming Your Spare Remote Control

**Note:** Your vehicle is equipped with one of the following center consoles.

### Programming Backup Location

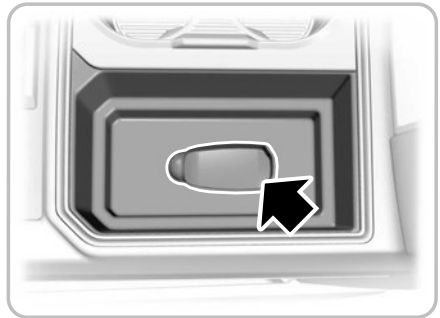
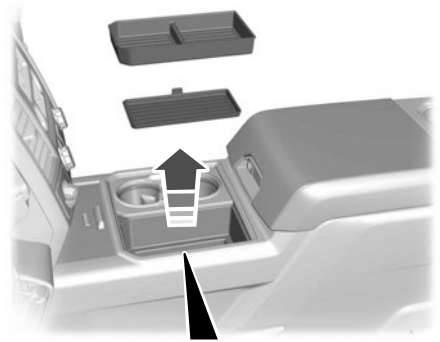

# Keys and Remote Controls

1. Place the first programmed remote in the backup slot inside the center console with your foot off the brake pedal, press and release the push button ignition switch.
2. Wait five seconds and then press and release the push button ignition switch again.
3. Remove the remote control.
4. Within 10 seconds, place a second programmed remote control in the backup slot. Press and release the push button ignition switch.
5. Wait five seconds and then press and release the push button ignition switch again. Keep the ignition on for at least three seconds, but no more than 10 seconds.
6. Remove the remote control.
7. Place the unprogrammed remote control in the backup slot and press and release the push button ignition switch.

Programming is now complete. With your foot on the brake pedal, press the push button ignition switch to verify the remote control functions operate and your vehicle starts with the new remote control.

If programming was not successful, wait 10 seconds and repeat Steps 1 through 7. If you are still unsuccessful, take your vehicle to an authorized dealer.

## **KEYS AND REMOTE CONTROLS AUDIBLE WARNINGS - VEHICLES WITH: PUSH BUTTON START**

### **Key In Reminder**

Sounds when the following conditions are met:

- Vehicle is out of park (P).
- You switch the vehicle off.
- You open the driver's door.
- You have left the key inside the vehicle.

## **KEYS AND REMOTE CONTROLS AUDIBLE WARNINGS - VEHICLES WITH: FLIP KEY**

Sounds when you open the driver's door, turn off the vehicle and you have left the key in the ignition.

## **KEYS AND REMOTE CONTROLS – TROUBLESHOOTING**

### **KEYS AND REMOTE CONTROLS – INFORMATION MESSAGES**

<b>Message</b>	<b>Action</b>
Key Battery Low Replace Soon	Replace remote control battery.

# Doors and Locks

## OPERATING THE DOORS FROM OUTSIDE YOUR VEHICLE

### UNLOCKING AND LOCKING THE DOORS USING THE REMOTE CONTROL

You can only use the remote control when your vehicle is stationary.

#### Unlocking the Doors



Press the button to unlock all doors. One long flash of the turn signal lamps confirms that your vehicle has unlocked.

#### Locking the Doors



Press the button to lock all doors. One short flash of the turn signal lamps confirms that your vehicle has locked.

### UNLOCKING AND LOCKING THE DOORS USING THE KEY BLADE

If there is a power door lock fault you can use the key blade to lock and unlock the doors.

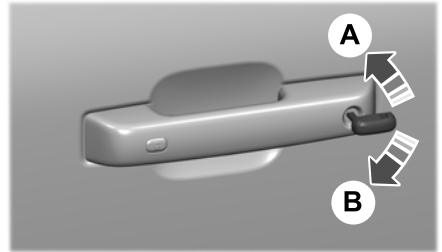

A Lock.

B Unlock.

## OPERATING THE DOORS FROM INSIDE YOUR VEHICLE

### UNLOCKING AND LOCKING THE DOORS USING THE CENTRAL LOCKING

The power door lock control is on the front doors.



Press the button to unlock all doors.



Press the button to lock all doors.

**Note:** The central locking only operates if the front doors are fully closed.

### OPENING THE DOORS FROM INSIDE YOUR VEHICLE

Pull the interior door handle twice to unlock and open a rear door. The first pull unlocks the door and the second pull opens the door.

# Doors and Locks

---

## AUTOUNLOCK

### WHAT IS AUTOUNLOCK

Autounlock is a feature that centrally unlocks the vehicle doors when your vehicle comes to a stop and you open the driver door.

### AUTOUNLOCK REQUIREMENTS

Autounlock unlocks all the doors after:

1. The vehicle speed exceeds 12 mph (20 km/h).
2. Your vehicle comes to a stop.
3. You open the driver door.

**Note:** *Autounlock operates for only 10 minutes after the ignition is switched off.*

### SWITCHING AUTOUNLOCK ON AND OFF

1. Press **Settings** on the touchscreen.
2. Press **Vehicle Settings**.
3. Press **Locks**.
4. Switch **Autounlock** on or off.

## AUTOLOCK

### WHAT IS AUTOLOCK

Autolock is a locking feature that centrally locks your vehicle doors when driving.

### AUTOLOCK REQUIREMENTS

Autolock locks all the doors after:

1. All doors are closed and the ignition is on.
2. Your vehicle speed exceeds 12 mph (20 km/h).

Autolock repeats if:

1. Your vehicle is stopped.
2. Any door is opened and closed again.
3. Your vehicle speed exceeds 12 mph (20 km/h).

## MISLOCK

### WHAT IS MISLOCK

Mislock is a locking feature that warns you if your vehicle has not locked.

### MISLOCK LIMITATIONS

When you press the lock button once, the turn signals do not flash if:

- Any door or the tailgate is open.
- The hood is open.

If you switch mislock off, the horn does not sound if you press the lock button on the remote control when a door is open.

### SWITCHING MISLOCK ON AND OFF

1. Press **Settings** on the touchscreen.
2. Press **Vehicle Settings**.
3. Press **Locks**.
4. Switch **Mislock Chirp** on or off.

## DOORS AND LOCKS AUDIBLE WARNINGS

### Door Ajar Audible Warning

Sounds when any front door is not fully closed and your vehicle is moving.

# Doors and Locks

---

## DOORS AND LOCKS – TROUBLESHOOTING

## DOORS AND LOCKS – WARNING LAMPS

### Door Ajar Warning Lamp



Illuminates when you switch the ignition on and remains on if any door or the hood is open.

## DOORS AND LOCKS – INFORMATION MESSAGES

Message	Details
Driver Door Ajar	Displays if a door is open. Fully close the door.
Passenger Door Ajar	
Rear Left Door Ajar	
Rear Right Door Ajar	
Hood Ajar	Displays if a hood is open. Fully close the hood.

# Doors and Locks

---

## **DOORS AND LOCKS – FREQUENTLY ASKED QUESTIONS**

### **Can accessories such as steps or handles be used with the latch assembly?**

- Do not use the door latch assembly to attach any accessory, such as handles or steps, as this can cause damage to your vehicle.



# Keyless Entry (If Equipped)

## KEYLESS ENTRY LIMITATIONS

Make sure your remote control is within 3 ft (1 m) from the front door handles and the tailgate.

The system could not function if:

- The remote control remains stationary for about a minute.
- The vehicle battery has no charge.
- The remote control battery has no charge.
- There is interference causing issues with the remote control frequencies.
- The remote control is too close to metal objects or electronic devices, for example keys or a cell phone.

## KEYLESS ENTRY SETTINGS

### Reprogramming the Unlocking Function

You can enable the two-stage unlocking function allowing you to unlock only the driver door when you touch the unlock sensor.

Press and hold both the lock and unlock buttons on the remote control for four seconds to disable or enable two-stage unlocking.

If you program the unlocking function so that only the driver door unlocks, you can unlock all of the other doors from inside your vehicle using the power door lock control. You can unlock individual doors by pulling the interior door handles on those doors.

## Keyless Detection Alert (If Equipped)

Displays a message in the instrument cluster if no valid key is detected, when you exit your vehicle with a key, after the last front door is closed and your keyless vehicle is in run, indicating your vehicle is still on. The horn sounds if you have driven the vehicle and reached a speed of 16 mph (25 km/h) and the above mentioned conditions are met.

You can switch the audible alert on or off.

1. From the settings menu, press Vehicle. See **Center Display** (page 562).
2. Switch Key Detection Alert On or Off.

## USING KEYLESS ENTRY

### Unlocking the Doors



With your passive key within 3 ft (1 m) of your vehicle, touch the unlock sensor on the back of the door handle for a brief period and then pull on the door handle to unlock, being careful not to touch the lock sensor at the same time or pull on the door handle too quickly. The intelligent access system requires a brief delay to authenticate your passive key.

### Locking the Doors



# Keyless Entry (If Equipped)

---

With your passive key within 3 ft (1 m) of your vehicle, touch the outer door handle lock sensor for approximately one second to lock, being careful not to touch the unlock sensor on the back of the door handle at the same time. After locking, you can immediately pull on the door handle to confirm locking occurred without inadvertently unlocking.

## KEYLESS ENTRY – TROUBLESHOOTING

### KEYLESS ENTRY – FREQUENTLY ASKED QUESTIONS

#### Why does the keyless entry system not function?

If the system does not function it may be limited. See **Keyless Entry Limitations** (page 81). If the system still does not function use the remote control or the key blade to lock and unlock your vehicle.

#### Why can I not lock my vehicle?

If you electronically lock your vehicle with a rear door or the tailgate open, the system searches for a passive key inside your vehicle after you close the last door. If the system detects a key, all doors unlock indicating that a key is inside. Your vehicle locks if another passive key is within the detection range after you close the last door.

## KEYLESS ENTRY VIDEOS

[\*Using Intelligent Access with Push-button Start Video Link\*](#)

# Keyless Entry Keypad (If Equipped)

## WHAT IS THE KEYLESS ENTRY KEYPAD

The keyless entry keypad allows you to lock and unlock your vehicle using the keypad on the window trim.

## KEYLESS ENTRY KEYPAD LIMITATIONS

The system may not function if:

- The vehicle battery has no charge.

## LOCATING THE KEYLESS ENTRY KEYPAD

The keypad is near the driver window and illuminates when you touch it.



## KEYLESS ENTRY KEYPAD MASTER ACCESS CODE

### What is the Master Access Code

The master access code is a factory-set five-digit entry code. You can operate the keypad with the master access code at any time. The master access code can be displayed in the instrument cluster display and is available from an authorized dealer.

## Displaying the Master Access Code in the Instrument Cluster Display

Read and understand the following before you begin the process.

- You must have two previously programmed intelligent access key inside your vehicle.
- Make sure that your vehicle is off.
- Make sure you do not press the brake pedal during the procedure.
- Make sure that you close all the doors and that they remain closed throughout the procedure.

Perform all steps within 30 seconds of starting the sequence. If you perform any of the steps out of sequence, stop and wait for at least one minute before starting again.

**Note:** Do not place the device on the wireless accessory charging area during the procedure.

1. Access the backup slot. See **Accessing the Passive Key Backup Position** (page 204).
2. Place the first intelligent access key into the backup slot.
3. Press the push button ignition switch once and wait for a few seconds.
4. Press the push button ignition switch again and remove the intelligent access key from the center console.
5. Insert the second programmed intelligent access key into the backup slot in the center console, then press the push button ignition switch.

The master access code appears in the instrument cluster display for a few seconds.

**Note:** The code may not display until after other warning messages display.

# Keyless Entry Keypad (If Equipped)

## KEYLESS ENTRY KEYPAD PERSONAL ACCESS CODES

### Programming a Personal Entry Code

1. Enter the five-digit master code.
2. Press **1-2** on the keypad within five seconds.
3. Enter your personal five-digit code. You must do this within five seconds of completing Step 2.
4. Press **1-2** on the keypad to save personal code 1.

The doors lock then unlock to confirm that programming was successful.

To program additional personal entry codes, repeat Steps 1 through 3, then for Step 4:

- Press **3-4** to save personal code 2.
- Press **5-6** to save personal code 3.
- Press **7-8** to save personal code 4.
- Press **9-0** to save personal code 5.

If your vehicle comes with the operating system, you can also program the system with a personal entry code.

Hints:

- Do not set a code that uses five of the same number.
- Do not use five numbers in sequential order.
- The five-digit master code works even if you have set your own personal code.

### Erasing a Personal Code

1. Enter the five-digit master code.
2. Press and release **1-2** on the keypad within five seconds.
3. Press and hold **1-2** for two seconds. You must do this within five seconds of completing Step 2.

All personal codes erase and only the five-digit master code works.

### Anti-Scan Feature

The keypad goes into an anti-scan mode if you enter the wrong code seven times. This mode turns off the keypad for one minute and the keypad lamp flashes.

The anti-scan feature turns off after:

- One minute of keypad inactivity.
- You press the unlock button on the remote control.
- You switch the ignition on.
- You unlock your vehicle using keyless entry.

## USING THE KEYLESS ENTRY KEYPAD

### Unlocking the Driver Door

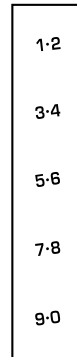

Enter the factory-set five-digit code or your personal code. You must press each number within five seconds of each other.

# Keyless Entry Keypad (If Equipped)

**Note:** All doors unlock if the two-stage unlocking feature is disabled. See **Keyless Entry Settings** (page 81).

## Unlocking All Doors

Enter the factory-set code or your personal code, then press **3-4** within five seconds.

## To Release the Remote Power Release Tailgate

Enter the factory-set code or your personal code, then press **5-6** control within five seconds.

## Locking the Doors

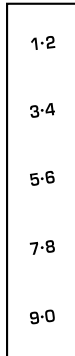

Press and hold **7-8** and **9-0** at the same time with the driver door closed.

**Note:** You do not need to enter the code first.

## KEYLESS ENTRY KEYPAD – TROUBLESHOOTING

### KEYLESS ENTRY KEYPAD – FREQUENTLY ASKED QUESTIONS

#### Why does the keypad not accept the access code?

If you enter the access code too fast on the keypad, the unlock function may not work. Slowly re-enter the access code.

#### Why does the keypad not function?

The keypad goes into an anti-scan mode if you enter a wrong code seven times. The anti-scan mode disables the keypad for one minute and the red light flashes.

## KEYLESS ENTRY KEYPAD VIDEOS

[SecuriCode Keyless Entry Keypad Video Link](#)

## Easy Entry and Exit (If Equipped)

---

### HOW DOES EASY ENTRY AND EXIT WORK

Easy entry and exit moves the driver seat rearward up to 2 in (5 cm) and the steering column up when you switch the ignition off. The driver seat and steering column return to their previous positions when you switch the ignition on.

**Note:** *Depending on your vehicle, the column may move up and in.*

### SWITCHING EASY ENTRY AND EXIT ON AND OFF

1. Press **Settings** on the touchscreen.
2. Press **Vehicle**.
3. Select **Easy Entry/Exit**.

If you press any adjustment or memory button when in easy exit mode, the system cancels the operation.

# Tailgate - Vehicles With: Manual Tailgate

## TAILGATE PRECAUTIONS



**WARNING:** It is extremely dangerous to ride in a cargo area, inside or outside of a vehicle. In a crash, people riding in these areas are more likely to be seriously injured or killed. Do not allow people to ride in any area of your vehicle that is not equipped with seats and seatbelts. Make sure everyone in your vehicle is in a seat and properly using a seatbelt. Failure to follow this warning could result in serious personal injury or death.

## OPENING THE TAILGATE

### OPENING THE TAILGATE FROM OUTSIDE YOUR VEHICLE

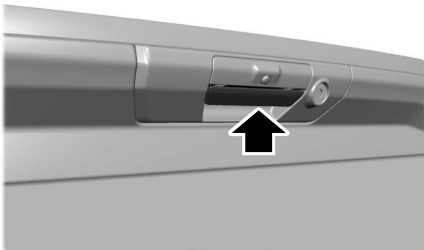

Pull up on the handle to release the tailgate.

**Note:** You may need to unlock the tailgate first.

## REMOVING AND INSTALLING THE TAILGATE



**WARNING:** Always properly secure cargo to prevent shifting cargo or cargo falling from the vehicle. Failure to do so could result in compromised vehicle stability and serious personal injury to vehicle occupants or others.



**WARNING:** The tailgate is heavy. Removal of the tailgate requires two adults. Failure to follow this instruction could result in personal injury or property damage.

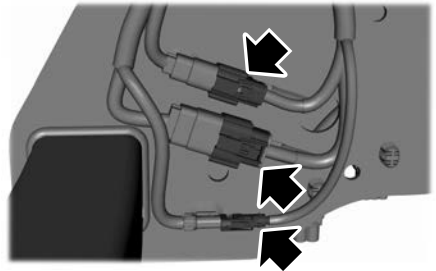

1. Obtain the tailgate removal kit from the glove compartment.
2. Locate and disconnect the frame connections. They are on the left-hand side of the vehicle.

**Note:** Your vehicle may have up to three frame connections.

3. Install the protective caps on the in-line connector portion that remains under the pickup box.

**Note:** If you do not install the caps on the connectors, some features may not operate as intended.

# Tailgate - Vehicles With: Manual Tailgate

- Partially lower the tailgate. Carefully feed the tailgate harness up through the gap between the pickup box and the bumper and place it out of the way under the pickup box.
- Lower the tailgate.

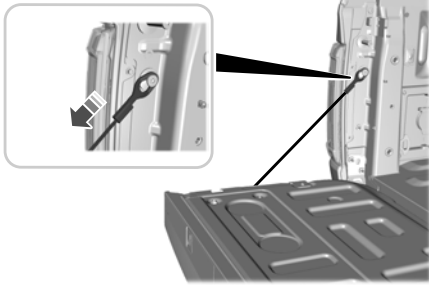

- Use a screwdriver to gently pry the spring clip on each connector past the head of the support screw. Disconnect the cable.
- Disconnect the other cable.
- Lift the tailgate to 45 degrees from the horizontal position.
- Lift the right-hand side off its hinge.
- Lift the tailgate to 80 degrees from the horizontal position.
- Remove the tailgate from the left-hand side hinge by sliding it to the right.
- Install the tailgate in reverse order.

## TAILGATE STEP

### ACCESSING THE TAILGATE STEP

- Lower the tailgate.
- Push the button in the center of the step molding. The step pops out slightly.

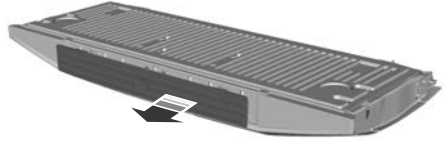
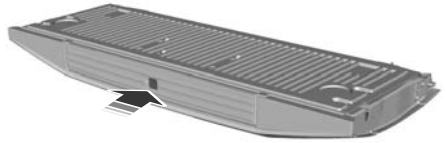

- Pull the step out fully. Lower the step to its lowest position.



- Pull the yellow handle stop backward out of the tailgate until it fully extends.
- To lock the handle in place, rotate the handle up from the horizontal to the vertical position until you hear a click.

**Note:** Do not tow with the step or grab handle.

Replace the slip resistance tape or grab handle molding if it appears as worn or damaged.

To reduce the risk of falling:

- Only operate the step when your vehicle is on a level surface.
- Only operate the step in areas with sufficient lighting.



## Tailgate - Vehicles With: Manual Tailgate

---

- Make sure you use the grab handle when climbing on the step.
- Do not use the step with bare feet.
- Make sure the step is clean before use.
- Keep the step load below the total maximum load of 350 lb (159 kg).

### STOWING THE TAILGATE STEP

1. Press the yellow button on the handle to lower and then press the yellow lever at the bottom of the handle to unlock. Rotate the handle down from the vertical to the horizontal position and push it into the tailgate.
2. Rotate the step up until it is horizontal, then push it back into the tailgate until the step is secure.

**Note:** *Make sure to close and fully latch the step before moving your vehicle. Do not drive with the step or grab handle open.*

**Note:** *The power tailgate cannot close if the step is open. A warning message appears and a tone sounds. After stowing the step the power close function is restored.*

### TAILGATE VIDEOS

[Integrated Tailgate Step Video Link](#)

[Remote tailgate release Video Link](#)

# Tailgate - Vehicles With: Power Tailgate

## TAILGATE PRECAUTIONS



**WARNING:** It is extremely dangerous to ride in a cargo area, inside or outside of a vehicle. In a crash, people riding in these areas are more likely to be seriously injured or killed. Do not allow people to ride in any area of your vehicle that is not equipped with seats and seatbelts. Make sure everyone in your vehicle is in a seat and properly using a seatbelt. Failure to follow this warning could result in serious personal injury or death.

## OPENING THE TAILGATE

### OPENING THE TAILGATE FROM INSIDE YOUR VEHICLE

To operate the power tailgate, the vehicle must be in park (P) or reverse (R) and the vehicle speed is less than 2.5 mph (4 km/h).



Press the button on the instrument panel.

**Note:** A tone sounds while the tailgate opens.

**Note:** The tailgate stops and reverses if it detects an obstruction when opening.

**Note:** An alert sounds if the electronic tailgate is in manual mode.

**Note:** A pop-up message appears on the touchscreen if the tailgate is in manual mode asking if you want to change back to power mode.

### OPENING THE TAILGATE FROM OUTSIDE YOUR VEHICLE

1. Unlock the vehicle with the remote control, power door unlock control or your phone as a key device.

**Note:** If an authorized device is within 3 ft (1 m) of the tailgate, the tailgate unlocks when you press the tailgate release button.

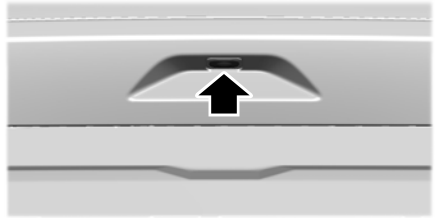

2. Press the button on the middle of the tailgate.

### OPENING THE TAILGATE USING THE REMOTE CONTROL



Press the remote control button twice within three seconds.

## CLOSING THE TAILGATE

### CLOSING THE TAILGATE FROM INSIDE YOUR VEHICLE



Press the button on the instrument panel.

**Note:** The tailgate does not close if the vehicle speed is at or above 2.5 mph (4 km/h).

**Note:** The tailgate does not close with the tailgate step ajar. A Step Ajar message displays on the instrument panel.

# Tailgate - Vehicles With: Power Tailgate

## CLOSING THE TAILGATE FROM OUTSIDE YOUR VEHICLE

You can close the power tailgate by:

- Pressing the tailgate button on your remote control twice within three seconds.
- Pressing the button on the tailgate once.

**Note:** A tone sounds while the tailgate closes.

**Note:** The tailgate stops and reverses if it detects an obstruction when closing.

## Lift-to-Close

To close the tailgate automatically using lift-to-close, lift the tailgate approximately 4 in (10 cm) and hold it for a few seconds.

**Note:** If the tailgate position is more than halfway open, it may not close automatically.

## Manual Close

You can close the tailgate manually when you lift the tailgate in a continuous motion.

If you stop the tailgate motion, the lift-to-close feature engages and power closes the tailgate.

## Putting the Tailgate in Manual Mode

You can put the tailgate in manual mode through the vehicle settings in your touchscreen.

**Note:** In manual mode, the tailgate only opens by the tailgate release button on the tailgate and messaging is reduced.

**Note:** A pop-up message appears on the touchscreen if you press the tailgate button on the instrument panel when the tailgate is in Manual mode.

## CLOSING THE TAILGATE USING THE REMOTE CONTROL



Press the remote control button twice within three seconds.

## REMOVING AND INSTALLING THE TAILGATE

**WARNING:** Always properly secure cargo to prevent shifting cargo or cargo falling from the vehicle. Failure to do so could result in compromised vehicle stability and serious personal injury to vehicle occupants or others.

**WARNING:** The tailgate is heavy. Removal of the tailgate requires two adults. Failure to follow this instruction could result in personal injury or property damage.

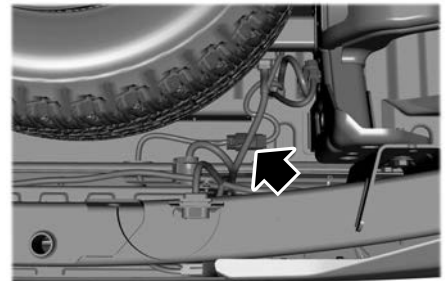

1. Put the tailgate into manual mode by accessing the vehicle settings using the touchscreen.
2. Open the tailgate.
3. Disconnect the power door locks in-line connector located under the pickup box on the right-hand side of the vehicle near the spare tire.

## Tailgate - Vehicles With: Power Tailgate

4. Install the protective cap on the in-line connector portion that remains under the pickup box.

**Note:** The protective cap is in the glove compartment.

5. Partially raise the tailgate. Carefully feed the tailgate harness up through the gap between the pickup box and the bumper and place it out of the way under the pickup box.
6. Fully lower the tailgate.

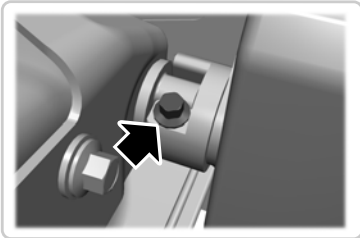
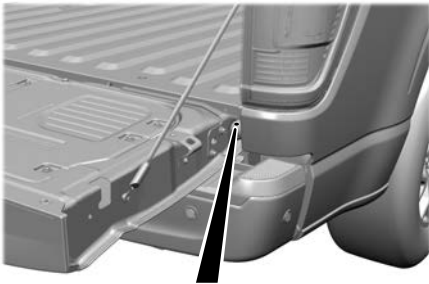

7. Remove the retaining screw.

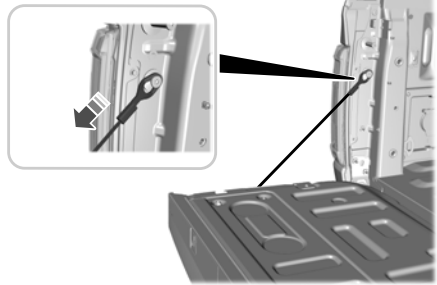

8. Use a screwdriver to gently pry the spring clip on each connector past the head of the support screw. Disconnect the cable.
9. Disconnect the other cable.
10. Lift the tailgate to 45 degrees from the horizontal position.
11. Lift the right-hand side off its hinge.
12. Lift the tailgate to 80 degrees from the horizontal position.
13. Remove the tailgate from the left-hand side hinge by sliding it to the right.
14. Install the tailgate in reverse order.

**Note:** After reinstalling the tailgate it is important to reinstall the retaining screw to the recommended torque, 11.06 lb.ft (15 Nm). Failure to install the retaining screw can cause the tailgate to detach.

### TAILGATE STEP

#### ACCESSING THE TAILGATE STEP

1. Lower the tailgate.
2. Push the button in the center of the step molding. The step pops out slightly.

## Tailgate - Vehicles With: Power Tailgate

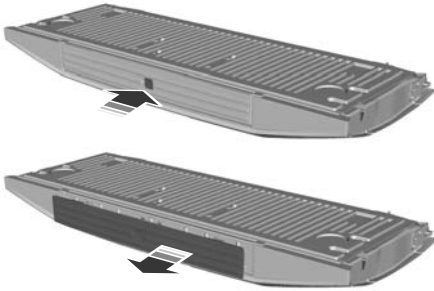

3. Pull the step out fully. Lower the step to its lowest position.



4. Pull the yellow handle stop backward out of the tailgate until it fully extends.
5. To lock the handle in place, rotate the handle up from the horizontal to the vertical position until you hear a click.

**Note:** Do not tow with the step or grab handle.

Replace the slip resistance tape or grab handle molding if it appears as worn or damaged.

To reduce the risk of falling:

- Only operate the step when your vehicle is on a level surface.
- Only operate the step in areas with sufficient lighting.
- Make sure you use the grab handle when climbing on the step.
- Do not use the step with bare feet.
- Make sure the step is clean before use.
- Keep the step load below the total maximum load of 350 lb (159 kg).

### STOWING THE TAILGATE STEP

1. Press the yellow button on the handle to lower and then press the yellow lever at the bottom of the handle to unlock. Rotate the handle down from the vertical to the horizontal position and push it into the tailgate.
2. Rotate the step up until it is horizontal, then push it back into the tailgate until the step is secure.

**Note:** Make sure to close and fully latch the step before moving your vehicle. Do not drive with the step or grab handle open.

**Note:** The power tailgate cannot close if the step is open. A warning message appears and a tone sounds. After stowing the step the power close function is restored.

# Tailgate - Vehicles With: Power Tailgate

---

## TAILGATE – TROUBLESHOOTING

### TAILGATE – INFORMATION MESSAGES

<b>Message</b>	<b>Action</b>
Tailgate Ajar	The tailgate is not completely closed.
Shift to Park to operate tailgate	The vehicle must be in park (P) to operate the remote release tailgate.

# Tailgate - Vehicles With: Power Tailgate

---

## **TAILGATE – FREQUENTLY ASKED QUESTIONS**

### **Why won't my power tailgate open?**

- Make sure the tailgate is in power mode.
- Make sure the vehicle is in park (P) or reverse (R) and the vehicle speed is less than 4 km/h.
- The tailgate will not close if your vehicle speed is at or above 2.5 mph (4 km/h).
- Make sure nothing is obstructing the tailgate path and or causing resistance such as tonneau cover or other aftermarket accessory, freezing conditions or being parked downhill.
- If you have continued issues, the battery voltage may be low or other system issues. See an authorized dealer.

### **Why won't my power tailgate close?**

- Make sure the tailgate is in power mode.
- Make sure the ignition is on and the vehicle is in park (P) or reverse (R) and the vehicle speed is less than 4 km/h.
- The tailgate will not close if your vehicle speed is at or above 2.5 mph (4 km/h).
- Make sure nothing is obstructing the tailgate path and or causing resistance such as tonneau cover or other aftermarket accessory, freezing conditions or being parked downhill.
- If you have continued issues, the battery voltage may be low or other system issues. See an authorized dealer.

## **TAILGATE VIDEOS**

[\*Integrated Tailgate Step Video Link\*](#)

[\*Remote tailgate release Video Link\*](#)

# Tailgate - Vehicles With: Remote Power Tailgate Release

## TAILGATE PRECAUTIONS



**WARNING:** It is extremely dangerous to ride in a cargo area, inside or outside of a vehicle. In a crash, people riding in these areas are more likely to be seriously injured or killed. Do not allow people to ride in any area of your vehicle that is not equipped with seats and seatbelts. Make sure everyone in your vehicle is in a seat and properly using a seatbelt. Failure to follow this warning could result in serious personal injury or death.



2. Press the button in the top of the tailgate handle twice within three seconds.

## OPENING THE TAILGATE

### OPENING THE TAILGATE FROM INSIDE YOUR VEHICLE

The vehicle must be in park (P) to operate the tailgate.



Press the button on the instrument panel twice within three seconds.

### OPENING THE TAILGATE FROM OUTSIDE YOUR VEHICLE

1. Unlock the vehicle with the remote control or power door unlock control.

**Note:** If an intelligent access transmitter is within 3 ft (1 m) of the tailgate, the tailgate unlocks when you press the tailgate release button.

### OPENING THE TAILGATE USING THE REMOTE CONTROL



Press the remote control button twice within three seconds.

### REMOVING AND INSTALLING THE TAILGATE



**WARNING:** Always properly secure cargo to prevent shifting cargo or cargo falling from the vehicle. Failure to do so could result in compromised vehicle stability and serious personal injury to vehicle occupants or others.



**WARNING:** The tailgate is heavy. Removal of the tailgate requires two adults. Failure to follow this instruction could result in personal injury or property damage.



# Tailgate - Vehicles With: Remote Power Tailgate Release

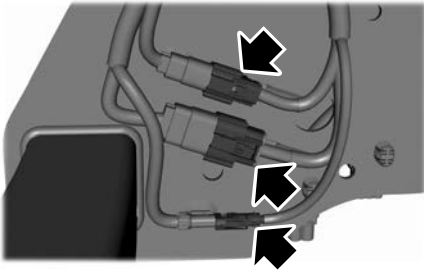

1. Obtain the tailgate removal kit from the glove compartment.
2. Locate and disconnect the frame connections. They are on the left-hand side of the vehicle.

**Note:** Your vehicle may have up to three frame connections.

3. Install the protective caps on the in-line connector portion that remains under the pickup box.

**Note:** If you do not install the caps on the connectors, some features may not operate as intended.

4. Partially lower the tailgate. Carefully feed the tailgate harness up through the gap between the pickup box and the bumper and place it out of the way under the pickup box.
5. Lower the tailgate.

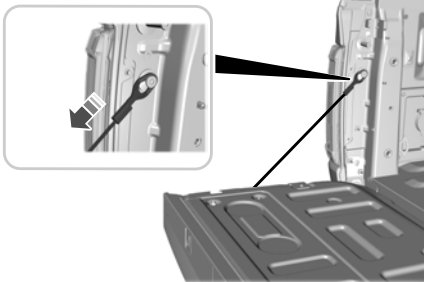

6. Use a screwdriver to gently pry the spring clip on each connector past the head of the support screw. Disconnect the cable.
7. Disconnect the other cable.
8. Lift the tailgate to 45 degrees from the horizontal position.
9. Lift the right-hand side off its hinge.
10. Lift the tailgate to 80 degrees from the horizontal position.
11. Remove the tailgate from the left-hand side hinge by sliding it to the right.
12. Install the tailgate in reverse order.

## TAILGATE STEP

### ACCESSING THE TAILGATE STEP

1. Lower the tailgate.
2. Push the button in the center of the step molding. The step pops out slightly.

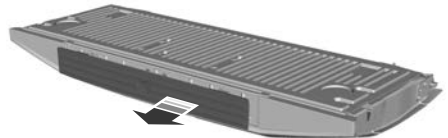

3. Pull the step out fully. Lower the step to its lowest position.

# Tailgate - Vehicles With: Remote Power Tailgate Release



4. Pull the yellow handle stop backward out of the tailgate until it fully extends.
5. To lock the handle in place, rotate the handle up from the horizontal to the vertical position until you hear a click.

**Note:** Do not tow with the step or grab handle.

Replace the slip resistance tape or grab handle molding if it appears as worn or damaged.

To reduce the risk of falling:

- Only operate the step when your vehicle is on a level surface.
- Only operate the step in areas with sufficient lighting.

- Make sure you use the grab handle when climbing on the step.
- Do not use the step with bare feet.
- Make sure the step is clean before use.
- Keep the step load below the total maximum load of 350 lb (159 kg).

## STOWING THE TAILGATE STEP

1. Press the yellow button on the handle to lower and then press the yellow lever at the bottom of the handle to unlock. Rotate the handle down from the vertical to the horizontal position and push it into the tailgate.
2. Rotate the step up until it is horizontal, then push it back into the tailgate until the step is secure.

**Note:** Make sure to close and fully latch the step before moving your vehicle. Do not drive with the step or grab handle open.

**Note:** The power tailgate cannot close if the step is open. A warning message appears and a tone sounds. After stowing the step the power close function is restored.

## TAILGATE – TROUBLESHOOTING

### TAILGATE – INFORMATION MESSAGES

Message	Action
Tailgate Ajar	The tailgate is not completely closed.
Shift to Park to operate tailgate	The vehicle must be in park (P) to operate the remote release tailgate.

# Tailgate - Vehicles With: Remote Power Tailgate Release

---

## TAILGATE – FREQUENTLY ASKED QUESTIONS

### Why won't my tailgate open?

- Make sure the transmission is in park (P), ensure nothing is obstructing the tailgate path and or causing resistance (tonneau cover or other aftermarket accessories, freezing conditions or being parked downhill). If you have continued issues, the battery voltage may be low or other system issues. See an authorized dealer.

## TAILGATE VIDEOS

[\*Integrated Tailgate Step Video Link\*](#)

[\*Remote tailgate release Video Link\*](#)

# Security

---

## PASSIVE ANTI-THEFT SYSTEM

### WHAT IS THE PASSIVE ANTI-THEFT SYSTEM

The passive anti-theft system prevents someone from starting your vehicle with an incorrectly coded key.

**Note:** *Do not leave a duplicate coded key in your vehicle. Always take the keys and lock all the doors when leaving your vehicle.*

### HOW DOES THE PASSIVE ANTI-THEFT SYSTEM WORK

The passive anti-theft system arms when you switch your vehicle off.

It disarms when you switch your vehicle on with a correctly coded key.

**Note:** *The system is not compatible with non-Ford aftermarket remote start systems.*

**Note:** *Do not leave a duplicate coded key in your vehicle. Always take the keys and lock all doors when leaving your vehicle.*

## ANTI-THEFT ALARM SYSTEM

### WHAT IS THE ANTI-THEFT ALARM SYSTEM

The anti-theft alarm system warns you of an unauthorized entry to your vehicle.

## HOW DOES THE ANTI-THEFT ALARM SYSTEM WORK

When armed, the anti-theft alarm is triggered in any of the following ways:

- If someone opens a door, the tailgate or the hood without a correctly coded key or remote control.
- If you turn the power on without a correctly coded key.
- If the interior sensors detect movement inside your vehicle.
- If the inclination sensors detect an attempt to raise your vehicle.
- If someone disconnects the vehicle battery or the battery backup alarm.
- If someone disconnects the trailer. See **Connecting a Trailer** (page 356).

Any further attempts to carry out one of the above, sounds the alarm again.

If the anti-theft alarm is triggered, the alarm horn sounds for 30 seconds and the turn signals flash for five minutes.

## WHAT IS THE PERIMETER ALARM

The perimeter alarm is designed to detect unauthorized access to your vehicle.

## WHAT ARE THE INTERIOR SENSORS (If Equipped)

The interior sensors are designed to detect any movement inside your vehicle.

The interior sensors are in the overhead console.

**Note:** *Do not cover the interior sensors.*

# Security

---

## WHAT ARE THE INCLINATION SENSORS (If Equipped)

The inclination sensor is designed to detect an attempt to raise your vehicle, for example to remove a wheel or to tow it away.

## WHAT IS THE BATTERY BACKUP ALARM (If Equipped)

The battery backup alarm is an additional alarm sounder that has its own battery. It can detect if your vehicle's 12V battery is disconnected to overcome the alarm system.

## ARMING THE ANTI-THEFT ALARM SYSTEM

The alarm is ready to arm when you switch your vehicle off.

Lock your vehicle with your remote control to arm the alarm.

## DISARMING THE ANTI-THEFT ALARM SYSTEM

Disarm the alarm by performing any of the following actions:

- Unlock the doors or luggage compartment with the remote control.
- Switch your vehicle on or start your vehicle.

## ANTI-THEFT ALARM SYSTEM SETTINGS (IF EQUIPPED)

## WHAT ARE THE ALARM SECURITY LEVELS

You can select two levels of alarm security, motion sensors on and motion sensors off.

## Motion Sensors On

Motion sensors on is the standard setting.

In motion sensors on, all equipped sensors are on when you arm the alarm.

**Note:** *Do not arm the alarm with motion sensors on if passengers, animals or other moving objects are inside your vehicle.*

## Motion Sensors Off

In motion sensors off, the interior sensor and the inclination sensor are off when you arm the alarm.

All the other equipped sensors activate when you arm the alarm in this mode.

## SETTING THE ALARM SECURITY LEVEL

1. Press **Settings** on the touchscreen.
2. Press **Vehicle**.
3. Press **Alarm System**.
4. Press **Motion Sensors**.
5. Press a setting.

## WHAT IS ASK ON EXIT

You can choose which level of security you require after you switch your vehicle off.

**Note:** *If you do not choose a setting, the system defaults to all sensors.*

## SWITCHING ASK ON EXIT ON AND OFF

1. Press **Settings** on the touchscreen.
2. Press **Vehicle**.
3. Press **Alarm System**.
4. Switch **Ask on Exit** on or off.

# Security

---

## SECURITY – TROUBLESHOOTING

### SECURITY – INFORMATION MESSAGES

<b>Message</b>	<b>Details</b>
No Key Detected	The system has not detected a correctly coded key.
Starting System Fault	The system has malfunctioned. Have your vehicle checked as soon as possible.
Vehicle Alarm To Stop Alarm, Start Vehicle.	Displays when the alarm has been triggered due to unauthorized entry.
Alarm	

# Security

---

## **SECURITY – FREQUENTLY ASKED QUESTIONS**

### **What should I do if there is a potential alarm problem with my vehicle?**

- Take all remote controls to an authorized dealer if there is a potential alarm problem with your vehicle.

### **What should I do if my vehicle is unable to start with a correctly coded key?**

- Have your vehicle checked as soon as possible.

# Power Running Boards (If Equipped)

## POWER RUNNING BOARD PRECAUTIONS



**WARNING:** In extreme climates, excessive ice buildup may occur, causing the running boards not to deploy. Make sure that the running boards have deployed, and have finished moving before attempting to step on them. The running boards will resume normal function once the blockage is cleared.



**WARNING:** Switch off the running boards before jacking or placing any object under your vehicle. Never place your hand between the extended running board and your vehicle. A moving running board may cause injury.

Do not use the running boards, front and rear hinge assemblies, running board motors, or the running board underbody mounts to lift your vehicle when jacking. Use proper jacking points.

The running boards could move slower in cold temperatures.

## POWER RUNNING BOARD SETTINGS

1. Press **Features** on the touchscreen.
2. Press **Power Running Board**.
3. Press **SETTINGS**.

### Power Boards Modes

**Note:** When the vehicle speed is more than 3 mph (5 km/h), the option to select the modes disables, to avoid unintended operation.

**Note:** The power running boards reverse direction and move to the end of travel if they encounter an object when moving. Keep the power running boards and brackets clean for optimum performance.

### Off

The power running boards remain stowed, regardless of door position.

### Auto

The power running boards deploy when you approach your vehicle with a remote control, unlock the door or open the door.

The power running boards stow:

- After a few seconds when you close the doors.
- Instantly after you close and lock the doors.
- If you unlock the door but do not open it, after the timeout.
- If you have switched approach detection on and do not open a door before the auto timer setting expires.
- When the vehicle speed is more than 3 mph (5 km/h).

**Note:** When you select this mode, an option displays that allows you to select how long the running boards stay deployed without opening the door.

### Out

The power running boards remain deployed, regardless of door position. The power running boards stow when the vehicle speed is more than 5 km/h, and the mode changes to auto. You need to select Out mode again if you want the power running boards to stay deployed at the end of each trip.



# Power Running Boards (If Equipped)

---

## Approach detection

When you switch approach detection on with auto switched on, the running boards deploy when you approach your vehicle with a remote control.

## POWER RUNNING BOARDS – TROUBLESHOOTING

### POWER RUNNING BOARDS – FREQUENTLY ASKED QUESTIONS

#### **Why is there unwanted noise coming from my power running boards?**

- The power running board mechanism could trap debris such as mud, dirt, snow, ice and salt. If this happens, set the running boards to the deployed position. Wash the system, in particular the front and rear hinge arms, with a high-pressure car wash wand.

# Steering Wheel

## ADJUSTING THE STEERING WHEEL - VEHICLES WITH: MANUAL ADJUSTABLE STEERING COLUMN



**WARNING:** Do not adjust the steering wheel when your vehicle is moving.

**Note:** Make sure that you are sitting in the correct position. See **Sitting in the Correct Position** (page 157).

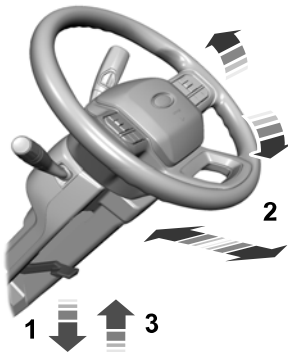

1. Unlock the steering column by pulling the lever down.
2. Adjust the steering wheel to the preferred position. The wheel can move up or down, in or out.
3. Lock the steering column into position by pushing the lever up into the locked position.

## ADJUSTING THE STEERING WHEEL - VEHICLES WITH: POWER ADJUSTABLE STEERING COLUMN



**WARNING:** Do not adjust the steering wheel when your vehicle is moving.

**Note:** Make sure that you are sitting in the correct position. See **Sitting in the Correct Position** (page 157).

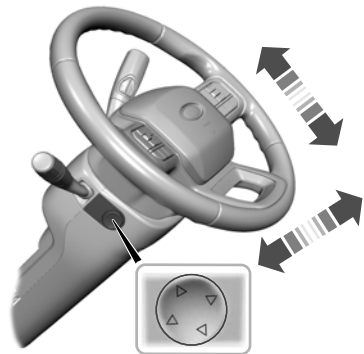

Use the control on the side of the steering column to adjust the position.

To adjust:

- Tilt: Press the top or bottom of the control.
- Telescope: Press the front or rear of the control.

# Steering Wheel

## End of Travel Position

The steering column sets a stopping position just short of the end of the column position to prevent damage to the steering column. A new stopping position sets if the steering column encounters an object when tilting or telescoping.

To reset the steering column to its normal stopping position:

1. Confirm there is nothing obstructing the motion of the steering column.
2. Press and hold the steering column control until the steering column stops moving.
3. Press the steering column control again.

**Note:** *The steering column may begin to move again.*

4. When the steering column stops, continue holding the control for a few seconds.
5. Repeat for each direction as necessary.

A new stopping position sets. The next time you tilt or telescope the steering column, it stops just short of the end of the column position.

## Memory Feature (If Equipped)

You can save and recall the steering column position with the memory function. See **Memory Function** (page 173).

Pressing the adjustment control during a memory recall cancels the operation.

## Easy Entry and Exit Feature

The column moves up when you switch the ignition off. Switch the ignition on to return the system to its previous settings. You can switch this feature on or off in the instrument cluster display.

**Note:** *If you press any adjustment or memory button when in easy exit mode, the system cancels the operation.*

**Note:** *Depending on your vehicle, the column may move up and in.*

## RESETTING THE STOPPING POSITION - VEHICLES WITH: POWER ADJUSTABLE STEERING COLUMN

**Note:** *The steering wheel stops when it detects an obstruction. This sets a new stopping position.*

To reset the steering column to its normal stopping position:

1. Confirm there is nothing obstructing the motion of the steering column.
2. Press and hold the steering column control until the steering column stops moving.
3. Press the steering column control again.

**Note:** *The steering column may start to move again.*

4. When the steering column stops, continue holding the control for a few seconds.
5. Repeat for each direction, as necessary.

## HORN



Press on the center of the steering wheel near the horn icon to activate the horn.

# Steering Wheel

---

## SWITCHING THE HEATED STEERING WHEEL ON AND OFF - VEHICLES WITH: HEATED STEERING WHEEL



To activate the heated steering wheel, press the button on the climate control unit. An indicator illuminates when the heated steering wheel is on. To turn it off, press the heated steering wheel button again.

**Note:** *The engine must be running to use the heated steering wheel.*

**Note:** *A sensor regulates the temperature of the steering wheel.*

**Note:** *The heated steering wheel may remain on after remote starting your vehicle, depending on the remote start settings. It may also turn on when you start your vehicle if it was on the last time the engine was switched off.*

**Note:** *In warm temperatures, the steering wheel quickly reaches its maximum temperature and the system reduces the current to the heating element. This could cause you to think that the system has stopped working but it has not. This is normal.*

## Adjustable Pedals (If Equipped)

### ADJUSTING THE PEDALS



**WARNING:** Do not use the pedal adjustment controls when the vehicle is moving. Failure to follow this instruction could result in personal injury or death.

Your control is on the left-hand side of the steering column or on the instrument panel.

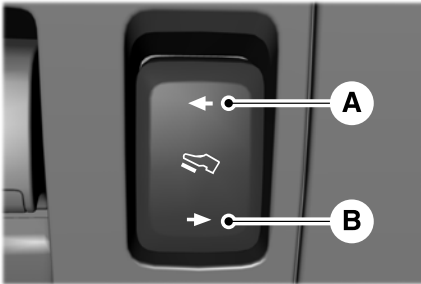

- A. Farther away from you.
- B. Closer to you.

You can save and recall the pedal positions with the memory feature. See **Memory Function** (page 173).

# Wipers and Washers

## WIPERS

### WIPER PRECAUTIONS

Do not operate the wipers on a dry windshield. This could scratch the glass or damage the wiper blades. Use the windshield washers before wiping a dry windshield.

Fully defrost the windshield before you switch the windshield wipers on.

Switch the windshield wipers off before entering a car wash.

### SWITCHING WINDSHIELD WIPERS ON AND OFF

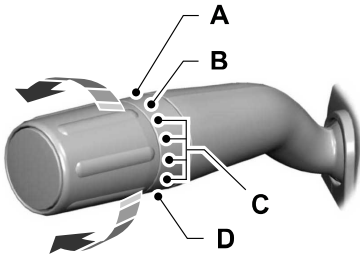

- A High-speed wipe.
- B Low-speed wipe.
- C Intermittent wipe.
- D Off.



Use the rotary control.

## AUTOWIPERS (IF EQUIPPED)

### WHAT ARE AUTOWIPERS

Autowipers turns on and controls the speed and frequency of the windshield wipers.

### AUTOWIPERS SETTINGS

1. Access the vehicle drawer on the touchscreen.
2. Press **SETTINGS**.
3. Press **Vehicle**.
4. Press **Wipers**.
5. Switch **Rain Sensing** on or off.

**Note:** When you switch the feature off, the wipers do not operate based on the rain sensor. When you switch on the windshield wipers to the intermittent wipe position with the feature off, the wipers use the wipe speed set by the rotary control.

### ADJUSTING THE SENSITIVITY OF THE RAIN SENSOR

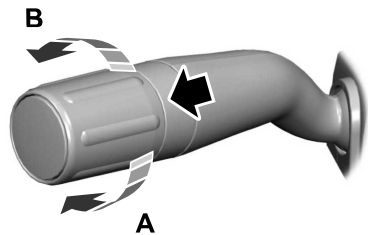

- A Low sensitivity.
- B High sensitivity.

# Wipers and Washers

Use the rotary control to set the rain sensor sensitivity.

**Note:** Use intermittent wipe positions to adjust the rain sensor sensitivity.

When you select low sensitivity, the wipers operate when the sensor detects a large amount of water on the windshield.

When you select high sensitivity, the wipers operate when the sensor detects a small amount of water on the windshield.



## CHECKING THE WIPER BLADES



Run the tip of your fingers over the edge of the blade to check for roughness.

## REPLACING THE FRONT WIPER BLADES

Make sure your vehicle is off before beginning this procedure.

1. Pull the wiper blade and arm away from the glass.

**Note:** Do not hold the wiper blade to lift the wiper arm.

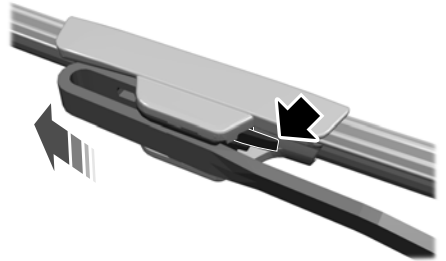

2. Press the wiper blade locking clip.
3. Remove the wiper blade.

**Note:** Make sure that the wiper arm does not spring back against the glass when the wiper blade is not attached.

4. To install, reverse the removal procedure.

**Note:** Make sure that the wiper blade locks into place.

# Wipers and Washers

## WASHERS

### WASHER PRECAUTIONS



**WARNING:** If you operate your vehicle in temperatures below 41°F (5°C), use washer fluid with antifreeze protection. Failure to use washer fluid with antifreeze protection in cold weather could result in impaired windshield vision and increase the risk of injury or accident.

Do not operate the washers when the washer reservoir is empty. This could cause the washer pump to overheat.

Keep the outside of the windshield clean. The rain sensor is very sensitive and the wipers may operate if dirt, mist or insects hit the windshield.

### USING THE WINDSHIELD WASHER

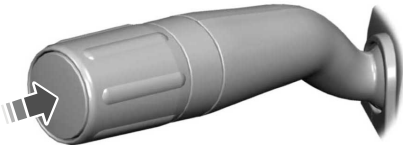

Press and hold the button at the end of the lever to operate the windshield washer.

**Note:** A courtesy wipe occurs a short time after the wipers stop to clear any remaining washer fluid when switched on. See **Switching the Courtesy Wipe On and Off** (page 112).

### SWITCHING THE COURTESY WIPE ON AND OFF

1. Press **Settings** on the touchscreen.
2. Press **Vehicle Settings**.
3. Press **Wipers**.
4. Switch **Courtesy Wipe** on or off.

**Note:** When you switch the feature on, the wipers make an additional single wipe at the end of the washer request. When you switch it off, the wipers finish the current washer request.

### ADDING WASHER FLUID

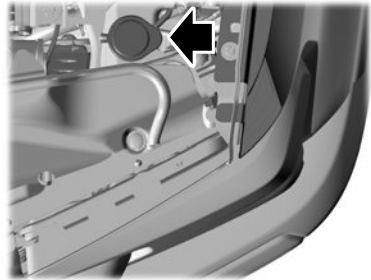

### WASHER FLUID SPECIFICATION

See **Washer Fluid Specification** (page 536).

### WIPERS AND WASHERS VIDEOS

[Improving Your Windshield Wiper Performance Video Link](#)

[Courtesy Wipe Video Link](#)



# Wipers and Washers

---

## WIPERS AND WASHERS – TROUBLESHOOTING

### WIPERS AND WASHERS – WARNING LAMPS



Illuminates when the windshield washer fluid is low.

### WIPERS AND WASHERS – FREQUENTLY ASKED QUESTIONS

#### Why are there streaks and smears on the windshield?

- The wiper blades could be dirty, worn or damaged. Check the wiper blades. See **Checking the Wiper Blades** (page 111). If the wiper blades are dirty, clean them with washer fluid or water applied with a soft sponge or cloth. If the wiper blades are worn or damaged, install new ones. See **Replacing the Front Wiper Blades** (page 111).

# Exterior Lighting

## EXTERIOR LIGHTING CONTROL

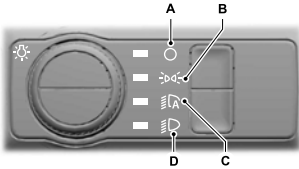

- A Lamps off.
- B Parking lamps on.
- C Autolamps on.
- D Headlamps on.

Rotate the control to make a selection.

**Note:** The lighting control defaults to autolamps every time you switch your vehicle on.

## HEADLAMPS

### USING THE HIGH BEAM HEADLAMPS

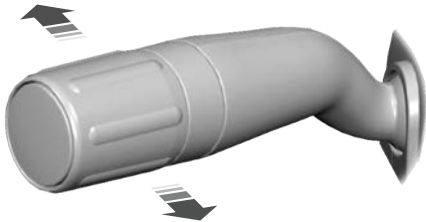

Push the lever away from you to switch the high beam on.

Push the lever forward again or pull the lever toward you to switch the high beams off.

Slightly pull the lever toward you and release it to flash the headlamps.

**Note:** Continuous activation only with headlamps on.

### ADJUSTING THE LEVEL OF THE HEADLAMPS

Your vehicle has a dynamic leveling system. The headlamps do not require additional aim adjustment.

## HEADLAMP INDICATORS

### Lamps On



Illuminates when you switch the low beam headlamps or the parking lamps on.

### Headlamp High Beam



Illuminates when you switch the high beam headlamps on.

## HEADLAMPS – TROUBLESHOOTING

### HEADLAMPS – FREQUENTLY ASKED QUESTIONS

#### Why is there condensation in the headlamps?

- Headlamps have vents to accommodate normal changes in air pressure. Condensation can be a natural by-product of this design. When moist air enters the lamp assembly through the vents, there is a possibility that condensation can occur

# Exterior Lighting

when the temperature is cold. When normal condensation occurs, a fine mist can form on the interior of the lens. The fine mist eventually clears and exits through the vents during normal operation.

## How much condensation is acceptable?

- The presence of a fine mist, for example no streaks, drip marks or large droplets. A fine mist covers less than 50% of the lens.

## How long does it take for the acceptable condensation to clear?

- Clearing time can take as long as 48 hours under dry weather conditions.

## How much condensation is unacceptable?

- A water puddle inside the lamp. Streaks, drip marks or large droplets present on the interior of the lens.

## What should I do if unacceptable condensation is present?

- Have your vehicle checked as soon as possible.

## Why do my headlamps turn off when I have them switched on when I switch my vehicle off?

- The battery saver turns the headlamps off after a short period of time after you switch your vehicle off.

## AUTOLAMPS

### WHAT ARE AUTOLAMPS

 **WARNING:** The system does not relieve you of your responsibility to drive with due care and attention. You may need to override the system if it does not turn the headlamps on in low visibility conditions, for example daytime fog.

Autolamps turn the headlamps on in low light situations or when the windshield wipers operate.

### AUTOLAMP SETTINGS

1. Press **Settings** on the touchscreen.
2. Press **Vehicle Settings**.
3. Press **Lighting**.
4. Press **Autolamp Delay**.
5. Press a setting.

## EXTERIOR LAMPS

### USING THE TURN SIGNAL LAMPS

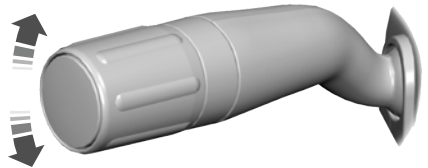

Push the lever up or down to switch the turn signal lamps on.

# Exterior Lighting

Set the lever to the middle position to switch the turn signal lamps off.

**Note:** Tap the lever up or down to make the turn signal lamps flash three times.

## Turn Signal Lamp Indicator



It flashes when you switch the turn signal lamps on.

**Note:** An increase in the rate of flashing warns of a failed turn signal lamp.

## HOW DO CORNERING LAMPS WORK

The cornering lamps illuminate the inside of a corner when you are turning the steering wheel or when you switch the turn signal lamps on. They turn on when the vehicle speed is below 25 mph (40 km/h).

**Note:** Only the cornering lamp on the side your vehicle is turning illuminates.

**Note:** Cornering lamps do not operate if you switch the front fog lamps on.

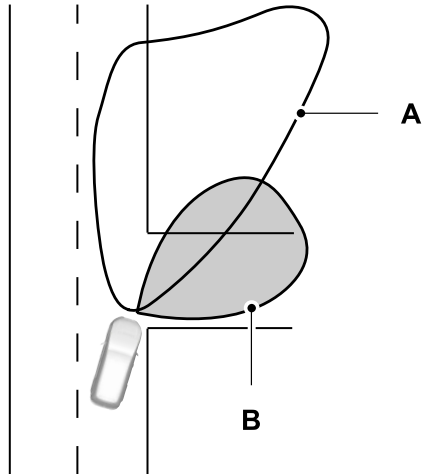

A Headlamp beam.

B Cornering lamp beam.

## SWITCHING THE DAYTIME RUNNING LAMPS ON AND OFF - VEHICLES WITH CONFIGURABLE DAYTIME RUNNING LAMPS



**WARNING:** The daytime running lamps system does not activate the rear lamps and may not provide adequate lighting during low visibility driving conditions. Make sure you switch the headlamps on, as appropriate, during all low visibility conditions. Failure to do so may result in a crash.

1. Press **Settings** on the touchscreen.
2. Press **Vehicle Settings**.
3. Press **Lighting**.

# Exterior Lighting

4. Switch **Daytime Running Lights** on or off.

The daytime running lamps turn on when all of the following occur:

- You switch the system on.
- You switch your vehicle on.
- The transmission is not in park (P) for vehicles with automatic transmissions or you release the parking brake for vehicles with manual transmissions.
- The lighting control is in the autolamps position.
- The headlamps are off.

**Note:** Other lighting control positions do not turn on the daytime running lamps.

## SWITCHING THE DAYTIME RUNNING LAMPS ON AND OFF - VEHICLES WITH: DAYTIME RUNNING LAMPS (DRL)



**WARNING:** The daytime running lamps system does not activate the rear lamps and may not provide adequate lighting during low visibility driving conditions. Make sure you switch the headlamps on, as appropriate, during all low visibility conditions. Failure to do so may result in a crash.

Daytime running lamps are always on unless you switch on the headlamps or your vehicle is in park (P).

## USING THE FRONT FOG LAMPS (If Equipped)

To switch the lamps on or off:

1. Set the lighting control to the parking lamps, headlamps or autolamps position.

**Note:** When the lighting control is in the autolamps position, you cannot switch the fog lamps on unless the low beam headlamps are on.

2.



Press the button on the lighting control to switch the front fog lamps on or off.

**Note:** Only switch the front fog lamps on during reduced visibility.

**Note:** The brightness of the daytime running lamps may decrease when the front fog lamps are switched on.

**Note:** The front fog lamps lights switch off automatically when high beams are activated.

## Front Fog Lamps Indicator



It illuminates when you switch the front fog lamps on.

## SWITCHING THE CARGO LAMPS ON (If Equipped)



Press the button in the lighting control or in the rear cargo box.

## SWITCHING THE SPOT LAMPS ON AND OFF (If Equipped)

The spot lamp buttons are near the lighting control.



Press the button to switch on the left-hand spot lamp.



Press the button to switch on the right-hand spot lamp.

Move the position of the exterior mirrors to adjust the aim.

# Exterior Lighting

**Note:** Make sure you switch your vehicle on, with the vehicle in accessory mode or running.

**Note:** The spot lamps turn off after 6 mph (10 km/h).

**Note:** The spot lamps illuminate the area in front of and to the side of your vehicle.

## SWITCHING WELCOME LIGHTING ON AND OFF

The system turns on the exterior lamps when you approach your vehicle with an authenticated device, unlock your vehicle or interact with any of the doors. If you open or close any door, the lamps stay on for a short period of time to provide courtesy lighting.

**Note:** Welcome lighting still displays when you use your remote control to unlock your vehicle or interact with any of the doors.

To switch the system on or off:

1. Press **Settings** on the touchscreen.
2. Press **Vehicle**.
3. Press **Lighting**.
4. Switch **Welcome Lighting** on or off.

**Note:** Depending on your vehicle's configuration, you may not have the option to switch the feature on and off.

To conserve power, the system may not work when you are approaching your vehicle if:

- The 12-volt battery is low.
- The system was triggered 10 times prior to starting the vehicle.
- The vehicle is left unused for a few days.

## EXTERIOR LAMPS ON AUDIBLE WARNING

Sounds when you open the driver door and the exterior lamps are on.

## EXTERIOR ZONE LIGHTING (IF EQUIPPED)

### WHAT IS EXTERIOR ZONE LIGHTING

Exterior zone lighting divides the exterior lighting into zones and allows you to switch them on and off to provide lighting around the perimeter of your vehicle.

### USING THE EXTERIOR ZONE LIGHTING

1. Press **Features** on the touchscreen.
2. Press **Zone Lighting**.

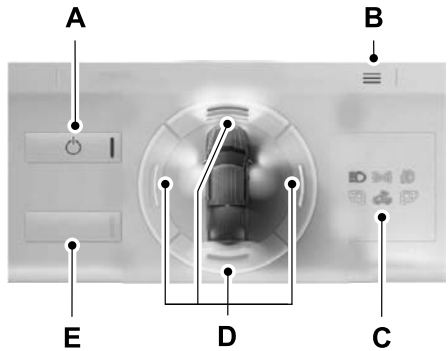

- A On and off button.
- B Settings menu.
- C Exterior lamp indicators.

# Exterior Lighting

---

- D Individual zones on and off.
- E All zones on and off.

You can use zone lighting when your vehicle is on or off. When it is off, the lighting turns off after a certain period of time.

You can also use individual zone controls to switch on each zone.

**Note:** *Make sure to remove exterior lighting covers when using zone lighting.*

**Note:** *When your vehicle is off and the timer has one minute remaining, the direction indicators flash six times.*

**Note:** *Indicators on the touchscreen illuminate when the lights outside of the zone lighting control are on.*

**Note:** *You can remotely control the zone lighting using the FordPass app.*

**Note:** *Vehicles without spot lamps only have two zones.*

## EXTERIOR ZONE LIGHTING SETTINGS

1. Press **Features** on the touchscreen.
2. Press **Zone Lighting**.
3. Press the settings menu in the upper right-hand corner.
4. Press a setting.

### Enable Autolamp Override

This setting allows your vehicle to override the autolamps when using zone lighting.

When you access zone lighting for the first time, you can choose this setting. You can change this setting at any time.

### Include Reverse Lamps

This setting turns the reverse lamps on when you switch the rear lighting zone on.

Switch this setting off if you have a backup alarm installed to prevent the reverse lamps from turning on and sounding the alarm when using zone lighting.

## AUTOMATIC HIGH BEAM CONTROL (IF EQUIPPED)

### HOW DOES AUTOMATIC HIGH BEAM CONTROL WORK

Automatic high beam control turns the high beams on if it is dark enough and no other traffic is present. If it detects an approaching vehicle's headlamps or tail lamps, or street lighting ahead, the system turns the high beams off.

A camera sensor, centrally mounted behind the windshield of your vehicle, continuously monitors conditions to turn the high beams on and off.

# Exterior Lighting

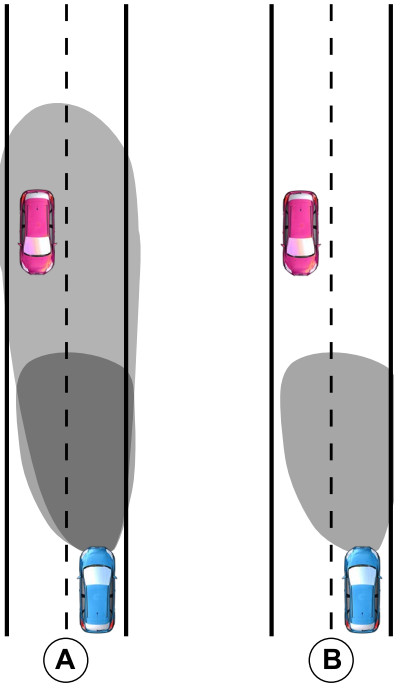

- A Without automatic high beam control.
- B With automatic high beam control.

## AUTOMATIC HIGH BEAM CONTROL PRECAUTIONS

**WARNING:** The system does not relieve you of your responsibility to drive with due care and attention. You may need to override the system if it does not turn the high beams on or off.

**WARNING:** The system may not switch the high beams off if the lights of oncoming vehicles are hidden by obstacles, for example guard rails.

**WARNING:** You may need to override the system when approaching other road users.

**WARNING:** In situations with poor visibility, such as fog, heavy rain or other inclement weather, you may need to override or completely switch off the system.

## AUTOMATIC HIGH BEAM CONTROL REQUIREMENTS

The system turns the high beams on if all of the following occur:

- You switch the system on.
- You set the lighting control to the autolamps position.
- The ambient light level is low enough that you require high beams.
- There is no traffic in front of your vehicle.
- The vehicle speed is greater than approximately 25 mph (40 km/h).

## AUTOMATIC HIGH BEAM CONTROL LIMITATIONS

The system turns the high beams off if any of the following occur:

- You switch the system off.
- You set the lighting control to any position except autolamps.
- The ambient light level is high enough that you do not require high beams.
- The system detects an approaching vehicle's headlamps or a leading vehicle's tail lamps.



# Exterior Lighting

- The system detects severe rain, snow or fog.
- The system detects street lighting.
- The camera has reduced visibility.
- The vehicle speed falls below approximately 19 mph (30 km/h).

**Note:** *The deactivation speed may be lower on curves.*

## SWITCHING AUTOMATIC HIGH BEAM CONTROL ON AND OFF

1. Using the instrument cluster controls on the steering wheel, select **Settings**.
2. Select **Vehicle**.
3. Select **Lighting**.
4. Switch **Auto High Beam** on or off.

## AUTOMATIC HIGH BEAM CONTROL INDICATORS



Illuminates to confirm when the system is ready to assist.

## OVERRIDING AUTOMATIC HIGH BEAM CONTROL

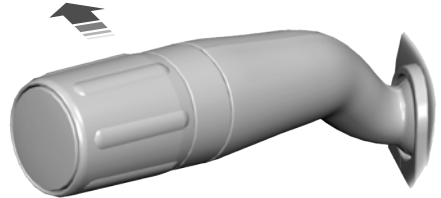

Push the lever away from you to switch the high beams on.

Push the lever away from you again to switch the high beams off.

Push the lever away from you for a third time to switch automatic high beam control back on.

## AUTOMATIC HIGH BEAM CONTROL – TROUBLESHOOTING (IF EQUIPPED)

### AUTOMATIC HIGH BEAM CONTROL – INFORMATION MESSAGES

Message	Details
Front Camera Low Visibility Clean Screen	The camera has reduced visibility. Clean the windshield. If the message continues to appear, have your vehicle checked as soon as possible.
Front Camera Temporarily Not Available	The camera has malfunctioned. Wait a short period of time for the camera to cool down. If the message continues to appear, have your vehicle checked as soon as possible.
Front Camera Malfunction Service Required	The camera has malfunctioned. Have your vehicle checked as soon as possible.

# Exterior Lighting

## ADAPTIVE FRONT LIGHTING (IF EQUIPPED)

### HOW DOES ADAPTIVE FRONT LIGHTING WORK

Adaptive front lighting adapts when you are steering around a curve or if the camera detects lane markings indicating a curve.

**Note:** Other lighting control positions do not turn on adaptive front lighting.

## EXTERIOR LIGHTING VIDEOS

[Intelligent Three Blink Turn Signal Video Link](#)

[Auto High Beams Video Link](#)

[Configurable Daytime Running Lamps Video Link](#)

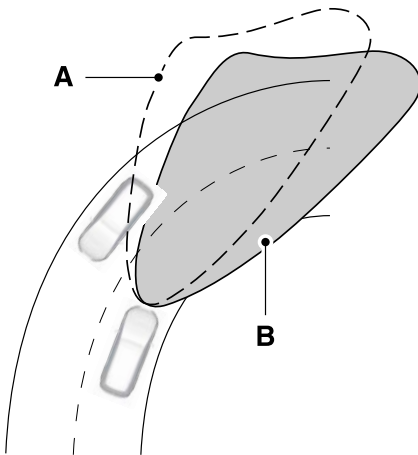

- A Without adaptive front lighting.
- B With adaptive front lighting.

### SWITCHING ADAPTIVE FRONT LIGHTING ON AND OFF

Set the lighting control to the autolamps position to use adaptive front lighting.

# Interior Lighting

## SWITCHING ALL OF THE INTERIOR LAMPS ON AND OFF

The lamps turn on under the following conditions:

- You open any door.
- You press a button on the remote control.
- You press the all lamps on button on the overhead console.



Press to switch all interior lamps on or off.

## SWITCHING THE FRONT INTERIOR LAMPS ON AND OFF



The front interior lamp switches are on the overhead console.

**Note:** The position of each button on the overhead console depends on your vehicle.

### Individual Map Lamps



Press to switch the left-hand individual dome lamp on and off.



Press to switch the right-hand individual dome lamp on and off.

## SWITCHING THE REAR INTERIOR LAMPS ON AND OFF



The rear interior lamps may be above the rear seat or above the rear windows.



Press to switch the lamps on or off.

**Note:** If you switch the rear lamps on through the overhead console, you cannot switch them off with the rear lamp switch.

## INTERIOR LAMP FUNCTION

### WHAT IS THE INTERIOR LAMP FUNCTION

The interior lamp function switches the courtesy and door lamps on or off.

### SWITCHING THE INTERIOR LAMP FUNCTION ON AND OFF



Press to switch the interior lamp function on and off.

**Note:** The indicator lamp illuminates amber when the door function is off.

# Interior Lighting

---

## ADJUSTING THE INSTRUMENT PANEL LIGHTING BRIGHTNESS

The instrument lighting dimmer buttons are on the lighting control.



Repeatedly press one of the buttons to adjust the brightness.



## AMBIENT LIGHTING (IF EQUIPPED)

### SWITCHING AMBIENT LIGHTING ON AND OFF

1. Press **Settings** on the touchscreen.
2. Press **Vehicle**.
3. Press **Ambient Light**.
4. Switch **Ambient Light** on or off.

**Note:** You can also drag the slider all the way to the left to switch ambient lighting off.

### ADJUSTING AMBIENT LIGHTING

Drag the slider left or right to adjust the ambient lighting intensity.

## INTERIOR LIGHTING – TROUBLESHOOTING

### INTERIOR LIGHTING – FREQUENTLY ASKED QUESTIONS

#### Why do my courtesy lamps or interior lamps turn off when I have them switched on when I switch my vehicle off?

- The battery saver turns the courtesy lamps and interior lamps off after a short period of time after you switch your vehicle off.

# Windows

## OPENING AND CLOSING THE WINDOWS



**WARNING:** Do not leave children or pets unattended in your vehicle and do not let children play with the power windows. Failure to follow this instruction could result in personal injury or death.



**WARNING:** When closing the power windows, verify that they are free of obstructions and make sure children and pets are not in the proximity of the window openings. Failure to follow this instruction could result in personal injury or death.



**WARNING:** If an obstruction is detected, release the switch and reverse the window immediately. Failure to follow this instruction could result in personal injury or death.



**WARNING:** Do not leave a key or remote control unattended in the vehicle. Children or pets could operate the power windows and could become trapped in a closing window. Failure to follow this instruction could result in personal injury or death.



Press the window control switch to open the window. Lift the window control switch to close the window.

**Note:** The power windows operate with the ignition on, and for several minutes after you switch the ignition off or until you open a front door.

To reduce wind noise or pulsing noise when one window is open, slightly open the opposite window.

### One-Touch Open

Fully press the window control switch and release it. Press again or lift it to stop the window.

### One-Touch Close

Fully lift the window control switch and release it. Press again or lift it to stop the window.

### Resetting One-Touch Close

Carry out all steps within 30 seconds of starting the sequence.

1. Close the window.
2. Press and hold the window control switch until the window is fully open. Keep the window control switch pressed for a few seconds.
3. Lift and hold the window control switch until the window is fully closed. Keep the window control switch held for a few seconds.
4. Press and hold the window control switch until the window is fully open. Keep the window control switch pressed for a few seconds.
5. Lift and hold the window control switch until the window is fully closed. Keep the window control switch held for a few seconds.

**Note:** Repeat the procedure if the window does not close when you use one-touch.

## GLOBAL OPENING

### WHAT IS GLOBAL OPENING

You can use the remote control to open the windows with the ignition off.

# Windows

## USING GLOBAL OPENING

1. Press and release the unlock button on the remote control.
2. Press and hold the unlock button on the remote control.
3. Release the button when the windows start to open.

Press the lock or the unlock button on the remote control to stop global opening.

**Note:** You can use global opening for a short period of time when you unlock your vehicle using the remote control.

## SWITCHING GLOBAL OPENING ON AND OFF

1. Press **Settings** on the touchscreen.
2. Press **Vehicle Settings**.
3. Press **Windows**.
4. Switch **Remote Open** on or off.

## WINDOW BOUNCE-BACK

### WHAT IS WINDOW BOUNCE-BACK

The window stops and reverses if it detects an obstruction when closing.

### OVERRIDING WINDOW BOUNCE-BACK



**WARNING:** If you override bounce-back, the window does not reverse if it detects an obstacle. Take care when closing the windows to avoid personal injury or damage to your vehicle.

1. Close the window until it reaches the point of resistance and let it reverse.

2. Lift and hold the window control switch within two seconds to override bounce-back and close the window. Bounce-back is now disabled and you can close the window manually.

**Note:** The window goes past the point of resistance and you can fully close it.

**Note:** If the window does not close, have your vehicle checked as soon as possible.

## LOCKING THE REAR WINDOW CONTROLS - CREW CAB/ SUPERCAB



**WARNING:** When children and pets are in the rear seat, use the power window lockout button to prevent accidental operation of the power windows.



Press the window control switch to lock or unlock the rear window controls. It illuminates when you lock the rear window controls.

## OPENING AND CLOSING THE SLIDING WINDOWS - VEHICLES WITH: POWER SLIDING REAR WINDOW



**WARNING:** Do not leave children or pets unattended in your vehicle and do not let children play with the power windows. Failure to follow this instruction could result in personal injury or death.

# Windows



**WARNING:** When closing the power windows, verify that they are free of obstructions and make sure children and pets are not in the proximity of the window openings. Failure to follow this instruction could result in personal injury or death.



**WARNING:** If an obstruction is detected, release the switch and reverse the window immediately. Failure to follow this instruction could result in personal injury or death.



**WARNING:** Do not leave a key or remote control unattended in the vehicle. Children or pets could operate the power windows and could become trapped in a closing window. Failure to follow this instruction could result in personal injury or death.

## WINDOWS VIDEOS

[One-Touch Power Windows - Troubleshooting Video Link](#)

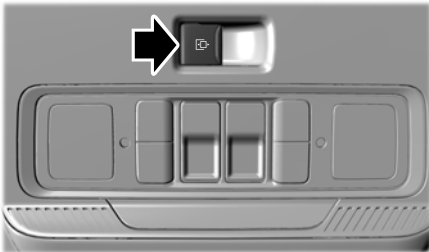

The sliding rear window control switch is on the overhead console.

Press and hold the sliding rear window control switch to open the rear window. Pull and hold the sliding rear window control switch to close the rear window.

# Interior Mirror

---

## INTERIOR MIRROR PRECAUTIONS



**WARNING:** Do not adjust the mirrors when your vehicle is moving. This could result in the loss of control of your vehicle, serious personal injury or death.

**Note:** Do not clean the mirror housing or glass with harsh abrasives, fuel or other petroleum-based cleaning products.

## MANUALLY DIMMING THE INTERIOR MIRROR

Pull the tab below the mirror toward you to reduce glare at night.

## AUTO-DIMMING INTERIOR MIRROR (IF EQUIPPED)

### WHAT IS THE AUTO-DIMMING INTERIOR MIRROR

The mirror dims to reduce the effect of bright light from behind. It returns to normal when the bright light from behind is no longer present or if you shift into reverse (R).

### AUTO-DIMMING INTERIOR MIRROR LIMITATIONS

Do not block the sensors on the front and back of the mirror.

**Note:** A rear center passenger or raised rear center head restraint could prevent light from reaching the sensor.



# Exterior Mirrors

## ADJUSTING THE EXTERIOR MIRRORS



**WARNING:** Do not adjust the mirrors when your vehicle is moving. This could result in the loss of control of your vehicle, serious personal injury or death.

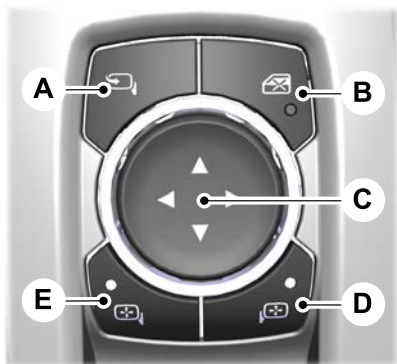

- A Power fold.
- B Window lock.
- C Adjustment control.
- D Right-hand mirror.
- E Left-hand mirror.

To adjust the mirrors, switch your vehicle on and place the ignition in accessory or start.

1. Select the mirror you want to adjust. The control light turns on.
2. Use the adjustment control to adjust the position of the mirror.
3. Press the mirror control again. The control light turns off.

## FOLDING THE EXTERIOR MIRRORS - VEHICLES WITH: MANUAL FOLDING MIRRORS

Push the mirror toward the door window glass.

Make sure that you fully engage the mirror in its support when returning it to its original position.

## FOLDING THE EXTERIOR MIRRORS - VEHICLES WITH: POWER FOLDING MIRRORS

The exterior mirrors fold when you lock your vehicle and unfold when you unlock your vehicle.

**Note:** This feature requires you to switch the exterior mirrors auto-fold on.



For tight parking conditions, press the control switch to fold the mirrors.

Press the control switch again to unfold the mirrors.

**Note:** Do not stop the mirrors midway through their movement. Wait until the mirrors stop moving and press the control switch again.

The left and right-hand mirrors move at different rates. For example, one mirror may stop while the other one continues to move. This is normal.

If you press the control switch to fold in the mirrors with auto-fold on, the mirrors do not unfold when you unlock your vehicle.

**Note:** The power folding mirrors operate with the ignition on, and for several minutes after you switch the ignition off.

# Exterior Mirrors

**Note:** If you fold and unfold the mirrors several times within one minute, the power fold function may turn off to protect the motors from overheating.

## Switching Auto-fold On and Off

1. Press **Settings** on the touchscreen.
2. Press **Vehicle**.
3. Press **Mirrors**.
4. Switch **Autofold** on and off.

## Loose Mirror

If you manually fold your power-folding mirrors, they may not work properly even after you reposition them. You need to reset them if:

- The mirrors vibrate when you drive.
- The mirrors feel loose.
- The mirrors do not stay in the folded or unfolded position.
- One of the mirrors is not in its normal driving position.

To reset the mirrors, perform the following steps:

1. By hand, fold or retract both mirrors.
2. Using the power folding/power telescoping mirror control switch, operate the mirrors until you hear an audible click.
3. Operate the power folding or power telescoping mirrors an additional 3 to 4 times to synchronize the mirrors.

## EXTENDING THE EXTERIOR MIRRORS

This optional feature lets you extend the mirror about 3 in (75 mm). It is useful when towing a trailer. You can manually pull out or push in the mirrors to various positions.

## Power Telescoping Mirrors (if Equipped)

This feature lets you position both mirrors at the same time.



- A. Extend.
- B. Retract.

To adjust your mirrors, make sure you switch your vehicle on, with the ignition in accessory mode or the engine running.

1. Press and release the control switch.
2. Press the adjustment control to position the mirrors.
3. Press the left arrow to extend the mirrors out. Press the right arrow to retract the mirrors in.

**Note:** Moving the mirrors 10 or more times within one minute, or repeated folding and unfolding of the mirrors when holding the control down during full travel, could disable the system to protect the motors from overheating. Wait approximately three minutes with the vehicle running, and up to 10 minutes with the vehicle off, for the system to reset and for function to return to normal.

## Moonroof (If Equipped)

### OPENING AND CLOSING THE SUNSHADE



**WARNING:** Do not leave a key or remote control unattended in the vehicle. Children or pets could operate the sunshade and get caught in a closing sunshade. Failure to follow this instruction could result in personal injury.



**WARNING:** Do not leave children or pets unattended in your vehicle and do not let children play with the sunshade. Failure to follow this instruction could result in personal injury.

The controls are on the overhead console.

#### Opening the Sunshade



Press and release the switch to activate the one-touch open feature. To stop movement, press the switch a second time. The sunshade also opens when you open the moonroof.

**Note:** *The sunshade stops short of its fully opened position for the comfort of rear passengers. To fully open the sunshade, press the switch again.*

#### Closing the Sunshade



**WARNING:** When closing the sunshade, verify that it is free of obstructions and make sure children and pets are not in the proximity of the sunshade. Failure to follow this instruction could result in personal injury.



**WARNING:** If an obstruction is detected, press the switch a second time and reverse the sunshade immediately. Failure to follow this instruction could result in personal injury.



Press and release the switch to activate the one-touch close feature. To stop movement, press the switch a second time.

**Note:** *If fully open, the sunshade stops after covering the rear glass panel. Press and release again to fully close the sunshade.*

### OPENING AND CLOSING THE MOONROOF



**WARNING:** Do not leave children or pets unattended in your vehicle and do not let children play with the moonroof. Failure to follow this instruction could result in personal injury or death.



**WARNING:** Do not leave a key or remote control unattended in the vehicle. Children or pets could operate the moonroof and could become trapped in a closing moonroof. Failure to follow this instruction could result in personal injury or death.

The controls are on the overhead console.

#### Opening the Moonroof



Press and release the switch to activate the one-touch open feature. To stop movement, press the switch a second time.

# Moonroof (If Equipped)

**Note:** *The moonroof stops short of the fully opened position to reduce wind noise or rumbling that may happen with the moonroof fully open.*

*Press and release the switch again to fully open the moonroof.*

## Closing the Moonroof



**WARNING:** When closing the moonroof, verify that it is free of obstructions and make sure children and pets are not in the proximity of the moonroof. Failure to follow this instruction could result in personal injury or death.



**WARNING:** If an obstruction is detected, release the switch and reverse the moonroof immediately. Failure to follow this instruction could result in personal injury or death.



Press and release the switch to activate the one-touch close feature, from either the open or vent positions. To stop movement, press the switch a second time.

## VENTING THE MOONROOF



**WARNING:** Do not leave children unattended in your vehicle and do not let them play with the moonroof. Failure to follow this instruction could result in personal injury.

The moonroof controls are on the overhead console.



With the moonroof in the closed position, press and release the switch to vent the moonroof. To close the moonroof from the vent position, press and release the switch again.

## MOONROOF BOUNCE-BACK

### WHAT IS MOONROOF BOUNCE-BACK

The moonroof stops and reverses some distance if it detects an obstacle when closing.

### OVERRIDING MOONROOF BOUNCE-BACK

Press and hold the close switch within two seconds after the moonroof comes to a stop.

## MOONROOF VIDEOS

[Twin-panel moonroof Video Link](#)

## Instrument Cluster

### INSTRUMENT CLUSTER OVERVIEW - VEHICLES WITH: 4.2 INCH SCREEN

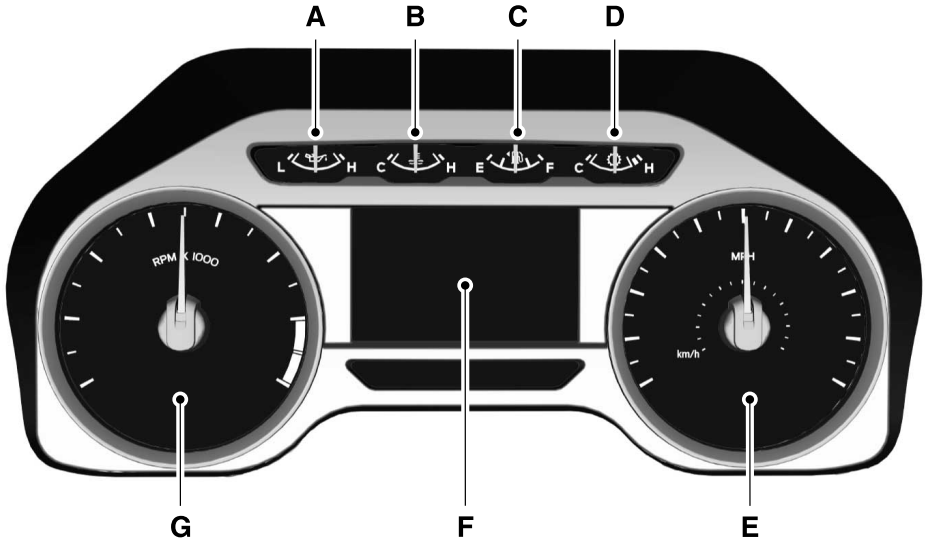

- A Engine oil pressure gauge.
- B Engine coolant temperature gauge.
- C Fuel gauge.
- D Transmission fluid temperature gauge (gas), turbo boost (diesel).
- E Speedometer.
- F Instrument cluster display.
- G Tachometer.

# Instrument Cluster

## INSTRUMENT CLUSTER OVERVIEW - VEHICLES WITH: 12 INCH SCREEN

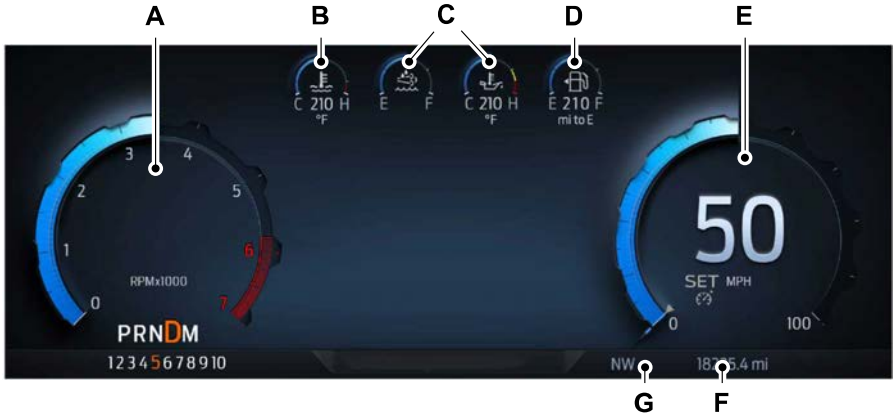

- A Tachometer.
- B Engine coolant temperature gauge.
- C Configurable gauges. Oil pressure, engine oil temperature, transmission fluid temperature, turbo boost or diesel exhaust fluid level.
- D Fuel gauge.
- E Speedometer.
- F Odometer.
- G Compass.

### TACHOMETER

Indicates the engine speed.

### SPEEDOMETER

Indicates the vehicle speed.

### FUEL GAUGE

#### WHAT IS THE FUEL GAUGE

Indicates approximately how much fuel is in the fuel tank.

# Instrument Cluster

---

## FUEL GAUGE LIMITATIONS

The fuel gauge may not provide an accurate reading when your vehicle is on an incline.

## LOCATING THE FUEL FILLER DOOR

The arrow adjacent to the fuel pump symbol indicates on which side of your vehicle the fuel filler door is located.

## WHAT IS THE LOW FUEL REMINDER

A low fuel level reminder displays and sounds when the distance to empty reaches 50 mi (80 km), 25 mi (40 km), 10 mi (20 km) and 0 mi (0 km).

**Note:** *The low fuel reminder can appear at different fuel gauge positions depending on fuel economy conditions. This variation is normal.*

## WHAT IS DISTANCE TO EMPTY

Indicates the approximate distance your vehicle can travel on the fuel remaining in the tank. Changes in driving pattern can cause the value to not only decrease but also increase or stay constant for periods of time.

**Note:** *When you have a trailer connected, your distance to empty accounts for the trailer.*

## ENGINE COOLANT TEMPERATURE GAUGE

Indicates the engine coolant temperature.

## ENGINE OIL PRESSURE GAUGE

Indicates the engine oil pressure.

**Note:** *This is a configurable gauge.*

## ENGINE OIL TEMPERATURE GAUGE

Indicates the engine oil temperature.

**Note:** *This is a configurable gauge.*

## TRANSMISSION FLUID TEMPERATURE GAUGE

Indicates the transmission fluid temperature.

Special operating conditions can cause higher than normal operating temperatures. See **General Maintenance Information** (page 589).

**Note:** *This is a configurable gauge.*

## TURBO BOOST GAUGE

Indicates the amount of manifold air pressure in the engine.

**Note:** *This is a configurable gauge.*

## DIESEL EXHAUST FLUID GAUGE

Indicates the current diesel exhaust fluid level.

## WHAT ARE THE INSTRUMENT CLUSTER WARNING LAMPS

Warning lamps alert you to a vehicle condition that could become serious. Some lamps illuminate when you start your vehicle to make sure they work. If any lamps remain on after starting your vehicle, refer to the respective system warning lamp for further information.

# Instrument Cluster

## INSTRUMENT CLUSTER WARNING LAMPS

Depending on your vehicle options, some warning lamps can appear different or not at all.

### Anti-Lock Brake System



If it illuminates when you are driving, this indicates a malfunction. Your vehicle continues to have normal braking without the anti-lock brake system function. Have your vehicle checked as soon as possible.

### Battery



It illuminates when you switch the ignition on.

If it illuminates when the engine is running, this indicates your vehicle requires service. Have your vehicle checked as soon as possible.

### Brake System



It illuminates when you apply the parking brake and the ignition is on.



If it illuminates when your vehicle is moving, make sure the parking brake is released. If the parking brake is released, this

indicates low brake fluid level or the brake system requires service. Have your vehicle checked as soon as possible.

**Note:** Indicators may vary depending on region.

### Diesel Exhaust Fluid



illuminates when the diesel exhaust fluid is low, contaminated or the system

requires service. See **Selective Catalytic Reduction System** (page 222).

### Door Ajar



It illuminates when you switch the ignition on and remains on if any door is open.

### Electric Parking Brake



It illuminates or flashes when the electric parking brake requires service.

**Note:** Indicators may vary depending on region.

### Engine Coolant Temperature



If it illuminates, safely stop your vehicle and switch the vehicle off.

### Fasten Seatbelt



It illuminates and a tone sounds until you fasten the seatbelts.

### Hood Ajar



It illuminates when the ignition is on and the hood is not completely closed.

### Low Fuel Level



It illuminates when the fuel level is low.

### Low Tire Pressure



It illuminates when your tire pressure is low. If illuminated, check your tire pressure as soon as possible. If it begins to flash at anytime, have the system checked as soon as possible.



# Instrument Cluster

## Low Washer Fluid Level



It illuminates when the washer fluid is low.

## Malfunction Indicator Lamp



It illuminates when the ignition is on and the engine is off, this is normal. If it illuminates when the engine is on this indicates the emission control system requires service. If it flashes, have your vehicle checked immediately. See **Emission Law** (page 674). See **Starting and Stopping the Engine – Warning Lamps** (page 204).

## Oil Pressure



It illuminates when the engine oil pressure is low.

## Powertrain Malfunction, Reduced Power, Electronic Throttle Control, Check 4X4



Illuminates when the powertrain or four-wheel drive require service. Have the system checked as soon as possible.

## Tailgate Ajar



It illuminates when the ignition is on and the tailgate is not completely closed.

## Water in Fuel



It illuminates when the fuel and water separator has a significant quantity of water in it and requires immediate draining.

## WHAT ARE THE INSTRUMENT CLUSTER INDICATORS

Indicators notify you of various features that are active on your vehicle.

## INSTRUMENT CLUSTER INDICATORS

Depending on your vehicle options, some warning lamps can appear different or not at all.

### Adaptive Cruise Control



See **Adaptive Cruise Control** (page 294).

### Automatic High Beam



See **Automatic High Beam Control Indicators** (page 121).

### Automatic Regen Control Off



See **Diesel Particulate Filter** (page 217).

### Auto Hold Active



See **Auto Hold Indicators** (page 263).

### Auto Hold Unavailable



See **Auto Hold Indicators** (page 263).

### Blind Spot Monitor



See **Blind Spot Information System** (page 324).

# Instrument Cluster

## Cruise Control



See **Cruise Control** (page 292).

## Distance Indication



See **Distance Indication Indicator** (page 339).

## Diesel Engine Brake



See **Diesel Engine Exhaust Brake** (page 253).



## Electronic Locking Differential



See **Electronic Locking Differential** (page 242).

## Four-Wheel Drive



See **Four-Wheel Drive** (page 234).



**Note:** Some indicators appear different depending on vehicle options.

## Front Airbag



See **Airbags** (page 57).

## Front Fog Lamp



See **Using the Front Fog Lamps** (page 117).

## High Beam



See **Using the High Beam Headlamps** (page 114).

## Hill Descent



See **Hill Descent Control** (page 275).

## Lane Centering



See **Lane Centering Indicators** (page 304).

## Lane Keeping System

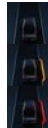

See **Lane Keeping System Indicators** (page 318).

## Parking Lamps



See **Exterior Lighting Control** (page 114).

## Stability Control and Traction Control



See **Traction Control** (page 265). See **Stability Control** (page 267).



# Instrument Cluster

---

## Trail Control



See **Trail Control Indicators** (page 271).

## Trail Turn Assist



See **Trail Turn Assist Indicators** (page 273).



## Trailer Distance To Empty



See **What Is Distance to Empty** (page 135).

## Turn Signal Lamps



See **Using the Turn Signal Lamps** (page 115).

## Wait to Start



See **Starting a Diesel Engine** (page 199). See **Starting a Diesel Engine** (page 199).

# Instrument Cluster Display

## USING THE INSTRUMENT CLUSTER DISPLAY CONTROLS



**WARNING:** Driving while distracted can result in loss of vehicle control, crash and injury. We strongly recommend that you use extreme caution when using any device that may take your focus off the road. Your primary responsibility is the safe operation of your vehicle. We recommend against the use of any hand-held device while driving and encourage the use of voice-operated systems when possible. Make sure you are aware of all applicable local laws that may affect the use of electronic devices while driving.

The controls are on the steering wheel.

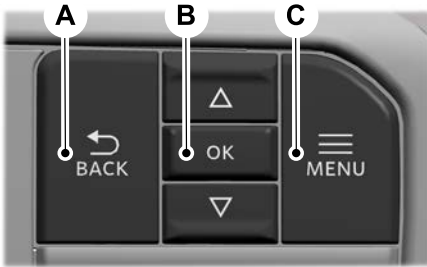

- A Back button.
- B OK button.
- C Menu button.

### Back Button

Press to go back or to exit a menu.

### OK Button

Press to make a selection.

### Menu Button

Press to display the submenus.

### Scroll Buttons

Press the up or down buttons to scroll through the menu items.

### Status Indicator



Menu items with a check box indicates a feature's status. A check in the box indicates the feature is on, and unchecked indicates the feature is off.

## INSTRUMENT CLUSTER DISPLAY MAIN MENU - VEHICLES WITH: 4.2 INCH SCREEN

Depending on your vehicle options, some menu items can appear different or not at all.

**Note:** For your safety, some features are speed-dependent and could be unavailable when your vehicle is above a certain speed.

Menu Item
Select Screens
Truck Info
Towing
Vehicle Maintenance
Settings

# Instrument Cluster Display

## INSTRUMENT CLUSTER DISPLAY MAIN MENU - VEHICLES WITH: 12 INCH SCREEN

Depending on your vehicle options, some menu items can appear different or not at all.

**Note:** For your safety, some features are speed-dependent and could be unavailable when your vehicle is above a certain speed.

Menu Item
MyView
Trip/Fuel
HUD
Gauges
Off Road
Towing
Status/Information
Navigation
Phone
Audio
Vehicle Maintenance
Settings

## CUSTOMIZING THE INSTRUMENT CLUSTER DISPLAY - VEHICLES WITH: 4.2 INCH SCREEN

### Adding Screens Using Select Screens

1. Select **Select Screens**.

2. Use the controls on the steering wheel to highlight a screen to add.
3. Press the **OK** button.

**Note:** The number of screens you can add is limited. If the selected screen does not appear you must deselect screens from the **Select Screens** menu.

### Configuring Gauges

1. Select **Settings** using the instrument cluster display controls.
2. Select **Gauge Selection**.
3. Select to swap or change left-hand side and right-hand side gauges.

## CUSTOMIZING THE INSTRUMENT CLUSTER DISPLAY - VEHICLES WITH: 12 INCH SCREEN

### Adding Screens Using MyView

1. Using the instrument cluster display controls on the steering wheel, select **MyView**.
2. Select **Configure MyView**.
3. Select a screen.
4. Press the **OK** button.

**Note:** The number of screens you can add is limited. If the selected screen does not appear you must deselect screens from the **MyView** menu.

### Configuring Gauges

1. Select **Settings**.
2. Select **Configure Gauges**.
3. Select to swap or change left-hand side and right-hand side gauges.

# Personalized Settings

---

## CHANGING THE LANGUAGE

1. Press **Settings** on the touchscreen.
2. Press **General**.
3. Press **Language**.
4. Select a language.

## CHANGING THE MEASUREMENT UNIT

1. Press **Settings** on the touchscreen.
2. Press **General**.
3. Press **Measurement Units**.
4. Select a measurement unit.

## CHANGING THE TEMPERATURE UNIT

1. Press **Settings** on the touchscreen.
2. Press **General**.
3. Press **Temperature Units**.
4. Select a temperature unit.

## CHANGING THE TIRE PRESSURE UNIT

1. Press **Settings** on the touchscreen.
2. Press **General**.
3. Press **Tire Pressure Units**.
4. Select a pressure unit.

# Trip Computer

---

## ACCESSING THE TRIP COMPUTER - VEHICLES WITH: 4.2 INCH SCREEN

**Note:** *Trip 1 and 2 are selectable screens. See **Accessing the Trip Computer** (page 143). See **Accessing the Trip Computer** (page 143).*

### Using Select Screens

1. Select **Select Screens**.
2. Use the controls on the steering wheel to navigate the menu. See **Customizing the Instrument Cluster Display** (page 141). or See **Customizing the Instrument Cluster Display** (page 141).

### Using the Home Screen

After screens have been added, use the controls on the steering wheel to view each trip screen.

## ACCESSING THE TRIP COMPUTER - VEHICLES WITH: 12 INCH SCREEN

1. Select Trip/Fuel.
2. Select Trip 1 or Trip 2.

## RESETTING THE TRIP COMPUTER

1. Use the instrument cluster display controls to navigate the home screen.
2. Select the trip screen you want to reset.
3. Press and hold the **OK** button until the system reset confirmation appears.

## TRIP DATA

### Trip 1 and 2

Provides trip timer, trip average fuel economy and total trip distance traveled.

# Head Up Display (If Equipped)

---

## WHAT IS THE HEAD UP DISPLAY

The system displays information on a display screen in your field of vision, allowing you to keep your eyes on the road. You can select which information the system displays.

## SWITCHING THE HEAD UP DISPLAY ON AND OFF

1. Using the instrument cluster display controls on the steering wheel, select HUD.
2. Switch **Head-Up Display (HUD)** on or off.

**Note:** The system remembers the last setting when you start your vehicle.

## HEAD UP DISPLAY SETTINGS

1. Using the instrument cluster display controls on the steering wheel, select HUD.

**Note:** If **HUD On** is unchecked, other options of the system are hidden.

You can adjust the following settings in the HUD menu:

- Brightness.
- Vertical position.
- Image rotation.
- Content.
- Drive mode layout.

**Note:** The head up display menu automatically closes after a certain period of inactivity.

**Note:** The head up display image brightness automatically adjusts to the brightness of the ambient environment. You have the ability to adjust the brightness further according to your preference.

**Note:** In some instances, sunlight can cause some reflections in and around the head up display image.

**Note:** When you save a memory preset position, your current HUD settings are also saved to that memory preset position. See **Memory Function** (page 173).



# Head Up Display (If Equipped)

---

## HEAD UP DISPLAY – TROUBLESHOOTING

### HEAD UP DISPLAY – INFORMATION MESSAGES

<b>Message</b>	<b>Action</b>
Head Up Display System Fault See Manual	The system is malfunctioning or something is obstructing the display. Make sure that the head up display is free from obstruction. If the message continues to appear, have your vehicle checked as soon as possible.
Head Up Display To Position Use the Information Display	Press the button on the steering wheel or center console. The head up display menu appears in the instrument cluster display. Make sure the blue frame is fully visible. Do not manually move the screen. This can cause damage not covered by your vehicle's warranty.

# Remote Start (If Equipped)

## WHAT IS REMOTE START

The system allows you to remotely start your vehicle and to adjust the interior temperature according to the settings that you chose.

## REMOTE START PRECAUTIONS



**WARNING:** Do not start the engine in a closed garage or in other enclosed areas. Exhaust fumes are toxic. Always open the garage door before you start the engine. Failure to follow this instruction could result in personal injury or death.

## REMOTE START LIMITATIONS

Remote start does not work under the following conditions:

- The alarm horn is sounding.
- The hood is open.
- The transmission is not in park (P).
- The ignition is on.
- The battery voltage is below the minimum operating voltage.
- Remote start is not enabled.

**Note:** Do not use remote start if the fuel level is low.

## ENABLING REMOTE START

1. Press **Settings** on the touchscreen.
2. Press **Vehicle**.
3. Press **Remote Start Setup**.
4. Switch **Remote Start** on or off.

**Note:** To remote start with FordPass, make sure that the modem is enabled. See **Connecting FordPass to the Modem** (page 547).

## REMOTELY STARTING AND STOPPING THE VEHICLE

### Remotely Starting the Vehicle



Press the button on the remote control.



Within three seconds, press the button on the remote control.

Within three seconds, press the button again.

**Note:** You can also use FordPass to start the vehicle.

**Note:** The vehicle doors lock when you successfully remote start your vehicle.

**Note:** The turn signal lamps flash twice.

**Note:** The parking lamps turn on when the vehicle is running.

**Note:** The horn sounds if the system fails to start.

**Note:** All other vehicle systems remain off when you have remotely started the vehicle.

**Note:** The vehicle remains secured when you have remotely started the vehicle. A valid key must be inside your vehicle to switch the ignition on and drive your vehicle.

### Remotely Stopping the Vehicle



Press the button on the remote control.

## Remote Start (If Equipped)

### EXTENDING THE REMOTE START DURATION

To extend the remote start duration during remote start, do the following:



Press the button on the remote control.



Within three seconds, press the button on the remote control.

Within three seconds, press the button again.

If the duration is set to 15 minutes, the duration extends by another 15 minutes. This provides a total of 30 minutes.

**Note:** Remote start can only be extended once.

**Note:** A maximum of two remote starts, or one remote start with an extension, are allowed. To reset the restart procedure switch the vehicle to on, then to off.

### REMOTE START SETTINGS

1. From the settings menu, press Vehicle. See **Center Display** (page 562).
2. Press Remote Start Setup.

### Switching Climate Control Auto Mode On and Off

1. Press Climate Control.
2. Press Auto or Last Setting.

**Note:** If you switch the auto mode on, the system attempts to heat or cool the interior to 72°F (22°C). When you switch the vehicle on, the climate control system returns to the last used settings.

**Note:** If you switch the last settings on, the system remembers the last used settings.

### Heated Seat Settings

1. Press Seats.

2. Press Auto or Off.

**Note:** If you switch the heated seat settings on, the heated seats turn on during cold weather.

**Note:** You cannot adjust the heated seat settings when you remotely start your vehicle.

### Heated Steering Wheel Settings

1. Press Seats and Steering Wheel.
2. Press Auto or Off.

**Note:** If you switch the heated steering wheel settings on, the heated steering wheel turns on during cold weather.

**Note:** You cannot adjust the heated steering wheel settings when you remotely start your vehicle.

### Remote Start Duration

1. Press Duration.
2. Press the duration you prefer.

# Climate Control - Vehicles With: Automatic Temperature Control

## IDENTIFYING THE CLIMATE CONTROL UNIT



Depending on your vehicle options, the controls could look different than what you see here.

## SWITCHING CLIMATE CONTROL ON AND OFF



Press the button.

## SWITCHING RECIRCULATED AIR ON AND OFF



Press the button to recirculate air currently in the passenger compartment.

**Note:** *Recirculated air may turn off automatically, or prevent you from switching on in all air flow modes except MAX A/C to reduce the risk of fogging. Recirculation may also turn on and off automatically in various air distribution control combinations to improve heating or cooling efficiency.*

## SWITCHING AIR CONDITIONING ON AND OFF



Press the button.

**Note:** *Under certain conditions, the air conditioning compressor could continue to operate after you switch air conditioning off.*

**Note:** *To keep the system and its components fully functional, switch air conditioning on and let your vehicle idle at least once per month for a minimum of two minutes.*

## SWITCHING DEFROST ON AND OFF



Press the button to activate the selection screen.



Press the button on the touchscreen to switch the windshield air vents on.



Make sure that the instrument panel air vents are switched off.



Make sure that the footwell air vents are switched off.

## SWITCHING MAXIMUM DEFROST ON AND OFF



Press the button.

Air flows through the windshield air vents, and the blower motor adjusts to the highest speed.

You can also use this setting to defog and clear the windshield of a thin covering of ice.

**Note:** *To prevent window fogging, you cannot select recirculated air when maximum defrost is on.*

**Note:** *The heated rear window also turns on when you select maximum defrost.*

**Note:** *When maximum defrost is on, the air conditioning compressor may continue to operate even though you switch off the air conditioning.*

# Climate Control - Vehicles With: Automatic Temperature Control

## SWITCHING MAXIMUM COOLING ON AND OFF



Press the button.

**Note:** When you switch maximum cooling off, air conditioning remains on.

## SWITCHING THE HEATED REAR WINDOW ON AND OFF



Press the button to clear the rear window of thin ice and fog. The heated rear window turns off after a short period of time.

**Note:** This button also activates the heated mirrors.

**Note:** Do not use harsh chemicals, razor blades or other sharp objects to clean or remove decals from the inside of the heated rear window as this could cause damage to the heated rear window grid lines not covered by the vehicle Warranty.

## SETTING THE BLOWER MOTOR SPEED



Press up or down on the control to select the blower motor speed.



**Note:** For Hybrid Electric Vehicle (HEV) and Plug-In Hybrid Electric Vehicle (PHEV) vehicles, the blower motor may run, and you may feel airflow when the climate control is off, to provide cooling to the battery.

## SWITCHING THE HEATED MIRRORS ON AND OFF

When you switch the heated rear window on, the heated exterior mirrors turn on. See **Switching the Heated Rear Window On and Off** (page 149).



You can also turn on and off the heated exterior mirrors using the mirror defrost button.

**Note:** Do not remove ice from the mirrors with a scraper or adjust the mirror glass when it is frozen in place.

**Note:** Do not clean the mirror housing or glass with harsh abrasives, fuel or other petroleum-based cleaning products. The vehicle warranty may not cover damage caused to the mirror housing or glass.

**Note:** The engine must be running or your vehicle must be ready to drive to switch the system on.

## SETTING THE TEMPERATURE

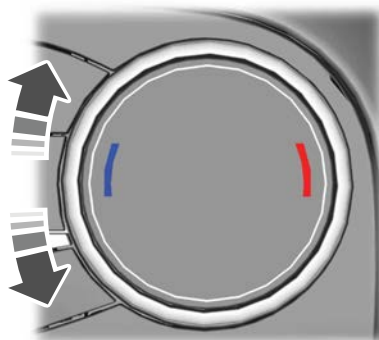

Turn the control on the left-hand side of the climate control to set the left-hand temperature.

# Climate Control - Vehicles With: Automatic Temperature Control

**Note:** This control also sets the right-hand side temperature when you switch off dual zone mode.

Turn the control on the right-hand side of the climate control to set the right-hand temperature.

## DIRECTING THE FLOW OF AIR

### Directing Air to the Windshield Air Vents



Press the button to activate the selection screen.



Press the button on the touchscreen.

### Directing Air to the Instrument Panel Air Vents



Press the button to activate the selection screen.



Press the button on the touchscreen.

### Directing Air to the Footwell Air Vents



Press the button to activate the selection screen.



Press the button on the touchscreen.

## AUTO MODE

### SWITCHING AUTO MODE ON AND OFF



Press the button to switch auto mode on. Repeatedly press the button to adjust auto mode.

**Note:** When you switch auto mode on, lights on the blower motor control do not illuminate to indicate the blower motor speed.

Adjust the blower motor control or air distribution control to switch auto mode off.

### SWITCHING DUAL MODE ON AND OFF



Press the button.

## CLIMATE CONTROL HINTS

### General Hints

- Prolonged use of recirculated air may cause the windows to fog up.
- You may feel a small amount of air from the footwell air vents regardless of the air distribution setting.
- To reduce humidity build-up inside your vehicle, do not drive with the system switched off or with recirculated air always switched on.
- Do not place objects under the front seats as this may interfere with the airflow to the rear seats.
- Remove any snow, ice or leaves from the air intake area at the base of the windshield.
- To improve the time to reach a comfortable temperature in hot weather, drive with the windows open until you feel cold air through the air vents.

# Climate Control - Vehicles With: Automatic Temperature Control

---

## Automatic Climate Control

- Adjusting the settings when your vehicle interior is extremely hot or cold is not necessary. Automatic mode is best recommended to maintain set temperature.
- The system adjusts to heat or cool the interior to the temperature you select as quickly as possible.
- For the system to function efficiently, the instrument panel and side air vents should be fully open.
- If you press **AUTO** during cold outside temperatures, the system directs air flow to the windshield and side window air vents. In addition, the blower motor may run at a slower speed until the engine warms up.
- If you press **AUTO** during hot temperatures and the inside of the vehicle is hot, the system uses recirculated air to maximize interior cooling. Blower motor speed may also reduce until the air cools.

## Quickly Heating the Interior

1. Press **AUTO**.
2. Adjust the temperature function to the setting you prefer.

## Recommended Settings for Heating

1. Press **AUTO**.
2. Adjust the temperature function to the setting you prefer. Use 72°F (22°C) as a starting point, then adjust the setting as necessary.

## Quickly Cooling the Interior

1. Press **MAX A/C**.
2. Drive with the windows open for a short period of time.

## Recommended Settings for Cooling

1. Press **AUTO**.
2. Adjust the temperature function to the setting you prefer. Use 72°F (22°C) as a starting point, then adjust the setting as necessary.

## Defogging the Side Windows in Cold Weather

1. Press and release defrost or maximum defrost.
2. Adjust the temperature control to the setting you prefer. Use 72°F (22°C) as a starting point, then adjust the setting as necessary.

## CLIMATE CONTROL VIDEOS

[Heated Mirrors](#)

# Climate Control - Vehicles With: Manual Temperature Control

## IDENTIFYING THE CLIMATE CONTROL UNIT



Depending on your vehicle options, the controls could look different than what you see here.

## SWITCHING CLIMATE CONTROL ON AND OFF



Press the button.

## SWITCHING RECIRCULATED AIR ON AND OFF



Press the button to recirculate air currently in the passenger compartment.

**Note:** Recirculated air may turn off automatically, or prevent you from switching on in all air flow modes except MAX A/C to reduce the risk of fogging. Recirculation may also turn on and off automatically in various air distribution control combinations to improve heating or cooling efficiency.

## SWITCHING AIR CONDITIONING ON AND OFF



Press the button.

**Note:** Under certain conditions, the air conditioning compressor could continue to operate after you switch air conditioning off.

**Note:** To keep the system and its components fully functional, switch air conditioning on and let your vehicle idle at least once per month for a minimum of two minutes.

## SWITCHING DEFROST ON AND OFF



Press the button to switch the windshield air vents on.



Make sure that the instrument panel air vents are switched off.



Make sure that the footwell air vents are switched off.

## SWITCHING MAXIMUM DEFROST ON AND OFF



Turn the temperature control clockwise past the highest setting to maximize defrosting.

**Note:** The temperature control springs back to the highest setting.

Air flows through the windshield air vents, and the blower motor adjusts to the highest speed.

**Note:** To prevent window fogging, you cannot select recirculated air when maximum defrost is on.

**Note:** The heated rear window also turns on when you select maximum defrost.



# Climate Control - Vehicles With: Manual Temperature Control

## SWITCHING MAXIMUM COOLING ON AND OFF

**MAX A/C** Turn the temperature control counterclockwise past the lowest setting to maximize cooling.

**Note:** The temperature control springs back to the lowest setting.

**Note:** When you switch maximum cooling off, air conditioning remains on.

## SWITCHING THE HEATED REAR WINDOW ON AND OFF (IF EQUIPPED)

**REAR** Press the button to clear the rear window of thin ice and fog. The heated rear window turns off after a short period of time.

**Note:** Do not use harsh chemicals, razor blades or other sharp objects to clean or remove decals from the inside of the heated rear window as this could cause damage to the heated rear window grid lines not covered by the vehicle Warranty.

## SETTING THE BLOWER MOTOR SPEED



Turn the blower motor control counterclockwise for a lower blower setting.

Turn the blower motor control clockwise for a higher blower setting.

**Note:** Lights on the control illuminate to indicate the blower motor speed.

**Note:** When you switch the blower motor off, air conditioning turns off and the windows could fog up.

## SWITCHING THE HEATED MIRRORS ON AND OFF

When you switch the heated rear window on, the heated exterior mirrors turn on. See **Switching the Heated Rear Window On and Off** (page 149).

**MIRROR** You can also turn on and off the heated exterior mirrors using the mirror defrost button.

**Note:** Do not remove ice from the mirrors with a scraper or adjust the mirror glass when it is frozen in place.

# Climate Control - Vehicles With: Manual Temperature Control

**Note:** Do not clean the mirror housing or glass with harsh abrasives, fuel or other petroleum-based cleaning products. The vehicle warranty may not cover damage caused to the mirror housing or glass.

**Note:** The engine must be running or your vehicle must be ready to drive to switch the system on.

## SETTING THE TEMPERATURE

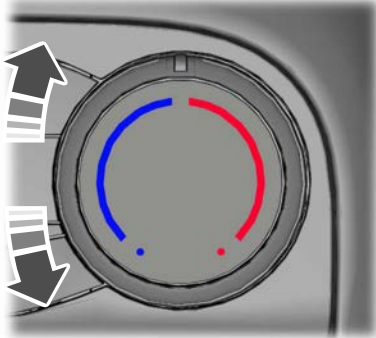

Turn the temperature control counterclockwise for cooler temperature settings.

Turn the temperature control clockwise for warmer temperature settings.

## DIRECTING THE FLOW OF AIR

### Directing Air to the Windshield Air Vents



Press the button.

### Directing Air to the Instrument Panel Air Vents



Press the button.

### Directing Air to the Footwell Air Vents



Press the button.

## CLIMATE CONTROL HINTS

### General Hints

- Prolonged use of recirculated air may cause the windows to fog up.
- You may feel a small amount of air from the footwell air vents regardless of the air distribution setting.
- To reduce humidity build-up inside your vehicle, do not drive with the system switched off or with recirculated air always switched on.
- Do not place objects under the front seats as this may interfere with the airflow to the rear seats.
- Remove any snow, ice or leaves from the air intake area at the base of the windshield.
- To improve the time to reach a comfortable temperature in hot weather, drive with the windows open until you feel cold air through the air vents.

### Quickly Heating the Interior

1. Adjust the blower motor speed to the highest speed setting.
2. Adjust the temperature control to the highest setting.
3. Direct air to the footwell air vents.

# Climate Control - Vehicles With: Manual Temperature Control

---

## Recommended Settings for Heating

1. Adjust the blower motor speed to the center setting.
2. Adjust the temperature control to the midway point of the hot settings.
3. Direct air to the footwell air vents.

## Quickly Cooling the Interior

1. Turn the temperature control counterclockwise past the lowest setting.
2. Drive with the windows open for a short period of time.

## Recommended Settings for Cooling

1. Adjust the blower motor speed to the center setting.
2. Adjust the temperature control to the midway point of the cold settings.
3. Direct air to the instrument panel air vents.

## Defogging the Side Windows in Cold Weather

1. Direct air to the instrument panel and windshield air vents.
2. Press and release **A/C**.
3. Adjust the temperature control to the setting you prefer.
4. Adjust the blower motor speed to the highest setting.
5. Direct air toward the side windows.
6. Close the instrument panel air vents.

## CLIMATE CONTROL VIDEOS

[\*Heated Mirrors\*](#)

# Interior Air Quality

## WHAT IS THE CABIN AIR FILTER

The cabin air filter improves the quality of air in your vehicle by trapping dust, pollen and other particles.

## REPLACING THE CABIN AIR FILTER

Replace the filter at regular intervals.

The cabin air filter is behind the glove compartment.

To remove the lower glove compartment and access the filter:

1. Open the glove compartment.

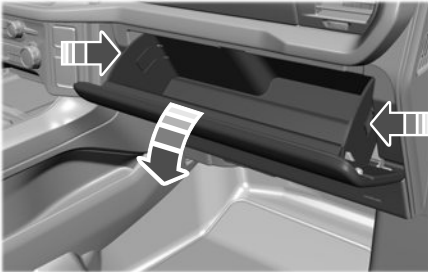

2. Press the tab on each side.
3. Fully lower the glove compartment.
4. Pull the glove compartment toward you.
5. Unclip both sides of the filter door and swing door down to access filter .

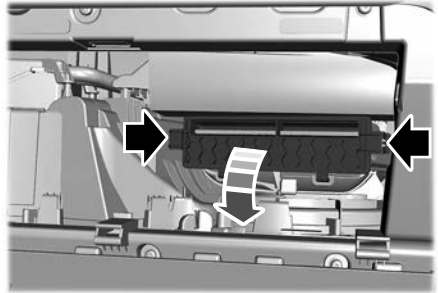

6. Remove the old filter and replace with a new filter.

# Front Seats

## FRONT SEAT PRECAUTIONS



**WARNING:** Sitting improperly, out of position or with the seatback reclined too far can take weight off the seat cushion and affect the decision of the passenger sensing system, resulting in serious injury or death in the event of a crash. Always sit upright against your seat back, with your feet on the floor.



**WARNING:** Do not recline the seat backrest too far as this can cause the occupant to slide under the seatbelt, resulting in personal injury in the event of a crash.



**WARNING:** Do not place objects higher than the top of the seat backrest. Failure to follow this instruction could result in personal injury or death in the event of a sudden stop or crash.



**WARNING:** Do not adjust the driver seat or seat backrest when your vehicle is moving. This may result in sudden seat movement, causing the loss of control of your vehicle.

## SITTING IN THE CORRECT POSITION

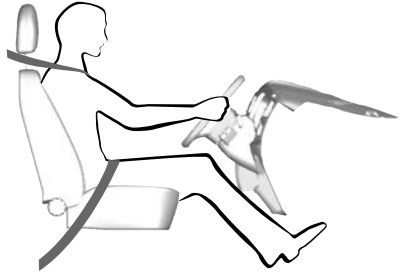

When you use them properly, the seat, head restraint, seatbelt and airbags will provide optimum protection in the event of a crash.

We recommend that you follow these guidelines:

- Sit in an upright position with the base of your spine as far back as possible.
- Do not recline the seat backrest so that your torso is more than 30 degrees from the upright position.
- Adjust the head restraint so that the top of it is level with the top of your head and as far forward as possible. Make sure that you remain comfortable.
- Keep sufficient distance between yourself and the steering wheel. We recommend a minimum of 10 in (25 cm) between your breastbone and the airbag cover.
- Hold the steering wheel with your arms slightly bent.

# Front Seats

- Bend your legs slightly so that you can press the pedals fully.
- Position the shoulder strap of the seatbelt over the center of your shoulder and position the lap strap tightly across your hips.

Make sure that your driving position is comfortable and that you can maintain full control of your vehicle.

## MANUAL SEATS

### HEADRESTRAINT COMPONENTS

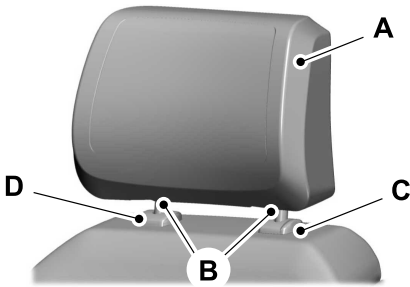

The head restraints consist of:

- A An energy absorbing head restraint.
- B Two steel stems.
- C Guide sleeve adjust and release button.
- D Guide sleeve unlock and remove button - if equipped.

### Center Head Restraint - If Equipped

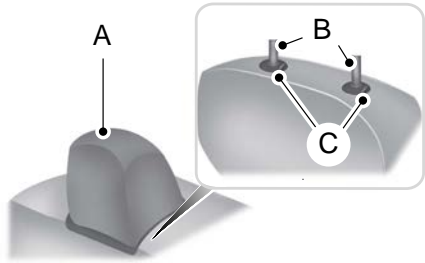

- A An energy absorbing head restraint.
- B Two steel stems.
- C Guide sleeve unlock and remove buttons.

### ADJUSTING THE HEAD RESTRAINT

**⚠ WARNING:** Fully adjust the head restraint before you sit in or operate your vehicle. This will help minimize the risk of neck injury in the event of a crash. Do not adjust the head restraint when your vehicle is moving.

**⚠ WARNING:** The head restraint is a safety device. Whenever possible it should be installed and properly adjusted when the seat is occupied. Failure to adjust the head restraint properly could reduce its effectiveness during certain impacts.

**⚠ WARNING:** Adjust the head restraints for all passengers before you drive your vehicle. This will help minimize the risk of neck injury in the event of a crash. Do not adjust the head restraints when your vehicle is moving.

# Front Seats

**Note:** Adjust the seat backrest to an upright driving position before adjusting the head restraint. Adjust the head restraint so that the top of it is level with the top of your head and as far forward as possible. Make sure that you remain comfortable. If you are extremely tall, adjust the head restraint to its highest position.

Pull the head restraint up to raise it.

To lower the head restraint:

1. Press and hold the adjust and release button.
2. Push the head restraint down.



For vehicles with tilting head restraints:

1. Adjust the seat backrest to an upright driving or riding position.
2. Pivot the head restraint forward toward your head to the preferred position.

After the head restraint reaches the forward-most tilt position, pivot it forward again to release it to the rearward, untilted position.

**Note:** Do not attempt to force the head restraint backward after it is tilted. Instead, continue tilting it forward until the head restraint releases to the upright position.

## REMOVING THE HEADRESTRAINT

1. Pull up the head restraint until it reaches the highest adjustment position.
2. Press and hold the adjust and release button and the unlock and remove button.
3. Pull up the head restraint.

**Note:** Your vehicle may have a front row center head restraint that you cannot adjust or remove.

## INSTALLING THE HEAD RESTRAINT

Align the steel stems into the guide sleeves and push the head restraint down until it locks.

## MOVING THE SEAT BACKWARD AND FORWARD



**WARNING:** Do not adjust the driver seat or seat backrest when your vehicle is moving. This may result in sudden seat movement, causing the loss of control of your vehicle.



**WARNING:** Make sure the seat fully locks into place by rocking it backward and forward. Not securing the seat into the locked position can be dangerous in a crash and could cause serious personal injury or death.

# Front Seats



## ADJUSTING THE LUMBAR SUPPORT

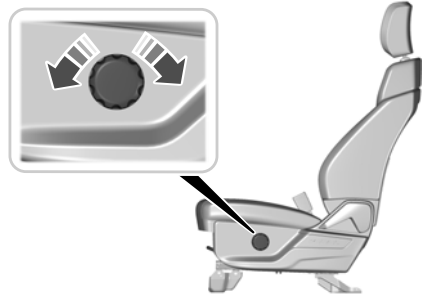

## ADJUSTING THE SEAT BACKREST

**WARNING:** Always drive and ride with your seatback upright and the lap belt snug and low across the hips.

**WARNING:** Do not place cargo or any objects behind the seat backrest before returning it to the original position. Pull on the seat backrest to make sure that it has fully latched after returning the seat backrest to its original position. An unlatched seat may become dangerous if you stop suddenly or have a crash.



## POWER SEATS (IF EQUIPPED)

## HEADRESTRAINT COMPONENTS

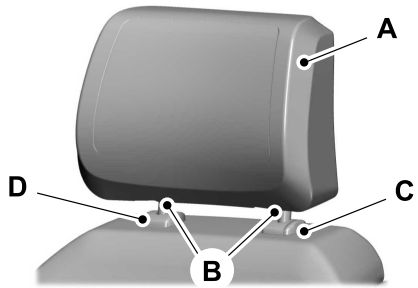

The head restraints consist of:

- A An energy absorbing head restraint.
- B Two steel stems.
- C Guide sleeve adjust and release button.
- D Guide sleeve unlock and remove button.



# Front Seats

## Center Head Restraint - If Equipped

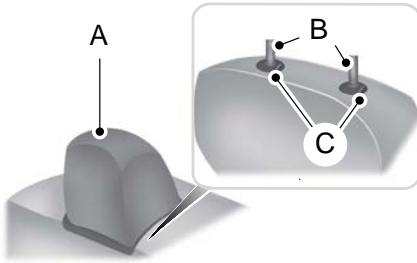

- A An energy absorbing head restraint.
- B Two steel stems.
- C Guide sleeve unlock and remove buttons.

## ADJUSTING THE HEAD RESTRAINT

**WARNING:** Fully adjust the head restraint before you sit in or operate your vehicle. This will help minimize the risk of neck injury in the event of a crash. Do not adjust the head restraint when your vehicle is moving.

**WARNING:** The head restraint is a safety device. Whenever possible it should be installed and properly adjusted when the seat is occupied. Failure to adjust the head restraint properly could reduce its effectiveness during certain impacts.

**WARNING:** Adjust the head restraints for all passengers before you drive your vehicle. This will help minimize the risk of neck injury in the event of a crash. Do not adjust the head restraints when your vehicle is moving.

To raise the head restraint, pull the head restraint up.

To lower the head restraint:

1. Press and hold the adjust and release button.
2. Push the head restraint down.

To tilt the head restraint:



1. Adjust the seat backrest to an upright driving or riding position.
2. Pivot the head restraint forward toward your head to the preferred position.

After the head restraint reaches the forward-most tilt position, pivot it forward again to release it to the rearward, untilted position.

**Note:** Do not attempt to force the head restraint backward after it is tilted. Instead, continue tilting it forward until the head restraint releases to the upright position.

## REMOVING THE HEAD RESTRAINT

1. Pull up the head restraint until it reaches its highest position.
2. Press and hold the adjust and release button and the unlock and remove button.
3. Pull up the head restraint.

# Front Seats

**Note:** Your vehicle may have a front row center head restraint that you cannot adjust or remove.

## INSTALLING THE HEAD RESTRAINT

Align the steel stems into the guide sleeves and push the head restraint down until it locks.

## MOVING THE SEAT BACKWARD AND FORWARD

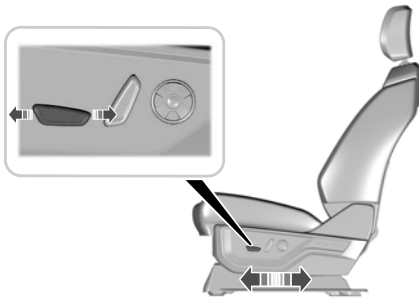

## ADJUSTING THE SEAT CUSHION

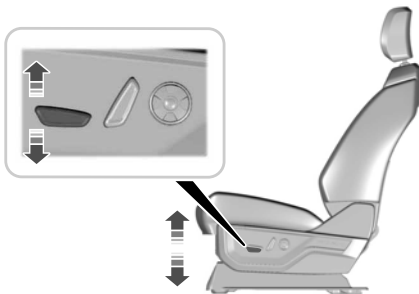

## ADJUSTING THE SEAT BACKREST

**WARNING:** Always drive and ride with your seatback upright and the lap belt snug and low across the hips.

**WARNING:** Do not place cargo or any objects behind the seatback before returning it to the original position.

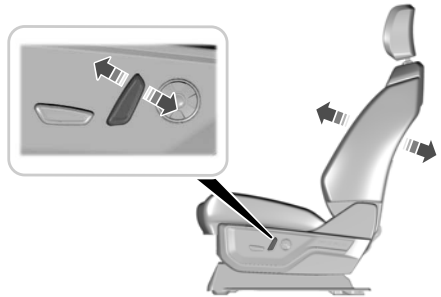

## Adjusting the Seat Flat (If Equipped)

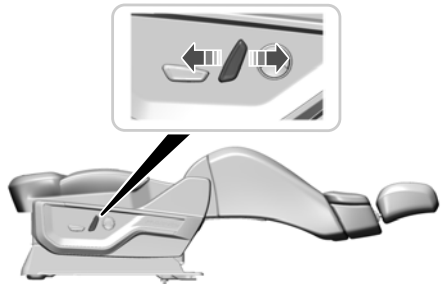

This feature allows the occupant to find a comfortable position to rest when the vehicle is not moving.

# Front Seats

**Note:** Before adjusting the seat backrest fully flat, place the rear seat cushion into the upright position and remove any objects that could obstruct the movement of the flat seat. See **Folding the Seats** (page 167).

As the seat folds flat, the cushion adjusts to support the hips and lower back. For additional support, you can also adjust the upper seat backrest.

If you fully recline the passenger seat and the vehicle is moving, a message appears on the instrument cluster and a tone sounds. To switch the warning off, return the seat to an upright position.

## Adjusting the Upper Seat Backrest (If Equipped)

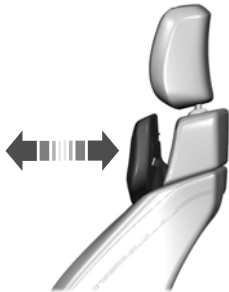

The front upper seat backrest tilts for extra comfort. To tilt the upper seat backrest, pivot the upper seat backrest toward your shoulders.

After the upper seat backrest reaches the forward-most tilt position, pivot it forward again to release it to the rearward, untilted position.

## ADJUSTING THE SEAT HEIGHT



E390743

## ADJUSTING THE LUMBAR SUPPORT

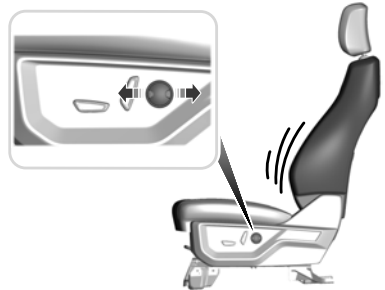

## MASSAGE SEATS (IF EQUIPPED)

### MASSAGE SEAT LIMITATIONS

Your vehicle must be running or be in accessory mode to activate the seats.

Allow a few seconds for any selection to activate. Selecting a different adjustment cancels the current one in progress. When the seat backrest and cushion are both active, the massage alternates between zones.

# Front Seats

## ADJUSTING THE MASSAGE SEAT SETTINGS

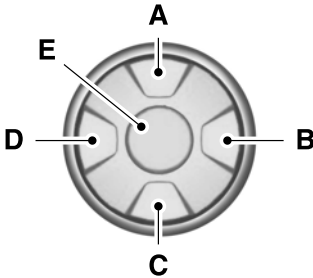

- A Select the previous massage pattern or lumbar area.
- B Decrease the massage or lumbar Intensity.
- C Select the next massage pattern or lumbar area.
- D Increase the massage or lumbar Intensity.
- E Select the massage or lumbar mode.

You can also adjust this feature through the touchscreen.

## HEATED SEATS (IF EQUIPPED)

### HEATED SEAT PRECAUTIONS



**WARNING:** Use caution when using the heated seat if you are unable to feel pain to your skin because of advanced age, chronic illness, diabetes, spinal cord injury, medication, alcohol use, exhaustion or other physical conditions. The heated seat could cause burns even at low temperatures, especially if used for long periods of time. Failure to follow this instruction could result in personal injury.



**WARNING:** Do not poke sharp objects into the seat cushion or seat backrest. This could damage the heated seat element and cause it to overheat. Failure to follow this instruction could result in personal injury.



**WARNING:** Do not place anything on the seat that blocks the heat, for example a seat cover or a cushion. This could cause the seat to overheat. Failure to follow this instruction could result in personal injury.

Do not:

- Place heavy objects on the seat.
- Operate the heated seat if water or any other liquid spills on the seat. Allow the seat to dry.

## SWITCHING THE HEATED SEATS ON AND OFF

The vehicle must be running to use this feature.

# Front Seats



Press the heated seat symbol on the climate controls or touchscreen to cycle through the various heat settings and off. The more indicators that display, the warmer the temperature of the seat.

**Note:** *The heated seats may remain on after you remote start your vehicle, based on your remote start settings. The heated seats may also turn on when you start your vehicle if they were on when you switched your vehicle off.*

## VENTILATED SEATS (IF EQUIPPED)

### VENTILATED SEAT PRECAUTIONS

Do not:

- Spill liquid on the front seats. This may cause the air vent holes to become blocked and not work properly.
- Place cargo or objects under the seats. They may block the air intake causing the air vents to not work properly.

### SWITCHING THE VENTILATED SEATS ON AND OFF

The vehicle must be running to use this feature.



Press this symbol on the climate controls or the touchscreen to cycle through the various ventilation settings and off. More indicator lights indicate higher fan speeds.

**Note:** *When you switch the climate control fan speed and the ventilated seats to their maximum settings, the ventilated seats provide increased cooling.*

If the engine falls below 350 RPM while the ventilated seats are on, the feature turns itself off unless the vehicle is in Auto-Start-Stop mode. You may need to reactivate the ventilated seats.

**Note:** *The ventilated seats may remain on after you remote start your vehicle, based on your remote start settings. The ventilated seats may also turn on when you start your vehicle if they were on when you switched your vehicle off.*

## FRONT SEATS VIDEOS

[4-Way Head Restraints Video Link](#)

[Max Recline Seats Video Link](#)

# Rear Seats - Crew Cab/SuperCab

## MANUAL SEATS

### HEADRESTRAINT COMPONENTS

#### Outermost Head Restraints

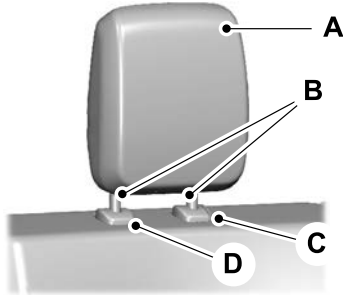

The head restraints consist of:

- A An energy absorbing head restraint.
- B Two steel stems.
- C Guide sleeve adjust and release button.
- D Guide sleeve unlock and remove button.

#### Center Head Restraint - Crew Cab and Super Cab

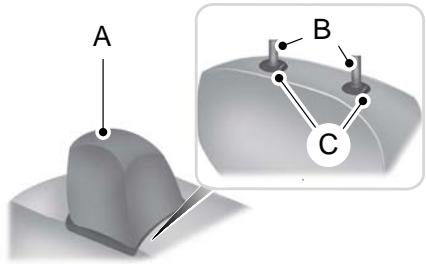

- A An energy absorbing head restraint.
- B Two steel stems.
- C Guide sleeve unlock and remove buttons.

### ADJUSTING THE HEAD RESTRAINT

Pull the head restraint up to raise it.

To lower the head restraint:

1. Press and hold the adjust and release button.
2. Push the head restraint down.

Your vehicle may have a rear seat center head restraint that you cannot adjust or remove.

### REMOVING THE HEAD RESTRAINT

1. Pull up the head restraint until it reaches its highest position.
2. Press and hold the adjust and release button and the unlock and remove button.
3. Pull up the head restraint.

# Rear Seats - Crew Cab/SuperCab

## INSTALLING THE HEAD RESTRAINT

Align the steel stems into the guide sleeves and push the head restraint down until it locks.

## FOLDING THE SEATS

If your vehicle has a split folding rear seat, you can flip each seat cushion up into a vertical storage position.



Rotate the seat cushion up until it locks in place.

### Locking the Cushion (If Equipped)

The locking key is in the remote control. See **Using the Remote Control** (page 69).

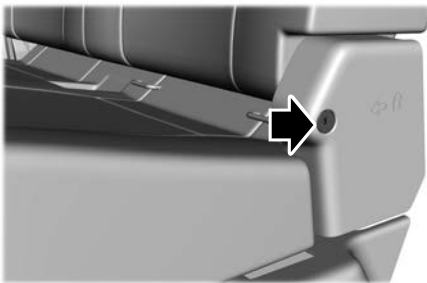

Turn the key to lock or unlock.

## UNFOLDING THE SEATS

**WARNING:** Make sure that cargo and other objects are not trapped under the seat cushion and that you return the seat cushion to the full-down position. Failure to do so may prevent the seat from operating properly, which could increase the risk of serious injury in a crash.



Pull the strap to lower the seat cushion.

### Rear Under Seat Storage (If Equipped)

The rear seat has storage space under the seat cushion.

## Rear Seats - Crew Cab/SuperCab

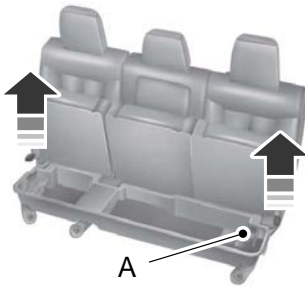

Lift the lever and flip up the seat cushion to access the storage space and the power point (A).

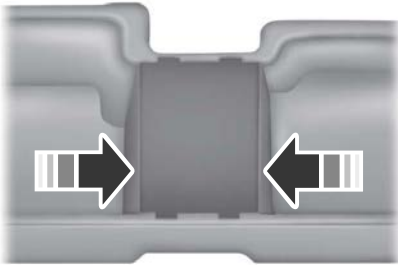

To remove the storage space divider, squeeze the sides and lift it from the storage tub.



Use your vehicle key to lock the storage space. See **Keys and Remote Controls** (page 69).

### HEATED SEATS (IF EQUIPPED)

#### HEATED SEAT PRECAUTIONS

**WARNING:** Use caution when using the heated seat if you are unable to feel pain to your skin because of advanced age, chronic illness, diabetes, spinal cord injury, medication, alcohol use, exhaustion or other physical conditions. The heated seat could cause burns even at low temperatures, especially if used for long periods of time. Failure to follow this instruction could result in personal injury.

**WARNING:** Do not poke sharp objects into the seat cushion or seat backrest. This could damage the heated seat element and cause it to overheat. Failure to follow this instruction could result in personal injury.

**WARNING:** Do not place anything on the seat that blocks the heat, for example a seat cover or a cushion. This could cause the seat to overheat. Failure to follow this instruction could result in personal injury.

Do not:

- Place heavy objects on the seat.
- Operate the heated seat if water or any other liquid spills on the seat. Allow the seat to dry.



# Rear Seats - Crew Cab/SuperCab

---

## **SWITCHING THE HEATED SEATS ON AND OFF**

The vehicle must be running to use this feature.

The rear seat heat controls are on the rear of the center console.



Press the heated seat symbol to cycle through the various heat settings and off. More indicator lights indicate warmer settings.

The heated seats turn off when you switch off the vehicle.

# Rear Occupant Alert System (If Equipped)

## WHAT IS THE REAR OCCUPANT ALERT SYSTEM

The rear occupant alert system monitors vehicle conditions and notifies you to check for rear seat occupants when you switch the ignition off. The notifications can be in the form of warnings inside the vehicle and sounding of the horn if activated for a short period of time.

## HOW DOES THE REAR OCCUPANT ALERT SYSTEM WORK

The system monitors the activity of the buckle on the rear seatbelt and the opening and closing of the rear doors to indicate the potential presence of an occupant in the rear seat.

When **Child Seat Installed** is selected, the system monitors only the opening and closing of the rear doors to indicate the potential presence of an occupant in the rear seat.

When **Child Seat Installed** is not selected, the system monitors the rear seatbelt buckle activity and the opening and closing of the rear doors to indicate the potential presence of an occupant in the rear seat.

A message displays in the touchscreen and an audible warning sounds when you switch the ignition off after any of the following conditions have been met:

- A rear door is opened or closed while the ignition is on.
- You switch the ignition on within 15 minutes of a rear door opening and closing.
- You switch the ignition on within 15 minutes of the alert having displayed or sounded.

If you do not open a rear door within a short period of time of the message appearing in the center display, the first audible warning sounding and driver door open to close, the horn sounds for a short period of time.

**Note:** *Horn sounds only when the **Rear Occupant Alert** is set to **Alert & Horn**. If you change the setting, then there is no horn sound.*

## REAR OCCUPANT ALERT SYSTEM PRECAUTIONS



**WARNING:** On hot days, the temperature inside the vehicle can rise very quickly. Exposure of people or animals to these high temperatures for even a short time can cause death or serious heat related injuries, including brain damage. Small children are particularly at risk.



**WARNING:** Do not leave children or pets unattended in your vehicle. Failure to follow this instruction could result in personal injury or death.

## REAR OCCUPANT ALERT SYSTEM LIMITATIONS

The system does not detect the presence of objects or passengers in the rear seat. It monitors the activity of the buckle on the rear seatbelt and the opening and closing of the rear doors.

**Note:** *It is possible to receive an alert when there is no rear seat occupant, but alert conditions are met.*

## Rear Occupant Alert System (If Equipped)

**Note:** It is possible to receive no alert when there is an occupant in the rear seat, if alert conditions are not met. For example, if a rear seat occupant does not enter the vehicle through a rear door.

### REAR OCCUPANT ALERT SYSTEM SETTINGS

1. From the settings menu, press vehicle See **Center Display** (page 562).
2. Press Rear Occupant Alert.
3. Select Alert & Horn or Alert Only or Off.

**Note:** The default setting is Alert Only.

**Note:** If you choose Alert only, the horn does not sound even when the alert conditions are met.

**Note:** Performing a master reset causes the system to switch on again.

### Switching Child Seat Installed On and Off

When the system is switched on, it monitors the opening and closing of the rear doors to indicate the potential presence of an occupant in the rear seat.

1. From the settings menu, press vehicle See **Center Display** (page 562).
2. Press Rear Occupant Alert.
3. Switch Child Seat Installed on or off.

**Note:** The default setting is on.

Switch the system on when the child restraint is mounted on any of the following:

- Forward facing seat.
- Rear facing seat.
- Toddler in a LATCH system child seat.

Switch the system off when the child is using any of the following:

- Seatbelt.
- Booster seat.

### Semiannual Reminder

When you switch the system off, a message appears every six months as a reminder that the system is off. You can switch the system back on or leave it off.

### REAR OCCUPANT ALERT SYSTEM INDICATORS



Message
Check rear seats for occupants.

Displays when you switch your vehicle off after the alert conditions are met.

The message displays for a short period of time. Press **Close** to acknowledge and remove the message.

**Note:** Depending on your SYNC version, the graphic may look different from what you see here.

## **Rear Occupant Alert System (If Equipped)**

---

### **REAR OCCUPANT ALERT SYSTEM AUDIBLE WARNINGS**

The first audible warning is an alert tone within the vehicle, which sounds when you switch your vehicle off after the alert conditions are met. The warning sounds for a short period of time.

The second audible warning is from the horn. It sounds when you do not open a rear door within a short period of time of the message appearing in the center display, the first audible warning sounding, and driver door open to close. The warning sounds for a short period of time.

# Memory Function (If Equipped)

## WHAT IS THE MEMORY FUNCTION

The memory function recalls the position of these features:

- Driver seat.
- Power mirrors.
- Optional power steering column.
- Optional power adjustable pedals.

## MEMORY FUNCTION PRECAUTIONS



**WARNING:** Before activating the memory seat, make sure that the area immediately surrounding the seat is clear of obstructions and that all occupants are clear of moving parts.



**WARNING:** Do not use the memory function when your vehicle is moving.

## LOCATING THE MEMORY FUNCTION BUTTONS



The memory function buttons are on the driver door.

## SAVING A PRESET POSITION

1. Adjust the memory features to your preferred position.
2. Press and hold the preferred preset button until you hear a single tone.

A confirmation message appears in the information display.

You can save up to three preset memory positions at any time.

## RECALLING A PRESET POSITION

Press and release a preset button.

**Note:** You can recall a preset memory position when the ignition is off, or when you place the transmission in park (P) or neutral (N) if the ignition is on and the vehicle is not moving.

**Note:** Pressing any of the preset buttons or any memory feature control during a memory recall cancels the operation.

You can also recall a preset memory position by:

- Pressing the unlock button on your remote control if you linked it to a preset position.
- Unlocking the intelligent driver door handle if a linked remote control is present.

Using a linked remote control to recall your memory position when the ignition is off moves the seat and steering column to the easy entry position.

## Linking a Preset Position to Your Remote Control or Passive Key

See **Linking or Unlinking a Personal Profile** (page 577).

# Garage Door Opener (If Equipped)

## GARAGE DOOR OPENER INTRODUCTION

### HomeLink Wireless Control System

The universal garage door opener replaces the common handheld garage door opener with a three-button transmitter integrated into the driver-side sun visor.



### How Does The Garage Door Opener Work

The system includes two primary features, a garage door opener and a platform for remote activation of devices within the home. You can program garage doors as well as entry gate operators, security systems, entry door locks and home or office lighting.

Additional assistance can be found online at [www.homelink.com/Ford](http://www.homelink.com/Ford) or by calling the toll-free help line at 1-800-355-3515.

### Garage Door Opener Limitations

Canadian radio-frequency laws require transmitter signals to time out, or quit, after several seconds – which may not be long enough for HomeLink to pick up the signal. U.S. gate operators time-out in the same manner.

## GARAGE DOOR OPENER PRECAUTIONS AND FREQUENCIES

### Garage Door Opener Precautions



**WARNING:** Do not use the system with any garage door opener that does not have the safety stop and reverse feature as required by U.S. Federal Safety Standards (this includes any garage door opener manufactured before April 1, 1982). A garage door opener which cannot detect an object, signaling the door to stop and reverse, does not meet current federal safety standards. Using a garage door opener without these features increases the risk of serious injury or death.

### FCC and RSS-210 Industry Canada Compliance



**WARNING:** Changes or modifications not expressly approved by the party responsible for compliance could void the user's authority to operate the equipment. The term "IC:" before the radio certification number only signifies that Industry Canada technical specifications were met.

This device complies with Part 15 of the FCC Rules and with RSS-210 of Industry Canada. Operation is subject to the following two conditions: (1) this device may not cause harmful interference, and (2) this device must accept any interference received, including interference that may cause undesired operation.

## Garage Door Opener (If Equipped)

This equipment complies with FCC radiation exposure limits set forth for an uncontrolled environment. End Users must follow the specific operating instructions for satisfying RF exposure compliance. This transmitter must be at least 8 in (20 cm) from the user and must not be co-located or operating in conjunction with any other antenna or transmitter.

### PROGRAMMING THE GARAGE DOOR OPENER

To clear all stored codes in the garage door opener in your vehicle, use the **clear** function. To override one button, use the **reprogram** function.

**Note:** Make sure that the garage door and security device are free from obstruction when you are programming. Do not program the system with the vehicle in the garage.

#### Clearing the Garage Door Opener

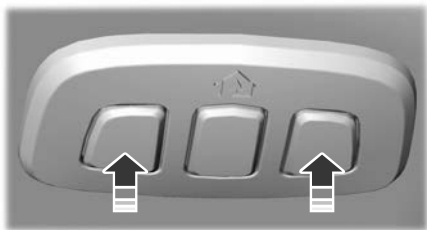

To clear all stored codes in the garage door opener in the vehicle:

1. Press and hold the outer two function buttons simultaneously for approximately 10 seconds until the indicator above the buttons flashes rapidly.
2. When the indicator flashes, release the buttons.

**Note:** This clears all stored codes. You cannot erase individual buttons.

**Note:** You can program a maximum of three devices. To change or replace any of the three devices after they have been initially programmed, you must either clear all codes, or reprogram each individual button.

**Note:** We recommend that upon the sale or lease termination of your vehicle, you erase the programmed function buttons for security reasons.

#### Reprogramming the Garage Door Opener

If a button on your garage door opener has already been programmed, you can override it. To program a device to a previously trained button:

1. Press and hold the desired button for approximately 20 seconds until the indicator begins to flash.
2. Without releasing the button, proceed to Step 3 of **Programming the Garage Door Opener to your Handheld Transmitter**.

#### Programming the Garage Door Opener to your Handheld Transmitter

**Note:** The programming steps below assume you are programming a HomeLink that was not previously programmed. If your HomeLink was previously programmed, you may need to **clear** or **reprogram** your HomeLink buttons.

**Note:** Put a new battery in the handheld transmitter. This allows for quicker training and accurate transmission of the radio-frequency signal.

**Note:** Make sure that the garage door and security device are free from obstruction when you are programming. Do not program the system with the vehicle in the garage.

## Garage Door Opener (If Equipped)

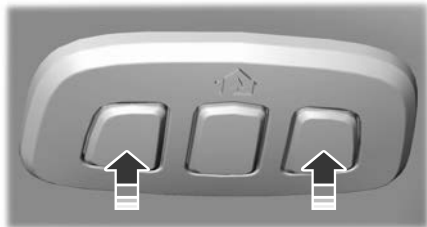

To program your in-vehicle HomeLink function button with your handheld transmitter:

1. With your vehicle parked outside of the garage, switch your vehicle on, but do not start your vehicle.
2. Press and release one of the three HomeLink function buttons that you would like to program.

**Note:** The indicator should begin to flash. If the indicator does not flash, press and hold the function button for 20 seconds until the indicator begins to flash.

3. Hold your handheld garage door transmitter 1–3 in (2–8 cm) away from the HomeLink button you want to program.
4. Press and hold the handheld transmitter button you want to program while watching the indicator on HomeLink. Continue to hold the handheld button until the HomeLink indicator flashes rapidly or is continuously on.

**Note:** You may need to use a different method if you live in Canada or have difficulties programming your gate operator or garage door opener.

5. Press and hold the HomeLink button you programmed for two seconds, then release. You may need to do this twice to activate the door.

**Note:** If the indicator stays on, the programming is complete.

**Note:** If the HomeLink indicator flashes rapidly, repeat Step 5.

**Note:** If your device still does not operate, you must program your garage door.

6. To program additional buttons, repeat Steps 1–4.

**Note:** Make sure you keep the original remote control transmitter for use in other vehicles as well as for future system programming.

### Programming the Garage Door Opener to your Garage Door Opener Motor

**Note:** Make sure that the garage door and security device are free from obstruction when you are programming. Do not program the system with the vehicle in the garage.



1. Press the learn button on the garage door opener motor and then you have 30 seconds to complete the next two steps.
2. Return to your vehicle.



## Garage Door Opener (If Equipped)

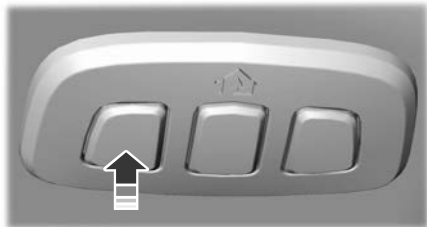

3. Press and hold one of the three HomeLink function buttons you want to program for two seconds, then release.
4. Repeat Step 3. Depending on your brand of garage door opener, you may need to repeat this sequence a third time.

Additional assistance can be found online at [www.homelink.com/Ford](http://www.homelink.com/Ford) or by calling the toll-free help line at 1-800-355-3515.

### Programming the Garage Door Opener to your Gate Opener Motor

#### Gate Operator / Canadian Programming

Canadian radio-frequency laws require transmitter signals to time-out (or quit) after several seconds of transmission – which may not be long enough for HomeLink to pick up the signal during programming. Similar to this Canadian law, some U.S. gate operators are designed to time-out in the same manner.

**Note:** *If programming a garage door opener or gate operator, it is advised that you unplug the device during the **cycling** process to prevent possible overheating.*

1. Press and release your handheld transmitter, **every two seconds**, until the HomeLink indicator flashes rapidly or is continuously on.

2. Release the handheld transmitter button.
3. Press and hold the HomeLink function button you want to program for two seconds, then release. You may need to do this twice to activate the door.

**Note:** *If the indicator stays on, the programming is complete.*

**Note:** *If the HomeLink indicator flashes rapidly, repeat Step 3.*

4. To program additional buttons, repeat Steps 1–4.

Additional assistance can be found online at [www.homelink.com/Ford](http://www.homelink.com/Ford) or by calling the toll-free help line at 1-800-355-3515.

## GARAGE DOOR OPENER ADDITIONAL ASSISTANCE

### Video Setup Instructions

[Universal Garage Door Opener: HomeLink](#)

[Universal Garage Door Opener: HomeLink for Genie Intellicode 2](#)

[Universal Garage Door Opener HomeLink for Genie Intellicode](#)

Additional assistance can be found online at [www.homelink.com/Ford](http://www.homelink.com/Ford) or by calling the toll-free help line at 1-800-355-3515.

# USB Ports

## LOCATING THE USB PORTS

### Data Transfer USB Ports



The USB ports could be in the following locations:

- On the lower instrument panel.
- Inside the center console.

**Note:** *These USB ports can also charge devices.*

**Note:** *Not all USB ports in your vehicle have data transfer capabilities.*

**Note:** *We recommend using only USB-IF certified cables and adapters. Non-certified cables and adapters may not work.*

### Charge Only USB Ports



The USB ports could be in the following locations:

- On the lower instrument panel.
- On the upper instrument panel.
- Inside the media bin.
- Inside the center console.
- On the rear of the center console.
- Behind the first row seats.
- In the cargo area.

## PLAYING MEDIA USING THE USB PORT



**WARNING:** Driving while distracted can result in loss of vehicle control, crash and injury. We strongly recommend that you use extreme caution when using any device that may take your focus off the road. Your primary responsibility is the safe operation of your vehicle. We recommend against the use of any hand-held device while driving and encourage the use of voice-operated systems when possible. Make sure you are aware of all applicable local laws that may affect the use of electronic devices while driving.

Connect your device to a data transfer USB port.



Press the audio button on the feature bar.

Select **Sources**.



Select the USB option.



Press to play a track. Press again to pause the track.



Press to skip to the next track.

Press and hold to fast forward through the track.



Press once to return to the beginning of a track. Repeatedly press to return to previous

tracks.

Press and hold to fast rewind.

## CHARGING A DEVICE

Connect your device to the USB port.

# USB Ports

---

## Data Transfer USB Ports



You can charge your device through the data transfer USB port when SYNC is on.

## Charge Only USB Ports



You can charge your device through the charge only USB port when the vehicle is in accessory mode or when the vehicle is running.

# Power Outlet - Vehicles With: 110V Power Outlet

## WHAT IS THE POWER OUTLET

The power outlet can power devices that require up to the rating on the outlet cover.

**Note:** The total power delivered is divided if more than one outlet is used.

## POWER OUTLET PRECAUTIONS



**WARNING:** Do not use an extension cord or connect multiple devices to the power outlet. Doing so could result in overloading the power outlet. Failure to follow this instruction could result in fire, personal injury or property damage.



**WARNING:** Do not keep electrical devices plugged into the power outlet whenever the device is not in use. The outlet provides power when the vehicle is on. Failure to follow this instruction could result in personal injury.

## POWER OUTLET LIMITATIONS

You should not use the power outlet for these types of electric devices:

- Cathode ray tube type televisions.
- Motor loads, such as vacuum cleaners, electric saws or other electric power tools and compressor-driven refrigerators.
- Measuring devices which process precise data, such as medical equipment or measuring equipment.
- Other appliances requiring an extremely stable power supply, such as microcomputer-controlled electric blankets or touch sensor lamps.

**Note:** Some devices may exceed the power rating on the device label when they are initially plugged-in and may require you to press the device power button more than one time in order to allow a soft start. After multiple attempts, if the device remains off, please consider that your device may require more than the available power.

**Note:** The power outlet provides full available power when the vehicle is in park (P). Power availability may be reduced when the vehicle is in drive (D). If more than one outlet is available in the vehicle, power is divided between the outlets that are in use at the same time.

## LOCATING THE POWER OUTLETS

The power outlet may be located on the instrument panel or the rear of the center console.

### Instrument Panel



# Power Outlet - Vehicles With: 110V Power Outlet

## Rear of the Center Console



2. Switch your vehicle off to let the system cool and reset the fault mode.
3. Switch your vehicle back on, but do not plug your device back in.
4. With your vehicle on, make sure the indicator light remains on.
5. Make sure your device does not exceed the power limits and then plug in your device.

**Note:** *If a fault occurs again, your device may exceed the capacity available from the power outlet.*

## POWER OUTLET VIDEOS

[Powerpoints Video Link](#)

## POWER OUTLET INDICATORS

The power outlet indicator illuminates to let you know the status of the system.

Indicator Status	Description
On	When the indicator light is on, the outlet is providing power.
Off	When the indicator light is off, there is no power to the outlet.
Flashing	When the indicator light is flashing, the outlet is in a fault mode.

## Fault mode

The power outlet temporarily turns off power if the device exceeds the watt limit.

1. Unplug your device.

# Onboard Generator (If Equipped)

## WHAT IS THE ONBOARD GENERATOR

The vehicle functions as a portable generator and can power devices that require up to the rating listed on the power outlet label.

## ONBOARD GENERATOR PRECAUTIONS



**WARNING:** Do not connect any vehicle power outlets to any premises. This can create a backfeed to utility lines. Failure to follow this instruction could result in property damage, fire, electrical shock or death.



**WARNING:** Do not keep electrical devices plugged into the power outlet whenever the device is not in use. The outlet provides power when the vehicle is on. Failure to follow this instruction could result in personal injury.



**WARNING:** Do not start the engine in a closed garage or in other enclosed areas. Exhaust fumes are toxic. Always open the garage door before you start the engine. Failure to follow this instruction could result in personal injury or death.



**WARNING:** Exhaust leaks may result in entry of harmful and potentially lethal fumes into the passenger compartment. If you smell exhaust fumes inside your vehicle, have your vehicle inspected immediately. Do not drive if you smell exhaust fumes.



**WARNING:** The vehicle's engine runs while the generator is switched on. Running engines emit carbon monoxide. Only use the generator when the vehicle is outdoors. Failure to follow this instruction could result in personal injury or death.

When you switch the power outlets on, the vehicle power down timer is disabled and the vehicle continues to be powered on.

**Note:** We recommend using UL approved devices for use with the power outlet.

**Note:** Make sure that plugged in devices do not exceed the ratings displayed on the outlet covers.

**Note:** Unplug electrical devices from the power outlet when they are not switched on.

**Note:** Make sure there is no damage to the outlets before driving your vehicle.

**Note:** Power could be limited during extreme hot or cold temperatures to optimize system performance.

**Note:** Close all outlet covers when not in use.

**Note:** Automatic engine stop is disabled and the gasoline engine will continue to idle when the outlet is switched on.

**Note:** Make sure that objects are not blocking the inverter inlet and exhaust near the rear underseat storage compartment.

**Note:** The climate control system may turn on and power may be limited during extreme hot or cold temperatures to optimize system performance.

**Note:** When the outlet is switched on and the vehicle is in park (P) the engine turns off 30 minutes after the low fuel warning is displayed. After the vehicle is turned off, generator mode only operates while driving or until the vehicle is refueled.

# Onboard Generator (If Equipped)

## Grounding Type

### Neutral Floating

The neutral of the inverter generator is isolated from system ground.

**Note:** *If additional grounding measures are required, consult with a qualified electrician.*

## LOCATING THE OUTLETS

The power outlets are in the cabin and bed of the vehicle.

### Bed Outlet

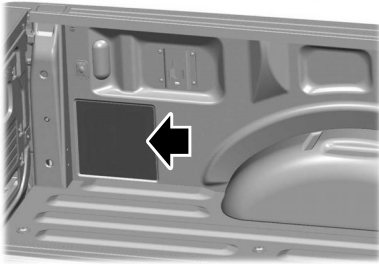

**Note:** *The outlet may be on the left or right-hand side of the bed depending on the vehicle.*

### Instrument Panel Outlet



### Rear Center Console Outlet



## ONBOARD GENERATOR INDICATORS

### Power Outlet Status Indicator

The power outlet indicator illuminates to let you know the status of the system.

## Onboard Generator (If Equipped)

Indicator Status	Description
On	The power point is working and the vehicle is on.
Off	The power point is off and the vehicle is off.
Flashing	The power point is in fault mode.

### Fault Mode

The power outlet temporarily turns off power if the device exceeds the watt limit.

1. Unplug your device.
2. Switch your vehicle off to let the system cool and reset the fault mode.
3. Switch your vehicle back on, but do not plug your device back in.
4. With your vehicle on, make sure the indicator light remains on.
5. Make sure your device does not exceed the power limits and then plug in your device.

**Note:** If a fault occurs again, your device may exceed the capacity available from the power outlet.

### Generator Mode Power Indicator

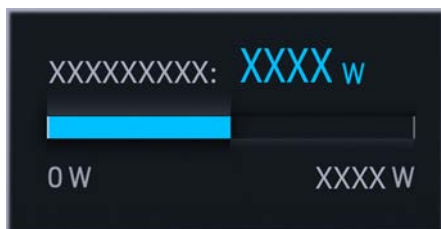

The generator mode power indicator displays the currently used power and total available power level on the touchscreen. When Generator Mode is switched off the indicator displays a reduced available power level. When generator mode is switched on the indicator displays the full available power.

**Note:** Additional indicators may be available based on vehicle configuration.

**Note:** Make sure that plugged in devices do not exceed the available power displayed on the power mode indicator.

**Note:** Maximum power may be reduced when the vehicle is in drive (D).

## SWITCHING THE OUTLETS ON AND OFF

### Using the Center Display Screen

1. Switch the vehicle on.
2. Press **Features** on the touchscreen.
3. Press **Pro Power Onboard**.

### Using the Bed Controls



Press the button to switch the power outlet on and off.



# Onboard Generator (If Equipped)

## WHAT IS UTILITY IDLE MODE

Utility idle mode allows you to remove the key from the ignition and keep the vehicle and bed power point running.

## SWITCHING UTILITY IDLE MODE ON AND OFF

### Switching Utility Idle On

1. Start the vehicle. See **Starting and Stopping the Engine** (page 197).
2. Press **Features** on the touchscreen.
3. Press **Pro Power Onboard**.
4. Press **Generator Mode**.
5. Press **Utility Idle**.
6. Press the brake pedal once.
7. Turn the key to position **0**.
8. Remove the key from the ignition.

### Switching Utility Idle Off using the Key

1. Insert the key into the ignition.
2. Turn the key to position **III**.

### Switching Utility Idle Off using the Center Display Screen

1. Start the vehicle. See **Starting and Stopping the Engine** (page 197).
2. Press **Features** on the touchscreen.
3. Press **Pro Power Onboard**.
4. Press **Generator Mode**.
5. Press **Utility Idle**.
6. Press **Turn Vehicle Off**.

## WHAT IS GENERATOR MODE

Generator mode uses the vehicle engine to increase power to the bed power outlets up to the rating listed on the power outlet label.

## SWITCHING GENERATOR MODE ON AND OFF

### Using the Center Display Screen

1. Start the vehicle. See **Starting and Stopping the Engine** (page 197).
2. Press **Features** on the touchscreen.
3. Press **Pro Power Onboard**.
4. Press Generator Mode.

### Using the Instrument Panel



Press the button to switch between off, low power mode and generator mode.

**Note:** *When the generator mode is off and the vehicle is on, you can power the devices up to 400W in the cabin through the low power mode.*

## RESETTING GROUND FAULT DETECTION

After disconnecting all electrical loads the ground fault can be reset using the switches on the power point, on the instrument panel or on the touchscreen.

Use the controls on the touchscreen to test the ground fault detection circuit.

## Onboard Generator (If Equipped)

### ONBOARD GENERATOR – TROUBLESHOOTING

#### ONBOARD GENERATOR – INFORMATION MESSAGES

Message	Description
Item(s) plugged in exceeded the system's maximum capacity. Try unplugging one or more items and reset. See owner's manual for details.	Make sure that plugged in devices do not exceed the available power displayed. Devices could exceed the power rating shown the device label when plugged in. Unplug the device and switch the vehicle on and off to reset the system.
Generator system is outside its operating temperature and capability is reduced. See owner's manual for details.	Power could be limited during extreme hot or cold temperatures to optimize the performance of the system.
Another power source is trying to supply power to your vehicle's AC outlets. Disconnect vehicle from that power source. See owner's manual for details.	Do not plug in any device that supplies power to the vehicle through the power outlets. This could result in damage to vehicle systems.
This button tests outlets for proper operation of ground fault detection. In a successful test, Pro Power Onboard detects the ground fault and turns off. See owner's manual for details.	The power outlet is in fault mode. Make sure that all devices are unplugged from the system. Use the controls on the touchscreen to reset the system. Switch your vehicle on and off if the touchscreen controls are unable to reset the system. See an authorized dealer if these steps do not fix the fault.

# Onboard Generator (If Equipped)

---

## **ONBOARD GENERATOR – FREQUENTLY ASKED QUESTIONS**

### **Why is there a warning about something being plugged into the bed power outlet when I do not have anything plugged in?**

- One or more of the bed power outlet covers could be ajar or broken. Make sure the generator is off and check the outlet covers. Select OK on the instrument cluster display to acknowledge the warning.

### **Why can I not shift my vehicle out of park (P)?**

- Make sure the bed power outlet covers are closed and not damaged. Press OK on the instrument cluster display to acknowledge the warning to be able to shift out of park (P).

### **What do I do when my instrument cluster display is malfunctioning and I cannot acknowledge the warning to put the vehicle in drive (D).**

- Power the vehicle off and make sure nothing is plugged into the bed power outlets and all outlet covers are closed. Start the vehicle and select OK on the instrument cluster display to acknowledge the warning. Have your vehicle serviced soon.

## Center Console Work Surface (If Equipped)

### USING THE CENTER CONSOLE WORK SURFACE

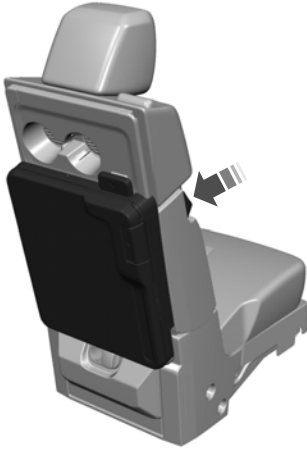

Push the lever on the side of the seat and fold the seat down.

There are three different positions:

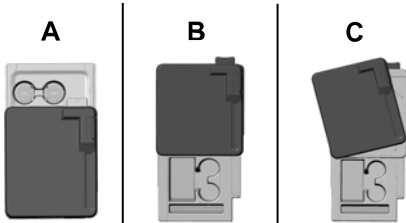

- A. Home.
- B. Forward.
- C. Rotated.



Push the latch down on the top of the work surface to move it to the forward position. There are 11 lockable positions.

## Center Console Work Surface (If Equipped)

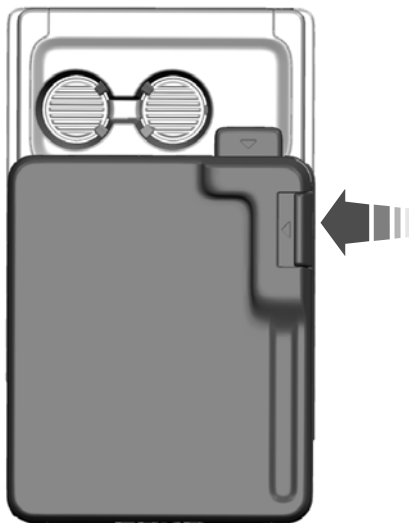

Push the latch on the side of the work surface to rotate it toward the driver. It rotates into 4 lockable positions in 5° increments.

**Note:** *The work surface must be in the home position when driving your vehicle.*

**Note:** *Do not drive with the work surface rotated. This could interfere with steering your vehicle.*

**Note:** *Do not adjust the steering column with a rotated work surface.*

**Note:** *Do not raise the seat when the work surface is in the forward or rotated positions to avoid damage.*

**Note:** *To avoid damaging the work surface, do not use it as a handle when entering or exiting the vehicle.*

## CENTER CONSOLE WORK SURFACE – TROUBLESHOOTING

### CENTER CONSOLE WORK SURFACE – INFORMATION MESSAGES

Message	Details
Stow work surface before driving	Displays when the work surface is not stowed and the vehicle is moving.

## Wireless Accessory Charger (If Equipped)

### WHAT IS THE WIRELESS ACCESSORY CHARGER

The wireless accessory charger allows you to charge one compatible Qi wireless charging device on the charging area.

### WIRELESS ACCESSORY CHARGER PRECAUTIONS



**WARNING:** Wireless charging devices can affect the operation of implanted medical devices, including cardiac pacemakers. If you have any implanted medical devices, we recommend that you consult with your physician.



**WARNING:** Remove all metal objects like coins and keys from the charging surface and remove any metal objects attached to your mobile phone before placing the device on the charging surface. Some mobile devices or cases may attract metal objects. Metal objects on the charging surface or attached to the phone may become hot while charging is active. If an object is left on or near the charging surface or attached to the phone while the device is charging, let the objects cool before removing to prevent personal injury.

Keep the charging area clean and remove foreign objects prior to charging a device.

Do not place items with a magnetic strip or radio-frequency identification chip, for example passports, parking tickets, transportation passes or credit cards, near the charging area when charging a device. Damage could occur to the magnetic strip or radio-frequency identification chip.

Do not place metal objects, for example remote controls, coins and candy wrappers, on or near the charging area when charging a device. Metal objects may heat up and degrade the charging performance, in addition to causing interruptions in charging.

Charging could be interrupted, degraded, or could stop if any of the following occur:

- The system detects a foreign object.
- The device is misaligned on the charging area.
- The device moves on the active charging area when the vehicle is in motion.
- The vehicle ambient temperature is too high.
- You attempt to charge a non-Qi compatible device on the wireless charger.

**Note:** During charging, the device and the charger could heat up, this is normal. If the battery gets hotter than usual, the device may stop charging.

### LOCATING THE WIRELESS ACCESSORY CHARGER



The charging area is in the center console media bin below the instrument panel.

### CHARGING A WIRELESS DEVICE

Place the device on the center of the charging surface with the charging side down. The charging stops after your device reaches a full charge.

You can use the charger when the vehicle is in accessory mode, when the vehicle is running or when the touchscreen is on.

## Wireless Accessory Charger (If Equipped)

---



Displays on the status bar when wireless charging is in progress.



Displays on the status bar when wireless charging has been interrupted.

**Note:** *The charging performance may be affected if your device is in a case. It may be necessary to remove the case to wirelessly charge your device.*

**Note:** *Software and firmware updates may affect device compatibility, including the use of unofficial software or firmware. You should verify charging functionality with your specific devices in-vehicle.*

### WIRELESS ACCESSORY CHARGER VIDEOS

[Wireless Charging Pad Video Link](#)

# Storage

## CUP HOLDERS

### CUP HOLDER PRECAUTIONS



**WARNING:** Use caution when stowing items or hot drinks in the cup holders. Items could become loose or spill during hard braking, acceleration or crashes. Failure to follow this instruction could result in personal injury.

## GLOVE COMPARTMENT

### OPENING THE GLOVE COMPARTMENT

#### Upper Glove Compartment (if Equipped)

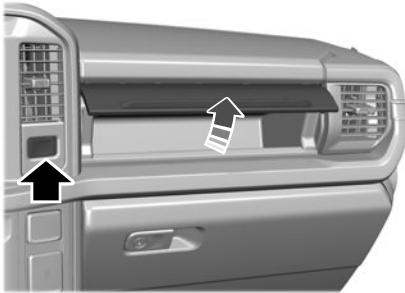

Push the button on the instrument panel to open.

#### Lower Glove Compartment



Pull the latch to the left to open.

### LOCKING THE GLOVE COMPARTMENT

Use the key to lock the lower glove compartment.

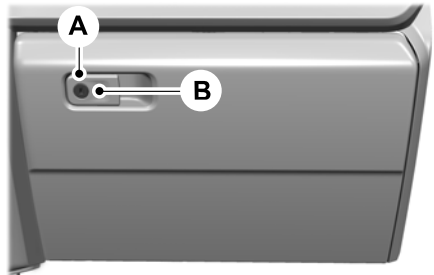

- A    Unlock.
- B    Lock.



# Storage

---

## CENTER CONSOLE

### OPENING THE CENTER CONSOLE

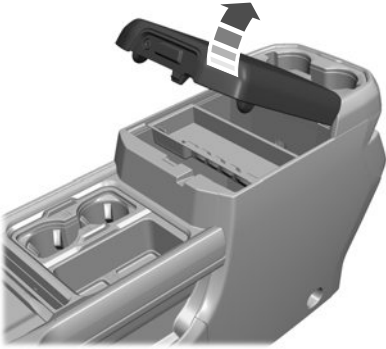

To open the center console push the button and lift up.

## UNDER SEAT STORAGE (IF EQUIPPED)

### LOCATING THE UNDER SEAT STORAGE COMPARTMENT

#### Front Under Seat Storage

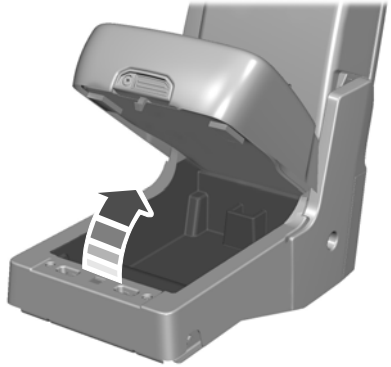

Lift the latch to access the storage compartment under the center seat cushion.

# Storage

## Locking the Front Under Seat Storage

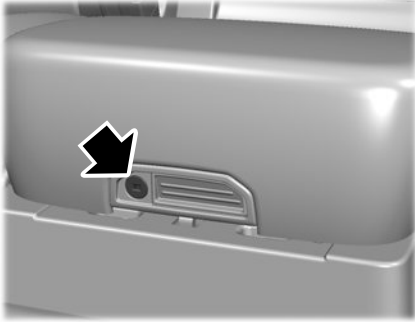

Lift the front seat to access the front under seat storage compartment.

1. Use the key in the remote control to unlock.

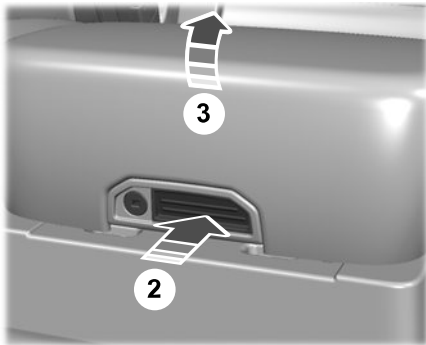

2. Press the latch to release the cushion.
3. Lift the cushion to access the storage compartment.

## Rear Under Seat Storage



Lift the rear seat to access the under seat storage bin.

## Locking the Rear Under Seat Storage



1. Lift the rear seat to access the under seat storage bin.

## Storage

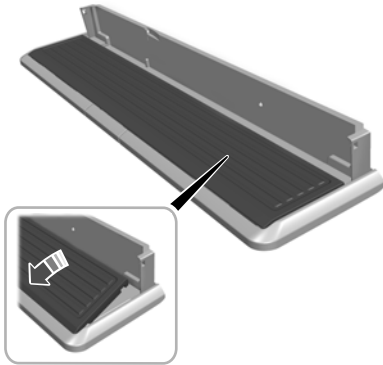

2. Lift the front panel to expand the storage bin.

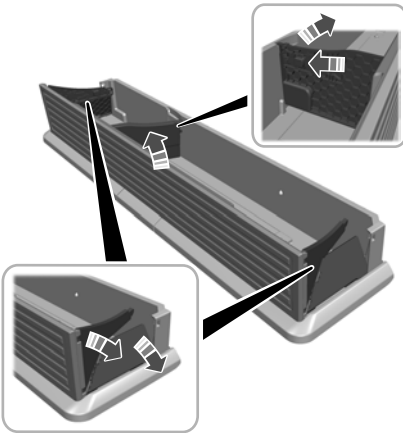

3. Lock the front and side panels in an open position.

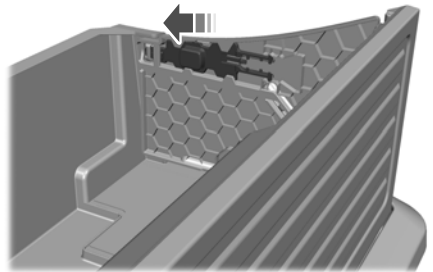

4. To collapse, unlatch the side panels and storage divider, push down to the stowed position and fold in the side and front panels.

**Note:** Make sure the storage divider is not locked into place when collapsing. Unlatch the sliding latch to release the storage divider and swing to the stowed position against the front panel.

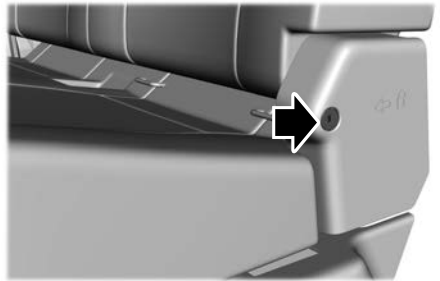

The locking key is in the remote control. Turn the key to lock or unlock the cushion.

# Storage

---

## GLASSES HOLDER

### LOCATING THE GLASSES HOLDER



The glasses holder is in the overhead console.

Press near the rear edge of the door to open it.

# Starting and Stopping the Engine

## STARTING AND STOPPING THE ENGINE – PRECAUTIONS



**WARNING:** Extended idling at high engine speeds can produce very high temperatures in the engine and exhaust system, creating the risk of fire or other damage.



**WARNING:** Do not park, idle or drive your vehicle on dry grass or other dry ground cover. The emission system heats up the engine compartment and exhaust system, creating the risk of fire.



**WARNING:** Do not start the engine in a closed garage or in other enclosed areas. Exhaust fumes are toxic. Always open the garage door before you start the engine. Failure to follow this instruction could result in personal injury or death.



**WARNING:** Do not use starting fluid, for example ether, in the air intake system. Such fluid could cause immediate explosive damage to the engine and possible personal injury.



**WARNING:** Exhaust leaks may result in entry of harmful and potentially lethal fumes into the passenger compartment. If you smell exhaust fumes inside your vehicle, have your vehicle inspected immediately. Do not drive if you smell exhaust fumes.

The powertrain control system meets all Canadian interference-causing equipment standard requirements regulating the impulse electrical field or radio noise.

**Note:** If you use your vehicle regularly above the altitude of 5,000 ft (1,524 m) and under the temperature of -4.0°F (-20°C), it is recommended to use the alternative engine oil. See **Capacities and Specifications** (page 520).

If you stop your vehicle and leave the engine idling for long periods, we recommend that you do one of the following:

- Open the windows at least 1 in (2.5 cm).
- Set your climate control to outside air.

## IGNITION SWITCH (IF EQUIPPED)

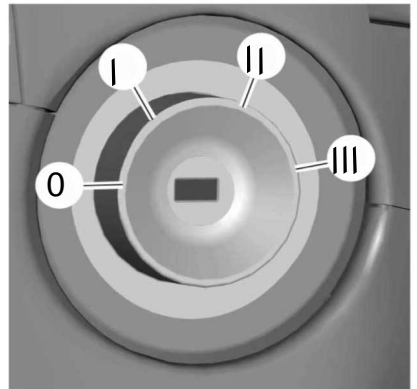

### Switching the Ignition Off

Turn the key to position **0**.

### Switching the Ignition to Accessory Mode

Turn the key to position **I**. Electrical accessories, for example the radio, operate without the engine running.

# Starting and Stopping the Engine

## Switching the Ignition On

Turn the key to position **II**. All electrical circuits and accessories are operational and the warning lamps and indicators illuminate.

## PUSH BUTTON IGNITION SWITCH (IF EQUIPPED)



## Switching the Ignition Off

When the ignition is on or in accessory mode, press the push button ignition switch once without your foot on the brake pedal.

## Switching the Ignition to Accessory Mode

When the ignition is off, press the push button ignition switch once without your foot on the brake pedal.

All electrical circuits and accessories are operational and the warning lamps and indicators illuminate.

**Note:** Your vehicle has a battery saver feature that shuts your vehicle off when it detects a certain amount of battery drain, or after approximately 30 minutes of inactivity in accessory mode.

**Note:** The system may not function if the remote control is close to metal objects or electronic devices, for example keys or a cell phone.

**Note:** You need a valid key inside your vehicle to switch the ignition on and start the engine.

## STARTING THE ENGINE

### STARTING A GASOLINE ENGINE - VEHICLES WITHOUT: PUSH BUTTON START

Before starting your vehicle, check the following:

- Make sure that the headlamps and electrical accessories are off.
- Make sure that the parking brake is on.
- Make sure that the transmission is in park (P).

1. Fully press the brake pedal.

**Note:** Do not touch the accelerator pedal.



2. Turn the key to position **III**.

**Note:** The engine may continue cranking for up to 15 seconds or until it starts.

**Note:** The engine takes longer to start at lower temperatures. It may crank for several seconds when very cold.

### STARTING A GASOLINE ENGINE - VEHICLES WITH: PUSH BUTTON START

Before starting your vehicle, check the following:

- Make sure that the headlamps and electrical accessories are off.
- Make sure that the parking brake is on.
- Make sure that the transmission is in park (P).

1. Fully press the brake pedal.

**Note:** Do not touch the accelerator pedal.

# Starting and Stopping the Engine



2. Press the push button ignition switch.

**Note:** The engine may continue cranking for up to 15 seconds or until it starts.

**Note:** The engine takes longer to start at lower temperatures. It may crank for several seconds when very cold.

## STARTING A DIESEL ENGINE - VEHICLES WITHOUT: PUSH BUTTON START

Before starting your vehicle, check the following:

- Make sure that the headlamps and electrical accessories are off.
- Make sure that the parking brake is on.
- Make sure that the transmission is in park (P).



1. Turn the key to position II.

**Note:** Wait until the glow plug indicator turns off.

2. Fully press the brake pedal.

**Note:** Do not touch the accelerator pedal.



3. Turn the key to position III.

**Note:** The engine may continue cranking for up to 15 seconds or until it starts.

**Note:** The engine takes longer to start at lower temperatures. It may crank for several seconds when very cold.

## Glow Plug Indicator



If it illuminates, wait until the glow plug indicator turns off before starting the engine.

## STARTING A DIESEL ENGINE - VEHICLES WITH: PUSH BUTTON START

Before starting your vehicle, check the following:

- Make sure that the headlamps and electrical accessories are off.
  - Make sure that the parking brake is on.
  - Make sure that the transmission is in park (P).
1. Fully press the brake pedal.

**Note:** Do not touch the accelerator pedal.



2. Press the push button ignition switch.

**Note:** The engine may continue cranking for up to 15 seconds or until it starts.

**Note:** The engine takes longer to start at lower temperatures. It may crank for several seconds when very cold.

## Glow Plug Indicator



The engine does not start until the glow plug indicator turns off. This may take several seconds in extremely cold conditions.

# Starting and Stopping the Engine

## RESTARTING THE ENGINE AFTER STOPPING IT - VEHICLES WITH: PUSH BUTTON START

The system allows you to start the engine within 10 seconds of switching it off, even if it does not detect a valid passive key.

Within 10 seconds of switching the engine off, fully press the brake pedal and press the push button ignition switch. After 10 seconds, you can no longer start the engine if the system does not detect a valid passive key.

When you start the engine, it remains running until you press the push button ignition switch, even if your vehicle does not detect a valid passive key. If you open and close a door when the engine is running, the system searches for a valid passive key.

## ENGINE BLOCK HEATER (IF EQUIPPED)

### ENGINE BLOCK HEATER PRECAUTIONS



**WARNING:** Failure to follow engine block heater instructions could result in property damage or serious personal injury.



**WARNING:** Do not use your heater with ungrounded electrical systems or two-pronged adapters. There is a risk of electrical shock.



**WARNING:** Do not fully close the hood, or allow it to drop under its own weight when using the engine block heater. This could damage the power cable and may cause an electrical short resulting in fire, injury and property damage.

We recommend that you do the following for a safe and correct operation:

- Use a 16-gauge outdoor extension cord that is product certified by Underwriter's Laboratory (UL) or Canadian Standards Association (CSA). This extension cord must be suitable for use outdoors, in cold temperatures, and be clearly marked Suitable for Use with Outdoor Appliances. Do not use an indoor extension cord outdoors. This could result in an electric shock or become a fire hazard.
- Use as short an extension cord as possible.
- Do not use multiple extension cords.
- Make sure that when in operation, the extension cord plug and engine block heater cord plug connections are free and clear of water. This could cause an electric shock or fire.
- If the engine block heater cord is under the hood, do not remove the wiring from its original location. Do not close the hood on the extension wiring.
- Park your vehicle in a clean area, clear of combustible materials.
- Firmly connect the engine block heater cord and the extension cord.
- Check the extension cord for heat anywhere when the system has been operating for approximately 30 minutes.
- Unplug and properly stow the system before starting and driving your vehicle. The protective cover seals the terminals of the engine block heater cord plug when not in use.
- Check the engine block heater system for proper operation before winter.



# Starting and Stopping the Engine

## HOW DOES THE ENGINE BLOCK HEATER WORK

The engine block heater warms the engine coolant. This allows the climate control system to quickly respond. The equipment includes a heater element installed in the engine block and a wire harness. You can connect the system to a grounded 110 volt AC electrical source.

**Note:** *The engine block heater is most effective when outdoor temperatures are below 0°F (-18°C). We recommend the use of engine block heater to improve engine cold start performance.*

## USING THE ENGINE BLOCK HEATER

Make sure the receptacle terminals are clean and dry prior to use. Clean them with a dry cloth if necessary.

The heater uses 0.4 to 1.0 kilowatt-hours of energy per hour of use. The system does not have a thermostat. It achieves maximum temperature after approximately three hours of operation. Using the engine block heater longer than three hours does not improve system performance and unnecessarily uses electricity.

## STOPPING THE ENGINE

### STOPPING THE ENGINE WHEN YOUR VEHICLE IS STATIONARY - VEHICLES WITHOUT: PUSH BUTTON START

1. Shift into park (P).
2. Apply the parking brake.
3. Wait until the engine reaches idle speed.

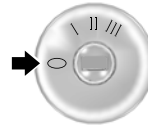

4. Turn the key to position **0**.

### STOPPING THE ENGINE WHEN YOUR VEHICLE IS STATIONARY - VEHICLES WITH: PUSH BUTTON START

1. Shift into park (P).
2. Apply the parking brake.
3. Wait until the engine reaches idle speed.



4. Press the push button ignition switch.

### STOPPING THE ENGINE WHEN YOUR VEHICLE IS MOVING - VEHICLES WITHOUT: PUSH BUTTON START



**WARNING:** Switching off the engine when your vehicle is still moving results in a significant decrease in braking assistance. Higher effort is required to apply the brakes and to stop your vehicle. A significant decrease in steering assistance could also occur. The steering does not lock, but higher effort

# Starting and Stopping the Engine

could be required to steer your vehicle. When you switch the ignition off, some electrical circuits, for example airbags, also turn off. If you unintentionally switch the ignition off, shift into neutral (N) and restart the engine.

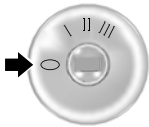

1. Turn the key to position **0**.
2. Shift into neutral and use the brakes to bring your vehicle to a safe stop.
3. Shift into park (P).
4. Apply the parking brake.

## STOPPING THE ENGINE WHEN YOUR VEHICLE IS MOVING - VEHICLES WITH: PUSH BUTTON START



**WARNING:** Switching off the engine when your vehicle is still moving results in a significant decrease in braking assistance. Higher effort is required to apply the brakes and to stop your vehicle. A significant decrease in steering assistance could also occur. The steering does not lock, but higher effort could be required to steer your vehicle. When you switch the ignition off, some electrical circuits, for example airbags, also turn off. If you unintentionally switch the ignition off, shift into neutral (N) and restart the engine.



1. Press and hold the push button ignition switch until the engine stops, or press it three times within two seconds.
2. Shift into neutral and use the brakes to bring your vehicle to a safe stop.
3. Shift into park (P).
4. Apply the parking brake.

## IDLE TIMER (IF EQUIPPED)

### WHAT IS IDLE TIMER

The idle timer system allows you to select how long the engine will idle before shutting down. It provides power to all equipment and accessories of the vehicle while active.

### HOW DOES IDLE TIMER WORK

The vehicle shuts down after a set amount of time when you are done driving and you place the shifter in park (P) and leave the vehicle idling.

The idle timer defaults to active with the length of idle set to 30 minutes. At any time, you can edit the length of time you would like the vehicle to idle before shutting down. It is possible to select any value from 1 to 30 minutes, in 1 minute increments. See **Idle Timer Settings** (page 203).

**Note:** When you disable Pro Eco Idle, the Idle Timer will be re-enabled and the system remembers your preference until another change occurs. It does not reset after each ignition cycle.

# Starting and Stopping the Engine

**Note:** When you activate Pro Eco Idle, the Idle Timer will be deactivated. If you do not confirm the activation of Pro Eco Idle within 30 seconds, the Idle Timer will be re-enabled.

When the idle timer is active and your vehicle is idling, you retain full control of the vehicle's accessories and equipment.

After the idle time expires, the system turns your vehicle off. Your vehicle does not restart until you switch it on.

## IDLE TIMER PRECAUTIONS



**WARNING:** Apply the parking brake, shift into park (P), switch the ignition off and remove the key before you open the hood or have any service or repair work completed. If you do not switch the ignition off, the engine could restart at any time. Failure to follow this instruction could result in personal injury or death.

## IDLE TIMER SETTINGS

1. Press **Settings** on the touchscreen.
2. Press **Vehicle Settings**.
3. Press **Idle Settings**.
4. Adjust the duration you wish the vehicle to idle.

## AUTOMATIC ENGINE STOP (IF EQUIPPED)

### WHAT IS AUTOMATIC ENGINE STOP

Automatic engine stop is a feature that switches the engine off if it has been idling for an extended period to help you save fuel.

## HOW DOES AUTOMATIC ENGINE STOP WORK

Automatic engine stop turns the engine off. The ignition also turns off in order to save battery power. Before the engine shuts down, a message appears in the information display showing a timer counting down. If you do not intervene within 30 seconds, the engine shuts down. Another message appears in the information display to inform you that the engine has shut down in order to save fuel. Start your vehicle as you normally do.

## SWITCHING AUTOMATIC ENGINE STOP ON AND OFF

1. Press **Settings** on the touchscreen.
2. Press **Vehicle Settings**.
3. Switch **30min Max Idle** on or off.

**Note:** You cannot permanently switch off the automatic shutdown. If you switch it off, it turns on each time you switch the ignition on.

## OVERRIDING AUTOMATIC ENGINE STOP

**Note:** You cannot permanently switch off the automatic engine stop feature. When you switch it off temporarily, it turns on at the next Ignition cycle.

You can stop the engine shutdown, or reset the timer, at any point before the 30-second countdown has expired by doing any of the following:

- Pressing the brake pedal or accelerator pedal.
- Pressing the **OK** or **RESET** button during the countdown.

# Starting and Stopping the Engine

## ACCESSING THE PASSIVE KEY BACKUP POSITION

If you are unable to start your vehicle, locate the backup slot in one of two positions:

Vehicles with center console storage:

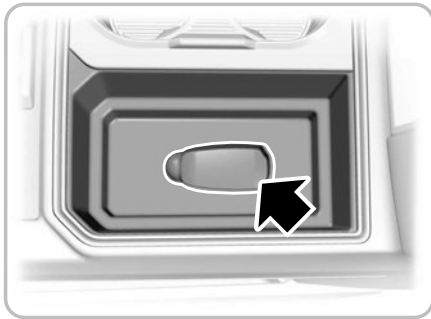
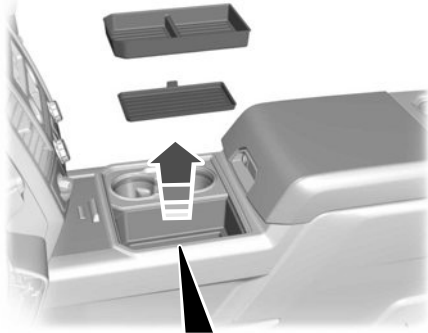

1. Remove the mat from the center console storage area.
2. Place the remote control in the backup slot with the buttons facing toward the rear of the vehicle.
3. Press the brake pedal.
4. Press the push button ignition switch to start the vehicle.

Vehicles without center console storage:



1. Raise the center armrest storage lid.
2. Place the remote control in the backup slot with the buttons facing toward the rear of the vehicle.
3. Press the brake pedal.
4. Press the push button ignition switch to start the vehicle.

## STARTING AND STOPPING THE ENGINE – TROUBLESHOOTING

### STARTING AND STOPPING THE ENGINE – WARNING LAMPS

#### Malfunction Indicator Lamp



If it illuminates when the engine is running, the on-board diagnostics system is detecting a malfunction of the vehicle emission control system.

If it flashes, engine misfire could be occurring. Increased exhaust gas temperatures could damage the catalytic converter or other vehicle components. Avoid heavy acceleration and deceleration, and have your vehicle checked as soon as possible.

# Starting and Stopping the Engine

## Powertrain Warning Lamp



If it illuminates when the engine is running, this indicates a powertrain or four-wheel drive fault. If it flashes when you are driving, immediately reduce the vehicle speed. Avoid heavy acceleration and deceleration, and have your vehicle checked as soon as

possible.

If both lamps illuminate when the engine is running, stop your vehicle as soon as it is safe to do so. Continuing to drive your vehicle could cause reduced power or the engine to stop. Switch the ignition off and attempt to restart the engine. Have your vehicle checked as soon as possible.

## STARTING AND STOPPING THE ENGINE – INFORMATION MESSAGES

Message	Action
Cranking Time Exceeded	Displays if you exceed the starting time limit. You cannot attempt to start the engine for 15 minutes. If you cannot start the engine after 15 minutes passes, have your vehicle immediately checked.
Starting System Fault	Displays if you are unable to start your vehicle with a correctly coded key. The system has detected a fault that requires service. Have your vehicle checked as soon as possible.
No Key Detected	Displays if the system does not detect a valid passive key.

# Starting and Stopping the Engine

## STARTING AND STOPPING THE ENGINE – FREQUENTLY ASKED QUESTIONS - DIESEL, VEHICLES WITHOUT: PUSH BUTTON START

### Why is the engine idle speed high when I am starting the engine?

- The speed at which the engine idles immediately after starting is optimized to minimize vehicle emissions and maximize cabin comfort and fuel economy.

### Why does the engine not crank?

- You can only attempt to start the engine for a limited amount of time before the starting system temporarily disables. If you exceed the starting time limit, a message may appear and you cannot attempt to start the engine for at least 15 minutes.

### Why do I experience different driving characteristics?

- If you disconnect the battery, your vehicle may exhibit some unusual driving characteristics for approximately 5 mi (8 km) after you reconnect it. This is because the engine management system must realign itself with the engine. You can disregard any unusual driving characteristics during this period.

### Why can I not start the engine?

- If you cannot start the engine, do the following:
- Fully press the brake pedal or the clutch pedal.

**Note:** Make sure that the parking brake is applied.

**Note:** Make sure that the transmission is in park (P) or neutral (N).



- Turn the key to position **III** until the engine starts.

## STARTING AND STOPPING THE ENGINE – FREQUENTLY ASKED QUESTIONS - DIESEL, VEHICLES WITH: PUSH BUTTON START

### Why is the engine idle speed high when I am starting the engine?

- The speed at which the engine idles immediately after starting is optimized to minimize vehicle emissions and maximize cabin comfort and fuel economy.

### Why does the engine not crank?

- You can only attempt to start the engine for a limited amount of time before the starting system temporarily disables. If you exceed the starting time limit, a message may appear and you cannot attempt to start the engine for at least 15 minutes.

### Why do I experience different driving characteristics?

- If you disconnect the battery, your vehicle may exhibit some unusual driving characteristics for approximately 5 mi (8 km) after you reconnect it. This is because the engine management system must realign itself with the engine. You can disregard any unusual driving characteristics during this period.

# Starting and Stopping the Engine

## Why can I not start the engine?

- If you cannot start the engine, do the following:
1. Fully press the brake pedal or the clutch pedal.

**Note:** Make sure that the parking brake is applied.

**Note:** Make sure that the transmission is in park (P) or neutral (N).



2. Press the push button ignition switch until the engine starts.

## Why does the system not detect a passive key?

- If the system does not detect a passive key and you are unable to start the engine, insert the passive key into the backup position and press the push button ignition switch to start the engine. See **Accessing the Passive Key Backup Position** (page 204).

## STARTING AND STOPPING THE ENGINE – FREQUENTLY ASKED QUESTIONS - GASOLINE, VEHICLES WITHOUT: PUSH BUTTON START

### Why is the engine idle speed high when I am starting the engine?

- The speed at which the engine idles immediately after starting is optimized to minimize vehicle emissions and maximize cabin comfort and fuel economy.

## Why does the engine not crank?

- You can only attempt to start the engine for a limited amount of time before the starting system temporarily disables. If you exceed the starting time limit, a message may appear and you cannot attempt to start the engine for at least 15 minutes.

## Why do I experience different driving characteristics?

- If you disconnect the battery, your vehicle may exhibit some unusual driving characteristics for approximately 5 mi (8 km) after you reconnect it. This is because the engine management system must realign itself with the engine. You can disregard any unusual driving characteristics during this period.

## Why can I not start the engine?

If you cannot start the engine after 3 attempts, wait 10 seconds and do the following:

1. Fully press the brake pedal or the clutch pedal.

**Note:** Make sure that the parking brake is applied.

**Note:** Make sure that the transmission is in park (P) or neutral (N).

2. Fully press the accelerator pedal and hold it there.



3. Turn the key to position **III** and wait until the engine stops cranking.
4. Release the accelerator pedal.
5. Turn the key to position **III**.

# Starting and Stopping the Engine

## STARTING AND STOPPING THE ENGINE – FREQUENTLY ASKED QUESTIONS - GASOLINE, VEHICLES WITH: PUSH BUTTON START

### Why is the engine speed high when I am starting the engine?

- The speed at which the engine idles immediately after starting is optimized to minimize vehicle emissions and maximize cabin comfort and fuel economy.

### Why does the engine not crank?

- You can only attempt to start the engine for a limited amount of time before the starting system temporarily disables. If you exceed the starting time limit, a message may appear and you cannot attempt to start the engine for at least 15 minutes.

### Why do I experience different driving characteristics?

- If you disconnect the battery, your vehicle may exhibit some unusual driving characteristics for approximately 5.0 mi (8 km) after you reconnect it. This is because the engine management system must realign itself with the engine. You can disregard any unusual driving characteristics during this period.

### Why can I not start the engine?

If you cannot start the engine after 3 attempts, wait 10 seconds and do the following:

1. Fully press the brake pedal or the clutch pedal.

**Note:** Make sure that the parking brake is applied.

**Note:** Make sure that the transmission is in park (P) or neutral (N).

2. Fully press the accelerator pedal and hold it there.
3. Press the push button ignition switch.

**Note:** The engine cranks for a short period of time and then it stops.

4. Release the accelerator pedal.



5. Press the push button ignition switch.

### Why does the system not detect a passive key?

- If the system does not detect a passive key and you are unable to start the engine, insert the passive key into the backup position and press the push button ignition switch to start the engine. See **Accessing the Passive Key Backup Position** (page 204).

## STARTING AND STOPPING THE ENGINE VIDEOS

[Push-Button Start: F-Series Diesel](#)





# Fuel and Refueling

## FUEL AND REFUELING PRECAUTIONS

 **WARNING:** Fuels can cause serious injury or death if misused or mishandled.

 **WARNING:** Fuel may contain benzene, which is a cancer-causing agent.

 **WARNING:** Read and follow all the instructions on the pump island.

 **WARNING:** When refueling always shut the engine off and never allow sparks or open flames near the fuel tank filler valve. Never smoke or use a cell phone while refueling. Fuel vapor is extremely hazardous under certain conditions. Avoid inhaling excess fumes.

Follow these guidelines when refueling:

- Extinguish all smoking materials and any open flames before refueling your vehicle.
- Switch the engine off before refueling.
- Automotive fuels can be harmful or fatal if swallowed. Fuel is highly toxic and if swallowed can cause death or permanent injury. If fuel is swallowed immediately call a physician, even if no symptoms are immediately apparent. The toxic effects of fuel may not be apparent for hours.
- Avoid inhaling fuel vapors. Inhaling fuel vapor can lead to eye and respiratory tract irritation. In severe cases, excessive or prolonged breathing of fuel vapor can cause serious illness and permanent injury.

- Avoid getting fuel in your eyes. If you splash fuel in your eyes, immediately remove contact lenses, if worn, flush with water for 15 minutes and seek medical attention. Failure to seek proper medical attention could lead to permanent injury.
- Fuels can be harmful if absorbed through the skin. If you splash fuel on your skin, clothing or both, promptly remove contaminated clothing and thoroughly wash your skin with soap and water. Repeated or prolonged skin contact causes skin irritation.
- Be particularly careful if you are taking Antabuse or other forms of Disulfiram for the treatment of alcoholism. Breathing fuel vapors could cause an adverse reaction, serious personal injury or sickness. Immediately call a physician if you experience any adverse reactions.

## FUEL QUALITY

### SELECTING THE CORRECT FUEL - 6.8L, GASOLINE

Flex fuel vehicles have one of the following identifiers:

- Yellow fuel filler cap.
- Yellow bezel around the fuel filler inlet.
- Yellow fuel filler housing.
- Yellow E85 label on the fuel tank filler door.

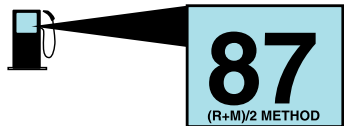

# Fuel and Refueling

Your vehicle operates on regular unleaded gasoline with a minimum pump (R+M)/2 octane rating of 87 or regular unleaded gasoline blended with a maximum of 85% ethanol (E85).

Some fuel stations, particularly those in high altitude areas, offer fuels posted as regular unleaded gasoline with an octane rating below 87. The use of these fuels could result in engine damage that will not be covered by the vehicle Warranty.

For best overall vehicle and engine performance, premium fuel with an octane rating of 91 or higher is recommended. The performance gained by using premium fuel is most noticeable in hot weather as well as other conditions, for example when towing a trailer. See **Towing a Trailer** (page 362).

Do not be concerned if the engine sometimes knocks lightly. However, if the engine knocks heavily while using fuel with the recommended octane rating, contact an authorized dealer to prevent any engine damage.

We recommend Top Tier detergent gasolines, where available to help minimize engine deposits and maintain optimal vehicle and engine performance.

For additional information, visit [www.toptiergas.com](http://www.toptiergas.com).

**Note:** *Use of any fuel for which the vehicle was not designed can impair the emission control system, cause loss of vehicle performance, and cause damage to the engine which may not be covered by the vehicle Warranty.*

Do not use:

- Diesel fuel.
- Fuels containing kerosene or paraffin.
- Fuels containing more than 85% ethanol or E100 fuel.
- Fuels containing methanol.

- Fuels containing metallic-based additives, including manganese-based compounds.
- Fuels containing the octane booster additive, methylcyclopentadienyl manganese tricarbonyl (MMT).
- Leaded fuel, using leaded fuel is prohibited by law.

The use of fuels with metallic compounds such as methylcyclopentadienyl manganese tricarbonyl, which is a manganese-based fuel additive, will impair engine performance and affect the emission control system.

## SELECTING THE CORRECT FUEL - 7.3L, GASOLINE

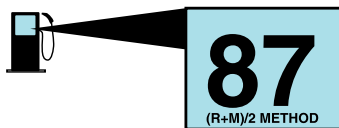

Your vehicle operates on regular unleaded gasoline with a minimum pump (R+M)/2 octane rating of 87.

Some fuel stations, particularly those in high altitude areas, offer fuels posted as regular unleaded gasoline with an octane rating below 87. The use of these fuels could result in engine damage that will not be covered by the vehicle Warranty.

For best overall vehicle and engine performance, premium fuel with an octane rating of 91 or higher is recommended. The performance gained by using premium fuel is most noticeable in hot weather as well as other conditions, for example when towing a trailer. See **Towing a Trailer** (page 362).

# Fuel and Refueling

Do not be concerned if the engine sometimes knocks lightly. However, if the engine knocks heavily while using fuel with the recommended octane rating, contact an authorized dealer to prevent any engine damage.

We recommend Top Tier detergent gasolines, where available to help minimize engine deposits and maintain optimal vehicle and engine performance.

For additional information, visit [www.toptiergas.com](http://www.toptiergas.com).

**Note:** Use of any fuel for which the vehicle was not designed can impair the emission control system, cause loss of vehicle performance, and cause damage to the engine which may not be covered by the vehicle Warranty.

Do not use:

- Diesel fuel.
- Fuels containing kerosene or paraffin.
- Fuel containing more than 15% ethanol or E85 fuel.
- Fuels containing methanol.
- Fuels containing metallic-based additives, including manganese-based compounds.
- Fuels containing the octane booster additive, methylcyclopentadienyl manganese tricarbonyl (MMT).
- Leaded fuel, using leaded fuel is prohibited by law.

The use of fuels with metallic compounds such as methylcyclopentadienyl manganese tricarbonyl, which is a manganese-based fuel additive, will impair engine performance and affect the emission control system.

## SELECTING THE CORRECT FUEL FOR COLD WEATHER - 6.7L DIESEL

### Choosing the Right Fuel: Vehicles Operated Where Ultra Low Sulfur Diesel Fuel Is Required (United States/Canada/Puerto Rico/U.S. Virgin Islands And Other Locales)

**Note:** Your Warranty will not cover damage caused by using an improper type of fuel or fuel additive.

**Note:** Do not blend used engine oil with diesel fuel under any circumstances. Blending used oil with the fuel significantly increases your vehicle's exhaust emissions and reduce engine life due to increased internal wear.

We recommend Top Tier diesel fuel where available to help minimize engine deposits and maintain optimal vehicle and engine performance.

For additional information, visit [www.toptiergas.com](http://www.toptiergas.com).

You should use ultra-low sulfur diesel fuel designated as number 1-D or 2-D with a maximum of 15-ppm sulfur in your diesel vehicle. You can operate your vehicle on diesel fuels containing up to 20% biodiesel, also known as B20. These fuels should meet the ASTM D975 diesel or the ASTM D7467 B6-B20 biodiesel industry specifications. Outside of North America, use fuels meeting EN590 or equivalent local market standard.



Using low-sulfur diesel fuel (16-500 ppm) or high-sulfur diesel fuel (greater than 500 ppm) in your diesel engine will cause certain emission components to malfunction which could also cause the service engine soon light to illuminate indicating an emissions-related concern.

# Fuel and Refueling

Diesel fuel is adjusted seasonally for cold temperature. For best results at temperatures below 19°F (-7°C), we recommend using a diesel fuel which has been seasonally adjusted for the ambient conditions.

## Choosing the Right Fuel: Vehicles Operated Where Ultra Low Sulfur Diesel Fuel Is Not Required

For the engine to operate reliably on low-sulfur or high-sulfur diesel fuel, the engine must be a factory-built high-sulfur engine (available as a dealer order option for select markets) or an ultra-low sulfur diesel fuel configured engine that has been retrofitted for high-sulfur diesel fuel using authorized dealer service parts. Failure to use retrofit components other than those available through your authorized dealer results in coolant system damage, engine overheating, selective catalyst reduction system or diesel particulate filter damage and possible base engine damage.

Use only a diesel engine configured for use with high-sulfur diesel fuel in markets with diesel fuel that has sulfur content greater than 15 ppm. Using low-sulfur diesel fuel (16–500 ppm) or high-sulfur diesel fuel (greater than 500 ppm) in a diesel engine designed to use only ultra-low sulfur diesel fuel could result in damage to engine emission control devices and the after treatment system, potentially rendering the vehicle inoperable.

Vehicles with engines configured for use with high-sulfur diesel fuel are only available for sale in countries where ultra-low sulfur diesel fuel is generally not available or mandated by the government. Vehicles originally sold in an ultra-low sulfur diesel fuel market that are

subsequently exported to non-ultra low sulfur diesel fuel markets will need to be retrofitted at the customer's expense using Ford authorized dealer service parts in order to be reliably operated on non-ultra low sulfur diesel fuel.

## Biodiesel



**WARNING:** Do not mix diesel with gasoline, gasohol or alcohol. This could cause an explosion.

**Note:** *Do not use home heating oil, agricultural fuel, raw fats and oils, waste cooking greases, biodiesel greater than 20% or any diesel not intended for highway use. Damage to the fuel injection system, engine and exhaust catalyst, and diesel particulate filter can occur if you use an improper fuel. Red dye is used to identify fuels intended for agricultural and non-highway use.*

You can operate your vehicle on diesel fuels containing up to 20% biodiesel, also known as B20.

Biodiesel fuel is a chemically converted product from renewable fuel sources, such as vegetable oils, animal fats and waste cooking greases.

To help achieve acceptable engine performance and durability when using biodiesel in your vehicle:

- Confirm the biodiesel content of the fuel to be B20 (20% biodiesel) or less.
- Only use biodiesel fuel of good quality that complies with industry standards.
- Follow the recommended service maintenance intervals. See **General Maintenance Information** (page 589).

# Fuel and Refueling

---

- Do not store biodiesel fuel in the fuel tank for more than 1 month.
- Consider changing brands or reducing biodiesel content if you have cold temperature fuel gelling issues or a frequently appearing LOW FUEL PRESSURE message.

Use of biodiesel in concentrations greater than 20% can cause damage to your vehicle, including engine and/or exhaust after-treatment hardware (exhaust catalyst and particulate filter) failures. Concentrations greater than 20% can also cause fuel filter restrictions that could result in a lack of power or damage to fuel system components, including fuel pump and fuel injector failures.

We recommend SAE 5W-40 oil for fuels with greater than 5% biodiesel (B5). For more information about oil change intervals and other maintenance when operating on biodiesel. See **General Maintenance Information** (page 589).

Look for a label on the fuel pump to confirm the amount of biodiesel contained in diesel fuel. Ask the service station attendant to confirm the biodiesel content of diesel fuel, if you do not see a label on the fuel pump.

If you plan to park or store your vehicle for more than 1 month, then you should empty your vehicle fuel tank of biodiesel fuel. You should fill the tank with a pure petroleum-based diesel fuel and run your vehicle for a minimum of 30 minutes.

**Note:** *Degraded or oxidized biodiesel can damage fuel system seals and plastics and corrode steel parts.*

During cold weather, if you have problems operating on biodiesel, you may need to use diesel fuel with lower biodiesel content, try another brand or discontinue the use of biodiesel.

## Diesel Fuel Additives

It should not be necessary to add any aftermarket additives to your fuel if you use a high-quality diesel fuel that conforms to ASTM industry specifications. Aftermarket additives can damage the fuel injector system or engine.

Use Motorcraft® cetane booster or an equivalent cetane booster additive if you suspect fuel has low cetane. Use Motorcraft® anti-gel and performance improver or an equivalent additive if there is fuel gelling.

Do not use alcohol-based additives to improve cetane quality, to prevent fuel gelling or any other use. The use of alcohol additives could result in damage to the fuel injectors and system.

Your Warranty may not cover repairs needed to correct the effects of using an aftermarket product that does not meet our specifications in your fuel.

## SWITCHING BETWEEN E85 AND GASOLINE - 6.8L, GASOLINE

We do not recommend repeatedly alternating between E85 and gasoline. If you switch from using E85 to gasoline, or from gasoline to E85, add as much fuel as possible, at least half a tank. Drive your vehicle immediately for a minimum of 5 mi (8 km) to allow it to adapt to the change in ethanol concentration. If you use E85 exclusively, we recommend that you fill the fuel tank with regular unleaded gasoline at each scheduled oil change.

# Fuel and Refueling

## RUNNING OUT OF FUEL

### FILLING A PORTABLE FUEL CONTAINER



**WARNING:** Flow of fuel through a fuel pump nozzle can produce static electricity. This can cause a fire if you are filling an ungrounded fuel container.

Use the following guidelines to avoid electrostatic charge build-up, which can produce a spark, when filling an ungrounded fuel container:

- Only use an approved fuel container to transfer fuel to your vehicle. Place the container on the ground when filling it.
- Do not fill a fuel container when it is inside your vehicle (including the cargo area).
- Keep the fuel pump nozzle in contact with the fuel container when filling it.
- Do not use a device that holds the fuel pump nozzle lever in the fill position.

### ADDING FUEL FROM A PORTABLE FUEL CONTAINER



**WARNING:** Do not pry open the fuel tank filler valve. This could damage the fuel system. Failure to follow this instruction could result in fire, personal injury or death.



**WARNING:** Do not dispose of fuel in the household refuse or the public sewage system. Use an authorized waste disposal facility.

When refueling the vehicle fuel tank from a fuel container, do the following:

1. Fully open the fuel filler door.

2. Turn the fuel filler cap counterclockwise and remove it.
3. Add fuel to your vehicle from the fuel container.
4. To replace the fuel filler cap, turn it clockwise until you feel a strong resistance and it clicks.
5. Fully close the fuel filler door.

**Note:** If your vehicle runs out of fuel add a minimum of 1.3 gal (5 L) of fuel to restart the engine.

**Note:** You may need to switch the ignition from off to on several times after refueling to allow the fuel system to pump the fuel from the tank to the engine. When restarting, cranking time takes a few seconds longer than normal.

## REFUELING

### REFUELING SYSTEM OVERVIEW

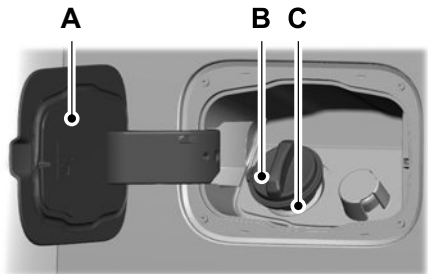

- A Fuel filler door.
- B Fuel cap.
- C Fuel tank filler pipe.

# Fuel and Refueling

## REFUELING YOUR VEHICLE

**WARNING:** When refueling always shut the engine off and never allow sparks or open flames near the fuel tank filler valve. Never smoke or use a cell phone while refueling. Fuel vapor is extremely hazardous under certain conditions. Avoid inhaling excess fumes.

**WARNING:** Fuel vapor burns violently and a fuel fire can cause severe injuries.

**WARNING:** The fuel system may be under pressure. If you hear a hissing sound near the fuel filler inlet, do not refuel until the sound stops. Otherwise, fuel may spray out, which could cause serious personal injury.

**WARNING:** Keep children away from the fuel pump. Never let children pump fuel.

**WARNING:** Do not pry open the fuel tank filler valve. This could damage the fuel system. Failure to follow this instruction could result in fire, personal injury or death.

**WARNING:** Stay outside your vehicle and do not leave the fuel pump unattended when refueling your vehicle.

**WARNING:** Do not remove the fuel pump nozzle from its fully inserted position when refueling.

**WARNING:** Stop refueling when the fuel pump nozzle automatically shuts off for the first time. Failure to follow this will fill the expansion space in the fuel tank and could lead to fuel overflowing.

**WARNING:** Do not overfill the fuel tank. The pressure in an overfilled tank may cause leakage and lead to fuel spray and fire.

**WARNING:** Wait at least five seconds before removing the fuel pump nozzle to allow any residual fuel to drain into the fuel tank.

1. Fully open the fuel filler door.
2. Remove the fuel filler cap by turning it counterclockwise.
3. Select the correct fuel pump nozzle for your vehicle.

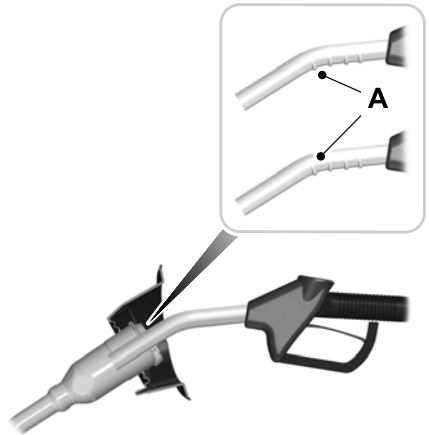

4. Insert the fuel pump nozzle up to the first notch. Keep the fuel pump nozzle resting on the fuel tank filler pipe.

# Fuel and Refueling

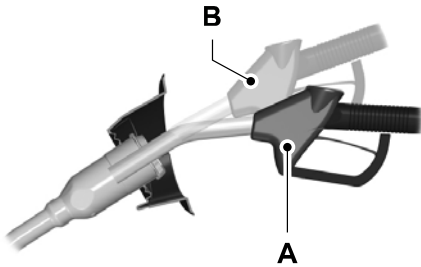

5. Hold the fuel pump nozzle in position A when refueling. Holding the fuel pump nozzle in position B can affect the flow of fuel and shut off the fuel pump nozzle before the fuel tank is full.

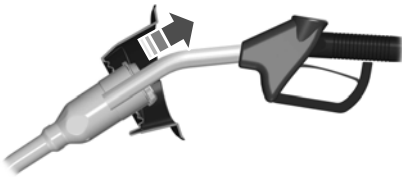

6. When the pump shuts off, wait five seconds, then raise the fuel pump nozzle and slowly remove it.
7. Install the fuel filler cap by turning it clockwise until it clicks.

8. Fully close the fuel filler door.

**Note:** Do not attempt to start the engine if you have filled the fuel tank with incorrect fuel. Incorrect fuel use could cause damage not covered by the vehicle Warranty. Have your vehicle immediately checked.

## FUEL TANK CAPACITY

### Advertised Capacity

The advertised capacity is the maximum amount of fuel that you can add to the fuel tank after running out of fuel. Included in the advertised capacity is an empty reserve. The empty reserve is an unspecified amount of fuel that remains in the fuel tank when the fuel gauge indicates empty.

**Note:** The amount of fuel in the empty reserve varies and should not be relied upon to increase driving range.

## FUEL AND REFUELING – TROUBLESHOOTING

### FUEL AND REFUELING – WARNING LAMPS



If it illuminates when you are driving, refuel as soon as possible.

## FUEL AND REFUELING – INFORMATION MESSAGES

Message	Action
Check Fuel Cap	You may not have installed the fuel filler cap properly. At the next opportunity, safely pull off of the road, remove the fuel filler cap, align the cap properly and reinstall it.



# Diesel Particulate Filter - Diesel

## WHAT IS THE DIESEL PARTICULATE FILTER

The diesel particulate filter is part of your vehicle's emissions system and filters harmful diesel particulates from the exhaust gas.

## HOW DOES THE DIESEL PARTICULATE FILTER WORK

The diesel particulate filter reduces emissions by trapping exhaust particles before they reach the tailpipe. The system must periodically clean the exhaust particles that gather inside the filter. This is carried out in three ways, passive regeneration, active regeneration and manual regeneration.

### Passive Regeneration

In passive regeneration, the normal exhaust system temperature cleans the filter by oxidizing the soot. Cleaning occurs during normal vehicle operating conditions due to driving patterns.

### Active Regeneration

Once the diesel particulate filter is full, active regeneration raises the exhaust temperature to eliminate the particles.

When the engine control module detects that the diesel particulate filter is nearly full of particulates, and you are not operating your vehicle in a manner to allow effective regeneration, messages appear in the information display as a reminder for you to drive your vehicle in order to clean the diesel particulate filter. If you drive your vehicle in a manner to allow effective regeneration, the information display shows a cleaning exhaust filter message.

## DIESEL PARTICULATE FILTER PRECAUTIONS



**WARNING:** Do not park or idle your vehicle over dry leaves, dry grass or other combustible materials. The regeneration process creates very high exhaust gas temperatures and the exhaust will radiate a considerable amount of heat during and after regeneration and after you have switched the engine off. This is a potential fire hazard.



**WARNING:** When the **Exhaust Filter Cleaning** message appears in the information display, do not park near flammable materials, vapors or structures until filter cleaning is complete.



**WARNING:** The normal operating temperature of the exhaust system is very high. Never work around or attempt to repair any part of the exhaust system until it has cooled. Use special care when working around the diesel oxidation catalytic converter or the diesel particulate filter. The diesel oxidation catalytic converter and the diesel particulate filter heat up to very high temperatures after only a short period of engine operation and remain hot after you switch the engine off.

**Note:** *Avoid running out of fuel.*

**Note:** *During regeneration at low speed or engine idle, you may smell a hot metallic odor and could notice a clicking metallic sound. This is due to high temperatures reached during regeneration and is normal.*

**Note:** *Changes in the engine or exhaust sound may be heard during the regeneration process.*

# Diesel Particulate Filter - Diesel

Failure to perform active or manual regeneration when instructed could result in a clogged diesel particulate filter. If the diesel particulate filter fills beyond the regeneration threshold, your vehicle disables the ability for active and manual regeneration. This could result in irreversible damage your vehicle Warranty may not cover.

## DIESEL PARTICULATE FILTER REQUIREMENTS

The diesel particulate filter on your vehicle requires periodic regeneration to maintain its correct function.

If your journeys meet one of the following conditions:

- You drive only short distances.
- You frequently switch the ignition on and off.
- Your journeys contain a high level of acceleration and deceleration.

You must carry out occasional trips with the following conditions to assist the regeneration process:

- Drive your vehicle in more favorable conditions, which you will find at higher vehicle speeds in normal driving, on a main road or freeway for a minimum of 20 minutes. This drive may include short stops that will not affect the regeneration process.
- Avoid prolonged idling and observe speed limits and road conditions.
- Do not switch the ignition off.
- Select a suitable gear to ideally maintain engine speed between 1500 and 3000 RPM.

## DIESEL PARTICULATE FILTER MANUAL REGENERATION

### WHAT IS DIESEL PARTICULATE FILTER MANUAL REGENERATION

Diesel particulate filter manual regeneration allows you to manually start regeneration of the diesel particulate filter at idle to clean the filter.

**Note:** *If you are not sure whether your vehicle has this feature, contact your authorized dealer.*

### DIESEL PARTICULATE FILTER MANUAL REGENERATION PRECAUTIONS



**WARNING:** Stay clear of the exhaust tailpipe during regeneration. Hot exhaust gases can burn you badly.

You may not be able to use manual regeneration if the service engine soon warning lamp appears in the information display.

**Note:** *During the use of manual regeneration, you may observe a light amount of white smoke. This is normal.*

### DIESEL PARTICULATE FILTER MANUAL REGENERATION REQUIREMENTS

You can use the manual regeneration feature when a message appears in the information display and you are not able to drive in a manner that allows effective automatic active regeneration or if you choose to manually start the regeneration of the diesel particulate filter while the vehicle is idle.

# Diesel Particulate Filter - Diesel

Before you start manual regeneration, do the following:

- Make sure the parking brake is on.
- Shift into park (P) on stable, level ground.
- Park your vehicle outside of any structure.
- Park your vehicle 10–15 ft (3–5 m) away from any obstructions and away from materials that can easily combust or melt, for example paper, leaves, petroleum products, fuels, plastics and other dry organic material.
- Make sure there is a minimum of 1/8 tank of fuel.
- Make sure all fluids are at proper levels.

## DIESEL PARTICULATE FILTER MANUAL REGENERATION LIMITATIONS

You cannot use manual regeneration until the diesel particulate filter load percentage has reached 100% or Full. The diesel particulate filter load percentage fluctuates up and down when driving your vehicle due to active and passive regenerations.

If your vehicle is operated with significant stationary operation, low speed drive cycles less than 25 mph (40 km/h), short drive cycles, drive time less than 15 minutes or the vehicle does not fully warm up, passive and active regeneration may not sufficiently clean the diesel particulate filter system.

Aftermarket devices or modifications to the exhaust system may reduce the effectiveness of the exhaust system as well as cause damage to the exhaust system or engine. This may also degrade vehicle performance and could lead to engine damage that may not be covered by the vehicle Warranty.

## STARTING DIESEL PARTICULATE FILTER MANUAL REGENERATION

Start with your vehicle engine and when it has reached the normal operating temperature, press the information display control button on the steering wheel. See **Instrument Cluster Display** (page 140).

If the diesel particulate filter is near or at saturation, a message requesting permission to initiate filter cleaning appears in the information display. See **Diesel Particulate Filter – Information Messages** (page 220). Answer yes to this prompt and then follow the next prompts regarding exhaust position required to initiate manual regeneration. Be sure to understand each prompt. If you are not sure what is being asked by each prompt, contact an authorized dealer. The display confirms the operation has started and when it has finished. You can also drive to clean the filter.



When the system is at the point of oversaturation, the malfunction indicator lamp illuminates and a message appears in the information display. You cannot initiate filter cleaning. You must have your vehicle checked as soon as possible.

Once manual regeneration starts, engine speed increases and the cooling fan speed increases. You will hear a change in audible sound due to engine speed and cooling fan speed increases.

It is not necessary to open the hood on the engine compartment. Once manual regeneration completes, the engine speed returns to normal idling. The exhaust system remains very hot for several minutes even after regeneration is complete. Do not reposition the vehicle over materials that could burn until the

# Diesel Particulate Filter - Diesel

exhaust system has had sufficient time to cool. Depending on the amount of soot collected by the diesel particulate filter, ambient temperature and altitude, manual regeneration lasts approximately 30 minutes.

## DIESEL PARTICULATE FILTER – TROUBLESHOOTING

### DIESEL PARTICULATE FILTER – WARNING LAMPS



If there are any issues with the diesel particulate filter system, or when the system is at the point of oversaturation, the powertrain warning lamp and the malfunction indicator lamp illuminate to inform you that your vehicle requires service. You may not be able to initiate filter cleaning. Have your vehicle checked as soon as possible.

## DIESEL PARTICULATE FILTER – INFORMATION MESSAGES

Message	Action
Exhaust Filter Cleaning	Your vehicle has entered the cleaning mode. Various engine actions will raise the exhaust temperature in the Diesel Particulate Filter system to burn off the particles (exhaust soot). After the vehicle burns the particles off, the exhaust temperature will return to normal levels. This message is NORMAL.
Exhaust Filter Overloaded Drive to Clean	The diesel particulate filter is full of particles (exhaust soot) and you are not operating the vehicle in a manner that allows normal cleaning. Drive the vehicle above 30 mph (50 km/h) when it is safe to do so, until the message turns off.
Exhaust Filter Overloaded Clean Now	
Exhaust Filter at Limit Clean Now	The diesel particulate filter is full of particles (exhaust soot) and you are not operating the vehicle in a manner that allows normal cleaning. Drive the vehicle above 30 mph (50 km/h) when it is safe to do so, until the message turns off.
Exhaust Filter at Limit Drive to Clean Now	
Exhaust Filter Drive Complete	Your diesel particulate filter is clean.

## Diesel Particulate Filter - Diesel

---

<b>Message</b>	<b>Action</b>
Exhaust Filter Cleaned	Your diesel particulate filter is clean (OCR Only).
Exhaust Filter Cleaning Stopped	The manual regeneration process has stopped (OCR Only).
Exhaust Filter Over Limit Service Now	You must have your vehicle serviced by an authorized dealer. Ignoring this warning message could lead to reduced drivability and customer expense, including damage to the diesel particulate filter. Your new vehicle warranty may not cover this damage.

# Selective Catalytic Reduction System - Diesel

## WHAT IS THE SELECTIVE CATALYTIC REDUCTION SYSTEM

The selective catalytic reduction system helps reduce tailpipe emissions and requires Diesel Exhaust Fluid (DEF) to convert nitrogen oxides into nitrogen and water.

## HOW DOES THE SELECTIVE CATALYTIC REDUCTION SYSTEM WORK

The selective catalytic reduction system injects diesel exhaust fluid into the exhaust system to enable correct selective catalytic reduction system function.

The usage of diesel exhaust fluid has increased from prior model years in order to meet more stringent emissions requirements. The diesel exhaust fluid usage ranges from approximately 2-6% of fuel burned (100.00 gal (378.54 L) of fuel requires approximately 2.00 gal (7.57 L) to 6.00 gal (22.71 L) of diesel exhaust fluid) depending on vehicle usage. Factors that influence diesel exhaust fluid usage may include:

- Payload/Towing
- Driving Style
- Altitude
- Humidity
- Temperature

## SELECTIVE CATALYTIC REDUCTION SYSTEM PRECAUTIONS



**WARNING:** Keep diesel exhaust fluid out of reach of children. Avoid contact with skin, eyes or clothing. In case of contact with your eyes, flush immediately with water and get prompt medical attention. In case of contact with your skin, clean immediately with soap and water. If you swallow any diesel exhaust fluid, drink plenty of water, call a physician immediately.



**WARNING:** Only refill the diesel exhaust fluid tank in a well ventilated area. When you remove the diesel exhaust fluid tank filler cap or a diesel exhaust fluid container cap, ammonia vapors may escape. Ammonia vapors can be irritating to skin, eyes and mucous membranes. Inhaling ammonia vapors can cause burning to the eyes, throat and nose and cause coughing and watery eyes.



**WARNING:** Diesel exhaust fluid must be refilled when low or replaced when contaminated or your vehicle speed becomes limited to 50 mph (80 km/h). In these conditions, drive with caution and refill diesel exhaust fluid immediately. If the diesel exhaust fluid becomes empty or contaminated and fluid is not replaced, your vehicle becomes limited to engine idle only once stopped. In these conditions, be cautious where you stop your vehicle because you may not be able to drive long distances or maintain highway speeds until you refill or replace the diesel exhaust fluid.

## Selective Catalytic Reduction System - Diesel



**WARNING:** Tampering with or disabling the selective catalytic reduction system results in severe vehicle performance limitation including eventual speed limiting to 5 mph (8 km/h).

**Note:** Do not put diesel exhaust fluid in the fuel tank. Do not start the engine if any amount of diesel exhaust fluid was added to the diesel fuel tank as it will likely lead to failure of the fuel pump and injectors and may result in severe engine damage which your vehicle Warranty may not cover. The diesel fuel tank must be completely drained and cleaned prior to being refilled with clean diesel fuel and starting the engine.

Selective catalytic reduction systems are sensitive to contamination of the diesel exhaust fluid. Maintaining the purity of the fluid is important to avoid system malfunctions. If you remove or drain the diesel exhaust fluid tank, do not use the same fluid to refill the tank. The system has a sensor to monitor fluid quality.

Driving without refilling, replacing contaminated diesel exhaust fluid, or having the selective catalytic reduction system repaired results in the following actions as required by the California Air Resources Board (CARB) and the U.S. Environmental Protection Agency (EPA):

- Within a preset distance to empty, speed is limited upon vehicle restart. Prior to this occurring a message appears in the information display.
- Further vehicle operation without refilling or replacing contaminated diesel exhaust fluid causes the engine to enter an idle-only condition. This only occurs upon vehicle refueling, vehicle idling in park for 1 hour, or engine shutdown for 10 minutes or more and is indicated by a message in the information display indicating required actions to resume normal operation. It is required to add a minimum of 1.0 gal (3.8 L) of diesel exhaust fluid to the tank to exit the idle-only condition, but your vehicle is still in the speed-limiting mode until you refill the tank completely.

**Note:** For vehicle speed limiting or idle-only condition, normal vehicle operation resumes when you refill the diesel exhaust fluid tank or repair the contaminated system. If the system is contaminated or inoperative, have your vehicle checked as soon as possible.

# Selective Catalytic Reduction System - Diesel

## SELECTIVE CATALYTIC REDUCTION SYSTEM REQUIREMENTS



Only use diesel exhaust fluid that is certified by the American Petroleum Institute (API).

You can purchase diesel exhaust fluid at an authorized dealer, or contact roadside assistance for help in finding a retailer that sells diesel exhaust fluid.

**Note:** *Non-certified diesel exhaust fluid use can cause damage that your Warranty may not cover*

## SELECTIVE CATALYTIC REDUCTION SYSTEM GUIDELINES

- Diesel exhaust fluid is non-flammable, non-toxic, colorless and water-soluble liquid.
- In order for the system to operate correctly you must maintain the diesel exhaust fluid level.
- Do not overfill the diesel exhaust fluid tank.
- Diesel exhaust fluid is corrosive.

- Avoid spilling diesel exhaust fluid on painted surfaces, carpeting or plastic components. Immediately wipe away any diesel exhaust fluid that has spilled with a damp cloth and water. If it has already crystallized, use warm water and a sponge.
- Do not store the diesel exhaust fluid bottle in your vehicle. If it leaks it could cause damage to interior components or release an ammonia odor inside your vehicle.
- Do not re-use the diesel exhaust fluid container once it is emptied.
- Store diesel exhaust fluid out of direct sunlight and in temperatures between 23–68°F (-5–20°C).
- The system has a diesel exhaust fluid quality sensor. Dilution of diesel exhaust fluid or use of any other liquid in the selective catalytic reduction system leads to a diesel exhaust fluid system fault, eventually leading to the vehicle only operating in idle-only mode.
- Do not dilute diesel exhaust fluid with water or any other liquid.

## FILLING THE SELECTIVE CATALYTIC REDUCTION SYSTEM TANK

### FILLING THE SELECTIVE CATALYTIC REDUCTION SYSTEM TANK IN COLD WEATHER

Diesel exhaust fluid may freeze if the ambient temperature is below 12°F (-11°C). Your vehicle has a preheating system which allows diesel exhaust fluid to operate below 12°F (-11°C). If you do not use your vehicle for an extended period when the ambient temperature is below 12°F (-11°C), the fluid in the tank may freeze.



## Selective Catalytic Reduction System - Diesel

If the DEF tank is frozen, it may not recognize when the tank is refilled. The DEF level will update once the tank thaws out. It is best to fill the DEF tank prior to, or after a drive cycle greater than 20 minutes to allow the remaining frozen DEF in the tank to liquefy. If the tank is overfilled and the fluid freezes it may cause damage that your Warranty will not cover.

**Note:** After filling the DEF tank, there may be a short period before the increased level is registered.

### FILLING THE SELECTIVE CATALYTIC REDUCTION SYSTEM TANK USING A FUEL STATION PUMP

Filling the diesel exhaust fluid tank using a fuel station pump is similar to refueling your vehicle.

1. Fully open the fuel filler door.

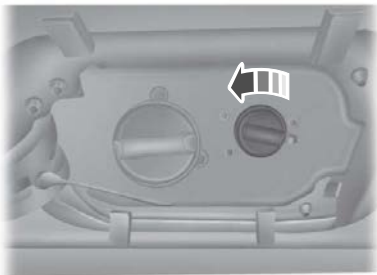

2. Remove the diesel exhaust fluid tank filler cap.

**Note:** The diesel exhaust fluid tank has a blue filler cap.

3. Fully insert the diesel exhaust fluid pump nozzle.

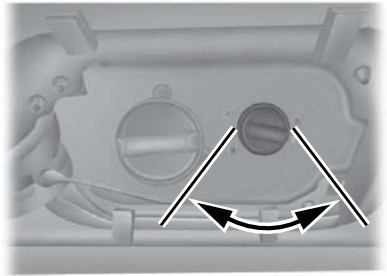

4. Operate the diesel exhaust fluid pump nozzle within the area shown.

**Note:** The pump nozzle shuts off when the tank is full.

5. Slightly raise the diesel exhaust fluid pump nozzle and then slowly remove it.
6. Replace the diesel exhaust fluid tank filler cap. Turn it clockwise until you feel a strong resistance and it clicks.

**Note:** After filling the DEF tank, there may be a short period before the increased level is registered.

### FILLING THE SELECTIVE CATALYTIC REDUCTION SYSTEM TANK USING A PORTABLE CONTAINER

The following procedure applies to Motorcraft diesel exhaust fluid or similar fluid containers. Follow the manufacturer's instructions.

1. Fully open the fuel filler door.
2. Remove the diesel exhaust fluid container cap.
3. Place the spout on to the container and tighten it until you feel a strong resistance.

## Selective Catalytic Reduction System - Diesel

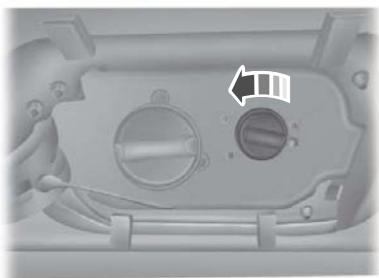

4. Remove the diesel exhaust fluid tank filler cap.

**Note:** The diesel exhaust fluid tank has a blue filler cap.

5. Insert the spout into the filler neck until the seal on the spout fully seats.
6. Pour the fluid into the tank.

**Note:** The fluid stops flowing when the tank is full.

7. Return the container to the vertical position slightly below the diesel exhaust fluid filler neck.
8. Allow any fluid remaining in the spout to drain back into the container.
9. Remove the spout from the diesel exhaust fluid filler neck.
10. Replace the diesel exhaust fluid tank cap. Turn it clockwise until you feel a strong resistance and it clicks.
11. Remove the spout from the diesel exhaust fluid container and replace the cap.

**Note:** If there is diesel exhaust fluid left in the container retain it for later use. The spout is reusable. Wash the spout with clean water prior to storage. Do not use the diesel exhaust fluid spout with any other fluid.

**Note:** After filling the DEF tank, there may be a short period before the increased level is registered.

### CHECKING THE SELECTIVE CATALYTIC REDUCTION SYSTEM STATUS

The information display shows a series of messages about the amount of diesel exhaust fluid available. A systems check displays messages indicating the amount of diesel exhaust fluid available or displays a warning message indicating the approximate distance remaining as the fluid in the diesel exhaust fluid tank nears empty. See **Selective Catalytic Reduction System – Information Messages** (page 227).

### DIESEL EXHAUST FLUID CAPACITY AND SPECIFICATION

For filling information please refer to the Capacities and Specifications section of the owner's manual. See **Diesel Exhaust Fluid Capacity and Specification** (page 537).

# Selective Catalytic Reduction System - Diesel

## SELECTIVE CATALYTIC REDUCTION SYSTEM – TROUBLESHOOTING

### SELECTIVE CATALYTIC REDUCTION SYSTEM – WARNING LAMPS



As the diesel exhaust fluid level nears empty, the warning

symbol displays and a series of tones and messages starting at 500 mi (800 km) remaining before diesel exhaust fluid is depleted. The warning symbol and messages continue until you refill the diesel exhaust fluid tank.

The warning lamp illuminates and a message appears in the information display if the system becomes contaminated or inoperative.

### SELECTIVE CATALYTIC REDUCTION SYSTEM – INFORMATION MESSAGES

Message	Action
DEF Level Range: XX mi/ km Refill Now	The distance you can travel before depleting the remaining diesel exhaust fluid. Refill as soon as possible.
DEF Level Empty Speed Limited to XX MPH / km/ h in XX mi/km	Your diesel exhaust fluid is nearing empty. Your vehicle's top speed will become limited in the displayed distance. You must replenish the diesel exhaust fluid to resume normal operation of your vehicle. See <b>Diesel Exhaust Fluid Capacity and Specification</b> (page 537).
DEF Level Empty Speed Limited to XX MPH/km/ h Upon Restart	Your remaining diesel exhaust fluid has depleted. Your speed will be limited upon restart. You must replenish the diesel exhaust fluid to resume normal operation of your vehicle. See <b>Diesel Exhaust Fluid Capacity and Specification</b> (page 537).
DEF Level Low Speed Limited to XX MPH/km/ h	The diesel exhaust fluid is empty. You must replenish the diesel exhaust fluid to resume normal operation of your vehicle. See <b>Diesel Exhaust Fluid Capacity and Specification</b> (page 537).
DEF Level Empty Engine Idled Soon	The selective catalytic reduction system detects low exhaust fluid. The engine will eventually enter into an idle only mode. You must replenish the diesel exhaust fluid to resume normal operation of your vehicle. See <b>Diesel Exhaust Fluid Capacity and Specification</b> (page 537).
DEF Level Empty Engine Idled See Manual	The vehicle will enter into an idle only mode. You must replenish the diesel exhaust fluid to resume normal operation of your vehicle. See <b>Diesel Exhaust Fluid Capacity and Specification</b> (page 537).

## Selective Catalytic Reduction System - Diesel

<b>Message</b>	<b>Action</b>
DEF Fault Speed Limited to XX MPH/km/h in XX mi/km	The selective catalytic reduction system detects a fault. The vehicle's top speed will become limited in the displayed distance and count down from this point. Have your vehicle checked as soon as possible.
DEF Fault Speed Limited to XX MPH/km/h Upon Restart	The selective catalytic reduction system detects a fault. The vehicle's top speed will become limited upon restarting. Have your vehicle checked as soon as possible.
DEF Fault Speed Limited to XX MPH/km/h	The selective catalytic reduction system detects a fault. The vehicle's top speed is limited. Have your vehicle checked as soon as possible.
DEF Fault Engine Idled Soon	The selective catalytic reduction system detects a fault. The engine will eventually enter into an idle only mode. Have your vehicle checked as soon as possible.

# Catalytic Converter

## WHAT IS THE CATALYTIC CONVERTER

The catalytic converter is part of your vehicle's emissions system and filters harmful pollutants from the exhaust gas.

## CATALYTIC CONVERTER PRECAUTIONS



**WARNING:** Do not park, idle or drive your vehicle on dry grass or other dry ground cover. The emission system heats up the engine compartment and exhaust system, creating the risk of fire.



**WARNING:** The normal operating temperature of the exhaust system is very high. Never work around or attempt to repair any part of the exhaust system until it has cooled. Use special care when working around the catalytic converter. The catalytic converter heats up to a very high temperature after only a short period of engine operation and stays hot after the engine is switched off.



**WARNING:** Exhaust leaks may result in entry of harmful and potentially lethal fumes into the passenger compartment. If you smell exhaust fumes inside your vehicle, have your vehicle inspected immediately. Do not drive if you smell exhaust fumes.

To avoid damaging the catalytic converter:

- Do not crank the engine for more than 10 seconds at a time.
- Do not run the engine with a spark plug lead disconnected.
- Do not push-start or tow-start your vehicle. Use booster cables. See **Jump Starting the Vehicle** (page 420).

- Use the correct fuel. See **Fuel and Refueling** (page 209).
- Do not switch the ignition off when your vehicle is moving.
- Avoid running out of fuel.
- Have the items listed in scheduled maintenance information performed according to the specified schedule.

**Note:** Do not make any unauthorized changes to your vehicle or engine. By law, vehicle owners and anyone who manufactures, repairs, or services a fleet of vehicles are not permitted to intentionally remove an emission control device or prevent it from working.

## CATALYTIC CONVERTER – TROUBLESHOOTING

### CATALYTIC CONVERTER – WARNING LAMPS

Your vehicle has an on-board diagnostics system that monitors the emission control system. If any of the following warning lamps illuminate, this may indicate that the on-board diagnostics system has detected an emission control system malfunction.



Continuing to drive your vehicle may cause reduced power or the engine to stop. Failure to respond to a warning lamp may cause damage that your vehicle Warranty may not cover. Have your vehicle checked as soon as possible.

# Automatic Transmission

## AUTOMATIC TRANSMISSION PRECAUTIONS



**WARNING:** Apply the parking brake, shift into park (P), switch the vehicle off and remove the key or remote control before you leave your vehicle. Failure to follow this instruction could result in personal injury or death.



**WARNING:** When your vehicle is stationary, keep the brake pedal fully pressed when shifting gears. Failure to follow this instruction could result in personal injury, death or property damage.



**WARNING:** Do not apply the brake pedal and accelerator pedal simultaneously. Applying both pedals simultaneously for more than a few seconds limits vehicle performance, which may result in difficulty maintaining speed in traffic and could lead to serious injury.

## AUTOMATIC TRANSMISSION POSITIONS

### PARK (P)



**WARNING:** Shift into park (P) only when your vehicle is stationary.

In park (P) power is not transmitted to the driven wheels.

**Note:** A tone sounds if you attempt to exit your vehicle without the vehicle in park (P).

**Note:** Your vehicle may not shift out of park (P) if the 12 V battery has run out of charge.

**Note:** Your vehicle may not shift out of park (P) if a fuse is blown.

**Note:** Your vehicle may not shift out of park (P) unless the key or remote control is inside your vehicle.

**Note:** The electronic parking brake could apply when you power your vehicle on with the selector in park (P).

**Note:** The electronic parking brake could apply if you shift to park (P) without fully pressing the brake pedal.

**Note:** The electronic parking brake could apply if you shift to park (P) on a slope.

**Note:** Do not manually release the parking brake when the selector is in park (P). See **Automatically Releasing the Electric Parking Brake** (page 251).

### REVERSE (R)



**WARNING:** Shift into reverse (R) only when your vehicle is stationary.

In reverse (R) power is transmitted to the driven wheels.

### NEUTRAL (N)



**WARNING:** In neutral (N) your vehicle is free to roll.

In neutral (N) power is not transmitted to the driven wheels.

### DRIVE (D)

In drive (D) power is transmitted to the driven wheels.

**Note:** Progressive range selection is available in drive (D). See **Using Progressive Range Selection** (page 231).

# Automatic Transmission

## MANUAL (M)

In manual (M) you can select a specific gear. See **Manually Shifting Gears** (page 232).

**Note:** We recommend using this mode for driving on hilly or mountainous roads or when towing a trailer. See **Towing a Trailer** (page 362).

## SHIFTING YOUR VEHICLE INTO GEAR

The transmission selector is on the steering column.



1. Press and hold the brake pedal.
2. Move the lever to select a position.
3. Press the manual (M) button when your vehicle is in drive (D) to enter or exit mode.

## AUTOMATIC TRANSMISSION POSITION INDICATORS

The instrument cluster displays the current position.



**Note:** The position could illuminate on the transmission selector.

## AUTOMATIC TRANSMISSION AUDIBLE WARNINGS

Sounds if any of the following occur:

- You switch your vehicle off before shifting into park (P).
- You open the driver door before shifting into park (P).

## USING PROGRESSIVE RANGE SELECTION

Progressive range selection gives you the ability to lock out gears from the automatic shifting range. This could provide you with an improved driving experience by reducing transmission shifts, for example, in slippery conditions or steep slopes.

With the transmission in drive (D), press the minus (-) button to begin to switch the feature on.

Press the minus (-) button again to continue locking out higher gears. Beginning with the highest gear, the instrument cluster will indicate the current gear and highest gear available. For example, press the minus (-) button twice to lock out 10th and 9th gears.

**Note:** The instrument cluster will indicate the current gear and highest gear available.

# Automatic Transmission

Press the plus (+) button to unlock gears to allow the transmission to shift to higher gears.

**Note:** *The transmission automatically shifts within the gear range you select.*

## MANUALLY SHIFTING GEARS

### SHIFTING USING THE BUTTONS ON THE COLUMN SHIFTER

The instrument cluster displays the current gear. The current gear flashes when your vehicle cannot shift into the requested gear. Your vehicle will not shift if the requested gear raises or lowers the engine speed beyond the limit.

Your vehicle could shift when you fully press the accelerator or brake pedal.

**Note:** *Prolonged driving with high engine speed could cause vehicle damage not covered by vehicle warranty.*

**Note:** *Drive modes could affect when the vehicle shifts into the requested gear.*



### Manually Shifting Gears in Manual (M)

Use this feature to select a specific gear.

**Note:** *We recommend using this feature for engine braking, driving on hilly or mountainous roads, or when towing a trailer. See **Towing a Trailer** (page 362).*

- Shift to manual (M) to switch the feature on.
- Press the upper (+) button to upshift.
- Press the lower (-) button to downshift.
- Shift to drive (D) to switch the feature off.

## POWER TAKE-OFF (IF EQUIPPED)

### HOW DOES THE POWER TAKE-OFF WORK

Auxiliary equipment called power take-off, or PTO, is often added to the engine or transmission to operate utility equipment. Examples include a wheel-lift for tow trucks, cranes, tools for construction or tire service, and pumping fluids. PTO applications draw auxiliary horsepower from the powertrain, often while the vehicle is stationary. In this condition, there is limited cooling air flow through the radiator and around the vehicle that normally occurs when a vehicle is moving. The aftermarket PTO system installer, having the most knowledge of the final application, is responsible for determining whether additional chassis heat protection or powertrain cooling is required, and alerting the user to the safe and proper operation.

**Note:** *Use of auxiliary equipment that exceeds the maximum Power Take-Off (PTO) load specified in our **Truck Body Builders Layout Book** can adversely affect the performance of the powertrain system. Refer to the **Body Builders Layout Book** for instructions about the appropriate installation of additional equipment.*



# Automatic Transmission

---

For additional information, visit [www.fordbbas.com/home](http://www.fordbbas.com/home).

## **WHAT IS THE SPLIT SHAFT CAPABILITY**

The split shaft capability feature allows you to install an aftermarket split shaft gearbox in your vehicle's driveline and run one or two power takeoffs on the gearbox. The output of the transmission or transfer case connects directly with the split shaft gearbox and allows the engine to power the power takeoff, when the engine is running and the split shaft software is enabled.

This feature is approved as a stationary power source, within the limits and operating guidelines detailed in our Truck Body Builders Layout Book. For additional information, visit [www.fordbbas.com/home](http://www.fordbbas.com/home).

## Four-Wheel Drive (If Equipped)

### HOW DOES FOUR-WHEEL DRIVE WORK

#### Using the Electronic Shift On the Fly System (If Equipped)

This four-wheel drive system utilizes a 2-speed Electronic Shift On the Fly (ESOF) transfer case which is also known as a part-time system. This system offers the driver two-wheel drive high, four-wheel drive high, and four-wheel drive low as available modes of operation. When you select either four-wheel drive high or four-wheel drive low, the system provides mechanically locked four-wheel drive power to both the front and rear wheels for use in off-road or slippery conditions such as deep snow, sand or mud. When you select four-wheel drive low, the system provides additional gearing for increased torque multiplication for conditions like deep sand, steep slopes, or pulling heavy objects. Additionally, the system is capable of recreational flat towing by putting the transfer case into a neutral position. See **Recreationally Towing Your Vehicle** (page 426).

There is further information available on driving in unique driving conditions. See **Off-Road Driving** (page 409).



Your vehicle has manual hub locks on either the driver side or the driver and passenger side of your vehicle. For proper operation, make sure that each hub is fully engaged and that both hub locks are set to the same position (both set to lock or both set to auto). To engage lock, turn the hub locks completely clockwise. To engage auto, turn the hub locks completely counterclockwise.

The ESOF four-wheel drive system:

- Provides 4x4 High engagement and disengagement while the vehicle is moving.
- Operates by a push button control located on the instrument panel that allows you select 4x2, 4x4 High or 4x4 Low operation.
- Uses auto-manual hub locks. When set to auto, the hubs engage and disengage automatically based on the 4x4 mode you select. When set to lock, the hubs remain engaged at all times.
- Increases fuel economy when used in the hub lock's recommended auto mode.

**Note:** *Auto-manual hub locks manually lock by rotating the hub lock control from auto to lock.*

**Note:** *Hub locks should be in auto mode when in 4x2 mode. If hub locks are in lock mode in 4x2 mode, there will be additional noise from the front axle.*

## Four-Wheel Drive (If Equipped)

### FOUR-WHEEL DRIVE PRECAUTIONS



**WARNING:** Vehicles with a higher center of gravity (utility and four-wheel drive vehicles) handle differently than vehicles with a lower center of gravity (passenger cars). Avoid sharp turns, excessive speed and abrupt steering in these vehicles. Failure to drive cautiously increases the risk of losing control of your vehicle, vehicle rollover, personal injury and death.



**WARNING:** Do not become overconfident in the ability of four-wheel drive vehicles. Although a four-wheel drive vehicle may accelerate better than a two-wheel drive vehicle in low traction situations, it won't stop any faster than two-wheel drive vehicles. Always drive at a safe speed.

Truck and utility vehicles differ from passenger cars. Your vehicle could be higher to allow it to travel over rough terrain without getting stuck or damaging underbody components. The differences that make your vehicle so versatile also make it handle differently than passenger cars. Always maintain steering wheel control, especially in rough terrain. Since sudden changes in terrain can result in abrupt steering wheel motion, make sure you grip the steering wheel from the outside. Do not grip the spokes. Drive cautiously to avoid vehicle damage from concealed objects such as rocks and stumps. Drive slower in strong crosswinds which can affect the normal steering characteristics of your vehicle. Be extremely careful when driving on pavement made slippery by loose sand, water, gravel, snow or ice.

**Note:** Your vehicle may come with a front air dam that can become damaged (due to reduced ground clearance) when taking your vehicle off-road. To prevent damage, remove the 15 bolts securing the air dam and remove.

### FOUR-WHEEL DRIVE LIMITATIONS

Do not use four-wheel drive high or four-wheel drive low mode on dry, hard surface roads. Doing so can produce excessive noise, increase tire wear and can damage drive components. Four-wheel drive high or four-wheel drive low modes are intended for consistently slippery or loose surfaces. Use of four low mode on these surfaces could produce some noise, such as occasional clunks, but should not damage drive components. When transitioning from consistently loose or slippery surfaces, be sure the four-wheel drive system is not mechanically blocked once on dry, hard surface roads in two-wheel drive high.

**Note:** In certain scenarios, where the four-wheel drive system has difficulty engaging, a **To Engage 4x4 Slow to 3 MPH** or **To Engage 4x4 Slow to 5 km/h** message could appear in the instrument cluster.

### Operating Four-Wheel Drive with a Spare or Worn Tires

Your four-wheel drive system is not intended to provide full function with tires that have different levels of wear or with a dissimilar spare tire. Incorrect use of four-wheel drive with such tires can cause system damage.

## Four-Wheel Drive (If Equipped)

If there is a difference in the level of wear among tires on the vehicle or if you install a dissimilar spare tire on the vehicle, do not use 4WD High or 4WD Low (if equipped) other than to get your vehicle unstuck. After getting your vehicle unstuck, shift to 2H by performing the following steps:

1. Come to a stop on a flat, horizontal surface
2. Shift the transmission to park (P) for automatic transmissions and neutral (N) for manual transmissions.
3. Switch to two-wheel drive mode.
4. Shift the transmission to reverse (R).
5. Shift the transmission to drive (D) for automatic transmissions and to first gear for manual transmissions. This ensures the transfer case system is not trapped in place.

**Note:** When the system detects a spare or worn tires and a four-wheel drive engagement request above a designated speed, a warning message appears in the instrument cluster. See **Four-Wheel Drive – Information Messages** (page 239).

**Note:** In certain scenarios, where the four-wheel drive system has difficulty engaging, a **To Engage 4x4 Slow to 3 MPH** or **To Engage 4x4 Slow to 5 km/h** message could appear in the instrument cluster.

### Mechanical Shift Blocking

On four-wheel drive vehicles with a mechanically locked four-wheel drive high mode, the transfer case distributes torque to the front wheels by mechanically interlocking the front and rear driveshafts together. Various external factors affect shifting performance of this type of system including, but not limited to:

- Vehicle acceleration.
- Dissimilar tire sizes.
- Steering input.

If the system detects a mechanical shift blockage at speed after you select two-wheel drive high, the message "4x4 Unable to Disengage See Manual", could display momentarily. If this message displays, one or more of the following actions can relieve the mechanical shift block:

- Momentary acceleration.
- Momentary braking.
- Bringing the vehicle to a stop.
- Shifting the transmission to neutral and back to drive.
- Shifting the transmission to reverse and back to drive.
- Driving the vehicle around a tight turn at a slow speed.

**Note:** In certain scenarios, where the four-wheel drive system has difficulty engaging, a warning message appears in the instrument cluster. See **Four-Wheel Drive – Information Messages** (page 239).

### SWITCHING FOUR-WHEEL DRIVE ON AND OFF

A vehicle that comes with four-wheel drive, when selected, has the ability to use all four wheels to power itself. This increases traction, which may enable you to safely drive over terrain and road conditions that a conventional two-wheel drive vehicle cannot.

On some four-wheel drive models, the initial shift from two-wheel drive to four-wheel drive while the vehicle is moving can cause a momentary clunk and ratcheting sound. These sounds are normal as the front drivetrain comes up to speed and are not cause for concern.

## Four-Wheel Drive (If Equipped)

### SELECTING A FOUR-WHEEL DRIVE MODE



The drive mode control is on the instrument panel.

Press the four-wheel drive mode button that best fits the current driving conditions. You can select two-wheel drive high (2H) or four-wheel drive high (4H) at a stop or while driving. When the shift is complete, the mode you select appears in the instrument cluster display. While shifting, the lights on the drive mode control can flash and you could see messages in the instrument cluster display indicating that a shift is in progress or to release the accelerator pedal to improve shift performance.

**Note:** *Momentarily releasing the accelerator pedal while a shift in progress message displays improves engagement or disengagement performance.*

**Note:** *Do not perform this operation when cruise control or trail control is selected and active. The system may not shift as expected.*

**Note:** *When the light is solid, the system has achieved the desired four-wheel drive mode. When a selected four-wheel drive mode light is blinking, the system is attempting to shift to that specific four-wheel drive mode.*

**Note:** *When you achieve recreational towing, all lights are off and Neutral Tow Enabled Leave Transmission in Neutral appears in the instrument cluster display.*

**Note:** *Do not perform this operation if the rear wheels are slipping, when making a tight turn or when applying the accelerator pedal. The system may not shift as expected.*

**Note:** *In certain scenarios, where the four-wheel drive system has difficulty engaging, a **To Engage 4x4 Slow to 3 MPH** or **To Engage 4x4 Slow to 5 km/h** message could appear in the instrument cluster.*

**Note:** *You could hear some noise as the system shifts or engages, this is normal.*

If the system detects a fault, a warning message appears in the instrument cluster display. See **Four-Wheel Drive – Information Messages** (page 239).

### Shifting to or from Four-Wheel Drive Low (4L)

To select or exit four-wheel drive low (4L):

1. Bring your vehicle to a speed of 3 mph (5 km/h) or less.
2. Place the transmission in neutral (N)
3. Press the desired four-wheel drive button on the drive mode control.

A message appears in the instrument cluster display indicating a four-wheel drive shift is in progress. If any of the above shift conditions are not present, the shift will not occur and information guiding you through the proper shifting procedures appears in the instrument cluster display.

## Four-Wheel Drive (If Equipped)

If there is a transfer case tooth blockage a message appears in the instrument cluster display. To alleviate this condition, place the transmission in a forward gear, move your vehicle forward approximately 5 ft (1.5 m), and shift the transmission back to neutral (N) to allow the transfer case to complete the range shift.

**Note:** *You could hear some noise as the system shifts or engages, this is normal.*

If the system detects a fault, a warning message appears in the instrument cluster display. See **Four-Wheel Drive – Information Messages** (page 239).

### FOUR-WHEEL DRIVE MODES

#### TWO-WHEEL DRIVE HIGH

Two-wheel drive high is for general on-road driving. Power is sent to the rear wheels only.

**Note:** *Two-wheel drive high can turn on or off automatically based on Drive Mode selection. See **Drive Mode Control** (page 309).*

#### FOUR-WHEEL DRIVE HIGH

Four-wheel drive high provides mechanically locked four-wheel drive power to both the front and rear wheels for use in off-road or winter conditions such as deep snow, sand or mud. This mode is not for use on dry pavement.

**Note:** *Four-wheel drive high can turn on or off automatically based on Drive Mode selection. See **Selecting a Drive Mode** (page 309).*

### FOUR-WHEEL DRIVE LOW

Four-wheel drive low provides mechanically locked four-wheel drive power to both the front and rear wheels for use on low traction surfaces, but does so with additional gearing for increased torque multiplication. This mode is only for off-road conditions such as deep sand, steep slopes, or pulling heavy objects.

**Note:** *Four-wheel drive low can turn on or off automatically based on drive mode selection. See **Selecting a Drive Mode** (page 309).*

### FOUR-WHEEL DRIVE INDICATORS

#### Two-wheel Drive High

**2H** Momentarily illuminates when you select two-wheel drive high.

#### Four-wheel Drive High

**4H** Continuously illuminates when you select four-wheel drive high.

#### Four-wheel Drive Low

**4L** Continuously illuminates when you select four-wheel drive low.

### TRANSFER CASE FLUID CAPACITY AND SPECIFICATION

See **Transfer Case Fluid Capacity and Specification** (page 539).

## Four-Wheel Drive (If Equipped)

### FOUR-WHEEL DRIVE – TROUBLESHOOTING

### FOUR-WHEEL DRIVE – WARNING LAMPS



Illuminates when a four-wheel drive or power train fault is

present.

**Note:** When a system fault is present, the system can typically remain in whichever mode was selected prior to the fault condition occurring. It does not default to two-wheel drive in all circumstances. When this warning is displayed, have your vehicle serviced by an authorized dealer.

### FOUR-WHEEL DRIVE – INFORMATION MESSAGES

Message	Action
Check 4x4	A four-wheel drive system fault is present. Have the system checked as soon as possible.
4x4 Shift in Progress	The four-wheel drive system is making a shift.
For 4x4 LOW Shift to N	Displays when you attempt to switch to four-wheel drive low mode and you do not shift the transmission to neutral (N).
For 4x4 LOW Slow to 3 MPH	Displays when you attempt to switch to four-wheel drive low mode and your vehicle's speed is greater than 3 mph (5 km/h).
For 4x4 LOW Slow to 5 km/h	
To Exit 4x4 LOW Shift to N	Displays when you attempt to switch from four-wheel drive low mode and you do not shift the transmission to neutral (N).
To Exit 4x4 LOW Slow to 3 MPH	Displays when you attempt to switch from four-wheel drive low mode and your vehicle's speed is greater than 3 mph (5 km/h).
To Exit 4x4 LOW Slow to 5 km/h	
Shift Delayed Drive Forward	Displays when there is a transfer case gear tooth blockage while shifting to or from four-wheel drive low mode or to the neutral state. Place the transmission in a forward gear, move your vehicle forward approximately 5 ft (1.5 m), and shift the transmission back to neutral (N) to allow the transfer case to complete the range shift.

## Four-Wheel Drive (If Equipped)

Message	Action
Shift to Neutral	Displays when the system requires an additional transmission shift to neutral (N) to complete a transfer case shift.
To Engage 4x4 Slow to 3 MPH	Displays when the system is unable to engage four-wheel drive high and requires the driver to slow down before attempting to engage.
To Engage 4x4 Slow to 5 km/h	
To Engage 4x4 Release Accelerator Pedal	Displays when the four-wheel drive system requests that you release the accelerator pedal to complete a four-wheel drive shift. See <b>Selecting a Four-Wheel Drive Mode</b> (page 237).
4x4 Unable to Disengage See Manual	Displays when the four-wheel drive system detects a mechanical shift block when shifting out of four-wheel drive high. See <b>Four-Wheel Drive Limitations</b> (page 235).

### FOUR-WHEEL DRIVE VIDEOS

[4-Wheel-Drive Systems Video Link](#)



# Rear Axle

---

## **LIMITED SLIP DIFFERENTIAL**

### **(IF EQUIPPED)**

This axle provides added traction on slippery surfaces, particularly when one wheel is on a poor traction surface. Under normal conditions, the limited-slip axle functions like a standard rear axle. The axle may exhibit a slight noise or vibration during tight turns with low vehicle speed. This is normal behavior and indicates the axle is working.

# Electronic Locking Differential (If Equipped)

## WHAT IS THE ELECTRONIC LOCKING DIFFERENTIAL

The electronic locking differential is a device housed in the rear axle and when activated, allows both wheels on that axle to turn at the same speed. The electronic locking differential provides additional traction should your vehicle become stuck.

## HOW DOES THE ELECTRONIC LOCKING DIFFERENTIAL WORK

You can activate the differential electronically and shift it on the fly within the operating speed range. The electronic differential disengages when the vehicle speed exceeds a set value and it reengages when the vehicle speed drops below a set value. See **Switching the Electronic Locking Differential On and Off** (page 242). The electronic locking differential could engage based on certain selected drive modes. See **Selecting a Drive Mode** (page 309). The electronic locking differential is for use in mud, rocks, sand, or any off-road condition where you need maximum traction.

**Note:** The electronic locking differential is for off-road use only and is not for use on dry pavement. Using the electronic locking differential on dry pavement results in increased tire wear, noise and vibration.

**Note:** The electronic locking differential activates or deactivates automatically based on speed, four-wheel drive mode, and drive mode selection. See **Switching the Electronic Locking Differential On and Off** (page 242).

## ELECTRONIC LOCKING DIFFERENTIAL PRECAUTIONS

### Operating the Electronic Locking Differential with a Spare or Mismatched Tires

On vehicles with an electronic locking differential, the size of the spare tire can affect performance of the system. If there is a significant difference between the two rear tires, you may have limited electronic locking differential functionality. If the system has difficulty disengaging, release the accelerator pedal and turn the steering wheel in the opposite direction when rolling. We recommend engaging and disengaging the electronic locking differential at a stop when you mount a spare on the rear axle.

## SWITCHING THE ELECTRONIC LOCKING DIFFERENTIAL ON AND OFF - 4X4

Press the electronic lock differential switch to engage and disengage the locking differential.



## Electronic Locking Differential (If Equipped)

### 4X4 Rear Electronic Locking Differential Engagement Speed and Availability

Drive Modes	Maximum Engagement Speed	Automatic Disengagement Speed	Automatic Re-Engagement Speed
Eco (2H, 4H)	20 mph (30 km/h)	25 mph (41 km/h)	20 mph (30 km/h)
Tow/Haul Mode (2H,4H)	20 mph (30 km/h)	25 mph (41 km/h)	20 mph (30 km/h)
Normal (2H, 4H)	20 mph (30 km/h)	25 mph (41 km/h)	20 mph (30 km/h)
Slippery (2H, 4H)	20 mph (30 km/h)	25 mph (41 km/h)	20 mph (30 km/h)
Off-Road (4H, 4L) <sup>1</sup>	No Speed Limit	No Speed Limit	No Speed Limit
Rock Crawl (4L) <sup>2</sup>	No Speed Limit	No Speed Limit	No Speed Limit

<sup>1</sup> Engages when you select these drive modes. You have the ability to manually override the automatic engagement by pressing the electronic locking differential.

<sup>2</sup> Engages when you select these drive modes. You have the ability to manually override the automatic engagement by pressing the electronic locking differential. Only available with Tremor Package.

4WD Mode	Maximum Engagement Speed	Automatic Disengagement Speed	Automatic Re-Engagement Speed
Four-Wheel Drive Low (4L)	No Speed Limit	No Speed Limit	No Speed Limit

**Note:** The electronic locking differential may not engage if you press the accelerator pedal during an engagement attempt. A message could display in the instrument cluster display guiding you to release the accelerator pedal.

**Note:** Switching the electronic locking differential off while turning results in disengagement difficulties. If the electronic locking differential has difficulty disengaging, release the accelerator pedal and turn the steering wheel back and forth in small increments while maintaining control and following a straight line.

**Note:** The electronic locking differential is for off-road use only and is not for use on dry pavement. Using the electronic locking differential on dry pavement results in increased tire wear, noise and vibration.

**Note:** Do not perform this operation when cruise control or trail control is selected and active. The system may not engage or disengage as expected.

# Electronic Locking Differential (If Equipped)

## SWITCHING THE ELECTRONIC LOCKING DIFFERENTIAL ON AND OFF - 4X2

Press the electronic locking differential switch to engage and disengage the electronic locking differential.

### 4X2 Rear Electronic Locking Differential Engagement Speed and Availability

Maximum Engagement Speed	Automatic Disengagement Speed	Automatic Re-Engagement Speed
20 mph (30 km/h)	25 mph (41 km/h)	20 mph (30 km/h)

**Note:** The electronic locking differential can activate or deactivate automatically based on speed, four-wheel drive mode, and drive mode selection. See **Selecting a Drive Mode** (page 309).



**Note:** The electronic locking differential may not engage if you press the accelerator pedal during an engagement attempt. A message could display in the instrument cluster display guiding you to release the accelerator pedal.

**Note:** Switching the electronic locking differential off while turning results in disengagement difficulties. If the electronic locking differential has difficulty disengaging, release the accelerator pedal and turn the steering wheel back and forth in small increments while maintaining control and following a straight line.

**Note:** The electronic locking differential is for off-road use only and is not for use on dry pavement. Using the electronic locking differential on dry pavement results in increased tire wear, noise and vibration.

**Note:** Do not perform this operation when cruise control or trail control is selected and active. The system may not engage or disengage as expected.

## ELECTRONIC LOCKING DIFFERENTIAL INDICATORS



If both rear wheel axle shafts lock together, the indicator in the cluster is amber, providing additional traction.

If you select the electronic locking differential and the indicator in the cluster is gray or turns from amber to gray while driving, one of the following has occurred:

- The vehicle speed is too high.
- The accelerator pedal is too high during an engagement attempt.
- The vehicle is experiencing an anti-lock brake activation.
- The left and right wheel speed difference is too high during an engagement attempt.

If you select the electronic locking differential and the indicator in the cluster does not turn on, the following has occurred:

## Electronic Locking Differential (If Equipped)

---

- The system has malfunctioned and accompanies a check locking differential message in the information display. See your dealer as soon as possible.

**Note:** *If the vehicle is experiencing an anti-lock braking event, the electronic locking differential may momentarily disengage.*

### ELECTRONIC LOCKING DIFFERENTIAL – TROUBLESHOOTING

### ELECTRONIC LOCKING DIFFERENTIAL – INFORMATION MESSAGES

Message	Description and Action
Check Locking Differential	An electronic locking differential system fault is present. Contact an authorized dealer as soon as possible.
To Engage Locking Differential Release Accelerator Pedal	Release the accelerator pedal to engage.

# Brakes

## BRAKE PRECAUTIONS

Wet brakes result in reduced braking efficiency. Gently press the brake pedal a few times when leaving a car wash or driving from standing water to dry the brakes.

**Note:** *Depending on applicable laws and regulations in the country for which your vehicle was originally built, your brake lamps may flash during heavy braking. Following this, your hazard lights may also flash when your vehicle comes to a stop.*

## ANTI-LOCK BRAKING SYSTEM

### ANTI-LOCK BRAKING SYSTEM LIMITATIONS

The anti-lock braking system does not eliminate the risk of crash when:

- You drive too closely to the vehicle in front of you.
- Your vehicle is hydroplaning.
- You take corners too fast.
- The road surface is poor.

**Note:** *If the system activates, the brake pedal could pulse and travel further. Maintain pressure on the brake pedal.*

## BRAKE OVER ACCELERATOR

In the event the accelerator pedal becomes stuck or entrapped, apply steady and firm pressure to the brake pedal to slow the vehicle and reduce engine power. If you experience this condition, apply the brakes and bring your vehicle to a safe stop. Move the transmission to park (P), switch the engine off and apply the parking brake. Inspect the accelerator pedal for any interference. If none are found and the condition persists, have your vehicle towed to the nearest authorized dealer.

## LOCATING THE BRAKE FLUID RESERVOIR

See **Under Hood Overview** (page 440).

## CHECKING THE BRAKE FLUID



**WARNING:** Do not use any fluid other than the recommended brake fluid as this will reduce brake efficiency. Use of incorrect fluid could result in the loss of vehicle control, serious personal injury or death.



**WARNING:** Only use brake fluid from a sealed container. Contamination with dirt, water, petroleum products or other materials may result in brake system damage or failure. Failure to adhere to this warning could result in the loss of vehicle control, serious personal injury or death.



**WARNING:** Do not allow the fluid to touch your skin or eyes. If this happens, rinse the affected areas immediately with plenty of water and contact your physician.



**WARNING:** The brake system could be affected if the brake fluid level is below the **MIN** mark or above the **MAX** mark on the brake fluid reservoir.

1. Park your vehicle on a level surface.

# Brakes



2. Look at the brake fluid reservoir to see where the brake fluid level is relative to the **MIN** and the **MAX** marks on the reservoir.

**Note:** To avoid fluid contamination, the reservoir cap must remain in place and fully tight, unless you are adding fluid.

Only use fluid that meets our specifications. See **Capacities and Specifications** (page 520).

## BRAKE FLUID SPECIFICATION

See **Brake Fluid Specification** (page 538).

## BRAKES – TROUBLESHOOTING

### BRAKES – WARNING LAMPS

 **WARNING:** Driving your vehicle with the warning lamp on is dangerous. A significant decrease in braking performance may occur. It may take you longer to stop your vehicle. Have your vehicle checked as soon as possible. Driving extended distances with the parking brake engaged can cause brake failure and the risk of personal injury.



If the ABS indicator illuminates when you are driving, this indicates a malfunction. Your vehicle continues to have normal braking without the anti-lock braking system function. See an authorized dealer.

It also momentarily illuminates when you switch the ignition on to confirm the lamp is functional. If it does not illuminate when you switch the ignition on, or begins to flash at any time, have the system checked by an authorized dealer.



The brake indicator momentarily illuminates when you switch the ignition on to confirm the lamp is functional. It may also illuminate when you apply the parking brake and the ignition is on. If it illuminates when your vehicle is moving, make sure the parking brake is disengaged. If the parking brake is disengaged, this indicates low brake fluid level or a brake system fault. See an authorized dealer.

**Note:** Lamps may vary depending on region.

# Brakes

---

## BRAKES – INFORMATION MESSAGES

Message	Details
Brake Fluid Level Low	The brake fluid level is low, check the brake system immediately. See <b>Checking the Brake Fluid</b> (page 246).
Check Brake System	Have the system checked as soon as possible.



# Brakes

---

## **BRAKES – FREQUENTLY ASKED QUESTIONS**

### **Is it normal for my brakes to make noise?**

Occasional brake noise is normal. If a metal-to-metal, continuous grinding, or squeal sound is present, the brake lining could be worn. Have the system checked.

### **There is an electrical motor sound when I press on the brake pedal or activate the park brake switch. Is this normal?**

Yes, those sounds are the electronic brake booster or the electronic park brake operating.

**Note:** *Brake dust could accumulate on the wheels, even under normal driving conditions. Some dust is normal as the brakes wear and does not contribute to brake noise. See **Cleaning Wheels** (page 469).*

# Electric Parking Brake

## WHAT IS THE ELECTRIC PARKING BRAKE

The electric parking brake is used to hold your vehicle on slopes and flat roads.

## APPLYING THE ELECTRIC PARKING BRAKE



**WARNING:** Apply the parking brake, shift into park (P), switch the ignition off and remove the key before you leave your vehicle. Failure to follow this instruction could result in personal injury or death.



**WARNING:** If you drive extended distances with the parking brake applied, you could cause damage to the brake system.



**WARNING:** The electric parking brake does not operate if the vehicle battery has run out of charge.



**WARNING:** If the parking brake is fully released, but the brake warning lamp remains illuminated, the brakes may not be working properly. Have your vehicle checked as soon as possible.



The switch is on the lower part of the instrument panel.

Pull the switch up to apply the electric parking brake. The red warning lamp flashes, then steadily illuminates when the parking brake is applied.

**Note:** You can apply the electric parking brake when the ignition is off.

**Note:** The electric parking brake could automatically apply when park (P) is selected. See **Park (P)** (page 230).

## APPLYING THE ELECTRIC PARKING BRAKE IN AN EMERGENCY

You can use the electric parking brake to slow or stop your vehicle in an emergency.

Pull the switch up and hold it.

The red warning lamp illuminates, a tone sounds and the stoplamps turn on when you use the electric parking brake in an emergency.

The electric parking brake continues to slow your vehicle down unless you release the switch.

**Note:** Do not apply the electric parking brake when your vehicle is moving, except in an emergency. If you repeatedly use the electric parking brake to slow or stop your vehicle, you could cause damage to the brake system.

## MANUALLY RELEASING THE ELECTRIC PARKING BRAKE

1. Switch the ignition on.
2. Press and hold the brake pedal.
3. Push the switch down.

The red warning lamp turns off.

## Pulling Away on a Hill When Towing a Trailer

1. Press and hold the brake pedal.
2. Pull the switch upward and hold it.
3. Shift into gear.
4. Press the accelerator pedal until engine has developed sufficient torque to prevent your vehicle from rolling down the hill.
5. Release the switch and pull away in a normal manner.

# Electric Parking Brake

## AUTOMATICALLY RELEASING THE ELECTRIC PARKING BRAKE

1. Close the driver door.
2. Shift into gear.
3. Press the accelerator pedal and pull away in a normal manner.

## ELECTRIC PARKING BRAKE AUDIBLE WARNING

Sounds when the parking brake is on and your vehicle is moving. If the warning tone continues after you have released the parking brake, this indicates a malfunction. Have your vehicle checked as soon as possible.

## RELEASING THE ELECTRIC PARKING BRAKE IF THE VEHICLE BATTERY HAS RUN OUT OF CHARGE



**WARNING:** The electric parking brake does not operate if the vehicle battery has run out of charge.

Connect a booster battery to the vehicle battery to release the electric parking brake if the vehicle battery has run out of charge. See **Jump Starting the Vehicle** (page 420).

## ELECTRIC PARKING BRAKE – TROUBLESHOOTING

### ELECTRIC PARKING BRAKE – WARNING LAMPS

#### Brake System



It illuminates red when you apply the parking brake and your vehicle is on. If the lamp flashes when the parking brake has been released, this indicates the parking brake system requires service. Have your vehicle checked as soon as possible.

**Note:** Lamps may vary depending on region.

#### Electric Parking Brake



When the lamp illuminates yellow, it indicates a malfunction in the electric parking brake. Have your vehicle checked as soon as possible.

**Note:** Lamps may vary depending on region.

# Electric Parking Brake

## ELECTRIC PARKING BRAKE – INFORMATION MESSAGES

<b>Message</b>	<b>Action</b>
To Release: Press Brake and Switch	The electric parking brake is set and a manual release is attempted without the brake pedal being pressed.
Park Brake Use Switch to Release	The electric parking brake is set and an automatic release is attempted but cannot be performed. Perform a manual release.
Release Park Brake	The electric parking brake is set and your vehicle speed exceeds 3 mph (5 km/h). Release the electric parking brake before continuing to drive.
Park Brake Not Applied	The electric parking brake is not fully applied.
Park Brake Not Released	The electric parking brake is not fully released.
Brake maintenance mode	The electric parking brake system has been put into a special mode to allow brake service. Have the system checked as soon as possible.
Park Brake Limited Function Service Required	The electric parking brake system has detected a condition that requires service. Some functionality may still be available. Have the system checked as soon as possible.
Park Brake Malfunction Service Now	The electric parking brake system has detected a condition that requires service. Have the system checked as soon as possible.

# Diesel Engine Exhaust Brake

## DIESEL ENGINE EXHAUST BRAKE – PRECAUTIONS



**WARNING:** Do not use tow/haul when the road surface is slippery. Failure to follow this instruction could result in the loss of control of your vehicle.



**WARNING:** Do not use diesel engine exhaust braking when the road surface is slippery. Failure to follow this instruction could result in the loss of control of your vehicle.

## USING THE DIESEL ENGINE EXHAUST BRAKE

This feature increases engine braking at higher engine speeds to provide better grade descent control with less brake and transmission wear and tear.

**Note:** Use this when driving downhill and carrying heavy loads or trailering.

Benefits of engine braking are:

- Lower brake temperature.
- Reduced brake fade.
- Longer brake life.
- Improved driving and trailering control.



Press the button on the switch bank next to the audio unit to switch the system on or off.

There are two engine brake modes, manual and automatic.

The following conditions must be met to use exhaust brake:

- Your vehicle is in a forward gear.
- The engine speed is above 1300 RPM.
- Your foot is off the accelerator.

You can use this feature with tow/haul or progressive range selection to provide further increased engine braking. The transmission upshifts to prevent the engine from entering the red zone on the tachometer.

## Manual Engine Braking

1. Press the button to switch on manual engine braking.
2. Release the accelerator pedal to maximize engine braking.
3. Apply the brakes. The transmission downshifts to lower gears.

**Note:** The engine braking feature only functions when you release the accelerator.

**Note:** You can shift the transmission to lower gears with progressive range selection or manual shifting independent of pressing the brakes.

**Note:** You can also use manual engine braking with cruise control to improve grade descent control.

**Note:** If your vehicle has adaptive cruise control, the speed control system uses the selected engine brake mode, transmission gears, and brakes to maintain the set speed and distance to the vehicle being followed.

## Automatic Engine Braking

1. Press the button twice to switch on automatic engine braking.
2. Release the accelerator or brake pedal. The system remembers your vehicle speed.

# Diesel Engine Exhaust Brake

**Note:** This feature offers smoother, less aggressive engine braking during downhill descents. It may not apply braking if the vehicle speed is not increasing, although it applies full engine braking force when needed to prevent acceleration. The system automatically activates the engine brake and, if necessary, downshifts the transmission to lower gears to not exceed your vehicle's set speed when the brake or accelerator were last released.

## DIESEL ENGINE EXHAUST BRAKE INDICATORS



## DIESEL ENGINE EXHAUST BRAKE GAUGE

Displays the diesel engine exhaust brake power in the form of a percentage. A full fill or 100% represents the total diesel engine exhaust brake power available.

The gauge displays zero to 100% depending on the engine brake power provided by the system.

**Note:** When the diesel engine exhaust brake is switched off, the gauge displays zero.

## Accessing the Diesel Engine Exhaust Brake Gauge

You can access the diesel engine exhaust brake gauge in the instrument cluster using the instrument cluster display control on the steering wheel:

- Press the menu button.
- Select **Gauges**.
- Select **Diesel Gauges**.

## DIESEL ENGINE EXHAUST BRAKE – TROUBLESHOOTING

### DIESEL ENGINE EXHAUST BRAKE – WARNING LAMPS

- Illuminates when this feature is switched on and the system is operating properly.
- Flashes when the engine brake is disabled due to a fault.
- Does not illuminate when the switch or indicator is faulty.

You can switch the system on at any time. The braking system becomes active once the braking conditions are met.

# Reverse Brake Assist (If Equipped)

## WHAT IS REVERSE BRAKE ASSIST

Reverse brake assist is designed to reduce impact damage or assist in avoiding a collision while in reverse (R). Using sensors on the rear of the vehicle, it can detect a possible collision and apply the brakes. If full braking occurs, the system attempts to stop the vehicle a safe distance from the obstacle.

## HOW DOES REVERSE BRAKE ASSIST WORK

Reverse brake assist functions when in reverse (R) and traveling at a speed of 1–7 mph (2–12 km/h).

If the system detects an obstacle behind your vehicle, it provides a warning through the rear parking aid or cross traffic alert system.

## REVERSE BRAKE ASSIST PRECAUTIONS



**WARNING:** You are responsible for controlling your vehicle at all times. The system is designed to be an aid and does not relieve you of your responsibility to drive with due care and attention. Failure to follow this instruction could result in the loss of control of your vehicle, personal injury or death.



**WARNING:** To help avoid personal injury, always use caution when in reverse (R) and when using the sensing system.



**WARNING:** The system may not operate properly during severe weather conditions, for example snow, ice, heavy rain and spray. Always drive with due care and attention. Failure to take care may result in a crash.



**WARNING:** Traffic control systems, fluorescent lamps, inclement weather, air brakes, external motors and fans may affect the correct operation of the sensing system. This may cause reduced performance or false alerts.



**WARNING:** Some situations and objects prevent hazard detection. For example low or direct sunlight, inclement weather, unconventional vehicle types, and pedestrians. Apply the brakes when necessary. Failure to follow this instruction could result in the loss of control of your vehicle, personal injury or death.



**WARNING:** Do not use the system with accessories that extend beyond the front or rear of your vehicle, for example a trailer hitch or bike rack. The system is not able to make corrections for the additional length of the accessories.

The system only applies the brakes for a short period of time when an event occurs. Act as soon as you notice the brakes apply to remain in control of the vehicle. If you do not intervene the vehicle may start to move again.

**Note:** Certain add-on devices around the bumper or fascia may create false alerts. For example, large trailer hitches, bicycle or surfboard racks, license plate brackets, bumper covers or any other device that may block the normal detection zone of the system. Remove the add-on device to prevent false alerts.

## Reverse Brake Assist (If Equipped)

**Note:** The system does not react to small or moving objects, particularly those close to the ground.

**Note:** The system does not operate during hard acceleration or steering.

**Note:** If your vehicle sustains damage to the bumper or fascia leaving it misaligned or bent, it could alter the sensing zone causing inaccurate measurement of obstacles or false alerts.

**Note:** Vehicle loading and suspension changes can impact the angle of the sensors and may change the normal detection zone of the system resulting in inaccurate measurement of obstacles or false alerts.

**Note:** When you connect a trailer, the system may detect the trailer and provide an alert, or the system turns off. If the system does not turn off, manually switch the system off after you connect the trailer.

**Note:** You may experience reduced system performance on road surfaces that limit deceleration. For example, roads with ice, loose gravel, mud or sand.

### SWITCHING REVERSE BRAKE ASSIST ON AND OFF

1. Press **Features** on the touchscreen.

2. Press **Driver Assistance**.

3. Switch **Reverse Brake Assist** on or off.

**Note:** The system is unavailable when the rear parking aid or cross traffic alert is off.

**Note:** If your vehicle is not equipped with cross traffic alert the reverse braking assist relies on input from the rear parking aid and rear camera sensors.

**Note:** The default setting is on in some regions.

### OVERRIDING REVERSE BRAKE ASSIST

There could be instances when unexpected or unwanted braking occurs. Firmly pressing the accelerator pedal or switching the feature off overrides the system.

### REVERSE BRAKE ASSIST INDICATORS

If the system determines that a collision with an obstacle may occur, full braking may apply.



A message and warning indicator appear when the system applies the brakes.



## Reverse Brake Assist (If Equipped)

---

### REVERSE BRAKE ASSIST – TROUBLESHOOTING

#### REVERSE BRAKE ASSIST – INFORMATION MESSAGES

<b>Message</b>	<b>Description</b>
Reverse Brake Assist	Displays when the system applies the brakes and remains on for a few seconds.
Reverse Brake Assist Not Available See Manual	Make sure that all doors, liftgate or tailgate and hood are closed. Drive the vehicle on a straight road for a short period. Make sure the parking aids and cross traffic alert systems are on. If the message remains on, have the system checked as soon as possible.
Reverse Brake Assist Fault	Displays when a system error has occurred. Have your vehicle checked as soon as possible.
Reverse Brake Assist Off	Displays when reverse brake assist is off.

## Reverse Brake Assist (If Equipped)

---

### REVERSE BRAKE ASSIST – FREQUENTLY ASKED QUESTIONS

#### Why is reverse brake assist unavailable?

- Make sure the reverse brake assist is on. See **Switching Reverse Brake Assist On and Off** (page 256).
- Make sure that all doors, liftgate or tailgate and hood are closed. Drive the vehicle on a straight road for a short period. If the message remains, have the system checked.
- If your vehicle has the cross traffic alert system, make sure it is on. See **Switching Cross Traffic Alert On and Off** (page 333).
- Make sure the rear parking aid system is on. See **Parking Aids** (page 280).
- Make sure the traction control is on. See **Switching Traction Control On and Off** (page 265).
- Your vehicle may have sustained a rear end impact. Have the sensors checked for proper coverage and operation.
- An anti-lock brake, traction control or stability control event may have occurred. Reverse brake assist resumes operation when the event is complete.
- Make sure the rear view camera and 360 degree camera are not dirty or obstructed. If dirty, clean the camera. If the message still appears after cleaning the camera, wait a short time for the message to clear. If the message does not clear, have the system checked.
- Make sure the cross traffic alert, rear parking aid and side parking aid sensors are not blocked or faulty. See **Locating the Cross Traffic Alert Sensors** (page 333). See **Locating the Rear Parking Aid Sensors** (page 281).

- You recently had your vehicle serviced, or the battery disconnected. Drive your vehicle a short distance to resume system operation.
- Reverse brake assist does not function when you connect a trailer. Operation resumes when you disconnect the trailer.

**Note:** *If the answers to why the system is unavailable do not assist in returning reverse brake assist to available, have the system checked as soon as possible.*

# Cross Traffic Braking (If Equipped)

## WHAT IS CROSS TRAFFIC BRAKING

The system is designed to reduce impact damage or assist in avoiding a collision by using the sensors on the rear of your vehicle to detect a possible collision and applying the brakes.

## HOW DOES CROSS TRAFFIC BRAKING WORK

The system only reacts for vehicles approaching from the sides when you shift into reverse (R).

If the system detects a vehicle approaching your vehicle, it provides a warning through the cross traffic alert system. See **What Is Cross Traffic Alert** (page 332).

The system only applies the brakes for a short period of time when an event occurs. Take action as soon as you notice the system applying the brakes in order to remain in control of your vehicle, the system does not do this for you.

**Note:** You need to enable cross traffic alert for the system to function.

## CROSS TRAFFIC BRAKING PRECAUTIONS



**WARNING:** You are responsible for controlling your vehicle at all times. The system is designed to be an aid and does not relieve you of your responsibility to drive with due care and attention. Failure to follow this instruction could result in the loss of control of your vehicle, personal injury or death.



**WARNING:** To help avoid personal injury, always use caution when in reverse (R) and when using the sensing system.



**WARNING:** The system may not operate properly during severe weather conditions, for example snow, ice, heavy rain and spray. Always drive with due care and attention. Failure to take care may result in a crash.



**WARNING:** Traffic control systems, fluorescent lamps, inclement weather, air brakes, external motors and fans may affect the correct operation of the sensing system. This may cause reduced performance or false alerts.



**WARNING:** Some situations and objects prevent hazard detection, for example, inclement weather, unconventional vehicle types and pedestrians. Apply the brakes when necessary. Failure to follow this instruction could result in the loss of control of your vehicle, personal injury or death.



**WARNING:** Do not use the system with accessories that extend beyond the front or rear of your vehicle, for example a trailer hitch or bike rack. The system is not able to make corrections for the additional length of the accessories.

**Note:** Certain add-on devices around the bumper or fascia may create false alerts. For example, large trailer hitches, bicycle or surfboard racks, license plate brackets, bumper covers or any other device that may block the normal detection zone of the system. Remove the add-on device to prevent false alerts.

## Cross Traffic Braking (If Equipped)

**Note:** If your vehicle sustains damage to the bumper or fascia leaving it misaligned or bent, it could alter the sensing zone causing inaccurate measurement of obstacles or false alerts.

**Note:** Vehicle loading and suspension changes can impact the angle of the sensors and may change the normal detection zone of the system resulting in inaccurate measurement of obstacles or false alerts.

**Note:** When you connect a trailer, the system may detect the trailer and provide an alert, or the system turns off. If the system does not turn off, switch the system off manually after you connect the trailer.

**Note:** You may experience reduced system performance on road surfaces that limit deceleration. For example, roads with ice, loose gravel, mud or sand.

### SWITCHING CROSS TRAFFIC BRAKING ON AND OFF

1. Press **Features** on the touchscreen.

2. Press **Driver Assistance**.
3. Switch **Cross Traffic Braking** on or off.

### OVERRIDING CROSS TRAFFIC BRAKING

There could be instances when unexpected or unwanted braking occurs. Firmly pressing the accelerator pedal or switching the feature off overrides the system.

### CROSS TRAFFIC BRAKING INDICATORS

If the system determines that a collision with an obstacle may occur, full braking may apply. Bring your vehicle to a stop a safe distance away from the obstacle.



A message and warning indicator appear when the system applies the brakes.

## CROSS TRAFFIC BRAKING – TROUBLESHOOTING

### CROSS TRAFFIC BRAKING – INFORMATION MESSAGES

Message	Action
Reverse Brake Assist Not Available See Manual	Drive the vehicle on a straight road for a short period. Make sure the parking aids and cross traffic alert systems are on. If the message remains on, have the system checked as soon as possible.
Reverse Brake Assist Fault	Displays when a system error has occurred. Have your vehicle checked as soon as possible.
Reverse Brake Assist Off	Displays when cross traffic braking is off.

# Cross Traffic Braking (If Equipped)

---

## CROSS TRAFFIC BRAKING – FREQUENTLY ASKED QUESTIONS

Why is cross traffic braking unavailable?

- Make sure the cross traffic alert system is on. See **Cross Traffic Alert** (page 332).
- The vehicle has sustained a rear end impact. Contact an authorized dealer to have the sensors checked for proper coverage and operation.
- An ABS, traction control or stability control event may have occurred. Cross traffic braking resumes operation when the event is complete.
- Make sure there are no blocked or faulted sensors. See **Cross Traffic Alert** (page 332).
- You recently had your vehicle serviced, or the battery disconnected. Drive your vehicle a short distance to resume system operation.

**Note:** *If the answers to why the system is unavailable do not assist in returning cross traffic braking to available, have the system checked as soon as possible.*

# Hill Start Assist

## WHAT IS HILL START ASSIST

Hill Start Assist applies the brakes to hold your vehicle after you bring it to a stop on a slope. This makes it easier for you to pull away without using the parking brake.

## HOW DOES HILL START ASSIST WORK

When the system activates, your vehicle remains stationary for a few seconds after you release the brake pedal. This gives you time to move your foot from the brake pedal to the accelerator pedal. The brakes release when you apply the accelerator pedal and the vehicle begins to move forward, or the system exceeds the time allowed for automatically applying the brakes.

The system activates when your vehicle is in any forward gear and facing uphill, or when your vehicle is in reverse (R) and facing downhill.

## HILL START ASSIST PRECAUTIONS



**WARNING:** The system does not replace the parking brake. When you leave your vehicle, always apply the parking brake.



**WARNING:** You must remain in your vehicle when the system turns on. At all times you are responsible for controlling your vehicle, supervising the system, and intervening if required. Failure to follow this instruction could result in the loss of control of your vehicle, personal injury or death.



**WARNING:** The system turns off if there is a malfunction.

## SWITCHING HILL START ASSIST ON AND OFF

Hill start assist is active when you switch the ignition on. You cannot switch the system on or off.

## HILL START ASSIST – TROUBLESHOOTING

### HILL START ASSIST – INFORMATION MESSAGES

Message	Details
Hill Start Assist Not Available	Displays when system is not available. Have your vehicle checked as soon as possible.

## HILL START ASSIST VIDEOS

[Hill Start Assist](#)

# Auto Hold (If Equipped)

## HOW DOES AUTO HOLD WORK

Auto hold applies the brakes to hold your vehicle after you bring the vehicle to a stop. This can help when waiting on a hill or in traffic.

## SWITCHING AUTO HOLD ON AND OFF



**WARNING:** The system does not replace the parking brake. When you leave your vehicle, always apply the parking brake.



**WARNING:** You must remain in your vehicle when the system turns on. At all times you are responsible for controlling your vehicle, supervising the system, and intervening if required. Failure to follow this instruction could result in the loss of control of your vehicle, personal injury or death.

You can switch the system on or off by accessing the menu in the SYNC display screen.

1. Press **Features** on the touchscreen.
2. Press **Driver Assistance**.

**Note:** You can only switch the system on after you close the driver door, and fasten your seatbelt.

**Note:** The system remembers the last setting when you start your vehicle.

**Note:** When using an automatic car wash, make sure to switch auto hold off, or shift to neutral (N) with the brake pedal applied to ensure auto hold is not active.

## USING AUTO HOLD

1. Bring your vehicle to a complete stop. The auto hold active indicator illuminates in the information display.
2. Release the brake pedal. The system holds your vehicle at a standstill. The auto hold active indicator remains illuminated in the information display.
3. Apply the accelerator and drive off in a normal manner. The system releases the brakes and the auto hold active indicator switches off.

**Note:** The system only activates if you apply enough brake pressure on the brake pedal to bring the vehicle to a standstill.

**Note:** Under certain conditions, the system could apply the electric parking brake. The brake system warning lamp illuminates. The electric parking brake releases when you press the accelerator pedal. See **Automatically Releasing the Electric Parking Brake** (page 251).

**Note:** Auto hold cancels if you shift into reverse (R), or neutral (N), and press the brake pedal.

There could be actions that can cause the auto hold system not to work when the following occur:

- When you use active park assist.
- The driver door is open.
- You shift into reverse (R), or neutral (N) before the system is active.
- Your vehicle is in temporary neutral mode.
- The driver seatbelt is unfastened.

## AUTO HOLD INDICATORS



Illuminates when the system is active.

## Auto Hold (If Equipped)

---



Illuminates when the system is on but cannot hold your vehicle at a standstill at this particular time.



# Traction Control

## WHAT IS TRACTION CONTROL

The traction control system helps to avoid drive wheel spin and loss of traction.

## HOW DOES TRACTION CONTROL WORK

If your wheels begin to spin, the loss of traction can compromise steering control and stability of the vehicle. The traction control system applies the brakes to individual wheels and when needed, reduces engine power at the same time to increase traction.

## SWITCHING TRACTION CONTROL ON AND OFF

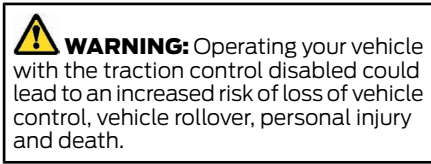

The traction control system turns on each time you switch the ignition on.

The button for the stability and traction control system is on the instrument panel.

Press and release the button to switch traction control off. The stability control system remains fully active, to switch it off, press and hold the button for a few seconds, then release.

When you switch traction control off, a message and an illuminated icon appear on the instrument cluster.

Press the switch again to turn the traction control system back on to normal operation.

If your vehicle is stuck in mud or snow, switching traction control off may be beneficial as this allows the wheels to spin.

## TRACTION CONTROL INDICATOR

### Stability and Traction Control Indicator



If the indicator does not illuminate when you switch the ignition on, or remains on when the engine is running, this indicates a malfunction. Have your vehicle checked by an authorized dealer as soon as possible.



The traction control off indicator illuminates when you switch the traction control system off, or when an alternative stability control mode is selected that requires the traction control off depending on the drive mode selected.

# Traction Control

---

## TRACTION CONTROL – TROUBLESHOOTING

### TRACTION CONTROL – INFORMATION MESSAGES

<b>Message</b>	<b>Action</b>
Service AdvanceTrac	The system detects a condition that requires service. Contact an authorized dealer as soon as possible.
AdvanceTrac Off	The status of the AdvanceTrac system after you switched it off.
AdvanceTrac On	The status of the AdvanceTrac system after you switched it on.
Traction Control Off	The status of the traction control system after you switched it off.
Traction Control On	The status of the traction control system after you switched it on.

# Stability Control

## HOW DOES STABILITY CONTROL WORK



**WARNING:** Vehicle modifications involving braking system, aftermarket roof racks, suspension, steering system, tire construction and wheel and tire size may change the handling characteristics of your vehicle and may adversely affect the performance of the electronic stability control system. In addition, installing any stereo speakers may interfere with and adversely affect the electronic stability control system. Reducing the effectiveness of the electronic stability control system could lead to an increased risk of loss of vehicle control, vehicle rollover, personal injury and death.



**WARNING:** Remember that even advanced technology cannot defy the laws of physics. It's always possible to lose control of a vehicle due to inappropriate driver input for the conditions. Aggressive driving on any road condition can cause you to lose control of your vehicle increasing the risk of personal injury or property damage. Activation of the electronic stability control system is an indication that at least some of the tires have exceeded their ability to grip the road; this could reduce the operator's ability to control the vehicle potentially resulting in a loss of vehicle control, vehicle rollover, personal injury and death.

If a driving condition activates either the stability control or traction control you may experience the following conditions:

- The stability and traction control light flashes.
- Your vehicle slows down.
- Reduced engine power.

The stability control system has several features built into it to help you maintain control of your vehicle:

### Electronic Stability Control

Electronic stability control enhances your vehicle's ability to prevent skids or lateral slides by applying brakes to one or more of the wheels individually and, if necessary, reducing engine power.

### Roll Stability Control

Roll stability control enhances your vehicle's ability to prevent rollovers by detecting your vehicle's roll motion and the rate at which it changes by applying the brakes to one or more wheels individually.

### Curve Control

Curve control enhances your vehicle's ability to follow the road when cornering severely or avoiding objects in the roadway. Curve control operates by reducing engine power and, if necessary, applying brakes to one or more of the wheels individually.

### Side Wind Stabilization

Side wind stabilization is an advanced feature that works by carefully applying the brakes on one side of the vehicle to reduce the effect of a side wind gust on the vehicle's path.

### Traction Control

Traction control enhances your vehicle's ability to maintain traction of the wheels by detecting and controlling wheel spin. See **What Is Traction Control** (page 265).

# Stability Control

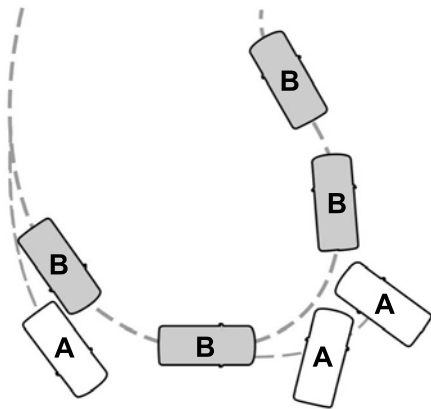

A Vehicle without stability control skidding off its intended route.

B Vehicle with stability control maintaining control on a slippery surface.

## SWITCHING STABILITY CONTROL ON AND OFF

The system turns on each time you switch the ignition on.

You can switch the electronic stability control system off by pressing and holding the ESC off button for over 5 seconds, or you can press the button again to switch the system on.

Shifting the transmission into reverse (R) will disable the system.

You can switch the traction control system off or on independently. See **Switching Traction Control On and Off** (page 265).

# Stability Control

## Stability Control and Traction Control with Roll Stability Control

	<b>Stability Control OFF Light</b>	<b>Roll Stability Control</b>	<b>Electronic Stability Control</b>	<b>Traction Control System</b>
Default at start-up	Illuminated during bulb check	Enabled	Enabled <sup>3</sup>	Enabled <sup>3</sup>
Button pressed momentarily	Illuminated	Enabled	Enabled <sup>3</sup>	Disabled <sup>1</sup>
Button pressed and held for 5 - 15 seconds	Illuminated	Enabled	Disabled <sup>2</sup>	Disabled <sup>1</sup>
Transfer case is switched to 4x4 Low or put into Rock Crawl Mode	Illuminated	Disabled	Disabled	Disabled <sup>1</sup>

<sup>1</sup> The Traction Control system can still be enabled but with tighter or looser thresholds.

<sup>2</sup> When you press and hold the button, a progress bar will display to show the button hold time progress.

<sup>3</sup> Functions can vary depending on what Selectable Drive Mode the vehicle is currently in.

## STABILITY CONTROL INDICATOR



If it does not illuminate when you switch the power on, or remains on, this indicates a malfunction.

Have your vehicle checked by an authorized dealer as soon as possible.

# Trail Control (If Equipped)

## WHAT IS TRAIL CONTROL



**WARNING:** The system does not control speed in low traction conditions or extremely steep slopes. The system is designed to be an aid and does not relieve you of your responsibility to drive with due care and attention. Failure to follow this instruction could result in personal injury.



**WARNING:** The system does not replace the parking brake. When you leave your vehicle, always apply the parking brake.

Trail control lets you focus on steering during low-speed and off-road use by controlling your vehicle's acceleration and braking to maintain the speed that you set.

You may hear a noise from the anti-lock brake system pump motor when you use the system. This is normal.

## TRAIL CONTROL LIMITATIONS

Trail control is unavailable when any of the following occur:

- Your vehicle speed is greater than 20 mph (32 km/h) in two-wheel drive high (2H) or four-wheel drive high (4H) modes.
- Your vehicle speed is greater than 9 mph (15 km/h) in four-wheel drive low (4L) mode.
- Your vehicle speed is greater than 5 mph (8 km/h) in reverse (R).
- The transmission is in park (P).
- The driver side door is open or your seatbelt is off when the driver side door is removed.
- Cruise control is on.

- Pro trailer backup assist is on.
- The parking brake is applied.

## SWITCHING TRAIL CONTROL ON AND OFF



Press the button.

The system switches off if you press the button again or exceed 42 mph (68 km/h).

## SETTING THE TRAIL CONTROL SPEED

**Note:** *The buttons are located on the steering wheel.*

Drive to your preferred speed.



Press button to increase the set current speed.



Press button to decrease the set current speed.

**Note:** *The indicator changes color.*

You can adjust the set speed in small or large increments. Press the toggle button upward or downward once to adjust the set speed in small increments. Press and hold the toggle button upward or downward to adjust the set speed in large increments.

You can also decrease the set speed by braking.

**Note:** *If a set speed is set and the trail control is active and the vehicle is stopped by the brake, releasing the brake will allow the vehicle to accelerate to the set speed. Pressing the brake pedal does not switch off the system.*

## Trail Control (If Equipped)

---

### CANCELING THE SET SPEED



Press the button.

### TRAIL CONTROL INDICATORS



## Trail Control (If Equipped)

### TRAIL CONTROL – TROUBLESHOOTING

#### TRAIL CONTROL – INFORMATION MESSAGES

Message	Details
Reduce Speed To Enter Trail Control	Displays when you must reduce your vehicle speed to use trail control.
Trail Control Not Available with Park Brake Applied	Displays when you must release the park brake to use trail control.
Trail Control Not Available While Pro Trailer Backup Assist™ Active	Displays when you must switch off the trailer backup assist to use trail control.
Trail Control Enabled Use SET Button to Set Speed	Displays when you successfully enabled trail control and can set a speed with the Set+ or Set- control.
Trail Control Off Driver Resume Control	Displays when a system fault has occurred when trail control was active and the driver must resume control.
Trail Control Off	Displays when the system has turned off.
Trail Control Fault See Manual	Displays when a system fault is present. See the trail control section in your Owner's Manual. See your authorized dealer for diagnosis.
Trail Control To Activate Select Gear	Displays when you must be in drive (D), neutral (N) or reverse (R) to use trail control.
Trail Control Not Available with Cruise Control Active	Displays when you must switch the cruise control off to use trail control.
Trail Control Not Available with Driver Door Open	Displays when you must close the driver door to use trail control.
Descent Control Now Active Press Trail Control Switch To Exit	Due to some driver action, Trail Control propulsion was turned off but the vehicle will still brake if descending a hill. The driver must press the Trail Control switch to turn the feature OFF, they can then turn it back on.
Trail Control Not Available with Seatbelt Off	Displays when you must have the seatbelt on to use trail control.



## Trail Turn Assist (If Equipped)

### WHAT IS TRAIL TURN ASSIST

Trail turn assist can reduce the turning radius of your vehicle by applying the brakes to the inside rear wheel in low-speed, high steering-angle maneuvers.

### TRAIL TURN ASSIST PRECAUTIONS

**Note:** *Do not use trail turn assist on dry, hard surfaced roads. Doing so can produce excessive noise, increase tire wear and may damage drive line, or braking components. Trail turn assist is only intended for slippery, or loose surfaces.*

You may hear noise from the anti-lock brake system while trail turn assist is active. This is normal operation.

### TRAIL TURN ASSIST LIMITATIONS

Trail turn assist can only be used when the vehicle's four-wheel drive system is in the four-wheel drive high (4H), or four-wheel drive low (4L) modes.

Trail Turn Assist cannot be used when the vehicle's rear differential is locked. If the rear differential has recently been locked prior to Trail Turn Assist being turned on, Trail Turn Assist may not activate until it can confirm that the rear differential is unlocked.

### SWITCHING TRAIL TURN ASSIST ON AND OFF

While your vehicle is in four-wheel drive high (4H) or four-wheel drive low (4L), press the trail turn assist button to switch the feature on. Trail turn assist is on at this time but does not activate until the:

- Vehicle speed is less than 12 mph (19.3 km/h).
- Rear differential is fully unlocked.
- Steering wheel is almost fully turned to the left or right.

Switch trail turn assist off by performing any of the following:

- Press the trail turn assist button again.
- Select two-wheel drive high (2H), or four-wheel drive auto (4A).
- Switch on the rear locking differential.

### TRAIL TURN ASSIST INDICATORS



When trail turn assist is on, one of these two indicators will be displayed, depending on the direction of the vehicle's last turn. When the feature is available but not in use, the indicator will be gray. When the feature is active the indicator will be green.

# Trail Turn Assist (If Equipped)

## TRAIL TURN ASSIST – TROUBLESHOOTING

### TRAIL TURN ASSIST – INFORMATION MESSAGES

Message	Details
Trail Turn Assist Available in 4L or 4H	Switch to four-wheel drive low (4L) or four-wheel drive high (4H) to activate trail turn assist. See <b>Selecting a Four-Wheel Drive Mode</b> (page 237).
Trail Turn Assist Not Available See Manual	Trail turn assist system malfunction could be present. If this condition persists, have your vehicle serviced.
Trail Turn Assist ON	You have activated trail turn assist.
Trail Turn Assist OFF	You have switched trail turn assist off.

### TRAIL TURN ASSIST – FREQUENTLY ASKED QUESTIONS

#### Why does Trail Turn Assist not activate after unlocking the rear differential?

The rear differential may not be fully disengaged. When possible, turn off the rear axle locker while driving straight before using trail turn assist. If you are already in a tight turn when you encounter this situation, driving the vehicle for a short distance in reverse could allow the differential to fully disengage.

# Hill Descent Control (If Equipped)

## WHAT IS HILL DESCENT CONTROL

Hill descent control allows the driver to set and maintain vehicle speed while descending steep slopes in various surface conditions.

## HOW DOES HILL DESCENT CONTROL WORK

Hill descent control can maintain vehicle speeds on downhill slopes between 2–20 mph (3–32 km/h). Above 20 mph (32 km/h), the system remains on but the descent speed cannot be set or maintained.

**Note:** *The system does not function below 2 mph (3 km/h).*

The system requires a cool down interval after a period of sustained use. Hill descent control provides a warning in the message center when the system is about to disengage for cooling. At this time, manually apply the brakes as needed to maintain descent speed.

**Note:** *The amount of time that the system can remain active before cooling varies with conditions.*

## HILL DESCENT CONTROL PRECAUTIONS



**WARNING:** The system does not control speed in low traction conditions or extremely steep slopes. The system is designed to be an aid and does not relieve you of your responsibility to drive with due care and attention. Failure to follow this instruction could result in personal injury.



**WARNING:** The system does not replace the parking brake. When you leave your vehicle, always apply the parking brake.

## SWITCHING HILL DESCENT CONTROL ON AND OFF



Press the button on the instrument panel. A light illuminates and a tone sounds when the system is active.

## SETTING THE HILL DESCENT SPEED

To increase or decrease the descent speed, press the accelerator or brake pedal, or use the SET + and SET - buttons on the steering wheel. Once you reach the preferred speed remove your feet from the pedals.

## HILL DESCENT CONTROL INDICATOR



Illuminates when you switch hill descent control on.

# Hill Descent Control (If Equipped)

## HILL DESCENT CONTROL – TROUBLESHOOTING

### HILL DESCENT CONTROL – INFORMATION MESSAGES

Message	Action
For Hill Descent Reduce Speed XX MPH/km/h or Less	Your vehicle speed requirement for off-road mode entry has not been met.
For Hill Descent Select Gear	You need to select a transmission gear for hill descent mode.
Hill Descent Driver Resume Control	Hill descent control mode is deactivated and you must resume control.
Hill Descent Control Fault	A hill descent system fault is present.
Hill Descent Control Off System Cooling	The hill descent system is cooling due to overuse.
Hill Descent Control not available with Cruise Control Active	The hill descent system cannot activate while Cruise Control is actively controlling speed.

## HILL DESCENT CONTROL VIDEOS

[Hill Descent Control](#)

# Steering

## HYDRAULIC POWER STEERING

### HYDRAULIC POWER STEERING GUIDELINES

To help prevent damage to the power steering system:

- Do not hold the steering wheel at its furthest turning points for more than three to five seconds when the engine is running.
- Avoid continuously steering back and forth with elevated engine RPM as this may overheat the system. If trying to free a stuck vehicle, pause between attempts to allow the power steering system to cool or seek assistance. Typical steering and driving maneuvers allow the system to cool.
- Do not operate your vehicle if the power steering pump fluid level is below the MIN mark on the reservoir.
- Some noise is normal during operation. If excessive, check for low power steering pump fluid level before seeking service by your dealer.
- Heavy or uneven steering efforts may be caused by low power steering fluid. Check for low power steering pump fluid level before seeking service by your dealer.
- Do not fill the power steering pump reservoir above the MAX mark on the reservoir, as this may result in leaks from the reservoir.

If the power steering system breaks down or if you switch the engine off, you can steer the vehicle manually, but it takes more effort.

If you have any steering components serviced or replaced, install new fasteners. Many fasteners have coatings with thread adhesive, or have prevailing torque features you cannot reuse. Do not reuse a bolt or nut. Torque fasteners to specifications.

### Steering Tips

If the steering wanders or pulls, check for:

- An improperly inflated tire.
- Uneven tire wear.
- Loose or worn suspension components.
- Loose or worn steering components.
- Improper vehicle alignment.

**Note:** *A high crown in the road or high crosswinds may also make the steering seem to wander or pull.*

### Electronic Torque Overlay Steering

(If Equipped)



**WARNING:** The electric power steering system has diagnostic checks that continuously monitor the system. If a fault is detected, a message displays in the information display. Stop your vehicle as soon as it is safe to do so. Switch the ignition off. After at least 10 seconds, switch the ignition on and watch the information display for a steering system warning message. If a steering system warning message returns, have the system checked as soon as possible.



**WARNING:** If the system detects an error, you may not feel a difference in the steering, however a serious condition may exist. Have your vehicle checked as soon as possible. Failure to do so may result in loss of steering control.

# Steering

---

The electronic torque overlay steering system adds supplemental steering assist to the hydraulic gear when needed, dependent on vehicle conditions such as vehicle speed, steering wheel angle, and steering wheel torque. The hydraulic steering system provides the majority of steering assistance. The electronic torque overlay enables features such as pro trailer backup assistance and lane departure warning.

If your vehicle loses electrical power while you are driving, your vehicle loses electric power steering assistance. The steering system still operates, and you can steer your vehicle with hydraulic assist. Steering your vehicle with only hydraulic assist requires more effort.

Extreme continuous steering may increase the effort required for you to steer your vehicle. This increased effort prevents overheating and permanent damage to the steering system. You do not lose the ability to steer your vehicle manually. Typical steering and driving maneuvers allow the system to cool and return to normal operation.

## Adaptive Learning

The electronic power steering system adaptive learning helps correct road irregularities and improves overall handling and steering feel. It communicates with the brake system to help operate advanced stability control and accident avoidance systems. Whenever the battery is disconnected or a new battery installed, you must drive your vehicle a short distance before the system relearns the strategy and reactivates all systems.

## LOCATING THE HYDRAULIC POWER STEERING FLUID RESERVOIR

The hydraulic power steering fluid reservoir is found in the engine compartment. See **Under Hood Overview** (page 440).

## CHECKING THE HYDRAULIC POWER STEERING FLUID

Check the power steering fluid. See **Scheduled Maintenance** (page 589). If adding fluid is necessary, use only MERCON LV ATF.

Check the fluid level when it is at ambient temperature.

1. Check the fluid level in the reservoir. It should be between the MIN and MAX range. Do not add fluid if the level is within this range.
2. If the fluid level is low, add fluid to bring the fluid level up to between the MIN and MAX range.
3. Switch the engine on.
4. While the engine idles, turn the steering wheel left and right several times.
5. Switch the engine off.
6. Recheck the fluid level in the reservoir. Do not add fluid if the level is between the MIN and MAX range.
7. If the fluid is low, add fluid in small amounts, continuously checking the level until it is between the MIN and MAX range. For proper fluid type, See **Capacities and Specifications** (page 520). Be sure to put the cap back on the reservoir.

# Steering

## STEERING – TROUBLESHOOTING

## STEERING – WARNING INDICATORS



The electric power steering system indicator illuminates if the system detects a fault during the continuous diagnostic checks.

**Note:** *If a red warning message displays, stop your vehicle as soon as it is safe to do so.*

## STEERING – INFORMATION MESSAGES

Message	Action
Steering Fault Service Now	The power steering system has detected a condition that requires service. Have your vehicle checked as soon as possible.
Steering Loss Stop Safely	The power steering system is not working. Stop your vehicle in a safe place. Have your vehicle checked as soon as possible.
Steering Assist Fault Service Required	The power steering system has detected a condition that requires service. Have your vehicle checked as soon as possible.
Steering Lock Malfunction Service Now	The steering system has detected a condition that could prevent you from starting your vehicle. Have your vehicle checked as soon as possible.

# Parking Aids (If Equipped)

## PARKING AID PRECAUTIONS



**WARNING:** To help avoid personal injury, always use caution when in reverse (R) and when using the sensing system.



**WARNING:** The system may not detect objects with surfaces that absorb reflection. Always drive with due care and attention. Failure to take care may result in a crash.



**WARNING:** Traffic control systems, fluorescent lamps, inclement weather, air brakes, external motors and fans may affect the correct operation of the sensing system. This may cause reduced performance or false alerts.



**WARNING:** The system may not detect small or moving objects, particularly those close to the ground.



**WARNING:** The parking aid system can only assist you to detect objects when your vehicle is moving at parking speeds. To help avoid personal injury you must take care when using the parking aid system.



**WARNING:** The system may not function if the sensor is blocked.



**WARNING:** In cold and severe weather conditions the system may not function. Rain, snow and spray can all limit sensor performance.



**WARNING:** If damage occurs in the immediate area surrounding the sensor, have your vehicle checked as soon as possible.

**Note:** If your vehicle sustains damage leaving the sensors misaligned, this will cause inaccurate measurements or false alerts.

When you connect a trailer to your vehicle, the rear parking aid detects the trailer and provides an alert. Disable the parking aid when you connect a trailer to prevent the alert.

**Note:** Connected trailers might be detected by the vehicle and parking aid turns off automatically in those instances.

**Note:** Certain add-on devices installed around the bumper or fascia may create false alerts. For example, large trailer hitches, bike or surfboard racks, license plate brackets, bumper covers or any other device could block the normal detection zone of the parking aid system. Aftermarket spare tires or spare tire covers mounted to the rear tailgate could cause false alerts from the park aid system. Remove the add-on device to prevent false alerts.

**Note:** Keep the sensors free from snow, ice and large accumulations of dirt. If the sensors are covered, the system's accuracy can be affected.

Do not clean the sensors with sharp objects.

## SWITCHING PARKING AID ON AND OFF - VEHICLES WITH: FRONT PARKING AID

### Muting the Audible Tone



Press the parking aid button to switch the system's audible tone on and off.

### Switching Parking Aid On and Off Long-Term

The system can be set to stay disabled in between ignition cycles.



# Parking Aids (If Equipped)

1. Press Features on the touchscreen.
2. Press Driver Assistance.
3. Press Park Aid sensors.
4. Switch Front Sensors (Always) or Rear Sensors (Always) on or off.

## SWITCHING PARKING AID ON AND OFF - VEHICLES WITH: REAR PARKING AID

### Muting the Audible Tone



Shift into reverse (R) and press the button on the rear view camera display screen to switch the system's audible tone on and off.

### Switching Parking Aid On and Off Long-Term

The system can be set to stay disabled in between ignition cycles.

1. Press Features on the touchscreen.
2. Press Driver Assistance.
3. Press Park Aid sensors.
4. Switch Front Sensors (Always) or Rear Sensors (Always) on or off.

## REAR PARKING AID

### WHAT IS THE REAR PARKING AID

Rear parking sensors detect objects behind your vehicle when in reverse (R).

### REAR PARKING AID LIMITATIONS

There is a decreased coverage area at the outer corners.

The rear parking aid sensors are active when your vehicle is in reverse (R) and the vehicle speed is less than 5 mph (8 km/h).

The sensor coverage area is up to 71 in (180 cm) from the rear bumper.

The rear parking aid detects large objects when you shift into reverse (R) and any of the following occur:

- Your vehicle is moving backward at a low speed.
- Your vehicle is stationary but an object is approaching the rear of your vehicle at a low speed.
- Your vehicle is moving backward at a low speed and an object is moving towards your vehicle, for example another vehicle at a low speed.

The system shall provide no audible warning for the object behind the vehicle when in neutral (N) gear.

### LOCATING THE REAR PARKING AID SENSORS



## Parking Aids (If Equipped)



The rear parking aid sensors are in the rear bumper and in the power tailgate.

**Note:** *Rear parking sensors in the bumper function with the tailgate is up, and the sensors in the power tailgate function when the power tailgate is down.*

**Note:** *Reverse braking assist is unavailable when the tailgate is down.*

### REAR PARKING AID AUDIBLE WARNINGS

A warning tone sounds when your vehicle approaches an object. As your vehicle moves closer to an object, the rate of the tone increases. The warning tone continuously sounds when an object is 12 in (30 cm) or less from the rear bumper.

If your vehicle remains stationary for a few seconds, the audible warning turns off. If your vehicle moves backward the tone sounds again.

**Note:** *When the parking aid system sounds a tone, the audio system could reduce the set volume.*

### FRONT PARKING AID

#### WHAT IS THE FRONT PARKING AID

Front parking sensors detect objects in front of your vehicle.

#### FRONT PARKING AID LIMITATIONS

The front parking aid sensors are active when your vehicle is in any position other than park (P) and the vehicle speed is less than 5 mph (8 km/h).

The sensor coverage area is up to 47 in (120 cm) from the bumper.

If your vehicle is in reverse (R), the front parking aid detects objects when your vehicle is moving at a low speed or an object is moving toward your vehicle and provides an audible warning, for example another vehicle at a low speed. If your vehicle remains stationary for a few seconds, the audible warning turns off. Visual indication is always active in reverse (R).

If your vehicle is in any forward gear, the front parking aid provides audible warnings and visual indication when your vehicle is moving at a speed of 5 mph (8 km/h) or below and the system detects an object within the detection zone. If your vehicle remains stationary for a few seconds, the visual indication and audible warning turns off.

If your vehicle is in neutral (N), the front and rear sensors provide visual indication only when your vehicle is moving below a speed of 5 mph (8 km/h) and obstacles are detected inside the detection areas. Once your vehicle stops, the visual indication and audible warning stops after a few seconds.

# Parking Aids (If Equipped)

## LOCATING THE FRONT PARKING AID SENSORS



The front parking aid sensors are in the front bumper.

## FRONT PARKING AID AUDIBLE WARNINGS

A warning tone sounds when there is an object within 47 in (120 cm) from the front bumper. As your vehicle moves closer to an object, the rate of the tone increases.

The warning tone continuously sounds when an object is 12 in (30 cm) or less from the front bumper.

**Note:** *If the detected object is 12 in (30 cm) or less from your vehicle, visual indication remains on.*

## PARKING AID INDICATORS



The system provides object distance indication through the center display.

- As the distance to the object decreases, the indicator blocks illuminate and move toward the vehicle icon.
- If there is no object detected, the distance indicator blocks are grey.

Visual indication remains on when the transmission is in reverse (R). When you stop your vehicle, visual indication turns off after four seconds.

If the parking aids are not available, the distance indicator blocks do not display.

# Parking Aids (If Equipped)

---

## PARKING AIDS – TROUBLESHOOTING

## PARKING AIDS – INFORMATION MESSAGES

If a fault is present in the parking aids, a warning message appears in the instrument cluster or the touchscreen.

<b>Message</b>	<b>Action</b>
Park Aid Fault	The system detects a condition that requires service. Have your vehicle checked as soon as possible.
Sensor Blocked	Inclement weather, ice, mud, or water is blocking the sensor, causing the system to become unavailable. You can typically clean the sensor to resolve.
Trailer Connected	A correct trailer connection is sensed during a given ignition cycle.

## PARKING AIDS VIDEOS

[\*Reverse Sensing System Video Link\*](#)

# Rear View Camera (If Equipped)

## WHAT IS THE REAR VIEW CAMERA

The rear view camera provides a video image of the area behind your vehicle when the transmission is in reverse (R).



The rear view camera button is above the center display.

## REAR VIEW CAMERA PRECAUTIONS



**WARNING:** The rear view camera system is a reverse aid supplement device that still requires the driver to use it in conjunction with the interior and exterior mirrors for maximum coverage.



**WARNING:** Objects that are close to either corner of the bumper or under the bumper, might not be seen on the screen due to the limited coverage of the camera system.



**WARNING:** Reverse your vehicle slowly. Failure to follow this instruction could result in the loss of control of your vehicle, personal injury or death.



**WARNING:** Use caution when the tailgate is ajar. If the tailgate is ajar, the camera is out of position and the video image could be incorrect. All guide lines disappear when the tailgate is ajar. Failure to follow this instruction could result in personal injury.



**WARNING:** Use caution when turning camera features on or off when the transmission is not in park (P). Make sure your vehicle is not moving.

**Note:** When towing, the camera only sees what you are towing. This might not provide adequate coverage and you might not see some objects. In some vehicles, the guide lines may disappear when you connect the trailer tow connector.

## LOCATING THE REAR VIEW CAMERA

The rear view camera is on the tailgate. It provides a video image of the area behind your vehicle.

## Rear View Camera (If Equipped)

### REAR VIEW CAMERA GUIDE LINES

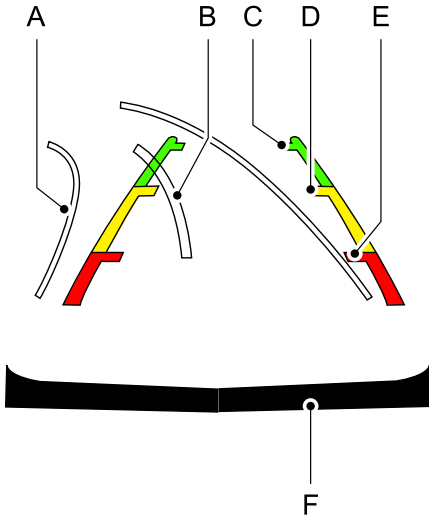

- A Active guide lines.
- B Centerline.
- C Fixed guide line: Green zone.
- D Fixed guide line: Yellow zone.
- E Fixed guide line: Red zone.
- F Rear bumper.

Active guide lines only show with fixed guide lines. To use active guide lines, turn the steering wheel to point the guide lines toward an intended path. If the steering wheel position changes while reversing, your vehicle might deviate from the intended path.

The fixed and active guide lines fade in and out depending on the steering wheel position. The active guide lines do not display when the steering wheel position is straight.

Use caution while reversing. Objects in the red zone are closest to your vehicle and objects in the green zone are farther away. Objects get closer to your vehicle as they move from the green zone to the yellow or red zones. Use the side view mirrors and rear view mirror to get better coverage on both sides and rear of your vehicle.

**Note:** Active guide lines and fixed guide lines are only available when the transmission is in reverse (R).

**Note:** The centerline is only available if the active or fixed guide lines are on.

**Note:** Not all camera modes work properly without an auxiliary camera.

### REAR VIEW CAMERA SETTINGS

#### ZOOMING THE REAR VIEW CAMERA IN AND OUT



**WARNING:** When manual zoom is on, the full area behind your vehicle may not show. Be aware of your surroundings when using the manual zoom feature.

Selectable settings for this feature are zoom in (+) and zoom out (-). Press the symbol on the camera screen to change the view. The default setting is zoom off.

This allows you to get a closer view of an object behind your vehicle. The zoomed image keeps the bumper in the image to provide a reference. The zoom is only active while the transmission is in reverse (R).

## Rear View Camera (If Equipped)

---

**Note:** *Zooming in also engages park hold which applies the electric park brake when you shift to park (P). When you press the zoom button, the electronic park hold button illuminates on the touchscreen. See **Connecting a Trailer** (page 356).*

**Note:** *Manual zoom is only available when the transmission is in reverse (R).*

**Note:** *Only the centerline shows when you enable manual zoom.*

### SWITCHING REAR VIEW CAMERA DELAY ON AND OFF

1. Press **Features** on the touchscreen.
2. Press **Driver Assistance**.
3. Press **Rear View Camera**.
4. Switch **Rear View Camera Delay** on or off.

When shifting the transmission out of reverse (R) and into any gear other than park (P), the camera image remains in the display until:

- Your vehicle speed reaches approximately 5 mph (8 km/h).
- You shift your vehicle into park (P).

## 360 Degree Camera (If Equipped)

### WHAT IS THE 360 DEGREE CAMERA

The 360 degree camera system consists of front, side and rear cameras which provide visibility around your vehicle.

### HOW DOES THE 360 DEGREE CAMERA WORK

The 360 degree camera system consists of front, side and rear cameras.

The 360 Degree Camera system:

- Allows you to see what is directly in front of or behind your vehicle.
- Provides a cross traffic view in front of and behind your vehicle.
- Allows you to see a top-down view of the area outside your vehicle, including the blind spots and obstacles near your vehicle.

### 360 DEGREE CAMERA PRECAUTIONS

 **WARNING:** The 360 degree camera system still requires the driver to use it in conjunction with looking out of the windows, and checking the interior and exterior mirrors for maximum coverage.

 **WARNING:** Objects that are close to either corner of the bumper or under the bumper, might not be seen on the screen due to the limited coverage of the camera system.

 **WARNING:** Do not switch the camera features on or off when your vehicle is moving.

 **WARNING:** You are responsible for controlling your vehicle at all times. The system is designed to be an aid and does not relieve you of your responsibility to drive with due care and attention. Failure to follow this instruction could result in the loss of control of your vehicle, personal injury or death.

 **WARNING:** Use caution when the tailgate is ajar. If the tailgate is ajar, the camera is out of position and the video image could be incorrect. All guide lines disappear when the tailgate is ajar. Failure to follow this instruction could result in personal injury.

 **WARNING:** When manual zoom is on, the full area behind your vehicle may not show. Be aware of your surroundings when using the manual zoom feature.

### LOCATING THE 360 DEGREE CAMERAS

#### Rear View Camera

The rear view camera is on the tailgate. It provides a video image of the area behind your vehicle.

#### Rear View Camera with Tailgate Lowered

This camera is on top of the tailgate and allows you to see the area behind your vehicle with the tailgate lowered. This view is available in the rear normal view and the 360 degree camera view. The vehicle icon in the 360 camera view on screen reflects that the tailgate is down. With the tailgate in the lowered position, you do not have a view of the hitch, split view, or zoom view.



## 360 Degree Camera (If Equipped)

**Note:** This feature is intended for special scenarios only and not for general driving conditions.

**Note:** These views are not identical to when the tailgate is up. The guidelines are not available.

### Front View Camera

The front view camera is in the grille. It provides a video image of the area in front of your vehicle.

### Side View Camera

The side view camera is on the outside mirror. It provides a video image of the area on the sides of your vehicle to aid you when parking or when backing up a trailer.

### Bed Camera

The bed camera is mounted within the high-mount stop lamp. It displays the contents of your truck bed. The camera contains a dynamic guideline to help locate the center of your vehicle. This view can be accessed while in drive (D) or reverse (R).

### Auxiliary Camera

The auxiliary camera is a variant of the rear view camera and you can access it by pressing the AUX button on the display screen when moving in reverse (R) or in drive (D). It displays a rear view image from the back of a trailer while in reverse.

## 360 DEGREE CAMERA GUIDE LINES

**Note:** Active guide lines are only available when the transmission is in reverse (R).

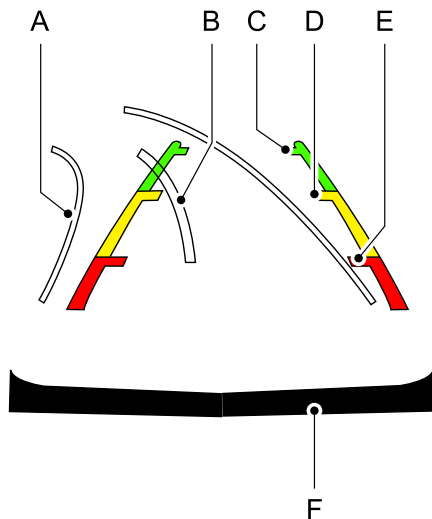

- A Active guide lines.
- B Centerline.
- C Fixed guide line: Green zone.
- D Fixed guide line: Yellow zone.
- E Fixed guide line: Red zone.
- F Rear bumper.

Active guide lines only show with fixed guide lines. Turn the steering wheel to point the guide lines toward an intended path. If the steering wheel position changes when reversing, your vehicle could deviate from the intended path.

The fixed and active guide lines fade in and out depending on the steering wheel position. The active guide lines do not display when the steering wheel position is straight.

## 360 Degree Camera (If Equipped)

Objects in the red zone are closest to your vehicle and objects in the green zone are farther away. Objects get closer to your vehicle as they move from the green zone to the yellow or red zones. Use the side view mirrors and rear view mirror to get better coverage on both sides and rear of your vehicle.

### Keep Out Zone

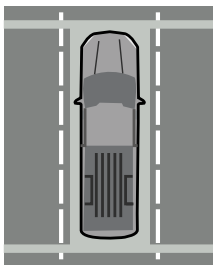

The keep out zone is represented by the yellow dotted lines running parallel to your vehicle.

### 360 DEGREE CAMERA SETTINGS

#### SWITCHING THE 360 DEGREE CAMERA ON AND OFF

 The 360 degree camera system button is above the center display. The front and rear cameras have multiple screens which consist of:

- Normal view.
- Normal view with 360.
- Split view.
- Bed camera.

- Auxiliary camera.
- Hitch view.

**Note:** *The rear view camera activates when you switch into reverse (R). Additional views are then accessible on the touchscreen.*

When in park (P), neutral (N) or drive (D), the front images display when the button is pressed. When in reverse (R), only the rear images display when the button is pressed.

**Note:** *Not all cameras are available.*

**Note:** *The 360 degree camera system turns off when your vehicle is in motion at low speed, except when in reverse (R).*

#### SWITCHING THE 360 DEGREE CAMERA VIEW



Press to access the different camera views.



Front normal view provides an image of what is directly in front of your vehicle.



Front split view provides an extended view of what is in front of your vehicle.



Normal + 360 degree view contains the normal camera view next to a 360 degree camera view.



Rear normal view provides an image of what is directly behind your vehicle.



Rear split view provides an extended view of what is behind your vehicle.



Bed camera shows the truck bed.

## 360 Degree Camera (If Equipped)

---



Trailer AUX camera shows a rear view camera image of what is behind your trailer. This camera needs to be purchased and installed separately.



The hitch view provides an image of the area around the tow hitch.



Trailer reverse guidance shows the sides of your truck and trailer. See **Trailer Reverse Guidance** (page 398).



Zooms in on the image and park hold is activated. See **Connecting a Trailer** (page 356).



Zooms in on the 360 degree image.

**Note:** *The rear normal view, bed camera view, hitch view and trailer auxiliary view are available when your vehicle speed is greater than 6 mph (10 km/h).*

# Cruise Control

## WHAT IS CRUISE CONTROL

Cruise control lets you maintain a set speed without keeping your foot on the accelerator pedal.

### Requirements

Use cruise control when the vehicle speed is greater than 20 km/h in metric units or 15 mph in imperial units.

## SWITCHING CRUISE CONTROL ON AND OFF



**WARNING:** Do not use cruise control on winding roads, in heavy traffic or when the road surface is slippery. This could result in loss of vehicle control, serious injury or death.

The cruise controls are on the steering wheel.

### Switching Cruise Control On



Press the button to activate the system. When the system activates, the set speed is equal to the current vehicle speed or 20 km/h (15 mph), whichever is greater. If the speed is too low, or other conditions are not correct for cruise control activation, the system enters standby mode.

### Switching Cruise Control Off



Press the button when the system is active or switch the ignition off.

**Note:** When you switch cruise control off, the set speed clears.

## SETTING THE CRUISE CONTROL SPEED



**WARNING:** When you are going downhill, your vehicle speed could increase above the set speed. The system does not apply the brakes.

Drive to the speed you prefer.

**SET+**

Press either the SET+ or SET- buttons to set the current speed.

**SET-**

Take your foot off the accelerator pedal.

**Note:** The indicator changes color in the information display.

### Changing the Set Speed

**SET+**

Press the SET+ button to increase the set speed in small increments. Press and hold the SET+ button to accelerate. Release the button when you have reached your preferred speed.

**SET-**

Press the SET- button to decrease the set speed in small increments. Press and hold the SET- button to decelerate. Release the button when you have reached your preferred speed.

**Note:** If you accelerate by pressing the accelerator pedal, the set speed does not change. When you release the accelerator pedal, your vehicle returns to the speed that you previously set.

# Cruise Control

---

## CANCELING THE SET SPEED



Press the button, or tap the brake pedal to cancel the set speed.

**Note:** *The system remembers the set speed.*

**Note:** *The system cancels if the vehicle speed drops below 10 mph (16 km/h) under the set speed when driving uphill.*

## RESUMING THE SET SPEED



Press the button.

## CRUISE CONTROL INDICATORS



Illuminates when you switch the system on.

# Adaptive Cruise Control (If Equipped)

## HOW DOES ADAPTIVE CRUISE CONTROL WITH STOP AND GO WORK

Adaptive cruise control with stop and go uses radar and camera sensors to maintain a set gap between your vehicle and the vehicle in front of you while following it to a complete stop. Stop and go can also be set to follow a vehicle directly in front of you and adjust the set speed, while you are at a complete stop.

## ADAPTIVE CRUISE CONTROL PRECAUTIONS

 **WARNING:** You are responsible for controlling your vehicle at all times. The system is designed to be an aid and does not relieve you of your responsibility to drive with due care and attention. Failure to follow this instruction could result in the loss of control of your vehicle, personal injury or death.

 **WARNING:** Do not use adaptive cruise control on winding roads, in heavy traffic or when the road surface is slippery. This could result in loss of vehicle control, serious injury or death.

 **WARNING:** Pay close attention to changing road conditions such as entering or leaving a highway, on roads with intersections or roundabouts, roads without visible lanes of travel, roads that are unpaved, or steep slopes. Failure to follow this instruction could result in the loss of control of your vehicle, personal injury or death.

 **WARNING:** The system is not a crash warning or avoidance system.

 **WARNING:** Do not use the system when towing a trailer that has aftermarket electronic trailer brake controls. Failure to follow this instruction could result in the loss of control of your vehicle, personal injury or death.

 **WARNING:** Do not use tire sizes other than those recommended because this can affect the normal operation of the system. Failure to do so may result in a loss of vehicle control, which could result in serious injury.

 **WARNING:** Do not use the system with a snow plow blade installed.

 **WARNING:** In situations with poor visibility, such as fog, heavy rain or other inclement weather, you may need to override or completely switch off the system.

## When Following a Vehicle

 **WARNING:** When following a vehicle that is braking, your vehicle does not always decelerate quickly enough to avoid a crash without driver intervention. Apply the brakes when necessary. Failure to follow this instruction could result in personal injury or death.

## Hilly Condition and Trailer Tow Usage

You should select a lower gear when the system is active in situations such as prolonged downhill driving on steep slopes, for example in mountainous areas. The system needs additional engine braking in these situations to reduce the load on the vehicle's regular brake system to prevent it from overheating.

# Adaptive Cruise Control (if Equipped)

**Note:** An audible alarm sounds and the system shuts down if it applies brakes for an extended period of time. This allows the brakes to cool. The system functions normally again after the brakes cool.

**Note:** When towing with adaptive cruise control, switch on Tow/Haul mode and diesel engine brake.

**Note:** Tow/Haul mode increases the time gaps and allows more distance for braking.

## ADAPTIVE CRUISE CONTROL LIMITATIONS

### Sensor Limitations

**WARNING:** On rare occasions, detection issues can occur due to the road infrastructures, for example bridges, tunnels and safety barriers. In these cases, the system may brake late or unexpectedly. At all times, you are responsible for controlling your vehicle, supervising the system and intervening, if required.

**WARNING:** If the system malfunctions, have your vehicle checked as soon as possible.

**WARNING:** Large contrasts in outside lighting can limit sensor performance.

**WARNING:** The system only warns of vehicles detected by the radar sensor. In some cases there may be no warning or a delayed warning. Apply the brakes when necessary. Failure to follow this instruction could result in personal injury or death.

**WARNING:** The system may not detect stationary or slow moving vehicles below 6 mph (10 km/h).

**WARNING:** The system does not detect pedestrians or objects in the road.

**WARNING:** The system does not detect oncoming vehicles in the same lane.

**WARNING:** The system may not operate properly if the sensor is blocked. Keep the windshield free from obstruction.

**WARNING:** The sensor may incorrectly track lane markings as other structures or objects. This can result in a false or missed warning.

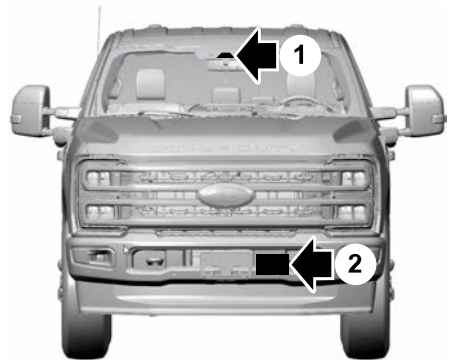

1. Camera.
2. Radar sensor.

The camera is on the windshield behind the interior mirror.

The radar sensor is in the lower grille.

# Adaptive Cruise Control (If Equipped)

**Note:** You cannot see the sensor. It is behind a fascia panel.

**Note:** Keep the front of your vehicle free of dirt, metal badges or objects. Vehicle front protectors, aftermarket lights, additional paint or plastic coatings could also degrade sensor performance.

A message displays if something obstructs the camera or the sensor. When something blocks the sensor, the system cannot detect a vehicle ahead and does not function. See **Adaptive Cruise Control – Information Messages** (page 308).

The radar sensor has a limited field of view. It may not detect vehicles at all or detect a vehicle later than expected in some situations. The lead vehicle image does not illuminate if the system does not detect a vehicle in front of you.

## Detection Issues Can Occur:

**A**

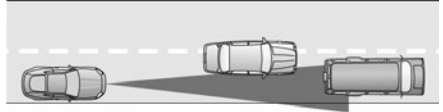

**B**



**C**

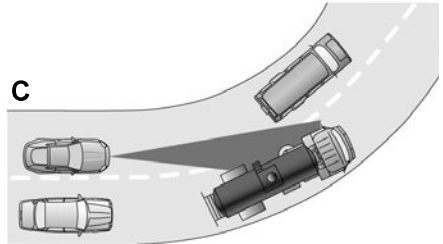

- A When driving on a different line than the vehicle in front.
- B With vehicles that edge into your lane. The system can only detect these vehicles once they move fully into your lane.
- C There may be issues with the detection of vehicles in front when driving into and coming out of a bend or curve in the road.

In these cases, the system may brake late or unexpectedly.

If something hits the front end of your vehicle or damage occurs, the radar-sensing zone may change. This could cause missed or false vehicle detection.



# Adaptive Cruise Control (If Equipped)

Optimal system performance requires a clear view of the road by the windshield camera.

Optimal performance may not occur if:

- The camera is blocked.
- There is poor visibility or lighting conditions.
- There are bad weather conditions.

## SWITCHING ADAPTIVE CRUISE CONTROL ON AND OFF

The cruise controls are on the steering wheel.

### Switching Adaptive Cruise Control On



Press the button to activate the system. When the system activates, the set speed is equal to whichever is greater, the current vehicle speed, or 15 mph when in imperial units or 20 km/h when in metric units. If the speed is too low, or other conditions are not correct for adaptive cruise control activation, the system enters standby mode. When you are below 15 mph when in imperial units or 20 km/h when in metric units, adaptive cruise control does not activate unless you are following another vehicle.

The indicator, current gap setting and set speed appear in the instrument cluster display.

### Switching Adaptive Cruise Control Off



Press the button when the system is in standby mode or switch the ignition off.

**Note:** When you switch the system off, the set speed clears.

## ADAPTIVE CRUISE CONTROL AUTOMATIC CANCELLATION

The system may cancel if:

- The tires lose traction.
- You apply the parking brake.

The system may cancel and set the parking brake if:

- You unbuckle the seatbelt and open the driver door after adaptive cruise control stops your vehicle.
- Adaptive cruise control holds your vehicle at a stop continuously for more than three minutes.

The system may deactivate or prevent activating when requested if:

- The vehicle has a blocked sensor.
- The brake temperature is too high.
- There is a failure in the system or a related system.

## SETTING THE ADAPTIVE CRUISE CONTROL SPEED

Drive to the speed you prefer.

**SET+**

Press the SET+ or SET- buttons to set the current speed.

**SET-**

Take your foot off the accelerator pedal.

The indicator, current gap setting and set speed appear in the instrument cluster display.

A vehicle image illuminates if there is a vehicle detected in front of you.

## Adaptive Cruise Control (If Equipped)



**Note:** When adaptive cruise control is active, the speedometer may vary slightly from the set speed displayed in the instrument cluster display.

### Setting the Adaptive Cruise Speed from a Complete Stop

SET+

Press the SET+ or SET- buttons while keeping the brake pedal fully depressed.

SET-

The set speed adjusts to 20 km/h when in metric units or 15 mph when in imperial units.

The indicator, current gap setting and set speed appear in the instrument cluster display.

**Note:** The system activates from a complete stop only when it detects a lead vehicle in close proximity.

### Manually Changing the Set Speed

SET+

Press the SET+ button to increase the set speed in small increments. Press and hold the SET+ button to increase set speed in large increments. Release the button when the indicated set speed reaches the preferred speed.

SET-

Press the SET- button to decrease the set speed in small increments. Press and hold the SET- button to decrease the set speed in large increments. Release the button when the indicated set speed reaches the preferred speed.

You can also press the accelerator or brake pedal until you reach the speed you prefer. Press the SET+ or SET- button to select the current speed as the set speed.

The system may apply the brakes to slow the vehicle to the new set speed. The set speed continuously displays in the instrument cluster display when the system is active.

### SETTING THE ADAPTIVE CRUISE CONTROL GAP



Press the button to cycle through the four gap settings.



The selected gap appears in the information display as shown by the bars in the image.

**Note:** The gap setting is time dependent and therefore, the distance adjusts with your vehicle speed.

**Note:** It is your responsibility to select a gap appropriate to the driving conditions.

# Adaptive Cruise Control (If Equipped)

## Adaptive Cruise Control Gap Settings

Graphic Display, Bars Indicated Between Vehicles	Gap Distance	Dynamic Behavior
1	Closest.	Sport.
2	Close.	Normal.
3	Medium.	Normal.
4	Far.	Comfort.

Each time you switch the system on, it selects the last chosen gap setting.

### Following a Vehicle

When a vehicle ahead of you enters the same lane or a slower vehicle is ahead in the same lane, the vehicle speed adjusts to maintain the gap setting.

**Note:** *When you are following a vehicle and you switch on a turn signal lamp, adaptive cruise control may provide a small, temporary acceleration to help you pass.*

Your vehicle maintains a consistent gap from the vehicle ahead until:

- The vehicle in front of you accelerates to a speed above the set speed.
- The vehicle in front of you moves out of the lane you are in.
- You set a new gap distance.

The system applies the brakes to slow down your vehicle to maintain a safe gap distance from the vehicle in front of you. The system only applies limited braking. You can override the system by applying the brakes.

**Note:** *The brakes may emit noise when applied by the system.*

If the system determines that its maximum braking level is not sufficient, an audible warning sounds, a message appears in the information display and an indicator flashes when the system continues to brake. Take immediate action.

## CANCELING THE SET SPEED



Press the button or tap the brake pedal.

The set speed does not erase.

## RESUMING THE SET SPEED



Press the button.

Your vehicle speed returns to the previously set speed and gap setting. The set speed displays continuously in the information display when the system is active.

**Note:** *Only use resume if you are aware of the set speed and intend to return to it.*

## Resuming the Set Speed from a Complete Stop (If Equipped)

If your vehicle follows a vehicle to a complete stop and remains stationary for less than a few seconds, your vehicle accelerates from a stationary position to follow the vehicle ahead.

If your vehicle follows a vehicle to a complete stop and remains stationary for more than a few seconds, an indicator and message displays.

# Adaptive Cruise Control (If Equipped)



Message	Details
Stopped	Cruise control does not resume automatically when this display is active.
Press button to resume	If the lead vehicle begins to move, you are prompted to press the resume button. Press and release the button or use the accelerator pedal to resume following the lead vehicle.
Auto-Resume	Displays when on a limited access highway after following a vehicle to a complete stop. In this situation, the vehicle resumes following the lead vehicle without a button press or pressing the accelerator pedal. The system can remain in auto-resume state for approximately 30 seconds, after which it no longer automatically resumes.

## OVERRIDING THE SET SPEED



**WARNING:** If you override the system by pressing the accelerator pedal, it does not automatically apply the brakes to maintain a gap from any vehicle ahead.

When you press the accelerator pedal, you override the set speed and gap distance.

Use the accelerator pedal to intentionally exceed the set speed limit.

When you override the system, the indicator remains blue, the set speed is dimmed and the lead vehicle icon does not appear in the instrument cluster display.

The system resumes operation when you release the accelerator pedal. The vehicle speed decreases to the set speed, or a lower speed if following a slower vehicle.

# Adaptive Cruise Control (If Equipped)

## ADAPTIVE CRUISE CONTROL INDICATORS



Illuminates when you switch adaptive cruise control on. The color of the indicator changes to indicate the system status.

White indicates the system is on but inactive.

Blue indicates that you set the speed and the system is active.

## SWITCHING FROM ADAPTIVE CRUISE CONTROL TO CRUISE CONTROL



**WARNING:** Normal cruise control will not brake when your vehicle is approaching slower vehicles. Always be aware of which mode you have selected and apply the brakes when necessary.

1. Press **Features** on the touchscreen.
2. Press **Driver Assistance**.
3. Press **Cruise Control**.
4. Press **Normal Cruise Control**.



The cruise control indicator replaces the adaptive cruise control indicator if you select normal cruise control. The gap setting does not display, and the system does not respond to lead vehicles. Automatic braking remains active to maintain set speed. The system remembers the last setting when you start your vehicle.

## LANE CENTERING

### HOW DOES LANE CENTERING WORK

Adaptive cruise control with lane centering uses the vehicle's front radar sensor and front windshield camera sensor, together with the steering sensor to operate.

Using these sensors, the system applies continuous steering assistance towards driving in the middle of the lane you choose on highway roads.

**Note:** *The gap setting for adaptive cruise control with lane centering, operates in the same way as normal adaptive cruise control.*

### LANE CENTERING PRECAUTIONS



**WARNING:** Do not use the system when towing a trailer or when the vehicle is loaded to near or over maximum payload. Failure to follow this instruction could result in the loss of control of your vehicle, personal injury or death.



**WARNING:** Do not use the system if any changes or modifications to the steering, suspension system or wheels and tires have been made. Any changes or modifications to the steering, suspension system or wheels and tires could affect the functionality and performance of the system. Failure to follow this instruction could result in the loss of control of your vehicle, personal injury or death.

Adaptive cruise control precautions apply to lane centering unless stated otherwise or contradicted by a lane centering precaution. See **Adaptive Cruise Control Precautions** (page 294).

# Adaptive Cruise Control (If Equipped)

## LANE CENTERING REQUIREMENTS

You must keep your hands on the steering wheel at all times.

Lane centering only activates when all of the following occur:

- Adaptive cruise control with lane centering is enabled in the touchscreen. See **Switching Lane Centering On and Off** (page 302).
- You have adaptive cruise control with stop and go enabled and set.
- The steering sensor detects your hands on the steering wheel.
- The system detects both lane markings when driving on a straight road.
- Your vehicle is initially centered in the lane between two visible line markings.

**Note:** *If the system does not detect valid lane line markings, the system remains in standby until valid line markings are available.*

**Note:** *If the system does not detect your hands on the steering wheel, apply a slight force to the steering wheel.*

## LANE CENTERING LIMITATIONS

Adaptive cruise control limitations apply to lane centering unless stated otherwise or contradicted by a lane centering limitation. See **Adaptive Cruise Control Limitations** (page 295).

Lane centering may not correctly operate in any of the following conditions:

- The lane width is too narrow or wide.
- The curve in the road is too small.
- The system does not detect the minimum required lane markings or when lanes merge or split.

- When the required steering effort to maintain lane center exceeds the lane centering system limit.
- When driving in areas that are under construction or when road work is in progress.
- If the front windshield camera and/or the front radar are blocked.
- When using a spare tire.
- Inclement weather conditions including, but not limited to, high wind, heavy rain, and fog.
- Driving into direct sunlight.
- When modification to the steering system has been made, including alterations to the steering wheel.
- When towing a trailer.
- When the vehicle is loaded to near or maximum payload. See **Load Carrying** (page 348).

See **Lane Centering Precautions** (page 301).

**Note:** *System operation may also be limited under snow, heavy rain, or road spray conditions.*

**Note:** *The system steering assistance is limited and may not have sufficient effort for all driving situations and/or conditions, such as driving through tight curves or driving through curves at high speeds.*

## SWITCHING LANE CENTERING ON AND OFF

Keep your hands on the steering wheel at all times.

The controls are on the steering wheel.



Press the button.

# Adaptive Cruise Control (If Equipped)

The indicator appears in the instrument cluster display. When the system is on, the color of the indicator changes to indicate the system status.

You can override the system at any time by steering your vehicle.

**Note:** *The correct requirements must be met before you can switch the system on. See **Lane Centering Requirements** (page 302).*

## Enabling and Disabling Lane Centering

1. Press **Features** on the touchscreen.
2. Press **Driver Assistance**.
3. Press **Cruise Control**.
4. Press **Lane Centering Assist**.

## LANE CENTERING ALERTS

You must keep your hands on the steering wheel at all times.

When the system is active and detects no steering activity for a period of time, the system alerts you to put your hands on the steering wheel. If you do not react appropriately to the warnings the adaptive cruise control with lane centering system cancels and slows your vehicle down to idle speeds while maintaining steering control. See **Lane Centering Automatic Cancellation** (page 303).

The system also alerts you if your vehicle crosses lane line markings without detected steering activity.

**Note:** *The system could detect a light grip or light touch on the steering wheel as hands-off driving.*

## LANE CENTERING AUTOMATIC CANCELLATION

When an external condition cancels the system, and your hands are on the steering wheel, a tone sounds and a message appears in the instrument cluster display.

When an external condition cancels the system, and your hands are not on the steering wheel, the system immediately alerts you to take control of the vehicle. If this alert is ignored, the system slows the vehicle while maintaining steering assistance when lane markings are available. When no lane markings are available, the vehicle comes to a stop.



If your vehicle starts to slow down after system cancellation, you must take full control of the vehicle. To re-enable adaptive cruise control with lane centering after cancellation, press and release the resume button.

Automatic cancellation can also occur if:

- The lane becomes too wide or narrow.
- The system cannot detect valid lane markings.
- Lane markings cross over one another.
- The curve of the road is too sharp.

**Note:** *If your vehicle slows down due to your inactivity twice within a key cycle, the system disables. To reset the system, when the vehicle is stationary, return the gear selector to park (P) and turn the vehicle off. Then, restart the vehicle with your foot on the brake pedal.*

## LANE CENTERING MANUAL CANCELLATION

When you perform the following actions, adaptive cruise control with lane centering will cancel:

# Adaptive Cruise Control (If Equipped)

- The brake pedal is pressed.
- Adaptive cruise control button on the steering wheel is switched off .

The lane centering system is momentarily suppressed when either of the following actions are performed:

- Turn signal indicator is latched or tapped with added steering input.
- You steer the vehicle out of lane.

## LANE CENTERING INDICATORS



Illuminates when you switch lane centering on. The color of the indicator changes to indicate the system status.

Gray status indicates the system is on but in standby mode.

Blue status indicates the system is enabled and applying steering assistance to keep the vehicle in the center of the lane.

Amber status with an audible tone, that then changes to gray status, indicates a system automatic cancellation.

## LANE CENTERING – TROUBLESHOOTING

### LANE CENTERING – INFORMATION MESSAGES

**Note:** Depending on your vehicle options and instrument cluster type, some messages can appear different or not at all.

Message	Details
Keep Hands on Steering Wheel	You must return your hands to the steering wheel and provide steering input to cancel the message.
Lane Centering Assist Not Available	Lane centering is currently not available, due to conditions that prevent the system from becoming active. To reset the system, when the vehicle is stationary, return the gear selector to park (P) and turn the vehicle off. Then, restart the vehicle with your foot on the brake pedal.
Resume Control	Adaptive cruise control with lane centering is about to cancel. You must immediately take full control of the vehicle.
Press Accelerator Pedal to Resume	Adaptive cruise control with lane centering is in standby mode. When safe to do so, you can resume adaptive cruise control with lane centering by applying pressure on the accelerator pedal. Alternatively, you can also re-enable adaptive cruise control with lane centering by pressing the resume button on the steering wheel.



# Adaptive Cruise Control (If Equipped)

## PREDICTIVE SPEED ASSIST (IF EQUIPPED)

### HOW DOES PREDICTIVE SPEED ASSIST WORK

Predictive Speed Assist works with adaptive cruise control and adjusts the vehicle speed to the road geometry and to the speed limit detected by the speed sign recognition system. As the system identifies curves and highway exits, the vehicle speed temporarily decreases ahead of and during the changing road geometry. When passing new speed signs, the set speed updates. See **Predictive Speed Assist Precautions** (page 305).

There are limitations that affect the accuracy of the speed sign recognition system and its ability to determine the current speed limit. Predictive speed assist and its ability to determine the current speed limit shares these limitations. See **Speed Sign Recognition** (page 343).

**Note:** *The adaptive cruise control gap setting operates normally when the feature is enabled.*

### PREDICTIVE SPEED ASSIST PRECAUTIONS



**WARNING:** You are responsible for controlling your vehicle at all times. The system is designed to be an aid and does not relieve you of your responsibility to drive with due care and attention. Failure to follow this instruction could result in the loss of control of your vehicle, personal injury or death.



**WARNING:** Pay close attention to changing road conditions. You may need to override the system by pressing the brake or accelerator pedal if the adjusted speed becomes higher or lower than necessary.



**WARNING:** The system only provides limited braking. Your vehicle may not always decelerate quickly enough to avoid a crash without driver intervention. Apply the brakes when necessary.



**WARNING:** The system does not activate the turn signal.

Adaptive cruise control precautions apply to predictive speed assist unless stated otherwise or contradicted by a predictive speed assist precaution. See **Adaptive Cruise Control Precautions** (page 294).

The system only applies limited braking. You can override the system with the accelerator pedal or cancel the system by applying the brakes.

The system may adapt to various factors such as time of day, lane width. This could influence speed adjustments and accelerations.

The system may adapt to various drive modes. See **Drive Mode Control** (page 309). This could influence speed adjustments and accelerations.

**Note:** *The system does not activate the turn signal automatically.*

# Adaptive Cruise Control (If Equipped)

## PREDICTIVE SPEED ASSIST LIMITATIONS



**WARNING:** The system may not always adjust vehicle speed in certain road or weather conditions such as crossing traffic, yield or stop signs, right of way, traffic lights, speed bumps, rain, snow, fog. You must always apply the brake or accelerator pedal when necessary.

The road geometry and speed limit information provided by the navigation map data could be inaccurate or out of date.

The system may not detect and read speed limit signs with conditional information, for example, when a sign is flashing, during specific time ranges, or when children are present.

**Note:** *The system does not set the vehicle speed to speed limits shown with a supplementary traffic sign.*

Under certain conditions, the system may not adjust the vehicle speed until after your vehicle passes the speed limit.

Detection of road geometry operates only where related information is available. Road geometry information may not be available in some areas.

## SWITCHING PREDICTIVE SPEED ASSIST MODE ON AND OFF

1. Press **Features** on the touchscreen.
2. Press **Driver Assistance**.
3. Press **Cruise Control**.
4. Press **Adaptive Cruise Control**.
5. Switch **Predictive Speed Assist** on or off.

## ADJUSTING THE SET SPEED TOLERANCE

1. Press **Features** on the touchscreen.
2. Press **Driver Assistance**.
3. Press **Cruise Control**.
4. Press **Adaptive Cruise Control**.
5. Switch **Predictive Speed Assist** on.
6. Press **Tolerance**.
7. Adjust the slider to set the tolerance.

**Note:** *You can set tolerance for vehicle speed adjustment based on speed sign recognition only.*

## PREDICTIVE SPEED ASSIST ALERTS

If the speed sign recognition system detects a speed limit below the minimum adaptive cruise control set speed, a tone sounds and the system returns to standby mode.

## PREDICTIVE SPEED ASSIST INDICATORS

A blue marker around the speed sign and a blue arrow next to the set speed indicates that the system is active.

# Adaptive Cruise Control (If Equipped)



## Speed sign indicator

When the system detects a new speed sign, a gray indicator appears above the set speed while the system adjusts the vehicle speed to the speed limit. When the speed limit is reached, the set speed updates and the gray indicator disappears.

## Road geometry indicator

When the system detects a curve or highway exit, the vehicle starts to decelerate, and the indicator appears and changes color.

## Road geometry indicator symbols



Left curve.



Right curve.

## PREDICTIVE SPEED ASSIST – TROUBLESHOOTING (IF EQUIPPED)

### PREDICTIVE SPEED ASSIST – INFORMATION MESSAGES

Message	Details
Adaptive Cruise Control Speed Sign Recognition Not Available	Navigation system based speed limit information is not available. If the message continues to appear, have your vehicle checked as soon as possible.
Driver Resume Control	The system is going to cancel and you must take control.

# Adaptive Cruise Control (If Equipped)

## ADAPTIVE CRUISE CONTROL – TROUBLESHOOTING

**Note:** Depending on your vehicle options and instrument cluster type, not all messages display or are available.

## ADAPTIVE CRUISE CONTROL – INFORMATION MESSAGES - VEHICLES WITH: STOP AND GO

**Note:** The system could abbreviate or shorten certain messages depending upon which cluster type you have.

Message	Action
Adaptive Cruise Malfunction	A malfunction is preventing the adaptive cruise from engaging.
Front Sensor Not Aligned	Contact an authorized dealer to have the radar checked for proper coverage and operation.
Adaptive Cruise Not Available	Conditions exist preventing the system from being available.
Adaptive Cruise Not Available Sensor Blocked See Manual	You have a blocked radar because of poor radar visibility due to inclement weather or ice, mud, or water in front of the radar. You can typically clean the sensor to resolve this. Due to the nature of radar technology, it is possible to get a blockage warning with no actual block. This happens, for example, when driving in sparse rural or desert environments. A false blocked condition either self clears, or clears after you restart your vehicle.
Normal Cruise Active Adaptive Braking Off	You have selected normal cruise control. The system does not brake or react to traffic.
Adaptive Cruise - Driver Resume Control	Displays when the adaptive cruise control is going to cancel and you must take control.
Adaptive Cruise Speed Too Low to Activate	Displays when the vehicle speed is too slow to activate the adaptive cruise control and there is no lead vehicle in range.

## ADAPTIVE CRUISE CONTROL VIDEOS

[Adaptive Cruise Control with Stop and Go and Lane-Centering Assist](#)

# Drive Mode Control

## WHAT IS DRIVE MODE CONTROL

This feature connects multiple vehicle systems through a single interface, providing you with enhanced vehicle control and driving dynamics for different driving scenarios, terrains, weather, or various road conditions.

## HOW DOES DRIVE MODE CONTROL WORK

When a drive mode is selected it alters various electrical and mechanical systems within the vehicle to a predetermined configuration. The systems altered and features available will depend on which mode is selected.

**Note:** The electronic locking differential is available and automatically engages in some drive modes. See **Electronic Locking Differential** (page 242).

**Note:** Off-Road drive modes automatically disable the Brake Over Accelerator system to allow for two-footed driving in off-road environments. See **Brake Over Accelerator** (page 246).

**Note:** Your vehicle automatically starts in the last selected drive mode, for applicable modes, when you return to your vehicle after short trips up to 2 hours between ignition cycles. At startup, the system displays a prompt on the instrument cluster display that gives you the option to return to the last drive mode that you chose prior to shutting the vehicle off. If you select yes, the system returns to the last selected drive mode and the default four-wheel drive mode associated with that mode. If you select no or do not make a selection, the system remains in normal Mode and the four-wheel drive mode remains the same as selected in the prior ignition cycle.

## SELECTING A DRIVE MODE



Rotate the controller located on the center console. Rotate the drive mode controller once to activate the drive mode selection menu in the display. Rotate the controller a second time to select and engage the drive mode.

**Note:** Button icons vary depending on the vehicle's configuration.

## DRIVE MODES

### ECO - 4X4



This mode decreases accelerator pedal responsiveness to soften driver inputs and encourage efficient driving.

Depending on your vehicle's options, adaptive cruise control is slower to return to the set speed and auto start-stop engages more often. The system decreases air conditioning output to conserve energy when set to auto mode.

# Drive Mode Control

Use this mode for fuel efficient driving which allows for an extended vehicle range.

**Note:** Two-wheel drive high (2H) is the default four-wheel drive mode. Four-wheel drive low (4L) is not available.

**Note:** The electronic locking differential is available below 25 mph (40 km/h). See **Switching the Electronic Locking Differential On and Off** (page 242).

## ECO - 4X2



This mode decreases accelerator pedal responsiveness to soften driver inputs and encourage efficient driving.

Depending on your vehicle's options, adaptive cruise control is slower to return to the set speed and auto start-stop engages more often. The system decreases air conditioning output to conserve energy when set to Auto Mode.

Use this mode for fuel efficient driving which allows for an extended driving range.

**Note:** The electronic locking differential is available below 25 mph (40 km/h). See **Switching the Electronic Locking Differential On and Off** (page 244).

## NORMAL - 4X4



This mode adjusts all systems to their base settings and balances vehicle performance for all around drivability. Each time you switch your vehicle off it defaults to this mode.

Use this mode for everyday driving, such as city and highway routes or commuting.

**Note:** Two-wheel drive high (2H) is the default four-wheel drive mode. All four-wheel drive modes are selectable when in normal mode.

**Note:** The electronic locking differential is available below 25 mph (40 km/h). See **Switching the Electronic Locking Differential On and Off** (page 242).

## NORMAL - 4X2



This mode adjusts all systems to their base settings and balances vehicle performance for all around drivability. Each time you switch your vehicle off it defaults to this mode.

Use this mode for everyday driving, such as city and highway routes or commuting.

**Note:** The electronic locking differential is available below 25 mph (40 km/h). See **Switching the Electronic Locking Differential On and Off** (page 244).

## OFF-ROAD - 4X4



This mode lowers accelerator pedal responsiveness and delays transmission upshifts for improved vehicle control in low speed off-road environments. Traction and stability controls allow the wheels to spin to maintain vehicle momentum and clear debris from the tires for improved traction.

Depending on your vehicle's options, the system inhibits auto start stop and engages the rear electronic locking differential.

Use this mode for driving through mud, sand, and rough, uneven off-road terrains.

**Note:** Four-wheel drive high (4H) is the default four-wheel drive mode. Depending on your vehicle options, four-wheel drive auto (4A) or two-wheel drive high (2H) is not available.

# Drive Mode Control

**Note:** The electronic locking differential engages when you select this mode at any speed, and you can disengage it at any time using the button. See **Switching the Electronic Locking Differential On and Off** (page 242).

**Note:** This mode is for Off-Road use only. Do not use this mode when driving on pavement. Depending on the four-wheel drive mode selection, this could cause driveline bind up and damage the system. See **Four-Wheel Drive** (page 234).

## ROCK CRAWL



This mode lowers accelerator pedal responsiveness and holds the transmission in lower gears to enhance vehicle control for low speed rock crawling. The system switches the traction and stability controls to their rock crawl settings.

Depending on your vehicle's options, this feature inhibits auto start stop and engages the rear electronic locking differential.

Use this mode when crossing aggressive terrain including rocks, mountain trails, and boulders.

**Note:** Four-wheel drive low (4L) is the only four-wheel drive mode available.

**Note:** This mode is for Off-Road use only. Do not use this mode when driving on pavement. This could cause driveline bind up and damage the system depending on the four-wheel drive mode you select. See **Four-Wheel Drive** (page 234).

## SLIPPERY - 4X4



This mode lowers accelerator pedal responsiveness, adjusts transmission shift points, and optimizes traction and stability controls to help mitigate wheel spin and maintain vehicle control in slick driving conditions.

Depending on your vehicle's options, this feature adjusts all-wheel drive control to provide optimum traction for slippery surfaces.

Use this mode for less than ideal road conditions such as snow and ice covered roads or for firm surfaces that are covered with loose or slippery materials.

**Note:** Four-wheel drive high (4H) is the default four-wheel drive mode. All four-wheel drive modes are selectable.

**Note:** The electronic locking differential is available below 25 mph (40 km/h). See **Switching the Electronic Locking Differential On and Off** (page 242).

**Note:** Do not use this mode when driving on dry pavement. This could cause driveline bind up and damage the system depending on the four-wheel drive mode you select. See **Four-Wheel Drive** (page 234).

## SLIPPERY - 4X2



This mode lowers accelerator pedal responsiveness, adjusts transmission shift points, and optimizes traction and stability controls to help mitigate wheel spin and maintain vehicle control in slick driving conditions.

Depending on your vehicle's options, this feature adjusts all-wheel drive control to provide optimum traction for slippery surfaces.

Use this mode for less than ideal road conditions such as snow and ice covered roads or for firm surfaces that are covered with loose or slippery materials.

# Drive Mode Control

**Note:** The electronic locking differential is available below 25 mph (40 km/h). See **Switching the Electronic Locking Differential On and Off** (page 244).

## TOW/HAUL - 4X4



For improved vehicle operation when towing a trailer or hauling a heavy load. This mode moves upshifts to higher engine speeds to reduce the frequency of transmission shifting. It also provides downshift engine braking to assist in maintaining vehicle speed when descending a slope.

Depending on your vehicle's options, the system enhances steering response to assist in controlling the vehicle when towing or hauling and auto-start stop is inhibited.

**Note:** All four-wheel drive modes are selectable. This mode does not default to a certain four-wheel drive mode and maintains the previous selection.

**Note:** The electronic locking differential is available below 25 mph (40 km/h). See **Switching the Electronic Locking Differential On and Off** (page 242).

## TOW/HAUL - 4X2



For improved vehicle operation when towing a trailer or hauling a heavy load. This mode moves upshifts to higher engine speeds to reduce the frequency of transmission shifting. It also provides downshift engine braking to assist in maintaining vehicle speed when descending a slope.

Depending on your vehicle's options, the system enhances steering response to assist in controlling the vehicle when towing or hauling and auto-start stop is inhibited.

**Note:** The electronic locking differential is available below 25 mph (40 km/h). See **Switching the Electronic Locking Differential On and Off** (page 244).

## TRAIL - 4X2



This mode lowers accelerator pedal responsiveness and delays transmission up-shifts for improved vehicle control in low speed off-road environments. The system optimizes the traction and stability controls for improved traction and to help maintain forward momentum through loose deformable terrains.

Depending on your vehicle's options, the system disables auto-start-stop and optimizes the all-wheel drive system for enhanced traction.

Use this mode for driving on two-track trails, loose gravel and mixed uneven terrain.

**Note:** The brake over accelerator system is on in this mode. See **Brake Over Accelerator** (page 246).

**Note:** The electronic locking differential is available below 25 mph (40 km/h). See **Switching the Electronic Locking Differential On and Off** (page 244).

## DRIVE MODE CONTROL – TROUBLESHOOTING

### DRIVE MODE CONTROL – WARNING LAMPS



Some drive modes reduce traction and stability control performance and the indicator illuminates in the instrument cluster.



# Drive Mode Control

---

**Note:** *The system has diagnostic checks that continuously monitor the system for proper operation. If a mode is unavailable due to a system fault, the drive mode system defaults to normal. When the system defaults to normal, the driveline settings remain the same as prior to the system fault.*

## DRIVE MODE CONTROL – INFORMATION MESSAGES

<b>Message</b>	<b>Details</b>
Selected 4x4 Mode Not Available in Current Drive Mode	You have selected a four-wheel drive mode that is not available in the current drive mode. Select an available four-wheel drive mode.

# Drive Mode Control

---

## **DRIVE MODE CONTROL – FREQUENTLY ASKED QUESTIONS**

### **Why did the system default to normal mode?**

- If a mode is unavailable due to a system fault, it defaults to normal mode and the driveline settings remain the same as prior to the system fault.

### **Can I switch drive modes while I am driving?**

- In most instances, you can switch drive modes while you are driving (if you maintain attention on the road), or while the vehicle is stationary. However, you should not switch the vehicle into a drive mode intended for off-road or track use while driving on paved, public roads. For example, while driving on a paved highway, it would be acceptable to switch from normal mode to eco mode, but not to off-road mode.

### **How long does it take for the vehicle to switch modes after I make a selection?**

- After switching modes, the new drive mode will activate within several seconds, if all the appropriate pre-conditions are met.

### **How should I decide which drive mode to use?**

- Selecting a drive mode usually depends on the driving experience you would like to have, and the driving conditions. For example, if you want to have a more exciting on-road driving experience, you could switch into sport mode. If you find yourself driving on slick roads, you could switch into slippery mode.

### **Will drive modes impact my vehicle's fuel consumption?**

- Drive modes can have an impact on your vehicle's fuel consumption. In addition to the active mode, your driving style will also affect the fuel consumption.

# Lane Keeping System (If Equipped)

## WHAT IS THE LANE KEEPING SYSTEM

The lane keeping system alerts you by providing temporary steering assistance or steering wheel vibration when it detects an unintended lane departure.

## HOW DOES THE LANE KEEPING SYSTEM WORK

The lane keeping system uses a forward looking camera mounted on the windshield to monitor vehicle movement within the lane of travel.

When the camera detects a drift out of the lane of travel, the lane keeping system alerts the driver by vibrating the steering wheel, or aids the driver by providing a small steering input to move the vehicle back into the lane of travel.

The driver can select one of three modes:

- Alert
- Aid
- Alert + Aid

## LANE KEEPING SYSTEM PRECAUTIONS

 **WARNING:** You are responsible for controlling your vehicle at all times. The system is designed to be an aid and does not relieve you of your responsibility to drive with due care and attention. Failure to follow this instruction could result in the loss of control of your vehicle, personal injury or death.

 **WARNING:** The system will not operate if the sensor cannot track the road lane markings.

 **WARNING:** The sensor may incorrectly track lane markings as other structures or objects. This can result in a false or missed warning.

 **WARNING:** In cold and severe weather conditions the system may not function. Rain, snow and spray can all limit sensor performance.

 **WARNING:** The system may not operate properly if the sensor is blocked. Keep the windshield free from obstruction.

 **WARNING:** If damage occurs in the immediate area surrounding the sensor, have your vehicle checked as soon as possible.

 **WARNING:** The system may not correctly operate if your vehicle is fitted with a suspension kit not approved by us.

 **WARNING:** Large contrasts in outside lighting can limit sensor performance.

## LANE KEEPING SYSTEM LIMITATIONS

The lane keeping system only operates when the vehicle speed is greater than 40 mph (64 km/h).

The system works when the camera can detect at least one lane marking or the edge of the road.

# Lane Keeping System (If Equipped)

**Note:** When you select *Aid* or *Alert and Aid* mode and the system detects no steering activity for a short period of time, the system alerts you to put your hands on the steering wheel. The system may detect a light grip or touch on the steering wheel as hands-off driving.

The lane keeping system may not correctly operate in any of the following conditions:

- The lane keeping system does not detect at least one lane marking.
- You switch the turn signal on.
- You apply direct steering, accelerate fast or brake hard.
- The vehicle speed is less than 40 mph (64 km/h).
- The anti-lock brake, stability control or traction control system activates.
- The lane is too narrow.
- Something is obscuring the camera or it is unable to detect the lane markings due to environment, traffic or vehicle conditions.
- Entering or exiting a tight curve when driving at high speeds.

The lane keeping system may not correct lane positioning in any of the following conditions:

- High winds.
- Uneven road surfaces.
- Heavy or uneven loads.
- Incorrect tire pressure.

## SWITCHING THE LANE KEEPING SYSTEM ON AND OFF



To activate the lane keeping system, press the button on the steering wheel.

To deactivate the lane keeping system, press the button again.

**Note:** When switching the system on or off a message appears in the instrument cluster display to show the status.

**Note:** The system stores the on or off setting until manually changed.

## SWITCHING THE LANE KEEPING SYSTEM MODE

The lane keeping system has different settings that you can view or adjust using the touchscreen.

The system stores the last known selection for each setting.

To change the lane keeping system mode, use the touchscreen:

1. Press **Features** on the touchscreen.
2. Press **Driver Assistance**.
3. Press **Lane-Keeping System**.
4. Press **Lane-Keeping Mode**.
5. Select a mode.

**Note:** The system remembers the last setting when you start your vehicle.

## ALERT MODE

### WHAT IS ALERT MODE

Alert mode vibrates the steering wheel when it detects an unintended lane departure.

# Lane Keeping System (If Equipped)

## HOW DOES ALERT MODE WORK

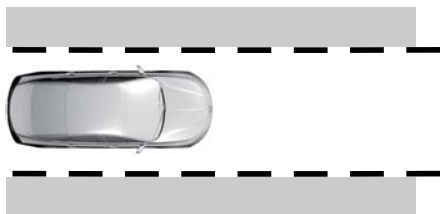

When in alert mode, the lane keeping system alerts you by vibrating the steering wheel. The intensity of the vibration is set through the lane keeping system menu.

## ADJUSTING THE STEERING WHEEL VIBRATION INTENSITY

To change the steering wheel vibration intensity, use the touchscreen:

1. Press **Features** on the touchscreen.
2. Press **Driver Assistance**.
3. Press **Lane-Keeping System**.
4. Press **Lane-Keeping Intensity**.
5. Select an intensity setting.

## AID MODE

### WHAT IS AID MODE

Aid mode provides temporary steering assistance toward the center of the lane.

## HOW DOES AID MODE WORK

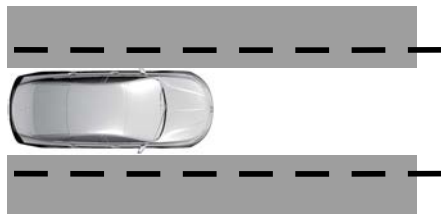

The lane keeping system aids you when an unintentional lane departure occurs. The system provides a small steering input to move the vehicle towards the center of the lane.

## ALERT AND AID MODE

### WHAT IS ALERT AND AID MODE

Alert and aid mode uses multiple features to keep you in your lane. The system first provides a small steering input to bring your vehicle back towards the center of the lane. If your vehicle moves too far from the center of the lane the system alerts you with vibration in the steering wheel.

# Lane Keeping System (If Equipped)

## HOW DOES ALERT AND AID MODE WORK

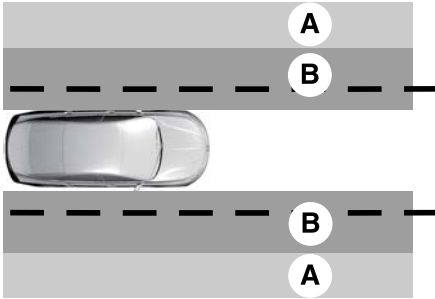

- A Alert.
- B Aid.

The lane keeping system detects a lane departure and provides aid when the vehicles enters **B** and applies the additional alert warning if **A** is entered.

## LANE KEEPING SYSTEM INDICATORS

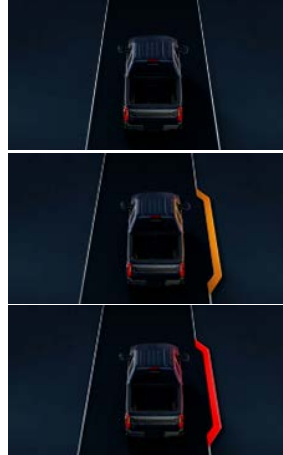

If you switch the lane keeping system on, a graphic with lane markings appears in the instrument cluster display.

When you switch the system off, the lane marking graphics do not display.

**Note:** *The overhead vehicle graphic may still display if adaptive cruise control is enabled.*

When the lane keeping system is on, the color of the lane markings change to indicate the system status.

Gray	Green	Yellow	Red
Indicates that the system is temporarily unavailable to provide a warning or intervention on the indicated side.	Indicates that the system is available or ready to provide a warning or intervention on the indicated side.	Indicates that the system is providing or has just provided a lane keeping aid intervention.	Indicates that the system is providing or has just provided a lane keeping alert warning.

# Lane Keeping System (If Equipped)

## BLIND SPOT ASSIST (IF EQUIPPED)

### WHAT IS BLIND SPOT ASSIST

Blind spot assist is an extension of the lane keeping system.

It may help you identify adjacent vehicles during a lane change.

Blind spot assist provides a blind spot warning and steering assistance to help you become aware of and steer away from vehicles in your blind spot during lane changes.

### HOW DOES BLIND SPOT ASSIST WORK



Activate and deactivate the system using the lane keeping system button on the steering wheel.

During lane changes, the design of the blind spot assist feature detects vehicles in, or approaching, your blind spot and provides a warning, plus steering assistance to direct your vehicle back into your lane.

When active, this system functions with or without the use of direction indicators and hazard flashers.

You must keep your hands on the steering wheel at all times.

### BLIND SPOT ASSIST LIMITATIONS

All system limitations present in the basic lane keeping system also apply to blind spot assist.

Blind spot assist does not function under the following conditions:

- No lane markings are detected.
- One or both rear radar sensors become blocked or faulty.
- Attaching bike or cargo racks could cause false alerts due to obstruction of the sensor.

Blind spot assist may have difficulty detecting hazards under the following conditions:

- If a vehicle is approaching in an adjacent lane at a speed higher than your vehicle.
- Bad weather obstructing the sensors.

## BLIND SPOT ASSIST WITH TRAILER COVERAGE (IF EQUIPPED)

### WHAT IS BLIND SPOT ASSIST WITH TRAILER COVERAGE

Blind spot assist with trailer coverage is an extension of the lane keeping system.

It may help you identify adjacent vehicles during a lane change.

Blind spot assist provides a blind spot warning and steering assistance to help you become aware of and steer away from vehicles in your blind spot during lane changes.

When attaching a trailer, ensure you have properly set up the trailer coverage settings. See **Blind Spot Information System With Trailer Coverage** (page 325).

### HOW DOES BLIND SPOT ASSIST WITH TRAILER COVERAGE WORK



Activate and deactivate the system using the lane keeping system button on the steering wheel.

## Lane Keeping System (If Equipped)

During lane changes, the design of the blind spot assist feature detects vehicles in, or approaching, your blind spot and provides a warning, plus steering assistance to direct your vehicle back into your lane.

If a supported trailer is connected, the function is reduced to only detecting vehicles on both sides of your vehicle and trailer, extending rearward from the exterior mirrors to the end of your trailer. See **Blind Spot Information System** (page 324).

When active, this system functions with or without the use of direction indicators and hazard flashers.

You must keep your hands on the steering wheel at all times.

### BLIND SPOT ASSIST WITH TRAILER COVERAGE LIMITATIONS

All system limitations present in the basic lane keeping system also apply to blind spot assist.

Blind spot assist does not function under the following conditions:

- No lane markings are detected.
- One or both rear radar sensors become blocked or faulty.
- You have not configured the attached trailer correctly in the trailer tow menus or you attached an unsupported trailer. The system only supports certain trailer shapes and dimensions.

**Note:** *Blind spot assist with trailer coverage could have reduced performance if any of the above limitations are present.*

Blind spot assist may have difficulty detecting hazards under the following conditions:

- If a vehicle is approaching in an adjacent lane at a relative speed much higher than your vehicle.
- Bad weather conditions are present that obstruct the sensors.
- Attaching bike or cargo racks could cause false alerts due to obstruction of the sensor.

### BLIND SPOT ASSIST WITH TRAILER COVERAGE INDICATORS

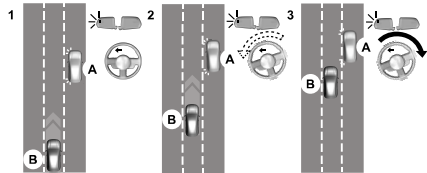

**Diagram 1:** Vehicle A uses its left turn signal preparing to change from the right lane to the middle lane. Vehicle B is already in the middle lane and just entered Vehicle A's blind spot causing the blind spot information system alert indicator to flash on the exterior mirror.

**Diagram 2:** The driver of Vehicle A begins to steer into the center lane not aware of Vehicle B.

**Diagram 3:** Blind spot assist counter steers to help alert the driver of Vehicle A to direct their vehicle back into the right lane to help avoid a possible collision with Vehicle B.

The lane keeping aid warning lamp or yellow lane marking in your instrument cluster display indicate blind spot assist activation. In addition, the blind spot information system alert indicator flashes on the exterior mirror on the same side as the detection. See **Blind Spot Information System** (page 324).



## Lane Keeping System (If Equipped)

### Blind Spot Assist Information Messages

Message	Action
Blind Spot Assist Not Available Trailer Attached	Displays if you attach a trailer to your vehicle with the blind spot information system switched off or you have not configured the trailer.
Blind Spot Assist Not Available Side Sensor Blocked	Displays if your blind spot information system sensors are blocked.
Blind Spot Assist System fault	The system has detected a fault that requires service. Have your vehicle checked as soon as possible.
Trailer Brake Module Fault	Lost communication with the trailer module. Blind spot assist is disabled until the failure is fixed.
Trailer Lighting Module Fault See Manual	Lost communication with the trailer module. Blind spot assist is disabled until the failure is fixed.
Front Camera Fault Service Required	Front camera fault. Blind spot assist is disabled until the failure is fixed.

## LANE KEEPING SYSTEM – TROUBLESHOOTING

### LANE KEEPING SYSTEM – INFORMATION MESSAGES

Message	Action
Lane Keeping Sys. Malfunction Service Required	The system has malfunctioned. Have your vehicle checked as soon as possible.
Front Camera Temporarily Not Available	The system has detected a condition that has caused the system to be temporarily unavailable.
Front Camera Low Visibility Clean Screen	The system has detected a condition that requires you to clean the windshield in order for it to operate properly.
Front Camera Malfunction Service Required	The system has malfunctioned. Have your vehicle checked as soon as possible.
Keep Hands on Steering Wheel	The system requests that you keep your hands on the steering wheel.

# Lane Keeping System (If Equipped)

## LANE KEEPING SYSTEM – FREQUENTLY ASKED QUESTIONS

<b>Why is the feature not available (lane markings are gray) when I can see the lane markings on the road?</b>
Your vehicle speed is less than 40 mph (65 km/h).
The sun is shining directly into the camera lens.
A quick intentional lane change has occurred.
Your vehicle stays too close to the lane markings for an extended interval of time.
Driving at high speeds in curves.
The last alert warning or aid intervention occurred a short time ago.
Ambiguous lane markings, for example, in construction zones.
Rapid transition from light to dark, or from dark to light.
Sudden offset in lane markings.
ABS or AdvanceTrac™ is active.
There is a camera blockage due to dirt, grime, fog, frost or water on the windshield.
You are driving too close to the vehicle in front of you.
Transitioning between no lane markings to lane markings, or vice versa.
There is standing water on the road.
Faint lane markings, for example, partial yellow lane markings on concrete roads.
Lane width is too narrow or too wide.
You have not calibrated the camera after a windshield replacement.
Driving on tight or on uneven roads.

## Lane Keeping System (If Equipped)

---

<b>Why does the vehicle not come back toward the middle of the lane, as expected, in the Aid, or Aid + Alert mode?</b>
High cross winds are present.
There is a large road crown.
Rough roads, grooves or shoulder drop-offs.
Heavy, uneven loading of the vehicle or improper tire inflation pressure.
You changed the tires or modified the suspension.

# Blind Spot Information System (If Equipped)

## WHAT IS BLIND SPOT INFORMATION SYSTEM

Blind spot information system detects vehicles that may have entered the blind spot zone.

## HOW DOES BLIND SPOT INFORMATION SYSTEM WORK

Blind spot information system uses sensors on both sides of your vehicle, detecting rearward from the exterior mirrors to approximately 13 ft (4 m) beyond the rear bumper. The detection area extends to approximately 59 ft (18 m) beyond the rear bumper when the vehicle speed is greater than 30 mph (48 km/h) to alert you of faster approaching vehicles.

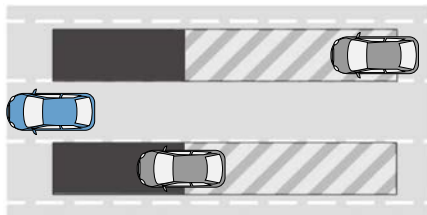

## BLIND SPOT INFORMATION SYSTEM PRECAUTIONS



**WARNING:** Do not use the blind spot information system as a replacement for using the interior and exterior mirrors or looking over your shoulder before changing lanes. The blind spot information system is not a replacement for careful driving.



**WARNING:** The system may not operate properly during severe weather conditions, for example snow, ice, heavy rain and spray. Always drive with due care and attention. Failure to take care may result in a crash.

**Note:** *Blind spot information system does not prevent contact with other vehicles. It does not detect parked vehicles, pedestrians, animals or other infrastructure.*

## BLIND SPOT INFORMATION SYSTEM LIMITATIONS

Blind spot information system does not operate in park (P) or reverse (R).

The system may not alert you if a vehicle quickly passes through the detection zone while overtaking.

**Note:** *For vehicles without the trailer coverage feature, we recommend that you switch the blind spot information system off when you attach a trailer.*

## BLIND SPOT INFORMATION SYSTEM REQUIREMENTS

Blind spot information system turns on when all the following occur:

- You start your vehicle.
- You shift into drive (D).
- The vehicle speed is greater than 6 mph (10 km/h).

## SWITCHING BLIND SPOT INFORMATION SYSTEM ON AND OFF

To switch blind spot information system on or off, use the touchscreen:

# Blind Spot Information System (If Equipped)

1. Press **Features** on the touchscreen.
2. Press **Driver Assistance**.
3. Press **Blind Spot Information System**.
4. Switch the feature on or off.

When you switch blind spot information system off, a warning lamp illuminates. When you switch the system on or off, the alert indicators flash twice.

**Note:** *The system remembers the last setting when you start your vehicle.*

## LOCATING THE BLIND SPOT INFORMATION SYSTEM SENSORS

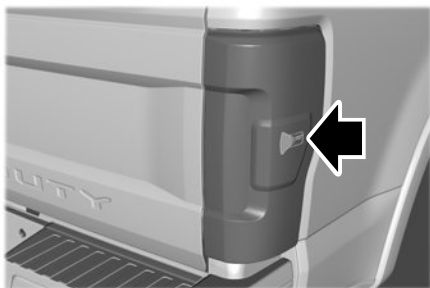

The sensors are inside the brake lamp on both sides of your vehicle.

**Note:** *Keep the sensors free from snow, ice and large accumulations of dirt.*

**Note:** *Do not cover the sensors with bumper stickers, repair compound or other objects.*

**Note:** *Bike and cargo racks could cause false alerts due to obstruction of the sensor. We recommend switching the feature off when using a bike or cargo rack.*

**Note:** *Blocked sensors may affect system accuracy.*

If the sensors become blocked, a message appears in the instrument cluster display. See **Blind Spot Information System – Information Messages** (page 328). The alert indicators illuminate but the system does not alert you.

## BLIND SPOT INFORMATION SYSTEM WITH TRAILER COVERAGE

### WHAT IS BLIND SPOT INFORMATION SYSTEM WITH TRAILER COVERAGE

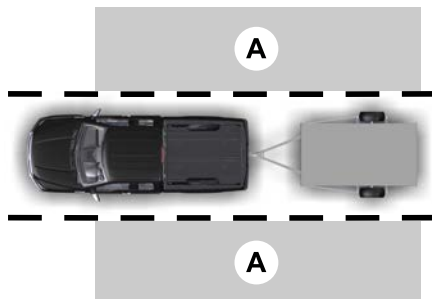

A. Trailer coverage detection zone.

Blind spot information system detects vehicles that may have entered the blind spot zone. The detection area is on both sides your vehicle and trailer, extending rearward from the exterior mirrors to the end of your trailer.

# Blind Spot Information System (If Equipped)

## BLIND SPOT INFORMATION SYSTEM WITH TRAILER COVERAGE LIMITATIONS

Trailer coverage automatically supports conventional trailers. To function with unconventional trailers such as fifth wheel and gooseneck variants, the vehicle needs to have trailer accessory sensors connected.

Make sure the trailer width is less than or equal to 8.5 ft (2.6 m) and the length is less than 33 ft (10.1 m) for conventional trailers and less than 50 ft (15.2 m) for unconventional trailers. If you input values higher, the system turns off.

Some trailers could cause a slight change in system performance:

- Large box trailers, including v-nose or horse trailers, could cause false alerts to occur when driving next to infrastructures or near parked cars. A false alert could also occur while making a 90° turn.
- Trailers that have a width greater than 8.5 ft (2.6 m) at the front and have a total length greater than 20 ft (6 m) could cause delayed alerts when a vehicle is passing at high speeds.
- Box trailers that have a width greater than 8.5 ft (2.6 m) at the front could cause early alerts when you pass a vehicle.
- Clam shell or v-nose box trailers with a width greater than 8.5 ft (2.6 m) at the front could cause delayed alerts when a vehicle traveling the same speed as your vehicle merges lanes.

Please contact your dealership for more information about trailer blind spot accessory sensors.

## SETTING A TRAILER LENGTH

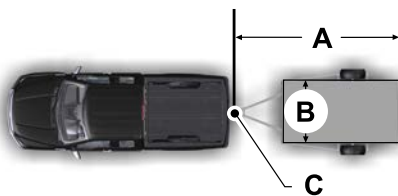

- A Trailer length.
- B Trailer width.
- C Trailer hitch ball.



**Note:** Measure the entire trailer length when setting up a gooseneck or fifth wheel trailer.

You can set-up a trailer to work with the blind spot information system through the touchscreen by using the add trailer menu.

1. Input the trailer name and trailer type, conventional, gooseneck or fifth wheel, then save to continue trailer setup.
2. Trailer width measurement. Measure the width at the front of the trailer. It is not measured at the widest point of the trailer. The maximum width at the front of the trailer the system can support is 8.5 ft (2.6 m).

**Note:** If the trailer is a bike rack or cargo rack with electrical lighting, enter a length of around 3 ft (1 m). Cross traffic alert remains on for trailers with a length of 3 ft (1 m) or less.

# Blind Spot Information System (If Equipped)

**Note:** *The system requires proper measurement and measure entry to properly function.*

## SELECTING A TRAILER

When you connect a trailer to your vehicle, the trailer set up menu appears in the touchscreen. This menu allows you to set up a new trailer or choose from a previously set up trailer. A warning message appears and the system turns off if you do not choose or add a new trailer.

**Note:** *The warning message may not appear until your vehicle reaches 22 mph (35 km/h).*

## BLIND SPOT INFORMATION SYSTEM INDICATORS



When blind spot information system detects a vehicle, an alert indicator illuminates in the exterior mirror on the side from which the vehicle is approaching. If you turn the turn signal on for that side of your vehicle, the alert indicator flashes.

# Blind Spot Information System (If Equipped)

## BLIND SPOT INFORMATION SYSTEM – TROUBLESHOOTING

### BLIND SPOT INFORMATION SYSTEM – INFORMATION MESSAGES

Message	Action
Blind Spot System Fault	A fault with the system has occurred. Have your vehicle checked as soon as possible.
Blind Spot Not Available Sensor Blocked See Manual	Something is blocking the sensors. Clean the sensors.
Blind Spot Alert Deactivated Trailer Attached	The system automatically turns off and displays this message when you connect a trailer to your vehicle under any of the following conditions: <ul style="list-style-type: none"><li>- Your vehicle does not have blind spot information system with trailer coverage.</li><li>- You switch the blind spot information system off through the touchscreen.</li><li>- Your trailer exceeds the limits for the system. See <b>Setting a Trailer Length</b> (page 326).</li></ul>

**Note:** When connecting a trailer, the system may detect the trailer and turn the system OFF. If the system does not automatically turn OFF, manually switch the blind spot information system OFF. If your vehicle has the blind spot information system with trailer coverage, the system prompts you to set up a trailer that allows the feature to function, if your trailer meets the requirements of the system.

## BLIND SPOT INFORMATION SYSTEM VIDEOS

[BLIS® with Cross-traffic Alert Video Link](#)



# Exit Warning (If Equipped)

## WHAT IS EXIT WARNING

Exit warning uses radar sensors to alert you to traffic objects approaching your open door.

## HOW DOES EXIT WARNING WORK

Exit warning detects traffic objects such as vehicles, cyclists, scooters and motorcycles that approach your vehicle from the rear and cross into the exit warning zone. The exit warning zones are along the left and right sides of your vehicle and extend slightly past a fully open door.



**Note:** The system cannot detect animals, slow moving pedestrians or any type of stationary object.

## EXIT WARNING PRECAUTIONS

**WARNING:** The system is not a crash warning or avoidance system.

**WARNING:** Always pay attention to the traffic situation and the area around the vehicle.

**WARNING:** In cold and severe weather conditions the system may not function. Rain, snow and spray can all limit sensor performance.

**WARNING:** If damage occurs in the immediate area surrounding the sensor, have your vehicle checked as soon as possible.

**WARNING:** You are responsible for controlling your vehicle at all times. The system is designed to be an aid and does not relieve you of your responsibility to drive with due care and attention. Failure to follow this instruction could result in the loss of control of your vehicle, personal injury or death.

**WARNING:** The system may not detect objects with surfaces that absorb reflection. Always drive with due care and attention. Failure to take care may result in a crash.

**Note:** The exit warning system becomes active once you have started your vehicle and the vehicle is not moving.

## EXIT WARNING LIMITATIONS

The exit warning system is operational in any gear position once you start your vehicle and anytime the vehicle is not moving. The exit warning system remains on for about 3 minutes after turning your vehicle off. The system immediately turns off when locking the doors. Exit warning informs you when it turns off.

**Note:** Do not use exit warning as a replacement for paying attention when exiting your vehicle.

**Note:** The system does not prevent contact with other vehicles by automatically closing the doors.

## Exit Warning (If Equipped)

**Note:** The system may not inform and/or alert you if a traffic object is approaching too quickly or if the parking position prevents detection.

### Exit Warning Alert

**Note:** Exit warning is designed to provide a visual and audible alert during an exit when an occupant opens any door and a traffic object is approaching on the same side.

### EXIT WARNING INDICATORS



When exit warning detects an approaching traffic object on one side, the corresponding alert indicator in the exterior mirror is illuminated. If exit warning alert or the optional exit warning prevention are active, the same alert indicator flashes. See **Blind Spot Information System Indicators** (page 327).

In addition to the mirror indicator there is also visual indicator in the information display noting what side a traffic object has been detected on.

### SWITCHING EXIT WARNING ON AND OFF

You can switch off the exit warning system using the touchscreen.

**Note:** The system remembers the last setting when you start your vehicle.

### LOCATING THE EXIT WARNING SENSORS

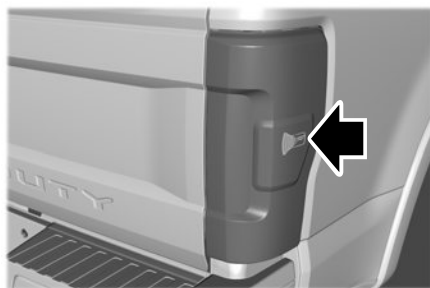

The sensors for exit warning are mounted inside the tail-lamp assembly on both sides of your vehicle.

**Note:** Keep the sensors free from snow, ice and large accumulations of dirt.

**Note:** Do not cover the sensors with bumper stickers, repair compound or other objects.

**Note:** Blocked sensors may affect system accuracy.

**Note:** The system may not correctly operate when towing a trailer or bike rack.

## Exit Warning (If Equipped)

---

### EXIT WARNING – TROUBLESHOOTING

#### EXIT WARNING – INFORMATION MESSAGES

Message	Reason
Left/Right Side Check surroundings before exiting	Left/Right exit warning alert or exit warning prevention is active.
Exit Warning turning off. Exit safely	Displays if the exit warning system turns off/shuts down.
Exit Warning System Fault	Displays if the exit warning system detects any system error.

If exit warning detects a fault, the system deactivates and the following message appears in the instrument cluster display.



# Cross Traffic Alert (If Equipped)

## WHAT IS CROSS TRAFFIC ALERT

The system alerts you of vehicles approaching from the sides behind your vehicle when you shift into reverse (R).

## HOW DOES CROSS TRAFFIC ALERT WORK

Cross traffic alert detects vehicles that approach at a speed between 4–37 mph (6–60 km/h). Coverage decreases when the sensors are partially, mostly or fully obstructed.

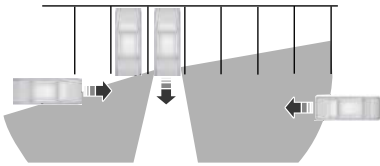

The sensor on the left-hand side is only partially obstructed and zone coverage on the right-hand side is maximized.

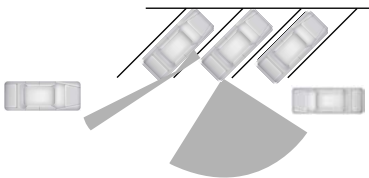

Zone coverage also decreases when parking at narrow angles. The sensor on the left-hand side is mostly obstructed and zone coverage on that side is severely reduced.

**Note:** *Slowly reversing helps increase the coverage area and effectiveness.*

## CROSS TRAFFIC ALERT PRECAUTIONS

**WARNING:** Do not use the cross traffic alert system as a replacement for using the interior and exterior mirrors or looking over your shoulder before reversing out of a parking space. The cross traffic alert system is not a replacement for careful driving.

**WARNING:** The system may not operate properly during severe weather conditions, for example snow, ice, heavy rain and spray. Always drive with due care and attention. Failure to take care may result in a crash.

## CROSS TRAFFIC ALERT LIMITATIONS

Cross Traffic Alert may not correctly operate when any of the following occur:

- Something is blocking the sensors.
- Adjacently parked vehicles or objects are obstructing the sensors.
- Vehicles approach at speeds less than 4 mph (6 km/h) or greater than 37 mph (60 km/h).
- Your vehicle speed is greater than 7 mph (12 km/h).
- You reverse out of an angled parking space.

## Cross Traffic Alert (If Equipped)

### Cross Traffic Alert Limitations with a Trailer Attached

The system remains on when you attach a trailer in vehicles with blind spot information system with trailer tow under the following conditions:

- You connect a trailer.
- The trailer is a bike rack or cargo rack with a maximum length of 3 ft (1 m).
- You set the trailer length to 3 ft (1 m) in the instrument cluster display.

**Note:** *The system may not correctly operate when towing a trailer. For vehicles with an approved trailer tow module and tow bar, the system turns off when you attach a trailer. For vehicles with an aftermarket trailer tow module or tow bar, we recommend that you switch the system off when you attach a trailer.*

### SWITCHING CROSS TRAFFIC ALERT ON AND OFF

To switch cross traffic alert on or off use the touchscreen.

1. Press **Features** on the touchscreen.
2. Press **Driver Assistance**.
3. Switch **Cross Traffic Alert** on or off.

When you switch the system on or off, the alert indicators flash twice.

**Note:** *The system switches on every time you switch the ignition on.*

### LOCATING THE CROSS TRAFFIC ALERT SENSORS

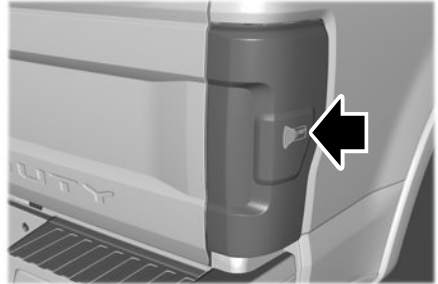

The sensors are inside the brake lamp on both sides of your vehicle.

**Note:** *Keep the sensors free from snow, ice and large accumulations of dirt.*

**Note:** *Do not cover the sensors with bumper stickers, repair compound or other objects.*

**Note:** *Blocked sensors may affect system accuracy.*

If something is blocking the sensors, a message may appear in the information display when you shift into reverse (R).

**Note:** *Bike and cargo racks could cause false alerts due to obstruction of the sensor. We recommend switching the feature off when using a bike or cargo rack.*

### CROSS TRAFFIC ALERT INDICATORS

When the cross traffic alert detects an approaching vehicle, a tone sounds, a warning lamp illuminates in the relevant exterior mirror and arrows appear in the instrument cluster display to show from which side the vehicle is approaching.

## Cross Traffic Alert (If Equipped)

If the system malfunctions, a warning lamp illuminates in the instrument cluster and a message appears in the instrument cluster display. Have your vehicle checked as soon as possible.

**Note:** *In some conditions, the system could alert you, even when there is nothing in the detection zone, for example a vehicle passing further away from your vehicle.*

### CROSS TRAFFIC ALERT – TROUBLESHOOTING

### CROSS TRAFFIC ALERT – INFORMATION MESSAGES

Message	Action
Cross Traffic Alert	Displays instead of indication arrows when the system detects a vehicle. Check for approaching traffic. Only available in vehicles with 8 inch displays.
Cross Traffic Not Available Sensor Blocked See Manual	Indicates blocked cross traffic alert system sensors. Clean the sensors. If the message continues to appear, have your vehicle checked as soon as possible.
Cross Traffic System Fault	The system has malfunctioned. Have your vehicle checked as soon as possible.
Cross Traffic Alert Deactivated Trailer Attached	Displays if you attach a trailer to your vehicle.

**Note:** *When connecting a trailer, the system may detect the trailer and turn the system OFF. If the system does not turn OFF automatically, switch the cross traffic alert system OFF manually. See **Switching Cross Traffic Alert On and Off** (page 333).*

# Pre-Collision Assist (If Equipped)

## WHAT IS PRE-COLLISION ASSIST

Pre-collision assist detects and warns of approaching hazards in the roadway. The system provides multiple levels of assistance to help avoid a collision if your vehicle is rapidly approaching another stationary vehicle, a vehicle traveling in the same direction as yours, or a pedestrian or cyclist within your driving path.

## HOW DOES PRE-COLLISION ASSIST WORK

The system warns the driver of potential hazards by providing three levels of assistance.



If your vehicle is rapidly approaching potential hazards the system provides the following levels of functionality:

1. Alert.
2. Brake support.
3. Automatic emergency braking.



**Alert:** When active, a flashing visual warning appears and an audible warning tone sounds.

**Brake Support:** The system helps reduce the impact speed by preparing the brakes for rapid braking. The system does not automatically apply the brakes. If you press the brake pedal, the system may apply additional braking up to maximum braking force, even if you lightly press the brake pedal.

**Automatic Emergency Braking:** Automatic emergency braking may activate if the system determines that a collision is imminent.

**Note:** If the pre-collision assist alerts are too frequent or disturbing, you can reduce the alert sensitivity. Setting the low sensitivity results in fewer and later warnings of a potential forward collision. The manufacturer recommends using the high sensitivity setting where possible.

**Note:** Automatic emergency braking performance is not affected by the sensitivity setting.

Each system has various levels of detection capabilities. See **Pre-Collision Assist Limitations** (page 336).

## PRE-COLLISION ASSIST PRECAUTIONS



**WARNING:** You are responsible for controlling your vehicle at all times. The system is designed to be an aid and does not relieve you of your responsibility to drive with due care and attention. Failure to follow this instruction could result in the loss of control of your vehicle, personal injury or death.





**WARNING:** The system does not detect vehicles moving in a different direction or animals. Apply the brakes when necessary. Failure to follow this instruction could result in the loss of control of your vehicle, personal injury or death.





**WARNING:** The system does not operate during hard acceleration or steering. Failure to take care may lead to a crash or personal injury.

## Pre-Collision Assist (If Equipped)

 **WARNING:** The system may operate with reduced function during cold and inclement weather conditions. Snow, ice, rain, spray and fog can adversely affect the system. Keep the front camera and radar free of snow and ice. Failure to follow this instruction may result in the loss of control of your vehicle, serious personal injury or death.

 **WARNING:** Take additional care if your vehicle is heavily loaded or you are towing a trailer. These conditions could result in reduced performance of this system. Failure to follow this instruction could result in the loss of control of your vehicle, personal injury or death.

 **WARNING:** The system cannot help prevent all crashes. Do not rely on this system to replace driver judgment and the need to maintain a safe distance and speed.

 **WARNING:** In situations where the vehicle camera has limited detection capability, this may reduce system performance. These situations include but are not limited to direct or low sunlight, vehicles at night without tail lights, unconventional vehicle types, pedestrians with complex backgrounds, running pedestrians, partly obscured pedestrians, or pedestrians that the system cannot distinguish from a group. Failure to take care may result in the loss of control of your vehicle, serious personal injury or death.

### PRE-COLLISION ASSIST LIMITATIONS

Pre-collision assist depends on the detection ability of its camera and sensors. Any obstructions or damage to these areas can limit detection or prevent the system from functioning. See **Locating the Pre-Collision Assist Sensors** (page 338).

The system is active at 3 mph (5 km/h) and above.

**Note:** *The pre-collision assist system automatically disables when you manually disable AdvanceTrac™, 4X4 low, and Rock Crawl (if available).*

**Note:** *Brake support and automatic emergency braking are active up to the maximum speed of the vehicle.*

#### Pedestrian Detection Limitations

Pedestrian detection is active at speeds up to 50 mph (80 km/h).

Pedestrian detection operates optimally when detected hazards are clearly identifiable. System performance may reduce in situations where pedestrians are running, partly obscured, have a complex background, or cannot be distinguished from a group.

#### Cyclist Detection Limitations

Cyclist detection is active at speeds up to 50 mph (80 km/h).

Cyclist detection functions optimally when detected hazards are clearly identifiable. System performance may reduce in situations where cyclists are fast-moving, partly obscured, have a complex background, or cannot be distinguished from a group.



## Pre-Collision Assist (If Equipped)

### Intersection Assist (If Equipped)

The pre-collision assist system may operate in a scenario where you are turning across the path of an oncoming vehicle, or with crossing pedestrians. Detection of vehicles driving in an oncoming direction is active if your vehicle is driving at speeds up to 50 mph (80 km/h). Detection of crossing pedestrians at an intersection is active if your vehicle is driving at speeds up to 19 mph (30 km/h).

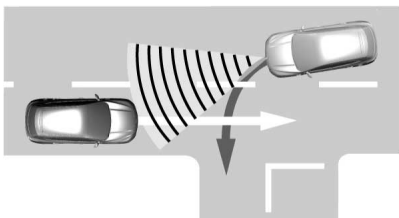

### SWITCHING PRE-COLLISION ASSIST ON AND OFF

To switch the system on or off, use the touchscreen:

1. Press **Features** on the touchscreen.
2. Press **Driver Assistance**.
3. Press **Pre-Collision Assist**.
4. Switch the feature on or off.

### Adjusting the Pre-Collision Assist Settings

You can adjust the following settings by using the touchscreen controls in the pre-collision assist menu:

- Change alert and distance alert sensitivity to one of three possible settings.
- Switch distance indication and alert on or off.
- If required, switch automatic emergency braking on or off.
- If required, switch evasive steering assist on or off.

**Note:** *Automatic emergency braking and evasive steering turn on every time you start your vehicle.*

**Note:** *If your vehicle has a radar sensor, we recommend that you switch the system off if you install a snow plow or similar object in such a way that it may block the radar sensor. Your vehicle remembers the selected setting across key cycles.*

**Note:** *If you switch automatic emergency braking off, evasive steering assist switches off.*

## Pre-Collision Assist (If Equipped)

### LOCATING THE PRE-COLLISION ASSIST SENSORS



1. Camera.
2. Radar sensor (if equipped).

If a message regarding a blocked sensor or camera appears in the instrument cluster display, something is obstructing the radar or front windshield camera. The radar sensor is behind the fascia cover in the center of the lower grille. With a blocked sensor or camera, the system may not function, or performance may reduce. See **Pre-Collision Assist – Information Messages** (page 341).

**Note:** Proper system operation requires a clear view of the road by the camera. Have any windshield damage in the area of the camera's field of view repaired.

**Note:** If something hits the front end of your vehicle or damage occurs and your vehicle has a radar sensor, the radar sensing zone could change. This could cause missed or false vehicle detections. Have your vehicle serviced to have the radar checked for proper coverage and operation.

**Note:** If your vehicle detects excessive heat at the camera or a potential misalignment condition, a message could appear in the instrument cluster display indicating temporary sensor unavailability. When operational conditions are correct, the message deactivates. For example, when the ambient temperature around the sensor decreases or the sensor successfully recalibrates.

### DISTANCE INDICATION

#### WHAT IS DISTANCE INDICATION

Distance indication displays the gap between your vehicle and the vehicle ahead of you.

**Note:** The graphic does not display if you switch on cruise control or adaptive cruise control.

Vehicle Speed	System Sensitivity	Distance Indicator Color	Distance Gap	Time Gap
62 mph (100 km/h).	Normal.	Blue.	Greater than 82 ft (25 m).	Greater than 0.9 seconds.
		Yellow.	56–82 ft (17–25 m).	0.6–0.9 seconds.
		Red.	Less than 56 ft (17 m).	Less than 0.6 seconds.

# Pre-Collision Assist (If Equipped)

## SWITCHING DISTANCE INDICATION ON AND OFF

To switch the system on or off, use the touchscreen:

1. Press **Features** on the touchscreen.
2. Press **Driver Assistance**.
3. Press **Pre-Collision Assist**.
4. Switch **Distance Indication** on or off.

## DISTANCE INDICATION INDICATOR

The indicator displays the time gap between your vehicle and vehicles traveling in the same direction ahead of you.



## DISTANCE ALERT

### WHAT IS DISTANCE ALERT

The system alerts you with a warning lamp if the distance to the vehicle ahead is small.

**Note:** *The warning lamp does not illuminate if cruise control or adaptive cruise control is active.*

### ADJUSTING THE SENSITIVITY OF DISTANCE ALERT

To adjust the sensitivity of the system, use the touchscreen:

1. Press **Features** on the touchscreen.
2. Press **Driver Assistance**.
3. Press **Pre-Collision Assist**.
4. Press **Alert Sensitivity**.
5. Select a setting.

## AUTOMATIC EMERGENCY BRAKING

### WHAT IS AUTOMATIC EMERGENCY BRAKING

Automatic emergency braking may activate if the system determines that a collision is imminent. The system may help to reduce impact damage or avoid the crash completely.

Automatic emergency braking is only available up to certain speeds. See **Locating the Pre-Collision Assist Sensors** (page 338).

# Pre-Collision Assist (If Equipped)

## SWITCHING AUTOMATIC EMERGENCY BRAKING ON AND OFF

To switch the system on or off, use the touchscreen:

1. Press **Features** on the touchscreen.
2. Press **Driver Assistance**.
3. Press **Pre-Collision Assist**.
4. Press **Auto Emergency Braking**.
5. Switch the feature on or off.

## EVASIVE STEERING ASSIST

### WHAT IS EVASIVE STEERING ASSIST

If your vehicle is rapidly approaching a road user, evasive steering assist helps you steer around the road user.

After you turn the steering wheel in an attempt to avoid a crash with the road user, the system applies additional steering torque to help you steer around the road user. After you pass the road user, the system applies steering torque when you turn the steering wheel to steer back into the lane. The system deactivates after you fully pass the road user.

**Note:** Road users are defined as pedestrians or bicyclists in your vehicle's path or another stationary vehicle in the same lane or a vehicle traveling in the same lane in the same direction as you. See **Pre-Collision Assist Precautions** (page 335).

## EVASIVE STEERING ASSIST LIMITATIONS

Evasive steering assist only activates when all the following occur:

- Automatic emergency braking and evasive steering assist are on.
- The system detects a road user ahead and starts to apply the brakes.
- You significantly turn the steering wheel to steer around a road user.

**Note:** Evasive steering assist does not automatically steer around a road user. If you do not turn the steering wheel, evasive steering assist does not activate.

**Note:** Evasive steering assist does not activate if the distance to the road user ahead is too small and the system cannot avoid a crash.

## SWITCHING EVASIVE STEERING ASSIST ON AND OFF

To switch the system on or off, use the touchscreen:

1. Press **Features** on the touchscreen.
2. Press **Driver Assistance**.
3. Press **Pre-Collision Assist**.
4. Switch **Evasive Steering** on or off.

**Note:** If you switch automatic emergency braking off, evasive steering assist turns off.

**Note:** Automatic emergency braking and evasive steering assist turn on every time you start your vehicle.

## Pre-Collision Assist (If Equipped)

### PRE-COLLISION ASSIST – TROUBLESHOOTING

### PRE-COLLISION ASSIST – WARNING LAMPS



A telltale illuminates in the instrument cluster display to indicate if the system is disabled, unavailable, or temporarily degraded due to external environmental conditions.

**Note:** No action is needed if the telltale illuminates without a corresponding information message. See **Pre-Collision Assist Precautions** (page 335).

### PRE-COLLISION ASSIST – INFORMATION MESSAGES

Message	Action
Pre-Collision Assist Not Available Sensor Blocked	You have a blocked sensor due to bad weather, ice, mud or water in front of the radar sensor. You can typically clean the sensor to resolve.
Pre-Collision Assist Not Available	A fault with the system has occurred. Have your vehicle checked as soon as possible.

## Pre-Collision Assist (If Equipped)

---

### PRE-COLLISION ASSIST – FREQUENTLY ASKED QUESTIONS

#### What should I do if the windshield in front of the camera is dirty or obstructed?

- Clean the outside of the windshield in front of the camera.

#### What if the windshield in front of the camera is clean, but the message remains in the instrument cluster display?

- Wait a short time. It could take several minutes for the camera to detect that there is no obstruction.

#### What should I do if the surface of the radar in the grille is dirty or obstructed?

- Clean the grille surface in front of the radar or remove the object causing the obstruction.

#### What if the surface of the radar in the grille is clean, but the message remains in the instrument cluster display?

- Wait a short time. It could take several minutes for the radar to detect that there is no obstruction.

#### Can weather or road conditions interfere with the radar signals?

- Yes, weather such as heavy rain, spray or fog as well as water, snow or ice on the surface of the road can interfere with the radar signals. In these situations, the system temporarily disables this feature. Pre-collision assist reactivates a short time after the weather conditions improve.

#### What if the radar is out of alignment due to a front end impact?

- Have your vehicle serviced to have the radar checked for proper coverage and operation.

### PRE-COLLISION ASSIST VIDEOS

[Forward Collision Warning with brake support: F-Series Video Link](#)

# Speed Sign Recognition (If Equipped)

## WHAT IS SPEED SIGN RECOGNITION

Speed sign recognition detects speed limit signs to inform you of the current speed limit. Detected speed signs appear in the instrument cluster display.

## HOW DOES SPEED SIGN RECOGNITION WORK

Speed sign recognition uses the front windshield camera to detect speed signs.

If your vehicle has speed sign recognition with navigation, stored speed sign data may influence the indicated speed limit value.

## SPEED SIGN RECOGNITION PRECAUTIONS



**WARNING:** You are responsible for controlling your vehicle at all times. The system is designed to be an aid and does not relieve you of your responsibility to drive with due care and attention. Failure to follow this instruction could result in the loss of control of your vehicle, personal injury or death.



**WARNING:** In cold and severe weather conditions the system may not function. Rain, snow and spray can all limit sensor performance.



**WARNING:** The system may not operate properly if the sensor is blocked. Keep the windshield free from obstruction.

**Note:** Do not carry out windshield repairs in the immediate area surrounding the sensor.

**Note:** If your vehicle has a suspension kit not approved by Ford, the system may not correctly function.

**Note:** The system may not detect all speed signs and may incorrectly read signs.

**Note:** Always fit our original parts when replacing headlamp bulbs. Other bulbs may reduce system performance.

## SPEED SIGN RECOGNITION LIMITATIONS

Speed sign recognition may not operate correctly due to:

- Outdated map data.
- Incorrect recognition of speed limits by the sensor of signs on parallel roads or exit ramps.
- Missed recognition of faded, dirty, or distorted signs.

## SPEED SIGN RECOGNITION INDICATORS



When the system detects a speed limit sign, it appears in the instrument cluster display.

**Note:** Sign indicator image may vary based on your vehicle's display type.

## Speed Sign Recognition (If Equipped)

### SETTING THE SPEED SIGN RECOGNITION SPEED WARNING

To set the speed warning, use the touchscreen.

1. Press **Features** on the touchscreen.
2. Press **Driver Assistance**.
3. Press **Speed Limit Assist**.
4. Switch the feature on or off.

### SETTING THE SPEED SIGN RECOGNITION SPEED TOLERANCE

To set the tolerance of the speed warning, use the touchscreen.

1. Press **Features** on the touchscreen.
2. Press **Driver Assistance**.
3. Press **Speed Limit Assist**.
4. Press **Tolerance**.
5. Use the slider bar to select the required level.

## SPEED SIGN RECOGNITION – TROUBLESHOOTING

### SPEED SIGN RECOGNITION – INFORMATION MESSAGES

Message	Details
Traffic Sign Reduced Performance See Manual	The traffic sign data provided by the navigation system is unavailable due to weak or no signal. Wait for a short period of time for the signal to improve. If the message continues to appear, have the system checked as soon as possible.



# Speed Sign Recognition (If Equipped)

---

## **SPEED SIGN RECOGNITION – FREQUENTLY ASKED QUESTIONS**

### **Why does the speed limit change without any sign on the road?**

- The speed limit changes due to the speed limit data stored in the map data.

### **Why does speed sign recognition show a wrong speed limit?**

- The system shows a wrong speed limit due to incorrect and outdated map data or due to incorrect recognition of the speed limits by the camera.

## Driver Alert (If Equipped)

### WHAT IS DRIVER ALERT

Driver alert alerts you if it determines that you are becoming drowsy or if your driving deteriorates.

### HOW DOES DRIVER ALERT WORK

Driver alert determines your alertness level based on your driving behavior in relation to the lane markings and other factors using the front windshield camera.

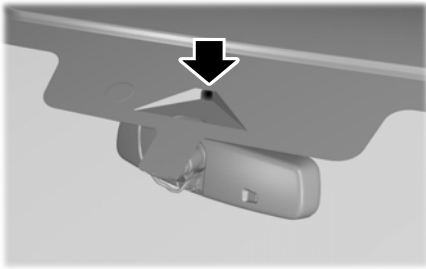

### DRIVER ALERT PRECAUTIONS

**WARNING:** You are responsible for controlling your vehicle at all times. The system is designed to be an aid and does not relieve you of your responsibility to drive with due care and attention. Failure to follow this instruction could result in the loss of control of your vehicle, personal injury or death.

**WARNING:** Take regular rest breaks if you feel tired. Do not wait for the system to warn you.

**WARNING:** Certain driving styles may result in the system warning you even if you are not feeling tired.

**WARNING:** In cold and severe weather conditions the system may not function. Rain, snow and spray can all limit sensor performance.

**WARNING:** The system will not operate if the sensor cannot track the road lane markings.

**WARNING:** If damage occurs in the immediate area surrounding the sensor, have your vehicle checked as soon as possible.

**WARNING:** The system may not correctly operate if your vehicle is fitted with a suspension kit not approved by us.

**WARNING:** The system may not operate properly if the sensor is blocked. Keep the windshield free from obstruction.

**Note:** If something is blocking the camera or damaged the windshield, Driver Alert may not function.

### DRIVER ALERT LIMITATIONS

Driver alert may not function correctly if:

- The sensor cannot track the road lane markings.
- Your vehicle's speed is less than approximately 40 mph (65 km/h).

### SWITCHING DRIVER ALERT ON AND OFF

1. Press **Features** on the touchscreen.

## Driver Alert (If Equipped)

---

2. Press **Driver Assistance**.
3. Switch **Driver Alert** on or off.

**Note:** *The system remains on or off depending on how it was last set.*

### Resetting Driver Alert

You can reset the system by either:

- Switching your vehicle off and on.
- Opening and closing the driver door when your vehicle is stationary, and it is safe to do so.

## DRIVER ALERT – TROUBLESHOOTING

### DRIVER ALERT – INFORMATION MESSAGES

Message	Action
Driver Alert Warning Rest Now	Stop and rest as soon as it is safe to do so.
Driver Alert Warning Rest Suggested	Take a rest soon.

# Load Carrying

## LOAD CARRYING PRECAUTIONS

Keep your loaded vehicle weight within its design rating capability, with or without a trailer. Properly loading your vehicle provides maximum return of vehicle design performance. Before you load your vehicle, become familiar with the following terms for determining your vehicle's weight rating, with or without a trailer, from the vehicle's Tire and Loading Information label or Safety Compliance Certification label.



**WARNING:** Vehicles with a higher center of gravity (utility and four-wheel drive vehicles) handle differently than vehicles with a lower center of gravity (passenger cars). Avoid sharp turns, excessive speed and abrupt steering in these vehicles. Failure to drive cautiously increases the risk of losing control of your vehicle, vehicle rollover, personal injury and death.



**WARNING:** The appropriate loading capacity of your vehicle can be limited either by volume capacity (how much space is available) or by payload capacity (how much weight the vehicle should carry). Once you have reached the maximum

payload of your vehicle, do not add more cargo, even if there is space available. Overloading or improperly loading your vehicle can contribute to loss of vehicle control and vehicle rollover.



**WARNING:** Exceeding the Safety Compliance Certification label vehicle weight limits can adversely affect the performance and handling of your vehicle, cause vehicle damage and can result in the loss of control of your vehicle, serious personal injury or death.



**WARNING:** Do not use replacement tires with lower load carrying capacities than the original tires because they may lower your vehicle's GVWR and GAWR limitations. Replacement tires with a higher limit than the original tires do not increase the GVWR and GAWR limitations.



**WARNING:** Do not exceed the GVWR or the GAWR specified on the certification label.



**WARNING:** Exceeding any vehicle weight rating can adversely affect the performance and handling of your vehicle, cause vehicle damage and can result in the loss of control of your vehicle, serious personal injury or death.

# Load Carrying



**WARNING:** When loading the roof racks, we recommend you evenly distribute the load, as well as maintain a low center of gravity. Loaded vehicles, with higher centers of gravity, may handle differently than unloaded vehicles. Take extra precautions, such as slower speeds and increased stopping distance, when driving a heavily loaded vehicle.

The gross combined weight must never exceed the Gross Combined Weight Rating.

## USING A SLIDE-IN CAMPER

For information regarding the use of slide-in campers, consult the Truck Camper Loading document supplied with your vehicle.

## LOCATING THE SAFETY COMPLIANCE CERTIFICATION LABELS

### Safety Compliance Certification Label Example:

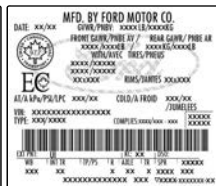
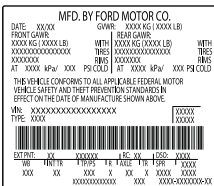

The Safety Compliance Certification label is located on the door hinge pillar, door-latch post, or the door edge that meets the door-latch post, next to the driver seating position.

## WHAT IS THE GROSS AXLE WEIGHT RATING

### GAWR (Gross Axle Weight Rating)

GAWR is the maximum allowable weight that a single axle (front or rear) can carry. These numbers are on the Safety Compliance Certification label.

## WHAT IS THE GROSS VEHICLE WEIGHT RATING

GVWR is the maximum allowable weight of the fully loaded vehicle. This includes all options, equipment, passengers and cargo. It appears on the Safety Compliance Certification label.

## WHAT IS THE GROSS COMBINED WEIGHT RATING

Gross Combined Weight Rating (GCWR) is the maximum allowable weight of the vehicle and the loaded trailer, including all cargo and passengers, that the vehicle can handle without risking damage. (Important: The towing vehicle's braking system is rated for operation at Gross Vehicle Weight Rating, not at Gross Combined Weight Rating.)

# Load Carrying

Separate functional brakes should be used for safe control of towed vehicles and for trailers where the Gross Combined Weight of the towing vehicle plus the trailer exceed the Gross Vehicle Weight Rating of the towing vehicle. See **Recommended Towing Weights** (page 365).

## CALCULATING PAYLOAD

### Tire and Loading Label Information Example:



**TIRE AND LOADING INFORMATION**

SEATING CAPACITY TOTAL: 5 FRONT: 2 REAR: 3

The combined weight of occupants and cargo should never exceed: **385 kg or 850 lbs.**

TIRE	SIZE	COLD TIRE PRESSURE
FRONT	235/45R18 94V	235 KPA, 34 PSI
REAR	235/45R18 94V	235 KPA, 34 PSI
SPARE	NONE	NONE

SEE OWNERS MANUAL FOR ADDITIONAL INFORMATION



**TIRE AND LOADING INFORMATION**  
**RENSEIGNEMENTS SUR LES PNEUS ET LE CHARGEMENT**

SEATING CAPACITY / NOMBRE DE PLACES TOTAL: 5 FRONT / AVANT: 2 REAR / ARRIERE: 3

The combined weight of occupants and cargo should never exceed 396 kg or 875 lbs.  
Le poids total des occupants et du chargement ne doit jamais dépasser 396 kg ou 875 lbs.

TIRE / PNEU	SIZE / DIMENSIONS	COLD TIRE PRESSURE / PRESSION DES PNEUS A FROID
FRONT / AVANT	235/40R19 96V	255 KPA, 37 PSI
REAR / ARRIERE	235/40R19 96V	255 KPA, 37 PSI
SPARE / SECOURS	T125/80R16 97M	415 KPA, 60 PSI

SEE OWNER'S MANUAL FOR ADDITIONAL INFORMATION  
VOIR LE MANUEL DE L'USAGER POUR PLUS DE RENSEIGNEMENTS

Payload is the combined weight of cargo and passengers that your vehicle is carrying. The maximum payload for your vehicle appears on the Tire and Loading label. The label is either on the B-pillar or the edge of the driver door. Vehicles exported outside the US and Canada may not have a tire and loading label. Look for "The combined weight of occupants and cargo should never exceed XXX kg or XXX lb" for maximum payload. The payload listed on the Tire and Loading Information label is the maximum payload for your vehicle as built by the assembly plant. If you install any additional equipment on your vehicle, you must determine the new payload. Subtract the weight of the equipment from the payload listed on the Tire and Loading label. When towing, trailer tongue weight or king pin weight is also part of payload.

## CALCULATING THE LOAD LIMIT

Steps for determining the correct load limit:

1. Locate the statement "The combined weight of occupants and cargo should never exceed XXX kg or XXX lb." on your vehicle's placard.
2. Determine the combined weight of the driver and passengers that will be riding in your vehicle.

## Load Carrying

3. Subtract the combined weight of the driver and passengers from XXX kg or XXX lb.
4. The resulting figure equals the available amount of cargo and luggage load capacity. For example, if the “XXX” amount equals 1,400 lb. and there will be five 150 lb. passengers in your vehicle, the amount of available cargo and luggage load capacity is 650 lb.  $(1400 - 750 (5 \times 150) = 650 \text{ lb.})$
5. Determine the combined weight of luggage and cargo being loaded on the vehicle. That weight may not safely exceed the available cargo and luggage load capacity calculated in Step 4.
6. If your vehicle will be towing a trailer, load from your trailer will be transferred to your vehicle. Consult this manual to determine how this reduces the available cargo and luggage load capacity of your vehicle.

### **Helpful examples for calculating the available amount of cargo and luggage load capacity**

Suppose your vehicle has a 1400-pound (635-kilogram) cargo and luggage capacity. You decide to go golfing. Is there enough load capacity to carry you, four of your friends and all the golf bags? You and four friends average 220 pounds (99 kilograms) each and the golf bags weigh approximately

30 pounds (13.5 kilograms) each. The calculation would be:  $1400 - (5 \times 220) - (5 \times 30) = 1400 - 1100 - 150 = 150$  pounds. Yes, you have enough load capacity in your vehicle to transport four friends and your golf bags. In metric units, the calculation would be:  $635 \text{ kilograms} - (5 \times 99 \text{ kilograms}) - (5 \times 13.5 \text{ kilograms}) = 635 - 495 - 67.5 = 72.5$  kilograms.

Suppose your vehicle has a 1400-pound (635-kilogram) cargo and luggage capacity. You and one of your friends decide to pick up cement from the local home improvement store to finish that patio you have been planning for the past two years. Measuring the inside of the vehicle with the rear seat folded down, you have room for twelve 100-pound (45-kilogram) bags of cement. Do you have enough load capacity to transport the cement to your home? If you and your friend each weigh 220 pounds (99 kilograms), the calculation would be:  $1400 - (2 \times 220) - (12 \times 100) = 1400 - 440 - 1200 = -240$  pounds. No, you do not have enough cargo capacity to carry that much weight. In metric units, the calculation would be:  $635 \text{ kilograms} - (2 \times 99 \text{ kilograms}) - (12 \times 45 \text{ kilograms}) = 635 - 198 - 540 = -103$  kilograms. You will need to reduce the load weight by at least 240 pounds (104 kilograms). If you remove three 100-pound (45-kilogram) cement bags, then the load calculation would be:  $1400 - (2 \times$

## Load Carrying

---

$220) - (9 \times 100) = 1400 - 440 - 900 = 60$  pounds. Now you have the load capacity to transport the cement and your friend home. In metric units, the calculation would be:  $635 \text{ kilograms} - (2 \times 99 \text{ kilograms}) - (9 \times 45 \text{ kilograms}) = 635 - 198 - 405 = 32$  kilograms.

The above calculations also assume that the loads are positioned in your vehicle in a manner that does not overload the front or the rear gross axle weight rating specified for your vehicle on the Safety Compliance Certification label.



# Pickup Bed

## PICKUP BED PRECAUTIONS

**WARNING:** Do not allow people or animals in truck beds that have modifications, such as bed covers or slide-in campers, when the engine is running. Exhaust fumes are toxic. Failure to follow this instruction could result in personal injury or death.

**WARNING:** It is extremely dangerous to ride in a cargo area, inside or outside of a vehicle. In a crash, people riding in these areas are more likely to be seriously injured or killed. Do not allow people to ride in any area of your vehicle that is not equipped with seats and seatbelts. Make sure everyone in your vehicle is in a seat and properly using a seatbelt. Failure to follow this warning could result in serious personal injury or death.

the maximum payload of your vehicle, do not add more cargo, even if there is space available. Overloading or improperly loading your vehicle can contribute to loss of vehicle control and vehicle rollover.

**WARNING:** Do not use the load retaining fixtures for towing. Failure to follow this instruction could result in personal injury.

**WARNING:** Do not exceed the maximum load rating of the load retaining fixtures. Failure to follow this instruction could result in personal injury.

**WARNING:** Check the load retaining fixtures for damage before using them. Failure to follow this instruction could result in personal injury.

## PICKUP BED ANCHOR POINTS

(IF EQUIPPED)

## PICKUP BED ANCHOR POINT PRECAUTIONS

**WARNING:** Always properly secure cargo to prevent shifting cargo or cargo falling from the vehicle. Failure to do so could result in compromised vehicle stability and serious personal injury to vehicle occupants or others.

**WARNING:** The appropriate loading capacity of your vehicle can be limited either by volume capacity (how much space is available) or by payload capacity (how much weight the vehicle should carry). Once you have reached

## LOCATING THE PICKUP BED ANCHOR POINTS

The pickup bed anchor points are located at each corner of the pickup bed.



# Pickup Bed

## INSTALLING AND REMOVING THE PICKUP BED TIE-DOWN CLEATS

### Installing the Cleats

1. Insert the key into the lock and turn clockwise to unlock.
2. Insert the cleat into the pickup bed anchor point and slide upward.
3. Turn the key counterclockwise to lock.

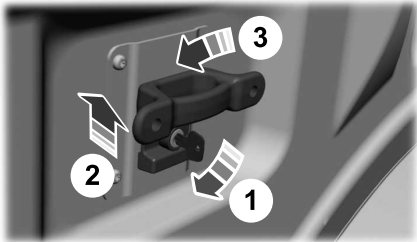
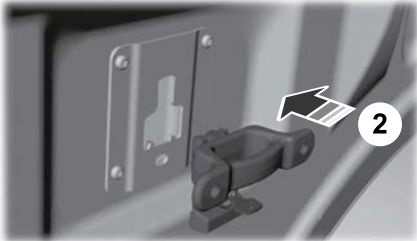

**Note:** Leave the key in the lock when removing or installing the cleats. The key cannot be removed unless it is in the locked position.

### Removing the Cleats

To remove, reverse the installation procedure.

## PICKUP BED ANCHOR POINT LOAD CAPACITIES

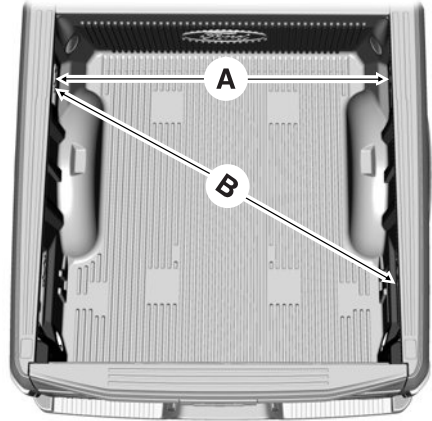

A	B
Maximum force between directly opposed cleats 276 lb (125 kg).	Maximum force between diagonally opposed cleats 600 lb (272 kg).

**Note:** You could damage the pickup bed walls if you overload the tie downs.

**Note:** Make sure that you properly balance and secure the cargo load. Failure to do this can cause cargo instability and damage to the box.

**Note:** Do not secure cargo with tie downs connected from the tie down brackets to the cargo box tie downs. This could cause the tailgate to detach.

# Pickup Bed

## TAILGATE ANCHOR POINTS

### LOCATING THE TAILGATE ANCHOR POINTS

The tailgate anchor points are located at each side of the tailgate.



**Note:** You could damage the tailgate if you overload the tie downs.

### TAILGATE ANCHOR POINT LOAD CAPACITIES

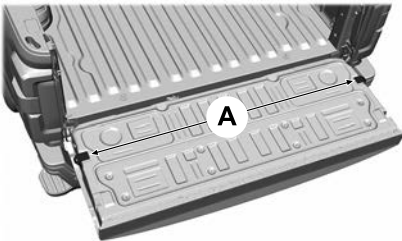

**A**

The maximum force between the tailgate anchor points 400 lb (181 kg).

**Note:** Do not secure cargo from a pickup bed anchor point to a tailgate anchor point. This could cause the tailgate to detach.

## PICKUP BED VIDEOS

[Boxlink Video Link](#)

# Connecting a Trailer

## CONNECTING A TRAILER PRECAUTIONS

Do not tow a trailer until you drive your vehicle at least 1,000 mi (1,600 km).

Consult your local motor vehicle laws for towing a trailer.

See the instructions included with towing accessories for the proper installation and adjustment specifications.

Service your vehicle more frequently if you tow a trailer. See **General Maintenance Information** (page 589).

If you use a rental trailer, follow the instructions the rental agency gives you.

When attaching the trailer wiring connector to your vehicle, only use a proper fitting connector that works with the vehicle and trailer functions.

Account for the trailer coupler weight as part of your vehicle load when calculating the total vehicle weight.

Do not exceed the load limits. See **Calculating the Load Limit** (page 350).

## HITCHES

### INSTALLING A HITCH



**WARNING:** You must use the drawbar pin supplied with your vehicle or a pin that is designed to meet the maximum rating of your hitch. Failure to follow this instruction could cause the trailer to disconnect resulting in the loss of control of your vehicle, personal injury or death.

Do not use a hitch that either clamps onto the bumper or attaches to the axle. Distribute the load in your trailer so that 10-15% for conventional towing or 15-25% for fifth wheel towing of the total weight of the trailer is on the tongue. Do not exceed the tongue load rating indicated on the conventional hitch receiver.

**Note:** *On pickup trucks, the trailer hitch provided on the vehicle enhances crash protection for the fuel system. Do not remove.*

### Hitch Components

The following components are required. Some are provided in certain vehicles.

- A trailer hitch with a 3 inch receiver and a 5/8 inch hitch pin. Check the stamped rating number on the pin to determine the 30,000 lb (13,607 kg) hitch pin capacity.
- A hitch pin sleeve stored in the glove compartment to use when mounting the 3 inch drawbar with the 3/4 inch pinhole.
- A cotter pin to help keep the hitch pin in place.

## Connecting a Trailer

### Installing a 3 Inch Drawbar with 3/4 Inch Pin Hole

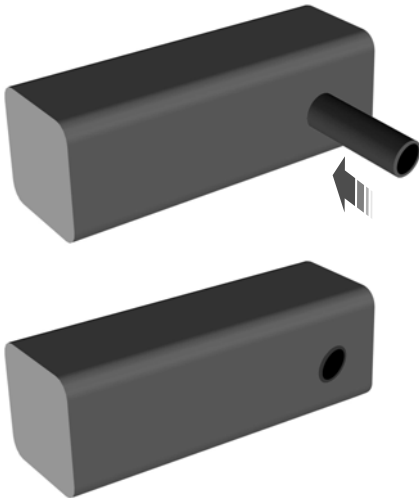

Insert the pin sleeve in the 3/4 inch pinhole of the 3 inch drawbar.

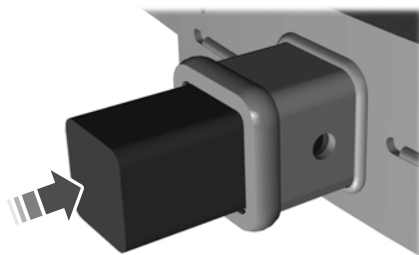

Remove the reducers before inserting the 3 inch drawbar. Insert the drawbar into the hitch receiver.

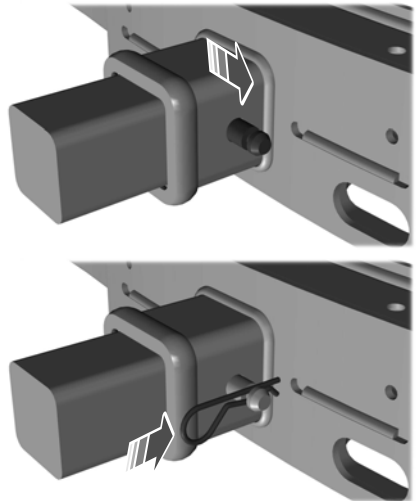

Put the 5/8 inch hitch pin through the pinhole. Place the cotter pin around the neck of the hitch pin.

### HOOKING UP A TRAILER USING A WEIGHT-DISTRIBUTING HITCH

**WARNING:** Do not adjust the spring bars so that your vehicle's rear bumper is higher than before attaching the trailer. Doing so will defeat the function of the weight-distributing hitch, which may cause unpredictable handling, and could result in serious personal injury.

A weight-distributing hitch helps distribute tongue load to all towing vehicle and trailer wheels. For more information, visit the links in the following table.

# Connecting a Trailer

Market	Website
United States of America	<a href="https://www.fleet.ford.com/towing-guides/">https://www.fleet.ford.com/towing-guides/</a>
Canada	<a href="https://www.fleet.ford.ca/towing-guides/">https://www.fleet.ford.ca/towing-guides/</a>

## FIFTH-WHEEL TRAILER HITCH (if Equipped)

Your vehicle has a fifth-wheel prep package. This package enables your vehicle to accept certain fifth-wheel trailer hitches and gooseneck ball hitches. The fifth-wheel trailer hitch attaches to the four mounting pads in the pick-up bed. A 7-pin trailer wiring connector could be in the bed as well. The gooseneck ball hitch is a separate mounting pad from the fifth-wheel hitch in the center of the bed.

Shorter pick-up boxes provide less clearance between the cab and the fifth-wheel and gooseneck trailer compared to longer box pick-ups. When selecting a trailer and tow vehicle, it is critical to check that this combination provides clearance between the front of the trailer and tow vehicle for turns up to 90°. Failure to follow this recommendation could result in the trailer contacting the cab of the tow vehicle during tight turns that are typical during low-speed parking and turning maneuvers. This contact could result in damage to the trailer and tow vehicle.

**Note:** Contact an authorized dealer to purchase gooseneck and fifth-wheel hitches that are compatible with your vehicle.

**Note:** The mounting pads in the bed are specifically designed for certain fifth-wheel trailer hitches and gooseneck ball hitches. Do not use these mounting pads for other purposes.

## CONNECTING A TRAILER

### Recognizing a Trailer

1. Attach the trailer and wiring connector to your vehicle.
2. Switch on your vehicle.
3. Set up a profile for the trailer using the SYNC screen.

**Note:** If your vehicle does not recognize the trailer, press and hold the brake pedal for a few seconds.

**Note:** Trailer profiles store trailer types, dimensions, preferences, trailer specific mileage and fuel economy.

**Note:** Disabling the trailer detection notification makes the default trailer profile active when a connection is detected.

**Note:** Trailer profiles allows you to setup several trailer maintenance reminders and maintenance intervals for multiple trailer components by specifying miles and months in service.

**Note:** Trailer maintenance reminder is designed to be an aid and does not relieve you of your responsibility to follow the trailer manufacturers recommended maintenance intervals. You are responsible for inputting maintenance intervals consistent with the trailer manufacturer.

# Connecting a Trailer



When attaching the trailer wiring connector to your vehicle, only use a proper fitting connector that works with the vehicle and trailer functions.

## Safety Chains

Install trailer safety chains to the trailer hitch as recommended by the manufacturer. Cross the chains under the trailer coupler and allow enough slack for turning tight corners. Do not allow the chains to drag on the ground.

**Note:** Do not attach safety chains to the bumper. Always connect the safety chains to the frame or hook retainers of your trailer hitch.

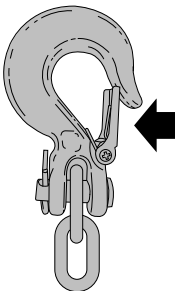

If the trailer safety chain hook has a latch, make sure to fully close the latch.

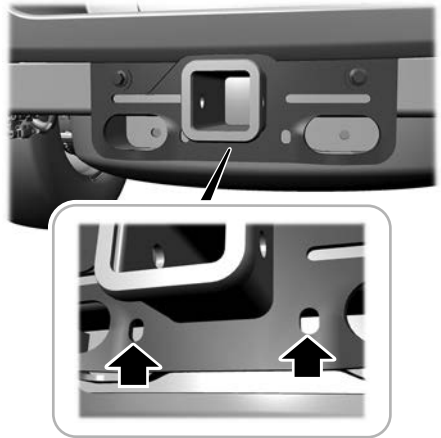

Use the smaller holes in the safety chain bracket for trailer breakaway cables and small 3/8" s-hooks.

## TRAILER BATTERY CHARGE/ TRAILER POWER FEED

This feature allows the trailer's battery to charge under the following situations:

- Your vehicle is in the accessory or engine run position
- If the vehicle's battery voltage is in optimum condition, above 12.5 volts, and the trailer's battery can still hold a charge, or is not too old.

The trailer power feed feature allows for a 12 volt power output on a 7-pin connector when the system detects a trailer.

**Note:** Trailer power feed can provide a maximum output rate of 15 amps.

**Note:** Never place more demand than 15 amps of power on the trailer power feed, this may damage the trailer lighting.

# Connecting a Trailer

## TRAILER LIGHTING CHECK



**WARNING:** Never connect any trailer lamp wiring to the vehicle's tail lamp wiring; this may damage the electrical system resulting in fire. Contact your authorized dealer as soon as possible for assistance in proper trailer tow wiring installation. Additional electrical equipment may be required.

Trailer light check feature allows one person to confirm that all taillights are functioning.

Perform a trailer light illumination sequence to confirm that all lights are functioning using the SYNC screen in the vehicle or the FordPass app.

### Performing the Trailer Light Check using the SYNC screen in vehicle

1. Press **Features** on the touchscreen.
2. Press **Towing**.

3. Press **Trailer Light Check**.
4. Press **Start**.
5. Follow the instructions until the lights sequence completes.

### Performing the Trailer Light Check using the FordPass app

1. Create or sign-in to the FordPass app and add the vehicle identification number to your account.
2. Once you add the vehicle identification number, follow the prompts in the FordPass app to complete the Sync Connect Authorization process.
3. After the authorization is complete, navigate to Vehicle Details screen and select Trailer Light Check.
4. Press **Start**.
5. Follow the instructions until the lights sequence completes.

**Note:** *Trailer light check feature is available only in vehicles with trailer capability and trailer must be electrically connected for feature to function.*



# Connecting a Trailer

## CONNECTING A TRAILER – TROUBLESHOOTING

### CONNECTING A TRAILER – INFORMATION MESSAGES

<b>Message</b>	<b>Description</b>
Trailer Disconnected	The system senses a trailer connection becomes disconnected, either intentionally or unintentionally, during a given ignition cycle.
Trailer Wiring Fault	There are certain faults in your vehicle wiring and trailer wiring or brake system.
Trailer Lighting Module Fault See Manual	The system detects a short induced by the trailer wiring. Inspect and repair the trailer wiring or see your authorized dealer.
Trailer Battery Not Charging See Manual	The vehicle's battery voltage is low or there is a fault with your trailer's battery. Your trailer's battery voltage is below 8 volts or it is connected in reverse polarity.
Trailer Tire Low Specified:	One or more tires on your trailer is below the specified tire pressure.
Trailer Tire Over Temperature	Displays when one or more tires on the trailer is above the recommended temperature.
Trailer Tire Pressure Sensor Fault	A trailer tire pressure sensor is malfunctioning. If the warning stays on or continues to come on, have the system checked as soon as possible.
Trailer Tire Pressure Monitor Fault	The trailer tire pressure monitoring system is malfunctioning. If the warning stays on or continues to come on, have the system checked.
Trailer Tire Pressure Monitor Capability Not Detected	The system cannot detect the trailer tire pressure monitoring system.
Trailer Tire Pressure Indication Not Setup See Manual	The trailer tire pressure monitoring system is not set up.

# Towing a Trailer

## TOWING A TRAILER PRECAUTIONS

 **WARNING:** Do not exceed the GVWR or the GAWR specified on the certification label.

 **WARNING:** Towing trailers beyond the maximum recommended gross trailer weight exceeds the limit of your vehicle and could result in engine damage, transmission damage, structural damage, loss of vehicle control, vehicle rollover and personal injury.

 **WARNING:** Do not exceed the lowest rating capacity for your vehicle or trailer hitch. Overloading your vehicle or trailer hitch can impair your vehicle stability and handling. Failure to follow this instruction could result in the loss of control of your vehicle, personal injury or death.

 **WARNING:** Make sure that the vertical load on the tow ball is between the minimum and maximum recommended weight at all times. Failure to follow this instruction could result in the loss of control of your vehicle, personal injury or death.

 **WARNING:** Do not cut, drill, weld or modify the trailer hitch. Modifying the trailer hitch could reduce the hitch rating.

 **WARNING:** The anti-lock brake system does not control the trailer brakes.

Towing a trailer also depends on additional systems present in your vehicle. See **Lane Centering Precautions** (page 301).

## TRAILER BRAKE PRECAUTIONS

 **WARNING:** Do not connect a trailer's hydraulic brake system directly to your vehicle's brake system. Your vehicle may not have enough braking power and your chances of having a collision greatly increase.

 **WARNING:** Do not tow a trailer fitted with electric trailer brakes unless your vehicle is fitted with a compatible aftermarket electronic trailer brake controller. Failure to follow this instruction could result in the loss of control of your vehicle, personal injury or death. For additional information and assistance, we recommend that you contact an authorized dealer.

Electric brakes and manual, automatic or surge-type trailer brakes are safe if you install them properly and adjust them to the manufacturer's specifications. The trailer brakes must meet local and federal regulations.

# Towing a Trailer

---

The rating for the tow vehicle's braking system operation is at the gross vehicle weight rating, not the gross combined weight rating.

Certain states require functioning trailer brakes for trailers over a specified weight. Be sure to check state regulations for this specified weight.

Ford Motor Company recommends separate functioning brake systems for trailers weighing more than 1,500 lb (680 kg) when loaded.

## TOWING A TRAILER LIMITATIONS

The vehicle's load capacity designation is by weight, not by volume, so you cannot necessarily use all available space when loading a vehicle or trailer.

Towing a trailer also depends on additional systems present in your vehicle. See **Lane Centering Limitations** (page 302).

**Note:** *Your vehicle could have reduced performance when operating at high altitudes and when heavily loaded or towing a trailer. When driving at elevation, to match driving performance as perceived at sea level, reduce gross vehicle weight and gross combination weight by 2% per 1,000 ft (300 m) elevation.*

## LOADING YOUR TRAILER

To help minimize how trailer movement affects your vehicle when driving:

- Load the heaviest items closest to the trailer floor.
- Load the heaviest items centered between the left-hand and right-hand side trailer tires.
- Load the heaviest items above the trailer axles or just slightly forward toward the trailer tongue. Do not allow the final trailer tongue weight to go above or below 10-15% of the loaded trailer weight. The trailer tongue weight should never exceed 10% of the maximum towing capacity when towing a conventional trailer, and should never exceed 15% of the maximum towing capacity when towing a fifth-wheel or gooseneck trailer.
- Select a ball mount with the correct rise or drop. When you connect both the loaded vehicle and trailer, the trailer frame should be level, or slightly angled down toward your vehicle, when viewed from the side.

# Towing a Trailer

## TRAILER TOWING HINTS

Towing a trailer places an extra load on your vehicle's engine, transmission, axle, brakes, tires and suspension. Periodically inspect these components during and after any towing operation.

When driving with a trailer or payload, a slight takeoff vibration or shudder may be present due to the increased payload weight.

Your vehicle may have a temporary or conventional spare tire. A temporary spare tire is different in diameter or width, tread-type, or is from a different manufacturer than the road tires on your vehicle. Consult information on the tire label or Safety Compliance label for limitations when using.

When towing a trailer:

- Obey country specific regulations for towing a trailer.
- Do not tow during the first 1,000 mi (1,609 km), the driveline requires a break-in during that time. See **Breaking-In** (page 414).
- Do not make full-throttle starts.
- Check your hitch, electrical connections and trailer wheel lug nuts thoroughly after you have traveled 50 mi (80 km).
- When stopped in congested or heavy traffic during hot weather, place the transmission in park (P) to aid engine and transmission cooling and to help A/C performance.
- Turn off the speed control with heavy loads or in hilly terrain. The speed control may turn off when you are towing on long, steep slopes.
- Shift to a lower gear when driving down a long or steep hill. Do not continuously apply the brakes, as they may overheat and become less effective.

- If your transmission has Grade Assist or Tow/Haul, use this feature when towing. This provides engine braking and helps eliminate excessive transmission shifting for optimum fuel economy and transmission cooling.
- If your vehicle has AdvanceTrac with roll stability control, this system may turn on during typical cornering maneuvers with a heavily loaded trailer. This is normal. Turning the corner at a slower speed when towing may reduce this tendency.
- Allow more distance for stopping with a trailer attached. Anticipate stops and gradually brake.
- Avoid parking on a slope. However, if you must park on a slope, turn the steering wheel to point your vehicle tires away from traffic flow, set the parking brake, place the transmission in park (P) and place wheel chocks in front and back of the trailer wheels.

**Note:** Chocks are not included with your vehicle.

## LAUNCHING OR RETRIEVING A BOAT OR PERSONAL WATERCRAFT

When backing down a ramp during boat launching or retrieval:

- Do not allow the static water level to rise above the bottom edge of the rear bumper.
- Do not allow waves to break higher than 6 in (15 cm) above the bottom edge of the rear bumper.

Exceeding 6 in (15 cm) could allow water to enter vehicle components, causing internal damage to the components and affecting driveability, emissions and reliability.

# Towing a Trailer

---

**Note:** Replace the rear axle lubricant anytime the rear axle has been submerged in water.

**Note:** Disconnect the trailer wiring connector before backing the trailer into the water.

**Note:** Reconnect the trailer wiring connector after removing the trailer from the water.

## TOWING WEIGHTS AND DIMENSIONS

### RECOMMENDED TOWING WEIGHTS

Market	Website
United States of America	<a href="https://www.fleet.ford.com/towing-guides/">https://www.fleet.ford.com/towing-guides/</a>
Canada	<a href="https://www.fleet.ford.ca/towing-guides/">https://www.fleet.ford.ca/towing-guides/</a>

# Towing a Trailer

---

## WHAT IS THE MAXIMUM LOADED TRAILER WEIGHT

The maximum loaded trailer weight is the highest possible weight of a fully loaded trailer the vehicle can tow.

## CALCULATING THE MAXIMUM LOADED TRAILER WEIGHT FOR YOUR VEHICLE

1. Start with the gross combined weight rating for your vehicle model and axle ratio.
2. Subtract all of the following that apply to your vehicle:
  - Vehicle curb weight.
  - Hitch hardware weight, for example a draw bar, ball, locks or weight distributing hardware.

- Driver weight.
- Passenger weight.
- Payload, cargo and luggage weight.
- Aftermarket equipment weight.

This equals the maximum loaded trailer weight for this combination.

**Note:** *The trailer tongue load is considered part of the payload for your vehicle. Reduce the total payload by the final trailer tongue weight.*

**Note:** *Consult an authorized dealer to determine the maximum trailer weight allowed for your vehicle if you are not sure.*

# Towing a Trailer

## TOWING A TRAILER – TROUBLESHOOTING

### TOWING A TRAILER – INFORMATION MESSAGES

<b>Message</b>	<b>Details</b>
Trailer Left Turn Lamps Fault Check Lamps	The left-hand trailer turn lamp requires service.
Trailer Right Turn Lamps Fault Check Lamps	The right-hand trailer turn lamp requires service.
Trailer Battery Not Charging See Manual	The vehicle's battery voltage is low or there is a fault with your trailer's battery. Your trailer's battery voltage is below 8 volts or it is connected in reverse polarity.
Trailer Lighting Module Fault See Manual	The system detects a short created by the trailer lamps. Inspect and repair the trailer wiring, or have the system checked as soon as possible.
Trailer Stop Lamps Fault Check Lamps	The trailer stoplamps require service.
Trailer Sway Reduce Speed	The trailer sway control detects trailer sway. Reduce the vehicle's speed.
Trailer Tire Over Temperature	Displays when one or more tires on the trailer is above the recommended temperature.
Trailer Tire Low Specified:	One or more tires on your trailer is below the specified tire pressure.
Trailer Tire Pressure Sensor Fault	A trailer tire pressure sensor requires service. If the warning stays on or continues to come on, have the system checked as soon as possible.
Trailer Tire Pressure Monitor Fault	The trailer tire pressure monitoring system requires service. If the warning stays on or continues to come on, have the system checked as soon as possible.
Trailer Tire Pressure Monitor Capability Not Detected	The system cannot detect the trailer tire pressure monitoring system.
Trailer Tire Pressure Indication Not Setup See Manual	The trailer tire pressure monitoring system is not setup.

# Towing a Trailer

Message	Details
Trailer Brake Module Fault	Perform a trailer brake and trailer light check if possible. If the message persists, have your vehicle checked as soon as possible.
Trailer brake system fault See manual	Verify the trailer brake connections are secure and that the aftermarket trailer brake controller device is correctly installed. Perform a trailer brake and trailer light check if possible. If the message persists, have your vehicle checked as soon as possible.

## TOWING A TRAILER VIDEOS

[Towing Overview Video Link](#)



# Integrated Trailer Brake Controller

## WHAT IS THE INTEGRATED TRAILER BRAKE CONTROLLER

The trailer brake controller assists in smooth and effective trailer braking based on the towing vehicle's brake pressure.

## INTEGRATED TRAILER BRAKE CONTROLLER PRECAUTIONS



**WARNING:** Use the integrated trailer brake controller to properly adjust the trailer brakes and check all connections before towing a trailer. Failure to follow this instruction could result in the loss of control of your vehicle, personal injury or death.

- Only use the manual control lever for proper adjustment of the gain during trailer setup. Misuse, such as application during trailer sway, could cause instability of trailer or tow vehicle.
- Avoid towing in adverse weather conditions. The trailer brake controller does not provide anti-lock control of the trailer wheels. Trailer wheels can lock up on slippery surfaces, resulting in reduced stability of trailer and tow vehicle.
- The trailer brake controller is only a factory-installed or dealer-installed item. Ford is not responsible for warranty or performance of the controller due to misuse or customer installation.

**Note:** Do not attempt removal of the trailer brake controller without consulting the *Workshop Manual*. Damage to the unit may result.

**Note:** Make sure to set the integrated trailer brake controller gain to 0 if you are using an aftermarket trailer brake controller.

## USING THE INTEGRATED TRAILER BRAKE CONTROLLER

1. Make sure the trailer brakes are in good working condition, functioning normally and properly adjusted. See your trailer dealer if necessary.

**Note:** An authorized dealer can diagnose the trailer brake controller to determine exactly which trailer fault has occurred. Your vehicle warranty does not cover issues with your trailer.

2. Hook up the trailer and make the electrical connections according to the trailer manufacturer's instructions.

**Note:** Select default mode if the trailer has surge brakes, or no brakes at all. The system has no effect on the braking performance of the trailer in either of these cases.

**Note:** If a trailer is connected by a four-pin connector, the trailer braking function will not be supported.

3. When you plug in a trailer with electric or electric-over-hydraulic brakes, a message confirming connection appears in the information display.
4. Use the gain adjustment to find the desired starting point. A gain setting of 6.0 is a good starting point for heavier loads.

**Note:** Use the following steps to adjust the gain setting whenever road, weather and trailer, or vehicle loading conditions, change from when you initially set the gain.

5. In a traffic-free environment, tow the trailer on a dry, level surface and squeeze the manual control lever completely.

# Integrated Trailer Brake Controller

6. If the trailer wheels lock up, indicated by squealing tires, reduce the gain setting. If the trailer wheels turn freely, increase the gain setting. Repeat Steps 5 and 6 until the gain setting is at a point just below trailer wheel lock-up. If towing a heavier trailer, trailer wheel lock-up may not be attainable even with the maximum gain setting of 10.

**Note:** Only perform this procedure at speeds of approximately 20–25 mph (30–40 km/h).

**Note:** The trailer brake controller reduces output at vehicle speeds below 11 mph (18 km/h) so that trailer and vehicle braking is not jerky or harsh. This feature is only available when applying the brakes using your vehicle's brake pedal, not the controller.

**Note:** Your vehicle's brake system and the trailer brake system work independently of each other. Changing the gain setting on the controller does not affect the operation of your vehicle's brakes whether you attach a trailer or not.

**Note:** With the proper electrical connection, pressing your vehicle brake pedal or using the manual control lever illuminates both trailer and vehicle brake lamps.

**Note:** When you switch the engine off, the controller output is disabled and the display and module shut down. The controller module and display turn on when you switch the ignition on.

**Note:** Trailer braking is suspended during stop/start events to minimize battery draw.

## Adjusting the Trailer Brake Gain

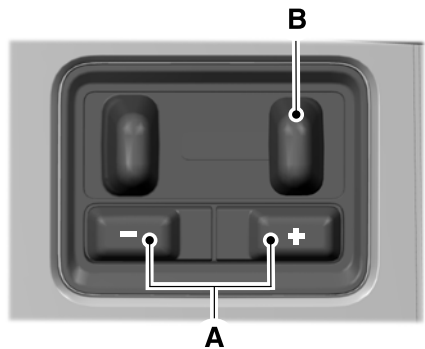

- A Use the gain adjustment (+) and (-) buttons to increase or decrease the gain setting to the desired starting point. The trailer brake controller allows adjustment of brake gain from 0% to 100% in 5% increments.
- B Trailer braking is directly applied by the driver through this manual slider.

**Note:** Adjust gain setting before using the trailer brake controller for the first time.

**Note:** The gain should be set to provide the maximum trailer braking assistance while making sure the trailer wheels do not lock when using the brakes. Locked trailer wheels may lead to trailer instability.

**Note:** Setting adjustments are saved when a trailer profile is selected.

**Note:** If you have installed an aftermarket trailer brake controller in addition to the integrated trailer brake controller, set the gain on the integrated trailer brake controller to zero.

# Integrated Trailer Brake Controller

---

## ADJUSTING THE INTEGRATED TRAILER BRAKE CONTROLLER MODE

Select the correct integrated trailer brake controller mode option using the touchscreen.

**Note:** Trailer brake gain settings are saved to the active trailer profile.

### Selecting the Trailer Brake Type

1. Press **Default** for trailers with electromagnetic drum brake systems or press **Electric over Hydraulic** for trailers with electrically actuated hydraulic brake systems.

2. Press **Save**.

### Selecting the Trailer Brake Effort

1. Select a setting for your trailer.

**Note:** The default value is **Low** and is the recommended setting for most trailers. Select a different setting if your trailer's brakes require more initial voltage, or you prefer more aggressive trailer braking.

2. Press **Save**.

# Integrated Trailer Brake Controller

## INTEGRATED TRAILER BRAKE CONTROLLER – TROUBLESHOOTING

### INTEGRATED TRAILER BRAKE CONTROLLER – INFORMATION MESSAGES

Message	Details
Trailer Connected	The system detects a correct trailer connection during a given ignition cycle.
Trailer Disconnected	The system detects the trailer wiring connection is disconnected during a given ignition cycle.
Trailer Wiring Fault	The system detects an electrical fault in the trailer brake circuit. If this message appears without a trailer attached, see your authorized dealer. If a trailer is attached, inspect and repair the trailer wiring.
Trailer Brake Gain: {trailer gain value:#0.0}	Displays the current gain setting for the trailer brake.
Trailer Brake Gain: {trailer gain value:#0.0} No Trailer	Displays the current gain setting for the trailer brake when you do not have a trailer connected.
Trailer Battery Not Charging See Manual	The vehicle's battery voltage is low or there is a fault with your trailer's battery. Your trailer's battery voltage is below 8 volts or it is connected in reverse polarity.
Trailer Brake Module Fault	Perform a trailer brake and trailer light check if possible. If the message persists, have your vehicle checked as soon as possible.
Trailer brake system fault See manual	Verify the trailer brake connections are secure and that the aftermarket trailer brake controller device is correctly installed. Perform a trailer brake and trailer light check if possible. If the message persists, have your vehicle checked as soon as possible.

# Integrated Trailer Brake Controller

---

## **INTEGRATED TRAILER BRAKE CONTROLLER – FREQUENTLY ASKED QUESTIONS**

### **How do I determine if there is an issue with the wiring on my vehicle?**

- A message displays accompanied by a single tone, when no trailer is connected. This indicates that the issue is between the trailer brake controller and the 7-pin connector at the bumper.

### **How do I determine if there is an issue with the wiring on my trailer?**

- A message only displays with a trailer connected. Consult your trailer dealer for assistance.

# Trailer Sway Control

---

## HOW DOES TRAILER SWAY CONTROL WORK

The system applies the brakes to the individual wheels and reduces engine torque to aid vehicle stability.

If the trailer begins to sway, the stability control lamp flashes and the message **Trailer Sway Reduce Speed** appears in the information display.

Stop your vehicle as soon as it is safe to do so. Check the vertical weight on the tow ball and trailer load distribution.

2. Press **Towing**.
3. Switch **Trailer Sway Control** on or off.

The system turns on each time you start your vehicle.

## TRAILER SWAY CONTROL VIDEOS

[Trailer Sway Control Video Link](#)

## TRAILER SWAY CONTROL PRECAUTIONS



**WARNING:** Turning off trailer sway control increases the risk of loss of vehicle control, serious injury or death. Ford does not recommend disabling this feature except in situations where speed reduction may be detrimental (such as hill climbing), the driver has significant trailer towing experience, and can control trailer sway and maintain safe operation.

**Note:** *This feature only activates when significant trailer sway occurs.*

**Note:** *This feature does not prevent trailer sway, but reduces it once it begins.*

**Note:** *This feature cannot stop all trailers from swaying.*

**Note:** *In some cases, if vehicle speed is too high, the system may activate multiple times, gradually reducing vehicle speed.*

## SWITCHING TRAILER SWAY CONTROL ON AND OFF

1. Press **Features** on the touchscreen.

# Trailer Hitching Assistance (If Equipped)

## WHAT IS TRAILER HITCHING ASSISTANCE

Trailer hitching assistance helps the driver align the vehicle hitch ball to a trailer coupler.

## HOW DOES TRAILER HITCHING ASSISTANCE WORK

Trailer hitching assistance uses the following to detect your trailer:

- Rear view camera.
- Radar.
- Parking aid sensors.
- External rear lighting.

This feature also controls the following to align the hitch ball with the trailer coupler:

- Steering.
- Braking and acceleration.

**Note:** Blocked sensors could affect system performance. Do not cover the sensors with bumper stickers, tape, repair compound or other objects.

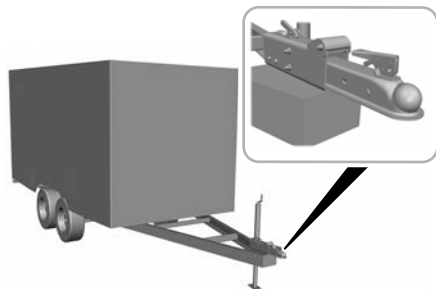

## TRAILER HITCHING ASSISTANCE PRECAUTIONS

**WARNING:** You are responsible for controlling your vehicle at all times. The system is designed to be an aid and does not relieve you of your responsibility to drive with due care and attention. Failure to follow this instruction could result in the loss of control of your vehicle, personal injury or death.

**WARNING:** The system is not designed to detect cyclists, motorcyclists, pedestrians or animals. Apply the brakes when necessary. Failure to follow this instruction could result in personal injury or death.

**WARNING:** The system may not operate properly during severe weather conditions, for example snow, ice, heavy rain and spray. Always drive with due care and attention. Failure to take care may result in a crash.

**Note:** Fifth wheel and gooseneck trailers are not supported.

**Note:** Trailer hitching assistance only works with conventional trailers, couplers and hitch balls.

**Note:** The hitch ball must be properly installed on the vehicle for the system to function as intended. An improperly installed hitch ball could result in damage to your vehicle or trailer.

**Note:** Certain aftermarket modifications such as oversized tires or lift kits could make trailer hitching assistance fail or not work as intended.

**Note:** Keep the sensors and camera free from snow, ice and dirt.

**Note:** Clean the camera lens with a soft, lint-free cloth and non-abrasive cleaner.

## Trailer Hitching Assistance (If Equipped)

### TRAILER HITCHING ASSISTANCE LIMITATIONS

The system could not function, or could function with reduced performance, during the following:

- When using trailer hitching assistance in tall grass and weeds.
- When safety chains, cables or wiring are dangling near the coupler.
- When using trailer hitching assistance on slippery surfaces.
- When using hitches that raise the hitch ball more than 4 in (10 cm), lower the hitch ball by more than 6 in (16 cm) or extend the hitch ball away from the vehicle more than 12 in (30 cm).
- When using hitches that are lower than 10 in (25 cm) off the ground.
- When using objects taller than 8 in (20 cm), such as large blocks under the jack stand.
- When you park the trailer on surfaces that are similar in color to the trailer coupler and hitch ball.
  - A black coupler or hitch ball over a dark asphalt surface.
  - A light color coupler or hitch ball over a light concrete surface.
- When there are low or no light sources, such as at night.
- The feature may not align accurately during cold weather. If this occurs, allowing the engine to reach normal operating temperature may improve performance.

For additional information, refer to the Ford Support website.

### SWITCHING TRAILER HITCHING ASSISTANCE ON AND OFF

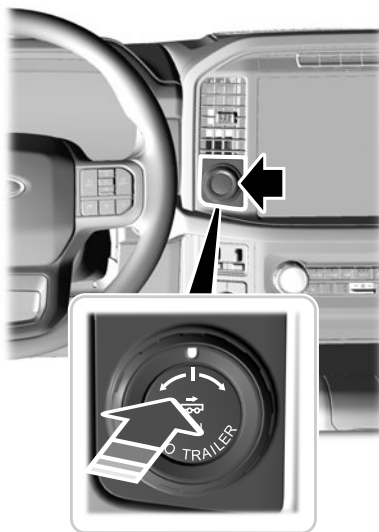

Press the button to switch the system on and off. You can also switch the system off through the touchscreen.

### USING TRAILER HITCHING ASSISTANCE

Before switching on the system, make sure that your vehicle:

- Is within 20 ft (6 m) of the trailer and no closer than 7 ft (2 m).
- Is less than a 15° approach angle to the trailer.
- Is within 3 ft (1 m) of the front of the trailer facing the same direction.



# Trailer Hitching Assistance (If Equipped)

- Is clear of obstacles or other vehicles within 6 ft (1.8 m) on either side of your vehicle or the trailer.
- Has the tailgate in the closed position.
- Has radar, sensor, and camera free from snow, ice and dirt.
- Has park aid sensors turned on in Sync settings.

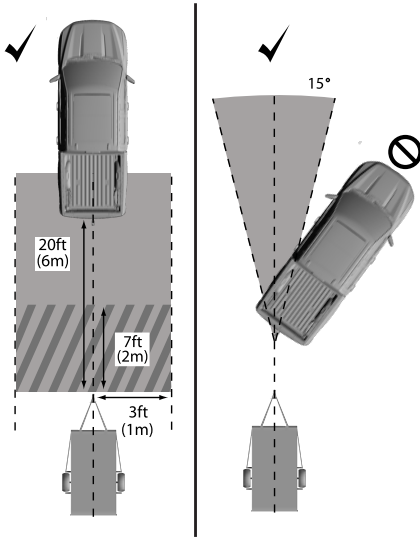

1. Press the Pro Trailer button.

**Note:** Press the Pro Trailer button to switch the system on and off.



2. Select No to Is a trailer connected on the touchscreen to activate the system.
3. Follow the instructions on the touchscreen.

**Note:** Pressing the Pro Trailer button other than when prompted turns off the system.

## TRAILER HITCHING ASSISTANCE INDICATORS



The white indicator represents the system searching for the trailer. Continue moving the vehicle until the trailer coupler is inside this indicator. The indicator turns green once the trailer coupler is in the correct position.



The bracket shows you the estimated location of your trailer.

## Trailer Hitching Assistance (If Equipped)

---



The yellow indicator represents that you have positioned your vehicle too close to the trailer and you need to pull away from the trailer until the indicator turns green.

### **Trailer Hitching Assistance Audible Indicators**

The system chimes as part of normal operation to alert the driver that an action needs to be taken or an event has been completed.

# Smart Hitch (If Equipped)

## WHAT IS SMART HITCH

Smart hitch shows how balanced the weight is from the trailer onto the vehicle's hitch and front axle.

## HOW DOES SMART HITCH WORK

Smart hitch uses sensors mounted to the suspension to calculate the tongue weight of the connected trailer.

## SMART HITCH LIMITATIONS

You cannot use the system if any of the following occur:

- The wheels are not pointed straight ahead.
- Your vehicle is not in park (P) or your vehicle speed is over 5 mph (8 km/h).
- Your vehicle is not on a level surface.
- The tire pressures are below the recommended levels.
- Your vehicle is off.

## USING SMART HITCH

1. Press **Features** on the touchscreen.
2. Press **Smart Hitch**.

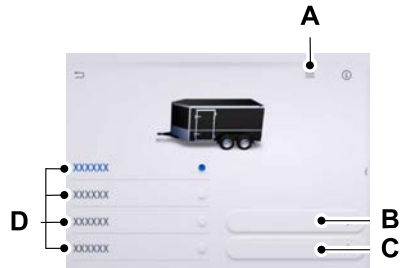

- A Settings menu.
- B Quick setup.
- C Connection checklist.
- D Hitch type selection.

## Smart Hitch Settings

Press the settings menu to adjust the smart hitch settings.

### Measurement Units

Press to change measurement units between pounds and kilograms.

### Quick Setup

Press to skip the trailer setup guide and adjust the load in the trailer to a balanced range.

### Connection Checklist

Press to go through the trailer setup guide and adjust the load in the trailer to a balanced range.

### Reset Hitch Weight

Press to reset the weight on the hitch to zero.

## Smart Hitch (If Equipped)

---

### **Loaded Trailer Weight**

Press to set the total weight of the loaded trailer.

**Note:** *Make sure you include both the trailer weight and the trailer cargo in your calculation for total weight of the loaded trailer.*

### **Tail Lamps**

Press to see the hitch load balance on the vehicle's tail lamps.

### **Hitch Type Selection**

Press to select the hitch type.

**Note:** *The vehicle's tongue weight is not available until you attach a trailer.*

# Onboard Scales (If Equipped)

## WHAT IS ONBOARD SCALES

Onboard scales provides the estimated payload of your vehicle and warns when your vehicle is overloaded.

## HOW DOES ONBOARD SCALES WORK

Onboard scales uses sensors mounted to the suspension to calculate the vehicle's payload.

## ONBOARD SCALES LIMITATIONS

You cannot use the system if any of the following occur:

- The wheels are not pointed straight ahead.
- Your vehicle is not in park (P).
- Your vehicle is not on a level surface.
- The tire pressures are below the recommended levels.
- Your vehicle is off.

## USING ONBOARD SCALES

1. Press **Features** on the touchscreen.
2. Press **Onboard Scales**.

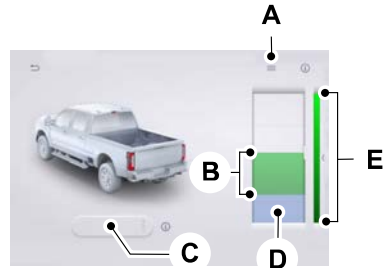

- A. Settings menu.
- B. Estimated payload.
- C. Tail lamps on and off.
- D. Passenger and Cargo Load Reminder.
- E. Vehicle capacity range.

## Tail Lamps

Press to see the estimated payload on the vehicle's tail lamps.

## Onboard Scales Settings

### Vehicle Mode

Press to see the current estimated payload.

### Scale Mode

Press to see a representation of the weight added to the vehicle's current payload and to reset the scale to zero.

### Passenger and Cargo Load Reminder

Press to switch the load reminder on or off.

### Set Passenger and Cargo Load Reminder

Press to set a value of weight to be considered in the vehicle that is not present while the vehicle is being loaded.

## Onboard Scales (If Equipped)

---

Example of application: Passenger(s) weight.

The default and minimum value is 150 lb (75 kg).

The maximum value is 1,550 lb (700 kg).

Press **Set Current Load as Estimate** to store the immediate payload reading as a Passenger and Cargo Load Reminder.

### ***Measurement Units***

Press to change measurement units between pounds and kilograms.

# Trailer Backup Assistance (If Equipped)

## WHAT IS TRAILER BACKUP ASSISTANCE

Trailer backup assistance utilizes the control knob on the instrument panel to help you steer a trailer. Turn the control knob in the direction you want the trailer to go and the system steers the vehicle.

## HOW DOES TRAILER BACKUP ASSISTANCE WORK

Trailer backup assistance uses a sticker or sensor attached to the trailer to detect the trailer angle relative to the towing vehicle and provides instructions, graphics and camera views on the touchscreen.

## TRAILER BACKUP ASSISTANCE PRECAUTIONS



**WARNING:** Driving while distracted can result in loss of vehicle control, crash and injury. We strongly recommend that you use extreme caution when using any device that may take your focus off the road. Your primary responsibility is the safe operation of your vehicle. We recommend against the use of any hand-held device while driving and encourage the use of voice-operated systems when possible. Make sure you are aware of all applicable local laws that may affect the use of electronic devices while driving.



**WARNING:** This system is an extra driving aid. It does not replace your attention and judgment, or the need to apply the brakes. This system does NOT automatically brake your vehicle. If you fail to press the brake pedal when necessary, you may collide with another vehicle.

**Note:** *The system is not a substitute for safe driving practices. Always be aware of your vehicle and trailer combination, and the surrounding environment.*

**Note:** *The system does not detect or prevent your vehicle or trailer from making contact with obstacles in the surrounding environment.*

**Note:** *The front end of your vehicle swings out when changing the direction of the trailer.*

**Note:** *In certain conditions, the trailer could turn faster or the trailer angle could increase more than anticipated. Always monitor the clearance between the trailer and vehicle and the surroundings.*

## SETTING UP THE TRAILER BACKUP ASSISTANCE FOR A CONVENTIONAL TRAILER

### CONFIGURING THE TRAILER

You must configure a trailer in the system to use trailer backup assistance. This is a one-time setup process and the trailer information is saved in the system for the next time you use that trailer.

The following illustration shows examples of conventional trailers.

# Trailer Backup Assistance (If Equipped)

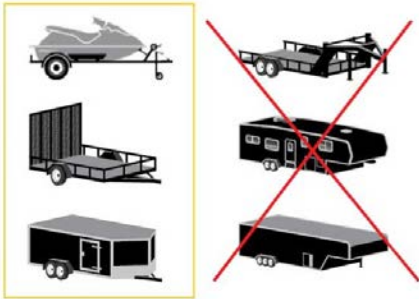

Make sure that the trailer and your vehicle are in line with each other. You can do this by putting the transmission in drive (D) and pulling straight forward.

## Configuring the Trailer in the Touchscreen



## Positioning the Trailer

Hitch the trailer to your vehicle and connect the electrical wiring harness. Check to make sure that the wiring is working. See **Connecting a Trailer** (page 356).



Park your vehicle and hitched trailer on a level surface.

For best results, make sure that your trailer rides level with the ground when you hitch your vehicle. See **Connecting a Trailer** (page 356).



1. Press the button to switch the system on.
2. Press **Add Trailer** on the touchscreen.
3. Follow the directions on the touchscreen to enter the trailer name and trailer type, then proceed to the sticker or sensor setup.

**Note:** If you configure the trailer and install a sensor, the trailer is saved with that sensor information. If you want to use this trailer with the sticker, you need to delete the trailer from the system and repeat the setup process.



## Trailer Backup Assistance (If Equipped)

**Note:** Your vehicle has two options for the trailer reversing aid setup. If your vehicle came with a trailer sensor kit or if a message displays to install a sensor, follow the sensor installation instructions. See **Trailer Sensor Installation** (page 385). If your vehicle did not come with a trailer sensor kit, follow the sticker installation instructions. See **Applying the Trailer Reversing Aid Sticker** (page 385).

### APPLYING THE TRAILER REVERSING AID STICKER

Place the sticker in an area visible by the rear view camera. The entire sticker must be within 4–19 in (10–48 cm) from the center of the hitch ball, as shown in the following illustration.

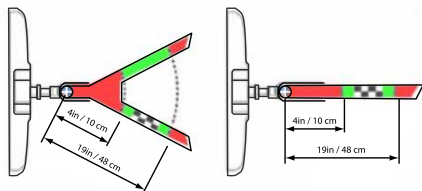

Use the supplied sticker placement card, a tape measure and pen to carefully mark the area to attach the sticker. The sticker is in the back cover pocket of your quick start guide. Make sure the entire sticker is within the green zone between the two arcs or distance markers on the diagram, and is also visible in the rear view camera display.

Once you have found the correct location, place the sticker.

**Note:** Make sure nothing can obstruct the rear view camera's view of the sticker such as a jack handle or wiring.

**Note:** Position the sticker on a flat, dry and clean horizontal surface. For best results, apply the sticker when temperatures are above 32°F (0°C).

**Note:** Do not move stickers after placing them. Do not re-use any stickers if removed.

**Note:** You can purchase additional stickers through your authorized dealer.

**Note:** If you previously setup the trailer with the trailer sensor, make sure it is not plugged in before configuring the trailer and placing the sticker.

### TRAILER SENSOR INSTALLATION



Refer to the instructions included with your trailer sensor for detailed information regarding installation.

## Trailer Backup Assistance (If Equipped)

**Note:** Make sure the arrows on the sensor housing are facing up. Mount the sensor to a vertical part of the trailer that pivots when you turn your vehicle. Do not mount to a stationary surface such as the truck side of the trailer hitch.

### CALIBRATING THE SYSTEM

Calibrating the system requires driving forward and turning left or right. Follow the instructions on the touchscreen to complete the calibration process.

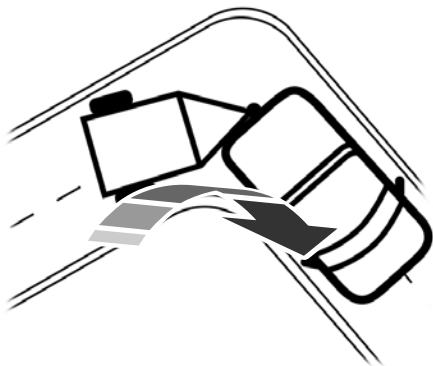

**Note:** To calibrate the system, you need an area where you can safely drive forward and turn left or right. An open parking lot is an ideal place to perform the calibration.

**Note:** Keep the steering wheel straight when instructed to by the touchscreen. If the steering wheel is in a turned position during this instruction, the calibration pauses.

**Note:** During calibration, the system determines the trailer length. The system supports trailer lengths of 6–33 ft (1.85–10.05 m) distance from the hitch point to the center of the axle or axles. The system is designed to work with drawbars that have a license plate to hitch ball center measurement of 9–18 in (23–46 cm) when installed. Do not attempt to use drawbars or trailers that have a length outside of this range as the system performance degrades and could cause improper system function.

**Note:** The touchscreen shows if you are going too slow or fast. Calibration pauses if the speed is outside the required range of 2–9 mph (4–15 km/h).

**Note:** You need to complete at least a 90° turn, and longer trailers could require a 180° turn. Camera trailer tracking requires the system to locate the hitch ball as well as determine the trailer length. Some trailers could require you to drive straight then turn multiple times before calibration completes. The touchscreen provides instructions and notifies you when calibration completes.

**Note:** For best results, do not calibrate the system at night when calibrating the system with the sticker.

### SETTING UP THE TRAILER BACKUP ASSISTANCE FOR A FIFTH-WHEEL OR GOOSENECK TRAILER

#### CONFIGURING THE TRAILER

You must configure a trailer in the system to use trailer backup assistance. This is a one-time setup process and the trailer information is saved in the system for the next time you use that trailer.

The following illustration shows examples of fifth-wheel and gooseneck trailers.

## Trailer Backup Assistance (If Equipped)

**Note:** Trailer reverse guidance camera views are available with no trailer setup. However, complete functionality including graphics and automatic view switching is enabled by setup. Setup is required to enable trailer backup assistance.

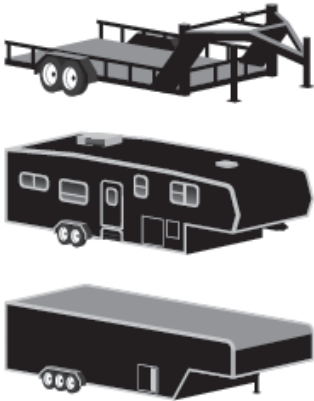

### Configuring the Trailer in the Instrument Cluster Display



1. Press the button to switch the system on.
2. Using the instrument cluster controls on the steering wheel, select **Add Trailer**.
3. Add a personalized name for the trailer using the instrument cluster display prompts. Use the down arrow to scroll to the preferred letter and then press the right arrow to advance to the next letter. Press the **OK** button.

4. Select the trailer brake type.

**Note:** Select **Default Electric/Surge/None** if the trailer has electric, surge or no brakes.

5. Select the trailer brake effort.

## Trailer Backup Assistance (If Equipped)

**Note:** The default value is **Low** and is the recommended setting for most trailers. Select a different setting if your trailer's brakes require more initial voltage, or you prefer more aggressive trailer braking.

6. Select the trailer type.

**Note:** The system could prompt you to setup **Trailer Blind Spot** before continuing the setup process.

7. Select whether you want to add the feature.

### TRAILER SENSOR INSTALLATION

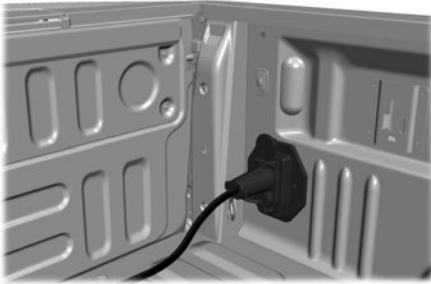

To use the system with a fifth-wheel or gooseneck trailer, you must install a sensor. Refer to the instructions in the sensor kit for proper installation.

**Note:** Make sure the arrows on the sensor housing are facing up. Mount the sensor to a vertical part of the trailer that pivots and moves when you turn your vehicle. Do not mount to a stationary surface or to the truck side of the fifth wheel-trailer hitch.

**Note:** You need to replace the 7/4 way connector in the bumper with the recommended 7/12 pin connector if your vehicle did not come with the fifth-wheel prep package. See your authorized dealer.

**Note:** If your vehicle has the fifth-wheel prep package, you have everything you need. If your vehicle does not have the fifth-wheel prep package, see your authorized dealer to purchase the sensor kit and the 7/12 pin connector.

### CALIBRATING THE SYSTEM

Calibrating the system requires driving forward and turning left or right. Follow the instructions on the instrument cluster display and touchscreen to complete the calibration process.

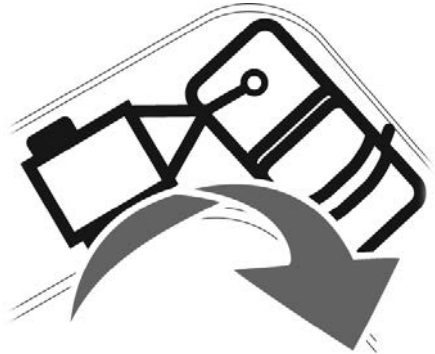

**Note:** Calibrating the system requires an area where you can safely drive forward and turn left or right. An open parking lot is an ideal place to perform the calibration.

## Trailer Backup Assistance (If Equipped)

**Note:** Keep the steering wheel straight when instructed to by the instrument cluster display and touchscreen. If the steering wheel is in a turned position during this instruction, the calibration pauses.

**Note:** During calibration, the system determines the trailer length. The system supports trailer lengths of 10–39 ft (3–11.94 m) distance from the hitch point to the center of the axle or axles.

**Note:** The instrument cluster displays and touchscreen shows if you are going too slow or fast. Calibration pauses if the speed is outside the required range of 2–16 mph (4–25 km/h).

**Note:** You need to complete at least a 90° turn, and longer trailers could require a 180° turn.

### SWITCHING TRAILER BACKUP ASSISTANCE ON AND OFF

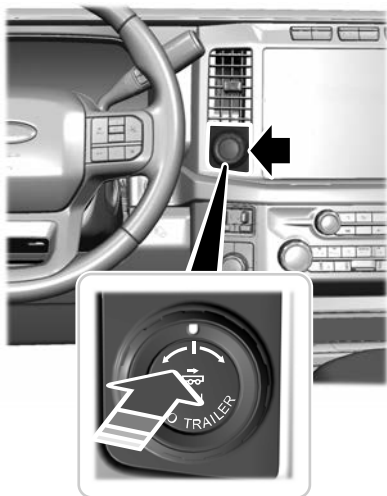

Press the button and use the touchscreen to select the connected trailer.

**Note:** A trailer must be configured to use trailer backup assistance. See **Configuring the Trailer** (page 383).

**Note:** If you use the steering wheel when using trailer backup assistance, the system turns off and a message displays in the touchscreen.

**Note:** If the trailer was connected just prior to turning the system on, you may need to drive forward to initialize the system. Follow the instructions on the touchscreen to activate the system.

### USING THE TRAILER BACKUP ASSISTANCE CONTROLLER

Use the control knob to steer the trailer. Take your hands off the steering wheel and turn the control knob instead. The control knob acts as the steering control for the trailer.

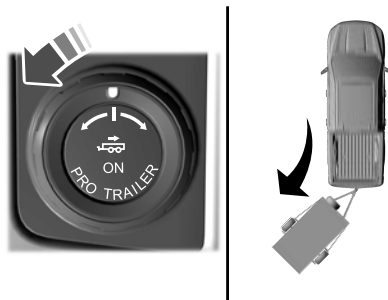

Turn and hold counterclockwise to make the trailer go left.

## Trailer Backup Assistance (If Equipped)

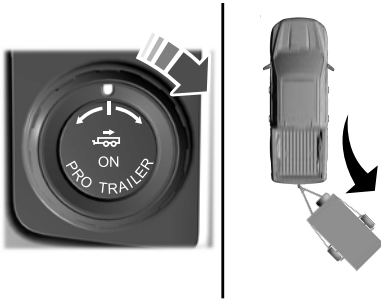

Turn and hold clockwise to make the trailer go right.

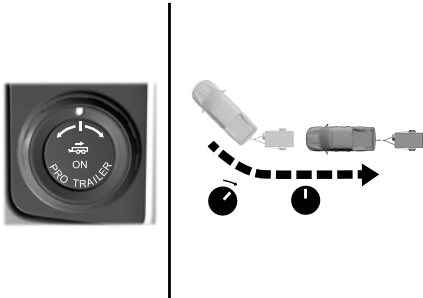

Release the knob when the trailer is moving in the direction you want.

**Note:** The more you turn the knob, the sharper the trailer turns.

**Note:** Quickly turning and releasing the knob results in a jerky movement of the vehicle.

**Note:** You may have to use the knob to correct the trailer direction when attempting to move the trailer straight back under some conditions.

### USING THE TRAILER BACKUP ASSISTANCE VIEWS

Up to seven camera views could be available when using trailer backup assistance. Use the view that helps you the most when reversing your vehicle and trailer.

**Note:** The rear view camera view is available on all vehicles with trailer backup assistance. Additional views are available on vehicles with trailer reverse guidance.

 360° camera view. Shows a 360° view on the right-hand side of the touchscreen with a rear camera view on the left-hand side of the touchscreen.

 Rear view camera view. Shows your trailer hitch or what is directly behind your vehicle.

 Rear split view camera view. Shows a 180° degree view of what is behind your vehicle.

 Bed camera view. Shows the truck bed.

**Note:** This view also provides a picture-in-picture view.

 Trailer AUX camera view. Shows a rear view camera image of what is behind your trailer. You need to separately purchase this camera and have it installed.

**Note:** This view also provides a picture-in-picture view.

 Trailer reverse guidance view. Shows you a view of the sides of your truck and the trailer. In auto mode, this view moves as the trailer moves so that you do not have to adjust the camera as you turn. Left and right arrows let you see other camera views.

## Trailer Backup Assistance (If Equipped)



Picture-in-picture view. Shows a main view and a secondary view when in bed camera view or trailer AUX camera view.

**Note:** If you have a 8 in (20 cm) touchscreen, picture-in-picture is off by default. Press the picture-in-picture icon on the touchscreen to switch picture-in-picture view on and off.

**Note:** If you have a 12 in (30 cm) touchscreen, picture-in-picture is on by default and you cannot switch it off.



Swap. Press to swap between picture-in-picture views.

Auto

Auto. Press to return to auto view.

**Note:** Auto is the default setting.

### Hitch Angle Graphic

The hitch angle graphic shows a small representation of your truck and trailer with visual feedback to help you monitor the trailer. The graphic shows two different colored lines for the trailer hitch angle. A black line shows you where your trailer is in relation to your vehicle. The white line represents the amount the trailer can turn based on knob input.

The graphic shows a yellow and red zone for the hitch angle to warn you of a high angle condition that could require you to pull forward to reduce the hitch angle. The angle limits for each zone vary based on the trailer length.

The yellow zone indicates you are approaching the maximum controllable trailer angle for the system. When the trailer enters this zone, it is more difficult to reduce the trailer turn when backing up. It may be necessary to put your vehicle back into drive (D) and pull forward to get the truck and trailer back to an in-line position.

The red zone indicates you have exceeded the maximum controllable trailer angle for the system. Immediately stop reversing. Put your vehicle into drive (D) and pull forward until the trailer is no longer in the red zone.

### Setting the Trailer Angle Limit

1. Press **Features** on the touchscreen.
2. Press **Towing**.
3. Press **Manage trailers**.
4. Press **Pro Trailer Backup Assist**.
5. Press **Trailer Angle Limit**.
6. Press a setting.

### Normal Control Angle

Default setting. This provides a balanced limit that returns from a turn to straight backing with minimal change to the trailer direction.

### Max Control Angle

Increases the trailer angle limit close to the maximum controllable angle to allow sharper turns but also causes more change in the trailer direction when straightening out from a turn.

# Trailer Backup Assistance (If Equipped)

## TRAILER BACKUP ASSISTANCE – TROUBLESHOOTING

### TRAILER BACKUP ASSISTANCE – INFORMATION MESSAGES

Message	Description
Detecting Trailer Please Wait...	Displays when the system turns on and is initializing.
Pro Trailer Backup Assist™ System is Not Available	A condition exists that prevents the system from turning on. If the message continues to display, visit your authorized dealer to have your vehicle checked.
Pro Trailer Backup Assist™ Driving Required to Initialize Steering Press Knob to Exit	The steering system needs to learn internal parameters to fully enable the feature. Drive your vehicle straight forward above 25 mph (40 km/h) for approximately 5 minutes.
Pro Trailer Backup Assist™ Stop now Maximum trailer angle Press Knob to Exit	Displays when you reach the maximum controllable trailer angle for the system. Place your vehicle in drive (D) and pull forward to get the truck and trailer back to an in-line position. If this message consistently displays, you may need to repeat the trailer calibration. Delete the trailer from the system and repeat the setup and calibration process.
Stop now. Deactivated by trailer angle.	Displays when you exceed the maximum controllable trailer angle for the system. Place your vehicle in drive (D) and pull forward to get your vehicle and trailer back to an in-line position, then activate the system by selecting the connected trailer and following the instructions on the touchscreen. If this message consistently displays, you may need to repeat the trailer setup and calibration. Delete the trailer from the system and repeat the setup and calibration process.
Pro Trailer Backup Assist™ Stop Now Take Control of Steering Wheel	Displays when the system can no longer steer the vehicle and you must take over steering.



## Trailer Backup Assistance (If Equipped)

Message	Description
<p>Pro Trailer Backup Assist™ Sensor Not Detected Refer to Owner's Manual Press Knob to Exit</p>	<p>Displays when the system does not detect the sensor. Check the sensor connection, check that there is no damaged wiring between the connector and sensor and check that there is only one sensor connected.</p> <p>If you do not want to use the sensor for this trailer, delete the trailer in the touchscreen then repeat the setup process with the sticker.</p>
<p>Pro Trailer Backup Assist™ Trailer Not Detected. Shift to Park Press Knob to Exit</p>	<p>These messages display when the system does not detect the trailer.</p>
<p>Pro Trailer Backup Assist™ Trailer Not Detected. Refer to Owner's Manual. Press Knob to Exit</p>	<p>If your trailer is setup with a sticker, make sure the rear camera is clean, and the sticker is clearly visible in the camera image. You can also move the trailer forward or backward to change the trailer position and lighting conditions.</p> <p>If your trailer is setup with a sensor, check that the sensor is correctly installed and the trailer length is within the allowed range.</p> <p>If these messages continue to display, visit your authorized dealer to have your vehicle checked.</p>

## Trailer Backup Assistance (If Equipped)

Message	Description
Pro Trailer Backup Assist™ Trailer Not Detected Pull Forward to Initialize Press Knob to Exit	If your trailer is setup with a sticker, this message displays when the camera system cannot detect the trailer and requires trailer movement to enable trailer detection. Drive forward above 2 mph (3 km/h) to initialize the system. If your trailer is setup with a sensor, this message displays when your vehicle has not moved after the trailer sensor is connected or extended operation below 1 mph (1 km/h). Drive forward above 2 mph (3 km/h) to initialize the system.
Pro Trailer Backup Assist™ Stop Now System Not Active Press Knob to Exit	Displays when your vehicle is backing up but the system is not activated. Select the connected trailer on the touchscreen and follow the instructions to activate the system. This message also displays when you back up during the calibration process.
Pro Trailer Backup Assist™ Backup Slowly Turn Knob to Steer Press Knob to Exit	Displays when the system turns on and is available to use.

# Trailer Backup Assistance (If Equipped)

## TRAILER BACKUP ASSISTANCE – FREQUENTLY ASKED QUESTIONS

### Why does the trailer not reverse straight?

Verify the sensor is correctly installed. Other factors such as the hitch connection, road camber, road slope and trailer suspension could influence how straight the system can reverse the trailer when the control knob is not turned. You can compensate for the trailer drifting to the right or left by slowly turning the knob until the trailer is following your desired path and then holding the knob in that position.

### Why does the system not detect a sensor?

There could be an issue with the connection, the wiring harness could be damaged, you could have multiple sensors connected or the sensor could be incorrectly installed. Check that the 12-way connector is fully inserted into the 12-way socket. The red rubber seal is not visible when the connector is fully inserted. Also check that the wiring harness sensor connection is fully inserted at the trailer sensor, and check for damaged wiring between the 12-way connector and the trailer sensor. Also, check that the sensor is installed on a vertical surface with the arrows pointing straight up.

### What does it mean if the system remains on one message for an extended time during calibration when setting up the system with the sticker?

The camera could need to be cleaned, the sticker could be blocked, the drawbar could be outside the allowed range of 4–19 in (10–48 cm) or you could need to move to a different area to change the lighting and background. Verify the sticker is in the proper location. See **Applying the Trailer Reversing Aid Sticker** (page 385). You can move to a different area or change the direction you are driving or setup the system at a different time of day. Some trailers are not compatible with the sticker and camera system. If the issue persists with the sticker setup, you may choose to setup the trailer with a sensor.

### What does it mean if the system pauses during calibration?

There could be steering input or trailer movement during the straight drive portion of the calibration process.

### What does it mean if the system remains on one message for an extended time during calibration when setting up the system with the sensor?

The sensor could be incorrectly installed, the trailer length could be outside the allowed range or the road surface could be too rough or bumpy.

### What does it mean if the system displays hold steering steady during turn?

Part of the calibration process for the sticker setup requires a steady turn. If you are continually moving the steering wheel during the turn, this delays the calibration process. To enable the calibration process, hold the steering wheel at the same position when turning.

# Trailer Backup Assistance (If Equipped)

---

## **What does it mean if the system displays that it is not available?**

There could be a sub-system that the system uses that is not correctly operating or there could be a battery voltage issue. If the system continues to display it is not available, visit your authorized dealer to have your vehicle checked.

## **What does it mean if the system displays that driving is required to initialize steering?**

The steering system needs to learn internal parameters to fully turn on the feature. Drive your vehicle straight forward above 25 mph (40 km/h) for approximately 5 minutes. This could also occur when your vehicle is new, there is a battery voltage issue or if the steering system has been serviced.

## **What does it mean if the system does not detect a trailer when configured with a sensor?**

Verify that the sensor is properly connected. See **Trailer Sensor Installation** (page 385). Repeat calibration on a different route if you have verified sensor installation.

## **What does it mean if the system requires you to pull forward to initialize?**

This occurs when the vehicle has not moved during the current key cycle after you connect and select the trailer in the touchscreen or you operate the system at speeds below 1 mph (1 km/h) for an extended period of time. Drive forward above 2 mph (3 km/h) and the system indicates when it initializes.

## **What does it mean if the trailer is at its maximum angle or the system deactivated by trailer angle?**

You are at the maximum controllable trailer angle for the system. Place your vehicle in drive (D) and pull forward to get the truck and trailer back to an in-line position. If this message consistently displays, this could indicate the sensor is incorrectly installed, the trailer needs to be recalibrated or the drawbar or the trailer dimensions are outside of the supported range. The system is designed to work with drawbars that have a license plate to hitch ball center measurement of 9–18 in (23–46 cm) when installed. The system is designed to work with trailers that have a hitch point to center of the axle or axles measurement of 6–33 ft (1.85–10.05 m). Do not attempt to use drawbars or trailers that have a length outside of this range as the system performance degrades and could cause improper system function. Check that the correct trailer is selected in the touchscreen. Verify the sensor is installed according to the instructions included in the sensor kit and check that the drawbar and the trailer dimensions are within the allowed range. Then, delete the trailer from the system and repeat the setup process to calibrate the trailer.

## Trailer Backup Assistance (If Equipped)

---

### What does it mean when the system tells you to take control of the steering wheel?

The system is no longer steering the vehicle and you must take over steering. There are four reasons the system could display this message. The first reason the system could display this message is that you have touched the steering wheel when the system is steering. The second reason the system could display this message is that you have exceeded the maximum speed for the feature. The third reason the system could display this message is that the trailer is not detected. The final reason the system could display this message is that an internal condition for system operation is not met that requires your vehicle to return to manual control of the steering.

### How do I use a sticker if I have previously setup a trailer with the sensor?

Disconnect the sensor wiring and add a new trailer to the system and follow the instructions for setup with a sticker. See **Applying the Trailer Reversing Aid Sticker** (page 385). If your vehicle does not support the sticker option, the touchscreen instructs you to install the sensor again.

### What if I want to use a sensor for the trailer instead of a sticker?

Install the sensor and connect the sensor wiring before adding the new trailer to the system. You must connect the sensor before you add the trailer. If your vehicle did not come with a sensor, you can purchase one from your authorized dealer.

### What does it mean if the system does not detect a trailer that is setup with a sticker?

The system requires a clear view of the sticker placed on the trailer. You must keep the camera lens and sticker clean for the system to correctly operate. If the system cannot initially detect the trailer, it could be necessary for you to change the lighting conditions by moving your vehicle and trailer or waiting until the conditions change. See **Applying the Trailer Reversing Aid Sticker** (page 385). Some trailers are not compatible with the sticker and camera system. If the system consistently does not detect the trailer with the sticker setup, you may choose to setup the trailer with a sensor.

**Note:** *The system is designed to be used with the same trailer connection every time you choose the trailer from the touchscreen. When using a different drawbar or a different pin hole on drawbars with more than one, connecting the drawbar to your vehicle affects the trailer position and you may need to repeat the trailer setup and calibration process.*

# Trailer Reverse Guidance (If Equipped)

## WHAT IS TRAILER REVERSE GUIDANCE

Trailer reverse guidance provides views and graphics on the touchscreen to help you steer your vehicle when you backup a trailer.

## HOW DOES TRAILER REVERSE GUIDANCE WORK

Trailer reverse guidance uses a sticker or sensor attached to the trailer to detect the trailer angle relative to the towing vehicle and provides instructions, graphics and camera views on the touchscreen.

## TRAILER REVERSE GUIDANCE PRECAUTIONS



**WARNING:** Driving while distracted can result in loss of vehicle control, crash and injury. We strongly recommend that you use extreme caution when using any device that may take your focus off the road. Your primary responsibility is the safe operation of your vehicle. We recommend against the use of any hand-held device while driving and encourage the use of voice-operated systems when possible. Make sure you are aware of all applicable local laws that may affect the use of electronic devices while driving.



**WARNING:** This system is an extra driving aid. It does not replace your attention and judgment, or the need to apply the brakes. This system does NOT automatically brake your vehicle. If you fail to press the brake pedal when necessary, you may collide with another vehicle.

**Note:** The system is not a substitute for safe driving practices. Always be aware of your vehicle and trailer combination, and the surrounding environment.

**Note:** The system does not detect or prevent your vehicle or trailer from making contact with obstacles in the surrounding environment.

**Note:** The front end of your vehicle swings out when changing the direction of the trailer.

**Note:** In certain conditions, the trailer could turn faster or the trailer angle could increase more than anticipated. Always monitor the clearance between the trailer and vehicle and the surroundings.

## SETTING UP TRAILER REVERSE GUIDANCE FOR A CONVENTIONAL TRAILER

### CONFIGURING THE TRAILER

You must configure a trailer in the system to use trailer reverse guidance. This is a one-time setup process and the trailer information is saved in the system for the next time you use that trailer.

The system only works with conventional trailers. It does not work with other types including fifth-wheel and gooseneck. The following illustration shows examples of conventional trailers on the left-hand side.

**Note:** Trailer reverse guidance camera views are available with no trailer setup. However, complete functionality including graphics and automatic view switching is enabled by setup. Setup is required to enable trailer backup assistance.

## Trailer Reverse Guidance (If Equipped)

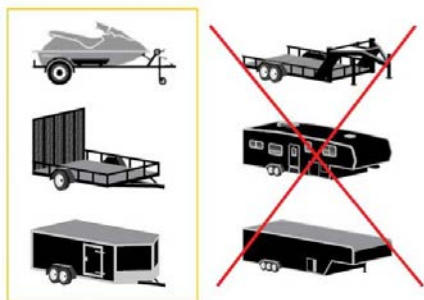

### Positioning the Trailer

Hitch the trailer to your vehicle and connect the electrical wiring harness. Check to make sure that the wiring is working. See **Connecting a Trailer** (page 356).



Park your vehicle and hitched trailer on a level surface.

For best results, make sure that your trailer rides level with the ground when you hitch your vehicle. See **Connecting a Trailer** (page 356).



Make sure that the trailer and your vehicle are in line with each other. You can do this by putting the transmission in drive (D) and pulling straight forward.

### Configuring the Trailer in the Touchscreen

1. Shift to reverse (R).
2. Press the camera view button.
3. Press the trailer view icon.
4. Press **Add Trailer**.
5. Follow the directions on the touchscreen to enter the trailer name and trailer type, then proceed to the sticker or sensor setup.

**Note:** If you configure the trailer and install a sensor, the trailer is saved with that sensor information. If you want to use this trailer with the sticker, you need to delete the trailer from the system and repeat the setup process.

**Note:** Your vehicle has two options for the trailer reversing aid setup. If your vehicle came with a trailer sensor kit or if a message displays to install a sensor, follow the sensor installation instructions. See **Trailer Sensor Installation** (page 400). If your vehicle did not come with a trailer sensor kit, follow the sticker installation instructions. See **Applying the Trailer Reverse Aid Sticker** (page 400).

**Note:** If your vehicle came with a trailer sensor kit, the vehicle will receive an update that allows the system to operate with a sensor or sticker. If your vehicle did not come with a trailer sensor kit, your vehicle can be setup using either method, but you need to separately purchase the trailer sensor kit from your authorized dealer.

# Trailer Reverse Guidance (If Equipped)

## APPLYING THE TRAILER REVERSE AID STICKER

Place the sticker in an area visible by the rear view camera. The entire sticker must be within 4–19 in (10–48 cm) from the center of the hitch ball, as shown in the following illustration.

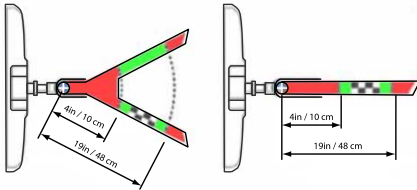

Use the supplied sticker placement card, a tape measure and pen to carefully mark the area to attach the sticker. The sticker is in the back cover pocket of your quick start guide. Make sure the entire sticker is within the green zone between the two arcs or distance markers on the diagram, and is also visible in the rear view camera display.

Once you have found the correct location, place the sticker.

**Note:** Make sure nothing can obstruct the rear view camera's view of the sticker such as a jack handle or wiring.

**Note:** Position the sticker on a flat, dry and clean horizontal surface. For best results, apply the sticker when temperatures are above 32°F (0°C).

**Note:** Do not move stickers after placing them. Do not re-use any stickers if removed.

**Note:** You can purchase additional stickers through your authorized dealer.

**Note:** If you previously setup the trailer with the trailer sensor, make sure it is not plugged in before configuring the trailer and placing the sticker.

## TRAILER SENSOR INSTALLATION

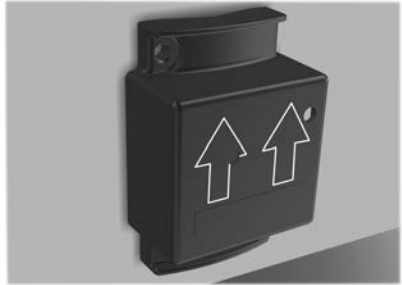

Refer to the instructions included with your trailer sensor for detailed information regarding installation.

**Note:** Make sure the arrows on the sensor housing are facing up. Mount the sensor to a vertical part of the trailer that pivots when you turn your vehicle. Do not mount to a stationary surface such as the truck side of the trailer hitch.



## Trailer Reverse Guidance (If Equipped)

**Note:** If your vehicle came with a trailer sensor kit, the vehicle will receive an update that allows the system to operate with a sensor or sticker. If your vehicle did not come with a trailer sensor kit, your vehicle can be setup using either method, but you need to separately purchase the trailer sensor kit from your authorized dealer. Once your vehicle is enabled for sticker setup, the default setup for new trailers requires placement of the sticker. To setup a trailer with a sensor, install the sensor on the trailer and plug the connector into the connector in your bumper prior to configuring the trailer. Trailers that were set up with a sensor still require the sensor to function. To change a trailer to use the sticker, delete the trailer in the system and repeat the trailer setup with the sticker.

### CALIBRATING THE SYSTEM

Calibrating the system requires driving forward and turning left or right. Follow the instructions on the touchscreen to complete the calibration process.

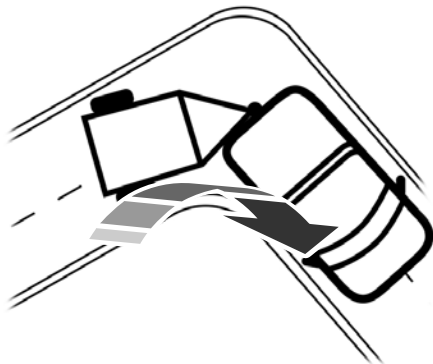

**Note:** To calibrate the system, you need an area where you can safely drive forward and turn left or right. An open parking lot is an ideal place to perform the calibration.

**Note:** Keep the steering wheel straight when instructed to by the touchscreen. If the steering wheel is in a turned position during this instruction, the calibration pauses.

**Note:** During calibration, the system determines the trailer length. The system supports trailer lengths of 6–33 ft (1.85–10.05 m) distance from the hitch point to the center of the axle or axles. The system is designed to work with drawbars that have a license plate to hitch ball center measurement of 9–18 in (23–46 cm) when installed. Do not attempt to use drawbars or trailers that have a length outside of this range as the system performance degrades and could cause improper system function.

**Note:** The touchscreen shows if you are going too slow or fast. Calibration pauses if the speed is outside the required range of 2–9 mph (4–15 km/h).

**Note:** You need to complete at least a 90° turn, and longer trailers could require a 180° turn. Camera trailer tracking requires the system to locate the hitch ball as well as determine the trailer length. Some trailers could require you to drive straight then turn multiple times before calibration completes. The touchscreen provides instructions and notifies you when calibration completes.

**Note:** For best results, do not calibrate the system at night when calibrating the system with the sticker.

### SWITCHING TRAILER REVERSE GUIDANCE ON AND OFF

Shift into reverse (R), press the rear camera button to expand the menu, press the trailer icon and use the touchscreen to select the connected trailer.

# Trailer Reverse Guidance (If Equipped)

**Note:** If the trailer was connected just prior to turning the system on, you may need to drive forward to initialize the system. Follow the instructions on the touchscreen to activate the system.

## USING TRAILER REVERSE GUIDANCE VIEWS

Up to seven camera views could be available when using trailer reverse guidance. Use the view that helps you the most when reversing your vehicle and trailer.



360° camera view. Shows a 360° view on the right-hand side of the touchscreen with a rear camera view on the left-hand side of the touchscreen.



Rear view camera view. Shows your trailer hitch or what is directly behind your vehicle.



Bed camera view. Shows the truck bed.

**Note:** This view also provides a picture-in-picture view.



Trailer AUX camera view. Shows a rear view camera image of what is behind your trailer. You need to separately purchase this camera and have it installed.

**Note:** This view also provides a picture-in-picture view.



Trailer reverse guidance view. Shows you a view of the sides of your truck and the trailer. In auto mode, this view moves as the trailer moves so that you do not have to adjust the camera as you turn. Left and right arrows let you see other camera views.



Straight backup mode. Shows which way to turn your steering wheel to keep the trailer straight. Use this view when you want to keep your trailer completely in line with your truck.

**Note:** This view also provides a picture-in-picture view.

**Note:** It may be helpful to shift your vehicle into drive (D), pull forward and straighten out the vehicle and trailer before engaging straight backup mode.



Picture-in-picture view. Shows a main view and a secondary view when in bed camera view, trailer AUX camera view or straight backup mode.

**Note:** If you have a 8 in (20 cm) touchscreen, picture-in-picture is off by default. Press the picture-in-picture icon on the touchscreen to switch picture-in-picture view on and off.

**Note:** If you have a 12 in (30 cm) touchscreen, picture-in-picture is on by default for bed camera view and trailer AUX camera view and cannot be switched off. Press the picture-in-picture icon on the touchscreen to switch picture-in-picture view on and off in straight backup mode.



Swap. Press to swap between picture-in-picture views.



This takes you back to the 360° camera system and out of the trailer reverse guidance feature.



Auto. Press to return to auto view.

**Note:** Auto mode is the default setting.

# Trailer Reverse Guidance (If Equipped)

## Hitch Angle Graphic



The hitch angle graphic shows a small representation of your truck and trailer with visual feedback to help you monitor the trailer. The graphic shows two different colored lines for the trailer hitch angle. A black line shows you where your trailer is in relation to your vehicle. The white line represents the amount the trailer can turn based on steering wheel position.

The graphic shows a yellow and red zone for the hitch angle to warn you of a high angle condition that could require you to pull forward to reduce the hitch angle. The angle limits for each zone vary based on the trailer length.

The yellow zone indicates you are approaching the maximum controllable trailer angle for the system. When the trailer enters this zone, it is more difficult to reduce the trailer turn when backing up. It may be necessary to put your vehicle back into drive (D) and pull forward to get the truck and trailer back to an in-line position.

The red zone indicates you have exceeded the maximum controllable trailer angle for the system. Immediately stop reversing. Put your vehicle into drive (D) and pull forward until the trailer is no longer in the red zone.

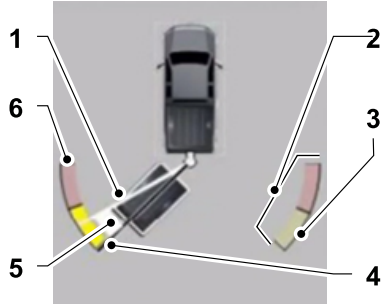

1. Projected line.
2. Dynamic warning zones.
3. Approaching point of no return zone.
4. Current trailer angle.
5. Projection bar.
6. Approaching trailer jackknife zone

# Trailer Reverse Guidance (If Equipped)

## TRAILER REVERSE GUIDANCE – TROUBLESHOOTING

### TRAILER REVERSE GUIDANCE – INFORMATION MESSAGES

Message	Description
Detecting Trailer Please Wait...	Displays when the system turns on and is initializing.
Trailer Reverse Guidance System is Not Available	A condition exists that prevents the system from turning on. If the message continues to display, visit your authorized dealer to have your vehicle checked.
Trailer Reverse Guidance Driving Required to Initialize Steering Press OK to Exit	The steering system needs to learn internal parameters to fully enable the feature. Drive your vehicle straight forward above 25 mph (40 km/h) for approximately 5 minutes.
Stop now. Deactivated by trailer angle.	Displays when you exceed the maximum controllable trailer angle for the system. Place your vehicle in drive (D) and pull forward to get your vehicle and trailer back to an in-line position, then activate the system by selecting the connected trailer and following the instructions on the touchscreen. If this message consistently displays, you may need to repeat the trailer setup and calibration. Delete the trailer from the system and repeat the setup and calibration process.
Trailer Reverse Guidance Sensor Not Detected Refer to Owner's Manual Press OK to Exit	Displays when the system does not detect the sensor. Check the sensor connection, check that there is no damaged wiring between the connector and sensor and check that there is only one sensor connected. If you do not want to use the sensor for this trailer, delete the trailer in the touchscreen then repeat the setup process with the sticker.

## Trailer Reverse Guidance (If Equipped)

Message	Description
Trailer Reverse Guidance Trailer Not Detected. Refer to Owner's Manual. Press OK to Exit	Displays when the system does not detect the trailer. If your trailer is setup with a sticker, make sure the rear camera is clean, and the sticker is clearly visible in the camera image. You can also move the trailer forward or backward to change the trailer position and lighting conditions. If your trailer is setup with a sensor, check that the sensor is correctly installed and the trailer length is within the allowed range. If this message continues to display, visit your authorized dealer to have your vehicle checked.
Trailer Reverse Guidance Trailer Not Detected Pull Forward to Initialize Press OK to Exit	Displays when your vehicle has not moved after the trailer sensor is connected or extended operation below 1 mph (1 km/h). Drive forward above 2 mph (3 km/h) to initialize the system.

# Trailer Reverse Guidance (If Equipped)

---

## TRAILER REVERSE GUIDANCE – FREQUENTLY ASKED QUESTIONS

### Why does the trailer not reverse straight?

Verify the sensor is correctly installed. Other factors such as the hitch connection, road camber, road slope and trailer suspension could influence how straight the system can reverse the trailer when the control knob is not turned. You can compensate for the trailer drifting to the right or left by slowly turning the knob until the trailer is following your desired path and then holding the knob in that position.

### Why does the system not detect a sensor?

There could be an issue with the connection, the wiring harness could be damaged, you could have multiple sensors connected or the sensor could be incorrectly installed. Check that the 12-way connector is fully inserted into the 12-way socket. The red rubber seal is not visible when the connector is fully inserted. Also check that the wiring harness sensor connection is fully inserted at the trailer sensor, and check for damaged wiring between the 12-way connector and the trailer sensor. Also, check that the sensor is installed on a vertical surface with the arrows pointing straight up.

### What does it mean if the system remains on one message for an extended time during calibration when setting up the system with the sticker?

The camera could need to be cleaned, the sticker could be blocked, the drawbar could be outside the allowed range of 4–19 in (10–48 cm) or you could need to move to a different area to change the lighting and background. Verify the sticker is in the proper location. See **Applying the Trailer Reverse Aid Sticker** (page 400). You can move to a different area or change the direction you are driving or setup the system at a different time of day. Some trailers are not compatible with the sticker and camera system. If the issue persists with the sticker setup, you may choose to setup the trailer with a sensor.

### What does it mean if the system pauses during calibration?

There could be steering input or trailer movement during the straight drive portion of the calibration process.

### What does it mean if the system remains on one message for an extended time during calibration when setting up the system with the sensor?

The sensor could be incorrectly installed, the trailer length could be outside the allowed range or the road surface could be too rough or bumpy.

### What does it mean if the system displays hold steering steady during turn?

Part of the calibration process for the sticker setup requires a steady turn. If you are continually moving the steering wheel during the turn, this delays the calibration process. To enable the calibration process, hold the steering wheel at the same position when turning.

# Trailer Reverse Guidance (If Equipped)

---

## **What does it mean if the system displays that it is not available?**

There could be a sub-system that the system uses that is not correctly operating or there could be a battery voltage issue. If the system continues to display it is not available, visit your authorized dealer to have your vehicle checked.

## **What does it mean if the system displays that driving is required to initialize steering?**

The steering system needs to learn internal parameters to fully turn on the feature. Drive your vehicle straight forward above 25 mph (40 km/h) for approximately 5 minutes. This could also occur when your vehicle is new, there is a battery voltage issue or if the steering system has been serviced.

## **What does it mean if the system does not detect a trailer when configured with a sensor?**

Verify that the sensor is properly connected. See **Trailer Sensor Installation** (page 400). Repeat calibration on a different route if you have verified sensor installation.

## **What does it mean if the system requires you to pull forward to initialize?**

This occurs when the vehicle has not moved during the current key cycle after you connect and select the trailer in the touchscreen or you operate the system at speeds below 1 mph (1 km/h) for an extended period of time. Drive forward above 2 mph (3 km/h) and the system indicates when it initializes.

## **What does it mean if the trailer is at its maximum angle or the system deactivated by trailer angle?**

You are at the maximum controllable trailer angle for the system. Place your vehicle in drive (D) and pull forward to get the truck and trailer back to an in-line position. If this message consistently displays, this could indicate the sensor is incorrectly installed, the trailer needs to be recalibrated or the drawbar or the trailer dimensions are outside of the supported range. The system is designed to work with drawbars that have a license plate to hitch ball center measurement of 9–18 in (23–46 cm) when installed. The system is designed to work with trailers that have a hitch point to center of the axle or axles measurement of 6–33 ft (1.85–10.05 m). Do not attempt to use drawbars or trailers that have a length outside of this range as the system performance degrades and could cause improper system function. Check that the correct trailer is selected in the touchscreen. Verify the sensor is installed according to the instructions included in the sensor kit and check that the drawbar and the trailer dimensions are within the allowed range. Then, delete the trailer from the system and repeat the setup process to calibrate the trailer.

# Trailer Reverse Guidance (If Equipped)

---

## What does it mean when the system tells you to take control of the steering wheel?

The system is no longer steering the vehicle and you must take over steering. There are four reasons the system could display this message. The first reason the system could display this message is that you have touched the steering wheel when the system is steering. The second reason the system could display this message is that you have exceeded the maximum speed for the feature. The third reason the system could display this message is that the trailer is not detected. The final reason the system could display this message is that an internal condition for system operation is not met that requires your vehicle to return to manual control of the steering.

## How do I use a sticker if I have previously setup a trailer with the sensor?

Disconnect the sensor wiring and add a new trailer to the system and follow the instructions for setup with a sticker. See **Applying the Trailer Reverse Aid Sticker** (page 400). If your vehicle does not support the sticker option, the touchscreen instructs you to install the sensor again.

## What if I want to use a sensor for the trailer instead of a sticker?

Install the sensor and connect the sensor wiring before adding the new trailer to the system. You must connect the sensor before you add the trailer. If your vehicle did not come with a sensor, you can purchase one from your authorized dealer.

## What does it mean if the system does not detect a trailer that is setup with a sticker?

The system requires a clear view of the sticker placed on the trailer. You must keep the camera lens and sticker clean for the system to correctly operate. If the system cannot initially detect the trailer, it could be necessary for you to change the lighting conditions by moving your vehicle and trailer or waiting until the conditions change. See **Applying the Trailer Reverse Aid Sticker** (page 400). Some trailers are not compatible with the sticker and camera system. If the system consistently does not detect the trailer with the sticker setup, you may choose to setup the trailer with a sensor.

**Note:** *The system is designed to be used with the same trailer connection every time you choose the trailer from the touchscreen. When using a different drawbar or a different pin hole on drawbars with more than one, connecting the drawbar to your vehicle affects the trailer position and you may need to repeat the trailer setup and calibration process.*



# Off-Road Driving

## BASIC OFF-ROAD DRIVING TECHNIQUES

### Off-road Driving Hints

Before taking your vehicle off-roading, perform a basic inspection to make sure your vehicle is in good working condition.

We recommend that you always use at least two vehicles while off-roading. The buddy system helps make sure that help is close at hand should a vehicle become stuck or damaged. It is also wise to take supplies such as a first aid kit, water, tow strap, cell phone with you.

The following are hints for safe off-road driving:

- Steer, brake and accelerate in a smooth controlled manner. Avoid jerky, unsteady movements.
- Look ahead on your route noting upcoming obstacles, or any other factors that may indicate a change in available traction and adjust the vehicle speed and route accordingly.
- If the front or rear suspension is bottoming out, or you encounter excessive contact with the skid-plates, reduce the vehicle speed to avoid potential damage to your vehicle.
- We recommend that you use vehicle communication, such as, turn signals, brake lights, and hazard flashers to alert other drivers of what you intend to do next, and of obstacles that could cause potential vehicle damage.

- Always keep available ground clearance in mind and pick a route that minimizes the risk of catching the underside of the vehicle on an obstacle.
- When negotiating low speed obstacles, applying light brake pressure in conjunction with the throttle helps prevent your vehicle from jerking and allows you to negotiate the obstacle in a more controlled manner. Using four-wheel drive low (4L) will also help with this.

### Crossing Obstacles

- Review the path ahead before attempting to cross an obstacle. It is best if you view the obstacle from outside your vehicle so that you have a good understanding of terrain conditions both in front of and behind the obstacle.
- Approach obstacles slowly.
- If you cannot avoid a large obstacle such as a rock, choose a path that places the rock directly under the tire rather than the undercarriage of your vehicle. This helps prevent damage to your vehicle.
- Cross ditches and washouts at a 45° angle, allowing each wheel to independently cross the obstacle.

### Climbing A Hill



**WARNING:** Extreme care should be used when steering the vehicle in reverse down a slope so as not to cause the vehicle to swerve out of control.

Do not drive over the crest of a hill without seeing what conditions are on the other side. Do not drive in reverse over a hill without the aid of an observer.

# Off-Road Driving

- Always attempt to climb a steep hill along the fall line of the slope and not diagonally.
- If the vehicle is unable to make it up the hill, DO NOT attempt to turn back down the slope. Place the vehicle in low range and slowly back down in reverse.
- When descending a steep slope, select low gear and engage hill descent control. Use the accelerator and brake pedals to control your descent speed.

**Note:** Hill descent control is functional in reverse and should be used in this situation.

**Note:** Avoid turning on steep slopes or hills. You could lose traction, slip sideways or a possible vehicle roll over.

## Driving Over Rocks and Gravel

Never attempt to straddle a rock that is large enough to strike your axles or undercarriage. Leave a generous gap between your vehicle and other vehicles to minimize the risk of damage. Avoid dust clouds as they reduce visibility.

## DRIVING THROUGH WATER LIMITATIONS



**WARNING:** Do not attempt to cross a deep, fast flowing body of water. Failure to follow this instruction could result in the loss of control of your vehicle, personal injury or death.

Determine the depth and speed of the current before attempting a water crossing. As the water depth increases, reduce your vehicle speed to avoid potential vehicle damage.

The key to a safe crossing is the water depth, current and bottom of the water's condition. On soft bottoms, the vehicle sinks in, effectively increasing the water level on the vehicle. Make sure to consider this when determining the depth of water. Be aware that obstacles and debris may be beneath the water's surface.

**Note:** Cross flowing water at an angle heading slightly upstream.

**Note:** Tread lightly and avoid damage to the environment.

Drive slowly when crossing water. Start very slowly when entering, then build momentum. Proceed with a constant slow speed lightly pressing on the accelerator. Ease off the accelerator as you reach the other side to diminish the front wave. Apply the accelerator slowly and as necessary to climb out of the other side

**Note:** Do not try to accelerate through the water crossing.

When driving too fast in water or through deep water, the engine, transmission, transfer case, axles, electrical components or vehicle interior could ingest water. Muddy waters can reduce the cooling system effectiveness by depositing debris into the radiator. The vehicle warranty does not cover water damage. See below for your vehicle's capabilities.

Model	Maximum Wading Capability
Vehicles without Tremor or XL Off-Road Packages	22 in (560 mm) <sup>1</sup>
XL Off-Road Package	30 in (762 mm)
Tremor Package	33 in (838 mm)

<sup>1</sup> Bottom of the doors.

# Off-Road Driving

**Note:** When you are driving through water do not exceed 4.3 mph (7 km/h)

Never stop or shut a vehicle off when crossing deep water unless your vehicle ingested water into the engine air intake. If the engine stalls, do not attempt to restart it. Keep the doors fully closed during a water crossing. Take extra care crossing any type of water. Do not drive into water unless necessary. Only drive through areas that are designated and approved. Determine exit points that are downstream of your entry point to allow for drifting. If there are other vehicles ahead, wait until they have left the water. Unsettled water can make a safe passage more challenging.

High currents even in shallow water can wash the dirt out from around your tires or push your vehicle across slippery rocks or surfaces. Never attempt to cross flowing water that is deeper than your vehicle's ground clearance. Even in low currents your vehicle's body surface area can be pushed downstream and out of control. Do not cross any body of water that is fast flowing and rising, wait for the flow rate to reduce.

Vehicles used to cross water regularly should be periodically inspected for signs of water ingestion in all of the vehicle's fluids. If water is found inside your vehicle fluids, service your vehicle or see an authorized dealer.

After driving through water and as soon as it is safe to do so, check the brakes, horn, lights, and steering wheel to make sure everything is still in working order.

## WATER WADING



**WARNING:** Do not attempt to cross a deep, fast flowing body of water. Failure to follow this instruction could result in the loss of control of your vehicle, personal injury or death.

As the water depth increases, you must reduce your vehicle speed to avoid potential vehicle damage.



- Always determine the depth before attempting a water crossing. Never drive through water that is higher than the bottom of the wheel hubs.
- Slowly proceed and avoid splashing water any more than is necessary.
- Be aware that obstacles and debris may be beneath the water's surface.
- Keep the doors fully closed during the water crossing.
- After driving through water and as soon as it is safe to do so, check the brakes, horn, lights, and steering wheel to confirm those systems are properly functioning.

# Off-Road Driving

---

**Note:** *Engine damage can occur if water enters the air filter.*

## AFTER DRIVING YOUR VEHICLE OFF-ROAD



**WARNING:** After off-road use, before returning to the road, check the wheels and tires for damage. Off-road use may cause damage to your wheels and tires that can lead to tire failure, loss of vehicle control, serious injury or death.



**WARNING:** Always re-inflate tires to recommended tire pressures before the vehicle is operated on-road. The recommended pressure is located on the tire label or safety certification label, located on the B-pillar, inside the driver's door.

After driving off-road check for damage to your vehicle and, if necessary, have your vehicle fixed as soon as possible. Inspect the underbody of your vehicle by checking tires, body structure, steering, suspension, and exhaust system for damage.

Check the radiator for mud and debris and clean as needed.

Remove accumulations of plants or brush. These things could be a fire hazard or hide damage to the fuel lines, brake hoses, and propeller shafts.

With the vehicle off, use a low pressure hose to wash away mud and fine debris. You may need to reach past the active grille shutters to remove larger debris.

If you experience unusual vibration after driving in mud, slush or similar conditions, check the wheels for impacted material. Impacted material can cause vibrations while driving and wheel imbalance. Remove the material to resolve the problem.

# Driving Hints

## COLD WEATHER PRECAUTIONS - 6.7L DIESEL

### Winter Grill Cover (If Equipped)

The winter grill cover enhances heater performance and will reduce the amount of time it takes to warm the inside of your vehicle in extremely cold conditions below  $-0.4^{\circ}\text{F}$  ( $-18^{\circ}\text{C}$ ).

The winter grill cover installs over the outside of the front grill and restricts the air flowing to the engine compartment by covering the radiator grill openings.



**Note:** The grill cover must be installed in extremely cold conditions below  $10.4^{\circ}\text{F}$  ( $-12^{\circ}\text{C}$ ) to prevent possible engine damage.

### Usage Guidelines

The winter grill cover should only be used while operating your vehicle in extremely cold temperatures or in heavy snow for extended periods of time. In these temperatures, the vehicle does not need a large amount of air to properly cool the engine. During periods of operation when more airflow is required to cool the vehicle, the winter grill cover should not be used.

The following usage guidelines will allow adequate airflow for proper radiator and air cooler performance:

- Do not use the cover when temperatures are above  $50.0^{\circ}\text{F}$  ( $10^{\circ}\text{C}$ ). Use of the cover in these conditions could cause your vehicle to overheat. Remove the cover if the vehicle overheats.
- Do not use the cover above  $32.0^{\circ}\text{F}$  ( $0^{\circ}\text{C}$ ) if towing a trailer. Your vehicle may overheat if the cover is used while towing a trailer.
- Do not modify the cover.

### Installation Instructions

Installation and removal instructions are included in the winter grill cover package. Refer to the usage guidelines to understand when to use the cover.

The cover will seem undersized during the first installation, which is normal. The cover stretches during installation to ensure a tight fit. The first installation is best performed when the grill cover is warm.

## COLD WEATHER PRECAUTIONS - 6.8L/7.3L

The functional operation of some components and systems can be affected at temperatures below approximately  $-13^{\circ}\text{F}$  ( $-25^{\circ}\text{C}$ ).

## DRIVING ON SNOW AND ICE



**WARNING:** If you are driving in slippery conditions that require tire chains or cables, then it is critical that you drive cautiously. Keep speeds down, allow for longer stopping distances and avoid aggressive steering to reduce the

# Driving Hints

chances of a loss of vehicle control which can lead to serious injury or death. If the rear end of your vehicle slides while cornering, steer in the direction of the slide until you regain control of your vehicle.

On ice and snow, you should drive more slowly than usual. Your vehicle has an anti-lock braking system, apply the brake pedal steadily. Do not pump the brake pedal. See **Anti-Lock Braking System Limitations** (page 246).

## BREAKING-IN

Your vehicle requires a break-in period. For the first 1,000 mi (1,600 km), avoid driving at high speeds, heavy braking, aggressive shifting or using your vehicle to tow. During this time, your vehicle may exhibit some unusual driving characteristics.

## DRIVING ECONOMICALLY

The following helps to improve fuel consumption:

- Drive smoothly, accelerate gently and anticipate the road ahead to avoid heavy braking.
- Regularly check your tire pressures and make sure that they are inflated to the correct pressure.
- Follow the recommended maintenance schedule and carry out the recommended checks.
- Plan your journey and check the traffic before you set off. It is more efficient to combine errands into a single trip whenever possible.
- Avoid idling the engine in cold weather or for extended periods. Start the engine only when you are ready to set off.

- Do not carry unnecessary weight in your vehicle as extra weight wastes fuel.
- Do not add unnecessary accessories to the exterior of your vehicle, for example running boards. If you use a roof rack, remember to fold it down or remove it when not in use.
- Do not shift into neutral when you are braking or when your vehicle is slowing down.
- Shut all windows when driving at high speeds.
- Switch off all electric systems when not in use, for example air conditioning. Make sure that you unplug any accessories from the auxiliary power points when not in use.

## DRIVING THROUGH MUD AND WATER



**WARNING:** Do not spin the wheels at over 34 mph (55 km/h). The tires may fail and injure a passenger or bystander.

## Mud

Be cautious of sudden changes in vehicle speed or direction when you are driving in mud. Even all-wheel drive and four-wheel drive vehicles can lose traction in mud. If your vehicle slides, steer in the direction of the slide until you regain control of your vehicle. After driving through mud, clean off residue stuck to rotating driveshafts and tires. Excess residue can cause an imbalance that could damage drive components.

**Note:** *If your vehicle gets stuck in mud, it could be rocked out by shifting between forward and reverse gears, stopping between shifts in a steady pattern. Press lightly on the accelerator in each gear.*

# Driving Hints

## Water

If you must drive through water approach it cautiously. See **Driving Through Water Limitations** (page 410).

## FLOOR MATS



**WARNING:** Use a floor mat designed to fit the footwell of your vehicle that does not obstruct the pedal area. Failure to follow this instruction could result in the loss of control of your vehicle, personal injury or death.



**WARNING:** Pedals that cannot move freely can cause loss of vehicle control and increase the risk of serious personal injury.



**WARNING:** Secure the floor mat to both retention devices so that it cannot slip out of position and interfere with the pedals. Failure to follow this instruction could result in the loss of control of your vehicle, personal injury or death.



**WARNING:** Do not place additional floor mats or any other covering on top of the original floor mats. This could result in the floor mat interfering with the operation of the pedals. Failure to follow this instruction could result in the loss of control of your vehicle, personal injury or death.



**WARNING:** Always make sure that objects cannot fall into the driver foot well while your vehicle is moving. Objects that are loose can become trapped under the pedals causing a loss of vehicle control.



To install floor mats that have eyelets, position the floor mat eyelet over the retention post and press down to lock in position. Repeat for all eyelets on the floor mat.

To remove the floor mats, reverse the installation procedure.

**Note:** *Regularly check the floor mats to make sure they are secure.*

# Snow Plowing - Vehicles With: Snow Plow Mode

## SNOW PLOWING PRECAUTIONS



**WARNING:** Modifying or adding equipment to the front of your vehicle could affect the performance of the airbag system, increasing the risk of injury. This includes the hood, bumper system, frame, front body structure, tow hooks, hood pins, push bar and snowplows.



**WARNING:** Do not attempt to service, repair, or modify the supplementary restraint system or associated components. Failure to follow this instruction could result in personal injury or death.



**WARNING:** All occupants of your vehicle, including the driver, should always properly wear their seatbelts, even when an airbag supplemental restraint system is provided. Failure to properly wear your seatbelt could seriously increase the risk of injury or death.



**WARNING:** Do not spin the wheels at over 34 mph (55 km/h). The tires may fail and injure a passenger or bystander.

**Note:** Look for an alterer's label on your vehicle from the snowplow installer certifying that the installation meets all applicable Federal Motor Vehicle Safety Standards (FMVSS).

**Note:** Federal and some local regulations require additional exterior lamps for snowplow-equipped vehicles. Contact an authorized dealer for additional information.

**Note:** Do not remove or defeat the tripping mechanisms designed into the snow removal equipment by its manufacturer. Doing so could cause damage to your vehicle and the snow removal equipment as well as possible airbag deployment.

## OPERATING YOUR VEHICLE WITH A SNOWPLOW

Weight limits and guidelines for selecting and installing the snowplow are in the Ford Truck Body Builders Layout Book. For additional information, visit [www.fordbbas.com](http://www.fordbbas.com).

A typical snowplow installation affects the following:

- Front gross axle weight rating. See **What Is the Gross Axle Weight Rating** (page 349).
- Gross vehicle weight rating. See **What Is the Gross Vehicle Weight Rating** (page 349).
- Braking and steering.
- Front wheel toe. See the **Ford Workshop Manual**.
- Headlight aim. See **Adjusting the Headlamps** (page 458).
- Tire air pressure. See **Information on the Tire Sidewall** (page 478).

**Note:** Do not exceed the front gross axle weight rating or gross vehicle weight rating.

**Note:** Your vehicle may require rear ballast weight for proper braking and steering.

Your vehicle has a driver and passenger airbag supplemental restraint system. The supplemental restraint system activates in certain frontal and offset frontal collisions when the vehicle sustains sufficient longitudinal deceleration.



## Snow Plowing - Vehicles With: Snow Plow Mode

---

When operating your vehicle with a snowplow:

- Do not exceed 45 mph (72 km/h).
- Your engine could run at a higher temperature than normal.
  - If you are driving more than 15 mi (24 km) at temperatures above freezing, angle the plow blade either full left or full right to provide maximum airflow to the radiator.
  - If you are driving less than 15 mi (24 km) at speeds up to 45 mph (72 km/h) in cold weather, you do not need to worry about blade position to provide maximum airflow.
- Shift to **4L** when plowing in small areas at speeds below 5 mph (8 km/h).
- Shift to **4H** when plowing larger areas or light snow at higher speeds above 5 mph (8 km/h). Do not exceed 15 mph (24 km/h).
- Do not shift the transmission from a forward gear to reverse (R) until the engine is at idle and the wheels have stopped.

**Note:** *Careless or high-speed driving when snowplowing, which results in significant vehicle decelerations, can deploy the airbag. Such driving also increases the risk of accidents.*

**Note:** *Drive your vehicle at least 500 mi (800 km) before using your vehicle for snowplowing.*

**Note:** *Follow the severe duty schedule for engine oil and transmission fluid change intervals. See **General Maintenance Information** (page 589).*

# Crash and Breakdown Information

---

## ROADSIDE ASSISTANCE

### Vehicles Sold in the United States: Getting Roadside Assistance

If you have a vehicle concern, Ford Motor Company offers a complimentary roadside assistance program. This program is separate from the New Vehicle Limited Warranty.

The service is available:

- 24 hours a day, seven days a week.
- For the coverage period supplied with your vehicle.

Knowing your vehicle's VIN, mileage and your specific location allows help to get to you faster.

Roadside Assistance covers:

- A flat tire change with a good spare (except vehicles supplied with a tire inflation kit).
- Battery jump start.
- Lock-out assistance (key replacement cost is the customer's responsibility).
- Fuel delivery — independent service contractors, if not prohibited by state, local or municipal law, shall deliver up to 2 gal (8 L) of gasoline or 5 gal (20 L) of diesel fuel to a disabled vehicle. Roadside assistance limits fuel delivery service to two no-charge occurrences within a 12-month period.
- Winch out — available within 100 ft (30 m) of a paved or county maintained road, no recoveries.

- Towing — independent service contractors, if not prohibited by state, local or municipal law, shall tow Ford eligible vehicles to an authorized dealer within 50 mi (80 km) of the disablement location or to the nearest authorized dealer. If a member requests a tow to an authorized dealer that is more than 50 mi (80 km) from the disablement location, the member shall be responsible for any mileage costs in excess of 50 mi (80 km). Warranty towing, non-warranty towing and collision towing are available.
- Roadside Assistance includes up to \$200 for a towed trailer if the disabled eligible vehicle requires service at the nearest authorized dealer. If the towing vehicle is operational but the trailer is not, then the trailer does not qualify for any roadside services.

### Vehicles Sold in the United States: Using Roadside Assistance

United States vehicle customers who require Roadside Assistance, call 1-800-241-3673.

If you need to arrange roadside assistance on your own, Ford Motor Company reimburses a reasonable amount for towing to the nearest dealership within 50 mi (80 km). To obtain reimbursement information, United States vehicle customers call 1-800-241-3673. Customers need to submit their original receipts.

### Vehicles Sold in Canada: Getting Roadside Assistance

If you have a vehicle concern, Ford Motor Company of Canada, Limited offers a complimentary roadside assistance program. This program is eligible within Canada or the continental United States.

The service is available 24 hours a day, seven days a week.

# Crash and Breakdown Information

This program is separate from the New Vehicle Limited Warranty, but the coverage is concurrent with the powertrain coverage period of your vehicle. Canadian roadside coverage and benefits may differ from the U.S. coverage. For complete details, see your Warranty Guide at [www.ford.com/support/warranty/](http://www.ford.com/support/warranty/).

Download the Sykes4Ford Roadside Assistance App for access to your roadside assistance services. For more information, scan here:



If you require more information, please call us in Canada at 1-800-665-2006, or visit our website at [www.ford.ca](http://www.ford.ca).

Ford Motor Company reserves the right to modify or discontinue Roadside Assistance at any time. Certain restrictions apply to Roadside Assistance benefits.

For further details, call  
**1-800-665-2006** (Canada)  
**1-800-241-3673** (United States)

## SWITCHING THE HAZARD FLASHERS ON AND OFF



The hazard flasher button is on the instrument panel. Press the button to switch the hazard flashers on if your vehicle is creating a safety hazard for other road users.

When you switch the hazard flashers on, all front and rear direction indicators flash.

**Note:** *The hazard flashers operate when the ignition is in any position, or if the key is not in the ignition. The battery loses charge and could have insufficient power to restart your vehicle.*

Press the button again to switch them off.

## JUMP STARTING THE VEHICLE

### JUMP STARTING PRECAUTIONS



**WARNING:** Batteries normally produce explosive gases which can cause personal injury. Therefore, do not allow flames, sparks or lighted substances to come near the battery. When working near the battery, always shield your face and protect your eyes. Always provide correct ventilation.



**WARNING:** Keep batteries out of reach of children. Batteries contain sulfuric acid. Avoid contact with skin, eyes or clothing. Shield your eyes when working near the battery to protect against possible splashing of acid solution. In case of acid contact with skin or eyes, flush immediately with water for a minimum of 15 minutes and get prompt medical attention. If acid is swallowed, call a physician immediately.



**WARNING:** Use only adequately sized cables with insulated clamps.



**WARNING:** Make sure that the cables are clear of any moving parts and fuel delivery system parts.



**WARNING:** Connect batteries with only the same nominal voltage.

# Crash and Breakdown Information



**WARNING:** If the engine is running while the hood is open, stay clear of moving engine components. Failure to follow this warning could result in serious personal injury or death.

Do not attempt to push-start an automatic transmission vehicle. This could cause transmission damage.

Do not disconnect the battery of the disabled vehicle. This could damage your vehicle's electrical system.

## PREPARING THE VEHICLE

Use only a 12 volt supply to start your vehicle.

Park the booster vehicle close to the hood of the disabled vehicle, making sure the two vehicles do not touch.

## JUMP STARTING THE VEHICLE

### Connecting the Jumper Cables



**WARNING:** Do not connect the negative jumper cable to any other part of your vehicle. Use the ground point.

**Note:** If you are using a jump pack or booster box, follow the manufacturer's instructions.

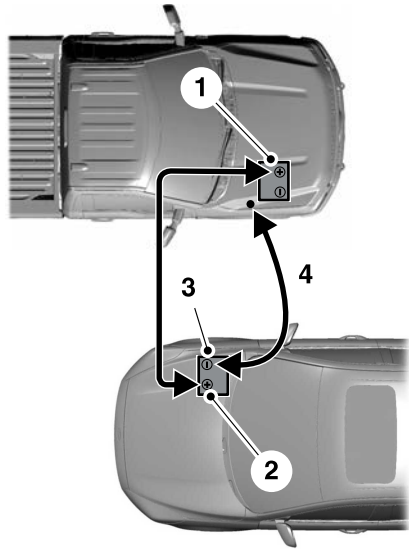

1. Pull the red rubber boot backward. Connect the positive (+) jumper cable to the positive (+) terminal of the discharged battery.
2. Connect the other end of the positive (+) jumper cable to the positive (+) terminal of the booster vehicle battery.
3. Connect the negative (-) jumper cable to the negative (-) terminal of the booster vehicle battery.
4. Make the final connection of the negative (-) jumper cable to the jump start stud as shown in the following illustration.

**Note:** Do not use the hood latch as a negative (-) connection point. This could cause springs in the latch to burn and prevent the hood from operating correctly.

# Crash and Breakdown Information

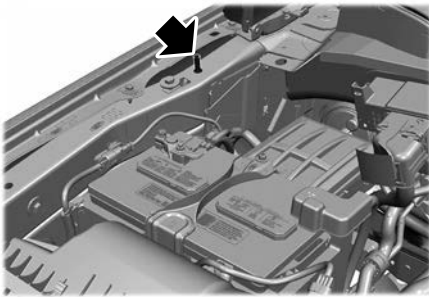

## HOW DOES THE POST-CRASH ALERT SYSTEM WORK

The system is designed to turn the hazard flashers on, turn the courtesy lamps on, intermittently sound the horn and unlock all doors in the event of a serious impact that deploys an airbag or the seatbelt pretensioners.

## POST-CRASH ALERT SYSTEM LIMITATIONS

Depending on applicable laws in the country your vehicle was built for, the horn does not sound in the event of a serious impact.

## SWITCHING THE POST-CRASH ALERT SYSTEM OFF

Press the hazard flasher switch, the unlock button on the remote control, the panic button on the remote control or cycle the ignition to switch the system off.

**Note:** *The alert turns off when the vehicle battery runs out of charge.*

## Starting the Engine

1. Start the engine of the booster vehicle and moderately rev the engine, or gently press the accelerator to keep the engine speed between 2000 RPM and 3000 RPM, as shown in your tachometer.
2. Start the engine of the disabled vehicle.
3. Once you start the disabled vehicle, run both vehicle engines for an additional three minutes before disconnecting the jumper cables.

## Removing the Jumper Cables

Remove the jumper cables in the reverse order that they were connected.

**Note:** *Do not switch the headlamps on when disconnecting the cables. The peak voltage could blow the bulbs.*

## POST-CRASH ALERT SYSTEM

### WHAT IS THE POST-CRASH ALERT SYSTEM

The system helps draw attention to your vehicle in the event of a serious impact.

## POST-COLLISION BRAKING

### How Does Post-Collision Braking Work

In the event of a moderate to severe crash, the braking system reduces the vehicle's speed to prevent or reduce the impact of a potential secondary crash.

### Post-Collision Braking Limitations

Post-collision braking does not activate if any of the following occur:

- The anti-lock braking system is damaged during the collision.
- Electronic stability control is disabled.

# Crash and Breakdown Information

## Overriding Post-Collision Braking

You can override post-collision braking by pressing the brake or accelerator pedal.

## Post-Collision Braking Indicators



It flashes when a post-collision braking event is occurring.

## AUTOMATIC CRASH SHUTOFF

### WHAT IS AUTOMATIC CRASH SHUTOFF

The automatic crash shutoff is designed to stop the fuel going to the engine in the event of a moderate or severe crash.

**Note:** *Not every impact causes a shutoff.*

### AUTOMATIC CRASH SHUTOFF PRECAUTIONS



**WARNING:** If your vehicle has been involved in a crash, have the fuel system checked. Failure to follow this instruction could result in fire, personal injury or death.

## RE-ENABLING YOUR VEHICLE

1. Switch the ignition off.
2. Attempt to start your vehicle.
3. Switch the ignition off.
4. Attempt to start your vehicle.

**Note:** *If your vehicle does not start after the third attempt, have your vehicle checked as soon as possible.*

## RECOVERY TOWING

### ACCESSING THE FRONT TOWING POINT



**WARNING:** Using recovery hooks is dangerous and should only be done by a person familiar with proper vehicle recovery safety practices. Improper use of recovery hooks may cause hook failure or separation from the vehicle and could result in serious injury or death.



**WARNING:** Slowly remove the slack from the recovery strap prior to pulling. Failure to do so can introduce significantly higher loads which can cause the recovery hooks to break off, or the recovery strap to fail which can cause serious injury or death.



**WARNING:** Never link two straps together with a clevis pin. These heavy metal objects could become projectiles if the strap breaks and can cause serious injury or death.



**WARNING:** Switch the ignition off before removing the recovery hook. Failure to do so could result in personal injury.



**WARNING:** The recovery hook can become hot. Let the recovery hook cool down before removing it. Failure to do so could result in personal injury.

Your vehicle has frame-mounted front recovery hooks.

**Note:** *Do not apply a load to the recovery hooks that is greater than the gross vehicle weight rating of your vehicle.*

# Crash and Breakdown Information

Before using recovery hooks:

- Make sure all attaching points are secure and capable of withstanding the applied load.
- Do not use chains, cables or tow straps with metal hook ends.
- Only use recovery straps that have a minimum breaking strength two to three times the gross vehicle weight of the stuck vehicle.
- Make sure the recovery strap is in good condition and free of visible cuts, tears or damage.
- Use a damper device such as a tarp, heavy blanket or piece of carpet, and place it over the recovery strap to help absorb the energy in the event the strap breaks.
- Make sure the stuck vehicle is not loaded heavier than its gross vehicle weight rating specified on the certification label.
- Align the tow vehicle and stuck vehicle in a straight line, within 10 degrees.
- Keep bystanders to the sides of the vehicle, at a distance of at least twice the length of the recovery strap. This helps avoid injury from the hazard of a recovery hook or strap breaking, or a vehicle lurching into their path.

**Note:** Use towing equipment that is properly rated for your vehicle. Always carefully follow the instructions and warnings provided by the equipment manufacturer.

## TRANSPORTING THE VEHICLE

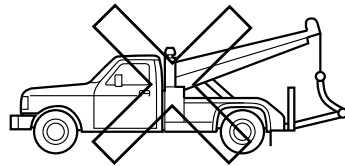
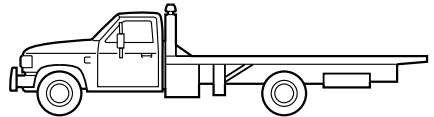
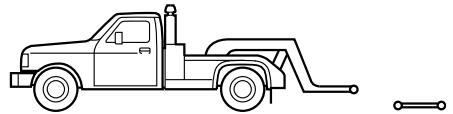

If you need to tow your vehicle, contact a professional towing service or your roadside assistance service provider.

Your manufacturer produces a towing manual for all authorized tow truck operators. Have your tow truck operator refer to this manual for proper hook-up and towing procedures.

We recommend the use of a wheel lift and dollies or flatbed equipment to tow your vehicle. Vehicle damage could occur if towed incorrectly, or by any other means.

Front-wheel and rear-wheel drive vehicles must have their designated drive wheels off the ground regardless of towing direction. Use tow dollies to prevent damage to the transmission.

# Crash and Breakdown Information

All-wheel or four-wheel drive vehicles require that all wheels be off the ground using a wheel lift and dollies or flatbed equipment. This prevents damage to the transmission and drive system.

**Note:** You need to switch on the ignition to unlock the steering.

**Note:** Make sure you check the steering column before towing. It could lock if the battery is dead.

## FAIL-SAFE COOLING

### WHAT IS FAIL-SAFE COOLING

Fail-safe cooling allows you to temporarily drive your vehicle before any incremental component damage occurs due to overheating.

The fail-safe distance depends on outside temperature, vehicle load and terrain.

### HOW DOES FAIL-SAFE COOLING WORK

If the engine reaches a preset over-temperature condition, the engine automatically switches to alternating cylinder operation. Each disabled cylinder acts as an air pump and cools the engine.

When this occurs, your vehicle still operates, however:

- Engine power is limited.
- The air conditioning system turns off.

Continued operation increases the engine temperature, causing the engine to completely shut down. Your steering and braking effort increases in this situation.

When the engine temperature cools, you can re-start the engine.

**Note:** Have your vehicle checked as soon as possible to minimize engine damage.

## DRIVING WHEN FAIL-SAFE MODE IS ACTIVATED



**WARNING:** Fail-safe mode is for use during emergencies only. Operate your vehicle in fail-safe mode only as long as necessary to bring your vehicle to rest in a safe location and seek immediate repairs. When in fail-safe mode, your vehicle will have limited power, will not be able to maintain high-speed operation, and may completely shut down without warning, potentially losing engine power, power steering assist, and power brake assist, which may increase the possibility of a crash resulting in serious injury.



**WARNING:** Do not remove the coolant reservoir cap when the engine is on or the cooling system is hot. Wait 10 minutes for the cooling system to cool down. Cover the coolant reservoir cap with a thick cloth to prevent the possibility of scalding and slowly remove the cap. Failure to follow this instruction could result in personal injury.

Continued operation increases the engine temperature, causing the engine to completely shut down. Your steering and braking effort increases in this situation.

When the engine temperature cools, you can re-start the engine. Have your vehicle checked as soon as possible to minimize engine damage.

Your vehicle has limited engine power when in the fail-safe mode, drive your vehicle with caution. Your vehicle does not maintain high-speed operation and the engine may operate poorly.

Remember that the engine is capable of automatically shutting down to prevent engine damage. In this situation:



# Crash and Breakdown Information

---

1. Pull off the road as soon as safely possible and switch the engine off.
2. If you are a member of a roadside assistance program, we recommend that you contact your roadside assistance service provider.
3. If this is not possible, wait for a short period of time for the engine to cool.
4. Check the coolant level. If the coolant level is at or below the minimum mark, add prediluted coolant immediately.
5. When the engine temperature cools, you can re-start the engine. Have your vehicle checked as soon as possible to minimize engine damage.

**Note:** *Driving your vehicle without repair increases the chance of engine damage.*

## FAIL-SAFE COOLING INDICATORS



If the engine begins to overheat, the coolant temperature gauge moves toward the red zone.



A warning lamp illuminates and a message may appear in the instrument cluster display.

# Towing Your Vehicle

## TOWING YOUR VEHICLE PRECAUTIONS

Use the following guidelines when towing your vehicle. Failure to follow this instruction could result in vehicle damage not covered by the vehicle warranty.

**Note:** Make sure you properly secure your vehicle to the tow vehicle.

**Note:** If you are unsure of the vehicle's configuration, contact an authorized dealer.

## RECREATIONALLY TOWING YOUR VEHICLE - 4X4



**WARNING:** Do not disconnect the battery when recreationally towing your vehicle. This prevents the transfer case from shifting properly and could cause the vehicle to roll, even if the transmission is in park (P).



**WARNING:** Placing the transfer case in its neutral position could cause your vehicle to freely roll. Make sure you press and hold the brake pedal and the vehicle is in a secure, safe position when you place the transfer case in its neutral position.

Follow these guidelines if you have a need for recreational towing. An example of recreational towing would be towing your vehicle behind a motorhome. These guidelines are to make sure that you do not damage the transmission.

You can only tow your vehicle with all wheels on the ground by placing the transfer case in its neutral position and engaging the neutral tow feature. Perform the following steps after positioning your vehicle behind the tow vehicle and properly securing them together.

**Note:** Put your climate control system in recirculated air mode to prevent exhaust fumes from entering your vehicle.

**Note:** Failure to put the transfer case in its neutral position can damage vehicle components.

**Note:** You can check the towing status at any time by opening the driver door or turning the ignition to the accessory or on position. **Neutral Tow Enabled Leave Transmission in Neutral** appears in the instrument cluster display to confirm you can recreationally tow your vehicle.

**Note:** If your vehicle has an anti-theft alarm, make sure you switch perimeter sensing off when towing. See **Setting the Alarm Security Level** (page 101).

### Switching Neutral Tow On

1. Place your vehicle in accessory mode by pressing the push button ignition switch once without pressing the brake pedal or by turning the ignition key to the on position.
2. Press and hold the brake pedal.
3. Press the **2H** button on the four-wheel drive mode control.
4. Shift the transmission into neutral (N).
5. Using the instrument cluster controls on the steering wheel, select **Settings**.
6. Select **Neutral Tow**.
7. Press and hold the **OK** button until a confirmation message appears in the information display.

**Note:** If completed successfully, the information display shows **Neutral Tow Enabled Leave Transmission in Neutral**. This indicates that your vehicle is safe to tow with all wheels on the ground.

**Note:** If you do not see a confirmation message in the instrument cluster display, you must perform the procedure again from the beginning.

# Towing Your Vehicle

---

**Note:** You may hear noise as the transfer case shifts into its neutral position. This is normal.

8. Release the brake pedal and leave the transmission in neutral (N) and switch your vehicle off by pressing the push button ignition switch once without pressing the brake pedal or turning the key as far toward the off position.

**Note:** Vehicles with keys do not turn to the off position when the transmission is in neutral (N). You must leave the key in the ignition when towing. Use the keyless entry keypad or an extra set of keys to lock and unlock your vehicle.

## Switching Neutral Tow Off

1. With your vehicle properly secured to the tow vehicle, place your vehicle in accessory mode by pressing the push button ignition switch once without pressing the brake pedal or by turning the ignition key to the on position.
2. Press and hold the brake pedal.
3. Shift the transmission to Park (P) and continue holding the brake pedal until the instrument cluster display shows 2H and Neutral Tow Disabled.
4. Release the brake pedal.

**Note:** If completed successfully, the instrument cluster displays **2H** and **Neutral Tow Disabled**.

**Note:** You must perform the switching neutral tow on and switching neutral tow off procedures again from the beginning if the indicator light and message do not display.

**Note:** You may hear a noise as the transfer case shifts out of its neutral position. This is normal.

5. Apply the parking brake, then disconnect your vehicle from the tow vehicle.

6. Release the parking brake, start the engine, and shift into drive (D) to make sure the transfer case is out of the neutral tow position.
7. If the transfer case does not successfully shift out of its neutral position, set the parking brake. Have your vehicle checked as soon as possible.

## Resolving the Shift Delayed Pull Forward Message

1. Press and hold the brake pedal.
2. Start your vehicle.
3. Shift into neutral (N).
4. With the vehicle running, shift into drive (D) and let the vehicle roll forward up to 3 ft (1 m).

**Note:** You may hear a noise as the transfer case shifts out of its neutral position. This is normal.

5. Make sure the instrument cluster displays **Neutral Tow Disabled**.

## RECREATIONALLY TOWING YOUR VEHICLE - 4X2

You cannot recreational tow your vehicle with all wheels on the ground because vehicle or transmission damage could occur. You must recreational tow your vehicle with all four wheels off the ground, such as when using a car-hauling trailer. Otherwise, you cannot recreational tow your vehicle.

# Towing Your Vehicle

## EMERGENCY TOWING

If your vehicle becomes inoperable without access to wheel dollies or a vehicle transport trailer, it can be flat-towed with all wheels on the ground, regardless of the powertrain and transmission configuration, under the following conditions:

- Your vehicle is facing forward for towing in a forward direction.
- The transmission is in neutral (N).
- Maximum speed is 35 mph (56 km/h).
- Maximum distance is 50 mi (80 km).

## TOWING YOUR VEHICLE – TROUBLESHOOTING

### TOWING YOUR VEHICLE – INFORMATION MESSAGES

Message	Details
Neutral Tow Enabled Leave Transmission in Neutral	The transfer case is in the neutral position and your vehicle is safe to tow with all four wheels on the ground.
Shift Delayed Drive Forward	There is a transfer case gear tooth blockage present. With your vehicle on, shift the transmission into drive (D) and let the vehicle roll forward, up to 3 ft (1 m).
Neutral Tow Disabled	The transfer case is not in the neutral position and your vehicle is not safe to tow with all four wheels on the ground.

# Fuses

## FUSE PRECAUTIONS



**WARNING:** Always disconnect the battery before servicing high current fuses.



**WARNING:** To reduce risk of electrical shock, always replace the cover to the power distribution box before reconnecting the battery or refilling fluid reservoirs.



**WARNING:** Always replace a fuse with one that has the specified amperage rating. Using a fuse with a higher amperage rating can cause severe wire damage and could start a fire.

## ACCESSING THE UNDER HOOD FUSE BOX

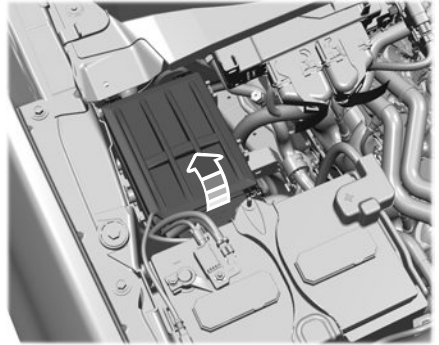

## UNDER HOOD FUSE BOX

### LOCATING THE UNDER HOOD FUSE BOX

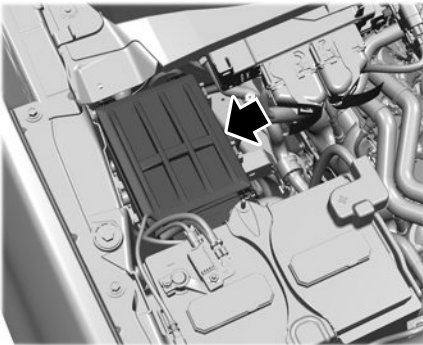

# Fuses

## IDENTIFYING THE FUSES IN THE UNDER HOOD FUSE BOX

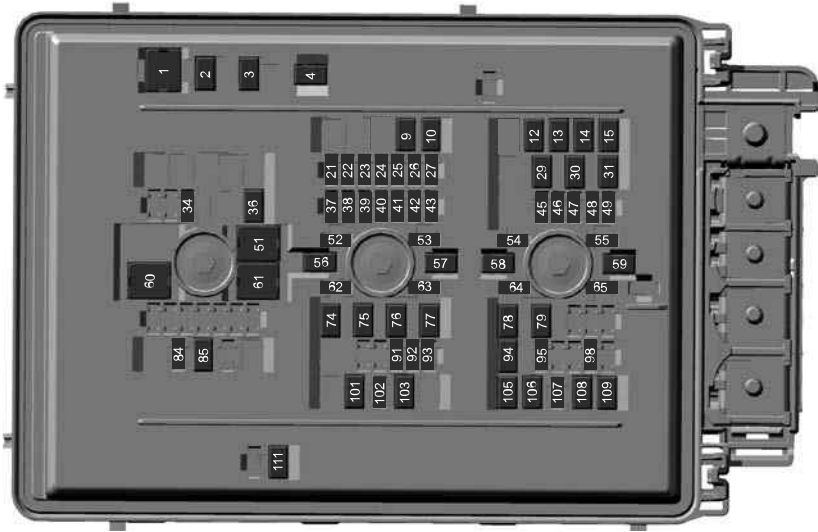

Item	Rating	Protected Component
1	50 A	Cooling fan 1.
2	50 A	Heater.
3	50 A	Heater.
4	50 A	Heater.
9	30 A	Four-wheel drive module.
10	30 A	Compressed natural gas module switch.
12	60 A	Anti-lock brake system pump.
13	30 A	Passenger power seat.
14	40 A	Anti-lock brake system valve.

# Fuses

<b>Item</b>	<b>Rating</b>	<b>Protected Component</b>
15	30 A	Body control module RP2 bus.
21	10 A	Trailer tow backup lamps.
22	10 A	Four-wheel drive system.
23	20 A	Vehicle power 1.
24	20 A	Vehicle power 2 (gas).
	10 A	Vehicle power 2 (diesel).
25	15 A	Vehicle power 3 (gas).
	10 A	Vehicle power 3 (diesel).
26	20 A	Vehicle power 4.
27	10 A	Vehicle power 5 (gas).
	20 A	Vehicle power 5 (diesel).
29	15 A	Diesel exhaust fluid tank heater.
30	15 A	Diesel exhaust fluid line heater.
31	15 A	Glow plug and dosing module.
34	20 A	Rear heated seats.
36	30 A	Climate controlled seat module.
37	5 A	24 V alternator.
38	10 A	Powertrain control module. Transmission control module.
39	10 A	Anti-lock brake system.
40	10 A	Electronic power assist steering.
41	10 A	Blind spot information system.

# Fuses

Item	Rating	Protected Component
		Trailer tow tire pressure monitoring system. Rear electronic module controller area network.
42	10 A	Snowplow.
43	15 A	Interior power distribution box run/start.
45	15 A	Heated steering wheel.
46	20 A	Not used (spare).
47	5 A	Not used (spare).
48	30 A	Amplifier.
49	25 A	Not used (spare).
51	40 A	Blower motor.
52	—	Not used.
53	10 A	Four-wheel drive - transfer case control module.
54	10 A	Not used (spare).
55	10 A	Not used (spare).
56	40 A	Electronic power assist steering.
57	20 A	Trailer tow lighting module.
58	50 A	Customer interface module.
59	60 A	Inverter.
60	60 A	Interior power distribution box B+.
61	30 A	Vehicle battery 2.
62	5 A	Smart trailer hitch.
63	10 A	Smart data link connector. Enhanced central gateway.
64	5 A	Glow plug relay coil (diesel).



# Fuses

<b>Item</b>	<b>Rating</b>	<b>Protected Component</b>
65	10 A	Compressed natural gas module power.
74	30 A	Trailer brake control. Aftermarket e-brake access.
75	30 A	Compressed natural gas powered at all times.
76	25 A	Trailer tow lighting module battery charge.
77	30 A	Vehicle battery 1.
78	20 A	Power point 2.
79	20 A	Power point 1.
84	20 A	Horn.
85	40 A	Heated rear windshield.
91	5 A	Headlamp control module.
92	15 A	Left-hand headlamp.
93	15 A	Right-hand headlamp.
94	20 A	Power point 3.
95	20 A	Power point 4. Smart charge module.
98	10 A	Tailgate release.
101	50 A	Customer interface module.
102	5 A	Rain sensor.
103	30 A	Front wiper motor.
105	30 A	Fuel pump.
106	30 A	Body control module RPI bus.
107	25 A	Trailer tow park lamps.

# Fuses

Item	Rating	Protected Component
108	40 A	Driver power seat.
109	30 A	Starter motor.
111	30 A	Power sliding rear window.

## INTERIOR FUSE BOX

### LOCATING THE INTERIOR FUSE BOX

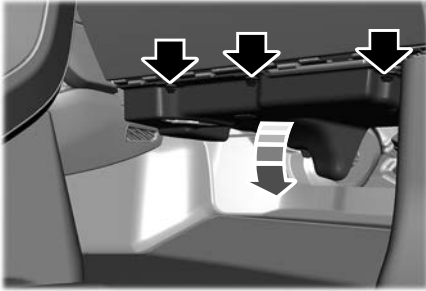

## ACCESSING THE INTERIOR FUSE BOX

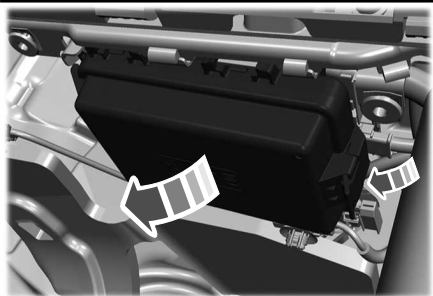
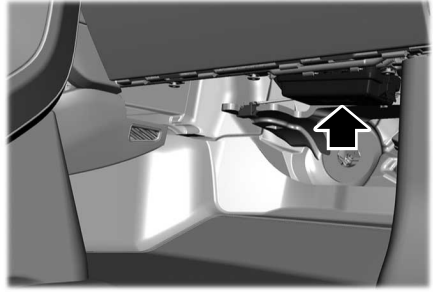

# Fuses

## IDENTIFYING THE FUSES IN THE INTERIOR FUSE BOX

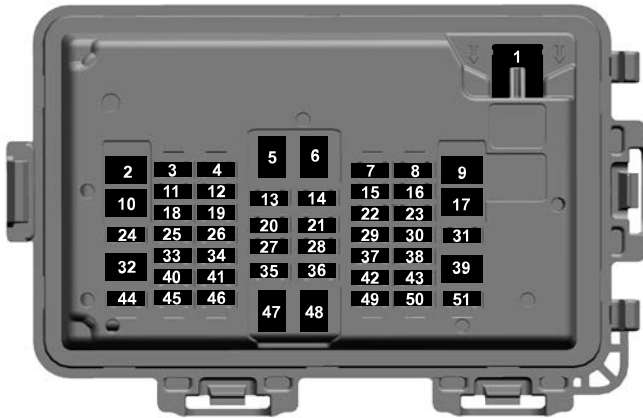

Item	Rating	Protected Component
1	30 A	Power windows.
2	30 A	Powered tailgate module.
3	30 A	Passenger door module.
4	15 A	Multi-contour seats.
5	—	Not used.
6	—	Not used.
7	20 A	Advanced driver assistance system module.
8	10 A	Delayed accessory logic.
9	—	Not used.
10	—	Not used.
11	5 A	Instrument cluster.
12	—	Not used.
13	7.5 A	Not used (spare).

## Fuses

Item	Rating	Protected Component
14	15 A	SYNC.
15	5 A	Center high-mounted stop lamp camera.
16	—	Not used.
17	—	Not used.
18	10 A	Radio transceiver module. Four-wheel drive switch. Enhanced central gateway.
19	—	Not used.
20	5 A	Inverter.
21	5 A	Upfitter switch.
22	10 A	Auxiliary camera.
23	—	Not used.
24	30 A	Moonroof.
25	5 A	Not used (spare).
26	5 A	Not used (spare).
27	5 A	Trailer brake control switch.
28	5 A	Electrochromatic mirror.
29	5 A	Heating, ventilation and air conditioning.
30	—	Not used.
31	—	Not used.
32	—	Not used.
33	10 A	Brake on-off switch.
34	7.5 A	Steering column control module. Instrument cluster.
35	5 A	Rear heated seats.
36	7.5 A	Manual shift. Select shift switch.

# Fuses

<b>Item</b>	<b>Rating</b>	<b>Protected Component</b>
37	5 A	Head up display.
38	7.5 A	Telematics control unit.
39	—	Not used.
40	10 A	Left-hand door switch. Telescopic exterior mirror switch.
41	10 A	Adjustable pedals.
42	5 A	Central security module.
43	5 A	Headlamps. Ignition switch.
44	30 A	Driver door module.
45	7.5 A	Wireless accessory charger module. Driver front seat module.
46	20 A	Radio.
47	—	Not used.
48	—	Not used.
49	7.5 A	SYNC display screen.
50	5 A	Auxiliary smart data link connector.
51	—	Not used.

# Fuses

## IDENTIFYING FUSE TYPES

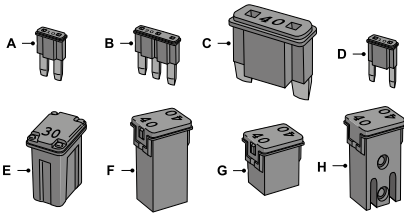

- A Micro 2.
- B Micro 3.
- C Maxi.
- D Mini.
- E M Case.
- F J Case.
- G J Case Low Profile.
- H Slotted M Case.

## FUSES – TROUBLESHOOTING

### FUSES – FREQUENTLY ASKED QUESTIONS

#### When do I need to check a fuse?

- If electrical components in the vehicle are not working.

#### When do I need to replace a fuse?

- If a fuse has blown.

#### How do I identify a blown fuse?

- You can identify a blown fuse by a broken wire within the fuse.

# Maintenance

## MAINTENANCE PRECAUTIONS

Service your vehicle regularly to help maintain its roadworthiness and resale value. There is a large network of authorized dealers that are there to help you with their professional servicing expertise. We believe that their specially trained technicians are best qualified to service your vehicle properly and expertly. They are supported by a wide range of highly specialized tools developed specifically for servicing your vehicle.

If your vehicle requires professional service, an authorized dealer can provide the necessary parts and service. Check your warranty information to find out which parts and services are covered.

Use only recommended fuels, lubricants, fluids and service parts conforming to specifications. See **Capacities and Specifications** (page 520).

- Do not work on a hot engine.
- Make sure that nothing gets caught in moving parts.
- Do not work on a vehicle with the engine running in an enclosed space, unless you are sure you have enough ventilation.
- Keep all open flames and other burning material, such as cigarettes, away from the battery and all fuel related parts.
- Set the parking brake, shift the transmission to park (P) and block the wheels.

## OPENING AND CLOSING THE HOOD

1. Inside the vehicle, pull the hood release handle located under the left hand side of the instrument panel.

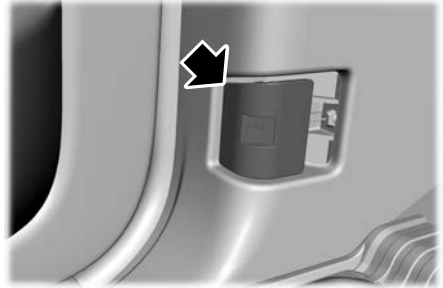

2. Go to the front of your vehicle and locate the secondary release lever under the front of the hood near the center of your vehicle.

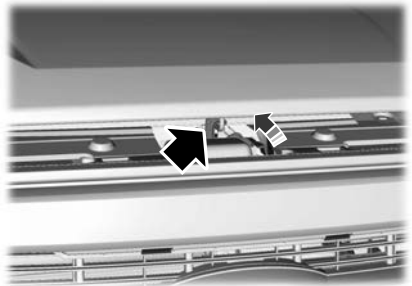

3. Raise the hood until the lift cylinders hold it open.
4. To close, lower the hood and make sure that it is closed properly and fully latched.

# Maintenance

## UNDER HOOD OVERVIEW - 6.7L DIESEL

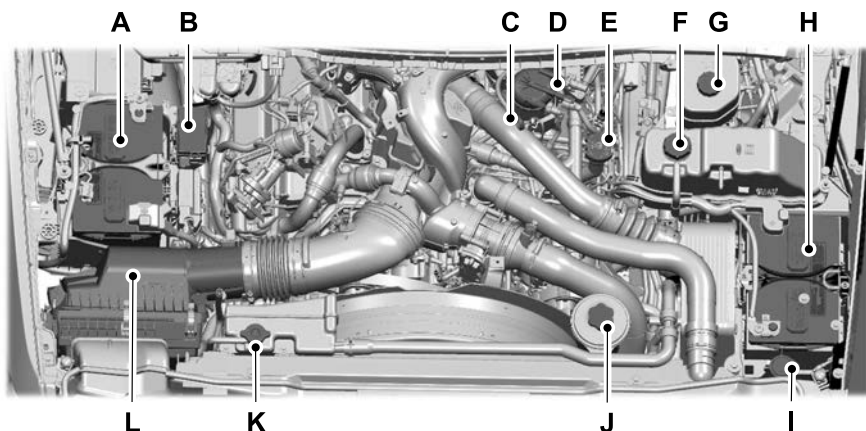

- A Battery. See **Changing the 12V Battery** (page 456).
- B Under hood fuse box. See **Accessing the Under Hood Fuse Box** (page 429).
- C Engine oil dipstick. See **Engine Oil Dipstick Overview** (page 443).
- D Secondary fuel filter. See **Changing the Fuel Filter** (page 452).
- E Engine oil filler cap. See **Checking the Engine Oil Level** (page 443).
- F Engine cooling system coolant reservoir - primary high-temperature cooling system. See **Checking the Coolant Level** (page 449).
- G Brake fluid reservoir. See **Checking the Brake Fluid** (page 246).
- H Battery. See **Changing the 12V Battery** (page 456).
- I Windshield washer fluid reservoir. See **Adding Washer Fluid** (page 112).
- J Power steering fluid reservoir. See **Checking the Hydraulic Power Steering Fluid** (page 278).
- K Secondary cooling system coolant reservoir. See **Checking the Coolant Level** (page 449).
- L Air filter assembly. See **Changing the Engine Air Filter** (page 444).



# Maintenance

## UNDER HOOD OVERVIEW - 6.8L, GASOLINE

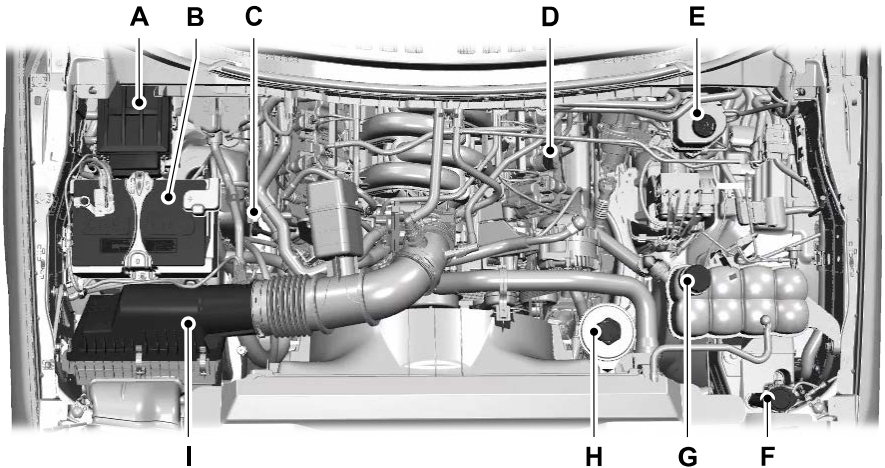

- A Engine compartment fuse box. See **Locating the Under Hood Fuse Box** (page 429).
- B Battery. See **Changing the 12V Battery** (page 456).
- C Engine oil dipstick. See **Engine Oil Dipstick Overview** (page 443).
- D Engine oil filler cap. See **Checking the Engine Oil Level** (page 443).
- E Brake fluid reservoir. See **Checking the Brake Fluid** (page 246).
- F Windshield washer fluid reservoir. See **Adding Washer Fluid** (page 112).
- G Engine coolant reservoir. See **Checking the Coolant Level** (page 449).
- H Power steering fluid reservoir. See **Checking the Hydraulic Power Steering Fluid** (page 278).
- I Air cleaner assembly. See **Changing the Engine Air Filter** (page 444).

# Maintenance

## UNDER HOOD OVERVIEW - 7.3L, GASOLINE

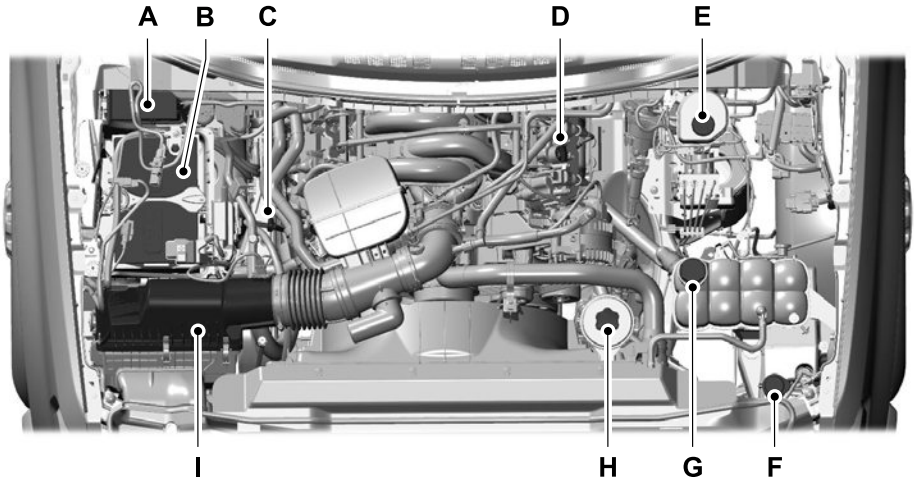

- A Under hood fuse box. See **Accessing the Under Hood Fuse Box** (page 429).
- B Battery. See **Changing the 12V Battery** (page 456).
- C Engine oil dipstick. See **Engine Oil Dipstick Overview** (page 443).
- D Engine oil filler cap. See **Adding Engine Oil** (page 444).
- E Brake fluid reservoir. See **Checking the Brake Fluid** (page 246).
- F Windshield washer fluid reservoir. See **Adding Washer Fluid** (page 112).
- G Engine coolant reservoir. See **Checking the Coolant Level** (page 449).
- H Power steering fluid reservoir. See **Checking the Hydraulic Power Steering Fluid** (page 278).
- I Air cleaner assembly. See **Changing the Engine Air Filter** (page 444).

# Maintenance

## ENGINE OIL

### ENGINE OIL DIPSTICK OVERVIEW - DIESEL

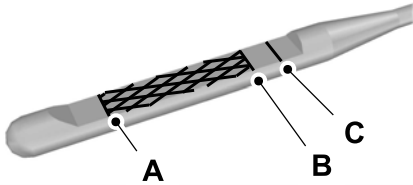

- A Minimum.
- B Nominal.
- C Maximum.

### ENGINE OIL DIPSTICK OVERVIEW - GASOLINE

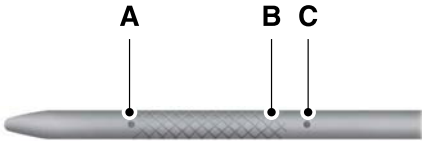

- A Minimum.
- B Nominal.
- C Maximum.

## CHECKING THE ENGINE OIL LEVEL

1. Make sure that your vehicle is on level ground.
2. Check the oil level before starting the engine, or switch the engine off after warm up and wait 15 minutes for the oil to drain into the oil pan.

**Note:** *Checking the oil level too soon could result in an inaccurate reading.*

3. Remove the dipstick and wipe it with a clean, lint-free cloth.
4. Reinstall the dipstick and make sure it is fully seated.
5. Remove the dipstick again to check the oil level.

**Note:** *Read both sides of the dipstick and use the lowest oil level as the correct reading.*

**Note:** *If the oil level is between the maximum and minimum marks, the oil level is acceptable. Do not add oil.*

6. If the oil level is at the minimum mark, immediately add oil.
7. Reinstall the dipstick. Make sure it is fully seated.

**Note:** *The oil consumption of new engines reaches its normal level after approximately 3,000 mi (5,000 km).*

**Note:** *Increases in oil level can occur from frequent short trips that do not allow the engine to get to operating temperature, as well as frequent idling or low speed driving for long periods of time.*

**Note:** *If oil levels are continuously noted above the maximum mark, have your vehicle checked as soon as possible.*

# Maintenance

## ADDING ENGINE OIL



**WARNING:** Do not remove the filler cap when the engine is running.



**WARNING:** Do not add engine oil when the engine is hot. Failure to follow this instruction could result in personal injury.

Do not use supplemental engine oil additives because they are unnecessary and could lead to engine damage that the vehicle warranty may not cover.

1. Clean the area surrounding the engine oil filler cap before you remove it.
2. Remove the engine oil filler cap.
3. Add engine oil that meets our specifications. See **Capacities and Specifications** (page 520).
4. Reinstall the engine oil filler cap. Turn it clockwise until you feel a strong resistance.

**Note:** *Do not add oil further than the maximum mark. Oil levels above the maximum mark may cause engine damage.*

**Note:** *Immediately soak up any oil spillage with an absorbent cloth.*

## INTELLIGENT OIL LIFE MONITOR

Under certain conditions the vehicle's intelligent oil life monitor may determine your oil requires replacement prior to your general service. Should this occur it is recommended you replace your oil within two weeks or 500 mi (800 km) of being alerted.

Your authorized dealer will be able to advise you whether only an engine oil and filter change is recommended or whether you should complete your general service inclusive of oil and oil filter.

## RESETTING THE INTELLIGENT OIL LIFE MONITOR

1. Press the Menu button on the steering wheel to enter the instrument cluster display main menu.
2. Select **Vehicle Maintenance**.
3. Select **Oil Life**.
4. Press and hold the **OK** button until the system reset confirmation appears.

## ENGINE OIL CAPACITY AND SPECIFICATION

For filling information, please refer to the Capacities and Specifications section of your owner's manual. See **Capacities and Specifications** (page 520).

## ENGINE AIR FILTER

### CHANGING THE ENGINE AIR FILTER



**WARNING:** To reduce the risk of vehicle damage and personal burn injuries, do not start your engine with the air cleaner removed and do not remove it while the engine is running.

Use the correct specification air filter element. See **Engine Air Filter** (page 444).

**Note:** *Failure to use the correct air filter element may result in severe engine damage not covered by the vehicle warranty.*

Change the air filter element at the correct service interval. See **Scheduled Maintenance** (page 589).

# Maintenance

Your vehicle may be equipped with an electronic engine air filter maintenance minder. The air filter minder provides optimized service intervals and reminders based on driving habits and environmental conditions.

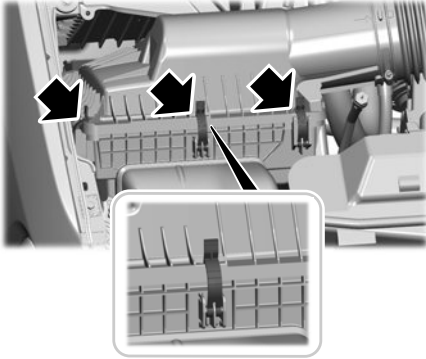

1. Clean any loose dirt or debris around the air filter housing.
2. Disconnect the mass air flow sensor electrical connector, if required.
3. Remove the three clips that secure the air filter housing cover. Remove the air filter housing cover. Disconnect and pull the air intake tube away, as needed.

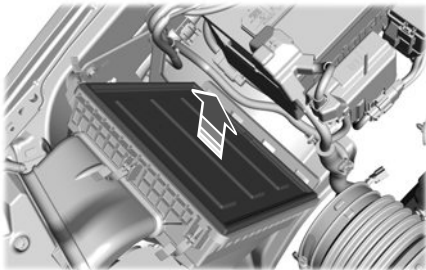

4. Remove the air filter element from the air filter housing.
5. Inspect the air filter element for any damage. Replace the air filter element if the seal, paper, foam or steel mesh has any holes, cuts or gouges.
6. Inspect the air filter housing for dirt, dust, snow, ice or debris in the air cleaner tray.
7. Reverse the removal procedure to install. You can oscillate the housing cover slightly left to right as needed until you are able to engage all three clips.

**Note:** For diesel applications, make sure the arrow on the new air filter element points toward the front of the vehicle.

After operating your vehicle during heavy snowfall or extreme rain, do the following:

- Snow: At the earliest opportunity, open the hood, clear any snow and ice from the air filter housing inlet.
- Extreme rain: Allow the air filter element to dry out for approximately 15–30 minutes of driving at highway speeds.

**Note:** Do not remove the foam block from the air cleaner tray.

## RESETTING THE AIR FILTER REMINDER

1. Press the menu button on the steering wheel to enter the instrument cluster display main menu.
2. Select **Vehicle Maintenance**.
3. Select **Engine Air Filter**.
4. Press and hold the **OK** button until the system reset confirmation appears.

**Note:** The system displays 100% after being successfully reset.

# Maintenance

## ENGINE AIR FILTER – INFORMATION MESSAGES

Message	Details
Replace Engine Air Filter Soon	Replace the engine air filter at the earliest opportunity.
Replace Engine Air Filter Now	Indicates an air filter at the end of useful life. After engine air filter replacement, you must reset the system in order to change the status. See <b>Resetting the Air Filter Reminder</b> (page 445).
Check Engine Air Filter See Manual	Indicates that there is a higher-than-expected restriction across the engine air filter, which could represent an air filter at the end of useful life or a filter with an obstruction. When this displays, inspect the engine air filter and replace if necessary. If you do not replace the air filter, there is no need for you to reset the air filter minder. The system resets the minder after you clear the obstruction and drive your vehicle for about an hour. If you replace the air filter, you need to reset the minder to change the status. See <b>Resetting the Air Filter Reminder</b> (page 445).
Engine Air Filter Fault See Manual	Indicates that there is an error within the electronic air filter maintenance minder system requiring service.
Engine Power Reduced Inspect Air Filter	When this displays, inspect the engine air filter and replace if necessary. If you do not replace the air filter, there is no need for you to reset the air filter minder. The system resets the minder after you clear the obstruction and drive your vehicle for about an hour. If you replace the air filter, you need to reset the minder to change the status. See <b>Resetting the Air Filter Reminder</b> (page 445).

## DRAINING THE FUEL FILTER WATER TRAP - DIESEL



**WARNING:** Do not drain the water-in-fuel separator while the engine is running. Failure to follow this warning may result in fire, serious injury, death or property damage.



**WARNING:** Do not dispose of fuel in the household refuse or the public sewage system. Use an authorized waste disposal facility.

Your vehicle has a diesel fuel conditioner module. The module is mounted between the outboard side of the fuel tank and the frame rail.

**Note:** The module is at the front of the fuel tank or at the front of the aft-axle fuel tank on some models.

# Maintenance



You should drain water from the module assembly whenever the warning light illuminates or a message appears in the information display advising you to drain the water separator. This occurs when approximately 6.76 fl oz (200 ml) of water accumulates in the module. If you allow the water level

to exceed this level, the water may pass through to the engine and may cause fuel injection equipment damage.

## Filter Location

Use the tables below to find the location of your filter.

### Pick-up Truck

Cab Type	Box Length	Filter Location
Regular.	8 ft (2.4 m)	Left side of fuel tank.
SuperCab.	6.75 ft (2.057 m)	
	8 ft (2.4 m)	In front of fuel tank.
Super Crew Cab.	6.75 ft (2.057 m)	Left side of fuel tank.
	8 ft (2.4 m)	

### Chassis Cab

Cab Type	Fuel Tank Type	Filter Location
Chassis Cab.	Single midship fuel tank	Right side of fuel tank.
Chassis Cab.	Aft axle/midship fuel tanks	Right side of midship fuel tank.
Chassis Cab.	Single aft axle fuel tank	Front of fuel tank.

## Draining the Diesel Fuel Conditioner Module

1. Switch the engine off.
2. Access the underside of your vehicle.

# Maintenance

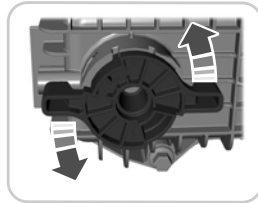
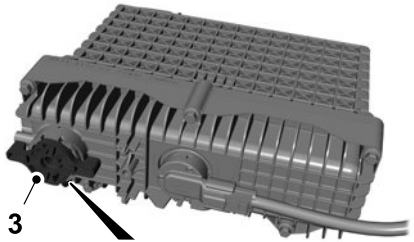
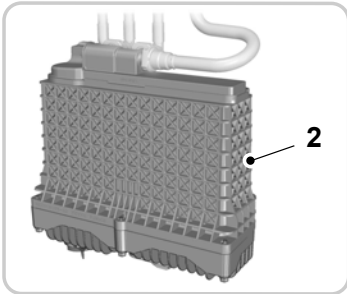
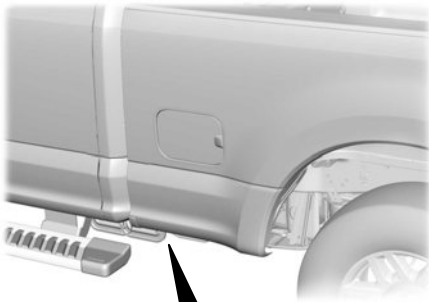

3. Use the table to find the location of your fuel filter.

4. Drain the diesel fuel conditioner module. Turn the drain plug counterclockwise until it stops. Do not use any tools to loosen the drain plug. Drain the filter, approximately 0.5 gal (2 L), into an appropriate container. Do not re-use the fuel drained from the module.
5. Tighten the drain plug, turn it clockwise until it stops and you feel a strong resistance. Do not use any tools to tighten the drain plug.
6. Prime the system by turning the key to the on position for 30 seconds. Turn the key to the off position, then the on position again for another 30 seconds. Repeat this twice.



# Maintenance

## COOLANT

### CHECKING THE COOLANT LEVEL



**WARNING:** Do not remove the coolant reservoir cap when the engine is on or the cooling system is hot. Wait 10 minutes for the cooling system to cool down. Cover the coolant reservoir cap with a thick cloth to prevent the possibility of scalding and slowly remove the cap. Failure to follow this instruction could result in personal injury.



**WARNING:** To reduce the risk of personal injury, make sure the engine is cool before unscrewing the coolant pressure relief cap. The cooling system is under pressure. Steam and hot liquid can come out forcefully when you loosen the cap slightly.

When the engine is cold, check the concentration and level of the coolant at the intervals listed in the scheduled maintenance information. See **Scheduled Maintenance** (page 589).

**Note:** Make sure that the coolant level is between the **MIN** and the **MAX** marks on the coolant reservoir.

**Note:** Coolant expands when it is hot. The level may extend beyond the **MAX** mark. This is normal.

Maintain coolant concentration within 48% to 50%, which equates to a freeze point between -29°F (-34°C) and -35°F (-37°C). Coolant concentration should be checked using a refractometer. We do not recommend the use of hydrometers or coolant test strips for measuring coolant concentration.

## ADDING COOLANT



**WARNING:** Do not add coolant when the vehicle is on or the cooling system is hot. Failure to follow this instruction could result in personal injury.



**WARNING:** Do not remove the coolant reservoir cap when the engine is on or the cooling system is hot. Wait 10 minutes for the cooling system to cool down. Cover the coolant reservoir cap with a thick cloth to prevent the possibility of scalding and slowly remove the cap. Failure to follow this instruction could result in personal injury.



**WARNING:** Do not allow the fluid to touch your skin or eyes. If this happens, rinse the affected areas immediately with plenty of water and contact your physician.



**WARNING:** Do not put coolant in the windshield washer reservoir. If sprayed on the windshield, coolant could make it difficult to see through the windshield.



**WARNING:** Do not add coolant further than the **MAX** mark.

**Note:** Do not use stop leak pellets, cooling system sealants, or non-specified additives as they can cause damage to the engine cooling or heating systems. Resulting component damage may not be covered by the vehicle Warranty.

**Note:** Automotive fluids are not interchangeable.

# Maintenance

---

It is very important to use prediluted coolant approved to the correct specification in order to avoid plugging the small passageways in the engine cooling system. See **Capacities and Specifications** (page 520). Do not mix different colors or types of coolant in your vehicle. Mixing of engine coolants or using an incorrect coolant may harm the engine or cooling system components and may not be covered by the vehicle Warranty.

**Note:** *If prediluted coolant is not available, use the approved concentrated coolant diluting it to 50/50 with deionised or distilled water. See **Capacities and Specifications** (page 520). Using water that has not been deionised may contribute to deposit formation, corrosion and plugging of the small cooling system passageways.*

**Note:** *Coolants marketed for all makes and models may not be approved to our specifications and may cause damage to the cooling system. Resulting component damage may not be covered by the vehicle Warranty.*

If the coolant level is at or below the minimum mark, add prediluted coolant immediately.

To top up the coolant level do the following:

1. Unscrew the cap slowly. Any pressure escapes as you unscrew the cap.
2. Add prediluted coolant approved to the correct specification. See **Capacities and Specifications** (page 520).
3. Add enough prediluted coolant to reach the correct level.
4. Replace the coolant reservoir cap. Turn the cap clockwise until it contacts the hard stop.

5. Check the coolant level in the coolant reservoir the next few times you drive your vehicle. If necessary, add enough prediluted engine coolant to bring the coolant level to the correct level.

If you have to add more than 1.1 qt (1 L) of engine coolant per month, have your vehicle checked as soon as possible. Operating an engine with a low level of coolant can result in engine overheating and possible engine damage.

In case of emergency, you can add a large amount of water without engine coolant in order to reach a vehicle service location.

Water alone, without engine coolant, can cause engine damage from corrosion, overheating or freezing.

Do not use the following as a coolant substitute:

- Alcohol.
- Methanol.
- Brine.
- Any coolant mixed with alcohol or methanol antifreeze.

Alcohol and other liquids can cause engine damage from overheating or freezing.

Do not add extra inhibitors or additives to the coolant. These can be harmful and compromise the corrosion protection of the coolant.

## CHANGING THE COOLANT

For coolant change, see your authorized dealer.

Changing the coolant is necessary at specific mileage intervals listed in the scheduled maintenance information. See **Scheduled Maintenance** (page 589).

# Maintenance

## MANAGING THE COOLANT TEMPERATURE

If you tow a trailer with your vehicle, the engine may temporarily reach a higher temperature during severe operating conditions, for example ascending a long or steep grade in high ambient temperatures.

At this time, you may notice the coolant temperature gauge moves toward the red zone and a message may appear in the information display.



**WARNING:** To reduce the risk of crash and injury, be prepared that the vehicle speed may reduce and the vehicle may not be able to accelerate with full power until the coolant temperature reduces.



**WARNING:** If you continue to drive your vehicle when the engine is overheating, the engine could stop without warning. Failure to follow this instruction could result in the loss of control of your vehicle.

You may notice a reduction in vehicle speed caused by reduced engine power in order to manage the engine coolant temperature. Your vehicle may enter this mode if certain high-temperature and high-load conditions take place. The amount of speed reduction depends on vehicle loading, grade and outside temperature. If this occurs, there is no need to stop your vehicle. You can continue to drive. See **Fail-Safe Cooling** (page 424).

The air conditioning may automatically turn on and off during severe operating conditions to protect the engine from overheating. When the coolant temperature decreases to the normal operating temperature, the air conditioning turns on.

If the coolant temperature gauge moves fully into the red zone, or if the coolant temperature warning or service engine soon messages appear in your information display, do the following:

1. Stop your vehicle as soon as it is safe to do so. Fully apply the parking brake, shift into park (P) or neutral (N).
2. Leave the engine running until the coolant temperature gauge needle returns to the normal position. If the temperature does not drop after several minutes, follow the remaining steps.
3. Switch the engine off and wait for it to cool. Check the coolant level.
4. If the coolant level is at or below the minimum mark, add prediluted coolant immediately.
5. If the coolant level is normal, restart the engine and continue.

## COOLANT – WARNING LAMPS



If the engine begins to overheat, the coolant temperature gauge moves toward the red zone.



A warning lamp illuminates and a message may appear in the information display.

# Maintenance

## COOLANT – INFORMATION MESSAGES

Message	Description and Action
High engine temperature Stop safely	Displays when the engine temperature is too high. Stop your vehicle as soon as it is safe to do so, switch the engine off and allow it to cool. If the problem persists, have your vehicle checked as soon as possible. See <b>Checking the Coolant Level</b> (page 449).

### CHANGING THE FUEL FILTER - DIESEL

Your fuel filters must be changed at the correct service interval or when you see the low fuel pressure message appear. Refer to scheduled maintenance for the correct service interval.

### CHANGING THE FUEL FILTER - GASOLINE

Your vehicle has a lifetime fuel filter that integrates with the fuel tank. It does not need regular maintenance or replacement.

### DRIVE BELT ROUTING OVERVIEW - 6.7L DIESEL, VEHICLES WITH: 110-120V 2KW PICKUP BED POWER OUTLET/ DUAL GENERATORS

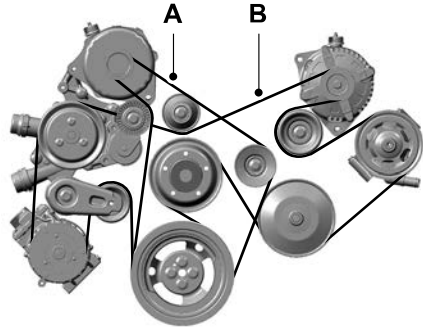

A.	Drivebelt furthest from the engine.
B.	Drivebelt closest to the engine.

# Maintenance

## DRIVE BELT ROUTING OVERVIEW - 6.7L DIESEL, VEHICLES WITH: DUAL GENERATORS

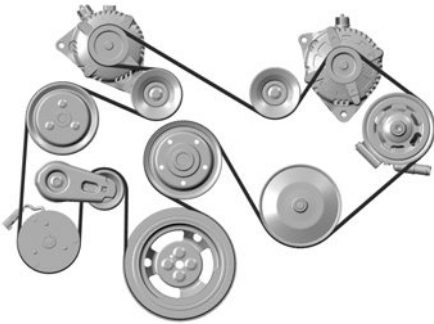

## DRIVE BELT ROUTING OVERVIEW - 6.8L, GASOLINE, VEHICLES WITH: DUAL GENERATORS

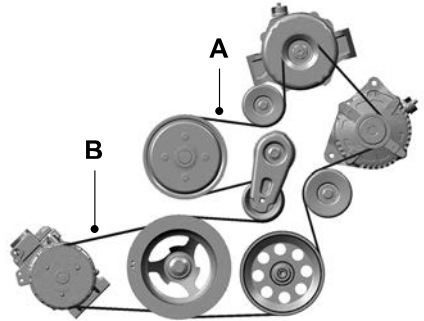

## DRIVE BELT ROUTING OVERVIEW - 6.7L DIESEL, VEHICLES WITH: SINGLE GENERATOR

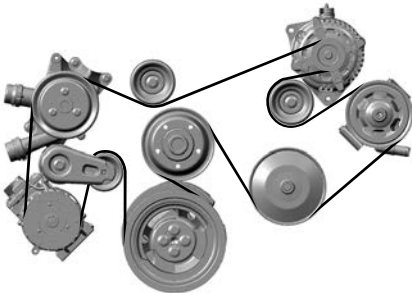

A.	Drivebelt furthest from the engine.
B.	Drivebelt closest to the engine.

# Maintenance

## DRIVE BELT ROUTING OVERVIEW - 6.8L, GASOLINE, VEHICLES WITH: SINGLE GENERATOR

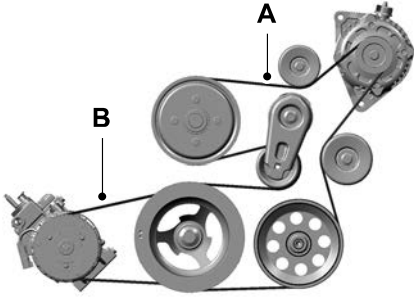

A.	Drivebelt furthest from the engine.
B.	Drivebelt closest to the engine.

## DRIVE BELT ROUTING OVERVIEW - 7.3L, GASOLINE, VEHICLES WITH: DUAL GENERATORS

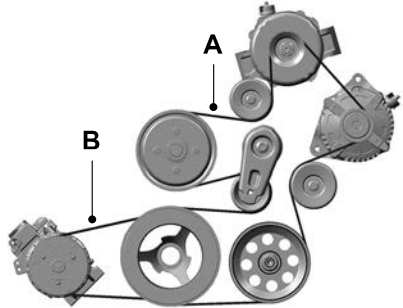

A.	Drivebelt furthest from the engine.
B.	Drivebelt closest to the engine.

# Maintenance

## DRIVE BELT ROUTING OVERVIEW - 7.3L, GASOLINE, VEHICLES WITH: SINGLE GENERATOR

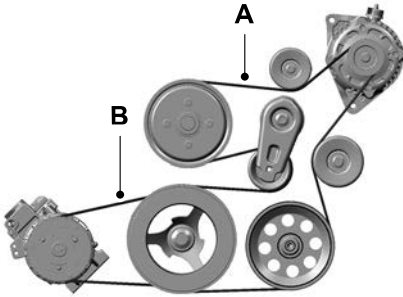

A.	Drivebelt furthest from the engine.
B.	Drivebelt closest to the engine.

## 12V BATTERY

### 12V BATTERY PRECAUTIONS

**WARNING:** Batteries normally produce explosive gases which can cause personal injury. Therefore, do not allow flames, sparks or lighted substances to come near the battery. When working near the battery, always shield your face and protect your eyes. Always provide correct ventilation.

**WARNING:** When lifting a plastic-cased battery, excessive pressure on the end walls could cause acid to flow through the vent caps, resulting in personal injury and damage to the vehicle or battery. Lift the battery with a battery carrier or with your hands on opposite corners.

**WARNING:** Keep batteries out of reach of children. Batteries contain sulfuric acid. Avoid contact with skin, eyes or clothing. Shield your eyes when working near the battery to protect against possible splashing of acid solution. In case of acid contact with skin or eyes, flush immediately with water for a minimum of 15 minutes and get prompt medical attention. If acid is swallowed, call a physician immediately.

**WARNING:** Battery posts, terminals and related accessories contain lead and lead compounds, chemicals known to the State of California to cause cancer and reproductive harm. **Wash your hands after handling.**

**WARNING:** This vehicle may have more than one battery. Removing the battery cables from only one battery does not disconnect your vehicle electrical system. Make sure you disconnect the battery cables from all batteries when disconnecting power. Failure to do so may cause serious personal injury or property damage.

**WARNING:** For vehicles with Auto-Start-Stop the battery requirement is different. You must replace the battery with one of exactly the same specification.

# Maintenance

---

## WHAT IS THE BATTERY MANAGEMENT SYSTEM

The battery management system monitors battery conditions and takes actions to extend battery life.

## HOW DOES THE BATTERY MANAGEMENT SYSTEM WORK

If excessive battery drain is detected, the system temporarily disables some electrical systems to protect the battery.

Systems included are:

- Heated rear window.
- Heated seats.
- Climate control.
- Heated steering wheel.
- Audio unit.
- Navigation system.

A message could appear in the information display to alert you that battery protection actions are active. This message is only for notification that an action is taking place, and not intended to indicate an electrical problem or that the battery requires replacement.

## BATTERY MANAGEMENT SYSTEM LIMITATIONS

After battery replacement, or in some cases after charging the battery with an external charger, the battery management system requires eight hours of vehicle sleep time to relearn the battery state of charge. During this time, your vehicle must remain fully locked with the ignition switched off.

**Note:** *Prior to relearning the battery state of charge, the battery management system could temporarily disable some electrical systems.*

## Electrical Accessory Installation

To make sure the battery management system works correctly, do not connect an electrical device ground connection directly to the battery negative post. This can cause inaccurate measurements of the battery condition and potential incorrect system operation.

**Note:** *If you add electrical accessories or components to the vehicle, it could adversely affect battery performance and durability. This could also affect the performance of other electrical systems in the vehicle.*

## CHANGING THE 12V BATTERY

The battery is in the engine compartment. See **Maintenance** (page 439).

Your vehicle has a maintenance-free battery. It does not require additional water during service.

If the vehicle battery has a cover, make sure you correctly install it after cleaning or replacing the battery.

For longer, trouble-free operation, keep the top of the battery clean and dry and the battery cables tightly fastened to the battery terminals. If any corrosion is present on the battery or terminals, remove the cables from the terminals and clean with a wire brush. You can neutralize the acid with a solution of baking soda and water.

We recommend that you disconnect the negative battery cable terminal from the battery if you plan to store your vehicle for an extended period.

**Note:** *If you only disconnect the negative battery cable terminal, make sure it is isolated or placed away from the battery terminal to avoid unintended connection or arcing.*



# Maintenance

If you disconnect or replace the battery and your vehicle has an automatic transmission, it must relearn its adaptive strategy. Because of this, the transmission may shift firmly when first driven. This is normal operation while the transmission fully updates its operation to optimum shift feel.

## Removing the Battery

1. Apply the parking brake and switch the ignition off.
2. Switch all electrical equipment off, for example lights and radio.
3. Wait a minimum of two minutes before disconnecting the battery.

**Note:** *The engine management system has a power hold function and remains powered for a period of time after you switch the ignition off. This is to allow diagnostic and adaptive tables to be stored. Disconnecting the battery without waiting can cause damage not covered by the vehicle Warranty.*

4. Disconnect and isolate the negative battery cable terminal.
5. Disconnect and isolate the positive battery cable terminal.
6. Remove the battery securing clamp.
7. Remove the battery.

If you disconnect or replace the vehicle battery, you must reset the following features:

- Window bounce-back. See **Window Bounce-Back** (page 126).
- Clock Settings.
- Pre-set radio stations.

## Replacing the Battery

**Note:** *Before reconnecting the battery, make sure the ignition remains switched off.*

You must replace the battery with one of exactly the same specification.

To install, reverse the removal procedure.

**Note:** *Make sure that you correctly install the battery terminal covers, battery cover and battery cable terminals.*

## RESETTING THE BATTERY SENSOR

When you install a new battery, reset the battery sensor by doing the following:

1. Switch the ignition on, and leave the engine off.

**Note:** *Complete Steps 2 and 3 within 10 seconds.*

2. Flash the high beam headlamps five times, ending with the high beams off.
3. Press and release the brake pedal three times.

The battery warning lamp flashes three times to confirm that the reset is successful.

## RECYCLING AND DISPOSING OF THE 12V BATTERY



Make sure that you dispose of old batteries in an environmentally friendly way. Seek advice from your local authority about recycling old batteries.

# Maintenance

## 12V BATTERY – TROUBLESHOOTING



If it illuminates while driving, it indicates a charging system error. Switch off all unnecessary electrical equipment and have your vehicle immediately checked.

## 12V BATTERY – WARNING LAMPS

## 12V BATTERY – INFORMATION MESSAGES

Message	Details
Charging System Service Soon	The charging system needs servicing. If this message stays on or continues to come on, have your vehicle checked as soon as possible.
Charging System Service Now	The charging system needs servicing. Have your vehicle immediately checked.
Turn Power Off To Save Battery	The battery management system determines that the battery is at a low state of charge. Switch the ignition off as soon as possible to protect the battery. This message clears when you start your vehicle and the battery state of charge has recovered. Switch off unnecessary electrical loads to allow for a faster battery state-of-charge recovery.
Electrical Power Saver Active Some Features Turned Off See Manual	Displays when the battery management system detects an extended low-voltage condition. The system disables various vehicle features to help preserve the battery. Switch off as many of the electrical loads as soon as possible to improve system voltage. When the system voltage recovers, the disabled features begin to operate as normal.

## ADJUSTING THE HEADLAMPS

### Vertical Aim Adjustment

The headlamps on your vehicle are properly aimed at the assembly plant. If your vehicle has been in an accident, have your vehicle checked as soon as possible.

# Maintenance

## Headlamp Aiming Target

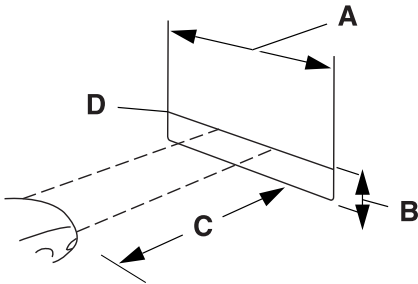

- A 8 ft (2.4 m).
- B Center height of lamp to ground.
- C 25 ft (7.6 m).
- D Horizontal reference line.

1. Park your vehicle directly in front of a wall or screen on a level surface, approximately 25 ft (7.6 m) away.
2. Measure the height from the center of your headlamp, indicated by a 3 millimeter circle on the lens, to the ground and mark an 8 ft (2.4 m) horizontal reference line on the vertical wall or screen at this height, a piece of masking tape works well.
3. Switch on the low beam headlamps to illuminate the wall or screen and open the hood. Cover one of the headlamps so no light hits the wall.



4. On the wall or screen, observe a light pattern with a distinct horizontal edge toward the right. If this edge is not at the horizontal reference line, adjust the beam so the edge is at the same height as the horizontal reference line.

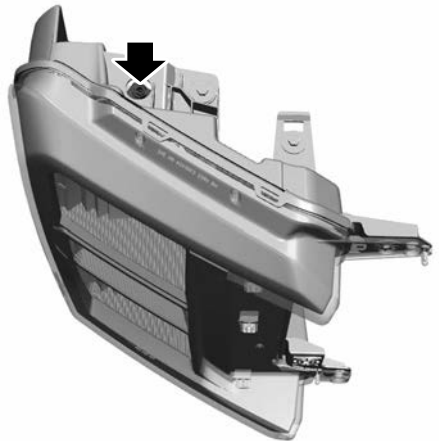

5. Locate the vertical adjuster on each headlamp. Using a Phillips #2 screwdriver, turn the adjuster either clockwise or counterclockwise to adjust the vertical aim of the headlamp.

**Note:** *Low/Mid series lamps: Use a Phillips #2 screwdriver to adjust.*

# Maintenance

*High Series Lamps: Use a 6 mm hex key or Phillips PH1 screwdriver to adjust.*

- Repeat Steps 3 through 5 to adjust the other headlamp.

**Note:** *The vertical adjuster is in the same location for all headlamps.*

- Close the hood and turn off the lamps.

## Horizontal Aim Adjustment

Horizontal aim is not required for this vehicle and is not adjustable.

## EXTERIOR BULBS

### EXTERIOR BULB SPECIFICATION CHART

Replacement bulbs are specified in the chart below. Headlamp bulbs must be marked with an authorized D.O.T. marking for North America to make sure they have the proper lamp performance, light brightness, light pattern and safe visibility. The correct bulbs will not damage the lamp assembly or void the lamp assembly warranty and will provide quality bulb illumination time.

Lamp	Specification	Power (Watt)
Headlamp. Low series.	H11L/9005LL	62/69
Headlamp. Mid/High series.	LED	LED
Front side marker lamp. Low series.	W5W	5
Front side marker lamp. Mid/High series.	LED	LED
Front fog lamp.	H11	62
Front fog lamp. <sup>3</sup>	LED	LED
Front turn signal and parking lamp. Low series.	4257NA	30/7
Front turn signal and parking lamp. Mid/High series.	LED	LED
Rear lamp, brake lamp, and rear side marker lamp. Low/Mid series. <sup>1</sup>	3157K	27/7
Rear turn signal lamp. Low/Mid series. <sup>1</sup>	3175K	27/7
Rear lamp, brake lamp, rear turn signal, rear side marker lamp and reverse lamp. High series. <sup>1</sup>	LED	LED
Rear lamp, brake lamp, rear turn signal and rear side marker lamp. <sup>2</sup>	3157K	27/7

# Maintenance

Lamp	Specification	Power (Watt)
Reversing lamp. Low series.	WT21W	21
License plate lamp. Low series.	168	5
License plate lamp. High series.	LED	LED
Central high mounted cargo lamp.	912	12.8
Central high mounted cargo lamp.	LED	LED
Side turn signal and mirror clearance lamp.	LED	LED
Front clearance lamp.	LED	LED
Rear clearance lamp.	LED	LED
Front identification lamp.	LED	LED
Rear identification lamp.	LED	LED
Under hood lamp.	LED	LED

<sup>1</sup>Pickup only.

<sup>2</sup>Chassis cab only.

<sup>3</sup>U.S. and Canada only

**Note:** LED lamps are not serviceable. See an authorized dealer if they fail.

# Maintenance

## REMOVING A REAR LAMP ASSEMBLY - CHASSIS CAB



1. Switch all of the lamps and the ignition off.
2. Remove the screws and the lamp lens from lamp assembly.
3. To install, reverse the removal procedure.

## REMOVING A REAR LAMP ASSEMBLY - PICKUP

1. Make sure the headlamps are off.
2. Open the tailgate to access the rear lamp assemblies.

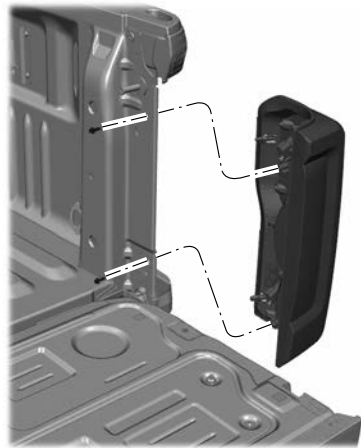

3. Remove the bolts from the tail lamp assembly.
4. Carefully pull the lamp assembly from the tailgate pillar by releasing the two retaining tabs.
5. To install, reverse the removal procedure.

## CHANGING A HEADLAMP BULB



**WARNING:** Make sure the bulbs have cooled down before removing them. Failure to follow this warning could result in serious personal injury.

**Note:** To access the right-hand side bulbs, remove the air intake pipe. See **Changing the Engine Air Filter** (page 444).

For vehicles with diesel engines, to access the left-hand side bulbs, remove the washer reservoir filler tube.

# Maintenance

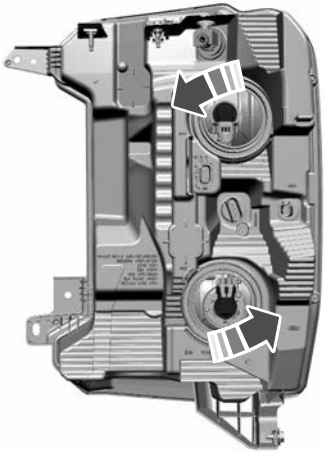

1. Switch all of the lamps and the ignition off.
2. Disconnect the electrical connector.
3. Turn the bulb holder counterclockwise and remove it.

**Note:** You cannot separate the bulb from the bulb holder.

4. To install, reverse the removal procedure.

**Note:** Handle a halogen headlamp bulb carefully and keep out of children's reach. Grasp the bulb only by its plastic base and do not touch the glass. The oil from your hand could cause the bulb to break the next time you operate the headlamps.

## CHANGING A FRONT TURN SIGNAL LAMP BULB



**WARNING:** Make sure the bulbs have cooled down before removing them. Failure to follow this warning could result in serious personal injury.

**Note:** To access the right-hand side bulbs, remove the air intake pipe. See **Changing the Engine Air Filter** (page 444).

To access the left-hand side bulbs, remove the washer reservoir filler tube. Vehicles with diesel engine only.

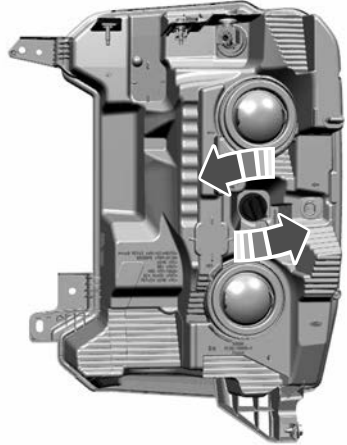

1. Switch all of the lamps and the ignition off.
2. Disconnect the electrical connector.
3. Turn the bulb holder counterclockwise and remove it.

**Note:** You cannot separate the bulb from the bulb holder.

4. To install, reverse the removal procedure.

# Maintenance

## CHANGING A FRONT FOG LAMP BULB

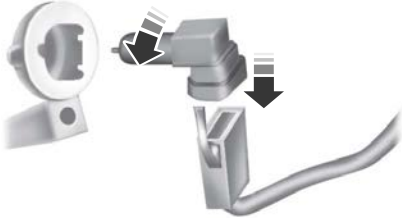

1. Make sure the fog lamps are off.
2. Disconnect the electrical connector from the fog lamp bulb.
3. Turn the bulb counterclockwise and remove it from the fog lamp.
4. To install, reverse the removal procedure.

## CHANGING A REAR LAMP BULB

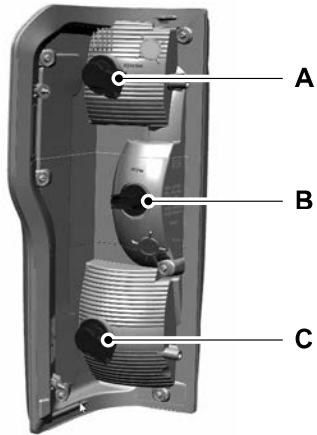

- A Stop lamp, rear lamp bulb, and turn signal lamp bulb.
- B Reversing lamp bulb.
- C Stop lamp, rear lamp bulb, and turn signal lamp bulb.

1. Remove the rear lamp assembly. See **Removing a Rear Lamp Assembly** (page 462).
2. Turn the bulb holder counterclockwise and remove it.
3. Remove the bulb by pulling it straight out.
4. To install, reverse the removal procedure.



# Maintenance

## CHANGING A STOPLAMP BULB

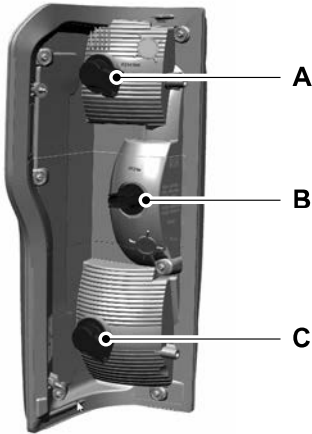

- A Stop lamp, rear lamp bulb, and turn signal lamp bulb.
- B Reversing lamp bulb.
- C Stop lamp, rear lamp bulb, and turn signal lamp bulb.

1. Remove the rear lamp assembly. See **Removing a Rear Lamp Assembly** (page 462).
2. Turn the bulb holder counterclockwise and remove it.
3. Remove the bulb by pulling it straight out.
4. To install, reverse the removal procedure.

## CHANGING A REAR TURN SIGNAL LAMP BULB

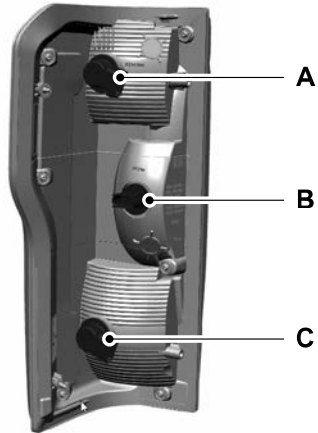

- A Stop lamp, rear lamp bulb, and turn signal lamp bulb.
- B Reversing lamp bulb.
- C Stop lamp, rear lamp bulb, and turn signal lamp bulb.

1. Remove the rear lamp assembly. See **Removing a Rear Lamp Assembly** (page 462).
2. Turn the bulb holder counterclockwise and remove it.
3. Remove the bulb by pulling it straight out.
4. To install, reverse the removal procedure.

# Maintenance

## CHANGING A REVERSING LAMP BULB

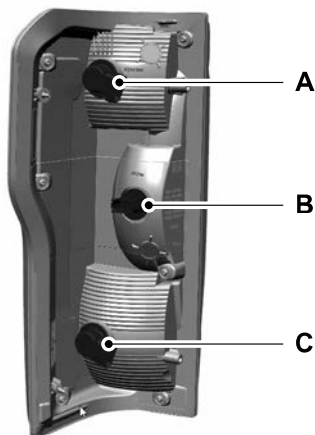

- A Stop lamp, rear lamp bulb, and Turn signal lamp bulb.
- B Reversing lamp bulb.
- C Stop lamp, rear lamp bulb, and Turn signal lamp bulb.

1. Remove the rear lamp assembly. See **Removing a Rear Lamp Assembly** (page 462).
2. Turn the bulb holder counterclockwise and remove it.
3. Remove the bulb by pulling it straight out.
4. To install, reverse the removal procedure.

## CHANGING A HIGH MOUNTED STOP/LAMP BULB

1. Make sure the lamps are off.

2. Remove the four screws and move the lamp assembly away from the vehicle to expose the bulb sockets.

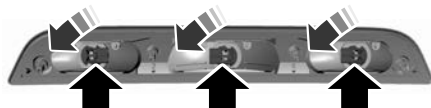

3. Remove the bulb socket by rotating it counterclockwise and pulling it out of the lamp assembly.
4. Pull the bulb straight out of the socket.
5. To install, reverse the removal procedure.

## CHANGING A LICENSE PLATE LAMP BULB

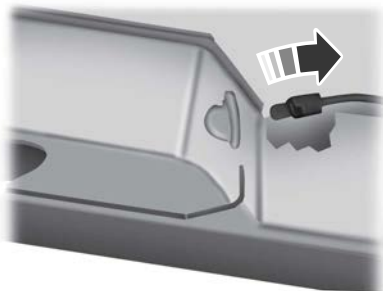

1. Switch all of the lamps and the ignition off.
2. To access the bulb, reach behind the bumper.
3. Turn the bulb holder counterclockwise and remove it.

# Maintenance

---

4. Remove the bulb by pulling it straight out.
5. To install, reverse the removal procedure.

## **INTERIOR BULBS**

### **INTERIOR BULB SPECIFICATION CHART**

Your vehicle has LED lamps. These are not serviceable items. See an authorized dealer if they fail.

# Vehicle Care

## CLEANING PRODUCTS

### Materials

For best results, use the following products

or products of equivalent quality:

For additional information and assistance, we recommend that you contact an authorized dealer.

Name	Specification
Motorcraft® Bug and Tar Remover, ZC-42 (U.S. & Canada)	
Motorcraft® Custom Bright Metal Cleaner, ZC-15 (U.S. & Canada)	ESR-M5B194-B
Motorcraft® Detail Wash, ZC-3-A (U.S. & Canada)	ESR-M14P4-A
Motorcraft® Engine Shampoo and Degreaser, ZC-20 (U.S.)	ESR-M14P3-A
Motorcraft® Engine Shampoo, CXC-66-A (Canada)	
Motorcraft® Premium Leather and Vinyl Cleaner, ZC-56 (U.S. & Canada)	
Motorcraft® Multi-Purpose Cleaner, CXC-101 (Canada)	
Motorcraft® Premium Windshield Wash Concentrate with Bitterant, ZC-32-B2 (U.S.)	WSS-M14P19-A
Motorcraft® Premium Quality Windshield Washer Fluid, CXC-37-F/M (Canada)	WSS-M14P19-A
Motorcraft® Professional Strength Carpet & Upholstery Cleaner, ZC-54 (U.S. & Canada)	
Motorcraft® Premium Glass Cleaner, CXC-100 (Canada)	ESR-M14P5-A
Motorcraft® Spot and Stain Remover, ZC-14 (U.S.)	
Motorcraft® Ultra-Clear Spray Glass Cleaner, ZC-23 (U.S.)	ESR-M14P5-A
Motorcraft® Wheel and Tire Cleaner, ZC-37-A (U.S. & Canada)	

# Vehicle Care

---

## CLEANING THE EXTERIOR

### CLEANING THE EXTERIOR PRECAUTIONS

Immediately remove fuel spillages, additive residuals, bird droppings, insect deposits and road tar. These may cause damage to your vehicle's paintwork or trim over time. Remove any exterior accessories, for example antennas, before entering a car wash.

### CLEANING HEADLAMPS AND REAR LAMPS

We recommend that you only use cold or lukewarm water containing car shampoo to clean the headlamps and the rear lamps.

Do not scrape the lamps.

Do not wipe lamps when they are dry.

### CLEANING WINDOWS AND WIPER BLADES

To clean the windshield and wiper blades:

- Clean the windshield with a non-abrasive glass cleaner.

**Note:** *When cleaning the interior of the windshield, avoid getting any glass cleaner on the instrument panel or door panels. Wipe any glass cleaner off these surfaces immediately.*

- Clean the wiper blades with washer fluid or water applied with a soft sponge or cloth.

**Note:** *Do not use razor blades or other sharp objects to clean or remove decals from the inside of the heated rear window. This can cause damage not covered by the vehicle Warranty.*

**Note:** *We recommend cleaning the power sliding rear window at regular intervals to avoid dust and debris accumulation to deliver appropriate function.*

### CLEANING CHROME, ALUMINIUM OR STAINLESS STEEL

We recommend that you only use a car shampoo, a soft cloth and water on bumpers and other chrome, aluminium or stainless steel parts.

**Note:** *For additional information and assistance, we recommend that you contact an authorized dealer.*

**Note:** *Rinse the area well after cleaning.*

**Note:** *Do not use abrasive materials, for example steel wool or plastic pads, as they can scratch these surfaces.*

**Note:** *Do not use chrome cleaner, metal cleaner or polish on wheels or wheel covers.*

### CLEANING WHEELS

Only use a recommended wheel and tire cleaner to clean the wheels weekly. For additional information and assistance, contact an authorized dealer.

1. Use a sponge to remove heavy deposits of dirt and brake dust.
2. Rinse well after cleaning.

**Note:** *Do not apply a cleaning chemical to warm or hot wheel rims and covers.*

If you intend on parking your vehicle for an extended period after cleaning the wheels with a wheel cleaner, drive your vehicle for a few minutes before parking your vehicle. This reduces the risk of corrosion of the brake discs, brake pads and linings.

Do not clean the wheels when they are hot.

**Note:** *Some car washes could damage wheel rims and covers.*

# Vehicle Care

---

**Note:** *Using non-recommended cleaners, harsh cleaning products, chrome wheel cleaners or abrasive materials could damage wheel rims and covers.*

## Cleaning Running Boards

We recommend that you clean your running boards in the following way:

1. Use a clean, soft, non-abrasive sponge or brush to remove heavy deposits of dirt.
2. Allow the cleaner to sit on the running board surface for the time specified. Rinse thoroughly with cold water.
3. For additional information and assistance, contact an authorized dealer.

**Note:** *Do not leave the cleaner on longer than the recommended wait time. This could damage the running boards.*

**Note:** *Do not allow the cleaner to dry unless instructed.*

**Note:** *Some car washes could damage the running boards.*

**Note:** *Using non-recommended cleaners, harsh cleaning products, chrome wheel cleaners or abrasive materials could damage the running boards.*

## CLEANING THE ENGINE COMPARTMENT

Use a vacuum cleaner to remove debris from the screen area below windshield.

**Note:** *If you are not familiar with the parts around the engine do not wash the engine compartment. Avoid frequent engine washes.*

When washing the engine compartment:

- Never wash or rinse the engine while it is hot or running.
- Never wash or rinse any ignition coil, spark plug wire or spark plug well.
- Cover the battery, power distribution box, and air filter assembly to prevent water damage.

**Note:** *If your vehicle has an engine cover remove the cover before application of shampoo and degreaser.*

- Spray an approved engine shampoo and degreaser on all parts that require cleaning and rinse with water.

## CLEANING STRIPES OR GRAPHICS

It is recommended to wash your vehicle by hand however, pressure washing may be used under the following conditions:

- Use a spray with a minimum of 40° wide spray angle pattern.
- Keep the nozzle 12 in (30 cm) and at a 90° angle to your vehicle.
- Do not use water pressure higher than 1,000 psi (6,895 kPa).
- Do not use water hotter than 73°F (23°C).

**Note:** *Holding the pressure washer nozzle at an angle to the vehicle's surface may damage graphics and cause the edges to peel away.*

## CLEANING CAMERA LENSES AND SENSORS

We recommend that you only use lukewarm or cold water and a soft cloth to clean the camera lens and sensors.

**Note:** *Do not pressure wash camera lens and sensors.*

# Vehicle Care

## CLEANING THE UNDERBODY

Flush the complete underside of your vehicle frequently. Keep body and door drain holes free from packed dirt.

Rear suspension components may require regular cleaning with a power washer or a thorough rinse with a strong stream of water if the vehicle is operated in dusty or muddy environments. Rear leaf springs or other suspension components may emit squeaking or popping noises while operating the vehicle if particles, such as dirt, rocks, or other debris, are present in the components.

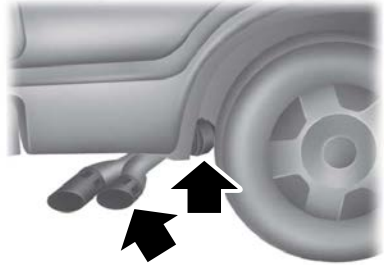

The visible holes in the exhaust tip and the holes under the shield just inboard of the right rear tire(s) are functional. Keep the holes clear of mud, debris or foreign material to maintain proper function of the exhaust system. Clean and remove debris or foreign material if present as needed. Spraying with a hose during regular washing of vehicle should help keep holes clean and clear of debris or foreign material.

## CLEANING THE EXHAUST

**WARNING:** Do not modify or remove the exhaust tailpipe. Blocked holes may result in increased exhaust gas temperatures, vehicle damage, property damage or personal injury.

**WARNING:** Failure to keep the holes in the exhaust tailpipe clean and free of debris or foreign material may result in blocked holes. Blocked holes may result in increased exhaust gas temperatures, vehicle damage, property damage or personal injury.

**WARNING:** The normal operating temperature of the exhaust system is very high. Never work around or attempt to repair any part of the exhaust system until it has cooled. Use special care when working around the diesel oxidation catalytic converter or the diesel particulate filter. The diesel oxidation catalytic converter and the diesel particulate filter heat up to very high temperatures after only a short period of engine operation and remain hot after you switch the engine off.

## CLEANING THE INTERIOR

### CLEANING THE INSTRUMENT PANEL

**WARNING:** Do not use chemical solvents or strong detergents when cleaning the steering wheel or instrument panel to avoid contamination of the airbag system.

We recommend that you only clean the instrument panel and cluster lens with a damp soft cloth. Dry the area with a clean, soft cloth.

For additional information and assistance, we recommend that you contact an authorized dealer.

# Vehicle Care

**Note:** Avoid cleaners or polishes that increase the gloss of the upper portion of the instrument panel. The dull finish in this area helps protect you from undesirable windshield reflection.

## CLEANING PLASTIC

We recommend that you only use a mild soap and water solution on a soft cloth. Dry the area with a clean, soft cloth.

## CLEANING DISPLAYS AND SCREENS

We recommend that you only use a microfiber cloth in a circular motion to clean off the fingerprint or dust.

If dirt or fingerprints are still on the screen, apply a small amount of alcohol to the cloth and try to clean it again.

**Note:** Do not pour or spray alcohol onto the touchscreen.

**Note:** Do not use detergent or any type of solvent to clean the touchscreen.

## CLEANING FABRIC



**WARNING:** On vehicles equipped with seat-mounted airbags, do not use chemical solvents or strong detergents. Such products could contaminate the side airbag system and affect performance of the side airbag in a crash.

We recommend that you only clean fabric in the following way:

1. Remove dust and loose dirt with a vacuum cleaner.
2. Wipe the surface with a soft, damp cloth and a mild soap and water solution. Dry the area with a clean, soft cloth.

3. For additional information and assistance, we recommend that you contact an authorized dealer.

For heavy stains, spot clean the area. If a ring forms on the fabric, clean the entire area immediately, but do not oversaturate or the ring could set.

## CLEANING LEATHER



**WARNING:** On vehicles equipped with seat-mounted airbags, do not use chemical solvents or strong detergents. Such products could contaminate the side airbag system and affect performance of the side airbag in a crash.

We recommend that you only clean the leather surfaces in the following way:

1. Remove dust and loose dirt with a vacuum cleaner.
2. Wipe the surface with a soft, damp cloth and a mild soap and water solution. Dry the area with a clean, soft cloth.
3. Make sure the leather is dry, then apply a small amount of conditioner to a clean, dry cloth.
4. Rub the conditioner into the leather until it disappears. Allow the conditioner to dry, then repeat the process for the entire interior. If a film appears, wipe it off with a dry, clean cloth.
5. For additional information and assistance, we recommend that you contact an authorized dealer.



# Vehicle Care

## CLEANING VINYL



**WARNING:** On vehicles equipped with seat-mounted airbags, do not use chemical solvents or strong detergents. Such products could contaminate the side airbag system and affect performance of the side airbag in a crash.

We recommend that you only clean vinyl surfaces in the following way:

1. Remove dust and loose dirt with a vacuum cleaner.
2. Wipe the surface with a soft, damp cloth and a mild soap and water solution. Dry the area with a clean, soft cloth.
3. For additional information and assistance, we recommend that you contact an authorized dealer.

## CLEANING CARPETS AND FLOOR MATS

We recommend that you only clean your carpets in the following way:

1. Remove dust and loose dirt with a vacuum cleaner.
2. Wipe the surface with a soft, damp cloth and a mild soap and water solution. Dry the area with a clean, soft cloth.
3. For additional information and assistance, we recommend that you contact an authorized dealer.

For heavy stains, spot clean the area. If a ring forms on the fabric, clean the entire area immediately, but do not oversaturate or the ring could set.

We recommend that you only clean your floor mats in the following way:

1. Remove dust and loose dirt with a vacuum cleaner.
2. Wash rubber floor mats using mild soap and lukewarm or cold water.
3. Completely dry the floor mat before placing them back in your vehicle.

## CLEANING SEATBELTS



**WARNING:** Do not use cleaning solvents, bleach or dye on the vehicle's seatbelts, as these actions may weaken the belt webbing.

1. Wipe the surface with a soft, damp cloth and a mild soap and water solution. Dry the area with a clean, soft cloth.

## CLEANING MOONROOF TRACKS

1. Remove debris from the tracks with a vacuum cleaner.
2. Wipe the bulb seal and mating painted roof metal surface with a soft, damp cloth and a mild soap and water solution.

**Note:** *The moonroof rail tracks are greased to maintain proper functionality. Do not wipe off the grease.*

## REPAIRING MINOR PAINT DAMAGE

We recommend that you contact an authorized dealer to identify your vehicle color code. Authorized dealers have touch-up paint to match your vehicle's color.

Before repairing minor paint damage, use a cleaner to remove particles such as bird droppings, tree sap, insect deposits, tar spots, road salt and industrial fallout.

# Vehicle Care

---

Read the instructions before using cleaning products.

## WAXING YOUR VEHICLE

Wax the high-gloss painted surface of your prewashed vehicle once or twice a year.

We recommend that you only use an approved quality wax that does not contain abrasives. Follow the manufacturer's instructions to apply and remove the wax. For additional information and assistance, we recommend that you contact an authorized dealer.

When washing and waxing, park your vehicle in a shaded area out of direct sunlight.

**Note:** *Avoid waxing unpainted or low-gloss black colored parts, they discolor over time.*

## VEHICLE CARE VIDEOS

[PVD "Chrome like" wheel and general wheel care Video Link](#)

# Storing Your Vehicle

---

## PREPARING YOUR VEHICLE FOR STORAGE

If you plan on storing your vehicle for 30 days or more, the following maintenance recommendations ensures your vehicle stays in good operating condition.

Under various conditions, long-term storage may lead to degraded engine performance or failure unless you use specific precautions to preserve your vehicle.

### General

- Store all vehicles in a dry, ventilated place.
- If vehicles are stored outside, they require regular maintenance to protect against rust and weather damage.
- Make sure all linkages, cables, levers and pins under your vehicle are covered with grease to prevent rust.
- Move vehicles at least 25 ft (7.5 m) every 15 days to lubricate working parts and prevent corrosion.
- Fill the fuel tank with high-quality fuel until the first automatic shutoff of the fuel pump nozzle.

### Engine

- Change the engine oil and filter prior to storage because used engine oil contains contaminants which may cause engine damage.
- Start the engine every 15 days for a minimum of 15 minutes. Run at fast idle with the climate controls set to defrost until the engine reaches normal operating temperature.
- With your foot on the brake, shift through all the gears while the engine is running.

### Body

- Wash your vehicle thoroughly to remove dirt, grease, oil, tar or mud from exterior surfaces, rear wheel housings and the underside of front fenders.
- Periodically wash your vehicle if it is stored in exposed locations.
- Touch-up exposed or primed metal to prevent rust.
- Cover chrome and stainless steel parts with a thick coat of auto wax to prevent discoloration. Rewax as necessary when you wash your vehicle.
- Lubricate all hood, door and luggage compartment hinges and latches with a light grade oil.
- Cover interior trim to prevent fading.
- Keep all rubber parts free from oil and solvents.

### 12 Volt Battery

- When storing your vehicle for longer than 30 days the state of charge should be approximately 50%. Additionally, we recommend to disconnect the 12v battery to reduce system loads on the battery, or you can use a trickle charger for longer storage periods.
- Check and recharge as necessary. Keep connections clean.

**Note:** *It is necessary to reset memory features if you disconnect the battery cables.*

# Storing Your Vehicle

---

## Tires

- Maintain recommended air pressure.
- To minimize flat spots on the tires, inflate all four tires to the recommended cold pressures listed on the Safety Compliance Certification label or Tire Label affixed to your vehicle. When the vehicle is taken out of storage, reset the tire pressures as necessary to the recommended levels listed on the Safety Compliance Certification label or Tire Label affixed to your vehicle.

**Note:** *If you store your vehicle in a location with low ambient temperatures, follow the instructions for care of summer tires.*

## Brakes

Make sure the brakes and parking brake fully release.

**Note:** *If you intend on parking your vehicle for an extended period after cleaning the wheels with a wheel cleaner, drive your vehicle for a few minutes before doing so to reduce the risk of increased corrosion of the brake discs, brake pads and linings.*

- Check the exhaust for any foreign materials.
- Check tire pressures and set tire inflation per the Tire Label.
- Check brake pedal operation. Corroded brake rotors could cause brake noise. Drive your vehicle and gently apply and release the brakes repeatedly over a 10-minute drive to reduce the corrosion from the brakes.
- Check fluid levels (including coolant, oil and gas) to make sure there are no leaks, and fluids are at recommended levels.
- If you remove the battery, clean the battery cable ends and check for damage.

Contact an authorized dealer if you have any concerns or issues.

## REMOVING YOUR VEHICLE FROM STORAGE

When your vehicle is ready to come out of storage, do the following:

- We recommend that you change the engine oil before you use your vehicle again.
- Wash your vehicle to remove any dirt or grease film build-up on window surfaces.
- Check windshield wipers for any deterioration.
- Check the underhood for any foreign materials such as mice or squirrel nests.

# Wheel and Tire Information

## LOCATING THE TIRE LABEL

You will find a Tire Label containing tire inflation pressure by tire size and other important information located on the B-Pillar or the edge of the driver's door. See **Locating the Safety Compliance Certification Labels** (page 349).

## DEPARTMENT OF TRANSPORTATION UNIFORM TIRE QUALITY GRADES



Tire Quality Grades apply to new pneumatic passenger car tires. The Quality grades can be found where applicable on the tire sidewall between tread shoulder and maximum section width. For example: **Treadwear 200 Traction AA Temperature A.**

These Tire Quality Grades are determined by standards that the United States Department of Transportation has set.

Tire Quality Grades apply to new pneumatic passenger car tires. They do not apply to deep tread, winter-type snow tires, space-saver or temporary use spare tires, light truck or LT type tires, tires with nominal rim diameters of 10 to 12 inches or limited production tires as defined in Title 49 Code of Federal Regulations Part 575.104 (c)(2).

**U.S. Department of Transportation Tire quality grades:** The U.S. Department of Transportation requires us to give you the following information about tire grades exactly as the government has written it.

### Treadwear

The treadwear grade is a comparative rating based on the wear rate of the tire when tested under controlled conditions on a specified government test course. For example, a tire graded 150 would wear 1½ times as well on the government course as a tire graded 100. The relative performance of tires depends upon the actual conditions of their use, however, and may depart significantly from the norm due to variations in driving habits, service practices, and differences in road characteristics and climate.

# Wheel and Tire Information

## Traction AA A B C



**WARNING:** The traction grade assigned to this tire is based on straight-ahead braking traction tests, and does not include acceleration, cornering, hydroplaning or peak traction characteristics.

The traction grades, from highest to lowest are AA, A, B, and C. The grades represent the tire's ability to stop on wet pavement as measured under controlled conditions on specified government test surfaces of asphalt and concrete. A tire marked C may have poor traction performance.

## Temperature A B C



**WARNING:** The temperature grade for this tire is established for a tire that is properly inflated and not overloaded. Excessive speed, underinflation, or excessive loading, either separately or in combination, can cause heat buildup and possible tire failure.

The temperature grades are A (the highest), B and C, representing the tire's resistance to the generation of heat and its ability to dissipate heat when tested under controlled conditions on a specified indoor laboratory

test wheel. Sustained high temperature can cause the material of the tire to degenerate and reduce tire life, and excessive temperature can lead to sudden tire failure. The grade C corresponds to a level of performance which all passenger car tires must meet under the Federal Motor Vehicle Safety Standard No. 139. Grades B and A represent higher levels of performance on the laboratory test wheel than the minimum required by law.

## INFORMATION ON THE TIRE SIDEWALL

Both United States and Canada Federal regulations require tire manufacturers to place standardized information on the sidewall of all tires. This information identifies and describes the fundamental characteristics of the tire and also provides a U.S. DOT Tire Identification Number for safety standard certification and in case of a recall.

# Wheel and Tire Information

## Information on P Type Tires

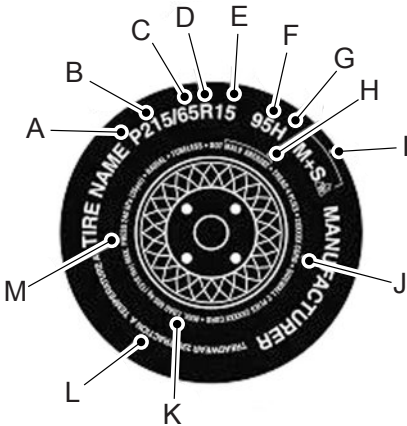

P215/65R15 95H is an example of a tire size, load index and speed rating. The definitions of these items are listed below. (Note that the tire size, load index and speed rating for your vehicle may be different from this example.)

**A. P:** Indicates a tire, designated by the Tire and Rim Association, that may be used for service on cars, sport utility vehicles, minivans and light trucks. **Note:** If your tire size does not begin with a letter this may mean it is designated by either the European Tire and Rim Technical Organization or the Japan Tire Manufacturing Association.

**B. 215:** Indicates the nominal width of the tire in millimeters from sidewall edge to sidewall edge. In general, the larger the number, the wider the tire.

**C. 65:** Indicates the aspect ratio which gives the tire's ratio of height to width.

**D. R:** Indicates a radial type tire.

**E. 15:** Indicates the wheel or rim diameter in inches. If you change your wheel size, you will have to purchase new tires to match the new wheel diameter.

**F. 95:** Indicates the tire's load index. It is an index that relates to how much weight a tire can carry. You may find this information in your owner's manual. If not, contact a local tire dealer.

**Note:** *You may not find this information on all tires because it is not required by federal law.*

**G. H:** Indicates the tire's speed rating. The speed rating denotes the speed at which a tire is designed to be driven for extended periods of time under a standard condition of load and inflation pressure. The tires on your vehicle may operate at different conditions for load and inflation pressure. These speed ratings may need to be adjusted for the difference in conditions. The ratings range from 81 mph (130 km/h) to 186 mph (299 km/h). These ratings are listed in the following chart.

# Wheel and Tire Information

**Note:** You may not find this information on all tires because it is not required by federal law.

Letter rating	Speed rating
M	81 mph (130 km/h)
N	87 mph (140 km/h)
Q	99 mph (159 km/h)
R	106 mph (171 km/h)
S	112 mph (180 km/h)
T	118 mph (190 km/h)
U	124 mph (200 km/h)
H	130 mph (210 km/h)
V	149 mph (240 km/h)
W	168 mph (270 km/h)
Y	186 mph (299 km/h)

**Note:** For tires with a maximum speed capability over 149 mph (240 km/h), tire manufacturers sometimes use the letters ZR. For those with a maximum speed capability over 186 mph (299 km/h), tire manufacturers always use the letters ZR.

**H. U.S. DOT Tire Identification Number (TIN):** This begins with the letters DOT and indicates that the tire meets all federal standards. The next two numbers or letters are the plant code designating where it was manufactured, the next two are

the tire size code and the last four numbers represent the week and year the tire was built. For example, the numbers 317 mean the 31st week of 1997. After 2000, the numbers go to four digits. For example, 2501 means the 25th week of 2001. The numbers in between are identification codes used for traceability. This information is used to contact customers if a tire defect requires a recall.

**I. M+S or M/S:** Mud and Snow, or  
**AT:** All Terrain, or  
**AS:** All Season.

**J. Tire Ply Composition and Material Used:** Indicates the number of plies or the number of layers of rubber-coated fabric in the tire tread and sidewall. Tire manufacturers also must indicate the ply materials in the tire and the sidewall, which include steel, nylon, polyester, and others.

**K. Maximum Load:** Indicates the maximum load in kilograms and pounds that can be carried by the tire. See the Safety Compliance Certification Label (affixed to either the door hinge pillar, door-latch post, or the door edge that meets the door-latch post, next to the driver's seating position), for the correct tire pressure for your vehicle.

**L. Treadwear, Traction and Temperature Grades:**



## Wheel and Tire Information

**\*Treadwear:** The treadwear grade is a comparative rating based on the wear rate of the tire when tested under controlled conditions on a specified government test course. For example, a tire graded 150 would wear one and one-half times as well on the government course as a tire graded 100.

**\*Traction:** The traction grades, from highest to lowest are AA, A, B, and C. The grades represent the tire's ability to stop on wet pavement as measured under controlled conditions on specified government test surfaces of asphalt and concrete. A tire marked C may have poor traction performance.

**\*Temperature:** The temperature grades are A (the highest), B and C, representing the tire's resistance to the generation of heat and its ability to dissipate heat when tested under controlled conditions on a specified indoor laboratory test wheel.

**M. Maximum Inflation Pressure:** Indicates the tire manufacturers' maximum permissible pressure or the pressure at which the maximum load can be carried by the tire. This pressure is normally higher than the vehicle manufacturer's recommended cold inflation pressure which can be found on the Safety Compliance Certification Label (affixed to either the door hinge pillar,

door-latch post, or the door edge that meets the door-latch post, next to the driver's seating position), or Tire Label which is located on the B-Pillar or the edge of the driver's door. The cold inflation pressure should never be set lower than the recommended pressure on the vehicle label.

The tire suppliers may have additional markings, notes or warnings such as standard load or radial tubeless.

### Additional Information Contained on the Tire Sidewall for LT Type Tires

**Note:** *Tire Quality Grades do not apply to this type of tire.*

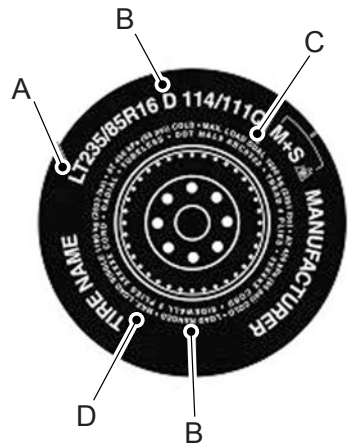

## Wheel and Tire Information

LT type tires have some additional information beyond those of P type tires; these differences are described below.

A. **LT:** Indicates a tire, designated by the Tire and Rim Association, that is intended for service on light trucks.

B. **Load Range and Load Inflation Limits:** Indicates the tire's load-carrying capabilities and its inflation limits.

C. **Maximum Load Dual lb (kg) at psi (kPa) cold:** Indicates the maximum load and tire pressure when the tire is used as a dual, defined as four tires on the rear axle (a total of six or more tires on the vehicle).

D. **Maximum Load Single lb (kg) at psi (kPa) cold:** Indicates the maximum load and tire pressure when the tire is used as a single, defined as two tires (total) on the rear axle.

### Information on T Type Tires

T145/80D16 is an example of a tire size.

**Note:** *The temporary tire size for your vehicle may be different from this example. Tire Quality Grades do not apply to this type of tire.*

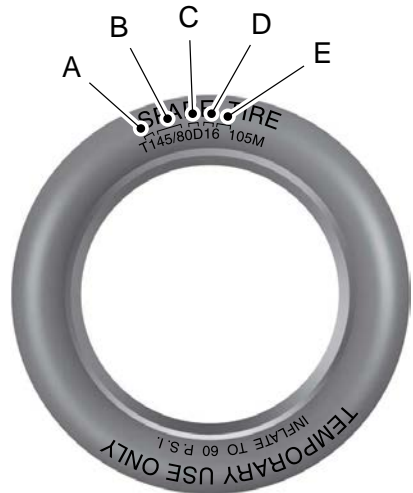

T type tires have some additional information beyond those of P type tires; these differences are described below:

A. **T:** Indicates a type of tire, designated by the Tire and Rim Association, that is intended for temporary service on cars, sport utility vehicles, minivans and light trucks.

B. **145:** Indicates the nominal width of the tire in millimeters from sidewall edge to sidewall edge. In general, the larger the number, the wider the tire.

# Wheel and Tire Information

---

C. **80:** Indicates the aspect ratio which gives the tire's ratio of height to width. Numbers of 70 or lower indicate a short sidewall.

D. **D:** Indicates a diagonal type tire.

**R:** Indicates a radial type tire.

E. **16:** Indicates the wheel or rim diameter in inches. If you change your wheel size, you will have to purchase new tires to match the new wheel diameter.

## GLOSSARY OF TIRE TERMINOLOGY

\***Tire label:** A label showing the original equipment tire sizes, recommended inflation pressure and the maximum weight the vehicle can carry.

\***Tire Identification Number (TIN):** A number on the sidewall of each tire providing information about the tire brand and manufacturing plant, tire size and date of manufacture. Also referred to as DOT code.

\***Inflation pressure:** A measure of the amount of air in a tire.

\***Standard load:** A class of P-metric or Metric tires designed to carry a maximum load at set pressure. For example: For P-metric tires 35 psi (2.4 bar) and for Metric tires 36 psi (2.5 bar). Increasing the inflation pressure beyond this pressure will not increase the tire's load carrying capability.

\***Extra load:** A class of P-metric or Metric tires designed to carry a heavier maximum load at 42 psi (2.9 bar). Increasing the inflation pressure beyond this pressure will not increase the tire's load carrying capability.

\***kPa:** Kilopascal, a metric unit of air pressure.

\***PSI:** Pounds per square inch, a standard unit of air pressure.

\***Cold tire pressure:** The tire pressure when the vehicle has been stationary and out of direct sunlight for an hour or more and prior to the vehicle being driven for 1 mi (1.6 km).

\***Recommended inflation pressure:** The cold inflation pressure found on the Safety Compliance Certification Label (affixed to either the door hinge pillar, door-latch post, or the door edge that meets the door-latch post, next to the driver's seating position), or Tire Label located on the B-Pillar or the edge of the driver door.

\* **B-pillar:** The structural member at the side of the vehicle behind the front door.

\***Bead area of the tire:** Area of the tire next to the rim.

\* **Sidewall of the tire:** Area between the bead area and the tread.

# Wheel and Tire Information

**\*Tread area of the tire:** Area of the perimeter of the tire that contacts the road when mounted on the vehicle.

**\*Rim:** The metal support (wheel) for a tire or a tire and tube assembly upon which the tire beads are seated.

## TIRE REPLACEMENT REQUIREMENTS

### AGE



**WARNING:** Tires degrade over time depending on many factors such as weather, storage conditions, and conditions of use (load, speed, inflation pressure) the tires experience throughout their lives.

In general, tires should be replaced after six years regardless of tread wear. However, heat caused by hot climates or frequent high loading conditions can accelerate the aging process and may require tires to be replaced more frequently.

You should replace your spare tire when you replace the road tires or after six years due to aging even if it has not been used.

## U.S. DOT Tire Identification Number

Both United States and Canada Federal regulations require tire manufacturers to place standardized information on the sidewall of all tires. This information identifies and describes the fundamental characteristics of the tire and also provides a U.S. DOT Tire Identification Number for safety standard certification and in case of a recall.

This begins with the letters DOT and indicates that the tire meets all federal standards. The next two numbers or letters are the plant code designating where it was manufactured, the next two are the tire size code and the last four numbers represent the week and year the tire was built. For example, the numbers 317 mean the 31st week of 1997. After 2000, the numbers go to four digits. For example, 2501 means the 25th week of 2001. The numbers in between are identification codes used for traceability. This information is used to contact customers if a tire defect requires a recall.

## Tire Replacement Requirements

Your vehicle is equipped with tires designed to provide a safe ride and handling capability.

## Wheel and Tire Information



**WARNING:** Only use replacement tires and wheels that are the same size, load index, speed rating and type (such as P-metric versus LT-metric or all-season versus all-terrain) as those originally provided by Ford. The recommended tire and wheel size may be found on either the Safety Compliance Certification Label (affixed to either the door hinge pillar, door-latch post, or the door edge that meets the door-latch post, next to the driver's seating position), or the Tire Label which is located on the B-Pillar or edge of the driver's door. If this information is not found on these labels, then you should contact your authorized dealer as soon as possible. Use of any tire or wheel not recommended by Ford can affect the safety and performance of your vehicle, which could result in an increased risk of loss of vehicle control, vehicle rollover, personal injury and death.



**WARNING:** To reduce the risk of serious injury, when mounting replacement tires and wheels, you should not exceed the maximum pressure indicated on the sidewall of the tire to set the beads without additional precautions listed below. If the beads do not seat at the maximum pressure indicated, re-lubricate and try again.



**WARNING:** For a mounting pressure more than 20 psi (1.38 bar) greater than the maximum pressure, a Ford dealer or other tire service professional should do the mounting.



**WARNING:** Always inflate steel carcass tires with a remote air fill with the person inflating standing at a minimum of 12 ft (3.66 m) away from the wheel and tire assembly.



**WARNING:** When inflating the tire for mounting pressures up to 20 psi (1.38 bar) greater than the maximum pressure on the tire sidewall, the following precautions must be taken to protect the person mounting the tire:

- Make sure that you have the correct tire and wheel size.
- Lubricate the tire bead and wheel bead seat area again.

# Wheel and Tire Information

- Stand at a minimum of 12 ft (3.66 m) away from the wheel and tire assembly.
- Use both eye and ear protection.

**Important:** Remember to replace the wheel valve stems when the road tires are replaced on your vehicle.

It is recommended that the two front tires or two rear tires generally be replaced as a pair if the worn tires still have usable depth.

To avoid potential Four-Wheel Drive (4WD) malfunction or (4WD) system damage, it is recommended to replace all four tires rather than mixing significantly worn tires with new tires.

The tire pressure sensors mounted in the wheels (originally installed on your vehicle) are not designed to be used in aftermarket wheels.

The use of wheels or tires not recommended may affect the operation of your tire pressure monitoring system.

If the tire pressure monitoring system indicator is flashing, your system is malfunctioning. Your replacement tire might be incompatible with your tire pressure monitoring system, or some component of the system may be damaged.

Tire can be damaged during off-road use, so inspection after off-road use is also recommended.

## Replacing a Tire That Is Greenhouse Gas Certified

The tires installed on this vehicle at the factory as original equipment are certified for Greenhouse Gas and Fuel Efficiency regulations. Replacement tires must be of equal or lower rolling resistance level (TRRL or Crr). Consult with your tire supplier(s) for appropriate replacement tires.

## USING SNOW CHAINS

 **WARNING:** Do not exceed 30 mph (50 km/h). Failure to follow this instruction could result in the loss of control of your vehicle, personal injury or death.

 **WARNING:** Do not use snow chains on snow-free roads.

 **WARNING:** Only fit snow chains to specified tires.

 **WARNING:** If your vehicle is fitted with wheel trims, remove them before fitting snow chains.

 **WARNING:** Wheels and tires must be the same size, load index and speed rating as those originally fitted on the vehicle. Use of any other tire or wheel can affect the safety and performance of your vehicle. Additionally, the use of non-recommended tires and wheels can

# Wheel and Tire Information

cause steering, suspension, axle, transfer case or power transfer unit failure. Follow the recommended tire inflation pressures found on the Safety Compliance Certification label, or the Tire Label on the B-Pillar or the edge of the driver door. Failure to follow this instruction could result in loss of vehicle control, vehicle rollover, or personal injury or death.

**Note:** Do not use snow chains on vehicles with LT275/65R20 or LT 285/75R18 sized tires.

**Note:** The suspension insulation and bumpers will help prevent vehicle damage. Do not remove these components from your vehicle when using snow tires and chains.

The tires on your vehicle have all-weather treads to provide traction in rain and snow. However, in some climates, you may need to use snow tires and cables. If you need to use cables, we recommend that you use steel wheels of the same size and specification, as cables may chip aluminum wheels.

Follow these guidelines when using snow tires and chains:

- If possible, avoid fully loading your vehicle.
- Use only SAE Class S chains.
- Install chains securely, verifying that the chains do not touch any wiring, brake lines or fuel lines.
- Only install snow chains on the rear axle.
- For Dual Rear Wheel (DRW) vehicles, only install snow chains on the outer wheel of each pair.
- Drive cautiously. If you hear the chains rub or bang against your vehicle, stop and retighten the chains. If this does not work, remove the chains to prevent damage to your vehicle.
- Remove the tire chains when you no longer need them. Do not use tire chains on dry roads.

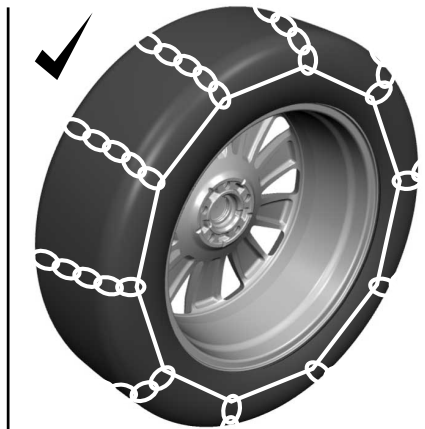
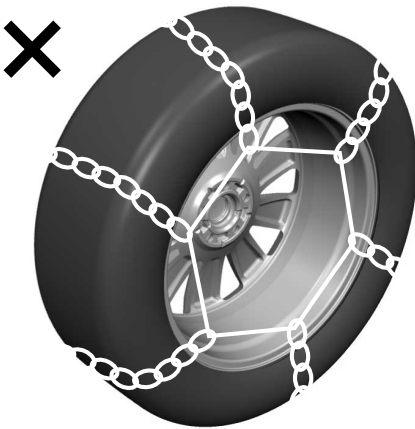

## Wheel and Tire Information

---

Use snow chains that fit against the sidewall of the tire to prevent the chains from touching the wheel rims or suspension. Refer to the previous illustration.

If you have any questions regarding snow chains, please contact your authorized dealer.



# Tire Care

## CHECKING THE TIRE PRESSURES

Safe operation of your vehicle requires that your tires are properly inflated. Every day before you drive, check your tires.

At least once a month and before long trips, inspect each tire and check the tire pressure with a tire gauge. Inflate all tires to the recommended inflation pressure. See **Inflating the Tires** (page 489).

## INFLATING THE TIRES



**WARNING:** Under-inflation is the most common cause of tire failures and may result in severe tire cracking, tread separation or blowout, with unexpected loss of vehicle control and increased risk of injury. Under-inflation increases sidewall flexing and rolling resistance, resulting in heat buildup and internal damage to the tire. It also may result in unnecessary tire stress, irregular wear, loss of vehicle control and accidents. A tire can lose up to half of its air pressure and not appear to be flat!

Use the recommended cold inflation pressure for optimum tire performance and wear. Under-inflation or over-inflation may cause uneven treadwear patterns.

Always inflate your tires to the recommended inflation pressure even if it is less than the maximum inflation pressure information found on the tire. You will find a Tire Label containing the manufacturer's recommended tire inflation pressure by the tire size and other important information located on the B-Pillar or the edge of the driver door.

The recommended tire inflation pressure is also found on the Safety Compliance Certification Label, affixed to either the door hinge pillar, door-latch post, or the door edge that meets the door-latch on the B-pillar, or on the edge of the driver door.

Failure to follow the tire pressure recommendations can cause uneven treadwear patterns and adversely affect the way your vehicle handles.

**Note:** *If you have to drive a distance to get air for your tire(s), check and record the tire pressure first and add the appropriate air pressure when you get to the pump. It is normal for tires to heat up and the air pressure inside to go up as you drive.*

To check the pressure in your tire(s):

# Tire Care

---

1. Make sure the tires are cool, meaning they are not hot from driving even a mile.

**Note:** *If you are checking tire pressure when the tire is hot, (for example, driven more than 1 mile [1.6 kilometers]), never bleed or reduce air pressure. The tires are hot from driving and it is normal for pressures to increase above recommended cold pressures. A hot tire at or below recommended cold inflation pressure could be significantly under-inflated.*

2. Remove the cap from the valve on one tire, then firmly press the tire gauge onto the valve and measure the pressure.

3. Add enough air to reach the recommended air pressure.

**Note:** *If you overfill the tire, release air by pressing on the metal stem in the center of the valve. Then recheck the pressure with your tire gauge.*

4. Replace the valve cap.

5. Repeat this procedure for each tire, including the spare.

**Note:** *Some spare tires operate at a higher inflation pressure than the other tires. For T type mini-spare tires, (see the Dissimilar spare wheel and tire assembly information for a description. Store and maintain at 60 psi (4.15 bar) 60 psi (4.15 bar). For full-size and dissimilar spare tires, see the Dissimilar spare wheel and tire assembly information for a description. Store and maintain at the higher of the front and rear inflation pressure as shown on the Safety Compliance Certification Label or Tire Label.*

**Note:** *Do not reduce tire pressure to change the ride characteristics of the vehicle. If you do not maintain the inflation pressure at the levels specified by Ford, your vehicle may experience a condition known as shimmy. Shimmy is a severe vibration and oscillation in the steering wheel after the vehicle travels over a bump or dip in the road that does not dampen out by itself. Shimmy may result from significant under-inflation of the tires, improper tires (load range, size, or type), or vehicle modifications such as lift-kits. In the event that your vehicle experiences shimmy, you should slowly reduce speed by either lifting off the accelerator pedal or lightly applying the brakes. The shimmy will cease as the vehicle speed decreases.*

# Tire Care

When weather temperature changes occur, tire inflation pressures also change. A 10°F (6°C) temperature drop can cause a corresponding drop of 1 psi (7 kPa) in inflation pressure. Check your tire pressures frequently and adjust them to the proper pressure which can be found on the Safety Compliance Certification Label or Tire Label.

## Checking Pressure when tires are hot:

If pressures are checked after tires have been driven for more than three minutes or more than 1 mile, (2 km) the tires become hot and the pressures will increase by approximately 4 psi (27.6 kPa). Therefore when the tire pressure is adjusted under these conditions, it should be increased to a gauge reading of 4 psi (27.6 kPa) greater than the recommended cold inflation pressure.

After inflating the tires while hot, make sure to recheck tire pressure later once the tires are cold.

## For Example Only

Gauge reading of hot tire	33 psi (230 kPa)
If recommended, cold inflation pressure is	32 psi (220 kPa)
The hot tire pressure is only 1 psi (10 kPa) greater than the recommended cold inflation pressure. Therefore, add 3 psi (20 kPa) more to increase the hot pressure to 4 psi (30 kPa) over the recommended cold inflation pressure.	
New hot pressure	36 psi (250 kPa)

## Steel Carcass Plies



**WARNING:** An inflated tire and rim can be very dangerous if improperly used, serviced or maintained. To reduce the risk of serious injury, never attempt to re-inflate a tire which has been run flat or seriously under-inflated without first removing the tire from the wheel assembly for inspection. Do not attempt to add air to tires or replace tires or wheels without first taking precautions to protect persons and property.

All tires with Steel Carcass Plies (if equipped):

## Tire Care

This type of tire utilizes steel cords in the sidewalls. As such, they cannot be treated like normal light truck tires. Tire service, including adjusting tire pressure, must be performed by personnel trained, supervised and equipped according to Federal Occupational Safety and Health Administration regulations. For example, during

any procedure involving tire inflation, the technician or individual must utilize a remote inflation device, and ensure that all persons are clear of the trajectory area.



**WARNING:** Always inflate steel carcass tires with a remote air fill with the person inflating standing at a minimum of 12 ft (3.66 m) away from the wheel and tire assembly.

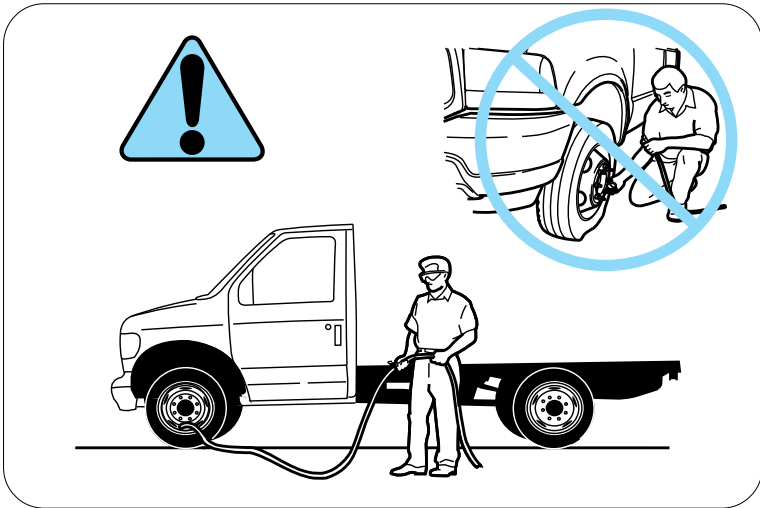

# Tire Care

## INSPECTING THE TIRE FOR WEAR

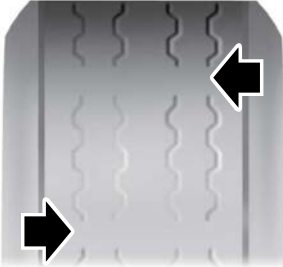

When the tread is worn down to 2/32 inch (1.6 mm), tires must be replaced to help prevent your vehicle from skidding and hydroplaning. Built-in treadwear indicators, or wear bars, which look like narrow strips of smooth rubber across the tread will appear on the tire when the tread is worn down to 2/32 inch (1.6 mm).

When the tire tread wears down to the same height as these wear bars, the tire is worn out and must be replaced.

The tires should also be balanced periodically. An unbalanced tire and wheel assembly may result in irregular tire wear.

Periodically inspect the tire treads for uneven or excessive wear and remove objects such as stones, nails or glass that may be wedged in the tread grooves.

## INSPECTING THE TIRE FOR DAMAGE

Inspect the tire sidewalls for cracking, cuts, bruises and other signs of damage or excessive wear. If internal damage to the tire is suspected, have the tire dismantled and inspected in case it needs to be repaired or replaced. For your safety, tires that are damaged or show signs of excessive wear should not be used because they are more likely to blow out or fail.

Periodically inspect the tire treads and sidewalls for damage, such as bulges in the tread or sidewalls, cracks in the tread groove and separation in the tread or sidewall. If damage is observed or suspected, have the tire inspected by a tire professional.

Tires can be damaged during off-road use, so inspection after off-road use is also recommended.

## Safety Practices



**WARNING:** If your vehicle is stuck in snow, mud or sand, do not rapidly spin the tires; spinning the tires can tear the tire and cause an explosion. A tire can explode in as little as three to five seconds.

# Tire Care



**WARNING:** Do not spin the wheels at over 34 mph (55 km/h). The tires may fail and injure a passenger or bystander.

## **HIGH SPEED DRIVING CAN BE DANGEROUS**

Correct inflation pressure is especially important. However, at high speeds, even with the correct inflation pressure, a road hazard for example is more difficult to avoid and if contact is made, has a greater chance of causing tire damage than at a lower speed. Moreover, driving at high speed reduces the reaction time available to avoid accidents and bring your vehicle to a safe stop.

If you see any damage to a tire or wheel, replace it with the spare at once and visit a participating Tire Retailer.

Exceeding the maximum speeds shown on the following page for each type of tire will cause the tire to build up excessive heat which can cause tire damage that could result in sudden tire destruction and rapid air loss. Failure to control a vehicle when one or more tires experience a sudden air loss can lead to an accident.

**In any case, you should not exceed reasonable speeds as indicated by the legal limits and driving conditions.**

## **DO NOT OVERLOAD: DRIVING ON ANY OVERLOADED TIRE IS DANGEROUS**

The maximum load rating of your tires is molded on the tire sidewall. Do not exceed this rating. Follow the loading instructions of the manufacturer of your vehicle and this will ensure that your tires are not overloaded. Tires which are loaded beyond their maximum allowable loads for the particular application will build up excessive heat that may result in sudden tire destruction. Do not exceed the gross axle weight rating for any axle on your vehicle.

## **TIRE ALTERATIONS**

Do not make or allow to be made any alterations on your tires. Alterations may prevent proper performance, leading to tire damage which can result in an accident. Tires which become unserviceable due to alterations such as truing, whitewall inlays, addition of balancing or sealant liquids, or the use of tire dressing containing petroleum distillates are excluded from warranty coverage.

# Tire Care

---

## **REPAIRS - WHEREVER POSSIBLE, SEE YOUR TIRE RETAILER AT ONCE**

If any tire sustains a puncture, have the tire demounted and thoroughly inspected by a tire retailer for possible damage that may have occurred. A tread area puncture in any passenger or light truck tire can be repaired provided that the puncture hole is not more than 1/4" in diameter, not more than one radial cable per casing ply is damaged, and the tire has not been damaged further by the puncturing object or by running underinflated. Tire punctures consistent with these guidelines should only be repaired by following the US Tire Manufacturers Association (USTMA) recommended repair procedures. Plug-only repairs done on-the-wheel are considered improper and therefore, not recommended. Such repairs are not reliable and may cause further damage to the tire.

## **STORAGE**

Tires contain waxes and emollients to protect their outer surfaces from ozone and weather checking. As the tire rolls and flexes, the waxes and emollients continually migrate to the surface, replenishing this protection throughout the normal use of the tire. Consequently, when tires sit unused for long periods of time (a month or more) their surfaces

become dry and more susceptible to ozone and weather checking and the casing becomes susceptible to flat spotting. **For this reason, tires should always be stored in a cool, dry, clean, indoor environment. If storage is for one month or more, eliminate the weight from the tires by raising the vehicle or by removing the tires from the vehicle. Failure to store tires in accordance with these instructions could result in damage to your tires or premature aging of the tires and sudden tire failure.**

When tires are stored, be sure they are placed away from sources of heat and ozone such as direct sunlight, hot pipes and electric generators. Be sure that surfaces on which tires are stored are clean and free from grease, gasoline or other substances, which could deteriorate the rubber. Failure to store tires in accordance with these instructions could result in damage to your tires or premature aging of the tires and sudden tire failure.

# Tire Care

---

## **FOLLOW THESE MOUNTING RECOMMENDATIONS**

**Tire changing can be dangerous and must be done by professionally trained persons using proper tools and procedures as specified by the US Tire Manufacturers Association (USTMA). Single or dual assemblies must be completely deflated before demounting.**

Your tires should be mounted on wheels of correct size and type and which are in good, clean condition. Wheels that are bent, chipped, rusted (steel wheels) or corroded (alloy wheels) may cause tire damage. The inside of the tire must be free from foreign material. Have your retailer check the wheels before mounting new tires. Mismatched tires and rims can explode during mounting. Also, mismatched tires and rims can result in dangerous tire failure on the road. If a tire is mounted by error on the wrong-sized rim, do not remount it on the proper rim - scrap it. It may have been damaged internally (which is not externally visible) by having been dangerously stretched and could fail on the highway.

**Old valves may leak. When new tubeless tires are mounted, have new valves of the correct type installed. Tubeless tires must only be mounted on wheels designed for tubeless tires i.e., wheels which have safety humps or ledges.**

It is recommended that you have your tires and wheels balanced. Tires and wheels, which are not balanced, may cause steering difficulties, a bumpy ride, and irregular tire wear.

**Be sure that all your valves have suitable valve caps. The valve cap is the primary seal against air loss.**

## **TEMPORARY SPARE TIRES**

When using any temporary spare tire, be sure to follow the vehicle manufacturer's instructions.

## **REMEMBER... TO AVOID DAMAGE TO YOUR TIRES AND POSSIBLE ACCIDENT:**

- CHECK TIRE PRESSURE AT LEAST ONCE EACH MONTH WHEN TIRES ARE COLD AND BEFORE LONG TRIPS.
- DO NOT UNDERINFLATE/OVERINFLATE.
- DO NOT OVERLOAD.
- DRIVE AT MODERATE SPEEDS, OBSERVE LEGAL LIMITS.



# Tire Care

---

- AVOID DRIVING OVER POTHoles, OBSTACLES, CURBS OR EDGES OF PAVEMENT.
- AVOID EXCESSIVE WHEEL SPINNING.
- IF YOU SEE ANY DAMAGE TO A TIRE, REPLACE WITH THE SPARE AND VISIT ANY AUTHORIZED RETAILER AT ONCE.
- IF YOU HAVE ANY QUESTIONS, CONTACT YOUR AUTHORIZED RETAILER.

## Highway Hazards

No matter how carefully you drive, there is always the possibility that you could eventually have a flat tire on the highway. Drive slowly to the closest safe area out of traffic. This could further damage the flat tire, but your safety is more important.

If you feel a sudden vibration or ride disturbance while driving, or you suspect your tire or vehicle has been damaged, immediately reduce your speed. Drive with caution until you can safely pull off the road. Stop and inspect the tires for damage. If a tire is under-inflated or damaged, deflate it, remove the wheel and replace it with your spare tire and wheel. If you cannot detect a cause, have the vehicle towed to the nearest repair facility or tire dealer to have the vehicle inspected.

## Tire and Wheel Alignment

A bad jolt from hitting a curb or pothole can cause the front end of your vehicle to become misaligned or cause damage to your tires. If your vehicle seems to pull to one side when you are driving, the wheels could be out of alignment. Have an authorized dealer check the wheel alignment periodically.

Wheel misalignment in the front or the rear can cause uneven and rapid treadwear of your tires and should be corrected by an authorized dealer.

## INSPECTING THE WHEEL VALVE STEMS

Check the valve stems for holes, cracks, or cuts that may permit air leakage and replace the valve stem if damaged.

**Note:** *A new valve stem (including new nut, new washer & new screw) must be installed whenever a new tire or wheel is installed.*

## TIRE ROTATION



**WARNING:** If the tire label shows different tire pressures for the front and rear tires and the vehicle has a tire pressure monitoring system, then you need to update the settings for the system sensors. Always

# Tire Care

perform the system reset procedure after tire rotation. If you do not reset the system, it may not provide a low tire pressure warning when necessary.

Rotating your tires at the recommended interval will help your tires wear more evenly, providing better tire performance and longer tire life.

**Note:** If your tires show any uneven wear have the alignment checked by an authorized dealer before rotating tires.

**Note:** If you have a dissimilar spare wheel and tire assembly, it is intended for temporary use only and should not be used in a tire rotation.

**Note:** After having your tires rotated, inflation pressure must be checked and adjusted to the vehicle requirements.

## Tire Rotation Diagram

Follow the diagram indicating the correct tire locations for rotating the tires.

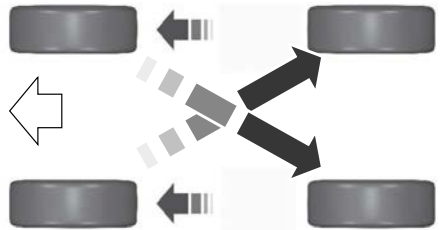

Rear-wheel drive vehicles and four-wheel drive vehicles (front tires at left of diagram).

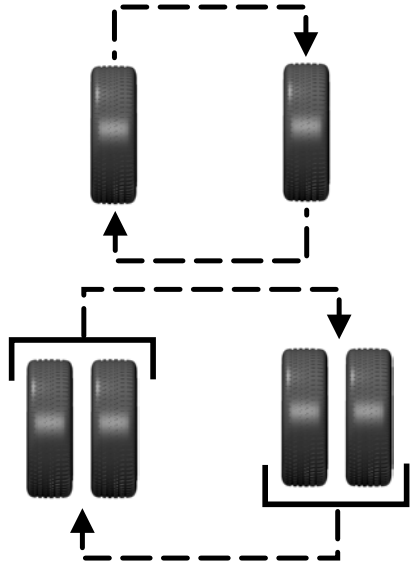

Dual rear wheel drive vehicle - six tire rotation (front tires at top of diagram).

## Tire Care

If your vehicle is equipped with dual rear wheels it is recommended that the front and rear tires (in pairs) be rotated only side to side. We do not recommend splitting up the dual rear wheels. Rotate them side to side as a set. After tire rotation, inflation pressures must be adjusted for the tires' new positions in accordance with vehicle requirements.

**Note:** When installing 17-inch dual rear wheels, align the valve stems facing each other. If your vehicle is equipped with 4 rear aluminum wheels, ensure the inner wheel valve stem is accessible through a vent hole in the outer wheel without the valve stem.

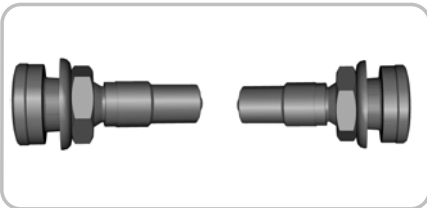
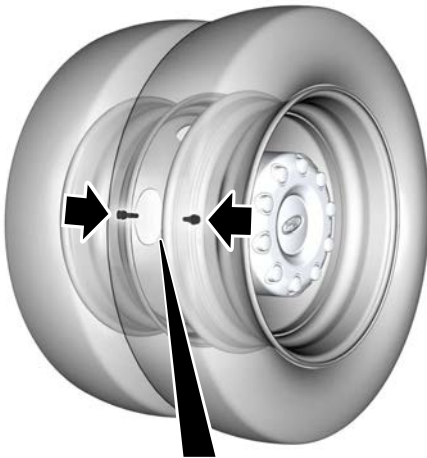

# Tire Pressure Monitoring System (If Equipped)

## WHAT IS THE TIRE PRESSURE MONITORING SYSTEM



The tire pressure monitoring system measures the vehicle's tire pressures. A warning lamp illuminates if one or more tires are significantly underinflated or if there is a system malfunction.

## TIRE PRESSURE MONITORING SYSTEM OVERVIEW



**WARNING:** Under-inflation is the most common cause of tire failures and may result in severe tire cracking, tread separation or blowout, with unexpected loss of vehicle control and increased risk of injury. Under-inflation increases sidewall flexing and rolling resistance, resulting in heat buildup and internal damage to the tire. It also may result in unnecessary tire stress, irregular wear, loss of vehicle control and accidents. A tire can lose up to half of its air pressure and not appear to be flat!



**WARNING:** To determine the required pressure(s) for your vehicle, see the Safety Compliance Certification Label (on the door hinge pillar, door-latch post or the door edge that meets the door-latch post, next to the driver seat) or the Tire Label on the B-Pillar or the edge of the driver door.

Each tire, including the spare (if provided), should be checked monthly when cold and inflated to the inflation pressure recommended by the vehicle manufacturer on the vehicle placard or tire inflation pressure label. (If your vehicle has tires of a different size than the size indicated on the vehicle placard or tire inflation pressure label, you should determine the proper tire inflation pressure for those tires).

As an added safety feature, your vehicle has been equipped with a Tire Pressure Monitoring System (TPMS) that illuminates a low tire pressure telltale when one or more of your tires is significantly under-inflated. Accordingly, when the low tire pressure telltale illuminates, you should stop and check your tires as soon as possible, and inflate them to the proper pressure. Driving on a significantly under-inflated tire causes the tire to overheat and can lead to tire failure. Under-inflation also reduces fuel efficiency and tire tread life, and may affect the vehicle's handling and stopping ability.

Please note that the TPMS is not a substitute for proper tire maintenance, and it is the driver's responsibility to maintain correct tire pressure, even if under-inflation has not reached the level to trigger illumination of the TPMS low tire pressure telltale.

Your vehicle has also been equipped with a TPMS malfunction indicator to indicate when the system is not operating properly. The TPMS malfunction indicator is combined with the low tire pressure telltale. When the system detects a malfunction, the telltale will flash for approximately one minute and then remain continuously illuminated. This sequence will continue upon subsequent vehicle start-ups as long as the malfunction exists.

# Tire Pressure Monitoring System (If Equipped)

When the malfunction indicator is illuminated, the system may not be able to detect or signal low tire pressure as intended. TPMS malfunctions may occur for a variety of reasons, including the installation of replacement or alternate tires or wheels on the vehicle that prevent the TPMS from functioning properly. Always check the TPMS malfunction telltale after replacing one or more tires or wheels on your vehicle to ensure that the replacement or alternate tires and wheels allow the TPMS to continue to function properly.



**WARNING:** Changes or modifications not expressly approved by the party responsible for compliance could void the user's authority to operate the equipment. The term "IC:" before the radio certification number only signifies that Industry Canada technical specifications were met.

This device complies with Part 15 of the FCC Rules and with License exempt RSS Standards of Industry Canada. Operation is subject to the following two conditions:

1. This device may not cause harmful interference, and
2. This device must accept any interference received, including interference that may cause undesired operation.

## TIRE PRESSURE MONITORING SYSTEM PRECAUTIONS



**WARNING:** The tire pressure monitoring system is not a substitute for manually checking tire pressures. You should periodically check tire pressures using a pressure gauge. Failure to correctly maintain tire pressures could increase the risk of tire failure, loss of control, vehicle rollover and personal injury.



**WARNING:** Do not use the tire pressure displayed in the information display as a tire pressure gauge. Failure to follow this instruction could result in personal injury or death.

**Note:** *The use of tire sealants can damage the tire pressure monitoring system.*

**Note:** *If the tire pressure monitor sensor becomes damaged it may not function.*

## TIRE PRESSURE MONITORING SYSTEM LIMITATIONS

When the outside temperature drops significantly, the tire pressure could decrease and activate the low tire pressure warning lamp.

The warning lamp could also illuminate when you use a spare wheel, or tire sealant from the inflator kit.

**Note:** *Regularly checking the vehicle tire pressures can reduce the possibility for the warning lamp to illuminate due to outside air temperature changes.*

**Note:** *After you inflate the tires to the recommended pressure it could take up to two minutes of driving over 20 mph (32 km/h) for the warning indicator to turn off.*

# Tire Pressure Monitoring System (If Equipped)

## VIEWING THE TIRE PRESSURES



Using the instrument cluster display arrow keys navigate to the truck info section where you can view the tire pressures.

## RESETTING TIRE PRESSURE MONITORING SYSTEM

### Tire Pressure Monitoring System Reset Procedure - Single Rear Wheel



**WARNING:** To determine the required pressure(s) for your vehicle, see the Safety Compliance Certification Label (on the door hinge pillar, door-latch post or the door edge that meets the door-latch post, next to the driver seat) or the Tire Label on the B-Pillar or the edge of the driver door.

You must reset the tire pressure monitoring system after each tire rotation on vehicles that require different recommended tire pressures in the front tires as compared to the rear tires.

**Note:** To reduce the chances of interference from another vehicle, perform the system reset procedure at least 3 ft (1 m) away from another vehicle undergoing the system reset procedure at the same time.

**Note:** Do not wait more than two minutes between resetting each tire sensor or the system can time-out and you need to repeat the entire procedure on all four wheels.

1. Drive the vehicle above 20 mph (32 km/h) for at least two minutes, then park in a safe location where you can easily get to all four tires and have access to an air pump.
2. Switch the ignition off.
3. Switch the ignition on but do not start the engine.
4. Switch the hazard flashers on then off three times.

**Note:** You must accomplish this within 10 seconds. If you successfully enter the reset mode, the horn sounds once, the system indicator flashes and a message shows in the instrument cluster display.

**Note:** If the system does not enter reset mode, repeat the procedure starting at step 2. If after repeated attempts to enter the reset mode, the horn does not sound, the system indicator does not flash and no message shows in the instrument cluster display, contact your authorized dealer.

5. Remove the valve cap from the valve stem on the left front tire. Decrease the air pressure until the horn sounds.

**Note:** The single horn tone confirms that the sensor identification code has been learned by the module for this position. If the horn sounds twice, the reset procedure was unsuccessful, and you must repeat it.

6. Remove the valve cap from the valve stem on the right front tire. Decrease the air pressure until the horn sounds.

# Tire Pressure Monitoring System (If Equipped)

7. Repeat the previous step on the right rear tire and then on the left rear tire.
8. Switch the ignition off.

**Note:** *If the horn sounds twice again after switching the ignition off, and repeating the procedure, contact your authorized dealer and have your vehicle checked as soon as possible.*

9. Set all four tires to the recommended air pressure as indicated on the Safety Compliance Certification Label.

## Tire Pressure Monitoring System Reset Procedure - Dual Rear Wheel

For further information see **Understanding Your Tire Pressure Monitoring System** and refer to **Dual Rear Wheel**, earlier in this section.

Read the entire procedure before attempting.

1. Drive the vehicle above 20 mph (32 km/h) for at least two minutes, then park in a safe location where you can easily get to all six tires and have access to an air pump.
2. Place the ignition in the off position and keep the key in the ignition.
3. Cycle the ignition to the on position with the engine off.
4. Turn the hazard flashers on then off three times. You must accomplish this within 10 seconds. If you successfully enter the reset mode, the horn sounds once, the system indicator flashes and a message shows in the instrument cluster display. If this does not occur, repeat the procedure starting at step 2. If after repeated attempts to enter the reset mode, the horn does not sound, the system indicator does not flash and no message shows in the instrument cluster display, contact your authorized dealer as soon as possible.

5. Train the tire pressure monitoring system sensors in the tires using the following system reset sequence starting with the left front tire in the following order: Left front - driver side front tire, Right front - passenger side front tire, Right outer rear -passenger side rear outer tire, Right inner rear - passenger side rear inner tire, Left outer rear - driver side rear outer tire, Left inner rear - driver side rear inner tire.
6. Remove the valve cap from the valve stem on the left front tire. Decrease the air pressure until the horn sounds.

**Note:** *The single horn chirp confirms that the sensor identification code has been learned by the module for this position. If a double horn is heard, the reset procedure was unsuccessful, and you must repeat it.*

7. Remove the valve cap from the valve stem on the right front tire. Decrease the air pressure until the horn sounds.
8. Remove the valve cap from the valve stem on the right outer rear tire. Decrease the air pressure until the horn sounds.
9. Remove the valve cap from the valve stem on the right inner rear tire. Decrease the air pressure until the horn sounds.
10. Remove the valve cap from the valve stem on the left outer rear tire. Decrease the air pressure until the horn sounds.
11. Remove the valve cap from the valve stem on the left inner rear tire. Decrease the air pressure until the horn sounds. Training is complete after the horn sounds for the last tire trained, the system indicator stops flashing, and a message is shown in the instrument cluster display.

## Tire Pressure Monitoring System (If Equipped)

12. Turn the ignition off. If two short horn beeps are heard, the reset procedure was unsuccessful and you must repeat it. If after repeating the procedure and two short beeps are heard when the ignition is turned off, contact your authorized dealer as soon as possible.
13. Set all six tires to the recommended air pressure as indicated on the Safety Compliance Certification Label, affixed to either the door hinge pillar, door-latch post, or the door edge that meets the door-latch post, next to the driver seating position or tire label located on the B-pillar or the edge of the driver door.

### Trailer Tire Pressure Monitoring System (If Equipped)

**Note:** Additional equipment may be required for your vehicle to support trailer tire pressure and temperature monitoring. See your authorized dealer for more information.

**Note:** The trailer tire pressure monitoring system is not a substitute for proper tire maintenance. It is your responsibility to maintain correct tire pressures at all times.

**Note:** Replace the screw and valve on the trailer tire pressure sensor anytime the trailer tire is repaired, replaced or in for service. See your authorized dealer for details.



The trailer tire pressure monitoring system is an added safety feature that allows you to view your trailer tire pressures and temperatures through the instrument cluster display. See **Tire Pressure Monitoring System – Information Messages** (page 507). Tire pressure sensors are mounted into each tire on your trailer. The sensors send a message to your vehicle indicating the current trailer tire pressure and temperature.

If the trailer tire pressure monitoring system detects that a tire is low, a warning message appears in the instrument cluster display. The trailer tire information screen in the instrument cluster display highlights the tire with a low pressure.

If the trailer tire pressure monitoring system detects that a tire temperature is over temp, a warning message appears in the instrument cluster display. The trailer tire information screen in the instrument cluster display highlights the tire with a high temperature.

The main function of the trailer tire pressure monitoring system is to warn you when your trailer tires need air or if the tires are experiencing high temperatures. It can also warn you if the system is no longer capable of functioning as intended. See **Tire Pressure Monitoring System – Information Messages** (page 507).

### When a Temporary Spare or New Tire is Installed

If you have replaced a trailer tire with a new or spare tire, a warning message appears and pressure readings are no longer displayed for that tire.



# Tire Pressure Monitoring System (If Equipped)

---

To restore the full function of the trailer tire pressure monitoring system:

- Have the damaged wheel and tire assembly repaired and remounted to your trailer.
- Install the trailer tire pressure monitoring sensor into the new wheel and tire assembly.
- Perform the trailer tire pressure monitoring system reset procedure.

## Trailer Tire Pressure Monitoring System Reset Procedure

**Note:** You need to perform the tire pressure monitoring system reset procedure after each tire rotation, or when a new trailer tire pressure sensor is installed into a trailer tire.

The trailer tire pressure monitoring system can be reset through the menu in the instrument cluster display. See **Tire Pressure Monitoring System – Information Messages** (page 507).

Performing the trailer setup process also resets the trailer tire pressure monitoring system.

**Note:** For further information on the trailer tire pressure monitoring system see the instructions that were included with the trailer tire pressure monitoring system kit.

## TIRE PRESSURE MONITORING SYSTEM – TROUBLESHOOTING

### TIRE PRESSURE MONITORING SYSTEM – WARNING LAMPS



The low tire pressure warning lamp has combined functions, as it warns you when your tires need air, and when the system is no longer capable of functioning as intended.

## Tire Pressure Monitoring System (If Equipped)

Warning Lamp	Possible Cause	Action Required
Solid warning lamp	One or more tires are significantly under inflated	After inflating your tires to the manufacturer's recommended pressure as shown on the tire label, on the edge of driver door or the B-pillar, drive your vehicle for at least two minutes over 20 mph (32 km/h) before the light turns off.
	Tire rotation without sensor training	On vehicles with different front and rear tire pressures, the system must be retrained following every tire rotation.
Solid warning lamp or flashing warning lamp	Temporary spare wheel in use	Repair the damaged road wheel and tire and refit it to your vehicle to restore operation of the system.
	Tire pressure monitoring system malfunction	If the tires are inflated to the recommended tire pressures and the temporary spare wheel is not in use, the system detected a fault that requires service. Have your vehicle checked as soon as possible.

# Tire Pressure Monitoring System (If Equipped)

## TIRE PRESSURE MONITORING SYSTEM – INFORMATION MESSAGES

Message	Action
Tire Pressure Low	After inflating your tires to the manufacturer's recommended pressure as shown on the Tire Label, on the edge of the driver door or the B-Pillar, drive your vehicle for at least two minutes over 20 mph (32 km/h) before the light turns off.
Tire Pressure Monitor Fault	The system has detected a fault that requires service. Have your vehicle checked as soon as possible.
Tire Pressure Sensor Fault	The system has detected a fault that requires service or a spare tire is in use. Have your vehicle checked as soon as possible.

## Trailer Tire Pressure Monitoring System

Message	Action
Trailer Tire Low Specified:	One or more tires on your trailer is below the specified tire pressure.
Trailer Tire Over Temperature	Displays when one or more tires on your trailer is above the recommended temperature.
Trailer Tire Pressure Sensor Fault	A trailer tire pressure sensor is malfunctioning. If the warning stays on or continues to come on, contact an authorized dealer as soon as possible.
Trailer Tire Pressure Monitor Fault	The trailer tire pressure monitoring system is malfunctioning. If the warning stays on or continues to come on, contact an authorized dealer.
Trailer Tire Pressure Monitor Capability Not Detected	The system cannot detect the trailer tire pressure monitoring system.
Trailer Tire Pressure Indication Not Setup See Manual	The trailer tire pressure monitoring system is not setup. See <b>Tire Pressure Monitoring System</b> (page 500).

# Changing a Road Wheel

## CHANGING A FLAT TIRE

If you get a flat tire when driving, do not apply the brake heavily. Instead, gradually decrease your speed, hold the steering wheel firmly and slowly move to a safe place on the side of the road.

Have a flat serviced by an authorized dealer to prevent damage to the system sensors. See **Tire Pressure Monitoring System Precautions** (page 501). Replace the spare tire with a road tire as soon as possible. During repairing or replacing the flat tire, have the authorized dealer inspect the system sensor for damage.

**Note:** Only use tire sealants in roadside emergencies as they may damage the tire pressure monitoring system sensor.

**Note:** The tire pressure monitoring system indicator light illuminates when the spare tire is in use. To restore the full functionality of the monitoring system, all road wheels equipped with tire pressure monitoring sensors must be mounted on this vehicle.

## Dissimilar Spare Wheel and Tire Assembly Information



**WARNING:** Failure to follow these guidelines could result in an increased risk of loss of vehicle control, injury or death.

If you have a dissimilar spare wheel and tire, then it is intended for temporary use only. This means that if you need to use it, you should replace it as soon as possible with a road wheel and tire assembly that is the same size and type as the road tires and wheels that were originally provided by Ford. If the dissimilar spare tire or wheel is damaged, it should be replaced rather than repaired.

A dissimilar spare wheel and tire assembly is defined as a spare wheel and tire assembly that is different in brand, size or appearance from the road tires and wheels.

### Full-size dissimilar spare

When driving with the full-size dissimilar spare wheel and tire assembly, do not:

- Exceed 70 mph (113 km/h).
- Use more than one dissimilar spare wheel and tire assembly at a time.
- Use snow chains on the end of the vehicle with the dissimilar spare wheel and tire assembly.
- Engage any four-wheel drive mode. See **Four-Wheel Drive Limitations** (page 235).

When driving with the full-size dissimilar spare wheel and tire assembly, 4WD functionality may be limited. You may experience the following:

- Additional noise from the transfer case or other drive components.
- Difficulty shifting out of a mechanically locked 4WD mode.

When driving with the full-size dissimilar spare wheel and tire assembly, it is recommended that you do not:

- Engage 4WD High or 4WD Low, if equipped, other than to get your vehicle unstuck.

Using a full-size dissimilar spare wheel and tire assembly can compromise the effectiveness of the following:

- Handling, stability and braking performance.
- Comfort and noise.
- Ground clearance and parking at curbs.
- Winter weather driving capability.
- Wet weather driving capability.
- Four-wheel drive capability.

# Changing a Road Wheel

When driving with the full-size dissimilar spare wheel and tire assembly additional caution should be given to:

- Towing a trailer.
- Driving vehicles equipped with a camper body.
- Driving vehicles with a load on the cargo rack.

Drive cautiously when using a full-size dissimilar spare wheel and tire assembly and seek service as soon as possible.

## Location of the Spare Tire and Tools

See the following table for their locations:

Item	Location
Spare tire - pick-up trucks only	Under the vehicle, just forward of the rear bumper.
Jack	Fastened to the floor pan behind the rear-most seat on the passenger side.
Jack handle, lug wrench, lug wrench extension - only provided on dual rear wheel vehicles.	Regular Cab: Fastened to floor behind the driver seat. Super Cab and Crew Cab: Fastened to the floor under the rear seat on the driver's side.

## Tire Change Procedure



**WARNING:** The jack supplied with this vehicle is only intended for changing a flat tire in an emergency. Do not attempt to do any other work on your vehicle when it is supported by the jack, as your vehicle could slip off the jack. Failure to follow this instruction could result in personal injury or death.

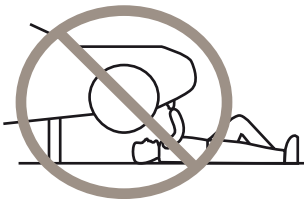

**WARNING:** To help prevent your vehicle from moving when changing a wheel, shift the transmission into park (P), set the parking brake and use an appropriate block or wheel chock to secure the wheel diagonally opposite to the wheel being changed. For example, when changing the front left wheel, place an appropriate block or wheel chock on the right rear wheel.



**WARNING:** Only use the jack provided as original equipment with your vehicle.



**WARNING:** Failure to follow these guidelines could result in an increased risk of loss of vehicle control, injury or death.



**WARNING:** Never place anything between the vehicle jack and your vehicle.

# Changing a Road Wheel

**WARNING:** Never place anything between the vehicle jack and the ground.

**WARNING:** Do not attempt to change a tire on the side of the vehicle close to moving traffic. Pull far enough off the road to not obstruct the flow of traffic and avoid the danger of being hit when operating the jack or changing the wheel.

**WARNING:** The jack supplied with this vehicle is only intended for changing a flat tire in an emergency. Do not attempt to do any other work on your vehicle when it is supported by the jack, as your vehicle could slip off the jack. Failure to follow this instruction could result in personal injury or death.

**WARNING:** Only use the spare wheel carrier to stow wheels provided with your vehicle.

**Note:** Do not use impact tools or power tools operating at over 200 RPM on the spare wheel carrier winch, which may cause it to malfunction and result in the wheel and tire not being securely stowed.

**Note:** Passengers should not remain in the vehicle when the vehicle is being jacked.

1. Park the vehicle on a level firm ground and activate the hazard flashers.
2. Apply the parking brake, place the transmission in park (P), switch the engine off.
3. Block the wheel diagonally opposite the flat tire. If equipped, use the wheel chocks attached to the tool bag. For example, if the left front tire is flat, block the right rear wheel.

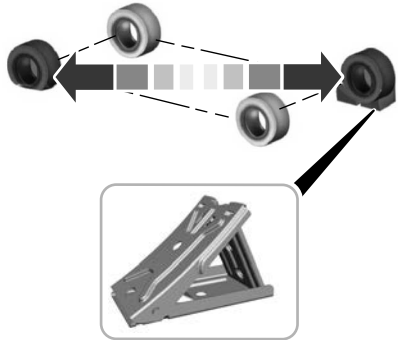

4. The jack is on the floor behind the rearmost seat on the passenger side. Turn the retainers counterclockwise to remove the jack.

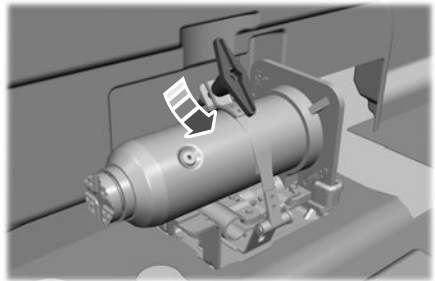

5. The tool kit is on the floor under the driver seat or under the rear seat on the driver side. The tool kit could be attached to the floor, inside the storage bin, or attached to a bracket. Turn the retainers counterclockwise to remove the tool kit.

# Changing a Road Wheel

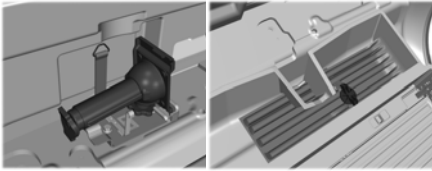

6. Use the ignition key to open the lock at the rear bumper.
7. One or more handle extensions are used to operate the spare tire carrier. To assemble, align the button with the hole and slide the parts together. To disconnect, press the button and pull apart.

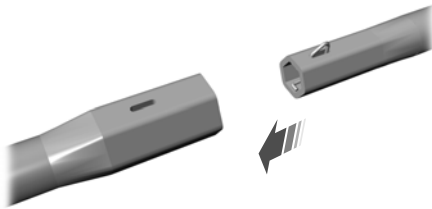

8. The lug wrench turns the handle extensions and the jack handle. Slide the square end of the handle extension into the square hold of the lug wrench until it clicks in place.

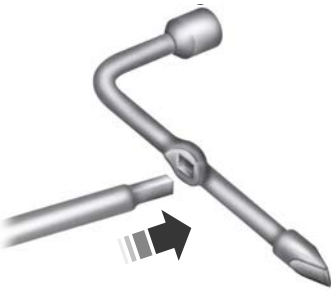

9. Fully insert the jack handle, with one extension, through the bumper hole and into the guide tube. Additional extensions are needed if the tailgate is in the lowered position and cannot be raised. Turn the handle counterclockwise and lower the spare tire until you can slide the tire rearward and the cable is slack. You will feel some resistance when you turn the jack handle assembly. If not replacing the spare or flat tire to the underbody storage area, raise the wheel retainer up into the installed position. Do not store spare or flat tire at other locations.
10. Slide the retainer through the center of the spare tire wheel and remove the spare tire.

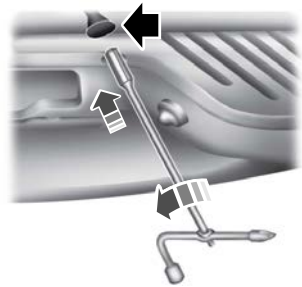

11. Remove the wheel trim with the lug wrench tip, or use the wheel trim tool described later in this section.
12. Loosen each wheel nut one-half turn counterclockwise, but do not remove them until the wheel is raised off the ground. For dual rear wheel, assemble the lug wrench and extension tool together to access the wheel nuts.

# Changing a Road Wheel

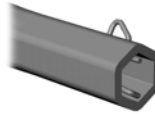

13. Position the jack under the correct jacking points.

## Removing Wheel Trim With Single Wheels

1. Insert the flat end of the lug wrench between the wheel rim and the wheel trim.
2. Carefully remove the wheel trim.

The wheel trim removal tool is in the storage bag near the lug wrench.

## Vehicles With Dual Rear Alloy Wheels

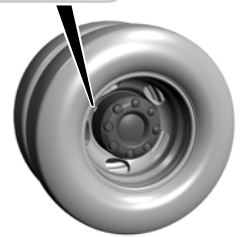
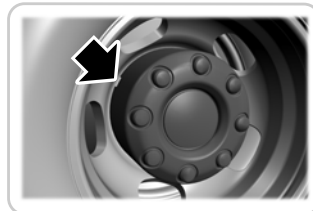
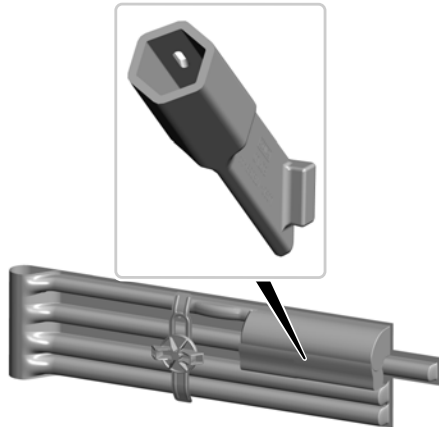

## Rear Wheel Trim

1. Locate the notch in the wheel trim.



# Changing a Road Wheel

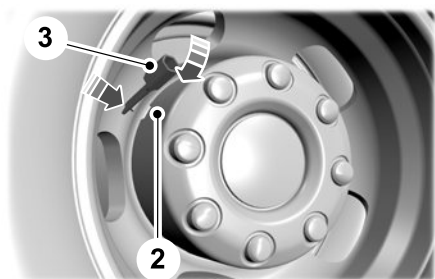

2. Insert the wheel trim removal tool into the notch in the wheel trim.
3. Rotate the wheel trim removal tool and remove the wheel trim.

## Jacking the Vehicle

F-250 and F-350 Single Rear Wheel Vehicles

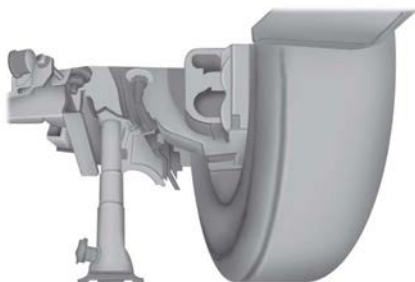
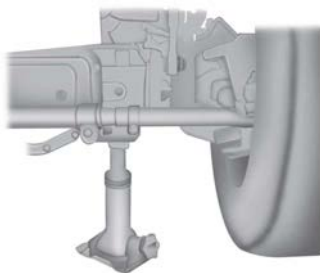
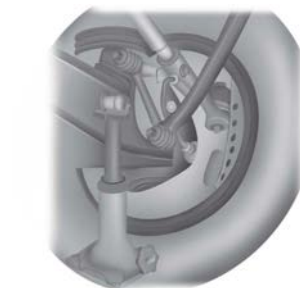

# Changing a Road Wheel

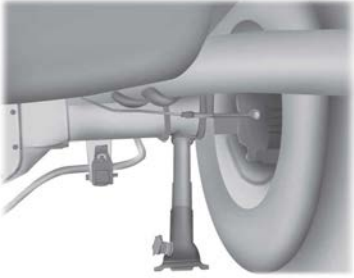

F-350 Dual Rear Wheel, F-450, F-550 and F-600 Vehicles



Front passenger side (4x4): F-350 dual rear wheel

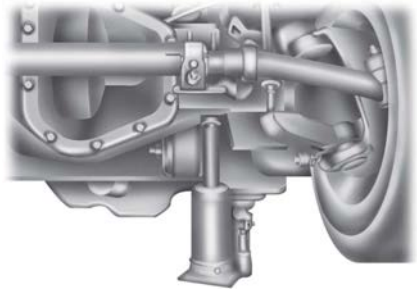

Front driver side (4x4): F-350 dual rear wheel

**Note:** Make sure the jack fits onto the flat area on the outboard side of the differential housing.



Front (4x2): F-350 Dual rear wheel

**Note:** Place the jack directly under the I-beam.

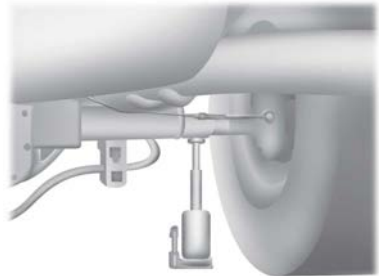

# Changing a Road Wheel

Rear: F-350 dual rear wheel



## F-350 Dual Rear Wheel Vehicles

Front: F-450 , F-550 and F-600

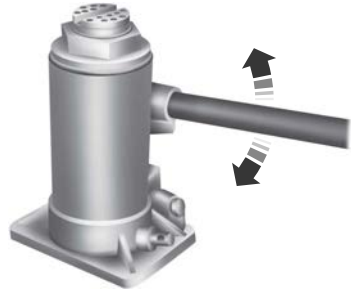
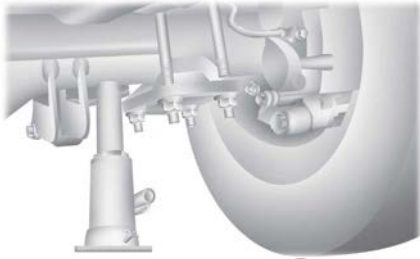

Rear: F-450 , F-550 and F-600

Insert the hooked end of the jack handle into the jack and turn the jack handle clockwise. For hydraulic jacks, operate the handle up and down until the wheel is completely off the ground and high enough to install the spare tire.

**Note:** Hydraulic jacks have a pressure relief valve that prevents lifting loads which exceed the jack's rated capacity.

## F-250 and F-350 Single Rear Wheel Vehicles

Remove the wheel nuts with the lug wrench, replace the flat tire with the spare, making sure the valve stem of the spare is facing outward when replacing a front wheel. For the rear wheel position on vehicles with single rear wheel fitments, install the spare with the valve stem facing outward. For vehicles with dual rear wheels, the valve stem of the spare must face outward when replacing an inner wheel, but must face inward when replacing an outboard wheel.

Reinstall the wheel nuts until the wheel is snug against the hub. Do not fully tighten the wheel nuts until the wheel has been lowered.

Lower the vehicle completely by turning the jack handle counterclockwise until the vehicle is completely lowered.

# Changing a Road Wheel

**Note:** For F-350 Dual Rear Wheel, F-450, F-550 and F-600 Vehicles, insert the notched end of the jack handle to the release valve, open the release valve slightly by turning the handle counterclockwise. Stop turning the release valve when vehicle starts to lower. Close the valve when you completely lower your vehicle.

## F-350 Dual Rear Wheel, F-450, F-550 and F-600 Vehicles.



10-wheel nut torque sequence

**Note:** When installing the wheel center ornaments, align the ornament retention towers on the back side of the ornament with the studs or nuts and retain to the flange on the wheel nuts.

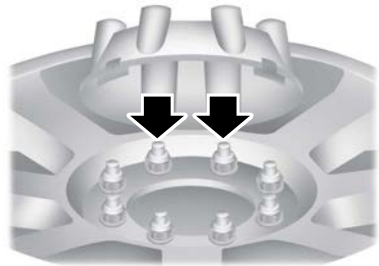

## Installing the Wheel Nuts and Ornaments



8-wheel nut torque sequence

**Note:** For dual rear wheels, align the ornament with the wheel nuts. (A) is the clip in the ornament and (B) is the flange of the wheel nut. Make sure that each of the retention clips are sitting on a wheel nut flange.

# Changing a Road Wheel

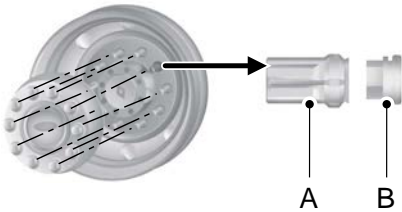

**Note:** If the ornament retention clips are misaligned between the studs or wheel nuts, the ornament will be improperly installed. This improper installation may appear and sound correct, but will not keep the ornament on the vehicle. Ornaments improperly installed in this manner may become loose or fall off during driving.

## Stowing the Flat Tire or Spare Tire

1. Place the tire on end with the valve stem facing toward the front of the vehicle. Lay the tire on the ground, near the rear of the vehicle, with the valve stem side facing up.



Use your hand or a rubber mallet to tap the ornament until the retention clips snap over the wheel nut flanges. Tap in a star pattern until the ornament seats fully onto the wheel. There should be an even gap between the ornament and the wheel when it is properly installed.



2. Slide the wheel partially under the vehicle and install the retainer through the wheel center. If equipped, you may have to remove the wheel center cap prior to pushing the retainer through the center of the wheel. To remove the center cap, press it off with the lug wrench tip from the inner side of the wheel. Pull on the cable to align the components at the end of the cable.

# Changing a Road Wheel

3. Reinsert the lug wrench extension(s) through the rear bumper and guide tube and turn the lug wrench clockwise until the tire is raised to its stowed position underneath the vehicle. The wrench becomes harder to turn and the spare tire winch ratchets or slips when the tire is raised to maximum tightness. You will hear a clicking sound from the winch indicating that the tire is properly stowed, tighten until a minimum of three clicks are heard. Check that the tire lies flat against the frame and is secure.
4. Carefully place all tools back in the tool kit bag.
5. Reinstall the tool kit bag and tighten the wing nut.

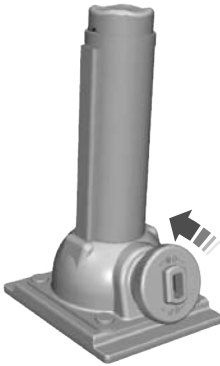

6. Properly reinstall the jack into the bracket and tighten the wing nut.

**Note:** For the mechanical style bottle jack tighten the jack counterclockwise as shown in the image above.

## WHEEL NUTS



**WARNING:** When you install a wheel, always remove any corrosion, dirt or foreign materials present on the mounting surfaces of the wheel or the surface of the wheel hub, brake drum or brake disc that contacts the wheel. Make sure to secure any fasteners that attach the rotor to the hub so they do not interfere with the mounting surfaces of the wheel. Installing wheels without correct metal-to-metal contact at the wheel mounting surfaces can cause the wheel nuts to loosen and the wheel to come off while your vehicle is in motion, resulting in loss of vehicle control, personal injury or death.

Bolt Size	lb.ft (Nm) <sup>1</sup>
M14 x 1.5	150 lb.ft (204 Nm)

<sup>1</sup> Torque specifications are for nut and bolt threads free of dirt and rust. Use only our recommended replacement wheel nuts and or wheel bolts.

Retighten the wheel nuts to the specified torque within 100 mi (160 km) after any wheel disturbance, such as tire rotation, changing a flat tire or wheel removal.

On vehicles equipped with dual rear wheels, retighten the wheel lug nuts to the specified torque at 100 mi (160 km), and again at 500 mi (800 km) of new vehicle operation and after any wheel disturbance, such as tire rotation, changing a flat tire, or wheel removal.

It is important to follow the proper wheel mounting and lug nut torque procedures.

# Changing a Road Wheel

---



A Hub pilot bore.

Inspect the wheel pilot hole and mounting surface prior to installation. Remove any visible corrosion or loose particles.

# Capacities and Specifications

---

## ENGINE SPECIFICATIONS - 6.7L DIESEL

<b>Engine</b>	<b>6.7L V8 Diesel Engine</b>
Displacement.	406 in <sup>3</sup> (6,651 cm <sup>3</sup> )
Required fuel.	Ultra Low Sulfur Diesel up to B20
Firing order.	1-3-7-2-6-5-4-8
Compression ratio.	15.2:1



# Capacities and Specifications

---

## ENGINE SPECIFICATIONS - 6.8L, GASOLINE

<b>Engine</b>	<b>6.8L V8</b>
Cubic inches	415
Firing order	1-5-4-8-6-3-7-2
Ignition system	Coil on plug
Spark plug gap	0.051 in (1.3 mm)
Compression ratio	10.8:1

# Capacities and Specifications

---

## ENGINE SPECIFICATIONS - 7.3L, GASOLINE

<b>Engine</b>	<b>7.3L V8 Engine</b>
Displacement.	445 in <sup>3</sup> (7,293 cm <sup>3</sup> )
Required fuel.	Minimum 87 octane
Firing order.	1-5-4-8-6-3-7-2
Ignition system.	Coil near spark plug with spark plug wire
Spark plug gap.	0.049 in (1.25 mm) - 0.053 in (1.35 mm)
Compression ratio.	10.5:1

# Capacities and Specifications

---

## MOTORCRAFT PARTS - 6.7L DIESEL

<b>Component</b>	<b>Motorcraft Part Number</b>
Air filter.	FA-2031
Foam pre-filter.	FA-1952
Battery (two required).	BAGM-65-A
Cabin air filter.	FP-119
Engine oil filter. <sup>1</sup>	FL-2124-S
Fuel filter.	FD-4625AA
Ten-speed automatic transmission fluid filter (10R140).	FT-221
Windshield wiper blades.	WW-2248-A

<sup>1</sup> If a Motorcraft oil filter is not available, use an oil filter that meets WSS-M99P55-D1.

We recommend Motorcraft® parts that are available at your authorized dealer or at [www.fordparts.com](http://www.fordparts.com). These parts are engineered for your vehicle, and meet or exceed our specifications. Use of other parts could impact vehicle performance, emissions and durability. Your warranty could be void for any damage related to use of other parts.

# Capacities and Specifications

---

## MOTORCRAFT PARTS - 6.8L, GASOLINE

<b>Component</b>	<b>Motorcraft Part number</b>
Air filter element.	FA-1950
One battery.	BXT-65-750
Two batteries (optional).	BAGM-65-A
Cabin air filter.	FP-119
Engine oil filter. <sup>1</sup>	FL-820-S
Spark plug.	SP-589
Transmission fluid filter.	FT-202
Windshield wiper blade.	WW-2248-A

<sup>1</sup>If a Motorcraft oil filter is not available, use an oil filter that aligns to SAE/USCAR – 36 Performance Specifications. Filter Type D.

We recommend Motorcraft parts that are available at your authorized dealer or at [www.fordparts.com](http://www.fordparts.com). These parts are engineered for your vehicle, and meet or exceed our specifications. Use of other parts could impact vehicle performance, emissions and durability. Your warranty could be void for any damage related to use of other parts.

# Capacities and Specifications

---

## MOTORCRAFT PARTS - 7.3L, GASOLINE

<b>Component</b>	<b>Motorcraft Part Number</b>
Air filter element.	FA-1950
One battery.	BXT-65-750
Two batteries (optional).	BAGM-65-A
Cabin air filter.	FP-119
Engine oil filter. <sup>1</sup>	FL-820-S
Spark plugs.	SP-589
Ten-speed automatic transmission fluid filter (10R140).	FT-221
Windshield wiper blades.	WW-2248-A

<sup>1</sup> If a Motorcraft oil filter is not available, use an oil filter that aligns to SAE/USCAR – 36 Performance Specifications. Filter Type D.

We recommend Motorcraft parts that are available at your authorized dealer or at [www.fordparts.com](http://www.fordparts.com). We engineer these parts for your vehicle to meet or exceed our specifications. Use of other parts could impact vehicle performance, emissions and durability. Your warranty could be void for any damage related to use of other parts.

# Capacities and Specifications

## ENGINE OIL CAPACITY AND SPECIFICATION - 6.7L DIESEL

Use oil that meets the defined specification and viscosity grade.

If you do not use oil that meets the defined specification and viscosity grade, it could result in:

- Component damage that your vehicle warranty does not cover.
- Longer engine cranking periods.
- Increased emission levels.
- Reduced vehicle performance.
- Reduced fuel economy.

### Engine Oil

We recommend Motorcraft motor oil for your vehicle. If Motorcraft motor oil is not available, use motor oil of the recommended viscosity grade that meets our specification WSS-M2C171-F1. You can find the list of approved motor oils at [www.motorcraft.com](http://www.motorcraft.com).

Do not use supplemental engine oil additives because they are unnecessary and could lead to engine damage that your vehicle warranty does not cover.

The use of correct oil viscosities for diesel engines is important for satisfactory operation. Determine which oil viscosity best suits the temperature range you expect to encounter for the next service interval from the SAE Viscosity Grades chart.

**Note:** An engine block heater is recommended at temperatures below  $-9^{\circ}\text{F}$  ( $-23^{\circ}\text{C}$ ).

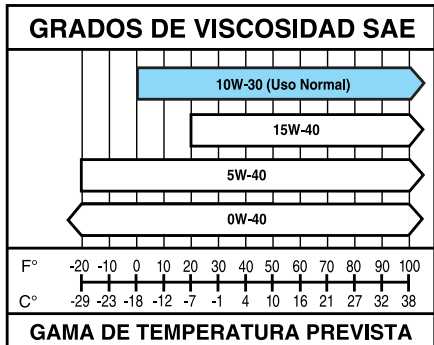
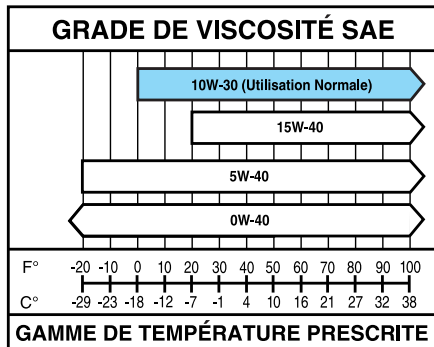
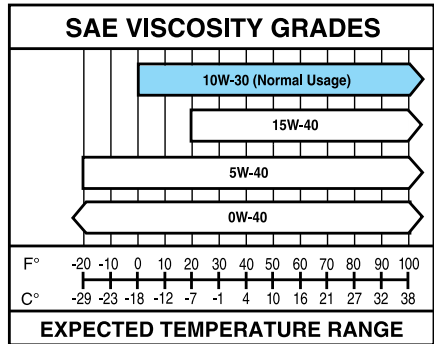

# Capacities and Specifications

## Capacities

Variant	Including the Oil Filter
All.	15.0 qt (14.2 L)

## Materials

Name	Specification
Motorcraft® SAE 10W-30 Super Duty Diesel Motor Oil(U.S.) Motorcraft® Super Duty Motor Oil SAE 10W-30 / Huile moteur Super Duty SAE 10W-30 Motor- craft®(Canada) XO-10W30-QSDF(U.S.) CXO-10W30-LSD12(Canada)	WSS-M2C171-F1

## Alternative Engine Oil for Extremely Cold Climates

To improve engine cold start performance, we recommend that you use the following alternative engine oil in extremely cold climates, where the ambient temperature reaches -22.0°F (-30°C) or below.

## Materials

Name	Specification
Engine Oil - SAE 0W-40	WSS-M2C171-F1

## Alternative Engine Oil for Biodiesel Fuel Blends (B20 Max)

# Capacities and Specifications

## Materials

Name	Specification
Motorcraft® SAE 5W-40 Full Synthetic Diesel Motor Oil(U.S.) (Canada) XO-5W40-5Q3SD(U.S.)	WSS-M2C171-F1
Motorcraft® SAE 15W-40 Super Duty Diesel Motor Oil(U.S.) Motorcraft® Super Duty Motor Oil SAE 15W-40 / Huile moteur Super Duty SAE 15W-40 Motor- craft®(Canada) XO-15W40-QSDF(U.S.) CXO-15W40-LSD12(Canada)	WSS-M2C171-F1

## Alternative Engine Oil for Severe Duty Service

### Materials

Name	Specification
Motorcraft® SAE 5W-40 Full Synthetic Diesel Motor Oil(U.S.) (Canada) XO-5W40-5Q3SD(U.S.)	WSS-M2C171-F1

## ENGINE OIL CAPACITY AND SPECIFICATION - 6.8L, GASOLINE

Use oil that meets the defined specification and viscosity grade.

If you do not use oil that meets the defined specification and viscosity grade, it could result in:

- Component damage that your vehicle warranty does not cover.
- Longer engine cranking periods.
- Increased emission levels.

- Reduced vehicle performance.
- Reduced fuel economy.





# Capacities and Specifications

An oil that displays this symbol conforms to current engine, emission system and fuel economy performance standards of ILSAC.

We recommend Motorcraft motor oil for your vehicle. If Motorcraft oil is not available, use motor oils of the recommended viscosity grade that display the API Certification Mark for gasoline engines.

Do not use supplemental engine oil additives because they are unnecessary and could lead to engine damage that your vehicle warranty does not cover.

## Capacities

Variant	Including the Oil Filter
All.	8.0 qt (7.57 L)

## Materials

Name	Specification
Motorcraft® SAE 5W-30 Motor Oil (U.S.) Motorcraft® SAE 5W-30 Motor Oil / Huile moteur SAE 5W-30 Motorcraft® (Canada) XO-5W30-Q1SP, XO-5W30-Q1FS (U.S.) CXO-5W30-LSP6, CXO-5W30-LFS6 (Canada)	WSS-M2C961-A1

## Alternative Engine Oil for Extremely Cold Climates

To improve engine cold start performance, we recommend that you use the following alternative engine oil in extremely cold climates, where the ambient temperature reaches -22°F (-30°C) or below.

## Materials

Name	Specification
Engine Oil - SAE 0W-30	WSS-M2C963-A1

# Capacities and Specifications

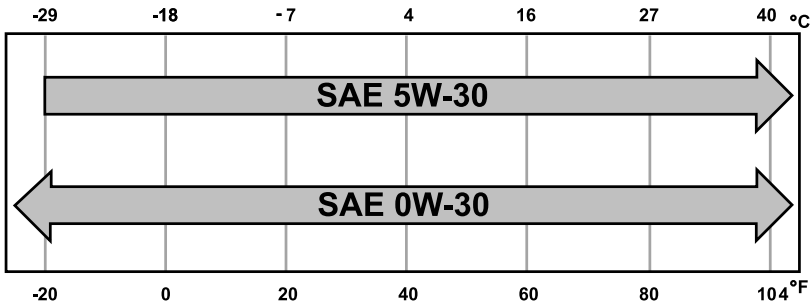

**Note:** If you use your vehicle regularly above the altitude of 5,000 ft (1,524 m) and under the temperature of  $-4.0^{\circ}\text{F}$  ( $-20^{\circ}\text{C}$ ), it is recommended to use the alternative engine oil.

## ENGINE OIL CAPACITY AND SPECIFICATION - 7.3L, GASOLINE

Use oil that meets the defined specification and viscosity grade.

If you do not use oil that meets the defined specification and viscosity grade, it could result in:

- Component damage that your vehicle warranty does not cover.
- Longer engine cranking periods.
- Increased emission levels.
- Reduced vehicle performance.
- Reduced fuel economy.



An oil that displays this symbol conforms to current engine, emission system and fuel economy performance standards of ILSAC.

We recommend Motorcraft motor oil for your vehicle. If Motorcraft oil is not available, use motor oils of the recommended viscosity grade that display the API Certification Mark for gasoline engines.

Do not use supplemental engine oil additives because they are unnecessary and could lead to engine damage that your vehicle warranty does not cover.

# Capacities and Specifications

## Capacities

Variant	Including the Oil Filter
All.	8.0 qt (7.57 L)

## Materials

Name	Specification
Motorcraft® SAE 5W-30 Motor Oil(U.S.) Motorcraft® SAE 5W-30 Motor Oil / Huile moteur SAE 5W-30 Motorcraft®(Canada) XO-5W30-Q1SP, XO-5W30-Q1FS(U.S.) CXO-5W30-LSP6, CXO-5W30-LFS6(Canada)	WSS-M2C961-A1

## Alternative Engine Oil for Extremely Cold Climates

To improve engine cold start performance, we recommend that you use the following alternative engine oil in extremely cold climates, where the ambient temperature reaches -22°F (-30°C) or below.

## Materials

Name	Specification
Engine Oil - SAE 0W-30	WSS-M2C963-A1

# Capacities and Specifications

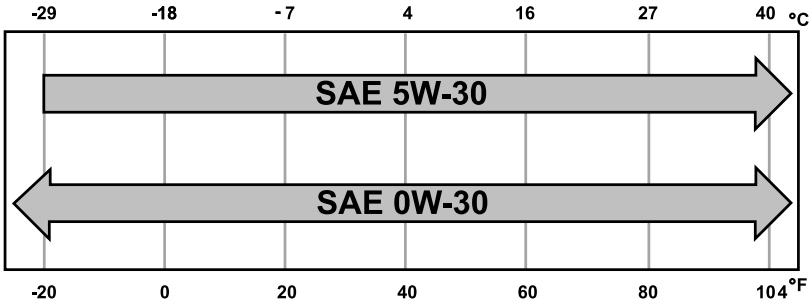

**Note:** If you use your vehicle regularly above the altitude of 5,000 ft (1,524 m) and under the temperature of -4.0°F (-20°C), it is recommended to use the alternative engine oil.

If you do not use coolant that meets the defined specification, it could result in:

- Component damage that your vehicle warranty does not cover.
- Reduced vehicle performance.

## COOLING SYSTEM CAPACITY AND SPECIFICATION - 6.7L DIESEL

**Note:** An engine block heater is recommended at temperatures below -9°F (-23°C).

Use coolant that meets the defined specification.

### Capacities

Variant	Quantity
Primary cooling system.	31.7 qt (30 L)
Primary cooling system with auxiliary radiator.	33.3 qt (31.5 L)
Secondary cooling system with urea injector cooling.	8.2 qt (7.8 L)
Secondary cooling system with urea injector cooling and cooled compressor.	10.0 qt (9.5 L)

# Capacities and Specifications

## Materials

Name	Specification
Motorcraft® Yellow Prediluted Antifreeze/ Coolant (U.S.) Motorcraft® Yellow Prediluted Antifreeze/Coolant / Antigel/liquide de refroidissement prédilué jaune Motorcraft® (Canada) VC-13DL-G (U.S.) CVC-13DL-G (Canada)	WSS-M97B57-A2

## COOLING SYSTEM CAPACITY AND SPECIFICATION - 6.8L, GASOLINE

Use coolant that meets the defined specification.

If you do not use coolant that meets the defined specification, it could result in:

- Component damage that your vehicle warranty does not cover.
- Reduced vehicle performance.

## Capacities

Variant	Quantity
All.	22.5 qt (21.3 L)

## Materials

Name	Specification
Motorcraft® Yellow Prediluted Antifreeze/ Coolant (U.S.) Motorcraft® Yellow Prediluted Antifreeze/Coolant / Antigel/liquide de refroidissement prédilué jaune Motorcraft® (Canada) VC-13DL-G (U.S.) CVC-13DL-G (Canada)	WSS-M97B57-A2

# Capacities and Specifications

## COOLING SYSTEM CAPACITY AND SPECIFICATION - 7.3L, GASOLINE

If you do not use coolant that meets the defined specification, it could result in:

- Component damage that your vehicle warranty does not cover.
- Reduced vehicle performance.

Use coolant that meets the defined specification.

### Capacities

Variant	Quantity
All.	22.5 qt (21.3 L)

### Materials

Name	Specification
Motorcraft® Yellow Prediluted Antifreeze/Coolant(U.S.) Motorcraft® Yellow Prediluted Antifreeze/Coolant / Antigel/liquide de refroidissement prédilué jaune Motorcraft®(Canada) VC-13DL-G(U.S.) CVC-13DL-G(Canada)	WSS-M97B57-A2

## FUEL TANK CAPACITY - DIESEL

### Capacities

Variant	Quantity
Complete vehicle-142 inch and 148 inch wheelbase, middle location.	29.0 gal (109.8 L)
Complete vehicle-160 inch and 164 inch wheelbase, middle location.	34.0 gal (128.7 L)
Complete vehicle-176 inch wheelbase, middle location.	48.0 gal (181.7 L)
Incomplete vehicle, middle location.	26.5 gal (100.3 L)
Incomplete vehicle, aft- axle -location.	40.0 gal (151.4 L)
Incomplete vehicle, middle and aft- axle - locations.	66.5 gal (251.7 L)

# Capacities and Specifications

---

## FUEL TANK CAPACITY - GASOLINE

### Capacities

<b>Variant</b>	<b>Quantity</b>
Complete vehicle-all except 176 inch wheelbase and incomplete vehicles.	34.0 gal (128.7 L)
Complete vehicle-176 inch wheelbase.	48.0 gal (181.7 L)
Incomplete vehicle, aft- axle -location.	40.0 gal (151.4 L)
Incomplete vehicle, middle location.	26.5 gal (100.3 L)

# Capacities and Specifications

## AIR CONDITIONING SYSTEM CAPACITY AND SPECIFICATION



**WARNING:** The air conditioning refrigerant system contains refrigerant under high pressure. Only qualified personnel should service the air conditioning refrigerant system. Opening

the air conditioning refrigerant system can cause personal injury.

Use refrigerant and oil that meets the defined specifications.

If you do not use refrigerant and oil that meets the defined specifications, it could result in:

- Component damage that your vehicle warranty does not cover.
- Reduced vehicle performance.

### Capacities

Variant	Refrigerant	Refrigerant Oil
All.	27 oz (0.765 kg)	3.7 fl oz (110 ml)

### Materials

Name	Specification
Motorcraft® R-134a Refrigerant(U.S.) R-134a Refrigerant / Frigorigène R-134a(Canada) YN-19(U.S.) CYN-19-RB(Canada)	WSH-M17B19-A
Motorcraft® PAG Refrigerant Compressor Oil(U.S.) Motorcraft® PAG Refrigerant Compressor Oil / Huile PAG pour compresseur frigorifique Motor- craft®(Canada) YN-12-D(U.S. & Canada)	WSH-M1C231-B

## WASHER FLUID SPECIFICATION

### Capacities

Variant	Quantity
All.	Fill as required.



# Capacities and Specifications

## Materials

Name	Specification
Motorcraft® Premium Windshield Wash Concentrate with Bitterant(U.S.) Motorcraft® Premium Quality Windshield Washer Fluid / Liquide lave-glace de haute qualité Motorcraft®(Canada) ZC-32-B2(U.S.) CXC-37-F/M(Canada)	WSS-M14P19-A

## DIESEL EXHAUST FLUID CAPACITY AND SPECIFICATION

Use fluid that meets the defined specification.

If you do not use fluid that meets the defined specification, it could result in:

- Component damage that your vehicle warranty does not cover.
- Reduced vehicle performance.

## Capacities

Variant	Quantity
Complete vehicle.	7.5 gal (28.4 L)
Incomplete vehicle.	7.2 gal (27.3 L)

## Materials

Name	Specification
Motorcraft® Diesel Exhaust Fluid(U.S.) Motorcraft® Diesel Exhaust Fluid / Fluide pour échappement diesel Motorcraft®(Canada) PM-27-GAL,PM-27-JUG(U.S.) CPM-27-JA(Canada)	WSS-M99C130-A

# Capacities and Specifications

## AUTOMATIC TRANSMISSION FLUID CAPACITY AND SPECIFICATION

Use fluid that meets the defined specification.

If you do not use fluid that meets the defined specification, it could result in:

- Component damage that your vehicle warranty does not cover.
- Reduced vehicle performance.

**Note:** Only use MERCON ULV transmission fluid for automatic transmissions that require MERCON ULV transmission fluid. The use of any other fluid could cause transmission damage.

### Materials

Name	Specification
Motorcraft® MERCON® ULV Automatic Transmission Fluid(U.S.) Motorcraft® MERCON® ULV Automatic Transmission Fluid / MERCON® ULV huile pour boîtes automatique Motorcraft®(Canada) XT-12-QULV(U.S. & Canada)	WSS-M2C949-A,

## BRAKE FLUID SPECIFICATION

Use fluid that meets the defined specification and viscosity grade.

If you do not use fluid that meets the defined specification and viscosity grade, it could result in:

- Component damage that your vehicle warranty does not cover.
- Reduced brake performance.

**Note:** We recommend you use Dot 4 Low Viscosity (LV) High Performance Brake Fluid meeting WSS-M6C65-A2 specifications or ISO 4925 Class 6 standards. If you use any fluid other than the recommended fluid, it could cause reduced brake performance and not meet our performance standards. Keep brake fluid clean and dry. Contamination with dirt, water, petroleum products or other materials could result in brake system damage and possible failure.

### Capacities

Variant	Quantity
All.	Fill as required.

# Capacities and Specifications

## Materials

Name	Specification
Motorcraft® DOT 4 LV High Performance Motor Vehicle Brake Fluid(U.S.) Motorcraft® DOT 4 LV High Performance Motor Vehicle Brake Fluid / Liquide de frein automobile haute performance DOT 4 LV Motorcraft®(Canada) PM-20(U.S. & Canada)	WSS-M6C65-A2

## TRANSFER CASE FLUID CAPACITY AND SPECIFICATION

Use fluid that meets the defined specification.

If you do not use fluid that meets the defined specification, it could result in:

- Component damage that your vehicle warranty does not cover.
- Reduced vehicle performance.

## Capacities

Variant	Quantity
All.	1.9 qt (1.8 L)

## Materials

Name	Specification
Motorcraft® MERCON® LV Automatic Transmission Fluid(U.S.) Motorcraft® MERCON® LV Automatic Transmission Fluid / Huile pour boîte automatique MERCON® LV Motorcraft®(Canada) XT-10-QLVC(U.S.) CXT-10-LV6(Canada)	WSS-M2C938-A

## FRONT AXLE FLUID CAPACITY AND SPECIFICATION

Use fluid that meets the defined specification and viscosity grade.

If you do not use fluid that meets the defined specification and viscosity grade, it could result in:

- Component damage that your vehicle warranty does not cover.
- Reduced vehicle performance.

# Capacities and Specifications

## Front Axle-9.25

### Capacities

Variant	Quantity
Four-wheel drive without limited slip.	2.20 qt (2.08 L)
Four-wheel drive with limited slip.	2.20 qt (2.08 L) <sup>1</sup>

<sup>1</sup>For complete refill of limited slip axles, add 4.4 fl oz. (130 ml) of Additive Friction Modifier XL-3 or equivalent, meeting specification EST-M2C118-A. Include this friction modifier in the total lube volume of 2.2 qt (2.08 L).

### Materials

Name	Specification
Motorcraft® Additive Friction Modifier(U.S.) Motorcraft® Additive Friction Modifier / Additif modificateur de friction Motorcraft®(Canada) XL-3(U.S. & Canada)	EST-M2C118-A
Motorcraft® SAE 80W-90 Premium Rear Axle Lubricant(U.S.) Motorcraft® SAE 80W-90 Premium Axle Lubricant / Lubrifiant pour essieux de très haute qualité SAE 80W-90 Motorcraft®(Canada) XY-80W90-QL(U.S.) CXY-80W90-1L(Canada)	WSP-M2C197-A

## Front Axle-10.08

### Capacities

Variant	Quantity
All.	2.75 qt (2.6 L)

# Capacities and Specifications

## Materials

Name	Specification
Motorcraft® SAE 80W-90 Premium Rear Axle Lubricant (U.S.) Motorcraft® SAE 80W-90 Premium Axle Lubricant / Lubrifiant pour essieux de très haute qualité SAE 80W-90 Motorcraft® (Canada) XY-80W90-QL (U.S.) CXY-80W90-1L (Canada)	WSP-M2C197-A

## REAR AXLE FLUID CAPACITY AND SPECIFICATION

Use fluid that meets the defined specification and viscosity grade.

If you do not use fluid that meets the defined specification and viscosity grade, it could result in:

- Component damage that your vehicle warranty does not cover.
- Reduced vehicle performance.

## Rear Axle - 10.5

### Capacities

Variant	Quantity
With electronic locking differential.	3.3–3.5 qt (3.1–3.3 L)
Without electronic locking differential.	3.5–3.6 qt (3.3–3.4 L)

## Materials

Name	Specification
Motorcraft® SAE 75W-85 Premium Synthetic Hypoid Gear Lubricant (U.S.) Motorcraft® SAE 75W-85 Premium Synthetic Hypoid Gear Lubricant / Huile synthétique de haute qualité pour engrenages hypoides SAE 75W-85 Motorcraft® (Canada) XY-75W85-QL (U.S. & Canada)	WSS-M2C942-A

# Capacities and Specifications

## Rear Axle - 10.8

### Capacities

Variant	Quantity
Open Differential Oil Only.	3.68 qt (3.48 L)
Limited Slip Differential Oil.	3.46 qt (3.271 L) <sup>1</sup>

<sup>1</sup>For complete refill of limited slip axles, add 7.06 fl oz. (208.8 ml) of Additive Friction Modifier XL-3 or equivalent, meeting Ford Specification EST-M2C118-A.

### Materials

Name	Specification
Motorcraft® Additive Friction Modifier(U.S.) Motorcraft® Additive Friction Modifier / Additif modificateur de friction Motorcraft®(Canada) XL-3(U.S. & Canada)	EST-M2C118-A
Motorcraft® SAE 75W-140 Synthetic Rear Axle Lubricant(U.S.) Motorcraft® SAE 75W-140 Synthetic Rear Axle Lubricant / Lubrifiant synthétique pour pont arrière SAE 75W-140 Motorcraft®(Canada) XY-75W140-QL(U.S.) CXY-75W140-1L(Canada)	WSL-M2C192-A

## Rear Axle - 11.6

### Capacities

Variant	Quantity
4.30 final Drive ratio .	4.44–4.54 qt (4.2–4.3 L)
All other final Drive ratios (3.31/3.55/3.73).	4.33–4.44 qt (4.1–4.2 L)

# Capacities and Specifications

## Materials

Name	Specification
Motorcraft® SAE 75W-140 Synthetic Rear Axle Lubricant(U.S.) Motorcraft® SAE 75W-140 Synthetic Rear Axle Lubricant / Lubrifiant synthétique pour pont arrière SAE 75W-140 Motorcraft®(Canada) XY-75W140-QL(U.S.) CXY-75W140-1L(Canada)	WSL-M2C192-A

## Rear Axle - 11.8 Light Duty and Heavy Duty

### Capacities

Variant	Quantity
Open Differential Oil Only.	4.21 qt (3.98 L)
Limited Slip Differential Oil.	3.95 qt (3.741 L) <sup>1</sup>

<sup>1</sup> For complete refill of limited slip axles, add 8.07 fl oz. (238.8 ml) of Additive Friction Modifier XL-3 or equivalent, meeting Ford Specification EST-M2C118-A.

## Materials

Name	Specification
Motorcraft® Additive Friction Modifier(U.S.) Motorcraft® Additive Friction Modifier / Additif modificateur de friction Motorcraft®(Canada) XL-3(U.S. & Canada)	EST-M2C118-A
Motorcraft® SAE 75W-140 Synthetic Rear Axle Lubricant(U.S.) Motorcraft® SAE 75W-140 Synthetic Rear Axle Lubricant / Lubrifiant synthétique pour pont arrière SAE 75W-140 Motorcraft®(Canada) XY-75W140-QL(U.S.) CXY-75W140-1L(Canada)	WSL-M2C192-A

# Capacities and Specifications

## Rear Axle - 11.8 Single Rear Wheel

### Capacities

Variant	Quantity
Electric Locking Differential Oil Only.	4.05 qt (3.83 L)

### Materials

Name	Specification
Motorcraft® Additive Friction Modifier(U.S.) Motorcraft® Additive Friction Modifier / Additif modificateur de friction Motorcraft®(Canada) XL-3(U.S. & Canada)	EST-M2C118-A
Motorcraft® SAE 75W-140 Synthetic Rear Axle Lubricant(U.S.) Motorcraft® SAE 75W-140 Synthetic Rear Axle Lubricant / Lubrifiant synthétique pour pont arrière SAE 75W-140 Motorcraft®(Canada) XY-75W140-QL(U.S.) CXY-75W140-1L(Canada)	WSL-M2C192-A

## Rear Axle - 12.4

### Capacities

Variant	Quantity
Limited Slip Differential Oil.	4.65 qt (4.399 L) <sup>1</sup>

<sup>1</sup> For complete refill of limited slip axles, add 9.49 fl oz. (280.8 ml) of Additive Friction Modifier XL-3 or equivalent, meeting Ford Specification EST-M2C118-A.



# Capacities and Specifications

## Materials

Name	Specification
Motorcraft® Additive Friction Modifier(U.S.) Motorcraft® Additive Friction Modifier / Additif modificateur de friction Motorcraft®(Canada) XL-3(U.S. & Canada)	EST-M2C118-A
Motorcraft® SAE 75W-140 Synthetic Rear Axle Lubricant(U.S.) Motorcraft® SAE 75W-140 Synthetic Rear Axle Lubricant / Lubrifiant synthétique pour pont arrière SAE 75W-140 Motorcraft®(Canada) XY-75W140-QL(U.S.) CXY-75W140-1L(Canada)	WSL-M2C192-A

## HYDRAULIC POWER STEERING FLUID CAPACITY AND SPECIFICATION

Use fluid that meets the defined specification.

If you do not use fluid that meets the defined specification, it could result in:

- Component damage that your vehicle warranty does not cover.
- Reduced vehicle performance.

## Capacities

Variant	Quantity
All.	Fill as required.

## Materials

Name	Specification
Motorcraft® MERCON® LV Automatic Transmission Fluid(U.S.) Motorcraft® MERCON® LV Automatic Transmission Fluid / Huile pour boîte automatique MERCON® LV Motorcraft®(Canada) XT-10-QLVC(U.S.) CXT-10-LV6(Canada)	WSS-M2C938-A

# Vehicle Identification

## VEHICLE IDENTIFICATION NUMBER

### LOCATING THE VEHICLE IDENTIFICATION NUMBER

The vehicle identification number is on the left-hand side of the instrument panel.

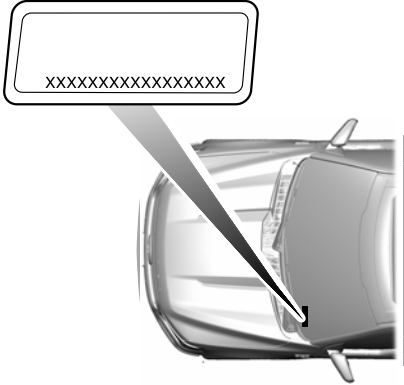

**Note:** In the illustration, XXXX is representative of your vehicle identification number.

### VEHICLE IDENTIFICATION NUMBER OVERVIEW

The vehicle identification number contains the following information:

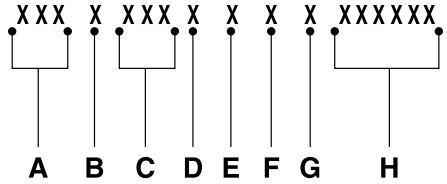

- A World manufacturer identifier.
- B Brake system, gross vehicle weight rating, restraint devices and their locations.
- C Make, vehicle line, series, body type.
- D Engine or motor type.
- E Check digit.
- F Model year.
- G Assembly plant.
- H Production sequence number.

# Connected Vehicle

## WHAT IS A CONNECTED VEHICLE

A connected vehicle has technology that allows your vehicle to connect to a mobile network and for you to access a range of features. When used in conjunction with the FordPass app, it could allow you to monitor and control your vehicle further, for example checking the tire pressures, the fuel level and the vehicle location. For additional information, refer to the local Ford website.

## CONNECTED VEHICLE REQUIREMENTS

Connected service and related feature functionality requires a compatible vehicle network.

Some remote features require additional service activation. Log in to your Ford account for details. Some restrictions, third party terms and message or data rates may apply.

## CONNECTED VEHICLE LIMITATIONS

Evolving technology, cellular networks, or regulations could affect functionality and availability, or continued provision of some features. These changes could even stop some features from functioning.

## CONNECTING THE VEHICLE TO A MOBILE NETWORK

### WHAT IS THE MODEM



The modem allows access to a range of features built into your vehicle.

## ENABLING AND DISABLING THE MODEM

1. Press **Settings** on the touchscreen.
2. Press **Connectivity**.
3. Press **Connected Vehicle Features**.
4. Switch vehicle connectivity on or off.

## CONNECTING FORDPASS TO THE MODEM

1. Make sure that the modem is enabled using the vehicle settings menu.
2. Open the FordPass app on your device and log in.
3. Add your vehicle or select your vehicle if already added.
4. Select the option to activate your vehicle.
5. Make sure that the name on the screen matches the name shown in your FordPass account.
6. Confirm that FordPass account is connected to the modem.

## CONNECTING THE VEHICLE TO A WI-FI NETWORK

1.  Press the button on the touchscreen.
2. Press **Connectivity**.
3. Press **Wi-Fi**.
4. Switch **Wi-Fi** on.
5. Press **View Available Networks**.
6. Select an available Wi-Fi network.

**Note:** Enter the network password to connect to a secure network.

# Connected Vehicle

## CONNECTED VEHICLE SETTINGS

You can adjust several settings on the touchscreen under the connected vehicle features menu, such as:

- Vehicle connectivity.
- Share vehicle data.
- Share vehicle location.
- Share driving data.

**Note:** Depending on your vehicle, different options may be available.

**Note:** Editing connectivity settings could result in some features not operating correctly or at all. When you edit connectivity settings, pop-up messages may appear to notify you that services will not work without that setting. If you switch a feature on, pop-up messages could appear informing you of the settings that will be turned on.



Press the button next to a menu option for more information.

## CONNECTED VEHICLE – TROUBLESHOOTING

### CONNECTED VEHICLE – FREQUENTLY ASKED QUESTIONS

#### Why can I not confirm the connection of my FordPass account to the modem?

- The modem is not enabled. Switch vehicle connectivity on.
- The network signal is weak. Move your vehicle closer to a place where the network signal is not obstructed.

#### Why can I not connect to a Wi-Fi network?

- You entered the wrong network password. Enter the correct password.
- The network signal is weak. Move your vehicle closer to the Wi-Fi router or to a place where the network signal is not obstructed.
- There are multiple access points in range with the same network name. Choose a unique name for your network. Do not use the default name unless it contains a unique identifier, for example as part of the MAC address.

#### Why does the Wi-Fi connection disconnect after successful connection?

- The network signal is weak. Move your vehicle closer to the Wi-Fi router or to a place where the network signal is not obstructed.

#### What can I do if I am close to a Wi-Fi router but the network signal strength is weak?

- If your vehicle has a heated windshield, position your vehicle so that the windshield is not facing the Wi-Fi router.
- If your vehicle has metallic tinting on the windows but not on the windshield, position your vehicle so that the windshield is facing the Wi-Fi router or open the windows that are facing the router.
- If your vehicle has metallic tinting on the windows and the windshield, open the windows that are facing the router.
- If your vehicle is in a garage and you have the garage door closed, open the garage door as it could block the signal.

# Connected Vehicle

---

## **Why can I not see a network I expect to see in the list of available networks?**

- The network is hidden. Make the network visible and try again, or manually add a network in the Wi-Fi settings menu.
- Some network security types are not supported, for example WEP.

## **Why do software downloads take too long?**

- The network signal is weak. Move your vehicle closer to the Wi-Fi router or to a place where the network signal is not obstructed.
- Wi-Fi network is in high demand or has a slow Internet connection. Use a more reliable Wi-Fi network.

## **Why does the software not update when the system seems to connect to a Wi-Fi network and the signal strength is excellent?**

- No software update is available at this time.
- Select automatic updates option in the settings menu to enable automatic software update or contact an authorized dealer.
- There could be a connection problem. Test the network using another device.

# Vehicle Wi-Fi Hotspot

## CREATING A VEHICLE WI-FI HOTSPOT

You can create a Wi-Fi hotspot in your vehicle and allow devices to connect to it for access to the Internet.



Select the settings option on the feature bar.

1. Press **Vehicle Hotspot**.

**Note:** The vehicle hotspot default setting is on.

2. Press **Settings**.
3. Press **Edit**.
4. Press **Hotspot visibility**.

**Note:** The hotspot visibility default setting is on.

## Finding the Wi-Fi Hotspot Name and Password



Select the settings option on the feature bar.

1. Press **Vehicle Hotspot**.
2. Press **Settings**.

**Note:** The network name is the hotspot name.

3. Press **View Password**.

## Connecting a Device to the Wi-Fi Hotspot

1. On your device, switch Wi-Fi on and select the hotspot from the list of available Wi-Fi networks.
2. When prompted, enter the password.

## Purchasing a Data Plan

1. Connect a device to the hotspot.

**Note:** The vehicle network carrier's portal opens on your device.

2. If the portal does not open on your device, open a website and it redirects to the vehicle network carrier's portal.

**Note:** Secure websites do not redirect.

3. Follow the instructions on the carrier portal to purchase a plan.

**Note:** If you have an active plan, the system does not redirect to the vehicle network carrier's portal when you connect a device. Visit the vehicle network carrier's website to purchase more data.

**Note:** If data usage information is available in the vehicle hotspot menu, it is approximate.

**Note:** If you carry out a factory reset, the system does not remove your vehicle from your vehicle network carrier's account. To remove your vehicle from the account, contact your vehicle network carrier.

**Note:** The vehicle network carrier provides Vehicle Hotspot services, subject to your vehicle network carrier agreement, coverage and availability.

## CHANGING THE VEHICLE WI-FI HOTSPOT NAME OR PASSWORD



Select the settings option on the feature bar.

1. Press **Vehicle Hotspot**.
2. Press **Settings**.
3. Press **Edit**.
4. Press **Change Network Name**.
5. Enter your required network name.
6. Press **Done**.
7. Press **Change Password**.
8. Enter your required password.
9. Press **Done**.

# Vehicle Wi-Fi Hotspot

---

## Changing the Wi-Fi Hotspot Frequency

**Note:** *The vehicle hotspot frequency band is selectable depending upon your device capabilities. You will not be able to connect your device to the vehicle hotspot if it does not support the selected frequency band.*



Select the settings option on the feature bar.

1. Press **Vehicle Hotspot**.
2. Press **Settings**.
3. Press **Edit**.
4. Select a frequency.

## VEHICLE WI-FI HOTSPOT – TROUBLESHOOTING

### VEHICLE WI-FI HOTSPOT – FREQUENTLY ASKED QUESTIONS

#### **Why can I not see the Wi-Fi hotspot name when I search for Wi-Fi networks on my cell phone or other device?**

- Make sure Wi-Fi hotspot visibility is on.
- The system does not provide a Wi-Fi hotspot at this time.
- Check what frequency the hotspot is transmitting in the vehicle hotspot settings menu. If the frequency is 5 GHz and your device cannot see the network, change the frequency to 2.4 GHz.

# Audio System

## AUDIO SYSTEM PRECAUTIONS



**WARNING:** Driving while distracted can result in loss of vehicle control, crash and injury. We strongly recommend that you use extreme caution when using any device that may take your focus off the road. Your primary responsibility is the safe operation of your vehicle. We recommend against the use of any hand-held device while driving and encourage the use of voice-operated systems when possible. Make sure you are aware of all applicable local laws that may affect the use of electronic devices while driving.

Listening to loud audio for long periods of time could damage your hearing.

## IDENTIFYING THE AUDIO UNIT



Depending on your vehicle options, the controls may look different from what you see here.

## SWITCHING THE AUDIO UNIT ON AND OFF



Press the button on the volume control.

## SELECTING THE AUDIO SOURCE

### Audio Unit



Press to open the media source menu.

You can press this multiple times to change the audio source or scroll through the media sources.

### Touchscreen

Press **Sources** on the touchscreen to open the media source menu.

## PLAYING OR PAUSING THE AUDIO SOURCE

### Audio Unit



Press the button to pause playback. Press again to resume playback.

### Touchscreen



Press the button to pause playback. Press again to resume playback.

**Note:** *Not all sources can be paused.*



# Audio System

## ADJUSTING THE VOLUME

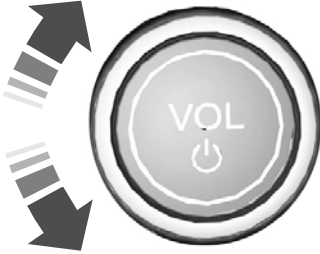

Turn to adjust the volume.

Some vehicles may be able to adjust the volume using buttons on the steering wheel.

## SWITCHING SHUFFLE MODE ON AND OFF



Press the button on the touchscreen to switch shuffle mode on or off.

**Note:** *Not all sources have shuffle mode.*

## SWITCHING REPEAT MODE ON AND OFF



Press the button on the touchscreen to switch repeat mode on or off.

**Note:** *Not all sources have repeat mode.*

## SETTING A MEMORY PRESET

1. Select a station or channel.
2. Press and hold a memory preset button on the touchscreen.

**Note:** *The audio mutes briefly while the system saves the preset and returns once it is stored.*

**Note:** *You can save presets from multiple sources to the memory preset bar.*

## MUTING THE AUDIO



Press to mute the signal. Press again to restore the signal.

## ADJUSTING THE SOUND SETTINGS

1.  Press the settings icon on the touchscreen.
2. Press **Sound Settings**.
3. Select the desired menu point and adjust the settings.

## SETTING THE CLOCK AND DATE

1. Press **Settings** on the touchscreen.
2. Press **Clock Settings**.
3. Set the time.

**Note:** *The AM and PM options are not available if 24-hour mode is on.*

## Switching Automatic Time Updates On and Off

1. Press **Settings** on the touchscreen.
2. Press **Clock Settings**.

# Audio System

3. Switch **Auto Time Update** on or off.

## FM RADIO

### FM RADIO LIMITATIONS

The further you travel from a FM station, the weaker the signal and the weaker the reception.

Hills, mountains, tall buildings, bridges, tunnels, freeway overpasses, parking garages, dense tree foliage and thunderstorms can interfere with the reception.

When you pass a ground-based broadcast repeating tower, a stronger signal may overtake a weaker one and result in the audio system muting.

### SELECTING AN FM RADIO STATION

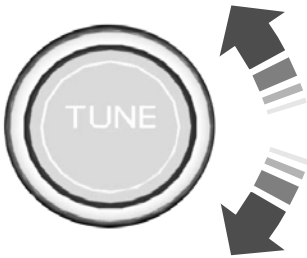

Turn to search through the radio frequency band.

### Using Direct Tune

1. Press **Direct Tune** to open the number pad.

2. Enter the station you prefer.

**Note:** You can only enter a valid station for the audio source you are currently listening to.

### Using Seek



Press either button. The system stops at the first station it finds in that direction.



### Using the Station List

1. Press **Browse**.
2. Press a station.

## SWITCHING THE DISPLAY ON AND OFF

### Audio Unit



Press the button.

### Touchscreen

To switch the display off:

1. Press **Settings** on the touchscreen.
2. Press **Display Settings**.
3. Press **Display Off**.

**Note:** The display defaults to on each time you switch your vehicle on.

To switch the display on, press anywhere on the touchscreen.

## DIGITAL RADIO (IF EQUIPPED)

### WHAT IS DIGITAL RADIO

HD Radio™ technology is the digital evolution of analog FM radio.

# Audio System

For additional information, visit [www.HDRadio.com](http://www.HDRadio.com).

HD Radio Technology is manufactured under license from iBiquity Digital Corporation and foreign patents. HD Radio and the HD and HD Radio logos are proprietary trademarks of XPERI. The vehicle manufacturer and XPERI are not responsible for the content sent using HD Radio technology. Content may be changed, added or deleted at any time at the station owner's discretion.

## HOW DOES DIGITAL RADIO WORK

Your system has a special receiver that allows it to receive digital broadcasts in addition to analog broadcasts.

HD1 signifies the main programming status and is available in both analog and digital broadcasts. Other multicast stations are only available digitally and could contain new or different content.

**Note:** *When the system first receives an HD1 station, it plays the station in the analog version until it verifies the station is an HD Radio station. Then it shifts to the digital version.*

**Note:** *There is an audio mute delay when switching to an HD2 or HD3 station because the system has to reacquire and decode the digital signal.*

## DIGITAL RADIO LIMITATIONS

If you are outside the reception area, the system could not work.

If you are on the fringe of the reception area, the station could mute due to weak signal strength.

**Note:** *If you are listening to HD1, the system changes back to the analog broadcast until the digital broadcast is available again. If you are listening to any other multicast channels, the station mutes and stays muted unless it is able to connect to the digital signal again.*

Depending on the station quality, you could hear a slight sound change when the station changes between analog and digital audio.

You cannot access a saved HD station if your vehicle is outside the station's reception area.

## SWITCHING DIGITAL RADIO RECEPTION ON AND OFF

1. Press **Settings** on the touchscreen.
2. Press **Radio Settings**.
3. Switch **HD Radio** on or off.

## DIGITAL RADIO INDICATORS

### HD Radio Indicator

The indicator appears when HD Radio is on and you tune to a station broadcasting HD Radio technology.



The color of the indicator changes to indicate the system status.

Gray indicates the system is acquiring a digital station.

Orange indicates digital audio is playing.

# Audio System

## Multicast Indicator

The multicast indicator appears if the current station is broadcasting multiple digital broadcasts. The highlighted numbers indicate additional digital channels available.

**Note:** For stations that have more than one HD multicast, the HD indicator and radio text appears as a button. Press the button to cycle through all of the HD stations on that specific frequency.

## SATELLITE RADIO (IF EQUIPPED)

### WHAT IS SATELLITE RADIO

Your factory-installed SiriusXM radio system includes a limited subscription term, which begins on the date of sale or lease of your vehicle. See an authorized dealer for availability.

For additional information about extended subscription terms, visit [www.SiriusXM.com](http://www.SiriusXM.com) in the United States, [www.SiriusXM.ca](http://www.SiriusXM.ca) in Canada, or call SiriusXM at 1-888-539-7474.

**Note:** SiriusXM reserves the unrestricted right to change, rearrange, add or delete programming including canceling, moving or adding particular channels, and its prices, at any time, with or without notice to you. Neither SiriusXM and its affiliates nor Ford Motor Company and its affiliates will be liable to you or any third party for any such modification, suspension or termination.

## SATELLITE RADIO LIMITATIONS

For optimal reception performance, keep the antenna clear of snow and ice build-up and keep luggage and other material as far away from the antenna as possible. Placing luggage over the antenna may reduce performance. Factory-installed and aftermarket vehicle structures including, but not limited to, roof racks and soft top roofs in a partially open position could reduce reception performance.

Hills, mountains, tall buildings, bridges, tunnels, freeway overpasses, parking garages, dense tree foliage and thunderstorms can interfere with your reception.

When you pass a ground-based broadcast-repeating tower, a stronger signal may overtake a weaker one and could result in the audio system muting. Your display could show an error message to indicate the interference.

## LOCATING THE SATELLITE RADIO IDENTIFICATION NUMBER

1. Select SiriusXM as the audio source.
2. Tune to channel 0.

## SELECTING A CHANNEL

### Manually Selecting a Channel

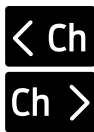

Press the button to find the previous or next available radio channel.

# Audio System

---

## Linear Tuner

The linear tuner is displayed when manually selecting a channel. You can swipe left or right on the linear tuner carousel to navigate through the channel list. Tap on a channel title to listen to it.

## Using Direct Tune

1. Press the channel up or down button to open the linear tuner screen.
2. Press **Direct Tune** to open the number pad.
3. Enter the channel you prefer.

## Using Browse

1. Press **Browse**.
2. Select a channel.

## SATELLITE RADIO SETTINGS

### Subscription

Your subscription status is displayed. You can subscribe or manage your subscription directly from the touchscreen.

### SiriusXM Favorites

While you are listening to SiriusXM, you can save favorites by:

- Tapping the currently tuned channel or show logo on the SiriusXM audio screen.
- Tuning to a channel or show you want to save as a favorite. Navigate to the SiriusXM Favorites screen and press the Add Current button. The currently tuned channel or show is saved as a favorite.
- Saving a radio preset. This saves the currently tuned SiriusXM channel or show as a favorite

**Note:** *Requires a trial or active subscription to use.*

### Listening History

Listening history is a list of recently listened to SiriusXM content. You can view, manage and reset the listening history using the controls on the touchscreen.

**Note:** *Requires a trial or active subscription to use.*

### Help and Support

You can contact SiriusXM Customer Care directly from the operating system and view information required to manage your SiriusXM account.

# Audio System

## AUDIO SYSTEM – TROUBLESHOOTING

### AUDIO SYSTEM – INFORMATION MESSAGES

#### Satellite Radio Troubleshooting

Error Message	Potential Effects	Recommended Action
Connectivity Disabled	Internet streaming and On Demand shows are unavailable and some SiriusXM features are disabled.	Internet connectivity is turned off. See <b>Connected Vehicle</b> (page 547).
No Internet	Audio system may mute. Switch to Satellite button may be displayed on the SiriusXM audio screen if the channel is also available via satellite.	SYNC attempts to connect. See <b>Satellite Radio Limitations</b> (page 556). Switch to a satellite connection for the current channel if the option is available.
No Satellite Signal	Audio system may mute. Switch to Internet button may be displayed on the SiriusXM audio screen if the channel is also available via streaming.	Antenna may be obstructed or satellite reception is weak in your location. See <b>Satellite Radio Limitations</b> (page 556). Switch to an internet connection for the current channel if the option is available.
Slow Network Connection	Audio system may mute while the audio attempts to load.	Allow some time for the audio to load or tune to a different channel.
Channel Unavailable	Audio system may mute. Radio may tune to a different channel.	A temporary update may be in progress. Allow some time before retrying to tune to the channel. If the issue continues, the channel may no longer be available.
Episode Unavailable	Audio system may mute. Radio may tune to a different channel.	A temporary update may be in progress. Allow some time before retrying to play the episode. If the issue continues, the episode may no longer be available.

# Audio System

Error Message	Potential Effects	Recommended Action
Something went wrong	Audio system may mute. Radio may tune to a different channel.	Allow some time and retry the action.
Subscribe to Listen	Cannot listen to selected content. Content may appear grayed out and some features may be disabled.	<p>Your subscription has expired or you have not yet subscribed for access to the listed content. Navigate to Subscription under the Satellite Radio Settings menu. If you have an active subscription which includes the listed channel or content and you see this error, you may need to refresh your radio. To refresh your SiriusXM radio, visit <a href="http://www.siriusxm.com/refresh">www.siriusxm.com/refresh</a> in the US, or <a href="http://www.siriusxm.ca/refresh">www.siriusxm.ca/refresh</a> in Canada.</p> <p>You may need to provide your SiriusXM Radio identification number. See <b>Locating the Satellite Radio Identification Number</b> (page 556).</p>

## Audio System

Error Message	Potential Effects	Recommended Action
Upgrade to Listen	Cannot listen to selected content. Content may appear grayed out and some features may be disabled.	<p>Your subscription does not include access to the listed content. You may need to upgrade your subscription. Navigate to Subscription under the Satellite Radio Settings menu. If you have an active subscription which includes the listed channel or content and you see this error, you may need to refresh your radio. To refresh your SiriusXM radio, visit <a href="http://www.siriusxm.com/refresh">www.siriusxm.com/refresh</a> in the US, or <a href="http://www.siri-usxm.ca/refresh">www.siri-usxm.ca/refresh</a> in Canada. You may need to provide your SiriusXM Radio identification number. See <b>Locating the Satellite Radio Identification Number</b> (page 556).</p>
Location Restricted Content	Audio may mute. Not available in your location or Unable to determine your location may be displayed.	Content is not available in your location or SiriusXM is unable to determine your location. Tuning to a different channel may resolve the issue.
Channel Blocked	Audio may mute. Radio may tune to a different channel.	<p>The Block Explicit Content filter is turned on. Navigate to Listener Settings under the Satellite Radio Settings menu to access the Block Explicit Content filter. Navigate to Listener Settings. See <b>Satellite Radio Settings</b> (page 557).</p>
Antenna Problem or Hardware Problem	Audio may mute. Access to SiriusXM features may be unavailable.	If issue persists, you may need to visit an authorized dealer for service.



# Audio System

---

<b>Error Message</b>	<b>Potential Effects</b>	<b>Recommended Action</b>
SiriusXM Updating...	Audio may mute.	Allow SiriusXM some time to complete updating.
Loading...	Audio may mute. Content may be temporarily unavailable while loading.	No action necessary. If loading time is longer than usual, See <b>Satellite Radio Settings</b> (page 557).
SiriusXM Loading...	Audio may mute. Content and controls may be temporarily unavailable.	No action necessary. Allow SiriusXM some time to finish loading.

# Center Display

## CENTER DISPLAY OVERVIEW



**WARNING:** Driving while distracted can result in loss of vehicle control, crash and injury. We strongly recommend that you use extreme caution when using any device that may take your focus off the road. Your primary responsibility is the safe operation of your vehicle. We recommend against the use of any hand-held device while driving and encourage the use of voice-operated systems when possible. Make sure you are aware of all applicable local laws that may affect the use of electronic devices while driving.

For your safety, features that are not critical while driving are not available when the vehicle is moving at or above 5 mph (8 km/h).

**Note:** Illustrations are provided for conceptual understanding only and may appear differently on your vehicle.

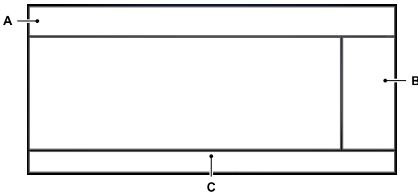

- A Status bar. See **Status Bar** (page 562).
- B Information on demand screen. See **Information On Demand Screen** (page 563).
- C Feature bar. See **Feature Bar** (page 563).

## STATUS BAR

The status bar appears at the top of the display. The following buttons and icons can appear in the status bar.

**Note:** Some buttons and icons may not apply to your vehicle or may not appear exactly as shown.

### Alexa Built-In



Press to set up Alexa. See **Alexa Built-In** (page 567).

### Wireless Charging



Wireless charging active.



Device connected and not charging.

### Traffic Announcements



Traffic announcements are turned on but are not supported by the selected station.



Traffic announcements are turned on and supported by the selected station but are not active.



Traffic announcements are active.

**Note:** If no traffic announcement icons are displayed, traffic announcements are turned off.

### Vehicle Data



Wi-Fi available.



Wi-Fi connected.

# Center Display



Vehicle data sharing on.



Vehicle data sharing off.



Vehicle location sharing on.



Vehicle data and vehicle location sharing on.

## Audio System



Audio system muted.

## Connected Device



Cell phone microphone muted.



Phone call in progress.



Media player connected using **Bluetooth®**.



Cell phone network signal strength.



Cell phone roaming.



Text message received.



Unread email message.



Automatic crash notification system off.



Cell phone battery status.

## Software Updates



Press to see details about software updates. See **Vehicle Software Updates** (page 582).

## Back Button



Some screens have a back button in the top corner. Press the button to return to the previous screen.

## INFORMATION ON DEMAND SCREEN

The information on demand screen displays cards on the side of the display and allows you to see information from different features.



Press the button to view the next card.



Press the button to view the previous card.



Press the button to view available cards.

On some screens, you can swipe a card toward the center of the screen to move the content into the main screen.

## FEATURE BAR

The feature bar is located on the bottom of the display and allows you to access vehicle features.

## Audio



Press to use the radio, a USB, a media player or a **Bluetooth®** device.

# Center Display

## Phone



Press to make calls and access the phonebook on your cell phone. See **Phone** (page 569).

## Navigation



Press to use the navigation system. See **Navigation** (page 579).

## Favorite



Press to replace this button with a shortcut to a feature or setting.

## Apps



Press to see a list of apps. To open an app, select the app.

## Settings



Press to access the settings menu. See **Settings** (page 564).

## Features



Press to view features.

**Note:** *The icon may be different depending on your vehicle.*

## SETTINGS

1.  Press the button in the feature bar to access the settings menu.
2. Select the required tile to access specific settings.



If you see this icon next to a menu option, press it for more information.

## REBOOTING THE CENTER DISPLAY

You can reboot the center display using the controls on the steering wheel.

1. Simultaneously press and hold the seek forward and audio system power button for 10 seconds.

# Voice Interaction

## FORD ASSISTANT

### USING FORD ASSISTANT

The digital assistant allows you to control vehicle features using conversational requests.

To begin a voice interaction using the wake word, say the selected wake word, then say your command.



Press the voice interaction button on the steering wheel. A tone sounds before you can say your command.

**Note:** You may need to enable your vehicle's modem to use certain voice commands. See **Enabling and Disabling the Modem** (page 547).

**Note:** When you are not driving, additional commands are available by using popular chat applications. Use FordPass to setup a conversation with your Ford assistant.

### Voice Command Examples

To see examples of what voice commands you can use with different features:



Press the button on the touchscreen.

1. Press **Ford Assistant**.
2. Press **Voice Command Help**.
3. Select a feature.

## FORD ASSISTANT SETTINGS

To access the settings menu:



Press the button on the touchscreen.

1. Press **Ford Assistant**.

From the settings menu you can do the following:

- Switch listen for wake word on or off.
- Set the preferred wake word.
- Switch advanced mode on or off.
- Switch phone confirmation on or off.
- Switch the commands list on or off.
- View the commands help menu.



Press the button next to a menu option for more information.

## FORD ASSISTANT – FREQUENTLY ASKED QUESTIONS

### Why does the system not understand what I am saying?

- You are speaking too soon. When using the button of the steering wheel, wait for the tone before you speak.

### Why does the system not understand the name of a track or artist?

- **Bluetooth®** does not support voice commands. Connect your device to a USB port.
- You are not saying the name exactly as it appears on your device. Say the name of the track or artist exactly as it appears on your device. Spell out any abbreviations in the name.
- The system does not recognize some special characters contained in the name of a song or artist, for example \*, - or +. Rename the files on your device or use the touchscreen to select and play the track.

# Voice Interaction

---

## **Why does the system not understand the name of a contact in the phonebook on my device and calls the wrong contact?**

- You are not saying the name exactly as it appears on your device. Say the first and last name of the contact exactly as it appears on your device. Spell out any abbreviations in the name.
- The name contains special characters, for example \*, - or +. Rename the contact on your device or use the touchscreen to select and call the contact.

## **Why does the system not understand foreign names of contacts in the phonebook on my device?**

- The system applies phonetic pronunciation rules of the selected language to the names of contacts in the phonebook on your device. Select the name of the contact on the touchscreen and use the Hear it option to get an idea of how the system expects you to pronounce it.

## **Why do the system voice prompts and the pronunciation of some words not seem accurate?**

- The system uses text-to-speech technology and a synthetically generated voice rather than a pre-recorded human voice.

# Alexa Built-In

## WHAT IS ALEXA BUILT-IN

Alexa Built-In allows you to use Alexa in your vehicle for auto-specific use cases on the road and gives you access to an ever-evolving number of skills that help to make your life more productive, entertaining, and connected while using your vehicle.

## ALEXA BUILT-IN REQUIREMENTS

To use Alexa, all of the following must occur:

- Your vehicle modem is enabled.
- You are signed in to an existing Amazon account.
- Vehicle location services are enabled.
- Vehicle connectivity and vehicle data sharing is enabled.

## SIGNING IN TO YOUR ACCOUNT



Press the button in the status bar and follow the on-screen prompts.

To sign in using the settings menu:

1. Press **Settings** on the touchscreen.
2. Press **Amazon Alexa**.
3. Press **Get Started**.
4. Sign in to your account by either scanning the QR code or entering the on-screen code into the Amazon website.
5. Once signed in, follow the on-screen prompts.
6. When complete, the vehicle informs you that Alexa is ready to be used in the vehicle.

## Signing Out of Your Account

1. Press **Settings** on the touchscreen.
2. Press **Amazon Alexa**.
3. Press **Sign Out**.

## USING ALEXA BUILT-IN

To use Alexa, say “Alexa” or press the voice interaction button on the steering wheel and then say “Alexa” to invoke Alexa to start listening.

**Note:** *If the wake word is not enabled, you can only use the voice interaction button.*

You can use Alexa for the following and more:

- Entertainment.
- Hands-free calling.
- Traffic and navigation.
- Vehicle controls.
- Smart home device control.
- Weather and news information.

## ALEXA BUILT-IN SETTINGS

### Enabling the Wake Word

1. Press **Settings** on the touchscreen.
2. Press **Amazon Alexa**.
3. Switch **Listen for Wake Word** on or off.

**Note:** *If the wake word is not enabled, you can only use the voice interaction button.*

### Contact List

Displays a list of connected phones and contact sharing status for each phone.

To change the contact sharing status:

1. Press **Settings** on the touchscreen.
2. Press **Amazon Alexa**.
3. Press **Contact List**.

# Alexa Built-In

---

4. Enable or disable sharing for each phone.

**Note:** *You can share contacts from more than one phone at a time.*

## Things to Try

Learn more about what you can do with Alexa by browsing the things to try.

1. Press **Settings** on the touchscreen.
2. Press **Amazon Alexa**.
3. Press **Things to Try**.



# Phone

## PHONE PRECAUTIONS



**WARNING:** Driving while distracted can result in loss of vehicle control, crash and injury. We strongly recommend that you use extreme caution when using any device that may take your focus off the road. Your primary responsibility is the safe operation of your vehicle. We recommend against the use of any hand-held device while driving and encourage the use of voice-operated systems when possible. Make sure you are aware of all applicable local laws that may affect the use of electronic devices while driving.

## CONNECTING YOUR PHONE

Go to the settings menu on your device and switch **Bluetooth®** on.



Press the phone option on the feature bar.

1. Press **Add Phone**.

**Note:** A prompt alerts you to search for your vehicle on your cell phone.

2. Select your vehicle on your cell phone.

**Note:** A number appears on your cell phone and on the touchscreen.

3. Confirm the number on your cell phone matches the number on the touchscreen.

**Note:** The touchscreen indicates that you have successfully paired your cell phone.

4. Approve phonebook download request on your cell phone.

## PHONE MENU

This menu becomes available after pairing a phone.

### Recent Call List

Display and select an entry from a list of previous calls.

### Contacts

Display a smart search form to look up your contacts. Use the List button to alphabetically sort your contacts.

### Favorites

Display the list of favorite contacts that are set up on your phone.

### Messaging

Displays the list of text messages to read, listen to, or respond to.

### Email

Displays the list of emails to read, listen to, or respond to.

### Phone List

Display the list of paired or connected devices that you can select.

**Note:** Up to 12 devices can be stored.

### Do Not Disturb

Reject incoming calls and switch ring tones and alerts off.

### Phone Keypad

Directly dial a number.

# Phone

---

## Voice Control

Press the button and say a command to use the Google or Siri voice assistant available on your connected phone to access supported features.

**Note:** *Some features under the phone menu may not be available if the feature is not supported through the phone.*

# Phone

## MAKING AND RECEIVING A PHONE CALL

### Making Calls

**To call a number in your contacts, select:**

Menu Item	Action and Description
Contacts	You can then select the name of the contact you want to call. Any numbers stored for that contact display along with any stored contact photos. You can then select the number that you want to call. The system begins the call.

**To call a number from your recent calls, select:**

Menu Item	Action and Description
Recent Call List	You can then select an entry that you want to call. The system begins the call.

**To call a number from your favorites, select:**

Menu Item	Action and Description
Favorites	You can then select an entry that you want to call. The system begins the call.

**To call a number that is not stored in your phone, select:**

Menu Item	Action and Description
Phone Keypad	Select the digits of the number you wish to call.
Call	The system begins the call.

Pressing the backspace button deletes the last digit you typed.

### Receiving Calls

During an incoming call, an audible tone sounds. Caller information appears in the display if it is available.

**To accept the call, select:**

Menu Item
Accept

**Note:** You can also accept the call by pressing the phone button on the steering wheel.

**To reject the call, select:**

Menu Item
Reject

Ignore the call by doing nothing. The system logs it as a missed call.

### During a Phone Call

During a phone call, the contacts name and number display on the screen along with the call duration.

The phone status items are also visible:

- Signal Strength.
- Battery.

You can select any of the following during an active phone call:

# Phone

Item	
End Call	Immediately end a phone call. You can also press the button on the steering wheel.
Keypad	Press this to access the phone keypad.

Item	
Mute	You can switch the microphone off so the caller does not hear you.
Privacy	Transfer the phone call audio to the cell phone or back to the touchscreen.

## SENDING AND RECEIVING A TEXT MESSAGE

Menu Item	Description
Hear It	Hear the text message.
View	View the text message.
Call	Call the sender.
Reply	Reply to the text message with a standard text message.

# Phone

---

## **SWITCHING TEXT MESSAGE NOTIFICATION ON AND OFF**

### **IOS**

1. Go to the settings menu on your cell phone.
2. Select **Bluetooth®**.
3. Select the information icon to the right of your vehicle.
4. Switch text message notification on or off.

### **Android**

1. Go to the settings menu on your cell phone.
2. Select **Bluetooth®**.
3. Select the profiles option.
4. Select the phone profile.
5. Switch text message notification on or off.

# Bluetooth®

## CONNECTING A BLUETOOTH® DEVICE

1. Make sure **Bluetooth®** is enabled on your device.
2. Press **Settings** on the touchscreen.
3. Press **Connectivity**.
4. Press **Bluetooth**.
5. Press **Add a Bluetooth Device**.

**Note:** A prompt alerts you to search for your vehicle on your device.

6. Select your vehicle on your device.

**Note:** A number appears on your device and on the touchscreen.

7. Confirm that the number on your device matches the number on the touchscreen.

**Note:** The touchscreen indicates that you have successfully paired your device.

The **Bluetooth®** word mark and logos are registered trademarks owned by **Bluetooth SIG, Inc.** and any use of such marks by Ford Motor Company is under license. Other trademarks and trade names are those of their respective owners.

## PLAYING MEDIA USING BLUETOOTH®



**WARNING:** Driving while distracted can result in loss of vehicle control, crash and injury. We strongly recommend that you use extreme caution when using any device that may take your focus off the road. Your primary responsibility is the safe operation of your vehicle. We recommend against the use of any

hand-held device while driving and encourage the use of voice-operated systems when possible. Make sure you are aware of all applicable local laws that may affect the use of electronic devices while driving.

Connect your device.



Press the audio button on the feature bar.



Press **Sources**.



Press the **Bluetooth®** option.



Press to play a track. Press again to pause the track.



Press to skip to the next track. Press and hold to fast forward through the track.



Press once to return to the beginning of a track. Repeatedly press to return to previous

tracks.

Press and hold to fast rewind through the track.

# Apps

## APP PRECAUTIONS



**WARNING:** Driving while distracted can result in loss of vehicle control, crash and injury. We strongly recommend that you use extreme caution when using any device that may take your focus off the road. Your primary responsibility is the safe operation of your vehicle. We recommend against the use of any hand-held device while driving and encourage the use of voice-operated systems when possible. Make sure you are aware of all applicable local laws that may affect the use of electronic devices while driving.

## APP REQUIREMENTS

When you start an app through the system for the first time, you could be asked to grant certain permissions. You can review and change the permissions that you have granted at any time when your vehicle is not moving. We recommend that you check your data plan before using your apps through the system. Using them could result in additional charges. We also recommend that you check the app provider's terms and conditions and privacy policy before using their app. Make sure that you have an active account for apps that you want to use through the system. Some apps will work with no setup. Others require you to configure some personal settings before you can use them.

## ACCESSING APPS



Select the apps option on the feature bar.

## ENABLING APPS ON AN IOS DEVICE



Select the apps option on the feature bar.

1. Select Mobile Apps Help.
2. Follow the instructions to pair and connect your device via **Bluetooth®** or with a USB cable.
3. Start the apps on your device that you want to use.
4. Select the app that you want to use on the touchscreen.

**Note:** Some apps may run through Apple CarPlay if it is enabled.

**Note:** Closing an app on your device will close it on the touchscreen.

**Note:** For troubleshooting assistance select Mobile Apps List under Mobile Apps Help.

## ENABLING APPS ON AN ANDROID DEVICE



Select the apps option on the feature bar.

1. Select Mobile Apps Help.
2. Follow the instructions to pair and connect your device via **Bluetooth®** or with a USB cable.
3. Start the apps on your device that you want to use.
4. Select **Find Mobile Apps**.
5. Select the app that you want to use on the touchscreen.

**Note:** Some devices may lose the ability to play music over USB when Mobile Apps are enabled.

**Note:** Some apps may run through Android Auto if it is enabled.

# Apps

**Note:** Closing an app on your device will close it on the touchscreen.

**Note:** For troubleshooting assistance select *Mobile Apps List* under *Mobile Apps Help*.

## SWITCHING APPLE CARPLAY ON AND OFF

### Enabling Apple CarPlay with USB

1. Connect your device to a USB port.
2. Follow the instructions on your device and the touchscreen.

**Note:** Selecting *Enable Wireless Apple CarPlay* on your device prepares for wireless Apple CarPlay when you reenter the vehicle.

### Enabling Apple CarPlay with Wireless

1. Pair your device to **Bluetooth®**.
2. Follow the instructions on your device and the touchscreen.

### Disabling Apple CarPlay



Select the settings option on the feature bar.

1. Press Phone List.
2. Select your device from the list.
3. Press the Apple Carplay icon to disconnect.

### Re-Enabling Apple CarPlay



Select the settings option on the feature bar.

1. Press Phone List.
2. Select your device from the list.
3. Press the Apple CarPlay icon to connect.

## SWITCHING ANDROID AUTO ON AND OFF

### Enabling Android Auto with USB

(If Equipped)

1. Connect your device to a USB port.
2. Follow the instructions on the touchscreen.

**Note:** Certain features of the system are not available when you are using Android Auto.

### Enabling Android Auto with Wireless

1. Pair your device to **Bluetooth®**.
2. Follow the instructions on your device and the touchscreen.

**Note:** Certain Android devices do not support Android Auto Wireless. Check your Android OS version for compatibility.

### Disabling Android Auto



Select the settings option on the feature bar.

1. Press Phone List.
2. Select your device from the list.
3. Press the Android Auto icon to disconnect.

### Re-Enabling Android Auto



Select the settings option on the feature bar.

1. Press Phone List.
2. Select your device from the list.
3. Press the Android Auto icon to connect.



# Personal Profiles

---

## HOW DO PERSONAL PROFILES WORK

You can create multiple personal profiles enabling users to personalize vehicle settings such as seats and mirrors, as well as non-positional settings like radio, navigation and driver assist system settings. Positional settings are saved by holding a memory seat button. Non-positional settings are saved when you change a setting while a profile is active.

## ENABLING OR DISABLING PERSONAL PROFILES

1. Press Settings on the touchscreen.
2. Press Personal Profiles.
3. Switch Personal Profiles on or off.

When enabled:

- Unlocking a door with a remote control or mobile device that is not linked to a driver profile does not change the active profile, but remains in the last known profile. It does not change the positional settings.
- Pressing a memory seat button that is not linked to a driver profile or saved to a preset setting does not change the active profile, but remains in the last known profile. It does not change the positional settings.
- Pressing a memory seat button that is not linked to a driver profile but is saved to a preset setting does not change the active profile, but remains in the last known profile. It recalls the positional settings that you saved to that memory seat button.

When disabled:

- Unlocking a door with a remote control or mobile device does not recall any non-positional settings but still recalls positional settings from the driver profile which the remote control or mobile device is linked to.
- Pressing a memory seat button that is not linked to a driver profile or saved to a preset setting does not change the positional or non-positional settings.
- Pressing a memory seat button that is linked to a driver profile or has saved to a preset setting recalls the positional settings that you saved to that memory seat button.

## CREATING A PERSONAL PROFILE

You can create one profile for each preset memory seat button. There is also a guest profile.

**Note:** *The guest profile consists of existing settings when there is no driver profile created. After you create a driver profile, the guest profile serves as an additional driver profile.*

1. Press Settings on the touchscreen.
2. Press Personal Profiles.
3. Press Add Profile.
4. Follow the prompts on the display.

## LINKING OR UNLINKING A PERSONAL PROFILE

You can link your profile to a remote control or mobile device so that your settings are activated when you use the remote control or mobile device to turn on the vehicle.

# Personal Profiles

---

## Remote Control

You can save preset memory positions for up to three remote controls by assigning a remote control to a personal profile.

1. Press Settings on the touchscreen.
2. Press Personal Profiles.
3. Select the profile to link or unlink.

**Note:** *You cannot link a remote control to a guest profile.*

4. Select the remote control to link or unlink.
5. Follow the instructions on the touchscreen.

**Note:** *If more than one linked remote control is in range, the memory function moves to the settings of the first key to initiate a memory recall.*

## Mobile Device

1. Press Settings on the touchscreen.
2. Press Personal Profiles.
3. Select the profile to link or unlink.

**Note:** *You cannot link a mobile device to a guest profile.*

4. Select the mobile device to link or unlink.

**Note:** *The mobile device must be in your vehicle, and previously set up as a remote control for your vehicle.*

5. Follow the instructions on the touchscreen.

**Note:** *If more than one linked mobile device is in range, the memory function moves to the settings of the first mobile device to initiate a memory recall.*

## SELECTING A PERSONAL PROFILE

You can select a profile using the touchscreen or the preset button you selected when you created your profile.

If you use a linked device, such as a remote control or mobile device, the active profile is set to the linked profile.

To change the active profile:

1. Press Settings on the touchscreen.
2. Press Personal Profiles.
3. Select the profile to use.
4. Press Make Profile Active.

## DELETING A PERSONAL PROFILE

1. Press Settings on the touchscreen.
2. Press Personal Profiles.
3. Select the profile to delete.
4. Press Delete Profile.

## Navigation (If Equipped)

### CONNECTED NAVIGATION (IF EQUIPPED)

Your vehicle may be equipped with connected navigation. Depending on your version, you are given a 90 day or 3 year trial. After the trial period, you need to sign up to continue the experience. For additional information, visit [ford.com/connectedservices](http://ford.com/connectedservices).

**Note:** *If you do not sign up or renew your subscription, you can still use navigation through a connected device.*

### ACCESSING NAVIGATION



Press the button to access Navigation.

**Note:** *As the driver, be aware of all local traffic regulations and road attributes, and operate your vehicle in a safe and legal manner.*

### NAVIGATION MAP UPDATES

To update your map data over Wi-Fi, your vehicle must be connected to a Wi-Fi access point. For USB updates and other details, contact dealers at 1-866-462-8837 in the United States and Canada, or 800-557-5539 in Mexico.

**Note:** *If you find map data errors, you may report them by going to [www.here.com/mapcreator](http://www.here.com/mapcreator).*

### ADJUSTING THE MAP

#### ZOOMING THE MAP IN AND OUT

You can use pinch gestures to zoom in and out. Place two fingers on the screen and move them apart to zoom in. Place two fingers on the screen and bring them together to zoom out.

#### CHANGING THE FORMAT OF THE MAP



Press the Menu button.

1. Press the Map Orientation tile.
2. Select a map orientation.

### LIVE TRAFFIC

#### WHAT IS LIVE TRAFFIC

You can observe real-time road congestion when live traffic is on.

#### SWITCHING LIVE TRAFFIC ON AND OFF



Press the Menu button.

1. Press the Traffic on Map tile.
2. Press Traffic on or Traffic Off.

### SETTING A DESTINATION

#### SETTING A DESTINATION USING THE TEXT ENTRY SCREEN

1. Press the search bar at the top of the screen.

# Navigation (If Equipped)

2. Enter your destination using the keyboard.
3. Press Search.
4. Select a destination from the list.
5. Press Start to begin navigation.

## SETTING A DESTINATION USING THE MAP SCREEN

Press and hold on the map to place a pin at that location. Information about the location of the pin appears on the screen.



Press the button to begin navigation to the pin.

## SETTING A DESTINATION USING A PREDICTIVE DESTINATION

Press the predicted destination card on the screen to navigate to it. These appear when the navigation system has learned your driving habits.

## SETTING A DESTINATION USING A RECENT DESTINATION



Press the button.

Press a destination from the list.

**Note:** You can also use the search button to view recent destinations.

## SETTING A DESTINATION USING A SAVED DESTINATION

Press the star icon next when viewing location details to save the location.



Press the button.

Press a destination from the list.

**Note:** You can also use the search button to view saved destinations.

## SETTING A DESTINATION USING A POINT OF INTEREST

Press a point of interest icon on the map. Information about the location of the point of interest appears on the screen.



Press the button to begin navigation to the point of interest.

**Note:** You can also use the search button to view points of interest.

## WAYPOINTS

### ADDING A WAYPOINT



Press the Add Waypoint button when in an active navigation session.

1. Enter your waypoint on the keyboard.
2. Press Search.
3. Select a waypoint from the list.
4. Press Add to Trip.

### EDITING WAYPOINTS

1. Press the waypoint you would like to edit.
2. Select an option to reorder or delete the waypoint.

## ROUTE GUIDANCE

### ADJUSTING THE GUIDANCE PROMPT VOLUME

Turn the volume control when a guidance prompt plays to adjust the volume.

# Navigation (If Equipped)

---

## REPEATING AN INSTRUCTION

Press the turn indicator to hear the last voice instruction.

## CANCELING ROUTE GUIDANCE



Press the button to cancel route guidance to the selected location.

## TRAILER TOWING NAVIGATION

The system calculates the best route for trailer towing by avoiding dangerous road conditions based on the dimensions of your trailer.

### Switching Trailer Towing Navigation On and Off

1. Press the **Navigation** button on the feature bar.
2. Press the **Menu** button.
3. Press **Trailer Routing**.
4. Switch **Trailer-optimized Routing** on or off.

### Entering Trailer Dimensions

1. Press the **Navigation** button on the feature bar.
2. Press the **Menu** button.
3. Press **Trailer Routing**.
4. Press **Towing Menu**.
5. Press **Add Trailer**.
6. Follow the instructions on the screen to enter the type and dimensions of the trailer into the system.

## Navigation Alerts

Alerts will appear on the navigation map while driving. An orange alert triangle indicates you should proceed with caution. When not following active guidance to a destination, a red alert triangle may appear and indicates you should avoid the road and find a detour.

# Vehicle Software Updates

This introduces new features and provides updates to the vehicle's software systems. Make sure to switch Automatic Updates on, set a recurring update schedule and connect your vehicle to Wi-Fi. Updates could take longer when not connected to Wi-Fi or could not download at all. See **Connecting the Vehicle to a Wi-Fi Network** (page 547).

Your vehicle may be able to receive drivable software updates, non-drivable software updates or both. Drivable software updates happen during normal vehicle usage and require limited input from you. You are notified on your touchscreen and connected device prior to a non-drivable update.

Most non-drivable updates complete in less than 30 minutes, although some updates could take up to a few hours.

You are notified of vehicle software update status on to the top left of touchscreen. You can also see the notifications in your connected device. See **Software Update Indicators** (page 583).

## Vehicle Software Update Requirements

Non-drivable software updates do not install if any of the following occur:

- Your vehicle is running.
- Your vehicle is switched on.
- Your vehicle is not parked.
- The 12 V battery charge is too low.
- The hazard indicators are switched on.
- The alarm is sounding.
- The doors are open.
- The parking lamps are switched on.
- You are pressing the brake pedal.
- An emergency call is in process.
- Your vehicle is in limp home mode.

## Vehicle Software Update Limitations

Once you begin a non-drivable software update, you cannot:

- Cancel the update.
- Enter your vehicle unless you have a key blade.
  - You can open the doors using the mechanical latch if child locks are not on.
- Use the remote control to lock, unlock or start your vehicle.
- Drive your vehicle.
- Charge your vehicle.
  - Charging resumes once the update completes.

## SOFTWARE UPDATE SETTINGS

To access the Software Updates menu:

1. Press **Settings** on the touchscreen.
2. Press **Software Updates**.

You can do the following in the Software Updates menu:

- Switch Automatic Updates on and off.
- Schedule and install software updates.
- View software update details.



Press the button next to a menu option for more information.

## Switching Automatic Updates On and Off

Your vehicle may come with Automatic Updates switched on. To make sure your vehicle always has the latest software, which could include security or other enhancements, we do not recommend switching Automatic Updates off.

# Vehicle Software Updates

**Note:** Software updates require approval to download or install with Automatic Updates switched off.

## Scheduling and Installing Software Updates

### Scheduling Software Updates

From the Software Updates menu:

1. Press **Schedule Updates**.
2. Select the days and time for updates.
3. Press **Save**.

The more days that updates are scheduled, the more frequently your vehicle installs new updates. We recommend selecting a time you normally do not need your vehicle, such as overnight.

Some updates require your vehicle to be switched off.

**Note:** The schedule you set is recurring. If Automatic Updates is on, every time a non-drivable update is available, it installs on this schedule unless you change it. You are notified on your touchscreen and connected device prior to a non-drivable update, with an option to reschedule it.

### Installing Software Updates

#### Using the Status Bar

1. Press a Software Update indicator on your touchscreen when it appears.
2. Follow the instructions on the touchscreen.

#### Using the Touchscreen

From the Software Updates menu:

1. Press **Update Details**.
2. Press **Update Now**.

### Viewing Software Update Details

From the Software Updates menu:

1. Press **Update Details**.

## SOFTWARE UPDATE INDICATORS

You can press the indicators in the status bar when they appear for more information.



Vehicle software update reminder, schedule required, confirmation of default schedule required, or consent required.



Vehicle software update canceled, update not successful, or precondition not met.



Vehicle software update successful.

# Vehicle System Reset

---

## PERFORMING A SYSTEM RESET

Performing a system reset allows you to remove all personal information and restore settings to their factory defaults.

1. Press **Settings** on the touchscreen.
2. Press **General**.
3. Press **Reset**.
4. Press **Factory Reset**.
5. Follow the prompts on the screen to complete the reset.



# Accessories

For a complete listing of the accessories that are available for your vehicle, please contact your authorized dealer or visit the online store web site:

<b>Web Address (United States)</b>
<a href="http://www.Accessories.Ford.com">www.Accessories.Ford.com</a>

<b>Web Address (Canada)</b>
<a href="http://www.Accessories.Ford.ca">www.Accessories.Ford.ca</a>

We will repair or replace any properly authorized dealer-installed Ford Original Accessory found to be defective in factory-supplied materials or workmanship during the warranty period, as well as any component damaged by the defective accessories.

We will warrant your Ford Original Accessory through the warranty that provides the greatest benefit:

- 24 months, unlimited mileage.
- The remainder of your new vehicle limited warranty.

Contact an authorized dealer for details and a copy of the warranty.

Ford Licensed Accessories are the accessory manufacturer's designs. The manufacturer develops and therefore warrants Ford Licensed Accessories, and does not design or test these accessories to Ford Motor Company engineering requirements. Contact an authorized Ford dealer for the manufacturer's limited warranty details, and request a copy of the Ford Licensed Accessories product limited warranty from the accessory manufacturer.

For maximum vehicle performance, keep the following information in mind when adding accessories or equipment to your vehicle:

- When adding accessories, equipment, passengers and luggage to your vehicle, do not exceed the total weight capacity of the vehicle or of the front or rear axle (GVWR or GAWR as indicated on the Safety Compliance Certification label). Ask an authorized dealer for specific weight information.
- The Federal Communications Commission (FCC) and Canadian Radio Telecommunications Commission (CRTC) regulate the use of mobile communications systems that are equipped with radio transmitters, for example two-way radios, telephones and theft alarms. Any such equipment installed in your vehicle should comply with Federal Communications Commission (FCC) and Canadian Radio Telecommunications Commission (CRTC) regulations and should be installed only by an authorized dealer.
- An authorized dealer needs to install mobile communications systems. Improper installation may harm the operation of your vehicle, particularly if the manufacturer did not design the mobile communication system specifically for automotive use.
- If you or an authorized Ford dealer add any non-Ford electrical or electronic accessories or components to your vehicle, you may adversely affect battery performance and durability. In addition, you may also adversely affect the performance of other electrical systems in the vehicle.

## Auxiliary Switches (If Equipped)

### WHAT ARE THE AUXILIARY SWITCHES

The auxiliary switchboard on the overhead console makes aftermarket customization easier with six prewired switches connected to the power distribution box. Each circuit is individually fused for connection of electrical accessories. For more information on connecting accessories to the auxiliary switches, see your authorized dealer or refer to the Super Duty Body Builders Layout Book (BBLB), if available.

For maximum vehicle performance, keep the following information in mind when adding accessories or equipment to your vehicle:

- When adding accessories, equipment, passengers and luggage to your vehicle, do not exceed the total weight capacity of the vehicle or of the front or rear axle (GVWR or GAWR as indicated on the safety compliance certification label). Ask an authorized dealer for specific weight information.
- It is your responsibility to ensure that any equipment you have fitted complies with applicable local legislation.
- An authorized dealer needs to install mobile communication systems. Improper installation may harm the operation of your vehicle, particularly if the manufacturer did not design the mobile communication system specifically for automotive use.
- If you or an authorized dealer add any electrical or electronic accessories or components not produced by us to your vehicle, you may adversely affect battery performance and durability. In addition, you may also adversely affect the performance of the other electrical systems in the vehicle.

### LOCATING THE AUXILIARY SWITCHES

The switches are labeled AUX 1 through AUX 6.

The auxiliary switches only operate when the ignition is in the on or off position and the delay accessory is active, whether the engine is running or not.

We recommend that you leave the engine running to maintain battery charge when using the switches for an extended time or when using higher current draw accessories.

When a switch is turned on, the indicator light on the switch illuminates and the circuit provides power to the device wired to that switch.



# Ford Protect

---

## WHAT IS FORD PROTECT

Protect yourself from the rising cost of vehicle repairs with a Ford Protect extended service plan.

### Ford Protect Extended Service Plans - United States Only

Ford Protect extended service plans mean peace of mind. Extended service plans are backed by Ford Motor Company, and provide more protection beyond the New Vehicle Limited Warranty coverage. When you visit your Ford Dealer, insist on the Ford Protect extended service plan.

### Ford Protect Can Quickly Pay for Itself

One trip to the service center could easily exceed the price of your Ford Protect extended service plan. With the Ford Protect extended service plan, you minimize your risk for unexpected repair bills and rising repair costs.

### Up to 1,000+ Covered Vehicle Components

There are four mechanical Ford Protect extended service plans with different levels of coverage. Ask your authorized dealer for details.

1. PremiumCARE - Our most comprehensive coverage. With over 1,000 covered components, this plan is so complete it is probably easier to list what is not covered.
2. ExtraCARE - Covers 113 components, and includes many high-tech items.
3. BaseCARE - Covers 84 components.
4. PowertrainCARE - Covers 29 critical components.

Ford Protect extended service plans are honored by all authorized Ford dealers in the United States, Canada and Mexico.

That means you get:

- Reliable, quality service at any Ford or Lincoln dealership.
- Repairs performed by factory trained technicians, using genuine parts.

### Rental Car Reimbursement

#### *First Day Rental Benefit*

If you bring your car into your dealer for service, we will give you a rental vehicle to use for the day.

#### *Extended Rental Benefits*

If your vehicle is kept overnight for covered repairs, you are eligible for rental car coverage, warranty repairs, and field service actions.

### Roadside Assistance

Exclusive 24/7 roadside assistance, including:

- Towing, flat-tire change and battery jump starts.
- Out of fuel and lock-out assistance.
- Travel expense reimbursement for lodging, meals and rental car.
- Assistance for taxi, shuttle, rental car coverage or other transportation.

### Transferable Coverage

If you sell your vehicle before your Ford Protect extended service plan coverage expires, you can transfer any remaining coverage to the new owner. This should give you and your potential buyer peace of mind.

# Ford Protect

---

## Less Cost to Properly Maintain Your Vehicle

The Ford Protect extended service plan also offers a Premium Maintenance Plan that covers all scheduled maintenance, and selected wear items. The coverage is prepaid, so you never have to worry about the cost of your vehicle's maintenance.

Covered maintenance includes:

- Windshield wiper blades.
- Spark plugs.
- The clutch disc (if equipped).
- Brake pads and linings.
- Shock absorbers.
- Struts.
- Engine belts.
- Engine coolant hoses, clamps and o-rings.
- Diesel exhaust fluid replenishment (if equipped).
- Cabin air filter replacement every 20,000 mi (32,000 km) for electric vehicles only.

## Interest Free Finance Options

Just a 5% down payment provides you with an affordable, no interest, no fee payment program allowing you all the security and benefits Ford Protect extended service plan has to offer while paying over time. You are pre-approved with no credit check or hassles. To learn more, call our Ford Protect extended service plan specialists at 800-367-3377.

Ford Protect Extended Service Plan  
P.O. Box 321067  
Detroit, MI 48232

## Ford Protect Extended Service Plan (Canada Only)

You can get more protection for your vehicle by purchasing a Ford Protect extended service plan. Ford Protect extended service plan is the only service contract backed by Ford Motor Company of Canada, Limited. Depending on the plan you purchase, Ford Protect extended service plan provides benefits such as:

- Rental reimbursement.
- Coverage for certain maintenance and wear items.
- Protection against repair costs after your New Vehicle Limited Warranty Coverage expires.
- Roadside Assistance benefits.

There are several Ford Protect extended service plans available in various time, distance and deductible combinations. Each plan is tailored to fit your own driving needs, including reimbursement for towing and rental. When you purchase Ford Protect extended service plan, you receive added peace-of-mind protection throughout Canada, the United States and Mexico, provided by a network of participating authorized Ford Motor Company dealers.

**Note:** *Repairs performed outside of Canada and the United States are not eligible for Ford Protect extended service plan coverage.*

This information is subject to change. Visit your local Ford of Canada dealer or [www.ford.ca](http://www.ford.ca) to find the Ford Protect extended service plan that is right for you.

# Scheduled Maintenance

---

## GENERAL MAINTENANCE INFORMATION

### Why Maintain Your Vehicle?

Carefully following the maintenance schedule helps protect against major repair expenses resulting from neglect or inadequate maintenance and may help to increase the value of your vehicle when you sell or trade it. Keep all receipts for completed maintenance with your vehicle.

It is important that you have your vehicle serviced at the proper times. These intervals serve two purposes: first is to maintain the reliability of your vehicle and the second is to keep the cost of owning your vehicle down.

It is your responsibility to have all scheduled maintenance performed and to make sure that the materials used meet the specifications identified in this owner's manual. See **Capacities and Specifications** (page 520).

Failure to perform scheduled maintenance and regularly inspect your vehicle may result in vehicle damage not covered by the vehicle Warranty.

### Why Maintain Your Vehicle at Your Dealership?

#### Our Genuine Replacement Parts

Dealerships stock our parts and our authorized branded remanufactured replacement parts. These parts meet or exceed our specifications. Parts installed at your dealership carry a nationwide 24-month or unlimited mile (kilometer) parts and labor limited warranty.

If you do not use our authorized parts, they may not meet our specifications and could affect emissions compliance.

### Protecting Your Investment

Maintenance is an investment that pays dividends in the form of improved reliability, durability and resale value. To maintain the proper performance of your vehicle and its emission control systems, make sure you have scheduled maintenance performed at the designated intervals.

Your vehicle comes with the Intelligent Oil-Life Monitor system, a message appears in the instrument cluster display at the proper oil change interval.

When the oil change message appears in the instrument cluster display, it is time for an oil change. Make sure you perform the oil change within two weeks or 500 mi (800 km) of the message appearing. Make sure to reset the Intelligent Oil-Life Monitor after each oil change. See **Resetting the Intelligent Oil Life Monitor** (page 444).

If your information display resets prematurely or becomes inoperative, you should never exceed one year or 15,000 mi (24,000 km) for diesel vehicles and 10,000 mi (16,000 km) for gas vehicles between oil change intervals.

You can drive vehicles in such a way that may lead to higher oil consumption including extended time at high engine speeds, high loads, engine braking, hard cornering maneuvers, track and off-road usage. Under these conditions, oil consumption of approximately 1 quart per 500 miles (1 liter per 800 km) is possible. Check the engine oil level at every refueling and adjust to maintain proper levels to avoid engine damage.

You can also drive your vehicle in such a way that dilutes and increases the level of oil by frequent short trips that do not allow the engine to get to operating temperature, extended idling and low speed driving for long periods of time.

# Scheduled Maintenance

It is important to rely upon your dealership to properly diagnose and repair your vehicle.

We strongly recommend only using our genuine or our authorized re-manufactured replacement parts engineered for your vehicle.

## Additives and Chemicals

We do not recommend using chemicals or additives not approved by us as part of your vehicle's normal maintenance. Please consult your warranty information.

## Oils, Fluids and Flushing

In many cases, fluid discoloration is a normal operating characteristic and, by itself, does not necessarily indicate a concern or that you need to have the fluid changed. Have discolored fluids that also show signs of overheating or foreign material contamination immediately checked.

Make sure to change the vehicle's oils and fluids at the specified intervals or in conjunction with a repair. Flushing is a viable way to change fluid for many vehicle sub-systems during scheduled maintenance. It is critical that systems are flushed only with new fluid that is the same as that required to fill and operate the system or using our approved flushing chemical.

## Scheduled Maintenance Service Intervals

For your scheduled maintenance service intervals, visit <https://www.ford.com/support/maintenance-schedule>.

## Owner Checks and Services

Make sure you perform the following basic maintenance checks and inspections.

Check Every Month
The air filter restriction gauge. <sup>1</sup>
The engine oil level.
Function of all interior and the exterior lights.
The tires including the spare for wear and proper pressure.
The windshield washer fluid level.
The fuel and water separator. Drain if necessary or if indicated by the information display. <sup>1</sup>
The holes and slots in the tail pipe to make sure they are functional and clear of debris. <sup>1</sup>

<sup>1</sup> Diesel vehicles only.

# Scheduled Maintenance

<b>Check Every Six Months</b>
The battery connections. Clean if necessary.
The body and door drain holes for obstructions. Clean if necessary.
The cooling system fluid level and the coolant system strength.
The door weatherstrips for wear. Lubricate if necessary.
The hinges, latches and outside locks for proper operation. Lubricate if necessary.
The parking brake for proper operation.
The seatbelts and seat latches for wear and function.
Safety warning lamps, brake, ABS, airbag and seatbelt for operation.
The washer spray and wiper operation. Clean or replace blades as necessary.

## Multi-Point Inspection

It is important to have the systems on your vehicle regularly checked. This can help identify potential issues and prevent major problems. We recommend having the following multi-point inspection performed at every scheduled maintenance interval to help make sure your vehicle keeps running great.

<b>Multi-Point Inspection</b>	
Accessory drive belt or belts	Hazard warning system operation
Battery performance	Horn operation
Engine air filter	Radiator, cooler, heater and air conditioning hoses
Exhaust system	Suspension components for leaks or damage
Exterior lamps operation	Steering and linkage
Fluid levels <sup>1</sup> ; fill if necessary	Tires including the spare for wear and proper pressure <sup>2</sup>

# Scheduled Maintenance

Multi-Point Inspection	
For oil and fluid leaks	Windshield for cracks, chips or pits
Halfshaft dust boots	Washer spray and wiper operation

<sup>1</sup> Brake, coolant recovery reservoir, automatic transmission and window washer.

<sup>2</sup> If your vehicle has a temporary mobility kit, check the tire sealant expiration Use By date on the canister. Replace as needed.

Make sure to ask your dealership service advisor or technician about the multi-point vehicle inspection. It is a comprehensive way to perform a thorough inspection of your vehicle. Your checklist gives you immediate feedback on the overall condition of your vehicle.

## Severe Driving Conditions

A vehicle that is driven for short trips of less than 5–10 mi (8–16 km) miles, driving in temperatures greatly below or above average, driving in any dusty conditions, idling more than recommended such as in traffic, and driving with a heavy load or while towing a load are considered severe driving conditions. If you drive your vehicle in any of these conditions, follow the severe service maintenance items listed in the scheduled maintenance chart.

## Axle and Transfer Case Maintenance

Axle(s) and transfer case (4X4 only) fluid changes or level checks are not required unless you suspect a leak or the assembly has been submerged in water. During long periods of trailer towing with outside temperatures above 70°F (21°C) or at wide-open throttle for long periods above 45 mph (72 km/h), change the rear axle fluid every 30,000 mi (48,000 km) if the rear axle is filled with non-synthetic fluid. This interval can be waived and the 150,000 mi (240,000 km) service interval can continue if the rear axle is filled with 75W140 synthetic gear fluid meeting Ford

specification WSL-M2C192-A, part number XY-75W140-QL, or equivalent. Add friction modifier XL-3 (EST-M2C118-A) or equivalent for a complete refill of Traction-Lok rear axles. See **Capacities and Specifications** (page 520).

## Additional Axle Maintenance for Dual Rear Wheels

Change rear axle fluid every 250,000 mi (400,000 km) under normal driving conditions on all commercial applications. When operating your vehicle at or near maximum gross vehicle weights, change the rear axle fluid every 60,000 mi (96,000 km). In addition, follow this 60,000 mi (96,000 km) schedule when operating your vehicle under the special operating conditions where noted.

## California Fuel Filter Replacement

If you register your vehicle in California, the California Air Resources Board has determined that the failure to perform this maintenance item does not nullify the emission warranty or limit recall liability before the completion of your vehicle's useful life. Ford Motor Company, however, urges you to have all recommended maintenance services performed at the specified intervals and to record all vehicle service.



# Scheduled Maintenance

---

## **Hot Climate Oil Change Intervals**

Vehicles operating in the Middle East, North Africa, Sub-Saharan Africa or locations with similar climates use an American Petroleum Institute (API) Certified for Gasoline Engines (Certification mark) oil of SM or SN quality.

## **Engine Air Filter and Cabin Air Filter Replacement**

The life of the engine air filter and cabin air filter is dependent on exposure to dusty and dirty conditions. Vehicles operated in these conditions require frequent inspection and replacement of the engine air filter and cabin air filter.

## **Diesel Particulate Filter**

Over time, a slight amount of ash builds up in the diesel particulate filter, which is not removed during the regeneration process. The filter may need to be replaced with a new or remanufactured part at approximately 250,000 mi (400,000 km). Actual mileage varies depending on engine and vehicle operating conditions.

In this case, the engine control system sets a service light (wrench icon) to inform you to bring your vehicle to the dealer for service. If there are any issues with the oxidation catalyst or particulate filter system, a service light (wrench or engine icon) sets by the engine control system to inform you to bring your vehicle into a dealer for service.

# Customer Information

## ROLLOVER WARNING



**WARNING:** Utility vehicles have a significantly higher rollover rate than other types of vehicles.



**WARNING:** Vehicles with a higher center of gravity (utility and four-wheel drive vehicles) handle differently than vehicles with a lower center of gravity (passenger cars). Avoid sharp turns, excessive speed and abrupt steering in these vehicles. Failure to drive cautiously increases the risk of losing control of your vehicle, vehicle rollover, personal injury and death.



**WARNING:** In a rollover crash, an unbelted person is significantly more likely to die than a person wearing a seatbelt.



**WARNING:** Do not become overconfident in the ability of four-wheel drive vehicles. Although a four-wheel drive vehicle may accelerate better than a two-wheel drive vehicle in low traction situations, it won't stop any faster than two-wheel drive vehicles. Always drive at a safe speed.

Utility vehicles and trucks handle differently than passenger cars in the various driving conditions that are encountered on streets, highways and off-road. Utility vehicles and trucks are not designed for cornering at speeds as high as passenger cars any more than low-slung sports cars are designed to perform satisfactorily under off-road conditions.

## THE BETTER BUSINESS BUREAU AUTO LINE PROGRAM

Your satisfaction is important to Ford Motor Company and to your dealer. If a warranty concern has not been resolved using the three-step procedure outlined earlier in this chapter in the Getting the Services you need section, you may be eligible to participate in the BBB AUTO LINE program.

The BBB AUTO LINE program consists of two parts – mediation and arbitration. During mediation, a representative of the BBB will contact both you and Ford Motor Company to explore options for settlement of the claim. If an agreement is not reached during mediation or you do not want to participate in mediation, and if your claim is eligible, you may participate in the arbitration process. An arbitration hearing will be scheduled so that you can present your case in an informal setting before an impartial person. The arbitrator considers the testimony provided and makes a decision after the hearing.

Disputes submitted to the BBB AUTO LINE program are usually decided within 40 days after you file your claim with the BBB. You are not bound by the decision, and may reject the decision and proceed to court where all findings of the BBB Auto Line dispute, and decision, are admissible in the court action. Should you choose to accept the BBB AUTO LINE decision, Ford is then bound by the decision, and must comply with the decision within 30 days of receipt of your acceptance letter.

**BBB AUTO LINE Application:** Using the information that follows, call or write to request a program application. You will be asked for your name and address, general information about your new vehicle, information about your warranty concerns, and any steps you have already taken to

## Customer Information

---

try to resolve them. A Customer Claim Form will be mailed that needs to be completed, signed and returned to the BBB along with proof of ownership. Upon receipt, the BBB reviews the claim for eligibility under the Program Summary Guidelines.

**You can get more information by calling BBB AUTO LINE at 1-800-955-5100, or writing to:**

**BBB AUTO LINE a Division of BBB National Programs, Inc.  
1676 International Drive, Suite 550  
McLean, VA 22102**

BBB AUTO LINE applications can also be requested by calling the Ford Motor Company Customer Relationship Center at 1-800-392-3673.

For additional information, refer to the Better Business Bureau website.

**Note:** *Ford Motor Company reserves the right to change eligibility limitations, modify procedures, or to discontinue this process at any time without notice and without obligation.*

### **THE MEDIATION AND ARBITRATION PROGRAM**

For vehicles delivered to authorized Canadian dealers. In those cases where you continue to feel that the efforts by Ford of Canada and the authorized dealer to resolve a factory-related vehicle service concern have been unsatisfactory, Ford of Canada participates in an impartial third party mediation/arbitration program administered by the Canadian Motor Vehicle Arbitration Plan (CAMVAP).

The CAMVAP program is a straightforward and relatively speedy alternative to resolve a disagreement when all other efforts to produce a settlement have failed. This procedure is without cost to you and is designed to eliminate the need for lengthy and expensive legal proceedings.

In the CAMVAP program, impartial third-party arbitrators conduct hearings at mutually convenient times and places in an informal environment. These impartial arbitrators review the positions of the parties, make decisions and, when appropriate, render awards to resolve disputes. CAMVAP decisions are fast, fair, and final as the arbitrator's award is binding on both you and Ford of Canada.

CAMVAP services are available in all Canadian territories and provinces. For more information, without charge or obligation, call your CAMVAP Provincial Administrator directly at 1-800-207-0685 or visit [www.camvap.ca](http://www.camvap.ca).

### **ORDERING A CANADIAN FRENCH OWNER'S MANUAL**

You can obtain a French owner's manual from an authorized dealer or by contacting Helm, LLC at:

HELM, LLC  
47911 Halyard Drive, Suite 200  
Plymouth, Michigan 48170  
Attention: Customer Service

Call toll free: 1-800-782-4356

Monday-Friday 8:00 a.m. - 6:00 p.m. EST

For additional information, visit [www.helminc.com](http://www.helminc.com).

## Customer Information

### REPORTING SAFETY DEFECTS IN THE UNITED STATES

If you believe that your vehicle has a defect which could cause a crash or could cause injury or death, you should immediately inform the National Highway Traffic Safety Administration (NHTSA) in addition to notifying Ford Motor Company.

If NHTSA receives similar complaints, it may open an investigation, and if it finds that a safety defect exists in a group of vehicles, it may order a recall and remedy campaign. However, NHTSA cannot become involved in individual problems between you, your dealer, or Ford Motor Company.

To contact NHTSA, you may call the Vehicle Safety Hotline toll-free at 1-888-327-4236 (TTY: 1-800-424-9153); go to [www.safercar.gov](http://www.safercar.gov); or write to:

Administrator

1200 New Jersey Avenue,  
Southeast

Washington, D.C. 20590

You can also obtain other information about motor vehicle safety from [www.safercar.gov](http://www.safercar.gov).

### REPORTING SAFETY DEFECTS IN CANADA

If you believe that your vehicle has a defect which could cause a crash or could cause injury or death, you should immediately inform Transport Canada and Ford of Canada.

#### Transport Canada Contact Information

Website (English)	<a href="http://tc.canada.ca/recalls">http://tc.canada.ca/recalls</a>
Website (French)	<a href="http://tc.canada.ca/rappels">http://tc.canada.ca/rappels</a>
Phone	1-800-333-0510

#### Ford of Canada Contact Information

Website	<a href="http://www.ford.ca">www.ford.ca</a>
Phone	1-800-565-3673

# Customer Information

## THIRD PARTY SOFTWARE COPYRIGHT ACKNOWLEDGMENT

Your vehicle could have components that use open source software. For additional information, visit <http://corporate.ford.com/ford-open-source.html>.

## RADIO FREQUENCY CERTIFICATION LABELS

### BLIND SPOT INFORMATION SYSTEM SENSORS

Device	Supplier	Type Designation
SRR5 BLIS Corner Radar (RRU2)	Aptiv	2F5TR

### Argentina

H-28070



### Europe Union EU

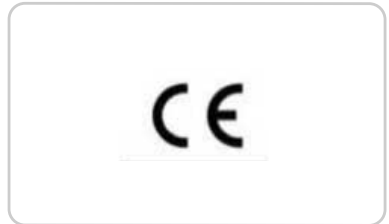

# Customer Information

## Ghana

NCA APPROVED: 7E6-M0-XDF-TME

## Jamaica

This product has been Type Approved by Jamaica: SMA - 2F5TR.

## Paraguay



NR: 2022-04-I-0255

## United Arab Emirates (U.A.E.)

TRA REGISTERED No:

ER10085/22

DEALER No:

DA37380/15

## United Kingdom



## United States and Canada



**WARNING:** Changes or modifications not expressly approved by the party responsible for compliance could void the user's authority to operate the equipment. The term "IC:" before the radio certification number only signifies that Industry Canada technical specifications were met.

FCC ID: L2C2F5TR

IC: 3432A-2F5TR

This device complies with Part 15 of the FCC Rules and with Innovation, Science and Economic Development Canada's licence-exempt RSS(s). Operation is subject to the following two conditions:

1. This device may not cause harmful interference, and
2. This device must accept any interference received, including interference that may cause undesired operation.

# Customer Information

## BLIND SPOT INFORMATION SYSTEM SENSORS

### Argentina



### Europe Union EU

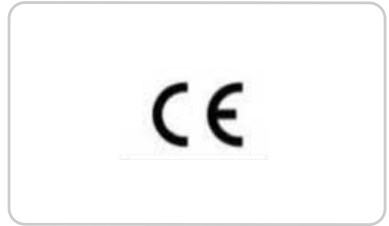

### Brazil



### Ghana



### Djibouti

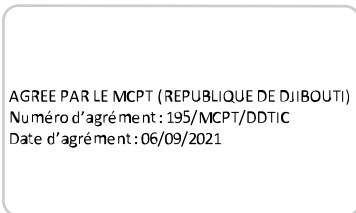

### Jamaica

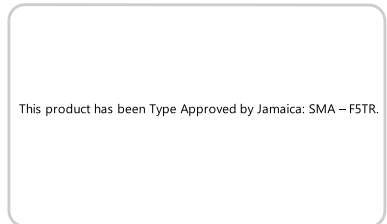

# Customer Information

---

## Mauritania

AGREE PAR L'ANEMAURITANIE  
Numéro d'agrément : 0985/ARE/2021  
Date d'agrément : 24/08/2021

## Paraguay



## Mexico

IFETEL: RCPAPF520-0480

## Morocco

AGREE PAR L'ANRT MAROC  
Nu méro d'agrément : MR00030033ANRT2021  
Date d'agrément : 16/09/2021

2020-10-I-0753

## Singapore

Complies with IMDA Standards

DA 00461

## South Africa





# Customer Information

## South Korea



## Taiwan



## Thailand

- (1) เครื่องใช้ทรงสนามและอุปกรณ์อื่น ๆ มีความสอดคล้องตามข้อกำหนดของ กทช.
- (2) เครื่องใช้ทรงสนามมีระดับการแผ่คลื่นแม่เหล็กไฟฟ้าที่สอดคล้องตามมาตรฐานความปลอดภัยต่อสุขภาพของมนุษย์สากลที่ใช้สำหรับอุปกรณ์ที่คณะกรรมการกิจการโทรคมนาคมแห่งชาติพิจารณา

## Ukraine



## United Arab Emirates (U.A.E.)



## United Kingdom



# Customer Information

## United States and Canada



**WARNING:** Changes or modifications not expressly approved by the party responsible for compliance could void the user's authority to operate the equipment. The term "IC:" before the radio certification number only signifies that Industry Canada technical specifications were met.

FCC ID: L2CF5TR

IC: 3432A-F5TR

This device complies with Part 15 of the FCC Rules and with Innovation, Science and Economic Development Canada's licence-exempt RSS(s). Operation is subject to the following two conditions:

1. This device may not cause harmful interference, and
2. This device must accept any interference received, including interference that may cause undesired operation.

## Vietnam

Ford Vietnam  
A00182015



## BODY CONTROL MODULE

### European Union EU



### Israel

1. מספר אישור התאמה סטנדרט משרד התקשורת: 51-87448
2. חל אישור לבצע פעולות במכשיר שיש בהן כדי לשנות את תכונותיו האלקטרוניות של המכשיר, ובכלל זה שינוי תוכנה, החלפת אנטנה מקורית או הוספת אפשרות לחיבור לאנטנה חיצונית, ככל שקבלת אישור משרד התקשורת, ככל החשש להפרעת אלקטרוניות.

## Malaysia



HIDF16000009

# Customer Information

---

## Moldova



## Singapore

Complies with IMDA Standards

DA 00461

## Morocco

AGREE PAR L'ANRT MAROC

Numéro d'agrément:  
MR00034975ANRT2022

Date d'agrément: 21/10/2022

## South Africa

## Serbia



V005 22



## Taiwan



**CCAB22LP1250T4**  
**CCAB22LP1260T7**

# Customer Information

## Ukraine



This device complies with Part 15 of the FCC Rules and with Innovation, Science and Economic Development Canada's licence-exempt RSS(s). Operation is subject to the following two conditions:

1. This device may not cause harmful interference, and
2. This device must accept any interference received, including interference that may cause undesired operation.

## CRUISE CONTROL MODULE

### Argentina



## United Kingdom



## United States and Canada



**WARNING:** Changes or modifications not expressly approved by the party responsible for compliance could void the user's authority to operate the equipment. The term "IC:" before the radio certification number only signifies that Industry Canada technical specifications were met.

FCC ID: M3NA2C780107

IC: 7812A-A2C780107

## Brazil



# Customer Information

## Djibouti

AGREE PAR LE MCPT (REPUBLIQUE DE DJIBOUTI)  
Numéro d'agrément : 059/DDTIC/2020  
Date d'agrément : 01/10/2020

## Ghana

NCA APPROVED: SRO-1M-7E4-X13

## EAC Marking - Russia, Belarus, Kazakhstan

EAC

## Europe Union EU

CE

## Independent State Of Samoa

SMO  
samoa

## Israel

1. מספר אישור התאמה מסעם משרד התקשורת: 51-82320
2. חל אישור לבצע פעולות במכשיר שיש בהן כדי לשנות את תכונותיו האלחוטיות של המכשיר, ובכלל זה שינוי תוכנה, החלפת אנטנה מקורית או חוספת אפשרות לחיבור לאנטנה חיצונית, בלא קבלת אישור משרד התקשורת, בשל החשש להפרעת אלחוטיות.

# Customer Information

## Jamaica

This product has been Type Approved by Jamaica: SMA – F3TR.

## Mexico

IFT: RCPAPF320-0479

## Moldova



## Malaysia



HIDF16000009

## Mauritania

AGREE PAR L'ANE MAURITANIE  
Numéro d'agrément : 0835/ARE/2020  
Date d'agrément : 31/08/2020

## Morocco

AGREE PAR L'ANRT MAROC

Numéro d'agrément:  
MR00030034ANRT2021

Date d'agrément: 16/09/2021

## Pakistan



# Customer Information

---

## Paraguay



NR: 2020-10-I-0752

## Sierra Leone



TAN: 2021-002-0028

## Singapore

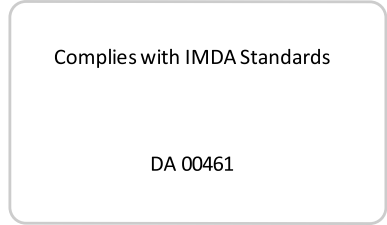

## South Africa



## South Korea



R-C-1Ap-F3TR

# Customer Information

## Taiwan



## Unites Arab Emirates (U.A.E.)

TRA  
REGISTERED NO: ER80143/20  
DEALER NO: DA83047/19

## Thailand

- (1) เครื่องนี้โทรคมนาคมและอยู่บริเวณนี้ มีความสอดคล้องตามข้อกำหนดของ กทท.
- (2) เครื่องนี้ระบุหมายเลขมีระดับการแก้ไขเพิ่มเติมแก้ไขให้สอดคล้องตามมาตรฐานความปลอดภัยของสุขภาพของมนุษย์จากทางวิทยุคลื่นวิทยุคมนาคมที่คณะกรรมการกิจการโทรคมนาคมแห่งชาติประกาศกำหนด

## United Kingdom



## Ukraine



## United States and Canada

 **WARNING:** Changes or modifications not expressly approved by the party responsible for compliance could void the user's authority to operate the equipment. The term "IC:" before the radio certification number only signifies that Industry Canada technical specifications were met.

FCC ID: L2CF3TR  
IC: 3432A-F3TR



# Customer Information

This device complies with Part 15 of the FCC Rules and with Innovation, Science and Economic Development Canada's licence-exempt RSS(s). Operation is subject to the following two conditions:

1. This device may not cause harmful interference, and
2. This device must accept any interference received, including interference that may cause undesired operation.

## Zambia



This device complies with Part 15 of the FCC Rules and with Innovation, Science and Economic Development Canada's licence-exempt RSS(s). Operation is subject to the following two conditions:

1. This device may not cause harmful interference, and
2. This device must accept any interference received, including interference that may cause undesired operation.

## KEYS AND REMOTE CONTROLS

### 434 MHz 1W Integrated Keyhead Transmitter

#### Israel

1. מספר אישור התאמה מסוג מסודר התקשורת: 51-81657
2. חל אישור לבצע פעולות במכשיר שיש בהן כדי לשנות את תכונותיו האלקטרוניות של המכשיר, ובכלל זה שינוי תדונה, החלפת אנטנה מקורית או הוספת אפשרות לחיבור לאנטנה חיצונית, בלא קבלת אישור מסודר התקשורת, כשל החשב להפרצות אלקטרוניות.

## GARAGE DOOR OPENER

### United States and Canada

 **WARNING:** Changes or modifications not expressly approved by the party responsible for compliance could void the user's authority to operate the equipment. The term "IC:" before the radio certification number only signifies that Industry Canada technical specifications were met.

FCC ID: NZLSAHL5E

IC: 4112A-SAHL5E

### United Arab Emirates (U.A.E.)

TRA  
REGISTERED NO: ER49357/16  
DEALER NO: DA37380/15

# Customer Information

## Integrated Keyhead Transmitter

### Jamaica

This product has been Type Approved by Jamaica: N5F – A08TBLP

## Passive Key Transmitter

### Argentina



H-28042

### Israel

## Paraguay



NR: 2022-03-I-0162

## Serbia

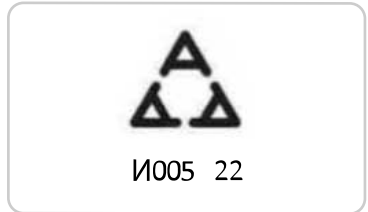

## Singapore

Complies with IMDA Standards

Dealer License Number:

DA 00461

### Jamaica

This product has been Type Approved by Jamaica: SMA – M3N-A3C108397

1. מספר אישור התאמה מסוג משרד התקשורת 51-85634  
2. חל אישור לבצע פעולות במכשיר שיש בהן כדי לשנות את תכונותיו האלחוטיות של המכשיר, ובכלל זה שינוי תוכנה, החלפת אנטנה מקורית או הוספת אפשרות לחיבור לאנטנה חיצונית, בלא קבלת אישור משרד התקשורת, כשל החשש להפרעת אלחוטיות.

# Customer Information

## South Africa



## PASSIVE ANTI-THEFT SYSTEM

## Argentina



## Thailand

- (1) เครื่องโทรคมนาคมและอุปกรณ์นี้ มีความสอดคล้องตามข้อกำหนดของ กทท.
- (2) เครื่องโทรคมนาคมและอุปกรณ์นี้ได้รับการแก้ไขที่สอดคล้องตามมาตรฐานความปลอดภัยต่อสุขภาพของมนุษย์สากลสำหรับคลื่นความถี่และการใช้งานโทรคมนาคมที่อาจมีผลกระทบต่อสุขภาพ

## Brazil



0106-14-03199

## United Arab Emirates (U.A.E.)

TRA REGISTERED No:

ER08930/22

DEALER No:

DA37380/15

Este equipamento opera em caráter secundário, isto é, não tem direito a proteção contra interferência prejudicial, mesmo de estações do mesmo tipo, e não pode causar interferência a sistemas operando em caráter primário.

## Canada and United States of America

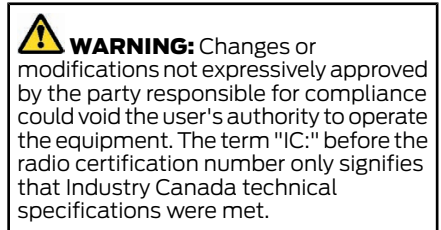

FCC ID: OUC11545917

# Customer Information

---

IC: OUC11545917

This device complies with Part 15 of the FCC Rules and with Innovation, Science and Economic Development Canada's licence-exempt RSS(s). Operation is subject to the following two conditions:

1. This device may not cause harmful interference, and
2. This device must accept any interference received, including interference that may cause undesired operation.

## Djibouti

AGREE PAR LE MCPT (REPUBLIQUE DE DJIBOUTI)  
Numéro d'agrément: 243/MCPT/SC/16  
Date d'agrément: 23/05/16

## Ghana

NCA APPROVED: NCA/TA/16/22

## Indonesia

SERTIFIKAT NOMOR : 44714/SDPPI/2016  
PLG ID: 4941

## Jamaica

This product has been Type Approved by Jamaica: SMA- OUC 11545917

## Malaysia



CIDF18000209

# Customer Information

## Mauritania

AGREE PAR L'ANE MAURITANIE  
Numéro d'agrément: 0231/ARE/2014  
Date d'agrément: 14/11/2014

## Pakistan



## Moldova



## Paraguay

NR: 2017-09-10000292



## Morocco

AGREE PAR L'ANRT MAROC  
Numéro d'agrément: MR 8922 ANRT 2014  
Date d'agrément: 04/02/2014

## Serbia



И011 16

# Customer Information

---

## Singapore

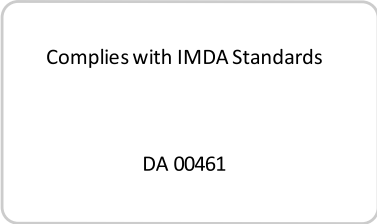

## Syria

SyTRA  
REGISTERED No:  
1510/4NK

## South Africa



## Taiwan

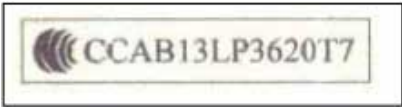

## South Korea



MSIP-RRM-OAC-OUC11541917

## Ukraine



# Customer Information

## United Arab Emirates (U.A.E.)

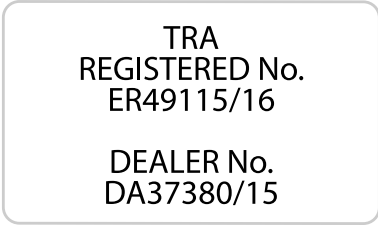

## Jamaica

This product has been Type Approved by Jamaica: SMA – FO2-RX433UDA

## Israel

1. מספר אישור התאמה מסעם משרד התקשורת: 51-8627
2. תל אישור לבצע פעולות במסגרת שיש בהן כדי לשנות את תכונות האלמנטים של המכשיר, ובכלל זה שינוי תוכנה, החלפת אנטנה מקורית או הוספת אפשרות לחיבור לאנטנה חיצונית, כלא קבלת אישור משרד התקשורת, בשל החשש להפרעת אלמנטים.

## Vietnam



## Malaysia



## RADIO TRANSCEIVER MODULE

## Europe Union EU

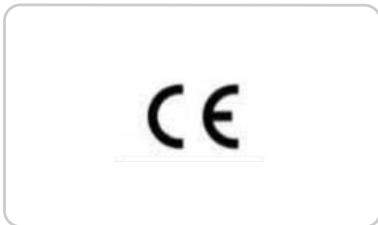

HIDF16000009

## Moldova



# Customer Information

## Morocco



## Taiwan



## Thailand

เพื่อให้บริการขนส่งและอยู่ภายใต้ กับการขนส่งของทางราชการของ กทท.

## Serbia



## Ukraine



## South Africa



## United Kingdom





# Customer Information

---

## United Arab Emirates (U.A.E.)

TRA  
REGISTERED No:  
ER81341/20

DEALER No:  
DA88113/20

## SYNC

Device	Supplier	Type Designation
SYNC	Ford	SYNC-G4 SYNC-G4L

## Argentina

**CNC** COMISIÓN NACIONAL  
DE COMUNICACIONES

**CNC ID: C-24008**

**CNC** COMISIÓN NACIONAL  
DE COMUNICACIONES

**CNC ID: C-24009**

# Customer Information

---

## Brazil



08657-19-01505

Este equipamento não tem direito à proteção contra interferência prejudicial e não pode causar interferência em sistemas devidamente autorizados.



08658-19-01505

Este equipamento não tem direito à proteção contra interferência prejudicial e não pode causar interferência em sistemas devidamente autorizados.

AGREE PAR LE MCPT (REPUBLIQUE DE DJIBOUTI)  
Numéro d'agrément : 125/DDTIC/2019  
Date d'agrément : 07/08/2019

## European Union EU



## Ghana

## Djibouti

AGREE PAR LE MCPT (REPUBLIQUE DE DJIBOUTI)  
Numéro d'agrément : 124/DDTIC/2019  
Date d'agrément : 07/08/2019

NCA APPROVED: ZRO-1H-7E3-182

NCA APPROVED: ZRO-1H-7E3-180

# Customer Information

---

## Indonesia

Model: SYNC-G4  
Sertifikat Nomor: 80700/SDPPI/2022  
PLG ID: 13493



This product has been Type Approved by Jamaica: SMA – SYNC-G4L

## Malaysia

Model: SYNC-G4L  
Sertifikat Nomor: 81116/SDPPI/2022  
PLG ID: 13493



## Jamaica

This product has been Type Approved by  
Jamaica: SMA – SYNC-G4.

HIDF16000009

## Mauritania

**AGREE PAR L'ANE MAURITANIE**  
**Numéro d'agrément : 0692/ARE/2018**  
**Date d'agrément : 08/08/2019**

# Customer Information

---

AGREE PAR L'ANEMAURITANIE  
Numéro d'agrément : 0691/ARE/2018  
Date d'agrément : 08/08/2019

AGREE PAR L'ANRT MAROC  
N° D'AGRÉMENT: MR 20606 ANRT 2019  
07 AOUT 2019

## Moldova



## Pakistan



## Morocco

AGREE PAR L'ANRT MAROC  
N° D'AGRÉMENT: MR 20608 ANRT 2019  
07 AOUT 2019

## Paraguay



2020-03-I-00192  
2020-03-I-00193

# Customer Information

---

## Serbia



## Singapore

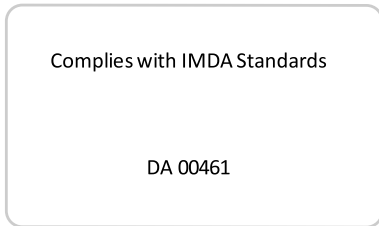

## South Korea



## South Africa



## Taiwan

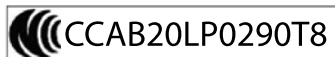

# Customer Information

---

 CCAB20LP0300T1

TRA  
REGISTERED No: ER74903/19  
DEALER No: DA37380/15

## Ukraine



## United Kingdom



## United Arab Emirates (U.A.E.)



## United States and Canada



**WARNING:** Changes or modifications not expressly approved by the party responsible for compliance could void the user's authority to operate the equipment. The term "IC:" before the radio certification number only signifies that Industry Canada technical specifications were met.

FCC ID: KMH-SYNCG4

FCC ID: KMH-SYNCG4L

IC: 1422A-SYNCG4

IC: 1422A-SYNCG4L

# Customer Information

---

This device complies with Part 15 of the FCC Rules and with Innovation, Science and Economic Development Canada's licence-exempt RSS(s). Operation is subject to the following two conditions:

1. This device may not cause harmful interference, and
2. This device must accept any interference received, including interference that may cause undesired operation.



## Zambia



## TELEMATICS CONTROL UNIT

Device	Supplier	Type Designation
Telematics Control Unit	Ford	FNV3-B6

# Customer Information

## China

CMIIT ID: 2023CJ1792

HIDF16000009

## European Union EU

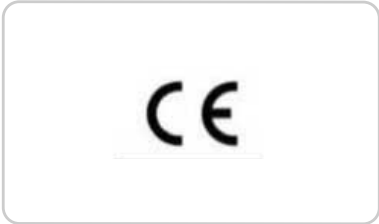

## Mexico



## Malaysia



## Paraguay





# Customer Information

---

NR: 2023-01-I-0047

## Serbia



## South Africa



## South Korea



R-C-FDM-FNV3B6ROW

## Taiwan



CCA235G0042T9

## United Arab Emirates (U.A.E.)

TRA REGISTERED No:

ER19896/23

DEALER No:

DA83047/19

## United Kingdom



## United States and Canada

 **WARNING:** Changes or modifications not expressly approved by the party responsible for compliance could void the user's authority to operate the equipment. The term "IC:" before the radio certification number only signifies that Industry Canada technical specifications were met.

FCC ID: KMH-14H317-NA1

IC: 1422A-14H317NA1

# Customer Information

---

This device complies with Part 15 of the FCC Rules and with Innovation, Science and Economic Development Canada's licence-exempt RSS(s). Operation is subject to the following two conditions:

1. This device may not cause harmful interference, and
2. This device must accept any interference received, including interference that may cause undesired operation.

## TIRE PRESSURE MONITORING SYSTEM SENSORS

### Argentina



### Brazil



18962-22-08001

### China

CMIIT ID:2014DJ1923

### Democratic Republic of Congo

Agréé par l'ARPTC

N° d'homologation: HIR -0051/4/2014

Date d'homologation: 16/4/2014

### Djibouti

AGREE PAR LE MCPT (REPUBLIQUE DE DJIBOUTI)

Numéro d'agrément : 198/MCPT/DDTCC

Date d'agrément : 7/9/2021

# Customer Information

---

## European Union (EU)



The RED 2014/53/EU (replacing R&TTE Directive 1999/5/EC on 13 June 2016) explicitly states that instructions for intentional radiators include reference to "(a) frequency band(s) in which the radio equipment operates; and (b) maximum radio-frequency power transmitted in the frequency band(s) in which the radio equipment operates," in addition to carrying over the general operational instruction and Declaration of Conformity inclusion requirements from the R&TTE Directive.

Hereby, Schrader Electronics Ltd. declares that the radio equipment type AG2SZ4 is in compliance with Directive 2014/53/EU. The full text of the EU declaration of conformity is available at the following internet address:

[http://www.tpmseuroshop.com/documents/declaration\\_conformities](http://www.tpmseuroshop.com/documents/declaration_conformities)

f=433.92MHz

P<10mW (e.i.r.p)

Schrader Electronics Ltd. 11 Technology Park, Belfast Road, Antrim BT41 1QS, Northern Ireland United Kingdom.

## Ghana

## Independent State of Samoa

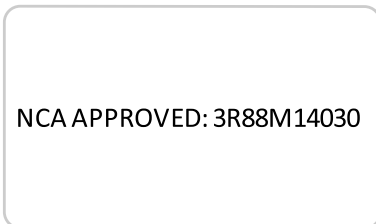

# Customer Information

## Israel

1. מספר אישור התאמה מסכם מסודר התקשורת: 51-77913
2. חל אישור לבצע פעולות במכשיר שיש בהן כדי לשנות את תכונותיו האלמנטיות של המכשיר, ובכלל זה שינויי תוכנה, החלפת אנטנה סוקרית או הוספת אפשרות לחיבור לאנטנה חיצונית, בלא קבלת אישור מסודר התקשורת, בשל החשש להפרעת אלמנטיות.

## Jamaica

This product has been Type Approved by Jamaica: SMA - AG2SZ4

## Malaysia



HIDF16000009

## Mauritania

AGREE PAR L'ANEMAURITANIE  
Numéro d'agrément : 0842/ARE/2020  
Date d'agrément : 21/09/2020

## Mexico

IFT: RLVSCMR15-1238

## Moldova



## Morocco

AGREE PAR L'ANRT MAROC  
Numéro d'agrément: MR9098  
ANRT 2014  
Date d'agrément: 14/03/2014

# Customer Information

---

## Nigeria

Connection and use of this communications equipment is permitted by the Nigerian Communications Commission

## Pakistan



## Oman

OMAN TRA  
TA-R/1752/14  
D090258

## Russia



## Paraguay



## Sierra Leone



NR: 2017-06-I-0000175

TAN: 2017-002-0035

# Customer Information

## Serbia

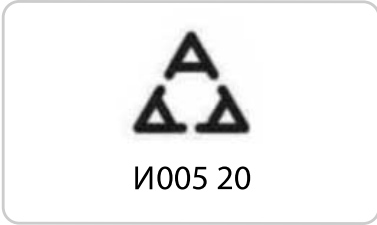

MSIP-CRM-SRD-AG2SZ4

## Taiwan

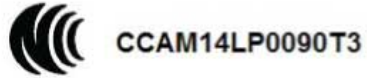

## Singapore

Complies with IMDA Standards  
DA 00461

## Thailand

## South Africa



TA-2014/064  
Approved

- (1) การใช้โทรคมนาคมและอุปกรณ์นี้ ได้รับความสอดคล้องตามข้อกำหนดของ กทท.
- (2) เครื่องใช้โทรคมนาคมจะได้รับการคุ้มครองแบบไร้สายที่ปลอดภัยต่อสุขภาพของประชาชนภายใต้ข้อกำหนดของ กทท. โดยไม่มีค่าใช้จ่ายเพิ่มเติมที่คิดค่าธรรมเนียมการใช้งานโทรคมนาคมแห่งชาติประเภทการโฆษณา

## South Korea



# Customer Information

## United Arab Emirates

TRA REGISTERED No:

ER80634/20

DEALER No:

DA83047/19

## United Kingdom



## United States and Canada



**WARNING:** Changes or modifications not expressly approved by the party responsible for compliance could void the user's authority to operate the equipment. The term "IC:" before the radio certification number only signifies that Industry Canada technical specifications were met.

FCC ID: MRXAG2SZ4

IC: 2546A-AG2SZ4

This device complies with Part 15 of the FCC Rules and with Innovation, Science and Economic Development Canada's licence-exempt RSS(s). Operation is subject to the following two conditions:

1. This device may not cause harmful interference, and
2. This device must accept any interference received, including interference that may cause undesired operation.

## Vietnam



## Zambia



## TIRE PRESSURE MONITORING SYSTEM SENSORS

## United States and Canada



**WARNING:** Changes or modifications not expressly approved by the party responsible for compliance could void the user's authority to operate the equipment. The term "IC:" before the radio certification number only signifies that Industry Canada technical specifications were met.

FCC ID: MRXAG2FSC4

# Customer Information

---

IC: 2546A-AG2FSC4

This device complies with Part 15 of the FCC Rules and with Innovation, Science and Economic Development Canada's licence-exempt RSS(s). Operation is subject to the following two conditions:

1. This device may not cause harmful interference, and
2. This device must accept any interference received, including interference that may cause undesired operation.

CNC ID: H-28035

## Brazil



## TIRE PRESSURE MONITORING SYSTEM SENSORS

### Argentina



13309-22-08001

## European Union EU

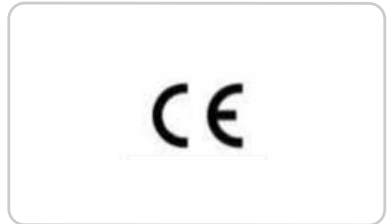

The RED 2014/53/EU (replacing R&TTE Directive 1999/5/EC on 13 June 2016) explicitly states that instructions for intentional radiators include reference to "(a) frequency band(s) in which the radio equipment operates; and (b) maximum radio-frequency power transmitted in the frequency band(s) in which the radio equipment operates," in addition to carrying over the general operational instruction and Declaration of Conformity inclusion requirements from the R&TTE Directive.

Hereby, Schrader Electronics Ltd. declares that the radio equipment type BG2BP4 is in compliance with Directive 2014/53/EU. The full text of the EU declaration of conformity is available at the following internet address:

[http://www.tpmseuroshop.com/documents/declaration\\_conformities](http://www.tpmseuroshop.com/documents/declaration_conformities)



# Customer Information

f=433.92MHz

P<10mW (e.i.r.p)

Schrader Electronics Ltd. 11 Technology Park, Belfast Road, Antrim BT41 1QS, Northern Ireland United Kingdom.

## Israel

1. מספר אישור התאמה מסעם משרד התקשורת: 51-86230  
2. תל אישור לבצע פעולות במשך שיש בהן כדי לשנות את תכונותיו האלחוטיות של המכשיר, ובכלל זה שינוי חובנה, החלפת אנטנה סקורית או חוספת אפשרות לחיבור לאנטנה חיצונית, בלא קבלת אישור משרד התקשורת, בשל החשש להפרות אלחוטיות.

## Jamaica

This product has been Type Approved by Jamaica: SMA - BG2BP4.

## Malaysia



HIDF16000009

## Mexico

IFT: RLVSCBG22-2502

## Moldova



## Morocco

AGREE PAR L'ANRT MAROC

Numéro d'agrément:  
MR00034968ANRT2022

Date d'agrément: 21/12/2022

## Paraguay



# Customer Information

NR: 2022-05-I-0000331

## South Korea

### Serbia

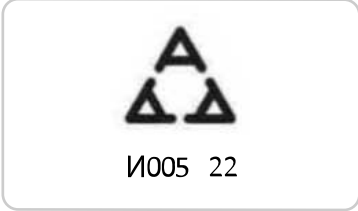

MSIP-R-C-SRD-BG2BP4

### Singapore

Complies with IMDA Standards  
DA 00461

### Taiwan



CCAB22LP0730T0

### Thailand

### South Africa



- (1) เครื่องใช้โทรคมนาคมและอุปกรณ์นี้มีความสอดคล้องตามข้อกำหนดของ กทท.
  - (2) เครื่องใช้โทรคมนาคมและอุปกรณ์นี้ผ่านการประเมินผลให้เป็นที่สอดคล้องของมาตรฐานความปลอดภัยข้อมูลของประเทศไทย
- รายการนี้เพื่อวัตถุประสงค์ในการแจ้งให้ทราบเท่านั้น ไม่สามารถนำมาใช้เพื่อวัตถุประสงค์อื่นใด

# Customer Information

## Ukraine



## Unites Arab Emirates (U.A.E.)

TRA REGISTERED No:

ER10488/22

DEALER No:

DA37380/15

## United Kingdom



## United States and Canada

 **WARNING:** Changes or modifications not expressly approved by the party responsible for compliance could void the user's authority to operate the equipment. The term "IC:" before the radio certification number only signifies that Industry Canada technical specifications were met.

FCC ID: MRXBG2BP4

IC: 2546A-BG2BP4

This device complies with Part 15 of the FCC Rules and with Innovation, Science and Economic Development Canada's licence-exempt RSS(s). Operation is subject to the following two conditions:

1. This device may not cause harmful interference, and
2. This device must accept any interference received, including interference that may cause undesired operation.

## TIRE PRESSURE MONITORING SYSTEM SENSORS

### Argentina



# Customer Information

---

## China

CMIIT ID: 2016DJ6033

## Djibouti

AGREE PAR LE MCPT  
(REPUBLIQUE DE DJIBOUTI)  
Numéro d'agrément : 547/MCPT/DPT/16  
Date d'agrément : 27/09/16

## Democratic Republic of Congo

Agréé par l'ARPTC

N° d'homologation: HIR-0099/09/2016

Date d'homologation: 15/09/2016

## European Union (EU)

The CE mark is displayed inside a rounded rectangular box. It consists of the letters 'C' and 'E' in a stylized, bold font, with the 'E' being slightly larger and positioned to the right of the 'C'.

The RED 2014/53/EU (replacing R&TTE Directive 1999/5/EC on 13 June 2016) explicitly states that instructions for intentional radiators include reference to "(a) frequency band(s) in which the radio equipment operates; and (b) maximum radio-frequency power transmitted in the frequency band(s) in which the radio equipment operates," in addition to carrying over the general operational instruction and Declaration of Conformity inclusion requirements from the R&TTE Directive.

Hereby, Schrader Electronics Ltd. declares that the radio equipment type FP4 is in compliance with Directive 2014/53/EU. The full text of the EU declaration of conformity is available at the following internet address:

[http://www.tpmseuroshop.com/documents/declaration\\_conformities](http://www.tpmseuroshop.com/documents/declaration_conformities)

# Customer Information

f=433.92MHz

P<10mW (e.i.r.p)

Schrader Electronics Ltd. 11 Technology Park, Belfast Road, Antrim BT41 1QS, Northern Ireland United Kingdom.

## Ghana

NCA APPROVED: 2R9-8M-7E0-0BE

## Independent State of Samoa



## Israel

1. מספר אישור התאמה סטנדר התקשורת: 51-83847
2. תל אישור לבצע פעולות במסגרת שיש בהן כדי לשמור את תכונותיה האלחוטיות של המכשיר, ובכלל זה שינוי תכונות, תחלופת אנטנה מקורית או הסמכת אנטנה לריכוז לאנטנה חיצונית, בלא קבלת אישור משרד התקשורת, כשל החשש להפרעת אלחוטיות.

## Jamaica

This product has been Type Approved by Jamaica: SMA - FP4.

## Mauritania

AGREE PAR L'ANE MAURITANIE  
Numéro d'agrément : 0358/ARE/2016  
Date d'agrément : 04/10/2016

## Moldova



# Customer Information

---

## Nigeria

Connection and use of this communications equipment is permitted by the Nigerian Communications Commission

## Paraguay



## Oman

OMAN TRA  
TA-R/3591/16  
D080134

## Serbia

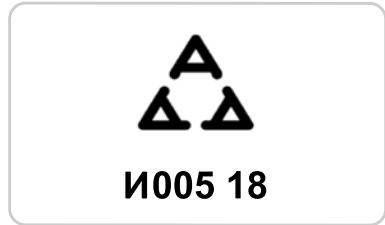

## Pakistan



## Sierra Leone



TAN: 2016-002-0035

# Customer Information

---

## South Korea



MSIP-CRM-SRD-FP4

## Ukraine



## United Arab Emirates (U.A.E.)

TRA REGISTERED No:

ER12204/22

DEALER No:

DA37380/15

## United Kingdom



## United States and Canada



**WARNING:** Changes or modifications not expressly approved by the party responsible for compliance could void the user's authority to operate the equipment. The term "IC:" before the radio certification number only signifies that Industry Canada technical specifications were met.

FCC ID: MRXFP4

IC: 2546A-FP4

This device complies with Part 15 of the FCC Rules and with Innovation, Science and Economic Development Canada's licence-exempt RSS(s). Operation is subject to the following two conditions:

1. This device may not cause harmful interference, and
2. This device must accept any interference received, including interference that may cause undesired operation.

# Customer Information

## WIRELESS ACCESSORY CHARGING MODULE

Device	Supplier	Type Designation
Wireless Charger (WCM)	LG/BH EVS	WCFDM00N2A1 WCFDM00N2A3 WCFDM00N2A5

### Argentina



### Brazil



### Democratic Republic of Congo

Agréé par l'ARPTC  
N° d'homologation : HER-0054/Juin/2021  
Date d'homologation : 02/06/2021



# Customer Information

## European Union

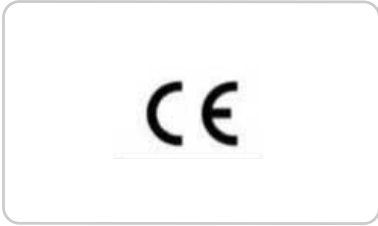

Model: WCFDM00N2A3  
Sertifikat Nomor: 80111/SDPPI/2022  
PLGID: 13493



## Ghana

Model: WCFDM00N2A5  
Sertifikat Nomor: 80112/SDPPI/2022  
PLGID: 13493

NCA APPROVED: 7ES-7M-XB1-RDR



## Indonesia

Model: WCFDM00N2A1  
Sertifikat Nomor: 80110/SDPPI/2022  
PLGID: 13493



## Israel

1. מספר אישור החאמה מטעם משרד התקשורת: 51-80014
2. חל אישור לבצע פעולות בביטויי שיש בידו לשנות את תכונותיו האלחוטיות של המכשיר, ובכלל זה שינוי תדירות, התקפת אנטנה מקורית או הספת אפשרות לחיבור לאנטנה חיצונית, בלא קבלת אישור משרד התקשורת, בשל החשש להפרעת אלחוטיות

# Customer Information

HIDF1600009

## Mauritania

1. מספר אישור התאמה מטעם משרד התקשורת: 51-80015
2. חל אישור לבצע מעולות במכשיר שיש בהן כדי לשנות את תכונותיו האלחוטיות של המכשיר, ובכלל זה שינוי תכונה, החלפת אנטנה מקורית או הספת אפשרות לחיבור לאנטנה חיצונית, בלא קבלת אישור משרד התקשורת, בשל החשש להפרעות אלחוטיות

AGREE PAR L'ANEMAURITANIE  
Numéro d'agrément : 0935/ARE/2021  
Date d'agrément : 23/03/2021

1. מספר אישור התאמה מטעם משרד התקשורת: 51-80013
2. חל אישור לבצע מעולות במכשיר שיש בהן כדי לשנות את תכונותיו האלחוטיות של המכשיר, ובכלל זה שינוי תכונה, החלפת אנטנה מקורית או הספת אפשרות לחיבור לאנטנה חיצונית, בלא קבלת אישור משרד התקשורת, בשל החשש להפרעות אלחוטיות

AGREE PAR L'ANEMAURITANIE  
Numéro d'agrément : 0934/ARE/2021  
Date d'agrément : 23/03/2021

## Jamaica

This product has been Type Approved by Jamaica:  
SMA - WCFDM00N2A.

## Malaysia



AGREE PAR L'ANEMAURITANIE  
Numéro d'agrément : 0933/ARE/2021  
Date d'agrément : 23/03/2021

# Customer Information

## Moldova



AGREE PAR L'ANRT MAROC  
Nu méro d'agrément : MR 00027923ANRT 2021  
Date d'agrément : 25/03/2021

## Morocco

AGREE PAR L'ANRT MAROC  
Nu méro d'agrément : MR 00027924ANRT 2021  
Date d'agrément : 25/03/2021

AGREE PAR L'ANRT MAROC  
Nu méro d'agrément : MR 00027925ANRT 2021  
Date d'agrément : 25/03/2021

## Paraguay



NR: 2021-04-I-0202

NR: 2021-04-I-0203

NR: 2021-04-I-0204

## Russia



# Customer Information

## Serbia

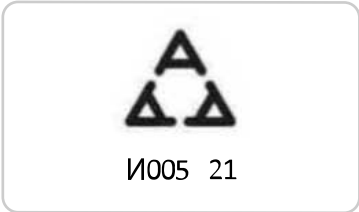

## South Africa



## Sierra Leone



## South Korea



R-R-LGE-WCFDM00N2A1

## Singapore

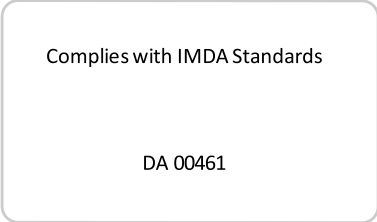

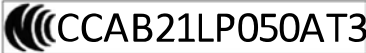

## Taiwan



## Customer Information

---

 CCAB21LP0500T1

 CCAB21LP050BT5

**品名 (Product name):** 無線充電座

**型號 (Type Designation):** WCFDM00N2A1, WCFDM00N2A3, WCFDM00N2A5 **產地 (Origin):** 馬來西亞

**額定電壓 (Input rating):** 12V

**製造日期 (Approval date):** 2021.04.21



R43208  
Kofu

**申請廠商名稱 (Approval name):** 福特六和汽車股份有限公司

**申請廠商地址 (Approval address):** 桃園市中壢區中華路一段705號

### Ukraine



### United Kingdom

**UK  
CA**

# Customer Information

---

## United Arab Emirates (U.A.E.)

TRA REGISTERED No:

ER98638/21

DEALER No:

DA37380/15

TRA REGISTERED No:

ER00422/21

DEALER No:

DA37380/15

## United States and Canada

TRA REGISTERED No:

ER00421/21

DEALER No:

DA37380/15

FCC ID: BEJWCDFM00N2A

IC: 2703H-WCFDM00N2A

This equipment generates, uses, and can radiate radio frequency energy and may cause harmful interference to radio communications. There is no guarantee that interference will not occur in a particular installation. If this equipment does cause harmful interference to radio or television reception, please consult the dealer.

This product is not end-user serviceable.

RF Radiation Exposure Statement: This equipment complies with FCC RF Radiation exposure limits set forth for an uncontrolled environment. This device and its antenna must not be co-located or operating in conjunction with any other antenna or transmitter. This equipment should be installed and operated with a minimum distance of 20cm between the radiator and your body.

This device complies with Part 15 of the FCC Rules and with Innovation, Science and Economic Development Canada's licence-exempt RSS(s). Operation is subject to the following two conditions:

1. This device may not cause harmful interference, and
2. This device must accept any interference received, including interference that may cause undesired operation.

*Le présent appareil est conforme aux CNR d'Industrie Canada applicables aux appareils radio exempts de licence. L'exploitation est autorisée aux deux conditions suivantes:*

1. *L'appareil ne doit pas produire de brouillage;*
2. *L'appareil doit accepter tout brouillage radioélectrique subi, même si le brouillage est susceptible d'en compromettre le fonctionnement.*

# Customer Information

---

## Zambia



## PERCHLORATE

Certain components in your vehicle such as airbag modules, seatbelt pretensioners and remote control batteries may contain perchlorate material. Special handling may apply for service or vehicle end of life disposal.

For more information visit:  
[www.dtsc.ca.gov/hazardouswaste/perchlorate](http://www.dtsc.ca.gov/hazardouswaste/perchlorate).

## REPLACEMENT PARTS RECOMMENDATION

We have built your vehicle to the highest standards using quality parts. We recommend that you demand the use of genuine Ford and Motorcraft parts whenever your vehicle requires scheduled maintenance or repair. You can clearly identify genuine Ford and Motorcraft parts by looking for the Ford, FoMoCo or Motorcraft branding on the parts or their packaging.

## Scheduled Maintenance and Mechanical Repairs

One of the best ways for you to make sure that your vehicle provides years of service is to have it maintained in line with our recommendations using parts that conform to the specifications detailed in this Owner's Manual.

Genuine Ford and Motorcraft parts meet or exceed these specifications.

## Collision Repairs

We hope that you never experience a collision, but accidents happen sometimes.

Genuine Ford replacement collision parts meet our stringent requirements for fit, finish, structural integrity, corrosion protection and dent resistance. During vehicle development we validate that these parts deliver the intended level of protection as a whole system. A great way to know for sure you are getting this level of protection is to use genuine Ford replacement collision parts.

## Warranty on Replacement Parts

Genuine Ford and Motorcraft replacement parts are the only replacement parts that benefit from a Ford Warranty.

The Ford Warranty may not cover damage caused to your vehicle as a result of failed non-Ford parts.

For additional information, refer to the terms and conditions of the Ford Warranty.

# Customer Information

---

## MOBILE COMMUNICATIONS EQUIPMENT



**WARNING:** Driving while distracted can result in loss of vehicle control, crash and injury. We strongly recommend that you use extreme caution when using any device that may take your focus off the road. Your primary responsibility is the safe operation of your vehicle. We recommend against the use of any hand-held device while driving and encourage the use of voice-operated systems when possible. Make sure you are aware of all applicable local laws that may affect the use of electronic devices while driving.

Using mobile communications equipment is becoming increasingly important in the conduct of business and personal affairs. However, you must not compromise your own or others' safety when using such equipment. Mobile communications can enhance personal safety and security when appropriately used, particularly in emergency situations. Safety must be paramount when using mobile communications equipment to avoid negating these benefits. Mobile communication equipment includes, but is not limited to, cellular phones, pagers, portable email devices, text messaging devices and portable two-way radios.

## FEDERAL HIGHWAY ADMINISTRATION REGULATION

Regulations such as those issued by the Federal Highway Administration or issued pursuant to the Occupational Safety and Health Act (OSHA), and state and local laws and regulations may require additional equipment for the way you intend to use your vehicle. It is the responsibility of the registered owner to determine the applicability of such laws and regulations to your intended use for the vehicle, and to arrange for the installation of required equipment. The dealer has information about the availability of equipment which can be ordered for your vehicle.



# Customer Information

## END USER LICENSE AGREEMENT

### VEHICLE SOFTWARE END USER LICENSE AGREEMENT (EULA)

- You ("You" or "Your" as applicable) have acquired a vehicle having several devices, including SYNC ® and various control modules, ("DEVICES") that include software licensed or owned by Ford Motor Company and its affiliates ("FORD MOTOR COMPANY"). Those software products of FORD MOTOR COMPANY origin, as well as associated media, printed materials, and "online" or electronic documentation ("SOFTWARE") are protected by international intellectual property laws and treaties. The SOFTWARE is licensed, not sold. All rights reserved.
- The SOFTWARE may interface with and/or communicate with, or may be later upgraded to interface with and/or communicate with additional software and/or systems provided by FORD MOTOR COMPANY.

**IF YOU DO NOT AGREE TO THIS END USER LICENSE AGREEMENT ("EULA") DO NOT USE THE DEVICES OR COPY THE SOFTWARE. ANY USE OF THE SOFTWARE, INCLUDING BUT NOT LIMITED TO USE ON THE DEVICES, WILL CONSTITUTE YOUR AGREEMENT TO THIS EULA (OR RATIFICATION OF ANY PREVIOUS CONSENT).**

**GRANT OF SOFTWARE LICENSE:** This EULA grants you the following license:

- You may use the SOFTWARE as installed on the DEVICES and as otherwise interfacing with systems and/or services provide by or through FORD MOTOR COMPANY or its third party software and service providers.

## Description of Other Rights and Limitations.

- **Speech Recognition:** If the SOFTWARE includes speech recognition component(s), you should understand that speech recognition is an inherently statistical process and that recognition errors are inherent in the process. Neither FORD MOTOR COMPANY nor its suppliers shall be liable for any damages arising out of errors in the speech recognition process. It is your responsibility to monitor any speech recognition functions included in the system.
- **Limitations on Reverse Engineering, Decompilation and Disassembly:** You may not reverse engineer, decompile, translate, disassemble or attempt to discover any source code or underlying ideas or algorithms of the SOFTWARE nor permit others to reverse engineer, decompile or disassemble the SOFTWARE, except and only to the extent that such activity is expressly permitted by applicable law notwithstanding this limitation or to the extent as may be permitted by the licensing terms governing use of any open source components included with the SOFTWARE.
- **Limitations on Distributing, Copying, Modifying and Creating Derivative Works:** You may not distribute, copy, make modifications to or create derivative works based on the SOFTWARE, except and only to the extent that such activity is expressly permitted by applicable law notwithstanding this limitation or to the extent as may be permitted by the licensing terms governing use of any open source components included with the SOFTWARE.

# Customer Information

---

- **Single EULA:** The end user documentation for the DEVICES and related systems and services may contain multiple EULAs, such as multiple translations and/or multiple media versions (e.g., in the user documentation and in the software). Even if you receive multiple EULAs, you are licensed to use only one (1) copy of the SOFTWARE.
- **SOFTWARE Transfer:** You may permanently transfer your rights under this EULA only as part of a sale or transfer of the DEVICES, provided you retain no copies, you transfer all of the SOFTWARE (including all component parts, the media and printed materials, any upgrades, and, if applicable, the Certificate(s) of Authenticity), and the recipient agrees to the terms of this EULA. If the SOFTWARE is an upgrade, any transfer must include all prior versions of the SOFTWARE.
- **Termination:** Without prejudice to any other rights, FORD MOTOR COMPANY may terminate this EULA if you fail to comply with the terms and conditions of this EULA.
- **Internet-Based Services Components:** The SOFTWARE may contain components that enable and facilitate the use of certain Internet-based services. You acknowledge and agree that FORD MOTOR COMPANY, third party software and service suppliers, its affiliates and/or its designated agent may automatically check the version of the SOFTWARE and/or its components that you are utilizing and may provide upgrades or supplements to the SOFTWARE that may be automatically downloaded to your DEVICES.
- **Additional Software/Services:** The SOFTWARE may permit FORD MOTOR COMPANY, third party software and service suppliers, its affiliates and/or its designated agent to provide or make available to you SOFTWARE updates, supplements, add-on components, or Internet-based services components of the SOFTWARE after the date you obtain your initial copy of the SOFTWARE ("Supplemental Components".) SOFTWARE updates may cause you to incur additional charges from your wireless service provider. If FORD MOTOR COMPANY or third party software and services suppliers provide or make available to you Supplemental Components and no other EULA terms are provided along with the Supplemental Components, then the terms of this EULA shall apply. FORD MOTOR COMPANY, its affiliates and/or its designated agent reserve the right to discontinue without liability any Internet-based services provided to you or made available to you through the use of the SOFTWARE.

# Customer Information

---

- **Links to Third Party Sites:** The SOFTWARE may provide you with the ability to link to third party sites. The third party sites are not under the control of FORD MOTOR COMPANY, its affiliates and/or its designated agent. Neither FORD MOTOR COMPANY nor its affiliates nor its designated agent are responsible for (i) the contents of any third party sites, any links contained in third party sites, or any changes or updates to third party sites, or (ii) webcasting or any other form of transmission received from any third party sites. If the SOFTWARE provides links to third party sites, those links are provided to you only as a convenience, and the inclusion of any link does not imply an endorsement of the third party site by FORD MOTOR COMPANY, its affiliates and/or its designated agent.
- **Obligation to Drive Responsibly:** You recognize your obligation to drive responsibly and keep attention on the road. You will read and abide with the DEVICES operating instructions particularly as they pertain to safety and you agree to assume any risk associated with the use of the DEVICES.

## **UPGRADES AND RECOVERY MEDIA:**

If the SOFTWARE is provided by FORD MOTOR COMPANY separate from the DEVICES on media such as a ROM chip, CD ROM disk(s) or via web download or other means, and is labeled "For Upgrade Purposes Only" or "For Recovery Purposes Only" you may install one (1) copy of such SOFTWARE onto the DEVICES as a replacement copy for the existing SOFTWARE, and use it in accordance with this EULA, including any additional EULA terms accompanying the upgrade SOFTWARE.

## **INTELLECTUAL PROPERTY RIGHTS:**

All title and intellectual property rights in and to the SOFTWARE (including but not limited to any images, photographs, animations, video, audio, music, text and "applets" incorporated into the SOFTWARE), the accompanying printed materials, and any copies of the SOFTWARE, are owned by FORD MOTOR COMPANY, or its affiliates or suppliers. The SOFTWARE is licensed, not sold. You may not copy the printed materials accompanying the SOFTWARE. All title and intellectual property rights in and to the content which may be accessed through use of the SOFTWARE is the property of the respective content owner and may be protected by applicable copyright or other intellectual property laws and treaties. This EULA grants you no rights to use such content outside its intended use. All rights not specifically granted under this EULA are reserved by FORD MOTOR COMPANY, its affiliates, and third party software and service providers and suppliers. Use of any on-line services which may be accessed through the SOFTWARE may be governed by the respective terms of use relating to such services. If this SOFTWARE contains documentation that is provided only in electronic form, you may print one copy of such electronic documentation.

**EXPORT RESTRICTIONS:** You acknowledge that the SOFTWARE is subject to U.S. and European Union export jurisdiction. You agree to comply with all applicable international and national laws that apply to the SOFTWARE, including the U.S. Export Administration Regulations, as well as end-user, end-use and destination restrictions issued by U.S. and other governments.

# Customer Information

---

**TRADEMARKS:** This EULA does not grant you any rights in connection with any trademarks or service marks of FORD MOTOR COMPANY, its affiliates, and third party software and service providers.

**PRODUCT SUPPORT:** Please refer to FORD MOTOR COMPANY instructions provided in the documentation for the DEVICES product support, such as the vehicle owner guide.

Should you have any questions concerning this EULA, or if you desire to contact FORD MOTOR COMPANY for any other reason, please refer to the address provided in the documentation for the DEVICES.

**No Liability for Certain Damages:** EXCEPT AS PROHIBITED BY LAW, FORD MOTOR COMPANY, ANY THIRD PARTY SOFTWARE OR SERVICES SUPPLIERS, AND THEIR AFFILIATES SHALL HAVE NO LIABILITY FOR ANY INDIRECT, SPECIAL, CONSEQUENTIAL OR INCIDENTAL DAMAGES ARISING FROM OR IN CONNECTION WITH THE USE OR PERFORMANCE OF THE SOFTWARE. THIS LIMITATION SHALL APPLY EVEN IF ANY REMEDY FAILS OF ITS ESSENTIAL PURPOSE. THERE ARE NO WARRANTIES OTHER THAN THOSE THAT MAY BE EXPRESSLY PROVIDED FOR YOUR NEW VEHICLE.

## **SYNC® Automotive Important Safety Information Read and follow instructions:**

- Before using your SYNC® system, read and follow all instructions and safety information provided in this end user manual ("Owner Guide".) Not following precautions found in the Owner Guide can lead to an accident or other serious injuries.

## General Operation

- **Voice Command Control:** Certain functions within the SYNC® system may be accomplished using voice commands. Using voice commands while driving helps you to operate the system without removing your hands from the wheel or eyes from the road.
- **Prolonged Views of Screen:** Do not access any function requiring a prolonged view of the screen while you are driving. Pull over in a safe and legal manner before attempting to access a function of the system requiring prolonged attention.
- **Volume Setting:** Do not raise the volume excessively. Keep the volume at a level where you can still hear outside traffic and emergency signals while driving. Driving while unable to hear these sounds could cause an accident.
- **Navigation Features:** Any navigation features included in the system are intended to provide turn by turn instructions to get you to a desired destination. Please make certain all persons using this system carefully read and follow instructions and safety information fully.
- **Distraction Hazard:** Any navigation features may require manual (non-verbal) setup. Attempting to perform such set-up or insert data while driving can distract your attention and could cause an accident or other serious injury. Stop the vehicle in a safe and legal manner before attempting these operations.
- **Let Your Judgment Prevail:** Any navigation features are provided only as an aid. Make your driving decisions based on your observations of local conditions and existing traffic regulations. Any such feature is not a

## Customer Information

---

substitute for your personal judgment. Any route suggestions made by this system should never replace any local traffic regulations or your personal judgment or knowledge of safe driving practices.

- **Route Safety:** Do not follow the route suggestions if doing so would result in an unsafe or illegal maneuver, if you would be placed in an unsafe situation, or if you would be directed into an area that you consider unsafe. The driver is ultimately responsible for the safe operation of the vehicle and therefore, must evaluate whether it is safe to follow the suggested directions.
- **Potential Map Inaccuracy:** Maps used by this system may be inaccurate because of changes in roads, traffic controls or driving conditions. Always use good judgment and common sense when following the suggested routes.
- **Emergency Services:** Do not rely on any navigation features included in the system to route you to emergency services. Ask local authorities or an emergency services operator for these locations. Not all emergency services such as police, fire stations, hospitals and clinics are likely to be contained in the map database for such navigation features.

Your Responsibilities and Assumptions of Risk

- You agree to each of the following:(a) Any use of the SOFTWARE while driving an automobile or other vehicle in violation of applicable law or otherwise driving in an unsafe manner presents a significant risk of distracted driving and should not be attempted under any circumstances;(b) Use of the SOFTWARE at excessive volume poses a significant risk of hearing damage and should not be attempted under any circumstances;(c) The SOFTWARE may not be compatible with new or different versions of an operating system, third party software, or third party services, and the SOFTWARE may potentially cause a critical failure of an operating system, third party software, or third party service.(d) Any third party service accessed by or third party software used with the SOFTWARE (i) may charge an additional fee for access, (ii) may not work correctly, on an uninterrupted basis, or error free, (iii) may change streaming formats or discontinue operation, (iv) may contain adult, profane or offensive content; and (v) may contain inaccurate, false or misleading traffic, weather, financial or safety information or other content; and (e) Use of the SOFTWARE may cause you to incur additional charges from your wireless service provider (WSP) and any data or minute calculators that may be included in the software program are for reference only, are not warranted in any way and should not be relied upon in anyway.
- When using the SOFTWARE, you agree to be responsible for and assume the entire risk to the items set forth in Section (a) – (e) above.

# Customer Information

---

## Disclaimer of Warranty

YOU EXPRESSLY ACKNOWLEDGE AND AGREE THAT USE OF THE DEVICES AND SOFTWARE IS AT YOUR SOLE RISK AND THAT THE ENTIRE RISK AS TO SATISFACTORY QUALITY, PERFORMANCE, COMPATIBILITY, ACCURACY AND EFFORT IS WITH YOU. TO THE MAXIMUM EXTENT PERMITTED BY APPLICABLE LAW, THE SOFTWARE AND ANY THIRD PARTY SOFTWARE OR THIRD-PARTY SERVICES ARE PROVIDED "AS IS" AND "AS AVAILABLE", WITH ALL FAULTS AND WITHOUT WARRANTY OF ANY KIND, AND FORD MOTOR COMPANY HEREBY DISCLAIMS ALL WARRANTIES AND CONDITIONS WITH RESPECT TO THE SOFTWARE, THIRD PARTY SOFTWARE, AND THIRD-PARTY SERVICES, EITHER EXPRESS, IMPLIED OR STATUTORY, INCLUDING, BUT NOT LIMITED TO, THE IMPLIED WARRANTIES AND/OR CONDITIONS OF MERCHANTABILITY, OF SATISFACTORY QUALITY, OF FITNESS FOR AN PARTICULAR PURPOSE, OF ACCURACY, OF QUIET ENJOYMENT, AND NON-INFRINGEMENT OF THIRD-PARTY RIGHTS. FORD MOTOR COMPANY DOES NOT WARRANT (a) AGAINST INTERFERENCE WITH YOUR ENJOYMENT OF THE SOFTWARE, THIRD PARTY SOFTWARE, OR THIRD-PARTY SERVICES, (b) THAT THE SOFTWARE, THIRD PARTY SOFTWARE, OR THIRD-PARTY SERVICES WILL MEET YOUR REQUIREMENTS, (c) THAT THE OPERATION OF THE SOFTWARE, THIRD PARTY SOFTWARE, OR THIRD-PARTY SERVICES WILL BE UNINTERRUPTED OR ERROR-FREE, (d) OR THAT DEFECTS IN THE SOFTWARE, THIRD PARTY SOFTWARE, OR THIRD-PARTY SERVICES WILL BE CORRECTED. NO ORAL OR WRITTEN INFORMATION OR ADVICE GIVEN BY FORD MOTOR COMPANY OR ITS AUTHORIZED REPRESENTATIVE SHALL

CREATE A WARRANTY. SHOULD THE SOFTWARE, THIRD PARTY SOFTWARE, OR THIRD-PARTY SERVICES PROVE DEFECTIVE, YOU ASSUME THE ENTIRE COST OF ALL NECESSARY SERVICING, REPAIR OR CORRECTION. SOME JURISDICTIONS DO NOT ALLOW THE DISCLAIMER OF IMPLIED WARRANTIES OR LIMITATIONS ON APPLICABLE STATUTORY RIGHTS OF A CONSUMER, SO THE ABOVE DISCLAIMER MAY NOT FULLY APPLY TO YOU. THE SOLE WARRANTY PROVIDED BY FORD MOTOR COMPANY SHALL BE FOUND IN THE WARRANTY INFORMATION INCLUDING WITH YOUR OWNER GUIDE. TO THE EXTENT THAT THERE IS ANY CONFLICT BETWEEN THE TERMS OF THIS SECTION AND THE WARRANTY BOOKLET, THE WARRANTY BOOKLET SHALL CONTROL.

## Applicable Law, Venue, Jurisdiction

- The laws of the State of Michigan govern this EULA and Your use of the SOFTWARE. Your use of the SOFTWARE may also be subject to other local, state, national, or international laws. Any litigation arising out of or related to this EULA shall be brought and maintained exclusively in a court of the State of Michigan located in Wayne County or in the United States District Court for the Eastern District of Michigan. You hereby consent to submit to the personal jurisdiction of a court in the State of Michigan located in Wayne County and the United States District Court for the Eastern District of Michigan for any dispute arising out of or relating to this EULA.

# Customer Information

---

## **Binding Arbitration and Class Action Waiver**

**(a) Application.** This Section applies to any dispute EXCEPT IT DOES NOT INCLUDE A DISPUTE RELATING TO COPYRIGHT INFRINGEMENT, OR TO THE ENFORCEMENT OR VALIDITY OF YOUR, FORD MOTOR COMPANY, OR ANY OF FORD MOTOR COMPANY'S LICENSORS' INTELLECTUAL PROPERTY RIGHTS. Dispute means any dispute, action, or other controversy between You and FORD MOTOR COMPANY, other than the exceptions listed above, concerning the SOFTWARE (including its price) or this EULA, whether in contract, warranty, tort, statute, regulation, ordinance, or any other legal or equitable basis.

**(b) Notice of Dispute.** In the event of a Dispute, You or FORD MOTOR COMPANY must give the other a "Notice of Dispute", which is a written statement of the name, address, and contact information of the party giving it, the facts giving rise to the dispute, and the relief requested. You and FORD MOTOR COMPANY will attempt to resolve any dispute through informal negotiation within 60 days from the date the Notice of Dispute is sent. After 60 days, You or FORD MOTOR COMPANY may commence arbitration.

**(c) Small claims court.** You may also litigate any dispute in small claims court in your county of residence or FORD MOTOR COMPANY'S principal place of business, if the dispute meets all requirements to be heard in the small claims court. You may litigate in small claims court whether or not You negotiated informally first.

**(d) Binding arbitration.** If You and FORD MOTOR COMPANY, do not resolve any dispute by informal negotiation or in small claims court, any other effort to resolve the dispute will be conducted exclusively by binding arbitration. You are giving up

the right to litigate (or participate in as a party or class member) all disputes in court before a judge or jury. Instead, all disputes will be resolved before a neutral arbitrator, whose decision will be final except for a limited right of appeal under the Federal Arbitration Act. Any court with jurisdiction over the parties may enforce the arbitrator's award.

**(e) Class action waiver.** Any proceedings to resolve or litigate any dispute in any forum will be conducted solely on an individual basis. Neither you nor FORD MOTOR COMPANY, will seek to have any dispute heard as a class action, as a private attorney general action, or in any other proceeding in which any party acts or proposes to act in a representative capacity. No arbitration or proceeding will be combined with another without the prior written consent of all parties to all affected arbitrations or proceedings.

**(f) Arbitration procedure.** Any arbitration will be conducted by the American Arbitration Association (the "AAA"), under its Commercial Arbitration Rules. If You are an individual and use the SOFTWARE for personal or vehicle use, or if the value of the dispute is \$75,000 or less whether or not You are an individual or how You use the SOFTWARE, the AAA Supplementary Procedures for Consumer-Related Disputes will also apply. To commence arbitration, submit a Commercial Arbitration Rules Demand for Arbitration form to the AAA. You may request a telephonic or in-person hearing by following the AAA rules. In a dispute involving \$10,000 or less, any hearing will be telephonic unless the arbitrator finds good cause to hold an in-person hearing instead. For more information, see [adr.org](http://adr.org) or call 1-800-778-7879. You agree to commence arbitration only in your county of residence or FORD MOTOR COMPANY'S principal place of business. The arbitrator

## Customer Information

---

may award the same damages to you individually as a court could. The arbitrator may award declaratory or injunctive relief only to you individually, and only to the extent required to satisfy your individual claim.

### **(g) Arbitration fees and incentives.**

- i. Disputes involving \$75,000 or less. FORD MOTOR COMPANY will promptly reimburse your filing fees and pay the AAA's and arbitrator's fees and expenses. If you reject FORD MOTOR COMPANY'S last written settlement offer made before the arbitrator was appointed ("last written offer"), your dispute goes all the way to an arbitrator's decision (called an "award"), and the arbitrator awards you more than the last written offer, FORD MOTOR COMPANY will give you three incentives: (1) pay the greater of the award or \$1,000; (2) pay twice your reasonable attorney's fees, if any; and (3) reimburse any expenses (including expert witness fees and costs) that your attorney reasonably accrues for investigating, preparing, and pursuing your claim in arbitration. The arbitrator will determine the amounts.
- ii. Disputes involving more than \$75,000. The AAA rules will govern payment of filing fees and the AAA's and arbitrator's fees and expenses.
- iii. Disputes involving any amount. In any arbitration you commence, FORD MOTOR COMPANY will seek its AAA or arbitrator's fees and expenses, or Your filing fees it reimbursed, only if the arbitrator finds the arbitration frivolous or brought for an improper purpose. In any arbitration FORD MOTOR COMPANY commences, it will pay all

filing, AAA, and arbitrator's fees and expenses. It will not seek its attorney's fees or expenses from you in any arbitration. Fees and expenses are not counted in determining how much a dispute involves.

**(h) Claims or disputes must be filed within one year.** To the extent permitted by law, any claim or dispute under this EULA to which this Section applies must be filed within one year in small claims court (Section c) or in arbitration (Section d). The one-year period begins when the claim or dispute first could be filed. If such a claim or dispute is not filed within one year, it is permanently barred.

**(i) Severability.** If the class action waiver (Section e) is found to be illegal or unenforceable as to all or some parts of a dispute, then that portion of Section e will not apply to those parts. Instead, those parts will be severed and proceed in a court of law, with the remaining parts proceeding in arbitration. If any other provision of that portion Section e is found to be illegal or unenforceable, that provision will be severed with the remainder of Section e remaining in full force and effect.

### **Telenav Software End User License Agreement**

Please read these terms and conditions carefully before you use the TeleNav Software. Your use of the TeleNav Software indicates that you accept these terms and conditions. If you do not accept these terms and conditions, do not break the seal of the package, launch, or otherwise use the TeleNav Software. TeleNav may revise this Agreement and the privacy policy at any time, with or without notice to you. You agree to visit <http://www.telenav.com> from time to time to review the then current version of this Agreement and of the privacy policy.



# Customer Information

---

## 1. Safe and Lawful Use

You acknowledge that devoting attention to the TeleNav Software may pose a risk of injury or death to you and others in situations that otherwise require your undivided attention, and you therefore agree to comply with the following when using the TeleNav Software:

- (a) observe all traffic laws and otherwise drive safely;
- (b) use your own personal judgment while driving. If you feel that a route suggested by the TeleNav Software instructs you to perform an unsafe or illegal maneuver, places you in an unsafe situation, or directs you into an area that you consider to be unsafe, do not follow such instructions;
- (c) do not input destinations, or otherwise manipulate the TeleNav Software, unless your vehicle is stationary and parked;
- (d) do not use the TeleNav Software for any illegal, unauthorized, unintended, unsafe, hazardous, or unlawful purposes, or in any manner inconsistent with this Agreement;
- (e) arrange all GPS and wireless devices and cables necessary for use of the TeleNav Software in a secure manner in your vehicle so that they will not interfere with your driving and will not prevent the operation of any safety device (such as an airbag).

You agree to indemnify and hold TeleNav harmless against all claims resulting from any dangerous or otherwise inappropriate use of the TeleNav Software in any moving vehicle, including as a result of your failure to comply with the directions above.

## 2. Account Information

You agree: (a) when registering the TeleNav Software, to provide TeleNav with true, accurate, current, and complete information about yourself, and (b) to inform TeleNav promptly of any changes to such information, and to keep it true, accurate, current and complete.

## 3. Software License

- Subject to your compliance with the terms of this Agreement, TeleNav hereby grants to you a personal, non-exclusive, non-transferable license (except as expressly permitted below in connection with your permanent transfer of the TeleNav Software license), without the right to sublicense, to use the TeleNav Software (in object code form only) in order to access and use the TeleNav Software. This license shall terminate upon any termination or expiration of this Agreement. You agree that you will use the TeleNav Software only for your personal business or leisure purposes, and not to provide commercial navigation services to other parties.

### 3.1 License Limitations

- **(a)** reverse engineer, decompile, disassemble, translate, modify, alter or otherwise change the TeleNav Software or any part thereof; **(b)** attempt to derive the source code, audio library or structure of the TeleNav Software without the prior express written consent of TeleNav; **(c)** remove from the TeleNav Software, or alter, any of TeleNav's or its suppliers' trademarks, trade names, logos, patent or copyright notices, or other notices or markings; **(d)**

# Customer Information

---

distribute, sublicense or otherwise transfer the TeleNav Software to others, except as part of your permanent transfer of the TeleNav Software; or **(e)** use the TeleNav Software in any manner that

- i. infringes the intellectual property or proprietary rights, rights of publicity or privacy or other rights of any party,
- ii. violates any law, statute, ordinance or regulation, including but not limited to laws and regulations related to spamming, privacy, consumer and child protection, obscenity or defamation, or
- iii. is harmful, threatening, abusive, harassing, tortuous, defamatory, vulgar, obscene, libelous, or otherwise objectionable; and (f) lease, rent out, or otherwise permit unauthorized access by third parties to the TeleNav Software without advanced written permission of TeleNav.

## 4. Disclaimers

- To the fullest extent permissible pursuant to applicable law, in no event will TeleNav, its licensors and suppliers, or agents or employees of any of the foregoing, be liable for any decision made or action taken by you or anyone else in reliance on the information provided by the TeleNav Software. TeleNav also does not warrant the accuracy of the map or other data used for the TeleNav Software. Such data may not always reflect reality due to, among other things, road closures, construction, weather, new roads and other changing conditions. You are responsible for the entire risk arising out of your use of the TeleNav Software. For example but without limitation, you agree not to rely on the TeleNav Software for critical navigation in areas where the well-being or survival of you or others

is dependent on the accuracy of navigation, as the maps or functionality of the TeleNav Software are not intended to support such high risk applications, especially in more remote geographical areas.

- TELENAV EXPRESSLY DISCLAIMS AND EXCLUDES ALL WARRANTIES IN CONNECTION WITH THE TELENAV SOFTWARE, WHETHER STATUTORY, EXPRESS OR IMPLIED, INCLUDING ALL WARRANTIES WHICH MAY ARISE FROM COURSE OF DEALING, CUSTOM OR TRADE AND INCLUDING, BUT NOT LIMITED TO, THE IMPLIED WARRANTIES OF MERCHANTABILITY, FITNESS FOR A PARTICULAR PURPOSE AND NON-INFRINGEMENT OF THIRD PARTY RIGHTS WITH RESPECT TO THE TELENAV SOFTWARE.
- Certain jurisdictions do not permit the disclaimer of certain warranties, so this limitation may not apply to you.

## 5. Limitation of Liability

- TO THE EXTENT PERMITTED UNDER APPLICABLE LAW, UNDER NO CIRCUMSTANCES SHALL TELENAV OR ITS LICENSORS AND SUPPLIERS BE LIABLE TO YOU OR TO ANY THIRD PARTY FOR ANY INDIRECT, INCIDENTAL, CONSEQUENTIAL, SPECIAL OR EXEMPLARY DAMAGES (INCLUDING IN EACH CASE, BUT NOT LIMITED TO, DAMAGES FOR THE INABILITY TO USE THE EQUIPMENT OR ACCESS DATA, LOSS OF DATA, LOSS OF BUSINESS, LOSS OF PROFITS, BUSINESS INTERRUPTION OR THE LIKE) ARISING OUT OF THE USE OF OR INABILITY TO USE THE TELENAV SOFTWARE, EVEN IF TELENAV HAS BEEN ADVISED OF THE POSSIBILITY OF SUCH DAMAGES. NOTWITHSTANDING ANY DAMAGES THAT YOU MIGHT INCUR FOR ANY

# Customer Information

---

REASON WHATSOEVER (INCLUDING, WITHOUT LIMITATION, ALL DAMAGES REFERENCED HEREIN AND ALL DIRECT OR GENERAL DAMAGES IN CONTRACT, TORT (INCLUDING NEGLIGENCE) OR OTHERWISE), THE ENTIRE LIABILITY OF TELENAV AND OF ALL OF TELENAV'S SUPPLIERS SHALL BE LIMITED TO THE AMOUNT ACTUALLY PAID BY YOU FOR THE TELENAV SOFTWARE. SOME STATES AND/OR JURISDICTIONS DO NOT ALLOW THE EXCLUSION OR LIMITATION OF INCIDENTAL OR CONSEQUENTIAL DAMAGES, SO THE ABOVE LIMITATIONS OR EXCLUSIONS MAY NOT APPLY TO YOU.

## **6. Arbitration and Governing Law**

- You agree that any dispute, claim or controversy arising out of or relating to this Agreement or the TeleNav Software shall be settled by independent arbitration involving a neutral arbitrator and administered by the American Arbitration Association in the County of Santa Clara, California. The arbitrator shall apply the Commercial Arbitration Rules of the American Arbitration Association, and the judgment upon the award rendered by the arbitrator may be entered by any court having jurisdiction. Note that there is no judge or jury in an arbitration proceeding and the decision of the arbitrator shall be binding upon both parties. You expressly agree to waive your right to a jury trial. This Agreement and performance hereunder will be governed by and construed in accordance with the laws of the State of California, without giving effect to its conflict of law provisions. To the extent judicial action is necessary in connection with the binding arbitration, both TeleNav and you agree to submit

to the exclusive jurisdiction of the courts of the County of Santa Clara, California. The United Nations Convention on Contracts for the International Sale of Goods shall not apply.

## **7. Assignment**

- You may not resell, assign, or transfer this Agreement or any of your rights or obligations, except in totality, in connection with your permanent transfer of the TeleNav Software, and expressly conditioned upon the new user of the TeleNav Software agreeing to be bound by the terms and conditions of this Agreement. Any such sale, assignment or transfer that is not expressly permitted under this paragraph will result in immediate termination of this Agreement, without liability to TeleNav, in which case you and all other parties shall immediately cease all use of the TeleNav Software. Notwithstanding the foregoing, TeleNav may assign this Agreement to any other party at any time without notice, provided the assignee remains bound by this Agreement.

## **8. Miscellaneous**

### **8.1**

This Agreement constitutes the entire agreement between TeleNav and you with respect to the subject matter hereof.

### **8.2**

Except for the limited licenses expressly granted in this Agreement, TeleNav retains all right, title and interest in and to the TeleNav Software, including without limitation all related intellectual property rights. No licenses or other rights which are not expressly granted in this Agreement are intended to, or shall be, granted or

# Customer Information

---

conferred by implication, statute, inducement, estoppel or otherwise, and TeleNav and its suppliers and licensors hereby reserve all of their respective rights other than the licenses explicitly granted in this Agreement.

## 8.3

By using the TeleNav Software, you consent to receive from TeleNav all communications, including notices, agreements, legally required disclosures or other information in connection with the TeleNav Software (collectively, "Notices") electronically. TeleNav may provide such Notices by posting them on TeleNav's Website or by downloading such Notices to your wireless device. If you desire to withdraw your consent to receive Notices electronically, you must discontinue your use of the TeleNav Software.

## 8.4

TeleNav's or your failure to require performance of any provision shall not affect that party's right to require performance at any time thereafter, nor shall a waiver of any breach or default of this Agreement constitute a waiver of any subsequent breach or default or a waiver of the provision itself.

## 8.5

If any provision herein is held unenforceable, then such provision will be modified to reflect the intention of the parties, and the remaining provisions of this Agreement will remain in full force and effect.

## 8.6

The headings in this Agreement are for convenience of reference only, will not be deemed to be a part of this Agreement, and will not be referred to in connection with the construction or interpretation of this Agreement. As used in this Agreement, the words "include" and "including" and variations thereof, will not be deemed to be terms of limitation, but rather will be deemed to be followed by the words "without limitation".

## 9. Other Vendors Terms and Conditions

- The Telenav Software utilizes map and other data licensed to Telenav by third party vendors for the benefit of you and other end users. This Agreement includes end-user terms applicable to these companies (included at the end of this Agreement), and thus your use of the Telenav Software is also subject to such terms. You agree to comply with the following additional terms and conditions, which are applicable to Telenav's third party vendor licensors.

## 9.1 End User Terms Required by HERE North America, LLC

The data ("Data") is provided for your personal, internal use only and not for resale. It is protected by copyright, and is subject to the following terms and conditions which are agreed to by you, on the one hand, and Telenav ("Telenav") and its licensors (including their licensors and suppliers) on the other hand.

© 2013 HERE. All rights reserved.

The Data for areas of Canada includes information taken with permission from Canadian authorities, including: © Her Majesty the Queen in Right of Canada, © Queen's Printer for Ontario, © Canada Post Corporation, GeoBase®, © Department of Natural Resources Canada.

# Customer Information

---

HERE holds a non-exclusive license from the United States Postal Service® to publish and sell ZIP+4® information.

©United States Postal Service® 2014. Prices are not established, controlled or approved by the United States Postal Service®. The following trademarks and registrations are owned by the USPS: United States Postal Service, USPS, and ZIP+4

The Data for Mexico includes certain data from Instituto Nacional de Estadística y Geografía.

## **9.2 End User Terms Required by NAV2 (Shanghai) Co., Ltd**

The data (“Data”) is provided for your personal, internal use only and not for resale. It is protected by copyright, and is subject to the following terms and conditions which are agreed to by you, on the one hand, and NAV2 (Shanghai) Co., Ltd (“NAV2”) and its licensors (including their licensors and suppliers) on the other hand. 20xx. All rights reserved

### **Terms and Conditions**

**Permitted Use.** You agree to use this Data together with the Telenav Software solely for the internal business and personal purposes for which you were licensed, and not for service bureau, time-sharing or other similar purposes. Accordingly, but subject to the restrictions set forth in the following paragraphs, you agree not to otherwise reproduce, copy, modify, decompile, disassemble, create any derivative works of, or reverse engineer any portion of this Data, and may not transfer or distribute it in any form, for any purpose, except to the extent permitted by mandatory laws.

**Restrictions.** Except where you have been specifically licensed to do so by Telenav, and without limiting the preceding paragraph, you may not use this Data (a) with any products, systems, or applications installed or otherwise connected to or in communication with vehicles, capable of vehicle navigation, positioning, dispatch, real time route guidance, fleet management or similar applications; or (b) with or in communication with any positioning devices or any mobile or wireless-connected electronic or computer devices, including without limitation cellular phones, palmtop and handheld computers, pagers, and personal digital assistants or PDAs.

**Warning.** The Data may contain inaccurate or incomplete information due to the passage of time, changing circumstances, sources used and the nature of collecting comprehensive geographic data, any of which may lead to incorrect results.

**No Warranty.** This Data is provided to you “as is,” and you agree to use it at your own risk. Telenav and its licensors (and their licensors and suppliers) make no guarantees, representations or warranties of any kind, express or implied, arising by law or otherwise, including but not limited to, content, quality, accuracy, completeness, effectiveness, reliability, fitness for a particular purpose, usefulness, use or results to be obtained from this Data, or that the Data or server will be uninterrupted or error-free.

**Disclaimer of Warranty:** TELENAV AND ITS LICENSORS (INCLUDING THEIR LICENSORS AND SUPPLIERS) DISCLAIM ANY WARRANTIES, EXPRESS OR IMPLIED, OF QUALITY, PERFORMANCE, MERCHANTABILITY, FITNESS FOR A

## Customer Information

---

PARTICULAR PURPOSE OR NON-INFRINGEMENT. Some States, Territories and Countries do not allow certain warranty exclusions, so to that extent the above exclusion may not apply to you.

**Disclaimer of Liability:** TELENAV AND ITS LICENSORS (INCLUDING THEIR LICENSORS AND SUPPLIERS) SHALL NOT BE LIABLE TO YOU: IN RESPECT OF ANY CLAIM, DEMAND OR ACTION, IRRESPECTIVE OF THE NATURE OF THE CAUSE OF THE CLAIM, DEMAND OR ACTION ALLEGING ANY LOSS, INJURY OR DAMAGES, DIRECT OR INDIRECT, WHICH MAY RESULT FROM THE USE OR POSSESSION OF THE INFORMATION; OR FOR ANY LOSS OF PROFIT, REVENUE, CONTRACTS OR SAVINGS, OR ANY OTHER DIRECT, INDIRECT, INCIDENTAL, SPECIAL OR CONSEQUENTIAL DAMAGES ARISING OUT OF YOUR USE OF OR INABILITY TO USE THIS INFORMATION, ANY DEFECT IN THE INFORMATION, OR THE BREACH OF THESE TERMS OR CONDITIONS, WHETHER IN AN ACTION IN CONTRACT OR TORT OR BASED ON A WARRANTY, EVEN IF TELENAV OR ITS LICENSORS HAVE BEEN ADVISED OF THE POSSIBILITY OF SUCH DAMAGES. Some States, Territories and Countries do not allow certain liability exclusions or damages limitations, so to that extent the above may not apply to you.

**Export Control.** You shall not export from anywhere any part of the Data or any direct product thereof except in compliance with, and with all licenses and approvals required under, applicable export laws, rules and regulations, including but not limited to the laws, rules and regulations administered by the Office of Foreign Assets Control of the U.S. Department of Commerce and the Bureau of Industry and Security of the U.S. Department of Commerce. To the extent that any such

export laws, rules or regulations prohibit HERE from complying with any of its obligations hereunder to deliver or distribute Data, such failure shall be excused and shall not constitute a breach of this Agreement.

**Entire Agreement.** These terms and conditions constitute the entire agreement between Telenav (and its licensors, including their licensors and suppliers) and you pertaining to the subject matter hereof, and supersedes in their entirety any and all written or oral agreements previously existing between us with respect to such subject matter.

**Governing Law.** The above terms and conditions shall be governed by the laws of the State of Illinois [insert "Netherlands" where European HERE Data is used], without giving effect to (i) its conflict of laws provisions, or (ii) the United Nations Convention for Contracts for the International Sale of Goods, which is explicitly excluded. You agree to submit to the jurisdiction of the State of Illinois [insert "The Netherlands" where European HERE Data is used] for any and all disputes, claims and actions arising from or in connection with the Data provided to you hereunder.

**Government End Users.** If the Data is being acquired by or on behalf of the United States government or any other entity seeking or applying rights similar to those customarily claimed by the United States government, this Data is a "commercial item" as that term is defined at 48 C.F.R. ("FAR") 2.101, is licensed in accordance with these End-User Terms, and each copy of Data delivered or otherwise furnished shall be marked and embedded as appropriate with the following "Notice of Use," and shall be treated in accordance with such Notice:

# Customer Information

## NOTICE OF USE

CONTRACTOR (MANUFACTURER/  
SUPPLIER) NAME: HERE

CONTRACTOR (MANUFACTURER/  
SUPPLIER) ADDRESS: c/o Nokia, 425  
West Randolph Street, Chicago, Illinois  
60606

This Data is a commercial item as  
defined in FAR 2.101 and is subject to  
these End-User Terms under which this  
Data was provided.

© 1987 – 2014 HERE – All rights reserved.

If the Contracting Officer, federal government agency, or any federal official refuses to use the legend provided herein, the Contracting Officer, federal government agency, or any federal official must notify HERE prior to seeking additional or alternative rights in the Data.

### I. US/Canada Territory

A. United States Data. The End-User Terms for any Application containing Data for the United States shall contain the following notices:

“HERE holds a non-exclusive license from the United States Postal Service® to publish and sell ZIP+4® information.”

“©United States Postal Service® 20XX. Prices are not established, controlled or approved by the United States Postal Service®. The following trademarks and registrations are owned by the USPS: United States Postal Service, USPS, and ZIP+4.”

B. Canada Data. The following provisions apply to the Data for Canada, which may include or reflect data from third party licensors (“Third Party Data”), including Her Majesty the Queen in Right of Canada (“Her Majesty”), Canada Post Corporation (“Canada Post”) and the Department of Natural Resources of Canada (“NRCan”):

1. Disclaimer and Limitation: Client agrees that its use of the Third Party Data is subject to the following provisions:

a. Disclaimer: The Third Party Data is licensed on an “as is” basis. The licensors of such data, including Her Majesty, Canada Post and NRCan, make no guarantees, representations or warranties respecting such data, either express or implied, arising by law or otherwise, including but not limited to, effectiveness, completeness, accuracy or fitness for a particular purpose.

b. Limitation on Liability: The Third Party Data licensors, including Her Majesty, Canada Post and NRCan, shall not be liable: (i) in respect of any claim, demand or action, irrespective of the nature of the cause of the claim, demand or action alleging any loss, injury or damages, direct or indirect, which may result from the use or possession of such Data; or (ii) in any way for loss of revenues or contracts, or any other consequential loss of any kind resulting from any defect in the Data.

# Customer Information

---

2. Copyright Notice: In connection with each copy of all or any portion of the Data for the Territory of Canada, Client shall affix in a conspicuous manner the following copyright notice on at least one of: (i) the label for the storage media of the copy; (ii) the packaging for the copy; or (iii) other materials packaged with the copy, such as user manuals or end user license agreements: "This data includes information taken with permission from Canadian authorities, including © Her Majesty the Queen in Right of Canada, © Queen's Printer for Ontario, © Canada Post Corporation, GeoBase®, © The Department of Natural Resources Canada. All rights reserved."

3. End-User Terms: Except as otherwise agreed by the parties, in connection with the provision of any portion of the Data for the Territory of Canada to End-Users as may be authorized under the Agreement, Client shall provide such End-Users, in a reasonably conspicuous manner, with terms (set forth with other end user terms required to be provided under the Agreement, or as otherwise may be provided, by Client) which shall include the following provisions on behalf of the Third Party Data licensors, including Her Majesty, Canada Post and NRCan:

The Data may include or reflect data of licensors, including Her Majesty the Queen in the Right of Canada ("Her Majesty"), Canada Post Corporation ("Canada Post") and the Department of Natural Resources Canada ("NRCan"). Such data is licensed on an "as is" basis. The licensors, including Her Majesty, Canada Post and NRCan, make no guarantees, representations or warranties respecting such data,

either express or implied, arising by law or otherwise, including but not limited to, effectiveness, completeness, accuracy or fitness for a particular purpose. The licensors, including Her Majesty, Canada Post and NRCan, shall not be liable in respect of any claim, demand or action, irrespective of the nature of the cause of the claim, demand or action alleging any loss, injury or damages, direct or indirect, which may result from the use or possession of the data or the Data. The licensors, including Her Majesty, Canada Post and NRCan, shall not be liable in any way for loss of revenues or contracts, or any other consequential loss of any kind resulting from any defect in the data or the Data.

End User shall indemnify and save harmless the licensors, including Her Majesty, Canada Post and NRCan, and their officers, employees and agents from and against any claim, demand or action, irrespective of the nature of the cause of the claim, demand or action, alleging loss, costs, expenses, damages or injuries (including injuries resulting in death) arising out of the use or possession of the data or the Data.

4. Additional Provisions: The terms contained in this Section are in addition to all of the rights and obligations of the parties under the Agreement. To the extent that any of the provisions of this Section are inconsistent with, or conflict with, any other provisions of the Agreement, the provisions of this Section shall prevail.



# Customer Information

II. Mexico. The following provision applies to the Data for Mexico, which includes certain data from the Instituto Nacional de Estadística y Geografía (“INEGI”):

A. Any and all copies of the Data and/or packaging containing Data for Mexico shall contain the following notice: “Fuente: INEGI (Instituto Nacional de Estadística y Geografía)”

### III. Latin America Territory

A. Third Party Notices. Any and all copies of the Data and/or packaging relating thereto shall include the respective Third Party Notices set forth below and used as described below corresponding to the Territory (or portion thereof) included in such copy:

Territory Notice

Argentina	IGN “INSTITUTO GEOGRAFICO NACIONAL ARGENTINO”
Ecuador	“INSTITUTO GEOGRAFICO MILITAR DEL ECUADOR AUTORIZACION N° IGM-2011-01- PCO-01 DEL 25 DE ENERO DE 2011” “source: © IGN 2009 - BD TOPO ®”
Guadeloupe, French Guiana and Martinique Mexico	“Fuente: INEGI (Instituto Nacional de Estadística y Geografía)”

### IV. Middle East Territory

A. Third Party Notices. Any and all copies of the Data and/or packaging relating thereto shall include the respective Third Party Notices set forth below and used as described below corresponding to the Territory (or portion thereof) included in such copy:

Country Notice

Jordan “© Royal Jordanian Geographic Centre”. The foregoing notice requirement for Jordan Data is a material term of the Agreement. If Client or any of its permitted sublicensees (if any) fail to meet such requirement, HERE shall have the right to terminate Client’s license with respect to the Jordan Data.

B. Jordan Data. Client and its permitted sublicensees (if any) are restricted from licensing and/or otherwise distributing HERE’s database for the country of Jordan (“Jordan Data”) for use in Enterprise Applications to (i) non-Jordanian entities for use of the Jordan Data solely in Jordan or (ii) Jordan-based customers. In addition, Client, its permitted sublicensees (if any) and End-Users are restricted from using the Jordan Data in Enterprise Applications if such party is (i) a non-Jordanian entity using the Jordan Data solely in Jordan or (ii) a Jordan-based customer. For purposes of the foregoing, “Enterprise Applications” shall mean Geomarketing applications, GIS applications, mobile business asset management applications, call center applications, telematics applications, public organization Internet applications or for providing geocoding services.

# Customer Information

---

## V. Europe Territory

### A. Use of Certain Traffic Codes in Europe

1. General Restrictions Applicable to Traffic Codes. Client acknowledges and agrees that in certain countries of the Europe Territory, Client will need to obtain rights directly from third party RDS-TMC code providers to receive and use the Traffic Codes in the Data and to deliver to End-Users Transactions in any way derived from or based on such Traffic Codes. For such countries, HERE shall deliver the Data incorporating Traffic Codes to Client only after receiving certification from Client of its having obtained such rights.

2. Display of Third Party Rights Legends for Belgium. Client shall, for each Transaction that uses Traffic Codes for Belgium, provide the following notice to the End-User: "Traffic Codes for Belgium are provided by the Ministerie van de Vlaamse Gemeenschap and the Ministère de l'Équipement et des Transports."

B. Paper Maps. With respect to any license granted to Client relating to making, selling or distributing paper maps (i.e., a map fixed on a paper or paper-like medium): (a) such license with respect to Data for the Territory of Great Britain is conditioned on Client's entering into and complying with a separate written agreement with the Ordnance Survey ("OS") to create and sell paper maps, Client's paying to the OS any and all applicable paper map royalties, and Client's complying with the OS copyright notice requirements; (b) such license for selling or otherwise distributing for charge with respect to Data for the Territory of Czech Republic

is conditioned on Client's obtaining prior written consent from Kartografie a.s.; (c) such license for selling or distributing with respect to Data for the Territory of Switzerland is conditioned on Client's obtaining a permit from Bundesamt für Landestopografie of Switzerland; (d) Client is restricted from using Data for the Territory of France to create paper maps with a scale between 1:5,000 and 1:250,000; and (e) Client is restricted from using any Data to create, sell or distribute paper maps that are the same or substantially similar, in terms of data content and specific use of color, symbols and scale, to paper maps published by the European national mapping agencies, including without limitation, Landvermessungämter of Germany, Topografische Dienst of the Netherlands, Nationaal Geografisch Instituut of Belgium, Bundesamt für Landestopografie of Switzerland, Bundesamt für Eich-und Vermessungswesen of Austria, and the National Land Survey of Sweden.

C. OS Enforcement. Without limiting Section IV(B) above, with respect to Data for the Territory of Great Britain, Client acknowledges and agrees that the Ordnance Survey ("OS") may bring a direct action against Client to enforce compliance with the OS copyright notice (see Section IV(D) below) and paper map requirements (see Section IV(B) above) contained in this Agreement.

D. Third Party Notices. Any and all copies of the Data and/or packaging relating thereto shall include the respective Third Party Notices set forth below and used as described below corresponding to the Territory (or portion thereof) included in such copy:

Country(ies) Notice

## Customer Information

Austria	“© Bundesamt für Eich- und Vermessungswesen”	Spain	“Información geográfica propiedad del CNIG”
Croatia Cyprus, Estonia, Latvia, Lithuania, Moldova, Poland, Slovenia and/or Ukraine	“© EuroGeographics”	Sweden	“Based upon electronic data © National Land Survey Sweden.”
France	“source: © IGN 2009 – BD TOPO ®”	Switzerland	“Topografische Grundlage: © Bundesamt für Landestopographie.
Germany	“Die Grundlagendaten wurden mit Genehmigung der zuständigen Behörden entnommen”	E. Respective Country Distribution. Client acknowledges that HERE has not received approvals to distribute map data for the following countries in such respective countries: Albania, Belarus, Kyrgyzstan, Moldova and Uzbekistan. HERE may update such list from time to time. The license rights granted to Client under this TL with respect to the Data for such countries are contingent upon Client’s compliance with all applicable laws and regulations, including, without limitation, any required licenses or approvals to distribute the Application incorporating such Data in such respective countries.	
Great Britain	“Contains Ordnance Survey data © Crown copyright and database right 2010 Contains Royal Mail data © Royal Mail copyright and database right 2010”	VI. Australia Territory	A. Third Party Notices. Any and all copies of the Data and/or packaging relating thereto shall include the respective Third Party Notices set forth below and used as described below corresponding to the Territory (or portion thereof) included in such copy:  Copyright. Based on data provided under license from PSMA Australia Limited (www.pasma.com.au).
Greece	“Copyright Geomatics Ltd.”		
Hungary	“Copyright © 2003; Top-Map Ltd.”		
Italy	“La Banca Dati Italiana è stata prodotta usando quale riferimento anche cartografia numerica ed al tratto prodotta e fornita dalla Regione Toscana.”		
Norway	“Copyright © 2000; Norwegian Mapping Authority”		
Portugal	“Source: IgeoE – Portugal”		

# Customer Information

---

Product incorporates data which is © 20XX Telstra Corporation Limited, GM Holden Limited, Intelomatics Australia Pty Ltd and Continental Pty Ltd.

B. Third Party Notices for Australia. In addition to the foregoing, the End-User Terms for any Application containing RDS-TMC Traffic Codes for Australia shall contain the following notice: “Product incorporates traffic location codes which is © 20XX Telstra Corporation Limited and its licensors.”

## **AT&T Vehicle Network Carrier Telematics Disclosure**

END USER FOR PURPOSES OF THIS SECTION MEANS YOU AND YOUR HEIRS, EXECUTORS, LEGAL PERSONAL REPRESENTATIVES AND PERMITTED ASSIGNS. FOR PURPOSES OF THIS SECTION “UNDERLYING WIRELESS SERVICE CARRIER” INCLUDES ITS AFFILIATES AND CONTRACTORS AND THEIR RESPECTIVE OFFICERS, DIRECTORS, EMPLOYEES, SUCCESSORS AND ASSIGNS. END USER HAS NO CONTRACTUAL RELATIONSHIP WITH THE UNDERLYING WIRELESS SERVICE CARRIER AND END USER IS NOT A THIRD PARTY BENEFICIARY OF ANY AGREEMENT BETWEEN FORD AND UNDERLYING CARRIER. END USER UNDERSTANDS AND AGREES THAT THE UNDERLYING CARRIER HAS NO LEGAL, EQUITABLE, OR OTHER LIABILITY OF ANY KIND TO END USER. IN ANY EVENT, REGARDLESS OF THE FORM OF THE ACTION, WHETHER FOR BREACH OF CONTRACT, WARRANTY, NEGLIGENCE, STRICT LIABILITY IN TORT OR OTHERWISE, END USER’S EXCLUSIVE REMEDY FOR CLAIMS ARISING IN ANY WAY IN CONNECTION WITH THIS AGREEMENT, FOR ANY CAUSE WHATSOEVER, INCLUDING BUT NOT LIMITED TO ANY FAILURE OR

DISRUPTION OF SERVICE PROVIDED HEREUNDER, IS LIMITED TO PAYMENT OF DAMAGES IN AN AMOUNT NOT TO EXCEED THE AMOUNT PAID BY END USER FOR THE SERVICES DURING THE TWO-MONTH PERIOD PRECEDING THE DATE THE CLAIM AROSE.

(ii) END USER AGREES TO INDEMNIFY AND HOLD HARMLESS THE UNDERLYING WIRELESS SERVICE CARRIER AND ITS OFFICERS, EMPLOYEES, AND AGENTS AGAINST ANY AND ALL CLAIMS, INCLUDING WITHOUT LIMITATION CLAIMS FOR LIBEL, SLANDER, OR ANY PROPERTY DAMAGE, PERSONAL INJURY OR DEATH, ARISING IN ANY WAY, DIRECTLY OR INDIRECTLY, IN CONNECTION WITH THIS AGREEMENT OR THE USE, FAILURE TO USE, OR INABILITY TO USE THE DEVICE EXCEPT WHERE THE CLAIMS RESULT FROM THE UNDERLYING CARRIER’S GROSS NEGLIGENCE OR WILLFUL MISCONDUCT. THIS INDEMNITY WILL SURVIVE THE TERMINATION OF THE AGREEMENT.

(iii) END USER HAS NO PROPERTY RIGHT IN ANY NUMBER ASSIGNED TO THE DEVICE.

(iv) END USER UNDERSTANDS THAT FORD AND THE UNDERLYING CARRIER CANNOT GUARANTY THE SECURITY OF WIRELESS TRANSMISSIONS, AND WILL NOT BE LIABLE FOR ANY LACK OF SECURITY RELATING TO THE USE OF THE SERVICES

THE SERVICE IS FOR [END USER’S] USE ONLY AND END USER MAY NOT RESELL THE SERVICE TO ANY OTHER PARTY END USER UNDERSTANDS THAT THE UNDERLYING CARRIER DOES NOT GUARANTEE ANY END USER UNINTERRUPTED SERVICE OR COVERAGE. THE UNDERLYING CARRIER DOES NOT WARRANT THAT END USERS CAN OR WILL BE LOCATED USING THE SERVICE. THE UNDERLYING CARRIER

# Customer Information

---

MAKES NO WARRANTY, EXPRESS OR IMPLIED, OF MERCHANTABILITY OR FITNESS FOR A PARTICULAR PURPOSE, SUITABILITY, OR PERFORMANCE REGARDING ANY SERVICES OR GOODS, AND IN NO EVENT SHALL AT&T BE LIABLE, WHETHER OR NOT DUE TO ITS OWN NEGLIGENCE, FOR ANY: (A) ACT OR OMISSION OF A THIRD PARTY; (B) MISTAKES, OMISSIONS, INTERRUPTIONS, ERRORS, FAILURES TO TRANSMIT, DELAYS, OR DEFECTS IN THE SERVICE PROVIDED BY OR THROUGH THE UNDERLYING CARRIER; (C) DAMAGE OR INJURY CAUSED BY SUSPENSION OR TERMINATION BY THE UNDERLYING CARRIER; OR (D) DAMAGE OR INJURY CAUSED BY A FAILURE OR DELAY IN CONNECTING A CALL TO ANY ENTITY, INCLUDING 911 OR ANY OTHER EMERGENCY SERVICE. TO THE FULL EXTENT ALLOWED BY LAW, THE END USER RELEASES, INDEMNIFIES AND HOLDS THE UNDERLYING CARRIER HARMLESS FROM AND AGAINST ANY AND ALL CLAIMS OF ANY PERSON OR ENTITY FOR DAMAGES OF ANY NATURE ARISING IN ANY WAY FROM OR RELATING TO, DIRECTLY OR INDIRECTLY, SERVICES PROVIDED BY THE UNDERLYING CARRIER OR ANY PERSON'S USE THEREOF, INCLUDING CLAIMS ARISING IN WHOLE OR IN PART FROM THE ALLEGED NEGLIGENCE OF THE UNDERLYING CARRIER.

## VII. China Territory

### *Personal Use Only*

You agree to use this Data together with [insert name of Client Application] for the solely personal, non-commercial purposes for which you were licensed, and not for service bureau, time-sharing or other similar purposes. Accordingly, but subject to the restrictions set forth in the following paragraphs, you may copy this Data only as necessary for your personal use to (i)

view it, and (ii) save it, provided that you do not remove any copyright notices that appear and do not modify the Data in any way. You agree not to otherwise reproduce, copy, modify, decompile, disassemble or reverse engineer any portion of this Data, and may not transfer or distribute it in any form, for any purpose, except to the extent permitted by mandatory laws.

### *Restrictions*

Except where you have been specifically licensed to do so by NAV2, and without limiting the preceding paragraph, you may not (a) use this Data with any products, systems, or applications installed or otherwise connected to or in communication with vehicles, capable of vehicle navigation, positioning, dispatch, real time route guidance, fleet management or similar applications; or (b) with or in communication with any positioning devices or any mobile or wireless-connected electronic or computer devices, including without limitation cellular phones, palmtop and handheld computers, pagers, and personal digital assistants or PDAs. You agree to cease using this Data if you fail to comply with these terms and conditions.

### *Limited Warranty*

NAV2 warrants that (a) the Data will perform substantially in accordance with the accompanying written materials for a period of ninety (90) days from the date of receipt, and (b) any support services provided by NAV2 shall be substantially as described in applicable written materials provided to you by NAV2, and NAV2's support engineers will make commercially reasonable efforts to solve any problem issues.

# Customer Information

---

## **Customer Remedies**

NAV2 and its suppliers' entire liability and your exclusive remedy shall be, at NAV2's sole discretion, either (a) return of the price paid, if any, or (b) repair or replacement of the Data that do not meet NAV2's Limited Warranty and that are returned to NAV2 with a copy of your receipt. This Limited Warranty is void if failure of the Data has resulted from accident, abuse, or misapplication. Any replacement Data will be warranted for the remainder of the original warranty period or thirty (30) days, whichever is longer. Neither these remedies nor any product support services offered by NAV2 are available without proof of purchase from an authorized international source.

## **No Other Warranty:**

EXCEPT FOR THE LIMITED WARRANTY SET FORTH ABOVE AND TO THE EXTENT PERMITTED BY APPLICABLE LAW, NAV2 AND ITS LICENSORS (INCLUDING THEIR LICENSORS AND SUPPLIERS) DISCLAIM ANY WARRANTIES, EXPRESS OR IMPLIED, OF QUALITY, PERFORMANCE, MERCHANTABILITY, FITNESS FOR A PARTICULAR PURPOSE, OWNERSHIP OR NON-INFRINGEMENT. Certain warranty exclusions may not be permitted under applicable law, so to that extent the above exclusion may not apply to you.

## **Limited Liability:**

TO THE EXTENT PERMITTED BY APPLICABLE LAW, NAV2 AND ITS LICENSORS (INCLUDING THEIR LICENSORS AND SUPPLIERS) SHALL NOT BE LIABLE TO YOU: IN RESPECT OF ANY CLAIM, DEMAND OR ACTION, IRRESPECTIVE OF THE NATURE OF THE CAUSE OF THE CLAIM, DEMAND OR ACTION ALLEGING ANY LOSS, INJURY OR DAMAGES, DIRECT OR INDIRECT, WHICH MAY RESULT FROM THE USE OR POSSESSION OF THE INFORMATION; OR

FOR ANY LOSS OF PROFIT, REVENUE, CONTRACTS OR SAVINGS, OR ANY OTHER DIRECT, INDIRECT, INCIDENTAL, SPECIAL OR CONSEQUENTIAL DAMAGES ARISING OUT OF YOUR USE OF OR INABILITY TO USE THIS INFORMATION, ANY DEFECT IN THE INFORMATION, OR THE BREACH OF THESE TERMS OR CONDITIONS, WHETHER IN AN ACTION IN CONTRACT OR TORT OR BASED ON A WARRANTY, EVEN IF NAV2 OR ITS LICENSORS HAVE BEEN ADVISED OF THE POSSIBILITY OF SUCH DAMAGES. UNDER NO CIRCUMSTANCES SHALL NAV2'S OR ITS SUPPLIERS' LIABILITY HEREUNDER EXCEED THE PRICE PAID. Certain liability exclusions may not be permitted under applicable law, so to that extent the above exclusion may not apply to you.

## **Export Control**

You agree not to export to anywhere any part of the Data provided to you or any direct product thereof except in compliance with, and with all licenses and approvals required under, applicable export laws, rules and regulations.

## **IP Protection**

The Data are owned by NAV2 or its suppliers and are protected by applicable copyright and other intellectual property law and treaties. The Data are provided solely on the basis of a license to use, not sale.

## **Entire Agreement**

These terms and conditions constitute the entire agreement between NAV2 (and its licensors, including their licensors and suppliers) and you pertaining to the subject matter hereof, and supersedes in their entirety any and all written or oral agreements previously existing between us with respect to such subject matter.

# Customer Information

---

## **Governing Law.**

The above terms and conditions shall be governed by the laws of the People's Republic of China, without giving effect to (i) its conflict of laws provisions, or (ii) the United Nations Convention for Contracts for the International Sale of Goods, which is explicitly excluded. Any dispute arising from or in connection with the Data provided to you hereunder shall be submitted to the Shanghai International Economic and Trade Arbitration Commission for arbitration.

## **Gracenote® Copyright**

CD and music-related data from Gracenote, Inc., copyright©

2000-2007 Gracenote. Gracenote Software, copyright © 2000-2007 Gracenote. This product and service may practice one or more of the following U.S. Patents 5,987,525; 6,061,680; 6,154,773; 6,161,132; 6,230,192; 6,230,207; 6,240,459; 6,330,593 and other patents issued or pending. Some services supplied under license from Open Globe, Inc. for U.S. Patent 6,304,523.

Gracenote and CDDb are registered trademarks of Gracenote. The Gracenote logo and logotype, and the "Powered by Gracenote™" logo are trademarks of Gracenote.

## **Gracenote® End User License Agreement (EULA)**

This device contains software from Gracenote, Inc. of 2000 Powell Street Emeryville, California 94608 ("Gracenote").

The software from Gracenote (the "Gracenote Software") enables this device to do disc and music file identification and obtain music-related information, including name, artist, track, and title information ("Gracenote Data") from online servers

("Gracenote Servers"), and to perform other functions. You may use Gracenote Data only by means of the intended End User functions of this device. This device may contain content belonging to Gracenote's providers. If so, all of the restrictions set forth herein with respect to Gracenote Data shall also apply to such content and such content providers shall be entitled to all of the benefits and protections set forth herein that are available to Gracenote. You agree that you will use the content from Gracenote ("Gracenote Content"), Gracenote Data, the Gracenote Software, and Gracenote Servers for your own personal, non-commercial use only. You agree not to assign, copy, transfer or transmit the Gracenote Content, Gracenote Software or any Gracenote Data (except in a Tag associated with a music file) to any third party. YOU AGREE NOT TO USE OR EXPLOIT GRACENOTE CONTENT, GRACENOTE DATA, THE GRACENOTE SOFTWARE, OR GRACENOTE SERVERS, EXCEPT AS EXPRESSLY PERMITTED HEREIN.

You agree that your non-exclusive licenses to use the Gracenote Content, Gracenote Data, the Gracenote Software, and Gracenote Servers will terminate if you violate these restrictions. If your licenses terminate, you agree to cease any and all use of the Gracenote Content, Gracenote Data, the Gracenote Software, and Gracenote Servers.

Gracenote, respectively, reserve all rights in Gracenote Data, the Gracenote Software, and the Gracenote Servers and Gracenote Content, including all ownership rights. Under no circumstances will either Gracenote become liable for any payment to you for any information that you provide,

# Customer Information

---

including any copyrighted material or music file information. You agree that Gracenote may enforce its respective rights, collectively or separately, under this agreement against you, directly in each company's own name.

Gracenote uses a unique identifier to track queries for statistical purposes. The purpose of a randomly assigned numeric identifier is to allow Gracenote to count queries without knowing anything about who you are. For more information, see the web page at [www.gracenote.com](http://www.gracenote.com) for the Gracenote Privacy Policy.

THE GRACENOTE SOFTWARE, EACH ITEM OF GRACENOTE DATA AND THE GRACENOTE CONTENT ARE LICENSED TO YOU "AS IS". NEITHER GRACENOTE MAKES ANY REPRESENTATIONS OR WARRANTIES, EXPRESS OR IMPLIED, REGARDING THE ACCURACY OF ANY GRACENOTE DATA FROM THE GRACENOTE SERVERS OR GRACENOTE CONTENT. GRACENOTE COLLECTIVELY AND SEPARATELY RESERVE THE RIGHT TO DELETE DATA AND/OR CONTENT FROM THE COMPANIES' RESPECTIVE SERVERS OR, IN THE CASE OF GRACENOTE, CHANGE DATA CATEGORIES FOR ANY CAUSE THAT GRACENOTE DEEMS SUFFICIENT. NO WARRANTY IS MADE THAT EITHER GRACENOTE CONTENT OR THE GRACENOTE SOFTWARE OR GRACENOTE SERVERS ARE ERROR-FREE OR THAT THE FUNCTIONING OF THE GRACENOTE SOFTWARE OR GRACENOTE SERVERS WILL BE UNINTERRUPTED. GRACENOTE IS NOT OBLIGATED TO PROVIDE YOU WITH ANY ENHANCED OR ADDITIONAL DATA TYPES THAT GRACENOTE MAY CHOOSE TO PROVIDE IN THE FUTURE AND IS FREE TO DISCONTINUE ITS ONLINE SERVICES AT ANY TIME. GRACENOTE DISCLAIMS ALL WARRANTIES EXPRESS OR IMPLIED, INCLUDING, BUT NOT LIMITED TO,

IMPLIED WARRANTIES OF MERCHANTABILITY, FITNESS FOR A PARTICULAR PURPOSE, TITLE, AND NON-INFRINGEMENT. NEITHER GRACENOTE WARRANTS THE RESULTS THAT WILL BE OBTAINED BY YOUR USE OF THE GRACENOTE SOFTWARE OR ANY GRACENOTE SERVER. IN NO CASE WILL GRACENOTE BE LIABLE FOR ANY CONSEQUENTIAL OR INCIDENTAL DAMAGES OR FOR ANY LOST PROFITS OR LOST REVENUES FOR ANY REASON WHATSOEVER. © Gracenote 2007.

## ***Taiwan Territory***

According to the "Technical Specifications for Low Power Radio Frequency Equipment" formulated by the National Communications and Communication Committee of the Executive Yuan: 3.8.2. For the low-power radio frequency equipment that has obtained the verification certificate, the company, firm or user shall not change the frequency, increase the power or change the characteristics and functions of the original design without authorization.

The use of low-power radio frequency equipment must not affect flight safety and interfere with legal communications: when the system detects interference, immediately stop using it until there is no interference.

The aforementioned legal communication refers to the wireless communication operated in accordance with the provisions of the Telecommunications Management Law. Low-power radio frequency equipment needs to endure the interference of legal communication or industrial, scientific and medical radio wave radiation electrical equipment.



# Customer Information

## SUNA TRAFFIC CHANNEL – TERMS AND CONDITIONS

By activating, using and/or accessing the SUNA Traffic Channel, SUNA Predictive or other content or material provided by Intelematics (together, **SUNA Products and/or Services**), you must accept certain terms and conditions. The following is a brief summary of the terms and conditions that apply to you. To view the full terms and conditions relevant to your use of the SUNA Products and/or Services, please consult:

Website
<a href="http://www.sunattraffic.com.au/termsandconditions/">www.sunattraffic.com.au/termsandconditions/</a>

### 1. Acceptance

By using SUNA Products and/or Services, you will be deemed to have accepted and agreed to be bound by the terms and conditions fully detailed at:

Website
<a href="http://www.sunattraffic.com.au/termsandconditions/">www.sunattraffic.com.au/termsandconditions/</a>

### 2. Intellectual Property

SUNA Products and/or Services are for your personal use. You may not record, or retransmit the content, nor use the content in association with any other traffic information or route guidance service or device not approved by Intelematics. You obtain no right of ownership in any Intellectual Property Rights (including copyright) in the data that is used to provide SUNA Products and/or Services.

### 3. Appropriate Use

SUNA Products and/or Services are intended as an aid to personal motoring and travel planning, and do not provide comprehensive or accurate information on all occasions. On occasions, you may experience additional delay as a result of using SUNA Products and/or Services. You acknowledge that it is not intended, or suitable, for use in applications where time of arrival or driving directions may impact the safety of the public or yourself.

### 4. Use of SUNA Products and Services while driving

You, and other authorized drivers of the vehicle in which SUNA Products and/or Services are available or installed and active, remain at all times responsible for observing all relevant laws and codes of safe driving. In particular, you agree to only actively operate SUNA Products and/or Services when the Vehicle is at a complete stop and it is safe to do so.

### 5. Service Continuity and Reception of the SUNA Traffic Channel

We will use reasonable endeavors to provide the SUNA Traffic Channel 24 hours a day, 365 days a year. The SUNA Traffic Channel may occasionally be unavailable for technical reasons or for planned maintenance. We will try to perform maintenance at times when congestion is light. We reserve the right to withdraw SUNA Products and/or Services at any time.

Also, we cannot assure the uninterrupted reception of the SUNA Traffic Channel RDS-TMC signal at any particular location.

### 6. Limitation of Liability

Neither Intelematics (nor its suppliers or the manufacturer of your device (the **"Suppliers"**)) shall be liable to you or to any third party for any damages either direct, indirect, incidental, consequential or otherwise arising out of the use of or inability to use SUNA Products and/or

# Customer Information

Services even if Intelematics or a Supplier has been advised of the possibility of such damages. You also acknowledge that neither Intelematics nor any Supplier guarantees nor make any warranties that relate to the availability, accuracy or completeness of SUNA Products and/or Services, and to the extent which it is lawful to do so, both Intelematics and each Supplier excludes any warranties which might otherwise be implied by any State or Federal legislation in relation to SUNA Products and/or Services.

## 7. Please Note

Great care has been taken in preparing this manual. Constant product development may mean that some information is not entirely up-to-date. The information in this document is subject to change without notice.

## EMISSION LAW



**WARNING:** Do not remove or alter the original equipment floor covering or insulation between it and the metal floor of the vehicle. The floor covering and insulation protect occupants of the vehicle from the engine and exhaust system heat and noise. On vehicles with no original equipment floor covering insulation, do not carry passengers in a manner that permits prolonged skin contact with the metal floor. Failure to follow these instructions may result in fire or personal injury.

U.S. federal laws and certain state laws prohibit removing or rendering inoperative emission control system components. Similar federal or provincial laws may apply in Canada. We do not approve of any vehicle modification without first determining applicable laws.



Tampering with emissions control systems including related sensors or the Diesel Exhaust Fluid system can result in reduced engine power and the illumination of the service engine soon light.

## Tampering With a Noise Control System

Federal laws prohibit the following acts:

- Removal or rendering inoperative by any person other than for purposes of maintenance.
- Repair or replacement of any device or element of the design incorporated into a new vehicle for the purpose of noise control prior to its sale or delivery to the ultimate purchaser or while it is in use.
- The use of the vehicle after any person removes or renders inoperative any device or element of the design.

The U.S. Environmental Protection Agency may presume to constitute tampering as follows:

- Removal of hood blanket, fender apron absorbers, fender apron barriers, underbody noise shields or acoustically absorptive material.
- Tampering or rendering inoperative the engine speed governor, to allow engine speed to exceed manufacturer specifications.

If the engine does not start, runs rough, experiences a decrease in engine performance, experiences excess fuel consumption or produces excessive exhaust smoke, check for the following:

- A plugged or disconnected air inlet system hose.
- A plugged engine air filter element.
- Water in the fuel filter and water separator.

# Customer Information

---

- A clogged fuel filter.
- Contaminated fuel.
- Air in the fuel system, due to loose connections.
- An open or pinched sensor hose.
- Incorrect engine oil level.
- Incorrect fuel for climatic conditions.
- Incorrect engine oil viscosity for climactic conditions.

**Note:** *Some vehicles have a lifetime fuel filter that is integrated with the fuel tank. Regular maintenance or replacement is not needed.*

**Note:** *If these checks do not help you correct the concern, have your vehicle checked as soon as possible.*

## Noise Emissions Warranty, Prohibited Tampering Acts and Maintenance

On January 1, 1978, Federal regulation became effective governing the noise emission on trucks over 10,000 lb (4,536 kg) Gross Vehicle Weight Rating (GVWR). The preceding statements concerning prohibited tampering acts and maintenance, and the noise warranty found in the Warranty Guide, are applicable to complete chassis cabs over 10,000 lb (4,536 kg) GVWR.

## EXPORT UNIQUE OPTIONS

For your particular global region, your vehicle may be equipped with features and options that are different from the features and options that are described in this Owner's Manual. A market unique supplement may be supplied that complements this book. By referring to the market unique supplement, if provided, you can properly identify those features, recommendations and specifications that are unique to your vehicle. This Owner's

Manual is written primarily for the U.S. and Canadian markets. Features or equipment listed as standard may be different on units built for export. **Refer to this Owner's Manual for all other required information and warnings.**

## WARRANTY INFORMATION

The following warranties may apply to your vehicle:

- New vehicle limited warranties.
- Emissions warranties, if applicable. (Note: Fully-electric vehicles are not eligible for emissions warranties.)
- Other warranties, if applicable.

Detailed warranty information specific to your vehicle can be found in the Warranty Guide at [www.owner.ford.com](http://www.owner.ford.com).

The following California Warranty Statement, required by California regulations, applies to vehicles certified to California emissions standards and registered in a state that requires California emissions warranty. If applicable, additional California Emissions Warranties can be found in the Warranty Guide at [www.owner.ford.com](http://www.owner.ford.com).

## CALIFORNIA EMISSION CONTROL WARRANTY STATEMENT

### YOUR WARRANTY RIGHTS AND OBLIGATIONS

The California Air Resources Board and Ford Motor Company are pleased to explain the emission control system warranty on your (year) vehicle. In California, new motor vehicles must be designated, built and equipped to meet

# Customer Information

---

the State's stringent anti-smog standards. Ford Motor Company must warrant the emission control system on your vehicle for the periods of time listed below provided there has been no abuse, neglect or improper maintenance of your vehicle.

Your emission control system may include parts such as the carburetor or fuel-injection system, the ignition system, catalytic converter and engine computer. Also included may be hoses, belts, connectors and other emission-related assemblies. Where a warrantable condition exists, Ford Motor Company will repair your vehicle at no cost to you including diagnosis, parts and labor.

## **MANUFACTURER'S WARRANTY COVERAGE:**

(For 1990 and subsequent model passenger cars, light-duty trucks, and medium-duty vehicles.)

- For 3 years or 50,000 miles (whichever occurs first);

1) If your vehicle fails a Smog Check inspection, all necessary repairs and adjustments will be made by Ford Motor Company to ensure that your emission control system **PERFORMANCE WARRANTY**.

2) If any emission-related part on your vehicle is defective, the part will be repaired or replaced by Ford Motor Company. This is your short-term emission control system **DEFECTS WARRANTY**.

- For 7 years or 70,000 miles (whichever occurs first);

1) If an emission-related part listed in this warranty booklet specially noted with coverage for 7 years or 70,000 miles is defective, the part will be repaired or replaced by Ford Motor Company. This is your long-term emission control system **DEFECTS WARRANTY**.

## **OWNER'S WARRANTY RESPONSIBILITIES:**

- As the vehicle owner, you are responsible for the performance of the required maintenance listed in your owner's manual. Ford Motor Company recommends that you retain all receipts covering maintenance on your vehicle, but Ford Motor Company cannot deny warranty solely for the lack of receipts or for your failure to ensure the performance of all scheduled maintenance.

- You are responsible for presenting your vehicle to a Ford or Lincoln dealer as soon as a problem exists. The warranty repairs should be completed in a reasonable amount of time, not to exceed 30 days.

- As the vehicle owner, you should also be aware that Ford Motor Company may deny you warranty coverage if your vehicle or a part has failed due to abuse, neglect, improper maintenance or unapproved modifications.

If you have any questions regarding your warranty rights and responsibilities, you should contact Ford Customer Service at 1-800-392-3673 or the California Air Resource Board at 9528 Telstar Avenue, El Monte, CA 91731.

# Appendices

## ELECTROMAGNETIC COMPATIBILITY



**WARNING:** Do not place objects or mount equipment on or near the airbag cover, on the side of the front or rear seatbacks, or in areas that may come into contact with a deploying airbag. Failure to follow these instructions may increase the risk of personal injury in the event of a crash.



**WARNING:** Keep antenna and power cables at least 4 in (10 cm) from any electronic modules and airbags.

**Note:** We test and certify your vehicle to meet electromagnetic compatibility legislation. It is your responsibility to make sure that any equipment an authorized dealer installs on your vehicle complies with applicable local legislation and other requirements. Installation of some aftermarket electronic devices could degrade the performance of vehicle functions, which use radio frequency signals such as broadcast radio receiver, tire pressure monitoring system, push button start, **Bluetooth®** connectivity or satellite navigation.

**Note:** Any radio frequency transmitter equipment in your vehicle, such as, cellular telephones and amateur radio transmitters, must keep to the parameters in the following illustrations and table. We do not provide any other special provisions or conditions for installations or use.

### Car

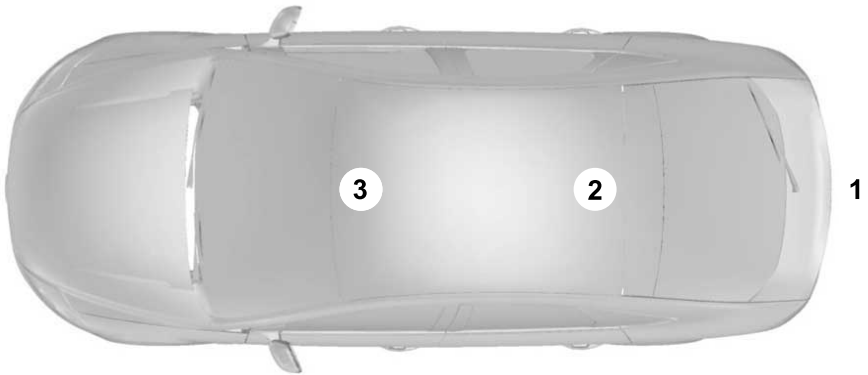

# Appendices

---

## Van



## Truck

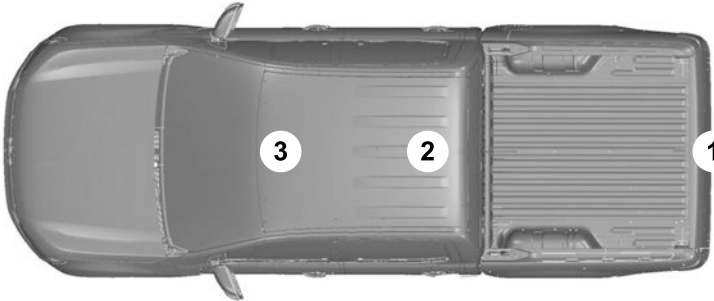

# Appendices

---

<b>Frequency Band MHz</b>	<b>Maximum Output Power Watt (Peak RMS)</b>	<b>Antenna Positions</b>
1-30	50	1
50-54	50	2, 3
68-88	50	2, 3
142-176	50	2, 3
380-512	50	2, 3
806-870	10	2, 3





# Index

## 1

12V Battery.....	455
12V Battery Precautions.....	455
Battery Management System	
Limitations.....	456
Changing the 12V Battery.....	456
How Does the Battery Management	
System Work.....	456
Recycling and Disposing of the 12V	
Battery.....	457
Resetting the Battery Sensor.....	457
What Is the Battery Management	
System.....	456
12V Battery – Troubleshooting.....	458
12V Battery – Information Messages.....	458
12V Battery – Warning Lamps.....	458

## 3

360 Degree Camera.....	288
360 Degree Camera Settings.....	290
360 Degree Camera Guide Lines.....	289
360 Degree Camera Precautions.....	288
360 Degree Camera Settings.....	290
Switching the 360 Degree Camera On and	
Off.....	290
Switching the 360 Degree Camera	
View.....	290

## 4

4WD	
See: Four-Wheel Drive.....	234

## 9

911 Assist.....	67
911 Assist Videos.....	68

## A

A/C	
See: Climate Control - Vehicles With:	
Automatic Temperature Control.....	148
See: Climate Control - Vehicles With: Manual	
Temperature Control.....	152
About This Publication.....	21

ABS	
See: Brakes.....	246
Accessing Apps.....	575
Accessing Navigation.....	579
Accessing the Passive Key Backup	
Position.....	204
Accessing the Trip Computer - Vehicles	
With: 12 Inch Screen.....	143
Accessing the Trip Computer - Vehicles	
With: 4.2 Inch Screen.....	143
Accessories.....	585
Adaptive Cruise Control.....	294
Adaptive Cruise Control –	
Troubleshooting.....	308
Lane Centering.....	301
Lane Centering – Troubleshooting.....	304
Predictive Speed Assist.....	305
Predictive Speed Assist –	
Troubleshooting.....	307
Adaptive Cruise Control Automatic	
Cancellation.....	297
Adaptive Cruise Control Indicators.....	301
Adaptive Cruise Control	
Limitations.....	295
Adaptive Cruise Control	
Precautions.....	294
Adaptive Cruise Control –	
Troubleshooting.....	308
Adaptive Cruise Control – Information	
Messages.....	308
Adaptive Cruise Control Videos.....	308
Adaptive Front Lighting.....	122
How Does Adaptive Front Lighting	
Work.....	122
Switching Adaptive Front Lighting On and	
Off.....	122
Adjustable Pedals.....	109
Adjusting the Exterior Mirrors.....	129
Adjusting the Headlamps.....	458
Adjusting the Instrument Panel Lighting	
Brightness.....	124
Adjusting the Integrated Trailer Brake	
Controller Mode.....	371
Adjusting the Map.....	579
Changing the Format of the Map.....	579
Zooming the Map In and Out.....	579
Adjusting the Pedals.....	109
Adjusting the Seatbelt Height.....	53

# Index

Adjusting the Seatbelt Length.....	54
Adjusting the Seatbelts During Pregnancy.....	53
Adjusting the Sound Settings.....	553
Adjusting the Steering Wheel - Vehicles With: Manual Adjustable Steering Column.....	106
Adjusting the Steering Wheel - Vehicles With: Power Adjustable Steering Column.....	106
Adjusting the Volume.....	553
After Driving Your Vehicle Off-Road.....	412
Aid Mode.....	317
How Does Aid Mode Work.....	317
What Is Aid Mode.....	317
Airbag Precautions.....	59
Airbags.....	57
Air Conditioning See: Climate Control - Vehicles With: Automatic Temperature Control.....	148
See: Climate Control - Vehicles With: Manual Temperature Control.....	152
Air Conditioning System Capacity and Specification.....	536
Alert and Aid Mode.....	317
How Does Alert and Aid Mode Work.....	318
What Is Alert and Aid Mode.....	317
Alert Mode.....	316
Adjusting the Steering Wheel Vibration Intensity.....	317
How Does Alert Mode Work.....	317
What Is Alert Mode.....	316
Alexa Built-In.....	567
Alexa Built-In Requirements.....	567
Alexa Built-In Settings.....	567
Ambient Lighting.....	124
Adjusting Ambient Lighting.....	124
Switching Ambient Lighting On and Off.....	124
Anti-Lock Braking System.....	246
Anti-Lock Braking System Limitations.....	246
Anti-Theft Alarm System.....	100
Arming the Anti-Theft Alarm System.....	101
Disarming the Anti-Theft Alarm System.....	101
How Does the Anti-Theft Alarm System Work.....	100
What Are the Inclination Sensors.....	101
What Are the Interior Sensors.....	100
What Is the Anti-Theft Alarm System.....	100
What Is the Battery Backup Alarm.....	101
What Is the Perimeter Alarm.....	100
Anti-Theft Alarm System Settings.....	101
Setting the Alarm Security Level.....	101
Switching Ask on Exit On and Off.....	101
What are the Alarm Security Levels.....	101
What Is Ask on Exit.....	101
Appendices.....	677
Applying the Electric Parking Brake.....	250
Applying the Electric Parking Brake in an Emergency.....	250
App Precautions.....	575
App Requirements.....	575
Approach Detection See: Switching Welcome Lighting On and Off.....	118
Apps.....	575
Audio System.....	552
Audio System – Troubleshooting.....	558
Digital Radio.....	554
FM Radio.....	554
Satellite Radio.....	556
Audio System Precautions.....	552
Audio System – Troubleshooting.....	558
Audio System – Information Messages.....	558
Auto-Dimming Interior Mirror.....	128
Auto-Dimming Interior Mirror Limitations.....	128
What Is the Auto-Dimming Interior Mirror.....	128
Auto Hold.....	263
Auto Hold Indicators.....	263
Autolamps.....	115
Autolamp Settings.....	115
What Are Autolamps.....	115
Autolock.....	78
Autolock Requirements.....	78
What Is Autolock.....	78
Automatically Releasing the Electric Parking Brake.....	251

# Index

Automatic Crash Shutoff.....	422	Automatic Transmission Fluid Capacity and Specification.....	538
Automatic Crash Shutoff		Automatic Transmission Position Indicators.....	231
Precautions.....	422	Automatic Transmission	
Re-Enabling Your Vehicle.....	422	Positions.....	230
What Is Automatic Crash Shutoff.....	422	Drive (D).....	230
Automatic Emergency Braking.....	339	Manual (M).....	231
Switching Automatic Emergency Braking		Neutral (N).....	230
On and Off.....	340	Park (P).....	230
What Is Automatic Emergency		Reverse (R).....	230
Braking.....	339	Automatic Transmission	
Automatic Engine Stop.....	203	Precautions.....	230
How Does Automatic Engine Stop		Auto Mode.....	150
Work.....	203	Switching Auto Mode On and Off.....	150
Overriding Automatic Engine Stop.....	203	Switching Dual Mode On and Off.....	150
Switching Automatic Engine Stop On and		Autounlock.....	78
Off.....	203	Autounlock Requirements.....	78
What Is Automatic Engine Stop.....	203	Switching Autounlock On and Off.....	78
Automatic High Beam Control.....	119	What Is Autounlock.....	78
Automatic High Beam Control		Autowipers.....	110
Indicators.....	121	Adjusting the Sensitivity of the Rain	
Automatic High Beam Control		Sensor.....	110
Limitations.....	120	Autowipers Settings.....	110
Automatic High Beam Control		What Are Autowipers.....	110
Precautions.....	120	Auxiliary Switches.....	586
Automatic High Beam Control			
Requirements.....	120		
How Does Automatic High Beam Control			
Work.....	119		
Overriding Automatic High Beam			
Control.....	121		
Switching Automatic High Beam Control			
On and Off.....	121		
Automatic High Beam Control –			
Troubleshooting.....	121		
Automatic High Beam Control –			
Information Messages.....	121		
Automatic Locking Mode.....	52		
Disengaging Automatic Locking Mode.....	53		
Engaging Automatic Locking Mode.....	52		
What Is Automatic Locking Mode.....	52		
When to Use Automatic Locking			
Mode.....	52		
Automatic Transmission Audible			
Warnings.....	231		
Automatic Transmission.....	230		
Automatic Transmission Positions.....	230		
Manually Shifting Gears.....	232		
Power Take-Off.....	232		

## B

Basic Off-Road Driving	
Techniques.....	409
Blind Spot Assist.....	319
Blind Spot Assist Limitations.....	319
How Does Blind Spot Assist Work.....	319
What Is Blind Spot Assist.....	319
Blind Spot Assist with Trailer	
Coverage.....	319
Blind Spot Assist with Trailer Coverage	
Indicators.....	320
Blind Spot Assist with Trailer Coverage	
Limitations.....	320
How Does Blind Spot Assist with Trailer	
Coverage Work.....	319
What Is Blind Spot Assist with Trailer	
Coverage.....	319
Blind Spot Information System.....	324
Blind Spot Information System –	
Troubleshooting.....	328

# Index

Blind Spot Information System With Trailer Coverage.....	325
Blind Spot Information System Indicators.....	327
Blind Spot Information System Limitations.....	324
Blind Spot Information System Precautions.....	324
Blind Spot Information System Requirements.....	324
Blind Spot Information System – Troubleshooting.....	328
Blind Spot Information System – Information Messages.....	328
Blind Spot Information System Videos.....	328
Blind Spot Information System With Trailer Coverage.....	325
Blind Spot Information System With Trailer Coverage Limitations.....	326
Selecting a Trailer.....	327
Setting a Trailer Length.....	326
What Is Blind Spot Information System with Trailer Coverage.....	325
Bluetooth®.....	574
Bonnet Lock	
See: Opening and Closing the Hood.....	439
Booster Seats.....	47
Brake Fluid Specification.....	247
Brake Over Accelerator.....	246
Brake Precautions.....	246
Brakes.....	246
Anti-Lock Braking System.....	246
Brakes – Troubleshooting.....	247
Brakes – Troubleshooting.....	247
Brakes – Frequently Asked Questions.....	249
Brakes – Information Messages.....	248
Brakes – Warning Lamps.....	247
Breaking-In.....	414
<b>C</b>	
Calculating Payload.....	350
Calculating the Load Limit.....	350
Canceling the Set Speed.....	271
Capacities and Specifications.....	520
Catalytic Converter.....	229
Catalytic Converter – Troubleshooting.....	229
Catalytic Converter Precautions.....	229
Catalytic Converter – Troubleshooting.....	229
Catalytic Converter – Warning Lamps.....	229
Center Console.....	193
Opening the Center Console.....	193
Center Console Work Surface.....	188
Center Console Work Surface – Troubleshooting.....	189
Center Console Work Surface – Troubleshooting.....	189
Center Console Work Surface – Information Messages.....	189
Center Display.....	562
Center Display Overview.....	562
Changing a Flat Tire.....	508
Changing a Road Wheel.....	508
Changing the Fuel Filter - Diesel.....	452
Changing the Fuel Filter - Gasoline.....	452
Changing the Language.....	142
Changing the Measurement Unit.....	142
Changing the Remote Control Battery - Vehicles With: Flip Key.....	71
Changing the Remote Control Battery - Vehicles With: Push Button Start.....	72
Changing the Temperature Unit.....	142
Changing the Tire Pressure Unit.....	142
Changing the Vehicle Wi-Fi Hotspot Name or Password.....	550
Charging a Device.....	178
Charging a Wireless Device.....	190
Checking the Brake Fluid.....	246
Checking the Seatbelts.....	56
Checking the Selective Catalytic Reduction System Status.....	226
Checking the Tire Pressures.....	489
Checking the Wiper Blades.....	111
Children and Airbags.....	64
Child Restraint Anchor Points.....	37
Locating the Child Restraint Lower Anchor Points.....	37
Locating the Child Restraint Top Tether Anchor Points.....	38

# Index

What Are the Child Restraint Anchor Points.....	37
Child Restraints.....	39
Child Restraint Position Information.....	39
Child Restraints Recommendation.....	40
Child Safety.....	36
Child Restraint Anchor Points.....	37
Child Restraints.....	39
Installing Child Restraints.....	40
Child Safety Locks - Crew Cab/ SuperCab.....	49
Child Safety Precautions.....	36
Cleaning Products.....	468
Cleaning the Exterior.....	469
Cleaning Camera Lenses and Sensors.....	470
Cleaning Chrome, Aluminium or Stainless Steel.....	469
Cleaning Headlamps and Rear Lamps.....	469
Cleaning Stripes or Graphics.....	470
Cleaning the Engine Compartment.....	470
Cleaning the Exhaust.....	471
Cleaning the Exterior Precautions.....	469
Cleaning the Underbody.....	471
Cleaning Wheels.....	469
Cleaning Windows and Wiper Blades.....	469
Cleaning the Interior.....	471
Cleaning Carpets and Floor Mats.....	473
Cleaning Displays and Screens.....	472
Cleaning Fabric.....	472
Cleaning Leather.....	472
Cleaning Moonroof Tracks.....	473
Cleaning Plastic.....	472
Cleaning Seatbelts.....	473
Cleaning the Instrument Panel.....	471
Cleaning Vinyl.....	473
Climate Control.....	148
Auto Mode.....	150
Climate Control Hints.....	150
Climate Control Videos.....	151
Closing the Tailgate.....	90
Closing the Tailgate From Inside Your Vehicle.....	90
Closing the Tailgate From Outside Your Vehicle.....	91
Closing the Tailgate Using the Remote Control.....	91
Cold Weather Precautions - 6.7L Diesel.....	413
Cold Weather Precautions - 6.8L/ 7.3L.....	413
Connected Navigation.....	579
Connected Vehicle.....	547
Connected Vehicle - Troubleshooting.....	548
Connecting the Vehicle to a Mobile Network.....	547
Connected Vehicle Data.....	28
Connected Vehicle Limitations.....	547
Connected Vehicle Requirements.....	547
Connected Vehicle Settings.....	548
Connected Vehicle - Troubleshooting.....	548
Connected Vehicle - Frequently Asked Questions.....	548
Connecting a Bluetooth® Device.....	574
Connecting a Trailer.....	358
Connecting a Trailer - Troubleshooting.....	361
Hitches.....	356
Connecting a Trailer Precautions.....	356
Connecting a Trailer - Troubleshooting.....	361
Connecting a Trailer - Information Messages.....	361
Connecting the Vehicle to a Mobile Network.....	547
Connecting FordPass to the Modem.....	547
Enabling and Disabling the Modem.....	547
What Is the Modem.....	547
Connecting the Vehicle to a Wi-Fi Network.....	547
Connecting Your Phone.....	569
Contacting Us.....	19
Coolant.....	449
Adding Coolant.....	449
Changing the Coolant.....	450
Checking the Coolant Level.....	449
Coolant - Information Messages.....	452
Coolant - Warning Lamps.....	451
Managing the Coolant Temperature.....	451
Cooling System Capacity and Specification - 6.7L Diesel.....	532

# Index

Cooling System Capacity and Specification - 6.8L, Gasoline.....	533
Cooling System Capacity and Specification - 7.3L, Gasoline.....	534
Crash and Breakdown Information.....	418
Automatic Crash Shutoff.....	422
Fail-Safe Cooling.....	424
Jump Starting the Vehicle.....	419
Post-Crash Alert System.....	421
Recovery Towing.....	422
Crash Sensors and Airbag Indicator.....	65
Creating a Personal Profile.....	577
Creating a Vehicle Wi-Fi Hotspot.....	550
Cross Traffic Alert.....	332
Cross Traffic Alert – Troubleshooting.....	334
Cross Traffic Alert Indicators.....	333
Cross Traffic Alert Limitations.....	332
Cross Traffic Alert Precautions.....	332
Cross Traffic Alert – Troubleshooting.....	334
Cross Traffic Alert – Information Messages.....	334
Cross Traffic Braking.....	259
Cross Traffic Braking – Troubleshooting.....	260
Cross Traffic Braking Indicators.....	260
Cross Traffic Braking Precautions.....	259
Cross Traffic Braking – Troubleshooting.....	260
Cross Traffic Braking – Frequently Asked Questions.....	261
Cross Traffic Braking – Information Messages.....	260
Cruise Control.....	292
Cruise Control Indicators.....	293
Cup Holders.....	192
Cup Holder Precautions.....	192
Customer Information.....	594
Radio Frequency Certification Labels.....	597
Customizing the Instrument Cluster Display – Vehicles With: 12 Inch Screen.....	141
Customizing the Instrument Cluster Display – Vehicles With: 4.2 Inch Screen.....	141

## D

Data Privacy.....	26
Deleting a Personal Profile.....	578
Department of Transportation Uniform Tire Quality Grades.....	477
Diesel Engine Exhaust Brake.....	253
Diesel Engine Exhaust Brake – Troubleshooting.....	254
Diesel Engine Exhaust Brake Gauge.....	254
Diesel Engine Exhaust Brake Indicators.....	254
Diesel Engine Exhaust Brake – Precautions.....	253
Diesel Engine Exhaust Brake – Troubleshooting.....	254
Diesel Engine Exhaust Brake – Warning Lamps.....	254
Diesel Exhaust Fluid Capacity and Specification.....	226
Diesel Exhaust Fluid Gauge.....	135
Diesel Particulate Filter.....	217
Diesel Particulate Filter Manual Regeneration.....	218
Diesel Particulate Filter – Troubleshooting.....	220
Diesel Particulate Filter Manual Regeneration.....	218
Diesel Particulate Filter Manual Regeneration Limitations.....	219
Diesel Particulate Filter Manual Regeneration Precautions.....	218
Diesel Particulate Filter Manual Regeneration Requirements.....	218
Starting Diesel Particulate Filter Manual Regeneration.....	219
What Is Diesel Particulate Filter Manual Regeneration.....	218
Diesel Particulate Filter Precautions.....	217
Diesel Particulate Filter Requirements.....	218
Diesel Particulate Filter – Troubleshooting.....	220
Diesel Particulate Filter – Information Messages.....	220

# Index

Diesel Particulate Filter – Warning Lamps.....	220
Digital Radio.....	554
Digital Radio Indicators.....	555
Digital Radio Limitations.....	555
How Does Digital Radio Work.....	555
Switching Digital Radio Reception On and Off.....	555
What Is Digital Radio.....	554
Dinghy Tow	
See: Recreationally Towing Your Vehicle - 4x2.....	427
See: Recreationally Towing Your Vehicle - 4x4.....	426
Directing the Flow of Air.....	150
Disposing of Airbags.....	66
Distance Alert.....	339
Adjusting the Sensitivity of Distance Alert.....	339
What Is Distance Alert.....	339
Distance Indication.....	338
Distance Indication Indicator.....	339
Switching Distance Indication On and Off.....	339
What Is Distance Indication.....	338
Doors and Locks Audible Warnings.....	78
Doors and Locks.....	77
Autolock.....	78
Autounlock.....	78
Doors and Locks – Troubleshooting.....	79
Mislock.....	78
Operating the Doors From Inside Your Vehicle.....	77
Operating the Doors From Outside Your Vehicle.....	77
Doors and Locks – Troubleshooting.....	79
Doors and Locks – Frequently Asked Questions.....	80
Doors and Locks – Information Messages.....	79
Doors and Locks – Warning Lamps.....	79
Draining the Fuel Filter Water Trap - Diesel.....	446
Drive Belt Routing Overview - 6.7L Diesel, Vehicles With: 110-120V 2kW Pickup Bed Power Outlet/Dual Generators.....	452
Drive Belt Routing Overview - 6.7L Diesel, Vehicles With: Dual Generators.....	453
Drive Belt Routing Overview - 6.7L Diesel, Vehicles With: Single Generator.....	453
Drive Belt Routing Overview - 6.8L, Gasoline, Vehicles With: Dual Generators.....	453
Drive Belt Routing Overview - 6.8L, Gasoline, Vehicles With: Single Generator.....	454
Drive Belt Routing Overview - 7.3L, Gasoline, Vehicles With: Dual Generators.....	454
Drive Belt Routing Overview - 7.3L, Gasoline, Vehicles With: Single Generator.....	455
Drive Mode Control.....	309
Drive Mode Control – Troubleshooting.....	312
Drive Modes.....	309
Drive Mode Control – Troubleshooting.....	312
Drive Mode Control – Frequently Asked Questions.....	314
Drive Mode Control – Information Messages.....	313
Drive Mode Control – Warning Lamps.....	312
Drive Modes.....	309
Eco.....	309
Normal.....	310
Off-Road.....	310
Rock Crawl.....	311
Slippery.....	311
Tow/Haul.....	312
Trail.....	312
Driver Alert.....	346
Driver Alert – Troubleshooting.....	347
Driver Alert Limitations.....	346
Driver Alert Precautions.....	346
Driver Alert – Troubleshooting.....	347
Driver Alert – Information Messages.....	347
Driving Economically.....	414
Driving Hints.....	413
Driving on Snow and Ice.....	413
Driving Through Mud and Water.....	414
Driving Through Water Limitations.....	410

# Index

Drowsiness Monitor  
See: Driver Alert.....346

## E

Easy Entry and Exit.....86

Electric Parking Brake Audible

Warning.....251

Electric Parking Brake.....250

Electric Parking Brake –  
Troubleshooting.....251

Electric Parking Brake –

Troubleshooting.....251

Electric Parking Brake – Information

Messages.....252

Electric Parking Brake – Warning

Lamps.....251

Electromagnetic Compatibility.....677

Electronic Locking Differential.....242

Electronic Locking Differential –  
Troubleshooting.....245

Electronic Locking Differential

Indicators.....244

Electronic Locking Differential

Precautions.....242

Electronic Locking Differential –

Troubleshooting.....245

Electronic Locking Differential –

Information Messages.....245

Emergency Call Limitations.....68

Emergency Call Requirements.....67

Emergency Call System Data.....29

Emergency Towing.....428

Emission Law.....674

Enabling Apps on an Android

Device.....575

Enabling Apps on an iOS Device.....575

Enabling or Disabling Personal

Profiles.....577

Enabling Remote Start.....146

End User License Agreement.....649

Engine Air Filter.....444

Changing the Engine Air Filter.....444

Engine Air Filter – Information

Messages.....446

Resetting the Air Filter Reminder.....445

Engine Block Heater.....200

Engine Block Heater Precautions.....200

How Does the Engine Block Heater

Work.....201

Using the Engine Block Heater.....201

Engine Coolant Temperature

Gauge.....135

Engine Oil Capacity and Specification –

6.7L Diesel.....526

Engine Oil Capacity and Specification –

6.8L, Gasoline.....528

Engine Oil Capacity and Specification –

7.3L, Gasoline.....530

Engine Oil.....443

Adding Engine Oil.....444

Checking the Engine Oil Level.....443

Engine Oil Capacity and

Specification.....444

Engine Oil Dipstick Overview.....443

Intelligent Oil Life Monitor.....444

Resetting the Intelligent Oil Life

Monitor.....444

Engine Oil Pressure Gauge.....135

Engine Oil Temperature Gauge.....135

Engine Specifications – 6.7L

Diesel.....520

Engine Specifications – 6.8L,

Gasoline.....521

Engine Specifications – 7.3L,

Gasoline.....522

Environment.....30

Evasive Steering Assist.....340

Evasive Steering Assist Limitations.....340

Switching Evasive Steering Assist On and

Off.....340

What Is Evasive Steering Assist.....340

Event Data.....27

Exit Warning.....329

Exit Warning – Troubleshooting.....331

Exit Warning Indicators.....330

Exit Warning Limitations.....329

Exit Warning Precautions.....329

Exit Warning – Troubleshooting.....331

Exit Warning – Information

Messages.....331

Export Unique Options.....675

Extending the Exterior Mirrors.....130

Extending the Remote Start

Duration.....147



# Index

Exterior Bulbs.....	460
Changing a Front Fog Lamp Bulb.....	464
Changing a Front Turn Signal Lamp Bulb.....	463
Changing a Headlamp Bulb.....	462
Changing a High Mounted Stoplamp Bulb.....	466
Changing a License Plate Lamp Bulb.....	466
Changing a Rear Lamp Bulb.....	464
Changing a Rear Turn Signal Lamp Bulb.....	465
Changing a Reversing Lamp Bulb.....	466
Changing a Stoplamp Bulb.....	465
Exterior Bulb Specification Chart.....	460
Removing a Rear Lamp Assembly.....	462
Exterior Lamps.....	115
Exterior Lamps On Audible Warning.....	118
How Do Cornering Lamps Work.....	116
Switching the Cargo Lamps On.....	117
Switching the Daytime Running Lamps On and Off.....	116
Switching the Spot Lamps On and Off.....	117
Switching Welcome Lighting On and Off.....	118
Using the Front Fog Lamps.....	117
Using the Turn Signal Lamps.....	115
Exterior Lighting Control.....	114
Exterior Lighting.....	114
Adaptive Front Lighting.....	122
Autolamps.....	115
Automatic High Beam Control.....	119
Automatic High Beam Control – Troubleshooting.....	121
Exterior Lamps.....	115
Exterior Zone Lighting.....	118
Headlamps.....	114
Headlamps – Troubleshooting.....	114
Exterior Lighting Videos.....	122
Exterior Mirrors.....	129
Exterior Zone Lighting.....	118
Exterior Zone Lighting Settings.....	119
Using the Exterior Zone Lighting.....	118
What Is Exterior Zone Lighting.....	118

## F

Fail-Safe Cooling.....	424
Driving When Fail-Safe Mode Is Activated.....	424
Fail-Safe Cooling Indicators.....	425
How Does Fail-Safe Cooling Work.....	424
What Is Fail-Safe Cooling.....	424
Fastening and Unfastening the Seatbelts.....	51
Feature Bar.....	563
Federal Highway Administration Regulation.....	648
Filling the Selective Catalytic Reduction System Tank.....	224
Filling the Selective Catalytic Reduction System Tank in Cold Weather.....	224
Filling the Selective Catalytic Reduction System Tank Using a Fuel Station Pump.....	225
Filling the Selective Catalytic Reduction System Tank Using a Portable Container.....	225
Flat Tire See: Changing a Flat Tire.....	508
Flat Tow See: Recreationally Towing Your Vehicle - 4x2.....	427
See: Recreationally Towing Your Vehicle - 4x4.....	426
Floor Mats.....	415
FM Radio.....	554
FM Radio Limitations.....	554
Selecting an FM Radio Station.....	554
Folding the Exterior Mirrors - Vehicles With: Manual Folding Mirrors.....	129
Folding the Exterior Mirrors - Vehicles With: Power Folding Mirrors.....	129
Foot Pedals See: Adjusting the Pedals.....	109
Ford Assistant.....	565
Ford Assistant – Frequently Asked Questions.....	565
Ford Assistant Settings.....	565
Using Ford Assistant.....	565
Ford Protect.....	587
Four-Wheel Drive.....	234
Four-Wheel Drive Modes.....	238

# Index

Four-Wheel Drive – Troubleshooting.....	239	Fuel Gauge.....	134
Four-Wheel Drive Indicators.....	238	Fuel Gauge Limitations.....	135
Four-Wheel Drive Limitations.....	235	Locating the Fuel Filler Door.....	135
Four-Wheel Drive Modes.....	238	What Is Distance to Empty.....	135
Four-Wheel Drive High.....	238	What Is the Fuel Gauge.....	134
Four-Wheel Drive Low.....	238	What Is the Low Fuel Reminder.....	135
Two-Wheel Drive High.....	238	Fuel Quality.....	209
Four-Wheel Drive Precautions.....	235	Selecting the Correct Fuel.....	209
Four-Wheel Drive –		Selecting the Correct Fuel for Cold	
Troubleshooting.....	239	Weather.....	211
Four-Wheel Drive – Information		Switching Between E85 and	
Messages.....	239	Gasoline.....	213
Four-Wheel Drive – Warning Lamps.....	239	Fuel Tank Capacity - Diesel.....	534
Four-Wheel Drive Videos.....	240	Fuel Tank Capacity.....	216
Four Wheels Down Tow		Fuel Tank Capacity - Gasoline.....	535
See: Recreationally Towing Your Vehicle -		Fuse Precautions.....	429
4x2.....	427	Fuses.....	429
See: Recreationally Towing Your Vehicle -		Fuses – Troubleshooting.....	438
4x4.....	426	Interior Fuse Box.....	434
Front Axle Fluid Capacity and		Under Hood Fuse Box.....	429
Specification.....	539	Fuses – Troubleshooting.....	438
Front Exterior.....	34	Fuses – Frequently Asked Questions.....	438
Front Parking Aid.....	282		
Front Parking Aid Audible Warnings.....	283	<b>G</b>	
Front Parking Aid Limitations.....	282	Garage Door Opener Additional	
Locating the Front Parking Aid		Assistance.....	177
Sensors.....	283	Garage Door Opener.....	174
What is the Front Parking Aid.....	282	Garage Door Opener Introduction.....	174
Front Seat Precautions.....	157	Garage Door Opener Precautions and	
Front Seats.....	157	Frequencies.....	174
Heated Seats.....	164	General Maintenance Information.....	589
Manual Seats.....	158	Glasses Holder.....	196
Massage Seats.....	163	Locating the Glasses Holder.....	196
Power Seats.....	160	Global Opening.....	125
Ventilated Seats.....	165	Switching Global Opening On and	
Front Seats Videos.....	165	Off.....	126
Fuel and Refueling.....	209	Using Global Opening.....	126
Fuel and Refueling –		What Is Global Opening.....	125
Troubleshooting.....	216	Glossary of Tire Terminology.....	483
Fuel Quality.....	209	Glove Compartment.....	192
Refueling.....	214	Locking the Glove Compartment.....	192
Running Out of Fuel.....	214	Opening the Glove Compartment.....	192
Fuel and Refueling Precautions.....	209		
Fuel and Refueling –		<b>H</b>	
Troubleshooting.....	216	Headlamp Adjusting	
Fuel and Refueling – Information		See: Adjusting the Headlamps.....	458
Messages.....	216		
Fuel and Refueling – Warning Lamps.....	216		

# Index

Headlamps.....	114	How Does 911 Assist Work.....	67
Adjusting the Level of the Headlamps.....	114	How Does Adaptive Cruise Control With Stop and Go Work.....	294
Headlamp Indicators.....	114	How Does Auto Hold Work.....	263
Using the High Beam Headlamps.....	114	How Does Blind Spot Information System Work.....	324
Headlamps – Troubleshooting.....	114	How Does Cross Traffic Alert Work.....	332
Headlamps – Frequently Asked Questions.....	114	How Does Cross Traffic Braking Work.....	259
Head Up Display.....	144	How Does Drive Mode Control Work.....	309
Head Up Display – Troubleshooting.....	145	How Does Driver Alert Work.....	346
Head Up Display Settings.....	144	How Does Easy Entry and Exit Work.....	86
Head Up Display – Troubleshooting.....	145	How Does Exit Warning Work.....	329
Head Up Display – Information Messages.....	145	How Does Four-Wheel Drive Work.....	234
Heated Seats.....	164	How Does Hill Descent Control Work.....	275
Heated Seat Precautions.....	164	How Does Hill Start Assist Work.....	262
Switching the Heated Seats On and Off.....	164	How Does Onboard Scales Work.....	381
Heating		How Does Pre-Collision Assist Work.....	335
See: Climate Control – Vehicles With: Automatic Temperature Control.....	148	How Does Reverse Brake Assist Work.....	255
See: Climate Control – Vehicles With: Manual Temperature Control.....	152	How Does Smart Hitch Work.....	379
Hill Descent Control.....	275	How Does Speed Sign Recognition Work.....	343
Hill Descent Control – Troubleshooting.....	276	How Does Stability Control Work.....	267
Hill Descent Control Indicator.....	275	How Does the 360 Degree Camera Work.....	288
Hill Descent Control Precautions.....	275	How Does the Diesel Particulate Filter Work.....	217
Hill Descent Control – Troubleshooting.....	276	How Does the Electronic Locking Differential Work.....	242
Hill Descent Control – Information Messages.....	276	How Does the Lane Keeping System Work.....	315
Hill Descent Control Videos.....	276	How Does the Rear Occupant Alert System Work.....	170
Hill Start Assist.....	262	How Does the Safety Canopy™ Work.....	58
Hill Start Assist – Troubleshooting.....	262	How Does the Selective Catalytic Reduction System Work.....	222
Hill Start Assist Precautions.....	262	How Does Traction Control Work.....	265
Hill Start Assist – Troubleshooting.....	262	How Does Trailer Backup Assistance Work.....	383
Hill Start Assist – Information Messages.....	262	How Does Trailer Hitching Assistance Work.....	375
Hill Start Assist Videos.....	262		
Hitches.....	356		
Fifth-Wheel Trailer Hitch.....	358		
Hooking Up a Trailer Using a Weight-Distributing Hitch.....	357		
Installing a Hitch.....	356		
Hood Lock			
See: Opening and Closing the Hood.....	439		
Horn.....	107		

# Index

How Does Trailer Reverse Guidance Work.....	398
How Does Trailer Sway Control Work.....	374
How Do Personal Profiles Work.....	577
How Do the Front Airbags Work.....	57
How Do the Side Airbags Work.....	57
Hydraulic Power Steering Fluid Capacity and Specification.....	545
Hydraulic Power Steering.....	277
Checking the Hydraulic Power Steering Fluid.....	278
Hydraulic Power Steering Guidelines.....	277
Locating the Hydraulic Power Steering Fluid Reservoir.....	278
<b>I</b>	
Icon Glossary	
See: Symbols Glossary.....	23
Icons	
See: Symbols Glossary.....	23
Identifying Fuse Types.....	438
Identifying the Audio Unit.....	552
Identifying the Climate Control Unit.....	148
Idle Timer.....	202
How Does Idle Timer Work.....	202
Idle Timer Precautions.....	203
Idle Timer Settings.....	203
What is Idle Timer.....	202
Ignition Switch.....	197
Inflating the Tires.....	489
Information On Demand Screen.....	563
Information on the Tire Sidewall.....	478
Inspecting the Tire for Damage.....	493
Inspecting the Tire for Wear.....	493
Inspecting the Wheel Valve Stems.....	497
Installing Child Restraints.....	40
Attaching the Front Seat Tether Strap.....	45
Attaching the Rear Seat Tether Strap.....	46
Combining the Seatbelt and Lower Anchors for Attaching Child Restraints.....	45
Installing a Child Restraint in a Center Seat.....	44
Using Lower Anchors and Tethers for Children.....	44
Using Seatbelts.....	40
Using Tether Straps.....	45
Instrument Cluster Display.....	140
Instrument Cluster Display Main Menu - Vehicles With: 12 Inch Screen.....	141
Instrument Cluster Display Main Menu - Vehicles With: 4.2 Inch Screen.....	140
Instrument Cluster Indicators.....	137
Instrument Cluster.....	133
Fuel Gauge.....	134
Instrument Cluster Overview - Vehicles With: 12 Inch Screen.....	134
Instrument Cluster Overview - Vehicles With: 4.2 Inch Screen.....	133
Instrument Cluster Warning Lamps.....	136
Instrument Panel.....	32
Integrated Trailer Brake Controller.....	369
Integrated Trailer Brake Controller - Troubleshooting.....	372
Integrated Trailer Brake Controller Precautions.....	369
Integrated Trailer Brake Controller - Troubleshooting.....	372
Integrated Trailer Brake Controller - Frequently Asked Questions.....	373
Integrated Trailer Brake Controller - Information Messages.....	372
Interior Air Quality.....	156
Interior Bulbs.....	467
Interior Bulb Specification Chart.....	467
Interior Fuse Box.....	434
Accessing the Interior Fuse Box.....	434
Identifying the Fuses in the Interior Fuse Box.....	435
Locating the Interior Fuse Box.....	434
Interior Lamp Function.....	123
Switching the Interior Lamp Function On and Off.....	123
What is the Interior Lamp Function.....	123
Interior Lighting.....	123
Ambient Lighting.....	124
Interior Lamp Function.....	123
Interior Lighting - Troubleshooting.....	124
Interior Lighting - Troubleshooting.....	124
Interior Lighting - Frequently Asked Questions.....	124

# Index

Interior Mirror.....	128
Auto-Dimming Interior Mirror.....	128
Interior Mirror Precautions.....	128
Introduction.....	21

## J

Jump Starting the Vehicle.....	419
Jump Starting Precautions.....	419
Jump Starting the Vehicle.....	420
Preparing the Vehicle.....	420

## K

Keyless Entry.....	81
Keyless Entry – Troubleshooting.....	82
Keyless Entry Keypad.....	83
Keyless Entry Keypad – Troubleshooting.....	85
Keyless Entry Keypad Limitations.....	83
Keyless Entry Keypad Master Access Code.....	83
Keyless Entry Keypad Personal Access Codes.....	84
Keyless Entry Keypad – Troubleshooting.....	85
Keyless Entry Keypad – Frequently Asked Questions.....	85
Keyless Entry Keypad Videos.....	85
Keyless Entry Limitations.....	81
Keyless Entry Settings.....	81
Keyless Entry – Troubleshooting.....	82
Keyless Entry – Frequently Asked Questions.....	82
Keyless Entry Videos.....	82
Keys and Remote Controls Audible Warnings - Vehicles With: Flip Key.....	76
Keys and Remote Controls Audible Warnings - Vehicles With: Push Button Start.....	76
Keys and Remote Controls.....	69
Keys and Remote Controls – Troubleshooting.....	76
Keys and Remote Controls – Troubleshooting.....	76
Keys and Remote Controls – Information Messages.....	76

## L

Lane Centering.....	301
How Does Lane Centering Work.....	301
Lane Centering Alerts.....	303
Lane Centering Automatic Cancellation.....	303
Lane Centering Indicators.....	304
Lane Centering Limitations.....	302
Lane Centering Manual Cancellation.....	303
Lane Centering Precautions.....	301
Lane Centering Requirements.....	302
Switching Lane Centering On and Off.....	302
Lane Centering – Troubleshooting.....	304
Lane Centering – Information Messages.....	304
Lane Keeping System Indicators.....	318
Lane Keeping System.....	315
Aid Mode.....	317
Alert and Aid Mode.....	317
Alert Mode.....	316
Blind Spot Assist.....	319
Blind Spot Assist with Trailer Coverage.....	319
Lane Keeping System – Troubleshooting.....	321
Lane Keeping System Limitations.....	315
Lane Keeping System Precautions.....	315
Lane Keeping System – Troubleshooting.....	321
Lane Keeping System – Frequently Asked Questions.....	322
Lane Keeping System – Information Messages.....	321
Launching or Retrieving a Boat or Personal Watercraft.....	364
Limited Slip Differential.....	241
Linking or Unlinking a Personal Profile.....	577
Live Traffic.....	579
Switching Live Traffic On and Off.....	579
What Is Live Traffic.....	579
Load Carrying.....	348
Load Carrying Precautions.....	348
Loading Your Trailer.....	363

# Index

Locating the 360 Degree Cameras.....	288
Locating the Auxiliary Switches.....	586
Locating the Blind Spot Information System Sensors.....	325
Locating the Brake Fluid Reservoir.....	246
Locating the Cross Traffic Alert Sensors.....	333
Locating the Exit Warning Sensors.....	330
Locating the Keyless Entry Keypad.....	83
Locating the Memory Function Buttons.....	173
Locating the Outlets.....	183
Locating the Power Outlets.....	180
Locating the Pre-Collision Assist Sensors.....	338
Locating the Rear View Camera.....	285
Locating the Safety Compliance Certification Labels.....	349
Locating the Tire label.....	477
Locating the USB Ports.....	178
Locating the Wireless Accessory Charger.....	190
Locating Your Vehicle.....	71
Locking the Rear Window Controls - Crew Cab/SuperCab.....	126

## M

Maintenance.....	439
12V Battery.....	455
12V Battery – Troubleshooting.....	458
Coolant.....	449
Engine Air Filter.....	444
Engine Oil.....	443
Exterior Bulbs.....	460
Interior Bulbs.....	467
Maintenance Precautions.....	439
Making and Receiving a Phone Call.....	571
Manually Dimming the Interior Mirror.....	128
Manually Releasing the Electric Parking Brake.....	250
Manually Shifting Gears.....	232
Shifting Using the Buttons on the Column Shifter.....	232

Manual Seats.....	158
Adjusting the Head Restraint.....	158
Adjusting the Lumbar Support.....	160
Adjusting the Seat Backrest.....	160
Folding the Seats.....	167
Head Restraint Components.....	158
Installing the Head Restraint.....	159
Moving the Seat Backward and Forward.....	159
Removing the Head Restraint.....	159
Unfolding the Seats.....	167
Massage Seats.....	163
Adjusting the Massage Seat Settings.....	164
Massage Seat Limitations.....	163
Memory Function.....	173
Memory Function Precautions.....	173
Mislock.....	78
Mislock Limitations.....	78
Switching Mislock On and Off.....	78
What Is Mislock.....	78
Mobile Communications Equipment.....	648
Mobile Device Data.....	29
Moonroof Bounce-Back.....	132
Overriding Moonroof Bounce-Back.....	132
What Is Moonroof Bounce-Back.....	132
Moonroof.....	131
Moonroof Bounce-Back.....	132
Moonroof Videos.....	132
Motorcraft Parts - 6.7L Diesel.....	523
Motorcraft Parts - 6.8L, Gasoline.....	524
Motorcraft Parts - 7.3L, Gasoline.....	525
Muting the Audio.....	553

## N

Navigation Map Updates.....	579
Navigation.....	579
Adjusting the Map.....	579
Live Traffic.....	579
Route Guidance.....	580
Setting a Destination.....	579
Waypoints.....	580
Neutral Towing	
See: Recreationally Towing Your Vehicle - 4x2.....	427
See: Recreationally Towing Your Vehicle - 4x4.....	426

# Index

Neutral Tow	
See: Recreationally Towing Your Vehicle - 4x2.....	427
See: Recreationally Towing Your Vehicle - 4x4.....	426
<b>O</b>	
Off-Road Driving.....	409
Onboard Generator Indicators.....	183
Onboard Generator.....	182
Onboard Generator – Troubleshooting.....	186
Onboard Generator Precautions.....	182
Onboard Generator – Troubleshooting.....	186
Onboard Generator – Frequently Asked Questions.....	187
Onboard Generator – Information Messages.....	186
Onboard Scales Limitations.....	381
Onboard Scales.....	381
Opening and Closing the Flip Key.....	70
Opening and Closing the Hood.....	439
Opening and Closing the Moonroof.....	131
Opening and Closing the Sliding Windows - Vehicles With: Power Sliding Rear Window.....	126
Opening and Closing the Sunshade.....	131
Opening and Closing the Windows.....	125
Opening the Tailgate.....	87
Opening the Tailgate From Inside Your Vehicle.....	90
Opening the Tailgate From Outside Your Vehicle.....	87
Opening the Tailgate Using the Remote Control.....	90
Operating the Doors From Inside Your Vehicle.....	77
Opening the Doors From Inside Your Vehicle.....	77
Unlocking and Locking the Doors Using the Central Locking.....	77
Operating the Doors From Outside Your Vehicle.....	77
Unlocking and Locking the Doors Using the Key Blade.....	77
Unlocking and Locking the Doors Using the Remote Control.....	77
Operating Your Vehicle With a Snowplow.....	416
Ordering a Canadian French Owner's Manual.....	595
OTA	
See: Software Update Settings.....	582
See: Vehicle Software Updates.....	582
Overriding Cross Traffic Braking.....	260
Overriding Reverse Brake Assist.....	256
Overriding the Set Speed.....	300
Over the air	
See: Software Update Settings.....	582
Over-the-air	
See: Software Update Settings.....	582
See: Vehicle Software Updates.....	582
See: Vehicle Software Updates.....	582
<b>P</b>	
Parking Aid Indicators.....	283
Parking Aid Precautions.....	280
Parking Aids.....	280
Front Parking Aid.....	282
Parking Aids – Troubleshooting.....	284
Rear Parking Aid.....	281
Parking Aids – Troubleshooting.....	284
Parking Aids – Information Messages.....	284
Parking Aids Videos.....	284
Passive Anti-Theft System.....	100
How Does the Passive Anti-Theft System Work.....	100
What Is the Passive Anti-Theft System.....	100
Perchlorate.....	647
Performing a System Reset.....	584
Personalized Settings.....	142
Personal Profiles.....	577
Phone Menu.....	569
Phone.....	569
Phone Precautions.....	569
Pickup Bed Anchor Points.....	353
Installing and Removing the Pickup Bed Tie-Down Cleats.....	354
Locating the Pickup Bed Anchor Points.....	353

# Index

Pickup Bed Anchor Point Load Capacities.....	354
Pickup Bed Anchor Point Precautions.....	353
Pickup Bed.....	353
Pickup Bed Anchor Points.....	353
Tailgate Anchor Points.....	355
Pickup Bed Precautions.....	353
Pickup Bed Videos.....	355
Playing Media Using Bluetooth®.....	574
Playing Media Using the USB Port.....	178
Playing or Pausing the Audio Source.....	552
Post-Collision Braking.....	421
Post-Crash Alert System.....	421
How Does the Post-Crash Alert System Work.....	421
Post-Crash Alert System Limitations.....	421
Switching the Post-Crash Alert System Off.....	421
What Is the Post-Crash Alert System.....	421
Power Outlet Indicators.....	181
Power Outlet Limitations.....	180
Power Outlet.....	180
Power Outlet Precautions.....	180
Power Outlet Videos.....	181
Power Running Board Precautions.....	104
Power Running Board Settings.....	104
Power Running Boards.....	104
Power Running Boards – Troubleshooting.....	105
Power Running Boards – Troubleshooting.....	105
Power Running Boards – Frequently Asked Questions.....	105
Power Seats.....	160
Adjusting the Head Restraint.....	161
Adjusting the Lumbar Support.....	163
Adjusting the Seat Backrest.....	162
Adjusting the Seat Cushion.....	162
Adjusting the Seat Height.....	163
Head Restraint Components.....	160
Installing the Head Restraint.....	162
Moving the Seat Backward and Forward.....	162
Removing the Head Restraint.....	161
Power Take-Off.....	232
How Does the Power Take-Off Work.....	232
What is the Split Shaft Capability.....	233
Power-Up	
See: Software Update Settings.....	582
See: Vehicle Software Updates.....	582
Pre-Collision Assist Limitations.....	336
Pre-Collision Assist Precautions.....	335
Pre-Collision Assist.....	335
Automatic Emergency Braking.....	339
Distance Alert.....	339
Distance Indication.....	338
Evasive Steering Assist.....	340
Pre-Collision Assist – Troubleshooting.....	341
Pre-Collision Assist – Troubleshooting.....	341
Pre-Collision Assist – Frequently Asked Questions.....	342
Pre-Collision Assist – Information Messages.....	341
Pre-Collision Assist – Warning Lamps.....	341
Pre-Collision Assist Videos.....	342
Predictive Speed Assist.....	305
Adjusting the Set Speed Tolerance.....	306
How Does Predictive Speed Assist Work.....	305
Predictive Speed Assist Alerts.....	306
Predictive Speed Assist Indicators.....	306
Predictive Speed Assist Limitations.....	306
Predictive Speed Assist Precautions.....	305
Switching Predictive Speed Assist Mode On and Off.....	306
Predictive Speed Assist – Troubleshooting.....	307
Predictive Speed Assist – Information Messages.....	307
Preparing Your Vehicle for Storage.....	475
Programming the Garage Door Opener.....	175
Programming the Remote Control – Vehicles With: Flip Key.....	74
Programming the Remote Control – Vehicles With: Push Button Start.....	75
Properly Adjusting the Driver and Front Passenger Seats.....	64
Protecting the Environment.....	30



# Index

Puncture	
See: Changing a Flat Tire.....	508
Push Button Ignition Switch.....	198
<b>R</b>	
Radio Frequency Certification	
Labels.....	597
Blind Spot Information System	
Sensors.....	597
Body Control Module.....	602
Cruise Control Module.....	604
Garage Door Opener.....	609
Keys and Remote Controls.....	609
Passive Anti-Theft System.....	611
Radio Transceiver Module.....	615
SYNC.....	617
Telematics Control Unit.....	623
Tire Pressure Monitoring System	
Sensors.....	626
Wireless Accessory Charging	
Module.....	640
Rear Axle Fluid Capacity and	
Specification.....	541
Rear Axle.....	241
Rear Cross Traffic Braking	
See: Cross Traffic Braking.....	259
Rear Exterior.....	35
Rear Occupant Alert System Audible	
Warnings.....	172
Rear Occupant Alert System	
Indicators.....	171
Rear Occupant Alert System	
Limitations.....	170
Rear Occupant Alert System	
Precautions.....	170
Rear Occupant Alert System.....	170
Rear Occupant Alert System	
Settings.....	171
Rear Parking Aid.....	281
Locating the Rear Parking Aid	
Sensors.....	281
Rear Parking Aid Audible Warnings.....	282
Rear Parking Aid Limitations.....	281
What is the Rear Parking Aid.....	281
Rear Seats.....	166
Heated Seats.....	168
Manual Seats.....	166
Rear View Camera Guide Lines.....	286
Rear View Camera Precautions.....	285
Rear View Camera.....	285
Rear View Camera Settings.....	286
Rear View Camera Settings.....	286
Switching Rear View Camera Delay On and	
Off.....	287
Zooming the Rear View Camera In and	
Out.....	286
Rebooting the Center Display.....	564
Recalling a Preset Position.....	173
Recovery Towing.....	422
Accessing the Front Towing Point.....	422
Recreationally Towing Your Vehicle -	
4x2.....	427
Recreationally Towing Your Vehicle -	
4x4.....	426
Refueling.....	214
Refueling System Overview.....	214
Refueling Your Vehicle.....	215
Releasing the Electric Parking Brake if	
the Vehicle Battery Has Run Out of	
Charge.....	251
Remote Control Limitations.....	69
Remotely Starting and Stopping the	
Vehicle.....	146
Remote Start Limitations.....	146
Remote Start Precautions.....	146
Remote Start.....	146
Remote Start Settings.....	147
Removing and Installing the	
Tailgate.....	87
Removing the Key Blade - Vehicles With:	
Push Button Start.....	70
Removing Your Vehicle From	
Storage.....	476
Repairing Minor Paint Damage.....	473
Replacement Parts	
Recommendation.....	647
Replacing a Lost Key or Remote	
Control.....	73
Replacing the Cabin Air Filter.....	156
Replacing the Front Wiper Blades.....	111
Reporting Safety Defects in	
Canada.....	596
Reporting Safety Defects in the United	
States.....	596
Resetting Ground Fault Detection.....	185

# Index

Resetting the Stopping Position - Vehicles With: Power Adjustable Steering Column.....	107
Resetting the Trip Computer.....	143
Resetting Tire Pressure Monitoring System.....	502
Resuming the Set Speed.....	293
Reverse Brake Assist Indicators.....	256
Reverse Brake Assist Precautions.....	255
Reverse Brake Assist.....	255
Reverse Brake Assist – Troubleshooting.....	257
Reverse Brake Assist – Troubleshooting.....	257
Reverse Brake Assist – Frequently Asked Questions.....	258
Reverse Brake Assist – Information Messages.....	257
Roadside Assistance.....	418
Rollover Warning.....	594
Route Guidance.....	580
Adjusting the Guidance Prompt Volume.....	580
Canceling Route Guidance.....	581
Repeating an Instruction.....	581
Running-In	
See: Breaking-In.....	414
Running Out of Fuel.....	214
Adding Fuel From a Portable Fuel Container.....	214
Filling a Portable Fuel Container.....	214
<b>S</b>	
Satellite Radio.....	556
Locating the Satellite Radio Identification Number.....	556
Satellite Radio Limitations.....	556
Satellite Radio Settings.....	557
Selecting a Channel.....	556
What Is Satellite Radio.....	556
Saving a Preset Position.....	173
Scheduled Maintenance.....	589
Seatbelt Extensions.....	56
Seatbelt Precautions.....	50
Seatbelt Reminder.....	54
How Does the Seatbelt Reminder Work.....	54
Seatbelt Reminder Audible Warnings.....	55
Seatbelt Reminder Indicators.....	55
Switching the Seatbelt Reminder On and Off.....	55
Seatbelts.....	50
Automatic Locking Mode.....	52
Seatbelt Reminder.....	54
Sensitive Locking Mode.....	52
SecuriCode	
See: Keyless Entry Keypad.....	83
Security.....	100
Anti-Theft Alarm System.....	100
Anti-Theft Alarm System Settings.....	101
Passive Anti-Theft System.....	100
Security – Troubleshooting.....	102
Security – Troubleshooting.....	102
Security – Frequently Asked Questions.....	103
Security – Information Messages.....	102
Selecting a Drive Mode.....	309
Selecting a Four-Wheel Drive Mode.....	237
Selecting a Personal Profile.....	578
Selecting the Audio Source.....	552
Selective Catalytic Reduction System Guidelines.....	224
Selective Catalytic Reduction System Precautions.....	222
Selective Catalytic Reduction System Requirements.....	224
Selective Catalytic Reduction System.....	222
Filling the Selective Catalytic Reduction System Tank.....	224
Selective Catalytic Reduction System – Troubleshooting.....	227
Selective Catalytic Reduction System – Troubleshooting.....	227
Selective Catalytic Reduction System – Information Messages.....	227
Selective Catalytic Reduction System – Warning Lamps.....	227
Sending and Receiving a Text Message.....	572
Sensitive Locking Mode.....	52
How Does Sensitive Locking Mode Work.....	52
What is Sensitive Locking Mode.....	52

# Index

Service Data.....	27	Calibrating the System.....	401
Setting a Destination.....	579	Configuring the Trailer.....	398
Setting a Destination Using a Point of Interest.....	580	Trailer Sensor Installation.....	400
Setting a Destination Using a Predictive Destination.....	580	Shifting Your Vehicle Into Gear.....	231
Setting a Destination Using a Recent Destination.....	580	Signing In to Your Account.....	567
Setting a Destination Using a Saved Destination.....	580	Sitting in the Correct Position.....	157
Setting a Destination Using the Map Screen.....	580	Smart Hitch Limitations.....	379
Setting a Destination Using the Text Entry Screen.....	579	Smart Hitch.....	379
Setting a Memory Preset.....	553	Snow Plowing Precautions.....	416
Settings Data.....	28	Snow Plowing.....	416
Settings.....	564	Software Update Indicators.....	583
Setting the Adaptive Cruise Control Gap.....	298	Software Update Settings.....	582
Setting the Adaptive Cruise Control Speed.....	297	Software Update.....	
Setting the Blower Motor Speed.....	149	See: Software Update Settings.....	582
Setting the Clock and Date.....	553	See: Vehicle Software Updates.....	582
Setting the Cruise Control Speed.....	292	Sounding the Panic Alarm.....	71
Setting the Hill Descent Speed.....	275	Speed Control.....	
Setting the Speed Sign Recognition Speed Tolerance.....	344	See: Cruise Control.....	292
Setting the Speed Sign Recognition Speed Warning.....	344	Speedometer.....	134
Setting the Temperature.....	149	Speed Sign Recognition Indicators.....	343
Setting the Trail Control Speed.....	270	Speed Sign Recognition Limitations.....	343
Setting Up the Trailer Backup Assistance for a Conventional Trailer.....	383	Speed Sign Recognition Precautions.....	343
Applying the Trailer Reversing Aid Sticker.....	385	Speed Sign Recognition.....	343
Calibrating the System.....	386	Speed Sign Recognition – Troubleshooting.....	344
Configuring the Trailer.....	383	Speed Sign Recognition – Troubleshooting.....	344
Trailer Sensor Installation.....	385	Speed Sign Recognition – Frequently Asked Questions.....	345
Setting Up the Trailer Backup Assistance for a Fifth-Wheel or Gooseneck Trailer.....	386	Speed Sign Recognition – Information Messages.....	344
Calibrating the System.....	388	Stability Control Indicator.....	269
Configuring the Trailer.....	386	Stability Control.....	267
Trailer Sensor Installation.....	388	Starter Switch.....	
Setting Up Trailer Reverse Guidance for a Conventional Trailer.....	398	See: Ignition Switch.....	197
Applying the Trailer Reverse Aid Sticker.....	400	Starting and Stopping the Engine – Precautions.....	197
		Starting and Stopping the Engine.....	197
		Automatic Engine Stop.....	203
		Engine Block Heater.....	200
		Idle Timer.....	202
		Starting and Stopping the Engine – Troubleshooting.....	204
		Starting the Engine.....	198
		Stopping the Engine.....	201

# Index

Starting and Stopping the Engine – Troubleshooting.....	204
Starting and Stopping the Engine – Frequently Asked Questions.....	206
Starting and Stopping the Engine – Information Messages.....	205
Starting and Stopping the Engine – Warning Lamps.....	204
Starting and Stopping the Engine Videos.....	208
Starting the Engine.....	198
Restarting the Engine After Stopping It.....	200
Starting a Diesel Engine.....	199
Starting a Gasoline Engine.....	198
Status Bar.....	562
Steering.....	277
Hydraulic Power Steering.....	277
Steering – Troubleshooting.....	279
Steering – Troubleshooting.....	279
Steering – Information Messages.....	279
Steering – Warning Indicators.....	279
Steering Wheel.....	31
Stopping the Engine.....	201
Stopping the Engine When Your Vehicle is Moving.....	201
Stopping the Engine When Your Vehicle is Stationary.....	201
Storage.....	192
Center Console.....	193
Cup Holders.....	192
Glasses Holder.....	196
Glove Compartment.....	192
Under Seat Storage.....	193
Storing Your Vehicle.....	475
Sunroof	
See: Moonroof.....	131
Switching Adaptive Cruise Control On and Off.....	297
Switching Air Conditioning On and Off.....	148
Switching All of the Interior Lamps On and Off.....	123
Switching Android Auto On and Off.....	576
Switching Apple CarPlay On and Off.....	576
Switching Auto Hold On and Off.....	263
Switching Blind Spot Information System On and Off.....	324
Switching Climate Control On and Off.....	148
Switching Cross Traffic Alert On and Off.....	333
Switching Cross Traffic Braking On and Off.....	260
Switching Cruise Control On and Off.....	292
Switching Defrost On and Off.....	148
Switching Driver Alert On and Off.....	346
Switching Easy Entry and Exit On and Off.....	86
Switching Exit Warning On and Off.....	330
Switching Four-Wheel Drive On and Off.....	236
Switching From Adaptive Cruise Control to Cruise Control.....	301
Switching Generator Mode On and Off.....	185
Switching Hill Descent Control On and Off.....	275
Switching Hill Start Assist On and Off.....	262
Switching Maximum Cooling On and Off.....	149
Switching Maximum Defrost On and Off.....	148
Switching Parking Aid On and Off - Vehicles With: Front Parking Aid.....	280
Switching Parking Aid On and Off - Vehicles With: Rear Parking Aid.....	281
Switching Pre-Collision Assist On and Off.....	337
Switching Recirculated Air On and Off.....	148
Switching Repeat Mode On and Off.....	553
Switching Reverse Brake Assist On and Off.....	256
Switching Shuffle Mode On and Off.....	553
Switching Stability Control On and Off.....	268
Switching Text Message Notification On and Off.....	573

# Index

Switching the Audio Unit On and Off.....	552
Switching the Display On and Off.....	554
Switching the Electronic Locking Differential On and Off - 4x2.....	244
Switching the Electronic Locking Differential On and Off - 4x4.....	242
Switching the Front Interior Lamps On and Off.....	123
Switching the Hazard Flashers On and Off.....	419
Switching the Head Up Display On and Off.....	144
Switching the Heated Mirrors On and Off.....	149
Switching the Heated Rear Window On and Off.....	149
Switching the Heated Steering Wheel On and Off - Vehicles With: Heated Steering Wheel.....	108
Switching the Lane Keeping System Mode.....	316
Switching the Lane Keeping System On and Off.....	316
Switching the Outlets On and Off.....	184
Switching the Passenger Airbag On and Off.....	60
Switching the Rear Interior Lamps On and Off.....	123
Switching Traction Control On and Off.....	265
Switching Trail Control On and Off.....	270
Switching Trailer Backup Assistance On and Off.....	389
Switching Trailer Hitching Assistance On and Off.....	376
Switching Trailer Reverse Guidance On and Off.....	401
Switching Trailer Sway Control On and Off.....	374
Switching Trail Turn Assist On and Off.....	273
Switching Utility Idle Mode On and Off.....	185
Symbols Glossary.....	23
Symbols Used on Your Vehicle.....	23
System Update See: Software Update Settings.....	582
See: Vehicle Software Updates.....	582
<b>T</b>	
Tachometer.....	134
Tailgate Anchor Points.....	355
Locating the Tailgate Anchor Points.....	355
Tailgate Anchor Point Load Capacities.....	355
Tailgate Precautions.....	87
Tailgate Step.....	88
Accessing the Tailgate Step.....	88
Stowing the Tailgate Step.....	89
Tailgate.....	87
Closing the Tailgate.....	90
Opening the Tailgate.....	87
Tailgate Step.....	88
Tailgate – Troubleshooting.....	94
Tailgate – Troubleshooting.....	94
Tailgate – Frequently Asked Questions.....	95
Tailgate – Information Messages.....	94
Tailgate Videos.....	89
Technical Specifications See: Capacities and Specifications.....	520
The Better Business Bureau Auto Line Program.....	594
The Mediation and Arbitration Program.....	595
Third Party Software Copyright Acknowledgment.....	597
Tire Care.....	489
Tire Pressure Monitoring System Limitations.....	501
Tire Pressure Monitoring System Overview.....	500
Tire Pressure Monitoring System Precautions.....	501
Tire Pressure Monitoring System.....	500
Tire Pressure Monitoring System – Troubleshooting.....	505
Tire Pressure Monitoring System – Troubleshooting.....	505
Tire Pressure Monitoring System – Information Messages.....	507

# Index

Tire Pressure Monitoring System – Warning Lamps.....	505
Tire Replacement Requirements.....	484
Tire Rotation.....	497
Towing a Trailer Limitations.....	363
Towing a Trailer Precautions.....	362
Towing a Trailer.....	362
Towing a Trailer – Troubleshooting.....	367
Towing Weights and Dimensions.....	365
Towing a Trailer – Troubleshooting.....	367
Towing a Trailer – Information Messages.....	367
Towing a Trailer Videos.....	368
Towing Weights and Dimensions.....	365
Calculating the Maximum Loaded Trailer Weight for Your Vehicle.....	366
Recommended Towing Weights.....	365
What Is the Maximum Loaded Trailer Weight.....	366
Towing Your Vehicle Precautions.....	426
Towing Your Vehicle.....	426
Towing Your Vehicle – Troubleshooting.....	428
Towing Your Vehicle – Troubleshooting.....	428
Towing Your Vehicle – Information Messages.....	428
Traction Control Indicator.....	265
Traction Control.....	265
Traction Control – Troubleshooting.....	266
Traction Control – Troubleshooting.....	266
Traction Control – Information Messages.....	266
Trail Control Indicators.....	271
Trail Control Limitations.....	270
Trail Control.....	270
Trail Control – Troubleshooting.....	272
Trail Control – Troubleshooting.....	272
Trail Control – Information Messages.....	272
Trailer Backup Assistance Precautions.....	383
Trailer Backup Assistance.....	383
Setting Up the Trailer Backup Assistance for a Conventional Trailer.....	383
Setting Up the Trailer Backup Assistance for a Fifth-Wheel or Gooseneck Trailer.....	386
Trailer Backup Assistance – Troubleshooting.....	392
Trailer Backup Assistance – Troubleshooting.....	392
Trailer Backup Assistance – Frequently Asked Questions.....	395
Trailer Backup Assistance – Information Messages.....	392
Trailer Brake Precautions.....	362
Trailer Hitching Assistance Indicators.....	377
Trailer Hitching Assistance Limitations.....	376
Trailer Hitching Assistance Precautions.....	375
Trailer Hitching Assistance.....	375
Trailer Lighting Check.....	360
Trailer Reverse Guidance Precautions.....	398
Trailer Reverse Guidance.....	398
Setting Up Trailer Reverse Guidance for a Conventional Trailer.....	398
Trailer Reverse Guidance – Troubleshooting.....	404
Trailer Reverse Guidance – Troubleshooting.....	404
Trailer Reverse Guidance – Frequently Asked Questions.....	406
Trailer Reverse Guidance – Information Messages.....	404
Trailer Sway Control Precautions.....	374
Trailer Sway Control.....	374
Trailer Sway Control Videos.....	374
Trailer Towing Hints.....	364
Trailer Towing Navigation.....	581
Trail Turn Assist Indicators.....	273
Trail Turn Assist Limitations.....	273
Trail Turn Assist Precautions.....	273
Trail Turn Assist.....	273
Trail Turn Assist – Troubleshooting.....	274
Trail Turn Assist – Troubleshooting.....	274
Trail Turn Assist – Frequently Asked Questions.....	274

# Index

Trail Turn Assist – Information Messages.....	274
Transfer Case Fluid Capacity and Specification.....	238
Transmission Fluid Temperature Gauge.....	135
Transporting the Vehicle.....	423
Trip Computer.....	143
Trip Data.....	143
Turbo Boost Gauge.....	135
<b>U</b>	
Under Hood Fuse Box.....	429
Accessing the Under Hood Fuse Box.....	429
Identifying the Fuses in the Under Hood Fuse Box.....	430
Locating the Under Hood Fuse Box.....	429
Under Hood Overview - 6.7L Diesel.....	440
Under Hood Overview - 6.8L, Gasoline.....	441
Under Hood Overview - 7.3L, Gasoline.....	442
Under Seat Storage.....	193
Locating the Under Seat Storage Compartment.....	193
USB Ports.....	178
Using Alexa Built-In.....	567
Using a Slide-In Camper.....	349
Using Auto Hold.....	263
Using Keyless Entry.....	81
Using Onboard Scales.....	381
Using Progressive Range Selection.....	231
Using Smart Hitch.....	379
Using Snow Chains.....	486
Using the Center Console Work Surface.....	188
Using the Diesel Engine Exhaust Brake.....	253
Using the Instrument Cluster Display Controls.....	140
Using the Integrated Trailer Brake Controller.....	369
Using the Keyless Entry Keypad.....	84
Using the Remote Control.....	69
Using the Trailer Backup Assistance Controller.....	389

Using the Trailer Backup Assistance Views.....	390
Using This Publication.....	22
Using Trailer Hitching Assistance.....	376
Using Trailer Reverse Guidance Views.....	402

## V

Vehicle Care.....	468
Cleaning the Exterior.....	469
Cleaning the Interior.....	471
Vehicle Care Videos.....	474
Vehicle Identification Number.....	546
Locating the Vehicle Identification Number.....	546
Vehicle Identification Number Overview.....	546
Vehicle Identification.....	546
Vehicle Identification Number.....	546
Vehicle Interior.....	33
Vehicle Software Updates.....	582
Vehicle System Reset.....	584
Vehicle Wi-Fi Hotspot – Troubleshooting.....	551
Vehicle Wi-Fi Hotspot – Frequently Asked Questions.....	551
Vehicle Wi-Fi Hotspot.....	550
Vehicle Wi-Fi Hotspot – Troubleshooting.....	551
Ventilated Seats.....	165
Switching the Ventilated Seats On and Off.....	165
Ventilated Seat Precautions.....	165
Ventilation	
See: Climate Control - Vehicles With: Automatic Temperature Control.....	148
See: Climate Control - Vehicles With: Manual Temperature Control.....	152
Venting the Moonroof.....	132
Viewing the Tire Pressures.....	502
Visual Search.....	31
Voice Interaction.....	565
Ford Assistant.....	565
<b>W</b>	
Warranty Information.....	675

# Index

Washer Fluid Specification.....	536	What Is the Electronic Locking Differential.....	242
Washers.....	112	What Is the Gross Axle Weight Rating.....	349
Adding Washer Fluid.....	112	What Is the Gross Combined Weight Rating.....	349
Switching the Courtesy Wipe On and Off.....	112	What Is the Gross Vehicle Weight Rating.....	349
Using the Windshield Washer.....	112	What Is the Head Up Display.....	144
Washer Fluid Specification.....	112	What Is the Integrated Trailer Brake Controller.....	369
Washer Precautions.....	112	What Is the Keyless Entry Keypad.....	83
Washers		What Is the Lane Keeping System.....	315
See: Wipers and Washers.....	110	What Is the Memory Function.....	173
Water Wading.....	411	What Is the Onboard Generator.....	182
Waxing Your Vehicle.....	474	What Is the Power Outlet.....	180
Waypoints.....	580	What Is the Rear Occupant Alert System.....	170
Adding a Waypoint.....	580	What Is the Rear View Camera.....	285
Editing Waypoints.....	580	What Is the Selective Catalytic Reduction System.....	222
What Are the Auxiliary Switches.....	586	What Is the Tire Pressure Monitoring System.....	500
What Are the Instrument Cluster Indicators.....	137	What Is the Wireless Accessory Charger.....	190
What Are the Instrument Cluster Warning Lamps.....	135	What Is Traction Control.....	265
What Is 911 Assist.....	67	What Is Trail Control.....	270
What Is a Connected Vehicle.....	547	What Is Trailer Backup Assistance.....	383
What Is Alexa Built-In.....	567	What Is Trailer Hitching Assistance.....	375
What Is Blind Spot Information System.....	324	What Is Trailer Reverse Guidance.....	398
What Is Cross Traffic Alert.....	332	What Is Trail Turn Assist.....	273
What Is Cross Traffic Braking.....	259	What Is Utility Idle Mode.....	185
What Is Cruise Control.....	292	Wheel and Tire Information.....	477
What Is Drive Mode Control.....	309	Wheel Nuts.....	518
What Is Driver Alert.....	346	Wi-Fi	
What Is Exit Warning.....	329	See: Changing the Vehicle Wi-Fi Hotspot Name or Password.....	550
What Is Ford Protect.....	587	See: Connecting the Vehicle to a Wi-Fi Network.....	547
What Is Generator Mode.....	185	See: Creating a Vehicle Wi-Fi Hotspot.....	550
What Is Hill Descent Control.....	275	See: Vehicle Wi-Fi Hotspot.....	550
What Is Hill Start Assist.....	262	Window Bounce-Back.....	126
What Is Onboard Scales.....	381	Overriding Window Bounce-Back.....	126
What Is Pre-Collision Assist.....	335	What Is Window Bounce-Back.....	126
What Is Remote Start.....	146	Windows Videos.....	127
What Is Reverse Brake Assist.....	255	Windows.....	125
What Is Smart Hitch.....	379	Global Opening.....	125
What Is Speed Sign Recognition.....	343		
What Is the 360 Degree Camera.....	288		
What Is the Cabin Air Filter.....	156		
What Is the Catalytic Converter.....	229		
What Is the Diesel Particulate Filter.....	217		
What Is the Electric Parking Brake.....	250		



# Index

---

Window Bounce-Back.....	126
Wipers and Washers – Troubleshooting.....	113
Wipers and Washers – Frequently Asked Questions.....	113
Wipers and Washers – Warning Lamps.....	113
Wipers and Washers Videos.....	112
Wipers and Washers.....	110
Autowipers.....	110
Washers.....	112
Wipers.....	110
Wipers and Washers – Troubleshooting.....	113
Wipers.....	110
Switching Windshield Wipers On and Off.....	110
Wiper Precautions.....	110
Wireless Accessory Charger Precautions.....	190
Wireless Accessory Charger Videos.....	191
Wireless Accessory Charger.....	190



