



2022

**UX 250h**

OWNER'S MANUAL QUICK GUIDE

The Quick Guide is not intended as a substitute for your *OWNER'S MANUAL*. We strongly encourage you to review the *OWNER'S MANUAL* and supplementary manuals so you will have a better understanding of your vehicle's capabilities and limitations.

# Contents

<b>Pictorial Index</b> .....	<b>3</b>
<b>Hybrid System</b>	
Hybrid System.....	11
<b>For safe use</b>	
Floor Mat Installation.....	14
<b>Entering and Exiting</b>	
Keys.....	15
Smart Access System with Push-button Start.....	17
<b>When Driving</b>	
Front Seats.....	18
Power (Ignition) Switch.....	19
EV Drive Mode.....	22
Hybrid Transmission.....	23
Turn Signal Lever.....	26
Parking Brake.....	27
Brake Hold.....	29
Multi-information Display.....	30
Head-up Display.....	33
Headlights.....	36
AHB (Automatic High Beam).....	37
Fog Light Switch.....	39
Windshield Wipers and Washer.....	40
Rear Window Wiper and Washer.....	42

## Driving Comfort

Remote Touch.....	43
Energy Monitor/Consumption Screen.....	48
Navigation System*.....	51
Hands-free System For Cellular Phone*.....	53
Audio System*.....	57
Lexus Climate Concierge.....	64
Air Conditioning System*.....	65

## Interior features

Voice Command System*.....	68
USB/AUX Ports.....	76
Garage Door Opener.....	77

## Lexus Enform

Lexus Enform Safety Connect.....	81
Lexus Enform Remote.....	83
Lexus Enform Service Connect.....	84

## Audio

SiriusXM Satellite Radio.....	85
-------------------------------	----

## Opening and Closing

Door Locks.....	86
Back Door.....	87
Fuel Tank Cap.....	90

## What to do if...

List of Warning/Indicator Lights.....	91
If the electronic key does not operate properly.....	95
If the hybrid system will not start.....	97

\*: These features may be operated by Voice Command (See P.68)

Depending on specifications, the vehicle shown in the illustration may differ from your vehicle in terms of equipment.

# Pictorial Index

## Instrument panel

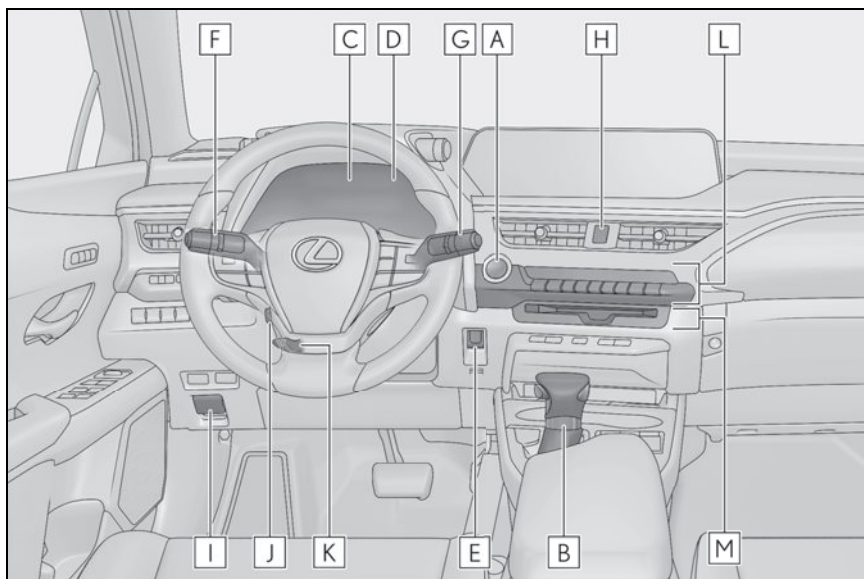

<b>A</b>	<b>Power switch</b> .....	<b>P.19</b>
	Starting the hybrid system/changing the mode .....	P.19, 20
	Emergency stop of the hybrid system .....	P.21
	When the hybrid system will not start .....	P.96
	Warning messages *1	
<b>B</b>	<b>Shift lever</b> .....	<b>P.23</b>
	Changing the shift position.....	P.23
	Precautions against towing *1	
	When the shift lever does not move *1	
<b>C</b>	<b>Meters</b> *1	
	Reading the meters/adjusting the instrument panel lights *1	
	Warning lights/indicator lights .....	P.91
	When the warning lights come on *1	
<b>D</b>	<b>Multi-information display</b> .....	<b>P.30</b>
	Display.....	P.30
	Energy monitor.....	P.48
	When the warning messages are displayed *1	

<b>E</b>	<b>Parking brake switch</b> .....	<b>P.27</b>
	Applying/releasing.....	P.27
	Precautions against winter season <sup>*1</sup>	
	Warning buzzer/message <sup>*1</sup>	
<b>F</b>	<b>Turn signal lever</b> .....	<b>P.26</b>
	<b>Headlight switch</b> .....	<b>P.36</b>
	Headlights/parking lights/tail lights/license plate lights/ daytime running lights.....	P.36
	AHB (Automatic High Beam).....	P.37
	Fog lights <sup>*2</sup> .....	P.39
<b>G</b>	<b>Windshield wiper and washer switch</b> .....	<b>P.40</b>
	<b>Rear window wiper and washer switch</b> .....	<b>P.42</b>
	Usage.....	P.40, 42
	Adding washer fluid <sup>*1</sup>	
	Headlight cleaners <sup>*2</sup> .....	P.40
	Warning messages <sup>*1</sup>	
<b>H</b>	<b>Emergency flasher switch</b> <sup>*1</sup>	
<b>I</b>	<b>Hood lock release lever</b> <sup>*1</sup>	
<b>J</b>	<b>Tilt and telescopic steering control switch</b> <sup>*1,2</sup>	
	Adjustment <sup>*1</sup>	
	Driving position memory <sup>*1,2</sup>	
<b>K</b>	<b>Tilt and telescopic steering lock release lever</b> <sup>*1,2</sup>	
	Adjustment <sup>*1</sup>	
<b>L</b>	<b>Air conditioning system</b> .....	<b>P.65</b>
	Usage.....	P.66
	Rear window defogger.....	P.65
<b>M</b>	<b>Audio system</b> .....	<b>P.57</b>

\*1: Refer to the "OWNER'S MANUAL".

\*2: If equipped

## ■ Switches

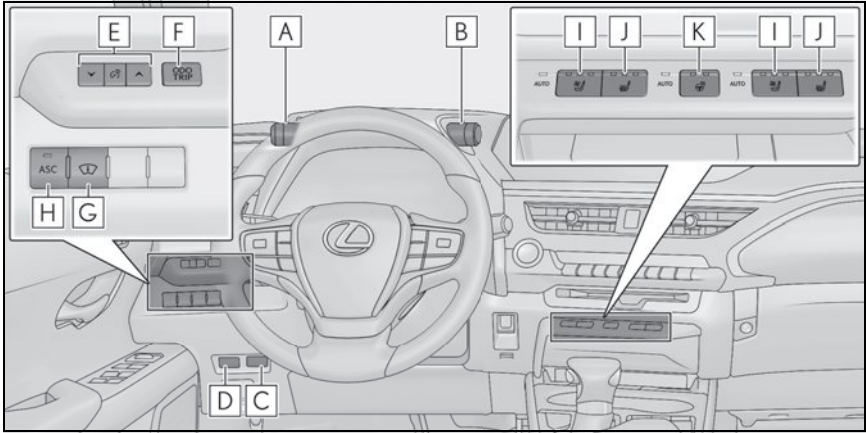

- A** VSC off switch \*1
- B** Driving mode select switch \*1
- C** Fuel filler door opener switch ..... P.90
- D** Power back door switch \*2 ..... P.87
- E** Instrument panel light control switches \*1
- F** Odometer/trip meter and trip meter reset button \*1
- G** Head-up display switch \*2 ..... P.33
- H** ASC switch \*1,2
- I** Seat ventilator switches \*1,2
- J** Seat heater switches \*1,2
- K** Heated steering wheel switch \*1,2

\*1: Refer to the "OWNER'S MANUAL".

\*2: If equipped

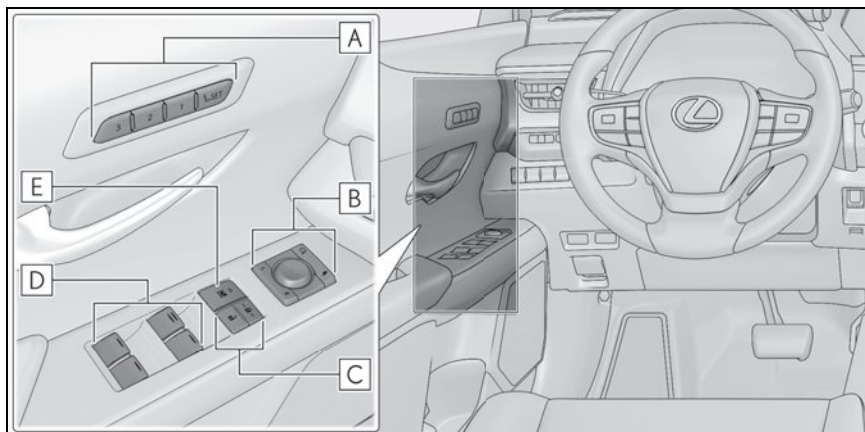

- A** Driving position memory switches \*1,2
- B** Outside rear view mirror switches \*2
- C** Door lock switches ..... P.86
- D** Power window switches \*2
- E** Window lock switch \*2

\*1: If equipped

\*2: Refer to the "OWNER'S MANUAL".

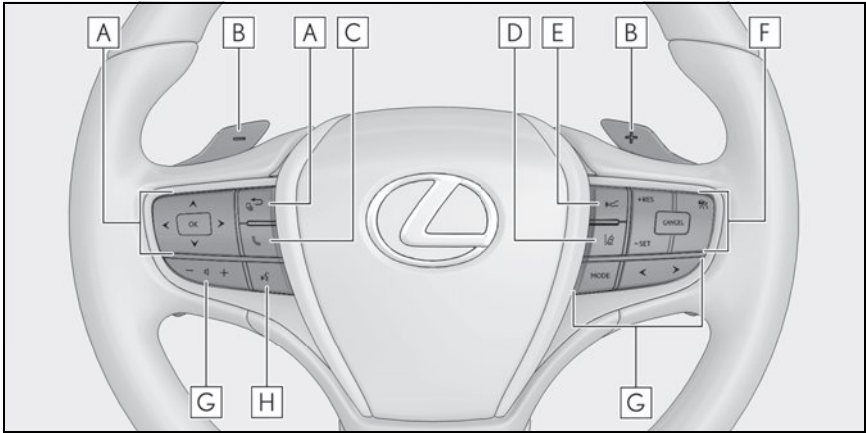

<b>A</b>	Meter control switches .....	P.32
<b>B</b>	Paddle shift switches *1 .....	P.24, 25
<b>C</b>	TEL switch.....	P.56
<b>D</b>	LTA (Lane Tracing Assist) switch *2	
<b>E</b>	Vehicle-to-vehicle distance switch *2	
<b>F</b>	Cruise control switches *2	
	Dynamic radar cruise control with full-speed range *2	
<b>G</b>	Audio remote control switches.....	P.58
<b>H</b>	Talk switch .....	P.56

\*1: If equipped

\*2: Refer to the "OWNER'S MANUAL".



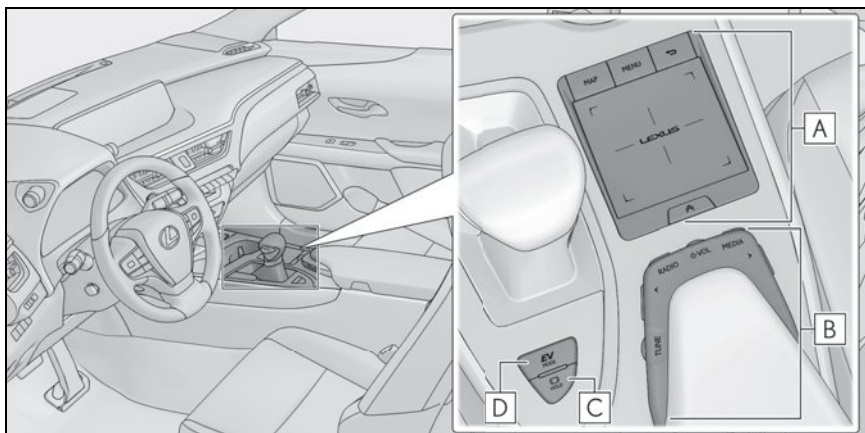

- A** Remote Touch ..... P.43
- B** Audio control switches ..... P.57
- C** Brake hold switch ..... P.29
- D** EV drive mode switch..... P.22

## ■ Interior

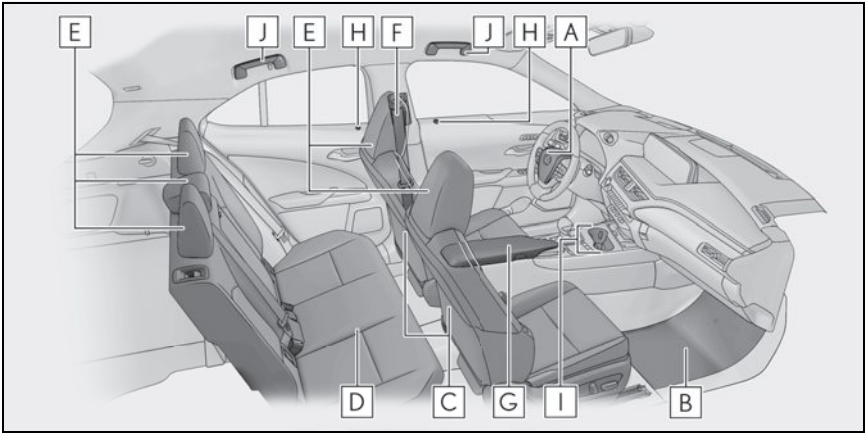

- A** SRS airbags\*
- B** Floor mats ..... P.14
- C** Front seats ..... P.18
- D** Rear seats\*
- E** Head restraints\*
- F** Seat belts\*
- G** Console box\*
- H** Inside lock buttons ..... P.86
- I** Cup holder\*
- J** Assist grips\*

\*: Refer to the "OWNER'S MANUAL".

## ■ Ceiling

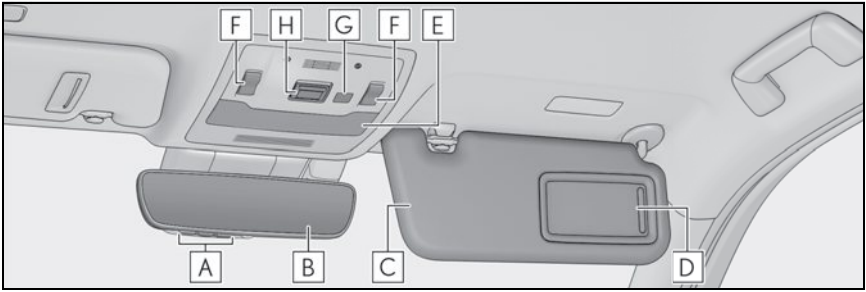

- A** Garage door opener buttons <sup>\*1</sup> .....P.77
- B** Inside rear view mirror <sup>\*2</sup>
- C** Sun visors <sup>\*2</sup>
- D** Vanity mirrors <sup>\*2</sup>
- E** Interior light <sup>\*2,3</sup>  
Personal lights <sup>\*2</sup>
- F** Moon roof switches <sup>\*1,2</sup>
- G** Door-linked interior light switch <sup>\*2</sup>
- H** "SOS" button <sup>\*1</sup> .....P.81

\*1: If equipped

\*2: Refer to the "OWNER'S MANUAL".

\*3: The illustration shows the front, but they are also equipped in the rear.

## Hybrid System

Your vehicle is a hybrid vehicle. It has characteristics different from conventional vehicles. Be sure you are closely familiar with the characteristics of your vehicle, and operate it with care.

The hybrid system combines the use of a gasoline engine and an electric motor (traction motor) according to driving conditions, improving fuel efficiency and reducing exhaust emissions.

For details, refer to the "OWNER'S MANUAL".

## Hybrid System Indicator

### ▶ Except F SPORT models

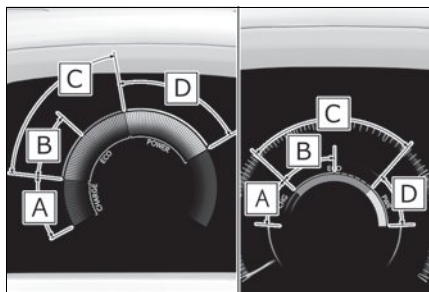

### ▶ F SPORT models

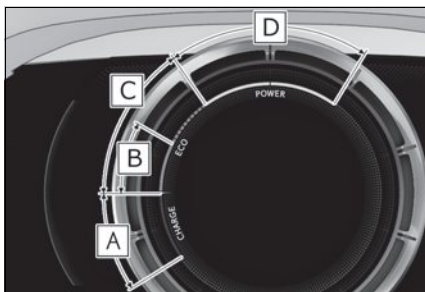

#### **A** Charge area

Shows regeneration\* status. Regenerated energy will be used to charge the hybrid battery (traction battery).

\*: When used in this manual, regeneration refers to the conversion of energy created by the movement of the vehicle into electrical energy.

#### **B** Hybrid Eco area

Shows that gasoline engine power is not being used very often.

The gasoline engine will automatically stop and restart under various conditions.

#### **C** Eco area

Shows that the vehicle is being driven in an Eco-friendly manner.

By keeping the bar display within Eco area, more Eco-friendly driving can be achieved.

#### **D** Power area

Shows that an Eco-friendly driving range is being exceeded (during full power driving etc.)

## Hybrid battery (traction battery) charge

If the shift lever is in N, the hybrid battery (traction battery) will not be charged even when the engine is running. Therefore, if the vehicle is left with the shift lever in N for a long period of time, the hybrid battery (traction battery) will discharge, and this may result in the vehicle not being able to start.

## Regenerative braking

In the following situations, kinetic energy is converted to electric energy and deceleration force can be obtained in conjunction with the recharging of the hybrid battery (traction battery).

- The accelerator pedal is released while driving with the shift lever in D or S.
- The brake pedal is depressed while driving with the shift lever in D or S.

## Sounds and vibrations specific to a hybrid vehicle

There may be no engine sound or vibration even though the vehicle is able to move with the "READY" indicator is illuminated. For safety, apply the parking brake and make sure to shift the shift lever to P when parked.

The following sounds or vibrations may occur when the hybrid system is operating and are not a malfunction:

- Motor sounds may be heard from the engine compartment.
- Sounds may be heard from the hybrid battery (traction battery) behind the rear seats when the hybrid system starts or stops.
- Relay operating sounds such as a snap or soft clank will be emitted from the hybrid battery (traction battery), behind the rear seats, when the hybrid system is started or stopped.
- Sounds from the hybrid system may be heard when the back door is open.
- Sounds may be heard from the hybrid transmission when the gasoline engine starts or stops, when driving at low speeds, or during idling.
- Engine sounds may be heard when accelerating sharply.
- Sounds may be heard due to regenerative braking when the brake pedal is depressed or as the accelerator pedal is released.
- Vibration may be felt when the gasoline engine starts or stops.
- Cooling fan sounds may be heard from the air intake vent under the right side of the rear seat.

## Running out of fuel

When the vehicle has run out of fuel and the hybrid system cannot be started, refuel the vehicle with at least enough gasoline to make the low fuel level warning light go off. If there is only a small amount of fuel, the hybrid system may not be able to start. (The standard amount of fuel is about 1.8 gal. [7.0 L, 1.5 Imp.gal.], when the vehicle is on a level surface. This value may vary when the vehicle is on a slope. Add extra fuel when the vehicle is inclined.)

## Hybrid warning message

A message is automatically displayed when a malfunction occurs in the hybrid system or an improper operation is attempted.



If a warning message is shown on the multi-information display, read the message and follow the instructions.

## Floor Mat Installation

Use only floor mats designed specifically for vehicles of the same model and model year as your vehicle. Fix them securely in place onto the carpet.

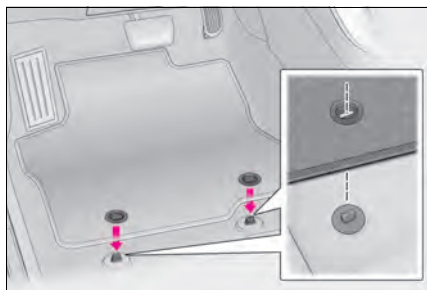

- 1** Insert the retaining hooks (clips) into the floor mat eyelets.

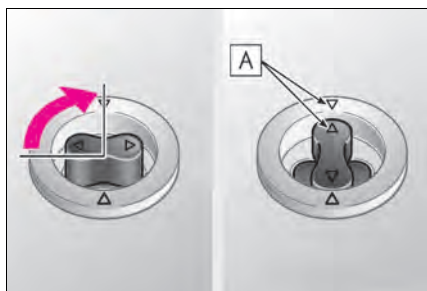

- 2** Turn the upper knob of each retaining hook (clip) to secure the floor mats in place.

Always align the  $\triangle$  marks **A**.

The shape of the retaining hooks (clips) may differ from that shown in the illustration.

# Keys

## Electronic key

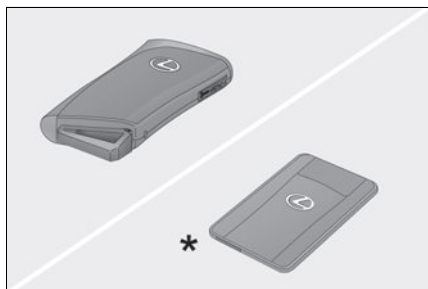

- Smart access system with push-button start (→P.17)
- Wireless remote control
- \*: If equipped

## Mechanical key

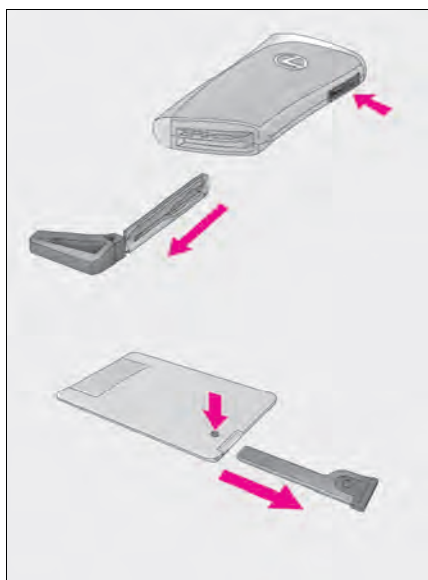

To take out the mechanical key, push the release button and take the key out.

The mechanical key can only be inserted in one direction, as the key only has grooves on one side. If the key cannot be inserted in a lock cylinder, turn it over and re-attempt to insert it.

After using the mechanical key, store it in the electronic key. Carry the mechanical key together with the electronic key. If the electronic key battery is depleted or the entry function does not operate properly, you will need the mechanical key.



## Wireless remote control

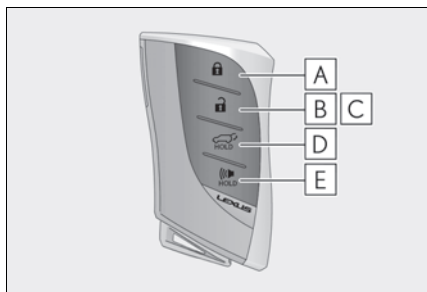

- A** Locks all the doors
- B** Unlocks all the doors
- C** Opens the windows and moon roof<sup>\*1,2</sup>
- D** Opens and closes the power back door<sup>\*1</sup>
- E** Sounds the alarm

<sup>\*1</sup>: If equipped

<sup>\*2</sup>: This setting must be customized at your Lexus dealer.

## Smart Access System with Push-button Start

The following operations can be performed simply by carrying the electronic key on your person, for example in your pocket. The driver should always carry the electronic key.

For details on starting the hybrid system, see page 19.

### Unlocking and locking the doors from the outside

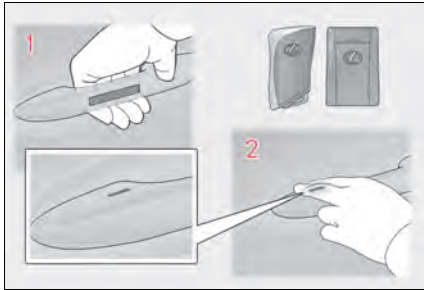

- 1** Grip the driver's door handle to unlock the door. Holding the driver's door handle for approximately 2 seconds unlocks all the doors. Grip the front passenger door handle to unlock all the doors.\*

Make sure to touch the sensor on the back of the handle.

The doors cannot be unlocked for 3 seconds after the doors are locked.

\*: The door unlock settings can be changed.

- 2** Touch the lock sensor (the indentation on the upper part of the front door handle) to lock all the doors.

Check that the door is securely locked.

### Unlocking and locking the back door from the outside

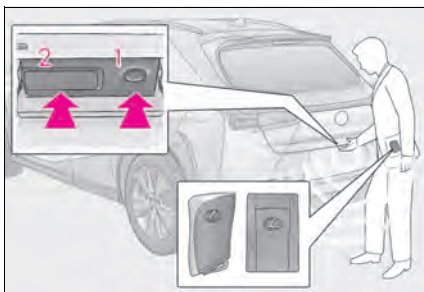

- 1** Locks all the doors  
Check that the door is securely locked.
- 2** Unlocks all the doors  
The doors cannot be unlocked for 3 seconds after the doors are locked.

For details on what to do when the electronic key does not operate properly, see page 95.

## Front Seats

### Adjustment procedure

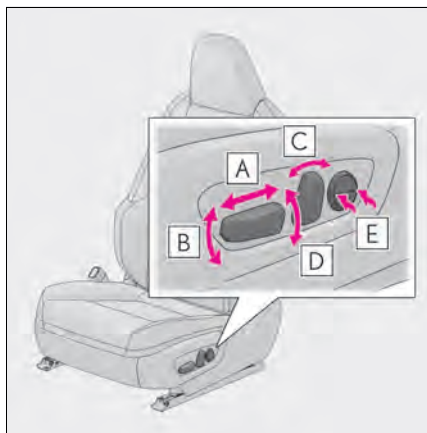

- A** Seat position adjustment switch
- B** Seat cushion (front) angle adjustment switch
- C** Seatback angle adjustment switch
- D** Vertical height adjustment switch
- E** Lumbar support adjustment switch (for driver's side)

## Power (Ignition) Switch

Performing the following operations when carrying the electronic key on your person starts the hybrid system or changes power switch modes.

### Starting the hybrid system

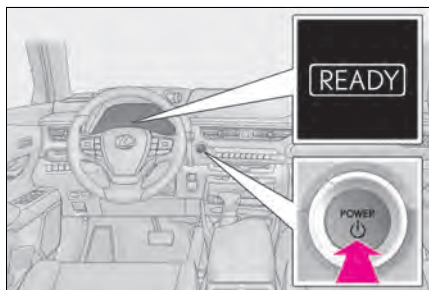

- 1 Press the parking brake switch to check that the parking brake is set. (→P.27)

Parking brake indicator will come on.

- 2 Check that the shift lever is in P
- 3 Firmly depress the brake pedal.

 and a message will be displayed on the multi-information display. If it is not displayed, the hybrid system cannot be started.

- 4 Press the power switch shortly and firmly.

When operating the power switch, one short, firm press is enough. It is not necessary to press and hold the switch.

If the "READY" indicator turns on, the hybrid system will operate normally.

Continue depressing the brake pedal until the "READY" indicator is illuminated.

The hybrid system can be started from any power switch mode.

- 5 Check that the "READY" indicator is illuminated.

The vehicle will not move when the "READY" indicator is off.

## Stopping the hybrid system

- 1 Stop the vehicle completely.
- 2 Set the parking brake (→P.27), and shift the shift lever to P. (→P.23)
- 3 Press the power switch.
- 4 Release the brake pedal and check that “ACCESSORY” or “IGNITION ON” is not shown on the meter.

## Changing power switch modes

Modes can be changed by pressing the power switch with the brake pedal released. (The mode changes each time the switch is pressed.)

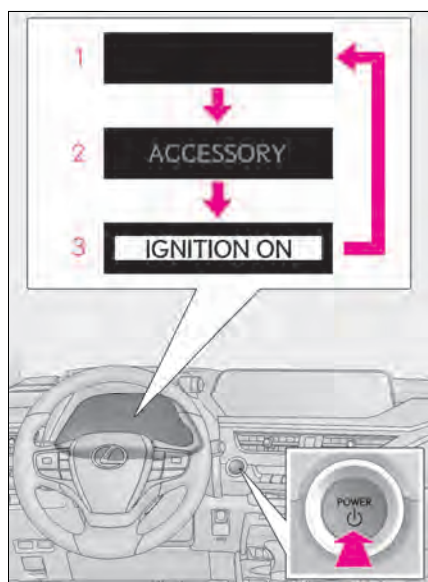

- 1 OFF\*  
The emergency flashers can be used.
  - 2 ACC  
Some electrical components such as the audio system can be used.  
“ACCESSORY” will be displayed on the meter.
  - 3 ON  
All electrical components can be used.  
“IGNITION ON” will be displayed on the meter.
- \*: If the shift lever is in a position other than P when turning off the hybrid system, the power switch will be turned to ACC, not to OFF.

## If your vehicle has to be stopped in an emergency

Only in an emergency, such as if it becomes impossible to stop the vehicle in the normal way, stop the vehicle using the following procedure:

- 1** Steadily step on the brake pedal with both feet and firmly depress it.  
Do not pump the brake pedal repeatedly as this will increase the effort required to slow the vehicle.
- 2** Shift the shift lever to N.
- ▶ **If the shift lever is shifted to N**
- 3** After slowing down, stop the vehicle in a safe place by the road.
- 4** Stop the hybrid system.
- ▶ **If the shift lever cannot be shifted to N**
- 3** Keep depressing the brake pedal with both feet to reduce vehicle speed as much as possible.

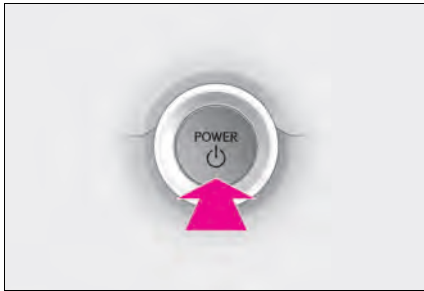

- 4** To stop the hybrid system, press and hold the power switch for 2 consecutive seconds or more, or press it briefly 3 times or more in succession.

- 5** Stop the vehicle in a safe place by the road.

## EV Drive Mode

In EV drive mode, electric power is supplied by the hybrid battery (traction battery), and only the electric motor (traction motor) is used to drive the vehicle.

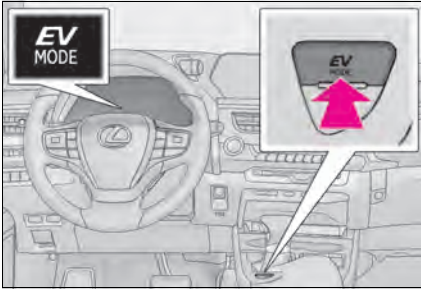

Turns EV drive mode on/off

When EV drive mode is turned on, the EV drive mode indicator will come on. Pressing the switch when in EV drive mode will return the vehicle to normal driving (using the gasoline engine and electric motor [traction motor]).

# Hybrid Transmission

## Shifting the shift lever

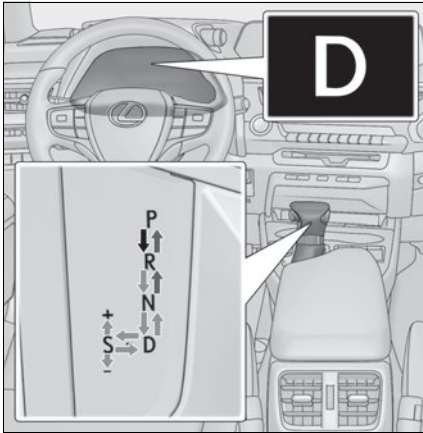

← While the power switch is in ON and the brake pedal depressed\*, shift the shift lever while pushing the shift release button on the shift knob.

← Shift the shift lever while pushing the shift release button on the shift knob.

← Shift the shift lever normally.

When shifting the shift lever between P and D, make sure that the vehicle is completely stopped and the brake pedal is depressed.

\*: For the vehicle be able to be shifted from P, the brake pedal must be depressed before the shift release button is pushed. If the shift release button is pushed first, the shift lock will not be released.



## Shift position purpose and functions

Shift position	Objective or function
P	Parking the vehicle/starting the hybrid system
R	Reversing
N	Neutral (Condition in which the power is not transmitted)
D	Normal driving <sup>*1</sup>
S	S mode driving <sup>*2</sup> (→P.25)

\*1: To improve fuel efficiency and reduce noise, shift the shift lever to D for normal driving.

\*2: By selecting shift ranges using S mode, you can control accelerating force and engine braking force.

## Selecting shift ranges in the D position (vehicles with paddle shift switches)

To drive using temporary shift range selection, operate the “-” or “+” paddle shift switch when driving with the shift lever in D.

When the “-” paddle shift switch is operated, the shift range switches to a range that enables engine braking force that is suitable to driving conditions. When the “+” paddle shift switch is operated, the shift range switches to a range that is one range higher than the current range.

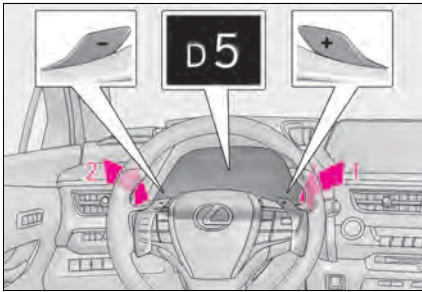

**1** Upshifting

**2** Downshifting

The selected shift range, from D1 to D6, will be displayed in the meter.

To return to normal D position driving, the “+” paddle shift switch must be held down for a period of time.

Meter display	Function
D2 - D6	A gear in the range between D1 and the selected shift range is automatically chosen depending on vehicle speed and driving conditions
D1	Setting the shift range at D1

## Changing shift ranges in the S position

To enter S mode, shift the shift lever to S. Shift ranges can be selected by operating the shift lever or paddle shift switches (if equipped).

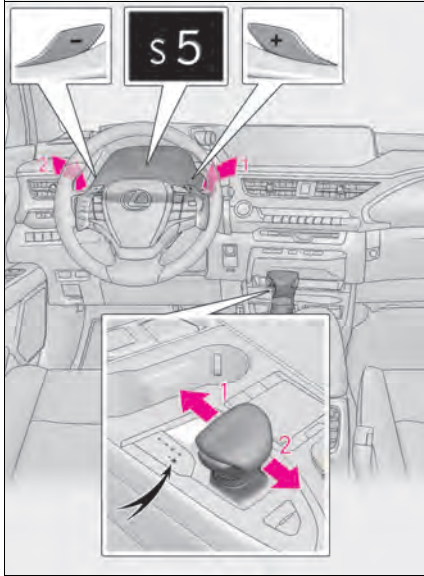

**1** Upshifting

**2** Downshifting

The selected shift range, from S1 to S6, will be displayed in the meter.

The initial shift range in S mode is 4.

### ■ Shift ranges and their functions

- You can choose from 6 levels of accelerating force and engine braking force.
- A lower shift range will provide greater accelerating force and engine braking force than a higher shift range, and the engine revolutions will also increase.

## Turn Signal Lever

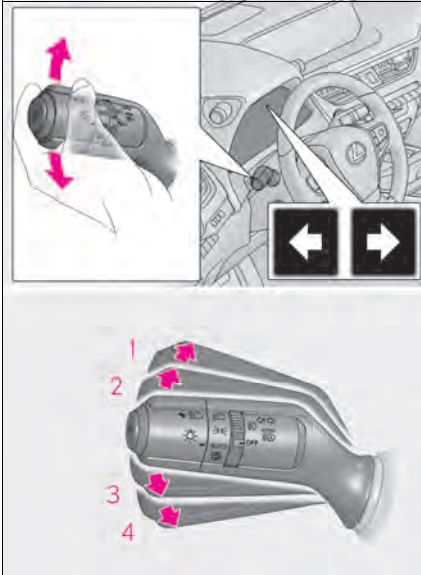

- 1** Right turn
- 2** Lane change to the right (move the lever partway and release it)  
The right hand signals will flash 3 times.
- 3** Lane change to the left (move the lever partway and release it)  
The left hand signals will flash 3 times.
- 4** Left turn

# Parking Brake

The parking brake can be set or released automatically or manually.

## Using the manual mode

The parking brake can be set and released manually.

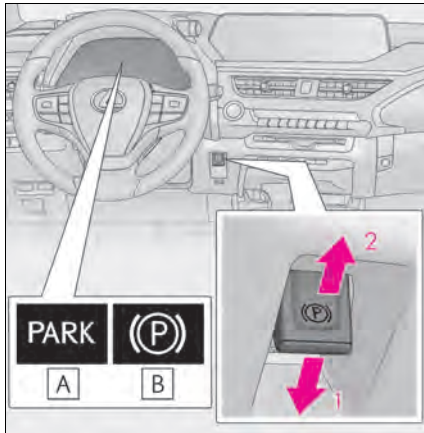

**A** U.S.A.

**B** Canada

- 1** Push the switch to set the parking brake

The parking brake indicator light will turn on.

Press and hold the parking brake switch if an emergency occurs and it is necessary to operate the parking brake while driving.

- 2** Pull the switch to release the parking brake

- Operate the parking brake switch while depressing the brake pedal.
- Using the parking brake automatic release function, the parking brake can be released by depressing the accelerator pedal. When using this function, slowly depress the accelerator pedal.

Make sure that the parking brake indicator light turn off.

## Turning the automatic mode on

In automatic mode, the parking brake can be set or released automatically according to shift lever operation. Also, even in automatic mode, the parking brake can be set or released manually.

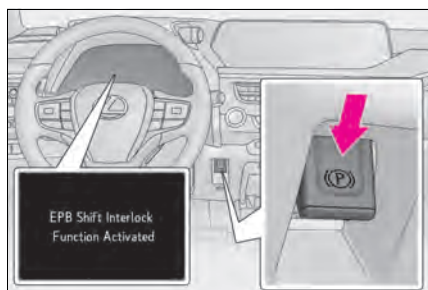

While the vehicle is stopped, press and hold the parking brake switch until a message is shown on the multi-information display

When the automatic mode is turned on, the parking brake operates as follows.

- When the shift lever is shifted from P, the parking brake will be released, and the parking brake indicator light will turn off.
- When the shift lever is shifted to P, the parking brake will be set, and the parking brake indicator light will turn on.

Operate the shift lever with the vehicle stopped and the brake pedal depressed.

## Turning the automatic mode off

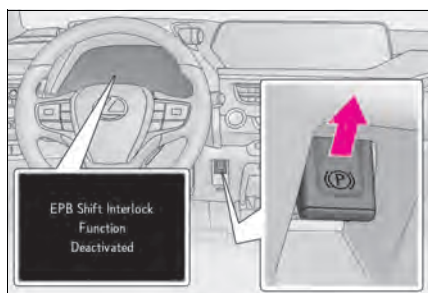

While the vehicle is stopped, pull and hold the parking brake switch until a message is shown on the multi-information display

## Brake Hold

The brake hold system keeps the brake applied when the shift lever is in D, S or N with the system on and the brake pedal has been depressed to stop the vehicle. The system releases the brake when the accelerator pedal is depressed with the shift lever in D or S to allow smooth start off.

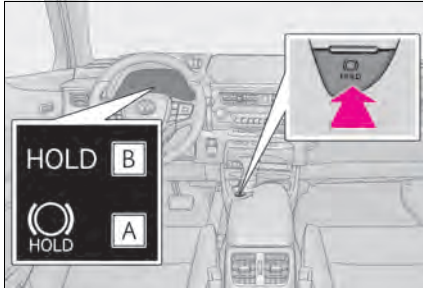

Turns the brake hold system on

The brake hold standby indicator **A** comes on. While the system is holding the brake, the brake hold operated indicator **B** comes on.

## Multi-information Display

The multi-information display presents the driver with a variety of vehicle data.

### Display and menu icons

#### ■ Display (except F SPORT models)



By selecting menu icons on the multi-information display, a variety of driving-related information can be displayed.

The multi-information display can also be used to change display settings and other vehicle settings.

Warning or suggestion/advice pop-up displays are also displayed in certain situations.

#### ■ Display (F SPORT models)

##### ► When the main meter is in the center position

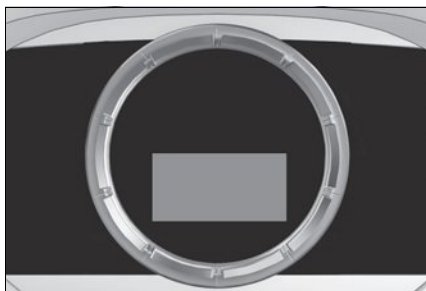

The multi-information display presents the driver with a variety of driving-related information.

Warning or suggestion/advice pop-up displays are also displayed in certain situations.

##### ► When the main meter is in the side position





By selecting menu icons on the multi-information display, a variety of driving-related information can be displayed.

The multi-information display can also be used to change display settings and other vehicle settings.

Warning or suggestion/advice pop-up displays are also displayed in certain situations.

## ■ Menu icons

The menu icons will be displayed by pressing  or  of the meter control switches.

F SPORT models: The menu icons can be displayed when the main meter is in the side position.



### Driving information display

Select to display various drive data.



### Navigation system-linked display (if equipped)

Select to display the following navigation system-linked information.

- Route guidance to destination
- Compass display



### Audio system-linked display

Select to enable selection of an audio source or track on the meter using the meter control switches.



### Driving support system information display

Select to display the operational status of the following systems:

- LTA (Lane Tracing Assist)
- Dynamic radar cruise control with full-speed range
- RSA (Road Sign Assist) (if equipped)



### Warning message display

Select to display warning messages and measures to be taken if a malfunction is detected.







### Settings display

Select to change the meter display settings

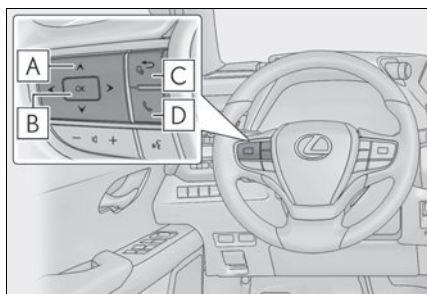

## Changing the meter display



- A**  /  : Select menu icons
-  /  : Change displayed content, scroll up/down the screen or move the cursor up/down
- B** Press: Enter/Set  
Press and hold: Reset
- C** Move the main meter\* or return to the previous screen

- D** Call sending/receiving and history display  
Linked with the hands-free system, sending or receiving call is displayed. For details regarding the hands-free system, refer to the "NAVIGATION AND MULTIMEDIA SYSTEM OWNER'S MANUAL".

\*: F SPORT models

## Head-up Display (if equipped)

The head-up display projects a variety of driving-related information and the operating state of the driving support systems on the windshield.

### System components

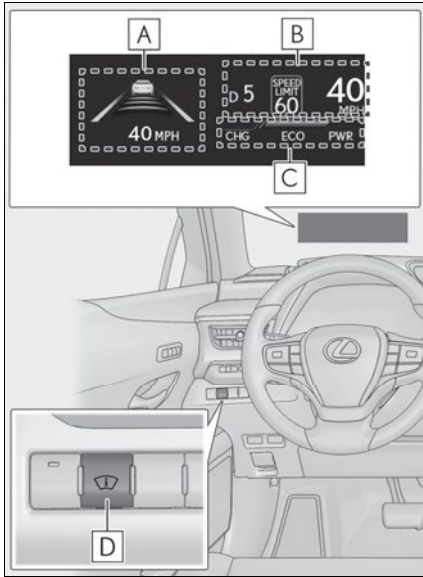

- A** Driving support system display area  
Navigation system-linked display area  
(if equipped)
- B** Driving information display area
- C** Hybrid System Indicator/tachometer  
display area
- D** Head-up display switch

Illustrations used in this text are intended as examples, and may differ from the image that is actually displayed by the head-up display.

## Using the head-up display

### ■ Enabling/disabling the head-up display

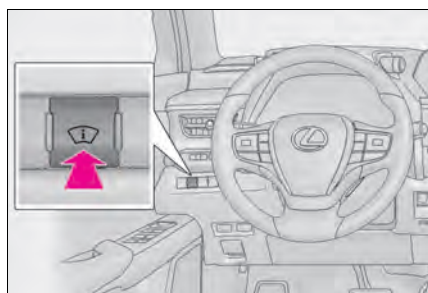

Press the head-up display switch.

### ■ Changing settings of the head-up display

The following settings can be changed on  of the multi-information display. For details, refer to the "OWNER'S MANUAL".

- Brightness and vertical position of the head-up display  
Select to adjust the brightness or vertical position of the head-up display.
- Hybrid System Indicator/tachometer<sup>\*1</sup>  
Select to display the Hybrid System Indicator, tachometer or no content.
- Display content<sup>\*1</sup>  
Select to enable/disable the following items:
  - Route guidance to destination/street name
  - Driving support system display<sup>\*2</sup>
  - Compass (heading-up display)
  - Audio system operation status
- Display angle<sup>\*1</sup>  
Select to adjust the angle of the head-up display.

<sup>\*1</sup>: To set this item, select  on the multi-information display, select "Vehicle Settings" and select "HUD".

<sup>\*2</sup>: Make sure to enable this display when using the driving support systems

## Hybrid System Indicator/tachometer display area

### Hybrid System Indicator

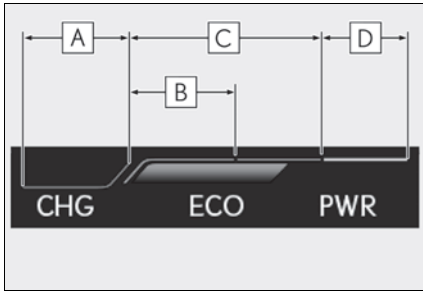

- A** Charge area
- B** Hybrid Eco area
- C** Eco area
- D** Power area

Displayed content is the same as that displayed on the meter (Hybrid System Indicator). For details, refer to P.11.

### Tachometer



Displays the engine speed in revolutions per minute.

The head-up display may seem dark or hard to see when viewed through sunglasses, especially polarized sunglasses. Adjust the brightness of the head-up display or remove your sunglasses.

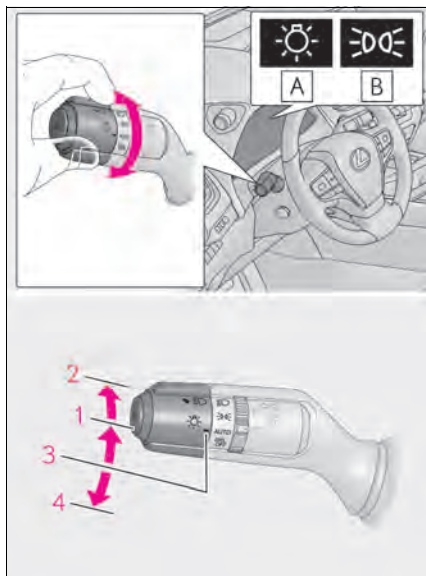
## Headlights



- A** U.S.A.
- B** Canada

- 1**  The side marker, parking, tail, license plate, instrument panel lights, and daytime running lights turn on.
- 2**  The headlights and all the lights listed above (except daytime running lights) turn on.
- 3** AUTO The headlights, daytime running lights and all the lights listed above turn on and off automatically.
- 4**  (U.S.A.) Off

## Turning on the high beam headlights

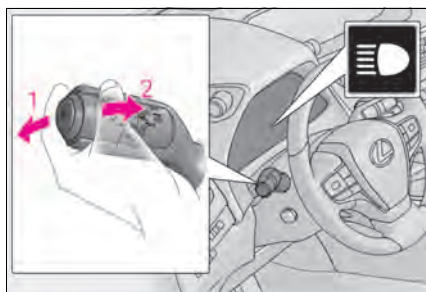

- 1** With the headlights on, push the lever away from you to turn on the high beams.  
Pull the lever toward you to the center position to turn the high beams off.
- 2** Pull the lever toward you and release it to flash the high beams once.  
You can flash the high beams with the headlights on or off.

## AHB (Automatic High Beam)

The Automatic High Beam uses a front camera located behind the upper portion of the windshield to assess the brightness of the lights of vehicles ahead, streetlights, etc., and automatically turns the high beams on or off as necessary.

### Activating the Automatic High Beam

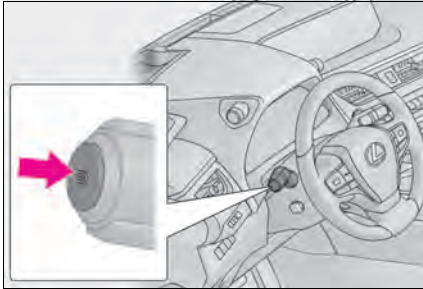

- 1 Press the Automatic High Beam switch.

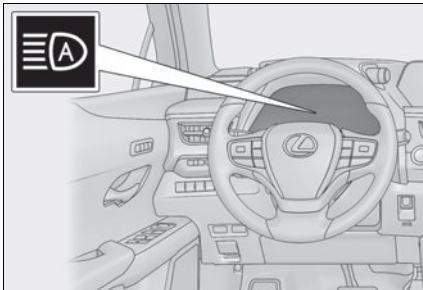

- 2 Turn the headlight switch to the  or AUTO position.

The Automatic High Beam indicator will come on when the system is operating.

## Turning the high beams on/off manually

### Switching to the high beams



Push the lever away from you.

The Automatic High Beam indicator will turn off and the high beam indicator will turn on.

Pull the lever to its original position to activate the Automatic High Beam system again.

### Switching to the low beams

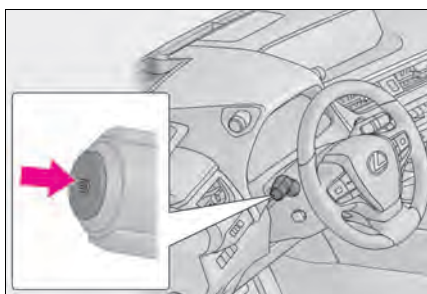

Press the Automatic High Beam switch.

The Automatic High Beam indicator will turn off.

Press the switch to activate the Automatic High Beam system again.

### Temporarily switching to the low beams

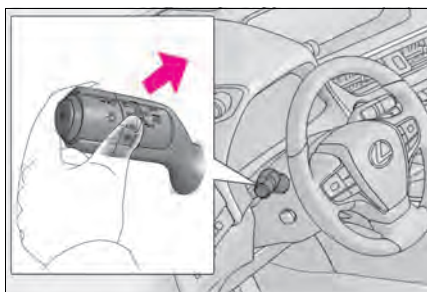

Pull the lever toward you and then return it to its original position.

The high beams are on while the lever is pulled toward you, however, after the lever is returned to its original position, the low beams remain on for a certain amount of time. Afterwards, the Automatic High Beam will be activated again.

## Fog Light Switch (if equipped)

When in difficult driving conditions, such as in rain and fog, turn on the fog lights to secure front visibility.

### Turning on the fog light

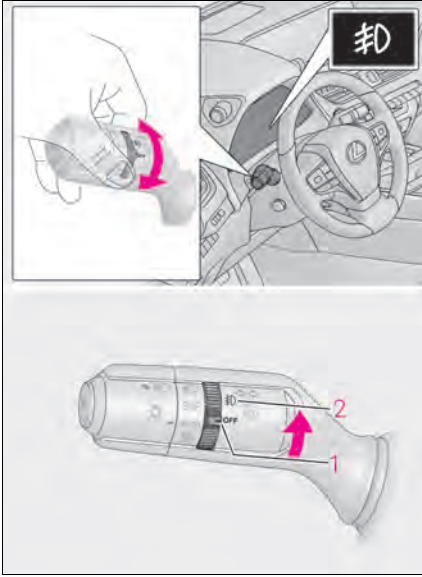

**1** **OFF** \*<sup>1</sup> or  $\circ$  \*<sup>2</sup> Turns the fog lights off

**2**  $\text{\textcircled{/}}$  Turns the fog lights on

\*<sup>1</sup>: For the U.S.A.

\*<sup>2</sup>: For Canada



# Windshield Wipers and Washer

## ► Intermittent windshield wipers with interval adjuster

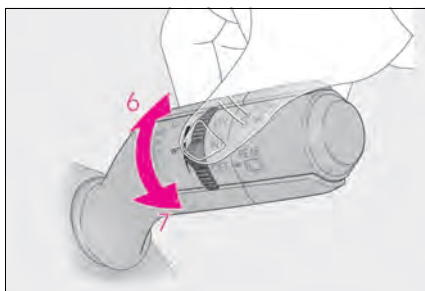
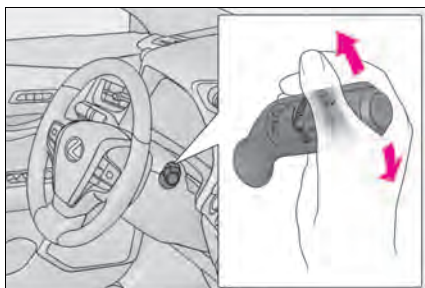

- 1 OFF** \*<sup>1</sup> or ○ \*<sup>2</sup> Off
- 2 INT** \*<sup>1</sup> or  \*<sup>2</sup> Intermittent operation
- 3 LO** \*<sup>1</sup> or ▼ \*<sup>2</sup> Low speed operation
- 4 HI** \*<sup>1</sup> or ▼ \*<sup>2</sup> High speed operation
- 5 MIST** \*<sup>1</sup> or ▲ \*<sup>2</sup> Temporary operation

\*<sup>1</sup>: For the U.S.A.

\*<sup>2</sup>: For Canada

Wiper intervals can be adjusted when intermittent operation is selected.

- 6** Increases the intermittent windshield wiper frequency
- 7** Decreases the intermittent windshield wiper frequency
- 8**  Washer/wiper dual operation

Pulling the lever operates the wipers and washer.

The wipers will automatically operate a couple of times after the washer squirts.

Vehicles with headlight cleaners: When the power switch is in ON and the headlights are on, if the lever is pulled, the headlight cleaners will operate once. After this, the headlight cleaners will operate every 5th time the lever is pulled.

► Rain-sensing windshield wipers

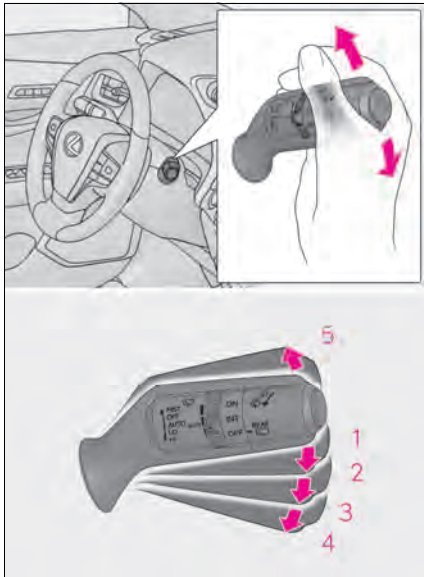

- 1 OFF** \*1 or ○ \*2 Off
- 2 AUTO** \*1 Rain-sensing operation
- 3 LO** \*1 or ▼ \*2 Low speed operation
- 4 HI** \*1 or ▼▼ \*2 High speed operation
- 5 MIST** \*1 or ▲ \*2 Temporary operation

\*1: For the U.S.A.

\*2: For Canada

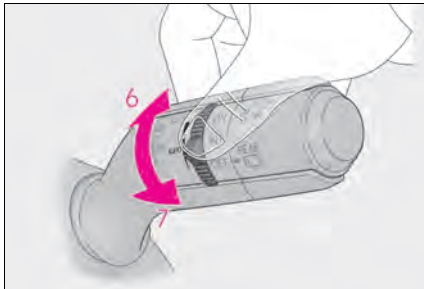

When **AUTO** is selected, the sensor sensitivity can be adjusted by turning the switch ring.

- 6** Increases the sensitivity
- 7** Decreases the sensitivity

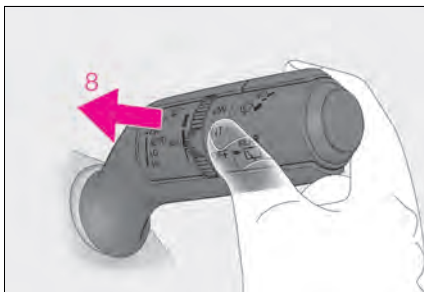

- 8**  Washer/wiper dual operation  
Pulling the lever operates the wipers and washer.  
The wipers will automatically operate a couple of times after the washer squirts.  
(After operating several times, the wipers operate once more time after a short delay to prevent dripping. However, the dripping prevention does not operate while the vehicle is moving.)

Vehicles with headlight cleaners: When the power switch is in ON and the headlights are on, if the lever is pulled, the headlight cleaners will operate once. After this, the headlight cleaners will operate every 5th time the lever is pulled.

## Rear Window Wiper and Washer

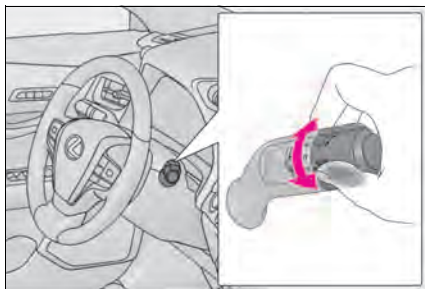

- 1 OFF** \*1 or ○ \*2 Off
- 2 INT** \*1 or --- \*2 Intermittent operation
- 3 ON** \*1 or — \*2 Normal operation

\*1: For the U.S.A.

\*2: For Canada

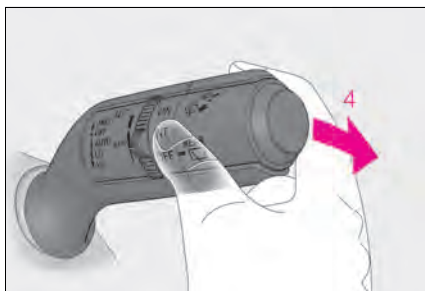
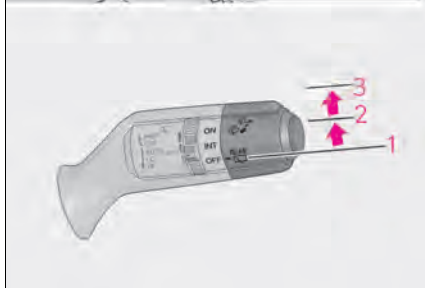

- 4**  Washer/wiper dual operation

Pushing the lever operates the wiper and washer.

The wiper will automatically operate a couple of times after the washer squirts.

## Remote Touch

The Remote Touch can be used to operate the Center Display.

Remote Touch is the name for the device that includes the "MAP" ("HOME") button, "MENU" button, back button, touchpad and sub function button.

### Names and operations of each part

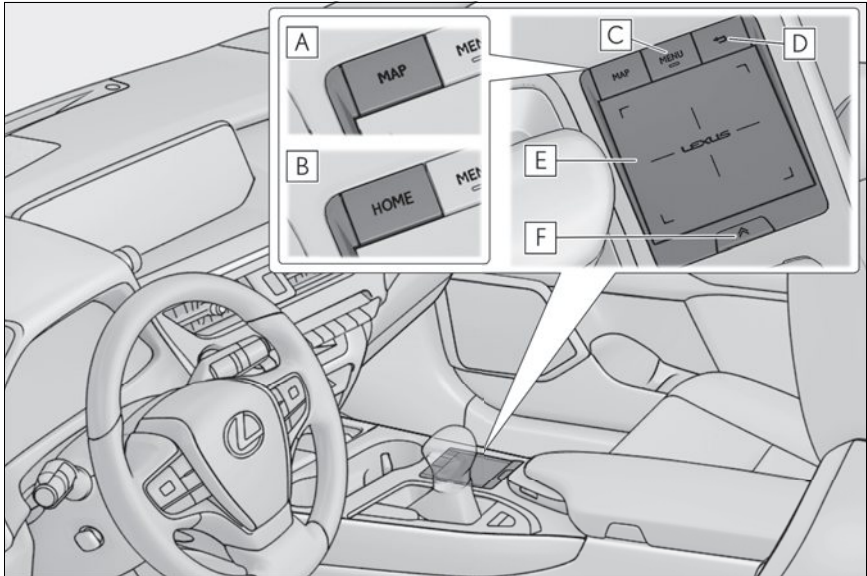

**A** "MAP" button \*1

Press to display the current location.

**B** "HOME" button \*2

Press to display the home screen.

**C** "MENU" button

Press to display the menu screen.

**D** Back button

Press to display the previous screen.

## **E** Touchpad

Slide your finger on the touchpad and move the pointer to select a function, letter and screen button.

Press the touchpad to enter the selected function, letter or screen button. Certain finger movements on the touchpad can perform functions, such as changing map scalings and scrolling list screens.

## **F** Sub function button

When  is displayed on the screen, a function screen assigned to the screen can be displayed.

\*1: 10.3-inch display model

\*2: 7-inch display model

## Menu screen

Press the "MENU" button on the Remote Touch to display the menu screen.









The displays shown in the illustrations are used for example only and may differ from the actual vehicle.

### ▶ 7-inch display model



### ▶ 10.3-inch display model



Switch	Function
	Select to display the destination screen. *1 (→P.51)
	Select to display the audio control screen. (→P.57)
	Select to display the hands-free control screen. (→P.53)
	Select to display the “Apps” screen. *2,3
	When an Apple CarPlay/Android Auto connection is established and this button displays “Apple CarPlay”/“Android Auto”, select to display the home screen of Apple CarPlay/Android Auto. *2,3
	Select to display the information screen. *2,4
	Select to display the setup screen. *2
	Select to display the air conditioning control screen. (→P.66)
	Select to adjust the contrast and brightness of the screens, turn the screen off, etc. *1,2

\*1: If equipped

\*2: Refer to the “NAVIGATION AND MULTIMEDIA SYSTEM OWNER’S MANUAL”.

\*3: This function is not made available in some countries or areas.

\*4: Refer to the “OWNER’S MANUAL”.

## Split-screen display (10.3-inch display model)

Different information can be displayed on the left and right of the screen. For example, the air conditioning system screen can be displayed and operated while the fuel consumption information screen is being displayed. The large screen on the left of the display is called the main display, and the small screen to the right is called the side display.

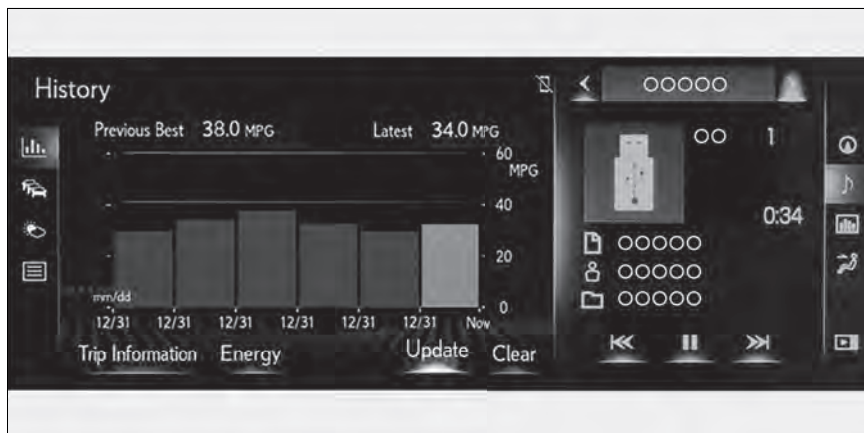

## Side display (10.3-inch display model)

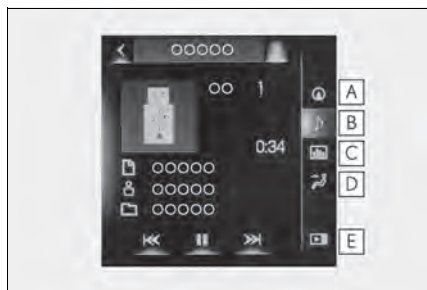

The following functions can be displayed and operated on the side display.

- A** Navigation system (→P.51)
- B** Audio (→P.60, 61, 62, 63)
- C** Vehicle information (→P.50)
- D** Air conditioning system (→P.67)
- E** Show/hide the side display

## Map scroll operation

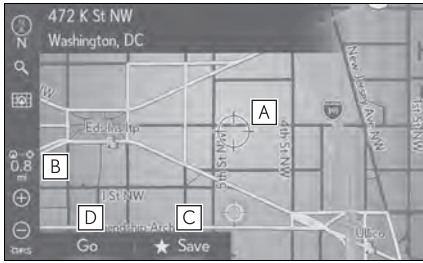

Select the desired point on the map screen.  
Move the desired point on the center of the map screen.

- A** Cursor mark
- B** Distance from the current position to the cursor mark
- C** Select to register as a memory point
- D** Select to set as a destination

Press the “MAP” button on the Remote Touch to return to the current position.

## Editing route

While route guidance is operating, you can change the route using the following method.

- 1 Select  on the map screen.

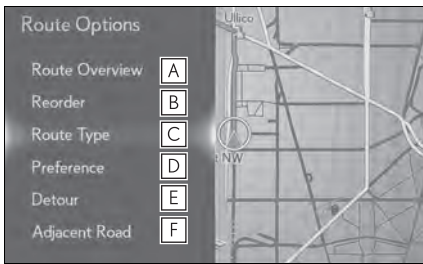

- 2 Select the desired item to be set.

- A** Select to display the overview of the entire route.
- B** Select to reorder destinations.
- C** Select to change route type.
- D** Select to set route preferences.
- E** Select to set detours.
- F** Select to start from adjacent road.

- 3 Check that the route overview is displayed.

Some functions are unavailable while the vehicle is in motion. Refer to the “NAVIGATION AND MULTIMEDIA SYSTEM OWNER’S MANUAL”.



## Energy Monitor/Consumption Screen

The status of your hybrid system and fuel consumption information can be displayed on the multi-information display and Center Display.

10.3-inch display model: The energy monitor and consumption screen can be displayed on the side display. For details, refer to the "OWNER'S MANUAL".

### Energy monitor

#### ■ How to display on Center Display

Press the "MENU" button on the Remote Touch, and then select  on the menu screen.

If the "Trip Information" or "History" screen is displayed, select "Energy".

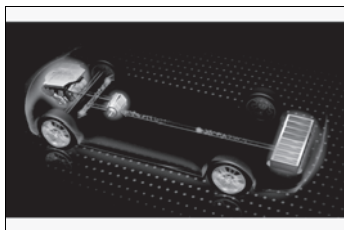

The flow of energy is displayed on Center Display.





Red: gasoline energy

Amber: electrical energy

Light blue: energy recovery

A light blue arrow appears when regenerative braking occurs.

#### ■ How to display on the multi-information display

Press  or  of the meter control switches and select , and then press  or  to select the energy monitor display.

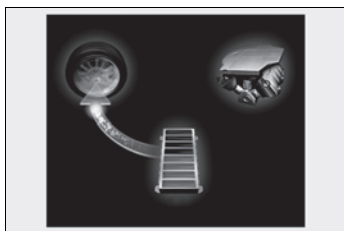

The flow of energy is indicated by the movement of the arrows on the multi-information display.

Red: gasoline energy

Amber: electrical energy

Light blue: energy recovery

A light blue arrow appears when regenerative braking occurs.

The displayed energy flow, battery level, etc. will change in response to the current driving conditions.

## Consumption

Press the “MENU” button on the Remote Touch, and then select  on the menu screen.

### Trip information

If a screen other than “Trip Information” is displayed, select “Trip Information”.

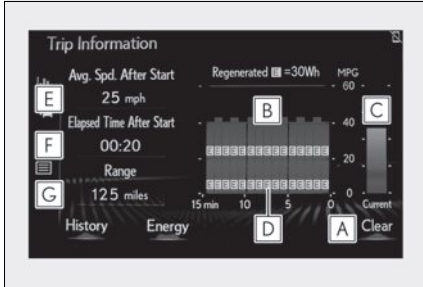

- A** Resetting the consumption data
- B** Fuel consumption in the past 15 minutes
- C** Current fuel consumption
- D** Regenerated energy in the past 15 minutes  
One symbol indicates 30 Wh. Up to 5 symbols are shown.

- E** Average vehicle speed since the hybrid system was started.
- F** Elapsed time since the hybrid system was started.
- G** Cruising range

### History

If a screen other than “History” is displayed, select “History”.

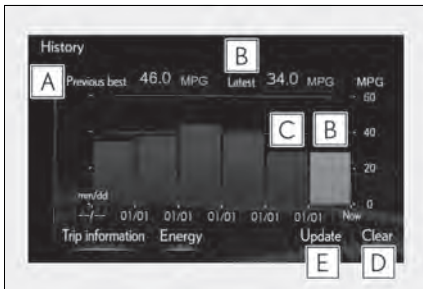

- A** Best recorded fuel consumption
- B** Latest fuel consumption
- C** Previous fuel consumption record
- D** Resetting the history data
- E** Updating the latest fuel consumption data

## Using the side display (10.3-inch display model)

Vehicle information can be displayed on the side display.

Select  or  to display the desired screen.

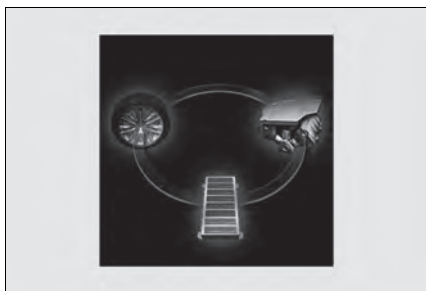

- Trip information (type A/type B)
- History
- Energy monitor

# Navigation System

## Registering home

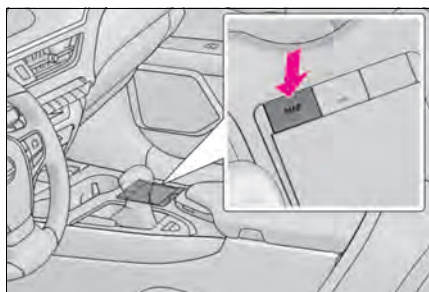

- 1 Press the “MAP” button on the Remote Touch.
  - 2 Select .
  - 3 Select “Home”.
  - 4 Select “Yes”.
  - 5 Select “Address” or “Current Location” to search for your home.
  - 6 Select “OK”.
- Registration of home is complete.

## Destination search

### ■ Searching by address

- 1 Display the destination search screen by either operation:
  - “MAP” button → 
  - “MENU” button → “Destination”
- 2 Select “Address”.  
If a state (province) has not been selected yet, “State/Province” screen is displayed.
- 3 Enter a house number and select “Search”.  
“Change State/Province”: Select to change the search area.
- 4 Enter a street name and select “Search”.
- 5 Select the desired street name.
- 6 Enter a city name and select “Search”.
- 7 Select the desired city name.  
If multiple locations with the same address exist, the address list screen will be displayed.  
Select the desired address.

## ■ Searching by point of interest

There are 3 methods to search for a destination by Points of Interest.

1 Display the destination search screen by either operation:

- “MAP” button → 
- “MENU” button → “Destination”

2 Select “Point of Interest”.

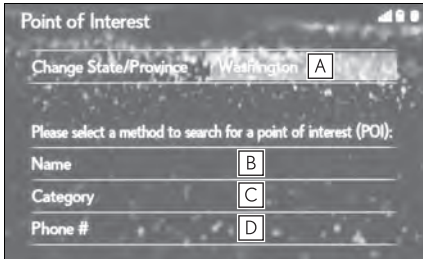

### ▶ Searching by name (B)

4 Select “Name”.

5 Enter a POI name and select “Search”.

6 Select the desired POI.

### ▶ Searching by category (C)

4 Select “Category”.

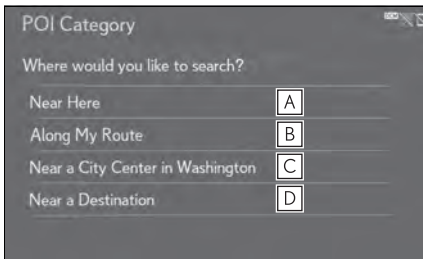

6 Select the desired POI category.

7 Select the desired POI.

### ▶ Searching by phone number (D)

4 Select “Phone #”.

5 Enter a phone number and select “OK”.

3 Select the desired search method.

A Select to change the search area.

B Select to search by name.

C Select to search by category.

D Select to search by phone number.

5 Select the desired search point.

A Select to search for POIs near your current position.

B Select to search for POIs along the set route.

C Select to search for POIs near a specific city center.

D Select to search for POIs near a destination. When more than 1 destination has been set, a list will be displayed on the screen. Select the desired destination.

# Hands-free System For Cellular Phone

## Registering/connecting Bluetooth® device

To use the hands-free system, it is necessary to register a Bluetooth® phone with the system. Refer to <http://www.lexus.com/MobileLink> to find approved Bluetooth® phones for this system.

- 1 Turn the Bluetooth® connection setting of your cellular phone on.
- 2 Press the “MENU” button on the Remote Touch.
- 3 Select “Phone”.
- 4 Select “Yes” to register a phone.

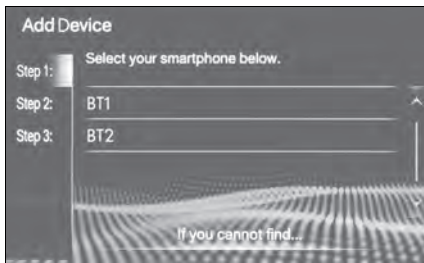

- 5 Select the desired Bluetooth® device.

- 6 Register the Bluetooth® device using your Bluetooth® device.



- 7 Check that the following screen is displayed, indicating pairing was successful.

- The system is connecting to the registered device.
- At this stage, the Bluetooth® functions are not yet available.

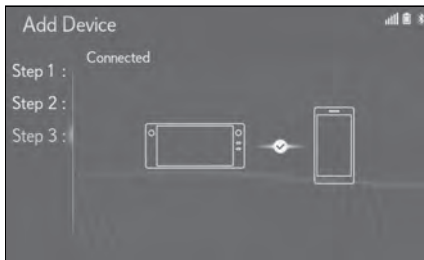

- 8 Check that “Connected” is displayed and registration is complete.

## Contacts transfer

- 1 Display the phone settings screen:
  - “MENU” button → “Setup” →  “Phone” on the sub menu
- 2 Select “Contacts/Call History”.

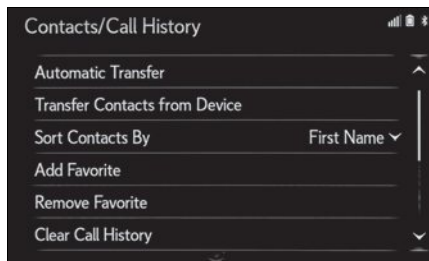

- 3 Select “Transfer Contacts from Device”.
- 4 Select “From Phone (Bluetooth)”.
- 5 Transfer the contact data to the system using a Bluetooth® phone.
- 6 Check that a confirmation screen is displayed when the operation is complete.

Depending on the type of Bluetooth® phone, certain functions may not be available.

## Registering the contacts in the favorites list

- 1 Display the phone settings screen:
  - “MENU” button → “Setup” →  “Phone” on the sub menu
- 2 Select “Contacts/Call History”.

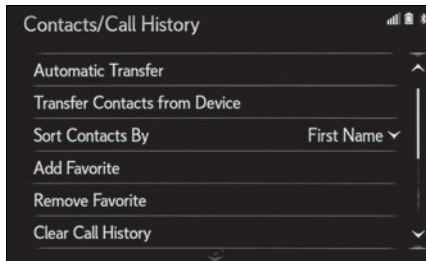



- 3 Select “Add Favorite”.
- 4 Select the desired contact to add to the favorites list.
- 5 Check that a confirmation screen is displayed when the operation is complete.

## Calling by favorites list

- 1 Press the “MENU” button on the Remote Touch.
- 2 Select “Phone”.
- 3 Select  “Favorites” on the sub menu and select the desired contact.
- 4 Select the desired number.
- 5 Check that the dialing screen is displayed.

## Calling the message sender

- 1 Display the message screen:
  - “MENU” button → “Phone” →  “Message” on the sub menu
- 2 Select a desired account name that is displayed on the left side of screen.
- 3 Select the desired message from the list.
- 4 Select , or press the  switch on the steering wheel.
- 5 Check that the dialing screen is displayed.



## Receiving a call

Select "Answer" or press the  switch on the steering wheel to talk on the phone.

### ► Main display

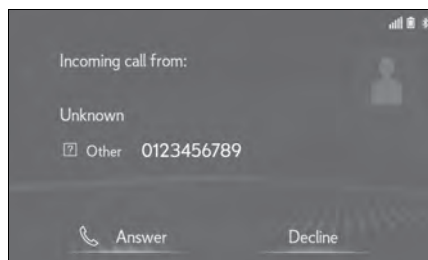

### ► Side display (10.3-inch display model)

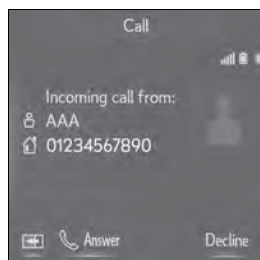

"Decline": Select to refuse to receive the call.

## Steering switches

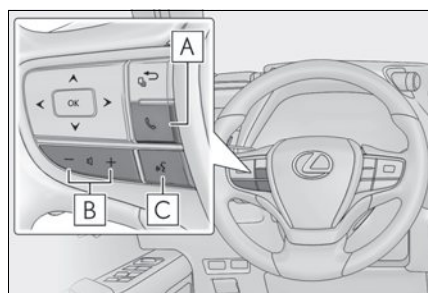

### **A** TEL switch

- Start talking
- End talking
- End dialing
- Depending on the system, if the switch is pressed when an Apple CarPlay connection is established, the Apple CarPlay phone application will be displayed on the system screen.\*

### **B** Volume control switch

- Press the "+" side to increase the volume.
- Press the "-" side to decrease the volume.

### **C** Talk switch

- Press the talk switch to start the voice command system.
- To cancel voice recognition, press and hold the talk switch.

\*: This function is not made available in some countries or areas.

# Audio System

## Audio control screen

The audio control screen can be reached by the following methods:

- ▶ **Using the audio control switch**  
Press the “RADIO” or “MEDIA” button.
- ▶ **Using the Remote Touch**  
Press the “MENU” button on the Remote Touch, then select “Audio”.

## Selecting an audio source

- ▶ **Using the audio control switch**
  - 1 Press the “RADIO” or “MEDIA” button.

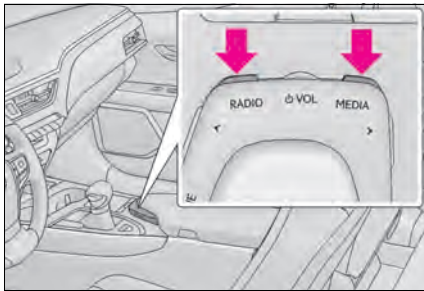

- 2 “RADIO” button: Press to change radio modes.

“MEDIA” button: Press to change media modes.

Each time the “RADIO” or “MEDIA” button is pressed, the audio source changes.

- ▶ **From the audio source selection screen**
  - 1 Display the audio control screen.
  - 2 Select  “Source” on the sub menu.
  - 3 Select the desired source.

## Steering switch operation

Some parts of the audio/visual system can be adjusted using the switches on the steering wheel.

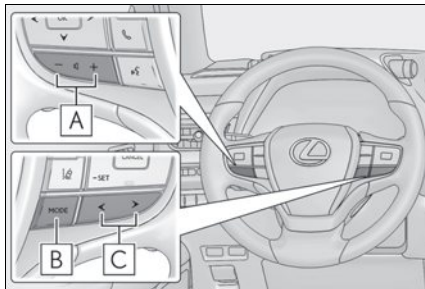

**A** Volume control switch

**B** "MODE" switch

**C** ◀ ▶ switch

### ■ Volume control switch

- Press: Volume up/down
- Press and hold (0.8 sec. or more): Volume up/down continuously

### ■ "MODE" switch

#### ▶ AM, FM, SXM\*<sup>1</sup>

- Press: Change audio modes
- Press and hold (0.8 sec. or more): Mute\*<sup>2</sup> (Press and hold again to resume the sound.)

#### ▶ AUX

- Press: Change audio modes
- Press and hold (0.8 sec. or more): Mute

#### ▶ CD, MP3/WMA/AAC disc, DVD\*<sup>3</sup>, USB\*<sup>4, 5</sup>, iPod/iPhone\*<sup>5</sup>, Android Auto\*<sup>4</sup>, Bluetooth® audio\*<sup>4, 5</sup>, APPS\*<sup>1, 4, 5</sup>

- Press: Change audio modes
- Press and hold (0.8 sec. or more): Pause

\*<sup>1</sup>: This function is not made available in some countries or areas.

\*<sup>2</sup>: If cached radio is enabled, pressing and holding the "MODE" switch pauses the broadcast. (Press and hold again to play back the cached radio program.)

\*<sup>3</sup>: 10.3-inch display model

\*<sup>4</sup>: When an Apple CarPlay connection is established, this function will be unavailable.

\*<sup>5</sup>: When an Android Auto connection is established, this function will be unavailable.

■ ◀ ▶ switch

▶ AM, FM, HD

- Press: Preset station up/down
- Press and hold (0.8 sec. or more): Seek up/down
- Press and hold (1.5 sec. or more): Seek up/down continuously while the switch is being pressed

▶ SXM\*1

- Press: Preset channel up/down
- Press and hold (0.8 sec. or more): Seek for stations in the relevant program type/channel category
- Press and hold (1.5 sec. or more): Seek for the channel while the switch is being pressed

▶ CD

- Press: Track up/down
- Press and hold (0.8 sec. or more): Fast forward/rewind

▶ MP3/WMA/AAC disc

- Press: File up/down
- Press and hold (0.8 sec. or more): Fast forward/rewind

▶ DVD\*2

- Press: Chapter up/down
- Press and hold (0.8 sec. or more): Fast forward/rewind

▶ USB\*3,4

- Press: File/Track up/down
- Press and hold (0.8 sec. or more): Fast forward/rewind

▶ iPod/iPhone\*4

- Press: Track up/down
- Press and hold (0.8 sec. or more): Fast forward/rewind

▶ Android Auto\*3

- Press: Track up/down

▶ Bluetooth® audio\*3,4

- Press: Track up/down
- Press and hold (0.8 sec. or more): Fast forward/rewind

\*1: This function is not made available in some countries or areas.

\*2: 10.3-inch display model

\*3: When an Apple CarPlay connection is established, this function will be unavailable.

\*4: When an Android Auto connection is established, this function will be unavailable.

# Radio

## Audio control switch

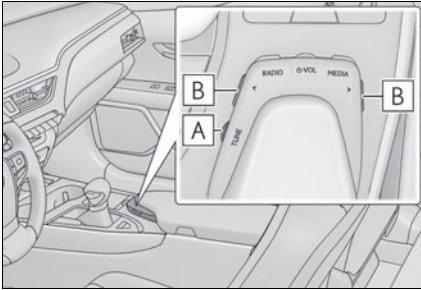

- A** Turn to step up/down frequencies/channels.
- B** Press to seek up/down. Press and hold for continuous seek.

## Control screen

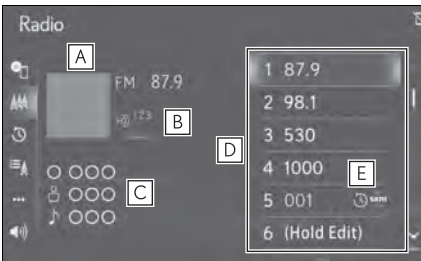

- A** Displays cover art.
- B** Select to display HD) multicast channels available.
- C** Displays the artist info and song title or album and genre. Select to change the displayed information. Displays messages when available from RBDS.
- D** Select to tune to preset stations/channels.
- E** Displays items on the channels registered to smart favorites.\*

\*: This function is not made available in some countries or areas.

## Presetting a station

Radio mode has a mix preset function, which can store up to 36 stations (6 stations per page x 6 pages) from any of the AM, FM or SXM bands.

**1** Tune in the desired station.



**2** Select and hold "(Hold Edit)". To change the preset station to a different one, select and hold the preset station.

# CD

## Audio control switch

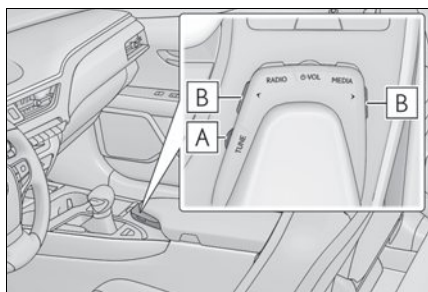

- A** Turn to select a track/file.
- B** Press to select a track/file.  
Press and hold to fast forward/rewind.

## Control screen

### Audio CD

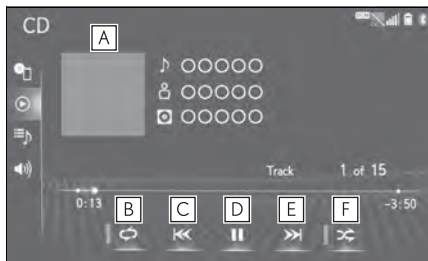

- A** Displays cover art.
- B** Select to set repeat playback.
- C** Select to change the track.  
Select and hold to fast rewind.
- D** Select to play/pause.
- E** Select to change the track.  
Select and hold to fast forward.
- F** Select to set random playback.

### MP3/WMA/AAC disc

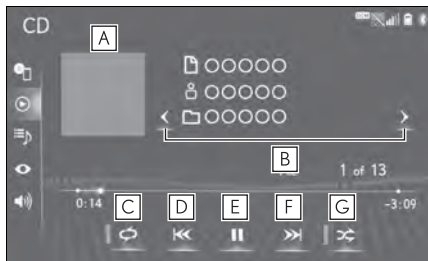

- A** Displays cover art.
- B** Select to change the folder.
- C** Select to set repeat playback.
- D** Select to change the file.  
Select and hold to fast rewind.
- E** Select to play/pause.
- F** Select to change the file.  
Select and hold to fast forward.
- G** Select to set random playback.

## DVD (10.3-inch display model)

### Audio control switch

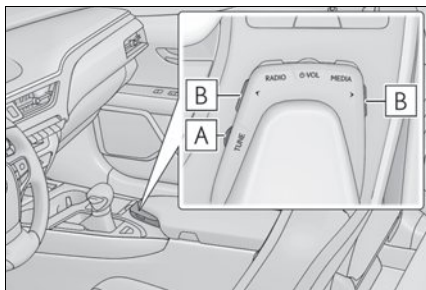

- A** Turn to select a chapter.
- B** Press to select a chapter.  
Press and hold to fast forward/rewind.

### Control screen

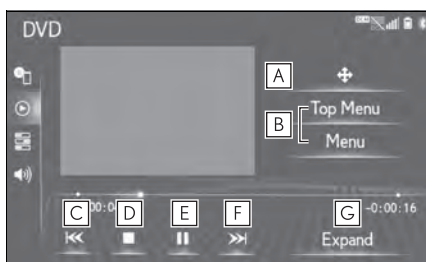

- A** Select to display the menu control key.
- B** Select to display the menu screen.
- C** Select to change the chapter.  
Select and hold to fast rewind.
- D** Select to stop the video screen.
- E** Select to play/pause.
- F** Select to change the chapter.  
During playback: Select and hold to fast forward.  
During a pause: Select and hold to slow forward.
- G** Select to display expanded screen video.

## iPod/iPhone (Apple CarPlay\*)

\*: This function is not made available in some countries or areas.

### ■ Audio control switch

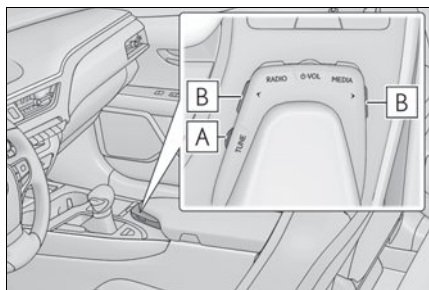

- A** Turn to select a track.\*  
Turn to move up/down the list.
- B** Press to select a track.  
Press and hold to fast forward/rewind.

\*: If equipped

### ■ Control screen

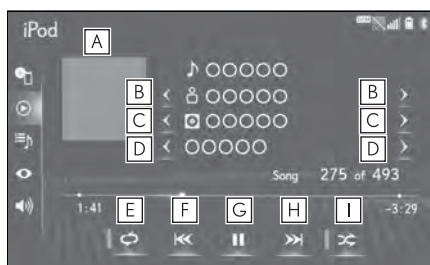

- A** Displays cover art.
- B** Select to change the artist.\*
- C** Select to change the album.\*
- D** Select to change the playlist.\*
- E** Select to set repeat playback.
- F** Select to change the track.  
Select and hold to fast rewind.
- G** Select to play/pause.
- H** Select to change the track.  
Select and hold to fast forward.
- I** Select to set random playback.

\*: When an Apple CarPlay connection is established, this switch will not be displayed.

Some functions may not be available depending on the type of model.



## Lexus Climate Concierge

The seat heaters (if equipped), seat ventilators (if equipped) and heated steering wheel (if equipped) are each automatically controlled according to the set temperature of the air conditioning system, the outside and cabin temperature, etc. Lexus Climate Concierge allows a comfortable condition to be maintained without adjusting each system.

### Displaying the Lexus Climate Concierge

Press the "MENU" button on the Remote Touch and select "Climate" to display the air conditioning control screen. Then, select  to display the Lexus Climate Concierge control screen.

### Turning on Lexus Climate Concierge



Select .

The indicator on the Lexus Climate Concierge control screen illuminates, and the automatic air conditioning system, seat heaters and ventilators (if equipped), and heated steering wheel (if equipped) operate in automatic mode.

If any of the system is operated manually, the indicator turns off. However, all other functions continue to operate in automatic mode.

## Air Conditioning System

Press the "MENU" button on the Remote Touch, then select "Climate" to display the air conditioning control screen.

### Air conditioning controls

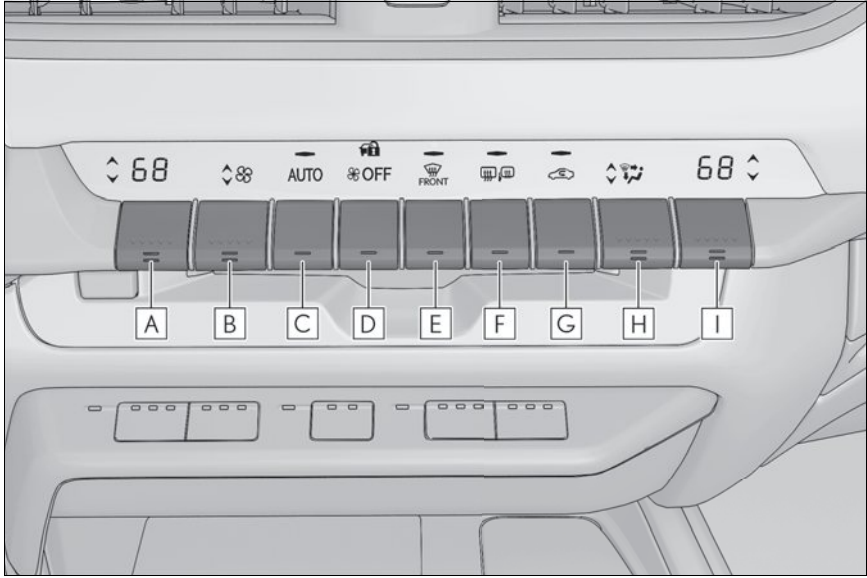

- A** Left-hand side temperature control switch

Operate the temperature control switch upwards to increase the temperature and downwards to decrease the temperature.

- B** Fan speed control switch

- C** Automatic mode switch

- D** Off switch

- E** Windshield defogger switch

- F** Rear window and outside rear view mirror defoggers switch

- G** Outside/recirculated air mode switch

- H** Airflow mode control switch

- I** Right-hand side temperature control switch

Operate the temperature control switch upwards to increase the temperature and downwards to decrease the temperature.

## Air conditioning control screen

### Main control screen

Using the touchpad of the Remote Touch, select the button on the screen.

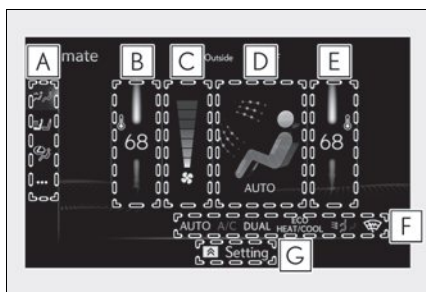

- A** Sub menu
- B** Adjust the left-hand side temperature setting
- C** Adjust the fan speed setting
- D** Select the air flow mode
- E** Adjust the right-hand side temperature setting

**F** Function on/off indicators

**G** Sub function menu

### Option control screen

Select **...** on the sub menu to display the option control screen.

The functions can be switched on and off.

When the function is on, the indicator illuminates on the screen.

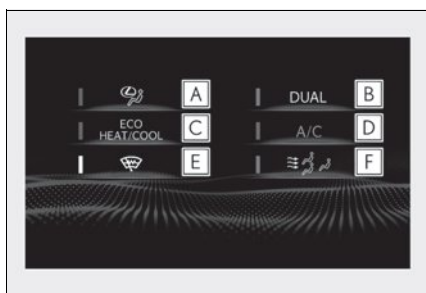

- A** Set Lexus Climate Concierge (→P.64)
- B** Adjusting the temperature for driver and front passenger seats separately ("DUAL" mode)
- C** Set eco air conditioning mode  
Air conditioning and heater output is limited to prioritize fuel economy.

**D** Cooling and dehumidification function

**E** Prevent ice from building up on the windshield and wiper blades (Windshield wiper de-icer) (if equipped)

**F** Select front seat concentrated airflow mode (S-FLOW)

## ■ Side display (10.3-inch display model)

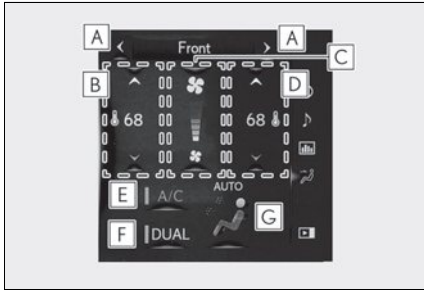

- A** Display the heated steering wheel/seat heaters/seat ventilators control screen (if equipped)
- B** Adjust the left-hand side temperature setting
- C** Adjust the fan speed setting
- D** Adjust the right-hand side temperature setting

- E** Set cooling and dehumidification function on/off
- F** Adjust the temperature for the driver's and front passenger's seats separately ("DUAL" mode)
- G** Select the air flow mode

## Using automatic mode

- 1** Press the automatic mode switch or select "AUTO" on the sub function menu (→P.66).
- 2** Adjust the temperature setting.
- 3** To stop the operation, press the off switch or select "Off" on the sub function menu (→P.66).

# Voice Command System

## Basic operation

The voice command system enables the radio, phone dialing, etc. to be operated using voice commands. Refer to the command list for samples of voice commands.



- 1** Press the talk switch.  
Voice guidance for the voice command system can be skipped by pressing the talk switch.
- 2** If "Getting Started with Voice" screen is displayed, select "OK" or press the talk switch.

- 3** After hearing a beep, say a supported command.
  - To display sample commands of the desired function, say the desired function or select the desired function button. To display more commands, select "More Commands".
  - Selecting "Help" or saying "Help" prompts the voice command system to offer examples of commands and operation methods.
  - Registered POIs, registered names in the contacts list etc., can be said in the place of the "<" next to the commands.

Continue on to pages 69-75 for a detailed list of Voice Commands for the following categories:

Common .....	P.69
Top menu .....	P.69
Navigation .....	P.70
Phone .....	P.71
Radio .....	P.72
Audio .....	P.73
Info .....	P.74
Apps .....	P.74
Climate .....	P.75

## Command list

### Common

Command	Action
"Help"	Displays examples of some of the available commands
"Go Back"	Returns to the previous screen
"Cancel"	Cancels the voice command system
"Start over"	Returns to top menu screen
"Pause"	Temporarily pauses a voice session until it is resumed by pressing the talk switch again.

### Top menu

Command	Action
"Show command examples for <menu>"	Displays the command list of the selected menu
"More Commands"	Displays more commonly used commands
"Voice Settings"	Displays Voice Setting screen
"Train my voice"	Displays Train Voice Recognition screen *

\*: Vehicle must be parked

## ■ Navigation\*1

Command	Action
"Get directions to <house #, street, city, state>"*2	Enables setting a destination by saying the address*3,4
"Find a <POI category/POI name>"	Displays a list of <POI category*5/POI name*6> near the current position
"Find a <POI> near my destination"	Displays a list of <POI> near the destination
"Find a <POI category> in a city"*2	Displays a list of <POI> in a specified city and state*4
"Go Home"	Displays the route to home
"Go to Favorite <1-10>"	Sets the location registered to the corresponding favorite number as the destination
"Show Recent Destinations"	Displays recent destinations. Selecting a number from the list will start navigation to the selected recent destination.
"Cancel Route"	Cancels the route guidance
"Delete destinations"	Displays a list of destination to delete*7
"Show <POI category> icons"	Displays the specified point of interest category*5 icons on the map
"Destination Assist"	Connects the system to the Lexus response center

\*1: 10.3-inch display model

\*2: English and French only

\*3: Best recognition results occur when saying the full address without the zipcode

\*4: When the language is set to French, the supported area is only Quebec Province in Canada

\*5: For example; "Gas stations", "Restaurants", etc.

\*6: Major national brands are always supported. Local brands are also supported with a subscription to the Lexus Enform. Contact your Lexus dealer for details.

\*7: Used when multiple destinations are set on a route

## ■ Phone

Command	Action
"Call <contact>"*	Places a call to the specified contact from the phone book
"Call <contact> <phonetype>"*	Places a call to the specified phone type of the contact from the phone book
"Dial <phone number>"	Places a call to the specified phone number
"Redial"	Places a call to the phone number of the latest outgoing call
"Call Back"	Places a call to the phone number of latest incoming call
"Show Recent Calls"	Displays the call history screen
"Send a message to <contacts>"	Sends a text message to specified contact from the phone book

\*: If the system does not recognize the name of a contact, create a voice tag. The name of a contact can also be recognized by adding a voice tag.

## ■ While in a phone call

Command	Action
"Send <digits>"	Sends DTMF tones has specified
"Mute"	Mutes the microphone (far side cannot hear the conversation)
"Unmute"	Unmutes the microphone



## ■ While incoming message notification is displayed\*

Command	Action
"Read Message"	Reads the incoming message over the vehicle speakers
"Ignore"	Ignores the incoming message notification
"Reply"	Initiates sending a reply to the incoming message
"Call"	Places a call to the phone number of incoming message

\*: Full screen message notification must be turned on within the phone settings

## ■ Radio

Command	Action
"Tune to <frequency> AM"	Changes the radio to the specified AM frequency
"Tune to <frequency> FM"	Changes the radio to the specified FM frequency
"Play a <genre> station"	Changes the radio to an FM station of the specified genre <sup>*1</sup>
"Tune to preset <1-36>"	Changes the radio to the specified preset radio station
"Tune to a <genre> satellite station"	Changes the radio to a satellite radio channel of the specified genre <sup>*2</sup>
"Tune to <satellite channel name>"	Changes the radio to the satellite radio channel with the specified name <sup>*2</sup>
"Tune to channel <number> on XM"	Changes the radio to a satellite radio channel of the specified number <sup>*2</sup>

\*1: A station list must be built first using the radio screen

\*2: Requires a satellite radio subscription

## ■ Audio\*

Command	Action
"Play Playlist <name>"	Plays tracks from the selected playlist
"Play Artist <name>"	Plays tracks from the selected artist
"Play Song <name>"	Plays the selected track
"Play Album <name>"	Plays tracks from the selected album
"Play Genre <name>"	Plays tracks from the selected genre
"Play Composer <name>"	Plays tracks from the selected composer
"Play Podcast <name>"	Plays tracks from the selected podcast
"Play Audiobook <name>"	Plays tracks from the selected audiobook
"Audio On"	Turns the audio system on
"Audio Off"	Turns the audio system off
"Change the audio source to <source name>"	Sets the source to the specified audio mode

\*: The audio device must be connected via a USB cable to use the functionality in this section

## ■ Info\*1

Command	Action
"Get the Forecast"	Displays weather information
"Get the Forecast for <city>"*2	Displays weather for the specified city
"Show Traffic"	Displays traffic information
"Show Traffic near here"	Displays traffic information near your current location
"Get traffic along my route"	Displays traffic information along your current route
"Show Traffic on this street"	Displays traffic information along road you are currently driving on
"Show Traffic for saved route"	Displays traffic information for a saved route
"Show Predictive Traffic"	Displays the predictive traffic map

\*1: 10.3-inch display model (This function is not made available in some countries, areas, or on some models.)

\*2: Only major US cities are supported by voice

## ■ Apps

Command	Action
"Launch <apps>"*	Activates the Lexus Enform App Suite 2.0 application

\*: When an application is opened and is in full screen mode, pressing the talk switch will start the voice command system and commands for the currently displayed application will be available

## ■ Climate

Command	Action
"Turn the AC on/Turn the AC off"	Turns air conditioning system on or off
"Change the Fan speed to <#>"	Changes the set fan speed of the air conditioning system to <#>
"Set temperature to <#> degrees"	Changes the set temperature of the air conditioning system to <#> degrees*
"Increase Temperature/Decrease Temperature"	Increases or decreases the temperature of the air conditioning system
"Increase Fan speed/Decrease Fan speed"	Increases or decreases the fan speed of the air conditioning system
"Show the front climate control screen"	Displays the screen to control the air conditioning or seat heating system
"Set the steering wheel temperature"	Displays the screen to control the air conditioning or seat heating system
"Show the front seat heater settings"	Displays the screen to control the air conditioning or seat heating system
"Show the concierge screen"	Displays the screen to control the air conditioning or seat heating system
"Concierge Mode On"	Turns Concierge Mode ON

\*: Only within the possible temperature range of the air conditioning system

## USB/AUX Ports

There are 2 USB ports and an AUX port in the console box.

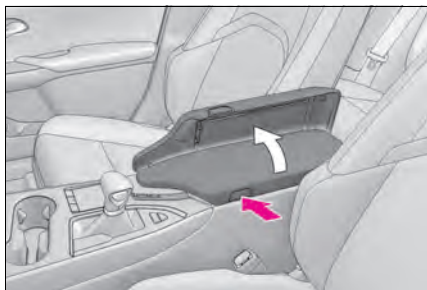

- 1** Press the button to release the lock and lift the armrest.

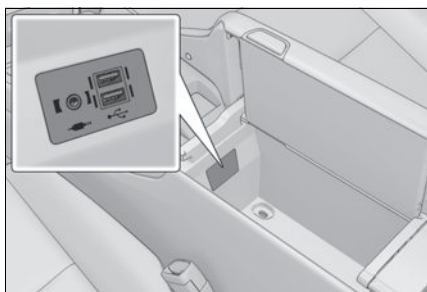

- 2** Connect a device.  
Turn on the power of the device if it is not turned on.

## Garage Door Opener (if equipped)

The garage door opener can be programmed using the HomeLink<sup>®</sup> to operate garage doors, gates, entry doors, door locks, home lighting systems, security systems, and other devices.

### System components

The HomeLink<sup>®</sup> wireless control system in your vehicle has 3 buttons which can be programmed to operate 3 different devices. Refer to the programming methods on the following pages to determine the method which is appropriate for the device.

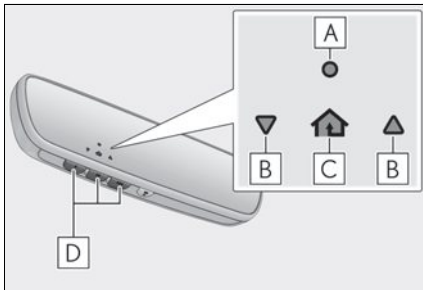

**A** HomeLink<sup>®</sup> indicator light

**B** Garage door operation indicators

**C** HomeLink<sup>®</sup> icon

Illuminates while HomeLink<sup>®</sup> is operating.

**D** Buttons

#### ■ Before programming HomeLink<sup>®</sup>

- During programming, it is possible that garage doors, gates, or other devices may operate. For this reason, make sure that people and objects are clear of the garage door or other devices to prevent injury or other potential harm.
- It is recommended that a new battery be placed in the remote control transmitter for more accurate programming.
- Garage door opener motors manufactured after 1995 may be equipped with rolling code protection. If this is the case, you may need a stepladder or other sturdy, safe device to reach the “Learn” or “Smart” button on the garage door opener motor.

#### ■ HomeLink<sup>®</sup> programming procedure

The programming procedures can also be found at the following URL.

Website: [www.homelink.com/lexus](http://www.homelink.com/lexus)



For support, contact customer support at the following.

Help Line: 1-800-355-3515

## ■ Programming HomeLink®

Steps **1** through **3** must be performed within 60 seconds, otherwise the indicator light will stop flashing and programming will not be able to be completed.

- 1** Press and release the HomeLink® button you want to program and check that the HomeLink® indicator light flashes (orange).

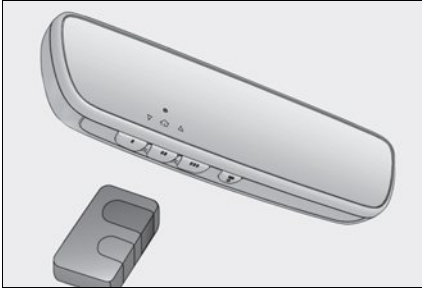

- 2** Point the remote control transmitter for the device at the rear view mirror, 1 to 3 in. (25 to 75 mm) from the HomeLink® buttons.

Keep the HomeLink® indicator light in view while programming.

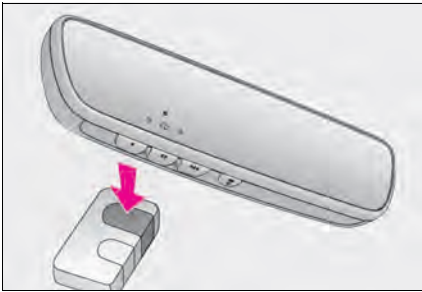

- 3** Program a device.

### ► Programming a device other than an entry gate (for U.S.A. owners)

Press and hold the remote control transmitter button until the HomeLink® indicator light changes from slowly flashing orange to rapidly flashing green (rolling code) or continuously lit green (fixed code), then release the button.

### ► Programming an entry gate (for U.S.A. owners)/Programming a device in the Canadian market

Press and release the remote control transmitter button at 2 second intervals, repeatedly, until the HomeLink® indicator light changes from slowly flashing (orange) to rapidly flashing (green) (rolling code) or continuously lit (green) (fixed code).

- 4 Test the HomeLink<sup>®</sup> operation by pressing the newly programmed button and observing the indicator light:
  - Indicator light illuminates: Programming of a fixed code device has completed. The garage door or other device should operate when a HomeLink<sup>®</sup> button is pressed and released.
  - Indicator light flashes rapidly: The garage door opener motor or other device is equipped with a rolling code. To complete programming, firmly press and hold the HomeLink<sup>®</sup> button for 2 seconds then release it.
  - If the garage door or other device does not operate, proceed to “Programming a rolling code system”.
- 5 Repeat the steps above to program another device for any of the remaining HomeLink<sup>®</sup> buttons.

### ■ Programming a rolling code system

2 or more people may be necessary to complete rolling code programming.

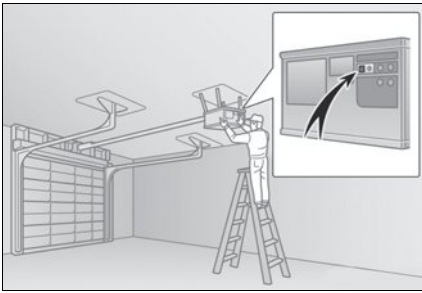

- 1 Locate the “Learn” or “Smart” button on the garage door opener motor in the garage.  
This button can usually be found where the hanging antenna wire is attached to the unit. The name and color of the button may vary by manufacturer. Refer to the owner’s manual supplied with the garage door opener motor for details.

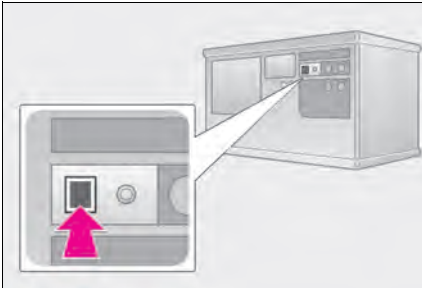

- 2 Press and release the “Learn” or “Smart” button.  
Perform 3 within 30 seconds after performing 2.



- 3 Press and hold the desired HomeLink<sup>®</sup> button (inside the vehicle) for 2 seconds and release it. Repeat this sequence (press/hold/release) up to 3 times to complete programming.  
If the garage door opener motor operates when the HomeLink<sup>®</sup> button is pressed, the garage door opener motor recognizes the HomeLink<sup>®</sup> signal.



## ■ Enabling 2-way communication with a garage door (only available for compatible devices)

When enabled, 2-way communication allows you to check the status of the opening and closing of a garage door through indicators in your vehicle.

2-way communication is only available if the garage door opener motor used is a compatible device. (To check device compatibility, refer to [www.homelink.com](http://www.homelink.com).)

- 1 Within 5 seconds after programming the garage door opener has been completed, if the garage door opener motor is trained to HomeLink<sup>®</sup>, both garage door operation indicators will flash rapidly (green) and the light on the garage door opener motor will blink twice, indicating that 2-way communication is enabled.

If the indicators do not flash, perform **2** and **3** within the first 10 presses of the HomeLink<sup>®</sup> button after programming has been completed.

- 2 Press a programmed HomeLink<sup>®</sup> button to operate a garage door.
- 3 Within 1 minute of pressing the HomeLink<sup>®</sup> button, after the garage door operation has stopped, press the "Learn" or "Smart" button on the garage door opener motor. Within 5 seconds of the establishment of 2-way communication with the garage door opener, both garage door operation indicators in the vehicle will flash rapidly (green) and the light on the garage door opener motor will blink twice, indicating that 2-way communication is enabled.

## ■ Reprogramming a single HomeLink<sup>®</sup> button

When the following procedure is performed, buttons which already have devices registered to them can be overwritten:

- 1 With one hand, press and hold the desired HomeLink<sup>®</sup> button.
- 2 When the HomeLink<sup>®</sup> indicator starts flashing (orange), continue to hold the HomeLink<sup>®</sup> button and perform "Programming HomeLink<sup>®</sup>" **1** (it takes 20 seconds for the HomeLink<sup>®</sup> indicator to start flashing).

## Operating HomeLink<sup>®</sup>

Press the appropriate HomeLink<sup>®</sup> button. The HomeLink<sup>®</sup> indicator light should turn on.

## Lexus Enform Safety Connect (if equipped)

Safety Connect is a subscription-based telematics service that uses Global Positioning System (GPS) data and embedded cellular technology to provide safety and security features to subscribers. Safety Connect is supported by Lexus' designated response center, which operates 24 hours per day, 7 days per week.

Safety Connect service is available by subscription on select, telematics hardware-equipped vehicles.

### System components

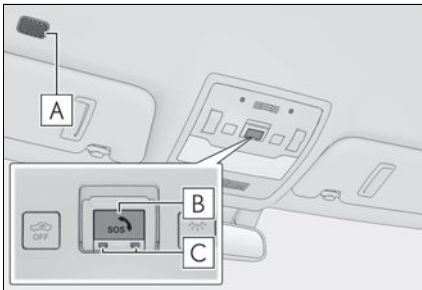

- A** Microphone
- B** "SOS" button
- C** LED light indicators

### Services

Subscribers have the following Safety Connect services available:

- Automatic Collision Notification

In case of either airbag deployment or severe rear-end collision, the system is designed to automatically call the response center. The responding agent receives the vehicle's location and attempts to speak with the vehicle occupants to assess the level of emergency. If the occupants are unable to communicate, the agent automatically treats the call as an emergency, contacts the nearest emergency services provider to describe the situation, and requests that assistance be sent to the location.

- **Stolen Vehicle Location**

If your vehicle is stolen, Safety Connect can work with local authorities to assist them in locating and recovering the vehicle. After filing a police report, call the Safety Connect response center at 1-800-25-LEXUS (1-800-255-3987) in the United States, 1-877-539-8777 in Puerto Rico or 1-800-265-3987 in Canada, and follow the prompts for Safety Connect to initiate this service.

In addition to assisting law enforcement with recovery of a stolen vehicle, Safety-Connect-equipped vehicle location data may, under certain circumstances, be shared with third parties to locate your vehicle. Further information is available at [Lexus.com](http://Lexus.com).

- **Emergency Assistance Button (“SOS”)**

In the event of an emergency on the road, push the “SOS” button to reach the Safety Connect response center. The answering agent will determine your vehicle’s location, assess the emergency, and dispatch the necessary assistance required.

If you accidentally press the “SOS” button, tell the response-center agent that you are not experiencing an emergency.

- **Enhanced Roadside Assistance**

Enhanced Roadside Assistance adds GPS data to the already included warranty-based Lexus roadside service.

Subscribers can press the “SOS” button to reach a Safety Connect response-center agent, who can help with a wide range of needs, such as: towing, flat tire, fuel delivery, etc. For a description of the Roadside Assistance services and their limitations, please see the Safety Connect Terms and Conditions, which are available at [Lexus.com](http://Lexus.com).

## Subscription

After you have signed the Telematics Subscription Service Agreement and are enrolled, you can begin receiving services.

A variety of subscription terms is available for purchase. Contact your Lexus dealer, call the following or push the “SOS” button in your vehicle for further subscription details.

- **The United States**

1-800-25-LEXUS (1-800-255-3987)

- **Canada**

1-800-26-LEXUS (1-800-265-3987)

- **Puerto Rico**

1-877-539-8777

## Lexus Enform Remote (if equipped)

Lexus Enform Remote is a smart phone application that lets you view and remotely control certain aspects of your vehicle.

For details about the functions and services of this application, refer to <http://www.lexus.com/enform/>.

Function of the Lexus Enform Remote is achieved by using DCM (Data Communication Module) and a smart phone.

## Subscription

After you sign the Telematics Subscription Service Agreement, download the Lexus App from your smart phone's app store, and register within the app (or enroll and complete registration at the dealer), you can begin using these services.

A variety of subscription terms are available. Contact your Lexus dealer, or call 1-800-25-LEXUS (1-800-255-3987) for further subscription details.

## Lexus Enform Service Connect (if equipped)

Lexus Enform Service Connect uses DCM (Data Communication Module) to collect and transmit vehicle data that allows Lexus to provide:

- Vehicle Health Report (VHR) (Safety Recalls, Service Campaigns, Current Vehicle Alerts, Required Maintenance, and Vehicle Condition Status)
- Maintenance Notifications
- Vehicle Alert Notifications

For details about this service and how to register, refer to <http://www.lexus.com/enform/>.

The Lexus Enform Service Connect is achieved by using a DCM built in the vehicle.

## SiriusXM Satellite Radio

Most in-car trials today include SiriusXM's best package — All Access. It includes every channel available on your radio, plus streaming.

For details, refer to the "NAVIGATION AND MULTIMEDIA SYSTEM OWNER'S MANUAL".

### Subscription

All SiriusXM services, including satellite radio and data services, plus streaming services, require a subscription, sold separately or as a package by Sirius XM Radio Inc. (or, in Canada, Sirius XM Canada Inc.), after any trial subscription which may be included with your vehicle purchase or lease. To subscribe after your trial subscription, call 1-877-447-0011 (U.S.A.) or 1-877-438-9677 (Canada).

## Door Locks

The vehicle can be locked and unlocked using the entry function, wireless remote control or door lock switches.

For details about the entry function or wireless remote control, refer to P.16, 17.

### Unlocking and locking the doors from the inside

#### ■ Door lock switches (to lock/unlock)

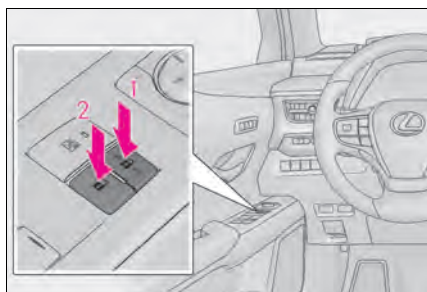

- 1 Locks all the doors
- 2 Unlocks all the doors

#### ■ Inside lock buttons (to lock)

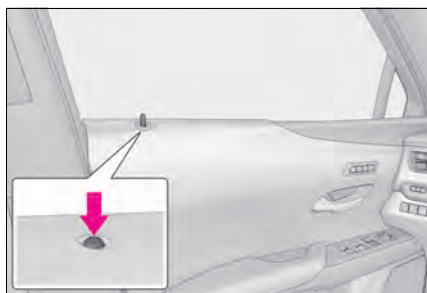

Push down the inside lock button to lock the door.

#### ■ Inside door handles (to unlock)

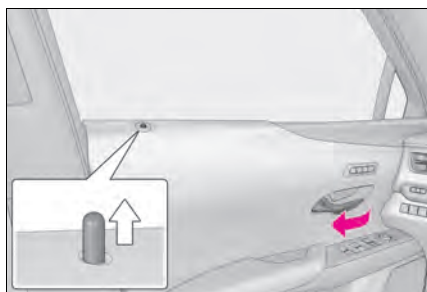

- ▶ **For the front doors**  
Pull the handle to unlock and open the door.  
When the door is unlocked, the inside lock button will pop up.
- ▶ **For the rear doors**  
Pull the handle to unlock the door. Pull the handle a second time to open the door.  
When the door is unlocked, the inside lock button will pop up.

## Back Door

### Opening the back door from the outside (vehicles without power back door)

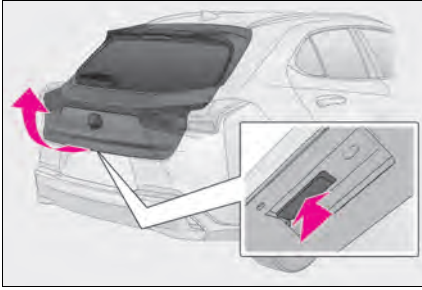

Raise the back door while pressing up the back door opener switch.

### Opening/closing the back door (vehicles with power back door)

#### ■ From the inside

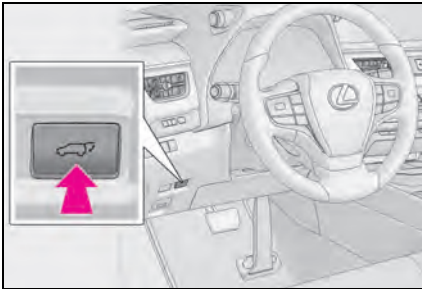

Press the switch for 1 second.

A buzzer sounds and the back door automatically opens and closes.



## ■ From the outside

### ▶ Wireless remote control

→ P.16

### ▶ Power back door opener switch

#### ● Open

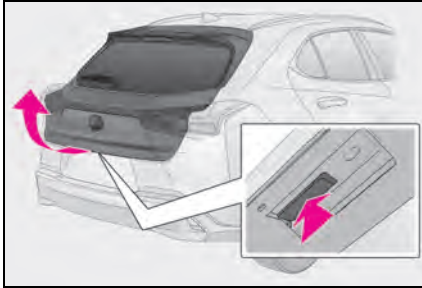

When the back door is unlocked: Press the back door opener switch.

When the back door is locked: While carrying the electronic key on your person, press the back door opener switch.

A buzzer sounds and the back door automatically opens.

#### ● Close

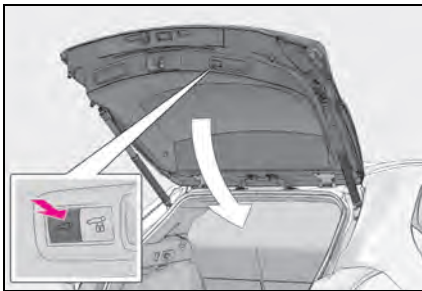

Press the switch.

A buzzer sounds and the back door automatically closes.

#### ● Close the back door and lock all doors (close & lock function)

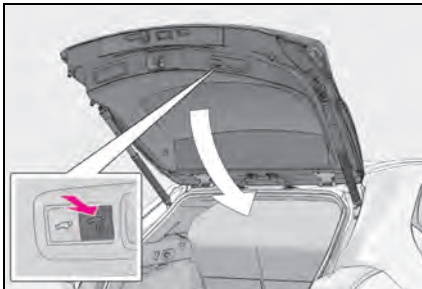

Press the switch.

A different buzzer than the normal one will sound and the power back door will begin closing automatically. When the power back door is closed, all of the doors will lock simultaneously and operation signals will indicate that all of the doors have been locked.

## ■ Opening/closing the back door using the Hands Free Power Back Door

- 1 While carrying an electronic key, stand within the smart access system with push-button start operation range, approximately 19.7 to 27.6 in. (50 to 70 cm) from the rear bumper.

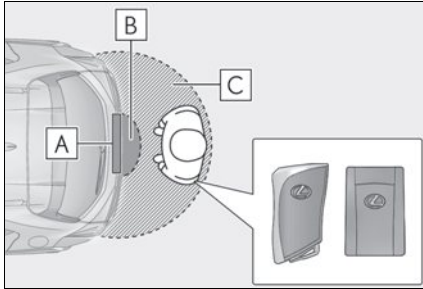

- A** Kick sensor
- B** Hands Free Power Back Door operation detection area
- C** Smart access system with push-button start operation detection area

- 2 Perform a kick operation by moving your foot to within approximately 3.9 in. (10 cm) of the rear bumper and then pulling it back.

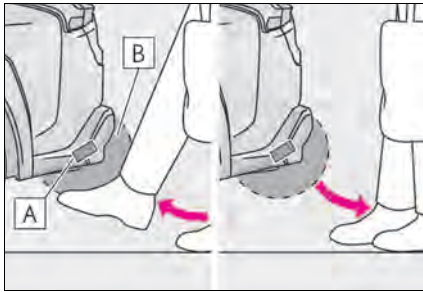

- A** Kick sensor
- B** Hands Free Power Back Door operation detection area

- 3 When the kick sensor detects that your foot is pulled back, a buzzer will sound and the back door will automatically fully open/close.

# Fuel Tank Cap

## Before refueling the vehicle

- Turn the power switch off and ensure that all the doors and windows are closed.
- Confirm the type of fuel.

## Opening the fuel tank cap

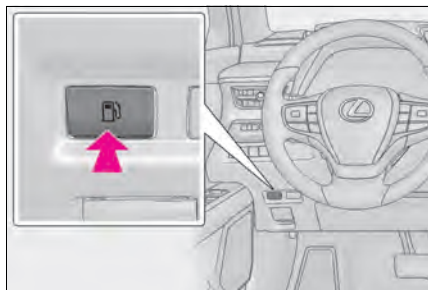

- 1 Press the opener switch.

The fuel filler door will open within about 10 seconds of the switch being pressed. Before refueling is possible, a message will be shown on the multi-information display in the instrument cluster to indicate the progress of the fuel filler door opener.

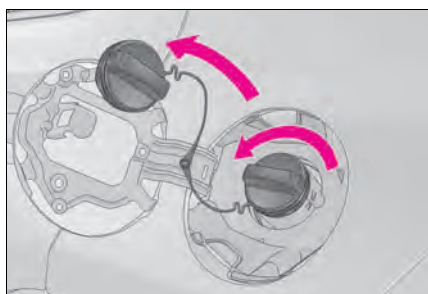

- 2 Turn the fuel tank cap slowly and remove it, then put it into the holder on the fuel filler door.

## Closing the fuel tank cap

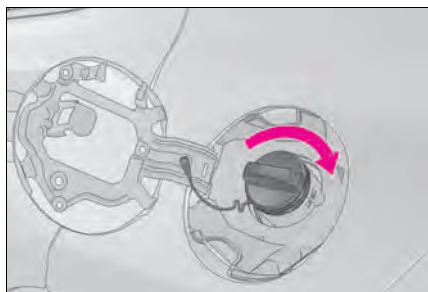

After refueling, turn the fuel tank cap until you hear a click. Once the cap is released, it will turn slightly in the opposite direction.

## What to do if...

### List of Warning/Indicator Lights

Immediately stop the vehicle in a safe place and contact your Lexus dealer. Continuing to drive the vehicle may be dangerous.

**BRAKE**

(U.S.A.)

Brake system warning light



(Canada)

(Red)

Immediately stop the vehicle in a safe place and contact your Lexus dealer.



Low engine oil pressure warning light



(U.S.A.)

Malfunction indicator lamp



Charging system warning light



(Canada)

Have the vehicle inspected by your Lexus dealer immediately.



SRS warning light

**HOLD**

Brake hold operated indicator

(Flashes)

**ABS**

(U.S.A.)

ABS warning light

**PARK**

(U.S.A.)

Parking brake indicator

(Flashes)



(Canada)



(Canada)

(Flashes)



Electric power steering system warning light

(Red or yellow)



Brake system warning light

(Yellow)



PCS warning light

(Flashes or illuminates)

**RCTA OFF**

RCTA OFF indicator (if equipped)

(Flashes)



Slip indicator



PKSB OFF indicator (if equipped)

(Flashes)

**P OFF**

Intuitive parking assist OFF indicator (if equipped)

(Flashes)

For further information, refer to the "OWNER'S MANUAL".

## What to do if...

### Follow the correction procedures.



Brake Override System warning light/Drive-Start Control warning light/PKSB warning light



Rear passengers' seat belt reminder lights



Tire pressure warning light

(Blinking and then continuously on)



LTA indicator

(Orange)



Tire pressure warning light\*

(Illuminates without blinking)



Low fuel level warning light



Driver's and front passenger's seat belt reminder light



Low traction battery charge warning light

### Stop and check.



High coolant temperature warning light































Hybrid system overheat warning light

For further information, refer to the "OWNER'S MANUAL".

## What to do if...

### See the "OWNER'S MANUAL"

	Turn signal indicator		BSM indicator (if equipped)
	Headlight indicator (U.S.A.)		Intuitive parking assist OFF indicator (if equipped)
	Tail light indicator (Canada)		RCTA OFF indicator (if equipped)
	Headlight high beam indicator		PKSB OFF indicator (if equipped)
	Automatic High Beam indicator		Brake hold standby indicator
	Fog light indicator (if equipped)		Brake hold operated indicator
	Cruise control indicator		Security indicator
	Dynamic radar cruise control indicator		Smart access system with push-button start indicator
	Cruise control "SET" indicator		Low outside temperature indicator
	LTA indicator (White or green)		"READY" indicator
	LTA indicator (Flashes in orange)		EV drive mode indicator
	Slip indicator (Flashes)		EV indicator
	VSC OFF indicator		(U.S.A.) Parking brake indicator
	PCS warning light		(Canada)
	BSM outside rear view mirror indicators (if equipped)		

For further information, refer to the "OWNER'S MANUAL".

## What to do if...

### See the "OWNER'S MANUAL"



"AIR BAG ON/OFF" indicator



"AIR BAG ON/OFF" indicator

#### ● Drive mode indicators

#### ▶ Except F SPORT models



Eco drive mode indicator



Sport mode indicator

#### ▶ F SPORT models



Eco drive mode indicator



Sport mode indicator

For further information, refer to the "OWNER'S MANUAL".

- \*: It also comes on due to natural causes such as natural air leaks and tire inflation pressure changes caused by temperature. Adjust the tire inflation pressure to the specified level. The light will turn off after a few minutes. In case the light does not turn off even if the tire inflation pressure is adjusted, have the system checked by your Lexus dealer.

## What to do if...

### If the electronic key does not operate properly

#### Locking and unlocking the door

##### ■ Unlocking the door

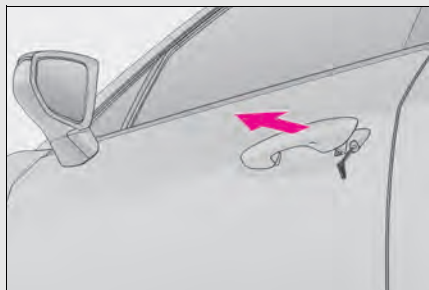

- 1 Insert the mechanical key while pulling on the driver's door handle.

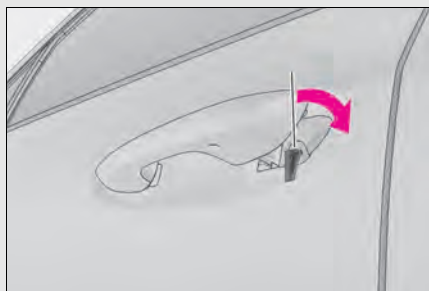

- 2 Unlock the door.

- 3 Remove the key, return the handle, and then pull the handle again.

##### ■ Locking the door

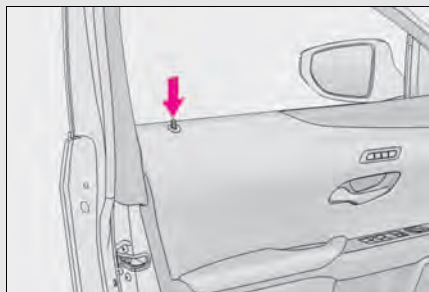

- 1 With the door open, push down the inside lock button.

- 2 Close the door.



## What to do if...

### Starting the hybrid system

- 1 Ensure that the shift lever is in P and depress the brake pedal.

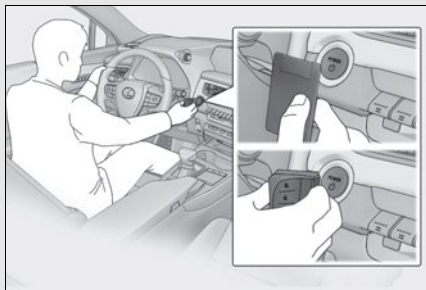

- 2 Touch the Lexus emblem side of the electronic key to the power switch.

When the electronic key is detected, a buzzer sounds and the power switch will turn to ON.

When the smart access system with push-button start is deactivated in customization setting, the power switch will turn to ACC.

- 3 Firmly depress the brake pedal and check that  is shown on the multi-information display.
- 4 Press the power switch.

In the event that the hybrid system still cannot be started, contact your Lexus dealer.

Replace the battery with a new one. For instructions on replacing the battery, refer to the "OWNER'S MANUAL".

If you need further assistance, contact your Lexus dealer.

## What to do if...

### If the hybrid system will not start

Make sure that the correct operating procedures have been followed.

#### Brake pedal

Make sure that the brake pedal is firmly depressed when attempting to start the hybrid system. (→P.19)

If the hybrid system still does not start, see the "OWNER'S MANUAL" for more information or contact your Lexus dealer.



### **Your Lexus dealer**

Your Lexus dealer will provide quality maintenance and any other assistance you may require.

If there is not a Lexus dealer near you, please call the following number:

#### **■ U.S. OWNERS**

- In the U.S. mainland or Canada:

Lexus Roadside Assistance

**1-800-25-LEXUS or 1-800-255-3987 (Toll-Free)**

- In Hawaii:

Servco Automotive Roadside Assistance/Customer Services

**1-800-25-LEXUS or 1-800-255-3987 (Toll-Free)**

#### **■ CANADIAN OWNERS**

- In Canada or the U.S. mainland:

Lexus Roadside Assistance/Customer Service

**1-800-26-LEXUS or 1-800-265-3987 (Toll-Free)**

Please access our **websites** for further information.

- The U.S. mainland: **[www.lexus.com](http://www.lexus.com)**
- Hawaii: **[www.servcolexus.com](http://www.servcolexus.com)**
- Canada: **[www.lexus.ca](http://www.lexus.ca)**

©2021 TOYOTA MOTOR CORPORATION

All rights reserved. This material may not be reproduced or copied, in whole or in part, without the written permission of Toyota Motor Corporation.



Owner's Manual Quick Guide:

Publication No. OM76572U

Part No. 01999-76572

Printed in Japan 01-2108-00 ©

UX 250h Owner's Manual Quick Guide (北米U)