



#### Digital – in the vehicle

Familiarize yourself with the contents of the Operator's Manual directly via the vehicle's multimedia system (menu item "Vehicle information"). Start with the quick guide or broaden your knowledge with practical tips.



#### Vehicle document wallet

Here you can find comprehensive information about operating your vehicle and about services and guarantees in printed form.



1675846921

Order no. P167 0514 13 Part no. 167 584 69 21  
Edition B 2022

GLS

Mercedes-Benz



# GLS

Operator's Manual

Mercedes-Benz



## Front passenger airbag warning

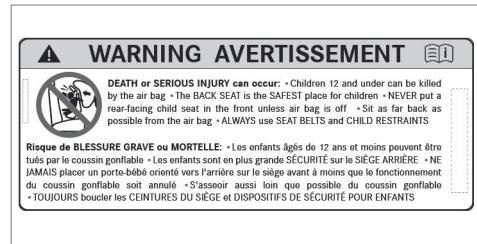
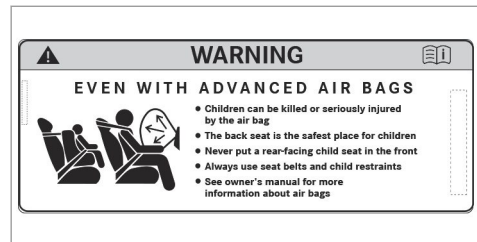

Airbag warning sticker for USA and Canada

## **⚠ WARNING** Risk of injury or death if the co-driver airbag is enabled

If the co-driver airbag is enabled, a child on the co-driver seat may be struck by the co-driver airbag during an accident.

NEVER use a rearward-facing child restraint system on a seat with an ENABLED FRONT AIRBAG; DEATH or SERIOUS INJURY to the CHILD can occur.

Observe the chapter "Children in the vehicle".

## Publication details

### Internet

Further information about Mercedes-Benz vehicles and about Mercedes-Benz AG can be found on the following websites:

<https://www.mbusa.com> (USA only)

<https://www.mercedes-benz.ca> (Canada only)

### Documentation team

©Mercedes-Benz AG: Not to be reprinted, translated or otherwise reproduced, in whole or in part, without written permission from Mercedes-Benz AG.

### Vehicle manufacturer

Mercedes-Benz AG

Mercedesstraße 120

70372 Stuttgart

Germany

As at 08.04.21

## Thank you for buying Mercedes-Benz

Before you first drive off, read this operator's manual carefully and familiarize yourself with your vehicle. For your own safety and a longer operating lifespan of the vehicle, follow the instructions and warning notices in this operator's manual. Disregarding them may lead to damage to the vehicle or injury to people.

Damage to the vehicle resulting from the disregard of the instructions is not covered by the Mercedes-Benz Limited Warranty.

The standard equipment and product description of your vehicle may vary and depends on the following factors:

- Model
- Order
- National version
- Availability

Your vehicle may therefore differ, in individual cases, from that shown in the descriptions and illustrations.

Mercedes-Benz reserves the right to introduce changes in the following areas:

- Design
- Equipment
- Technical features

The following documents are integral parts of the vehicle:

- Digital Operator's Manual
- Printed operator's manual
- Maintenance Booklet
- Equipment-dependent supplements
- Supplementary documents

Keep these documents in the vehicle at all times. Ensure that all documents are in the vehicle or passed on in the event of sale or rental.

Mercedes-Benz USA, LLC

Mercedes-Benz Canada, Inc.

A Daimler Company

1675846921



<b>Symbols</b> .....	5	Diagnostics connection .....	28	Doors .....	74
<b>At a glance</b> .....	6	Qualified specialist workshop .....	29	Running boards .....	77
Cockpit .....	6	Correct use of the vehicle .....	29	Cargo compartment .....	78
Indicator and warning lamps .....	10	Sport Utility Vehicle .....	30	Side windows .....	85
Overhead control panel .....	12	Notes for persons with electronic medical aids .....	30	Sliding sunroof .....	88
Door operating unit and seat adjustment .....	14	Problems with your vehicle .....	31	Roller sun blinds .....	93
Control settings in the rear passenger compartment .....	16	Reporting safety defects .....	31	Anti-theft protection .....	93
Emergencies and breakdowns .....	18	Limited Warranty .....	32		
		QR code for rescue card .....	32	<b>Seats and stowing</b> .....	<b>97</b>
<b>Digital Operator's Manual</b> .....	<b>20</b>	Data storage .....	32	Notes on the correct driver's seat position ....	97
Calling up the Digital Operator's Manual .....	20	Copyright .....	36	Seats .....	97
				Steering wheel .....	116
<b>General notes</b> .....	<b>22</b>	<b>Occupant safety</b> .....	<b>38</b>	Easy entry and exit feature .....	118
Protection of the environment .....	22	Restraint system .....	38	Memory function .....	119
Genuine Mercedes-Benz parts .....	22	Seat belts .....	40	Memory function in the rear passenger compartment .....	120
Operator's Manual .....	23	Airbags .....	44	Stowage areas .....	124
Mercedes me app .....	24	PRE-SAFE® system .....	52	Cup holder .....	139
Service and vehicle operation .....	24	Automatic measures after an accident .....	53	Sockets .....	140
Operating safety .....	25	Safely transporting children in the vehicle .....	53	Refrigerator box .....	143
Declaration of conformity for wireless vehicle components .....	27	Notes on pets in the vehicle .....	69	Wireless charging of the mobile phone and connection with the exterior antenna ....	144
				Installing/removing the floor mats .....	147
		<b>Opening and closing</b> .....	<b>70</b>		
		SmartKey .....	70		

<b>Light and visibility</b> .....	<b>148</b>
Exterior lighting .....	148
Interior lighting .....	153
Windshield wiper and windshield washer system .....	155
Mirrors .....	160
Area permeable to radio waves on the windshield .....	163
Infrared-reflective windshield function .....	163
<b>Climate control</b> .....	<b>164</b>
Overview of climate control systems .....	164
Operating the climate control system .....	165
<b>Driving and parking</b> .....	<b>173</b>
Driving .....	173
DYNAMIC SELECT switch .....	188
Automatic transmission .....	192
Transfer case .....	197
Function of the 4MATIC .....	198
Refueling .....	199
Parking .....	201
Driving and driving safety systems .....	209
Trailer hitch .....	277

Vehicle towing instructions .....	281
<b>Instrument display and on-board computer</b> .....	<b>282</b>
Notes on the instrument display and on-board computer .....	282
Overview of instrument display .....	283
Overview of the buttons on the steering wheel .....	284
Operating the on-board computer .....	284
Overview of displays in the instrument display .....	286
Head-up Display .....	286

<b>MBUX multimedia system</b> .....	<b>289</b>
Overview and operation .....	289
System settings .....	298
Navigation .....	302
Telephone .....	312
Mercedes me app .....	316
Mercedes-Benz emergency call system .....	323
Radio & media .....	326
Sound settings .....	333

<b>Maintenance and care</b> .....	<b>334</b>
ASSYST PLUS service interval display .....	334
Engine compartment .....	335
Cleaning and care .....	341

<b>Breakdown assistance</b> .....	<b>350</b>
Emergency .....	350
Flat tire .....	351
Battery (vehicle) .....	357
Tow starting or towing away .....	362
Electrical fuses .....	367

<b>Wheels and tires</b> .....	<b>370</b>
Notes on noise or unusual handling characteristics .....	370
Notes on regularly inspecting wheels and tires .....	370
Notes on snow chains .....	371
Tire pressure .....	371
Loading the vehicle .....	376
Tire labeling .....	381
Definition of terms for tires and loading .....	386
Changing a wheel .....	388
Emergency spare wheel .....	399

## 4 Contents

---

Collapsible spare wheel ..... 401

---

### **Technical data ..... 404**

Notes on technical data ..... 404

Vehicle electronics ..... 404

Regulatory radio identification and notes ..... 406

Vehicle identification plate, VIN and

engine number overview ..... 407

Operating fluids ..... 408

Vehicle data ..... 416

Trailer hitch ..... 420

---

### **Display messages and warning/indicator**

**lamps ..... 423**

Display messages ..... 423

Warning and indicator lamps ..... 479

---

**Index ..... 495**

In this Operator's Manual, you will find the following symbols:

**⚠ WARNING** Danger due to not observing the warning notices

Warning notices draw your attention to hazards that may endanger your health or life, or the health or life of others.

▶ Observe the warning notices.

**🌿 ENVIRONMENTAL NOTE** Environmental damage due to failure to observe environmental notes

Environmental notes include information on environmentally responsible behavior or environmentally responsible disposal.

▶ Observe environmental notes.

**! NOTE** Damage to property due to failure to observe notes on material damage

Notes on material damage inform you of risks which may lead to your vehicle being damaged.

▶ Observe notes on material damage.

**i** These symbols indicate useful instructions or further information that could be helpful to you.

▶ Instruction

(→ page) Further information on a topic

**Display** Display field in the Instrument Display/media display

↗▶ Highest menu level, which is to be selected in the multimedia system





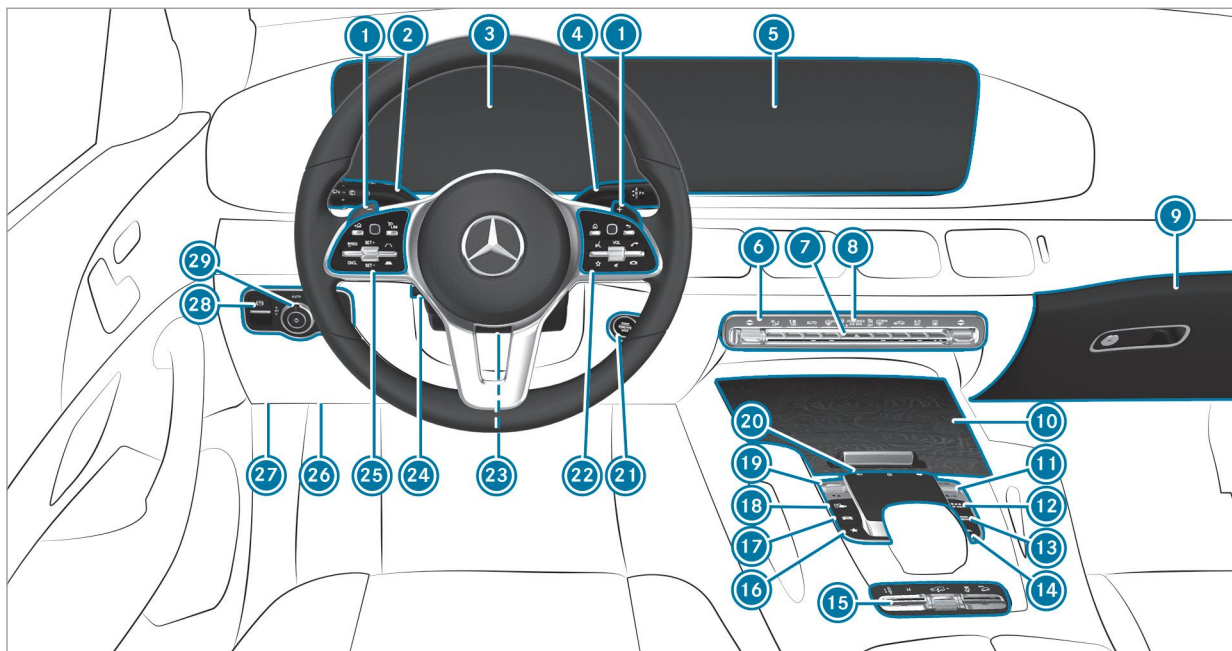











▶▶ Relevant submenus, which are to be selected in the multimedia system

\* Indicates a cause













Left-hand-drive vehicles



1	Steering wheel paddle shifters	→	195
2	Combination switch	→	149
3	Instrument display	→	283
4	DIRECT SELECT lever	→	192
5	Media display	→	289
6	Climate control systems	→	165
7	 Hazard warning light system	→	150
8	PASSENGER AIR BAG indicator lamps	→	49
9	Glove box	→	127
10	Stowage space	→	127
11	 Controller for volume and switching sound on/off	→	289
	 Switches the MBUX multimedia system on/off	→	289
12	 Calls up navigation	→	291
13	 Calls up radio or media	→	291
14	 Calls up the telephone	→	291
15	Switch panel for:		
	 Individual wheel control (vehicles without off-road package) or	→	257
	 Transfer case (vehicles with off-road package)	→	197
	 Manual gearshifting	→	195
	 AIRMATIC or	→	246
	 E-ACTIVE BODY CONTROL	→	253
	 Activates/deactivates ESP®	→	212
	 Downhill Speed Regulation	→	227
16	 Calls up favorites	→	291
17	 Calls up vehicle functions	→	291
18	 Active Parking Assist	→	274
19	DYNAMIC SELECT switch	→	190
20	Touchpad	→	291
21	Start/stop button	→	174
	 ECO start/stop function	→	186

## 8 At a glance – Cockpit







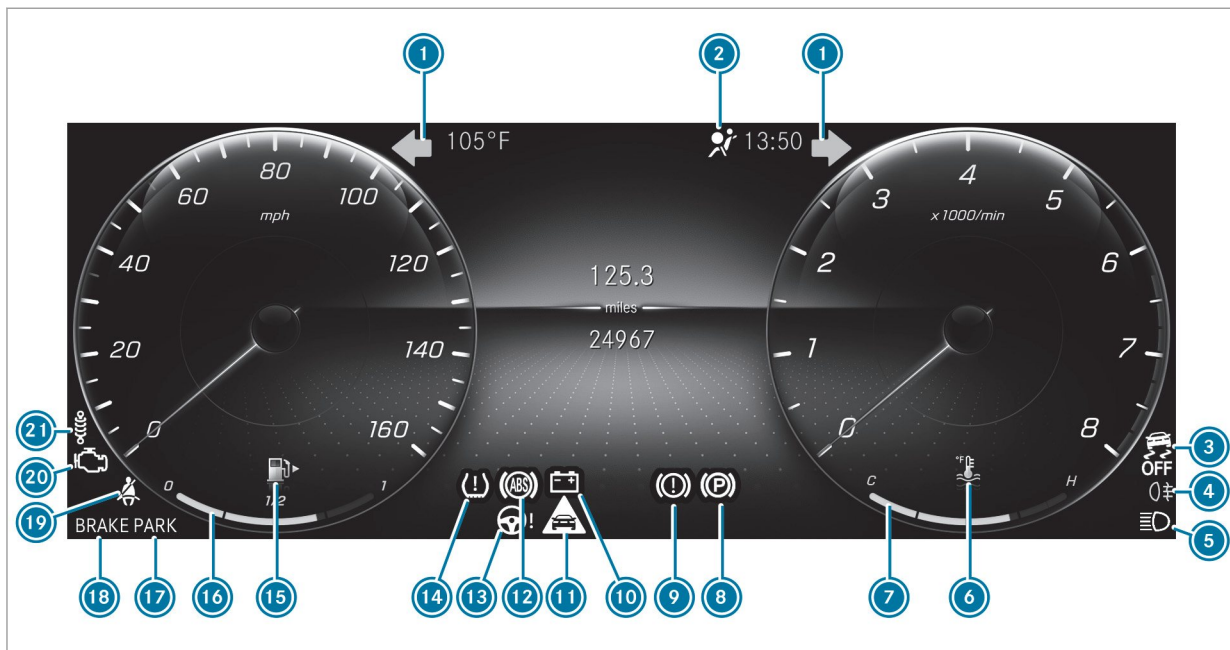



















---

 22	Control panel for the MBUX multimedia system	→	284		Cruise control	→	219
 23	Adjusts the steering wheel mechanically	→	116		Active Distance Assist DISTRONIC	→	222
 24	Adjusts the steering wheel electrically	→	117	 26	Diagnostics connection	→	28
	Switches the steering wheel heater on/off	→	117	 27	Opens the hood	→	335
 25	Control panel: On-board computer	→	284	 28	 Electric parking brake	→	206
				 29	Light switch	→	148











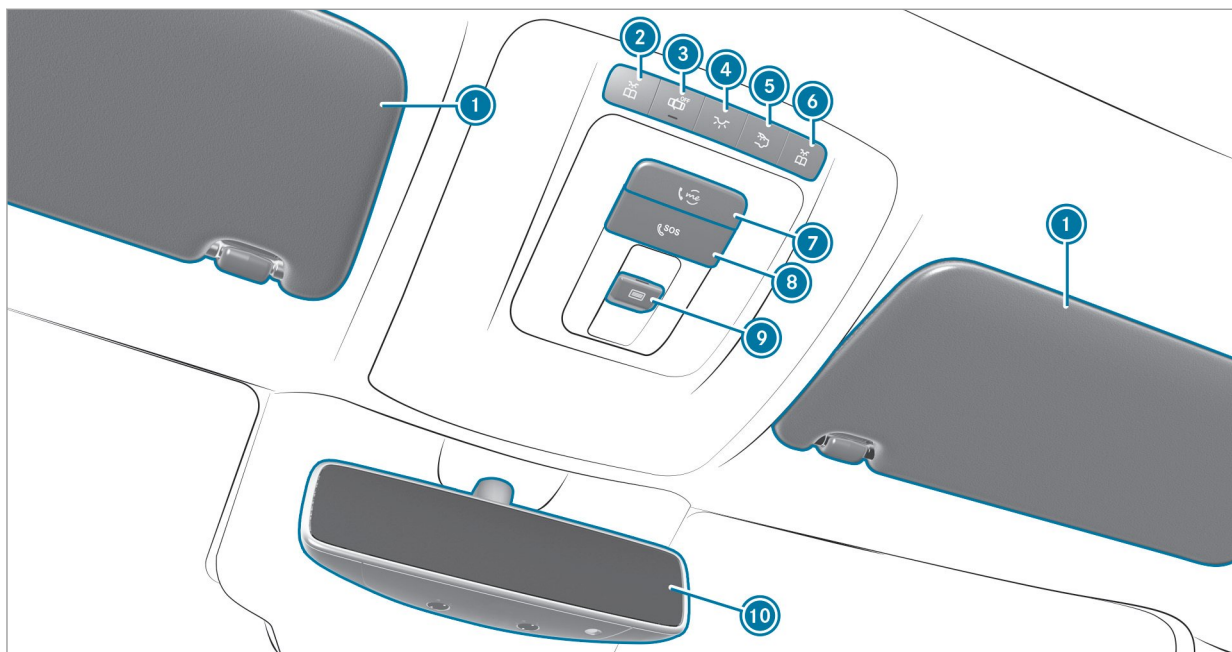



Instrument display

1		Turn signal lights	→	149	13		Power steering	→	481
2		Restraint system	→	480	14		Tire pressure monitoring system	→	493
3		ESP® OFF	→	491	15		Reserve fuel with fuel filler flap location indicator	→	482
		ESP®	→	491	16		Fuel level	→	283
4		Rear fog lamp	→	149	17		Electric parking brake (red)	→	486
5		High beam	→	149			USA only		
		Low beam	→	148			Canada only		
		Parking lamps	→	148	18		Brakes (red)	→	486
6		Coolant temperature	→	482			USA only		
7		Coolant temperature display	→	283			Canada only		
8		Electric parking brake (yellow)	→	486	19		Seat belt	→	480
9		Recuperative Brake System, USA only	→	486	20		Check Engine	→	482
		Brakes (yellow), Canada only	→	486	21		Suspension (red)	→	489
10		Electrical malfunction	→	482			Suspension (yellow)	→	489
11		Distance warning	→	489					
12		ABS	→	491					

## 12 At a glance - Overhead control panel









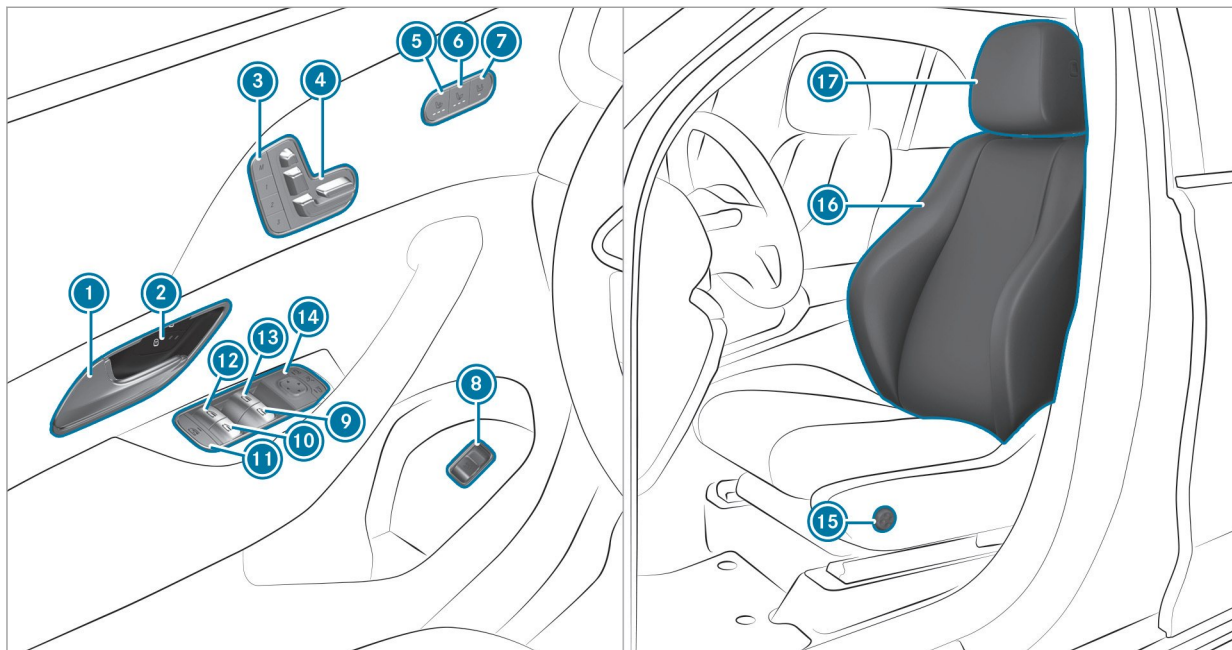





①	Sun visors		
②	 Switches the left-hand reading lamp on/off	→	153
③	 Switches automatic interior lighting control on/off	→	153
④	 Switches the front interior lighting on/off	→	153
⑤	 Switches the rear interior lighting on/off	→	153
⑥	 Switches the right-hand reading lamp on/off	→	153

⑦	 me button	→	316
⑧	 SOS button	→	316
⑨	 Opens/closes the panorama roof with power tilt/sliding panel	→	88
	 Opens/closes the roller sunblind	→	88
⑩	Inside rearview mirror	→	161

14 At a glance - Door operating unit and seat adjustment









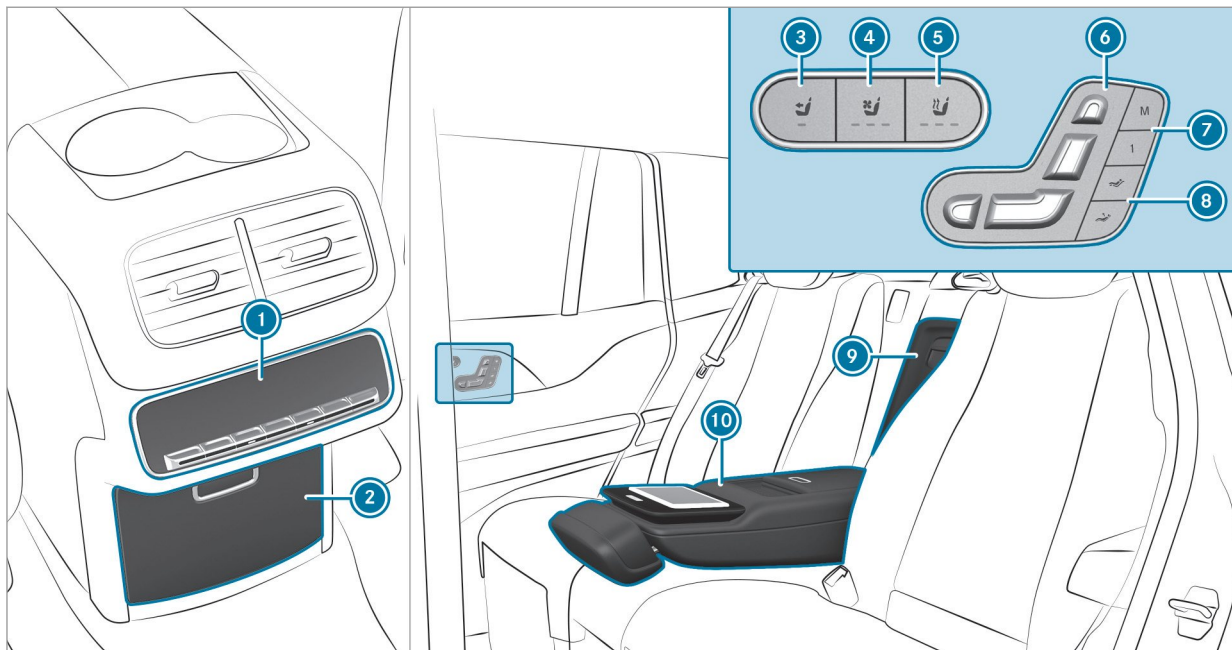

①	Opens the door	→	74	⑩	 Opens/closes the right rear side window	→	85
②	  Locks/unlocks the vehicle	→	74	⑪	 Child safety lock for the rear passenger compartment side windows	→	68
③	 Sets the memory function	→	120	⑫	 Opens/closes the left rear side window	→	85
④	Adjusts the seats electrically	→	97	⑬	 Opens/closes the left side window	→	85
⑤	 Switches the seat heating on/off	→	113	⑭	 Operates the outside mirrors	→	160
⑥	 Switches the seat ventilation on/off	→	115	⑮	Adjusts the 4-way lumbar support	→	101
⑦	 Adjusts the front passenger seat from the driver's seat	→	100	⑯	Seat adjustment using the multimedia system	→	111
⑧	 Opens/closes the tailgate	→	78	⑰	Adjusts the head restraints	→	107
⑨	 Opens/closes the right side window	→	85				

16 At a glance - Control settings in the rear passenger compartment

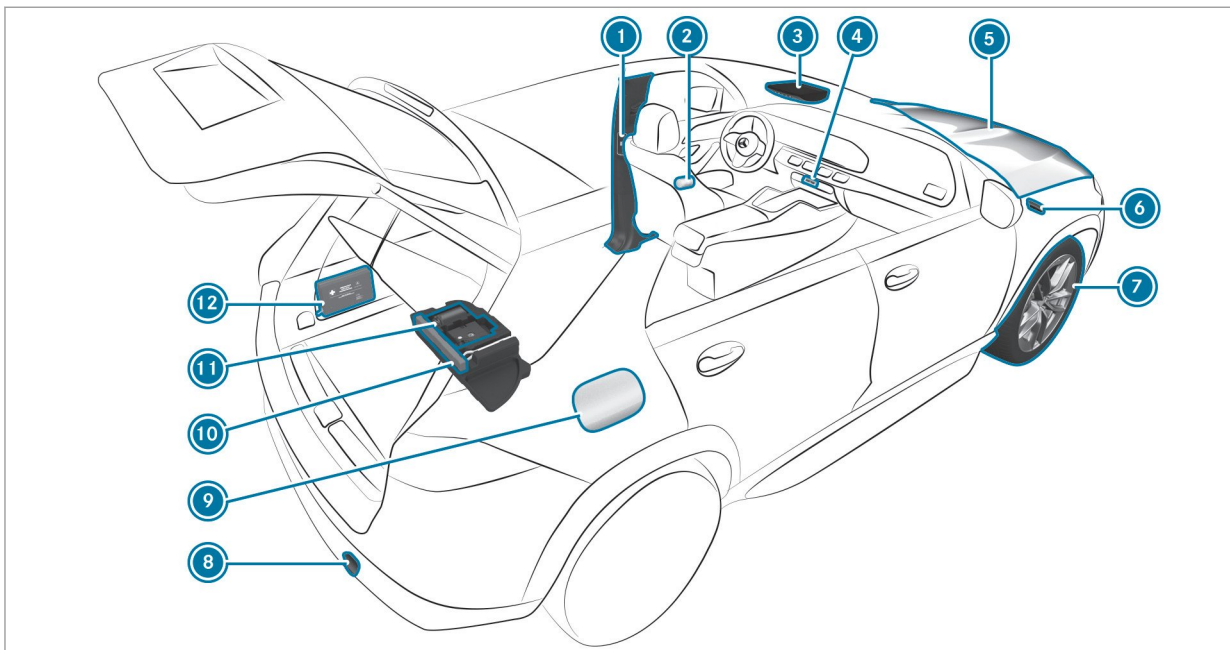

①	Rear climate control operating unit	→	165	⑦	Mercedes-Maybach vehicles: operates the memory function	→	121
②	Storage compartment in the center console			⑧	Mercedes-Maybach vehicles: sets the fully reclined position	→	103
	115 V socket	→	141	⑨	Mercedes-Maybach vehicles: access to the refrigerator box	→	143
③	Adjusts the front passenger seat electrically	→	101	⑩	Storage compartment in the rear armrest		
④	 Switches the rear seat ventilation on/off	→	115		MBUX rear tablet bracket		
⑤	 Switches the rear seat heating on/off	→	113				
⑥	Adjusts the rear seats electrically	→	102				
	Mercedes-Maybach vehicles: adjusts a reclining rear seat electrically	→	102				



① B-pillar with: QR code for accessing the rescue card	→	32	⑦ Flat tire	→	351
② Safety vests	→	350	⑧ Tow-starting or towing away	→	363
③  me button	→	316	⑨ Fuel filler flap with: information label on fuel type	→	199
 SOS button	→	316	Information label on tire pressure	→	373
④  Hazard warning light system	→	150	QR code for accessing the rescue card	→	32
⑤ Checking and refilling operating fluids	→	408	⑩ Warning triangle	→	350
Starting assistance	→	360	⑪ TIREFIT kit	→	353
⑥ Tow-starting or towing away	→	363	⑫ First-aid kit (soft sided)	→	351

### Calling up the Digital Operator's Manual

Multimedia system:

→ [Home] ▶▶ Info ▶▶ Operator's Manual  
▶▶ [Info]



The Digital Operator's Manual describes the functions and operation of the vehicle and the multimedia system.

▶ Select one of the following menu items in the Digital Operator's Manual:

- **Search:** search for keywords in order to find quick answers to questions about the operation of the vehicle.

- **Quick start:** here is where you find the first steps towards setting up your vehicle.
- **Tips:** find information that prepares you for certain everyday situations with your vehicle.
- **Animations:** watch animations of the vehicle functions.
- **Messages:** receive additional information about the messages in the Instrument Display.
- **Bookmarks:** gain access to your personally saved bookmarks.
- **Language:** select the language for the Digital Operator's Manual.

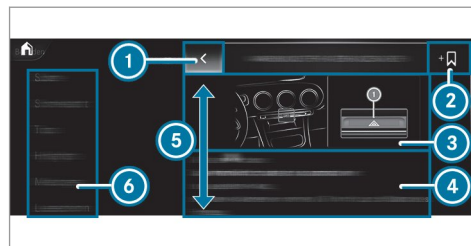

- 1 Back
- 2 Adds bookmarks
- 3 Picture
- 4 Contents section
- 5 Directions of movement of contents section
- 6 Menu

Some sections in the Digital Operator's Manual, such as warning notes, can be expanded and collapsed.

**Additional methods of calling up the Digital Operator's Manual:**

**Direct access:** open the required content in the Digital Operator's Manual by pressing and holding an entry on the tab bar in the multimedia system:

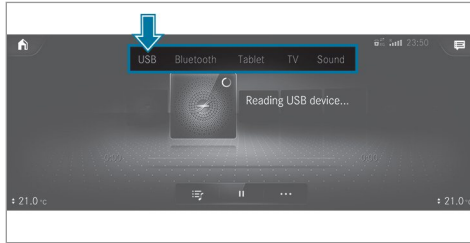

**Instrument Display:** call up brief information as display messages in the instrument cluster

**Voice Control System:** call up via the voice control system

For safety reasons, the Digital Operator's Manual is deactivated while driving.

## Protection of the environment

 **ENVIRONMENTAL NOTE** Environmental damage due to operating conditions and personal driving style

The pollutant emission of the vehicle is directly related to the way you operate the vehicle.

Operate your vehicle in an environmentally responsible manner to help protect the environment. Please observe the following recommendations on operating conditions and personal driving style.

### Operating conditions:

- ▶ Make sure that the tire pressure is correct.
- ▶ Do not carry any unnecessary weight (e.g. roof luggage racks once you no longer need them).
- ▶ Adhere to the service intervals. A regularly serviced vehicle will contribute to environmental protection.

- ▶ Always have maintenance work carried out at a qualified specialist workshop.

### Personal driving style:

- ▶ Do not depress the accelerator pedal when starting the engine.
- ▶ Do not warm up the vehicle while stationary.
- ▶ Drive carefully and maintain a suitable distance from the vehicle in front.
- ▶ Avoid frequent, sudden acceleration and braking.
- ▶ Change gear in good time and use each gear only up to  $\frac{2}{3}$  of its maximum engine speed.
- ▶ Switch off the vehicle in stationary traffic, e.g. by using the ECO start/stop function.
- ▶ Drive in a fuel-efficient manner. Observe the ECO display for an economical driving style.

### Environmental issues and recommendations

It is recommended that you re-use or recycle materials instead of just disposing of them.

The relevant environmental guidelines and regulations serve to protect the environment and must be strictly observed.

## Genuine Mercedes-Benz parts

 **ENVIRONMENTAL NOTE** Environmental damage due to not using recycled reconditioned components

Mercedes-Benz AG offers recycled reconditioned components and parts with the same quality as new parts. The same entitlement from the Limited Warranty is valid as for new parts.

- ▶ Use recycled reconditioned components and parts from Mercedes-Benz AG.



**!** **NOTE** Impairment of the operating efficiency of the restraint systems from installing accessory parts or from repairs or welding

Airbags and Emergency Tensioning Devices, as well as control units and sensors for the restraint systems, may be installed in the following areas of your vehicle:

- Doors
- Door pillars
- Door sills
- Seats
- Cockpit
- Instrument cluster
- Center console
- Lateral roof frame

- ▶ Do not install accessory parts such as audio systems in these areas.
- ▶ Do not carry out repairs or welding.
- ▶ Have accessory parts retrofitted at a qualified specialist workshop.

You could jeopardize the operating safety of your vehicle if you use parts, tires and wheels as well as accessories relevant to safety which have not been approved by Mercedes-Benz. Safety-relevant systems, e.g. the brake system, may malfunction. Only use genuine Mercedes-Benz parts or parts of equal quality. Only use tires, wheels and accessory parts that have been specifically approved for your vehicle model.

Genuine Mercedes-Benz parts are subject to strict quality inspections. Each part has been specially developed, manufactured or selected for Mercedes-Benz vehicles and adapted to them. Therefore, only genuine Mercedes-Benz parts should be used.

More than 300,000 different genuine Mercedes-Benz parts are available for Mercedes-Benz models.

All authorized Mercedes-Benz Centers maintain a supply of genuine Mercedes-Benz parts for necessary service and repair work. In addition, strategically located parts delivery centers provide for quick and reliable parts service.

Always specify the vehicle identification number (VIN) (→ page 407) when ordering genuine Mercedes-Benz parts.

### Operator's Manual

This Operator's Manual and the Digital Operator's Manual in the vehicle describe the following models and the standard and special equipment for your vehicle:

- The models and the standard and special equipment available at the time of this Operator's Manual going to press.
- The models and the standard and special equipment only available in certain countries.
- The models and the standard and special equipment, which will only be available at a later date.

Note that your vehicle may not be equipped with all features described. This is also the case for systems relevant to safety. Therefore, the equipment on your vehicle may differ from that in the descriptions and illustrations.

The original purchase agreement for your vehicle contains a list of the equipment in your vehicle at the time of delivery.

Should you have any questions concerning equipment and operation, please consult an authorized Mercedes-Benz Center.

The Operator's Manual, Supplement, further supplementary documents and Maintenance Booklet are important documents and should be kept in the vehicle.

### Mercedes me app

#### Notes about the on-demand feature

You can also activate various functions (on-demand feature) subsequently via Mercedes me after purchasing your vehicle.

Information is available at any authorized Mercedes-Benz Center.

#### Activating on-demand feature using Mercedes me

##### Requirements:

- The vehicle has GPS reception.

- The vehicle is linked to the Mercedes me user account.

#### Ordering and activating on-demand feature

- ▶ Add the desired on-demand feature for the vehicle to the shopping basket in the Mercedes me Store.
- ▶ Complete the order.  
The on-demand feature is activated when operating the vehicle.

#### Speeding up activation

- ▶ Switch the vehicle off and lock it.
- ▶ After about 2 minutes, unlock the vehicle and switch on the vehicle.  
The on-demand feature has been activated. For some features, a notification also appears in the vehicle's multimedia system.

If the activation was not successful, repeat the process.

### Service and vehicle operation

#### Vehicle operation outside the USA or Canada

When you are abroad with your vehicle, observe the following points:

- Service points or replacement parts may not be available immediately.
- Unleaded fuel may not be available for vehicles with a catalytic converter. Leaded fuel may cause damage to the catalytic converter.
- The fuel may have an extremely low octane number. Unsuitable fuel can cause engine damage.

Some Mercedes-Benz models are available in Europe through our European Delivery Program. For more information, please consult an authorized Mercedes-Benz service center, or write to one of the following address:

##### In the USA:

Mercedes-Benz USA, LLC  
European Delivery Department  
One Mercedes-Benz Drive  
Sandy Springs, GA 30328

**In Canada:**

Mercedes-Benz Canada, Inc.  
 European Delivery Department  
 98 Vanderhoof Avenue  
 Toronto, Ontario M4G 4C9

**Maintenance**

Your customer advisor confirms the service in the service report.

**Roadside Assistance**

The Mercedes-Benz Roadside Assistance Program offers technical help in the case of a breakdown. Your calls to the toll-free Roadside Assistance Hotline are answered by our agents 24 hours a day, 365 days a year.

1-800-FOR-MERCEdes (1-800-367-6372) (USA)  
 1-800-387-0100 (Canada)

You can find further information in the Mercedes-Benz Roadside Assistance Program brochure (USA) or the "Roadside Assistance" section in the

Service and Warranty booklet (Canada). You will find both in the vehicle document wallet.

**Change of address or change of ownership**

In the event of a change of address, please send us the "Notification of address change" in the Service and Guarantee booklet or simply call the Mercedes-Benz Customer Assistance Center (USA) on the hotline number 1-800-FOR-MERCEdes (1-800-367-6372) or Customer Service (Canada) on 1-800-387-0100. We can then reach you in a timely fashion, if necessary.

If you sell your Mercedes, please leave all literature in the vehicle so that it is available to the next owner. If you have purchased a used vehicle, please send us the "Notice of Purchase of Used Car" in the Service and Guarantee booklet or simply call the Mercedes-Benz Customer Assistance Center (USA) at the hotline number 1-800-FOR-MERCEdes (1-800-367-6372) or Customer Service (Canada) at 1-800-387-0100.

**Possible danger due to substances hazardous to health**

In compliance with Proposition 65 ("Prop65"), the following detachable label has been added to each vehicle sold in California:

**Operating safety**

**⚠ WARNING** Risk of accident due to malfunctions or system failures

To avoid malfunctions or system failures:

- ▶ Always have the prescribed service and maintenance work as well any required

repairs carried out at a qualified specialist workshop.

**⚠ WARNING** Risk of accident or injury due to incorrect modifications on electronic component parts

Modification of electronic components, their software or wiring could impair their function and/or the function of other networked component parts or safety-relevant systems.

This can endanger the operating safety of the vehicle.

- ▶ Never tamper with the wiring and electronic component parts or their software.
- ▶ You should have all work on electrical and electronic components carried out at a qualified specialist workshop.

Observe the "On-board electronics" section in "Technical data".

**⚠ WARNING** Risk of fire due to flammable materials on hot parts of the exhaust system

Flammable material such as leaves, grass or twigs may ignite if they come into contact with hot parts of the exhaust system.

- ▶ When driving on unpaved roads or off-road, regularly check the vehicle underside.
- ▶ Remove trapped plants or other flammable material, in particular.
- ▶ If there is damage, consult a qualified specialist workshop immediately.

**! NOTE** Damage to the vehicle due to driving too fast and due to impacts to the vehicle underbody or suspension components

In the following situations, in particular, there is a risk of damage to the vehicle:

- The vehicle becomes grounded, e.g. on a high curb or an unpaved road
- The vehicle is driven too fast over an obstacle, e.g. a curb, speed bump or pothole
- A heavy object strikes the underbody or suspension components

In situations such as these, damage to the body, underbody, suspension components, wheels or tires may not be visible. Components damaged in this way can unexpectedly fail or, in the case of an accident, may no longer absorb the resulting force as intended.

If the underbody paneling is damaged, flammable materials such as leaves, grass or twigs can collect between the underbody and the

underbody paneling. These materials may ignite if they come into contact with hot parts of the exhaust system.

- ▶ Have the vehicle checked and repaired immediately at a qualified specialist workshop.

or

- ▶ If driving safety is impaired while continuing your journey, pull over and stop the vehicle immediately, while paying attention to road and traffic conditions, and contact a qualified specialist workshop.

### Vehicles with a 48 V on-board electrical system

**⚠ DANGER** Risk of fatal injury by touching damaged high-voltage components

Vehicles with a 48 V on-board electrical system contain individual high-voltage components. These high-voltage components are under high voltage.

If you modify component parts of these high-voltage components or touch damaged component parts, you may be electrocuted.

High voltage components may be damaged in an accident, although the damage may not be visible.

- ▶ Never perform modifications to component parts of high-voltage components.
- ▶ Never touch damaged component parts of high-voltage components.
- ▶ Never touch component parts of high-voltage components after an accident.

Vehicles with a 48 V on-board electrical system contain high voltage components. These components are marked with a high voltage label:

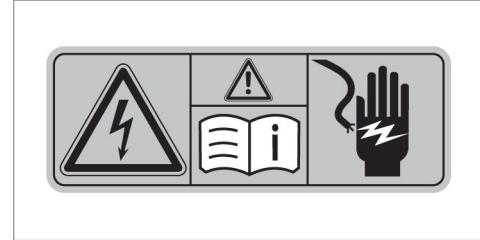

All work on high voltage components must be carried out at a qualified specialist workshop.

### Declaration of conformity for wireless vehicle components



USA: "Radio based devices of this vehicle comply with Part 15 of the FCC Rules. Operation is subject to the following two conditions: 1) These devices may not cause harmful interference, and 2) These devices must accept any interference received, including interference that may cause

undesired operation. Changes or modifications not expressly approved by the party responsible for compliance could void the user's authority to operate the equipment."

Canada: "This vehicle contains licence-exempt transmitter(s)/receiver(s) that comply with Innovation, Science and Economic Development Canada's licence-exempt RSS(s). Operation is subject to the following two conditions: (1) These devices may not cause interference. (2) These devices must accept any interference, including interference that may cause undesired operation of the devices." "Les émetteurs/récepteurs dans ce véhicule sont conformes aux CNR d'Innovation, Sciences et Développement économique Canada applicables aux appareils radio exempts de licence. L'exploitation est autorisée aux deux conditions suivantes : 1) Ces appareils ne doivent pas produire de brouillage; 2) Ces appareils doivent accepter tout brouillage radioélectrique subi, même si le brouillage est susceptible d'en compromettre le fonctionnement."

### Diagnostics connection

The diagnostics connection is a technical interface in the vehicle. It is used, for example, in the context of repair and maintenance work or for reading out vehicle data in a specialist workshop. Diagnostic devices should therefore only be connected in a qualified specialist workshop.

**⚠ WARNING** Risk of accident due to connecting devices to the diagnostics connection

If you connect devices to the diagnostics connection of the vehicle, the function of vehicle systems and operating safety may be impaired.

- ▶ For safety reasons, we recommend that you only use and connect products approved by your authorized Mercedes-Benz Center.

**⚠ WARNING** Risk of accident due to objects in the driver's footwell

Objects in the driver's footwell may impede pedal travel or block a depressed pedal.

This jeopardizes the operating and road safety of the vehicle.

- ▶ Stow all objects in the vehicle securely so that they cannot get into the driver's footwell.
- ▶ Always install the floor mats securely and as prescribed in order to ensure that there is always sufficient room for the pedals.
- ▶ Do not use loose floor mats and do not place floor mats on top of one another.

**! NOTE** Battery discharging from using devices connected to the diagnostics connection

Using devices at the diagnostics connection drains the battery.

- ▶ Check the charge level of the battery.

- ▶ If the charge level is low, charge the battery, e.g. by driving a considerable distance.

Please also note the information about the 12 V battery and short-distance trips in the "Driving and Parking" chapter (→ page 178).

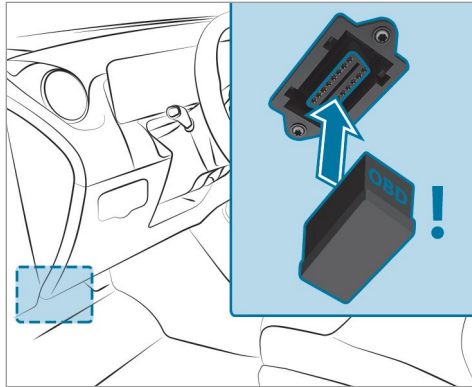

Connecting and using another device with the diagnostics connection can have the following effects:

- Malfunctions in the vehicle system
- Permanent damage to vehicle components

Please refer to the warranty terms and conditions for this matter.

Moreover, connecting equipment to the diagnostics connection can lead to emissions monitoring information being reset, for example. This may lead to the vehicle failing to meet the requirements of the next emissions inspection during the main inspection.

#### Qualified specialist workshop

An authorized Mercedes-Benz Center is a qualified specialist workshop. It has the necessary special skills, tools and qualifications to correctly carry out the work required on your vehicle. This particularly applies to safety-relevant works.

For the following, always have your vehicle checked at an authorized Mercedes-Benz Center:

- Safety-relevant works
- Service and maintenance work
- Repair work
- Modifications as well as installations and conversions
- Work on electronic components
- **Vehicles with 48 V on-board electrical system:** work on the high-voltage component of the 48 V on-board electrical system

Mercedes-Benz recommends a Mercedes-Benz service center.

#### Correct use of the vehicle

If you remove any warning stickers, you or others could fail to recognize certain dangers. Leave warning stickers in position.

Observe the following information in particular when driving your vehicle:

- The safety notes in this Operator's Manual, vehicle-specific supplements and further supplementary documents
- Technical data for the vehicle
- Traffic rules and regulations
- Laws and safety standards pertaining to motor vehicles

### Sport Utility Vehicle

**⚠ WARNING** Risk of accident when the center of gravity is too high

The vehicle may start to skid and rollover in the event of sudden steering maneuvers and/or when the vehicle's speed is not adapted to the road conditions.

- ▶ Always adapt your speed and driving style to the vehicle's driving characteristics and to the prevailing road and weather conditions.

Utility vehicles have a significantly higher rollover rate than other types of vehicles.

If this type of vehicle is not driven safely, an accident can occur, the vehicle can roll over and occupants can suffer serious or even fatal injuries.

In a rollover crash, an unbelted person is significantly more likely to die than a person wearing a seat belt.

You and all vehicle occupants should always wear your seat belts.

### Notes for persons with electronic medical aids

Mercedes-Benz AG cannot, despite carefully developing vehicle systems, completely rule out the interaction of vehicle systems with electronic medical aids such as cardiac pacemakers.

In addition, there are components installed in the vehicle that, regardless of the operating status of the vehicle, can generate magnetic fields on a par with permanent magnets. These fields can be found, for example, in the area around the multi-

media and sound system or also in the area of the seats, depending on the vehicle equipment.

For this reason, the following can occur in isolated cases, depending on the aids used:

- Medical aids malfunctioning
- Adverse health effects

Observe the notes and warnings of the manufacturer of the medical aids; if in doubt, contact the device manufacturer and/or your doctor. If there is continuing uncertainty concerning the possibility of medical aids malfunctioning, Mercedes-Benz AG recommends using only few electrical vehicle systems and/or maintaining a distance from the components.

Only have repairs and maintenance work in the area of the following components carried out at a qualified specialist workshop:

- Vehicle components carrying live voltage
- Transmission antenna
- Multimedia system and sound system

If you have any queries or suggestions, consult a qualified specialist workshop.



### Problems with your vehicle

If you should experience a problem with your vehicle, particularly one that you believe may affect its safe operation, we urge you to contact an authorized Mercedes-Benz Center immediately to have the problem diagnosed and rectified. If the problem is not resolved to your satisfaction, please discuss the problem again with an authorized Mercedes-Benz Center or, if necessary, contact us at one of the following addresses:

#### In the USA:

Mercedes-Benz USA, LLC  
Customer Assistance Center  
One Mercedes-Benz Drive  
Sandy Springs, GA 30328

#### In Canada:

Mercedes-Benz Canada, Inc.  
Customer Relations Department  
98 Vanderhoof Avenue  
Toronto, Ontario M4G 4C9

### Reporting safety defects

#### USA only:

The following text is published as required of manufacturers under Title 49, Code of U.S. Federal Regulations, Part 575 pursuant to the "National Traffic and Motor Vehicle Safety Act of 1966".

If you believe that your vehicle has a defect which could cause a crash or could cause injury or death, you should immediately inform the National Highway Traffic Safety Administration (NHTSA) in addition to notifying Mercedes-Benz USA, LLC.

If NHTSA receives similar complaints, it may open an investigation, and if it finds that a safety defect exists in a group of vehicles, it may order a recall and remedy campaign. However, NHTSA cannot become involved in individual problems between you, your dealer, or Mercedes-Benz USA, LLC.

To contact NHTSA, you may call the Vehicle Safety Hotline toll-free at 1-888-327-4236 (TTY: 1-800-424-9153); go to the <https://www.safercar.gov/>; or write to: Administrator, NHTSA, 400 Seventh Street, SW., Washington, DC 20590; USA.

You can also obtain other information about motor vehicle safety from: <https://www.safercar.gov>

#### Canada only:

The following text is published as required of manufacturers under subsection 18.4 (4) of the Motor Vehicle Safety Regulations.

If you believe that your vehicle has a defect which could cause a crash or could cause injury or death, you should immediately inform Transport Canada in addition to notifying Mercedes-Benz Canada Inc.

If Transport Canada received similar complaints, it may open an investigation, and if it finds that a safety defect exists in a group of vehicles, it may order a recall and remedy campaign. However, Transport Canada cannot become involved in individual problems between you, your dealer or Mercedes-Benz Canada Inc.

To contact Transport Canada, you may call the Defect Investigations and Recalls Division toll-free in Canada at 1-800-333-0510 or 819-994-3328 in the Gatineau-Ottawa area or internationally; you may also go to the following websites for more information:

- English: <https://www.tc.gc.ca/recalls>
- French: <https://www.tc.gc.ca/rappels>

### Limited Warranty

**!** **NOTE** Damage to the vehicle arising from violation of these operating instructions.

Damage to the vehicle can arise from violation of these operating instructions.

This damage is not covered either by the Mercedes-Benz implied warranty or by the New- or Used-Vehicle Warranty.

- ▶ Follow the instructions in these operating instructions on proper operation of your vehicle as well as on possible vehicle damage.

### QR code for rescue card

QR codes are attached in the fuel filler flap and on the opposite side on the B-pillar. In the event of an accident, rescue services can use the QR code to quickly find the appropriate rescue card for

your vehicle. The current rescue card contains the most important information about your vehicle in a compact form, e.g. the routing of the electric lines.

Further information can be obtained at <https://www.mercedes-benz.de/qr-code>.

### Data storage

#### Data processing in the vehicle

##### Electronic control units

Electronic control units are installed in your vehicle. Control units process data which, for example, they receive from vehicle sensors, generate themselves or exchange between themselves. Some control units are required for the safe operation of your vehicle, some assist you when driving, such as driver assistance systems, while others enable convenience or infotainment functions.

The following provides you with general information regarding data processing in the vehicle. Additional information regarding exactly which data in your vehicle are collected, saved and transmitted to third parties, and for what purpose,

can be found in the information directly related to the functional characteristics in question in their respective Operator's Manual. This information is also available online and, depending on the vehicle equipment, digitally.

##### Personal data

Every vehicle is identified by a unique vehicle identification number. Depending on the country, this vehicle identification number can be used by, for example, governmental authorities to determine the identity of the owner. There are other possibilities to use data collected from the vehicle to identify the owner or driver, such as the license plate number.

Therefore, data generated or processed by control units may be attributable to a person or, under certain conditions, become attributable to a person. Depending on which vehicle data are available, it may be possible to make inferences about, for example, your driving behavior, your location, your route or your use patterns.

### Legal requirements regarding the disclosure of data

If legally required to do so, manufacturers are, in individual cases, legally obliged to provide governmental entities, upon request and to the extent required, data stored by the manufacturer. For example, this may be the case during the investigation of a criminal offense.

Governmental entities are themselves, in individual cases and within the applicable legal framework, authorized to read out data from the vehicle. In the case of an accident, information that can help with an investigation can, therefore, be taken from the airbag control unit, for example.

### Operational data in the vehicle

This is data regarding the operation of the vehicle, which have been processed by control units.

This includes the following data, for example:

- Vehicle status information such as the speed, longitudinal acceleration, lateral acceleration, number of wheel revolutions or the fastened seat belts display
- Ambient conditions, such as temperature, rain sensor or distance sensor

Generally, the use of these data is temporary; they will not be stored beyond the period of operation and will only be processed within the vehicle itself. Control units often contain data memories for vehicle keys, for example. Their use permits the temporary or permanent documentation of technical information about the vehicle's operating state, component loads, maintenance requirements and technical events or malfunctions.

Depending on the vehicle equipment, the following data are stored:

- Operating status of system components, such as fill levels, tire pressure or battery status
- Malfunctions or faults in important system components, such as lights or brakes
- System reactions in special driving situations, such as airbag deployment or the intervention of stability control systems
- Information on events leading to vehicle damage

In certain cases, it may be required to store data that would have otherwise been used only temporarily. This may be the case if the vehicle has detected a malfunction, for example.

If you use services, such as repair services and maintenance work, stored operational data as well as the vehicle identification number can be read out and used. They can be read out by service network employees, such as workshops and manufacturers or third parties, such as breakdown services. The same is true in the case of warranty claims and quality assurance measures.

In general, the readout is performed via the legally prescribed port for the diagnostics connection in the vehicle. The operational data that are read out document technical states of the vehicle or of individual components and assist in the diagnosis of malfunctions, compliance with warranty obligations and quality improvement. To that end, these data, in particular information about component loads, technical events, malfunctions and other faults may be transmitted along with the vehicle identification number to the manufacturer. Furthermore, the manufacturer is subject to product liability. For this reason the manufacturer also uses operational data from the vehicle, for example, for recalls. These data can also be used to examine the customer's warranty and guarantee claims.

Fault memories in the vehicle can be reset by a service outlet or at your request as part of repair or maintenance work.

### Convenience and infotainment functions

You can store convenience settings and individual settings in the vehicle and change or reset them at any time.

Depending on the vehicle equipment, this includes the following settings, for example:

- Seat and steering wheel positions
- Suspension and climate control settings
- Individual settings, such as interior lighting

Depending on the selected equipment, you can import data into vehicle infotainment functions yourself.

Depending on the vehicle equipment, this includes the following data, for example:

- Multimedia data, such as music, films or photos for playback in an integrated multimedia system

- Address book data for use in connection with an integrated hands-free system or an integrated navigation system
- Entered navigation destinations
- Data about the use of Internet services

These data for convenience and infotainment functions may be saved locally in the vehicle or they may be located on a device which you have connected to the vehicle, such as a smartphone, USB flash drive or MP3 player. If you have entered these data yourself, you can delete them at any time.

This data is transmitted from the vehicle to third parties only at your request. This applies, in particular, when you use online services in accordance with the settings that you have selected.

### Smartphone integration (e.g. Android Auto or Apple CarPlay®)

If your vehicle is accordingly equipped, you can connect your smartphone or another mobile end device to the vehicle. You can then control them by means of the control elements integrated in the vehicle. Images and audio from the smart-

phone can be output via the multimedia system. Certain information is simultaneously transferred to your smartphone. Depending on the type and integration, this includes position data, day/night mode and other general vehicle statuses. For more information please consult the Operator's Manual of the vehicle/infotainment system.

This integration allows the use of selected smartphone apps, such as navigation or music player apps. There is no further interaction between the smartphone and the vehicle; in particular, vehicle data is not directly accessible. The type of additional data processing is determined by the provider of the app being used. Which settings you can make, if any, depends on the specific app and the operating system of your smartphone.

### Online services

---

#### Wireless network connection

If your vehicle has a wireless network connection, it enables data to be exchanged between your vehicle and additional systems. The wireless network connection is made possible by the vehicle's own transmitter and receiver or by a mobile end

device that you have brought into the vehicle, for example, a smartphone. Online functions can be used via the wireless network connection. This includes online services and applications/apps provided to you by the manufacturer or by other providers.

### **Manufacturer's services**

Regarding the manufacturer's online services, the individual functions are described by the manufacturer in a suitable place, for example, in the Operator's Manual or on the manufacturer's website, where the relevant data protection information is also given. Personal data may be used for the provision of online services. Data are exchanged via a secure connection, such as the manufacturer's designated IT systems. Any personal data which are collected, processed and used, other than for the provision of services, is done so exclusively on the basis of legal permission. This is the case, for example, for a legally prescribed emergency call system, a contractual agreement or when consent has been given.

You can have services and functions, some of which are subject to a fee, activated or deactiva-

ted. This excludes legally prescribed functions and services, such as an emergency call system.

### **Third party services**

If you use online services from other providers (third parties), these services are the responsibility of the provider in question and subject to that provider's data protection conditions and terms of use. As a general rule, the manufacturer has no influence on the content exchanged.

For this reason, when services are provided by third parties, please ask the service provider in question for information about the type, extent and purpose of the collection and use of personal data.

### Data protection rights

Depending on your country or the equipment and range of functions of your vehicle as well as the services you use and the services on offer, you are entitled to different data protection rights. Further information on data protection and your data protection rights can either be found on the manufacturer's website or you will receive this information as part of the various services and

service offers. There you will also find the contact information for the manufacturer and its data protection officers.

At a workshop, for example, with the support of a specialist and possibly for a fee, you can have data read out which is stored only locally in the vehicle.

### MBUX multimedia system/Mercedes me connect

If the vehicle is equipped with the MBUX multimedia system or Mercedes me connect, additional data about the vehicle's operation, the use of the vehicle in certain situations, and the location of the vehicle may be compiled by the MBUX multimedia system or Mercedes me connect.

For additional information, please refer to the "MBUX multimedia system" section and/or the Mercedes me connect Terms and Conditions.

### Event data recorders

#### **USA only:**

This vehicle is equipped with an event data recorder (EDR). The main purpose of an EDR is to

record, in certain crash or near crash-like situations, such as an airbag deployment or hitting a road obstacle, data that will assist in understanding how a vehicle's systems performed. The EDR is designed to record data related to vehicle dynamics and safety systems for a short period of time, typically 30 seconds or less.

The EDR in this vehicle is designed to record such data as:

- How various systems in your vehicle were operating
- Whether or not the driver and front passenger seat belts were buckled/fastened
- How far (if at all) the driver was depressing the accelerator and/or brake pedal and
- How fast the vehicle was traveling

This data can help provide a better understanding of the circumstances in which accidents and injuries occur. NOTE: EDR data is recorded by your vehicle only if a non-trivial crash situation occurs; no data is recorded by the EDR under normal driving conditions and no personal data (e.g. name, gender, age and accident location) is recorded. However, other parties, such as law enforcement,

could combine EDR data with the type of personally identifying data routinely acquired during a crash investigation.

To read data recorded by an EDR, special equipment is required, and access to the vehicle or the EDR is needed. In addition to the vehicle manufacturer, other parties that have the special equipment, such as law enforcement, can read the information by accessing the vehicle or the EDR.

EDR data may be used in civil and criminal matters as a tool in accident reconstruction, accident claims and vehicle safety. Since the Crash Data Retrieval (CDR) tool that is used to extract data from the EDR is commercially available, Mercedes-Benz USA, LLC ("MBUSA") expressly disclaims any and all liability arising from the extraction of this information by unauthorized Mercedes-Benz personnel.

MBUSA will not share EDR data with others without the consent of the vehicle owner or, if the vehicle is leased, without the consent of the lessee. Exceptions to this representation include responses to subpoenas by law enforcement; by federal, state or local government; in connection with or arising out of litigation involving MBUSA or

its subsidiaries and affiliates; or, as required by law.

Warning: The EDR is a component of the Restraint System Module. Tampering with, altering, modifying or removing the EDR component may result in a malfunction of the Restraint System Module and other systems.

State laws or regulations regarding EDRs that conflict with federal regulation are pre-empted. This means that in the event of such conflict, the federal regulation governs. As of December 2016, 17 states have enacted laws relating to EDRs.

### Copyright

#### Free and open source software

Information on license for free and open-source software used in your vehicle can be found on the data carrier in your vehicle document wallet and with updates on the following website:

<https://www.mercedes-benz.com/opensource>

### Registered trademarks

- Bluetooth® is a registered trademark of Bluetooth SIG, Inc.
- DTS™ is a registered trademark of DTS, Inc.
- Dolby® and MLP™ are registered trademarks of DOLBY Laboratories.
- ESP® and PRE-SAFE® are registered trademarks of Daimler AG.
- HomeLink® is a registered trademark of Genex Corporation.
- iPod® and iTunes® are registered trademarks of Apple Inc.
- Burmester® is a registered trademark of Burmester Audiosysteme GmbH.
- Microsoft® and Windows Media® are registered trademarks of Microsoft Corporation.
- SIRIUS® is a registered trademark of Sirius XM Radio Inc.
- HD Radio™ is a registered trademark of iBiquity Digital Corporation.
- Gracenote® is a registered trademark of Gracenote, Inc.
- ZAGAT Survey® and related brands are registered trademarks of Zagat Survey, LLC.

## Restraint system

### Protection provided by the restraint system

The restraint system includes the following components:

- Seat belt system
- Airbags
- Child restraint system
- Child seat securing systems

The restraint system can help prevent the vehicle occupants from coming into contact with parts of the vehicle interior in the event of an accident. In the event of an accident, the restraint system can also reduce the forces to which the vehicle occupants are subjected.

A seat belt can only provide the best level of protection if it is worn correctly. Depending on the detected accident situation, Emergency Tensioning Devices and/or airbags supplement the protection offered by a correctly worn seat belt. Emergency Tensioning Devices and/or airbags are not deployed in every accident.

In order for the restraint system to provide the intended level of protection, each vehicle occupant must observe the following information:

- Fasten seat belts correctly.
- Sit in an almost upright seat position with their back against the seat backrest.
- Sit with their feet resting on the floor, if possible.
- Always secure persons under 5 ft (1.50 m) tall in an additional restraint system suitable for Mercedes-Benz vehicles.

However, no system available today can completely eliminate injuries and fatalities in every accident situation. In particular, the seat belt and airbag generally do not protect against objects penetrating the vehicle from the outside. It is also not possible to completely rule out the risk of injury caused by the airbag deploying.

### Limitations of the protection provided by the restraint system

**⚠ WARNING** Risk of injury or death due to modifications to the restraint system

Vehicle occupants may no longer be protected as intended if alterations are made to the restraint system.

- ▶ Never alter the parts of the restraint system.
- ▶ Never tamper with the wiring or any electronic component parts or their software.

If it is necessary to modify the vehicle to accommodate a person with disabilities, contact an authorized Mercedes-Benz Center for details.

USA only: for details, contact our Customer Assistance Center on 1-800-FOR-MERCEdes (1-800-367-6372).





### Restraint system functionality

When the vehicle is switched on, a self-test is performed, during which the  restraint system warning lamp lights up. It goes out no later than a few seconds after the vehicle is started. The components of the restraint system are then functional.

### Malfunctioning restraint system

A malfunction has occurred in the restraint system if:

- The  restraint system warning lamp does not light up when the vehicle is switched on
- The  restraint system warning lamp lights up continuously or repeatedly during a journey

**⚠ WARNING** Risk of injury due to malfunctions in the restraint system

Components in the restraint system may be activated unintentionally or not deploy as planned in an accident.

▶ Have the restraint system checked and repaired immediately at a qualified specialist workshop.

### Function of the restraint system in an accident

How the restraint system works depends on the severity of the impact detected and the apparent type of accident:

- Frontal impact
- Rear impact
- Side impact
- Rollover

The activation thresholds for the components of the restraint system are determined based on the evaluation of the sensor values measured at various points in the vehicle. This process is pre-emptive in nature. The triggering/deployment of the components of the restraint system must take place in good time at the start of the collision.

Factors which can only be seen and measured after a collision has occurred cannot play a deci-

sive role in airbag deployment. Nor do they provide an indication of airbag deployment.

The vehicle may be deformed significantly without an airbag being deployed. This is the case if only parts which are relatively easily deformed are affected and the rate of vehicle deceleration is not high. Conversely, an airbag may be deployed even though the vehicle suffers only minor deformation. If very rigid vehicle parts such as longitudinal members are hit, this may result in sufficiently high levels of vehicle deceleration.

Depending on the detected deployment situation, the components of the restraint system can be activated or deployed independently of each other:

- Emergency Tensioning Device: frontal impact, rear impact, side impact, rollover
- Driver's airbag, front passenger airbag: frontal impact
- Knee airbag: frontal impact
- Side airbag: side impact
- Window curtain airbag: side impact, rollover, frontal impact

- Cushionbag: frontal impact
- PRE-SAFE® Impulse Side: side impact

The front passenger airbag can only be deployed in an accident if the PASSENGER AIR BAG OFF indicator lamp is off. If the front passenger seat is occupied, make sure, both before and during the journey, that the status of the front passenger airbag is correct (→ page 49).

**⚠ WARNING** Risk of burns from hot air bag components

The air bag parts are hot after an air bag has been deployed.

- ▶ Do not touch the air bag parts.
- ▶ Have a deployed air bag replaced at a qualified specialist workshop as soon as possible.

Mercedes-Benz recommends that you have the vehicle towed to a qualified specialist workshop after an accident. Take this into account, particularly if an Emergency Tensioning Device is triggered or an airbag deployed.

If the Emergency Tensioning Devices are triggered or an airbag is deployed, you will hear a bang, and a small amount of powder may also be released:

- The bang will not generally affect your hearing.
- In general, the powder released is not hazardous to health but may cause short-term breathing difficulties to persons suffering from asthma or other pulmonary conditions.

Provided it is safe to do so, leave the vehicle immediately or open the window in order to prevent breathing difficulties.

Airbags and pyrotechnic Emergency Tensioning Devices contain perchlorate material, which may require special handling or environmental protection measures. National guidelines regarding waste disposal must be observed. In California, see <https://dtsc.ca.gov/>. Using the search function, you will find information on perchlorate, for example.

## Seat belts

### Protection provided by the seat belt

Always fasten your seat belt correctly before starting a journey. A seat belt can only provide the best level of protection if it is worn correctly.

**⚠ WARNING** Risk of injury or death due to incorrectly fastened seat belt

If the seat belt is not worn correctly, it cannot perform its intended protective function.

In addition, an incorrectly fastened seat belt can also cause injuries, for example, in the event of an accident or when braking or changing direction suddenly.

- ▶ Always ensure that all vehicle occupants have their seat belts fastened correctly and are sitting properly.

Always observe the instructions about the correct driver's seat position and adjusting the seat (→ page 97).

In order for the correctly worn seat belt to provide the intended level of protection, each vehicle occupant must observe the following information:

- The seat belt must not be twisted and must fit tightly and snugly across the body.
- The seat belt must be routed across the center of the shoulder and as low down across the hips as possible.
- The shoulder section of the seat belt should not touch your neck nor be routed under your arm or behind your back.
- Avoid wearing bulky clothing, e.g. a winter coat.
- Push the lap belt down as far as possible across your hips and pull tight with the shoulder section of the belt. Never route the lap belt across your abdomen.  
Pregnant women must also take particular care with this.
- Never route the seat belt across sharp, pointed, abrasive or fragile objects.
- Only one person should use each seat belt at any one time.

- Never secure objects with a seat belt if the seat belt is also being used by one of the vehicle's occupants.

Also ensure that no objects, e.g. a cushion, are ever placed between a person and the seat.

The seat belts on the following seats are equipped with a child seat safety feature:

- Front passenger seat
- Rear seats

Activate or deactivate the child seat safety feature of the seat belt (→ page 58).

If children are traveling in the vehicle, be sure to observe the instructions and safety notes on "Children in the vehicle" (→ page 54).

Always observe the instructions for loading the vehicle when securing objects, luggage or loads (→ page 124).

### Limitations of the protection provided by the seat belt

**⚠ WARNING** Risk of injury or death due to an incorrect seat position

The seat belt does not offer the intended level of protection if you have not moved the seat backrest to an almost vertical position.

In particular, you could slip beneath the seat-belt and become injured.

- ▶ Adjust the seat properly before beginning your journey.
- ▶ Always ensure that the seat backrest is in an almost vertical position and that the shoulder belt is routed across the center of your shoulder.

**⚠ WARNING** Risk of injury or death when additional restraint systems are not used for persons with a smaller stature

Persons under 5 ft (1.50 m) tall cannot wear the seat belt correctly without a suitable additional restraint system.

- ▶ Always secure persons under 5 ft (1.50 m) tall in a suitable restraint system.

**⚠ WARNING** Danger of injury or death due to blocked seat belt anchorage

The restraint effect of the seat belt is impaired if objects between the front seat and the door are blocking the movable seat belt anchorage on the front seat.

- ▶ Before starting a journey, make sure that there are no objects between the front seat and the door.

**⚠ WARNING** Risk of injury or death due to damaged or modified seat belts

Seat belts cannot provide protection in the following situations:

- The seat belt is damaged, has been modified, is extremely dirty, bleached or dyed

- The seat belt buckle is damaged or extremely dirty
- Modifications have been made to the Emergency Tensioning Device, seat belt anchorage or seat belt retractor

Seat belts may sustain non-visible damage in an accident, e.g. due to glass splinters.

Modified or damaged seat belts could tear or fail in the event of an accident, for example.

Modified Emergency Tensioning Devices could accidentally trigger or fail to function as intended.

- ▶ Never modify the seat belt system, for example the seat belt, seat belt buckle, Emergency Tensioning Device, seat belt anchorage and seat belt retractor.
- ▶ Make sure that the seat belts are undamaged, not worn and clean.
- ▶ Always have the seat belts checked immediately after an accident at a qualified specialist workshop.

Only use seat belts which have been approved for your vehicle by Mercedes-Benz.

**⚠ WARNING** Risk of injury or death from deployed pyrotechnic Emergency Tensioning Devices

Pyrotechnic Emergency Tensioning Devices that have been deployed are no longer operational and are unable to perform their intended protective function.

- ▶ Therefore, have deployed pyrotechnic Emergency Tensioning Devices immediately replaced at a qualified specialist workshop.

Mercedes-Benz recommends that you have the vehicle towed to a qualified specialist workshop after an accident.

**! NOTE** Damage caused by trapping the seat belt

If an unused seat belt is not fully retracted, it may become trapped in the door or in the seat mechanism.

- ▶ Always ensure that an unused seat belt is fully retracted.

### Fastening and adjusting seat belts

If the seat belt is pulled quickly or sharply, the seat belt retractor locks. The seat belt strap cannot be pulled out any further.

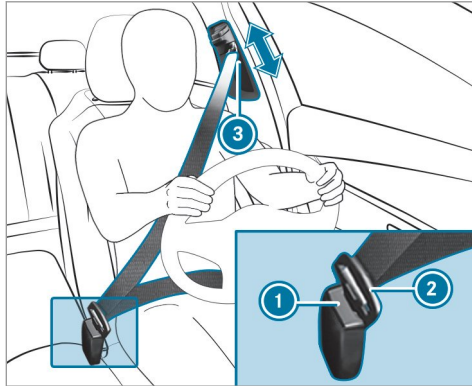

- ▶ Always engage seat belt tongue ② of the seat belt into seat belt buckle ① of the corresponding seat.
- ▶ **To adjust the seat belt height:** press and hold the belt guide release and slide seat belt outlet ③ into the desired position.
- ▶ **To engage the seat belt outlet:** let go of the belt guide release and ensure that seat belt outlet ③ locks into position.

- ① A seat belt can only provide the best level of protection if it is worn correctly. Observe the notes on fastening the seat belt (→ page 40).

**!** **NOTE** Deployment of components of the restraint system when the front passenger seat is unoccupied and a seat belt is buckled

When the front passenger seat is unoccupied and the seat belt tongue of the seat belt is engaged in the seat belt buckle, components of the restraint system may deploy unnecessarily on the front passenger side, e.g. the Emergency Tensioning Device.

- ▶ Only buckle the seat belts as intended.

- ① Observe the notes on stowage areas (→ page 124). Information on installing a child restraint system and on children traveling in the vehicle can be found in the "Children in the vehicle" section (→ page 57).

### Seat belt adjustment function

**Vehicles with PRE-SAFE®:** After a front seat belt has been fastened, the automatic seat belt adjustment may apply a certain tightening force. Do not hold the seat belt tightly while it is adjusting.

You can activate and deactivate the seat belt adjustment function using the multimedia system (→ page 44).

### Activating/deactivating seat belt adjustment via the multimedia system

Multimedia system:

→  ▶ Settings ▶ Vehicle

- ▶ Activate or deactivate **Belt Adjustment**.

### Releasing seat belts

- ▶ Press the release button in the seat belt buckle and guide the seat belt back with the seat belt tongue.

### Seat belt warning function for the driver and front passenger

The  seat belt warning lamp in the Instrument Display is a reminder that all vehicle occupants must wear their seat belts correctly.

The  seat belt warning lamp lights up for six seconds every time the vehicle is started.

In addition, a warning tone may sound.

When the driver's and front passenger's doors are closed and the driver and front passenger have

fastened their seat belts, the seat belt warning goes out.

In the following cases, the seat belt warning lights up during a journey if:

- The vehicle speed exceeds 15 mph (25 km/h) and the driver's or front passenger seat belt is not fastened.
- The driver or front passenger unfastens their seat belt while the vehicle is in motion.

## Airbags

### Overview of airbags

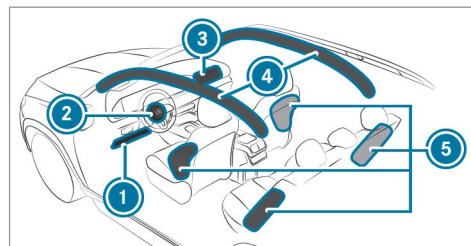

- 1 Driver's knee airbag
- 2 Driver's airbag
- 3 Front passenger airbag
- 4 Window curtain airbag
- 5 Side airbag

The installation location of an airbag is identified by the AIRBAG symbol.

When enabled, an airbag can provide additional protection for the respective vehicle occupant.

Potential protection provided by each airbag:

- Knee airbag: thigh, knee and lower leg
- Driver's airbag, front passenger airbag: head and ribcage
- Window curtain airbag: head
- Side airbag: ribcage and pelvis

**⚠ WARNING** Risk of injury or death if the co-driver airbag is enabled

If the co-driver airbag is enabled, a child on the co-driver seat may be struck by the co-driver airbag during an accident.

NEVER use a rearward-facing child restraint system on a seat with an ENABLED FRONT AIRBAG; DEATH or SERIOUS INJURY to the CHILD can occur.

When installing a child restraint system on the front passenger seat, observe the vehicle-specific information (→ page 66). Also, always observe the notes on rearward-facing or forward-facing child restraint systems on the front passenger seat (→ page 65).

**Information on automatic front passenger airbag shutoff**

The front passenger airbag can only be deployed in an accident if the PASSENGER AIR BAG OFF indicator lamp is off. If the front passenger seat is occupied, make sure, both before and during the journey, that the status of the front passenger airbag is correct (→ page 49).

**!** **NOTE** Deployment of components of the restraint system when the front passenger seat is unoccupied

In an accident, the components of the restraint system may deploy unnecessarily on the front passenger side if:

- There are heavy objects on the front passenger seat.
  - The seat belt tongue is engaged in the seat belt buckle of the front passenger seat and the front passenger seat is unoccupied.
- ▶ Store objects in a suitable place.
- ▶ Only one person should use each seat belt at any one time.

Depending on the detected accident situation, the window curtain airbag on the front passenger side may deploy. The airbag is deployed regardless of whether the front passenger seat is occupied.

**Information on the cushionbag in the reclining rear seat**

The cushionbag offers additional occupant protection in the event of frontal impacts. When enabled, the cushionbag deploys under the seat cushion. This helps prevent the vehicle occupant from slipping off the seat cushion.

If you install a child restraint system on the reclining rear seat, always observe the additional notes (→ page 54).

**Protection provided by the airbags**

Depending on the accident situation, an airbag may supplement the protection offered by a correctly fastened seat belt.

**⚠ WARNING** Risk of injury or death due to an incorrect seat position

If you deviate from the correct seat position, the airbag cannot perform its intended protective function.

Each vehicle occupant must make sure of the following:

- Fasten seat belts correctly. Pregnant women must take particular care to ensure that the lap belt never lies across the abdomen.
  - Adopt the correct seat position and keep as far away as possible from the airbags.
  - Observe the following information.
- ▶ Always make sure that there are no objects between the airbag and vehicle occupant.

To avoid the risks resulting from the deployment of an airbag, each vehicle occupant must observe the following information in particular:

- Before starting your journey, adjust your seat correctly; the driver's seat and front

passenger seat should be moved as far back as possible.

When doing so, always observe the information on the correct driver's seat position (→ page 97).

- Only hold the steering wheel by the steering wheel rim. This allows the airbag to be fully deployed.
- Always lean against the seat backrest when the vehicle is in motion. Do not lean forwards or against the door or side window. You may otherwise be in the deployment area of the airbags.
- The occupants must always keep their feet on the floor. Do not put your feet on the cockpit, for example. Your feet may otherwise be in the deployment area of the airbag.
- If children are traveling in the vehicle, observe the additional notes (→ page 54).
- Always stow and secure objects correctly.

Objects in the vehicle interior may prevent an airbag from functioning correctly. Each vehicle occupant must always make sure of the following in particular:

- There are no people, animals or objects between the vehicle occupants and an airbag.
- There are no objects between the seat, door and door pillar (B-pillar).
- There are no hard objects, e.g. coat hangers, hanging on the grab handles or coat hooks.
- There are no accessories, such as mobile navigation devices, mobile phones or cup holders, within the deployment area of an airbag, e.g. on the cockpit, on the door, on the side window or on the side trim.

In addition, no connecting cables, tensioning straps or retaining straps must be routed or attached to the vehicle within the deployment area of an airbag. Always comply with the accessory manufacturer's installation instructions and, in particular, the notes on suitable places for installation.



- There are no heavy, sharp-edged or fragile objects in the pockets of your clothing. Store such objects in a suitable place.

### Limitations of the protection provided by airbags

**⚠ WARNING** Risk of injury due to modifications to the cover of an airbag

If you modify the cover of an airbag or affix objects such as stickers to it, the airbag may no longer function correctly.

- ▶ Never modify the cover of an airbag and do not affix objects to it.

The installation location of an airbag is identified by the AIRBAG symbol (→ page 44).

Objects in the deployment area of an airbag may prevent the airbag from functioning correctly.

**⚠ WARNING** Risk of injury from objects in the deployment area of an airbag

Objects in the deployment area of an airbag can hinder or prevent the correct deployment of the airbag.

The airbag may then deploy in an uncontrolled manner and may even cause additional injuries to the vehicle occupants by deploying. This may be the case in particular if the airbag is integrated into the seat.

- ▶ Always stow and secure objects correctly.
- ▶ Before commencing your journey, make sure that no objects are stowed in the deployment area of an airbag.

**⚠ WARNING** Risk of injury or death due to the use of unsuitable seat covers

Due to unsuitable seat covers, the airbags cannot protect vehicle occupants as intended.

In addition, the operation of the automatic front passenger airbag shutoff could be restricted.

- ▶ You should only use seat covers that have been approved for the corresponding seats by Mercedes-Benz.

**⚠ WARNING** Risk of injury due to malfunctioning sensors in the door

The function of the airbags can be impaired due to modifications or incorrect work performed on the doors or door trim, or if the doors are damaged.

- ▶ Never modify the doors or parts of the doors.
- ▶ Always have work on the doors or door trim carried out at a qualified specialist workshop.

**⚠ WARNING** Risk of injury due to deployed airbag

A deployed airbag no longer offers any protection.

- ▶ Have the vehicle towed to a qualified specialist workshop in order to have the deployed airbag replaced.

Have deployed airbags replaced immediately.

### Status of the front passenger front airbag

#### **Function of the automatic front passenger airbag shutoff**

The automatic front passenger airbag shutoff is able to detect whether the front passenger seat is occupied by a person or a child restraint system. The front passenger airbag is enabled or disabled accordingly.

- ⚠ WARNING** Risk of injury or death due to objects under the co-driver seat

Objects trapped under the co-driver seat can interfere with the function of the automatic co-driver airbag shutoff or damage the system.

- ▶ Do not store any objects under the co-driver seat.

- ▶ When the co-driver seat is occupied, make sure that no objects are trapped under the co-driver seat.

When installing a child restraint system on the front passenger seat, observe the vehicle-specific information (→ page 66). Also, always observe the notes on rearward-facing or forward-facing child restraint systems on the front passenger seat (→ page 65).

A person on the front passenger seat must observe the following information:

- Fasten seat belts correctly (→ page 40).
- Sit in an almost upright seat position with their back against the seat backrest.
- Sit with their feet resting on the floor, if possible.

The front passenger airbag may otherwise be disabled by mistake, for example, in the following situations:

- The front passenger transfers their weight by supporting themselves on a vehicle armrest.

- The front passenger sits in such a way that their weight is raised from the seat surface.

- ⚠ WARNING** Risk of injury or death due to a disabled front passenger airbag

The front passenger airbag is disabled when the PASSENGER AIR BAG OFF indicator lamp is lit.

A person in the front passenger seat could then, for example, come into contact with the vehicle interior, especially if the person is sitting too close to the cockpit.

If the front passenger seat is occupied, always ensure that:

- The classification of the person in the front passenger seat is correct and the front passenger airbag is enabled or disabled in accordance with the person in the front passenger seat.
- The front passenger seat has been moved as far back as possible.
- The person is seated correctly.

- ▶ Both before and during the journey, ensure that the status of the front passenger airbag is correct.

If the front passenger seat is occupied, the classification of the person or child restraint system on the front passenger seat takes place after the front passenger airbag shutoff self-test. The PASSENGER AIR BAG indicator lamps display the status of the front passenger airbag.

Always observe the notes on the function of the PASSENGER AIR BAG indicator lamps (→ page 49).

### Function of the PASSENGER AIR BAG indicator lamps

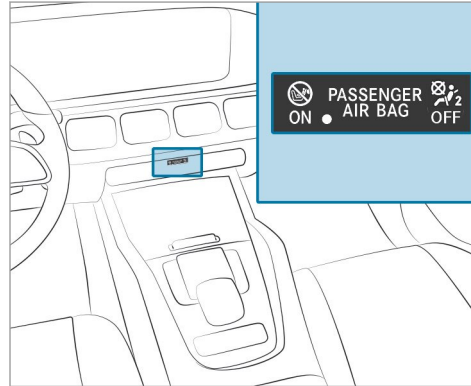

### Self-test of automatic front passenger airbag shutoff

When the vehicle is switched on, a self-test is performed during which the two PASSENGER AIR BAG ON and OFF indicator lamps light up simultaneously.

The status of the front passenger airbag is displayed via the PASSENGER AIR BAG indicator lamps after the self-test:

- **ON is lit:** the front passenger airbag may deploy during an accident. The indicator lamp goes out after 60 seconds.
- **ON and OFF are not lit:** the front passenger airbag may deploy during an accident.
- **OFF is lit:** the front passenger airbag is disabled. It will then not be deployed in the event of an accident.

If the PASSENGER AIR BAG ON indicator lamp is off, only the PASSENGER AIR BAG OFF indicator lamp shows the status of the front passenger airbag. The PASSENGER AIR BAG OFF indicator lamp may be lit continuously or be off.

If the PASSENGER AIR BAG OFF indicator lamp and the  restraint system warning lamp light up simultaneously, the front passenger seat may not be used. Also in this case, do not install a child restraint system on the front passenger seat. Have the automatic front passenger airbag

shutoff checked and repaired immediately at a qualified specialist workshop.

### Status display

If the front passenger seat is occupied, ensure, both before and during the journey, that the status of the front passenger airbag is correct for the current situation.

**After installing a rearward-facing child restraint system on the front passenger seat:** PASSENGER AIR BAG OFF must be lit continuously.

**▲ WARNING** Risk of injury or fatal injury when using a rearward-facing child restraint system while the co-driver airbag is enabled

If you secure a child in a rearward-facing child restraint system on the co-driver seat and the PASSENGER AIR BAG OFF indicator lamp is off, the co-driver airbag can deploy in the event of an accident.

The child could be struck by the airbag.

- ▶ Always ensure that the co-driver airbag is disabled. The PASSENGER AIR BAG OFF indicator lamp must be lit.
- ▶ NEVER use a rearward-facing child restraint system on a seat with an ENABLED FRONT AIRBAG; DEATH or SERIOUS INJURY to the CHILD can occur.

When installing a child restraint system on the front passenger seat, observe the vehicle-specific information (→ page 65).

Depending on the child restraint system and the stature of the child, the PASSENGER AIR BAG OFF indicator lamp may be off. In this case, do not install the rearward-facing child restraint system on the front passenger seat.

Instead, install the rearward-facing child restraint system on a suitable rear seat.

**After installing a forward-facing child restraint system on the front passenger seat:** depending on the child restraint system and the stature of the child, PASSENGER AIR BAG OFF may be lit continuously or be off. Always observe the following information.

**▲ WARNING** Risk of injury or death due to incorrect positioning of the forward-facing child restraint system

If you secure a child in a forward-facing child restraint system on the front passenger seat that is positioned too close to the cockpit, in the event of an accident, the child could:

- come into contact with the vehicle interior if the PASSENGER AIR BAG OFF indicator lamp is lit, for example
  - be struck by the airbag if the PASSENGER AIR BAG OFF indicator lamp is off.
- ▶ Always move the front passenger seat as far back as possible and fully retract the seat cushion length adjustment. While doing so, always make sure that the shoulder belt strap is correctly routed from the seat belt outlet of the vehicle to the shoulder belt guide on the child restraint system. The shoulder belt strap must be routed forwards and downwards from the seat belt outlet. If necessary,

adjust the seat belt outlet and the front passenger seat accordingly.

- ▶ Always comply with the child restraint system manufacturer's installation instructions.

When installing a child restraint system on the front passenger seat, observe the vehicle-specific information (→ page 65).

**If a person is sitting on the front passenger seat:** PASSENGER AIR BAG OFF may be lit continuously or be off, depending on the person's stature.

A person on the front passenger seat must always observe the following information:

- If the front passenger seat is occupied by an adult or a person with a stature corresponding to that of an adult, the PASSENGER AIR BAG OFF indicator lamp must be off. This indicates that the front passenger airbag is enabled. If the PASSENGER AIR BAG OFF indicator lamp is lit continuously, an adult or person with a build corresponding to that of an adult must not use the front passenger seat. Instead, they should use a rear seat.

- If the front passenger seat is occupied by a person of smaller stature (e.g. a teenager or small adult), the PASSENGER AIR BAG OFF indicator lamp is either lit continuously or remains off, depending on the classification.
  - If the PASSENGER AIR BAG OFF indicator lamp is off: move the front passenger seat as far back as possible, or the person of smaller stature should use a rear seat.
  - If the PASSENGER AIR BAG OFF indicator lamp is lit continuously: the person of smaller stature should not use the front passenger seat.

**⚠ WARNING** Risk of injury or death when the PASSENGER AIR BAG OFF indicator lamp is lit

If the PASSENGER AIR BAG OFF indicator lamp remains lit after the self-test, the front passenger airbag is disabled.

If the front passenger seat is occupied, always ensure that:

- The classification of the person in the front passenger seat is correct and the front passenger airbag is enabled or disabled in accordance with the person in the front passenger seat.
- The person is seated properly with a correctly fastened seat belt.
- The front passenger seat has been moved as far back as possible.

Be sure to also observe the following further related subjects:

- Child restraint system on the front passenger seat (→ page 65)

## PRE-SAFE® system

### Function of PRE-SAFE® (anticipatory occupant protection)

PRE-SAFE® is able to detect certain critical driving situations and implement pre-emptive measures to protect the vehicle occupants.

PRE-SAFE® can implement the following measures independently of each other:

- Tightening the seat belts on the driver's seat and front passenger seat.
- Closing the side windows.
- **Vehicles with sliding sunroof:** closing the sliding sunroof.
- **Vehicles with memory function:** moving the front passenger seat to a more favorable seat position.
- **Vehicles with memory function in the rear passenger compartment:** moving the outer rear seats to a more favorable seat position.
- **Vehicles with multicontour seat:** increasing the air pressure in the seat side bolsters of the seat backrest.

- PRE-SAFE® Sound: provided that the multimedia system is switched on, generating a brief noise signal to stimulate the innate protective mechanism of a person's hearing.

**!** **NOTE** Damage caused by objects in the footwell or behind the seat

The automatic adjustment of the seat position may result in damage to the seat and/or the object.

▶ Stow objects in a suitable place.

### Reversing the PRE-SAFE® system measures

If an accident did not occur, the pre-emptive measures that were taken are reversed.

You will need to perform certain settings yourself.

▶ If the seat belt pre-tensioning is not reduced, move the seat backrest back slightly. The locking mechanism releases.

### Function of PRE-SAFE® PLUS (anticipatory occupant protection plus)

PRE-SAFE® PLUS can detect certain impacts, particularly an imminent rear impact, and take pre-emptive measures to protect the vehicle occupants. These measures cannot necessarily prevent an imminent impact.

PRE-SAFE® PLUS can implement the following measures independently of each other:

- Tightening the seat belts on the driver's seat and front passenger seat.
- Increasing brake pressure when the vehicle is stationary. This brake application is canceled automatically when the vehicle pulls away.

If an accident did not occur, the pre-emptive measures that were taken are reversed.

### System limits

The system will not initiate any action in the following situations:

- When backing up
- or

- When the vehicle is towing a trailer and there is a risk of a rear impact

The system will not initiate any braking application in the following situations:

- Whilst driving  
or
- When entering or exiting a parking space while using Active Parking Assist

### Function of PRE-SAFE® Impulse Side

If an imminent side impact is detected, PRE-SAFE® Impulse Side can pre-emptively move the front seat vehicle occupant's upper body towards the center of the vehicle. It does this by rapidly inflating an air cushion in the outer seat side bolster of the seat backrest on the side on which the impact is anticipated. This increases the distance between the door and the vehicle occupant.

If PRE-SAFE® Impulse Side has been deployed or is faulty, the **PRE-SAFE Impulse Side Inoperative** See Operator's Manual (→ page 424) display message appears.

### Automatic measures after an accident

Depending on the type and severity of the accident, and depending on the vehicle's equipment, the following measures can be implemented, for example:

- Automatic braking (post-collision brake)
- Activating the hazard warning light system
- Triggering an automatic emergency call (→ page 323)
- Switching off the engine

To start the vehicle again, switch the vehicle off and on once more (→ page 174). Depending on the type and severity of the accident, you may no longer be able to start the vehicle.

- Switching off the fuel supply system
- Unlocking the vehicle doors
- Lowering the side windows
- Displaying the emergency guide in the multimedia system display
- Switching on the interior lighting

### Function of the post-collision brake

Depending on the accident situation, the post-collision brake can minimize the severity of a further collision or even avoid it.

If an accident is detected, the post-collision brake can implement automatic braking. When the vehicle has come to a standstill, the electric parking brake is automatically applied.

The driver can cancel automatic braking by taking the following actions:

- Braking more strongly than automatic braking
- Fully depressing the accelerator pedal with force

### Safely transporting children in the vehicle

#### Always observe when children are traveling in the vehicle

- ① Also strictly observe the safety notes for the specific situation. In this way you can recognize potential risks and avoid dangers if children are traveling in the vehicle (→ page 54).

### Be diligent

Bear in mind that negligence when securing a child in the child restraint system may have serious consequences. Always be diligent in securing a child carefully before every journey.

Never allow babies and children to travel sitting on the lap of another vehicle occupant.

To improve protection for children younger than 12 years old or under 5 ft (1.50 m) in height, Mercedes-Benz recommends you observe the following information:

- Always secure the child in a child restraint system suitable for this Mercedes-Benz vehicle.
- The child restraint system must be appropriate to the age, weight and size of the child.
- The vehicle seat must be suitable for installing a child restraint system.

Accident statistics show that children secured on the rear seats are generally safer than children secured on the front seats. For this reason, Mercedes-Benz strongly advises that you install a child restraint system on a rear seat.

### The generic term child restraint system

The generic term child restraint system is used in this Operator's Manual. A child restraint system is, for example:

- A baby car seat
- A rearward-facing child seat
- A forward-facing child seat
- A child booster seat with a backrest and seat belt guide

Mercedes-Benz recommends using a child booster seat with a backrest.

The child restraint system must be appropriate to the age, weight and size of the child.

### Observe laws and legal requirements

Always observe the legal requirements when using a child restraint system in the vehicle.

### Observe standards for child restraint systems

All child restraint systems must meet the following standards:

- U.S. Federal Motor Vehicle Safety Standards 213 and 225

- Canadian Motor Vehicle Safety Standards 213 and 210.2

Confirmation that the child restraint system complies with the standards can be found on an instruction label on the child restraint system. This confirmation can also be found in the installation instructions that are included with the child restraint system.

### Detecting risks, avoiding danger

#### Securing systems for child restraint systems in the vehicle

Only use the following securing systems for child restraint systems:

- The LATCH-type (ISOFIX) securing rings
- The vehicle's seat belt system
- The Top Tether anchorages

Installing a LATCH-type (ISOFIX) child restraint system is preferred.

Simply attaching to the securing rings on the vehicle can reduce the risk of installing the child restraint system incorrectly.



When securing a child with the integrated seat belt of the LATCH-type (ISOFIX) child restraint system, always comply with the permissible gross weight for the child and child restraint system (→ page 59).

A booster seat may be necessary to achieve proper seat belt positioning for children over 40 lbs (18 kg) in weight or until they reach a height where a three-point seat belt can be fastened properly without a booster seat.

Mercedes-Benz recommends a suitable child booster seat with a backrest and seat belt guide.

#### Advantage of a rearward-facing child restraint system

It is preferable to transport a baby or a small child in a suitable rearward-facing child restraint system. In this case, the child sits in the opposite direction to the direction of travel and faces backwards.

Babies and small children have comparatively weak neck muscles in relation to the size and weight of their head. The risk of injury to the cervical spine during an accident can be reduced in a rearward-facing child restraint system.

#### Always secure a child restraint system correctly

**⚠ WARNING** Risk of injury or death due to incorrect installation of the child restraint system

The child can then not be protected or restrained as intended.

- ▶ Be sure to comply with the manufacturer's installation instructions for the child restraint system and its correct use.
- ▶ Make sure that the entire base of the child restraint system always rests on the sitting surface of the seat.
- ▶ Never place objects (e.g. cushions) under or behind the child restraint system.
- ▶ Use child restraint systems only with the original cover designed for them.
- ▶ Always replace damaged covers with genuine covers.

**⚠ WARNING** Risk of injury or death due to unsecured child restraint systems in the vehicle

If the child restraint system is incorrectly installed or not secured, it can come loose.

The child restraint system could be flung around and hit vehicle occupants.

- ▶ Always install child restraint systems correctly, even when not in use.
- ▶ Always comply with the child restraint system manufacturer's installation instructions.

- Always observe the child restraint system manufacturer's installation and operating instructions as well as the vehicle-specific information:
  - Installing the LATCH-type (ISOFIX) child restraint system on the right and left rear seats (→ page 59).
  - Securing the child restraint system with the seat belt on the rear seat (→ page 64).

- Securing the child restraint system with the seat belt on the front passenger seat (→ page 66). Observe the specific instructions for the rearward-facing and forward-facing child restraint systems (→ page 65).

If the front passenger seat is occupied, ensure, both before and during the journey, that the status of the front passenger airbag is correct for the current situation (→ page 49).

- Observe the warning labels in the vehicle interior and on the child restraint system.
- Also secure Top Tether if present.

#### Do not modify the child restraint system

**⚠ WARNING** Risk of injury due to modifications to the child restraint system

The child restraint system can no longer function properly. This poses an increased risk of injury.

- ▶ Never modify a child restraint system.

- ▶ Only affix accessories which have been specially approved for this child restraint system by the child restraint system's manufacturer.

#### Only use child restraint systems which are in proper working condition

**⚠ WARNING** Risk of injury or death caused by the use of damaged child restraint systems

Child restraint systems or their retaining systems that have been subjected to stress in an accident may not be able to perform their intended protective function.

It may be the case that the child cannot be properly restrained.

- ▶ Always immediately replace child restraint systems that have been damaged or involved in an accident.
- ▶ Have the securing systems for the child restraint systems checked at a qualified specialist workshop before installing a child restraint system again.

#### Avoid direct sunlight

**⚠ WARNING** Risk of burns when the child seat is exposed to direct sunlight

If the child restraint system is exposed to direct sunlight or heat, parts could heat up excessively.

Children could suffer burns from these parts, particularly the metallic parts of the child restraint system.

- ▶ Always make sure that the child restraint system is not exposed to direct sunlight.
- ▶ Cover the child restraint system with a blanket, for example.
- ▶ If the child restraint system has been exposed to direct sunlight, allow it to cool before securing a child into it.
- ▶ Never leave children unattended in the vehicle.

## Observe when stopping or parking

**⚠ WARNING** Risk of accident and injury due to children left unattended in the vehicle

If children are left unsupervised in the vehicle, they could, in particular:

- open doors, thereby endangering other persons or road users.
- get out and be struck by oncoming traffic.
- operate vehicle equipment and become trapped, for example.

In addition, the children could also set the vehicle in motion, for example by:

- releasing the parking brake.
- changing the transmission position.
- starting the vehicle.

- ▶ Never leave children unattended in the vehicle.
- ▶ When leaving the vehicle, always take the SmartKey with you and lock the vehicle.

- ▶ Keep the vehicle SmartKey out of reach of children.

**⚠ WARNING** Risk of fatal injury due to exposure to extreme heat or cold in the vehicle



If persons, particularly children, are subjected to prolonged exposure to intense heat or cold, there is a risk of severe injury or even death.

- ▶ Never leave persons, particularly children, unattended in the vehicle.



## Overview of suitable seats in the vehicle for installing a child restraint system

### Left/right rear seat



Second row of seats (left and right seat) – preferred securing system:

-  LATCH-type (ISOFIX) child seat securing system
-  Also secure Top Tether if present (→ page 62).

Third row of seats – preferred securing system:

-  LATCH-type (ISOFIX) child seat securing system
-  Also secure Top Tether if present (→ page 62).

Left/right rear seat (second and third seat row) – alternative securing system:

-  Vehicle seat belt
-  Also secure Top Tether if present (→ page 62).

### Front passenger seat

Securing system:

-  Vehicle seat belt

Be sure to observe:

- If the front passenger seat is occupied, ensure, both before and during the journey, that the status of the front passenger airbag is correct for the current situation (→ page 49).
- Notes on automatic front passenger airbag shutoff (→ page 48).

### Center rear seat (second seat row)

Securing system:



Vehicle seat belt



Also secure Top Tether if present  
(→ page 62).

### Activating or deactivating the special seat belt retractor of the seat belt

**⚠ WARNING** Risk of injury or death if a seat belt is unfastened while the vehicle is in motion

If the seat belt is released while the vehicle is in motion, the special seat belt retractor is deactivated and the child restraint system is no longer correctly secured. The seat belt is drawn in slightly by the inertia reel and cannot be immediately closed again.

- ▶ Stop the vehicle immediately in accordance with the traffic conditions.

- ▶ Activate the special seat belt retractor again and correctly secure the child restraint system.

When enabled, the special seat belt retractor ensures that the seat belts of the front passenger seat and rear seats do not slacken once the child restraint system is secured.

The seat belts on the following seats are equipped with a special seat belt retractor:

- Front passenger seat
- Rear seats

### Installing a child restraint system

- ▶ When installing a child restraint system, always observe the manufacturer's installation and operating instructions as well as the information in this Operator's Manual.
- ▶ Pull the seat belt smoothly from the seat belt outlet.
- ▶ Engage the seat belt tongue in the seat belt buckle.

### Activating the special seat belt retractor

- ▶ Pull the seat belt out fully and let the inertia reel retract it again. When the special seat belt retractor is activated, you will hear a ratcheting sound.
- ▶ Push the child restraint system down until the seat belt sits tightly.

### Deactivating the special seat belt retractor

- ▶ Press the release button of the seat belt buckle.
- ▶ Hold the seat belt tongue and guide back to the seat belt outlet.

### Installing a LATCH-type (ISOFIX) child restraint system on the left and right rear seats

#### Installing a LATCH-type (ISOFIX) child restraint system on the left and right rear seats

**⚠ WARNING** Risk of accident if the rear bench seat, rear seat and seat backrest are not engaged

The rear bench seat, rear seat and seat backrest may fold forwards, even when you are driving.

- As a result, the vehicle occupant will be pushed into the seat belt with increased force. The seat belt will not be able to protect as intended and could cause additional injury.
- Objects or loads in the trunk or cargo compartment will not be restrained by the seat backrest.
- ▶ Make sure that the rear bench seat, the rear seat and the seat backrest are engaged before every trip.

If the seat backrest is not engaged and locked in place, this will be shown on the display on the instrument cluster (folding the rear seat back electrically) or the red lock verification indicator will be visible (folding the rear seat back mechanically).

**⚠ WARNING** Risk of injury or death if the permissible gross mass of the child and child restraint system together is exceeded.

Too much load may be placed on the LATCH-type (ISOFIX) child restraint system and the child may not be restrained correctly in the event of an accident, for example.

- ▶ If the child and the child restraint system together weigh more than the permissible gross mass of 73 lb (33 kg), only use a LATCH-type (ISOFIX) child restraint system with which the child is secured with the vehicle seat belt.
- ▶ Also secure the child restraint system with the Top Tether belt, if available.

Always comply with the information about the mass of the child restraint system:

- In the manufacturer's installation and operating instructions for the child restraint system used
- On a label on the child restraint system, if present

Regularly check that the permissible gross mass of the child and child restraint system is still complied with.

When installing a child restraint system, observe the following:

- Always observe the correct use of the seats and consider their suitability for attaching a child restraint system.
- Always comply with the manufacturer's installation and operating instructions for the child restraint system used.
- Make sure that the child's feet do not touch the front seat. If necessary, move the front seat slightly forwards.

 When installing a LATCH-type (ISOFIX) child restraint system, also observe the following:

✓ **When using a baby car seat in weight group 0/0+ and a rearward-facing child restraint system in weight group I on a rear seat:** adjust the front seat so that the seat does not touch the child restraint system.

✓ **When using a forward-facing child restraint system in weight group I:** remove the head restraint from the respective seat, if possible. In addition, the backrest of the child restraint system must lie as flat as possible against the backrest of the vehicle seat.

After the child restraint system has been removed, replace the head restraint immediately and adjust all head restraints correctly.

✓ **When using a child restraint system on a seat on the third row of seats:** adjust the front seat so that it does not touch the child restraint system and move the seat backrest of the front seat into an upright position if necessary.

✓ If the head restraint of the child seat cannot be fully extended when it is installed in the

vehicle, this will result in restrictions on the maximum size setting for child restraint systems in weight group II or III.

Contact with the roof when the head restraint is fully extended and locked in place will not result in any restrictions on use.

✓ The child restraint system must not be put under strain between the roof and the seat cushion and/or be installed facing the wrong direction. Where possible, adjust the seat cushion inclination accordingly.

✓ The child restraint system must not be put under strain by the head restraint. Adjust the head restraints as appropriate.

▶ Before every journey, make sure that the LATCH-type (ISOFIX) child restraint system is engaged in both mounting brackets in the vehicle.

**!** **NOTE** Damage to the seat belt for the center seat during installation of the child restraint system

▶ Make sure that the seat belt is not trapped.

#### Vehicles with individual rear seats:

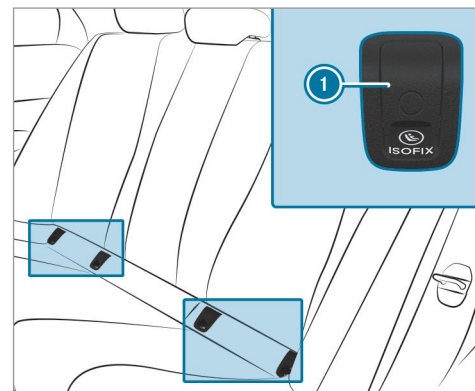

① LATCH-type (ISOFIX) mounting bracket

- ▶ Remove and stow away covers ① of the mounting brackets in the vehicle.
- ▶ Attach the LATCH-type (ISOFIX) child restraint system to both mounting brackets in the vehicle.
- ▶ After removing the child restraint system, reattach covers ①.

#### Vehicles with a rear bench seat:

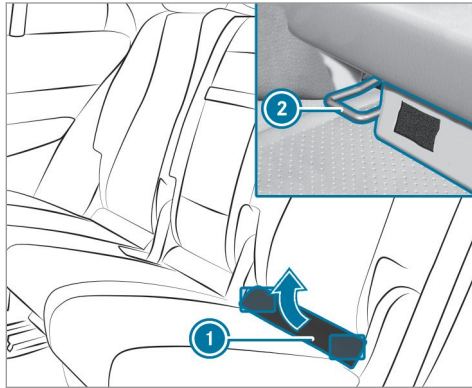

- ▶ **Mercedes-Maybach vehicles with reclining rear seats:** Before a LATCH-type (ISOFIX) or i-Size child restraint system is installed, tilt the backrest of the reclining rear seat back slightly.
- ▶ Remove upholstered lining ①.
- ▶ **Vehicles without reclining rear seats:** Fold upholstered lining ① upwards.
- ▶ Turn the support on the back of upholstered lining ① by 90°. Upholstered lining ① will remain folded upwards.
- ▶ Attach the LATCH-type (ISOFIX) child restraint system to both mounting brackets ② in the vehicle.
- ▶ **Mercedes-Maybach vehicles with reclining rear seats:** Return the reclining rear seat backrest to an upright position. The reclining rear seat backrest must be in contact with the child restraint system.

#### Vehicles with a third row of seats:

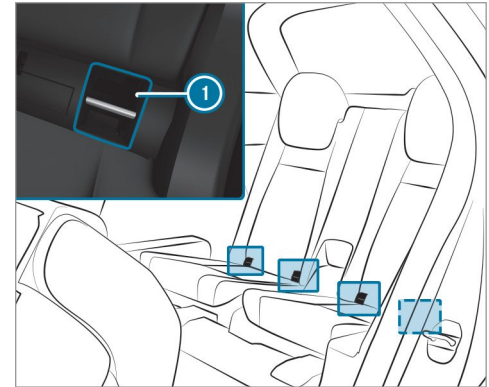

- ▶ Attach the LATCH-type (ISOFIX) child restraint system to both LATCH-type (ISOFIX) mounting brackets ①.

### Fastening a Top Tether

**⚠ WARNING** Risk of injury or death if the rear seat backrests are not locked after Top Tether belts are installed

The rear seat backrests may fold forwards when you are driving.

As a result, child restraint systems will no longer be able to perform their intended protective function. This may also cause additional injuries.

- ▶ Always lock rear seat backrests after installing Top Tether belts.
- ▶ Observe the lock verification indicator.

If the seat backrest is not engaged and locked in place, this will be shown on the display on the instrument cluster (folding the rear seat back electrically) or the red lock verification indicator will be visible (folding the rear seat back mechanically).



If the child restraint system is equipped with a Top Tether belt:

The risk of injury may be reduced by Top Tether. The Top Tether belt enables an additional connection between the child restraint system attached with LATCH-type (ISOFIX) (left and right rear seats) or the seat belt (all rear seats) and the vehicle.

The Top Tether anchorages for the second row of seats are located on the back of the seat backrest. For the third row of seats, use the Top Tether anchorage on the back of the seat backrest.

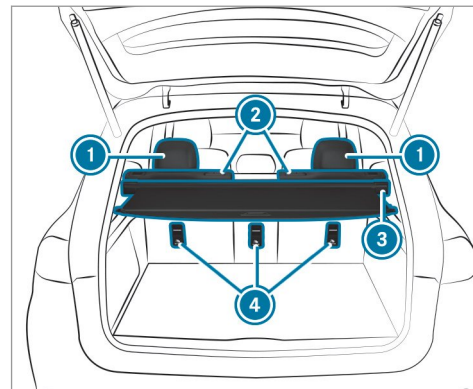

Second row of seats



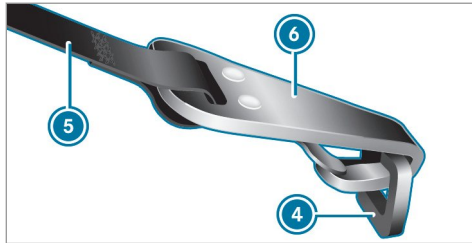

- ▶ If necessary, slide head restraint ① upwards (→ page 109).
- ▶ Install the LATCH-type (ISOFIX) or belt-secured child restraint system with Top Tether. In doing so, comply with the child restraint system manufacturer's installation instructions.
- ▶ Guide Top Tether belt ⑤ under head restraint ① between the two head restraint bars.
- ▶ If cargo compartment cover ③ is installed, guide Top Tether belt ⑤ downwards between cargo compartment cover ③ and seat backrest ②.

- ▶ Hook Top Tether hook ⑥ of Top Tether belt ⑤ into Top Tether anchorage ④ without twisting.
- ▶ Tension Top Tether belt ⑤. In doing so, comply with the child restraint system manufacturer's installation instructions.
- ▶ If necessary, slide head restraint ① downwards (→ page 109). Make sure that you do not interfere with the correct routing of Top Tether belt ⑤.

### Mercedes-Maybach vehicles

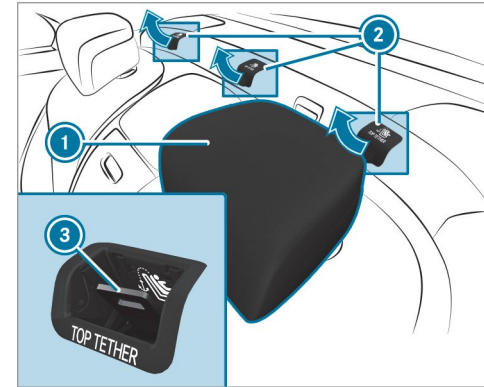

- ▶ If necessary, slide head restraint ① upwards (→ page 109).
- ▶ Remove cover ② of Top Tether anchorage ③.
- ▶ Install the LATCH-type (ISOFIX) or belt-secured child restraint system with Top Tether. In doing so, comply with the child restraint

system manufacturer's installation instructions.

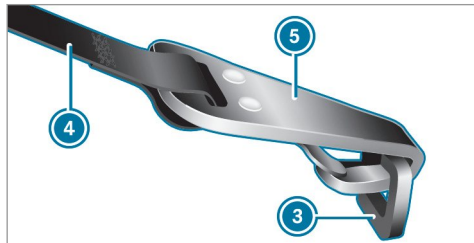

- ▶ Guide Top Tether belt ④ under head restraint ① between the two head restraint bars.
- ▶ Hook Top Tether hook ⑤ of Top Tether belt ④ into Top Tether anchorage ③ without twisting.
- ▶ Tension Top Tether belt ④. In doing so, comply with the child restraint system manufacturer's installation instructions.
- ▶ If necessary, slide head restraint ① downwards (→ page 109). Make sure that you do

not interfere with the correct routing of Top Tether belt ④.

### Securing the child restraint system with the seat belt

#### Securing the child restraint system with the seat belt on the rear seat

**⚠ WARNING** Risk of accident if the rear bench seat, rear seat and seat backrest are not engaged

The rear bench seat, rear seat and seat backrest may fold forwards, even when you are driving.

- As a result, the vehicle occupant will be pushed into the seat belt with increased force. The seat belt will not be able to protect as intended and could cause additional injury.
- Objects or loads in the trunk or cargo compartment will not be restrained by the seat backrest.

▶ Make sure that the rear bench seat, the rear seat and the seat backrest are engaged before every trip.

If the seat backrest is not engaged and locked in place, this will be shown on the display on the instrument cluster (folding the rear seat back electrically) or the red lock verification indicator will be visible (folding the rear seat back mechanically).

#### When installing a belt-secured child restraint system, observe the following:

- ☑ Always comply with the manufacturer's installation and operating instructions for the child restraint system used.
- ☑ Also secure Top Tether if present (→ page 62).
- ☑ **When using a weight category 0/0+ baby car seat and a weight category I rearward-facing child restraint system on a rear seat:** adjust the front seat so that the seat does not touch the child restraint system.
- ☑ **When using a weight category I forward-facing child restraint system:** remove the

head restraint from the respective seat, if possible.

After the child restraint system has been removed, replace the head restraint immediately and adjust all head restraints correctly.

- ☑ The backrest of the forward-facing child restraint system must, as far as possible, be resting on the seat backrest of the rear seat.
- ☑ If the head restraint of the child seat cannot be fully extended when it is installed in the vehicle, this will result in restrictions on the maximum size setting for child restraint systems in weight category II or III.  
Contact with the roof when the head restraint is fully extended and locked in place will not result in any restrictions on use.
- ☑ The child restraint system must not be put under strain between the roof and the seat cushion and/or be installed facing the wrong direction. Where possible, adjust the seat cushion inclination accordingly.
- ☑ The child restraint system must not be put under strain by the head restraint. Adjust the head restraints as appropriate.

- ☑ Make sure that the child's feet do not touch the front seat. If necessary, move the front seat slightly forwards.

The seat belts on the following seats are equipped with a special seatbelt retractor:

- Front passenger seat
- Rear seats

When enabled, the special seatbelt retractor ensures that the seat belts of the front passenger seat and rear seats do not slacken once the child restraint system is secured (→ page 58).

- ▶ Install the child restraint system.  
The entire base of the child restraint system must always rest on the seat surface of the rear seat.
- ▶ Always make sure that the shoulder belt strap is correctly routed from the seat belt outlet of the vehicle to the shoulder belt guide on the child restraint system.  
The shoulder belt strap must be routed forward from the seat belt outlet.

### Notes on rearward-facing and forward-facing child restraint systems on the front passenger seat

**⚠ WARNING** Risk of injury or fatal injury when using a rearward-facing child restraint system while the co-driver airbag is enabled

If you secure a child in a rearward-facing child restraint system on the co-driver seat and the PASSENGER AIR BAG OFF indicator lamp is off, the co-driver airbag can deploy in the event of an accident.

The child could be struck by the airbag.

- ▶ Always ensure that the co-driver airbag is disabled. The PASSENGER AIR BAG OFF indicator lamp must be lit.
- ▶ NEVER use a rearward-facing child restraint system on a seat with an ENABLED FRONT AIRBAG; DEATH or SERIOUS INJURY to the CHILD can occur.

Observe the specific instructions for the rearward-facing and forward-facing child restraint systems (→ page 66).

Always observe the status of the front passenger airbag on the PASSENGER AIR BAG OFF indicator lamp:

- When using a rearward-facing child restraint system on the front passenger seat, the front passenger airbag must always be disabled. This is only the case if the PASSENGER AIR BAG OFF indicator lamp is lit continuously (→ page 49).
- If the PASSENGER AIR BAG OFF indicator lamp is off, the front passenger airbag is enabled. The front passenger airbag may deploy during an accident.

### Securing the child restraint system with the seat belt on the front passenger seat

When installing a belt-secured child restraint system on the front passenger seat, always observe the following:

- ☑ Observe the notes on rearward-facing and forward-facing child restraint systems on the front passenger seat (→ page 65).
- ☑ Observe the child restraint system manufacturer's installation and operating instructions.

- ☑ When using a forward-facing child restraint system in weight category I: remove the head restraint from the respective seat, if possible.

After the child restraint system has been removed, replace the head restraint immediately and adjust all head restraints correctly.

- ☑ The backrest of the forward-facing child restraint system must, as far as possible, be resting on the seat backrest of the front passenger seat.
- ☑ If the head restraint of the child seat cannot be fully extended when it is installed in the vehicle, this will result in restrictions on the maximum size setting for child restraint systems in weight category II or III.

Contact with the roof when the head restraint is fully extended and locked in place will not result in any restrictions on use.

- ☑ The child restraint system must not be put under strain between the roof and the seat cushion and/or be installed facing the wrong direction.

- ☑ The child restraint system must not be put under strain by the head restraint. Adjust the head restraints as appropriate.

- ☑ Never place objects (e.g. cushions) under or behind the child restraint system.

The seat belt on the front passenger side is equipped with a special seatbelt retractor.

When enabled, the special seatbelt retractor ensures that the seat belt does not slacken once the child seat is secured (→ page 58).

**⚠ WARNING** Risk of injury or death due to objects between the seat surface and the child restraint system

Objects between the seat surface and the child restraint system could affect the function of the automatic front passenger airbag shut-off.

- ▶ Do not place any objects between the seat surface and the child restraint system.
- ▶ Always make sure that the child restraint system is correctly installed.

- ▶ Set the front passenger seat as far back as possible and move the seat into the highest position if possible.
- ▶ Fully retract the seat cushion length adjustment.
- ▶ Adjust the seat cushion inclination so that the front edge of the seat cushion is in the highest position and the rear edge of the seat cushion is in the lowest position.
- ▶ Set the seat backrest to the most vertical position possible.
- ▶ Install the child restraint system. The entire base of the child restraint system must always rest on the sitting surface of the front passenger seat.
- ▶ Always make sure that the shoulder belt strap is correctly routed from the seat belt outlet of the vehicle to the shoulder belt guide on the child restraint system. The shoulder belt strap must be routed forwards and downwards from the seat belt outlet.
- ▶ If necessary, adjust the seat belt outlet and the front passenger seat accordingly.

### Child-proof locks

#### Activating or deactivating the child safety lock for the rear doors

**⚠ WARNING** Risk of accident and injury due to children left unattended in the vehicle

If children are left unsupervised in the vehicle, they could, in particular:

- open doors, thereby endangering other persons or road users.
- get out and be struck by oncoming traffic.
- operate vehicle equipment and become trapped, for example.

In addition, the children could also set the vehicle in motion, for example by:

- releasing the parking brake.
- changing the transmission position.
- starting the vehicle.

▶ Never leave children unattended in the vehicle.

- ▶ When leaving the vehicle, always take the SmartKey with you and lock the vehicle.
- ▶ Keep the vehicle SmartKey out of reach of children.

**⚠ WARNING** Risk of fatal injury due to exposure to extreme heat or cold in the vehicle

If persons, particularly children, are subjected to prolonged exposure to intense heat or cold, there is a risk of severe injury or even death.

- ▶ Never leave persons, particularly children, unattended in the vehicle.

**⚠ WARNING** Risk of accident and injury due to children left unattended in the vehicle

If children are traveling in the vehicle, they could, in particular:

- Open doors, thereby endangering other persons or road users.
- Get out and be struck by oncoming traffic.
- Operate vehicle equipment and become trapped, for example.

- ▶ Always activate the installed child safety locks if children are traveling in the vehicle.
- ▶ Never leave children unattended in the vehicle.
- ▶ When leaving the vehicle, always take the SmartKey with you and lock the vehicle.

There are child safety locks for the rear doors and the rear side windows. The child safety lock on the rear doors secures each door separately. The doors can no longer be opened from the inside.

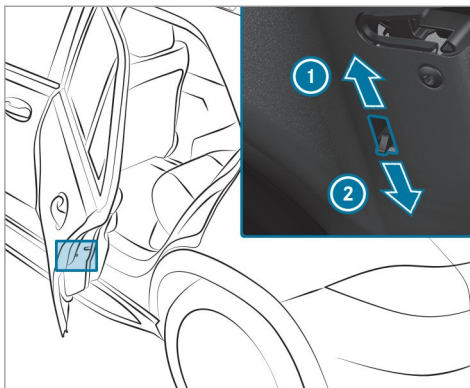

- ▶ Press the lever in direction ① (activate) or ② (deactivate).
- ▶ Make sure that the child safety locks are working properly.

#### Activating and deactivating the child safety lock for the rear side windows

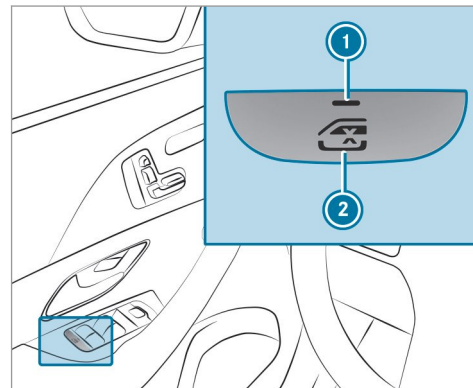

- ▶ **To activate/deactivate:** press button ②.

The rear side window can be opened or closed in the following cases:

- indicator lamp ① is lit: via the switch on the driver's door

- indicator lamp  is off: via the switch on the corresponding rear door or driver's door

### Notes on pets in the vehicle

 **WARNING** Risk of accident and injury due to animals left unsecured or unattended in the vehicle

If you leave animals in the vehicle unattended or unsecured, they could possibly press buttons or switches.

An animal may:

- Activate vehicle equipment and become trapped, for example
- Switch systems on or off and endanger other road users

Unsecured animals may be thrown around in the vehicle in the event of an accident or sudden steering and braking maneuvers and injure vehicle occupants in the process.

- ▶ Never leave animals in the vehicle unattended.
- ▶ Always correctly secure animals while driving, e.g. using a suitable animal carrier.

## SmartKey

### Overview of SmartKey functions

**⚠ WARNING** Risk of accident and injury due to children left unattended in the vehicle

If children are left unsupervised in the vehicle, they could, in particular:

- open doors, thereby endangering other persons or road users.
- get out and be struck by oncoming traffic.
- operate vehicle equipment and become trapped, for example.

In addition, the children could also set the vehicle in motion, for example by:

- releasing the parking brake.
- changing the transmission position.
- starting the vehicle.

▶ Never leave children unattended in the vehicle.

- ▶ When leaving the vehicle, always take the SmartKey with you and lock the vehicle.
- ▶ Keep the vehicle SmartKey out of reach of children.

**! NOTE** Damage to the SmartKey caused by magnetic fields

- ▶ Keep the SmartKey away from strong magnetic fields.



Vehicle key with panic alarm

- ① Locks
- ② Indicator lamp

- ③ Unlocks
- ④ Opens/closes the tailgate
- ⑤ Panic alarm

ⓘ If indicator lamp ② does not light up after pressing the or button, the battery is weak or possibly discharged. Replace the battery as soon as possible.

Replace the key battery (→ page 72).

The key locks and unlocks the following components:

- Doors
- Fuel filler flap
- Tailgate

If the vehicle is not opened within approximately 40 seconds after unlocking, it locks again. Anti-theft protection is activated again.

Do not keep the key together with electronic devices or metal objects. This can affect the key's functionality.

Do not keep the key in the temperature-controlled cup holder. Otherwise, the key will not be reliably detected.



### Activating/deactivating the acoustic locking verification signal

Multimedia system:

→  » Settings » Vehicle

▶ Activate or deactivate **Acoustic Lock**.

### Arming/disarming the panic alarm

#### Requirements:

- The vehicle is switched off.



▶ **To activate:** press button ① for approximately one second.  
A visual and audible alarm is triggered.



▶ **To deactivate:** briefly press button ① again.  
or

▶ Press the start/stop button.  
A SmartKey belonging to the vehicle must be detected in the vehicle.

### Changing the unlocking settings

Possible unlocking functions of the SmartKey:

- Central unlocking
- Unlocking the driver's door and fuel filler flap

▶ **To switch between settings:** press the  and  buttons simultaneously for approximately six seconds until the indicator lamp flashes twice.

Options if the unlocking function for the driver's door and fuel filler flap has been selected:

- **To unlock the vehicle centrally:** press the  button twice.
- **Vehicles with KEYLESS-GO:** if you touch the inner surface of the door handle on the driver's door, only the driver's door and the fuel filler flap are unlocked.

### Deactivating the function of the SmartKey

**Vehicles with KEYLESS-GO:** if you deactivate the function of the SmartKey, the KEYLESS-GO functions are also deactivated. Access or drive authorization by KEYLESS-GO is then no longer possible with that particular SmartKey. Activate the function of the SmartKey so that all its functions will again be available.

You can also deactivate the function of the SmartKey to reduce the energy consumption of the SmartKey if you do not use the vehicle or a SmartKey for an extended period of time.

▶ **To deactivate:** press the  button on the SmartKey twice in quick succession.

The SmartKey indicator lamp flashes twice briefly and lights up once.

▶ **To activate:** press any button on the SmartKey.

① When the vehicle is started with the SmartKey in the marked space of the center console, the function of the SmartKey is automatically activated (→ page 175).

### Removing/inserting the emergency key

#### Removing the emergency key

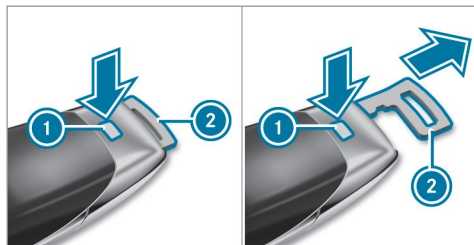

- ▶ Press release button ①. Emergency key ② is pushed out slightly.
- ▶ Pull out emergency key ② until it engages in the intermediate position.
- ▶ Press release button ① again and fully remove emergency key ②.

#### Inserting the emergency key

- ▶ Press release button ①.
- ▶ Insert emergency key ② to the intermediate position or fully until it engages.

- ① You can use the intermediate position of emergency key ② to attach the SmartKey to a key ring.

### Replacing the SmartKey battery

**⚠ DANGER** Risk of fatal injuries due to swallowing batteries

Batteries contain toxic and corrosive substances. Swallowing batteries may cause severe internal burns to occur within two hours.

There is a risk of fatal injury.

- ▶ Keep batteries out of the reach of children.
- ▶ If the cap and/or the battery compartment does not close securely, do not use the SmartKey any longer and keep out of the reach of children.
- ▶ If batteries are swallowed, seek medical attention immediately.

**🔥 ENVIRONMENTAL NOTE** Environmental damage due to improper disposal of batteries



Batteries contain pollutants. It is illegal to dispose of them with the household rubbish.



Dispose of batteries in an environmentally responsible manner. Take discharged batteries to a qualified specialist workshop or to a collection point for used batteries.

#### Requirements:

- You require a CR 2032 3 V cell battery.

Mercedes-Benz recommends that you have the battery replaced at a qualified specialist workshop.

- ▶ Remove the emergency key (→ page 72).

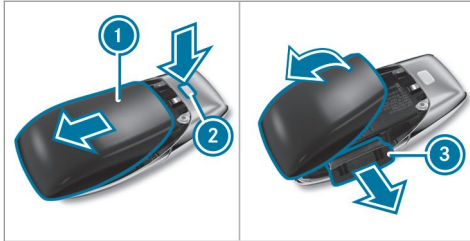

- ▶ Press release knob ② down fully and slide cover ① in the direction of the arrow.
- ▶ Fold out cover ① in the direction of the arrow and remove.
- ▶ Remove battery compartment ③ and take out the discharged battery.
- ▶ Insert the new battery into battery compartment ③. Observe the positive pole marking in the battery compartment and on the battery when doing this.
- ▶ Push in battery compartment ③.
- ▶ Re-attach cover ① and push it until it engages.

### Problems with the SmartKey, troubleshooting

#### You can no longer lock or unlock the vehicle

Possible causes:

- The SmartKey battery is weak or discharged.
- ▶ Check the battery using the indicator lamp (→ page 70).
- ▶ Replace the SmartKey battery, if necessary (→ page 72).
- ▶ Use the replacement SmartKey.
- ▶ Use the emergency key to lock or unlock (→ page 76).
- ▶ Have the SmartKey checked at a qualified specialist workshop.

#### There is interference from a powerful radio signal source

Possible causes if the function of the SmartKey is impaired:

- High voltage power lines
- Mobile phones
- Electronic devices (notebooks, tablets)

- Shielding due to metal objects or induction loops for electrical gate systems or automatic barriers

- ▶ Make sure that there is sufficient distance between the SmartKey and the potential source of interference.

#### You have lost a SmartKey

- ▶ Have the SmartKey deactivated at a qualified specialist workshop.
- ▶ If necessary, have the mechanical lock replaced as well.

## Doors

## Unlocking/opening the doors from the inside

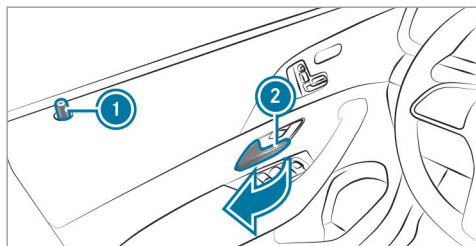

- ▶ **To unlock and open a front door:** pull door handle (2). Locking pin (1) pops up when the door is unlocked.
- ▶ **To unlock a rear door:** pull the rear door handle. The locking pin pops up when the rear door is unlocked.
- ▶ **To open a rear door:** pull the rear door handle again.

## Centrally locking and unlocking the vehicle from the inside

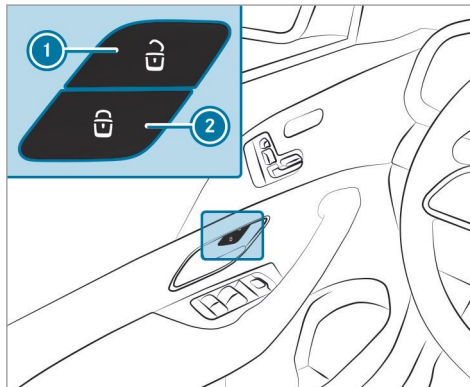

- ▶ **To unlock:** press button (1).
- ▶ **To lock:** press button (2).
- ⓘ **Mercedes-Maybach vehicles:** the buttons are also located on the front passenger and rear doors.

This does not lock or unlock the fuel filler flap.

The vehicle is not unlocked:

- If you have locked the vehicle using the SmartKey
- If you have locked the vehicle using KEYLESS-GO

## Locking/unlocking the vehicle with KEYLESS-GO

## Requirements:

- The SmartKey is outside the vehicle.
- The distance between the SmartKey and the vehicle does not exceed 3 ft (1 m).
- The driver's door and the door on which the door handle is used are closed.

**!** **NOTE** Vehicle damage due to unintentional opening of the tailgate

- When using an automatic car wash
- When using a high pressure cleaner

▶ Deactivate the function of the SmartKey in these situations.

or

- ▶ Make sure that the SmartKey is at a minimum distance of 10 ft (3 m) away from the vehicle.

Observe the notes:

- On washing the vehicle in a car wash (→ page 341)
- On using a high pressure cleaner (→ page 343)

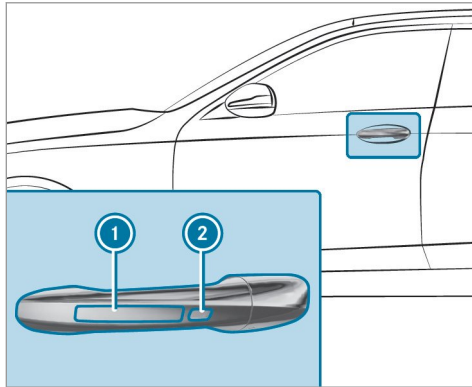

- ▶ **To unlock the vehicle:** touch the inner surface of the door handle.
- ▶ **To lock the vehicle:** touch sensor surface ① or ②.
- ▶ **Convenience closing:** touch recessed sensor surface ② until the closing process has been completed.
- ① Further information on convenience closing (→ page 87).

If you open the tailgate from outside, it is automatically unlocked.

#### Problems with KEYLESS-GO, troubleshooting

##### **You can no longer lock or unlock the vehicle using KEYLESS-GO**

Possible causes:

- The function of the SmartKey has been deactivated.
- The SmartKey battery is weak or discharged.
- ▶ Activate the function of the SmartKey (→ page 71).

- ▶ Check the battery using the indicator lamp (→ page 70).
- ▶ Replace the SmartKey battery, if necessary (→ page 72).
- ▶ Use the replacement SmartKey.
- ▶ Use the emergency key to lock or unlock (→ page 76).
- ▶ Have the vehicle and SmartKey checked at a qualified specialist workshop.

##### **There is interference from a powerful radio signal source**

Possible causes if the function of KEYLESS-GO is impaired:

- High voltage power lines
- Mobile phones
- Electronic devices (notebooks, tablets)
- Shielding due to metal objects or induction loops for electrical gate systems or automatic barriers
- ▶ Make sure that there is sufficient distance between the SmartKey and the potential source of interference.

### Activating/deactivating the automatic locking feature

The vehicle is locked automatically when the vehicle is switched on and the wheels are turning faster than walking pace.

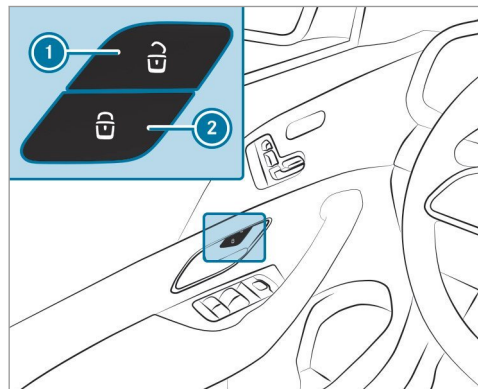

▶ **To activate:** press and hold button ② for approximately five seconds until an acoustic signal sounds.

▶ **To deactivate:** press and hold button ① for approximately five seconds until an acoustic signal sounds.

In the following situations, there is a danger of being locked out when the function is activated:

- While the vehicle is being tow-started or pushed
- If the vehicle is being tested on a roller dynamometer

### Power closing function

**⚠ WARNING** Risk of becoming trapped when the doors close automatically

Body parts or objects can become trapped, causing injuries.

- ▶ Ensure that no body parts or objects are in the closing area.
- ▶ Automatic closing of the doors can be canceled by pulling the outer or inner door handle.

If you push the door into the lock to the first detent position, the power closing function will automatically pull the door into the lock.

### Locking/unlocking the driver's door with the emergency key

ⓘ If you wish to lock the vehicle entirely using the emergency key, first press the button for locking from the inside while the driver's door is open. Then proceed to lock the driver's door using the emergency key.

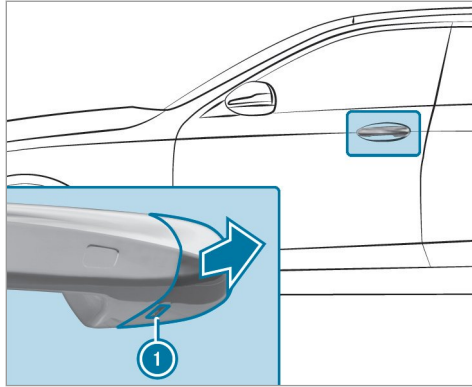

- ▶ Remove the emergency key (→ page 72).
- ▶ Insert the emergency key as far as it will go into opening ① in the cover.
- ▶ Pull and hold the door handle.
- ▶ Pull the cover on the emergency key as straight as possible away from the vehicle until it releases.
- ▶ Release the door handle.

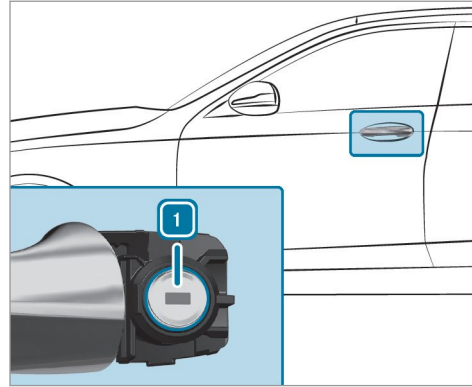

- ▶ **To unlock:** turn the emergency key counter-clockwise to position ①.
- ▶ **To lock:** turn the emergency key clockwise to position ①.
- ▶ Carefully press the cover onto the lock cylinder until it engages and is seated firmly.

## Running boards

### Operation of the running boards

**Mercedes-Maybach vehicles:** the vehicle is equipped with electrically extendable running boards. If you have selected the automatic mode in the multimedia system, (→ page 78) the running board will extend automatically on the respective side when a door is opened. When the running boards are extended, check the excess width of the vehicle.

You can extend or retract the running boards manually for cleaning (→ page 78).

ⓘ The running boards will extend and retract only if the vehicle is stationary.

In the following cases, the running boards will retract automatically:

- If you select an off-road drive program (→ page 188).
- If you activate car wash mode (→ page 343).
- If the outside mirrors fold in automatically (→ page 163).

- If you are driving at a speed greater than 2.5 mph (4 km/h).

If you have selected the automatic mode in the multimedia system and you manually extend the running boards when the doors are closed, the running boards will remain extended. Even if you open a door and then close it again, the running boards will remain extended. Automatic mode will be reactivated only when you are driving at a speed greater than 2.5 mph (4 km/h).

**⚠ WARNING** Risk of injury when extending or retracting the running boards

The running boards extend at the side during extension. During retraction, the running boards are integrated in the side skirt. Parts of the body could become trapped. There may be people in the range of movement. There is a risk of injury.

- ▶ Always ensure that there are no people within the range of movement of the running boards.

**!** **NOTE** Damage to the running boards during extension or retraction

The running boards extend at the side during extension. During retraction, the running boards are integrated in the side skirt.

- ▶ Make sure that there is sufficient space during extension and retraction.

**!** **NOTE** Damage to the vehicle body or underbody due to low ground clearance

The running boards are attached to the vehicle body via the underbody. This limits the ground clearance.

- ▶ Drive over obstacles, such as curbs, particularly carefully and slowly.

Observe the corresponding display messages in the instrument cluster (→ page 423).

### Extending and retracting the running boards via the multimedia system

Multimedia system:

→  **▶▶ Settings ▶▶ Vehicle**  
**▶▶ SIDE RUNNING BOARD**

- ▶ Select **Extend** or **Retract**.

### Automatically extending and retracting the running boards

- ▶ Activate or deactivate **AUTOMATIC EXTENSION**.

**i** This equipment is available only for Mercedes-Maybach vehicles.

### Cargo compartment

#### Opening the tailgate

**⚠ DANGER** Risk of poisoning from exhaust gases

Combustion engines emit poisonous exhaust gases, such as carbon monoxide. Exhaust gases can enter the vehicle interior if the tail-



gate is open when the vehicle is running, especially if the vehicle is in motion.

- ▶ Always switch off the vehicle before opening the tailgate.
- ▶ Never drive with the tailgate open.

**!** **NOTE** Damage to the tailgate caused by obstacles above the vehicle

The tailgate swings rearwards and upwards when it is opened.

- ▶ Make sure that there is sufficient space behind and above the tailgate.

- ▶ If the tailgate is unlocked, pull the tailgate handle and release it again immediately.
- ▶ **Vehicles with HANDS-FREE ACCESS:** Make a kicking movement with your foot below the bumper (→ page 82).

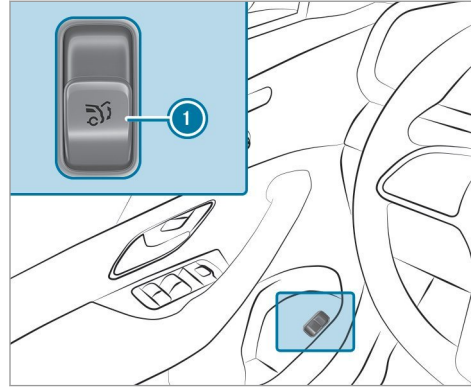

- ▶ Pull remote operating switch ① until the tailgate opens.
- or
- ▶ Press and hold the  button on the Smart-Key.
  - ▶ If the tailgate is stopped in an intermediate position, pull it upwards. Release it as soon as it begins to open.

If an obstacle obstructs the tailgate during the automatic opening process, blockage detection will stop the tailgate. The automatic blockage detection function is only an aid. It is not a substitute for your attentiveness.

### Closing the tailgate

**!** **WARNING** Risk of injury from unsecured items in the vehicle

If objects, luggage or loads are not secured or not secured sufficiently, they could slip, tip over or be thrown around and thereby hit vehicle occupants.

There is a risk of injury, particularly in the event of sudden braking or a sudden change in direction.

- ▶ Always stow objects in such a way that they cannot be thrown around.
- ▶ Before the journey, secure objects, luggage or loads against slipping or tipping over.

Observe the notes on loading the vehicle.

**Notes on closing the tailgate:** your vehicle is equipped with automatic key recognition. If a SmartKey belonging to the vehicle is detected in the vehicle, the tailgate will not be locked.

Note that the tailgate will not be locked in the following situation:

- You have locked the vehicle and close the tailgate while a SmartKey belonging to the vehicle is inside the vehicle.
- and
- A second SmartKey belonging to the vehicle is not detected outside the vehicle.

Automatic SmartKey recognition is only an aid and is not a substitute for your attentiveness.

- ▶ Before locking, ensure that at least one SmartKey belonging to the vehicle is outside the vehicle.
- ▶ **To close the tailgate:** pull the tailgate downwards slightly. Release it as soon as it begins to close.

**⚠ WARNING** Risk of becoming trapped during automatic closing of the tailgate

Body parts may become trapped. There may be people in the closing area.

- ▶ Make sure that nobody is in the vicinity of the closing area during the closing process.

Use one of the following options to stop the closing process:

- Press the  button on the SmartKey.
- Press or pull the remote operating switch on the driver's door.
- Press the closing or locking button on the tailgate.
- Pull the tailgate handle.

**Vehicles with HANDS-FREE ACCESS:** it is also possible to stop the closing process by making a kicking movement below the rear bumper.

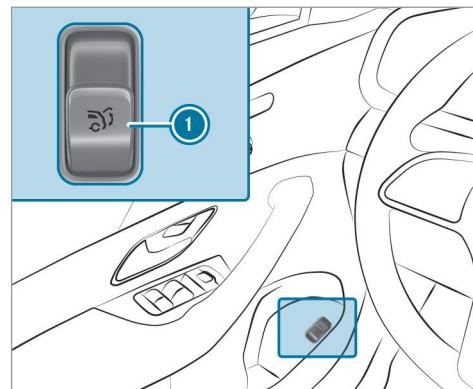

- ▶ Switch on the power supply or the vehicle.
- ▶ Push remote operating switch ① until the tailgate is fully closed.

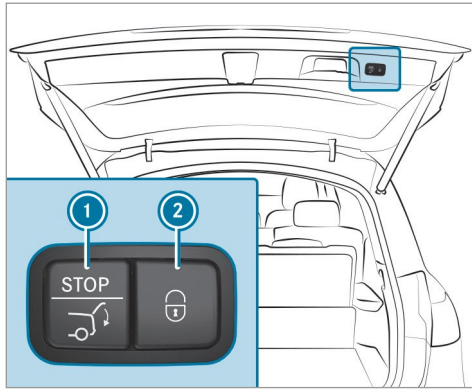

- ▶ Press closing button ① on the tailgate.

#### Vehicles with KEYLESS-GO

- ▶ Press locking button ② on the tailgate. If a SmartKey is detected outside the vehicle, the tailgate will close and the vehicle will be locked.

- ▶ Press and hold the  button on the SmartKey (with the SmartKey in the vicinity of the vehicle).

#### Vehicles with HANDS-FREE ACCESS

- ▶ Make a kicking movement with your foot below the bumper (→ page 82).

#### Automatic reversing function for the tailgate

The tailgate is equipped with automatic blockage detection with a reversing function. If a solid object hinders or restricts the tailgate when it is closing automatically, the tailgate will automatically open again slightly. Automatic blockage detection with reversing function is only an aid. It is not a substitute for your attentiveness when you are closing the tailgate.

- ▶ During the closing process, make sure that no body parts are in the closing area.

**⚠ WARNING** Risk of becoming trapped despite reversing function

The reversing function will not react:

- To soft, light and thin objects, e.g. fingers

- Towards the end of the closing procedure

In these situations in particular, the reversing function cannot prevent someone being trapped.

- ▶ Ensure that no body parts are in the closing area.

If someone is trapped, either:

- Press the  button on the SmartKey.
- Press or pull the remote operating switch on the driver's door.
- Press the closing or locking button on the tailgate.
- Pull the tailgate handle.

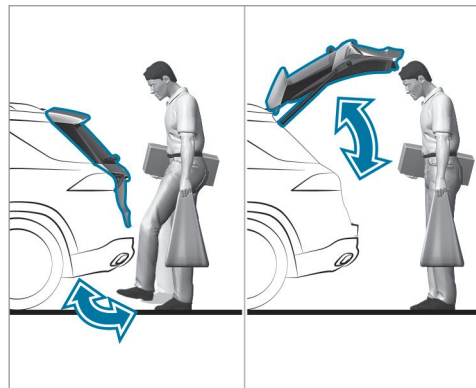
**HANDS-FREE ACCESS function**

With HANDS-FREE ACCESS you can open, close or stop the closing process of the tailgate by performing a kicking movement under the rear bumper.

The kicking movement triggers the opening or closing process alternately.

Observe the notes when opening (→ page 78) and closing (→ page 79) the tailgate.

- ❗ Two warning tones sound when the tailgate is opening or closing.

**⚠ WARNING** Risk of burns caused by a hot exhaust system

The vehicle exhaust system can become very hot. If you use HANDS-FREE ACCESS, you could burn yourself by touching the exhaust system.

- ▶ Always ensure that you only make a kicking movement within the detection range of the sensors.

**! NOTE** Vehicle damage due to unintentional opening of the tailgate

- When using an automatic car wash
- When using a high pressure cleaner

▶ Deactivate the function of the SmartKey in these situations.

or

- ▶ Make sure that the SmartKey is at a minimum distance of 10 ft (3 m) away from the vehicle.

When making the kicking movement, make sure that you are standing firmly on the ground. You could otherwise lose your balance, e.g. on ice.

Observe the following notes:

- The SmartKey is behind the vehicle.
- Stand at least 12 in (30 cm) away from the vehicle while performing the kicking movement.
- Do not come into contact with the bumper while making the kicking movement.
- Do not carry out the kicking movement too slowly.
- The kicking movement must be towards the vehicle and back again.

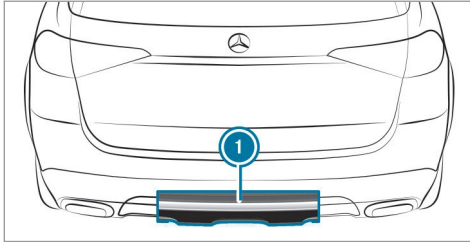

#### ① Detection range of the sensors

If several consecutive kicking movements are not successful, wait ten seconds.

#### System limits

The system may be impaired or may not function in the following cases:

- The sensors are dirty, e.g. due to road salt or snow.
- The kicking movement is made using a prosthetic leg.

The tailgate can open or close unintentionally in the following situations:

- A person's arms or legs are moving in the sensor detection range, e.g. when polishing the vehicle or picking up objects.
- Objects are moved or placed behind the vehicle, e.g. the hose of a fuel dispenser, a charging cable, or luggage
- Clamping straps, tarps or other coverings are pulled over the bumper.
- A protective mat with a length reaching over the trunk sill down into the detection range of the sensors is used.
- The protective mat is not secured correctly.
- Work is being done on the trailer hitch, trailers or rear bicycle racks.

Deactivate the function of the SmartKey (→ page 71) or do not carry the SmartKey about your person in such situations.

#### Limiting the opening angle of the tailgate

##### Activating the opening angle limiter

You can limit the opening angle of the tailgate in the top half of its opening range up to a point shortly before the end position.

- ▶ Stop the opening procedure of the tailgate at the desired position.
- ▶ Press and hold the closing button on the tailgate until you hear a short acoustic signal. The opening angle limiter will be activated. The tailgate will then stop in the stored position when opened.

To open the tailgate fully, pull the handle on the outside of the tailgate again after it has stopped automatically.

##### Deactivating the opening angle limiter

- ▶ Press and hold the closing button on the tailgate until two short acoustic signals sound.

#### Releasing the tailgate in an emergency

##### Requirements:

- Only for Mercedes-Maybach vehicles.

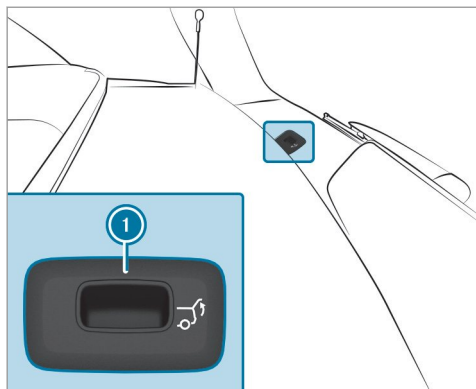

▶ Remove cover ①.

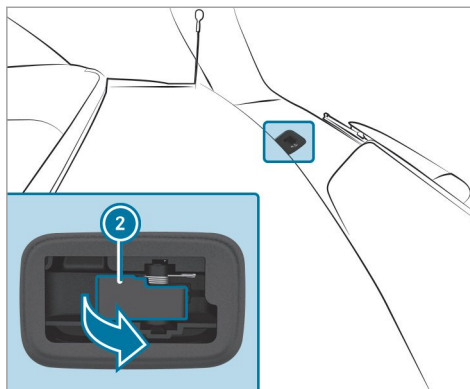

▶ Pull lever ② in the direction of the arrow until the tailgate unlocks.

#### Unlocking the tailgate with the emergency key

**Requirements:**

- Not for Mercedes-Maybach vehicles.
- The rear seat backrest has been folded forward.

- The cargo compartment cover has been removed.

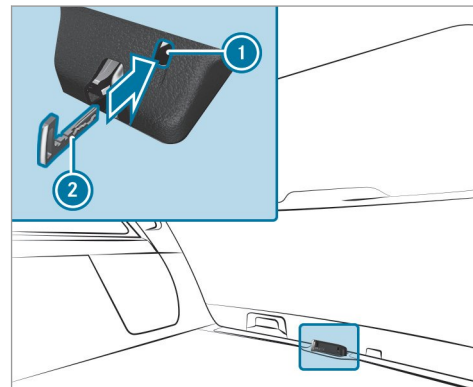

- ▶ Remove the emergency key (→ page 72).
- ▶ Insert emergency key ② into opening ① in the trim and push it in. The tailgate will be unlocked.

## Side windows

### Opening and closing the side windows

**⚠ WARNING** Risk of entrapment when opening a side window

When opening a side window, parts of the body could be drawn in or become trapped between the side window and window frame.

- ▶ When opening, make sure that nobody is touching the side window.
- ▶ If someone is trapped, release the button immediately or pull it in order to close the side window again.

**⚠ WARNING** Risk of becoming trapped when closing a side window

When closing a side window, body parts could be trapped in the closing area in the process.

- ▶ When closing, make sure that no body parts are in the closing area.

- ▶ If someone is trapped, release the button immediately or press the button in order to reopen the side window.

**⚠ WARNING** Risk of becoming trapped when children operate the side windows

Children could become trapped if they operate the side windows, particularly when unattended.

- ▶ Activate the child safety lock for the rear passenger compartment side windows.
- ▶ When leaving the vehicle, always take the SmartKey with you and lock the vehicle.
- ▶ Never leave children unattended in the vehicle.

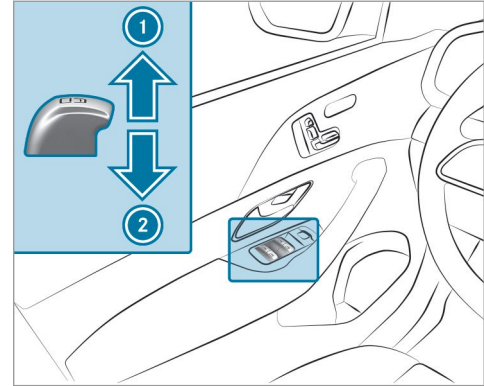

#### Requirements:

- The power supply or the vehicle has been switched on.



- ① Closes
- ② Opens

The buttons on the driver's door take precedence.

- ▶ **To start automatic operation:** press the  button beyond the point of resistance or pull and release it.
- ▶ **To interrupt automatic operation:** press or pull the  button again.

When the vehicle is switched off, you can continue to operate the side windows.

This function is available for around four minutes or until a front door is opened.

- ❶ **Vehicles with electric roller sunblinds on the left and right rear doors:** The buttons for the rear side windows also open and close the roller sunblinds (→ page 93).

#### Automatic reversing function of the side windows

If an obstacle impedes a side window during the closing process, the side window will open again automatically. The automatic reversing function is only an aid and is not a substitute for your attentiveness.

- ▶ During the closing process, make sure that no body parts are in the closing area.

**⚠ WARNING** Risk of becoming trapped despite there being reversing protection on the side window

The reversing function does not react:

- To soft, light and thin objects, e.g. fingers.

- During resetting.

The reversing function cannot prevent someone from becoming trapped in these situations.

- ▶ During the closing process, make sure that no body parts are in the closing area.
- ▶ If someone becomes trapped, press the  button to open the side window again.

#### Convenience opening (ventilating the vehicle before starting a journey)

**⚠ WARNING** Risk of entrapment when opening a side window

When opening a side window, parts of the body could be drawn in or become trapped between the side window and window frame.

- ▶ When opening, make sure that nobody is touching the side window.

- ▶ Release the button immediately if somebody becomes trapped.

#### Requirements:

- The SmartKey is in the immediate vicinity of the vehicle.



- ▶ Press and hold the  button on the SmartKey.

The following functions are performed:

- The vehicle is unlocked.
- The side windows are opened.
- The sliding sunroof is opened.
- The panoramic sliding roof is opened.
- The seat ventilation of the driver's seat is switched on.

- ❶ If the roller sunblind of the panoramic sliding sunroof is closed, the roller sunblind is opened first.
- ❶ If the roller sunblinds of the rear doors are closed, the roller sunblinds are opened first.



- ▶ **To interrupt convenience opening:** release the  button.
- ▶ **To continue convenience opening:** press and hold the  button again.

### Convenience closing (closing the vehicle from outside)

**⚠ WARNING** Risk of entrapment due to not paying attention during convenience closing

When the convenience closing feature is operating, parts of the body could become trapped in the closing area of the side window and the sliding sunroof.

- ▶ When the convenience closing feature is operating, monitor the entire closing process and make sure that no body parts are in the closing area.

#### Requirements:

- The SmartKey is in the immediate vicinity of the vehicle.

- ▶ Press and hold the  button on the SmartKey.

The following functions are performed:

- The vehicle is locked.
- The side windows are closed.
- The sliding sunroof is closed.
- The panoramic sliding roof is closed.

- ▶ **To interrupt convenience closing:** release the  button.

- ▶ **To continue convenience closing:** press and hold the  button again.

- ① Convenience closing also functions with KEY-LESS-GO (→ page 74).

### Resolving problems with the side windows

**⚠ WARNING** Risk of becoming trapped or fatally injured if reversing protection is not activated

If you close a side window again immediately after it has been blocked, the side window will

close with increased or maximum force. The reversing function is then not active and body parts may become trapped.

- ▶ Make sure that no parts of the body are in the closing area.
- ▶ To stop the closing process, release the button or press the button again to reopen the side window.

#### A side window cannot be closed and you cannot see the cause.

- ▶ Check to see whether any objects are in the window guide.
- ▶ Adjust the side windows.

#### Adjusting the side windows

If a side window is obstructed during closing and reopens again immediately:

- ▶ Immediately after this, pull and hold the corresponding button again until the side window

has closed and hold the button for at least one more second (re-adjustment).  
The side window will be closed without the automatic reversing function.

If the side window is obstructed again and reopens again immediately:

- ▶ Immediately after this, pull and hold the corresponding button again until the side window has closed and hold the button for at least one more second (follow-up adjustment).  
The side window will be closed without the automatic reversing function.

#### The side windows cannot be opened or closed using the convenience opening feature.

Possible causes:

- The SmartKey battery is weak or discharged.
- ▶ Check the battery using the indicator lamp (→ page 70).
- ▶ Replace the SmartKey battery, if necessary (→ page 72).

### Sliding sunroof

#### Opening and closing the sliding sunroof

- ① The term "sliding sunroof" also refers to the panoramic sliding sunroof.

**⚠ WARNING** Risk of becoming trapped when the sliding sunroof is being opened and closed

Body parts may become trapped in the range of movement.

- ▶ During opening and closing, make sure that no body parts are in the range of movement.
- ▶ Release the button immediately if somebody becomes trapped.

or

- ▶ Briefly press the button in any direction during automatic operation.  
The opening or closing process will be stopped.

**⚠ WARNING** Risk of becoming trapped if the sliding sunroof is operated by children

Children operating the sliding sunroof could get caught in the moving parts, particularly if unattended.

- ▶ Never leave children unattended in the vehicle.
- ▶ When leaving the vehicle, always take the key with you and lock the vehicle.

**⚠ WARNING** Risk of becoming trapped when the roller sunblind is being opened and closed

Body parts may become trapped between the roller sunblind and frame or sliding roof.

- ▶ When opening or closing, make sure that no body parts are in the roller sunblind's range of movement.
- ▶ Release the button immediately if somebody becomes trapped.

or

- ▶ Briefly press the button in any direction during automatic operation. The opening or closing process will be stopped.

**! NOTE** Malfunction due to snow and ice

Snow and ice may cause the sliding sunroof to malfunction.

- ▶ Open the sliding sunroof only if it is free of snow and ice.

**! NOTE** Damage caused by protruding objects

Objects that protrude from the sliding sunroof may damage the seals.

- ▶ Do not allow anything to protrude from the sliding sunroof.

**! NOTE** Damage to the sliding sunroof when a roof luggage rack is installed

When a roof luggage rack is installed, raising or opening the sliding sunroof may be restricted.

- ▶ Check whether the sliding sunroof can be raised or opened when a roof luggage rack is installed.
- ▶ If in doubt, do not raise or open the sliding sunroof.

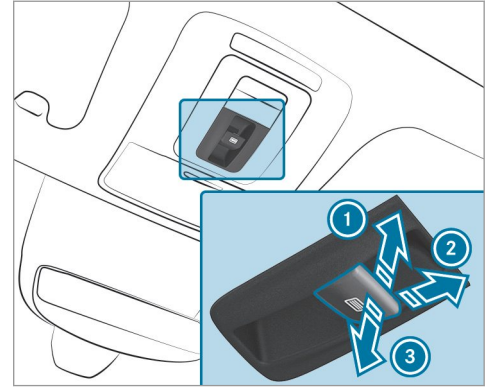

- 1 Raises
- 2 Opens
- 3 Closes/lowers

Use the  button to operate the panoramic sliding sunroof.

The panoramic sliding sunroof can be operated only when the roller sunblind is open.

**i** The roller sunblind can be opened only when the panoramic sliding panel is closed or in a raised position.

▶ Check whether the sliding sunroof can be raised or opened when a roof luggage rack is installed.

▶ **To start automatic operation:** press the  button beyond the point of resistance or pull and release it.

▶ **To interrupt automatic operation:** briefly press the  button in any direction. The opening/closing process will be stopped.

**Vehicles with a panoramic sliding sunroof:** The automatic raising feature is available only when the sliding sunroof is closed or raised.

**Vehicles without a panoramic sliding sunroof:** The automatic opening and raising features are available only when the sliding sunroof is closed.

▶ **To ventilate the vehicle interior:** raise the sliding sunroof. The roller sunblind will open slightly.

### Operating the roller sunblind for the sliding sunroof from the rear passenger compartment

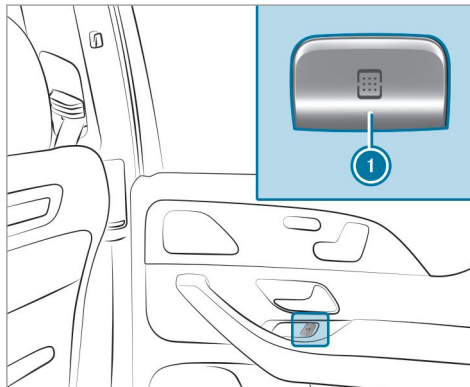

▶ **To open:** press button **1**.

▶ **To close:** pull button **1**.

**i** When the sliding sunroof is open, it will close first. To close the roller sunblind, you must pull button **1** again.

If you press or pull button **1** beyond the point of resistance, you will start automatic operation in the direction in question. You can stop automatic operation by pushing or pulling the button again.

### Automatic reversing function of the sliding sunroof

If an obstacle obstructs the sliding sunroof during the closing process, the sliding sunroof will open again automatically. The automatic reversing function is only an aid and is not a substitute for your attentiveness.

▶ During the closing process, make sure that no body parts are in the closing area.

**⚠ WARNING** Risk of becoming trapped despite the reversing function being active

In particular, the reversing function does not react:

- To soft, light and thin objects, e.g. fingers.
- Towards the end of the closing procedure.
- During resetting.

- ▶ During the closing process, make sure that no body parts are in the closing area.
- ▶ Release the button immediately if somebody becomes trapped.

or

- ▶ Briefly press the button in any direction during automatic operation. The closing process will be stopped.

#### Automatic reversing function of the roller sunblind

If an obstacle obstructs the roller sunblind during the closing process, the roller sunblind will open again automatically. The automatic reversing function is only an aid and is not a substitute for your attentiveness.

- ▶ When closing the roller sunblind, make sure that no body parts are in the range of movement.

#### **⚠ WARNING** Risk of becoming trapped despite reversing function

In particular, the reversing function does not react to soft, light and thin objects, e.g. fingers.

- ▶ When closing the roller sunblind, make sure that no body parts are in the range of movement.
- ▶ Release the button immediately if somebody becomes trapped.

or

- ▶ Briefly press the button in any direction during the automatic closing process. The closing process will be stopped.

#### Automatic functions of the sliding sunroof

- ⓘ The term "sliding sunroof" also refers to the panorama roof with power tilt/sliding panel.

#### Rain closing function when driving

**Vehicles with a panorama roof with power tilt/sliding panel:** If it starts to rain, the raised sliding

sunroof will automatically be lowered while the vehicle is in motion.

#### Automatic lowering function

**Vehicles with a panorama roof with power tilt/sliding panel:** If the sliding sunroof is raised at the rear, it will automatically be lowered slightly at higher speeds. At low speeds, it will be raised again automatically.

#### **⚠ WARNING** Risk of becoming trapped by automatic lowering of the sliding sunroof

At higher speeds, the raised sliding sunroof will automatically be lowered slightly at the rear.

- ▶ Make sure that nobody reaches into the sliding sunroof's range of movement while the vehicle is in motion.
- ▶ If somebody becomes trapped, briefly push the sliding sunroof button forwards or backwards.

- ① By pushing or pulling the  button, you can interrupt the automatic functions "Rain closing function when driving" and "Automatic lowering".

### Rectifying problems with the sliding sunroof

**⚠ WARNING** Risk of becoming trapped or fatal injuries when the sliding sunroof is closed again

If the sliding sunroof is closed again immediately after it has been blocked or reset, it will close with increased force.

- ▶ Make sure that no parts of the body are in the closing area.
- ▶ Release the button immediately if somebody becomes trapped.

or

- ▶ Briefly press the button in any direction during the automatic closing process. The closing process will be stopped.

**The sliding sunroof cannot be closed and you cannot see the cause.**

- ① The term "sliding sunroof" also refers to the panorama roof with power tilt/sliding panel.

If the sliding sunroof is obstructed during closing and reopens again slightly:

- ▶ Immediately after automatic reversing, pull and hold the  button down again to the point of resistance until the sliding sunroof is closed. The sliding sunroof will be closed with increased force.



If the sliding sunroof is obstructed again and opens again slightly:

- ▶ Repeat the previous step. The sliding sunroof will be closed again with increased force.

**Vehicles without a panorama roof with power tilt/sliding panel: The sliding sunroof is not operating smoothly.**

- ▶ Reset the sliding sunroof.



### Resetting the sliding sunroof

- ▶ Push the  button up to the point of resistance repeatedly until the sliding sunroof is fully open.
- ▶ Press the  button for another second.
- ▶ Close the sliding sunroof.

**Vehicles with a panorama roof with power tilt/sliding panel: The sliding sunroof or the roller sunblind is not operating smoothly.**

- ▶ Reset the sliding sunroof and the roller sunblind.

### Resetting the sliding sunroof and the roller sunblind

- ▶ Pull and hold the  button little by little until the sliding sunroof is fully closed.
- ▶ Pull and hold the  button little by little until the roller sunblind is fully closed.
- ▶ Use automatic operation to fully open and then close the sliding sunroof.

## Roller sun blinds

### Extending or retracting the roller sunblinds on the rear side windows

**⚠ WARNING** Risk of becoming trapped when extending or retracting the roller sunblind

Body parts could become trapped in the sweep of the roller sunblind when it is being extended or retracted.

- ▶ Make sure that no body parts are in the sweep of the roller sunblind when it is being extended or retracted.
- ▶ If someone becomes trapped, briefly press the button in the opposite direction.  
The opening or closing process will briefly be stopped. The roller sunblind will then return to its starting position.

**❗ NOTE** Damage caused by objects

Objects can cause the roller sunblind to malfunction.

- ▶ Ensure that the roller sunblind can move freely.

The roller sunblinds for the rear side windows can be operated with the buttons for the side windows in the driver's door and in the rear doors.

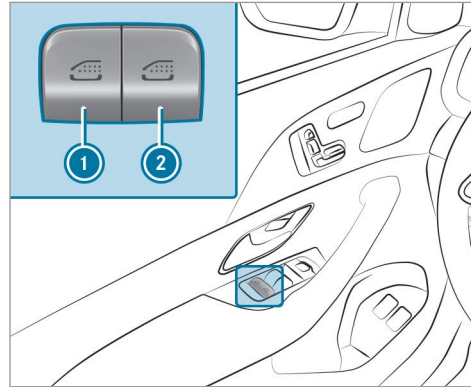

- ① Rear left side window / roller sunblind
- ② Rear right side window / roller sunblind

- ▶ **To close fully:** briefly pull the corresponding button when the side window is closed.
- ▶ **To open fully:** briefly press the corresponding button.

## Anti-theft protection

### Function of the immobilizer

The immobilizer prevents your vehicle from being started without the correct SmartKey.

The immobilizer is automatically activated when the vehicle is switched off, and deactivated when the vehicle is switched on.

When leaving the vehicle, always take the SmartKey with you and lock the vehicle. Anyone can start the vehicle if a valid SmartKey has been left inside the vehicle.

- ❗ In the event the engine cannot be started (yet the vehicle's battery is charged), the system is not operational. Contact an authorized Mercedes-Benz Center or call 1-800-FOR-MERCEdes (in the USA) or 1-800-387-0100 (in Canada).

### ATA (anti-theft alarm system)

#### Function of the ATA system

If the ATA system is armed, a visual and audible alarm is triggered in the following situations:

- When a door is opened
- When the tailgate is opened
- When the hood is opened
- When the interior motion sensor is triggered (→ page 95)
- When the tow-away alarm is triggered (→ page 94)

The ATA system is armed automatically after approximately ten seconds in the following situations:

- After locking the vehicle with the SmartKey
- After locking the vehicle using KEYLESS-GO

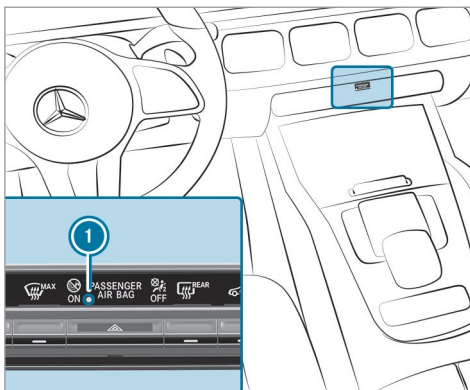

Indicator lamp ❶ flashes when the ATA system is armed.

The ATA system is deactivated automatically in the following situations:

- After unlocking the vehicle with the SmartKey
- After unlocking the vehicle using KEYLESS-GO
- After pressing the start/stop button with the SmartKey in the marked space (→ page 175)

❶ When the Mercedes-Benz emergency call system is active and the alarm stays on for more than 30 seconds, a message is automatically sent to the Customer Assistance Center (→ page 324).

❶ In the case of severe battery discharging, the anti-theft alarm system is automatically deactivated to facilitate the next engine start.

#### Deactivating the ATA

▶ Press the , or button on the SmartKey.

or

▶ Press the start/stop button with the SmartKey in the stowage compartment (→ page 175)

#### Deactivating the alarm using KEYLESS-GO

▶ Grasp the outside door handle with the SmartKey outside the vehicle.

#### Function of the tow-away alarm

❶ This function may not be available in all countries.



An audible and visual alarm is triggered if an alteration to your vehicle's angle of inclination is detected while the tow-away alarm is armed.



The tow-away alarm is automatically armed after approximately 60 seconds:

- After locking the vehicle with the SmartKey
- After locking the vehicle using KEYLESS-GO

The tow-away alarm is only armed when the following components are closed:

- Doors
- Tailgate

The tow-away alarm is automatically deactivated:

- After pressing the  or  button on the SmartKey
- After pressing the start/stop button with the SmartKey in the marked space (→ page 175)
- After unlocking the vehicle using KEYLESS-GO
- When using HANDS-FREE ACCESS

Information on collision detection on a parked vehicle (→ page 208).

### Arming/disarming the tow-away alarm

Multimedia system:

  **Settings**  **Quick Access**

 Arm or disarm **Tow-away Protection**.

The tow-away alarm is armed again in the following cases:

- The vehicle is unlocked again.
- A door is opened.
- The vehicle is locked again.

 If quick access is unavailable, select the **Vehicle** submenu in the **Settings** main menu to arm or disarm the tow-away alarm.

### Function of the interior motion sensor

 This function may not be available in all countries.

When the interior motion sensor is activated, a visual and audible alarm is triggered if movement is detected in the vehicle interior.



The interior motion sensor is activated automatically after approximately ten seconds:

- After locking the vehicle with the SmartKey
- After locking the vehicle using KEYLESS-GO

The interior motion sensor is only activated when the following components are closed:

- Doors
- Tailgate

The interior motion sensor is automatically deactivated:

- After pressing the  or  button on the SmartKey
- After pressing the start/stop button with the SmartKey in the marked space (→ page 175)
- After unlocking the vehicle using KEYLESS-GO
- When using HANDS-FREE ACCESS

The following situations can lead to a false alarm:

- When there are moving objects such as mascots in the vehicle interior
- When a side window is open

- When a sliding sunroof is open
- When a panoramic sliding sunroof is open

### Arming/deactivating the interior motion sensor

Multimedia system:

→  >> Settings >> Quick Access

▶ Activate or deactivate **Interior Motion Sensor**.

The interior motion sensor is activated again in the following cases:

- The vehicle is unlocked again.
  - A door is opened.
  - The vehicle is locked again.
-  If quick access is unavailable, select the **Vehicle** menu under **Settings** to activate or deactivate the interior motion sensor.

### Notes on the correct driver's seat position

**⚠ WARNING** Risk of accident due to adjusting the vehicle settings while the vehicle is in motion

You could lose control of the vehicle in the following situations in particular:

- If you adjust the driver's seat, the head restraint, the steering wheel or the mirror while the vehicle is in motion
  - If you fasten your seat belt while the vehicle is in motion
- ▶ Before starting the engine: In particular, adjust the driver's seat, head restraint, steering wheel and mirror, and fasten your seat belt.

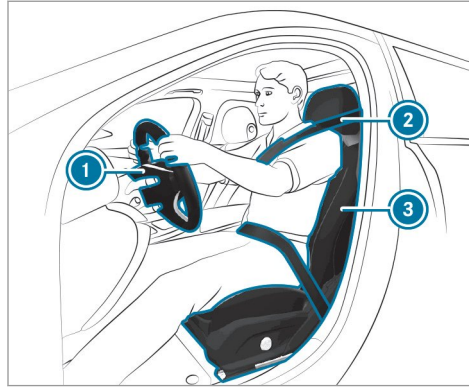

Ensure the following when adjusting steering wheel ①, seat belt ② and driver's seat ③:

- You are sitting as far away from the driver's airbag as possible, taking the following points into consideration:
- You are sitting in an upright position
- Your thighs are slightly supported by the seat cushion

- Your legs are not fully extended and you can depress the pedals properly
- The back of your head is supported at eye level by the center of the head restraint
- You can hold the steering wheel with your arms slightly bent
- You can move your legs freely
- You can see all the displays on the instrument cluster clearly
- You have a good overview of the traffic conditions
- Your seat belt sits snugly against your body and passes across the center of your shoulder and across your hips in the pelvic area

### Seats

#### Adjusting the front seat

**⚠ WARNING** Risk of becoming trapped if the seats are adjusted by children

Children could become trapped if they adjust the seats, particularly when unattended.

- ▶ When leaving the vehicle, always take the SmartKey with you and lock the vehicle.
- ▶ Never leave children unattended in the vehicle.

You can adjust the seats when the vehicle is switched off.

**⚠ WARNING** Risk of becoming trapped when adjusting the seat

When you adjust a seat, you or other vehicle occupants could become trapped, e.g. on the seat guide rail.

- ▶ When adjusting a seat, make sure that no one has any part of their body within the sweep of the seat.

Observe the safety notes on "Airbags" and "Children in the vehicle".

**⚠ WARNING** Risk of accident due to adjusting the vehicle settings while the vehicle is in motion

You could lose control of the vehicle in the following situations in particular:

- If you adjust the driver's seat, the head restraint, the steering wheel or the mirror while the vehicle is in motion
- If you fasten your seat belt while the vehicle is in motion

- ▶ Before starting the vehicle: in particular, adjust the driver's seat, head restraint, steering wheel and mirror, and fasten your seat belt.

**⚠ WARNING** Risk of becoming trapped if the seat height is adjusted carelessly

If you adjust the seat height carelessly, you or other vehicle occupants could be trapped and thereby injured.

Children in particular could accidentally press the electrical seat adjustment buttons and become trapped.

- ▶ While moving the seats, make sure that hands or other body parts do not get under the lever assembly of the seat adjustment system.

**⚠ WARNING** Risk of injury due to head restraints not being installed or being adjusted incorrectly

If head restraints have not been installed or have not been adjusted correctly, there is an increased risk of injury in the head and neck area, e.g. in the event of an accident or when braking.

- ▶ Always drive with the head restraints installed.
- ▶ Before driving off, make sure for every vehicle occupant that the center of the head restraint supports the back of the head at about eye level.

Do not interchange the head restraints of the front and rear seats. Otherwise, you will not be able to adjust the height and angle of the head restraints correctly.

Adjust the head restraint fore-and-aft position so that it is as close as possible to the back of your head.

**⚠ WARNING** Risk of injury or death due to an incorrect seat position

The seat belt does not offer the intended level of protection if you have not moved the seat backrest to an almost vertical position.

In particular, you could slip beneath the seat-belt and become injured.

- ▶ Adjust the seat properly before beginning your journey.
- ▶ Always ensure that the seat backrest is in an almost vertical position and that the shoulder belt is routed across the center of your shoulder.

**⚠ WARNING** Risk of injury due to excessive strain on the grab handle

If you apply your full body weight to the grab handle or pull it abruptly, the grab handle may be damaged or become loose from its anchorage.

- ▶ Use the grab handles only to stabilize the seating position or to assist in getting in and out of the seat.

**⚠ WARNING** Risk of injury or death due to objects under the co-driver seat

Objects trapped under the co-driver seat can interfere with the function of the automatic co-driver airbag shutoff or damage the system.

- ▶ Do not store any objects under the co-driver seat.
- ▶ When the co-driver seat is occupied, make sure that no objects are trapped under the co-driver seat.

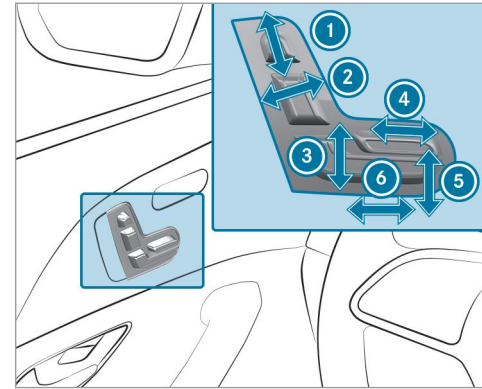

- ① Head restraint height
- ② Seat backrest inclination
- ③ Seat height
- ④ Seat cushion length
- ⑤ Seat cushion inclination
- ⑥ Seat fore-and-aft position

- ▶ Save the settings with the memory function (→ page 120).

### Adjusting the front passenger seat electrically from the driver's seat

**⚠ WARNING** Risk of injury or death due to the front seat being positioned too close to the cockpit

The front airbags can also injure the occupants in the front of the vehicle.

- ▶ Always adjust the front seats so they are as far away as possible from the front airbags.
- ▶ In addition, observe the notes on correct seat adjustment.

#### Requirements:

- The power supply is switched on.

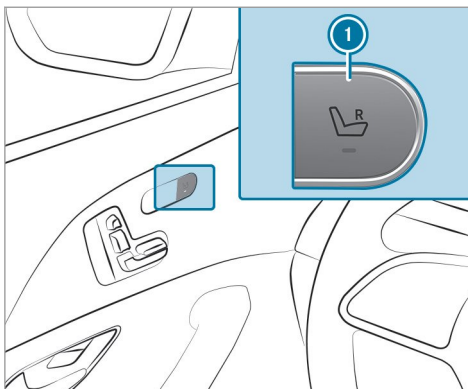

You can call up the following functions for the front passenger seat:

- Seat adjustment
- Seat heating
- Seat ventilation
- Memory function

- ▶ **To select the front passenger seat:** press button ①. When the indicator lamp lights up, the front passenger seat is selected.
- ▶ Adjust the front passenger seat using the buttons on the driver's side door operating unit.
- ▶ **To select the driver's seat:** press button ① again. When the indicator lamp goes out, the driver's seat has been selected.

### Adjusting the front passenger seat electrically from the rear passenger compartment

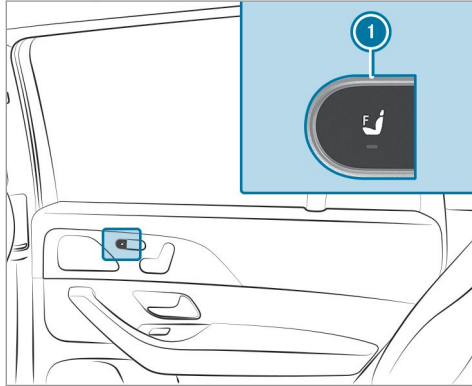

- ▶ **To select the front passenger seat:** press button ①. When the indicator lamp lights up, the front passenger seat is selected.
- ▶ Adjust the front passenger seat using the buttons on the door operating unit in the rear passenger compartment (→ page 102).

- ① **Mercedes-Maybach vehicles:** if the front passenger seat is in the foremost position, you can set the seat backrest at a very steep angle. This will provide a better forward view from the rear passenger compartment. Despite the steep angle of the seat backrest, a person may occupy the front passenger seat.

### Adjusting the 4-way lumbar support

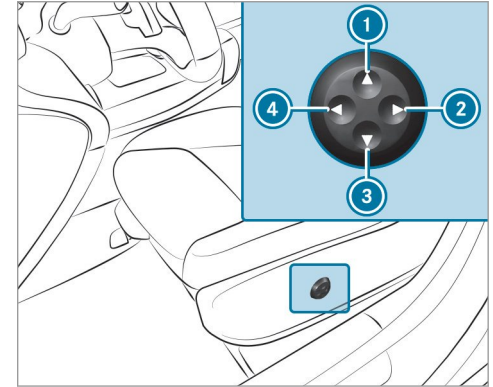

- ① Higher
- ② Softer
- ③ Lower
- ④ Firmer

- ▶ Use buttons ① to ④ to adjust the contour of the backrest.

### Adjusting the rear seats electrically

**NOTE** Damage to the rear seat armrest when folding the center seat backrest forward

If the rear seat armrest is folded down, it can be damaged when the center seat backrest is folded forward.

- ▶ Fold the rear seat armrest upwards before folding the center seat backrest forward.

The middle seat backrest is adjusted together with the left seat.

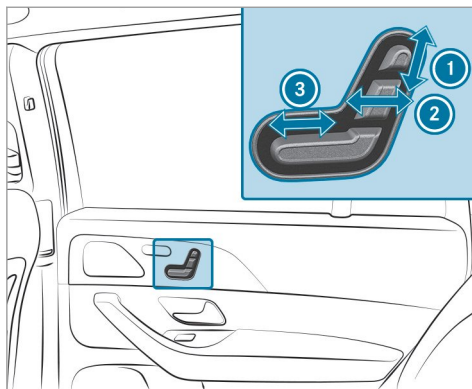

- ① Head restraint height
- ② Seat backrest inclination
- ③ Seat fore-and-aft position

▶ Save the settings with the memory function (→ page 121).

### Adjusting reclining rear seats electrically

The reclining rear seats are on the driver's and front passenger sides.

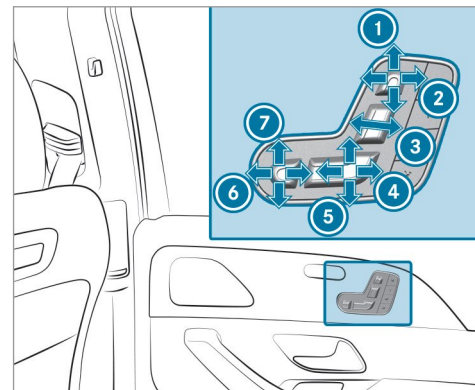

- ① Head restraint height
- ② Head restraint fore-and-aft position
- ③ Seat backrest inclination
- ④ Combined seat cushion inclination and length
- ⑤ Combined seat cushion inclination and length



- ⑥ Fore-and-aft position of the leg rest
- ⑦ Angle of the leg rest
- ▶ Save the settings with the memory function (→ page 121).
- ⓘ The leg rest will fold down if overloaded. If this is the case, fold up the leg rest and engage it.

### Setting the fully reclined position

#### Requirements:

- The power supply is switched on.

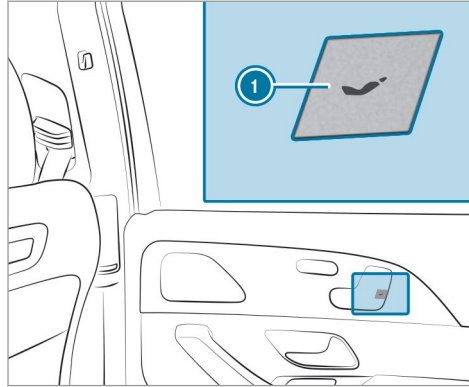

- ▶ **To set the fully reclined position:** press button ①.
  - The rear seat will move into the fully reclined position.
  - The rear seat head restraint will move.
  - The leg rest will rise.
  - The front passenger seat will move as far forwards as possible.

- The front passenger seat head restraint will be completely retracted.
- The front passenger seat backrest will move as far forwards and as far down as it will go.

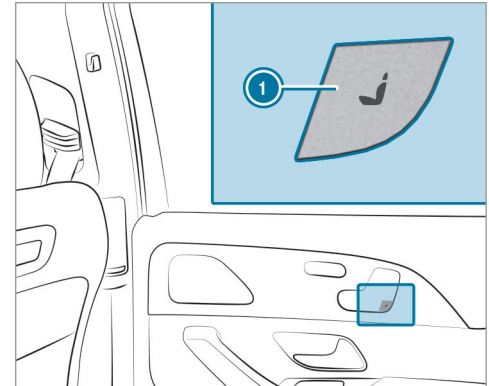

- ▶ **To restore the standard seat settings:** press button ①.

or

- ▶ Call up the settings with the memory function (→ page 121).
- ⓘ You can use the rear passenger compartment child safety lock to disable this function (→ page 68).
- ⓘ The leg rest will fold down if overloaded. If this is the case, fold up the leg rest and engage it.

### Attaching and removing the additional cushion of the leg rest

Use the additional cushion only when the vehicle is stationary. The additional cushion is in the vehicle.

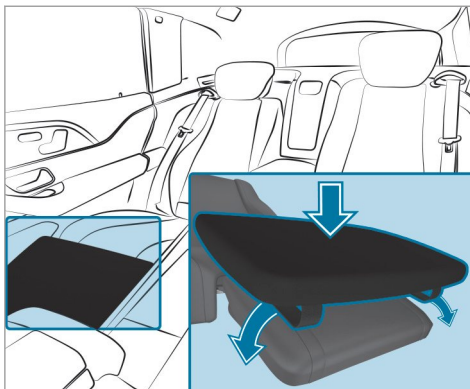

- ▶ **To attach:** place the additional cushion on the leg rest.
- ▶ Pull the rubber straps laterally over the leg rest.
- ▶ **To remove:** remove the rubber straps from the leg rest and stow the additional cushion safely in the vehicle.

### Folding the rear seats on the second row of seats forwards and back electrically

**⚠ WARNING** Risk of injury due to seat backrests folded forwards

If the seat backrest of the rear seat is folded forwards, persons in the third row of seats may hit parts of the seat mechanism, especially in the event of an accident, braking maneuver or abrupt change of direction.

- ▶ If there is a person in the third row of seats, the rear seat in front of them must be folded back to the driving position before the journey begins.
- ▶ Persons in the third row of seats should not rest their legs on a seat backrest that has been folded forwards.

Always ensure that all vehicle occupants have their seat belts fastened correctly and are sitting properly. Particular attention must be paid to children.

If you no longer require the seat backrest to be folded down for loading or for getting in and out, fold it back into place.

**⚠ WARNING** Risk of becoming trapped if the seat is not engaged

The seat does not engage when folded forwards. The seat can fold backwards unexpectedly, e.g. when accelerating, braking or in the event of an abrupt change of direction or an accident.

People in the seat's sweep can become trapped.

- ▶ If a seat is folded forwards, always fold it back before driving off.
- ▶ Make sure that the seat is engaged.

If a seat on the second row of seats is not engaged, this will be shown on the multifunction display on the instrument cluster.

**Requirements:**

- The area into which the rear seat is folded is clear.

- The rear seat has been folded up.
- Vehicles with comfort seating: the center armrest is folded up.
- Vehicles with an extended center console: the stowage compartment in the center console is closed.
- Vehicles with a folding rear armrest: the rear armrest has been folded up.
- Vehicles with center seat backrests: the center seat backrest has been folded up.

**Folding the rear seat into the front position**

You can fold the seats on the second row of seats forwards for the following situations:

- For easier access to the cargo compartment
- Vehicles with a third row of seats: for getting in or out

Vehicles with a center seat backrest: the center rear seat folds forwards and backwards together with the left rear seat.

Depending on the vehicle equipment, you can fold the rear seats forwards as follows:

- Six-seater: on the right-hand side of the vehicle only
  - Seven-seater with center seat backrest: both sides
- i** To increase the size of the cargo compartment, you can move the seat backrests into the cargo compartment floor position (→ page 129).

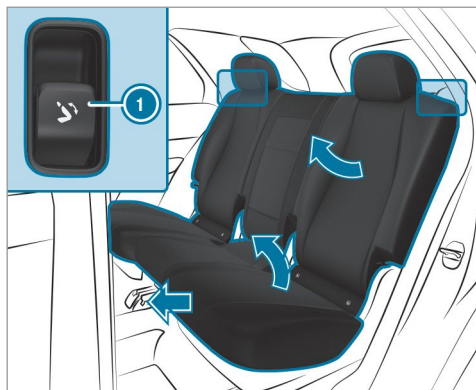

Button on the backrest shoulder of the second row of seats

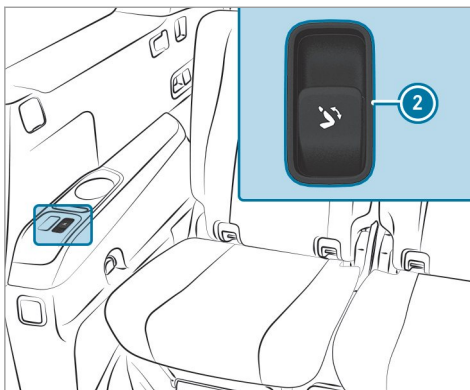

Button on the armrest of the third row of seats (seven-seater)

- ▶ When the rear door is open: briefly pull button ① on the backrest shoulder of the rear seat.
- or
- ▶ Briefly press button ② on the armrest of the third row of seats.

- ▶ When the rear door is closed: pull and hold button ① on the backrest shoulder of the rear seat.

or

- ▶ Press and hold button ② on the armrest of the third row of seats. The head restraint will move downwards. The seat backrest will move into the front position. The rear seat will move forwards until it unlocks. The rear seat will then tip forwards. If a seat on the second row of seats is not engaged, this will be shown on the multifunction display on the instrument cluster.

- ⓘ You can prevent the rear seats from folding forwards when the rear door is closed by activating the child safety lock for the side windows (→ page 68).

#### Folding back the rear seat

- ▶ Press button ① on the backrest shoulder of the rear seat or ② on the armrest of the third

row of seats and hold it down until the rear seat audibly engages. The rear seat will tip downwards and move back. The seat backrests and head restraint will then move into a suitable seat position automatically.

If a seat on the second row of seats is not engaged, this will be shown on the multifunction display on the instrument cluster.

- ▶ To interrupt the folding procedure before engagement, let go of button ①. To continue the folding procedure, press and hold button ① again.

#### Folding the rear seats forwards mechanically (emergency release)

You can also fold the rear seats forwards mechanically using release loops. The release loops are located on the outer sides and rear sides of the seats on the second row of seats.

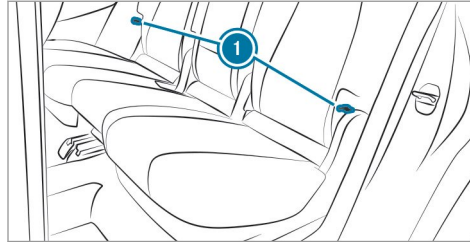

Release loops on the second row of seats

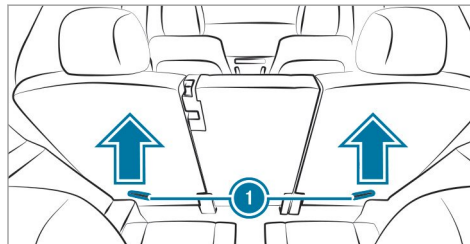

Release loops on the rear sides of the second row of seats

- ▶ Pull one of release loops ①.
- ▶ Fold the seat backrest forwards.
- ▶ Before commencing your journey, make sure that the seat backrest and the rear bench seat are engaged.

#### Head restraints

##### Adjusting the front seat head restraints manually

**⚠ WARNING** Risk of accident due to adjusting the vehicle settings while the vehicle is in motion

You could lose control of the vehicle in the following situations in particular:

- If you adjust the driver's seat, the head restraint, the steering wheel or the mirror while the vehicle is in motion
- If you fasten your seat belt while the vehicle is in motion

- ▶ Before starting the engine: In particular, adjust the driver's seat, head restraint,

steering wheel and mirror, and fasten your seat belt.

**⚠ WARNING** Risk of injury due to head restraints not being installed or being adjusted incorrectly

If head restraints have not been installed or have not been adjusted correctly, there is an increased risk of injury in the head and neck area, e.g. in the event of an accident or when braking.

- ▶ Always drive with the head restraints installed.
- ▶ Before driving off, make sure for every vehicle occupant that the center of the head restraint supports the back of the head at about eye level.

Do not interchange the head restraints of the front and rear seats. Otherwise, you will not be able to adjust the height and angle of the head restraints correctly.

Adjust the head restraint fore-and-aft position so that it is as close as possible to the back of your head.

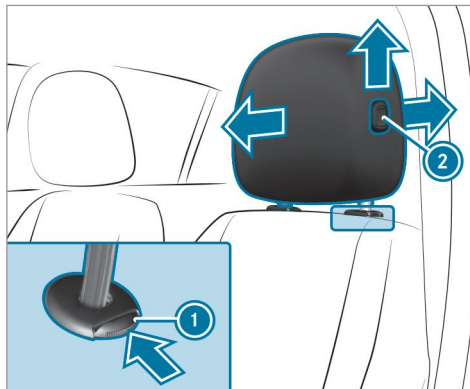

- ▶ **To raise:** pull the head restraint up.
- ▶ **To lower:** press release knob ① in the direction of the arrow and push the head restraint down.

- ▶ **To move forward:** press release knob ② and pull the head restraint forward.
- ▶ **To move backwards:** press release knob ② and push the head restraint backwards.

#### Adjusting the front seat luxury head restraints manually

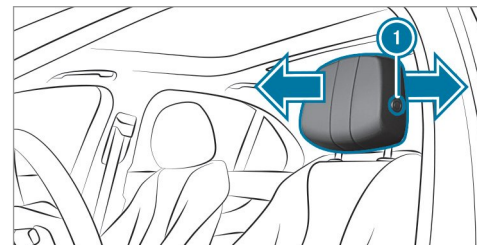

- ▶ **To move forward:** press release knob ① and pull the head restraint forward.
- ▶ **To move backwards:** press release knob ① and push the head restraint backwards.

### Adjusting the EASY ADJUST luxury head restraints on the front seats mechanically

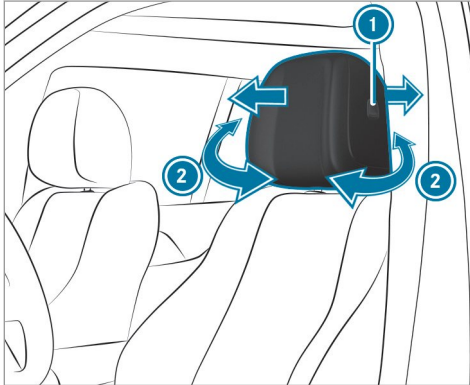

- ▶ **To move forward:** press release knob ① and pull the head restraint forward.
- ▶ **To move backwards:** press release knob ① and push the head restraint backwards.

- ▶ **To adjust the side bolsters of the head restraint:** pull or push right or left side bolster ②.

① The fore-and-aft position of the head restraint will be adjusted automatically when you adjust the seat backrest inclination using the button on the door operating unit.

### Adjusting the head restraints of the rear seats mechanically

Depending on the vehicle equipment, you can mechanically adjust the head restraints on the third row of seats as well as the center head restraint on the second row of seats.

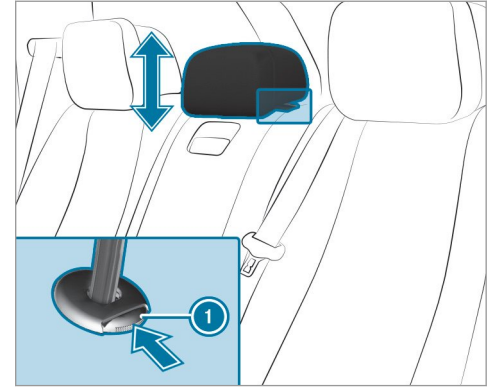

Head restraint of the standard vehicle (example)

- ▶ **To raise:** pull the head restraint up.
- ▶ **To lower (standard vehicle):** press release knob ① in the direction of the arrow and push the head restraint down.
- ▶ **To lower (Mercedes-Maybach vehicles):** push the head restraint down.

### Vehicles with a third row of seats

The head restraints on the third row of seats have a usage position and a non-usage position. The usage position is the extended, top position in which the head restraint engages; the non-usage position is the bottom, retracted position of the head restraint. If the seats on the third row of seats are being used, the head restraint must be in the top, engaged usage position.

- ▶ **If the third row of seats is occupied:** move the head restraints to the very top and have them engage there.
- ▶ **If the third row of seats is not occupied:** move the head restraints to the very bottom.

### Installing/removing the head restraint of the middle rear seat on the second row

#### Removing

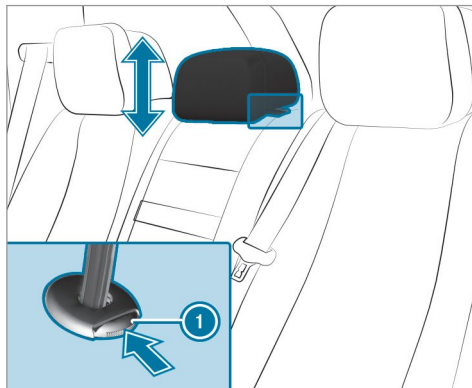

- ▶ Release the middle rear seat backrest and fold it forward slightly (→ page 129).
- ▶ Pull the head restraint upwards as far as it will go.

- ▶ Push release knob ① in the direction of the arrow and pull out the head restraint.

#### Installing

- ▶ Insert the head restraint such that the notches on the bar are on the left when viewed in the direction of travel.
- ▶ Push the head restraint down until it engages.
- ▶ Fold the middle rear seat backrest back until it engages.

#### Adjusting the luxury head restraints of the rear seats mechanically

**Mercedes-Maybach vehicles:** you can set only the side bolsters mechanically. You can adjust the angle of the head restraint electrically.



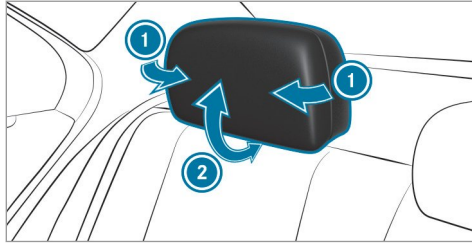

Head restraint of the standard vehicle (example)

- ▶ **To adjust the side bolsters of the head restraint:** pull or push right or left-hand side bolster ①.
- ▶ **To adjust the angle of the head restraint:** pull or push the head restraint in the direction of arrow ②.

**Attaching and removing the additional cushion of the luxury head restraint in the rear compartment**  
Use the additional cushion only when the vehicle is stationary. The additional cushion is in the vehicle.

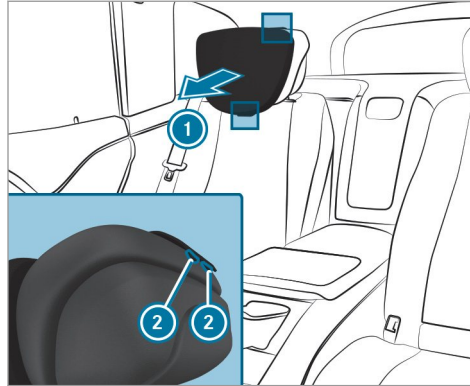

- ▶ Position the head restraint as far forwards as possible.
- ▶ **To attach the additional cushion:** hold additional cushion ① against the head restraint and push press studs ② into the counterpieces.
- ▶ **To remove the additional cushion:** release press studs ② and remove additional cushion ①.

### Configuring the seat settings

Multimedia system:

➤ ➤ **Comfort** ➤ **Seat Comfort**

#### Adjusting the backrest contour in the lumbar region of the seat backrest (lumbar)

- ▶ Select **Lumbar**.
- ▶ Select the settings for the desired seat.
- ▶ Adjust the air cushions.

#### Adjusting the backrest side bolsters

- ▶ Select **Side Bolsters**.
- ▶ Adjust the air cushion for the desired seat.

#### Setting the seat heating balance

- ▶ Select **Seat Heating Balance**.
- ▶ Adjust the heat distribution for the desired seat.

### Setting automatic seat adjustment

**⚠ WARNING** Risk of becoming trapped during adjustment of the driver's seat after calling up a driver profile

Selecting a user profile may trigger an adjustment of the driver's seat to the position saved under the user profile. You or other vehicle occupants could be injured in the process.

- ▶ Make sure that when the position of driver's seat is being adjusted using the multimedia system, no people or body parts are in the seat's range of movement.

If there is a risk of someone becoming trapped, stop the adjustment process immediately:

- ▶ a) Tap the warning message on the media display.
  - or
  - ▶ b) Press a memory position button or a seat adjustment switch on the driver's door.
- The adjustment process will be stopped.

#### Requirements:

- Adapting the driver's seat and steering wheel position to body size: automatic seat adjustment has been switched on.

Multimedia system:

→  ▶ Settings ▶ Vehicle  
▶▶ Automatic Seat Adjustment

#### Switching automatic seat adjustment on/off

When the active user profile is changed while the vehicle is stationary, the driver's seat, steering wheel, outside mirrors and seat contour will automatically be adapted to the driver.

- ▶ Select **On** or **Off**.

- ⓘ This setting is available only for individual user profiles. For the guest profile, automatic seat adjustment cannot be switched on or off.

#### Adjusting driver's seat and steering wheel position to body size

The vehicle calculates a suitable driver's seat and steering wheel position on the basis of the driver's body size and sets this directly.

- ▶ **To set the unit of measurement:** select **cm** or **ft/in**.

- ▶ Set the size using the scale.

- ▶ Select **Start Positioning**.

The driver's seat and steering wheel position is adjusted to the body size that has been set.

- ⓘ If the driver's seat and steering wheel position calculated by the vehicle is not practical or comfortable, it can be manually changed at any time via the buttons.

The exterior mirrors are not set via this function. Instead, they have to be set manually via the switches.

- ⓘ You can also configure these settings via the Mercedes me portal for your user profile. By synchronizing the profiles in the vehicle and the Mercedes me connect profiles, you can carry over these settings for your vehicle.

#### Setting the easy entry and exit feature

- ▶ Select **Steering Wheel & Seat, Steering Wheel Only** or **Off**.

- ❗ If you use an individual user profile and have set your body size, this information is carried over for the easy entry and exit feature. This will cause the driver's seat and steering wheel to move into the correct position automatically.

### Overview of massage programs

- **Hot Relaxing Back** Combination of heat and massage. It starts by massaging the back. In addition, warm pressure points become noticeable, starting in the pelvic area.
- **Hot Relaxing Shoulder:** Combination of heat and massage. It starts by massaging the shoulders. In addition, warm pressure points become noticeable, starting in the pelvic area.
- **Activating Massage:** Activating massage with upward-moving massage waves.
- **Classic Massage:** Relaxing back massage.
- **Wave Massage:** Regenerating massage via massage waves across the back and in the seat cushion.

- **Mobilizing Massage:** Mobilizing massage with upward-moving massage waves. Can promote deeper respiration and hence improve circulation and blood pressure.
- **Active Workout, Backrest and Active Workout, Cushion:** These programs require your cooperation. Alternating between tensing and releasing helps to improve blood flow to your muscles. Press against a pressure point as soon as you feel it.

### Selecting the massage program for the front seats

Multimedia system:

→  ▶▶ Comfort ▶▶ Massage

- ▶ Select a massage program (→ page 113).
- ▶ Start the program for the desired seat .
- ▶ **To set the massage intensity:** switch **High Intensity** on or off.

- ❗ For the rear seats, the massage program can be selected on the following devices (if available):
  - On the rear displays

The selection can be made for the rear seats on the second and third rows of seats.

- On the MBUX rear tablet

The selection is made in the same way as on the rear displays for the rear seats on the second row of seats.

### Resetting seat settings

Multimedia system:

→  ▶▶ Comfort ▶▶ Seat Comfort

- ▶ Select  for the desired seat.
- ▶ Confirm the prompt.

### Switching the seat heating on/off

**⚠ WARNING** Risk of burns due to repeatedly switching on the seat heating

Repeatedly switching on the seat heating can cause the seat cushion and seat backrest padding to become very hot.

In particular, the health of persons with limited temperature sensitivity or a limited ability to react to high temperatures may be affected or they may even suffer burn-like injuries.

- ▶ Do not repeatedly switch on the seat heating.

To protect against overheating, the seat heating may be temporarily deactivated after it has been switched on repeatedly.

**!** **NOTE** Damage to the seats caused by objects or documents when the seat heating is switched on

When the seat heating is switched on, overheating may occur due to objects or documents placed on the seats, e.g. seat cushions or child seats. This could cause damage to the seat surface.

- ▶ Make sure that no objects or documents are on the seats when the seat heating is switched on.

**Requirements:**

- The power supply is switched on.

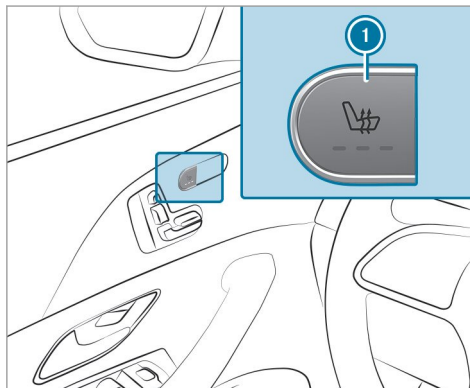

Seat heating in the cockpit

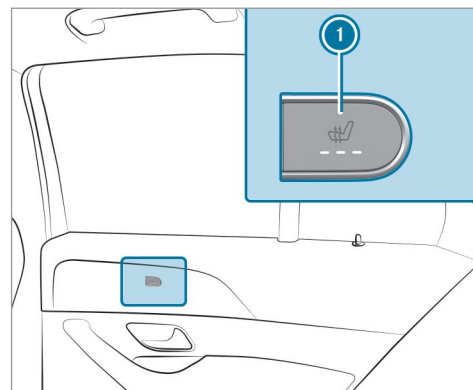

Seat heating in the rear passenger compartment

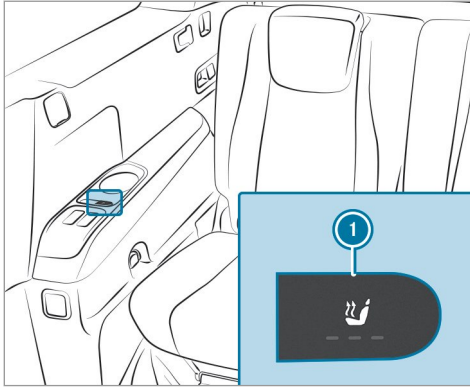

Seat heating in the third row of seats

- ▶ Press button ❶ repeatedly until the desired heating level is set. Depending on the heating level, up to three indicator lamps will light up. If all indicator lamps are off, the seat heating is switched off.
- ❶ The seat heating will automatically switch down from the three heating levels after 8, 10

and 20 minutes until the seat heating is switched off.

### Setting the panel heating

Multimedia system:

- ▶ Home ▶ Settings ▶ Vehicle
- ▶ Panel Heating

When the seat heating is switched on, the armrests, the door center panel and the center console can be heated.

- ▶ Switch the function for the desired seats on or off.

### Switching the seat ventilation on/off

Requirements:

- The power supply is switched on.

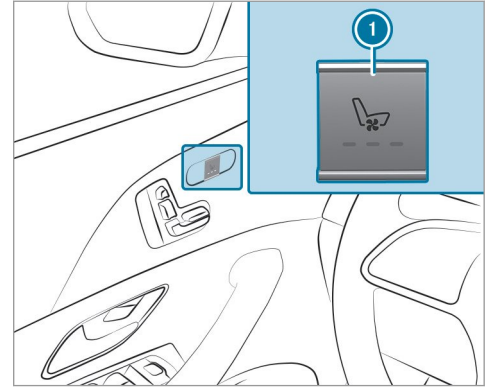

Seat ventilation in the cockpit

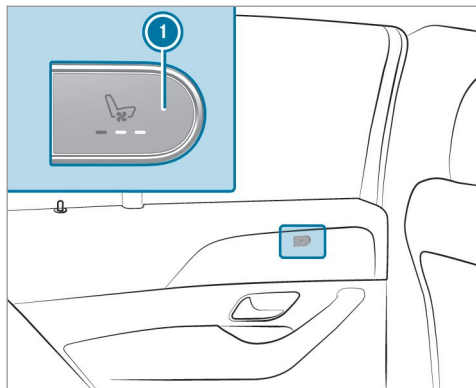

Seat ventilation in the rear passenger compartment

- ▶ Press button ① repeatedly until the desired ventilation level is set. Depending on the ventilation level, up to three indicator lamps will light up. If all indicator lamps are off, the seat ventilation is switched off.

### Steering wheel

#### Adjusting the steering wheel mechanically

- ⚠ **WARNING** Risk of accident due to adjusting the vehicle settings while the vehicle is in motion

You could lose control of the vehicle in the following situations in particular:

- If you adjust the driver's seat, the head restraint, the steering wheel or the mirror while the vehicle is in motion
- If you fasten your seat belt while the vehicle is in motion

- ▶ Before starting the vehicle: in particular, adjust the driver's seat, head restraint, steering wheel and mirror, and fasten your seat belt.

- ⚠ **WARNING** Risk of entrapment for children when adjusting the steering wheel

Children could injure themselves if they adjust the steering wheel.

- ▶ Never leave children unattended in the vehicle.
- ▶ When leaving the vehicle, always take the SmartKey with you and lock the vehicle.

### Unlocking

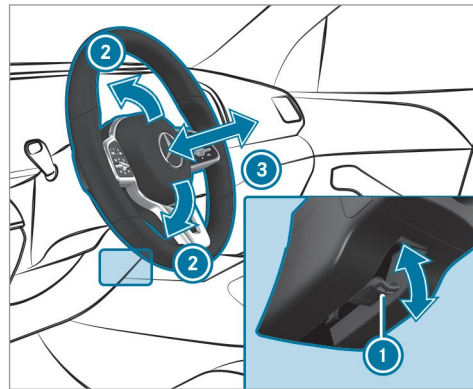

- ▶ Fold release lever ① down as far as it will go.

- ▶ Adjust height ② and distance ③ to the steering wheel.

### Locking

- ▶ Fold release lever ① up as far as it will go.
- ▶ Check and make sure that the steering column is locked by moving the steering wheel.

### Adjusting the steering wheel electrically

The steering wheel can be adjusted when the vehicle is switched off.

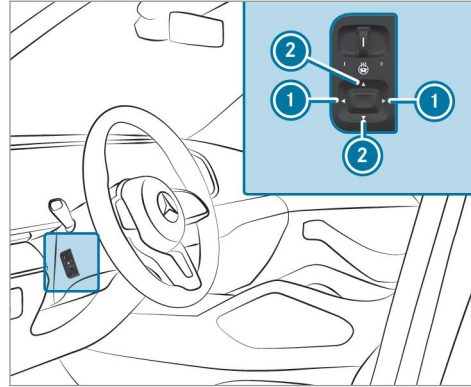

- ① To adjust the distance to the steering wheel
- ② To adjust the height
- ▶ Save the settings with the memory function (→ page 120).

### Switching the steering wheel heater on/off

#### Requirements:

- The ignition is switched on.

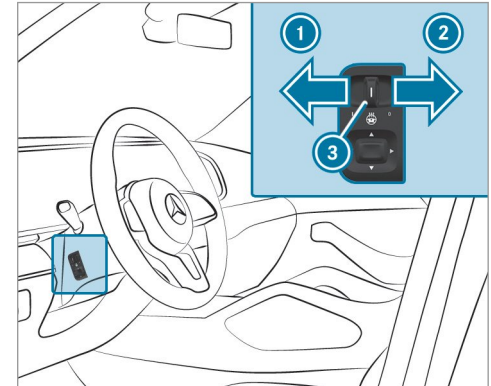

- ▶ **To switch on:** push switch into position ①. Indicator lamp ③ lights up.
- ▶ **To switch off:** push switch into position ②. Indicator lamp ③ goes out.

When you switch the ignition off, the steering wheel heater will switch off.

### Easy entry and exit feature

#### Using the easy entry and exit feature

**⚠ WARNING** Risk of accident when pulling away during the adjustment process of the easy entry and exit feature

You could lose control of the vehicle.

- ▶ Always wait until the adjustment process is complete before driving off.

**⚠ WARNING** Risk of becoming trapped during adjustment of the easy entry and exit feature

You and other vehicle occupants – particularly children – could become trapped.

- ▶ Ensure that no one has a body part in the sweep of the steering wheel or driver's seat.

If there is a risk of becoming trapped by the steering wheel:

- ▶ Move the adjustment lever of the steering wheel.  
The adjustment process will be stopped.

If there is a risk of becoming trapped by the driver's seat:

- ▶ Press the seat adjustment switch.  
The adjustment process will be stopped.
- ▶ Never leave children unattended in the vehicle.
- ▶ When leaving the vehicle, always take the SmartKey with you and lock the vehicle.

You can stop the adjustment process by pressing one of the memory function position switches.

**⚠ WARNING** Risk of becoming trapped if children activate the easy entry and exit feature-

Children could become trapped if they activate the easy entry- and exit feature, particularly when unattended.

- ▶ Never leave children unattended in the vehicle.
- ▶ When leaving the vehicle, always take the SmartKey with you and lock the vehicle.

If the easy entry and exit feature is active, the steering wheel will move upwards and the driver's seat will move back in the following situations:

- You switch off the vehicle when the driver's door is open.
  - You open the driver's door when the vehicle is switched off.
- i** The steering wheel will then move upwards only if it is not already as high as it will go. The driver's seat will then move backwards only if it is not already at the rear of the seat adjustment range.



The driver's seat backrest will then move forwards only if it is not already in the foremost position.

The steering wheel and the driver's seat will move back to the last drive position in the following cases:

- You switch the power supply or the vehicle on when the driver's door is closed
- You close the driver's door when the vehicle is switched on.

The last drive position will be saved when:

- You switch off the vehicle.
- You save the seat settings via the memory function.

If you press one of the memory function position buttons, the adjustment process will be stopped.

## Memory function

### Function of the memory function

**⚠ WARNING** Risk of an accident if the memory function is used while driving

If you use the memory function on the driver's side while driving, you could lose control of the vehicle as a result of the adjustments being made.

- ▶ Only use the memory function on the driver's side when the vehicle is stationary.

**⚠ WARNING** Risk of entrapment when adjusting the seat with the memory function

When the memory function adjusts the seat, you and other vehicle occupants – particularly children – could become trapped.

- ▶ During the adjustment process of the memory function, make sure that no one

has any body parts in the sweep of the seat.

- ▶ If someone becomes trapped, press a preset position button or seat adjustment switch immediately.

**⚠ WARNING** Risk of entrapment if the memory function is activated by children

Children could become trapped if they activate the memory function, particularly when unattended.

- ▶ Never leave children unattended in the vehicle.
- ▶ When leaving the vehicle, always take the SmartKey with you and lock the vehicle.

You can use the memory function when the ignition is switched off.

Seat adjustments for up to three people can be stored and called up using the memory function.

You can save settings for the following systems:

- Front seat
- Outside mirrors

- Head-up display
- Steering column
- Seat contour

### Operating the memory function

#### Storing

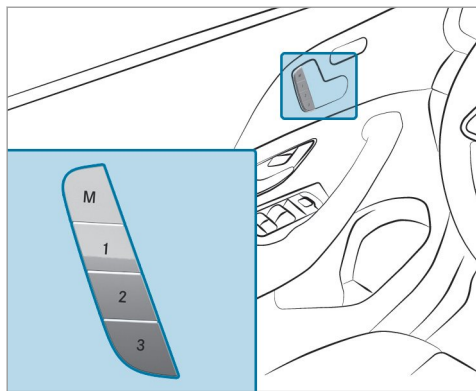

- ▶ Set the desired position for all systems.

- ▶ Briefly press the **M** memory button and then press preset position button **1**, **2** or **3** within three seconds. An acoustic signal sounds. The settings are stored.
- ▶ **To call up:** press and briefly hold preset position button **1**, **2** or **3**. After releasing the button, all systems are moved into the stored position.

#### Memory function in the rear passenger compartment

#### Function of the memory function in the rear passenger compartment

#### Operating the rear seat

Seat adjustments for the rear seat can be stored and called up using the memory function in the rear passenger compartment.

- Driver's side: two persons
- Front passenger side: one person

You can save the following settings for the rear seat:

- Position of the seat, backrest and head restraint
- Seat heating: distribution of the heated sections of the seat cushion and seat backrest

#### Operating the front passenger seat and rear seat

Seat adjustments for the front passenger seat and the rear seat can be stored and called up using the rear seat memory function.

You can save the following settings for the front passenger seat:

- Position of the seat, backrest and head restraint

You can save the following settings for the rear seat:

- Position of the seat, backrest and head restraint
- Seat heating: distribution of the heated sections of the seat cushion and seat backrest

## Operating the rear seat via the memory function in the rear passenger compartment

### Storing

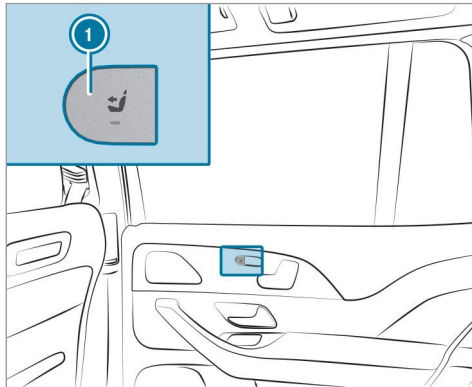

- ▶ Press button ①.  
The rear seat is selected if the indicator lamp in the button does not light up.
- ▶ Adjust the rear seat using the buttons in the door control panel (→ page 102).

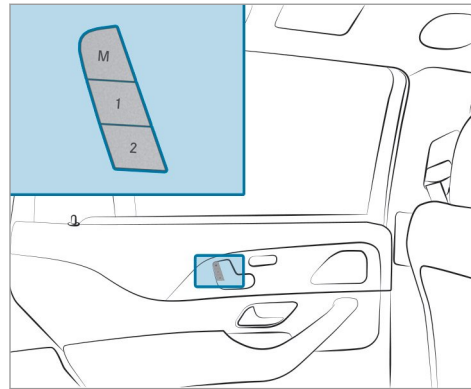

- ▶ Briefly press memory button M and, within three seconds, press either preset position button ① or ②.  
The settings for the rear seat are stored in the corresponding preset position.
- ⓘ You cannot store any settings on the button for straightening the fully reclined position.

### Calling up

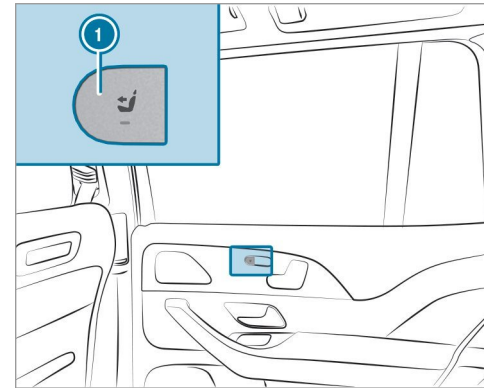

- ▶ Press button ①.  
The rear seat is selected if the indicator lamp in the button does not light up.

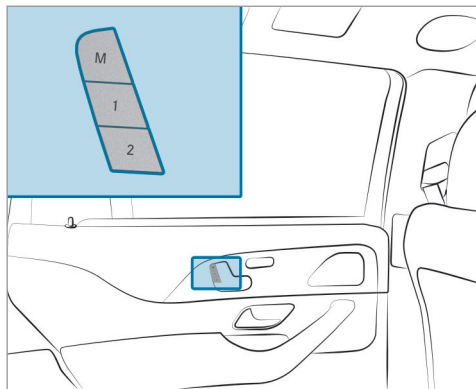

- ▶ Press corresponding preset position button **1** or **2**.  
The rear seat will move to the stored position.

### Operating the front passenger seat and rear seats via the memory function in the rear passenger compartment

#### Requirements:

- For selecting the front passenger seat: the power supply is switched on

#### Storing

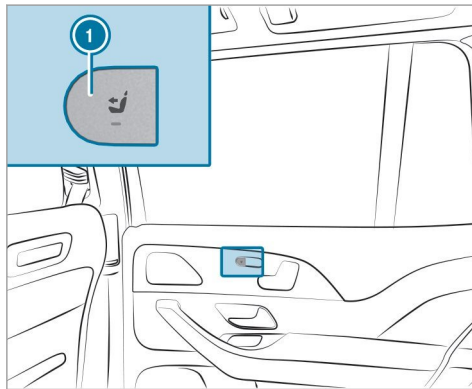

- ▶ Press button **1**.  
The rear seat is selected if the indicator lamp in the button does not light up.
- ▶ Adjust the rear seat using the buttons in the door control panel (→ page 102).
- ▶ Press button **1**.  
When the indicator lamp lights up, the front passenger seat is selected.
- ▶ Adjust the front passenger seat using the buttons on the door operating unit in the rear passenger compartment (→ page 97).
- ▶ Ensure that the indicator lamp in button **1** lights up.

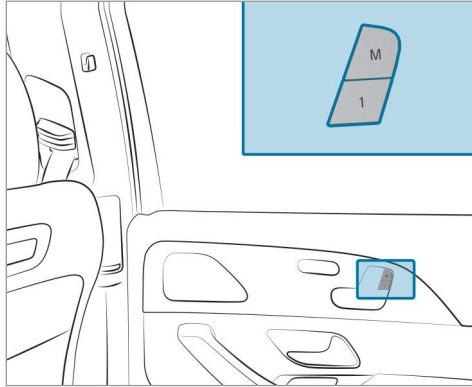

- ▶ Press memory button M and, within three seconds, press preset position button **1**. The settings for the front passenger seat and the rear seat are stored in the preset position.
- ⓘ You cannot store any settings on the buttons for setting and straightening the fully reclined position.

### Calling up

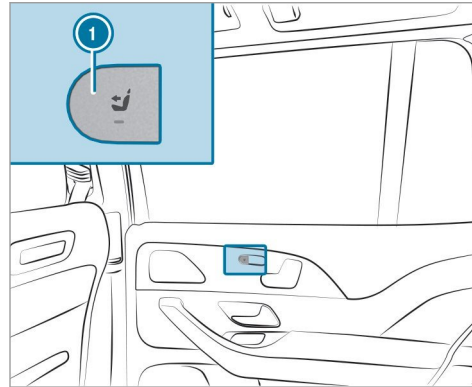

- ▶ Press button **1**. When the indicator lamp lights up, the front passenger seat is selected.

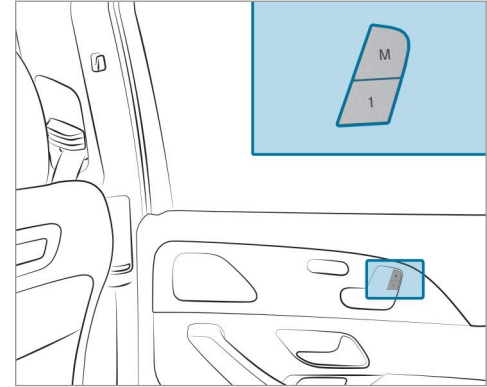

- ▶ Press preset position button **1**. Both seats move into the stored position.
- ⓘ You can use the rear passenger compartment child safety lock to disable this function (→ page 68).

## Stowage areas

### Notes on loading the vehicle

**⚠ DANGER** Risk of poisoning from exhaust gases

Combustion engines emit poisonous exhaust gases, such as carbon monoxide. Exhaust gases can enter the vehicle interior if the tailgate is open when the vehicle is running, especially if the vehicle is in motion.

- ▶ Always switch off the vehicle before opening the tailgate.
- ▶ Never drive with the tailgate open.

**⚠ WARNING** Risk of injury from unsecured items in the vehicle

If objects, luggage or loads are not secured or not secured sufficiently, they could slip, tip over or be thrown around and thereby hit vehicle occupants.

There is a risk of injury, particularly in the event of sudden braking or a sudden change in direction.

- ▶ Always stow objects in such a way that they cannot be thrown around.
- ▶ Before the journey, secure objects, luggage or loads against slipping or tipping over.

**⚠ WARNING** Risk of injury due to objects being stowed incorrectly

If objects in the vehicle interior are stowed incorrectly, they can slide or be thrown around and hit vehicle occupants. In addition, cup holders, open storage spaces and mobile phone receptacles cannot always retain all objects within.

There is a risk of injury, particularly in the event of sudden braking or abrupt changes in direction.

- ▶ Always store objects such that they cannot be thrown around in such situations.
- ▶ Always make sure that objects do not protrude from storage spaces, parcel nets or storage nets.

- ▶ Close the lockable storage spaces before starting a journey.
- ▶ Stow and secure objects that are heavy, hard, pointed, sharp-edged, fragile or too large in the cargo compartment.

**⚠ WARNING** Risk of accident from objects in the driver's footwell and front-passenger footwell

Objects in the driver's footwell and front-passenger footwell may impede pedal travel or block a depressed pedal.

This jeopardizes the operating and road safety of the vehicle.

- ▶ Stow all objects in the vehicle securely so that they cannot get into the driver's footwell or front-passenger footwell.
- ▶ Always install the floor mats securely and as prescribed in order to ensure that there is always sufficient clearance for the pedals.

- ▶ Do not use loose floor mats and do not lay multiple floor mats on top of one another.

### Vehicles with automatic front passenger airbag shutoff:

Objects trapped under the front passenger seat may interfere with the function of the automatic front passenger airbag shutoff or damage the system. Please observe the notes on the function of the automatic front passenger airbag shutoff (→ page 48).

**⚠ WARNING** - Risk of accident or injury when using the cup holder while the vehicle is moving

The cup holder cannot secure containers while the vehicle is moving.

If you use a cup holder while the vehicle is moving, the container may be flung around and liquids may be spilled. The vehicle occupants may come into contact with the liquid and if it is hot, they could be scalded. You could be distracted from traffic conditions and you may lose control of the vehicle.

- ▶ Only use the cup holder when the vehicle is stationary.
- ▶ Only use the cup holder for containers of the right size.
- ▶ Close the container, particularly if the liquid is hot.

**! NOTE** Damage to the cup holder

When the rear armrest is folded back the cup holder could become damaged.

- ▶ Only fold the rear armrest back when the cup holder is closed.

**! NOTE** Damage to the rear armrest due to body weight

When folded out, the rear armrest can be damaged by body weight.

- ▶ Do not sit or support yourself on the rear seat armrest.

**⚠ WARNING** Risk of injury due to an open cargo compartment floor

If you drive with the cargo compartment floor open, objects could be flung around and hit vehicle occupants as a result. There is a risk of injury, particularly in the event of sudden braking or a sudden change in direction.

- ▶ Always close the cargo compartment floor before a journey.

**⚠ WARNING** - Risk of fire and injury from hot cigarette lighter

You can burn yourself if you touch the hot heating element or the socket of the cigarette lighter.

In addition, flammable materials may ignite if:

- you drop the hot cigarette lighter
  - a child holds the hot cigarette lighter to objects, for example
- ▶ Always hold the cigarette lighter by the knob.

- ▶ Always make sure that the cigarette lighter is out of reach of children.
- ▶ Never leave children unattended in the vehicle.

**⚠ WARNING** Risk of burns from the tailpipe and tailpipe trims

The exhaust tailpipe and tailpipe trims can become very hot. If you come into contact with these parts of the vehicle, you could burn yourself.

- ▶ Always be particularly careful around the tailpipe and the tailpipe trims and supervise children especially closely in this area.
- ▶ Allow vehicle parts to cool down before touching them.

The driving characteristics of your vehicle are dependent on the distribution of the load within the vehicle. You should bear the following in mind when loading the vehicle:

- Never exceed the permissible gross mass or the gross axle weight rating for the vehicle (including occupants). The values are specified on the vehicle identification plate on the vehicle's B-pillar.
- The load must not protrude above the upper edge of the seat backrests.
- All vehicles except Mercedes-Maybach vehicles: always use the partitioning net when transporting objects in the cargo compartment.
- Always place the load behind unoccupied seats if possible.
- Secure the load using the tie-down eyes and distribute the load evenly.

Notes on driving with a roof load

- Evenly distribute the roof load, and place heavy objects at the bottom. Also comply with the notes on loading the vehicle.

- Drive attentively, and avoid suddenly pulling away, braking and steering as well as rapid cornering.
- When transporting roof loads and when the vehicle is fully loaded or fully occupied, select drive programs **E** and **C**. These are designed to focus on stability (→ page 188).
- i** For more information on stowage compartments and stowage areas, please refer to the Digital Operator's Manual.



## Stowage spaces in the vehicle interior

### Overview of the front stowage compartments

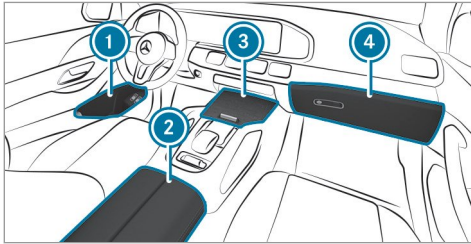

- ① Stowage spaces in the doors
- ② Stowage compartment in the armrest with USB ports (depending on vehicle equipment)
- ③ Stowage/telephone compartment with cup holder in the front center console

- ③ Mercedes-Maybach vehicles: stowage/telephone compartment with temperature-controlled cup holder, USB ports (depending on the vehicle equipment) and charging module for wireless charging of mobile phones (depending on the vehicle equipment) in the front center console
- ④ Glove box

### Folding the folding table out or in

**⚠ WARNING** Risk of injury from an open folding table

Vehicle occupants may bump into the folding table and injure themselves.

- ▶ Close the folding table before each journey.

**! NOTE** Damage to the folding tables when moving the seats back

Open folding tables may be damaged when the seats are moved back.

- ▶ Make sure that the folding tables are folded in when moving the front seats back.

### Folding out

This equipment is available only for Mercedes-Maybach vehicles.

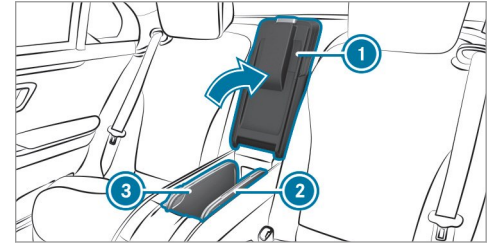

- ▶ Open rear armrest ①.
- ▶ Pull the folding table forwards and upwards by recess ② or ③ and swing outwards.
- ▶ Fold the table panels apart.
- ▶ **To fold in:** fold the table panels together and swing in the folding table.

### Opening the stowage box in the backrest in the rear compartment

**!** **NOTE** Damage to the rear armrest due to body weight

When folded out, the rear armrest can be damaged by body weight.

- ▶ Do not sit or support yourself on the rear seat armrest.

This equipment is available only for Mercedes-Maybach vehicles.

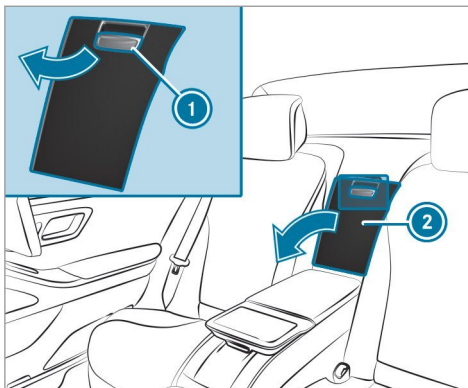

Vehicles with individual seats (example)

- ▶ Vehicles with 5-seater variant: fold down the rear armrest.
- ▶ Pull handle ① and fold down cover ②.

### Removing the handset from the storage compartment in the rear passenger compartment

#### Opening the drawer

This equipment is available only for Mercedes-Maybach vehicles with individual rear seats.

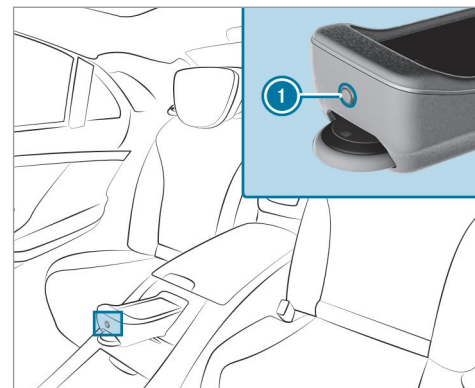

Vehicles with individual rear seats

- ▶ Press button ①.

- ▶ Remove the handset.

### Closing the drawer

- ▶ Place the handset in the drawer.
- ▶ Press the handset drawer back until it engages.

### Through-loading facility to cargo compartment

#### Folding the rear seat backrest forwards

**⚠ WARNING** Risk of becoming trapped when adjusting the seats

When you adjust a seat, you may trap yourself or a vehicle occupant.

- ▶ When adjusting a seat, make sure that no one has any body parts in the sweep of the seat.

**⚠ WARNING** Risk of accident if the seat and seat backrest are not engaged

The seat and seat backrest can fold forwards.

There is a risk of the following, in particular:

- The vehicle occupant may be pressed against the seat belt. The seat belt cannot protect as intended and could cause additional injury.
- A child restraint system will no longer be properly supported or positioned and will no longer fulfill its function as intended.
- The seat backrest will not be able restrain objects or goods in the cargo compartment.

Always ensure that the seat and seat backrest are engaged, in particular:

- Before persons travel in the vehicle while sitting on a seat with the easy entry and exit feature
- After the seat has been adjusted.
- After the easy entry and exit feature has been used
- After the cargo compartment enlargement has been folded forwards

Always ensure that all vehicle occupants have their seat belts fastened correctly and are sitting properly. Particular attention must be paid to children.

If you no longer require the folded-down rear seat backrest as a load area, fold the backrest back into place.

Make sure that the red marking of the lock verification indicator is no longer visible. Otherwise, the seat backrest will not be locked.

#### Requirements:

- Vehicles with a center seat backrest: the center seat backrest is not in the trunk floor position.
- Vehicles with a folding rear armrest: the rear armrest has been folded up.

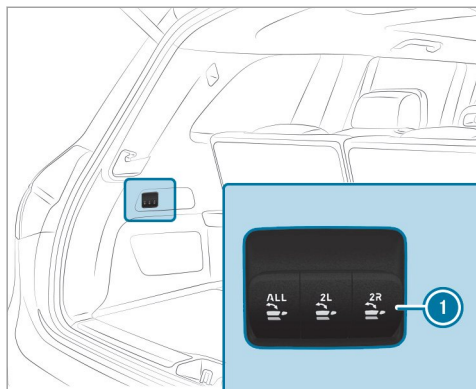

Seven-seater (example)

- ▶ **To fold the left or right seat backrest forwards:** briefly press one of buttons ①.

The head restraint on the seat backrest will move into a suitable position. The rear seat will fold forwards.

Vehicles with a center seat backrest: the center seat backrest will fold forwards together with the left seat backrest.

If a seat in the second row of seats is not engaged and locked, this will be shown on the multifunction display on the instrument cluster.

- ① Seven-seaters: all seat backrests can be folded forwards together using the **ALL** button.

#### Folding the rear center seat backrest forwards separately (seven-seaters)

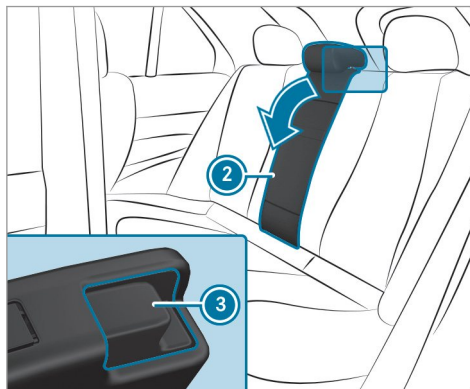

- ▶ Fold the rear seat armrest back if necessary.

- ▶ Press release catch ③.
- ▶ Fold seat backrest ② forwards.

#### Folding back the rear seat backrest

**!** **NOTE** Damage caused by trapping the seat belt when folding back the seat backrest

The seat belt could become trapped and thus damaged when the seat backrest is folded back.

- ▶ Make sure that the seat belt is not trapped when folding back the seat backrest.

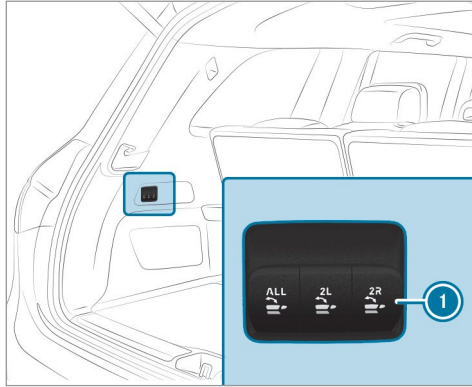

Seven-seater (example)

- ▶ **To fold back the seat backrest:** briefly pull one of buttons ①.  
The rear seat will fold back.
- Vehicles with a center seat backrest: the center seat backrest will fold back together with the left seat backrest.

If a seat backrest is not engaged and locked, this will be shown on the multifunction display on the instrument cluster.

- ① Seven-seaters: all seat backrests can be folded back together using the **ALL** button.

#### Folding back the center seat backrest separately (seven-seaters)

- ▶ Swing the seat backrest back until it audibly engages.

#### Folding the seat backrest on the third row of seats forwards

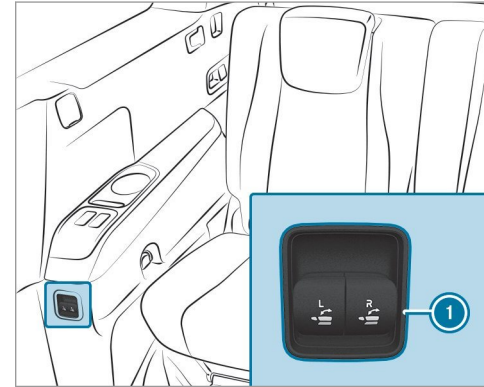

Left-hand-drive vehicle (example)

- ▶ In the rear passenger compartment (seven-seater): briefly pull one of buttons ①.

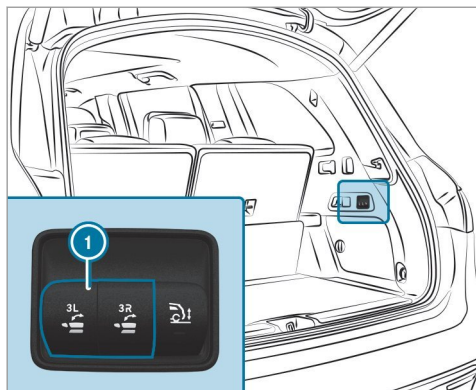

- ▶ In the cargo compartment: briefly press one of buttons ①.

### Folding back the seat backrest on the third row of seats

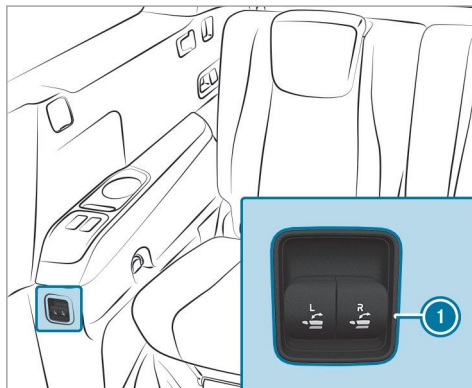

Left-hand-drive vehicle (example)

- ▶ In the rear passenger compartment: briefly press one of buttons ①.  
If a seat backrest is not engaged and locked, this will be shown on the multifunction display on the instrument cluster.

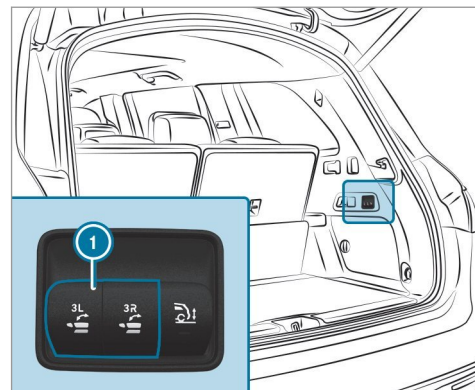

- ▶ In the cargo compartment: briefly pull one of buttons ①.  
If a seat backrest is not engaged and locked, this will be shown on the multifunction display on the instrument cluster.

## EASY-PACK cargo compartment cover and partitioning net cassette

### Notes on the cargo compartment cover

**⚠ WARNING** Risk of injury or death due to poorly secured objects

The cargo compartment cover alone cannot secure or restrain heavy objects, items of luggage or heavy loads.

You could be hit by an unsecured load, particularly in the event of abrupt changes in direction, sudden braking or an accident.

- ▶ Always stow objects in such a way that they cannot be thrown around.
- ▶ Secure objects, luggage or loads against slipping or tipping over, e.g. by using tie downs, even if you are using the cargo compartment cover.

**! NOTE** Damage to the cargo compartment cover when loading the vehicle

The cargo compartment cover may be damaged when the vehicle is being loaded.

- ▶ Do not place any objects above the lower edge of the side windows or on the cargo compartment cover.

This equipment is available for all vehicles except Mercedes-Maybach vehicles.

### Extending/retracting the cargo compartment cover

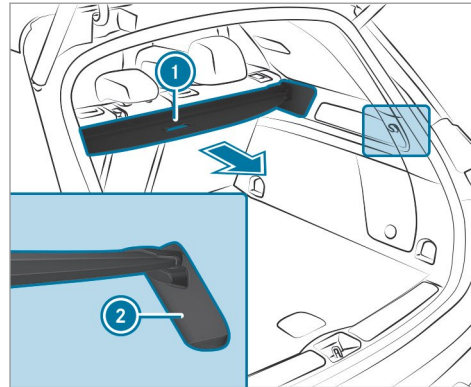

- ▶ **To extend:** pull the cargo compartment cover back by grab handle ① and clip it into brackets ② on the left and right.

### Retracting

- ▶ Remove the cargo compartment cover from the brackets on the left and right.
- ▶ Guide the cargo compartment cover forwards using the grab handle until it is fully retracted.

The rolled-up cargo compartment cover can be used in two positions:

- Folded 45° upwards for loading (fold down before commencing your journey)
- Horizontal position

### Installing or removing the cargo compartment cover

#### Requirements:

- The cargo compartment cover is rolled up.

### Removing the cargo compartment cover

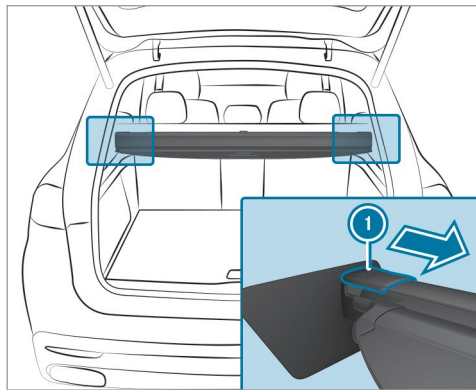

- ▶ Press end cap ① on the left or right inwards.
- ▶ Pull out the cargo compartment cover backwards.

### Storing the cargo compartment cover

The cargo compartment cover can be stored beneath the cargo compartment floor.

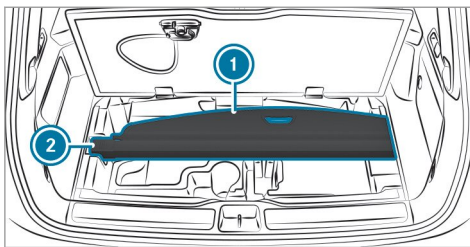

- ▶ Open the cargo compartment floor .
- ▶ **To insert:** place cargo compartment cover ① into brackets ②. Ensure it is seated correctly.
- ▶ **To remove:** take the cargo compartment cover out of brackets ②.

### Installing the cargo compartment cover

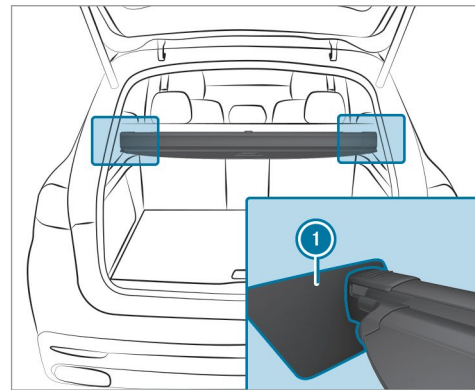

- ▶ Place the cargo compartment cover in brackets ① on the left and right. The end caps of the cargo compartment cover engage audibly.



### Attaching/removing the partitioning net

**⚠ WARNING** Risk of injury or death due to poorly secured objects

The partitioning net alone cannot secure or restrain heavy objects, items of luggage or heavy loads.

You could be hit by an unsecured load, particularly in the event of abrupt changes in direction, sudden braking or an accident.

- ▶ Always stow objects in such a way that they cannot be thrown around.
- ▶ Secure objects, luggage or loads against slipping or tipping over, e.g. by using tie downs, even if you are using the partitioning net.

For safety reasons, always use a partitioning net when transporting a load. The partitioning net can be used with or without cargo compartment enlargement

Damaged partitioning nets can no longer fulfill their functions and must be replaced. Visit a qualified specialist workshop.

This equipment is available for all vehicles except Mercedes-Maybach vehicles.

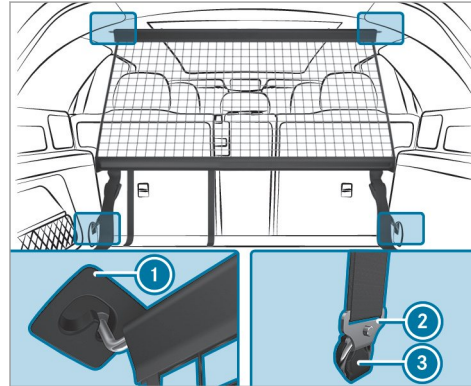

Partitioning net without cargo compartment enlargement

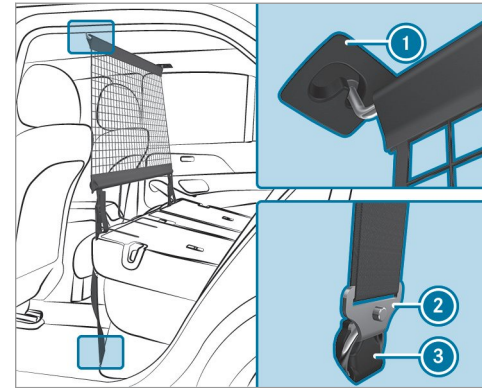

Partitioning net with cargo compartment enlargement

- ▶ **To attach:** extend the partition net.
- ▶ Attach the top guide rod to holders ① on the headliner.
- ▶ Engage hooks ② in eyelets ③ on the left and right.

- ▶ Pull on the loose ends of the lashing straps until the partitioning net is tight.
- ▶ After driving a short distance, check the tension of the partitioning net and re-tension it if necessary.
- ▶ **To remove:** pull the belt clamps until the lashing straps are loose.
- ▶ Remove hooks ② from eyelets ③ on the left and right.
- ▶ Remove the top guide rod from holders ①.

### Overview of the tie-down eyes in the cargo compartment

Observe the notes on loading the vehicle (→ page 124).

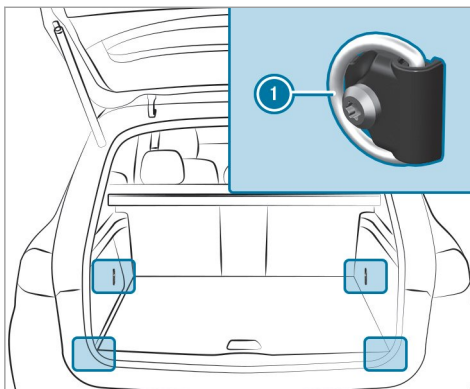

#### ① Tie-down eyes

The front tie-down eyes are accessible when the third row of seats is in the trunk floor position (→ page 129).

- ① Mercedes-Maybach vehicles: both tie-down eyes on Mercedes-Maybach vehicles are located at the rear of the cargo compartment on the left and right.

### Overview of bag hooks

**⚠ WARNING** Risk of injury when using bag hooks with heavy objects

The bag hooks cannot restrain heavy objects or items of luggage.

Objects or items of luggage may be flung around and hit vehicle occupants.

- ▶ Only hang light objects on the bag hooks.
- ▶ Never hang hard, sharp-edged or fragile objects on the bag hooks.

Observe the notes on loading the vehicle (→ page 124).

Subject the bag hooks to a maximum load of 6.6 lbs (3 kg) and do not attach any goods to them.

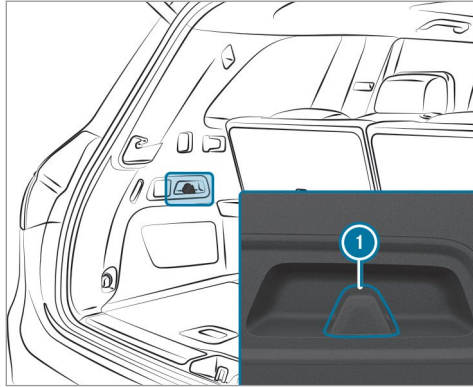

1 Bag hook

### Coat hook on the tailgate

This equipment is available for all vehicles except Mercedes-Maybach vehicles.

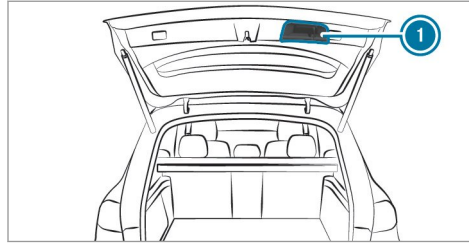

1 Coat hook on the tailgate

Coat hooks are not suitable for heavy objects. Use the coat hooks only for light objects such as jackets.

### Locking and unlocking the cargo compartment floor

This equipment is available for all vehicles except Mercedes-Maybach vehicles.

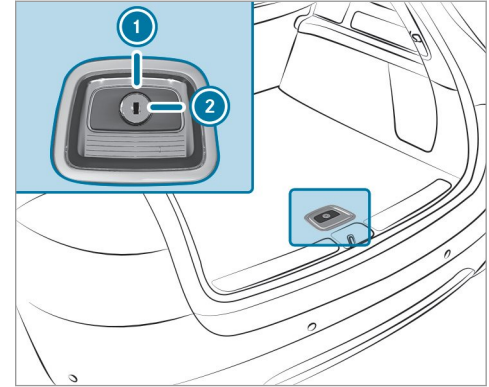

- ▶ Turn the emergency key a quarter turn clockwise **2** (to lock) or counter-clockwise **1** (to unlock).

### Attaching a roof luggage rack

**⚠ WARNING** Risk of accident due to exceeding the maximum roof load

The vehicle center of gravity and the usual driving characteristics as well as the steering and braking characteristics alter.

If you exceed the maximum roof load, the driving characteristics, as well as steering and braking, will be greatly impaired.

- ▶ Never exceed the maximum roof load and adjust your driving style.

You will find information on the maximum roof load in the "Technical data" section.

**! NOTE** Damage to the vehicle due to not observing the maximum permitted headroom clearance

If the vehicle height is greater than the maximum permitted headroom clearance, the roof and other parts of the vehicle may be damaged.

- ▶ Observe the signposted headroom clearance.
- ▶ If the vehicle height is greater than the permitted headroom clearance, do not enter.
- ▶ Observe the changed vehicle height with add-on roof equipment.

**! NOTE** Vehicle damage from non-approved roof luggage racks

The vehicle could be damaged by roof luggage racks that have not been tested and approved for Mercedes-Benz.

- ▶ Use only roof luggage racks tested and approved for Mercedes-Benz.
- ▶ Depending on the vehicle equipment, ensure that the sliding sunroof can be fully raised when the roof luggage rack is installed.
- ▶ Depending on the vehicle equipment, ensure that the tailgate can be fully

opened when the roof luggage rack is installed.

- ▶ Position the load on the roof luggage rack in such a way that the vehicle will not sustain damage even when it is in motion.

**! NOTE** Damage to the panorama roof with power tilt/sliding panel due to non-approved roof luggage racks

The panorama roof with power tilt/sliding panel may be damaged by the roof luggage rack if you attempt to open it when using a roof luggage rack not tested and approved for Mercedes-Benz.

- ▶ When a roof luggage rack is installed, open the panorama roof with power tilt/sliding panel only if this has been tested and approved for Mercedes-Benz.

The panorama roof with power tilt/sliding panel may be raised to allow ventilation of the vehicle interior.

## Notes on driving with a roof load

- Evenly distribute the roof load, and place heavy objects at the bottom. Also comply with the notes on loading the vehicle (→ page 124).
  - Drive attentively, and avoid suddenly pulling away, braking and steering as well as rapid cornering.
  - When transporting roof loads and when the vehicle is fully loaded or fully occupied, select drive programs **E** and **C**. These are designed to focus on stability (→ page 188).
- ▶ Secure the roof luggage rack to the roof railing.
- ▶ Observe the manufacturer's installation instructions.

**Cup holder****Switching the cooling or heating function for the temperature-controlled cup holder on or off**

**⚠ WARNING** Risk of injury by touching the heating elements

The cup holder's heating elements may be very hot.

You can burn yourself on them.

- ▶ Do not touch the cup holder's hot heating elements.
- ▶ Ensure that no children can access the cup holder's hot heating elements.
- ▶ Never leave children unattended in the vehicle.

**! NOTE** Damage to objects in the temperature-controlled cup holder

If you place objects into the temperature-controlled cup holder, they may become damaged.

- ▶ Do not place objects into the temperature-controlled cup holder.

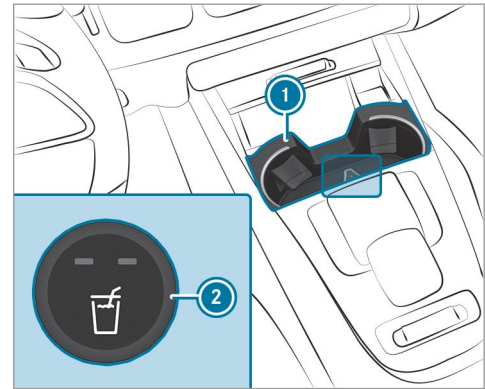

Cup holder in the front center console

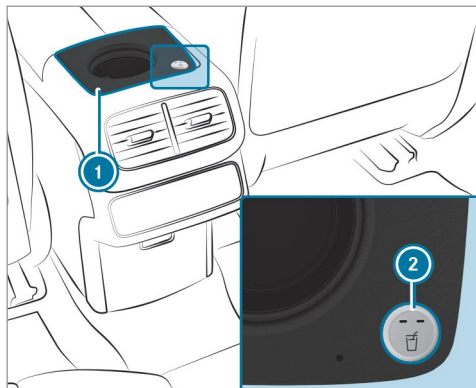

Cup holder in the rear passenger compartment center console

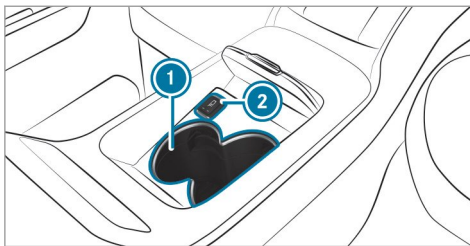

Cup holder in the rear passenger compartment center console (Mercedes-Maybach four-seater vehicles)

▶ **To switch on:** on cup holder ①, press button ② repeatedly until the blue (keep cool) or red (keep warm) indicator lamp on the button lights up.

If you use the heating function, the metal insert of the cup holder is heated. Once a certain temperature has been reached, the warning lamp lights up. Do not reach into the cup holder's metal insert when the warning lamp is lit.

▶ **To switch off:** press button ② repeatedly until the indicator lamp on the button goes out.

- ❗ Clean the removable rubber mat only with clean, lukewarm water and the cup holder only with a soft cloth.

### Sockets

#### Using the 12 V socket

##### Requirements:

- Only connect devices up to a maximum of 240 W (20 A).

Depending on the vehicle equipment, the vehicle has the following 12 V sockets:

- In the storage compartment in the front center console
- In the cargo compartment

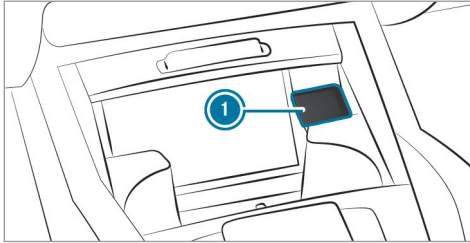

Example: 12 V socket in the storage compartment in the front center console

- ▶ Lift up cap ① of the socket and insert the plug of the device.

If you have connected a device to the 12 V socket, leave the cover of the storage compartment open.

### Using the 115 V socket in the rear passenger compartment

- ⚠ **DANGER** Risk of fatal injuries due to a damaged connecting cable or a damaged socket

You could receive an electric shock if the connecting cable or the 115 V power socket is pulled out of the trim or is damaged or wet.

- ▶ Use only connecting cables that are dry and free of damage.
- ▶ When the vehicle is switched off, make sure that the 115 V power socket is dry.
- ▶ Immediately have the 115 V power socket checked or replaced at a qualified specialized workshop if it is damaged or has been pulled out of the trim.
- ▶ Never plug the connecting cable into a 115 V power socket that is damaged or has been pulled out of the trim.

- ⚠ **DANGER** Risk of death due to using the socket incorrectly

In particular, you could receive an electric shock:

- If you touch the inside of the socket
- If you insert unsuitable devices or objects into the socket
- ▶ Do not touch the inside of the socket.
- ▶ Only connect suitable devices to the socket.

#### Requirements:

- Only connect devices with a suitable plug which conforms to the standards specific to the country you are in.
- Only connect devices up to a maximum of 150 W (1.3 A).
- Do not use multiple socket outlets.

Depending on the vehicle equipment, the design of the center console and stowage compartment may differ.

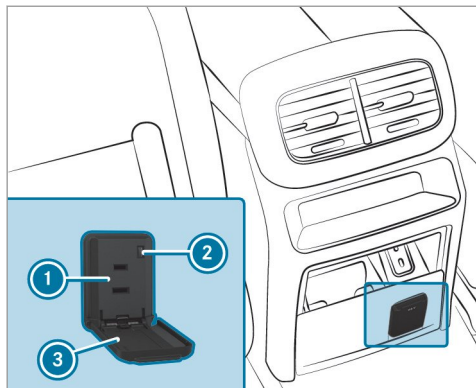

Using the 115 V socket in the center console of the rear passenger compartment



115 V socket in the center console of the rear passenger compartment (Mercedes-Maybach 4-seat vehicles)

- ▶ Mercedes-Maybach vehicles with individual rear seats: open the stowage compartment of the center console of the rear passenger compartment .
- ▶ Open flap ③ .

- ▶ Insert the plug of the device into 115 V socket ① .  
When the on-board electrical system voltage is sufficient, indicator lamp ② lights up.

### Overview of USB ports

Depending on the vehicle equipment, the vehicle has the following USB ports:

- In the stowage compartment of the cockpit armrest (→ page 127)
- In the front center console next to the mobile phone stowage compartment
- In the rear center console
- Vehicles with Rear Comfort Package: in the center armrest of the second row of seats in the rear passenger compartment
- Mercedes-Maybach vehicles with 5 seats in the rear passenger compartment: in the center armrest in the rear passenger compartment
- Mercedes-Maybach vehicles with individual rear seats: in the center console of the rear passenger compartment



- Vehicles with three rows of seats: to the right and left next to the seat

If the vehicle is switched on you can charge USB devices, e.g. mobile phones, at USB ports. The charging voltage is approximately 5 V (up to 3 A).

### Refrigerator box

#### Using the refrigerator box

**⚠ WARNING** Risk of fire due to a covered vent grille on the refrigerator box

If you cover the vent grille for the refrigerator box, it may overheat.

▶ Always make sure that the vent grille is not covered.

The vent grille for the refrigerator box is in the trunk.

This equipment is available only for Mercedes-Maybach vehicles.

The refrigerator box can bear a maximum load of 7.7 lb (3.5 kg).

Store only plastic bottles in the upper compartment of the refrigerator box. The contents of the bottle must be no more than 17 fl. oz. (0.5 liters).

If you do not need to use the refrigerator box for an extended period, switch it off, defrost it and clean it. After doing so, leave the lid open for a time.

More condensation may occur during intensive use. Cleaning may be required.

The refrigerator box will reduce its cooling capacity or switch off in the following cases:

- Too many electrical consumers are turned on.
- The starter battery is not sufficiently charged.

If this is the case, the indicator lamps will flash on the button for switching the refrigerator box on and off. The cooling function will automatically switch back on as soon as there is sufficient voltage.

**i** To install the refrigerator box in the cargo compartment or remove it, please contact a qualified specialist workshop.

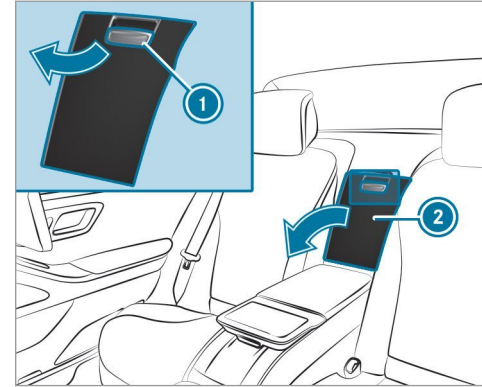

Example: vehicles with individual rear seats

- ▶ Vehicles with 5-seater variant: fold down the rear armrest.
- ▶ Pull handle on storage box **1** and fold down the cover of storage box **2**.

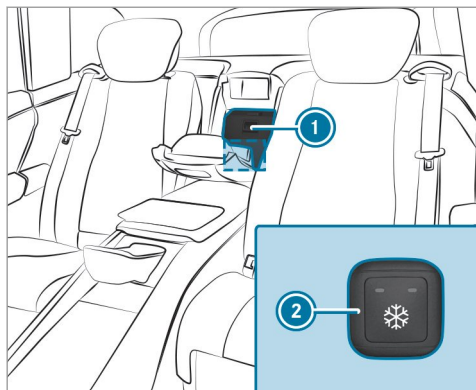

Example: vehicles with individual rear seats

- ▶ **To open:** pull the handle on refrigerator box ① and fold down the cover of the refrigerator box.
- ▶ **To switch on:** press button ② repeatedly until an indicator lamp (low cooling) lights up or two indicator lamps (high cooling) light up.

- ▶ **To switch off:** press button ② repeatedly until both indicator lamps go out.

### Wireless charging of the mobile phone and connection with the exterior antenna

#### Notes on wirelessly charging the mobile phone

**⚠ WARNING** Risk of injury due to objects being stowed incorrectly

If objects in the vehicle interior are stowed incorrectly, they can slide or be thrown around and hit vehicle occupants. In addition, cup holders, open stowage spaces and mobile phone receptacles cannot always retain all objects within.

There is a risk of injury, particularly in the event of sudden braking or a sudden change in direction.

- ▶ Always stow objects so that they cannot be thrown around in such situations.

- ▶ Always make sure that objects do not protrude from stowage spaces, parcel nets or stowage nets.
- ▶ Close the lockable stowage spaces before starting a journey.
- ▶ Always stow and secure heavy, hard, pointed, sharp-edged, fragile or bulky objects in the trunk/cargo compartment.

Observe the notes on loading the vehicle.

**⚠ WARNING** Risk of fire from placing objects in the mobile phone storage compartment

Placing other objects in the mobile phone storage compartment could constitute a fire hazard.

- ▶ Apart from a mobile phone, do not place any other objects in the mobile phone storage compartment, especially those made of metal.

**!** **NOTE** Damage to objects caused by placing them in the mobile phone storage compartment

If objects are placed in the mobile phone storage compartment, these may be damaged by electromagnetic fields.

▶ Do not place credit cards, storage media, ski passes or other objects sensitive to electromagnetic fields in the mobile phone storage compartment.

**!** **NOTE** Damage to the mobile phone storage compartment caused by liquids

If liquids enter the mobile phone storage compartment, the compartment may be damaged.

▶ Ensure that no liquids enter the mobile phone storage compartment.

Always observe the notes for persons with electronic medical aids (→ page 30).

- Depending on the vehicle equipment, the mobile phone is connected to the vehicle's exterior antenna via the charging module.
- The charging function and wireless connection of the mobile phone to the vehicle's exterior antenna are only available if the vehicle is switched on.
- Small mobile phones may not be able to be charged in every position of the mobile phone storage compartment.
- Large mobile phones which do not rest flat in the mobile phone storage compartment may not be able to be charged or connected with the vehicle's exterior antenna.
- The mobile phone may heat up during the charging process. This may also depend on the applications (apps) currently open in the background.
- To ensure more efficient charging and connection with the vehicle's exterior antenna, remove the protective cover from the mobile phone. Protective covers which are necessary for wireless charging are an exception.

### Wireless charging of a mobile phone in the cockpit

#### Requirements:

- The mobile phone is suitable for wireless charging.
- ① A list of compatible mobile phones can be found at: <https://www.mercedes-benz-mobile.com/>

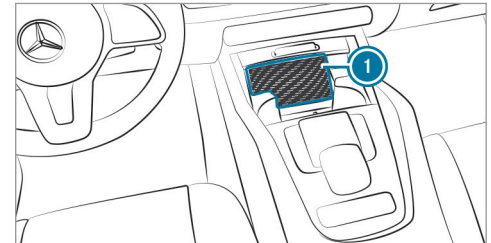

▶ Place the mobile phone as close to the center of mat ① as possible with the display facing upwards. When a message is shown in the multimedia system, the mobile phone is being charged.

Malfunctions detected during the charging process are shown in the multimedia system display.

- ① The mat can be removed for cleaning, e.g. using clean, lukewarm water.

### Wirelessly charging a mobile phone in the rear passenger compartment

**!** **NOTE** Damage to the drawer in the center console of the rear passenger compartment due to body weight

When open, the drawer in the center console of the rear passenger compartment can be damaged by body weight.

- ▶ Do not support yourself on the open drawer.

#### Requirements:

- The mobile phone must be suitable for wireless charging.

- ① A list of compatible mobile phones can be found at: <https://www.mercedes-benz-mobile.com/>

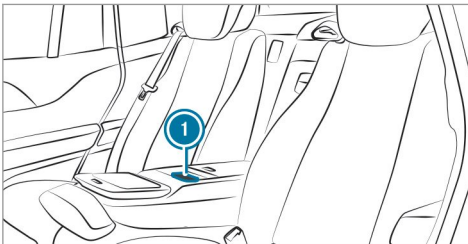

Mat in front of the stowage compartment in the rear armrest

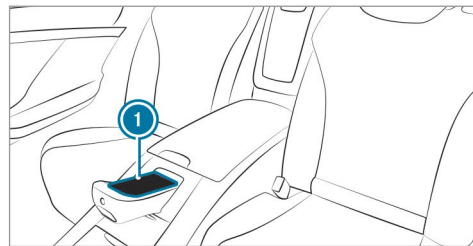

Mat in the center console of the rear passenger compartment (only Mercedes-Maybach vehicles with individual rear seats)

- ▶ Place the mobile phone as close to the center of mat ① as possible with the display facing upwards.  
When the indicator lamp lights up, the mobile phone is being charged.

### Installing/removing the floor mats

**⚠ WARNING** Risk of accident due to objects in the driver's footwell

Objects in the driver's footwell may impede pedal travel or block a depressed pedal.

This jeopardizes the operating and road safety of the vehicle.

- ▶ Stow all objects in the vehicle securely so that they cannot get into the driver's footwell.
- ▶ Always install the floor mats securely and as prescribed in order to ensure that there is always sufficient room for the pedals.
- ▶ Do not use loose floor mats and do not place floor mats on top of one another.

### Installing floor mats

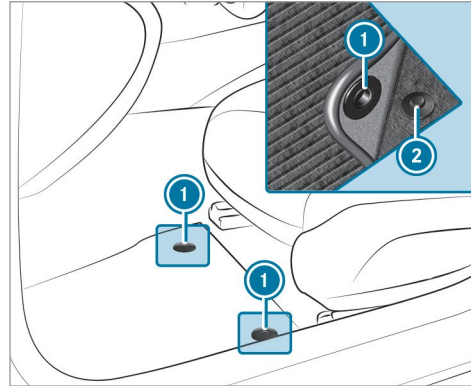

- ▶ Move the corresponding seat backwards and lay the floor mat in the footwell.
  - ▶ Press studs ① onto holders ②.
  - ▶ Adjust the corresponding seat.
- i** **Vehicles with a third row of seats (all vehicles except Mercedes-Maybach vehicles):** To install the floor mats on the third row of seats,

slide the corresponding seat on the second row of seats forwards.

### Removing floor mats

- ▶ Pull the floor mat off holders ②.
  - ▶ Remove the floor mat.
- i** **Vehicles with a third row of seats (all vehicles except Mercedes-Maybach vehicles):** To remove the floor mats on the third row of seats, slide the corresponding seat on the second row of seats forwards.

## Exterior lighting

### Information about lighting systems and your responsibility

The various lighting systems of the vehicle are only aids. The driver of the vehicle is responsible for correct vehicle illumination in accordance with the prevailing light and visibility conditions, legal requirements and traffic situation.

### Light switch

#### Operating the light switch

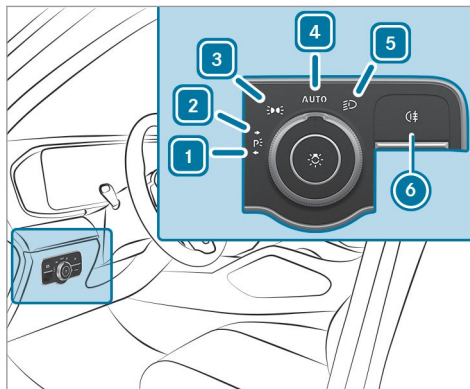

- 1 Left-hand standing lights
- 2 Right-hand standing lights
- 3 Parking lights and license plate lamp
- 4 **AUTO** Automatic driving lights (preferred light switch position)

- 5 Low beam/high beam
- 6 Switches the rear fog light on/off

When low beam is activated, the indicator lamp for the parking lights will be deactivated and replaced by the low-beam indicator lamp.

▶ Always park your vehicle safely using sufficient lighting, in accordance with the relevant legal stipulations.

**!** **NOTE** Battery discharging by operating the standing lights

Operating the standing lights over a period of hours puts a strain on the battery.

▶ Where possible, switch on the right or left parking light.

If the battery is insufficiently charged, the standing lights or parking lights will be switched off automatically to facilitate the next engine start.

The exterior lighting (except standing and parking lights) will switch off automatically when the driver's door is opened.

- Observe the notes on surround lighting (→ page 153).

### Automatic driving lights function

When the vehicle is switched on, the parking lamps, low beam and daytime running lamps are switched on automatically depending on the ambient light.

**⚠ WARNING** Risk of accident when the low beam is switched off in poor visibility



When the light switch is set to **AUTO**, the low beam may not be switched on automatically if there is fog, snow or other causes of poor visibility such as spray.

- ▶ In such cases, turn the light switch to .

The automatic driving lights are only an aid. You are responsible for vehicle lighting.

### Switching the rear fog lamps on or off

#### Requirements:

- The light switch is in the  or **AUTO** position.
- ▶ Press the  button.

Please observe the country-specific laws on the use of rear fog lamps.

- ⓘ Vehicles with AIRMATIC or E-ACTIVE BODY CONTROL with off-road package: when the rear fog lamp is switched on, off-road level +3 will not be available. If the rear fog lamp is switched on and off-road level +3 is activated, the vehicle will be lowered to off-road level +2.

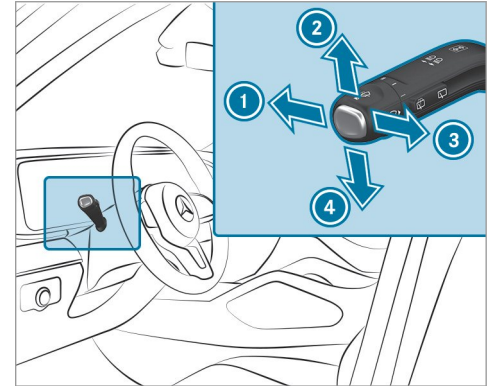

### Operating the combination switch for the lights



- ① High beam
- ② Turn signal light, right
- ③ High-beam flasher
- ④ Turn signal light, left

- ▶ Use the combination switch to activate the desired function.

**Switching on high beam**

- ▶ Turn the light switch to the  or **AUTO** position.
- ▶ Push the combination switch in the direction of arrow ①.  
When the high beam is activated, the  indicator lamp for low beam will be deactivated and replaced by the  indicator lamp for high beam.

**Switching off high beam**

- ▶ Push the combination switch in the direction of arrow ① or pull it in the direction of arrow ③.

**High-beam flasher**

- ▶ Pull the combination switch in the direction of arrow ③.

**Turn signal light**

- ▶ **To indicate briefly:** push the combination switch briefly to the point of resistance in the direction of arrow ② or ④.  
The corresponding turn signal light will flash three times.

**To indicate continuously:** push the combination switch beyond the point of resistance in the direction of arrow ② or ④.

Vehicles with Active Lane Change Assist:

- A turn signal indicator activated by the driver may continue to operate for the duration of the lane change.
- If the driver indicated directly beforehand but a lane change was not immediately possible, the turn signal indicator may activate automatically.

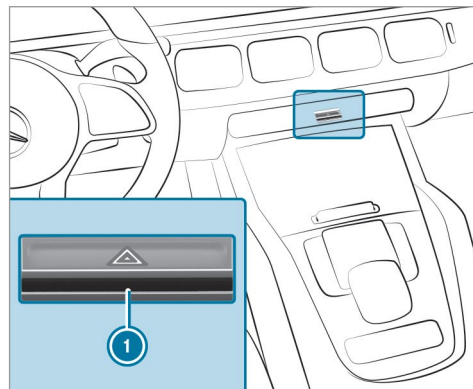
**Activating/deactivating the hazard warning lights**

- ▶ Press button ①.

The hazard warning lights will switch on automatically if:

- The airbag has been deployed.

When the turn signal indicator is activated, the hazard warning lights will be interrupted.



## Cornering light

### Cornering light function

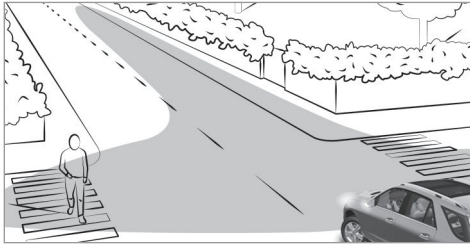

The cornering light improves the illumination of the road over a wide angle in the turning direction, enabling better visibility on tight curves, for example. It can be activated only when the low beam is switched on.

The function is active under the following conditions:

- At speeds below 25 mph (40 km/h) when the turn signal light is switched on or the steering wheel is turned

- At speeds between 25 mph (40 km/h) and 45 mph (70 km/h) when the steering wheel is turned

**Roundabout and intersection function:** the cornering light will be activated on both sides based on an evaluation of the vehicle's current GPS position. It will remain active until after the vehicle has left the roundabout or the intersection.

## Active headlamps

### Active headlamps function

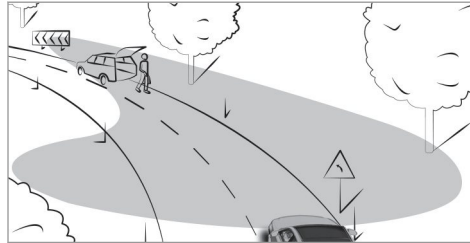

- The headlamps follow the steering movements.

- Relevant areas are better illuminated during a journey.

The functions are active when the low beam is switched on.

Depending on the vehicle's equipment, the course of the lane in which you are driving will also be evaluated and the active headlamps function will adjust the light in advance.

## Adaptive Highbeam Assist

### Adaptive Highbeam Assist function

**⚠ WARNING** Risk of accident despite Adaptive Highbeam Assist

Adaptive Highbeam Assist does not react to:

- Road users without lights, e.g. pedestrians
- Road users with poor lighting, e.g. cyclists
- Road users whose lighting is obstructed, e.g. by a barrier

On very rare occasions, Adaptive Highbeam Assist may fail to recognize other road users

with their own lighting, or may recognize them too late.

In these, or in similar situations, the automatic high beam will not be deactivated or will be activated despite the presence of other road users.

- ▶ Always observe the road and traffic conditions carefully and switch off the high beam in good time.

### System limits

Adaptive Highbeam Assist cannot take into account road, weather or traffic conditions.

Detection may be restricted in the following cases:

- In poor visibility, e.g. fog, heavy rain or snow
- If there is dirt on the sensors or the sensors are obscured

Adaptive Highbeam Assist is only an aid. You are responsible for adjusting the vehicle's lighting to the prevailing light, visibility and traffic conditions.

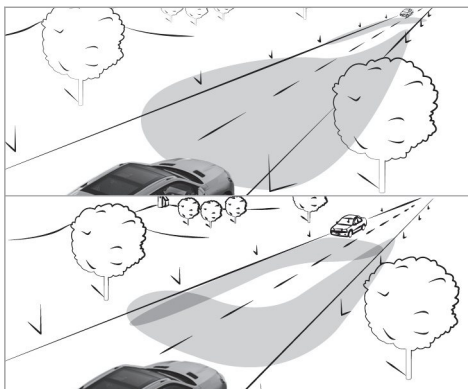

Adaptive Highbeam Assist automatically switches between the following types of light:

- Low beam
- High beam

At speeds greater than 19 mph (30 km/h):

- If no other road users are detected, the high beam will switch on automatically.

The high beam will switch off automatically in the following cases:

- At speeds below 16 mph (25 km/h)
- If other road users are detected
- If street lighting is sufficient

At speeds greater than approximately 31 mph (50 km/h):

- The headlamp range of the low beam is regulated automatically based on the distance to other road users.

- ❗ The system's optical sensor is located behind the windshield near the overhead control panel.

### Switching Adaptive Highbeam Assist on/off

#### Switching on

- ▶ Turn the light switch to the **AUTO** position.
- ▶ Switch on the high beam using the combination switch.

If Adaptive Highbeam Assist is activated, the  indicator lamp will light up on the

central display section of the instrument display.

### Switching off

- ▶ Switch off the high beam using the combination switch.

### Switching the daytime running lamps on/off

Multimedia system:

-  ▶ Settings ▶ Light
- ▶▶ Daytime Run. Lights
- ▶ Switch the function on or off.

### Setting the exterior lighting switch-off delay time

#### Requirements:

- The light switch is in the **AUTO** position.

Multimedia system:

-  ▶ Settings ▶ Light
- ▶▶ Exterior Lighting Delay

- ▶ Set the switch-off delay time. When the vehicle engine is switched off, the exterior lighting will be activated for the set time.

### Switching the surround lighting on/off

Multimedia system:

-  ▶ Settings ▶ Light
- ▶▶ Locator Lighting

When **Locator Lighting** is active, the exterior lighting lights up for 40 seconds after the vehicle is unlocked. When you start the vehicle, the surround lighting is deactivated and the automatic driving lights are activated.

**Illuminated running boards:** when the surround lighting is switched on, the illumination of the running boards is activated when a door is opened. If the door is not closed, the running board courtesy lighting is automatically deactivated after 40 seconds.





- ▶ Activate or deactivate the function.

### Interior lighting

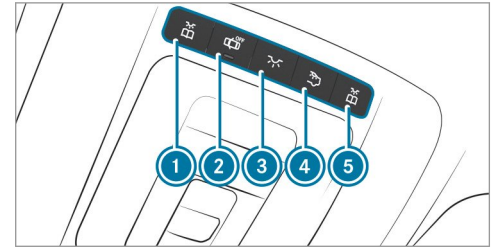
#### Adjusting the interior lighting

#### Front overhead control panel



-  Front left reading lamp
-  Automatic interior lighting control
-  Front interior lighting
-  Rear interior lighting
-  Front right reading lamp

- ▶ To switch on/off: press button ① - ⑤ accordingly.

### Control panel in the grab handle

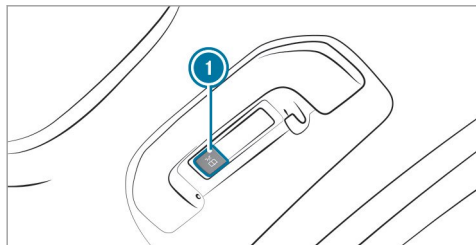

- ①  Rear reading lamp

- ▶ To switch on/off: press button ①.

### Adjusting the ambient lighting

Multimedia system:

- ▶  ▶ Settings ▶ Light
- ▶ ▶ Ambient Lighting

#### Setting the color

- ▶ Select **Color**.
- ▶ Set the desired color.

#### Adjusting the brightness

- ▶ Select **Brightness**.

Adjust the brightness.

#### Activating the brightness for zones

- ▶ Select **Brightness**.
- ▶ Select **Brightness Zones**.  
The **ACCENT**, **AMBIANCE** and **ROOF** zones can be set separately.

#### Activating multi-color lighting

- ▶ Select **Color**.
- ▶ Select **Multi-color**.
- ▶ Select a color combination.

#### Activating multi-color animation

- ▶ Select **Color**.
- ▶ Select **Multi-color Animation**.  
The chosen color combination will change at predefined intervals.

#### Activating welcome lighting

- ▶ Select **Color**.
- ▶ Select **Welcome**.  
When the vehicle is unlocked, a special ambient lighting sequence will run.

#### Activating dependency on air conditioning settings

- ▶ Select **Color**.
- ▶ Select **Climate**.  
If changes are made to the temperature setting in the vehicle, the color of the ambient lighting will change briefly.

### Switching the interior lighting switch-off delay time on/off

Multimedia system:



→  » Settings » Light  
» Interior Lighting Delay

- ▶ Switch the switch-off delay time on or off. When this function is active, the interior lighting lights up for a short time after the vehicle is locked.

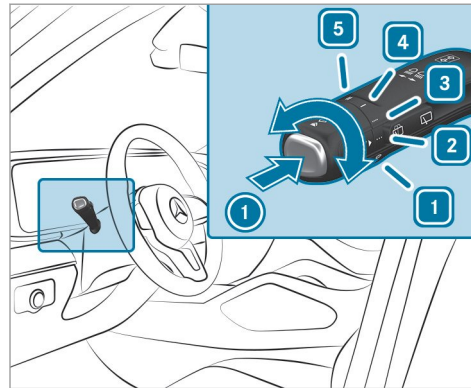
### Windshield wiper and windshield washer system Switching the windshield wipers on/off





- |   |      |                            |
|---|------|----------------------------|
| 1 | 0    | Windshield wipers off      |
| 2 | ...  | Automatic wiping, normal   |
| 3 | .... | Automatic wiping, frequent |
| 4 | —    | Continuous wiping, slow    |
| 5 | =    | Continuous wiping, fast    |

- ▶ Turn the combination switch to the corresponding position **1** - **5**.
- ▶ **Single wipe/washing:** push the button on the combination switch in the direction of arrow **1**.
  -  Single wipe
  -  Wiping with washer fluid
- ⓘ Observe the notes on washing the vehicle in a car wash (→ page 341).

**Vehicles with MAGIC VISION CONTROL:** in position **2** or **3**, the windshield washing process is automatically triggered if dirt is detected on the windshield unless the **Check Washer Fluid** message is being displayed.

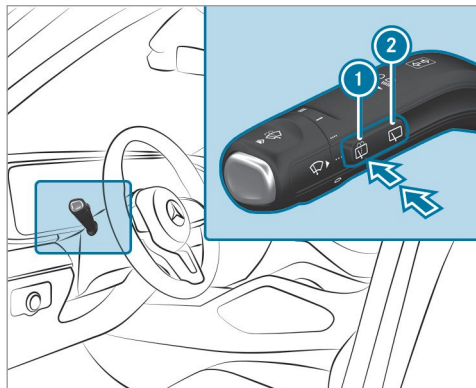
### Switching the rear window wiper on/off



- ①  Single wipe/washing
- ②  Intermittent wiping

- ▶ **Single wipe:** press button ① to the point of resistance.
- ▶ **To wipe with washer fluid:** press button ① beyond the point of resistance.

- ▶ **To switch intermittent wiping on/off:** press button ②.
- Vehicles with rain sensor:** The wipe interval automatically adapts to the driving conditions. The  symbol will appear on the instrument cluster when the rear window wiper is switched on.

### Replacing the windshield wiper blades

**⚠ WARNING** Risk of becoming trapped if the windshield wipers are switched on while wiper blades are being replaced

If the windshield wipers begin to move while you are changing the wiper blades, you can be trapped by the wiper arm.

- ▶ Always switch off the windshield wipers and vehicle before changing the wiper blades.

### Moving the wiper arms into the replacement position

- ▶ Switch the vehicle on and then off again immediately.
- ▶ Within around 15 seconds, press and hold the  button on the combination switch for approximately three seconds (→ page 155). The wiper arms will move into the replacement position.

### Removing the wiper blades

- ▶ Fold the wiper arms away from the windshield.

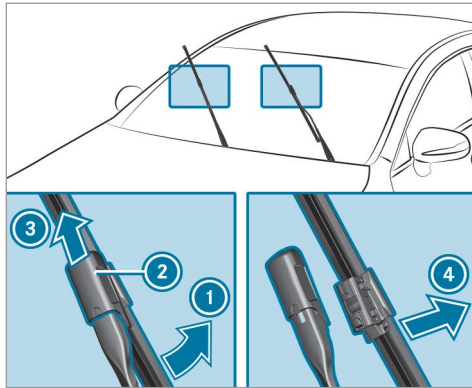

- ▶ Hold the wiper arm with one hand. With the other hand, turn the wiper blade away from the wiper arm in the direction of arrow ① as far as it will go.
- ▶ Slide catch ② in the direction of arrow ③ until it engages in the removal position.
- ▶ Remove the wiper blade from the wiper arm in the direction of arrow ④.

### Installing the wiper blades

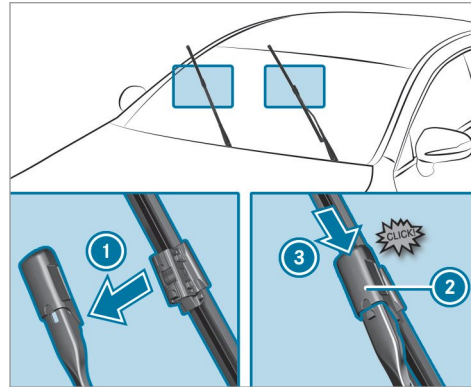

- ▶ Insert the new wiper blade into the wiper arm in the direction of arrow ①.
- ▶ Slide catch ② in the direction of arrow ③ until it engages in the locking position.
- ▶ Make sure that the wiper blade is seated correctly.
- ▶ Fold the wiper arms back onto the windshield.

- ▶ Switch on the vehicle.
  - ▶ Press the  button on the combination switch. The wiper arms will return to their original positions.
  - ▶ Switch off the vehicle.
- ⓘ Check the condition of the wiper blades regularly and replace them in the event of visible damage or ongoing smearing.

### Maintenance display

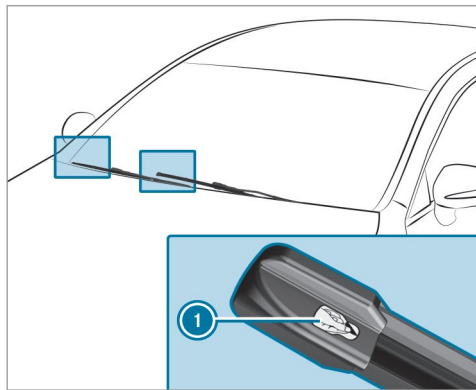

- ▶ Remove protective film ① from the maintenance displays on the tips of the newly installed wiper blades.

When the color of the maintenance displays changes from black to yellow, replace the wiper blades.

- ① The duration until the color changes varies depending on the usage conditions.

### Replacing the windshield wiper blades (MAGIC VISION CONTROL)

#### Moving the wiper arms into the replacement position

- ▶ Switch off the vehicle.
- ▶ Within around 15 seconds, press the button on the combination switch (→ page 155). The wiper arms will move into the replacement position.

### Removing the wiper blades

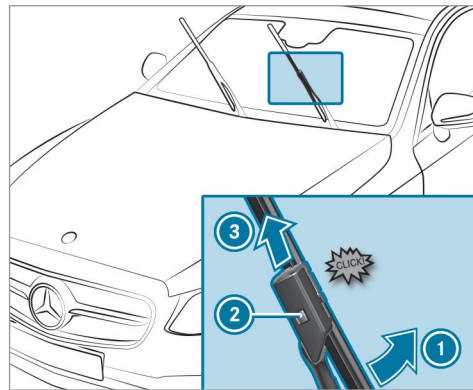

- ▶ **To bring the wiper blade into position to be removed:** hold the wiper arm firmly with one hand. With the other hand, turn the wiper blade in the direction of arrow ① beyond the point of resistance. The wiper blade will engage in the removal position with a click.



- ▶ **To remove the wiper blade:** press release knob ②, pull the wiper blade in the direction of arrow ③ and remove.

### Installing the wiper blades

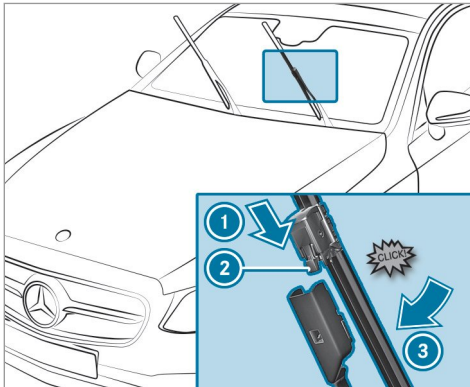

- ▶ Push the new wiper blade onto the wiper arm in the direction of arrow ① until release knob ② engages.

- ▶ Press the wiper blade beyond the point of resistance in the direction of arrow ③ on the wiper arm. The wiper blade will engage with a noticeable click and move freely again.
- ▶ Fold the wiper arm back onto the windshield.
- ⓘ Check the condition of the wiper blades regularly and replace them in the event of visible damage or ongoing smearing.

### Replacing the rear window wiper blade

**⚠ WARNING** Risk of becoming trapped if the windshield wipers are switched on while wiper blades are being replaced

If the windshield wipers begin to move while you are changing the wiper blades, you can be trapped by the wiper arm.

- ▶ Always switch off the windshield wipers and vehicle before changing the wiper blades.

### Removing the wiper blade

- ▶ Switch the vehicle off.

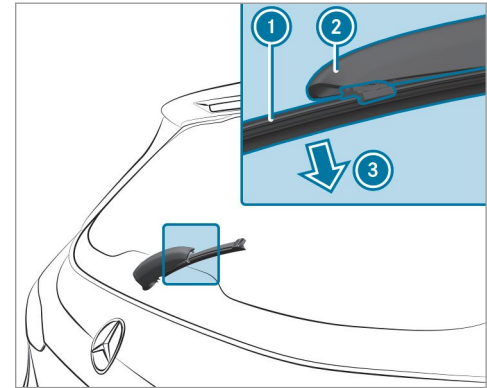

- ▶ Fold wiper arm ② away from the rear window until it engages in the replacement position.
- ▶ Unclip wiper blade ① from wiper arm ② and remove it in the direction of arrow ③.

### Installing the wiper blade

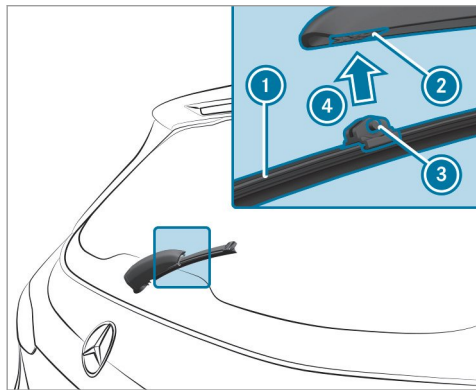

- ▶ Position wiper blade ① with both lugs ③ on holder ② on the wiper arm.
- ▶ Push wiper blade ① in the direction of arrow ④ until it engages in holder ②.
- ▶ Make sure that wiper blade ① is seated correctly.

- ▶ Fold the wiper arm from the replacement position back onto the rear window.

### Mirrors

#### Operating the outside mirrors

- ⚠ **WARNING** Risk of accident due to adjusting the vehicle settings while the vehicle is in motion

You could lose control of the vehicle in the following situations in particular:

- If you adjust the driver's seat, the head restraint, the steering wheel or the mirror while the vehicle is in motion
  - If you fasten your seat belt while the vehicle is in motion
- ▶ Before starting the vehicle: in particular, adjust the driver's seat, head restraint, steering wheel and mirror, and fasten your seat belt.

- ⚠ **WARNING** Risk of accident due to misjudgment of distance when using the front-passenger mirror

The outside mirror on the front passenger side reflects objects on a smaller scale. The objects in view are in fact closer than they appear.

- ▶ Therefore, always look over your shoulder to check the actual distance between you and the road users traveling behind you.

### Folding the outside mirrors in/out

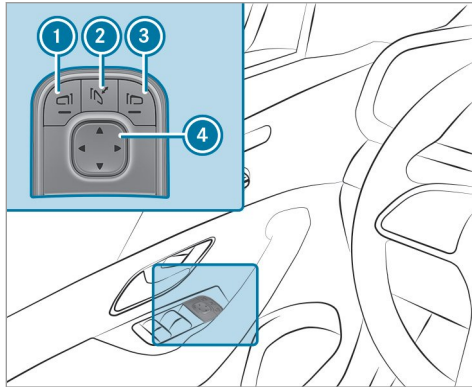

- ▶ Briefly press button ②.

ⓘ If the battery has been disconnected or has discharged, the outside mirrors must be moved briefly using button ②. Only then will the automatic mirror folding function work properly.

ⓘ Mercedes-Maybach vehicles: when the outside mirrors fold in, the extendable running boards will retract if they were previously extended.

### Adjusting the outside mirrors

- ▶ Press button ① or ③ to select the outside mirror to be adjusted.
- ▶ Use button ④ to adjust the position of the mirror glass.

### Engaging the outside mirrors

If an outside mirror has been forcibly disengaged, proceed as follows.

- ▶ Vehicles without electrically folding outside mirrors: manually move the outside mirror into the correct position.
- ▶ Vehicles with electrically folding outside mirrors: press and hold button ②. You will hear a click and the mirror will audibly click into place. The outside mirror will now be set to the correct position.

### Automatic anti-glare mirrors function

**⚠ WARNING** Risk of acid burns and poisoning due to the anti-glare mirror electrolyte

Electrolyte may escape if the glass in an automatic anti-glare mirror breaks.

The electrolyte is hazardous to health and causes irritation. It must not come into contact with your skin, eyes, respiratory organs or clothing or be swallowed.

- ▶ If you come into contact with electrolyte, observe the following:
  - Immediately rinse the electrolyte from your skin with water and seek medical attention.
  - If electrolyte comes into contact with your eyes, immediately rinse them thoroughly with clean water and seek medical attention.
  - If the electrolyte is swallowed, immediately rinse your mouth out thoroughly. Do not induce vomiting. Seek medical attention immediately.

- Immediately change out of clothing which has been contaminated with electrolyte.
- If an allergic reaction occurs, seek medical attention immediately.

The inside rearview mirror and the outside mirror on the driver's side will automatically go into anti-glare mode if light from a headlamp hits the sensor on the inside rearview mirror.

### System limits

The system will not go into anti-glare mode if:

- The vehicle is switched off.
- Reverse gear is engaged.
- The interior lighting is switched on.

### Front-passenger outside mirror parking position function

**i** The parking position is available only in vehicles with a memory function.

The parking position makes parking easier.

In the following situations, the front-passenger outside mirror will swivel downwards in the direction of the rear wheel on the front passenger's side:

- The parking position is stored (→ page 162)
- The front-passenger mirror is selected
- Reverse gear is engaged.

The front-passenger outside mirror will move back to its original position in the following situations:

- You shift the transmission to another transmission position
- You are traveling at speeds greater than 9 mph (15 km/h)
- You press the button for the outside mirror on the driver's side

### Storing and calling up the parking position of the front-passenger outside mirror

#### Storing

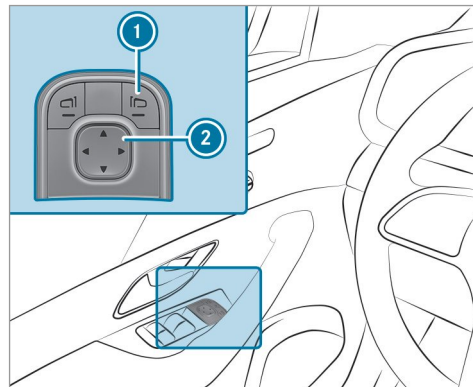

- ▶ Select the front-passenger outside mirror using button **1**.
- ▶ Engage reverse gear.
- ▶ Move the front-passenger outside mirror into the desired parking position using button **2**.

**Calling up**

- ▶ Select the front-passenger outside mirror using button ❶.
- ▶ Engage reverse gear.  
The front-passenger outside mirror will move to the stored parking position.

**Activating/deactivating the automatic mirror folding function**

Multimedia system:

- ▶  **Settings** ▶ **Vehicle**
- ▶ Switch **Automatic Folding** on or off.

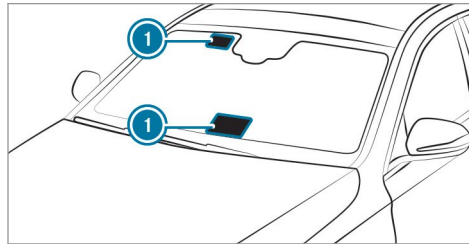
**Area permeable to radio waves on the windshield**

Radio-controlled equipment, such as toll systems, can be mounted only on areas ❶ of the windshield that are permeable to radio waves.

Areas permeable to radio waves ❶ are best visible from outside the vehicle when the windshield is illuminated with an external light source.

Note this position for vehicles with:

- Windshield heating
- Infrared reflective windshield

**Infrared-reflective windshield function**

The infrared-reflective windshield is coated and reduces the build-up of heat in the vehicle interior. The coating shields the vehicle interior from radio waves.

## Overview of climate control systems

### Notes on climate control

An interior air filter in combination with the prefilter in the engine compartment must always be used so that the air conditioning system, pollution level monitoring and the air filtration work correctly. Use filters recommended and approved by Mercedes-Benz. Always have maintenance work carried out at a qualified specialist workshop.

### Overview of the air conditioning control panel

The indicator lamps on the buttons indicate that the corresponding function is activated.

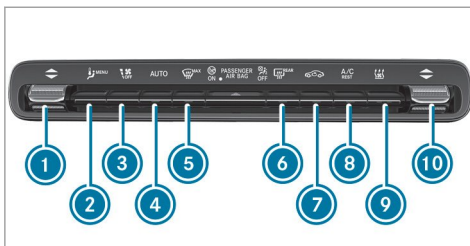

Control panel for 3-zone automatic climate control with stationary heater (example)

- ① Sets the temperature on the driver's side
- ② Calls up the air conditioning menu
- ③ Sets the airflow or switches off climate control
- ④ **AUTO** Sets climate control to automatic mode (→ page 166)
- ⑤ Defrosts the windshield
- ⑥ Switches the rear window heater on/off
- ⑦ Switches air-recirculation mode on/off (→ page 167)

- ⑧ Switches the A/C function on/off (→ page 165)  
Switches residual heat on/off (→ page 167)
- ⑨ Vehicles with control panel for dual-zone or 3-zone automatic climate control with stationary heater: switches stationary heater on/off  
Vehicles with control panel for dual-zone or 3-zone automatic climate control without stationary heater: **SYNC** switches synchronization on/off (→ page 167)
- ⑩ Sets the temperature on the front passenger side
- ① Dual-zone automatic climate control equipment is available for all vehicles except Mercedes-Maybach vehicles.

## Overview of the rear operating unit

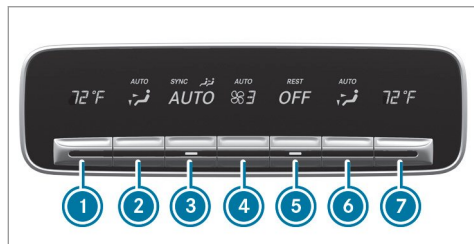



Example: USA

- ① Sets the temperature, left
- ② Sets the air distribution, left
- ③ Sets climate control to automatic mode (→ page 166)
- ④ Sets the airflow
- ⑤ Switches climate control on/off (→ page 165)  
Switches residual heat on/off (→ page 167)
- ⑥ Sets the air distribution, right
- ⑦ Sets the temperature, right

The settings for the second and third row of seats (equipment-dependent) can be made via the rear operating unit, the multimedia system (→ page 166) or the MBUX rear tablet depending on the vehicle's equipment.

## Operating the climate control system

### Switching climate control on/off

- ▶ **To switch on:** set the airflow to level 1 or higher using the  button.
- ▶ **To switch off:** set the airflow to level 0 using the  button.

If climate control is switched off, the windows may fog up more quickly. Switch climate control off only briefly.

### Switching the climate control in the rear passenger compartment on/off

- ▶ Press button ⑤.
- ⓘ When climate control in the second seat row is switched off, the indicator lamp is activated and **OFF** is shown on the rear display.

### Switching the A/C function on/off using the air conditioning control panel

The A/C function heats, cools and dehumidifies the vehicle's interior air.

- ▶ Press the  button.

Switch off the A/C function only briefly; otherwise, the windows may fog up more quickly.

Condensation may drip from the underside of the vehicle when cooling mode is active. This is not indicative of a malfunction.

### Calling up the air conditioning menu

#### Calling up the air conditioning menu using the multimedia system

- ▶ Select one of the temperature displays at the lower edge of the media display.

### Activating/deactivating the A/C function via the multimedia system

Multimedia system:

↳ Climate Menu ▶▶ First Row of Seats

The A/C function heats, cools and dehumidifies the vehicle's interior air.

▶ Select A/C.

### Setting climate control to automatic mode

In automatic mode, the set temperature is controlled and maintained at a constant level by the air supply.

▶ Press the **AUTO** button.

▶ **To switch to manual mode:** press the **AUTO** button.

In automatic mode, you can choose between five different air quantities using the  button. Automatic mode is retained.

### Automatically controlling the climate control in the rear passenger compartment

In automatic mode, the set temperature is regulated by the temperature of the dispensed air and the airflow.

▶ Press the **AUTO** button (→ page 165).



### Setting the air distribution

Multimedia system:

↳ Climate Menu

▶ Call up the air conditioning menu (→ page 165).

▶ Select a row of seats.

▶ **To set the air distribution:** select ,  or .

▶ Set the airflow.

ⓘ Several air distribution options can be selected at the same time, for example to set the climate control for the windshield and the footwells simultaneously.

The  climate control for the windshield can only be selected for the first seat row.

### Setting climate control for the rear passenger compartment (multimedia system)

Multimedia system:

↳ Climate Menu ▶▶ Second Row of Seats

#### Setting the temperature

▶ Select **Second Row of Seats** or **Third Row of Seats**.

ⓘ Maybach vehicles are only equipped with one and two rows of seats.

▶ Set the temperature.

#### Setting the airflow

▶ Select **Second Row of Seats** or **Third Row of Seats**.

ⓘ Maybach vehicles are only equipped with one and two rows of seats.

▶ Set the airflow.

#### Controlling the rear climate control automatically

▶ Select **REAR AUTO**.

Rear climate control is controlled automatically.



### Deactivating rear climate control

- ▶ Select **REAR OFF**.  
Rear climate control is deactivated.

### Switching the synchronization function on/off via the air conditioning control panel

Climate control can be set centrally using the synchronization function. The temperature and air distribution setting for the driver's side will be adopted automatically for all climate control zones.

- ▶ Press the **SYNC** button.

The synchronization function will be deactivated if the settings for one of the other climate zones are changed.

### Switching the synchronization function on/off via the multimedia system

Multimedia system:

- ▶ **Climate Menu** ▶ **First Row of Seats**

Climate control can be set centrally using the synchronization function. The driver's settings for

temperature, air quantity and air distribution are adopted automatically for all climate zones.

- ▶ Select **SYNC** and switch on or off.

### Removing condensation from the windows

#### Windows fogged up on the inside

- ▶ Press the **AUTO** button.
- ▶ If the windows continue to fog up: press the **MAX** button.

#### Windows fogged up on the outside

- ▶ Switch on the windshield wipers.
- ▶ Press the **AUTO** button.

### Switching air-recirculation mode on/off

- ▶ Press the  button.  
The interior air will be recirculated.

Air-recirculation mode automatically switches to fresh air mode after a while.

- ⓘ If air-recirculation mode is switched on, the windows may fog up more quickly. Switch on air-recirculation mode only briefly.

### Switching the residual heat on or off

#### Requirements:

- The vehicle is parked.

It is possible to make use of the residual heat from the engine to continue heating or ventilating the front compartment of the vehicle for approximately 30 minutes, depending on the temperature set.

- ▶ **To activate:** press **A/C RES** button.

Residual heat will be switched off automatically.

### Switching the residual heat in the rear passenger compartment on/off

#### Requirements:

- The vehicle is parked.

When the residual heat of the engine is activated in the rear compartment, you can heat or ventilate

the rear passenger compartment for approximately 30 minutes.

- ▶ Press button  (→ page 165).

### Activating/deactivating ionization

Multimedia system:

- ▶  [Climate Menu](#) ▶ [Air Quality](#)

Ionization improves the quality of the vehicle's interior air. Ionization of the interior air is odorless.

- ▶ Select **IONIZATION** and activate or deactivate the function.

### Fragrance system

#### Setting the fragrance system

##### Requirements:

- Automatic climate control is activated.
- The glove box is closed.

Multimedia system:

- ▶  [Climate Menu](#) ▶ [Air Quality](#)

The fragrance system distributes a pleasant fragrance throughout the vehicle interior from a flacon located in the glove box.

- ▶ Select **AIR FRESHENER**.
- ▶ Keep pressing until the desired intensity is reached.

#### Inserting or removing the flacon of the fragrance system

 **WARNING** Risk of injury from liquid perfume

If children open the flacon, they could drink the liquid perfume or it could come into contact with their eyes.

- ▶ Do not leave children unattended in the vehicle.
- ▶ Consult a doctor immediately if liquid perfume has been drunk.

- ▶ If liquid perfume comes into contact with your eyes or skin, rinse your eyes with clean water.
- ▶ If symptoms continue, consult a doctor.

 **ENVIRONMENTAL NOTE** Environmental damage due to improper disposal of full flacons



Full flacons must not be disposed of with household waste.



Full flacons must be taken to a harmful substance collection point.

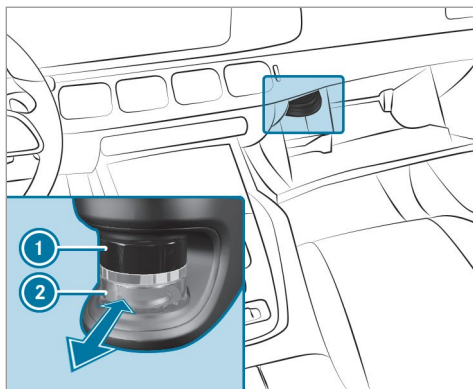

- ① Cap
- ② Flacon

- ▶ **To insert:** slide the flacon into the holder as far as it will go.
- ▶ **To remove:** after opening the glove box, wait for approximately seven seconds and pull out the flacon.

If you do not use genuine Mercedes-Benz interior perfumes, observe the manufacturers' safety notices on the perfume packaging.

Dispose of the genuine Mercedes-Benz interior perfume flacon when it is empty and do not refill it.

#### Refillable flacon

- ▶ Unscrew the cap of the empty flacon.
- ▶ Fill the flacon with a maximum of 0.5 fl. oz. (15 ml).
- ▶ Screw the cap back on to the flacon.

Always refill the empty refillable flacon with the same perfume. Observe the separate information sheet with the flacon.

#### Information on the windshield heater

The windshield heater is switched on automatically if the  button is activated.

In addition, it is automatically switched on when necessary.

#### Air vents

##### Adjusting the front air vents

**⚠ WARNING** Risk of burns or frostbite due to being too close to the air vents

Very hot or very cold air can flow from the air vents.

- ▶ Make sure that all vehicle occupants always maintain a sufficient distance from the air vents.
- ▶ If necessary, direct the airflow to another area of the vehicle interior.

To guarantee the flow of fresh air through the air vents into the vehicle interior, comply with the following:

- Always keep the vents and ventilation grilles in the vehicle interior clear.
- Keep the air inlet free of deposits (→ page 341).
- Optimum climate comfort is achieved with the air vents in the center position.

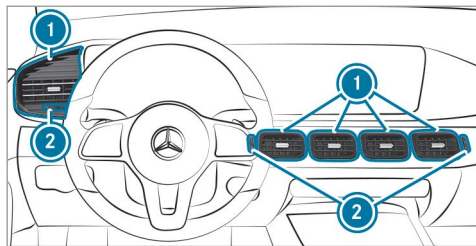

- ▶ **To open or close center air vent:** turn controller ② up or down as far as it will go.
- ▶ **To open or close side air vents:** turn controller ② to the left or right as far as it will go.
- ▶ **To adjust the air direction:** hold air vent ① in the center and move it up or down or to the left or right.

### Adjusting the rear air vents

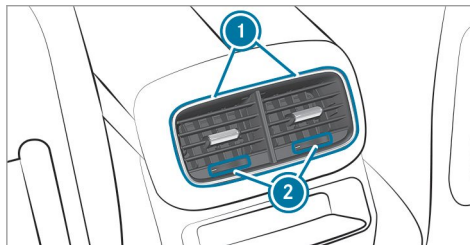

Air vents in the center console

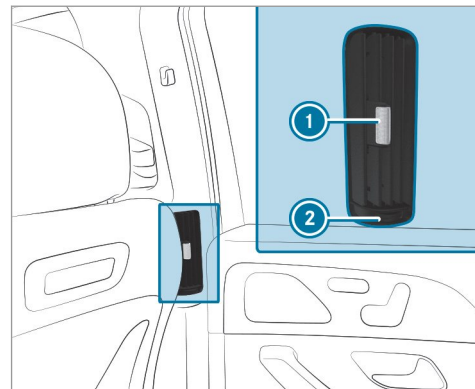

Air vents in the B-pillar

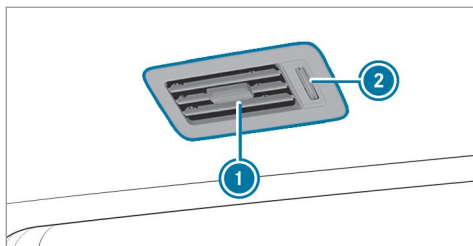

Air vents above the second and third rows of seats (all vehicles except Mercedes-Maybach vehicles)

- ▶ **To set the airflow direction:** hold air vent ① in the center and move it accordingly.
- ▶ **To open or close:** turn controller ② as far as it will go.

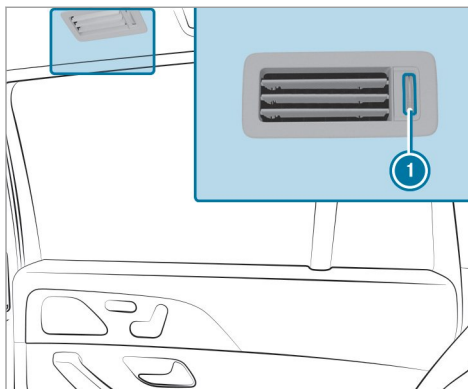

Air vents above the second row of seats, towards the cargo compartment (Mercedes-Maybach vehicles)

- ▶ **To open or close:** turn controller ① as far as it will go.

### Opening or closing the air vent in the glove box

**!** **NOTE** Damage to temperature-sensitive objects in the glove box

Temperature-sensitive objects stored in the glove box may be damaged by the air vent located inside it.

- ▶ Close the air vent when you heat the vehicle.
- ▶ At high outside temperatures, open the air vent and switch on the A/C function.

The automatic climate control must be switched on to cool the glove box.

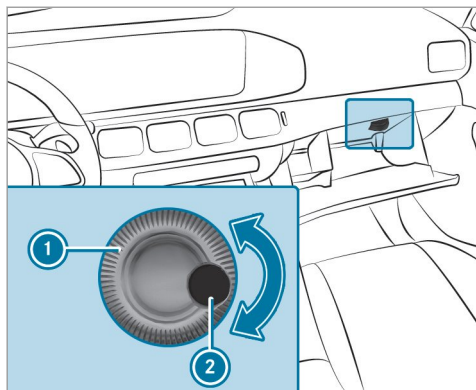

► **To open or close:** turn controller ① of air vent ② clockwise or counter-clockwise.

## Driving

### Notes on Mercedes-AMG vehicles

Observe the notes on the following topics in the Supplement, otherwise you may fail to recognize dangers.

- ① The availability of certain functions depends on the equipment and model of the vehicle.
- Emotion Start
- AMG performance exhaust system
- AMG ceramic high-performance composite brake system
- AMG adaptive sport suspension system +
- AMG active adaptive sport suspension system
- AMG steering-wheel buttons

### Switching on the power supply to the vehicle

**⚠ WARNING** Risk of accident and injury due to children left unattended in the vehicle

If children are left unsupervised in the vehicle, they could, in particular:

- open doors, thereby endangering other persons or road users.
- get out and be struck by oncoming traffic.
- operate vehicle equipment and become trapped, for example.

In addition, the children could also set the vehicle in motion, for example by:

- releasing the parking brake.
- changing the transmission position.
- starting the vehicle.

▶ Never leave children unattended in the vehicle.

▶ When leaving the vehicle, always take the SmartKey with you and lock the vehicle.

▶ Keep the vehicle SmartKey out of reach of children.

#### Requirements:

- The SmartKey is in the vehicle and is recognized.
- The brake pedal is not depressed.

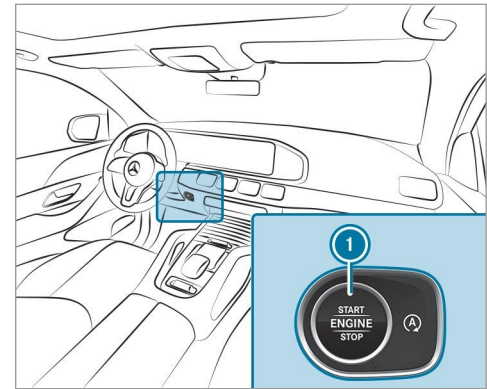

- ▶ **To switch on the power supply:** press button ① once.  
You can, for example, activate the windshield wipers.

The power supply is switched off again if the following conditions are met:

- You open the driver's door.
- You press button ① twice more.

- ▶ **To switch on the vehicle:** press button ① twice.  
Indicator and warning lamps go on in the instrument cluster.

The vehicle is switched off again if one of the following conditions is met:

- You do not start the vehicle within 15 minutes and the transmission is in position **P** or the electric parking brake is applied.
- You press button ① once.

## Starting the vehicle

### Starting the vehicle with the start/stop button

**⚠ DANGER** Risk of fatal injuries caused by exhaust gases

Combustion engines emit poisonous exhaust gases, such as carbon monoxide. Inhaling these exhaust gases is hazardous to health and leads to poisoning.

- ▶ Never run the vehicle and, if present, the stationary heater indoors without sufficient ventilation.

**⚠ WARNING** Risk of fire due to flammable material in the engine compartment or the exhaust system

Flammable materials may ignite.

- ▶ Therefore, check regularly that there are no flammable materials in the engine compartment or on the exhaust system.

### Requirements:

- The SmartKey is in the vehicle and is recognized.

- ▶ Shift the transmission to position **P** or **N**.
- ▶ Depress the brake pedal and press button ① once.
- ▶ If the vehicle does not start: switch off non-essential consumers and press button ① once.
- ▶ If the vehicle still does not start and the display message **Place the Key in the Marked Space See Operator's Manual** appears in the instrument display: start the vehicle with the SmartKey in the marked space (emergency operation mode) (→ page 175).

- ① You can switch off the vehicle while driving. To do this, press button ① for about three seconds or by pressing button ① three times within three seconds. Be sure to observe the safety notes under "Driving tips" (→ page 178).



Observe any information regarding display messages that can be displayed on the instrument display.

### Starting the vehicle with the SmartKey in the marked space (emergency operation mode)

If the vehicle does not start and the [Place the Key in the Marked Space See Operator's Manual](#) message appears in the instrument display, you can start the vehicle in emergency operation mode.

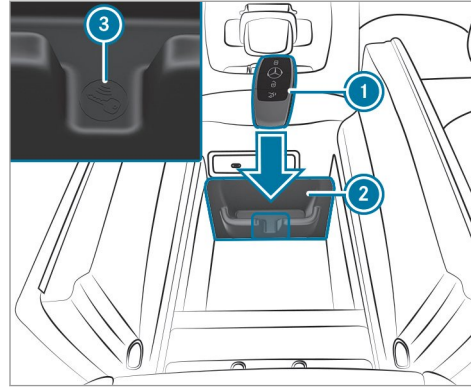

- ▶ Make sure that marked space ② is empty.
- ▶ Remove SmartKey ① from the key ring.
- ▶ Place SmartKey ① in marked space ② next to symbol ③.  
The vehicle will start after a short time.  
When you remove SmartKey ① from marked space ②, the vehicle can be driven. For further engine starts however, SmartKey ①

must be located in marked space ② next to symbol ③ during the entire journey.

- ▶ Have SmartKey ① checked at a qualified specialist workshop.

### If the vehicle does not start:

- ▶ Place SmartKey ① in marked space ② and leave it there.
- ▶ Depress the brake pedal and start the vehicle using the start/stop button.

ⓘ You can switch on the power supply or the vehicle with the start/stop button.

Observe any information regarding display messages that can be displayed on the instrument display.

### Starting the vehicle via Remote Online Services

#### Cooling or heating the vehicle interior before starting the journey

Ensure the following before starting the engine:

- The legal stipulations in the area where your vehicle is parked allow engine starting via smartphone.

- It is safe to start and run the engine where your vehicle is parked.
- The fuel tank is sufficiently full.
- The starter battery is sufficiently charged.

### Charging the starter battery before starting the journey

You can receive a message on your smartphone when the state of charge of the starter battery is low. You can then start the vehicle with the smartphone to charge the battery. The vehicle is automatically switched off after ten minutes.

Ensure the following before starting the vehicle:

- The legal stipulations in the area where your vehicle is parked allow engine starting via smartphone.
- It is safe to start and run the engine where your vehicle is parked.
- The fuel tank is sufficiently full.

### Starting the vehicle (Remote Online)

**⚠ WARNING** Risk of crushing or entrapment due to unintentional starting of the engine

Limbs could be crushed or trapped if the engine is started unintentionally during service or maintenance work.



- ▶ Always secure the engine against unintentional starting before carrying out maintenance or repair work.

#### Requirements:

- Park position **P** is selected.
  - The anti-theft alarm system is not activated.
  - The panic alarm is not activated.
  - The hazard warning light system is switched off.
  - The hood is closed.
  - The doors are closed and locked.
  - The windows and sliding sunroof are closed.
- ▶ Start the vehicle using the smartphone. After every engine start, the engine runs for ten minutes.

You can carry out a maximum of two consecutive starting attempts. You must start the engine with the SmartKey before trying to start the vehicle again with the smartphone.

You can switch off the vehicle at any time as follows:

- Via the smartphone app
  - By pressing the  or  button on the SmartKey
- i** Further information can be found in the smartphone app.

#### Securing the vehicle against starting before carrying out maintenance or repair work:

- ▶ Switch on the hazard warning light system.
- or
- ▶ Unlock the doors.
- or
- ▶ Open a side window or the sliding sunroof.

### Breaking-in notes

To preserve the engine during the first 1,000 miles (1,500 km):

- Drive at varying road speeds and engine speeds.
- Do not drive at speeds greater than 85 mph (140 km/h).
- Drive the vehicle in drive program **C** or **E**.
- Shift to the next highest gear at the very latest when the needle reaches the last third before the red area in the tachometer.
- Do not shift down manually in order to brake.
- Avoid overstraining the vehicle, e.g. driving at full throttle.
- Do not depress the accelerator pedal past the pressure point (kickdown).
- Only increase the engine speed gradually and accelerate the vehicle to full speed after 1,000 miles (1,500 km).

This also applies when the engine or parts of the drivetrain have been replaced.

Please also observe the following breaking-in notes:

- In certain driving and driving safety systems, the sensors adjust automatically while a certain distance is being driven after the vehicle has been delivered or after repairs. Full system effectiveness is not reached until the end of this teach-in process.
- Brakepads, brake discs and tires that are either new or have been replaced only achieve optimum braking effect and grip after several hundred kilometers of driving. Compensate for the reduced braking effect by applying greater force to the brake pedal.

### Notes on optimized acceleration

If all necessary requirements and activation conditions are fulfilled, the best possible acceleration can be achieved from a standstill.

Do not use the optimized acceleration on public roads. Individual wheels could spin and you could lose control of the vehicle. There is an increased risk of skidding and/or accident.

Be sure to observe the safety notes and information on ESP® (→ page 212).

### Pulling away with optimized acceleration

**⚠ WARNING** Risk of skidding and having an accident from wheels spinning

When you use optimized acceleration, individual wheels could spin and you could lose control of the vehicle.

If ESP® is deactivated, there is a risk of skidding and accident.

- ▶ Make sure that no persons or obstacles are in the close vicinity of your vehicle.

### Requirements:

- The vehicle has been broken in (→ page 177).
- The vehicle and tires are in good condition.
- You are on a high-grip roadway.
- The engine and transmission are at normal operating temperature.

**NOTE** Increased wear due to optimized acceleration

When pulling away with optimized acceleration, all components of the drivetrain are subjected to a very high load.

This can lead to increased component wear.

- ▶ Do not always pull away with optimized acceleration.

- ▶ Engage the **D** drive position (→ page 194).
- ▶ Move the steering wheel to the straight-ahead position.
- ▶ Select the sportiest available drive program **S** or **S** (→ page 190).
- ▶ Deactivate ESP® (→ page 214).
- ▶ Depress and hold the brake pedal firmly with your left foot.
- ▶ With your right foot, fully depress the accelerator pedal.

- ▶ After no more than five seconds, take your left foot quickly off the brake, but keep the accelerator pedal depressed. The vehicle pulls away at maximum acceleration.
- ▶ Switch on ESP® once the acceleration procedure is complete.

#### Ending optimized acceleration

- ▶ Remove your foot from the accelerator pedal.
- ▶ Reactivate the ESP®.
- ⓘ After you pull away with optimized acceleration, components of the drivetrain can become very hot, which means that optimized acceleration values may be reached again only after a few minutes.

#### Notes on driving

**WARNING** Risk of accident due to objects in the driver's footwell

Objects in the driver's footwell may impede pedal travel or block a depressed pedal.

This jeopardizes the operating and road safety of the vehicle.

- ▶ Stow all objects in the vehicle securely so that they cannot get into the driver's footwell.
- ▶ Always install the floor mats securely and as prescribed in order to ensure that there is always sufficient room for the pedals.
- ▶ Do not use loose floor mats and do not place floor mats on top of one another.

**WARNING** Risk of accident due to incorrect footwear

Incorrect footwear includes, for example:

- Shoes with platform soles
- Shoes with high heels
- Slippers

There is a risk of an accident.

- ▶ Always wear suitable footwear so that you can operate the pedals safely.

**⚠ WARNING** Risk of accident if the vehicle is switched off while driving

If you switch off the vehicle while driving, safety functions are restricted or no longer available.

This may affect the power steering system and the brake force boosting, for example.

You will need to use considerably more force to steer and brake, for example.

- ▶ Do not switch off the vehicle while driving.

**⚠ DANGER** Risk of fatal injuries caused by exhaust gases

Combustion engines emit poisonous exhaust gases, such as carbon monoxide. Inhaling these exhaust gases is hazardous to health and leads to poisoning.

- ▶ Never run the vehicle and, if present, the stationary heater indoors without sufficient ventilation.

**⚠ WARNING** Risk of skidding and of an accident due to shifting down on slippery road surfaces

If you shift down on slippery road surfaces to increase the engine braking effect, the drive wheels may lose traction.

- ▶ Do not shift down on slippery road surfaces to increase the engine braking effect.

**⚠ DANGER** Risk of fatal injury due to poisonous exhaust gases

If the tailpipe is blocked or sufficient ventilation is not possible, poisonous exhaust gases such as carbon monoxide may enter the vehicle. This is the case, for example, if the vehicle gets stuck in the snow.

- ▶ Keep the tailpipe and the area around the vehicle free from snow when the vehicle or the stationary heater is running.

- ▶ Open a window on the side of the vehicle facing away from the wind to ensure an adequate supply of fresh air.

**⚠ WARNING** Risk of accident and injury due to being under the influence of alcohol and drugs while driving

Drinking and driving and/or taking drugs and driving are very dangerous combinations. Even a small amount of alcohol or drugs can affect your reflexes, perceptions and judgment.

The possibility of a serious or even fatal accident are greatly increased when you drink or take drugs and drive.

- ▶ Do not drink or take drugs and drive or allow anyone to drive who has been drinking or taking drugs.

**⚠ WARNING** Risk of accident due to the brake system overheating

If you leave your foot on the brake pedal when driving, the brake system may overheat.

This increases the braking distance and the brake system can even fail.

- ▶ Never use the brake pedal as a footrest.
- ▶ Do not depress the brake pedal and the accelerator pedal at the same time while driving.

**!** **NOTE** Engine damage due to excessively high engine speeds

The engine will be damaged if you drive with the engine in the overrevving range.

- ▶ Do not drive with the engine in the overrevving range.

**!** **NOTE** Wearing out the brake linings by continuously depressing the brake pedal

- ▶ Do not depress the brake pedal continuously whilst driving.
- ▶ To use the braking effect of the engine, shift to a lower gear in good time.

**!** **NOTE** Damage to the drivetrain and engine when pulling away

- ▶ Do not warm up the engine while the vehicle is stationary. Pull away immediately.
- ▶ Avoid high engine speeds and driving at full throttle until the engine has reached its operating temperature.

**!** **NOTE** Damage to the catalytic converter due to non-combusted fuel

The engine is not running smoothly and is misfiring.

Non-combusted fuel may get into the catalytic converter.

- ▶ Only depress the accelerator pedal slightly.
- ▶ Have the cause rectified immediately at a qualified specialist workshop.

**!** **NOTE** Reduced battery life due to frequent short-distance trips

The 12 V battery may not be sufficiently charged when the vehicle is used only for short-distance trips. This reduces the life of the battery.

- ▶ Drive longer distances regularly to charge the battery.

**!** **NOTE** Damage to the vehicle due to not observing the maximum permitted headroom clearance

If the vehicle height is greater than the maximum permitted headroom clearance, the roof and other parts of the vehicle may be damaged.

- ▶ Observe the signposted headroom clearance.
- ▶ If the vehicle height is greater than the permitted headroom clearance, do not enter.

- ▶ Observe the changed vehicle height with add-on roof equipment.

### Notes on driving with a roof load, trailer or fully laden vehicle

When driving with a loaded roof luggage rack or trailer as well as with a fully laden or fully occupied vehicle, the vehicle's driving and steering characteristics change.

You should bear the following in mind:

- Do not exceed the permissible roof load and towing capacity. Also observe the technical data in the printed Operator's Manual.
- Evenly distribute the roof load, and place heavy objects at the bottom. Also comply with the notes on loading the vehicle (→ page 124).
- Drive attentively, and avoid suddenly pulling away, braking and steering as well as rapid cornering.

### Notes on driving on salt-treated roads

The braking effect is limited on salt-treated roads.

Therefore, observe the following notes:

- Due to salt build-up on the brake discs and brakepads, the braking distance can increase considerably or result in braking only on one side
- Maintain a much greater safe distance to the vehicle in front

To remove salt build-up:

- Brake occasionally while paying attention to the traffic conditions
- Carefully depress the brake pedal at the end of the journey and when starting the next journey

### Notes on hydroplaning

Hydroplaning can take place once a certain amount of water has accumulated on the road surface.

Observe the following notes during heavy precipitation or in conditions in which hydroplaning may occur:

- Reduce speed
- Avoid tire ruts

- Avoid sudden steering movements
- Brake carefully

**i** Also observe the notes on regularly checking wheels and tires (→ page 370).

### Notes on driving through water on the road surface

Water which has entered into the vehicle can damage the engine, electrics and transmission.

Water can also enter the air intake of the engine and cause engine damage.

Observe the following if you must drive through water:

- Observe the maximum permissible fording depth (→ page 418).
- Drive at a maximum speed of 6 mph (10 km/h); water can otherwise enter the vehicle interior or engine compartment.
- Vehicles traveling in front, or oncoming vehicles, can create waves which may exceed the maximum permissible depth of the water.

The braking effect of the brakes is reduced after fording. Brake carefully while paying attention to

the traffic conditions until braking power has been fully restored.

### Notes on off-road driving

**⚠ WARNING** Risk of accident if you do not keep to line of fall on inclines

If you drive at an angle or turn on an incline, the vehicle could slip sideways, tip and roll-over.

- ▶ Always drive on inclines in the line of fall (straight up or down) and do not turn.

**⚠ WARNING** Risk of fire due to flammable materials on hot parts of the exhaust system

Flammable material such as leaves, grass or twigs may ignite if they come into contact with hot parts of the exhaust system.

- ▶ When driving on unpaved roads or off-road, regularly check the vehicle underside.

- ▶ Remove trapped plants or other flammable material, in particular.
- ▶ If there is damage, consult a qualified specialist workshop immediately.

When driving off-road, sand, mud and water or water mixed with oil may get into the brakes. This may lead to a reduction in braking effect or total brake failure as a result of increased wear. The braking characteristics will vary depending on the material that has entered the system. Clean the brakes after driving off-road. If you then notice reduced braking effect or hear scraping noises, have the brake system checked at a qualified specialist workshop. Adapt your driving style to the changed braking characteristics.

**! NOTE** Damage caused by driving over obstacles

The vehicle can be damaged by:

- Driving onto high curbs or unpaved roads.
- Quickly driving over obstacles such as curbs, speed bumps or potholes.

- Heavy objects hitting the underbody or chassis components.
- ▶ Do not drive over obstacles that could damage the vehicle.
- ▶ Check the vehicle regularly for damage during off-road driving.
- ▶ Adjust the vehicle speed to suit the road surface conditions.
- ▶ If there is damage, consult a qualified specialist workshop immediately.

**🔥 ENVIRONMENTAL NOTE** Environmental damage due to non-observance of prohibition signs

Environmental protection has priority. Treat nature with respect.

- ▶ Be sure to observe prohibition signs.

### Checklist before driving off-road

Check the following points before driving off-road:



- Fuel level



- Engine oil level: fill engine oil to the maximum level to ensure full gradeability (→ page 337)
  - Tire-change tool kit and spare wheel
  - Tires and wheels
- i** Further information about special all-terrain tires for retrofitting can be obtained from a qualified specialist workshop.

### Off-road driving

Read this section before driving your vehicle off-road. Practice by driving over more gentle off-road terrain first.

- Observe the notes on the cross-country ABS (→ page 211).
- If necessary, select the  or  drive program (vehicles with Off-road package) before driving off-road (→ page 190).
- Before driving off-road, shift the transfer case to the **LOW RANGE** off-road gear (vehicles with Off-road package) (→ page 198).
- Select a vehicle level suitable for off-road terrain (→ page 249). To avoid damaging the

vehicle, make sure there is always sufficient ground clearance.

- Always keep the engine running and in gear when driving on downhill gradients and embankments. Observe the notes on driving in mountainous terrain.
- Do not drive on unknown terrain that is not easily visible and stay on marked routes.
- Always keep the doors and windows closed while the vehicle is in motion.
- Deactivate Active Distance Assist DISTRONIC and cruise control.
- Adapt your driving style to the terrain.
- Do not use the HOLD function on steep downhill or uphill gradients with slippery or loose surfaces.

### Driving on sand

When driving on sand, also observe the following instructions:

- Select the  drive program.
- Select a higher vehicle level.
- Shift to a lower gear.

- Drive quickly to overcome the rolling resistance; the vehicle may otherwise dig itself in.
- Drive in the tracks of other vehicles if possible. Make sure that the following prerequisites are met:
  - The tire ruts are not too deep
  - The sand is firm enough
  - The ground clearance is sufficient

### Fording

Also observe the following information when fording:

- **Vehicles with AIR BODY CONTROL:** select the highest possible vehicle level (→ page 249).
- **Vehicles with E-ACTIVE BODY CONTROL:** select the highest possible vehicle level (→ page 257).
- Drive no faster than 6 mph (10 km/h).
- Observe the maximum permissible fording depth (→ page 418).
- Switch off automatic climate control (→ page 166).

- Ensure that a bow wave does not form as you drive.
- Do not stop in the water and do not switch off the engine. Ensure the ECO start/stop function is switched off (→ page 186).

### Driving in mountainous terrain

Also observe the following information when driving in mountainous terrain:

- Observe the values of the approach/departure angle and of the maximum gradient (→ page 418).
- Avoid high engine speeds.
- Use the braking power of the engine when driving downhill.
- Shift to a lower gear on uphill gradients and on long, steep downhill gradients.
- Activate DSR before driving downhill, if necessary (→ page 227).

### Checklist after driving off-road

Driving off-road places greater demands on your vehicle than driving on normal roads. Check the entire vehicle for damage and foreign bodies

every time after driving off-road. Foreign bodies in the wheels or drivetrain can lead to imbalances and therefore vibrations.

- If the  or  drive program is selected: select another drive program.
- Shift the transfer case to the on-road position **HIGH RANGE**.
- Deactivate DSR.
- Lower the vehicle level again to a level suitable to the road conditions, e.g. to the normal level.
- Apply the brakes to dry them after fording.
- Check that the service brake is working normally after a long downhill stretch.
- Clean the following components every time after driving off-road:
  - License plate number
  - Headlamps and tail lamps
  - Tires, wheels and wheel arches
  - Underbody

- After driving through sand, mud, water or gravel, have the following components checked and cleaned:
  - Brake discs and brakepads
  - Tires and wheels
  - Axle joints

### ECO start/stop function

#### ECO start/stop function

 Depending on the engine, the ECO start/stop function is not available in all drive programs. Observe the status display in the instrument display for this.

**Mercedes-Maybach vehicles:** the Glide mode function is not available.

The engine is switched off automatically in the following situations if all vehicle conditions for an automatic engine stop are met:

- You brake the vehicle to a standstill in transmission position **D** or **N**.

- **Vehicles with a 48 V on-board electrical system:** you depress the brake pedal when traveling at a low speed.

If the system has detected one of the following situations, the engine will not stop:

- You stop at a stop sign and there is no vehicle in front of you.
- The vehicle that stopped in front of you starts up again.
- You maneuver, turn the steering wheel sharply or engage reverse gear.





- **i** If the system detects an intelligent stop inhibitor, for example, a stop sign, the engine will not stop.  
If you activate the HOLD function or engage the park position **P**, the engine can be switched off in spite of an intelligent stop inhibitor.

The engine restarts automatically in the following cases:

- You engage transmission position **D** or **R**.
- You depress the accelerator pedal.

- The vehicle requires an automatic engine start.
- You release the brake pedal.
- **Vehicles with a 48 V on-board electrical system:**
  - You release the brake pedal on a downhill gradient and the vehicle does not roll.
  - The vehicle rolls on a downhill gradient and does not automatically enter glide mode at 15 mph (20 km/h).

ECO start/stop function symbols in the instrument display:

- The  symbol (green) appears when the vehicle is at a standstill: the engine was switched off by the ECO start/stop function.
- The  symbol (yellow) appears when the vehicle is at a standstill: not all vehicle conditions for an engine stop have been met.
- Neither the  nor  symbol appears when the vehicle is at a standstill: an intelligent stop inhibitor was detected, e.g. a stop sign.

- The  symbol appears: the ECO start/stop function is deactivated or there is a malfunction.

If the engine was switched off by the ECO start/stop function and you leave the vehicle, a warning tone sounds and the engine is not restarted. In addition, the following display message appears in the instrument display:

**Vehicle Ready to Drive Switch the Ignition Off Before Exiting**

If you do not switch off the vehicle, it is automatically switched off after three minutes.

## Deactivating or activating the ECO start/stop function

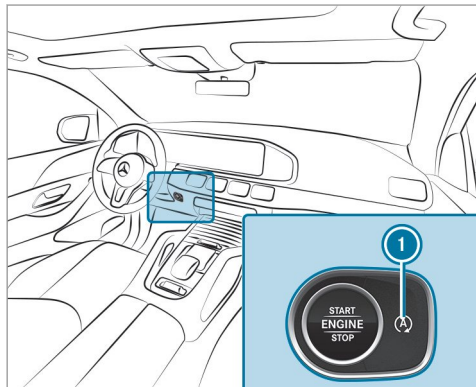

▶ Press button ①.  
A display appears in the instrument cluster when switching the ECO start/stop function off/on.

ⓘ A continuous  display appears in the instrument cluster while the ECO start/stop function is deactivated.

## ECO display function

The ECO display summarizes your driving characteristics from the start of the journey to its completion and assists you in achieving the most economical driving style.

You can influence consumption by doing the following:

- Driving with particular care.
- Driving in drive program 
- Following the gearshift recommendations.

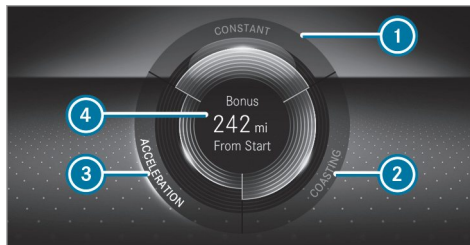

The lettering in the segment will light up brightly, the outer edge will light up and the segment will fill up when the following driving style is adopted:

- ① Steady speed
- ② Gentle deceleration and rolling
- ③ Moderate acceleration

The lettering in the segment will be gray, the outer edge will be dark and the segment will empty when the following driving style is adopted:

- ① Fluctuations in speed
- ② Heavy braking
- ③ Sporty acceleration

The ECO display will show you when you have driven economically:

- The three segments will fill up completely at the same time
- The edges around all three segments will light up

The additional range achieved as a result of your driving style in comparison with a driver with a very sporty driving style will be shown on the cen-

ter of display ④. The range displayed does not indicate a fixed reduction in consumption.

### ECO Assist function (vehicles with 48 V on-board electrical system)

ECO Assist analyzes data for the vehicle's expected route. This allows the system to optimally adjust the driving style for the route ahead, save fuel and recuperate.

ECO Assist is displayed on the Assistance menu (→ page 284).

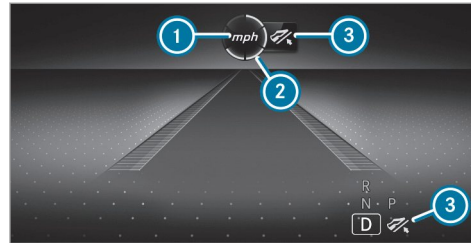

- ① Event ahead
- ② Distance display for the event ahead
- ③ "Foot off the accelerator" prompt

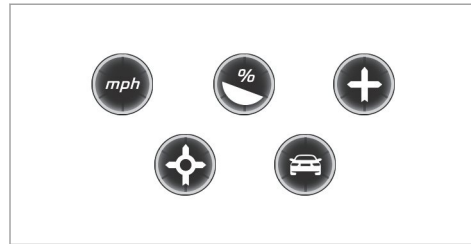

Displayable route events ①

The segments of distance display ② show the distance to the event ahead as follows:

- A few segments light up: the event ahead is near.
- Many segments light up: the event ahead is further away.

When the vehicle nears the event, ECO Assist will calculate the optimal speed for maximum fuel economy and recuperative energy based on the distance, speed and gradient. The **Foot off the Accelerator** message ③ appears in the instrument display. The first segments in front of the vehicle will turn green. The remaining segments will initially stay white. If you take your foot off the accelerator pedal in good time, the remaining segments on the display will successively turn green until the event shown is reached. The drivetrain will be set for maximum fuel economy. Recuperation will charge the battery. Recuperation will be adapted to the selected drive program.

The event will be shown for a short time after it has been passed. If there is no response to the **Foot off the Accelerator** prompt, the segments will remain white.

If the event involves a vehicle in front, all segments will immediately turn green once there is a response to the **Foot off the Accelerator** prompt.

For active ECO Assist in drive program **[E]**, symbol **③** will appear on the instrument display and on the head-up display beside transmission position **[D]**. Symbol **③** will also appear when the assistant display is not selected.

If the system does not intervene during the event ahead, nothing will be displayed. The system will be passive.

ECO Assist is active only in drive programs **[E]** and **[C]**.

### System limits

ECO Assist can function even more precisely if the route is adhered to when route guidance is active. The basic function is also available without active route guidance. Not all information and traffic situations can be foreseen. The quality depends on the map data.

ECO Assist is only an aid. The driver is responsible for keeping a safe distance from the vehicle in front, for vehicle speed and for braking in good time. The driver must be ready to brake at all

times irrespective of whether the system intervenes.

The system may be impaired or may not function in the following situations:

- If visibility is poor, e.g. due to insufficient illumination of the road, highly variable shade conditions, rain, snow, fog or heavy spray.
- If there is glare, e.g. from oncoming traffic, direct sunlight or reflections.
- If there is dirt on the windshield in the area of the multifunction camera or the camera is fogged up, damaged or obscured.
- If road signs are hard to detect, e.g. due to dirt, snow or insufficient lighting, or because they are obscured.
- If the information on the navigation system's digital map is incorrect or out of date.
- If signs are ambiguous, e.g. road signs in roadworks or in adjacent lanes.

## DYNAMIC SELECT switch

### Function of the DYNAMIC SELECT switch

#### **!** NOTE Mercedes-AMG vehicles

- ▶ Observe the notes in the Supplement. You could otherwise fail to recognize dangers.

**i** Depending on the engine and equipment, the vehicle has different drive programs.

Use the DYNAMIC SELECT switch to change between the following drive programs.

The drive program selected appears in the instrument display.

#### **I\*** Individual

- Individual settings

#### **S\*** Sport+

- Particularly sporty driving
- Emphasizes the vehicle's own oversteering and understeering characteristics for a more active driving style

- Only suitable for good road conditions, a dry road surface and a clear stretch of road

#### **S** Sport

- Continues to offer stability but with a sporty setup
- Allows the sporty driver a more active driving style
- Only suitable for good road conditions, a dry road surface and a clear stretch of road

#### **C** Comfort

- Comfortable and economical driving
- Balance between traction and stability
- Recommended for all road conditions

#### **C<sup>+</sup>** Maybach

- Only available for Mercedes-Maybach vehicles
- Highest driving comfort for comfortable and luxurious travel

#### **E** Eco

- Particularly economical driving
- Balance between traction and stability

- Recommended for all road conditions

#### **CV** Curve

- Only available for vehicles with E-ACTIVE BODY CONTROL
- Comfortable driving with curve tilting function
- Balance between traction and stability
- Recommended for all road conditions



#### Offroad

- Only available for vehicles with Off-road package
- Intervenes later if there is oversteering or understeering, thus improving traction
- Suitable for easily negotiable off-road terrain, such as dirt tracks, gravel or sandy surfaces
- Not suitable for use on public roads

#### Offroad+

- Only available for vehicles with Off-road package
- Intervenes later if there is oversteering or understeering, thus improving traction

- Suitable for rough terrain, such as steep and/or uneven terrain or for driving on rocky terrain
- Not suitable for use on public roads

**i** **Mercedes-Maybach vehicles:** in the drive programs  and , the extendible running boards remain retracted or retract if they have already been extended.

**i** Depending on the situation, the cylinder can be briefly deactivated in the drive programs **E** and **C**, depending on the engine.

**i** The ESP<sup>®</sup> settings in the drive programs **E** and **C** are designed for stability. Therefore, choose one of these driving programs, especially when transporting roof loads, in trailer operation and when the vehicle is fully loaded or fully occupied.

Depending on the drive program, the following systems change their characteristics:

- Drive
  - engine and transmission management
  - Active Distance Assist DISTRONIC

- ESP®
- **Vehicles with AIRMATIC or E-ACTIVE BODY CONTROL:**
  - Suspension tuning
  - Vehicle level
- Electric power steering

### Notes on the roof load display

Certain drive programs and ESP® settings are unsuitable for transporting a roof load.

If one of these drive programs is set or selected, the  symbol is shown as a warning. When this symbol is shown, the selected drive program is not suitable for transporting a load on the roof.

The following drive programs are affected:

- **Sport** drive program
- **Sport +** drive program
- **Individual** drive program with the ESP® setting Sport or Sport+

 The symbol is also shown in the following situations:

- Within the themes if a corresponding drive program is saved  
For more information on themes see .
- Within the reset display if the previously active drive program is unsuitable for the transport of a roof load  
For further information on the reset display, see (→ page 191).

### Selecting the drive program

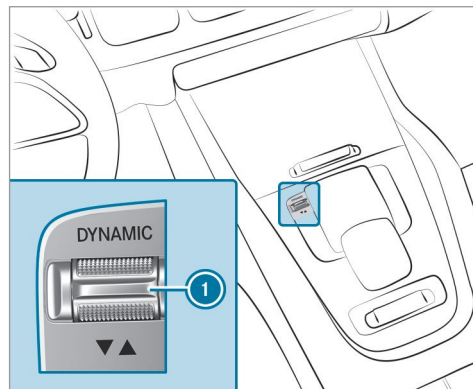

- ▶ Press DYNAMIC SELECT switch  forwards or backwards.  
The drive program selected appears in the instrument display.



### Configuring DYNAMIC SELECT (multimedia system)

Multimedia system:

→  » Settings » Vehicle  
» DYNAMIC SELECT

#### Setting drive program I

- ▶ Select **Individual Configuration**.
- ▶ Select and set a category.

#### Switching the restoration display on or off

- ▶ Activate or deactivate **Request at Start**.

**Function on:** the next time the vehicle is started a prompt appears asking whether the last active drive program should be restored. If the ECO start/stop function was deactivated, an additional prompt appears asking if the function should remain deactivated.

- ⓘ The prompt appears only if the previously active settings deviate from the standard settings.

**Function off:** the next time the vehicle is started the  drive program is set automatically. The

ECO start/stop function is activated automatically.

- ⓘ This function must be activated for each user profile separately. Only when this function is activated will the drive program and ECO start/stop setting for the previous journey be saved for the respective user profile.

### Displaying vehicle data

Multimedia system:

→  » Info

- ▶ Select **Vehicle**.  
The vehicle data is displayed.

### Displaying engine data

Multimedia system:

→  » Info

- ▶ Select **Engine**.  
The engine data is displayed.
- ⓘ The actual (maximum) values that can be achieved for engine output and engine torque may deviate from the certified values within

the country-specific guidelines for permissible tolerances (basis: UN-ECE No. 85 or country-specific guidelines).

Influencing variables that can influence this are, for example:

- Sea level
  - Fuel grade
  - Outside temperature
  - Operating temperature of the engine
- ⓘ The values displayed serve only as orientation. The values for engine output and engine torque shown on the media display may deviate from the actual values.

### Calling up the fuel consumption indicator

Multimedia system:

→  » Info

- ▶ Select **Consumption**.  
The current and average fuel consumption is displayed.

## Displaying the Offroad Score

Multimedia system:



Use the Offroad Score only for off-road driving and not on public roads. When choosing the route, take into account the vehicle characteristics, the ground conditions and your driving skills. Do not let the system distract you from what is happening on the route.

▶ Select **Offroad Score**.

A menu appears. You can start a new trip.

Further functions are available in the lower menu bar:

- Display the current trip via the route symbol.
- Display a list of all notes for the current trip using the list icon.

In the list, a note is displayed with a time stamp, the number of points currently achieved and the note text.

- Display the ranking by clicking on the symbol for the winner's podium.

The ranking list shows the following information:

- Profile name and profile picture (if available)
- The number of points obtained
- Date and time of the completed trip
- The places for gold, silver and bronze

### Starting or ending a new trip

The "Start new trip" function is available when the vehicle is stationary and the engine is running.

▶ Select **Start new trip**.

The display "Trip and tips" appears.

The following information is displayed:

- the vehicle inclination in longitudinal direction in percent (%)
- the lateral inclination of the vehicle in degrees (°)
- the currently achieved score for the ongoing trip
- a tip for the upcoming driving maneuver

▶ **To stop the display:** select **End trip**.

An evaluation of the trip is displayed. It shows the achieved score and a message, for example **Great job!**.

## Automatic transmission

### DIRECT SELECT lever

#### Function of the DIRECT SELECT lever

**▲ WARNING** Risk of accident due to incorrect gearshifting

If the engine speed is higher than the idle speed and you engage the transmission position **D** or **R**, the vehicle may accelerate sharply.

▶ If you engage the transmission position **D** or **R** when the vehicle is at a standstill, always depress the brake pedal firmly and do not accelerate at the same time.

**⚠ WARNING** Risk of accident and injury due to children left unattended in the vehicle

If children are left unsupervised in the vehicle, they could, in particular:

- open doors, thereby endangering other persons or road users.
- get out and be struck by oncoming traffic.
- operate vehicle equipment and become trapped, for example.

In addition, the children could also set the vehicle in motion, for example by:

- releasing the parking brake.
  - changing the transmission position.
  - starting the vehicle.
- ▶ Never leave children unattended in the vehicle.
- ▶ When leaving the vehicle, always take the SmartKey with you and lock the vehicle.
- ▶ Keep the vehicle SmartKey out of reach of children.

Use the DIRECT SELECT lever to switch the transmission position. The current transmission position is displayed in the instrument display.

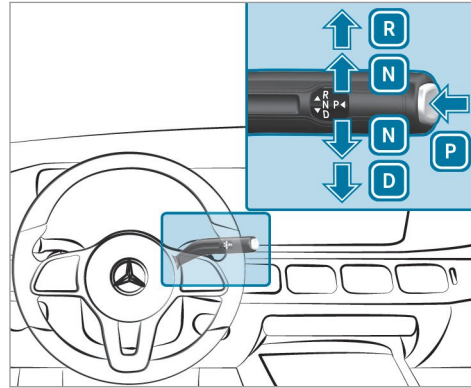

- P** Park position
- R** Reverse gear
- N** Neutral
- D** Drive position

### Engaging reverse gear R

- ▶ Depress the brake pedal and push the DIRECT SELECT lever upwards past the first point of resistance.

### Engaging neutral N

- ▶ Depress the brake pedal and push the DIRECT SELECT lever up or down to the first point of resistance.

- i** To shift into neutral **N** with the vehicle switched on, push the selector lever up or down for several seconds to the first point of resistance.

Subsequently releasing the brake pedal will allow you to move the vehicle freely, e.g. to push it or tow it away.

Proceed as follows if you want the automatic transmission to remain in neutral **[N]** even if the vehicle is switched off or the driver's door is opened:

- ▶ Depress the brake pedal and engage neutral **[N]** when the vehicle is stationary. The **N Permanently Active Risk of Rolling Away** message appears in the instrument display.
- ▶ Release the brake pedal.
- ▶ Switch off the vehicle.
- ⓘ If you then exit the vehicle leaving the Smart-Key in the vehicle, the automatic transmission remains in neutral **[N]**.

The park position **[P]** is automatically re-engaged as soon as one of the following conditions is met:

- You switch to transmission position **[D]** or **[R]**.
- You press the **[P]** button.

### Engaging park position P

- ▶ Observe the notes on parking the vehicle (→ page 201).

- ▶ Depress the brake pedal until the vehicle comes to a standstill.
- ▶ When the vehicle is at a standstill, press button **[P]**. When the transmission position display shows **[P]**, the park position is engaged. If no transmission position display **[P]** appears, secure the vehicle to prevent it from rolling away.
- ⓘ Depending on the situation, it may take a short time until **[P]** is engaged. Therefore, always pay attention to the transmission position display.

Park position **[P]** is engaged automatically if one of the following conditions is met:

- You switch the stationary vehicle off in transmission position **[D]** or **[R]**.
- You open the driver's door when the vehicle is at a standstill or when driving at a very low speed and the transmission position is **[D]** or **[R]**.
- When the vehicle is rolling, you switch it off in transmission position **[D]** or **[R]** and bring it to a standstill.

- You switch off the engine, bring the vehicle to a standstill and open the driver's door when the vehicle is stationary or when the vehicle is rolling and the transmission position is **[N]**.
- Engaging park position **[P]** automatically is required by the vehicle.
- ⓘ To maneuver with an open driver's door, open the driver's door while at a standstill and engage transmission position **[D]** or **[R]** again.

### Engaging drive position D

- ▶ Depress the brake pedal and push the DIRECT SELECT lever down past the first point of resistance.

When the automatic transmission is in transmission position **[D]**, it shifts the gears automatically. This depends, among other things, on the following factors:

- The selected drive program
- The position of the accelerator pedal
- The driving speed

## Manual gearshifting

### Permanent setting (vehicles with Off-Road package or E-ACTIVE BODY CONTROL)

#### NOTE Mercedes-AMG vehicles

- ▶ Observe the notes in the Supplement. You could otherwise fail to recognize dangers.

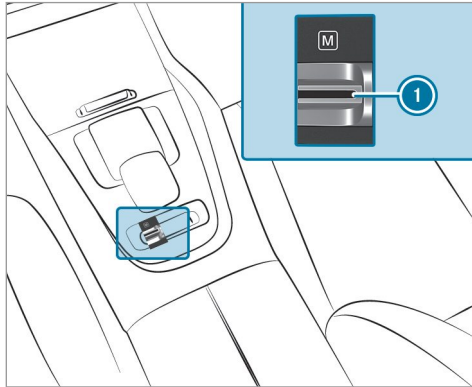

- ▶ **To activate/deactivate:** pull rocker switch ①. If indicator lamp is lit, manual shifting is activated. The current gear is displayed in the instrument display.

### Temporary setting

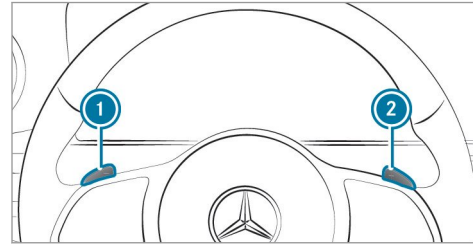

- ▶ **To activate:** pull steering wheel paddle shifter ① or ②. Manual shifting is activated for a short time. Transmission position **M** and the current gear appear in the instrument display.
- ▶ **To deactivate:** pull steering wheel paddle shifter ② and hold it in place. Transmission position **D** appears in the instrument display.

- ① To permanently shift the gears manually in drive program **L+** using the steering wheel paddle shifters, select the **M** setting for the transmission.

### Shifting

- ▶ **To shift up:** pull steering wheel paddle shifter ②.
- ▶ **To shift down:** pull steering wheel paddle shifter ①.

### Gearshift recommendation

The gearshift recommendation assists you in adopting an economical driving style.

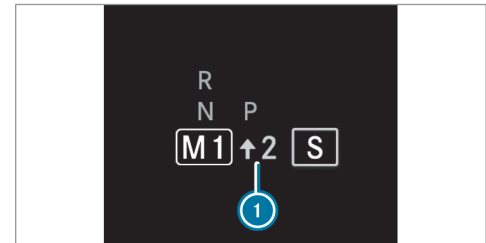

- ▶ If gearshift recommendation  appears next to the transmission position display, shift to the recommended gear.

### Using kickdown

- ▶ **Maximum acceleration:** depress the accelerator pedal beyond the pressure point.

To protect against engine overrev, the automatic transmission shifts up to the next gear when maximum engine speed has been reached.

### Glide mode function

#### **NOTE** Mercedes-AMG vehicles

- ▶ Observe the notes in the Supplement. You could otherwise fail to recognize dangers.

-  **Mercedes-Maybach vehicles:** the Glide mode function is not available.



With an anticipatory driving style, Glide mode helps you to reduce fuel consumption.

Glide mode is characterized by the following:

- The combustion engine is disconnected from the drivetrain and continues to run in neutral.
- The transmission position display  is shown in green.
- **Vehicles with 48 V on-board electrical system:** the combustion engine can be switched off. All of the vehicle functions remain active.

Glide mode is activated if the following conditions are met:

- Drive program  is selected.
- The speed is within a suitable range.
- The road's course is suitable, e.g. no steep uphill or downhill inclines or tight curves.
- There is no trailer hitched up to the trailer hitch, and no bicycle rack installed.
- You do not depress the accelerator or brake pedal (except for light brake applications).

-  Glide mode can also be activated if you have selected the "Eco" setting for the drive in the drive program .

Glide mode is deactivated again if one of the conditions is no longer met.

Glide mode can also be prevented by the following parameters:

- Incline
- Downhill gradient
- Temperature
- Height
- Speed
- Operating status of the engine
- Traffic situation

**Transfer case****Function of the transfer case**

**⚠ WARNING** Risk of skidding and having an accident when in LOW RANGE on slippery road surfaces

The wheels can block and thus lose traction on slippery road surfaces, particularly in the following situations:

- if you release the accelerator pedal when the vehicle is in motion.
- if off-road ABS intervenes when braking.

**▶** Never select the LOW RANGE off-road gear when driving on slippery road surfaces.

**⚠ WARNING** Risk of accident when the transfer case is in neutral position

The vehicle may roll away unintentionally if you do not wait until the transfer case shift operation is complete.

**▶** Wait until the transfer case shift operation is complete.

This function is only available in vehicles with Off-road package.

Shift the transfer case to the on-road position **HIGH RANGE** or into the **LOW RANGE** off-road gear.

Do not switch off the engine during shift operation and do not shift the automatic transmission to another position.

**Shift ranges**

- **HIGH RANGE:** Road position for all normal on-road driving situations
- **LOW RANGE:** Off-road gear for driving off-road, when fording and on steep uphill or downhill inclines

Properties of the LOW RANGE off-road gear:

- Reduced maximum permissible speed: 31 mph (50 km/h)
- Increased tractive power

- Changing the transmission ratio by a factor of about three
- Increased drive torque

Do not use LOW RANGE in the following situations:

- When driving on public roads.

## Shifting the transfer case

### Shifting to the LOW RANGE off-road gear

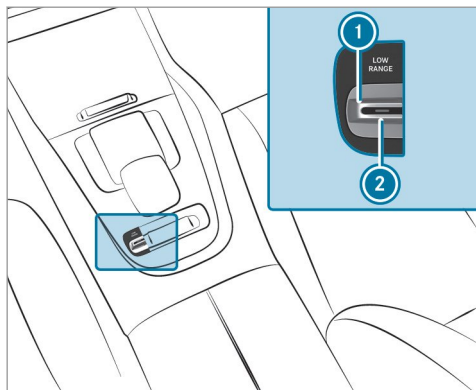

Requirements:

- You are not driving on a paved or public road.
- The vehicle is stationary.

- ▶ Pull **LOW RANGE** ① rocker switch. Indicator lamp ② will flash. The shift request stays active for a maximum of 30 seconds. If all requirements for shift operation are not fulfilled within this time, indicator lamp ② switches off again and the shift operation must be started again.
- ▶ Shift the transmission to position **N**. If shift operation is successful, the **LOW RANGE On** message appears on the instrument cluster, an audible signal sounds and indicator lamp ② and an indicator lamp in the instrument cluster light up continuously.
- ▶ Shift the transmission to position **D**.
- ⓘ If you switch off the vehicle in **LOW RANGE**, it remains in **LOW RANGE** the next time you start the engine.
- ⓘ You will not be able to switch on **LOW RANGE** if drive program **S** or **S\*** is switched on. The vehicle switches to drive program **C**.

### In the on-road position, shift to HIGH RANGE

Requirements:

- The vehicle is started and you are not driving faster than 31 mph (50 km/h).
- ▶ Pull **LOW RANGE** ① rocker switch. The shift request stays active for a maximum of 30 seconds. If all requirements for shift operation have not been fulfilled within this time, shift operation must be started again.
  - ▶ Shift the transmission to position **N**. If shift operation is successful, the **LOW RANGE Off** message appears on the instrument cluster, an audible signal sounds and the indicator lamps go out.
  - ▶ Shift the transmission to position **D**.

### Function of the 4MATIC

4MATIC ensures that all four wheels are driven. Together with ESP® and 4ETS, 4MATIC improves the traction of your vehicle whenever a driven wheel spins due to insufficient traction.



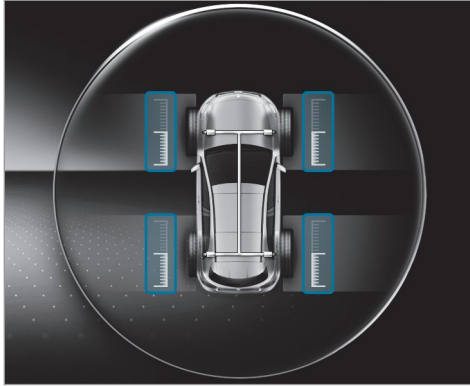

You can display the current distribution of drive torques on all four wheels in the head-up display and in the right-hand display range of the instrument display. The higher the respective scale is filled, the higher the corresponding drive torque is.

If you fail to adapt your driving style, 4MATIC can neither reduce the risk of an accident nor override the laws of physics. 4MATIC cannot take account

of road, weather and traffic conditions. 4MATIC is only an aid. You are responsible especially for maintaining a safe distance from the vehicle in front, for vehicle speed, for braking in good time and for staying in lane.

- ❗ In wintry road conditions, the maximum effect of 4MATIC can be achieved only if you use winter tires (M+S tires), with snow chains if necessary.

## Refueling

### Refueling the vehicle

- ⚠ **WARNING** Risk of fire or explosion from fuel

Fuels are highly flammable.

- ▶ Fire, open flames, smoking and creating sparks must be avoided.
- ▶ Before refueling, switch off the vehicle and, if installed, the stationary heater, and leave them switched off during refueling.

- ⚠ **WARNING** Risk of injury from fuels

Fuels are poisonous and hazardous to your health.

- ▶ Do not swallow fuel or let it come into contact with skin, eyes or clothing.
- ▶ Do not inhale fuel vapor.
- ▶ Keep children away from fuel.
- ▶ Keep doors and windows closed during the refueling process.

If you or other people come into contact with fuel, observe the following:

- ▶ Immediately rinse fuel off your skin with soap and water.
- ▶ If fuel comes into contact with your eyes, immediately rinse them thoroughly with clean water. Seek medical attention immediately.
- ▶ If you swallow fuel, seek medical attention immediately. Do not induce vomiting.

- ▶ Change immediately out of clothing that has come into contact with fuel.

**⚠ WARNING** Risk of fire and explosion due to electrostatic charge

Electrostatic charge can ignite fuel vapor.

- ▶ Before you open the fuel filler cap or take hold of the pump nozzle, touch the metallic vehicle body.
- ▶ To avoid creating another electrostatic charge, do not get into the vehicle again during the refueling process.

**! NOTE** Damage caused by the wrong fuel

Vehicles with a gasoline engine:

Even small amounts of the wrong fuel could result in damage to the fuel system, the engine and the emission control system.

- ▶ Only refuel with low-sulfur spark-ignition engine fuel.

This fuel may contain up to 10% ethanol. Your vehicle is suitable for use with E10 fuel.

Never refuel with one of the following fuels:

- Diesel
- Gasoline with more than 10% ethanol by volume, e.g. E15, E85, E100
- Gasoline with more than 3% methanol by volume, e.g. M15, M30, M85, M100
- Gasoline with additives containing metal

If you have accidentally refueled with the wrong fuel:

- ▶ Do not switch on the vehicle.
- ▶ Consult a qualified specialist workshop.

**! NOTE** Do not use diesel to refuel vehicles with a gasoline engine

If you have accidentally refueled with the wrong fuel:

- Do not switch on the vehicle. Otherwise fuel can enter the engine.

Even small amounts of the wrong fuel could result in damage to the fuel system and the engine. The repair costs are high.

- ▶ Consult a qualified specialist workshop.
- ▶ Have the fuel tank and fuel lines drained completely.

**! NOTE** Damage to the fuel system due to overfilling the fuel tank

- ▶ Only fill the fuel tank until the pump nozzle switches off.

If too much fuel has been added due, for example, to a faulty filling pump:

- ▶ Do not switch on the vehicle.
- ▶ Consult a qualified specialist workshop.

**! NOTE** Fuel may spray out when you remove the fuel pump nozzle

- ▶ Only fill the fuel tank until the pump nozzle switches off.

**Requirements:**

- The vehicle is unlocked.
- i** Do not get into the vehicle again during the refueling process. Otherwise, electrostatic charge could build up again.

Observe the notes on operating fluids and fuel.

Only refuel with fuel that has at least the octane number specified in the information label in the fuel filler flap. Otherwise, engine output can be reduced and fuel consumption increased.

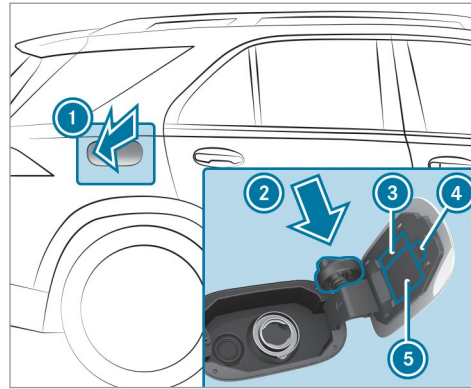

- 1 Fuel filler flap
- 2 Bracket for fuel filler cap
- 3 Fuel type
- 4 QR code for rescue card
- 5 Tire pressure table

- ▶ Press on the back area of fuel filler flap ①.
- ▶ Turn the fuel filler cap counter-clockwise and remove it.

- ▶ Insert fuel filler cap from above into bracket ②.
- ▶ Completely insert the pump nozzle into the tank filler neck, hook in place and refuel.
- ▶ Only fill the fuel tank until the pump nozzle switches off.
- ▶ Replace the cap on the filler neck and turn clockwise until it engages audibly.
- ▶ Close fuel filler flap ①.

**Parking****Parking the vehicle**

**⚠ WARNING** Risk of accident and injury caused by an insufficiently secured vehicle rolling away

If the vehicle is not securely parked sufficiently, it can roll away in an uncontrolled way even at a slight downhill gradient.

- ▶ On uphill or downhill gradients, turn the front wheels so that the vehicle rolls towards the curb if it starts moving.

- ▶ Apply the parking brake.
- ▶ Switch the transmission to position **P**.

**⚠ WARNING** Risk of fire caused by hot exhaust system parts

Flammable materials such as leaves, grass or twigs may ignite.

- ▶ Park the vehicle so that no flammable material can come into contact with hot vehicle components.
- ▶ In particular, do not park on dry grass-land or harvested grain fields.

**⚠ WARNING** Risk of accident and injury due to children left unattended in the vehicle

If children are left unsupervised in the vehicle, they could, in particular:

- open doors, thereby endangering other persons or road users.
- get out and be struck by oncoming traffic.

- operate vehicle equipment and become trapped, for example.

In addition, the children could also set the vehicle in motion, for example by:

- releasing the parking brake.
  - changing the transmission position.
  - starting the vehicle.
- ▶ Never leave children unattended in the vehicle.
  - ▶ When leaving the vehicle, always take the SmartKey with you and lock the vehicle.
  - ▶ Keep the vehicle SmartKey out of reach of children.

**! NOTE** Damage to the vehicle due to it rolling away

- ▶ Always secure the vehicle against rolling away.

**! NOTE** Damage due to the vehicle lowering

**Vehicles with AIRMATIC or E-ACTIVE BODY CONTROL:** The vehicle can lower because of temperature differences or longer non-operational times. This can cause damage to parts of the body.

- ▶ When stopping the vehicle and when driving off, make sure that there are no obstacles such as curbs under or in the immediate vicinity of the body.

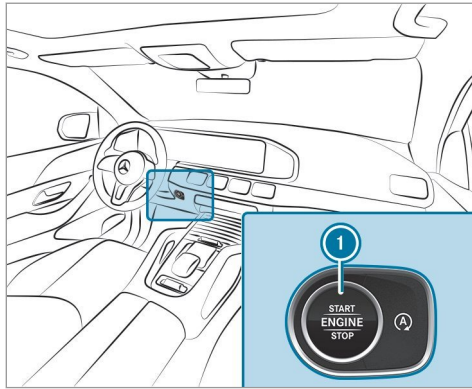

- ▶ Bring the vehicle to a standstill by pressing the brake pedal.
- ▶ On gradients, turn the front wheels so that the vehicle will roll towards the curb if it starts moving.
- ▶ Apply the electric parking brake.

- ▶ Engage transmission position **P** in a stationary vehicle with the brake pedal applied (→ page 194).
  - ▶ Switch off the vehicle by pressing button ①.
  - ▶ Release the service brake slowly.
  - ▶ Get out of the vehicle and lock it.
- ① When you park the vehicle, you can still operate the side windows and the sliding sunroof for approximately four minutes if the driver's door is closed.
- ① When you park the vehicle, you can still operate the side windows and the panoramic sliding sunroof for approximately four minutes if the driver's door is closed.

### Garage door opener

#### Programming buttons for the garage door opener

- ⚠ DANGER** Risk of fatal injuries caused by exhaust gases

Combustion engines emit poisonous exhaust gases, such as carbon monoxide. Inhaling

these exhaust gases is hazardous to health and leads to poisoning.

- ▶ Never run the vehicle and, if present, the stationary heater indoors without sufficient ventilation.

- ⚠ WARNING** Risk of injury by becoming trapped when opening and closing a garage door

When you operate or program a garage door with an integrated garage door opener, persons can become trapped or struck by the garage door if they stand within its range of movement.

- ▶ Always make sure that nobody is within the range of the garage door's movement.

Only operate the following doors using the garage door opener:

- Doors with a safety stop and reversing feature
- Doors which conform to the current U.S. safety standards

Before programming the garage door opener, park the vehicle outside the garage. Make sure that the vehicle is switched on but not started.

#### Requirements:

- The vehicle has been parked outside the garage or outside the range of movement of the door.
  - The vehicle is switched on.
  - The vehicle has not been started.
- i** The garage door opener function is always available when the vehicle is switched on.

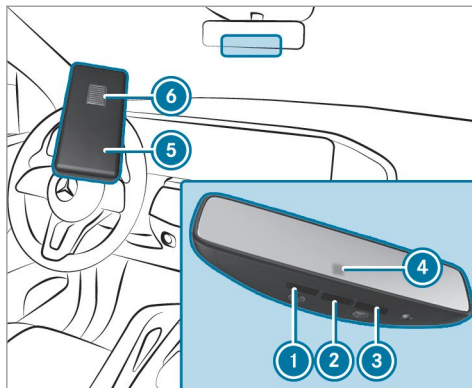

- ▶ Check if the transmitter frequency of the remote control has the frequency range of 280 to 868 MHz.

Radio equipment approval number:

- NZLMUAHL5 (USA)
- 4112A-MUAHL5 (Canada)

- ▶ Press and hold button **1**, **2** or **3** that you wish to program.  
Indicator lamp **4** flashes yellow.

**i** It can take up to 20 seconds before the indicator lamp flashes yellow.

- ▶ Release the previously pressed button.  
Indicator lamp **4** continues to flash yellow.

- ▶ Point remote control **5** from a distance of 0.4 in (1 cm) to 3 in (8 cm) towards button **1**, **2** or **3**.

- ▶ Press and hold button **6** of remote control **5** until one of the following signals appears:

- Indicator lamp **4** lights up green continuously. Programming is complete.
- Indicator lamp **4** flashes green. Programming was successful. Additionally, synchronization of the rolling code with the door system must be carried out.

- ▶ If indicator lamp **4** does not light up or flash green: repeat the procedure.

- ▶ Release all of the buttons.

- i** The remote control for the door drive is not included in the scope of delivery of the garage door opener.

### Synchronizing the rolling code

#### Requirements:

- The door system uses a rolling code.
- The vehicle must be within range of the garage door or door drive.
- The vehicle as well as persons and objects are located outside the range of movement of the door.

- ▶ Press the programming button on the door drive unit. Initiate the next step within approximately 30 seconds.
  - ▶ Press previously programmed button **1**, **2** or **3** repeatedly until the door closes. When the door closes, programming is completed.
- i** Please also read the operating instructions for the door drive.

### Troubleshooting when programming the remote control

- ▶ Check if the transmitter frequency of remote control **5** is supported.
  - ▶ Replace the batteries in remote control **5**.
  - ▶ Hold remote control **5** at various angles from a distance of 0.4 in (1 cm) to 3 in (8 cm) front of the inside rearview mirror. You should test every position for at least 25 seconds before trying another position.
  - ▶ Hold remote control **5** at the same angles at various distances in front of the inside rearview mirror. You should test every position for at least 25 seconds before trying another position.
  - ▶ On remote controls that transmit only for a limited period, press button **6** on remote control **5** again before transmission ends.
  - ▶ Angle the antenna line of the garage door opener unit towards the remote control.
- i** It is possible that older garage doors cannot be operated using the remote control in the inside rearview mirror even after you have successfully performed the measures descri-

bed above. If this is the case, contact the HomeLink® Hotline.

- i** Support and additional information on programming:
- On the toll free HomeLink® Hotline on 1-800-355-3515
  - On the Internet at <https://www.homelink.com/mercedes>

### Opening or closing the garage door

#### Requirements:

- The corresponding button is programmed to operate the door.
- ▶ Press and hold buttons **1**, **2** or **3** until the door opens or closes.
  - ▶ If indicator lamp **4** flashes yellow after approximately 20 seconds: press and hold the previously pressed button again until the door opens or closes.

### Clearing the garage door opener memory

- ▶ Press and hold buttons **1** and **3**. Indicator lamp **4** lights up yellow.

- ▶ If indicator lamp ④ flashes green: release buttons ① and ③.  
The entire memory has been deleted.

### Electric parking brake

#### Function of the electric parking brake (applying automatically)

**⚠ WARNING** Risk of accident and injury due to children left unattended in the vehicle

If children are left unsupervised in the vehicle, they could, in particular:

- open doors, thereby endangering other persons or road users.
- get out and be struck by oncoming traffic.
- operate vehicle equipment and become trapped, for example.

In addition, the children could also set the vehicle in motion, for example by:

- releasing the parking brake.
- changing the transmission position.

- starting the vehicle.
- ▶ Never leave children unattended in the vehicle.
- ▶ When leaving the vehicle, always take the SmartKey with you and lock the vehicle.
- ▶ Keep the vehicle SmartKey out of reach of children.

The electric parking brake is applied if the transmission is in position **P** and one of the following conditions is fulfilled:

- The vehicle is switched off.
  - The seat belt tongue is not inserted in the seat belt buckle of the driver's seat and the driver's door is opened.
  - The transfer case is in the **LOW RANGE** position.
- i** To prevent application: pull the handle of the electric parking brake (→ page 207).

In the following situations, the electric parking brake is also applied:

- The HOLD function is keeping the vehicle stationary.
- Active Parking Assist is keeping the vehicle stationary.
- Active Distance Assist DISTRONIC is bringing the vehicle to a standstill.
- In addition, one of the following conditions must be fulfilled:
  - The vehicle is switched off.
  - The seat belt tongue is not inserted in the seat belt buckle of the driver's seat and the driver's door is opened.
  - There is a system malfunction.
  - The power supply is insufficient.
  - The vehicle is stationary for a lengthy period.

When the electric parking brake is applied, the red **PARK** (USA) or **(P)** (Canada) indicator lamp lights up in the instrument cluster.



- ❗ The electric parking brake is not automatically applied if the vehicle is switched off by the ECO start/stop function.

### Function of the electric parking brake (releasing automatically)

The electric parking brake is released when the following conditions are fulfilled:

- The driver's door is closed.
- The vehicle has been started.
- The transmission is in position **D** or **R** and you depress the accelerator pedal or you shift from transmission position **P** to **D** or **R** when on level ground.
- If the transmission is in position **R**, the tail-gate must be closed.
- The seat belt tongue is inserted into the seat belt buckle of the driver's seat.

If the seat belt tongue is not inserted into the seat belt buckle of the driver's seat, one of the following conditions must be fulfilled:

- You shift from transmission position **P**.
- or

- You have previously driven at speeds greater than 2 mph (3 km/h).

When the electric parking brake is released, the red **PARK** (USA) or **(P)** (Canada) indicator lamp in the instrument cluster goes out.

### Applying/releasing the electric parking brake manually

#### Applying

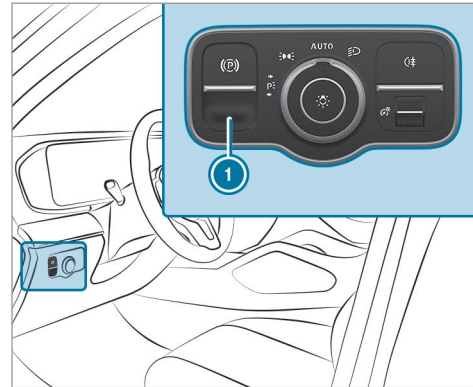

- ▶ Push handle ①.  
The red **PARK** (USA) or **(P)** (Canada) indicator lamp lights up in the instrument cluster.

- ❗ The electric parking brake is only securely applied if the red **PARK** (USA) or **(P)** (Canada) indicator lamp is lit continuously.

#### Releasing

- ▶ Switch on the vehicle.
- ▶ Pull handle ①.  
The red **PARK** (USA) or **(P)** (Canada) indicator lamp in the instrument cluster goes out.

#### Emergency braking

- ▶ Press and hold handle ①.  
As long as the vehicle is driving, the **Please Release Parking Brake** message is displayed and the red **PARK** (USA) or **(P)** (Canada) indicator lamp flashes.

When the vehicle has been braked to a standstill, the electric parking brake is applied. The red **PARK** (USA) or **(P)** (Canada) indicator lamp lights up in the instrument cluster.

### Information on collision detection on a parked vehicle

---

If a collision is detected when the tow-away alarm is armed on a locked vehicle, you will receive a notification in the multimedia system when you switch the vehicle on.

You will receive information about the following points:

- The area of the vehicle that may have been damaged.
- The force of the impact.

The following situation can lead to inadvertent activation:

- The parked vehicle is moved, for example, in a two-story garage.
- ① Deactivate the tow-away alarm in order to prevent inadvertent activation. If you deactivate the tow-away alarm, collision detection will also be deactivated.
- ① If the battery is severely discharged, the function for detecting a collision on a parked vehi-

cle is automatically deactivated to facilitate the next engine start.

### System limits

Detection may be restricted in the following situations:

- The vehicle is damaged without impact, for example, if an outside mirror is torn off or the paint is damaged by a key
- An impact occurs at low speed
- The electric parking brake is not applied

### Notes on parking the vehicle for an extended period

---

If you leave the vehicle parked for longer than six weeks, it may suffer damage through disuse.

The 12 V battery may also be impaired or damaged by heavy discharging.

- ① Further information can be obtained at a qualified specialist workshop.

### Standby mode (extension of the starter battery's period out of use)

---

#### Standby mode function

① This function is not available for all models.

If standby mode is activated, energy loss will be minimized during extended periods of non-operation.

Standby mode is characterized by the following:

- The starter battery is preserved.
- The maximum non-operational time appears in the media display.
- The connection to online services is interrupted.
- The ATA (anti-theft alarm system) is not available.
- The interior motion sensor and tow-away alarm functions are not available.
- The function for detecting collisions on a parked vehicle is not available.

If the following conditions are fulfilled, standby mode can be activated or deactivated using the multimedia system:

- The vehicle is switched on.
- The vehicle has not been started.

Exceeding the vehicle's displayed non-operational time may cause inconvenience; i.e. it cannot be guaranteed that the starter battery will reliably start the vehicle.

Charge the starter battery in the following situations:

- The vehicle's non-operational time must be extended.
- The **Battery Charge Insufficient for Standby Mode** message appears in the media display.

**i** Standby mode is automatically deactivated when the vehicle is switched on.

### Activating/deactivating standby mode (parking the vehicle for an extended period)

#### Requirements:

- The engine is switched off.

Multimedia system:

→  >> Settings >> Vehicle

- ▶ Activate or deactivate **Standby Mode**.
- ▶ Select **Yes**.

## Driving and driving safety systems

### Driving systems and your responsibility

Your vehicle is equipped with driving systems which assist you in driving, parking and maneuvering the vehicle. The driving systems are only aids. They are not a substitute for your attention to the surroundings and do not relieve you of your responsibility pertaining to road traffic law. The driver is always responsible for maintaining a safe distance to the vehicle in front, for vehicle speed, for braking in good time and for staying in lane. Pay attention to the traffic conditions at all times and intervene when necessary. Be aware of the limitations regarding the safe use of these systems.

Driving systems can neither reduce the risk of accident if you fail to adapt your driving style nor override the laws of physics. They cannot always

take into account road, weather or traffic conditions.

### Information on vehicle sensors and cameras

Some driving and driving safety systems use cameras as well as radar or ultrasonic sensors to monitor the area in front of, behind or next to the vehicle.

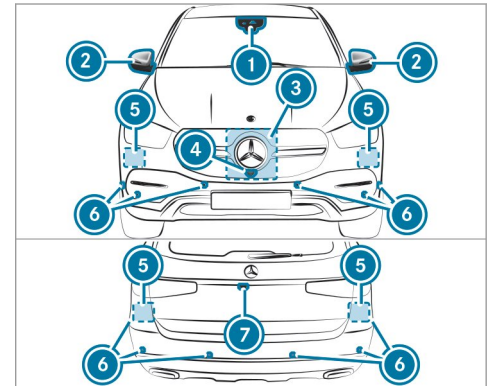

- 1 Multifunction camera
- 2 Cameras in the outside mirrors
- 3 Front radar
- 4 Front camera
- 5 Corner radars
- 6 Ultrasonic sensors
- 7 Rear view camera

**⚠ WARNING** Risk of accident due to restricted detection performance of vehicle sensors and cameras

If the area around vehicle sensors or cameras is covered, damaged or dirty, certain driving and safety systems cannot function correctly. There is a risk of an accident.

- ▶ Keep the area around vehicle sensors or cameras clear of any obstructions and clean.
- ▶ Have damage to the bumper, radiator grille or stone chipping in the area of the front and rear windows repaired at a qualified specialist workshop.

Particularly, keep the areas around the sensors and cameras free of dirt, ice or slush (→ page 346). The sensors and cameras must not be covered and the detection ranges around them must be kept free. Do not attach additional license plate bracket, advertisements, stickers, foils or foils to protect against stone chippings in the detection range of the sensors and cameras. Make sure that there are no overhanging loads protruding into the detection range.

If there is damage to a bumper or the radiator grille, or after an impact, have the function of the sensors checked at a qualified specialist workshop. Have damage or stone chipping in the area of the cameras on the front and rear windows repaired at a qualified specialist workshop.

### Overview of driving systems and driving safety systems

- ABS (**A**nti-**l**ock **B**raking **S**ystem) (→ page 211)
- Off-road ABS (→ page 211)
- BAS (**B**rake **A**ssist **S**ystem) (→ page 212)

- ESP® (**E**lectronic **S**tability **P**rogram) (→ page 212)
- ESP® Crosswind Assist (→ page 213)
- ESP® trailer stabilization (→ page 213)
- EBD (**E**lectronic **B**rakeforce **D**istribution) (→ page 215)
- STEER CONTROL (→ page 215)
- HOLD function (→ page 215)
- Hill Start Assist (→ page 216)
- ATTENTION ASSIST (→ page 216)
- Cruise control (→ page 218)
- Traffic Sign Assist (→ page 238)
- AIRMATIC (→ page 246)
- E-ACTIVE BODY CONTROL (→ page 253)

### **Driving Assistance package**

The following functions are part of the Driving Assistance Package. Certain functions are only available in some countries. Some functions are also available without the Driving Assistance Package, albeit with restricted functionality.

- Active Distance Assist DISTRONIC (→ page 220)
- Active Speed Limit Assist (country-dependent) (→ page 224)
- Route-based speed adaptation (country-dependent) (→ page 225)
- DSR (**D**ownhill **S**peed **R**egulation) (→ page 227)
- Active Brake Assist (→ page 233)
- Active Steering Assist (country-dependent) (→ page 229)
- Active Emergency Stop Assist (country-dependent) (→ page 231)
- Active Lane Change Assist (country-dependent) (→ page 232)
- Active Stop-and-Go Assist (country-dependent) (→ page 226)
- Blind Spot Assist and Active Blind Spot Assist with exit warning (→ page 242)
- Active Lane Keeping Assist (→ page 244)

### Parking Package

- Rear view camera (→ page 261)

- Surround view camera (→ page 264)
- Parking Assist PARKTRONIC (→ page 267)
- Active Parking Assist (→ page 272)

### Functions of ABS

The Anti-lock Brake System (ABS) regulates the brake pressure in critical driving situations:

- During braking, for instance, at maximum full-stop braking or if there is insufficient tire traction, the wheels are prevented from locking.
- Vehicle steerability while braking is ensured.



If ABS intervenes when braking, you will feel a pulsing in the brake pedal. The pulsating brake pedal can be an indication of hazardous road conditions and can serve as a reminder to take extra care while driving.

### System limits

- ABS is active from speeds of approx. 3 mph (5 km/h).
- ABS may be impaired or may not function if a malfunction has occurred and the yellow 

ABS warning lamp lights up continuously after the vehicle is started.

### Functions of Off-road ABS

 Off-road ABS is activated automatically when you select the  or  drive program.

Off-road ABS is specially adapted for driving off-road:

- The front wheels lock cyclically during braking.
- The braking distance is shortened due to the digging-in effect.

### System limits

- Off-road ABS functions at speeds below 25 mph (40 km/h).
- If Off-road ABS intervenes, the ability to steer may be restricted.

### Function of BAS

**⚠ WARNING** Risk of an accident caused by a malfunction in BAS (Brake Assist System)

If BAS is malfunctioning, the braking distance in an emergency braking situation is increased.

- ▶ Depress the brake pedal with full force in emergency braking situations. ABS prevents the wheels from locking.

The Brake Assist System (BAS) supports your emergency braking situation with additional brake force.

If you depress the brake pedal quickly, BAS is activated:

- BAS automatically boosts the brake pressure.
- BAS can shorten the braking distance.
- ABS prevents the wheels from locking.

The brakes will function as usual once you release the brake pedal. BAS is deactivated.

### Functions of ESP®

**⚠ WARNING** Risk of skidding if ESP® is deactivated

If you deactivate ESP®, ESP® cannot carry out vehicle stabilization.

- ▶ ESP® should only be deactivated in the following situations.

**! NOTE** Mercedes-AMG vehicles

- ▶ Observe the notes in the Supplement. You could otherwise fail to recognize dangers.

The Electronic Stability Program (ESP®) can monitor and improve driving stability and traction in the following situations within physical limits:

- When pulling away on wet or slippery road.
- When braking.

If the vehicle deviates from the direction desired by the driver, ESP® can stabilize the vehicle by intervening in the following ways:

- One or more wheels are braked.
- The engine output is adapted according to the situation.

ESP® is deactivated if the  ESP® OFF warning lamp lights up continuously in the instrument cluster:

- Driving stability will no longer be improved.
- The drive wheels could spin.
- ETS/4ETS traction control is still active.

**i** When ESP® is deactivated, you are still assisted by ESP® when braking.

If the  ESP® warning lamp flashes in the instrument cluster, one or several wheels has reached its grip limit:

- Adapt your driving style to suit the current road and weather conditions.
- Do not deactivate ESP®.

- Only depress the accelerator pedal as far as is necessary when pulling away.

It can be advantageous to deactivate ESP® in the following situations to improve traction:

- When using snow chains.
- In deep snow.
- On sand or gravel.

 Spinning the wheels results in a cutting action, which enhances traction.



If the  ESP® warning lamp lights up continuously, ESP® is not available due to a malfunction.

Observe the following information:

- Indicator and warning lamps (→ page 479)
- Display messages (→ page 423)

### ETS/4ETS (Electronic Traction System)

ETS/4ETS traction control is part of ESP® and makes it possible to pull away and accelerate on a slippery road.

If you select the  or  drive program, a special ETS system specifically suited to off-road terrain is automatically activated.

ETS/4ETS can improve the vehicle's traction by intervening in the following ways:

- The drive wheels are braked individually if they spin.
- More drive torque is transferred to the wheel or wheels with traction.

### Influence of drive programs on ESP®

The drive programs enable ESP® to adapt to different weather and road conditions as well as the driver's preferred driving style. Depending on the selected drive program, the appropriate ESP® mode will be activated. You can select the drive programs using the DYNAMIC SELECT switch (→ page 190).

### Function of ESP® Crosswind Assist

ESP® Crosswind Assist detects sudden gusts of side wind and helps the driver to keep the vehicle in the lane:

- ESP® Crosswind Assist is active at vehicle speeds between approx. 47 mph (75 km/h) and 125 mph (200 km/h) when driving straight ahead or cornering slightly.

- The vehicle is stabilized by means of individual brake application on one side.

### Function of ESP® trailer stabilization

 **WARNING** Risk of accident in poor road and weather conditions

In poor road and weather conditions, the trailer stabilization cannot prevent lurching of the vehicle/trailer combination. Trailers with a high center of gravity may tip over before ESP® detects this.

- ▶ Always adapt your driving style to suit the current road and weather conditions.

When driving with a trailer, ESP® can stabilize your vehicle if the trailer begins to swerve from side to side:

- ESP® trailer stabilization is active above speeds of 40 mph (65 km/h).
- Slight swerving is reduced by means of a targeted, individual brake application on one side.

- In the event of severe swerving, the engine output is also reduced and all wheels are braked.

ESP® trailer stabilization may be impaired or may not function if:

- The trailer is not connected correctly or is not detected properly by the vehicle.

### Activating/deactivating ESP® (Electronic Stability Program) (vehicles without Off-road package)

Multimedia system:

→  → Settings → Quick Access

- ⓘ ESP® can only be activated/deactivated using quick access when at least one other function is available in quick access. ESP® can otherwise be found in the [Assistance](#) menu.

#### **NOTE** Mercedes-AMG vehicles

- ▶ Observe the notes in the Supplement. You could otherwise fail to recognize dangers.

- ▶ Select **ESP**.
- ▶ Select **On** or  **Off**.

ESP® is deactivated if the  ESP® OFF warning lamp lights up continuously in the instrument cluster.

Observe the information on warning lamps and display messages which may be shown in the instrument cluster.

### Activating/deactivating ESP® (Electronic Stability Program) (vehicles with Off-road package or E-Active Body Control)

#### **NOTE** Mercedes-AMG vehicles

- ▶ Observe the notes in the Supplement. You could otherwise fail to recognize dangers.

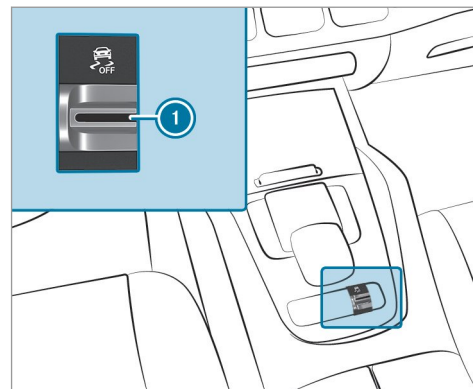

- ▶ Pull rocker switch .

ESP® is deactivated if the  ESP® OFF warning lamp lights up continuously in the instrument cluster.

Observe the information on warning lamps and display messages which may be shown in the instrument cluster.



### Function of EBD

Electronic Brakeforce Distribution (EBD) is characterized by the following:

- Monitoring and regulating the brake pressure on the rear wheels.
- Improved driving stability when braking, especially on bends.

### Function of STEER CONTROL

STEER CONTROL assists you by transmitting a noticeable steering force to the steering wheel in the direction required for vehicle stabilization.

This steering recommendation is given in the following situations:

- Both right wheels or both left wheels are on a wet or slippery road surface when you brake
- The vehicle starts to skid

#### System limits

STEER CONTROL may be impaired or may not function in the following situations:

- ESP® is deactivated.

- ESP® is malfunctioning.
- The steering is malfunctioning.

If ESP® is malfunctioning, you will be assisted further by the electric power steering.

### HOLD function

#### HOLD function

The HOLD function holds the vehicle at a standstill without requiring you to depress the brake pedal, e.g. while waiting in traffic.

The HOLD function is only an aid. The responsibility for the vehicle safely standing still remains with the driver.

#### System limits

The HOLD function is only intended to provide assistance when driving and is not a sufficient means of safeguarding the vehicle against rolling away when stationary.

- The incline must not be greater than 30%.

### Activating/deactivating the HOLD function

**⚠ WARNING** Risk of an accident due to the HOLD function being active when you leave the vehicle

If the vehicle is only braked with the HOLD function it could, in the following situations, roll away:

- If there is a malfunction in the system or in the power supply.
- If the HOLD function is deactivated by depressing the accelerator pedal or brake pedal, e.g. by a vehicle occupant.

▶ Always secure the vehicle against rolling away before you leave it.

#### Requirements:

- The vehicle is stationary.
- The driver's door is closed or the seat belt on the driver's side is fastened.
- The vehicle has been started or has been automatically switched off by the ECO start/stop function.

- The electric parking brake is released.
- Active Distance Assist DISTRONIC is deactivated.
- The transmission is in position **D**, **R** or **N**.

#### Activating the HOLD function

- ▶ Depress the brake pedal, and after a short time quickly depress further until the **HOLD** display appears in the Instrument Display.
- ▶ Release the brake pedal.

#### Deactivating the HOLD function

- ▶ Depress the accelerator pedal to pull away.  
or
- ▶ Depress the brake pedal until the **HOLD** display disappears from the Instrument Display.

The HOLD function is deactivated in the following situations:

- Active Distance Assist DISTRONIC is activated.
- The transmission is shifted to position **P**.
- The vehicle is secured with the electric parking brake.

In the following situations, the vehicle is held by transmission position **P** and/or by the electric parking brake:

- The seat belt is unfastened and the driver's door is opened.
- The vehicle is switched off.
- There is a system malfunction.
- The power supply is insufficient.

#### Function of Hill Start Assist

Hill Start Assist holds the vehicle for a short time when pulling away on a hill under the following conditions:

- The transmission is in position **D** or **R**.
- The electric parking brake is released.

This gives you enough time to move your foot from the brake pedal to the accelerator pedal and depress it before the vehicle begins to roll away.

**⚠ WARNING** Risk of accident and injury due to the vehicle rolling away

After a short time, Hill Start Assist no longer holds the vehicle.

- ▶ Swiftly move your foot from the brake pedal to the accelerator pedal. Do not leave the vehicle when it is being held by Hill Start Assist.

#### ATTENTION ASSIST

##### Function of ATTENTION ASSIST

ATTENTION ASSIST assists you on long, monotonous journeys, e.g. on highways and trunk roads. If ATTENTION ASSIST detects indicators of fatigue or increasing lapses in concentration on the part of the driver, it suggests taking a break.

ATTENTION ASSIST is only an aid. It cannot always detect fatigue or lapses in concentration in time. The system is not a substitute for a well-rested and attentive driver. On long journeys, take regular breaks in good time that allow for adequate recuperation.

You can choose between two settings:

- **Standard:** normal system sensitivity.
- **Sensitive:** higher system sensitivity. The driver is warned earlier and the attention level detected by ATTENTION ASSIST is adapted accordingly.

If drowsiness or increasing lapses in concentration are detected, the **ATTENTION ASSIST: Take a Break!** warning appears in the Instrument Display. You can acknowledge the message and take a break if necessary. If you do not take a break and ATTENTION ASSIST continues to detect increasing lapses in concentration, you will be warned again after a minimum of 15 minutes.



You can have the following status information for ATTENTION ASSIST displayed in the assistance menu of the on-board computer:

- The length of the journey since the last break.
- The attention level determined by ATTENTION ASSIST:
  - The fuller the circle, the higher the attention level determined
  - As your attention wanes, the circle in the center of the display becomes smaller

If ATTENTION ASSIST is unable to calculate the attention level and cannot issue a warning, the **System Suspended** message appears.

If a warning is given in the Instrument Display, the multimedia system offers to search for a rest area. You can select a rest area and start navigation to this rest area. This function can be activated and deactivated in the multimedia system.

If ATTENTION ASSIST is deactivated, the  symbol appears in the assistance graphic in the Instrument Display. After the vehicle is started, ATTENTION ASSIST is automatically activated. The last selected sensitivity level remains stored.

### System limits

ATTENTION ASSIST is active in the 37 mph (60 km/h) to 124 mph (200 km/h) speed range.

Particularly in the following situations, ATTENTION ASSIST only functions in a restricted manner and warnings may be delayed or not occur:

- If you have been driving for less than approximately 30 minutes.
- If the road condition is poor (uneven road surface or potholes).
- If there is a strong side wind.
- If you adopt a sporty driving style (high cornering speeds or high rates of acceleration).
- If Active Steering Assist is activated and active (→ page 229).
- If the time has been set incorrectly.
- If you change lanes and vary your speed frequently in active driving situations.

The ATTENTION ASSIST drowsiness or alertness assessment is reset and restarted when continuing the journey in the following situations:

- You switch off the vehicle.

- If you unfasten your seat belt and open the driver's door (e.g. to change drivers or take a break).

### Setting ATTENTION ASSIST

Multimedia system:

→  >> Settings >> Assistance  
>> Attention Assist

### Setting options

▶ Select **Standard**, **Sensitive** or **Off**.

### Suggesting a rest area

- ▶ Select **Suggest Rest Area**.
- ▶ Activate or deactivate the function. If ATTENTION ASSIST detects fatigue or increasing lack of attention, it suggests a rest area in the vicinity.
- ▶ Select the suggested rest area. You are guided to the selected rest area.

### Speed control cruise control

#### Function of cruise control

Cruise control regulates the speed to the value selected by the driver.



If you accelerate to overtake, for example, the stored speed is not deleted. If you remove your foot from the accelerator pedal after overtaking, cruise control will resume speed regulation back to the stored speed.

You can store any speed above 15 mph (20 km/h) up to the maximum design speed.

Observe the notes on driving systems and your responsibility; you may otherwise fail to recognize dangers (→ page 209).

**Mercedes-AMG vehicles:** Cruise control is available up to a maximum speed of 155 mph (250 km/h).

#### Displays in the Instrument Display

-  (gray): cruise control is selected but not yet activated.
-  (green): cruise control is active.

A stored speed appears along with the  display.

 The segments between the stored speed and the end of the segment display light up in the speedometer.

#### System limits

Cruise control may be unable to maintain the stored speed on uphill gradients. The stored speed is resumed when the gradient evens out.

Change into a lower gear in good time on long and steep downhill gradients. Take particular note of this when driving a laden vehicle. By doing so, you will make use of the engine's braking effect. This relieves the load on the brake system and prevents the brakes from overheating and wearing too quickly.

Do not use cruise control in the following situations:

- In traffic situations which require frequent changes of speed, e.g. in heavy traffic, on winding roads

- On slippery roads. Accelerating can cause the drive wheels to lose traction and the vehicle could then skid.
- When visibility is poor

### Operating cruise control

**⚠ WARNING** Risk of accident due to stored speed

If you call up the stored speed and this is lower than your current speed, the vehicle decelerates.

- ▶ Take into account the traffic situation before calling up the stored speed.

### Requirements:

- ESP® must be activated, but not intervening.
- The vehicle speed is at least 15 mph (20 km/h).
- The transmission is in position **D**.

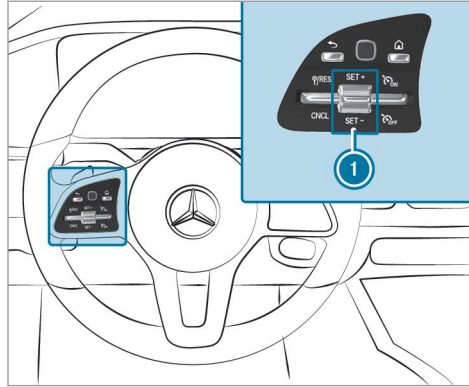

### Operating cruise control

- ▶ Press the rocker switches on the steering wheel control panel up or down to the desired position.

### Activating cruise control

- ▶ Select **RES/SET** with the right rocker switch.

### Activating cruise control

- ▶ Press rocker switch **1** up **SET+** or down **SET-**.  
The current speed is stored and maintained by the vehicle.

or

- ▶ Select **RES/SET** with the left rocker switch.  
The last stored speed is called up and maintained by the vehicle.  
If the last stored speed has previously been deleted, the current vehicle speed is stored.

- i** When you switch off the vehicle, the last speed stored is deleted.

### Increasing or decreasing the stored speed

- ▶ 1 mph (1 km/h): press rocker switch **1** up **SET+** or down **SET-** to the pressure point.
- or
- ▶ 5 mph (10 km/h): press rocker switch **1** up **SET+** or down **SET-** beyond the pressure point.

or

- ▶ Accelerate the vehicle to the desired speed and press rocker switch **1** up **SET+**.

### Adopting a detected speed

- ▶ Activate cruise control.
- ▶ If a traffic sign has been detected and is displayed in the instrument cluster: select  with the left rocker switch. The maximum permissible speed shown by the traffic sign is stored and the vehicle maintains or does not exceed this speed.

### Deactivating cruise control

- ▶ Select  with the left rocker switch.

### Deactivating cruise control

- ▶ Select  with the right rocker switch.
- ① If you brake, deactivate ESP® or if ESP® intervenes, cruise control is deactivated.

## Active Distance Assist DISTRONIC

### Function of Active Distance Assist DISTRONIC

Active Distance Assist DISTRONIC maintains the set speed on free-flowing roads. If vehicles in front are detected, the set distance is maintained, if necessary, until the vehicle comes to a halt. The

vehicle accelerates or brakes depending on the distance to the vehicle in front and the set speed. The speed and distance to the vehicle in front are set and saved using the steering wheel.

Available speed range:

- **Vehicles without Driving Assistance Package:** 15 mph (20 km/h) - 120 mph (200 km/h)
- **Vehicles with Driving Assistance Package:** 15 mph (20 km/h) - 130 mph (210 km/h)

- ① The maximum speed is reduced when driving in **LOW RANGE** off-road gear (→ page 197).

Other features of Active Distance Assist DISTRONIC:

- Adjusts the driving style depending on the selected drive program (fuel-saving, comfortable or dynamic)
- Initiates acceleration to the stored speed if the turn signal indicator is switched on to change to the overtaking lane
- **Vehicles with Driving Assistance Package:**
  - Reacts to stationary vehicles detected in urban speed ranges (except bicycles and motorcycles)

- Takes one-sided overtaking restrictions into account on highways or on multi-lane roads with separate roadways (country-dependent)

**Vehicles with Driving Assistance Package and Parking Package:** if the vehicle has been braked to a standstill on multi-lane, separate roadways by Active Distance Assist DISTRONIC, it can automatically follow the vehicle in front when driving off again within 30 seconds. If a critical situation is detected when driving off, a visual and acoustic warning is given indicating that the driver must now take control of the vehicle. The vehicle is not accelerated any further.

Observe the notes on driving systems and your responsibility; you may otherwise fail to recognize dangers (→ page 209).

### Active Distance Assist DISTRONIC displays in the Instrument Display

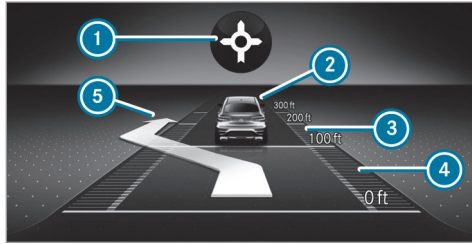

#### Assistance graphic

- ① Route-based speed adaptation: type of route event (→ page 225)
- ② Vehicle in front
- ③ Distance indicator
- ④ Set specified distance
- ⑤ Active Lane Change Assist lane change display

### Permanent status display of Active Distance Assist DISTRONIC

- (white): Active Distance Assist DISTRONIC selected, specified distance set
- (white vehicle, green speedometer): Active Distance Assist DISTRONIC active, specified distance set and vehicle detected
- (green): Active Distance Assist DISTRONIC active, specified distance set and vehicle detected
- : Route-based speed adaptation active (→ page 225).

The stored speed is shown along with the permanent status display and highlighted on the speedometer. When Active Distance Assist DISTRONIC is passive, the speed is grayed out.

- ① On highways or high-speed major roads, the green vehicle symbol is displayed cyclically when the vehicle is ready to pull away.
- ① If you depress the accelerator pedal beyond the setting of the Active Distance Assist DISTRONIC, the system is switched to passive

mode. The **Suspended** message appears in the Instrument Display.

### Display on the speedometer

The stored speed is highlighted on the speedometer. If the speed of the vehicle in front or the speed adjustment for the route event ahead is less than the stored speed, the segments in the speedometer light up. The Instrument Display shows the deactivation of Active Distance Assist DISTRONIC, as well as alterations to the speed due to manual or automatic adoption of the maximum permissible speed.

### System limits

The system may be impaired or may not function in the following situations, for example:

- In snow, rain, fog, heavy spray, if there is glare, in direct sunlight or in greatly varying ambient light.
- If there is swirling dust, e.g. when driving off-road or on sandy surfaces.
- The windshield in the area of the camera is dirty, fogged up, damaged or covered.
- If the radar sensors are dirty or covered.

## 222 Driving and parking

- In parking garages or on roads with steep uphill or downhill gradients.
- If there are narrow vehicles in front, such as bicycles or motorcycles.

In addition, on slippery roads, braking or accelerating can cause one or several wheels to lose traction and the vehicle could then skid.

Do not use Active Distance Assist DISTRONIC in these situations.

**⚠ WARNING** Risk of accident from acceleration or braking by Active Distance Assist DISTRONIC

Active Distance Assist DISTRONIC may accelerate or brake in the following cases, for example:

- If the vehicle pulls away using Active Distance Assist DISTRONIC.
- If the stored speed is called up and is considerably faster or slower than the currently driven speed.

- If Active Distance Assist DISTRONIC no longer detects a vehicle in front or does not react to relevant objects.

- ▶ Always carefully observe the traffic conditions and be ready to brake at all times.
- ▶ Take into account the traffic situation before calling up the stored speed.

**⚠ WARNING** Risk of accident due to insufficient deceleration by Active Distance Assist DISTRONIC

Active Distance Assist DISTRONIC brakes your vehicle with up to 50% of the possible deceleration. If this deceleration is not sufficient, Active Distance Assist DISTRONIC alerts you with a visual and acoustic warning.

- ▶ Adjust your speed and maintain a suitable distance from the vehicle in front.
- ▶ Brake the vehicle yourself and/or take evasive action.

**⚠ WARNING** Risk of accident if detection function of Active Distance Assist DISTRONIC is impaired

Active Distance Assist DISTRONIC does not react or has a limited reaction:

- when driving on a different lane or when changing lanes
- to pedestrians, animals, bicycles or stationary vehicles, or unexpected obstacles
- to complex traffic conditions
- to oncoming vehicles and crossing traffic

As a result, Active Distance Assist DISTRONIC may neither give warnings nor intervene in such situations.

- ▶ Always observe the traffic conditions carefully and react accordingly.

### Operating Active Distance Assist DISTRONIC

#### Requirements:

- The electric parking brake is released.
- ESP® is activated and is not intervening.



- The transmission is in position **D**.
- The driver's door is closed.
- Check of the radar sensor system has been successfully completed.
- Parking Assist PARKTRONIC is not being used to park the vehicle or to exit from a parking space.
- DSR is deactivated.
- **Vehicles with Off-road package:** the  drive program is deactivated.

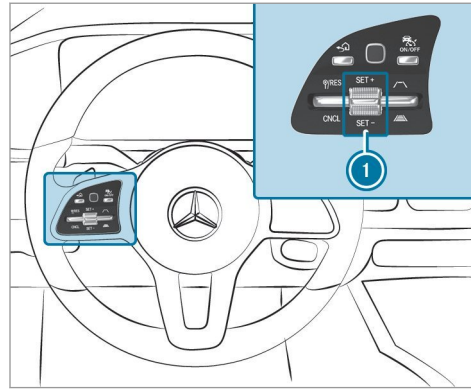

- ▶ **To operate Active Distance Assist DISTRONIC:** press the rocker switches on the steering wheel control unit up or down to the desired position.

#### Activating/deactivating Active Distance Assist DISTRONIC

- ▶ Press the  button.

#### Activating Active Distance Assist DISTRONIC

- ▶ **To activate without a stored speed:** press rocker switch **1** up **SET+** or down **SET-**, or select **RES/SET** with the left rocker switch.

or

- ▶ **To activate with a stored speed:** select **RES/SET** with the left rocker switch.
- ▶ Remove your foot from the accelerator pedal. The current speed is stored and maintained by the vehicle.

#### Adopting a detected speed limit

- ▶ Activate Active Distance Assist DISTRONIC.
- ▶ If a traffic sign has been detected and is displayed in the instrument cluster: select **RES/SET** with the left rocker switch. The maximum permissible speed on the traffic sign is adopted as the stored speed. The vehicle adapts its speed to that of the vehicle in front, but only up to the stored speed.

#### Pulling away with Active Distance Assist DISTRONIC

- ▶ Activate Active Distance Assist DISTRONIC and remove your foot from the brake pedal.

▶ Select **RES** with the left rocker switch.  
or

▶ Depress the accelerator pedal briefly and firmly.  
The functions of Active Distance Assist DISTRONIC continue to be carried out.

#### Deactivating Active Distance Assist DISTRONIC

**⚠ WARNING** Risk of an accident due to Active Distance Assist DISTRONIC being active when you leave the driver's seat

If you leave the driver's seat while the vehicle is being braked by Active Distance Assist DISTRONIC only, the vehicle can roll away.

▶ Always deactivate Active Distance Assist DISTRONIC and secure the vehicle to prevent it from rolling away before you leave the driver's seat.

▶ Select **CNCL** with the left rocker switch.

**i** If you brake, deactivate ESP® or if ESP® intervenes, Active Distance Assist DISTRONIC is deactivated.

#### Increasing or decreasing the speed

▶ 1 mph (1 km/h): press rocker switch **1** up **SET+** or down **SET-** to the pressure point.

or

▶ 5 mph (10 km/h): press rocker switch **1** up **SET+** or down **SET-** beyond the pressure point.

or

▶ Accelerate the vehicle to the desired speed and press rocker switch **1** up **SET+**.

#### Changing the specified distance to the vehicle in front

▶ **To reduce the specified distance:** press the right rocker switch up (.

▶ **To increase the specified distance:** press the right rocker switch down (.

#### Function of Active Speed Limit Assist

If a change in the speed limit of 12 mph (20 km/h) or more is detected and automatic adoption of speed limits is activated, the new speed limit is automatically adopted as the stored speed (→ page 239).

The driven speed is adjusted when the vehicle is level with the traffic sign at the latest. In the case of signs indicating entry into an urban area, the speed is adapted according to the speed permitted within the urban area. The speed limit display in the Instrument Display is always updated when the vehicle is level with the traffic sign.

If there is no speed restriction on an unlimited stretch of road (e.g. on a freeway), the recommended speed is automatically adopted as the stored speed. The system uses the speed stored on an unlimited stretch of road as the recommended speed. If you do not alter the stored speed on an unlimited stretch of road, the recommended speed is 80 mph (130 km/h).

If Active Distance Assist DISTRONIC has been put into passive mode by pressing the accelerator pedal, only speed limits which are higher than the set speed are adopted.

Observe the notes on driving systems and your responsibility; you may otherwise fail to recognize dangers (→ page 209).

### System limits

The system limits of Traffic Sign Assist apply to the detection of traffic signs (→ page 238).

Speed limits below 12 mph (20 km/h) are not automatically adopted by the system as the stored speed. Temporary speed restrictions (e.g. for a certain time or due to weather conditions) cannot be properly detected by the system. The maximum permissible speed applying to a vehicle with a trailer is not detected by the system.

Adjust the speed in these situations.

**⚠ WARNING** Risk of accident due to Active Speed Limit Assist adapting the vehicle's speed

The speed adopted by Active Speed Limit Assist may be too high or incorrect in some individual cases, such as:

- at speed limits below 12 mph (20 km/h)
- in wet conditions or in fog
- when towing a trailer

- ▶ Ensure that the driven speed complies with traffic regulations.
- ▶ Adjust the driving speed to suit current traffic and weather conditions.

### Function of route-based speed adaptation

When Active Distance Assist DISTRONIC is activated, the vehicle speed will be adapted accordingly to the route events ahead. Depending on the drive program selected, the vehicle negotiates a route event ahead in an economical, comfortable or dynamic manner. When the route event has been passed, the vehicle accelerates again to the stored speed. The set distance to the vehicle in front, vehicles detected ahead and speed restrictions ahead are taken into account.

You can activate and deactivate route-based speed adaptation in the multimedia system (→ page 226).

The following route events are taken into account:

- Curves
- T-intersections, roundabouts and toll plazas
- Turns and exits

- Traffic jams ahead (only with Live Traffic Information)

**i** When the toll station is reached, Active Distance Assist DISTRONIC adopts the speed as the stored speed.

Also, the speed is reduced if the turn signal indicator to change lanes is switched on and one of the following situations is detected:

- Turning off at intersections
- Driving on slowing-down lanes
- Driving on lanes adjacent to slowing-down lanes

The driver is responsible for choosing the right speed and observing other road users. This applies in particular to intersections, roundabouts and traffic lights, as route-based speed adaptation does not brake the vehicle to a standstill.

When route guidance is active, the first speed adjustment is carried out automatically. If the turn signal indicator is switched on, the selected route is confirmed and further speed adjustment is activated.

Speed adaptation is canceled in the following cases:

- If the turn signal indicator is switched off before the route event.
- If the driver depresses the accelerator or brake pedal during the process.

### System limits

Route-based speed adaptation does not take right of way regulations into account. The driver is responsible for complying with road traffic regulations and driving at a suitable speed.

The speed adaptation made by the system may not always be suitable, particularly in the following situations:

- The road's course not clearly visible
- Road narrowing
- Varying maximum permissible speeds in individual lanes, for example at toll plazas
- Wet road surfaces, snow or ice
- When towing a trailer

In these situations the driver must intervene accordingly.

### **WARNING** Risk of accident in spite of route-based speed adaptation

Route-based speed adaptation can malfunction or be temporarily unavailable in the following situations:

- If the driver does not follow the calculated route
- If map data is not up-to-date or available
- In the event of roadworks
- In bad weather or road conditions
- If the accelerator pedal is depressed
- In the event of electronically displayed speed limitations

 Adapt the speed to the traffic situation.

### Setting route-based speed adaptation

#### Requirements:

- Active Distance Assist DISTRONIC is activated.
- ECO Assist is active.

Multimedia system:

  **Settings**  **Assistance**  
 **Route-based Speed**

 Activate or deactivate the function. When the function is active, the vehicle speed is adjusted depending on the route events ahead.

 Further information on the route-based speed adaptation (→ page 225).

### Function of Active Traffic Jam Assist

Active Traffic Jam Assist helps you when in traffic jams on multi-lane roads with separate roadways by automatically pulling away within 60 seconds and with moderate steering maneuvers. It orients itself using the vehicle in front and lane markings. Active Traffic Jam Assist automatically maintains a safe distance from the vehicle in front and vehicles cutting in.

Active Traffic Jam Assist requires you, as the driver, to keep your hands on the steering wheel at all times so that you are able to intervene at any time to correct the course of the vehicle and keep it in lane. Observe the notes on driving sys-

tems and your responsibility; you may otherwise fail to recognize dangers (→ page 209).

Active Traffic Jam Assist activates automatically as soon as all of the requirements are met: The  status display appears in the instrument cluster when the function is active.

Requirements:

- You are in a traffic jam on a freeway or high-speed major road.
- Active Distance Assist DISTRONIC is activated and active (→ page 222).
- Active Brake Assist is available (→ page 233).
- Active Steering Assist is activated and active (→ page 231).
- Active Traffic Jam Assist is activated (→ page 227).
- You are traveling no faster than 35 mph (60 km/h).

#### System limits

The system limitations of Active Distance Assist DISTRONIC and Active Steering Assist apply to Active Traffic Jam Assist.

#### Activating/deactivating Active Traffic Jam Assist

Multimedia system:

  **Settings**  **Quick Access**

 **Select** .

#### DSR (Downhill Speed Regulation)

##### Function of DSR (Downhill Speed Regulation)

DSR is an aid to assist you when driving downhill. It keeps the speed of travel at the selected target speed. The steeper the downhill gradient, the greater the DSR braking effect on the vehicle. On flat stretches of road and uphill gradients, the DSR brakes the vehicle minimally or not at all.

When DSR is activated and the transmission is in position **D**, **R** or **N**, DSR controls the driving speed. The target speed can be set to a value between 1 mph (2 km/h) and 11 mph (18 km/h). By braking or accelerating, you can drive at a higher or lower speed than the target speed at any time.

DSR is deactivated automatically if you drive at speeds greater than 28 mph (45 km/h) or select drive program **S** or **S**. The  **Off** mes-

sage then appears in the multifunction display. The status indicator in the multifunction display disappears. You also hear a warning tone.

**Mercedes-Maybach vehicles:** in drive program , the DSR function is likewise not available.

#### Notes on DSR

 **WARNING** Risk of skidding and accident when DSR is activated on slippery road surfaces

If the driven speed and the target speed differ, the wheels may lose traction.

 Take into account the road surface and the difference between the driving speed and target speed before activating DSR.

Observe the notes on driving systems and your responsibility; you may otherwise fail to recognize dangers (→ page 209).

You are always responsible for keeping control of the vehicle and for assessing whether the downhill gradient can be negotiated. Depending on road surface and tires, DSR may not always be able to keep to the target speed. Select a target speed

suitable for the environmental conditions and also apply the brakes yourself if required.

### Activating/deactivating DSR (vehicles with Off-road package or E-Active Body Control)



#### Requirements:

- You are driving at 24 mph (40 km/h) or slower.

If the current vehicle speed is too high, the **Max. Speed 24 mph** message appears in the multifunction display.

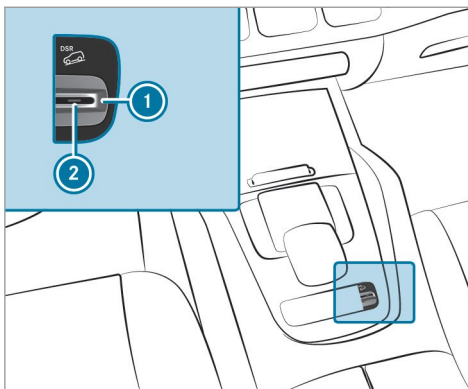
- You have not selected drive program **S** or **S+**.
- Active Distance Assist DISTRONIC is deactivated.



- To activate:** pull rocker switch ①. Indicator lamp ② lights up. The  symbol appears in the multifunction display.
- To deactivate:** pull rocker switch ①. Indicator lamp ② and the  symbol go out.

### Activating/deactivating DSR (Downhill Speed Regulation) (vehicles without Off-road package)

#### Requirements:



- You are driving at 24.8 mph (40 km/h) or slower.

If the current vehicle speed is too high, the **Max. Speed 24 mph** message appears in the multifunction display.

- Active Distance Assist DISTRONIC is deactivated.

#### Multimedia system:

- ➔  **Settings**
- ➔ **Schnellzugriff** (Quick access)

- ▶ Select  **DSR**. The  **DSR** symbol appears in the multifunction display when the function is activated.

- ⓘ When you switch to the  drive program, the function is automatically activated.

## Changing the target speed

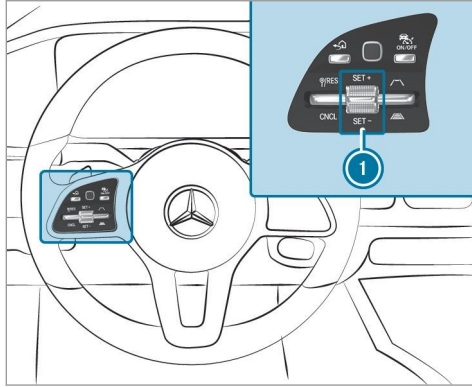

- ▶ **To increase/reduce the target speed:** press rocker switch ① up **SET+** or down **SET-** to the point of resistance. The selected target speed increases or decreases by 1 mph (1 km/h) and appears along with the  symbol in the multifunction display.

## Active Steering Assist



### Function of Active Steering Assist





Active Steering Assist is only available up to a speed of 130 mph (210 km/h). The system helps you to stay in the center of the lane by means of moderate steering interventions. Depending on the speed driven, Active Steering Assist uses the vehicles ahead and lane markings as a reference.

- ① Depending on the country, in the lower speed range Active Steering Assist can use the surrounding traffic as a reference. If necessary, Active Steering Assist can then also provide assistance when driving away from the center of the lane, for example, to form a rescue lane.

If the detection of lane markings and vehicles ahead is impaired, Active Steering Assist switches to passive mode. The system provides no support in this case.

### Status display of Active Steering Assist in the Instrument Display

-  (gray): activated and passive
-  (green): activated and active

-  (red): system limits detected
-  (white, red hands): "hands on the steering wheel" prompt
- ① During the transition from active to passive status, the  symbol is shown as enlarged and flashing. Once the system is passive, the  symbol is shown as gray in the Instrument Display.
- ① Depending on the selected vehicle settings, Active Steering Assist may be unavailable.

### Steering and touch detection

The driver is required to keep their hands on the steering wheel at all times and be able to intervene at any time to correct the course of the vehicle and keep it in lane. The driver must expect a change from active to passive mode or vice versa at any time.

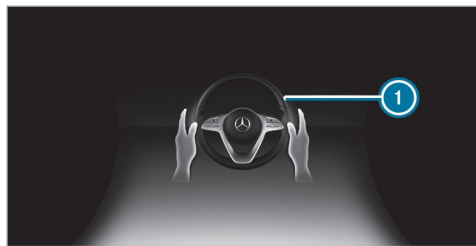

If the system detects that the driver has not steered the vehicle for a considerable period of time or has removed their hands from the steering wheel, display ❶ appears. If the driver still does not steer the vehicle, a warning tone sounds in addition to the visual warning message.

If the driver does not react to the warning for a considerable period, the system can initiate an emergency stop (→ page 231).

The warning is not issued or is stopped when the driver gives confirmation to the system:

- The driver steers the vehicle.

- **Depending on the country:** the driver presses a steering wheel button or operates Touch Control

If Active Steering Assist detects that a system limit has been reached, a visual warning is issued and a warning tone sounds.

Observe the notes on driving systems and your responsibility; you may otherwise fail to recognize dangers (→ page 209).

#### System limits

Active Steering Assist has a limited steering torque for lateral guidance. In some cases, the steering intervention is not sufficient to keep the vehicle in the lane or to drive through exits.

The system may be impaired or may not function in the following instances:

- There is poor visibility, e.g. due to snow, rain, fog, heavy spray, greatly varying ambient light or strong shadows on the road.
- There is glare, e.g. from oncoming traffic, direct sunlight or reflections.
- Insufficient road illumination.

- The windshield is dirty, fogged up, damaged or covered in the vicinity of the camera, e.g. by a sticker.
- No, or several, unclear lane markings are present for one lane, or the markings change quickly, for example, in a construction area or intersections.
- The lane markings are worn away, dark or covered up, e.g. by dirt or snow.
- If the distance to the vehicle in front is too short and thus the lane markings cannot be detected.
- The road is narrow and winding.
- There are obstacles on the lane or projecting out into the lane, such as object markers.

The system does not provide assistance in the following conditions:

- On tight curves and when turning.
- When crossing intersections.
- At roundabouts or toll stations.
- When towing a trailer.
- When the tire pressure is too low.



**⚠ WARNING** Risk of accident if Active Steering Assist unexpectedly stops functioning

If the system limits of Active Steering Assist are reached there is no guarantee that the system will remain active or will keep the vehicle in lane.

- ▶ Always keep your hands on the steering wheel and observe the traffic carefully.
- ▶ Always steer the vehicle paying attention to traffic conditions.

**⚠ WARNING** Risk of accident if Active Steering Assist unexpectedly intervenes

The detection of lane markings and objects may malfunction and cause unexpected steering interventions.

- ▶ Steer according to traffic conditions.



### Activating/deactivating Active Steering Assist

#### Requirements:

- ESP® is activated, but is not intervening.

- Active Distance Assist DISTRONIC is activated.

Multimedia system:

- ➔  ➔ **Settings** ➔ **Quick Access**
- ▶ Select  **Steering Assist.**

### Function of Active Emergency Stop Assist

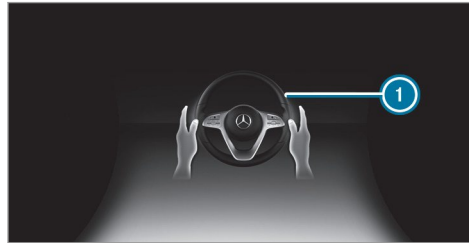

If the system detects that the driver has not steered the vehicle for a considerable period of time or has removed their hands from the steering wheel, display ① appears in the Instrument Display. If the driver still does not steer the vehicle, or gives no confirmation to the system, a warning

tone sounds in addition to the visual warning message.

If the driver still does not respond to the warning, the **Beginning Emergency Stop** message appears in the Instrument Display. If the driver still does not respond, Active Distance Assist DISTRONIC reduces the speed. The vehicle is decelerated in stages to a standstill.

Depending on the country, at speeds below 40 mph (60 km/h) the hazard warning lights switch on automatically.

When the vehicle is stationary, the following actions are carried out:

- The vehicle is secured with the electric parking brake.
- Active Distance Assist DISTRONIC is ended.
- The vehicle is unlocked.
- If possible, an emergency call is placed to the Mercedes-Benz emergency call center.

The driver can cancel the deceleration at any time by performing one of the following actions:

- Steering

- Braking or accelerating
- Deactivating Active Distance Assist DISTRONIC

### Active Lane Change Assist

#### Function of Active Lane Change Assist

Active Lane Change Assist supports the driver when changing lanes by applying steering torque if the driver activates a turn signal indicator.

Observe the notes on driving systems and your responsibility; you may otherwise fail to recognize dangers (→ page 209).

Assistance when changing lanes is provided if all the following conditions are met:

- You are driving on a freeway or road with multiple lanes in the direction of travel.
- The neighboring lane is separated by a broken lane marking.
- No vehicle is detected in the adjacent lane.
- The vehicle speed is between 50 mph (80 km/h) and 110 mph (180 km/h).

- Active Lane Change Assist is switched on in the multimedia system.
- Active Steering Assist is activated and active.

If no vehicle is detected in the adjacent lane and a lane change is permitted, the lane change begins after the driver has activated the turn signal indicator. This is shown to the driver with a green arrow next to the  steering wheel symbol.

The **Lane Change to the Left** message, for example, also appears. If Active Lane Change Assist has been activated with the turn signal indicator but a lane change is not immediately possible, a gray arrow appears next to the  steering wheel symbol, which remains green.

When lane change assistance starts, the turn signal indicator is automatically activated along with the display in the Instrument Display.

If the assistance graphic is shown when changing lanes, an additional arrow appears in it pointing towards the adjacent lane (→ page 220).

If a lane change is not possible, the arrow is faded out after a few seconds and a new lane change must be initiated. An immediate lane change is

only possible on freeway sections without speed limits.

If the system is impaired, Active Lane Change Assist may be canceled. If it is canceled, the **Lane Change Canceled** message appears in the Instrument Display.

In addition, a warning tone may sound, depending on the situation.

 **WARNING** Risk of accident when changing lane to an occupied adjacent lane

Lane Change Assist cannot always clearly detect if the adjacent lane is free.

The lane change might be initiated although the adjacent lane is not free.

- ▶ Before changing lanes, make sure that the neighboring lane is free and there is no danger to other road users.
- ▶ Monitor the lane change.

**⚠ WARNING** Risk of accident if Lane Change Assist unexpectedly stops functioning

If the system limitations for Lane Change Assist have been reached, there is no guarantee that the system will remain active.

Lane Change Assist cannot then assist you by applying steering torque.

- ▶ Always monitor the lane change and keep your hands on the steering wheel. Observe the traffic conditions and steer and/or brake if necessary.

### System limits

The system limitations of Active Steering Assist apply to Active Lane Change Assist (→ page 229).

The system may also be impaired or may not function in the following situations:

- The sensors in the rear bumper are dirty, damaged or covered by a sticker or ice and snow, for example.
- The exterior lighting shows a malfunction.

- ① The Active Lane Change Assist sensors adjust automatically while a certain distance is being driven after the vehicle has been delivered. Active Lane Change Assist is unavailable or only partially available during this teach-in process; no arrow appears next to the  Active Steering Assist symbol when the turn signal indicator is activated.

### Selecting Active Lane Change Assist

Multimedia system:

-  ▶ Settings ▶ Assistance
- ▶▶ Active Lane Change Assist
- ▶ Select the function.

### Active Brake Assist

#### Function of Active Brake Assist

Active Brake Assist consists of the following functions:

- Distance warning function
- Autonomous braking function
- Situation-dependent braking assistance

- **Vehicles with Driving Assistance Package:** Evasive Steering Assist and cornering function

Active Brake Assist can help you to minimize the risk of a collision with vehicles, cyclists or pedestrians or to reduce the effects of such a collision.

If Active Brake Assist has detected a risk of collision, a warning tone sounds and the  distance warning lamp lights up in the instrument cluster.

**Vehicles with PRE-SAFE®:** depending on the country, an additional haptic warning occurs in the form of slight, repeated tensioning of the seat belt.

If you do not react to the warning, autonomous braking can be initiated in critical situations.

In especially critical situations, Active Brake Assist can initiate autonomous braking directly. In this case, the warning lamp and warning tone occur simultaneously with the braking application.

If you apply the brake yourself in a critical situation or apply the brake during autonomous braking, situation-dependent braking assistance

occurs. The brake pressure increases up to maximum full-stop braking if necessary.

Observe the notes on driving systems and your responsibility; you may otherwise fail to recognize dangers (→ page 209).

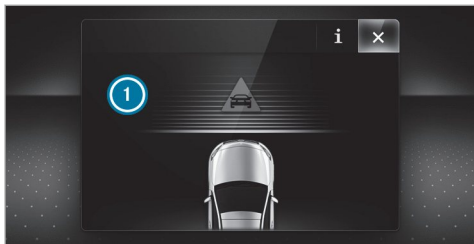

If autonomous braking or situation-dependent braking assistance has occurred, display ① appears in the Instrument Display and then automatically goes out after a short time.

If the autonomous braking function or the situation-dependent braking assistance is triggered, additional preventive measures for occupant protection (PRE-SAFE®) may also be initiated.

**⚠ WARNING** Risk of an accident caused by limited detection performance of Active Brake Assist

Active Brake Assist cannot always clearly identify objects and complex traffic situations.

In such cases, Active Brake Assist might:

- Give a warning or brake without reason
- Not give a warning or not brake

Active Brake Assist is only an aid. The driver is responsible for maintaining a sufficiently safe distance to the vehicle in front, vehicle speed and for braking in good time.

- ▶ Always pay careful attention to the traffic situation; do not rely on Active Brake Assist alone.
- ▶ Be prepared to brake or swerve if necessary.

Also observe the system limits of Active Brake Assist.

**The individual subfunctions are available in various speed ranges:**

The distance warning function can issue a warning in the following situations:

- From approximately 4 mph (7 km/h), if your vehicle is critically close to a vehicle, cyclist or pedestrian, you will hear an intermittent warning tone and the  distance warning lamp lights up in the instrument cluster.

**Vehicles with PRE-SAFE®:** depending on the country, an additional haptic warning occurs in the form of slight, repeated tensioning of the seat belt.

Brake immediately or take evasive action, provided it is safe to do so and the traffic situation allows this.

**Distance warning function (vehicles without Driving Assistance Package)**

The distance warning function can aid you in the following situations with an intermittent warning tone and a warning lamp:

- at speeds up to approximately 155 mph (250 km/h) when approaching vehicles ahead

- at speeds up to approximately 50 mph (80 km/h) when approaching stationary vehicles, moving pedestrians, and cyclists ahead
- at speeds up to approximately 37 mph (60 km/h) when approaching crossing cyclists

#### **Distance warning function (vehicles with Driving Assistance Package)**

The distance warning function can aid you in the following situations with an intermittent warning tone and a warning lamp:

- at speeds up to approximately 155 mph (250 km/h) when approaching vehicles ahead
- at speeds up to approximately 62 mph (100 km/h) when approaching stationary vehicles
- at speeds up to approximately 50 mph (80 km/h) when approaching moving pedestrians and cyclists ahead
- at speeds up to approximately 43 mph (70 km/h) when approaching stationary pedestrians, crossing vehicles and stationary and crossing cyclists

#### **Autonomous braking function (vehicles without Driving Assistance Package)**

If the vehicle is traveling at speeds above approximately 4 mph (7 km/h), the autonomous braking function may intervene in the following situations:

- at speeds up to approximately 124 mph (200 km/h) when approaching vehicles ahead
- at speeds up to approximately 50 mph (80 km/h) when approaching cyclists ahead
- at speeds up to approximately 37 mph (60 km/h) when approaching moving pedestrians and crossing cyclists
- at speeds up to approximately 31 mph (50 km/h) when approaching stationary vehicles

#### **Autonomous braking function (vehicles with Driving Assistance Package)**

If the vehicle is traveling at speeds above approximately 4 mph (7 km/h), the autonomous braking function may intervene in the following situations:

- at speeds up to approximately 155 mph (250 km/h) when approaching vehicles ahead

- at speeds up to approximately 62 mph (100 km/h) when approaching stationary vehicles
- at speeds up to approximately 50 mph (80 km/h) when approaching cyclists ahead
- at speeds up to approximately 43 mph (70 km/h) when approaching stationary and moving pedestrians, crossing vehicles and stationary and crossing cyclists

#### **Situation-dependent braking assistance (vehicles without Driving Assistance Package)**

The situation-dependent braking assistance can intervene from a speed of approximately 4 mph (7 km/h) in the following situations:

- at speeds up to approximately 155 mph (250 km/h) when approaching vehicles ahead
- at speeds up to approximately 50 mph (80 km/h) when approaching stationary vehicles and vehicles ahead
- at speeds up to approximately 37 mph (60 km/h) when approaching moving pedestrians and crossing cyclists

### **Situation-dependent braking assistance (vehicles with Driving Assistance Package)**

The situation-dependent braking assistance can intervene from a speed of approximately 4 mph (7 km/h) in the following situations:

- at speeds up to approximately 155 mph (250 km/h) when approaching vehicles ahead
- at speeds up to approximately 62 mph (100 km/h) when approaching stationary vehicles
- at speeds up to approximately 50 mph (80 km/h) when approaching cyclists ahead
- at speeds up to approximately 37 mph (60 km/h) when approaching stationary and moving pedestrians, crossing vehicles, and stationary and crossing cyclists

### **Canceling a brake application of Active Brake Assist**

You can cancel a brake application of Active Brake Assist at any time by:

- sharply depressing the accelerator pedal or with kickdown
- releasing the brake pedal

Active Brake Assist may cancel the brake application when one of the following conditions is fulfilled:

- You maneuver to avoid the obstacle
- There is no longer a risk of collision
- An obstacle is no longer detected in front of your vehicle

### **Evasive Steering Assist (only vehicles with Driving Assistance Package)**

Evasive Steering Assist has the following characteristics:

- The ability to detect stationary or moving pedestrians.
- Assistance through power-assisted steering if it detects a swerving maneuver.
- Activation by an abrupt steering movement during a swerving maneuver.
- Assistance during swerving and straightening of the vehicle.
- Reaction from a speed of approximately 12 mph (20 km/h) up to a speed of approximately 43 mph (70 km/h).

You can prevent the assistance at any time by actively steering.

### **Cornering function (only vehicles with Driving Assistance Package)**

If the system detects a risk of a collision with an oncoming vehicle when turning across an oncoming lane, autonomous braking can be initiated at speeds below 9 mph (15 km/h) before you have left the lane in which you are driving.

#### **⚠ WARNING Risk of accident despite Evasive Steering Assist**

Evasive Steering Assist cannot always recognize objects or complex traffic situations clearly.

Moreover, the steering support provided by Evasive Steering Assist is not sufficient to avoid a collision.

- ▶ Always pay careful attention to the traffic situation; do not rely on Evasive Steering Assist alone.
- ▶ Be prepared to brake or swerve if necessary.

- ▶ End the support by actively steering in non-critical situations.
- ▶ Drive at an appropriate speed if there are pedestrians close to the path of your vehicle.

### System limits

Full system performance is not yet available for a few seconds after switching on the vehicle or after driving off.

If Active Brake Assist is impaired or inoperative due to a malfunction, the  warning lamp appears in the Instrument Display.

The system may be impaired or may not function, particularly in the following situations:

- In snow, rain, fog, heavy spray, if there is glare, in direct sunlight or in greatly varying ambient light.
  - If the sensors are dirty, fogged up, damaged or covered.
  - If the sensors are impaired due to interference from other radar sources, e.g. strong radar reflections in a parking garage.
  - If a loss of tire pressure or a malfunctioning tire has been detected and displayed.
  - If DSR is active.
  - In complex traffic situations where objects cannot always be clearly identified.
  - If pedestrians or vehicles move quickly into the sensor detection range.
  - If pedestrians are hidden by other objects.
  - If the typical outline of a pedestrian cannot be distinguished from the background.
  - If a pedestrian is not detected as such, e.g. due to special clothing or other objects.
  - If the driver's seat belt is not fastened.
  - On curves with a tight radius.
-  The Active Brake Assist sensors adjust automatically while a certain distance is being driven after the vehicle has been delivered. Active Brake Assist is unavailable or only partially available during the teach-in process.

### Activating/deactivating Active Brake Assist

#### Requirements:



- The vehicle is switched on.

Multimedia system:

  **▶▶ Settings ▶▶ Assistance**  
**▶▶ Active Brake Assist**

- ▶ Select the desired setting.  
The setting is retained when the drive system is next started.

#### Deactivating Active Brake Assist

-  It is recommended that you always leave Active Brake Assist activated.
- ▶ Select **Off**.  
The distance warning function, the autonomous braking function and Evasive Steering Assist are deactivated.  
When the vehicle is next started, the middle setting is automatically selected.
-  If Active Brake Assist is deactivated, the  symbol appears in the status bar of the Instrument Display.

## Traffic Sign Assist

### Function of Traffic Sign Assist

Traffic Sign Assist detects traffic signs with the multifunction camera (→ page 209). It assists you by displaying detected speed limits and overtaking restrictions in the Instrument Display.

Observe the notes on driving systems and your responsibility; you may otherwise fail to recognize dangers (→ page 209).

Since Traffic Sign Assist also uses the data stored in the navigation system, it can update the display in the following situations without detecting traffic signs.

The camera also detects traffic signs with a restriction indicated by an additional sign (e.g. when wet). These are only displayed if a restriction applies or if the system cannot clearly determine whether the restriction applies.

### Warning when the maximum permissible speed is exceeded

The system can warn you if you unintentionally exceed the maximum permissible speed. To do this, you can specify in the multimedia system by how much the maximum permissible speed can

be exceeded before a warning is issued. You can specify whether the warning is to be just a visual warning or an acoustic one as well.

### Display in the Instrument Display

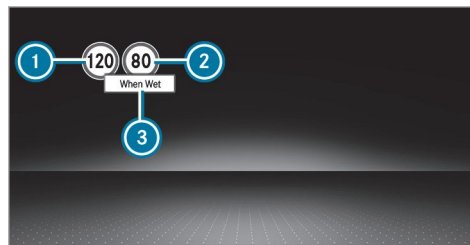

Instrument Display in the Widescreen Cockpit

- ① Maximum permissible speed
  - ② Maximum permissible speed when there is a restriction
  - ③ Additional sign with restriction
- ⓘ **Vehicles with a standard Instrument Display:** A + symbol next to a traffic sign in the Instrument Display indicates that additional traffic signs have been detected. These can also be

displayed in the media display and optionally in the Head-up Display.

If Traffic Sign Assist cannot determine the maximum permissible speed (e.g. due to missing signs), the following display appears in the Instrument Display:



This is displayed continuously if the vehicle is in a country where Traffic Sign Assist is not supported. Traffic Sign Assist is not available in all countries.

ⓘ Also observe the information on display messages in Traffic Sign Assist (→ page 423).

### System limits

The system may be impaired or may not function particularly in the following situations:

- If there is poor visibility, e.g. due to insufficient illumination of the road, highly variable shade conditions, rain, snow, fog or heavy spray.
- If there is glare, e.g. from oncoming traffic, direct sunlight or reflections.



- If the windshield in the area of the multifunction camera is dirty, or if the camera is fogged up, damaged or covered.
- If the traffic signs are hard to detect, e.g. due to dirt, snow or insufficient lighting, or because they are covered.
- If the information in the navigation system's digital map is incorrect or out-of-date.
- If signs are ambiguous, e.g. road signs in roadworks or in adjacent lanes.
- If you turn sharply when passing traffic signs outside the camera's field of vision.

### Setting Traffic Sign Assist

#### Requirements:

- **Only vehicles with Driving Assistance Package:**  
Active Distance Assist DISTRONIC and ECO Assist must be activated for the automatic adoption of speed limits.

Multimedia system:

→  ► Settings ► Assistance  
► Traffic Sign Assist

### Activating or deactivating automatic adoption of speed limits (only vehicles with Driving Assistance Package)

- Select **Limit Adoption**.
- Switch the function on or off.  
The speed limits detected by Traffic Sign Assist are automatically adopted by Active Distance Assist DISTRONIC.

 If one of the following systems is activated, the detected speed can be manually adopted as the speed limit:

- Active Distance Assist DISTRONIC
- Cruise control
- Variable limiter

Further information about Active Distance Assist DISTRONIC: (→ page 222).

### Displaying detected traffic signs in the media display

- Select **Display in Central Display**.
- Switch the function on or off.

### Setting the type of warning

- Select **Visual & Audible**, **Visual** or **Off**.

### Setting the warning threshold

This value determines the speed at which a warning is issued when exceeded.

- Select **Warning Threshold**.
- Set the desired speed.

### Traffic Light Information service

 **WARNING** Risk of an accident or injury due to distraction, incorrect or missing data

The traffic light information display is an aid and cannot replace the observation of the actual driving situation.

- ▶ Keep the actual traffic situation constantly in view when approaching a traffic light and when changing lanes.
- ▶ Avoid looking at the Instrument Display and Head-up Display for a long time.

The Instrument Display and Head-up Display (if available) show the traffic light icon and remaining time 1 until the next green phase as a countdown.



Example representation in the Instrument Display

The display is hidden about five seconds before the traffic lights change to green.

- ❗ The display also goes out in the following cases:
  - When turning off before the intersection into a cross or side street
  - When turning before the intersection
- ❗ The direction arrows are displayed depending on the following functions:
  - A turn signal is set
  - A lane is recommended during active route guidance

If neither function is active, the remaining time until the next green phase for the lane straight ahead is displayed.

- ❗ Use of the traffic light information service requires the regular transmission of vehicle positions and driving directions to Mercedes-Benz. The data is immediately anonymized by Mercedes-Benz and forwarded to the provider of the traffic light information service. The vehicle positions and driving directions are deleted after a very short time (a few seconds) and are not permanently saved.

If you do not want to transmit the vehicle positions and driving directions, you have the following options:

- You deactivate the service in the Mercedes me portal.
- You have the service deactivated at an authorized Mercedes-Benz Center.
- You deactivate the service in the **Assistance** menu in the multimedia system (→ page 241).

- ❗ This traffic light information service is only available in certain cities and regions.

The function is supported under the following conditions:

- The vehicle is equipped with a multimedia system featuring navigation and a communication module with an activated, integrated SIM card.
- You have a user account for the Mercedes me Portal.
- The vehicle has been connected with the user account.

- The navigation services option is available, subscribed to and activated in the Mercedes me Portal.
- The traffic light data service belongs to the scope of the navigation services.

The current vehicle position and the direction of travel are transmitted via the communication module and aligned with the data from the traffic light data service provider. The provider gathers data from traffic lights which transmit their changing phases. When the vehicle approaches an intersection with networked traffic lights, data is transmitted to the vehicle.

A set turn signal left or right and lane recommendations during active route guidance are taken into account for the display.

The service is for information purposes only and is not linked to any other vehicle functions, systems or components. Please note that the displayed data is not available in all traffic areas and may be incorrect.

Certain light signal systems automatically adapt their switching times to the current traffic situa-

tion. This can lead to a sudden change in the countdown display.

The information in the Instrument Display is shown after selecting the display contents in the **Assistance** menu. If another menu is selected, the traffic light countdown is not displayed.

Also observe the following information:

- select a speed adapted to the traffic, surroundings and weather conditions
- observe actual traffic signs
- observe applicable traffic rules and regulations

Please observe the notes on driving systems and your responsibility. You could otherwise fail to recognize dangers.

### System limits

The display does not appear in the following situations, for example:

- There is no traffic light data available.
- The time remaining until the next green phase is less than ten seconds.

- Emergency vehicles or local public transport are located in the vicinity of the intersection.
- The data transmission from the vehicle has been interrupted.
- The traffic light systems are located in a construction site area or are undergoing maintenance.
- The light signal system is malfunctioning.
- The subscription to the service has expired.

### Switching the traffic light information display on or off

Multimedia system:

  **» Settings » Assistance**

 Switch **Traffic Light Information** on  or off .



## Blind Spot Assist and Active Blind Spot Assist with exit warning

### Function of Blind Spot Assist and Active Blind Spot Assist with exit warning

Blind Spot Assist and Active Blind Spot Assist use two lateral, rear-facing radar sensors to monitor the area up to 130 ft (40 m) behind and 10 ft (3 m) next to your vehicle.

If a vehicle is detected at speeds above approximately 8 mph (12 km/h) and this vehicle subsequently enters the monitoring range directly next to your vehicle, the warning lamp in the outside mirror lights up red.

Permanent status display in the instrument cluster:

-  (gray): system is activated but inoperative
-  (green): system is activated and operational

If a vehicle is detected close to your vehicle and you switch on the turn signal indicator in the corresponding direction, a double warning tone sounds and the red warning lamp in the outside

mirror flashes. If the turn signal indicator remains switched on, all other detected vehicles are indicated only by the flashing of the red warning lamp.

If you overtake a vehicle quickly, no warning is given.

#### **WARNING** Risk of accident despite Blind Spot Assist

Blind Spot Assist does not react to vehicles approaching and overtaking you at a greatly different speed.

Blind Spot Assist cannot warn drivers in this situation.

- ▶ Always pay careful attention to the traffic situation and maintain a safe distance at the side of the vehicle.

Observe the notes on driving systems and your responsibility; you may otherwise fail to recognize dangers (→ page 209).

#### Exit warning

The exit warning is an additional function of Blind Spot Assist and can warn vehicle occupants about

approaching vehicles when leaving the vehicle when stationary.

#### **WARNING** Risk of accident despite exit warning

The exit warning neither reacts to stationary objects nor to persons or road users approaching you at a greatly differing speed.

The exit warning cannot warn drivers in these situations.

- ▶ Always pay particular attention to the traffic situation when opening the doors and make sure there is sufficient clearance.

If there is a vehicle in the monitoring range, this is indicated in the outside mirror. If a vehicle occupant opens the door on the side with the warning, a warning tone sounds and the warning lamp in the outside mirror starts to flash.

This additional function is only available when Blind Spot Assist is active. When the exit warning is activated, it can warn vehicle occupants for up to three minutes after switching the vehicle off.

The exit warning is no longer available once the warning lamp in the outside mirror flashes three times.

The exit warning is only an aid and not a substitute for the attention of vehicle occupants. The responsibility for opening and closing the doors and for leaving the vehicle remains with the vehicle occupants.

### System limits

Blind Spot Assist and Active Blind Spot Assist may be limited in the following situations, in particular:

- if there is dirt on the sensors or the sensors are obscured
- in poor visibility, e.g. due to fog, heavy rain or snow
- if there are narrow vehicles, e.g. bicycles or motorbikes
- if the road has very wide or narrow lanes
- if vehicles are not driving in the middle of their lane

Warnings may be issued in error when driving close to crash barriers or similar continuous lane

borders. Always make sure that there is sufficient distance to the side for other traffic or obstacles.

Warnings may be interrupted when driving alongside long vehicles, for example trucks, for a prolonged time.

Blind Spot Assist is not operational when reverse gear is engaged.

Blind Spot Assist and the exit warning are not operational when a trailer is coupled to the vehicle and the electrical connection has been correctly established.

The exit warning may be limited in the following situations:

- when the sensors are covered by adjacent vehicles in narrow parking spaces
- when people approach the vehicle
- in the event of stationary or slowly moving objects

### Function of brake application (Active Blind Spot Assist)

If Active Blind Spot Assist detects a risk of a side impact in the monitoring range, a course-correct-

ing brake application is carried out. This is designed to help you avoid a collision.

The course-correcting brake application is available in the speed range between approximately 20 mph (30 km/h) and 125 mph (200 km/h).

#### **WARNING** Risk of accident despite brake application of Active Blind Spot Assist

A course-correcting brake application cannot always prevent a collision.

- ▶ Always steer, brake or accelerate yourself, especially if Active Blind Spot Assist warns you or makes a course-correcting brake application.
- ▶ Always maintain a safe distance at the sides.



If a course-correcting brake application occurs, the red warning lamp flashes in the outside mirror and a warning tone sounds. In addition, display **1** indicating the danger of a side collision appears in the Instrument Display.

In rare cases, the system may make an inappropriate brake application. This brake application may be interrupted at any time if you steer slightly in the opposite direction or accelerate.

#### System limits

Note the system limitations of Active Blind Spot Assist; you may otherwise not recognize the dangers (→ page 242).

Either a course-correcting brake application appropriate to the driving situation, or none at all, may occur in the following situations:

- Vehicles or obstacles, e.g. crash barriers, are located on both sides of your vehicle.
- A vehicle approaches too closely on the side.
- You have adopted a sporty driving style with high cornering speeds.
- You brake or accelerate significantly.
- A driving safety system intervenes, e.g. ESP® or Active Brake Assist.
- ESP® is deactivated.
- A loss of tire pressure or a malfunctioning tire is detected.
- You are driving with a trailer and the electrical connection to the trailer hitch has been correctly established.

#### Activating/deactivating Blind Spot Assist or Active Blind Spot Assist

Multimedia system:

→  **» Settings » Assistance**

▶ Activate or deactivate **Blind Spot Assist**.

or

▶ Activate or deactivate **Act. Blind Spot Assist**.

#### Active Lane Keeping Assist



##### Function of Active Lane Keeping Assist

Active Lane Keeping Assist monitors the area in front of your vehicle by means of the multifunction camera (→ page 209). It serves to protect you against unintentionally leaving your lane. You will be warned by vibration pulses in the steering wheel and guided by a course-correcting brake application back into your lane.

Active Lane Keeping Assist is available in the speed range between 37 mph (60 km/h) and 124 mph (200 km/h).

Active Lane Keeping Assist can neither reduce the risk of an accident if you fail to adapt your driving style nor override the laws of physics. It cannot take into account road, weather or traffic conditions. Active Lane Keeping Assist is only an aid. You are responsible for maintaining a safe distance to the vehicle in front, for vehicle speed, for braking in good time and for staying in lane.

The status of Active Lane Keeping Assist is displayed in the on-board computer:

-  (green): Active Lane Keeping Assist is active and operating.
-  (gray): Active Lane Keeping Assist is active but not operating.
- : Active Lane Keeping Assist is deactivated or there is a malfunction.



If a lane-correcting brake application occurs, display ① appears in the Instrument Display.

The system does not apply the brake if you activate the turn signal indicator.

**Vehicles with Driving Assistance Package:** if the system detects an obstacle, such as another vehicle in the adjacent lane, it will apply the brake regardless of the turn signal indicator.

You are warned by vibrations in the steering wheel in the following circumstances:

- Active Lane Keeping Assist detects a lane marking.
- A front wheel drives over this lane marking.

**Conditions for a course-correcting brake application (vehicles without Driving Assistance Package)**

Lane markings were detected on both sides of the lane. The front wheel drives over a continuous lane marking.

- ① A brake application may be interrupted at any time if you steer slightly in the opposite direction.

**Conditions for a course-correcting brake application (vehicles with Driving Assistance Package)**

- A continuous lane marking was detected and driven over with the front wheel.
- A lane marking and an approaching vehicle, an overtaking vehicle or vehicles driving parallel

to your vehicle were detected in the adjacent lane. The front wheel drives over the lane marking.

- ① A brake application may be interrupted at any time if you steer slightly in the opposite direction.

### System limits

No lane-correcting brake application occurs in the following situations:

- You clearly and actively steer, brake or accelerate.
- If a driving safety system intervenes, such as ESP®, Active Brake Assist or Active Blind Spot Assist.
- You have adopted a sporty driving style with high cornering speeds or high rates of acceleration.
- When ESP® is deactivated.
- When driving with a trailer, the electrical connection to the trailer has been correctly established.

- If a loss of tire pressure or a faulty tire is detected and displayed.

If you deactivate the Active Lane Keeping Assist warning and the lane markings cannot be clearly detected, it is possible that no lane-correcting brake application takes place (→ page 246).

The system may be impaired or may not function particularly in the following situations:

- If there is poor visibility, e.g. due to insufficient illumination of the road, highly variable shade conditions, rain, snow, fog or heavy spray.
- If there is glare, e.g. from oncoming traffic, the sun or reflections.
- If the windshield in the area of the multifunction camera is dirty, or if the camera is fogged up, damaged or covered.
- If there are no lane markings, or several unclear lane markings are present for one lane, e.g. around roadworks.
- If the lane markings are worn, dark or covered.

- If the distance to the vehicle in front is too short and thus the lane markings cannot be detected.
- If the lane markings change quickly, e.g. lanes branch off, cross one another or merge.
- If the road is very narrow and winding.
- **Vehicles with Driving Assistance Package:** if the radar sensors in the rear bumper are dirty or covered in snow and an obstacle is detected in your lane, no lane-correcting brake application takes place.

### Activating/deactivating Active Lane Keeping Assist

Multimedia system:

→  **» Settings » Quick Access  
» Active Lane Keeping Assist**

- ▶ Activate or deactivate the function.

### Setting Active Lane Keeping Assist

Multimedia system:

→  **» Settings » Assistance  
» Active Lane Keeping Assist**

### Activating or deactivating the haptic warning

- ▶ Select **Warning**.  
Activate or deactivate the function.

## AIRMATIC

### Function of AIRMATIC

 <b>NOTE</b> Mercedes-AMG vehicles
▶ Observe the notes in the Supplement. You could otherwise fail to recognize dangers.

AIRMATIC is an air suspension system with an all-round level control system, which also ensures the best possible suspension and constant ground clearance, even with a laden vehicle. When driving at speed, the vehicle is lowered automatically to improve driving safety and to reduce fuel con-



sumption. You also have the option of manually adjusting the vehicle level.

AIRMATIC is comprised of the following functions and components:

- All-round air suspension
- Speed-dependent lowering
- Manually selectable high level setting for greater ground clearance which can be adjusted using a level button
- **Vehicles with ADS PLUS:** also Adaptive Damping System with constant adjustment of damping characteristics for improved driving comfort

### Suspension setting and vehicle level per drive program

Drive program  and :

- The suspension setting is comfortable.
- The vehicle is set to the normal level.
- When driving at speeds above approximately 87 mph (140 km/h), the vehicle is lowered.
- When driving at speeds below approximately 25 mph (40 km/h), the vehicle is raised again.

Drive program  (Mercedes-Maybach vehicles only):

- The suspension setting is very comfortable.
- The vehicle is set to the normal level.
- When driving at speeds above approximately 87 mph (140 km/h), the vehicle is lowered.
- When driving at speeds below approximately 25 mph (40 km/h), the vehicle is raised again.

Drive program :

- The suspension setting is firmer.
- The vehicle is lowered to sport level.

Drive program :

- The suspension setting is even firmer.
- The vehicle is lowered to Sport + level.

Drive program  (vehicles without Off-road package):

- The suspension setting is suitable for easily negotiable off-road terrain.
- The vehicle is set to off-road level +1.

- When driving at speeds above approximately 50 mph (80 km/h), the vehicle is lowered.
- When driving at speeds below approximately 28 mph (45 km/h), the vehicle is raised.

Drive program  (vehicles with Off-road package):

- The suspension setting is suitable for easily negotiable off-road terrain.
- The vehicle is set to off-road level +1.
- When driving at speeds above approximately 71 mph (115 km/h), the vehicle is lowered.
- When driving at speeds below approximately 47 mph (75 km/h), the vehicle is raised.

Drive program  (vehicles with Off-road package):

- The suspension setting is suitable for difficult off-road terrain.
- The vehicle is set to off-road level +1.
- When driving at speeds above approximately 50 mph (80 km/h), the vehicle is lowered.
- When driving at speeds below approximately 28 mph (45 km/h), the vehicle is raised.

Individual suspension settings can be called up in drive program  (→ page 191).

#### Differences between different vehicle levels compared to the normal level



Vehicle level	Vehicles without Off-road package	Vehicles with Off-road package
Car wash	Approx. +3.5 in (+90 mm)	Approx. +3.5 in (+90 mm)
Off-road level +3	Unavailable	Approx. +3.5 in (+90 mm)
Off-road level +2	Unavailable	Approx. +2.4 in (+60 mm)

Vehicle level	Vehicles without Off-road package	Vehicles with Off-road package
Off-road level +1	Mercedes-Maybach vehicles: approx. +2.0 in (+50 mm) All other models: approx. +2.4 in (+60 mm)	Approx. +1.2 in (+30 mm)
Sport	Approx. -0.6 in (-15 mm)	Approx. -0.6 in (-15 mm)
Sport +	Approx. -1.0 in (-25 mm)	Approx. -1.0 in (-25 mm)

If the entry/exit level function is activated, the vehicle is lowered to the Sport + level to facilitate entering/exiting the vehicle. When driving at speeds of approximately 19 mph (30 km/h) or above, the entry/exit level is deactivated and the vehicle is raised (→ page 252).

#### Operation with a trailer or bicycle rack

If transport equipment, for example a trailer or bicycle rack, is attached to the trailer hitch and the electrical connection has been correctly established:

- In drive program  and , the vehicle adopts the normal level starting from a speed of 19 mph (30 km/h).
- In all other drive programs, the vehicle remains at normal level irrespective of speed.

#### System limits

AIRMATIC may not be available or have only limited availability in the following cases:

- The overheating protection has been activated due to frequent level changes within a short time. The  warning lamp appears in the multifunction display.

After the cooling phase, the system is again available without restriction.

### Setting the vehicle level (vehicles with AIRMATIC)

**⚠ WARNING** Risk of accident because vehicle level is too high

Driving characteristics may be impaired.

The vehicle can drift outwards, for example, when steering or cornering.

- ▶ Choose a vehicle level which is suited to the driving style and the road surface conditions.

**⚠ WARNING** Risk of entrapment from vehicle lowering

When lowering the vehicle, people could become trapped if their limbs are between the vehicle body and the tires or underneath the vehicle.

- ▶ Make sure no one is underneath the vehicle or in the immediate vicinity of the wheel arches when the vehicle is being lowered.

**⚠ WARNING** Risk of becoming trapped due to the vehicle lowering

**Vehicles with AIRMATIC or level control:** when you unload luggage or leave the vehicle, the vehicle first rises slightly and then returns to the set level shortly afterwards.

You or anyone else in the vicinity of the wheel arches or the underbody could thus become trapped.

The vehicle can also be lowered after being locked.

- ▶ When leaving the vehicle, make sure that nobody is in the vicinity of the wheel arches or the underbody.

**! NOTE** Damage due to vehicle lowering

Parts of the body could be damaged when the vehicle is lowered.

- ▶ Make sure that there are no obstacles such as curbs underneath or in the immediate vicinity of the body when the vehicle is being lowered.

**! NOTE** Mercedes-AMG vehicles

- ▶ Observe the notes in the Supplement. You could otherwise fail to recognize dangers.

#### Requirements:

- The vehicle has been started.
- **Vehicles without Off-road package:** the vehicle is not moving faster than 40 mph (65 km/h).
- **Vehicles with Off-road package:**
  - Off-road level +1: the vehicle is not moving faster than 62 mph (100 km/h).
  - Off-road level +2: the vehicle is not moving faster than 40 mph (65 km/h).
  - Off-road level +3: the vehicle is not moving faster than 12 mph (20 km/h) and the rear fog lamp is not switched on.

### Raising the vehicle (vehicles without Off-road package)

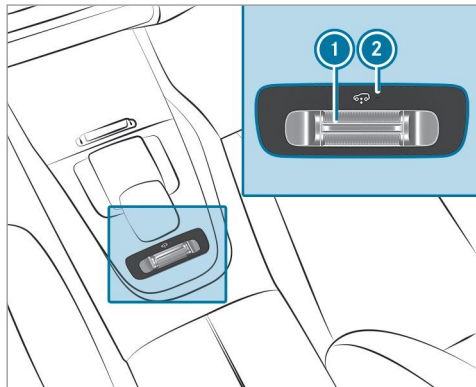

- ▶ Push rocker switch ① forwards. Indicator lamp ② flashes while the vehicle is being raised and lights up continuously when it has finished rising.

Your selection is saved. The off-road level set remains stored even after the ignition has been switched off.

The vehicle is lowered again in the following situations:

- When driving faster than 50 mph (80 km/h).
- When driving briefly between 40 mph (65 km/h) and 50 mph (80 km/h).
- After selecting a different drive program using the DYNAMIC SELECT switch.

The vehicle is adjusted to the height of the active drive program.

### Lowering the vehicle (vehicles without Off-road package)

- ▶ Pull rocker switch ①. The vehicle is adjusted to the height of the active drive program.

### Operation with a trailer or bicycle rack

If the electrical connection has been correctly established to the trailer or bicycle rack:

- From approx. 18.7 mph (30 km/h): off-road level +1 can be selected, regardless of drive program.
- From approx. 18.7 mph (30 km/h): the vehicle is adjusted to normal level, regardless of drive program.

### Raising the vehicle (vehicles with Off-road package)

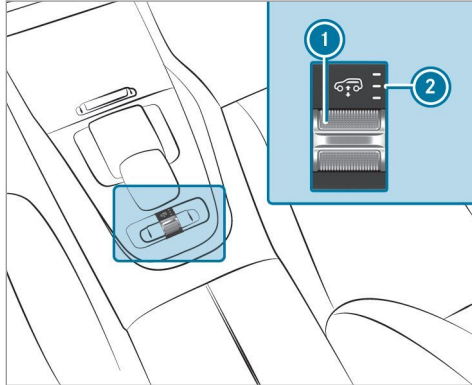

- ▶ Push rocker switch ① forwards.
- Off-road level +1: one indicator lamp ② lights up continuously when the vehicle has finished rising.
  - Off-road level +2: two indicator lamps ② light up continuously when the vehicle has finished rising.

- Off-road level +3: three indicator lamps ② light up continuously when the vehicle has finished rising.

Your selection is saved. The off-road level set remains stored even after the ignition has been switched off.

The vehicle is lowered again in the following situations:

- Off-road level +3: when driving faster than 12 mph (20 km/h) or when the rear fog lamp is switched on.  
The vehicle is lowered to off-road level +2.
- Off-road level +2:
  - When driving faster than 50 mph (80 km/h).
  - When driving briefly between 40 mph (65 km/h) and 50 mph (80 km/h).  
The vehicle is lowered to off-road level +1.
- Off-road level +1:
  - When driving faster than 71 mph (115 km/h).

- When driving briefly between 62 mph (100 km/h) and 71 mph (115 km/h).

The vehicle is lowered to the normal level.

- After selecting a different drive program using the DYNAMIC SELECT switch.  
The vehicle is adjusted to the height of the active drive program.

### Lowering the vehicle (vehicles with Off-road package)

- ▶ Pull rocker switch ①.
- Off-road level +3: the vehicle is lowered to off-road level +2. Two indicator lamps ② light up continuously when the vehicle has finished lowering.
  - Off-road level +2: the vehicle is lowered to off-road level +1. One indicator lamp ② lights up continuously when the vehicle has finished lowering.
  - Off-road level +1: the vehicle is lowered to the normal level. No indicator lamp ② lights up when the vehicle has finished lowering.

Your selection is saved. The off-road level set remains stored even after the ignition has been switched off.

### Operation with a trailer or bicycle rack

If the electrical connection has been correctly established to the trailer or bicycle rack:

- Up to approx. 12 mph (20 km/h): off-road levels +1, +2 and +3 can be selected, regardless of the drive program.
- Up to approx. 19 mph (30 km/h): off-road levels +1 and +2 can be selected, regardless of the drive program.
- From approx. 19 mph (30 km/h): the vehicle is adjusted to normal level, regardless of the drive program.

### Setting the entering and exiting level (AIRMATIC)

#### Requirements:

- The engine is running.
- The vehicle is moving at speeds below 20 mph (30 km/h).

Multimedia system:



Settings

» Schnellzugriff (Quick access)

▶ Select **Lower When Getting In On.**

The vehicle is lowered to low level -2 to facilitate entering and exiting.

ⓘ The availability of this function depends on the vehicle equipment.

ⓘ Further information on AIRMATIC (→ page 246).

### Lowering and raising the rear of the vehicle

**⚠ WARNING** Risk of entrapment from vehicle lowering

When lowering the vehicle, people could become trapped if their limbs are between the vehicle body and the tires or underneath the vehicle.

▶ Make sure no one is underneath the vehicle or in the immediate vicinity of the wheel arches when the vehicle is being lowered.

#### Requirements:

- All vehicle doors are closed
- There is no trailer coupled
- There is no bicycle rack installed
- The battery is sufficiently charged (if necessary, start the engine)

### Lowering the rear of the vehicle

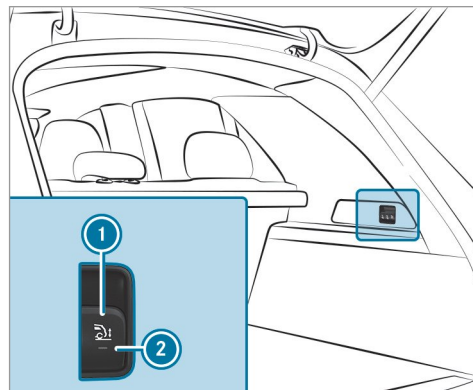

- ▶ Apply the electric parking brake.
  - ▶ Shift the transmission to position **P** (→ page 194).
  - ▶ Pull button **1** in the cargo compartment trim briefly. Indicator lamp **2** flashes until the vehicle has been lowered.
- The vehicle is lowered at the rear axle by approx. 1.5 in (40 mm). When the vehicle has been lowered, indicator lamp **2** remains lit.

Lowering is interrupted in the following situations:

- A vehicle door is opened.
  - Switch **1** is pulled again.
  - The vehicle is being driven faster than 1.2 mph (2 km/h).
- i** The vehicle is automatically set to the level of the selected drive program if you drive at speeds greater than 1.2 mph (2 km/h).

If indicator lamp **2** flashes twice and the rear of the vehicle does not lower:

- ▶ Make sure that the requirements are met.

- i** Lowering the rear of the vehicle allows the vehicle to be loaded more easily. Observe the notes on loading the vehicle when doing this (→ page 124).

#### Raising the rear of the vehicle

- ▶ Check if the battery is sufficiently charged. If necessary, start the engine.
  - ▶ Pull switch **1** briefly. Indicator lamp **2** goes out.
- The vehicle will be raised to the currently selected level.
- i** The vehicle is automatically set to the level of the selected drive program if you drive at speeds greater than 1.2 mph (2 km/h).
- If the vehicle cannot be raised:
- ▶ Ensure that the battery is sufficiently charged; if necessary, start the engine.
- The raising process continues.

#### E-ACTIVE BODY CONTROL

##### Function of E-ACTIVE BODY CONTROL

E-ACTIVE BODY CONTROL is an electrohydraulic suspension system with variable damping for improved driving comfort. The all-round level control system ensures the best possible suspension and constant ground clearance, even with a laden vehicle. When driving at speed, the vehicle is lowered automatically to improve driving safety and to reduce fuel consumption. The suspension setting is adjusted depending on the road surface, vehicle load and the drive program selected.

The ROAD SURFACE SCAN function detects areas of unevenness in the road before you drive over them by means of a multifunction camera. This reduces chassis movements.

The damping is adjusted individually to each wheel and depends on the following factors:

- Driving style, e.g. sporty
- Road condition, e.g. bumps
- Drive program

E-ACTIVE BODY CONTROL is comprised of the following functions and components:

• **Vehicles with Driving Assistance Package:**

- ROAD SURFACE SCAN
- Curve inclination function CURVE
- Recovery mode
- Individual wheel control
- Air suspension with automatic level control
- Speed-dependent lowering to reduce fuel consumption
- Manual level adjustment
- ADS PLUS: Adaptive Damping System with constant adjustment of damping characteristics
- DYNAMIC SELECT switch and level button

**Suspension setting and vehicle level per drive program**

Drive program **[S]**

- The suspension setting is firmer.
- The vehicle is set to Sport level.
- ROAD SURFACE SCAN is deactivated.

- The curve inclination function is deactivated.

Drive program **[S<sup>+</sup>]**

- The suspension setting is even firmer.
- The vehicle is set to Sport + level.
- ROAD SURFACE SCAN is deactivated.
- The curve inclination function is active.

Drive program **[C]**

- The suspension setting is comfortable.
- The vehicle is set to the normal level.
- When driving at speeds above approximately 87 mph (140 km/h), the vehicle is lowered.
- When driving at speeds below approximately 25 mph (40 km/h), the vehicle is raised.
- ROAD SURFACE SCAN is active.
- The curve inclination function is deactivated.

Drive program **[C<sup>+</sup>]**

- The suspension setting is very comfortable.
- The vehicle is set to the normal level.
- When driving at speeds above approximately 87 mph (140 km/h), the vehicle is lowered.

- When driving at speeds below approximately 25 mph (40 km/h), the vehicle is raised.
- ROAD SURFACE SCAN is active.
- The curve inclination function is active.

Drive program **[CV]**

- The suspension setting is comfortable.
- The vehicle is set to the normal level.
- When driving at speeds above approximately 87 mph (140 km/h), the vehicle is lowered.
- When driving at speeds below approximately 25 mph (40 km/h), the vehicle is raised again.
- ROAD SURFACE SCAN is active.
- The curve inclination function is active.

Drive program **[E]**

- The suspension setting is comfortable.
- The vehicle is set to the normal level.
- When driving at speeds above approximately 87 mph (140 km/h), the vehicle is lowered.
- When driving at speeds below approximately 25 mph (40 km/h), the vehicle is raised again.



- ROAD SURFACE SCAN is deactivated.
- The curve inclination function is deactivated.

#### Drive program

- The suspension setting is suitable for easily negotiable off-road terrain.
- The vehicle is set to off-road level +1.
- ROAD SURFACE SCAN is deactivated.
- The curve inclination function is deactivated.
- When the necessary conditions are met, recovery mode and individual wheel control can be activated.
- Vehicles without Off-road package:
  - When driving at speeds above approximately 50 mph (80 km/h) the vehicle is lowered.
  - When driving at speeds below approximately 28 mph (45 km/h), the vehicle is raised.
- Vehicles with Off-road package:
  - When driving at speeds above approximately 71 mph (115 km/h), the vehicle is lowered.

- When driving at speeds below approximately 47 mph (75 km/h), the vehicle is raised.

#### Drive program









- The suspension setting is suitable for difficult off-road terrain.
- The vehicle is set to off-road level +1.
- When driving at speeds above approximately 50 mph (80 km/h), the vehicle is lowered.
- When driving at speeds below approximately 28 mph (45 km/h), the vehicle is raised.
- ROAD SURFACE SCAN is deactivated.
- The curve inclination function is deactivated.
- Recovery mode or individual wheel control can be activated.

#### Drive program

- You can call up individual suspension settings here.

### Operation with a trailer or bicycle rack

If the electrical connection has been correctly established to the trailer or bicycle rack:

- Drive program , , , , ,  and : the vehicle remains at normal level irrespective of speed.
- The curve inclination function is deactivated.
- Drive program  and : the vehicle adopts the normal level starting from a speed of 19 mph (30 km/h).

### Level differences compared to the normal level

Vehicle level	Vehicles without Off-road package	Vehicles with Off-road package
Car wash	Approx. +3.5 in (+90 mm)	Approx. +3.5 in (+90 mm)
Off-road level +3	Unavailable	Approx. +3.5 in (+90 mm)
Off-road level +2	Unavailable	Approx. +2.4 in (+60 mm)



Vehicle level	Vehicles without Off-road package	Vehicles with Off-road package
Off-road level +1	Mercedes-Maybach vehicles: approx. +2.0 in (+50 mm) All other models: approx. +2.4 in (+60 mm)	Approx. +1.2 in (+30 mm)
Sport	Approx. -0.6 in (-15 mm)	Approx. -0.6 in (-15 mm)
Sport +	Approx. -1.0 in (-25 mm)	Approx. -1.0 in (-25 mm)

### Function of ROAD SURFACE SCAN

 This function is not available in all countries. The ROAD SURFACE SCAN function monitors the road in front of your vehicle using a multifunction camera (→ page 209). ROAD SURFACE SCAN

detects unevenness in the road surface, e.g. bumps, before the vehicle drives over them. Chassis movements are reduced and driving comfort is increased.

ROAD SURFACE SCAN is automatically activated if the following conditions are met:

- Drive program  or  is selected.
- The vehicle is set to the normal level.
- You are driving at a speed between 4 mph (7 km/h) and 112 mph (180 km/h).

### System limits

ROAD SURFACE SCAN can be impaired in the following situations or can stop functioning:

- If the road is insufficiently lit, e.g. at night.
- In snow, rain, fog, heavy spray, if there is glare, in direct sunlight or in greatly varying ambient light.
- If the windshield in the area of multifunction camera is dirty, fogged up, damaged or covered.
- If the road surface has no optic structure or reflects light.

- If you are driving too close to the vehicle in front.
- If sections of the route have a very small radius of curvature.
- During abrupt driving maneuver, e.g. heavy braking or sudden acceleration.

Observe the notes on cleaning the multifunction camera (→ page 346).

### Function of recovery mode

 **WARNING** Risk of injury due to the vehicle moving up and down

During recovery mode, the vehicle moves up and down and can cause injuries.

 When activating recovery mode, make certain that no one is in the vicinity of the vehicle.

**!** **NOTE** Risk of damage due to the vehicle moving up and down

When free driving mode is activated, the vehicle moves up and down. Vehicle parts may be damaged if the underbody bottoms out.

- ▶ Make sure that there is sufficient ground clearance when rocking free mode is activated.

Recovery mode is a function of the suspension which can assist the driver on loose surfaces (e.g. sand, snow) when freeing a vehicle which has become stuck.

The vehicle body rocks in slow, vertical motions when recovery mode has been activated. This temporarily puts the wheels under greater load, which means they have increased traction and the vehicle is freed.

You can activate free driving mode via Off-road Assist (→ page 260).

### Function of individual wheel control

**!** **WARNING** Risk of becoming trapped due to the vehicle lowering

The vehicle can be lowered when the individual wheel control function has been activated. Body parts could become trapped if they are between the vehicle body and the tires or underneath the vehicle.

- ▶ Make sure that nobody is under the vehicle or in the immediate vicinity of the wheel arches when individual wheel control is activated.

**!** **NOTE** Risk of damage due to the vehicle moving up and down

The vehicle can be lowered or raised on one or more wheels when the individual wheel control function has been activated. Vehicle parts could be damaged due to contact with objects.

- ▶ Make sure that the vehicle has sufficient room to move when the individual wheel control function has been activated.

Individual wheel control is a function of the suspension, which can be used to set the vehicle level for each wheel individually. This can help to improve alignment of the body when driving off-road.

You can activate individual wheel control via Off-road Assist (→ page 260).

### Adjusting the vehicle level (vehicles with E-ACTIVE BODY CONTROL)

**!** **WARNING** Risk of accident because vehicle level is too high

Driving characteristics may be impaired.

The vehicle can drift outwards, for example, when steering or cornering.

- ▶ Choose a vehicle level which is suited to the driving style and the road surface conditions.

**⚠ WARNING** Risk of entrapment from vehicle lowering

When lowering the vehicle, people could become trapped if their limbs are between the vehicle body and the tires or underneath the vehicle.

- ▶ Make sure no one is underneath the vehicle or in the immediate vicinity of the wheel arches when the vehicle is being lowered.

**⚠ WARNING** Risk of becoming trapped due to the vehicle lowering

**Vehicles with AIRMATIC or level control:** when you unload luggage or leave the vehicle, the vehicle first rises slightly and then returns to the set level shortly afterwards.

You or anyone else in the vicinity of the wheel arches or the underbody could thus become trapped.

The vehicle can also be lowered after being locked.

- ▶ When leaving the vehicle, make sure that nobody is in the vicinity of the wheel arches or the underbody.

**Requirements:**

- The vehicle has been started.
- **Vehicles without Off-road package:** the vehicle is being driven no faster than 40 mph (65 km/h).
- **Vehicles with Off-road package:**
  - Off-road level +1: the vehicle is not moving faster than 62 mph (100 km/h).
  - Off-road level +2: the vehicle is not moving faster than 40 mph (65 km/h).
  - Off-road level +3: the vehicle is not moving faster than 12 mph (20 km/h).

**Raising the vehicle (vehicles without Off-road package)**

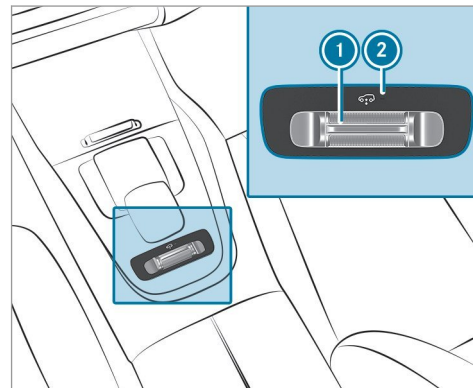

- ▶ Push rocker switch ① forwards. Indicator lamp ② flashes while the vehicle is being raised and lights up continuously when it has finished rising.

Your selection is saved. The off-road level set remains stored even after the ignition has been switched off.

The vehicle is lowered again in the following situations:

- When driving faster than 50 mph (80 km/h).
- When driving briefly between 40 mph (65 km/h) and 50 mph (80 km/h).
- After selecting a different drive program using the DYNAMIC SELECT switch.

The vehicle is adjusted to the height of the active drive program.

#### Lowering the vehicle (vehicles without Off-road package)

- ▶ Pull rocker switch ①.  
The vehicle is adjusted to the height of the active drive program.

#### Operation with a trailer or bicycle rack

If the electrical connection has been correctly established to the trailer or bicycle rack:

- From approx. 18.7 mph (30 km/h): off-road level +1 can be selected, regardless of drive program.
- From approx. 18.7 mph (30 km/h): the vehicle is adjusted to normal level, regardless of drive program.

#### Raising the vehicle (vehicles with Off-road package)

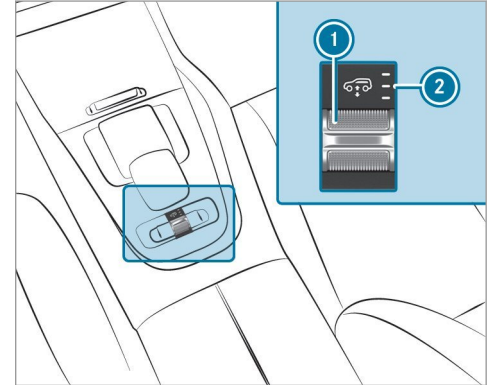

- ▶ Push rocker switch ① forwards.
  - Off-road level +1: one indicator lamp ② lights up continuously when the vehicle has finished rising.
  - Off-road level +2: two indicator lamps ② light up continuously when the vehicle has finished rising.

- Off-road level +3: three indicator lamps ② light up continuously when the vehicle has finished rising.

Your selection is saved. The off-road level set remains stored even after the ignition has been switched off.

The vehicle is lowered again in the following situations:

- Off-road level +3: when driving faster than 12 mph (20 km/h).  
The vehicle is lowered to off-road level +2.
- Off-road level +2:
  - When driving faster than 50 mph (80 km/h).
  - When driving briefly between 40 mph (65 km/h) and 50 mph (80 km/h).

The vehicle is lowered to off-road level +1.

- Off-road level +1:
  - When driving faster than 71 mph (115 km/h).

- When driving briefly between 62 mph (100 km/h) and 71 mph (115 km/h).

The vehicle is lowered to the normal level.

- After selecting a different drive program using the DYNAMIC SELECT switch.

The vehicle is adjusted to the height of the active drive program.

### Operation with a trailer or bicycle rack

If the electrical connection has been correctly established to the trailer or bicycle rack:

- Up to approx. 12 mph (20 km/h): off-road levels +1, +2 and +3 can be selected, regardless of drive program.
- Up to approx. 19 mph (30 km/h): off-road levels +1 and +2 can be selected, regardless of drive program.
- From approx. 19 mph (30 km/h): the vehicle is adjusted to normal level, regardless of drive program.

### Lowering the vehicle (vehicles with Off-road package)

▶ Pull rocker switch ①.

- Off-road level +3: the vehicle is lowered to off-road level +2. Two indicator lamps ② light up continuously when the vehicle has finished lowering.
- Off-road level +2: the vehicle is lowered to off-road level +1. One indicator lamp ② lights up continuously when the vehicle has finished lowering.
- Off-road level +1: the vehicle is lowered to the normal level. No indicator lamp ② lights up when the vehicle has finished lowering.

Your selection is saved. The off-road level set remains stored even after the ignition has been switched off.

### Setting Off-road Assist

#### Requirements:

- the vehicle is stationary.
- the vehicle is set to off-road level 1 or 2

- the Off-road or Off-road Plus (only vehicles with Off-road package) drive program has been selected
- the ignition is switched on
- all doors and the hood are closed
- the transmission is not engaged in position **P**
- there is no trailer coupled
- the vehicle is outdoors
- the detected lateral inclination of the vehicle must not exceed approx. 15°
- the system is within its operating temperature
- the on-board voltage is sufficiently high

Multimedia system:

**Settings** >> **Assistance**  
 >> **Offroad Assistant**

### Recovery mode

Recovery mode assists the driver when pulling away on rough terrain, such as sand or snow.

- ▶ Select **Recovery Mode**.
  - ▶ Select **Start**.
- Recovery mode is activated.

- ▶ Select **Stop** to stop recovery mode.

Recovery mode is automatically deactivated in the following situations:

- you are actually traveling faster than 9 mph (15 km/h)
  - after a running time of 30 seconds
  - it is detected that an object has hit the underbody of the vehicle hard
  - not all conditions are met
- i** Further information on recovery mode (→ page 256).

### Individual wheel control

Individual wheel control enables the vehicle level to be set separately for each wheel.

- ▶ Select **Individual Wheel Ctrl..**
  - ▶ Set the vehicle level for the desired wheel.
- i** You can also use the touchscreen to set the level for two or more wheels at the same time.
- ▶ Select **Reset** to set all wheels to the default setting.

Individual wheel control is automatically deactivated in the following situations:

- you are traveling faster than 9 mph (15 km/h)
  - it is detected that an object has hit the underbody of the vehicle hard
  - not all conditions are met
- i** Further information on individual wheel control (→ page 257).

### Rear view camera

#### Function of the rear view camera

When you engage reverse gear, the image from the rear view camera is shown in the media display. Dynamic guide lines show the path the vehicle will take with the current steering angle. This helps you to orient yourself and to avoid obstacles when backing up.

The rear view camera is only an aid. It is not a substitute for your attention to the surroundings. The responsibility for safe maneuvering and parking remains with you. Make sure that there are no persons, animals or objects etc., in the maneuvering area while maneuvering and parking.

## 262 Driving and parking

**i** You can open the cover of the rear view camera manually (→ page 267).

The guide lines in the media display show the distances to your vehicle. The distances displayed only apply to road level.

Depending on the vehicle equipment, you can select from the following views:

- Normal view
- Wide-angle view
- Trailer view

The area behind the vehicle is displayed as a mirror image, as in the inside rearview mirror.

### Vehicles without Parking Assist PARKTRONIC

The following camera views are available in the multimedia system:

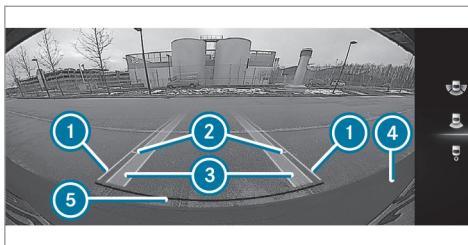

#### Normal view

- 1 Yellow guide line, vehicle width (driven surface) depending on the current steering angle (dynamic)
- 2 Yellow guide line at a distance of approximately 3.3 ft (1.0 m) from the rear area
- 3 Yellow lanes marking the course the tires will take with the current steering angle (dynamic)
- 4 Bumper
- 5 Red guide line at a distance of approximately 1.0 in (0.3 m) from the rear area

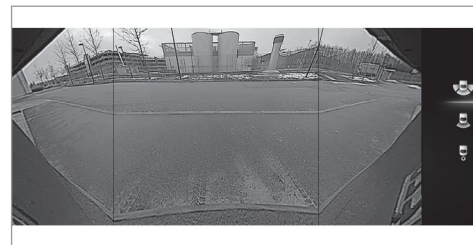

#### Wide-angle view

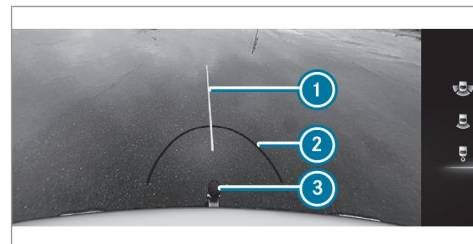

#### Trailer view (vehicles with a trailer hitch)

- 1 Yellow guide line, locating aid



- ② Red guide line at a distance of approximately 1.0 ft (0.3 m) from the ball head of the trailer hitch
- ③ Ball head of the trailer hitch

### Vehicles with Parking Assist PARKTRONIC

The following camera views are available in the multimedia system:

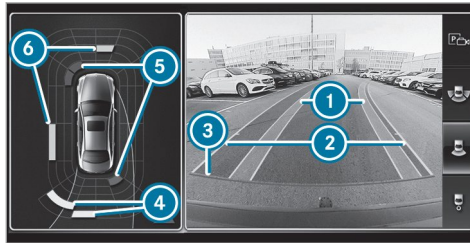

Normal view

- ① Yellow lanes marking the course the tires will take with the current steering angle (dynamic)
- ② Yellow guide line, vehicle width (driven surface) depending on the current steering angle (dynamic)

- ③ Red guide line at a distance of approximately 1.0 in (0.3 m) from the rear area
- ④ Yellow warning indicator of Parking Assist PARKTRONIC: obstacles at a distance between approximately 2.0 ft (0.6 m) and 3.3 ft (1.0 m)
- ⑤ Red warning display of Parking Assist PARKTRONIC: obstacles are very close (approximately 1.0 ft (0.3 m) or less)
- ⑥ Orange warning display of Parking Assist PARKTRONIC: obstacles are a medium distance away (between approximately 1.0 ft (0.3 m) and 2.0 ft (0.6 m))



Wide-angle view

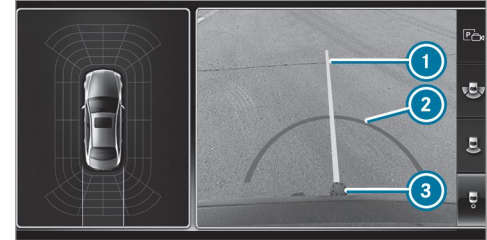

Trailer view (vehicles with a trailer hitch)

- ① Yellow guide line, locating aid
- ② Red guide line at a distance of approximately 1.0 ft (0.3 m) from the ball head of the trailer hitch
- ③ Ball head of the trailer hitch

### System failure

If the rear view camera is not operational, the following display appears in the multimedia system.



### System limits

The rear view camera will not function or will only partially function in the following situations:

- The tailgate is open.
- There is heavy rain, snow or fog.
- The ambient light conditions are poor, e.g. at night.
- Cameras, or vehicle components in which the cameras are installed, are damaged, dirty or covered. Observe the information on vehicle sensors and cameras (→ page 209).

**i** Do not use the rear view camera in these types of situations. You could otherwise injure others or collide with objects when parking the vehicle.

For technical reasons, the standard height of the vehicle may be altered if the vehicle is carrying a heavy load and can result in inaccuracies in the guide lines and in the display of the generated images.

**i** The contrast of the display may be impaired by direct sunlight or by other light sources,

e.g. when driving out of a garage. In this case, pay particular attention.

**i** Have the display repaired or replaced if, for example, pixel errors considerably restrict its use.

### 360° camera

#### Function of the surround view camera

The surround view camera is a system that consists of four cameras. The cameras cover the immediate vehicle surroundings. The system assists you when you are parking or at exits with reduced visibility, for example.

The views of the surround view camera are always available when driving forwards up to a speed of approx. 10 mph (16 km/h) and when backing up.

The surround view camera is only an aid and may show a distorted view of obstacles, show them incorrectly or not show them at all. It is not a substitute for your attention to the surroundings. The responsibility for safe maneuvering and parking remains with you. Make sure that there are no persons, animals or objects etc., in the maneuvering area while maneuvering and parking.

The system evaluates images from the following cameras:

- Rear view camera
- Front camera
- Two side cameras in the outside mirrors

**i** You can open the cover of the rear view camera manually (→ page 267).

#### Views of the surround view camera

You can select from different views:



- 1 Wide-angle view, front
- 2 Top view with image from the front camera

- ③ Top view with images from the side cameras in the outside mirrors
- ④ Wide-angle view, rear
- ⑤ Top view with image from the rear view camera
- ⑥ Top view with trailer view (vehicles with a trailer hitch)

### Top view

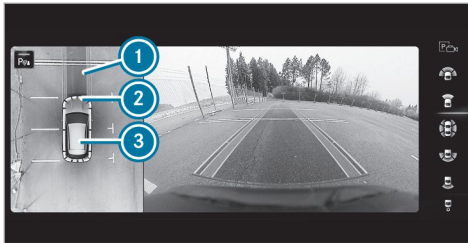

- ① Lane indicating the route the vehicle will take at the current steering wheel angle
- ② Warning display of Parking Assist PARKTRONIC
- ③ Your vehicle from above

The color of the individual segments of warning display ② is based on the distance to the detected obstacle:

- **Yellow segments:** obstacles at a distance between approx. 2.0 ft (0.6 m) and 3.3 ft (1.0 m)
- **Orange segments:** obstacles at a distance between approx. 1.0 ft (0.3 m) and 2.0 ft (0.6 m)
- **Red segments:** obstacles at a very short distance of approx. 1.0 ft (0.3 m) or less

When Parking Assist PARKTRONIC is operational and no object is detected, the segments of the warning display are shown in gray.

### Guide lines

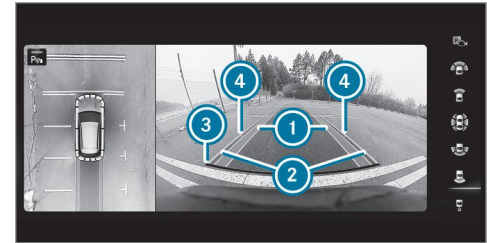

- ① Yellow lane marking the course the tires will take at the current steering wheel angle (dynamic)
- ② Yellow guide line, vehicle width (driven surface) depending on the current steering wheel angle (dynamic)
- ③ Red guide line at a distance of approximately 1.0 in (0.3 m) from the rear area
- ④ Mark at a distance of approx. 3.3 ft (1.0 m)
- ⓘ When Active Parking Assist is active, lanes ① are displayed in green.

The guide lines in the media display show the distances to your vehicle. The distances apply to road level.

In trailer mode, the guide lines are shown at the level of the trailer hitch.

### Trailer view (vehicles with a trailer hitch)

If you select trailer view and no trailer is coupled to the vehicle, the following display appears:



- ① Yellow guide line, locating aid
- ② Red guide line at a distance of approximately 1.0 ft (0.3 m) from the ball head of the trailer hitch
- ③ Ball head of the trailer hitch



When the electrical connection is established between the vehicle and the trailer, the display changes to the side camera view.

This view supports maneuvering procedures with a trailer.

### Side view of the mirror cameras

The sides of the vehicle can be seen in this view.

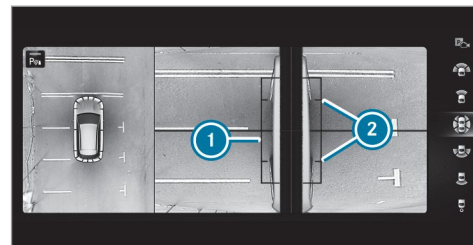

- ① Guide line of external vehicle dimensions with outside mirrors folded out
- ② Marker of the wheel contact points

### System failure

If the system is not ready for operation, the following message appears in the media display:



### System limits

The surround view camera will not function or will only partially function in the following situations:

- The doors are open.
- The outside mirrors are folded in.
- The tailgate is open.
- There is heavy rain, snow or fog.
- The ambient light conditions are poor, e.g. at night.
- Cameras, or vehicle components in which the cameras are installed, are damaged, dirty or covered. Observe the information on vehicle sensors and cameras (→ page 209).

- ⓘ Do not use the surround view camera under such circumstances. You could otherwise injure others or collide with objects when parking the vehicle.

For technical reasons, the standard height of the vehicle may be altered if the vehicle is carrying a heavy load and can result in inaccuracies in the guide lines and in the display of the generated images.

- ⓘ The contrast of the display may be impaired by abrupt, direct sunlight or by other light sources, e.g. when driving out of a garage. In this case, pay particular attention.
- ⓘ Have the display repaired or replaced if, for example, pixel errors considerably restrict its use.

See the notes on cleaning the surround view camera (→ page 346).

### Calling up the view of the surround view camera using reverse gear

- ▶ Engage reverse gear.
- ▶ Select the desired view in the multimedia system (→ page 264).
- ▶ If, after shifting to reverse gear, the image of the rear view camera is not shown: switch off the vehicle, press and hold the  button, switch on the vehicle and engage reverse gear again.

### Opening the camera cover of the rear view camera

Multimedia system:

- ▶  ▶ Settings ▶ Assistance
- ▶ ▶ Camera & Parking

- ▶ Select **Open Camera Cover**.

- ⓘ The camera cover closes automatically after some time or after an ignition cycle.

### Parking Assist PARKTRONIC

#### Function of Parking Assist PARKTRONIC

Parking Assist PARKTRONIC is an electronic parking assistance system with ultrasound. It monitors the area around your vehicle using multiple sensors on the front bumper and on the rear bumper. Parking Assist PARKTRONIC shows you the distance between your vehicle and a detected obstacle visually and audibly.

Parking Assist PARKTRONIC is only an aid. It is not a substitute for your attention to the surroundings. The responsibility for safe maneuvering and parking remains with you. Make sure that there are no persons, animals or objects in the maneu-

vering area while maneuvering and parking in/exiting parking spaces.

In the standard setting, an intermittent warning tone sounds from a distance of approximately 1.0 ft (0.3 m) to an obstacle in front and approximately 3.3 ft (1.0 m) to an obstacle behind. A continuous warning tone sounds from a distance of approximately 0.7 ft (0.2 m). Using the **Warn Early All Around** setting in the multimedia system, the warning tones for front and side impact protection can be set to sound at a greater distance of approximately 3.3 ft (1.0 m) in front and 2.0 ft (0.6 m) on the sides (→ page 272).

- ① The **Warn Early All Around** setting is always active at the rear of the vehicle.

### Parking Assist PARKTRONIC display in the multimedia system

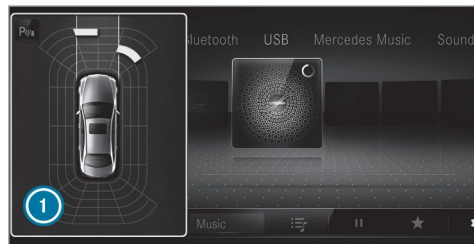

Vehicles without surround view camera

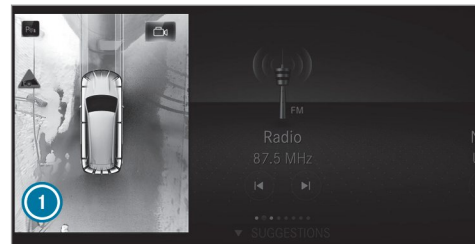

Vehicles with surround view camera

If you have not selected the **Camera & Parking** menu and an obstacle is detected in the path of the vehicle, a pop-up window for Parking Assist PARKTRONIC ① appears in the multimedia system at speeds below 6 mph (10 km/h).

The color of the individual segments of the warning display is based on the distance to the detected obstacle:

- **Yellow segments:** obstacles at a distance between approx. 2.0 ft (0.6 m) and 3.3 ft (1.0 m)

- **Orange segments:** obstacles at a distance between approx. 1.0 ft (0.3 m) and 2.0 ft (0.6 m)
- **Red segments:** obstacles at a very short distance of approx. 1.0 ft (0.3 m) or less

#### Display of Parking Assist PARKTRONIC in the Head-up Display

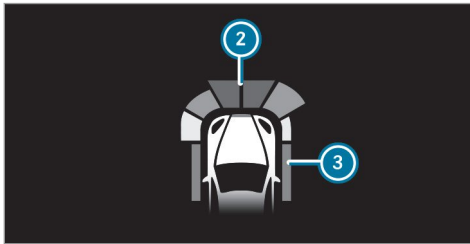

Optionally, obstacles detected by Parking Assist PARKTRONIC from a distance of approximately 3.3 ft (1.0 m) in front ② and 2.0 ft (0.6 m) on the sides ③ can also be displayed in the Head-up Display.

#### System limits

Parking Assist PARKTRONIC does not necessarily take into account the following obstacles:

- Obstacles below the detection range, e.g. persons, animals or objects.
- Obstacles above the detection range, e.g. overhanging loads, overhangs or loading ramps of trucks.

The sensors must be free of dirt, ice and slush. Otherwise, they may not function correctly. Clean the sensors regularly, especially after driving off-road, taking care not to scratch or damage them (→ page 209).

**Vehicles with trailer hitch:** Parking Assist PARKTRONIC is deactivated for the rear zone when you establish an electrical connection between your vehicle and a trailer.

#### Problems with Parking Assist PARKTRONIC

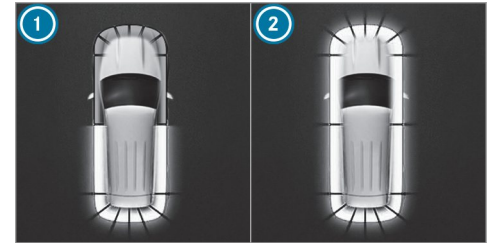

Example: vehicles with surround view camera

When rear segments ① or all-around segments ② light up red and the  symbol appears in the Instrument Display, Parking Assist PARKTRONIC may have been deactivated due to signal interference. Start the vehicle again and check if Parking Assist PARKTRONIC is working at a different location.

If a warning tone also sounds for approximately two seconds every time the vehicle is started, it may be due to one of the following causes:

- **The sensors are dirty:** clean the sensors and observe the notes on care of vehicle parts (→ page 346).
- **Parking Assist PARKTRONIC has been deactivated due to a malfunction:** restart the vehicle. If the problem persists, consult a qualified specialist workshop.

#### Function of the passive side impact protection

Passive side impact protection is an additional Parking Assist PARKTRONIC function which warns the driver about obstacles at the side of the vehicle. A warning is issued when obstacles are detected between the front and rear detection range. In order for an object on the side to be detected, the sensors in the front and rear bumper must first detect the object while you are driving past it.

During the parking procedure or maneuvering, objects are detected as the vehicle drives past. If you steer in the direction of a detected obstacle and there is a risk of a lateral collision, a warning

is issued and the segments light up in color on the display.

The segment color changes depending on the distance to the detected obstacle:

- **Yellow:** approximately 1.0 - 2.0 ft (30 - 60 cm)
- **Red:** less than approximately 1.0 ft (30 cm)

In order for lateral, front or rear segments to be displayed, the vehicle must first travel a distance of at least half a vehicle's length. Once the vehicle has travelled the length of the vehicle, all of the lateral front and rear segments can be displayed.

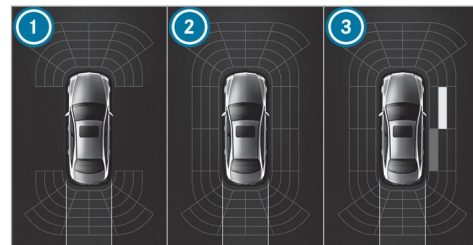

Parking Assist PARKTRONIC display: vehicles without a surround view camera

- ① Operational front and rear
- ② Operational front, rear and sides
- ③ Obstacle detected at the front right (yellow) and rear (red)



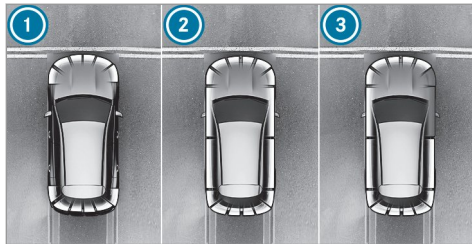

Parking Assist PARKTRONIC display: vehicles with a surround view camera

- ① Operational front and rear
- ② Operational front, rear and sides
- ③ Obstacles detected at the front right (red)

Saved obstacles on the sides are deleted in the following situations, for example:

- You park the vehicle and switch it off.
- You open the doors.

After the engine is restarted, obstacles on the sides must be detected again before a new warning can be issued.

### System limits

The system limits for Parking Assist PARKTRONIC apply to passive side impact protection.

The following objects are not detected, for example:

- Pedestrians who approach the vehicle from the side
- Objects placed next to the vehicle

### Activating/deactivating Parking Assist PARKTRONIC using the multimedia system

**NOTE** Risk of an accident from objects at close range

Parking Assist PARKTRONIC may not detect certain objects at close range.

- ▶ When parking or maneuvering the vehicle, pay particular attention to any objects which are above or below the sensors, e.g. flower pots or drawbars. The vehicle or other objects could otherwise be damaged.

### Requirements:

- The camera menu is open.
  - Or: Active Parking Assist is active.
  - Or: the PARKTRONIC pop-up window appears.
- ▶ Tap **P** on the media display.

If the indicator lamp in the **P OFF** button is not lit, Parking Assist PARKTRONIC is active. If the indicator lamp is lit or the **P OFF** symbol appears in the instrument cluster, Parking Assist PARKTRONIC is not active.

- ① Parking Assist PARKTRONIC is automatically activated when the vehicle is started.

Alternatively, Parking Assist PARKTRONIC can be activated or deactivated in the quick access menu.

### Setting the warning tones of Parking Assist PARKTRONIC

Multimedia system:

- ➔  ➔ Settings ➔ Assistance
- ➔ Camera & Parking

### Adjusting the volume of the warning tones

- ▶ Select **Warning Tone Volume**.
- ▶ Set a value.

### Adjusting the pitch of the warning tones

- ▶ Select **Warning Tone Pitch**.
- ▶ Set a value.

### Specifying the starting point for the warning tones

You can specify whether the Parking Assist PARKTRONIC warning tones should commence when the vehicle is further away from an obstacle.

- ▶ Select **Warn Early All Around**.
- ▶ Switch the function on or off.

### Activating/deactivating audio fadeout

You can specify whether the volume of a media source in the multimedia system is to be reduced

when Parking Assist PARKTRONIC sounds a warning tone.

- ▶ Select **Audio Fadeout During Warning Tones**.
- ▶ Switch the function on or off.

### Active Parking Assist

#### Function of Active Parking Assist

Active Parking Assist is an electronic parking assistance system, which uses ultrasound with the assistance of the rear view camera and surround view camera. When you are driving forwards up to approximately 22 mph (35 km/h), the system automatically measures parking spaces on both sides of the vehicle.

Active Parking Assist offers the following functions:

- Parking in parking spaces parallel to the road
- Parking in parking spaces perpendicular to the road (optionally either forwards or reverse)
- Exiting parking spaces if you have parked using Active Parking Assist

As soon as all requirements are met for searching for parking spaces, the  display appears in the Instrument Display.

When Active Parking Assist has detected parking spaces, the  display appears in the Instrument Display. The arrows show on which side of the road detected parking spaces are located. They are then shown on the media display.

The parking space can be selected as desired. Depending on the location of the parking space, the parking direction (rearwards or forwards) can also be selected as desired.

When Active Parking Assist is activated, the turn signal indicators are activated based on the calculated path of your vehicle.

When you are entering or exiting a parking space, the procedure is assisted by acceleration, braking, steering and gear changes.

Active Parking Assist is only an aid. It is not a substitute for your attention to the surroundings. The responsibility for safe maneuvering and parking remains with you. Make sure that no persons, animals or objects etc. are in the maneuvering range.

Active Parking Assist will be canceled in the following situations:

- Parking Assist PARKTRONIC is deactivated.
- You begin steering.
- You apply the parking brake.
- You engage transmission position **P**.
- ESP® intervenes.
- You open the doors or the tailgate while driving.

### System limits

If the exterior lighting is malfunctioning, Active Parking Assist is not available.

Objects located above or below the detection range of the sensors, e.g. overhanging loads, overhangs or loading ramps of trucks, or the borders of parking spaces, are not detected during measurement of the parking space. These are also then not taken into account when calculating the parking procedure. In some circumstances, Active Parking Assist may therefore guide you into the parking space incorrectly.

**⚠ WARNING** Risk of accident due to objects located above or below the detection range of Active Parking Assist

If there are objects above or below the detection range, the following situations may arise:

- Active Parking Assist may steer too early.
- The vehicle may not stop in front of these objects.

There is a danger of collision!

▶ In these situations, do not use Active Parking Assist.

Extreme weather conditions, such as snow or heavy rain, may lead to a parking space being measured inaccurately. Parking spaces that are partially occupied by trailer drawbars might not be identified as such or be measured incorrectly. Only use Active Parking Assist on level, high-grip ground.

Do not use Active Parking Assist in the following situations:

- In extreme weather conditions such as ice, packed snow or in heavy rain.

- When transporting a load that protrudes beyond the vehicle.
- On steep uphill or downhill gradients of more than approximately 15%.
- When snow chains are installed.
- When a trailer or bicycle rack is attached.
- Directly after a tire change or when spare tires are installed.
- If the tire pressure is too low or too high.
- If the suspension is out of alignment, e.g. after bottoming out on a curb.

Active Parking Assist may also display parking spaces that are not suitable for parking, such as:

- Parking spaces where parking is prohibited.
- Parking spaces on unsuitable surfaces.

## Parking with Active Parking Assist

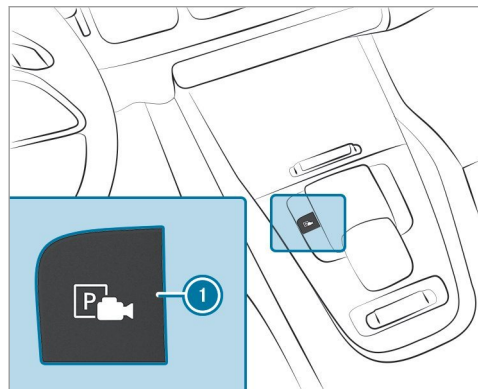

▶ Press button ①.

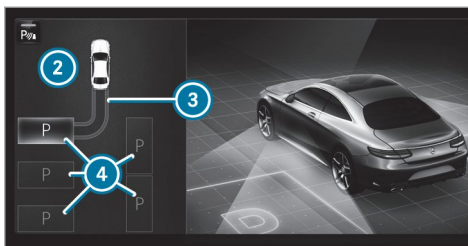

The media display shows the view of Active Parking Assist. Area ② displays detected parking spaces ④ and vehicle path ③.

- ① Vehicle path ③ shown on the media display may differ from the actual vehicle path.
- ▶ If a parking space is displayed: stop the vehicle.
- ▶ Select desired parking space ④ and confirm.
- ▶ If necessary, select the parking direction (forwards or reverse), and confirm. Vehicle path ③ is shown, depending on selected parking space ④ and the parking direction.

① The turn signal indicator is switched on automatically when the parking procedure begins.

You are responsible for selecting the turn signal indicator in accordance with the traffic conditions. If necessary, select the turn signal indicator accordingly.

**⚠ WARNING** Risk of accident due to vehicle swinging out while parking or pulling out of a parking space

While parking or exiting a parking space, the vehicle swings out and can drive onto areas of the oncoming lane.

This could cause you to collide with objects or other road users.

- ▶ Pay attention to objects and other road users.
- ▶ Where necessary, stop the vehicle or cancel the parking procedure with Active Parking Assist.

▶ If, for example, the **Please Engage Reverse Gear** message appears in the media display:

select the corresponding transmission position.

The vehicle drives into the selected parking space.

- During the parking procedure with Active Parking Assist, the lane markings are displayed in green in the camera image.

On completion of the parking procedure, the  **Parking Assist Finished, Take Control of Vehicle** display message appears. Further maneuvering may still be necessary.

- After completion of the parking procedure, safeguard the vehicle against rolling away. When required by legal requirements or local conditions: turn the wheels towards the curb.

- You can stop the vehicle and change the transmission position during the parking procedure. The system then calculates a new vehicle path. If no new vehicle path is available, the system can change the transmission position again or cancel the parking procedure.

### Exiting a parking space with Active Parking Assist

#### Requirements:

- The vehicle has been parked with Active Parking Assist.

Please note that you are responsible for the vehicle and surroundings during the entire parking procedure.

- Start the vehicle.

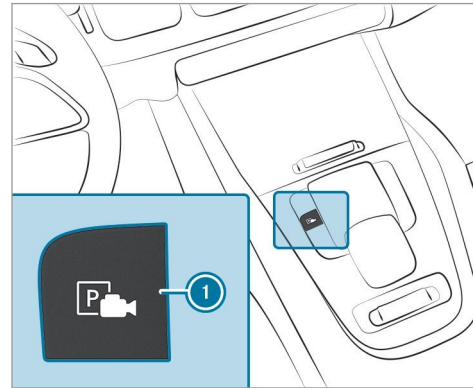

- Press button **1**. The media display shows the view of Active Parking Assist.

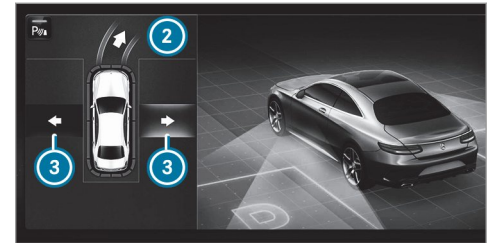

- If the vehicle has been parked perpendicular to the direction of travel: in area **2**, select direction of travel **3** **Left** or **Right**.
- The vehicle path shown on the media display may differ from the actual vehicle path.
- Confirm direction of exit **3** to drive out of the parking space.
- The turn signal indicator is switched on automatically when the exiting procedure begins.

You are responsible for selecting the turn signal indicator in accordance with the traffic conditions. If necessary, select the turn signal indicator accordingly.

**⚠ WARNING** Risk of accident due to vehicle swinging out while parking or pulling out of a parking space

While parking or exiting a parking space, the vehicle swings out and can drive onto areas of the oncoming lane.

This could cause you to collide with objects or other road users.

- ▶ Pay attention to objects and other road users.
- ▶ Where necessary, stop the vehicle or cancel the parking procedure with Active Parking Assist.

▶ If, for example, the **Please Engage Forward Gear** message appears in the media display:

select the corresponding transmission position.

The vehicle moves out of the parking space. The turn signal indicator is switched off automatically.

After the parking space has been exited, a warning tone and the  **Parking Assist Finished, Take Control of Vehicle** message prompt you to take control of the vehicle.

The vehicle is not automatically braked and can roll away. You have to accelerate, brake, steer and change gear yourself again.

### Maneuvering assistance

#### Function of Drive Away Assist

Drive Away Assist can reduce the severity of an impact when pulling away. If an obstacle is detected in the direction of travel, the vehicle's speed is briefly reduced to approx. 1 mph (2 km/h). If a critical situation is detected, the  symbol appears in the media display.

Drive Away Assist can be deactivated or activated in the **Maneuvering Assistance** menu (→ page 277).

**ⓘ** You can cancel an intervention by Drive Away Assist at any time by deactivating Parking Assist PARKTRONIC (→ page 271).

**⚠ WARNING** Risk of accident caused by limited detection performance of Drive Away Assist

Drive Away Assist cannot always clearly identify objects and traffic situations.

- ▶ Always pay careful attention to the traffic situation; do not rely on Drive Away Assist alone.
- ▶ Be prepared to brake or swerve as necessary, provided the traffic situation permits and that it is safe to take evasive action.

Drive Away Assist is only an aid. It is not a substitute for your attention to the surroundings. The responsibility for safe maneuvering and parking remains with you. Make sure that no persons, ani-

mals or objects etc. are in the maneuvering range.

A risk of collision may occur in the following situations, for example:

- If the accelerator and brake pedals are interchanged.
- If an incorrect transmission position is engaged.

Drive Away Assist is active under the following conditions:

- If Parking Assist PARKTRONIC is activated.
- If you shift the transmission position to **R** or **D** when the vehicle is stationary.
- If the detected obstacle is less than approx. 3.3 ft (1.0 m) away.
- If the maneuvering assistance function is activated in the multimedia system.

### System limits

The performance of Drive Away Assist is limited on inclines.

When driving with a trailer, Drive Away Assist is not available.

- ⓘ Also observe the system limits of Parking Assist PARKTRONIC (→ page 267).

### Function of Cross Traffic Alert

- ⓘ Cross Traffic Alert is only available for vehicles with Blind Spot Assist or Active Blind Spot Assist.

Cross Traffic Alert can warn drivers of any crossing traffic when backing up and maneuvering out of a parking space. The radar sensors in the bumper also monitor the area adjacent to the vehicle. If a critical situation is detected, the  symbol appears in the media display and the vehicle can be braked automatically.

If the radar sensors are obstructed by vehicles or other objects, detection is not possible.

Cross Traffic Alert is active under the following conditions:

- If the vehicle is backing up at a walking pace.
- Maneuvering assistance is activated (→ page 277).
- ⓘ Also observe the instructions on Blind Spot Assist and Active Blind Spot Assist (→ page 242).

### System limits

Cross Traffic Alert is not available on inclines.

Cross Traffic Alert is not available when driving with a trailer.

### Activating/deactivating the maneuvering assistant

Multimedia system:

 **Settings** **Assistance**

**Camera & Parking**

 Switch **Maneuvering Assistance** on or off.

- ⓘ The maneuvering assistant must be active for the function of Drive Away Assist (→ page 276) and Cross Traffic Alert (→ page 277).

### Trailer hitch

#### Notes on trailer operation

 **NOTE** Mercedes-AMG vehicles

-  Observe the notes in the Supplement. You could otherwise fail to recognize dangers.

**⚠ WARNING** Risk of accident due to unsuitable ball neck

If you install an unsuitable ball neck, the trailer hitch and the rear axle may be overloaded.

This can significantly impair the driving characteristics and the trailer may become loose. There is a risk of fatal injury.

- ▶ Only install a ball neck that complies with the permissible dimensions and is designed for the requirements of trailer operation.
- ▶ Do not modify the ball neck or the trailer hitch.

The values approved by the manufacturer can be found on the identification plates and in the "Technical data" section under "Trailer hitch" for the towing vehicle (→ page 420).

**⚠ WARNING** Swerving of the vehicle/trailer combination due to increased speed

You could lose control of the vehicle/trailer combination.

The vehicle/trailer combination may even tip over.

- ▶ Under no circumstances should you try to straighten the vehicle/trailer combination by increasing the speed.
- ▶ Reduce your speed and do not counter-steer.
- ▶ If necessary, apply the brakes.

**! NOTE** Damage to the engine as a result of overheating

- ▶ If you retrofit a trailer hitch, modifications to the engine cooling system may be necessary, depending on the vehicle model.

When retrofitting a trailer hitch, observe the fastening points on the chassis.

Retrofitting a trailer hitch is permissible only if a trailer load is specified in your vehicle documents. If this is not the case, the vehicle is not approved for trailer operation.

Further information can be obtained at a qualified specialist workshop.

For a detachable trailer coupling, it is essential to comply with the operating instructions of the trailer coupling manufacturer.

Couple and uncouple the trailer carefully. If you do not connect the trailer to the towing vehicle correctly, the trailer may become detached.

Observe the following notes on the tongue weight:

- Do not use a tongue weight that exceeds or falls below the permissible tongue weight
- Use a tongue weight as close as possible to the maximum tongue weight

Do not exceed the following values:

- Permissible towing capacity
- Permissible rear axle load of the towing vehicle
- Permissible gross weight of the towing vehicle
- Permissible gross weight of the trailer
- Maximum permissible speed of the trailer



Ensure the following before starting a journey:

- The tire pressure on the rear axle of the towing vehicle is set for a maximum load
- The lighting of the connected trailer is operational

In the event of increased rear axle load, the vehicle/trailer combination must not exceed a maximum speed of 62 mph (100 km/h) for reasons concerning the operating permit. This also applies in countries in which the permissible maximum speed for vehicle/trailer combinations is above 62 mph (100 km/h).

**Vehicles with AIRMATIC or E-ACTIVE BODY CONTROL:** if the socket of the trailer hitch is occupied, e.g. by a trailer or rear-mounted bicycle rack, the vehicle is set to the normal level at speeds greater than 19 mph (30 km/h). This is done regardless of which drive program has been selected.

### Attaching the ball neck

**⚠ WARNING** Risk of accident and injury due to incorrectly installed ball neck

If the ball neck is not correctly installed and secured, it may become loose during a journey and endanger other road users. There is a risk of fatal injuries.

- ▶ Install and secure the ball neck as described in the ball neck manufacturer's installation instructions.
- ▶ If a ball neck is installed, ensure sure that it is properly secured before every journey.

**⚠ WARNING** Risk of accident due to a ball neck that is not correctly installed or secured

If the ball neck is not correctly installed and secured, the trailer may come loose.

- ▶ Install and secure the ball neck as described in the ball neck manufacturer's installation instructions.

- ▶ If a ball neck is installed, ensure sure that it is properly secured before every journey.

#### Requirements:

- The vehicle is secured against rolling away.

#### Attaching the ball neck

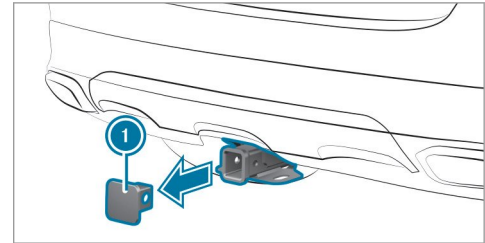

- ▶ Remove cover ❶ from the ball neck mount in the direction of the arrow.
- ▶ Store cover ❶ such that it cannot move around.
- ▶ Observe the manufacturer's installation instructions.

Observe the notes on loading the vehicle.

### Coupling up/uncoupling a trailer

**▲ WARNING** Risk of injury from the vehicle level being changed

**Vehicles with level control system:** the vehicle level may be changed unintentionally, e.g. by other persons. You may become trapped if you couple up or uncouple a trailer while the vehicle level is changing. In addition, other people could become trapped if their limbs are between the vehicle body and the tires or underneath the vehicle.

When coupling up or uncoupling a trailer, make sure that:

- ▶ The doors or tailgate are not opened or closed.
- ▶ You do not initiate the level control system and do not operate the DYNAMIC SELECT switch.
- ▶ Do not lock or unlock the vehicle.

#### Requirements:

- The vehicle is secured with the electric parking brake.
- The transmission is in position **P**.

The trailer will be correctly detected by the vehicle only if the following conditions are met:

- The trailer is connected correctly.
- The trailer lighting system is in working order.

The functions of the following systems will be affected by a correctly connected trailer:

- ESP® trailer stabilization
- Active Lane Keeping Assist
- Parking Assist PARKTRONIC
- Active Parking Assist
- Blind Spot Assist or Active Blind Spot Assist
- Drive Away Assist
- Cross Traffic Alert
- Rear view camera
- Surround view camera
- AIRMATIC

- E-ACTIVE BODY CONTROL

**Vehicles without level control:** the ball head height will change depending on the vehicle's load. In this case, use a trailer with a height-adjustable drawbar.

#### Coupling up a trailer

**!** **NOTE** Damage to the starter battery due to full discharge

Charging the trailer battery using the power supply of the trailer can damage the starter battery.

- ▶ Do not use the vehicle's power supply to charge the trailer battery.

Information about a suitable ball neck for Mercedes-Benz vehicles can be obtained from a qualified specialist workshop, e.g. an authorized Mercedes-Benz Center.

- ▶ Remove the cover cap from the ball neck mount and store it in a safe place (→ page 279).

- ▶ Position the trailer on a level surface behind the vehicle and couple it up to the vehicle.
- ▶ Establish the electrical connection between the vehicle and the trailer.
- ⓘ Accessories can be connected to the permanent power supply up to 180 W and to the power supply that is switched on via the ignition lock.

### Uncoupling a trailer

**⚠ WARNING** Risk of being crushed and becoming trapped when uncoupling a trailer

When uncoupling a trailer with an engaged inertia-activated brake, your hand may become trapped between the vehicle and the trailer drawbar.

- ▶ Do not uncouple trailers with an engaged overrun brake.

**! NOTE** Damage when uncoupling in a state of overrun

Uncoupling in a state of overrun can damage the vehicle.

- ▶ Do not uncouple trailers with an engaged overrun brake.

**⚠ WARNING** Risk of becoming trapped when disconnecting the trailer cable

**Vehicles with level control system:** The vehicle may lower when the trailer cable is disconnected.

This could result in you or other people becoming trapped if your or their limbs are between the vehicle body and the tires or underneath the vehicle.

- ▶ Make sure that nobody is underneath the vehicle or in the immediate vicinity of the wheel arches when you disconnect the trailer cable.

- ▶ Disconnect the electrical connection between the vehicle and the trailer.

- ▶ Uncouple the trailer.
- ▶ Place the cover on the ball neck mount.

### Vehicle towing instructions

The vehicle is not suitable for the use of tow bar systems that are used for flat towing or dinghy towing, for example. Attaching and using tow bar systems can result in damage to the vehicle. When you are towing a vehicle with tow bar systems, safe driving characteristics cannot be guaranteed for the towing vehicle or the towed vehicle. The vehicle-trailer combination may swerve from side to side.

Observe the following information:

- Permitted towing methods (→ page 362)
- The notes on towing the vehicle with both axles on the ground (→ page 363)

### Notes on the instrument display and on-board computer

**⚠ WARNING** Risk of accident if the instrument display fails

If the instrument display has failed or is malfunctioning, function restrictions in systems relevant to safety cannot be detected.

The operating safety of your vehicle may be impaired.

- ▶ Drive on carefully.
- ▶ Have the vehicle checked immediately at a qualified specialist workshop.

If the operating safety of your vehicle is impaired, park the vehicle immediately and safely. Contact a qualified specialist workshop.

**⚠ WARNING** Risk of distraction due to information systems and communications equipment

If you operate information systems and communications equipment integrated in the vehi-

cle when driving, you could be distracted from the traffic situation. This could also cause you to lose control of the vehicle.

- ▶ Only operate this equipment when the traffic situation permits.
- ▶ If you cannot be sure of this, stop the vehicle in accordance with the traffic conditions and operate the equipment with the vehicle stationary.

**! NOTE** Mercedes-AMG vehicles

- ▶ Observe the notes in the Supplement. You could otherwise fail to recognize dangers.

You must observe the legal requirements for the country in which you are currently driving when operating the on-board computer.

The on-board computer shows only display messages and warnings from specific systems on the instrument display. You must therefore ensure that your vehicle is always reliable.

If the operating safety of your vehicle is impaired, park the vehicle immediately and in accordance with the traffic conditions. Contact a qualified specialist workshop.

## Overview of instrument display

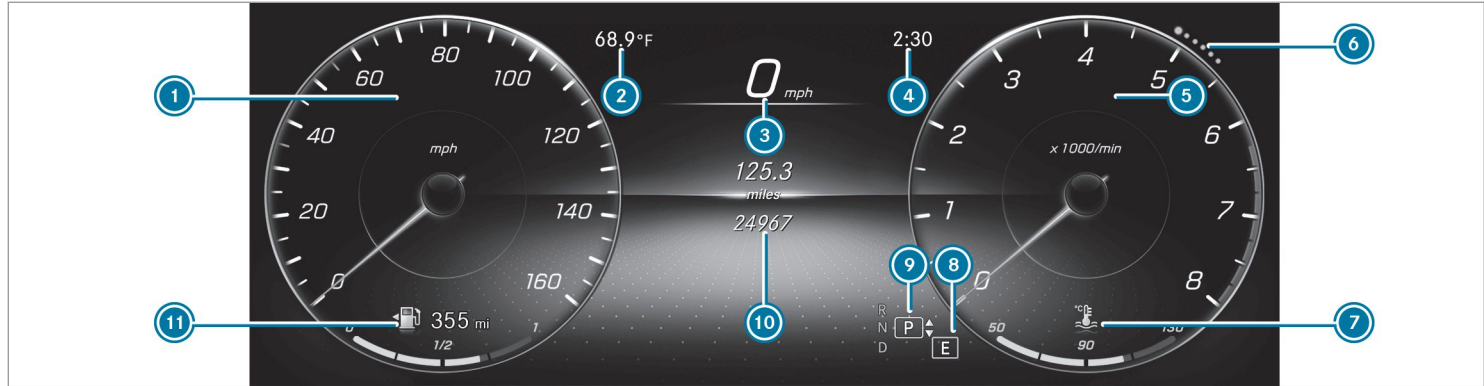

① Display content on left (example: speedometer): speedometer/time/date/trip computer **From Start** and **From Reset**/range/audio/angle of incline and approach/departure  
The segments on the speedometer indicate the statuses of the following systems: cruise control/limiter/Active Distance Assist/DISTRONIC

② Outside temperature  
③ Digital speedometer  
④ Time  
⑤ Display content on right (example: tachometer): tachometer/average fuel consumption/ECO display/navigation/G-meter/assistant display/4MATIC/suspension/power meter/power availability display of the electric motor (equipment-dependent)

⑥ Index points  
These show the selected display or menu content.  
The fuel supply will be interrupted to protect the engine when the red mark on the tachometer (overrevving range) is reached.

- ⑦ Coolant temperature display  
During normal operation, the coolant temperature display is permitted to rise to 248°F (120°C).  
Vehicles with 48 V on-board electrical system: POWER and CHARGE display (electrical drive support and recuperation power of the electric motor)
- ⑧ Selected drive program
- ⑨ Selected transmission position
- ⑩ Center display area of the instrument display (example: standard display for trip): Assistance/Telephone/Navigation/Trip/Media/Radio/Styles and displays/Service/Power meter (equipment-dependent)
- ⑪ Fuel level, fuel filler flap location indicator, range

#### Overview of the buttons on the steering wheel

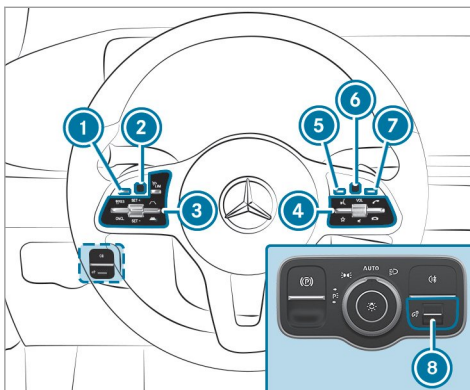

- ① Back/Home button, on-board computer  
Press and hold: shows standard display
- ② Touch Control, on-board computer
- ③ Control panel for cruise control or Active Distance Assist DISTRONIC
- ④ Control panel for MBUX multimedia system:  
 Voice Control System

- ★ Displays favorites  
VOL: control knob, adjusts the volume or switches the sound off (press)
- Makes/accepts a call
- Rejects/ends a call
- ⑤ Calls up the home screen
- ⑥ Touch Control multimedia system
- ⑦ Back button
- ⑧ Brightness control to adjust the lighting in the Instrument Display and in the control elements of the vehicle interior

#### Operating the on-board computer

Observe the legal requirements for the country in which you are currently driving when operating the on-board computer.



The on-board computer is operated using the left-hand Touch Control and the left-hand back/home button.

When the on-board computer is being operated, different acoustic signals will sound as operating feedback, e.g. when the end of a list is reached or when you are scrolling through a list.

The following menus are available:

- [Assistance](#)
  - [Phone](#)
  - [Navigation](#)
  - [Trip](#)
  - [Radio](#)
- [Media](#)
  - [Designs & Disp.](#)
  - [Service](#)
- i** You can find information about the possible settings and selections on the menus in the Digital Operator's Manual.
- The menu can be called up from the menu bar on the instrument display.
- ▶ **To call up the menu bar:** briefly press the left-hand back button until the menu bar is displayed.
  - ▶ **To scroll on the menu bar:** swipe left or right on the left-hand Touch Control.
  - ▶ **To call up a menu, submenu or possible settings on the menu, or confirm a selection or setting:** press the left-hand Touch Control.
  - ▶ **To scroll through displays or lists on the menu, or select display content, a function,**

**an entry or a display:** swipe upwards or downwards on the left-hand Touch Control.

- ▶ **To exit a submenu:** press the left-hand back button.

### Selecting the head-up display

- ▶ **To switch on the head-up display:** switch on the head-up display via the multimedia system or activate it on the menu bar by swiping upwards on the left-hand Touch Control. The head-up display menu will be selected on the head-up display.
- ▶ **To switch to the head-up display:** press the left-hand Touch Control or swipe upwards on the left-hand Touch Control.
- ▶ **To set the three display ranges of the head-up display:** swipe upwards or downwards on the left-hand Touch Control.

### Full-screen menus

You can display the following menus full-screen on the instrument display:









- [Assistance](#)
- [Trip](#)





- **Navigation**

- ▶ On the corresponding menu, use the left-hand Touch Control to scroll to the end of the list.
- ▶ Press the left-hand Touch Control. The selected menu will be displayed full-screen.

### Overview of displays in the instrument display

Displays on the instrument display:

- ▶  Active Parking Assist (→ page 274)
- ▶  Parking Assist PARKTRONIC deactivated (→ page 271)
- ▶  DSR (→ page 227)
- ▶  Cruise control (→ page 218)
- ▶  Active Distance Assist DISTRONIC (→ page 220)
- ▶  Active Brake Assist (→ page 233)
- ▶  Active Steering Assist (→ page 229)
- ▶  Active Stop-and-Go Assist (→ page 227)
- ▶  Active Lane Keeping Assist (→ page 244)

- ▶  Active Lane Change Assist (→ page 232)
- ▶  ECO start/stop function (→ page 184)
- ▶  HOLD function (→ page 215)
- ▶  Adaptive Highbeam Assist (→ page 151)

**Vehicles with Traffic Sign Assist:** Detected instructions and traffic signs (→ page 238).

For an overview of the indicator and warning lamps, see (→ page 479).

### Head-up Display

#### Function of the Head-up Display

**NOTE** Mercedes-AMG vehicles

- ▶ Observe the notes in the Supplement. You could otherwise fail to recognize dangers.

The Head-up Display projects the following information into the driver's field of vision above the cockpit, for example:

- The vehicle speed

- Information from the navigation system
- Information from the driving systems and driving safety systems
- Some warning messages

Depending on the vehicle's equipment, different content can be shown in the three areas of the Head-up Display (→ page 287).

#### Display content

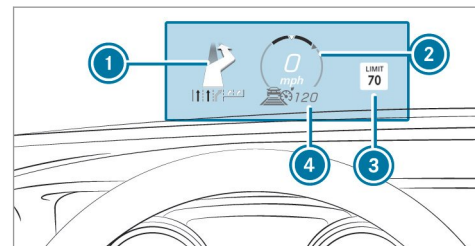

- ① Navigation instructions
- ② Current speed



- ③ Detected instructions and traffic signs
- ④ Set speed in the driving system (e.g. cruise control)

### System limits

The visibility of the displays will be affected by the following conditions:

- Seat position
- Image position setting
- Ambient light
- Wet road surface
- Objects on the display cover
- Polarization in sunglasses

- ① In extreme sunlight, sections of the display may appear washed out. You can correct this by switching the Head-up Display off and on again.

### Setting the Head-up Display using the on-board computer

On-board computer:

#### → HEAD-UP DISPLAY

The following Head-up Display settings or displays can be selected or shown:

- Position
- Brightness
- Messages
- Assistance status
- Telephone
- Audio
- Voice Control System

- ▶ **To select the Settings menu:** swipe to the right on the left-hand Touch Control. The Settings menu ⑤ will be selected.
- ▶ **To call up the Settings menu:** press the left-hand Touch Control.
- ▶ **To adjust the position:** swipe upwards or downwards on the left-hand Touch Control.

- ▶ **To adjust the brightness:** swipe to the left or right on the left-hand Touch Control.

### Setting messages, assistance status, telephone, audio and the Voice Control System

- ▶ Press the left-hand Touch Control. The list of setting options will be displayed.
- ▶ Swipe upwards or downwards on the left-hand Touch Control and select a setting by pressing the left-hand Touch Control.

### Selecting what the Head-up Display shows

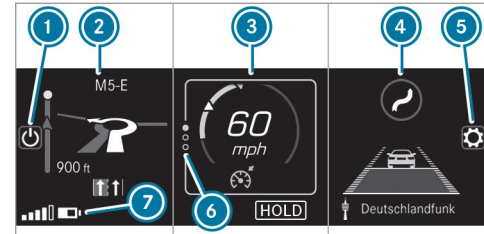

(Example)

- ① Switches the Head-up Display on/off
- ② Left display area

Navigation system  
Inclination, gradient and compass  
Average consumption

- ③ Central display area  
Speedometer  
Set speed in the driver assistance system,  
e.g. cruise control  
Warnings from driver assistance systems, e.g.  
distance warning

- ④ Right display area  
Traffic Sign Assist  
Vehicle level  
Differential  
Distribution of the drive torques, 4MATIC  
(→ page 198)

Assistant display

- ⑤ To adjust the position, brightness and lower  
display area
- ⑥ Index points
- ⑦ Lower display area (example: left display area)

Display areas ② to ④ that are not required can  
be hidden.

- ① In audio mode, the station name or track will  
be shown temporarily when the audio source  
is being actively operated. In addition, the lat-  
est calls will be displayed when the telephone  
list on the instrument display is actively oper-  
ated.

- ▶ Swipe upwards on the left-hand Touch Con-  
trol.
- ▶ Press the left-hand Touch Control.

### Switching the Head-up Display on/off via the mul- timedia system

Multimedia system:

↳  ▶ Settings ▶ Quick Access

- ▶ Select HUD.  
The Head-up Display is activated.

## Overview and operation

### Notes on the MBUX multimedia system

**⚠ WARNING** Risk of distraction from information systems and communications equipment

If you operate information systems and communication devices integrated in the vehicle when driving, you could be distracted from the traffic situation. This could also cause you to lose control of the vehicle.

- ▶ Only operate this equipment when the traffic situation permits.
- ▶ If you cannot be sure of this, stop the vehicle whilst paying attention to road and traffic conditions and operate the equipment with the vehicle stationary.

You must observe the legal requirements for the country in which you are currently driving when operating the multimedia system. Depending on the equipment, the scope of function and product designation of your MBUX multimedia system may differ from the description and

images in this Operator's Manual. For example, route guidance with augmented reality is not available in all equipment variants.

### Overview of the MBUX multimedia system

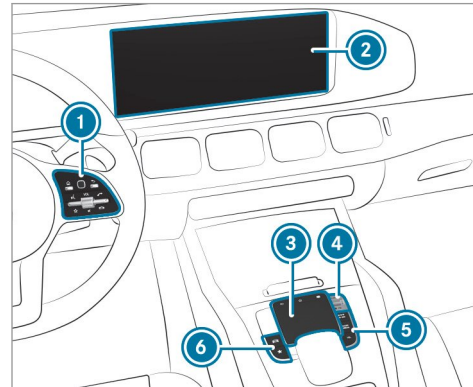

- ① Touch Control and control panel for the MBUX multimedia system
- ② Media display with touch functionality

- ③ Touchpad
- ④ Controller

Turn: adjusts the volume

Press briefly: switches the mute function on/off

Press and hold: switches the MBUX multimedia system or media display on or off

- ⑤ Buttons for navigation, radio/media and telephone
- ⑥ Buttons for vehicle functions/system settings and favorites/themes

Further operating options:

- Conducting a voice dialog with the Voice Control System.
- Operating functions contact-free with the MBUX Interior Assistant.

**i** You can find further information about operation as well as about applications and services in the Digital Operator's Manual.

### Anti-theft protection

This device is equipped with technical provisions to protect it against theft. Further information on

protection against theft can be obtained from an authorized Mercedes-Benz Center.

### Home screen overview

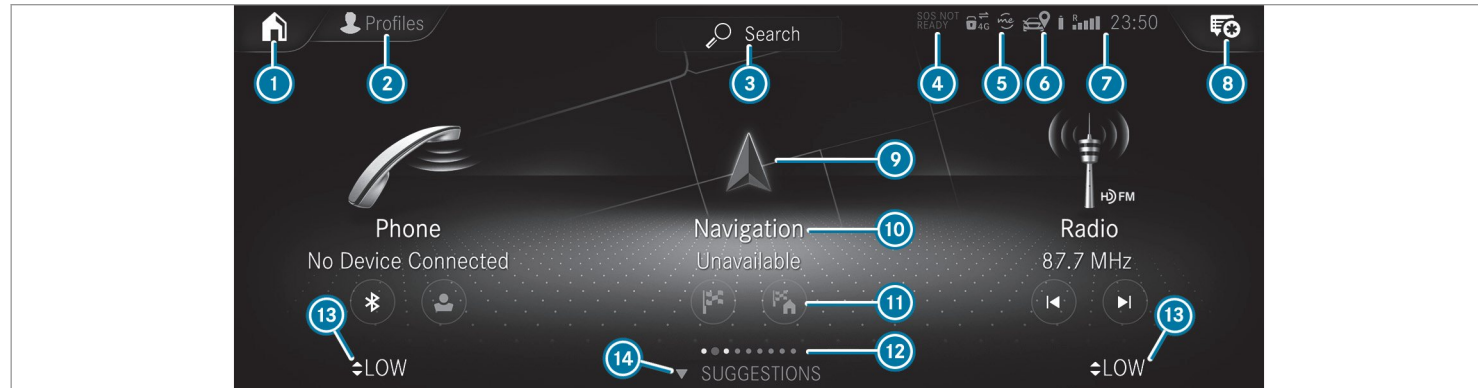

- ① Depending on the display, calls up the first three applications or the home screen
- ② Calls up the profile
- ③ Calls up the global search

- ④ SOS NOT READY (only when the Mercedes-Benz emergency call system is not available)
- ⑤ Mercedes me connect active
- ⑥ Transmission of vehicle position active

- ⑦ Signal strength of the mobile phone network, network display, battery status of the mobile phone connected, time
- ⑧ Calls up the Notifications Center
- ⑨ Calls up an application using the symbol

- ⑩ Application and current information
  - ⑪ Quick-access, e.g. enter home address
  - ⑫ Index points and selected display area
  - ⑬ Calls up the air conditioning menu
  - ⑭ Calls up **SUGGESTIONS**, **THEMES** and **FAVORITES**
- ① If Mercedes me connect ⑤ is active, the vehicle is linked with Mercedes me connect. Vehicle data is then transmitted to the back-end system. What data is transmitted depends on which services are activated. Further details can be found in the Mercedes me connect terms and conditions and data protection information. The function is country-dependent.
- If transmission of vehicle position ⑥ is active, Mercedes me connect services have been activated for this vehicle which access the vehicle's geolocation. In which instances the geolocation is transmitted depends on the particular services. Further details can be found in the Mercedes me connect terms and conditions and data protection information. The function is country-dependent.

## Operating the MBUX multimedia system

### Using Touch Control

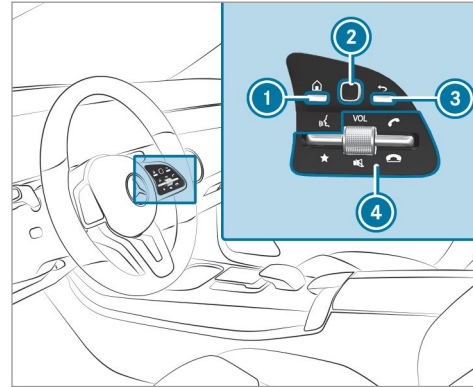

- ① Calls up the home screen
- ② Touch Control
- ③ Press briefly: returns to the previous display
- ④ Press the rocker switch down briefly: shows favorites

- Press the rocker switch down and hold: adds favorites and themes
- VOL** Turn controller: adjusts the volume
- Press controller: switches off the sound
- Press the rocker switch up: makes or accepts a call
- Press the rocker switch down: rejects or ends a call

Navigation through the menus is carried out with Touch Control ② with single-finger swipes.

- ▶ **To select a menu option:** swipe and press.
- ▶ **To move the digital map:** swipe in any direction.

### Using the touchscreen

- ▶ Select menu options, symbols or characters by pressing briefly.
- ▶ **To navigate in menus:** swipe up, down, left or right.
- ▶ **To use handwriting to enter characters:** write the character with one finger on the touchscreen.

- ▶ **To zoom in and out of the map:** move two fingers together or apart.
- ▶ **To call up the global menu:** press and hold on the touchscreen until the **OPTIONS** menu appears.

**i** For more information on operation, please refer to the Digital Operator's Manual.

### Using the touchpad

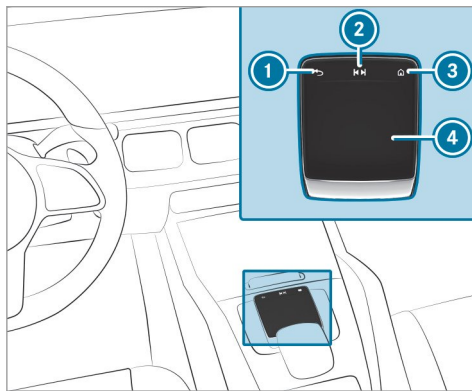



- ① Returns to the previous display
- ② Calls up the audio control menu  
Swiping to the left of right: selects the previous or next radio station/music track
- ③ Calls up the home screen
- ④ Touchpad

- ▶ **To select a menu option:** swipe and press.
- ▶ **To use handwriting recognition:** write a character on the touchpad.
- ▶ **To open or close the Notifications Center:** swipe down or up with two fingers.
- ▶ **To zoom in and out of the map:** move two fingers together or apart.

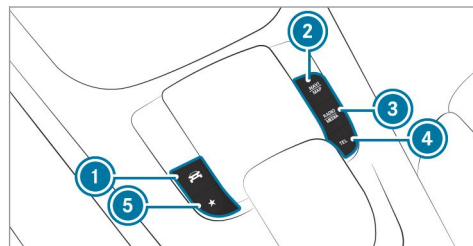
### Calling up applications using buttons



- ① Calls up vehicle functions
- ② Calls up navigation
- ③ Calls up radio or media
- ④ Calls up the telephone

- 5  Press briefly: calls up favorites  
Press and hold: adds a favorite or theme
- ▶ Alternatively, tap  on the touchscreen.
- ▶ Call up the application (→ page 290).

### Functions of the Voice Control System

**⚠ WARNING** Risk of distraction from information systems and communications equipment

If you operate information systems and communication devices integrated in the vehicle when driving, you could be distracted from the traffic situation. This could also cause you to lose control of the vehicle.

- ▶ Only operate this equipment when the traffic situation permits.
- ▶ If you cannot be sure of this, stop the vehicle whilst paying attention to road and traffic conditions and operate the equipment with the vehicle stationary.

For your own safety, always observe the following points when operating mobile communications equipment and especially your voice control system:

- Observe the legal requirements for the country in which you are driving.
- If you use the voice control system in an emergency your voice can change and your telephone call, e.g. an emergency call, can thereby be unnecessarily delayed.
- Familiarize yourself with the voice control system functions before starting the journey.

With the Voice Control System, various applications in the MBUX multimedia system are operable using voice input. The Voice Control System is operational approximately thirty seconds after the ignition is switched on and is available for the driver's seat and front passenger seat.

The following multimedia system applications can be operated:

- Telephone
- Text messages
- Navigation

- Address book
- Radio
- Media
- Vehicle functions

### Starting the Voice Control System

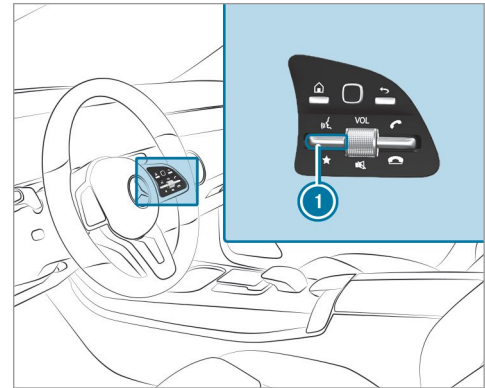

- ▶ Press rocker switch  up.

or

▶ Say "Hello Mercedes".

### Overview of the MBUX Interior Assistant

**⚠ WARNING** Risk of injury from the camera's laser radiation

This product uses a classification 1 laser system. If the housing is opened or damaged, laser radiation may damage your retina.

- ▶ Do not open the housing.
- ▶ Always have maintenance work and repairs carried out by a qualified specialist workshop.

This product complies with the requirements of the FDA 21 CFR 1040.10 and 1040.11 with exception of the variations according to the FDA Laser Notice No. 50 from 24. June 2007.

The camera is located in the overhead control panel.

If the vehicle is equipped with the MBUX Interior Assistant, selected functions of the multimedia system can be operated contact-free. The MBUX Interior Assistant can differentiate between driver and front passenger interactions and detects specific hand positions (poses).

#### System limits, display messages and notes for rectification

The system may be impaired or may not function in the following situations:

- The camera in the overhead control panel may heat up due to operating conditions. As a result the camera may switch off temporarily, particularly during longer periods of operation and at high outside temperatures.

Do not touch or cover the camera and wait until the camera has cooled down and is available again.

- The camera is covered, dirty, fogged up or scratched.

Wait until the camera has cooled down before cleaning the camera lens.

Clean the outside of the camera lens with a dry or damp cotton cloth. Do not use micro-fiber cloths. Do **not** remove the cover when cleaning.

- Recognition can be impaired by reflective clothing, an adverse color of clothing or by accessories, for example.
- Clothing being worn (hat, shawl, scarf) may be limiting the detection area of the camera. Keep the camera's field of vision clear.
- The camera is not operational. Consult an authorized Mercedes-Benz Center.



The MBUX Interior Assistant supports the following interactions:

Interaction area	Interaction	Description
In front of the media display or above the touchpad	Proximity to the control element	The Interior Assistant recognizes the approach of the hand towards a control element. Depending on the active application, the display will be adjusted in the media display. Some functions differentiate between driver and front passenger. No specific hand position is required.
Above the center console	Defined pose	A favorite is called up with a defined pose.
Below the inside rearview mirror	Brief up and down movements	With brief vertical up and down movements below the inside rearview mirror the reading light for the driver or the front passenger is switched on and off.
Above the front passenger seat	Stretching out a hand above the front passenger seat	By stretching out a hand above the front passenger seat the search light is switched on. If you withdraw a hand from this area, the search light is switched off again.

### Switching the reading light and search light and on or off

#### Requirements:

- **For the reading light:**
  - The function is available when it is dark.
- **For the search light:**
  - The hand movement takes place in the interaction area below the inside rearview mirror.
  - The hand movement takes place in the interaction area above the front passenger seat.
  - The seat belt on the front passenger seat must **not** be inserted in the seat belt buckle.
  - The function is available when it is dark.

### Switching the reading light on and off



- ▶ Briefly move a hand up or down beneath the inside rearview mirror.  
The reading light is switched on or off for the driver or the front passenger.

### Switching the search light on and off



- ▶ **To switch on:** reach across the front passenger seat with a hand.  
The search light is switched on for the driver.
- ▶ **To switch off:** take a hand back away from the front passenger seat.  
The search light is switched off again.

### Information on profiles, themes, suggestions and favorites

For electrically adjustable seats observe the following notes.

**⚠ WARNING** Risk of becoming trapped during adjustment of the driver's seat after calling up a driver profile

Selecting a user profile may trigger an adjustment of the driver's seat to the position saved under the user profile. You or other vehicle occupants could be injured in the process.

- ▶ Make sure that when the position of driver's seat is being adjusted using the multimedia system, no people or body parts are in the seat's range of movement.

If there is a risk of someone becoming trapped, stop the adjustment process immediately:

- ▶ a) Tap the warning message on the media display.
- or
- ▶ b) Press a memory position button or a seat adjustment switch on the driver's door.  
The adjustment process will be stopped.

The driver's seat is equipped with an access preventer.

If the driver's door is open, the driver's seat will **not** be set after calling up the driver's profile.

Profiles store your vehicle settings and settings for the multimedia system. If the vehicle is used by several drivers, the driver can select their own profile without changing the stored profile settings of other drivers.

 Information on profiles from Mercedes me connect can be found in the Digital Operator's Manual.

Vehicle settings are, for example, driver's seat, steering wheel and mirror settings, climate control and ambient lighting. For the settings of the multimedia system, you can select, for example, radio stations, previous destinations as well as themes, suggestions and favorites.

For recurring driving situations, such as long drives on the freeway, you can save your preferred settings in a theme in the vehicle. In a theme you can save the display of the digital map, your preferred radio station and preferred drive program, for example.

The vehicle can learn the habits of the driver. It then offers suggestions for the most probable navigation destinations, media sources, radio stations or contacts. The requirements for that are the selection of a profile, your consent to the recording of data and sufficient collected data.



Favorites provide quick access to applications that are used often. You can select favorites from categories or add them directly to an application.

### Configuring profiles, themes and suggestions

Multimedia system:



#### Creating a new profile

- ▶ Select  **Create Profile** .
- ▶ Select an avatar.
- ▶ Enter the name and confirm with .
- ▶ Select **Continue** .
- ▶ Select **Current Settings**.
- ▶ Select **Save**.

- ▶ Activate Bluetooth® and select **Connect Phone**, to connect a mobile phone with the user profile .
- ▶ Select **Finish**.

#### Selecting profile options

- ▶ Select  for a profile.

The following functions are available:







- Editing, resetting or deleting a profile
- Resetting themes or favorites
- Configuring suggestions

#### Configuring suggestions

- ▶ Select  for a profile.
- ▶ Select **Suggestion Settings**.
- ▶ Switch **Allow Destination Suggestions, Allow Music Suggestions** and **Allow Contact Suggestions** on or off.
- ▶ **To deactivate the learning function for one day:** activate **Deact. Learning for 24 h**. For 24 hours no new actions will be trained and no data recorded for the active profile. Suggestions will continue to be shown.

Example: if the option is switched on and a route to a new destination has been calculated, this destination would not be taken into account for the learning function.

### Creating new themes

- ▶ Select .
- ▶ Select **THEMES**.
- ▶ Select  **Create Theme**.  
The settings which are saved in the theme are shown.
- ▶ Select **Continue** .
- ▶ Select **Audio** and **Navigation** (Navigation) and store the active settings in the theme.
- ▶ Select **Continue** .
- ▶ Select an entry screen.
- ▶ Select **Continue** .
- ▶ Select an image.
- ▶ Enter the names into the entry field and confirm with .
- ▶ Select **Save**.

## System settings

### Overview of the system settings menu

In the system settings menu, you can make settings in the following menus and control elements:

- Display
  - Styles
  - Instrument lighting
  - Display brightness
  - Edge lighting
  - Day/night design
- Control elements
  - Keyboard language and handwriting recognition
  - Sensitivity of the touchpad
  - Sensitivity of the Touch Controls
- Voice Control System
- Sound
  - Entertainment
  - Navigation and traffic announcements

- Telephone
- Voice amplification to the rear
- Connectivity
  - Wi-Fi, Bluetooth®, NFC
- Time & date
- Language
- Units for distance
- Software updates
- Data import/export
- PIN protection
- System Reset

### Information on important system updates

Important system updates may be necessary for the security of your multimedia system's data. Install these updates, or else the security of your multimedia system cannot be ensured.

A system update consists of three steps:

- Downloading or copying of the data required for installation
- Installation of the downloaded system update

- Activation of the downloaded system update by restarting the system
- ① If automatic software updates are activated, the system updates will be downloaded automatically.

The multimedia system provides a message when a system update is available.

You have the following selection options:

- **Accept and Install**  
The system update will be downloaded in the background.
- **Information**  
Information about the pending system update is displayed.
- **Later**  
The system update can be downloaded manually at a later time.

### Deep system updates

Deep system updates access vehicle or system settings and can therefore only be carried out when the vehicle is stationary and the ignition is switched off.

If the download of a deep system update is completed and the downloaded system update is ready for installation, you will be informed of this after the next ignition cycle, for example.

- ① Park the vehicle safely in a suitable location before starting the installation.

Requirements for the installation:

- The ignition is switched off.
- Notes and warnings have been read and accepted.
- The electric parking brake is applied.

If all requirements have been fulfilled, the downloaded system update is installed. The multimedia system cannot be operated while the downloaded system update is being installed and vehicle functions are restricted.

If errors should occur during the installation, the multimedia system automatically attempts to restore the previous version. If restoration of the previous version is not possible, a symbol appears on the media display. Consult a qualified specialist workshop to resolve the problem.

## Setting up a Wi-Fi hotspot

### Requirements:

- **To set up the Wi-Fi connection of the multimedia system with external hotspots:** your vehicle does not have a permanently installed communication module.
- The device to be connected supports at least one of the types of connection described.

Multimedia system:

[Settings](#)

[System](#)  

[Wi-Fi & Bluetooth](#)

### Activating/deactivating Wi-Fi

- ▶ Select [Wi-Fi](#).

### Connecting the multimedia system with an external hotspot using Wi-Fi

The type of connection established must be selected on the multimedia system and on the device to be connected.

 The connection procedure may differ depending on the device. Follow the instructions that are shown in the display. Further information can be found in the manufacturer's operating instructions.

- ▶ Select **Internet Settings**.
- ▶ Select **Connect via Wi-Fi**.
- ▶ Select **Add Hotspot**.

#### Connecting using a QR code

- ▶ Select the options  of the desired Wi-Fi network.
- ▶ Select **Connect using QR code**.
- ▶ Scan the displayed QR code with the device to be connected.  
The Wi-Fi connection is established.

#### Connecting using a security key

- ▶ Select the options  of the desired Wi-Fi network.
- ▶ Select **Connect Using Security Key**.

- ▶ Have the security key displayed on the device to be connected (see the manufacturer's operating instructions).
- ▶ Enter this security key on the multimedia system.
- ▶ Confirm the entry with **ok**.

#### Connecting using a WPS PIN

- ▶ Select the options  of the desired Wi-Fi network.
- ▶ Select **Connect via WPS PIN Input**.  
The multimedia system generates an eight-digit PIN.
- ▶ Enter this PIN on the device to be connected.
- ▶ Confirm the entry.

#### Connecting using a button

- ▶ Select the options  of the desired Wi-Fi network.
- ▶ Select **Connect via WPS PBC**.
- ▶ Select "Connect via WPS PBC" in the options on the device to be connected (see the manufacturer's operating instructions).

- ▶ Press the WPS button on the device to be connected.
- ▶ Select **Continue** in the multimedia system.

#### Activating automatic connection

- ▶ Select **Connect via Wi-Fi**.
- ▶ Select the options  of the desired Wi-Fi network.
- ▶ Activate **Permanent Internet Connection**.

#### Connecting with a known Wi-Fi network

- ▶ Select **Connect via Wi-Fi**.
- ▶ Select a Wi-Fi network.  
The connection is established again.

#### Configuring the multimedia system as a Wi-Fi hotspot for external devices

The type of connection established depends on the device to be connected. The function must be supported by the multimedia system and by the device to be connected. The type of connection established must be selected on the multimedia system and on the device to be connected.

- ▶ Select **Vehicle Hotspot**.

- ▶ Select [Connect Device to Vehicle Hotspot](#).

#### Connecting using WPS PIN generation

- ▶ Select [Connect via WPS PIN Generation](#).
- ▶ Enter the PIN shown in the media display on the device to be connected and confirm.

#### Connecting using WPS PIN entry

- ▶ Select [Connect via WPS PIN Input](#).
- ▶ Enter the PIN that is shown on the external device's display on the multimedia system.

#### Connecting using a button

- ▶ Select [Connect via WPS PBC](#).
- ▶ Press the push button on the device to be connected (see the manufacturer's operating instructions).
- ▶ Select [Continue](#).

#### Connecting using a security key

- ▶ Select [Connect Device to Vehicle Hotspot](#).  
A security key is displayed.

- ▶ Select the vehicle from the device to be connected. The vehicle is displayed with the [DIRECT-MBUX XXXXX](#) network name.
- ▶ Enter the security key which is shown in the media display on the device to be connected.
- ▶ Confirm the entry.

#### Connecting using NFC

- ▶ Select [Connect via NFC](#).
- ▶ Activate NFC on the mobile device (see the manufacturer's operating instructions).
- ▶ Hold the device to be connected at the vehicle's NFC interface.
- ▶ Select [Finished](#).  
The mobile device is now connected to the multimedia system hotspot via NFC.

#### Generating a new security key

- ▶ Select [Vehicle Hotspot](#).
- ▶ Select [Generate Security Key](#).  
A connection will be established with the newly created security key.

- ▶ **To save a security key:** select [Save](#).  
When a new security key is saved, all existing Wi-Fi connections are then disconnected. If the Wi-Fi connections are being re-established, the new security key must be entered.



### System language

#### Notes on the system language

This function allows you to determine the language for the menu displays and the navigation announcements. The selected language affects the characters available for entry. The navigation announcements are not available in all languages. If a language is not available, the navigation announcements will be in English.

#### Setting the system language

Multimedia system:

- ▶  ▶ [Settings](#) ▶ [System](#)
- ▶  [Language](#)
- ▶ Set the language.

- ① If you are using Arabic map data, the text information can also be shown in Arabic on the navigation map. To do so, select العربية as the language from the language list. Navigation announcements are then also made in Arabic.

### Resetting the multimedia system (reset function)

**⚠ WARNING** Risk of accidents due to failure of multimedia display functions

While the multimedia system is being reset, its functions such as the rear view camera are not available.

- ▶ Only reset the multimedia system when the vehicle is stationary.

Multimedia system:

→  ▶▶ Settings ▶▶ System ▶▶ Reset

Personal data is deleted, for example:

- Vehicles with rear telephony: handset connection
- Individual user profiles
- ① The guest profile is reset when the settings are restored to the factory settings.
- ① Vehicles with rear telephony: The handset must be in the cradle while the system is reset.

A prompt appears again asking whether you really wish to reset.

- ▶ Select **Yes**.  
The multimedia system is reset to the factory settings. If you have set a PIN for your system, this will also be reset.

## Navigation

### Notes on navigation

#### Route guidance with augmented reality

**⚠ WARNING** Risk of accident and injury as a result of distraction, incorrect depiction or wrong interpretation of the display

The camera image of the augmented reality display is not suitable as a guide for driving.

- ▶ Always keep an eye on the actual traffic situation.
- ▶ Avoid extended observation of the camera image.

**⚠ WARNING** Risk of accident and injury due to imprecise positioning of additional information



The additional information from the augmented reality display may be inaccurate and is not a substitute for observing and assessing the actual driving situation.



- ▶ Always keep an eye on the actual traffic situation when carrying out all driving maneuvers.

### Switching navigation on

Multimedia system:

-  → **Navigation** (Navigation)
- ▶ Alternatively: press the  button.  
The map displays the current vehicle position.  
The navigation menu is shown.  
The navigation menu is hidden if route guidance is active.
- ▶ **To show:** tap on the touchscreen.  
The menu is hidden automatically.

## Navigation overview

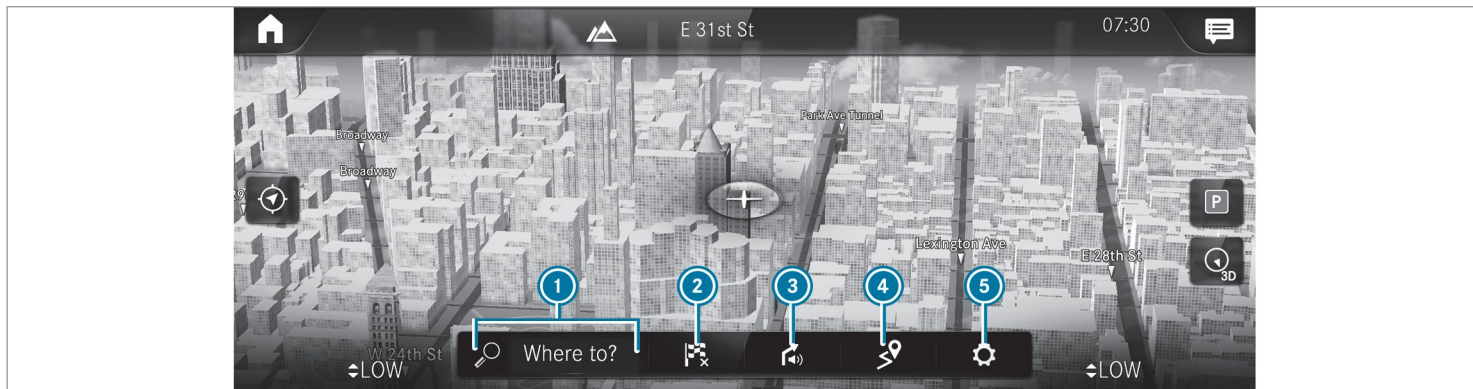

Example: digital map with navigation menu

- ① Enters a POI or address and additional destination entry options
- ② Interrupts route guidance (if route guidance is active)
- ③ Repeats a navigation announcement and switch navigation announcements on or off
- ④ Calls up the **ON THE WAY** menu

- To show **Route Overview**
- To select **Alternative Routes**
- **Report Traffic Incident** (Car-to-X)
- To call up the **TRAFFIC** menu
- To display **Traffic Announcements**
- To display **Area Alerts**
- To display **Provider Information**

- To show **Route List**
- To call up the **POSITION** menu
- **Save Position**
- To display **Compass**
- ⑤ Quick-access and settings
  - To show **Traffic**
  - To show **Parking**

- To show [Highway Information](#)
- Via [Advanced](#) options to use [View](#), [Announcements](#) and [Route](#)

### Overview of the toll system

Debiting of toll charges at highway toll gates is facilitated with an electronic payment system.

The toll system uses RFID (Radio Frequency Identification) for data transfer between the control unit and the toll station.

The toll system is initially switched off at the factory.

The control unit is in the vehicle glove box.

To register and activate the control unit, the following steps are required:

- Activate the toll system in the settings of the MBUX multimedia system.
- In the Mercedes me app, register the unit identification number of the control unit and activate the toll system.  
Registration and activation of the toll system can take up to 24 hours.

When the toll system is activated, the number of vehicle occupants is first transmitted manually and is preset with one person.

The number of vehicle occupants can be transmitted automatically. In the process, the number of seat belts worn is determined.

The toll system is operational in all states in the USA and in all provinces in Canada.

- ① In Mexico, for example, the toll system can be registered and activated for journeys to the USA.

### Notices

- Drive at the prescribed vehicle speed in the toll lane.
- The toll will be debited automatically only after registration and activation of the toll system.
- Mercedes-Benz recommends operation using the MBUX multimedia system. Alternatively, this can also be done on the control unit in the glove box.
- For safety reasons, entries should be made while the vehicle stationary.
- For further information, please consult the Mercedes me app or an authorized Mercedes-Benz Center.

Or call 1-800-FOR-MERCEdes (in the USA) or 1-800-387-0100 (in Canada).

## Entering a destination

Multimedia system:

→ Home ▶ Navigation ▶ Where to?

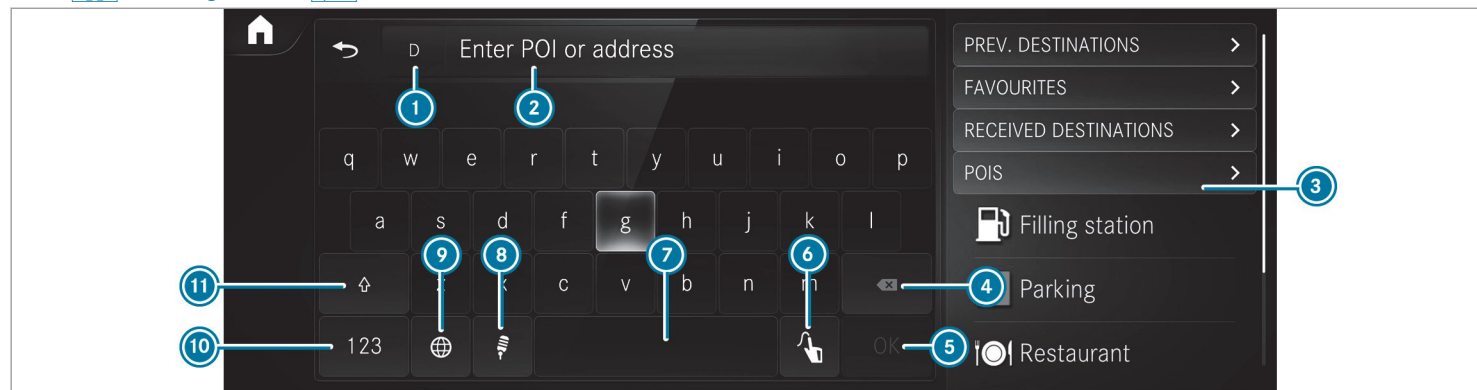

- ① Federal state or province in which the vehicle is located
  - ② Enters a POI or address
  - ③ List with additional destination entry options
  - ④ Deletes an entry
  - ⑤ **OK** Confirms an entry
  - ⑥ Switches to handwriting recognition
  - ⑦ Enters a space
  - ⑧ Switches to voice input
  - ⑨ Sets the written language
  - ⑩ Switches to digits, special characters and symbols
  - ⑪ Switches to upper-case or lower-case letters
- ▶ Enter the destination in ②. The entries can be made in any order.

The following entries can be made, for example:

- City, street, house number
- Street, city
- ZIP code
- POI name or POI category, e.g. **Parking**
- Contact name

- ▶ Select a search result in list ③.
- ▶ Calculate the route (→ page 307).

① You can find further information about destination entry, e.g. 3 word addresses, in the Digital Operator's Manual.

### Changing country

- ▶ Select the indicator for federal state or province ①.
- ▶ Select the federal state or the province in ①.
- ▶ Enter the country indicator.
- ▶ Select the country on list ③.
- ▶ Select the federal state or the province from list ③.

### Using online search

① Requirements: the media display shows an Internet connection in the status line with the  symbol.

Destination entry uses online map services. If the on-board search finds no suitable destinations or if you change countries, the online search is available.

For the destination you can enter an address, a POI or a three-word address.

- ▶ Enter the destination in input line ②. The search results are displayed.
  - ▶ Select the destination in the list. The detailed view for the route is displayed.
- or
- ▶ Select country indicator ①.
  - ▶ Select the provider for the online service from the countries list.
  - ▶ Enter the destination in input line ②.
  - ▶ Select the destination in the list.

### Calculating a route and using settings for route guidance



#### Requirements:

- The destination has been entered.
- The destination address is shown.

Multimedia system:

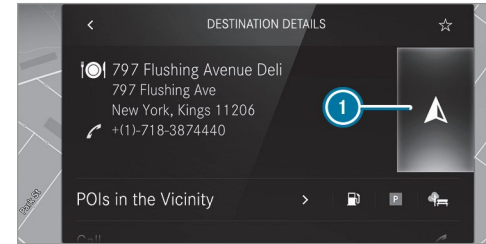
  **▶▶ Navigation**



- ①  No route yet.
-  A route has been mapped.

- ▶ Select . The route to the destination is calculated. Route guidance begins.



or

- ▶ Select .
- ▶ Select **Set as Waypoint**. The destination address is set as the next intermediate destination.

or

- ▶ Select **Start New Route Guidance**. The destination address is set as the new destination. The previous destination and the intermediate destinations are deleted. Route guidance to the new destination begins.

### Selecting route settings

- ▶ Select .
- ▶ Select **Advanced**.
- ▶ Select **Route**.
- ▶ Select the route type.
- ▶ Take traffic information into consideration with **Dynamic Route Guidance** .

- ▶ Select route options with **Avoid Options**.
- ▶ Activate **Suggest Alternative Route**. Alternative routes are calculated for every route.
- ▶ Activate **Activate Commuter Route**. If the requirements are met, the multimedia system automatically detects that the vehicle is on a commuter route. Route guidance begins without voice output.

### Activating route guidance with augmented reality

- ▶ During route guidance, tap on the camera symbol on the media display. The camera image will be shown instead of the navigation map before a turning maneuver and will show additional information.
- ▶ **To return to the navigation map:** tap on the camera symbol again.

### Displaying additional information in the camera image

- ▶ Select .
- ▶ Select **Advanced**.
- ▶ Select **Augmented Reality**.

- ▶ Activate **Street Names** and **House Numbers**. During route guidance, street names and house numbers are shown in the camera image.

### Using map functions

Multimedia system:

  **▶▶ Navigation**

### Setting the map scale

- ▶ **To zoom in:** tap twice quickly with one finger on the media display.
- ▶ **To zoom out:** tap with two fingers on the media display.

### Moving the map

- ▶ Move one finger in any direction on the touchscreen.
- ▶ **To reset the map to the current vehicle position:** press  briefly.

### Selecting map orientation

- ▶ Tap repeatedly on the  compass symbol on the map.  
The view changes in the sequence **3D, 2D Heading Up** to **2D North Up**.

### Switching highway information on/off

- ▶ Select .
- ▶ Activate or deactivate **Highway Information**.

### Using services

#### Requirements:

- There is an Internet connection.
- Mercedes me connect is available.
- You have set up a user account in the Mercedes me Portal.
- The vehicle is connected to a user account and you have accepted the conditions of use for the service.  
Further information can be found at: <https://www.mercedes.me>
- The service is available.

- The service has been activated at an authorized Mercedes-Benz Center.
- The following additional conditions apply to the Parking service:
  - The navigation services option is available, subscribed to and activated in the Mercedes me Portal.
  - The Parking service is within the scope of the Navigation Services.

Multimedia system:

 ▶▶ **Navigation**

#### Displaying the traffic situation with Live Traffic Information

- ▶ Select .
- ▶ Activate **Traffic**.
- ▶ Select **Advanced**.
- ▶ Select **View**.
- ▶ Select **Map Elements**.

- ▶ Switch on **Traffic Incidents, Free Flowing Traffic** and **Delay**.

If traffic information has been received, then traffic incidents such as roadworks, road blocks, local area reports (e.g. fog) and warning messages are displayed.

The traffic delay is displayed for the current route. Traffic delays lasting one minute or longer are taken into consideration.

#### Displaying hazard warnings with Car-to-X-Communication

If hazard warnings are available these can be shown as symbols on the map. The display depends on the settings for the **Traffic** and **Traffic Incidents** options.

- ▶ Set the options.  
If **Traffic** is switched off and **Traffic Incidents** is switched on, the symbols are shown on the prospective route.

#### Displaying weather information and other map contents

- ▶ Select .
- ▶ Select **Advanced**.

- ▶ Select **View**.
- ▶ Select **Map Elements**.
- ▶ Scroll up and show the **ONLINE MAP CONTENT** category.
- ▶ Switch on a service, e.g. **Weather**.  
Current weather information is displayed on the navigation map, e.g. temperature or cloud cover.

### Parking service

**!** **NOTE** Damage to the vehicle due to not observing the maximum permitted headroom clearance

If the vehicle height is greater than the maximum permitted headroom clearance, the roof and other parts of the vehicle may be damaged.

- ▶ Observe the signposted headroom clearance.
- ▶ If the vehicle height is greater than the permitted headroom clearance, do not enter.

- ▶ Observe the changed vehicle height with add-on roof equipment.

### **!** NOTE Before selecting the parking option

The data is based on information provided by the respective service provider.

Mercedes Benz accepts no liability for the accuracy of the information provided relating to the parking garage/parking lot.

- ▶ Always observe the local Information and conditions.

**i** This service is not available in all countries.

- ▶ Select  and activate **Parking**.
- ▶ Tap on **P** in the map.
- ▶ Select a parking option.  
The map shows the parking options in the vicinity.  
The following information is displayed (if available):
  - Destination address, distance from current vehicle position and arrival time

- Information on the parking garage/parking lot, for example:
    - Opening times
    - Parking charges
    - Current occupancy
    - Maximum parking time
    - **Maximum access height**  
The maximum access height shown by the parking service does not replace the need for observation of the actual circumstances.
  - Available payment options (Mercedes pay, coins, bank notes, cards)
  - Details on parking tariffs
  - Number of available parking spaces
  - Payment method (e.g. at the parking meter)
  - Services/facilities at the parking option
  - Telephone number
- ▶ Calculate the route (→ page 307).



## Notes on the dashcam

### **NOTE** Before using the dashcam

You are legally responsible for operation and use of the dashcam functions. The legal requirements relating to operation and use of the dashcam can vary depending on the country in which the dashcam is operated. Therefore, observe the legal requirements, in particular the data protection regulations, in your country.

For this reason, before using the dashcam inform yourself about the regulation details for the respective country.

This function is not permitted in all countries.

- ▶ Observe the country-specific regulations.

## Selecting a USB device for a video recording with the dashcam

### Requirements:

- At least one USB device is connected with the multimedia system .

Multimedia system:

- ➔  ➔ Mercedes me & Apps
- ➔➔ Dashcam

- ▶ Select the USB device.

- ① When USB devices contain multiple partitions, recorded video files are not always displayed in the recording list. Mercedes-Benz recommends that you use USB devices with one partition.

## Starting or stopping video recording with the dashcam

### Requirements:

- A USB device is connected with the multimedia system .
- The vehicle is switched on.

Multimedia system:

- ➔  ➔ Mercedes me & Apps
- ➔➔ Dashcam

- ▶ If several USB devices are connected with the multimedia system, select a USB device (→ page 311).
- ▶ Select the **Individual Recording** or **Loop Recording** recording mode. If **Individual Recording** is selected and the memory is full the recording stops. If **Loop Recording** has been selected, several short video files are recorded. When the memory limit is reached, the oldest video file is deleted and recording is continued automatically.
- ▶ **To start:** select **Start Recording**. The length of the recording is shown. The **Please do not remove the storage medium** message appears. The video file is stored on the USB device.
- ▶ **To end:** select **End Recording**.

A report may appear in the following cases:

- For the **Individual Recording** recording mode: the memory is full or there are only a few minutes recording time available. The video recording stops or will be stopped imminently. Change the USB device or delete a video file.
- If a video recording has started and a national border is detected, the **National Border Crossed. Please observe the country-specific regulations on video recording.** message appears.  
This function is not available in all countries.
- The camera is not functional, the **Camera Unavailable** message appears.  
Have the camera checked in an authorized Mercedes-Benz Center.

## Telephone

### Telephony

#### Notes on telephony

**⚠ WARNING** Risk of distraction from operating integrated communication equipment while the vehicle is in motion

If you operate communication equipment integrated in the vehicle when driving, you could be distracted from the traffic situation. This could also cause you to lose control of the vehicle.

- ▶ Only operate this equipment when the traffic situation permits.
- ▶ If you cannot be sure of this, stop the vehicle whilst paying attention to road and traffic conditions and operate the equipment with the vehicle stationary.

**⚠ WARNING** Risk of an accident from operating mobile communication equipment while the vehicle is in motion

Mobile communications devices distract the driver from the traffic situation. This could also cause the driver to lose control of the vehicle.

- ▶ As the driver, only operate mobile communications devices when the vehicle is stationary.
- ▶ As a vehicle occupant, only use mobile communications devices in the areas intended for this purpose, e.g. in the rear passenger compartment.

You must observe the legal requirements for the country in which you are currently driving when operating mobile communication equipment in the vehicle.

**⚠ WARNING** Risk of injury due to objects being stowed incorrectly

If objects in the vehicle interior are stowed incorrectly, they can slide or be thrown around

and hit vehicle occupants. In addition, cup holders, open stowage spaces and mobile phone receptacles cannot always retain all objects within.

There is a risk of injury, particularly in the event of sudden braking or a sudden change in direction.

- ▶ Always stow objects so that they cannot be thrown around in such situations.
- ▶ Always make sure that objects do not protrude from stowage spaces, parcel nets or stowage nets.
- ▶ Close the lockable stowage spaces before starting a journey.
- ▶ Always stow and secure heavy, hard, pointed, sharp-edged, fragile or bulky objects in the trunk/cargo compartment.

Observe the additional information on stowing mobile communications devices correctly:

- Loading the vehicle (→ page 124)

#### **Bluetooth® connection:**

The menu view and the available functions in the telephone menu are in part dependent on the Bluetooth® profile of the connected mobile phone. Full functionality is only available if the mobile phone supports both of the following Bluetooth® profiles:

- PBAP (Phone Book Access Profile)
  - The contacts on the mobile phone are shown automatically on the multimedia system.
- MAP (Message Access Profile)
  - The mobile phone message functions can be used on the multimedia system.

Irrespective of this, Bluetooth® audio functionality can be used with any mobile radio unit.

For information on the range of functions of the mobile radio unit to be connected, see the manufacturer's operating instructions.

#### **Network connection:**

The following cases can lead to the call being disconnected while the vehicle is in motion:

- You switch into a transmission/reception station, in which no communication channel is free.
- The SIM card used is not compatible with the network available
- A mobile phone with "Twincard" is logged into the network with the second SIM card at the same time

The multimedia system supports calls in HD Voice® for improved speech quality. A requirement for this is that the mobile phone and the mobile phone network provider of the person you are calling support HD Voice®.

Depending on the quality of the connection, the voice quality may fluctuate.

Further information can be obtained from an authorized Mercedes-Benz Center or at: <https://www.mercedes-benz.com/connect>

## Telephone menu overview

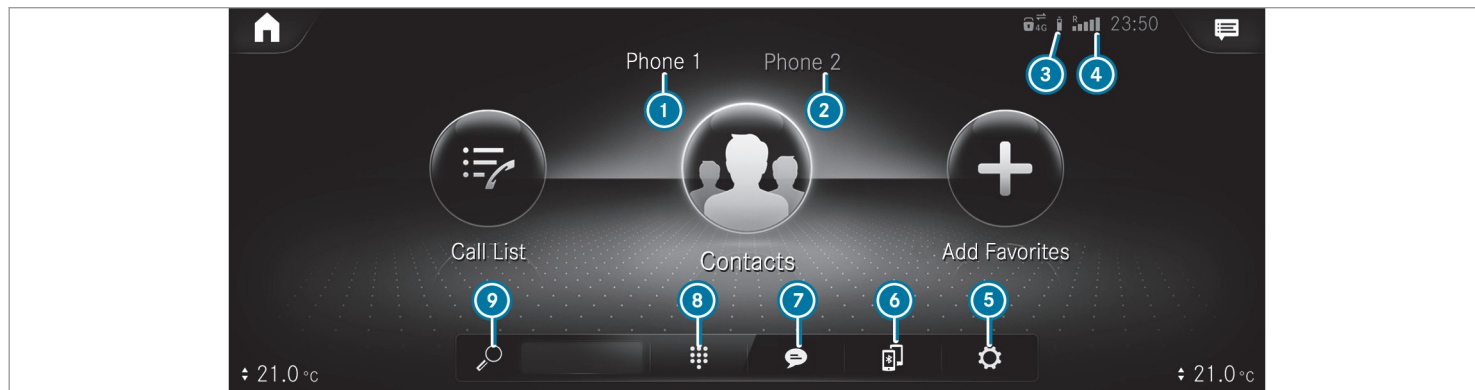

- |   |                  |
|---|------------------|
| ① Bluetooth® device name of the currently connected mobile phone/of the mobile phone                  | ⑥ Device manager |
| ② Bluetooth® device name of the currently connected mobile phone/of the mobile phone (two phone mode) | ⑦ Messages       |
| ③ Battery status of the connected mobile phone  | ⑧ Numerical pad  |
| ④ Signal strength of the mobile phone network   | ⑨ Contact search |
| ⑤ Options   |                  |

## Telephony operating modes overview

Depending on your equipment, the following telephony operating modes are available:

- A mobile phone is connected to the multimedia system via Bluetooth®.

- Two mobile phones are connected with the multimedia system via Bluetooth® (two phone mode).
  - You can use all the functions of the multimedia system with the mobile phone in the foreground.
  - You can receive incoming calls and messages with the mobile phone in the background.

You can interchange the mobile phone in the foreground and background.

### Connecting a mobile phone

#### Requirements:

- Bluetooth® is activated on the mobile phone (see the manufacturer's operating instructions).
- Bluetooth® is activated on the multimedia system.

Multimedia system:



#### Searching for a mobile phone

- ▶ Select .
- ▶ Select **Connect New Device**.



#### Connecting a mobile phone

Authorization follows using secure simple pairing.

- ▶ Select a mobile phone.  
A code is displayed in the multimedia system and on the mobile phone.
- ▶ If both codes match, confirm the code on the mobile phone.

#### Functions in the telephony menu

In the telephony menu you have the following functions, for example:

- Making calls, e.g.:
  -  Accept a call
  -  **End Call**
  -  **Create Confer. Call**
  - Accepting or rejecting a waiting call

- Managing contacts, e.g.:
  - Downloading mobile phone contacts
  - Managing the format of a contact's name
  - Saving a contact as a favorite
- Receiving and sending messages, e.g.:
  - Using the read-aloud function
  - Dictating a new message

## Mercedes me app

### Mercedes me calls

#### Making a call via the overhead control panel

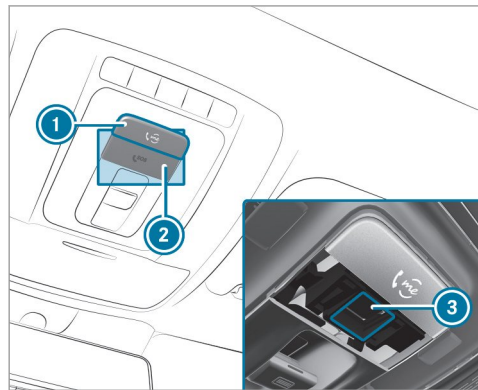

- ① me button for service or information calls
- ② SOS button cover
- ③ SOS button (emergency call system)

#### Making a Mercedes me call

- ▶ Press me button ①.

#### Making an emergency call

- ▶ To open the cover of SOS button ②, press it briefly.
- ▶ Press and hold SOS button ③ for at least one second.

If a Mercedes me call is active, an emergency call can still be triggered. This has priority over all other active calls.

#### Information about the Mercedes me call

A call to the Mercedes-Benz customer center has been initiated via the me button in the overhead control panel or the multimedia system (→ page 316).

Using the voice dialog system you access the desired service:

- Accident and Breakdown Management
- Mercedes-Benz customer center for general information about the vehicle

You can find information on the following topics:

- Activation of Mercedes me connect

- Operating the vehicle
- Nearest authorized Mercedes-Benz Center
- Other products and services from Mercedes-Benz

Data is transferred during the connection to the Mercedes-Benz customer center (→ page 318).

#### Calling the Mercedes-Benz customer center using the multimedia system

##### Requirements:

- Access to a mobile phone network is available.
- The contract partner's mobile network coverage is available in the respective region.
- The vehicle must be switched on so that vehicle data can be transferred automatically.

Multimedia system:



- ▶ Call **Mercedes me connect**. After confirmation, the multimedia system sends the required vehicle data. The data transfer is shown in the media display.

Then, you can select a service and be connected to a specialist at the Mercedes-Benz customer center.

### Calling the Mercedes-Benz Customer Center after automatic accident or breakdown detection

#### Requirements:

- The vehicle has detected an accident or breakdown situation.
- The vehicle is stationary.
- The hazard warning lights are switched on.

**i** This function is not available in all countries.

The vehicle can detect accident or breakdown situations under certain circumstances.

In the event an accident or breakdown is detected, the emergency guide shows safety notes in the multimedia system display.

After quitting the emergency guide display on the multimedia system, a prompt appears asking whether you would like to get support from the Mercedes-Benz Customer Center.

▶ Select **Call**.

- The vehicle data is sent automatically (→ page 319).
- The Mercedes-Benz Customer Center takes your call and organizes the breakdown and accident assistance.

You may be charged for these services.

- i** Depending on the severity of the accident, an automatic emergency call can be initiated. This has priority over all other active calls.
- i** In addition, if the Mercedes me connect service "Telediagnosics" is active, a similar prompt can appear after a delay in the event of a breakdown. If you are already in contact with the Mercedes-Benz Customer Center or have already received support, this prompt can be ignored or declined.
- i** If you answer the prompt for support from the Mercedes-Benz Customer Center with **Later**, the message will be hidden and appear again later.  
The prompt triggered by the Mercedes me connect service "Telediagnosics", can either

be confirmed or declined. After being declined, this will not be shown again.

### Arranging a service appointment via a Mercedes me call

If you have activated the maintenance management service, relevant vehicle data is transferred automatically to the Mercedes-Benz customer center. You will then receive individual recommendations regarding the maintenance of your vehicle.

Regardless of whether you have consented to the maintenance management service, the multimedia system reminds you after a certain amount of time that a service is due. A prompt appears asking if you would like to make an appointment.

▶ **To arrange a service appointment:** select **Call**. After your agreement, the vehicle data is transferred and the Mercedes-Benz customer center takes your preferred appointment date. The information is then sent to your desired service outlet.

This will contact you to confirm the appointment and if necessary consult about the details.

- i** If you select **Later** after the service message appears, the message is hidden and reappears at a later time.

### Transferred data during a Mercedes me call

When you make a service call via Mercedes me, data is transmitted. This enables targeted advice and a smooth service.

The following requirements must be fulfilled for the transfer of the data:

- The vehicle is switched on.
- The required data transfer technology is supported by the mobile phone network provider.
- The quality of the mobile connection is sufficient.

Multi-stage transfer depends on the following factors:

- Reason for the initiation of the call
- The available mobile phone transmission technology.
- The activated Mercedes me connect services.
- The service selected in the voice control system.

### Data transfer if Mercedes me connect services are not activated

If no Mercedes me connect services are activated, the following data is transferred:

- Vehicle identification number
- Time of the call
- Reason for the initiation of the call
- Country indicator of the vehicle
- Set language for the multimedia system
- Telephone number of the communication platform installed in the vehicle

If a call is made for a service appointment via the service reminder, the following data is also transmitted:

- Current mileage and maintenance data

If a call is made after automatic accident or breakdown detection using the multimedia system, the following data is also transmitted:

- Current mileage and maintenance data
- Current vehicle location

If Accident and Breakdown Management is called via the voice control system, the following data can also be called up from the vehicle by the Mercedes-Benz customer center:

- Current vehicle location

### Data transfer if Mercedes me connect services are activated

An overview of the data transmitted can be found in the respective terms of use for Mercedes me connect services. These can be obtained in the Mercedes me portal: <https://me.secure.mercedes-benz.com>

### Data processing

The data transmitted within the scope of the call is deleted from the processing system after the call is finished, in so far as this data is not being used for other activated Mercedes me connect services.

The incident-specific data is processed and stored in the Mercedes-Benz customer center and, if required to process the incident, forwarded to the service partner authorized by the Mercedes-Benz customer center. Please take note of the data protection information on the Mercedes me Internet



page <https://www.mercedes.me> or in the recorded message immediately after calling the Mercedes-Benz customer center.

- ❶ The recorded message is not available in every country.

### Mercedes me connect

#### Information on Mercedes me connect

Mercedes me connect consists of multiple services.

You can use the following services via the multimedia system and the overhead control panel, for example:

- Accident and Breakdown Management (me button or situation-dependent display in the multimedia system)
- Mercedes-Benz emergency call system (automatic emergency call and SOS button)

The Mercedes me connect Accident and Breakdown Management and the Mercedes-Benz emergency call center are available to you around the clock.

The me button and the SOS button can be found on the vehicle's overhead control panel (→ page 316).

You can also call the Mercedes-Benz customer center using the multimedia system (→ page 316).

Please note that Mercedes me connect is a Mercedes-Benz service. In emergencies, first call the national emergency services using the standard national emergency service telephone numbers. In emergencies, you can also use the Mercedes-Benz emergency call system (→ page 323).

Observe the conditions of use for Mercedes me connect and other services. These can be obtained in the Mercedes me Portal: <https://me.secure.mercedes-benz.com>

Further information about Mercedes me connect services can be obtained in the Mercedes me Portal: <https://me.secure.mercedes-benz.com>

#### Information on Mercedes me connect Accident and Breakdown Management

The Accident and Breakdown Management can include the following functions:

- Supplement to the Mercedes-Benz emergency call system (→ page 323)

If necessary, the contact person at the Mercedes-Benz emergency call center forwards the call to Mercedes me connect Accident and Breakdown Management. Forwarding the call is however not possible in all countries.

- Breakdown assistance by a technician on location and/or the towing away of the vehicle to the nearest authorized Mercedes-Benz Center

You may be charged for these services.

- Addition to the emergency guide after automatic accident or breakdown detection (→ page 317)

In the event of a breakdown or accident, further vehicle data is sent which enables optimal support by the Mercedes-Benz customer cen-

ter and the authorized service partner or breakdown assistance.

- Addition to the Mercedes me connect service Telediagnosics

With the Telediagnosics function, specific wear and failure reports are recorded by the service provider, in so far as these can be clearly interpreted and are available through the monitoring of components that are subject to diagnostics.

If your vehicle detects a breakdown or threat of a breakdown, you may be prompted via the multimedia system to contact the Mercedes-Benz customer center for further help. This prompt in the multimedia system only appears when the vehicle is stationary.

- ① These services are subject to technical restrictions such as the mobile phone coverage, mobile network quality and the ability of the processing systems to interpret the transferred data. In some circumstances, this can

result in delays or the failure of the information to appear in the multimedia system.

More information about Mercedes me connect services can be obtained in the Mercedes me Portal: <https://me.secure.mercedes-benz.com>

#### **Data transferred during Mercedes me connect call services**

The data transferred during a Mercedes me connect call depends on:

- The reason for initiation of the call
- The service that is selected in the voice control system
- The activated Mercedes me connect services

You can find out which data is transferred when using the services in the currently valid Mercedes me connect terms of use and the data protection information for Mercedes me connect. You can find these in your Mercedes me user account.

#### **Overview of the Mercedes me & Apps menu**

When you log in with a user account to the Mercedes me Portal, then services and offers from Mercedes-Benz will be available to you.

For more information consult an authorized Mercedes-Benz Center or visit the Mercedes me portal: <https://me.secure.mercedes-benz.com>

- ① Make sure you always keep the Mercedes me apps updated.

You can call up the menu using **Mercedes me & Apps** in the multimedia system.

In the **Mercedes me & Apps** menu, the following options can be available:

- Connecting the vehicle with the **Mercedes me** user account
- Deleting a connection between a **Mercedes me** user account and the vehicle
- Calling up the Mercedes me services
- Calling up apps such as, In-Car Office or the web browser depending on availability

## Web browser overview

The web browser is started using the [Mercedes me & Apps](#) menu.

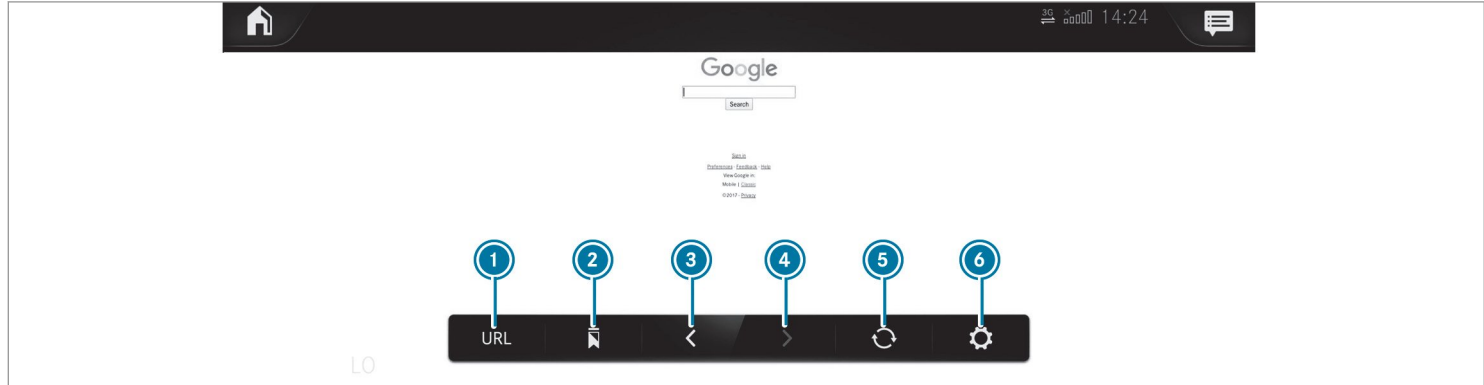

- ① URL entry
- ② Bookmarks
- ③ Web page, back
- ④ Web page, forwards
- ⑤ To refresh/stop
- ⑥ Options

ⓘ Websites cannot be shown while the vehicle is in motion.

## Overview of smartphone integration

With Smartphone Integration, you can use certain functions on your mobile phone via the multimedia system display.

Only one mobile phone at a time can be connected via Smartphone Integration to the multimedia

system. Also for use with two phone mode with smartphone integration, only one additional mobile phone can be connected using Bluetooth® with the multimedia system.

The full range of functions for Smartphone Integration is only possible with an Internet connection. The appropriate application must be downloaded on the mobile phone to use Smartphone Integration. The mobile phone must be switched on and connected to a USB port with the  symbol on the multimedia system using a suitable cable.

### Apps for Smartphone Integration

- Apple CarPlay®
- Android Auto

 For safety reasons, the first activation of Smartphone Integration on the multimedia system must be carried out when the vehicle is stationary and the parking brake is applied.

You can start Apple CarPlay® or Android Auto from the device manager.

 Mercedes-Benz recommends disconnecting the connecting cable only when the vehicle is stationary.

### Overview of transferred vehicle data

When using Smartphone Integration, certain vehicle data is transferred to the mobile phone. This enables you to get the best out of selected mobile phone services. Vehicle data is not directly accessible.

The following system information is transmitted:

- Software release of the multimedia system
- System ID (anonymized)

The transfer of this data is used to optimize communication between the vehicle and the mobile phone.

To do this, and to assign several vehicles to the mobile phone, a vehicle identifier is randomly generated.

This has no connection to the vehicle identification number (VIN) and is deleted when the multimedia system is reset (→ page 302).

The following driving status data is transmitted:

- Transmission position engaged
- Distinction between parked, standstill, rolling and driving
- Day/night mode of the instrument cluster
- Drive type

The transfer of this data is used to alter how content is displayed to correspond to the driving situation.

The following position data is transmitted:

- Coordinates
- Speed
- Compass direction
- Acceleration direction

This data is used by the mobile phone to improve the accuracy of the navigation (e.g. for continuation in a tunnel).

## Mercedes-Benz emergency call system

### Information on the Mercedes-Benz emergency call system

Your vehicle is equipped with the Mercedes-Benz emergency call system ("eCall"). This feature can help save lives in the event of an accident. eCall in no way replaces assistance provided from dialing 911.

Mercedes-Benz eCall only functions in areas where mobile phone coverage is available from the wireless service providers. Insufficient network coverage from the wireless service providers may result in an emergency call not being transmitted.

eCall is a standard feature in your Mercedes-Benz vehicle. In order to function as intended, the system relies on the transmission of data detailed in the "Mercedes-Benz emergency call system data transmission" section that follows (→ page 325).

To disable eCall, a customer must visit an authorized Mercedes-Benz Service department to deactivate the vehicle's communication module.

**Deactivation of this module prevents the activation of any and all Mercedes me connect services. After the deactivation of eCall, automatic emergency call and manual emergency call will not be available.**

The vehicle must be switched on before an automatic emergency call can be made.

- ① eCall is activated at the factory.
- ① eCall can be deactivated by an authorized Mercedes-Benz dealer. Please note that in the event ownership of the vehicle is transferred to another owner in its deactivated state, eCall will remain deactivated unless the new owner visits an authorized Mercedes-Benz dealership to reactivate the system.

### Overview of the Mercedes-Benz emergency call system

eCall can help to reduce the time between an accident and the arrival of emergency services at the site of the accident. It helps locate an accident site in places that are difficult to access. However, even if a vehicle is equipped with eCall, this does not mean the system is ON. As such,

eCall does not replace dialing 911 in the event of an accident.

An emergency call can be made automatically or manually.

Only make emergency calls if you or others are in need of rescue. Do not make an emergency call in the event of a breakdown or a similar situation.

#### Messages on the display

SOS NOT READY: the vehicle is not on or eCall not available.

During an active emergency call, <schär> appears in the display.

You can find more information on the regional availability of eCall at: <https://www.mercedes-benz-mobile.com/extra/ecall/>

- ① If there is a malfunction in the Mercedes-Benz emergency call system (e.g. a malfunction with the speaker, microphone, airbag, SOS button), a corresponding message appears on the display in the instrument cluster.

### Triggering an automatic Mercedes-Benz emergency call

#### Requirements:

- The vehicle is switched on.
- The starter battery is sufficiently charged.

The Mercedes-Benz emergency call system triggers an emergency call automatically in the following cases:

- After activation of the restraint systems such as airbags or Emergency Tensioning Devices after an accident
- After an emergency stop automatically initiated by Active Emergency Stop Assist

The emergency call has been made:

- A voice connection is made to the Mercedes-Benz emergency call center.
- A message with accident data is transmitted to the Mercedes-Benz emergency call center.

The Mercedes-Benz emergency call center can transmit the vehicle position data to one of the emergency call centers.

The SOS button in the overhead control panel flashes until the emergency call is finished.

It is not possible to immediately end an automatic emergency call.

If no connection can be made to the emergency services either, a corresponding message appears in the media display.

- ▶ Dial the local emergency number on your mobile phone.

If an emergency call has been initiated:

- Remain in the vehicle if the road and traffic conditions permit you to do so until a voice connection is established with the emergency call center operator.
- Based on the call, the operator decides whether it is necessary to call rescue teams and/or the police to the accident site.
- If no vehicle occupant answers, an ambulance is sent to the vehicle immediately.

### Triggering a manual Mercedes-Benz emergency call

- ▶ **To use the SOS button in the overhead control panel:** press and hold the SOS button for at least one second (→ page 316).
- ▶ **To use voice control:** use the Voice Control System voice commands .

The emergency call has been made:

- A voice connection is made to the Mercedes-Benz emergency call center.
- A message with accident data is transmitted to the Mercedes-Benz emergency call center. The Mercedes-Benz emergency call center can transmit the vehicle position data to one of the emergency call centers.
- Remain in the vehicle if the road and traffic conditions permit you to do so until a voice connection is established with the emergency call center operator.
- Based on the call, the operator decides whether it is necessary to call rescue teams and/or the police to the accident site.

If no connection can be made to the emergency services either, a corresponding message appears in the media display.

- ▶ Dial the local emergency number on your mobile phone.

### Ending an unintentionally triggered manual Mercedes-Benz emergency call

- ▶ **Using the multifunction steering wheel:** select . Depress the button for several seconds.

### Data transfer of the Mercedes-Benz emergency call system

In the event of an automatic or manual emergency call the following data is transmitted, for example:

- Vehicle's GPS position data
- GPS position data on the route (a few hundred meters before the incident) ()
- Direction of travel
- Vehicle identification number
- Vehicle drive type
- Number of people determined to be in the vehicle

- Whether Mercedes me connect is available or not
- Whether the emergency call was initiated manually or automatically
- Time of the accident
- Language setting on the multimedia system

Data transmitted is vehicle information. For any questions about the collection, use and sharing of the eCall system data, please contact MBUSA's Customer Assistance Center at 800-FOR-MERC.

For Canada, please contact MBC's Customer Assistance Center at 1-800-387-0100.









Customer requests for covered information should be submitted via the same channels.

For accident clarification purposes, the following measures can be taken up to an hour after the emergency call has been initiated:





- The current vehicle position can be determined.
- A voice connection to the vehicle occupants can be established.

## Radio &amp; media

## Overview of the symbols and functions in the media menu

Symbol	Designation	Function
	Play	Select to start or continue playback.
	Rest	Select to pause the playback.
	Repeat a track	Select to repeat the current track or the active playlist. <ul style="list-style-type: none"> <li>• Select once: the active playlist is repeated.</li> <li>• Select twice: the current track is repeated.</li> <li>• Select three times: the function is deactivated.</li> </ul>
	Random playback	Select to play back the tracks in random order.
	Skip forwards/back	Select to skip to the next or to the previous track.
	Options	Select to show additional options.
	Categories	Select to show or search through available categories (e.g. playback lists, albums, artists, etc.).
	Search	Select to search in the active menu. You can search for artists, genres or moods, for example.



Symbol	Designation	Function
	Settings	Select to make settings.
	Home	Select to return to the home screen.
	Messaging	Select to call up messaging.
	Full screen	Select to switch to full screen mode.

The following functions and settings are available in the media menu:

- Connecting external data storage media with the multimedia system (e.g. using USB or Bluetooth®)
- Playing back audio or video files

### Authorizing a Bluetooth® audio device for media playback

#### Requirements:

- Bluetooth® is activated on the multimedia system and audio equipment.

- The audio equipment supports the Bluetooth® audio profiles A2DP and AVRCP.
- The audio equipment is "visible" for other devices.

Multimedia system:



With Bluetooth® audio, you can play back music files from an external data storage medium, e.g. your smartphone, using the MBUX multimedia system.

- ▶ To play back audio files using the multimedia system, authorize the external data storage medium on the MBUX multimedia system.





#### Authorizing a new Bluetooth® audio device





- ▶ Select **Connect New Device**.
- ▶ Select an audio device. Authorization starts. A code is displayed on the multimedia system and on the mobile phone.
- ▶ If the codes are identical, confirm on the audio equipment.
- ▶ Select **Only as Bluetooth Audio Device**. The Bluetooth® audio equipment is connected with the multimedia system.

### Connecting previously authorized Bluetooth® audio equipment

- ▶ Select a Bluetooth® audio device from the list.  
The connection is being established.





### Overview of the symbols and functions in the radio menu

Symbol	Designation	Function
	Home	Select to return to the home screen.
	Messaging	Select to call up messaging.
	Skip forwards/back	Select to skip to the next or to the previous station.
	Settings	Select to have further options shown. Settings can be made to the following additional functions, for example: <ul style="list-style-type: none"><li>• Navigation and traffic announcements</li><li>• Frequency fix function</li><li>• Radio additional text</li><li>• Emergency warnings</li></ul> The setting options are country-dependent.

Symbol	Designation	Function
HD	HD radio®	Select to switch the HD Radio® function on or off. This function is not available in all countries.
	Silent function	Select to switch off the sound.
	Store radio stations	Select to save a station in the presets.
	Station list	Select to have the station list shown.
	Search	Select to search in the active menu. You can search for artists, genres or moods, for example.

#### Additional functions of Tuneln radio

-  A relatively large volume of data can be transmitted when using Tuneln Radio.





Symbol	Designation	Function
	Settings	The following additional settings are available in the TuneIn Radio menu: <ul style="list-style-type: none"> <li>• Selecting stream</li> <li>• Logging on to or out of the TuneIn account</li> </ul>
	Favorites	Select during playback to save the station currently set as a favorite.
	Play/Pause	Select to start, stop or continue playback.
	Browse	Select to choose a category and then a radio station.

#### Additional functions of the satellite radio

SIRIUS XM® satellite radio offers more than 175 digital-quality radio channels providing 100% commercial-free music, sports, news and entertainment, for example. SIRIUS XM® satellite radio employs a fleet of high-performance satellites to

broadcast around the clock throughout the USA and Canada. The satellite radio program is available for a monthly fee. Information about this can be obtained from a Sirius XM® Service Center and at <https://www.siriusxm.com> (USA) or <https://www.siriusxm.ca> (Canada).

 Sirius, XM and all related marks and logos are trademarks of Sirius XM Radio Inc. and its subsidiaries. All other marks, channel names and logos are the property of their respective owners. All rights reserved.

Symbol	Designation	Function
	Settings	The following additional settings are available in the satellite radio menu: <ul style="list-style-type: none"> <li>• Activate child safety lock to lock channels with adult content</li> <li>• Set alarm programming for music and sport alerts</li> <li>• Create TuneMix lists to listen to music seamlessly</li> </ul>
	Playback control	Select to show the timeline. Tap any point on the timeline to skip forwards or back. Navigate to the end of the timeline to return to live mode.
	Play	Select to start or continue playback.
	Rest	Select to pause the playback.

Depending on the frequency band selected, different functions are available to you.

Select the desired frequency band in the radio menu head runner.

### [Calling up TuneIn Radio](#)

#### Requirements:

- The TuneIn Radio service is activated in the Mercedes me Portal.
- The data volume is available.  
Depending on the country, data volume may need to be purchased.
- A fast Internet connection for data transmission free of interference.

- ① Data volume can be purchased **directly from a mobile phone network provider** via the Mercedes me Portal.
- ① The functions and services are country-dependent. For more information, consult an authorized Mercedes-Benz Center.

Multimedia system:

 **▶▶ Radio**

- ▶ Select **TuneIn Radio**.  
The TuneIn menu appears. The last station set starts playing.
- ① The connection quality depends on the local mobile phone reception.

### Setting up satellite radio

#### Requirements:

- Satellite radio equipment is available.
- Registration with a satellite radio provider has been completed.
- If registration is not included when purchasing the system, your credit card details will be required to activate your account.

Multimedia system:

 **▶▶ Radio ▶▶ SiriusXM**  
**▶▶  Options**

- ▶ Select **Service Information**.  
The service information screen appears showing the radio ID and the current subscription status.
- ▶ Establish a telephone connection.
- ▶ Follow the service staff's instructions.  
The activation process may take up to ten minutes.
- ① You can also have the satellite service activated online. To do so, please visit <https://www.siriusxm.com> (USA) or <https://www.siriusxm.ca> (Canada).

[www.siriusxm.com](https://www.siriusxm.com) (USA) or <https://www.siriusxm.ca> (Canada).

### Music and sport alerts

Multimedia system:

 **▶▶ Radio ▶▶ SiriusXM ▶▶ **  
**▶▶ Alerts**

#### Setting music and sport alerts

This function enables you to program an alert for your favorite artists, tracks or sporting events. Music alerts can be saved whilst a track is being played and sport alerts can be saved during a live game. You can also specify sport alerts via the menu option. The system then continuously searches through all the channels.

- ▶ Set a music or sports alert, to be informed of matches in the Live program.

#### Activating the music information function

- ▶ Activate **Music Alerts** .

#### Setting a music alert

- ▶ Select **Add Alert**.

- ▶ Select **Artists** or **Song** in the dialog window. The alert is set for the current artist or track. If a match is found, a prompt appears asking whether you wish to change to the station.

#### Activating sports information

- ▶ Activate **Activate Sports Alerts** .

#### Setting a sport alert

- ▶ Select **Add Alert**.
- ▶ Select the team name or league in the dialog window.

#### Deleting individual sports and music alerts

- ▶ Select **Manage Music Alerts**.

or

- ▶ Select **Manage Sports Alerts**.
- ▶ Select an artist or track.

or

- ▶ Select a team.
- ▶ Select **Delete Selected Entries**. All highlighted alerts are deleted.

#### Deleting all sports and music alerts

- ▶ Select **Manage Music Alerts**.

or

- ▶ Select **Manage Sports Alerts**.
- ▶ Select **Delete All Entries**. All alerts are deleted.

### Sound settings

#### Overview of functions in the sound menu

The setting options and functions available depend on the sound system installed. You can find out which sound system is installed in your vehicle in the Digital Operator's Manual.

#### Standard sound system and Advanced sound system

The following functions are available:

- Equalizer:
  - Treble, mid-range and bass
- Balance and fader
- Volume:
  - Automatic adjustment

#### Burmester® surround sound system and Burmester® high-end 3D surround sound system

The following functions are available:

- Equalizer:
  - Treble, mid-range and bass
- Balance and fader
- Sound focus
- VIP seat (Burmester® high-end 3D surround sound system only)
- Sound profiles
- Volume:
  - Automatic adjustment

### ASSYST PLUS service interval display

#### Function of the ASSYST PLUS service interval display

The ASSYST PLUS service interval display on the instrument display informs you of the time or distance remaining before the next service due date.

You can hide this service display using the  back button on the left-hand side of the steering wheel.

Depending on how the vehicle is used, the ASSYST PLUS service interval display may shorten the service interval, e.g. in the following cases:

- Mainly short-distance driving
- When the engine is often left idling for long periods
- In the event of frequent cold start phases

Mercedes-Benz recommends avoiding such operating conditions.



You can obtain information concerning the servicing of your vehicle from a qualified specialist workshop, e.g. an authorized Mercedes-Benz Center.

#### Displaying the service due date

On-board computer:

 Service  ASSYST PLUS

The next service due date is displayed.

 **To exit the display:** press the  back button on the left-hand side of the steering wheel.

Bear in mind the following related topic:

- Operating the on-board computer (→ page 284).

#### Information on regular maintenance work

 **NOTE** Premature wear through failure to observe service due dates

Maintenance work which is not carried out at the right time or incompletely can lead to increased wear and damage to the vehicle.

 Adhere to the prescribed service intervals.

 Always have the prescribed maintenance work carried out at a qualified specialist workshop.

#### Notes on special service requirements

The prescribed service interval is based on normal operation of the vehicle. Have the maintenance work carried out more often than prescribed if operating conditions are difficult or the vehicle is subject to increased stress.

The ASSYST PLUS service interval display is only an aid. The driver of the vehicle bears responsibility as regards to whether maintenance work needs to be performed more often than specified based on the actual operating conditions and/or loads.

Examples of arduous operating conditions:

- Regular city driving with frequent intermediate stops
- Mainly short-distance driving
- Frequent operation in mountainous terrain or on poor road surfaces



- When the engine is often left idling for long periods
- Operation in particularly dusty conditions and/or if air-recirculation mode is frequently used

In these or similar operating conditions, have the interior air filter, air filter, engine oil and oil filter, for example, changed more frequently. The tires must be checked more frequently if the vehicle is operated under increased loads. Further information can be obtained at a qualified specialist workshop.

### Battery disconnection periods

The ASSYST PLUS service interval display can calculate the service due date only when the battery is connected.

- ▶ Display and note down the service due date on the instrument display before disconnecting the battery (→ page 334).

## Engine compartment

### Opening and closing the hood

**⚠ WARNING** Risk of accident due to driving with the hood unlocked

The hood may open and block your view.

- ▶ Never release the hood when driving.
- ▶ Before every trip, ensure that the hood is locked.

**⚠ WARNING** Risk of accident and injury when opening and closing the hood

The hood may suddenly drop into the end position.

There is a risk of injury for anyone in the hood's range of movement.

- ▶ Do not open or close the hood if there is a person in the hood's range of movement.

**⚠ WARNING** Risk of burns when opening the hood

If you open the hood in the event of an overheated engine or fire in the engine compartment, the following situations may occur:

- You may come into contact with hot gases.
- You may come into contact with other escaping hot operating fluids.
- ▶ Before opening the hood, allow the engine to cool down.
- ▶ In the event of a fire in the engine compartment, keep the hood closed and call the fire service.

**⚠ WARNING** Risk of injury due to moving parts

Components in the engine compartment may continue to run or start unexpectedly even when the drive system is switched off.

Observe the following if you must open the hood:

- ▶ Switch off the vehicle.
- ▶ Never touch the danger zones surrounding moving components, e.g. the rotation area of the fan.
- ▶ Remove jewelry and watches.
- ▶ Keep items of clothing and hair away from moving parts.

**⚠ WARNING** Risk of injury from touching live components

The ignition system and the fuel injection system operate with a high voltage. You could receive an electric shock.

- ▶ Never touch components of the ignition system or fuel injection system when the vehicle is switched on.

The live components include the following, for example:

- Ignition coils
- Fuel injectors

- Electric lines to the ignition coils and the fuel injectors

**⚠ WARNING** Risk of burns from hot component parts in the engine compartment

Certain component parts in the engine compartment can be very hot, e.g. the engine, the cooler and parts of the exhaust system.

- ▶ Allow the engine to cool down and only touch component parts described in the following.

**⚠ WARNING** Risk of injury from using the windshield wipers when the hood is open

If the windshield wipers start moving when the hood is open, you could be trapped by the wiper linkage.

- ▶ Always switch off the windshield wipers and the vehicle first if you need to open the hood.

### Opening the hood

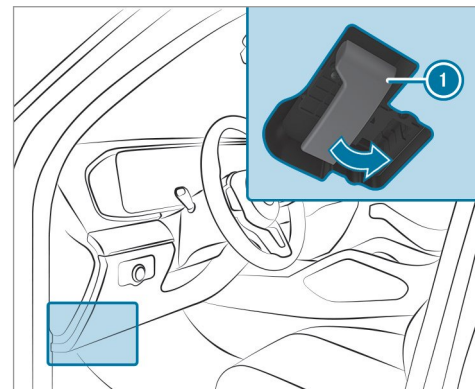

- ▶ To release the hood, pull on handle ①.

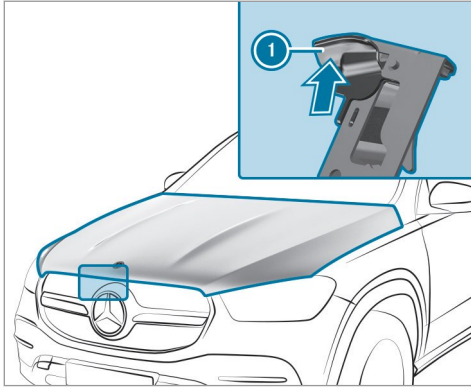

- ▶ Push handle ① of the hood catch upwards and lift the hood until it opens automatically.

### Closing the hood

#### **!** NOTE Damage to the hood

If the hood is closed manually, there is a risk of dents.

- ▶ Do not close the hood manually.

- ▶ Lower the hood to a height of around 8 in (20 cm) and then allow it to fall, applying a little force as you let it go.
- ▶ If the hood can still be lifted slightly, open the hood again and close it with a little more force until it engages correctly.

### Engine oil

#### Checking the engine oil level using the on-board computer

##### Requirements:

- The engine has been warmed up.
- The vehicle is parked on a level surface.
- The engine is running at idle speed.
- The hood is closed.

The engine oil level is determined during driving. Determining the engine oil level can take up to 30 minutes with a normal driving style and even longer with an active driving style.

On-board computer:

#### ↗ Service ▶ Engine Oil Level

One of the following messages will appear on the instrument display:

- **Measuring Engine Oil Level...**: measurement of the oil level is not yet possible.
- ▶ Repeat the request after a maximum of 30 minutes' driving.
- **Engine Oil Level OK** and the bar display for indicating the oil level on the instrument display is green and is between "min" and "max": the oil level is correct.
- **Engine Oil Level Add 1, 1 qts.** and the bar display for indicating the oil level on the instrument display is orange and is below "min":
- ▶ Add 1.1 US qt (1 l) of engine oil.
- **Reduce Engine Oil Level** and the bar display for indicating the oil level on the instrument display is orange and is above "max":

▶ Drain off any excess engine oil that has been added. To do so, consult a qualified specialist workshop.

- **For Engine Oil Level Switch Ignition On**

▶ Switch on the vehicle to check the engine oil level.

- **Engine Oil Level System Inoperative:** The oil level sensor is defective or not connected.

▶ Consult a qualified specialist workshop.

- **Engine Oil Level System Currently Unavail.**

▶ Close the hood.

### Refilling engine oil

**⚠ WARNING** Risk of burns from hot component parts in the engine compartment

Certain component parts in the engine compartment can be very hot, e.g. the engine, the cooler and parts of the exhaust system.

- ▶ Allow the engine to cool down and only touch component parts described in the following.

**⚠ WARNING** Risk of fire and injury from engine oil

If engine oil comes into contact with hot component parts in the engine compartment, it may ignite.

- ▶ Make sure that no engine oil is spilled next to the filler opening.
- ▶ Allow the engine to cool off and thoroughly clean the engine oil from component parts before starting the vehicle.

**⚠ NOTE** Engine damage caused by an incorrect oil filter, incorrect oil or additives

- ▶ Do not use engine oils or oil filters which do not correspond to the specifications explicitly prescribed for the service intervals.
- ▶ Follow the instructions on the service interval display for changing the engine oil and observe the prescribed change intervals.
- ▶ Do not use additives.

**⚠ NOTE** Damage caused by refilling too much engine oil

Too much engine oil can damage the engine or the catalytic converter.

- ▶ Have excess engine oil removed at a qualified specialist workshop.

**i** Depending on driving style, the vehicle consumes up to 0.9 US qt (0.8 liter) of oil per 600 miles (1000 km). The oil consumption may be higher than this when the vehicle is new or if you frequently drive at high engine speeds.

**i** Depending on the engine, the cap may be installed in the engine compartment in different locations.

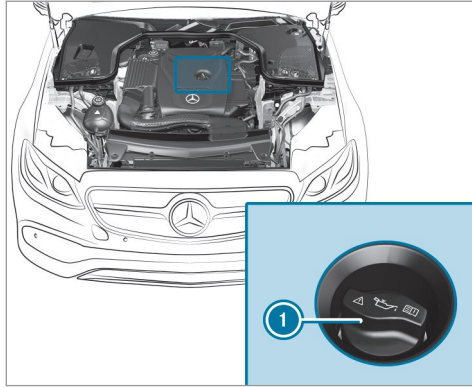

- ▶ Turn cap ❶ counter-clockwise and remove it.
- ▶ Add engine oil.
- ▶ Replace cap ❶ and turn it clockwise until it engages.
- ▶ Check the oil level again (→ page 337).

### Checking the coolant level

**⚠ WARNING** Risk of injury due to moving parts

Components in the engine compartment may continue to run or start unexpectedly even when the drive system is switched off.

Observe the following if you must open the hood:

- ▶ Switch off the vehicle.
- ▶ Never touch the danger zones surrounding moving components, e.g. the rotation area of the fan.
- ▶ Remove jewelry and watches.
- ▶ Keep items of clothing and hair away from moving parts.

**⚠ WARNING** Risk of burns from hot component parts in the engine compartment

Certain component parts in the engine compartment can be very hot, e.g. the engine, the cooler and parts of the exhaust system.

- ▶ Allow the engine to cool down and only touch component parts described in the following.

**⚠ WARNING** Risk of scalding from hot coolant

If you open the cap, you could be scalded.

- ▶ Let the motor cool down before opening the cap.
- ▶ When opening the cap, wear protective gloves and safety glasses.
- ▶ Open the cap slowly to release pressure.

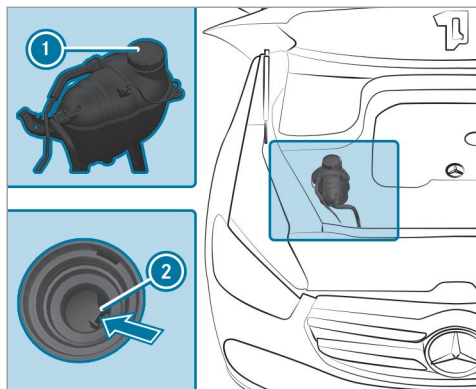

- ▶ Park the vehicle on a level surface.
- ▶ Check the coolant temperature display in the instrument cluster.  
The coolant temperature must be in the bottom quarter of the temperature display.
- ▶ Slowly turn cap ① counter-clockwise to release overpressure.

- ▶ Continue turning cap ① counter-clockwise and remove it.

The coolant level is correct in the following cases:

- If the engine is cold, the coolant is up to marker bar ②.
- If the engine is warm, the coolant is up to 0.6 in (1.5 cm) over the marker bar ②.
- ▶ If necessary, add coolant that has been approved for Mercedes-Benz.
- ① Further information on coolant (→ page 413)

### Refilling the windshield washer system

- ⚠ **WARNING** Risk of burns from hot component parts in the engine compartment

Certain component parts in the engine compartment can be very hot, e.g. the engine, the cooler and parts of the exhaust system.

- ▶ Allow the engine to cool down and only touch component parts described in the following.

- ⚠ **WARNING** - Risk of fire and injury from windshield washer concentrate

Windshield washer concentrate is highly flammable. It could ignite if it comes into contact with hot engine component parts or the exhaust system.

- ▶ Make sure that no windshield washer concentrate spills out next to the filler opening.

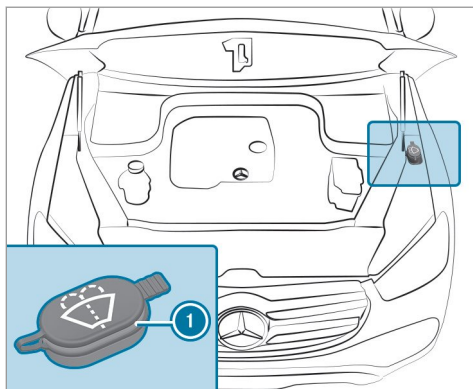

- ▶ Remove cap ① by the tab.
- ▶ Add washer fluid.

① Further information about the windshield washer fluid (→ page 414)

### Keeping the air-water duct free

- ▶ Keep the area between the hood and the windshield free of deposits, e.g. ice, snow and leaves.

### Cleaning and care

#### Notes on washing the vehicle in a car wash

**⚠ WARNING** Risk of accident due to reduced braking effect after washing the vehicle

The braking effect is reduced after washing the vehicle.

- ▶ After the vehicle has been washed, brake carefully while paying attention to the traffic conditions until the braking effect has been fully restored.

#### **!** NOTE Damage from automatic braking

If one of the following functions is switched on, the vehicle brakes automatically in certain situations:

- Active Brake Assist
- Active Distance Assist DISTRONIC
- HOLD function
- Active Parking Assist

To avoid damage to the vehicle, deactivate these systems in the following or similar situations:

- ▶ During towing
- ▶ In a car wash

#### **!** NOTE Damage due to unsuitable car wash

- ▶ Before driving into a car wash make sure that the car wash is suitable for the vehicle dimensions.

- ▶ Ensure there is sufficient ground clearance between the underbody and the guide rails of the car wash.
- ▶ Ensure that the clearance width of the car wash, in particular the width of the guide rails, is sufficient.

To avoid damage to your vehicle when using a car wash, ensure the following beforehand:

- Active Distance Assist DISTRONIC is deactivated.
- The HOLD function is switched off.
- The surround view camera or the rear view camera is switched off.
- The side windows and sliding sunroof are completely closed.
- The outside mirrors are folded in.
- The blower for the ventilation/heating is switched off.
- The windshield wiper switch is in position **0**.
- The SmartKey is at a minimum distance of 10 ft (3 m) away from the vehicle. Otherwise the tailgate could open unintentionally.

- In automatic car washes with conveyor systems:
  - Neutral **N** is engaged.
  - If you would like to leave the vehicle while it is being washed, make sure the SmartKey is located in the vehicle. The park position **P** is otherwise automatically engaged.
- ⓘ To prevent damage to the tires and wheels, drive straight and in to the center of the guide rails of the car wash.
- ⓘ If, after the car wash, you remove the wax from the windshield and wiper rubbers, this will prevent smearing and reduce wiper noise.

#### Automatic car wash mode

In car wash mode, the vehicle is prepared for driving into the automatic car wash. Car wash mode can be activated at a speed of up to 12 mph (20 km/h) (→ page 343).

The following settings are made when car wash mode is activated:

- The outside mirrors are folded in.

- To prevent the windshield washer system from starting up automatically, the rain sensor is deactivated.
- The rear window wiper is deactivated.
- **Mercedes-Maybach vehicles:** the running boards are retracted.
- The air conditioning system is set to air-recirculation mode.
- Parking Assist PARKTRONIC is deactivated.
- **Vehicles with surround view camera:** the front image is activated after approx. eight seconds.
- **Vehicles with AIRMATIC:** the vehicle is raised to the maximum possible chassis level (→ page 249).

If rising takes longer than 25 seconds, the following message appears on the multifunction display:

**Preparation for Automatic Car Wash Incomplete See Media Display.** After some time, the vehicle automatically continues rising.

- **Vehicles with E-ACTIVE BODY CONTROL:** the vehicle is raised to the maximum possible chassis level (→ page 257).



If rising takes longer than 25 seconds, the following message appears on the multifunction display:

**Preparation for Automatic Car Wash Incomplete** See Media Display. After some time, the vehicle automatically continues rising.

If one of the settings cannot be selected, this is displayed by a  behind the respective setting.

Above a speed of 12 mph (20 km/h) car wash mode is automatically deactivated.

The following settings are reset when car wash mode is deactivated:

- The outside mirrors are folded out.
- The rain sensor is activated.
- The rear window wiper is activated.
- The air conditioning system is set to fresh air mode.
- Parking Assist PARKTRONIC is reset to the previously selected setting.
- **Mercedes-Maybach vehicles:** the running boards remain retracted.

- **Vehicles with surround view camera:** the front image is deactivated at speeds above 11 mph (18 km/h).
- **Vehicles with AIRMATIC:** the vehicle is lowered to the previously set chassis level.
- **Vehicles with E-ACTIVE BODY CONTROL:** the vehicle is lowered to the previously set chassis level.

### Activating/deactivating automatic car wash mode

#### Requirements:

- The vehicle is stationary.
- The engine is running.

Multimedia system:

  **» Settings » Quick Access**

#### Activating automatic car wash mode

- ▶ Select **Automatic Car Wash Mode**.
- ▶ Select **Start**.

If one of the settings cannot be selected, this is displayed by a  behind the respective setting.

- ⓘ For an overview of the settings made when activating automatic car wash mode (→ page 341).

#### Deactivating automatic car wash mode

- ▶ Select **Stop**.  
The automatic car wash settings are reset.
- ⓘ The automatic car wash mode is automatically deactivated as soon as a speed of 12 mph (20 km/h) is exceeded.

### Notes on using a power washer

 **WARNING** Risk of an accident when using power washers with round-spray nozzles

The water jet can cause externally invisible damage.

Components damaged in this way may unexpectedly fail.

- ▶ Do not use a power washer with round-spray nozzles.
- ▶ Have damaged tires or chassis parts replaced immediately.

To avoid damage to your vehicle, observe the following when using a power washer:

- The SmartKey is at a minimum distance of 10 ft (3 m) away from the vehicle. Otherwise, the tailgate could open unintentionally.
- Maintain a distance of at least 11.8 in (30 cm) to the vehicle.
- **Vehicles with decorative foil:** Parts of your vehicle are covered with a decorative foil. Maintain a distance of at least 27.6 in (70 cm) between the foil-covered parts of the vehicle and the nozzle of the power washer. Move the power washer nozzle around whilst cleaning. The water temperature of the power washer must not exceed 140°F (60°C).
- Observe the information on the correct distance in the equipment manufacturer's operating instructions.
- Do not direct the nozzle of the power washer directly at sensitive parts, such as tires, gaps, electrical components, batteries, light sources and ventilation slits.

### Washing the vehicle by hand

**!** NOTE Engine damage due to water ingress

▶ Take care not to point the water jet directly towards the air inlet grille below the hood.

Observe the legal requirements, e.g. in a number of countries, washing by hand is only permitted in specially designated wash bays.

- ▶ Use a mild cleaning agent, e.g. car shampoo.
  - ▶ Wash the vehicle with lukewarm water using a soft car sponge. When doing so, do not expose the vehicle to direct sunlight.
  - ▶ Carefully hose the vehicle off with water and dry using a chamois.
- i** Observe the notes on the care of vehicle parts (→ page 346).

### Notes on paintwork/matte finish paintwork care

To avoid damaging the paintwork and interfering with the driving assistance systems, please observe the following notes:

### Paint

- Insect remains: soak with insect remover and rinse off the treated areas afterwards.
- Bird droppings: soak with water and rinse off afterwards.
- Tree resin, oils, fuels and greases: remove by rubbing gently with a cloth soaked in petroleum ether or lighter fluid.
- Coolant and brake fluid: remove with a damp cloth and clean water.
- Tar stains: use tar remover.
- Wax: use silicone remover.
- Do not attach stickers, films or similar materials. Only have film attached to the bumper at a qualified specialist workshop.
- Remove dirt immediately, where possible.

### Matte finish

- Only use care products approved for Mercedes-Benz.
- Do not attach stickers, films or similar materials. Only have film attached to the bumper at a qualified specialist workshop.

- Do not polish the vehicle and alloy wheels.
- Only use car washes that correspond to the latest engineering standards.
- Do not use car wash program with a final hot wax treatment.
- Do not use paint cleaners, buffing or polishing products, gloss preservers, e.g. wax.

In the event of paintwork damage:

- Always have paintwork repairs carried out at a qualified specialist workshop.
- Make sure the radar sensors function (→ page 209).

### Notes on cleaning decorative foils

Observe the notes on matte finish care in the chapter "Notes on paintwork/matte finish paintwork care" (→ page 344). They also apply to matte decorative foils.

Observe the notes on cleaning decorative foils to avoid vehicle damage.

### Cleaning

- For cleaning, use plenty of water and a mild cleaning agent without additives or abrasive substances, e.g. a car shampoo approved for Mercedes-Benz.
- Remove dirt immediately, where possible, whilst avoiding rubbing too hard. There is otherwise a risk of damaging the decorative foil irreparably.
- If there is dirt on the finish or if the decorative foil is dull: Use the Paint Cleaner recommended and approved for Mercedes-Benz.
- Insect remains: Soak with insect remover and rinse off the treated areas afterwards.
- Bird droppings: Soak with water and rinse off afterwards.
- To prevent water stains, dry a foil-wrapped vehicle with a soft, absorbent cloth after every car wash.

### Avoiding damage to the decorative foil

- The service life and color of decorative foils are impaired by:
  - Sunlight

- Temperature, e.g. hot air blower
- Weather conditions
- Stone chippings and dirt
- Chemical cleaning agents
- Oily products
- Do not use polish on matte decorative foil. Polishing will have the effect of shining the foil-wrapped surface.
- Do not treat matte or structured decorative foils with wax. Permanent stains may occur.

Scratches, corrosive deposits, areas affected by corrosion and damage caused by incorrect care cannot always be completely repaired. In such cases, visit a qualified specialist workshop.

You can obtain more information on care and cleaning products from the manufacturer.

In the case of foil-wrapped surfaces, optical differences may occur between the surfaces that were not protected by a decorative foil after removing a decorative foil.

- Have work or repairs to decorative foils carried out at a qualified specialist workshop, e.g. in an authorized Mercedes-Benz Center.

### Notes on care of vehicle parts

**⚠ WARNING** Risk of entrapment if the windshield wipers are switched on while the windshield is being cleaned

If the windshield wipers are set in motion while you are cleaning the windshield or wiper blades, you can be trapped by the wiper arm.

- ▶ Always switch off the windshield wipers and the vehicle before cleaning the windshield or wiper blades.

**⚠ WARNING** Risk of burns from the tailpipe and tailpipe trims

The exhaust tailpipe and tailpipe trims can become very hot. If you come into contact with these parts of the vehicle, you could burn yourself.

- ▶ Always be particularly careful around the tailpipe and the tailpipe trims and supervise children especially closely in this area.
- ▶ Allow vehicle parts to cool down before touching them.

To avoid damage to the vehicle, observe the notes on cleaning and care of the following vehicle parts:

#### Wheels and rims

- Use water and acid-free alloy wheel cleaners.
- Do not use acidic alloy wheel cleaners to remove brake dust. This could damage wheel bolts and brake components.
- To avoid corrosion of the brake discs and brakepads, drive the vehicle for a few minutes after cleaning before parking it. The brake discs and brakepads warm up and dry out.

#### Windows

- Clean the windows inside and outside with a damp cloth and with a cleaning agent recommended for Mercedes-Benz.

- Do not use dry cloths or abrasive or solvent-based cleaning agents to clean the inside of windows.

- After changing the wiper blades or treating the vehicle with wax, clean the windshield thoroughly with cleaning agents recommended for Mercedes-Benz. Failure to observe the application instructions may result in damage, smear marks or blinding spots.

- Remove external fogging or dirt on the windshield in front of the multifunction camera. Otherwise, driving systems and driving safety systems may be impaired or not available (→ page 209).

#### Wiper blades

- Move the wiper arms into the replacement position (→ page 156).
- With the wiper arms folded out, clean the wiper blades with a damp cloth.
- Make sure that the wiper blades are coated. The coating can leave residues on a cloth. Do not rub the wiper blades excessively or clean them too often.

**Exterior lighting**

- Clean the lenses with a wet sponge and mild cleaning agent, e.g. car shampoo.
- Only use cleaning agents or cleaning cloths that are suitable for plastic lenses.

**Sensors**

- Clean the sensors in the front and rear bumpers with a soft cloth and car shampoo (→ page 209).
- When using a power washer, maintain a minimum distance of 11.8 in (30 cm).

**Running boards**

- Use water and acid-free cleaning agents.
- Do not clean the aluminum trim inserts of the running board with alkaline or acidic cleaning agents such as wheel cleaners. Do not use acidic alloy wheel cleaners to remove brake dust. The aluminum trim inserts could otherwise be damaged.

**Rear view camera and surround view camera**

- Open the camera cover with the multimedia system (→ page 267).

- Use clean water and a soft cloth to clean the camera lens.
- Do not use a power washer.

**Tailpipes**

- Clean with a cleaning agent recommended for Mercedes-Benz, especially in the winter and after washing the vehicle.
- Do not use acidic cleaning agents.

**Trailer hitch**

- Observe the notes on care in the trailer hitch manufacturer's operator manual.
- Do not clean the ball neck with a power washer or solvent.
- Remove traces of rust on the ball, for example, with a wire brush.
- Remove dirt with a lint-free cloth.
- After cleaning, lightly oil or grease the ball head.

- ① Before using trailers with anti-torsional coupling, observe the manufacturer's operator manual.

**Notes on care of the interior**

**⚠ WARNING** Risk of injury from plastic parts breaking off after the use of solvent-based care products

Care and cleaning products containing solvents can cause surfaces in the cockpit to become porous. When the airbags are deployed, plastic parts may break away.

- ▶ Do not use any care or cleaning products containing solvents to clean the cockpit.

**⚠ WARNING** Risk of injury or fatal injuries from bleached seat belts

Bleaching or dyeing seat belts can severely weaken them.

This can, for example, cause seat belts to tear or fail in an accident.

- ▶ Never bleach or dye seat belts.

To avoid damage to the vehicle, observe the following notes on cleaning and care:

### Seat belts

- Clean with lukewarm and soapy water.
- Do not use chemical cleaning agents.
- Do not dry by heating them to over 176°F (80°C) or exposing them to direct sunlight.

### Display

- Switch off the display and let it cool down.
- Clean the surface carefully with a microfiber cloth and a suitable display care product (TFT-LCD).
- Do not use any other agents.

### Head-up Display

- Clean with a soft, non-static, lint-free cloth.
- Do not use cleaning agents.

### Plastic trim

- Clean with a damp microfiber cloth.
- For heavy soiling: Use a cleaner recommended for Mercedes-Benz.
- Do not attach stickers, films or similar materials.

- Do not allow cosmetics, insect repellent or sun cream to come in contact with the plastic trim.

### Real wood and trim elements

- Clean with a microfiber cloth.
- Black piano-lacquer look: Clean with a damp cloth and soapy water.
- For heavy soiling: Use a cleaner recommended for Mercedes-Benz.
- Do not use solvent-based cleaning agents, polishes or waxes.

### Headliner

- Clean with a brush or dry shampoo.

### Carpet

- Use a carpet and textile cleaning agent recommended for Mercedes-Benz.

### Steering wheel made of genuine leather or DINAMICA

**I** NOTE Damage caused by wrong cleaners

- ▶ Do not use solvent-based cleaning agents such as tar remover or wheel

cleaner; neither should you use polishes or waxes. Otherwise you may damage the finish.

- Clean with a damp cloth and 1% soapy water solution and then wipe with a dry cloth.
- For heavy soiling: Use a cleaner recommended for Mercedes-Benz.
- Leather care: Use a leather care agent that has been recommended for Mercedes-Benz.
- Do not allow the leather to become too damp.
- Do not use a microfiber cloth.
- **i** Leather is a natural product. It has natural surface properties, such as differences in structure, marks caused by growth and injury or subtle color differences. These surface properties are characteristics of leather and not material faults. What's more, leather is subject to a natural aging process during which the surface properties change.

### Genuine leather seat covers

- Clean with a damp cloth and then wipe with a dry cloth.

- Leather care: Use a leather care agent that has been recommended for Mercedes-Benz.
  - Do not allow the leather to become too damp.
  - Do not use a microfiber cloth.
- i** Regular cleaning and care of the leather reduces soiling, wear marks and aging damage and thus significantly extends its life span. Clothing that can leave stains, e.g. jeans, can leave discoloration on the leather.

**DINAMICA seat covers**

- Clean with a damp cloth.
- Do not use a microfiber cloth.

**Imitation leather seat covers**

- Clean with a damp cloth and 1% soapy water.
- Do not use a microfiber cloth.

**Fabric seat covers**

- Clean with a damp microfiber cloth and 1% soapy water and allow to dry.

**Emergency****Removing the safety vest**

The safety vests are located in the safety vest compartments in the driver's and front passenger door stowage compartments.

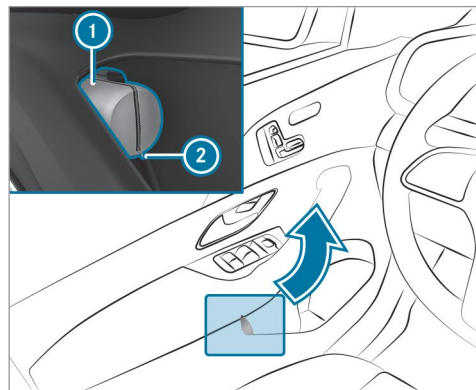

▶ **To remove:** pull out safety vest bag ① by loop ②.

▶ Open safety vest bag ① and remove the safety vest.

① Additional safety vests can be stored in the stowage space of the rear passenger compartment and in the cargo compartment.

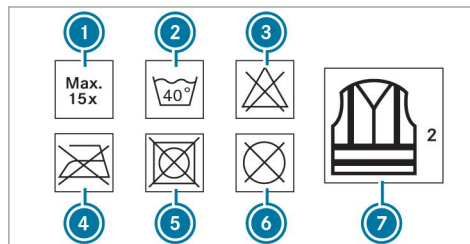

- ① Maximum number of washes
- ② Maximum wash temperature
- ③ Do not bleach
- ④ Do not iron
- ⑤ Do not tumble dry
- ⑥ Do not dry clean
- ⑦ This is a class 2 vest

The requirements defined by the legal standard are only fulfilled if the safety vest is the correct size and is fully closed.

Replace the safety vest in the following cases:

- It is damaged or dirt on the reflective strips can no longer be removed.
- The maximum number of washes is exceeded.
- The fluorescence of the safety vest has faded.

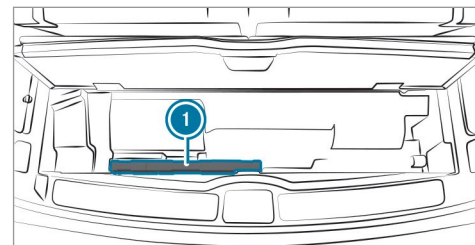
**Warning triangle****Removing the warning triangle (not plug-in hybrid)**

▶ Remove warning triangle ①.



### Setting up the warning triangle

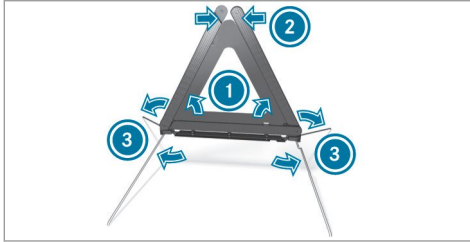

- ▶ Fold side reflectors ① upwards to form a triangle and attach at the top using upper press-stud ②.
- ▶ Fold legs ③ down and out to the side.

### First-aid kit (soft-sided) overview

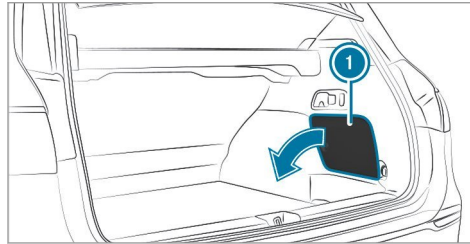

When delivered from the factory, the first-aid kit (soft sided) is in the cargo compartment on the right-hand side behind service flap ①.

#### Flat tire

#### Notes on flat tires

**⚠ WARNING** Risk of accident due to a flat tire

A flat tire severely affects the driving characteristics as well as the steering and braking of the vehicle.

#### Tires without run-flat characteristics:

- ▶ Do not drive with a flat tire.
- ▶ Change the flat tire immediately with an emergency spare wheel or spare wheel. Alternatively, consult a qualified specialist workshop.

#### Tires with run-flat characteristics:

- ▶ Observe the information and warning notes on MOExtended tires (run-flat tires).

In the event of a flat tire, the following options are available depending on your vehicle's equipment:

- **Vehicles with MOExtended tires:** it is possible to continue the journey for a short period of time. Make sure you observe the notes on MOExtended tires (run-flat tires) (→ page 352).
- **Vehicles with a TIREFIT kit:** you can repair the tire so that it is possible to continue the journey for a short period of time. To do this, use the TIREFIT kit (→ page 353).

- **Vehicles with Mercedes me connect:** you can make a call for breakdown assistance via the overhead control panel in the case of a breakdown (→ page 316).
  - **All vehicles:** change the wheel (→ page 392).
- i** The emergency spare wheel is only available in certain countries.

### Notes on MOExtended tires (run-flat tires)

**⚠ WARNING** Risk of accident when driving in limp-home mode

When driving in emergency mode the handling characteristics are impaired.

- ▶ Do not exceed the specified maximum speed of the MOExtended tires.
- ▶ Avoid any abrupt steering and driving maneuvers as well as driving over obstacles (curbs, pot holes, off-road). This applies, in particular, to a loaded vehicle.
- ▶ Stop driving in the emergency mode if you notice:

- Banging noise
- Vehicle vibration
- Smoke which smells like rubber
- Continuous ESP® intervention
- Cracks in the tire side walls

- ▶ After driving in emergency mode, have the rims checked by a qualified specialist workshop with regard to their further use.
- ▶ The defective tire must be replaced in every case.

With MOExtended tires (run-flat tires), you can continue to drive your vehicle even if there is a total loss of pressure in one or more tires. However, the tire affected must not show any clearly visible damage.

You can recognize MOExtended tires by the MOExtended marking which appears on the side wall of the tire.

**Vehicles with tire pressure monitoring system:** MOExtended tires may only be used in conjunc-

tion with an activated tire pressure monitoring system.

If a pressure loss warning message appears in the driver's display, proceed as follows:

- Check the tire for damage.
- If driving on, observe the following notes.

### Driving distance possible in emergency mode after the pressure loss warning:

Load condition	Driving distance possible in emergency mode
Partially laden	50 miles (80 km)
Fully laden	19 miles (30 km)

The driving distance possible in emergency mode may vary depending on the driving style. Observe the maximum permissible speed of 50 mph (80 km/h).

If a tire has gone flat and cannot be replaced with an MOExtended tire, you can use a standard tire as a temporary measure.

### Storage location of the TIREFIT kit (not plug-in hybrid)

The TIREFIT kit is located under the cargo compartment floor.

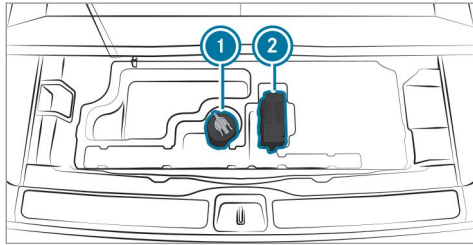

Example: TIREFIT kit

- ① Tire sealant bottle
- ② Tire inflation compressor

Depending on the model, the TIREFIT kit may also be located in other places under the cargo compartment floor.

### Using the TIREFIT kit

#### Requirements:

- Tire sealant bottle and tire inflation compressor (→ page 353)
- TIREFIT sticker
- Gloves

You can use TIREFIT tire sealant to seal perforation damage of up to 0.16 in (4 mm), particularly those in the tire contact surface. You can use TIREFIT in outside temperatures down to -4 °F (-20 °C).

#### **⚠ WARNING** Risk of accident when using tire sealant

The tire sealant may be unable to seal the tire properly, especially in the following cases:

- There are large cuts or punctures in the tire (larger than damage previously mentioned)
- The wheel rims have been damaged
- After journeys with very low tire pressure or with flat tires

- ▶ Do not continue driving.
- ▶ Consult a qualified specialist workshop.

#### **⚠ WARNING** Risk of injury and poisoning from tire sealant

The tire sealant is harmful and causes irritation. Do not allow it to come into contact with the skin, eyes or clothing, and do not swallow it. Do not inhale tire sealant fumes. Keep the tire sealant away from children.

If you come into contact with the tire sealant, observe the following:

- ▶ Rinse off the tire sealant from your skin immediately using water.
- ▶ If tire sealant gets into your eyes, thoroughly rinse out the eyes using clean water.
- ▶ If tire sealant has been swallowed, immediately rinse out the mouth thoroughly and drink plenty of water. Do not induce vomiting and seek medical attention immediately.

- ▶ Change out of any clothes contaminated with tire sealant immediately.
- ▶ If allergic reactions occur, seek medical attention immediately.

**!** **NOTE** Overheating due to the tire inflation compressor running too long

- ▶ Do not run the tire inflation compressor for longer than ten minutes without interruption.

Comply with the manufacturer's safety notes on the sticker on the tire inflation compressor.

Have the tire sealant bottle replaced in a qualified specialist workshop every five years.

- ▶ Do not remove any foreign objects which have entered the tire.

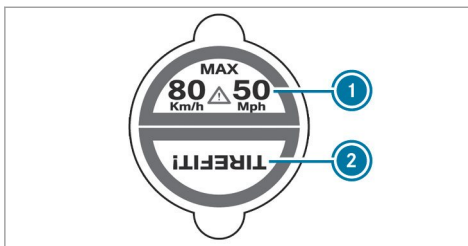

- ▶ Affix part ① of the TIREFIT sticker to the instrument cluster within the driver's field of vision.
- ▶ Affix part ② of the TIREFIT sticker near the valve on the wheel with the faulty tire.

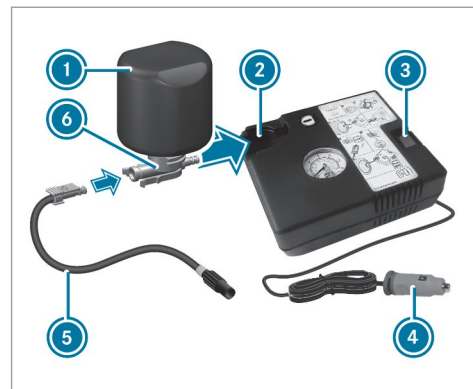

- ▶ Pull plug ④ with the cable and hose ⑤ out of the tire inflation compressor housing.
- ▶ Push the plug of hose ⑤ into flange ⑥ of tire sealant bottle ① until the plug engages.
- ▶ Place tire sealant bottle ① head downwards into recess ② of the tire inflation compressor.

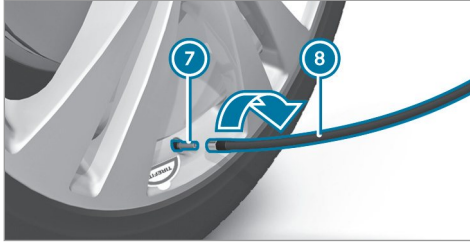

- ▶ Remove the valve cap from valve ⑦ on the faulty tire.
  - ▶ Screw filling hose ⑧ onto valve ⑦.
  - ▶ Insert plug ④ into a 12 V socket in your vehicle.
  - ▶ Switch on the vehicle.
  - ▶ Switch on the tire inflation compressor using On/Off switch ③.
- The tire is inflated. First, tire sealant is pumped into the tire. The pressure may briefly rise to approximately 500 kPa (5.0 bar/73 psi).

**Do not switch off the tire inflation compressor during this phase!**

- ▶ Let the tire inflation compressor run for a maximum of ten minutes.  
The tire should then have attained a tire pressure of at least 200 kPa (2.0 bar/29 psi).

If tire sealant leaks out, make sure you clean the affected area as quickly as possible. It is preferable to use clean water.

If you get tire sealant on your clothing, have it cleaned as soon as possible with perchloroethylene.

**If, after ten minutes, a tire pressure of 200 kPa (2.0 bar/29 psi) has not been attained:**

- ▶ Switch off the tire inflation compressor.
- ▶ Unscrew the filling hose from the valve of the faulty tire.

Please note that tire sealant may leak out when unscrewing the filling hose.

- ▶ Drive forwards or in reverse very slowly for approximately 33 ft (10 m).

- ▶ Pump up the tire again.  
After a maximum of ten minutes the tire pressure must be at least 200 kPa (2.0 bar/29 psi).

**⚠ WARNING** Risk of accident due to the specified tire pressure not being achieved

If the specified tire pressure is not achieved after the specified time, the tire is too badly damaged. The tire sealant cannot repair the tire in this instance.

The braking characteristics as well as the driving characteristics may be greatly impaired.

- ▶ Do not continue driving.
- ▶ Consult a qualified specialist workshop.

**If, after ten minutes, a tire pressure of 200 kPa (2.0 bar/29 psi) has been attained:**

- ▶ Switch off the tire inflation compressor.
- ▶ Unscrew the filling hose from the valve of the faulty tire.

**⚠ WARNING** Risk of accident from driving with sealed tires

A tire temporarily sealed with tire sealant impairs the handling characteristics and is not suitable for higher speeds.

- ▶ Adapt your driving style accordingly and drive carefully.
- ▶ Do not exceed the maximum speed limit with a tire that has been repaired using tire sealant.

- ▶ Observe the maximum permissible speed for a tire sealed with tire sealant 50 mph (80 km/h).

**! NOTE** Staining caused by leaking tire sealant

After use, excess tire sealant may leak out from the filling hose.

- ▶ Therefore, place the filling hose in the plastic bag that contained the TIREFIT kit.

**🔥 ENVIRONMENTAL NOTE** Environmental pollution caused by environmentally irresponsible disposal

Tire sealant contains pollutants.

- ▶ Have the tire sealant bottle disposed of professionally, e.g. at an authorized Mercedes-Benz Center.

- ▶ Stow the tire sealant bottle and the tire inflation compressor.
- ▶ Pull away immediately.
- ▶ Stop driving after approximately ten minutes and check the tire pressure using the tire inflation compressor. The tire pressure must now be at least 130 kPa (1.3 bar/19 psi).

**⚠ WARNING** Risk of accident due to the specified tire pressure not being attained

If the specified tire pressure is not reached, the tire is too badly damaged. The tire sealant cannot repair the tire in this instance.

The braking and driving characteristics may be greatly impaired.

- ▶ Do not continue driving.
- ▶ Consult a qualified specialist workshop.

In cases such as the one mentioned above, contact an authorized Mercedes-Benz Center. Or call 1-800-FOR-MERCEdes (in the USA) or 1-800-387-0100 (in Canada).

- ▶ **To increase the tire pressure:** switch on the tire inflation compressor.

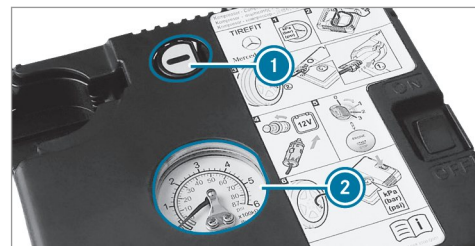

- ▶ **To reduce the tire pressure:** press pressure release button ① next to manometer ②.

- ▶ When the tire pressure is correct, unscrew the filling hose from the valve of the sealed tire.
- ▶ Screw the valve cap onto the valve of the sealed tire.
- ▶ Pull the tire sealant bottle out of the tire inflation compressor.  
The filling hose stays on the tire sealant bottle.
- ▶ Drive to the nearest qualified specialist workshop and have the tire, tire sealant bottle and filling hose replaced there.

### Battery (vehicle)

#### Notes on the 12 V battery

- ⚠ WARNING** Risk of an accident due to work carried out incorrectly on the battery

Work carried out incorrectly on the battery can, for example, lead to a short circuit. This can restrict functions relevant for safety systems and impair the operating safety of your vehicle.

You could lose control of the vehicle in the following situations in particular:

- When braking
- In the event of abrupt steering maneuvers and/or when the vehicle's speed is not adapted to the road conditions
- ▶ In the event of a short circuit or a similar incident, contact a qualified specialist workshop immediately.
- ▶ Do not drive on.
- ▶ Always have work on the battery carried out at a qualified specialist workshop.

- Further information on ABS (→ page 211)
- Further information on ESP® (→ page 212)

For safety reasons, Mercedes-Benz recommends that you only use batteries which have been tested and approved for your vehicle by Mercedes-Benz.

### All vehicles except vehicles with a lithium-ion battery

- ⚠ WARNING** Risk of explosion due to electrostatic charge

Electrostatic charge can ignite the highly explosive gas mixture in the battery.

- ▶ To discharge any electrostatic charge that may have built up, touch the metal vehicle body before handling the battery.

The highly flammable gas mixture is created while the battery is charging and during starting assistance.

- ⚠ WARNING** Danger of chemical burns from the battery acid

Battery acid is caustic.

- ▶ Avoid contact with the skin, eyes or clothing.
- ▶ Do not lean over the battery.
- ▶ Do not inhale battery gases.
- ▶ Keep children away from the battery.

- ▶ Immediately rinse battery acid off thoroughly with plenty of clean water and seek medical attention immediately.

### All vehicles

 **ENVIRONMENTAL NOTE** Environmental damage due to improper disposal of batteries



Batteries contain pollutants. It is illegal to dispose of them with the household rubbish.



▶ Dispose of batteries in an environmentally responsible manner. Take discharged batteries to a qualified specialist workshop or to a collection point for used batteries.

If you have to disconnect the 12 V battery, contact a qualified specialist workshop.

Comply with safety notes and take protective measures when handling batteries.



Risk of explosion.



Fire, open flames and smoking are prohibited when handling the battery. Avoid creating sparks.



Electrolyte or battery acid is corrosive. Avoid contact with the skin, eyes or clothing. Wear suitable protective clothing, in particular gloves, an apron and a face mask. Immediately rinse electrolyte or acid splashes off with clean water. Consult a doctor if necessary.



Wear safety glasses.



Keep children away.



Observe this Operator's Manual.

Observe the following if you do not intend to use the vehicle over an extended period of time:

- Activate standby mode.
- Alternatively: connect the battery to a battery charger approved by Mercedes-Benz or consult a qualified specialist workshop to disconnect the battery.

### Notes on starting assistance and charging the 12 V battery

#### All vehicles

When charging the battery and during starting assistance, always use the jump-start connection point in the engine compartment.



**!** **NOTE** Damage to the battery from over-voltage

When charging using a battery charger without a maximum charging voltage, the battery or the on-board electronics may be damaged.

- ▶ Only use battery chargers with a maximum charging voltage of 14.8 V.

**⚠** **WARNING** Risk of explosion due to igniting hydrogen gas

If there is a short circuit or sparks start to form when charging a battery, there is a danger of the hydrogen gas igniting.

- ▶ Take care that the positive terminal of a connected battery does not come into contact with vehicle parts.
- ▶ Never place metal objects or tools on a battery.
- ▶ When connecting and disconnecting the battery, always observe the sequence of battery terminals described.

- ▶ Always take care to connect only battery terminals of identical polarity when jump starting a vehicle.
- ▶ During starting assistance, it is essential to observe the sequence described for connecting and disconnecting the jumper cables.
- ▶ Do not connect or disconnect the battery terminals while the engine is running.

**⚠** **WARNING** Risk of explosion due to a mixture of explosive gases

A mixture of explosive gases can escape from the battery during charging and jump starting.

- ▶ Fire, open flames, smoking and creating sparks must be avoided.
- ▶ Make sure that there is sufficient ventilation.
- ▶ Do not stand over the battery.

**⚠** **WARNING** Risk of explosion from a frozen battery

A discharged battery may freeze at temperatures slightly above or below freezing point.

During starting assistance or battery charging, battery gas can be released.

- ▶ Always allow a battery to thaw before charging it or performing starting assistance.

If the indicator/warning lamps in the instrument cluster do not light up at low temperatures, it is very likely that the discharged battery has frozen. In this case you may neither jump-start the vehicle nor charge the battery.

The service life of a battery that has been thawed may be dramatically shortened. The starting characteristics may be impaired, especially at low temperatures.

It is recommended that you have a thawed battery checked at a qualified specialist workshop.

### All vehicles

**!** **NOTE** Damage caused by numerous or extended attempts to start the engine

Numerous or extended attempts to start the engine may damage the catalytic converter due to non-combusted fuel.

▶ Avoid numerous and extended attempts to start the engine.

Observe the following points during starting assistance and when charging the battery:

- Only use undamaged jumper cables/charging cables with a sufficient cross-section and insulated terminal clamps.
- Non-insulated parts of the terminal clamps must not come into contact with other metal parts while the jumper cable/charging cable is connected to the battery/jump-start connection point.
- The jumper cable/charging cable must not come into contact with any parts which may move when the engine is running.

- Always make sure that neither you nor the battery is electrostatically charged.
- Keep away from fire and open flames.
- Do not lean over the battery.

Observe the additional following points when charging the battery:

- Only use battery chargers tested and approved for Mercedes-Benz.
- Read the battery charger's operating instructions before charging the battery.

Observe the additional following points during starting assistance:

- Starting assistance may only be provided using vehicles, batteries or other jump start devices with a nominal voltage of 12 V.
- The vehicles must not touch.
- **Vehicles with a gasoline engine:** jump-start the vehicle only when the engine and exhaust system are cold.

### Starting assistance and charging the 12 V battery

#### Requirements:

- The vehicle is secured with the electric parking brake.
- **Vehicles with automatic transmission:** The transmission is in position **P**.
- The vehicle and all electrical consumers are switched off.
- The hood is open.

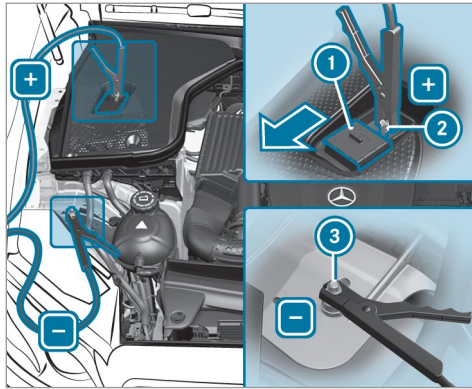

Example: engine compartment

- ▶ Slide cover ① of POSITIVE contact ② on the jump-starting connection point in the direction of the arrow.
- ▶ Connect POSITIVE contact ② on your vehicle to the positive terminal of the donor battery using the jumper cable/charging cable.

Always begin with POSITIVE contact ② on your own vehicle first.

- ▶ **During starting assistance:** start the engine of the donor vehicle and run at idle speed.
- ▶ Connect the negative terminal of the donor battery and ground point ③ of your own vehicle by using the jumper cable/charging cable. Begin with the donor battery first.
- ▶ **During starting assistance:** start the engine of your own vehicle.
- ▶ **During the charging process:** start the charging process.
- ▶ **During starting assistance:** let the engines run for several minutes.
- ▶ **During starting assistance:** before disconnecting the jumper cable, switch on an electrical consumer on your own vehicle, e.g. the rear window heater or lighting.

When the starting assistance/charging process is complete, perform the following steps:

- ▶ First, remove the jumper cable/charging cable from ground point ③ and the negative termi-

nal of the donor battery, then POSITIVE contact ② and the positive terminal of the donor battery. Begin each time with the contacts on your own vehicle first.

- ▶ After removing the jumper cable/charging cable, close cover ① of POSITIVE contact ②.

Further information can be obtained at a qualified specialist workshop.

### Replacing the 12 V battery

- ▶ Observe the notes on the 12 V battery (→ page 357).

Mercedes-Benz recommends that you have the 12 V battery replaced at a qualified specialist workshop, e.g. at an authorized Mercedes-Benz Center.

Observe the following notes if you want to replace the battery yourself:

- Always replace a faulty battery with a battery which meets the specific vehicle requirements.

The vehicle is equipped with an AGM technology battery (Absorbent Glass Mat) or a lithium-ion battery. Full vehicle functionality is only guaranteed with an AGM battery or lithium-ion battery. For safety reasons, Mercedes-Benz recommends that you only use batteries which have been tested and approved for your vehicle by Mercedes-Benz.

- Carry over detachable parts, such as vent hoses, elbow fittings or terminal covers from the battery being replaced.
- Make sure that the vent hose is always connected to the original opening on the side of the battery.

Install any existing or supplied cell caps. Otherwise, gases or battery acid could escape.

- Make sure that detachable parts are reconnected in the same way.

#### Tow starting or towing away

#### Overview of the permitted towing methods (not plug-in hybrid)

##### **!** NOTE Damage from automatic braking

If one of the following functions is switched on, the vehicle brakes automatically in certain situations:

- Active Brake Assist
- Active Distance Assist DISTRONIC
- HOLD function

- Active Parking Assist

To avoid damage to the vehicle, deactivate these systems in the following or similar situations:

- ▶ During towing
- ▶ In a car wash



Mercedes-Benz recommends transporting your vehicle in the case of a breakdown, rather than towing it away.

For towing, use a tow rope or tow bar with both axles on the ground. Do not use tow bar systems.

##### **!** NOTE Damage to the vehicle due to towing away incorrectly

- ▶ Observe the instructions and notes on towing away.

## Permitted towing methods

Vehicle equipment/towing method	 Both axes on the ground	 Front axle raised	 Rear axle raised
4MATIC vehicles	Yes, maximum 31 miles (50 km) at 31 mph (50 km/h)	No	No
Vehicles with rear wheel drive	Yes, maximum 31 miles (50 km) at 31 mph (50 km/h)	No	Yes, if the steering wheel is fixed in the center position with a steering wheel lock.

### Towing away the vehicle with both axes on the ground

- ▶ Observe the notes on the permitted towing methods (→ page 362).
- ▶ Make sure that the battery is connected and charged.

A discharged battery has the following effects:

- The vehicle cannot be switched on

- The electric parking brake cannot be released or applied
- The transmission cannot be shifted to position **N** or **P**
- ⓘ If the transmission cannot be shifted to position **N**, or the multifunction display in the instrument cluster does not show anything, the vehicle must be transported away (→ page 365). A towing vehicle with lifting

equipment is required for vehicle transportation.

**!** **NOTE** Damage due to towing away at excessively high speeds or over long distances

The drivetrain could be damaged when towing at excessively high speeds or over long distances.

- ▶ A towing speed of 30 mph (50 km/h) must not be exceeded.
- ▶ A towing distance of 30 miles (50 km) must not be exceeded.

**⚠ WARNING** Risk of accident when towing a vehicle which is too heavy

If the vehicle to be tow-started or towed away is heavier than the permissible gross mass of your vehicle, the following situations can occur:

- The towing eye may become detached.
  - The vehicle/trailer combination may swerve or rollover.
- ▶ Before tow-starting or towing away, check if the vehicle to be tow-started or towed away exceeds the permissible gross mass.
- ▶ Information on the permissible gross mass of the vehicle can be found on the vehicle identification plate (→ page 407).

- ▶ Do not open the driver's door or front passenger door as the transmission may otherwise shift to position **P** automatically.
- ▶ Install the towing eye (→ page 366).
- ▶ Fasten the towing device.

**! NOTE** Damage due to incorrect connection of the tow bar

- ▶ Only connect the tow rope or tow bar to the towing eyes.

- ① You can also attach the tow bar to the trailer hitch.
- ▶ Deactivate the automatic locking mechanism (→ page 76).
- ▶ Do not activate the HOLD function.
- ▶ Deactivate the tow-away alarm (→ page 95).
- ▶ Deactivate Active Brake Assist (→ page 237).
- ▶ Shift the transmission to position **N** (→ page 193).
- ▶ Release the electric parking brake.

**⚠ WARNING** Risk of accident due to limited safety-related functions during the towing process

Safety-related functions are limited or no longer available in the following situations:

- The vehicle is switched off.
- The brake system or power steering system is malfunctioning.
- The energy supply or the on-board electrical system is malfunctioning.

When your vehicle is towed away, significantly more effort may be required to steer and brake than is normally required.

- ▶ Use a tow bar.
- ▶ Make sure that the steering wheel can move freely before towing the vehicle away.

**!** **NOTE** Damage due to excessive tractive power

If you pull away sharply, the tractive power may be too high and the vehicles could be damaged.

- ▶ Pull away slowly and smoothly.

### Loading the vehicle for transport

- ▶ Observe the notes on towing away (→ page 363).
- ▶ Connect the towing device to the towing eye in order to load the vehicle.
- i** You can also attach the tow bar to the trailer hitch.
- ▶ Shift the automatic transmission to position **N**.
- i** The automatic transmission may be locked in position **P** in the event of damage to the electrics. To shift to **N**, provide the on-board electrical system with power (→ page 360).

- ▶ Load the vehicle onto the transporter.
- ▶ Shift the automatic transmission to position **P**.
- ▶ Use the electric parking brake to secure the vehicle against rolling away.
- ▶ Only secure the vehicle by the wheels.

### Vehicles with ADS PLUS (Adaptive Damping System PLUS)

**!** **WARNING** Risk of an accident when transporting vehicles with Adaptive Damping System PLUS

When transporting vehicles with Adaptive Damping System PLUS, the vehicle/trailer combination may begin to rock and start to skid.

- ▶ Load the vehicle correctly onto the transporter.
- ▶ Secure the vehicle on all four wheels with suitable tensioning straps.

- ▶ Do not exceed the maximum permissible speed of 35 mph (60 km/h) when transporting.

**!** **NOTE** Damage to the vehicle from securing it incorrectly

- ▶ After loading, the vehicle must be secured on all four wheels. Otherwise, the vehicle could be damaged.
- ▶ A minimum distance of 8 in (20 cm) upwards and 4 in (10 cm) downwards must be kept to the transport platform.

- ▶ Secure the vehicle on all four wheels after loading.

### 4MATIC vehicles/vehicles with automatic transmission

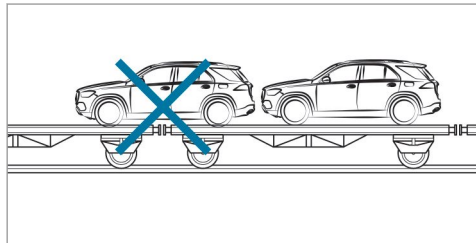

- ▶ Make sure that the front and rear axles come to rest on the same transportation vehicle.

**!** **NOTE** Damage to the drive train due to incorrect positioning of the vehicle

- ▶ Do not position the vehicle above the connection point of the transport vehicle.

### Towing eye storage location

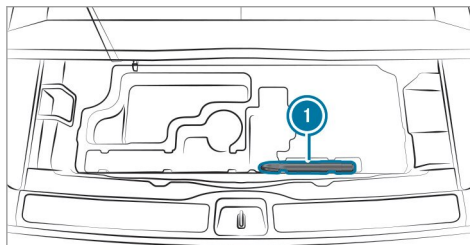

Example: towing eye

Towing eye ① is located under the cargo compartment floor.

### Installing and removing the towing eye

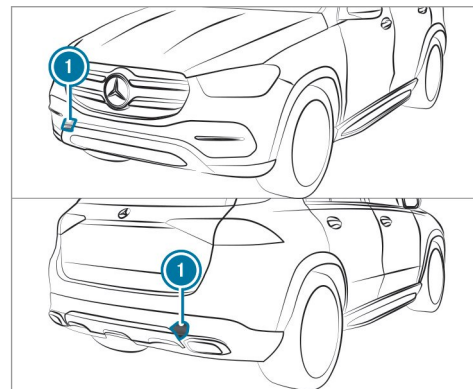

- ▶ Press the mark on cover ① inwards and remove.
- ▶ Screw in the towing eye clockwise as far as it will go and tighten.

**Vehicles with a trailer hitch:** vehicles with a trailer hitch do not have a rear bracket for the towing eye. Fasten the tow bar to the trailer hitch.



- ▶ Make sure that cover ❶ engages in the bumper when you remove the towing eye.

**!** **NOTE** Damage to the vehicle due to incorrect use of the towing eye or trailer hitch

When a towing eye or trailer hitch is used to recover a vehicle, the vehicle may be damaged in the process.

- ▶ Only use the towing eye or trailer hitch to tow away or tow start the vehicle.
- ▶ Do not use the towing eye or trailer hitch to tow the vehicle during recovery.

### Tow-starting the vehicle

#### Vehicles with automatic transmission

**!** **NOTE** Damage to the automatic transmission due to tow starting

The automatic transmission may be damaged in the process of tow starting vehicles with automatic transmission.

- ▶ Vehicles with automatic transmission must not be tow started.

- ▶ Vehicles with an automatic transmission must not be tow-started.

### Electrical fuses

#### Notes on electrical fuses

**!** **WARNING** Risk of accident and injury due to overloaded lines

If you manipulate or bridge a faulty fuse or if you replace it with a fuse with a higher amperage, the electric line could be overloaded.

This could result in a fire.

- ▶ Always replace faulty fuses with specified new fuses containing the correct amperage.

**!** **NOTE** Damage due to incorrect fuses

Electrical components or systems may be damaged by incorrect fuses, or their functionality may be significantly impaired.

- ▶ Only use fuses that have been approved by Mercedes-Benz and which have the correct fuse rating.

Blown fuses must be replaced with fuses of the same rating, which you can recognize by the color and the label. The fuse ratings and further information to be observed can be found in the fuse assignment diagram.

**Fuse assignment diagram:** on the fuse box in the cargo compartment (→ page 369).

**!** **NOTE** Damage or malfunctions caused by moisture

Moisture may cause damage to the electrical system or cause it to malfunction.

- ▶ When the fuse box is open, make sure that no moisture can enter the fuse box.

- ▶ When closing the fuse box, make sure that the seal of the lid is positioned correctly on the fuse box.

If the newly inserted fuse also blows, have the cause traced and rectified at a qualified specialist workshop.

Ensure the following before replacing a fuse:

- The vehicle is secured against rolling away.
- All electrical consumers are switched off.
- The vehicle is switched off.

The electrical fuses are located in various fuse boxes:

- Fuse box in the engine compartment on the left-hand side of the vehicle, when viewed in the direction of travel (→ page 368)
- Fuse box on the driver's side of the cockpit (→ page 369)
- Fuse box in the front passenger footwell (→ page 369)

- Fuse box in the cargo compartment on the right-hand side of the vehicle, when viewed in the direction of travel (→ page 369)

### Opening and closing the fuse box in the engine compartment

#### Requirement:

- You need a dry cloth and a screwdriver.

Observe the notes on electrical fuses (→ page 367).

#### Opening

**⚠ WARNING** Risk of injury from using the windshield wipers when the hood is open

If the windshield wipers start moving when the hood is open, you could be trapped by the wiper linkage.

- ▶ Always switch off the windshield wipers and vehicle before opening the hood.

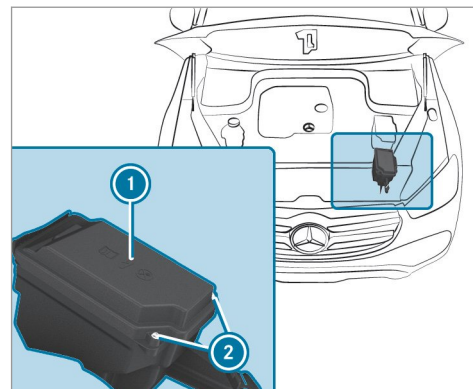

- ▶ Remove any existing moisture from the fuse box using a dry cloth.
- ▶ Loosen screws ② and remove fuse box lid ① from the top.

#### Closing

- ▶ Check whether the seal is positioned correctly in the lid.

- ▶ Insert the lid into the bracket at the rear of the fuse box.
- ▶ Fold down the lid of the fuse box and tighten screws ②.
- ▶ Close the hood.

#### Opening and closing the fuse box in the cockpit

- Observe the notes on electrical fuses (→ page 367).

The fuse box is on the driver's side on the side of the cockpit under a cover.

- ▶ To open and close it, consult an authorized Mercedes-Benz Center.

#### Opening and closing the fuse box in the front passenger footwell

- ▶ Contact an authorized Mercedes-Benz Center for further information.

#### Opening and closing the fuse box in the cargo compartment

Observe the notes on electrical fuses (→ page 367).

- ▶ Open the side cover.

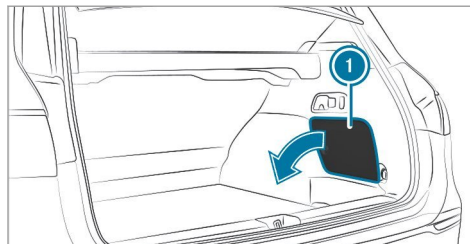

- ▶ Remove cover ①.

The fuse assignment diagram is on the side of the fuse box.

### Notes on noise or unusual handling characteristics

Make sure there are no vibrations, noises or unusual handling characteristics when the vehicle is in motion. This may indicate that the wheels or tires are damaged. Hidden tire damage could also be causing the unusual handling characteristics.

If you suspect that a tire is malfunctioning, reduce your speed immediately and have the tires and wheels checked at a qualified specialist workshop.

### Notes on regularly inspecting wheels and tires

**⚠ WARNING** Risk of injury through damaged tires

Damaged tires can cause tire pressure loss.

- ▶ Check the tires regularly for signs of damage and replace any damaged tires immediately.

**⚠ WARNING** Risk of hydroplaning due to insufficient tire tread

Insufficient tire tread will result in reduced tire grip.

In heavy rain or slush the risk of hydroplaning is increased, in particular where speed is not adapted to suit the conditions.

- ▶ Thus, you should regularly check the tread depth and the condition of the tread across the entire width of all tires.

Minimum tread depth for:

- Summer tires:  $\frac{1}{8}$  in (3 mm)
- M+S tires:  $\frac{1}{6}$  in (4 mm)

- ▶ For safety reasons, replace the tires before the legally-prescribed limit for the minimum tread depth is reached.

Carry out the following checks on all wheels regularly, at least once a month or as required, for example, prior to a long journey or driving off-road:

- Check the tire pressure (→ page 371).

- Visually inspect wheels and tires for damage.
- Check the valve caps.
- Visual check of the tire tread depth and the tire contact surface across the entire width.

The minimum tread depth for summer tires is  $\frac{1}{8}$  in (3 mm) and for winter tires  $\frac{1}{6}$  in (4 mm).

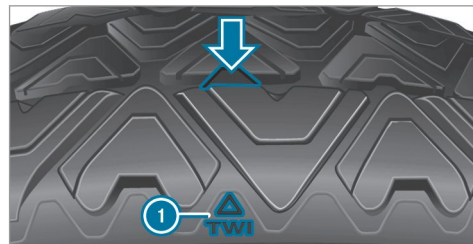

Six marks ① show where the bar indicators (arrow) are integrated into the tire tread. They are visible once a tire tread depth of approximately  $\frac{1}{16}$  in (1.6 mm) has been reached.

### Notes on snow chains

**⚠ WARNING** Risk of accident due to incorrectly installed snow chains

If you have installed snow chains on the front wheels, they may drag against the vehicle body or chassis components.

- ▶ Never install snow chains on the front wheels.
- ▶ Only install snow chains on the rear wheels in pairs.

**! NOTE** Damage to components of the vehicle body or chassis due to mounted snow chains

If you mount snow chains to the front wheels of 4MATIC vehicles, you may damage components of the vehicle body or chassis.

- ▶ Only mount snow chains to the rear wheels of 4MATIC vehicles.

- Snow chains are only permissible for certain wheel/tire combinations. You can obtain infor-

mation about this from an authorized Mercedes-Benz Center.

- For safety reasons, only use snow chains that have been specifically approved for your vehicle by Mercedes-Benz, or snow chains with the same quality standard.
  - Comply with the installation instructions of the snow chain manufacturer.
  - If snow chains are installed, the maximum permissible speed is 30 mph (50 km/h).
  - **Vehicles with Active Parking Assist:** Do not use Active Parking Assist when snow chains are installed.
- i** You can deactivate ESP® to pull away (→ page 214). This allows the wheels to spin, achieving an increased driving force.

### Tire pressure

#### Notes on tire pressure

**⚠ WARNING** Risk of accident due to insufficient or excessive tire pressure

Underinflated or overinflated tires pose in particular the following risks:

- The tires can burst.
- The tires can wear excessively and/or unevenly.
- The driving characteristics as well as the steering and braking characteristics may be greatly impaired.

▶ Comply with the recommended tire pressures and check the tire pressure of all tires, including the spare wheel, regularly:

- Monthly
- When the load changes
- Before embarking on a longer journey

- If operating conditions change, e.g. off-road driving
- ▶ Adjust the tire pressure, if necessary.

Tire pressure which is too high or too low can:

- Shorten the service life of the tires.
- Cause increased tire damage.
- Adversely affect driving characteristics and thus driving safety, e.g. due to hydroplaning.

**⚠ WARNING** Risk of accident due to too low a tire pressure

Tires with pressure that is too low can overheat and burst as a consequence.

In addition, they also suffer from irregular wear, which can significantly impair the braking properties and the handling characteristics.

- ▶ Avoid excessively low tire pressure.

Tire pressure which is too low can cause:

- Tire malfunctions as a result of overheating

- Impaired handling characteristics
- Irregular wear
- Increased fuel consumption

**⚠ WARNING** Risk of accident due to too high a tire pressure

Tires with excessively high pressure can burst. In addition, they also suffer from irregular wear, which can significantly impair the braking properties and the handling characteristics.

- ▶ Avoid excessively high tire pressures.

Tire pressure which is too high can cause:

- Increased braking distance
- Impaired handling characteristics
- Irregular wear
- Impaired driving comfort
- Susceptibility to damage

**⚠ WARNING** Risk of accident due to repeated pressure drop in the tires

The wheels, valves or tires could be damaged. Too low a tire pressure can lead to the tires bursting.

- ▶ Examine the tires for foreign objects.
- ▶ Check whether the tire has a puncture or the valve has a leak.
- ▶ If you are unable to rectify the damage, contact a qualified specialist workshop.

You can find information on tire pressure for the vehicle's factory-installed tires on the following labels:

- Tire and Loading Information placard on the B-pillar of your vehicle (→ page 376).
- Tire pressure table on the inside of the fuel filler flap (→ page 373).

Observe the maximum tire pressure (→ page 383).

Use a suitable pressure gauge to check the tire pressure. The outer appearance of a tire does not

permit any reliable conclusion about the tire pressure.

Only correct tire pressure when the tires are cold. Conditions for cold tires:

- The vehicle has been parked with the tires out of direct sunlight for at least three hours.
- The vehicle has traveled less than 1 mile (1.6 km).

The vehicle's tires heat up when driving. As the temperature of the tires increases, so too does the tire pressure.

#### Vehicles with a tire pressure monitoring system:

You can also check the tire pressure using the on-board computer.

The tire pressure recommended for increased load/speed in the tire pressure table can affect the ride comfort.

**⚠ WARNING** Risk of accident due to unsuitable accessories on tire valves

If you mount unsuitable accessories onto tire valves, the tire valves may be overloaded and

malfunction, which can cause tire pressure loss.

- ▶ Only screw standard valve caps or valve caps specifically approved by Mercedes-Benz for your vehicle onto the tire valve.

#### Notes on trailer operation

Always inflate the rear axle tires to the recommended tire pressure on the tire pressure table for increased load.

#### Tire pressure table

The tire pressure table is on the inside of the fuel filler flap.

- ⓘ The data shown in the images is example data.

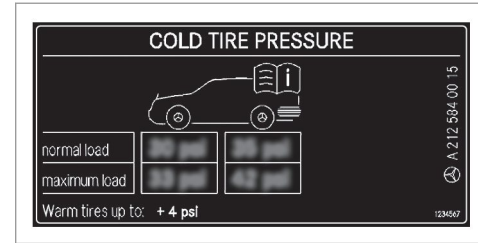

The tire pressure table shows the recommended tire pressure for all tires approved for this vehicle. The recommended tire pressures apply for cold tires under various operating conditions, i.e. loading and/or speed of the vehicle.

If one or more tire sizes precede a tire pressure, the following tire pressure information is only valid for those tire sizes and their respective load condition.

The load conditions "partially laden" and "fully laden" are defined in the table for different numbers of passengers and amounts of luggage. The actual number of seats may differ from this.

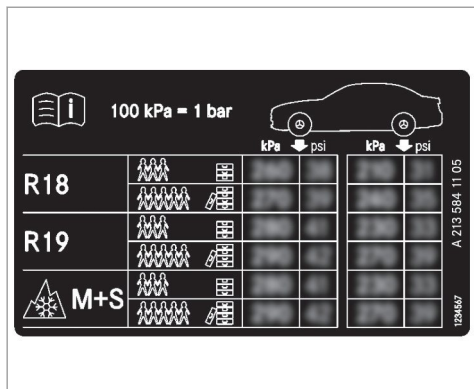

Some tire pressure tables only show the rim diameter instead of the complete tire size, e.g. **R18**. The rim diameter is part of the tire size and can be found on the tire side wall (→ page 384).

- Tire and Loading Information placard (→ page 376)
- Maximum tire pressure (→ page 383)

### Checking the tire pressure manually

- ▶ Read the tire pressure recommended for the current operating conditions from the Tire and Loading Information placard or the tire pressure table. Observe the notes on tire pressure.
- ▶ Remove the valve cap of the tire to be checked.
- ▶ Press the tire pressure gauge securely onto the valve.
- ▶ Read the tire pressure.
- ▶ If the tire pressure is lower than the recommended value, increase the tire pressure to the recommended value.
- ▶ If the tire pressure is higher than the recommended value, release air. To do so, press down the metal pin in the valve, e.g. using the tip of a pen. Then, check the tire pressure again using the tire pressure gauge.
- ▶ Screw the valve cap onto the valve.

Further related subjects:

- Notes on tire pressure (→ page 371)
- Tire pressure table (→ page 373)

- Tire and Loading Information placard (→ page 376)

### Tire pressure monitoring system

#### Function of the tire pressure monitoring system

**⚠ DANGER** Risk of accident due to incorrect tire pressure

Each tire, including the spare (if provided), should be checked monthly when cold and inflated to the inflation pressure recommended by the vehicle manufacturer on the vehicle placard or tire inflation pressure label. (If your vehicle has tires of a different size than the size indicated on the vehicle placard or tire inflation pressure label, you should determine the proper tire inflation pressure for those tires.)

As an added safety feature, your vehicle has been equipped with a tire pressure monitoring system (TPMS) that illuminates a low tire pressure telltale when one or more of your tires is significantly under-inflated. Accordingly, when



the low tire pressure telltale illuminates, you should stop and check your tires as soon as possible, and inflate them to the proper pressure. Driving on a significantly under-inflated tire causes the tire to overheat and can lead to tire failure. Under-inflation also reduces fuel efficiency and tire tread life, and may affect the vehicle's handling and stopping ability. Please note that the TPMS is not a substitute for proper tire maintenance, and it is the driver's responsibility to maintain correct tire pressure, even if under-inflation has not reached the level to trigger illumination of the TPMS low tire pressure telltale.

Your vehicle has also been equipped with a TPMS malfunction indicator to indicate when the system is not operating properly. The TPMS malfunction indicator is combined with the low tire pressure telltale. When the system detects a malfunction, the telltale will flash for approximately one minute and then remain continuously illuminated. This sequence will continue upon subsequent vehicle start-ups as long as the malfunction exists.

When the malfunction indicator is illuminated, the system may not be able to detect or signal low tire pressure as intended. TPMS malfunctions may occur for a variety of reasons, including the installation of replacement or alternate tires or wheels on the vehicle that prevent the TPMS from functioning properly.

The system checks the tire pressure and the tire temperature of the tires installed on the vehicle by means of a tire pressure sensor.

The tire pressure and the tire temperature appear in the on-board computer (→ page 375).

If there is a substantial pressure loss or if the tire temperature is excessive, you will be warned with display messages (→ page 473) or the  warning lamp in the instrument cluster (→ page 493).

The tire pressure monitoring system is only an aid. It is the driver's responsibility to set the tire pressure to the recommended cold tire pressure suitable for the operating situation.

In most cases, the tire pressure monitoring system will automatically update the new reference

values after you have changed the tire pressure. You can, however, also update the reference values by restarting the tire pressure monitoring system manually (→ page 376).

### System limits

The system may be impaired or may not function particularly in the following situations:

- Incorrect reference values were taught in
- Sudden pressure loss caused by a foreign object penetrating the tire, for example
- There is a malfunction caused by another radio signal source

### Checking the tire pressure with the tire pressure monitoring system

#### Requirements:

- The vehicle is switched on.

On-board computer:

 [Service](#)  [Tires](#)

One of the following displays appears:

- Current tire pressure and tire temperature of the individual wheels:

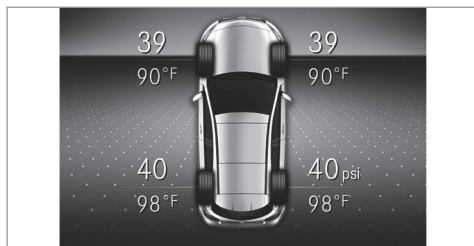

- **Tire pressure will be displayed after driving a few minutes**
- **Tire Pressure Monitor Active:** the teach-in process of the system is not yet complete. The tire pressures are already being monitored.

▶ Compare the tire pressure with the recommended tire pressure for the current operating condition (→ page 373). Additionally, observe the notes on cold tires (→ page 371).

ⓘ The values displayed in the on-board computer may deviate from those of the tire pressure gauge as they refer to sea level. At high elevations, the tire pressure values indicated by a pressure gauge are higher than those

shown by the on-board computer. In this case, do not reduce the tire pressure.

### Restarting the tire pressure monitoring system

#### Requirements:

- The recommended tire pressure is correctly set for the respective operating status on all of the wheels (→ page 371).

Restart the tire pressure monitoring system in the following situations:

- The tire pressure has changed.
- The wheels or tires have been changed or newly installed.

On-board computer:

↳ **Service** ▶ **Tires**

▶ Swipe downwards on Touch Control on the left-hand side of the steering wheel. The **Use Current Pressures as New Reference Values** message is shown in the Instrument Display.

▶ To restart, press Touch Control on the left-hand side of the steering wheel. The **Tire Press. Monitor Restarted** message is shown in the Instrument Display.

Current warning messages are deleted and the yellow  warning lamp goes out.

After you have been driving for a few minutes, the system checks whether the current tire pressures are within the specified range. The current tire pressures are then accepted as reference values and monitored.

Be sure to also pay attention to the following related topic:

- Notes on tire pressure (→ page 371)

### Loading the vehicle

#### Notes on Tire and Loading Information placard

**⚠ WARNING** Risk of accident from overloaded tires

Overloaded tires may overheat and burst as a consequence. Overloaded tires can also

impair the steering and handling characteristics and lead to brake failure.

- ▶ Observe the load rating of the tires.
- ▶ The load rating must be at least half the permissible axle load of the vehicle.
- ▶ Never overload the tires by exceeding the maximum load.

The Tire and Loading Information placard is on the B-pillar on the driver's side of the vehicle.

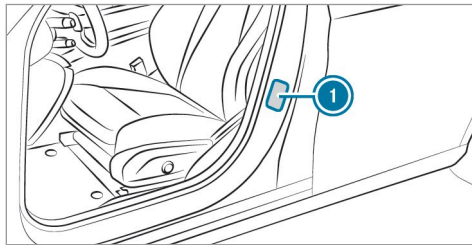

1 Tire and Loading Information placard

TIRE AND LOADING INFORMATION		RENSEIGNEMENTS POUR LES PNEUS ET LE CHARGEMENT	
SEATING CAPACITY NOMBRE DE PLACES	TOTAL 7	FRONT AVANT 2	REAR ARRIÈRE 2
The combined weight of occupants and cargo should never exceed XXX kg or XXX lbs. Le poids total des occupants et du chargement ne doit jamais dépasser XXX kg ou XXX lbs.*			
TIRE PNEU	SIZE DIMENSIONS	COLD TIRE PRESSURE PRESSION DES PNEUS À FROID	SEE OWNER'S MANUAL FOR ADDITIONAL INFORMATION
FRONT AVANT	255/40 ZR18 99Y XL	200 KPA, 29 PSI	VOIR LE MANUEL DE L'USAGER POUR PLUS DE RENSEIGNEMENTS
REAR ARRIÈRE	285/35 ZR18 101Y XL	200 KPA, 29 PSI	
SPARE DE SECOURS	175/55-18 95P	420 KPA, 60 PSI	

i The data shown in the illustration is example data.

The Tire and Loading Information placard shows the following information:

- Maximum number of seats 2 according to the maximum number of people permitted to travel in the vehicle.

- Maximum permissible load 3 comprises the gross weight of all vehicle occupants, load and luggage.
- Recommended tire pressure 1 for cold tires. The recommended tire pressures are valid for the maximum permissible load and up to the maximum permissible vehicle speed.

Please also note:

- Information on permissible weights and loads on the vehicle identification plate (→ page 407).
- Information on tire pressure in the tire pressure table (→ page 373).

Further related subjects:

- Determining the maximum permissible load (→ page 377)
- Notes on tire pressure (→ page 371).

### Steps for Determining Correct Load Limit

The following steps have been developed as required of all manufacturers under Title 49, Code of U.S. Federal Regulations, Part 575, pursuant to

the "National Traffic and Motor Vehicle Safety Act of 1966".

- ▶ **(1):** Locate the statement "The combined weight of occupants and cargo should never exceed XXX kg or XXX lbs." on your vehicle's placard.
- ▶ **(2):** Determine the combined weight of the driver and passengers that will be riding in your vehicle.
- ▶ **(3):** Subtract the combined weight of the driver and passengers from XXX kg or XXX lbs.
- ▶ **(4):** The resulting figure equals the available amount of cargo and luggage load capacity. For example, if the "XXX" amount equals 1,400 lbs. and there will be five 150 lb passengers in your vehicle, the amount of available cargo and luggage load capacity is 650 lbs. (1,400 - 750 (5 x 150) = 650 lbs.)
- ▶ **(5):** Determine the combined weight of luggage and cargo being loaded on the vehicle. That weight may not safely exceed the availa-

ble cargo and luggage load capacity calculated in Step 4.

- ▶ **(6):** If your vehicle will be towing a trailer, load from your trailer will be transferred to your vehicle. Consult this manual to determine how this reduces the available cargo and luggage load capacity of your vehicle.
- ⓘ Not all vehicles are permitted to tow a trailer. Towing a trailer is only permitted if a trailer-hitch is installed. Please consult an authorized Mercedes-Benz dealer if you have any questions about towing a trailer with your vehicle.

Even if you have calculated the total load carefully, you should still make sure that the maximum permissible gross weight and the maximum gross axle weight rating of your vehicle are not exceeded. Details can be found on the vehicle identification plate.

- ▶ Have your loaded vehicle – including driver, occupants and load – weighed on a vehicle weighbridge. The measured values may not exceed the maximum permissible values stated on the vehicle identification plate.

Further related subjects:

- Calculation example for determining the maximum load (→ page 378)
- Tire and Loading Information placard (→ page 376)
- Tire pressure table (→ page 373)
- Vehicle identification plate (→ page 407)

#### Calculation example for determining the maximum load

The following table shows examples of how to calculate total and load capacities with varying seating configurations and different numbers and sizes of occupants. The following examples use a maximum load of 1500 lbs (680 kg). **This is for illustration purposes only.** Make sure you are using the actual load limit for your vehicle stated on your vehicle's Tire and Loading Information placard (→ page 376).

The higher the weight of all the occupants, the smaller the maximum load for luggage.

**Step 1**

	Example 1	Example 2
Combined maximum weight of occupants and load (data from the Tire and Loading Information placard)	1500 lbs (680 kg)	1500 lbs (680 kg)

**Step 2**

	Example 1	Example 2
Number of people in the vehicle (driver and occupants)	5	1
Distribution of the occupants	Front: 2 Rear: 3	Front: 1
Weight of occupants	Occupant 1: 150 lbs (68 kg) Occupant 2: 180 lbs (82 kg) Occupant 3: 160 lbs (73 kg) Occupant 4: 140 lbs (63 kg) Occupant 5: 120 lbs (54 kg)	Occupant 1: 200 lbs (91 kg)
Total weight of all occupants	750 lbs (340 kg)	200 lbs (91 kg)

**Step 3**

	Example 1	Example 2
Permissible load (maximum gross vehicle weight rating from the Tire and Loading Information placard minus the gross weight of all occupants)	1500 lbs (680 kg) - 750 lbs (340 kg) = 750 lbs (340 kg)	1500 lbs (680 kg) - 200 lbs (91 kg) = 1300 lbs (589 kg)

## Tire labeling

### Overview of tire labeling

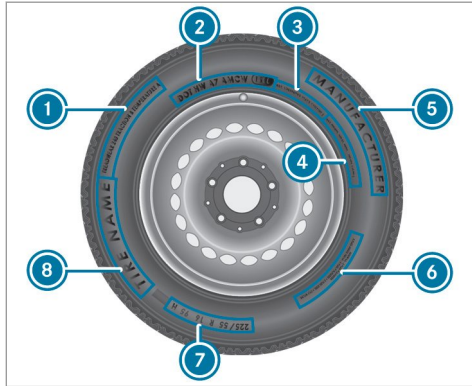

- ① Uniform Tire Quality Grading Standards
- ② DOT (Department of Transportation), (TIN) Tire Identification Number
- ③ Maximum tire load (→ page 383)
- ④ Maximum tire pressure (→ page 383)

- ⑤ Manufacturer
- ⑥ Tire characteristics (→ page 384)
- ⑦ Tire size designation, load-bearing capacity, speed rating and load index (→ page 384)
- ⑧ Tire name
- ⑨ The data shown in the illustration is example data.

### Tire Quality Grading

In accordance with the US Department of Transportation's "Uniform Tire Quality Grading Standards", tire manufacturers are required to grade their tires on the basis of the following three performance factors:

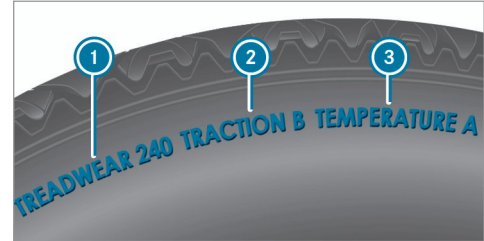

- ① Tread wear grade
- ② Traction grade
- ③ Temperature grade
- ⑨ The data shown in the illustration is example data.
- ⑨ The classification is not legally stipulated for Canada, but it is generally stated.

### Tread wear grade

The treadwear grade is a comparative rating based on the wear rate of the tire when tested under controlled conditions on a specified government test course. For example, a tire graded 150 would wear one and one-half (1\1/2) times as

well on the government course as a tire graded 100.

The relative performance of tires depends upon the actual conditions of their use, however, and may depart significantly from the norm due to variations in driving habits, service practices and differences in road characteristics and climate.

### Traction grade

**⚠ DANGER** Risk of accident due to inadequate traction

The traction grade assigned to this tire is based on straight-ahead braking traction tests.

- ▶ Always adapt your driving style and drive at a speed to suit the prevailing traffic and weather conditions.

**! NOTE** Damage to the drivetrain from wheelspin

- ▶ Avoid wheelspin.

The traction grades, from highest to lowest, are AA, A, B, and C. Those grades represent the tire's ability to stop on wet pavement as measured under controlled conditions on specified government test surfaces of asphalt and concrete. A tire marked C may have poor traction performance.

### Temperature grade

**⚠ WARNING** Risk of accident from tire overheating and tire failure

Excessive speed, underinflation, or excessive loading, either separately or in combination, can cause excessive heat build-up and possible tire failure.

- ▶ Observe the recommended tire pressure.
- ▶ Regularly check the pressure of all the tires.
- ▶ Adjust the tire pressure, if necessary.

The temperature grades are A (the highest), B, and C, representing the tire's resistance to the generation of heat and its ability to dissipate heat when tested under controlled conditions on a specified indoor laboratory test wheel. Sustained

high temperature can cause the material of the tire to degenerate and reduce tire life, and excessive temperature can lead to sudden tire failure. The grade C corresponds to a level of performance which all passenger car tires must meet under the Federal Motor Safety Standard No. 109. Grades B and A represent higher levels of performance on the laboratory test wheel than the minimum required by law.

### DOT, Tire Identification Number (TIN)

US tire regulations stipulate that every tire manufacturer or retreader must imprint a TIN in or on the side wall of each tire produced.

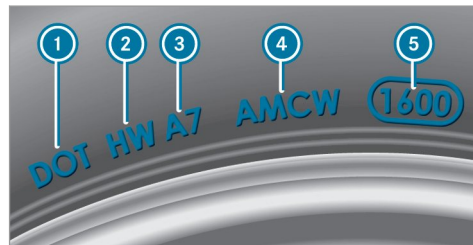



**i** The data shown in the image is example data. The TIN is a unique identification number to identify tires and comprises the following:

- **DOT (Department of Transportation):** tire symbol marks **1** indicating that the tire complies with the requirements of the US Department of Transportation.
- **Manufacturer identification code:** manufacturer identification code **2** contains details of the tire manufacturer. New tires have a code with two symbols. Retreaded tires have a code with four symbols. Further information on retreaded tires (→ page 388).
- **Tire size:** identifier **3** describes the tire size.
- **Tire type code:** tire type code **4** can be used by the manufacturer as a code to describe specific characteristics of the tire.
- **Manufacturing date:** manufacturing date **5** provides information about the age of a tire. The 1st and 2nd positions represent the calendar week and the 3rd and 4th positions state the year of manufacture (e.g. "3208" represents the 32nd week of 2008).

### Information on the maximum tire load



**i** The data shown in the image is example data. Maximum tire load **1** is the maximum permissible weight for which the tire is approved. Do not overload the tires by exceeding the specified load limit. The maximum permissible load can be found on the vehicle's Tire and Loading Information placard on the B-pillar on the driver's side (→ page 376).

### Specifications for maximum tire pressure

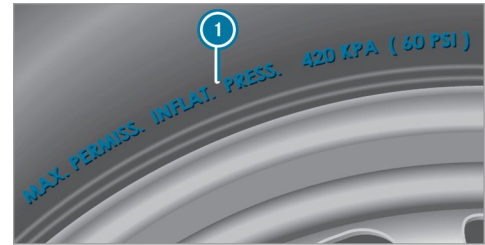

**i** The data shown in the illustration is example data. Never exceed maximum tire pressure **1** specified for the tire. Always observe the recommended tire pressure for your vehicle when adjusting the tire pressure (→ page 373).

### Information on tire characteristics



**i** The data shown in the image is example data. This information describes the type of tire cord and the number of layers in side wall **1** and under tire tread **2**.

### Tire size designation, load-bearing capacity, speed rating and load index

**⚠ WARNING** Risk of injury through exceeding the specified tire load-bearing capacity or the permissible speed rating

Exceeding the specified tire load rating or the permissible speed rating may lead to tire damage and to the tires bursting.

- ▶ Therefore, only use tire types and sizes approved for your vehicle model.
- ▶ Observe the tire load rating and speed rating required for your vehicle.

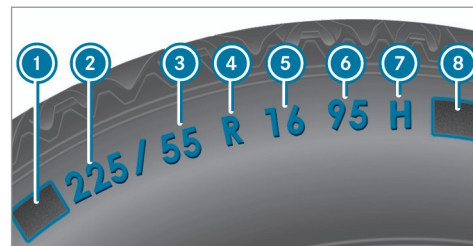

- 1** First letter(s)
- 2** Nominal tire width in millimeters
- 3** Aspect ratio in %
- 4** Tire code
- 5** Rim diameter
- 6** Load-bearing index
- 7** Speed rating
- 8** Load index

**i** The data shown in the illustration is example data.

Information about reading tire data can be obtained from any qualified specialist workshop.

**First letter(s) 1:**

- Without: passenger vehicle tires according to European manufacturing standards.
- "P": passenger vehicle tires according to US manufacturing standards.
- "LT": light truck tires according to US manufacturing standards.
- "T": compact emergency spare wheels with high tire pressure that are only designed for temporary use in an emergency.

**Aspect ratio 3:**

Ratio between tire height and tire width in percent (tire height divided by tire width).

**Tire code 4 (tire type):**

- "R" radial tire
- "D": bias ply tire
- "B": bias belted tires
- "ZR": radial tire with a maximum speed above 149 mph (240 km/h) (optional)

**Rim diameter 5:**

The diameter of the bead seat (not the diameter of the rim flange). The rim diameter is specified in inches (in).

**Load-bearing index 6:**

Numerical code that specifies the maximum load-bearing capacity of a tire (e.g. "91" corresponds to 1356 lbs (615 kg)).

The load-bearing capacity of the tire must be at least half the gross axle weight rating of your vehicle. Do not overload the tires by exceeding the specified load limit.

See also:

- Maximum permissible load on the Tire and Loading Information placard (→ page 376)
- Maximum tire load (→ page 383)
- Load index

**Speed rating 7:**

Specifies the approved maximum speed of the tire.

- **i** An electronic speed limiter prevents your vehicle from exceeding a speed of 130 mph (210 km/h).

Make sure that your tires have the required speed rating. You can obtain information on the required speed rating from an authorized Mercedes-Benz Center.

**Summer tires**

Index	Speed rating
Q	up to 100 mph (160 km/h)
R	up to 106 mph (170 km/h)
S	up to 112 mph (180 km/h)
T	up to 118 mph (190 km/h)
H	up to 130 mph (210 km/h)
V	up to 149 mph (240 km/h)
W	up to 168 mph (270 km/h)
Y	up to 186 mph (300 km/h)

Index	Speed rating
ZR...Y <sup>1</sup>	up to 186 mph (300 km/h)
ZR...(..Y) <sup>1</sup>	over 186 mph (300 km/h)
ZR <sup>1</sup>	over 149 mph (240 km/h)

- Specifying the speed rating as the "ZR" index in tire code ④ is optional for tires up to 186 mph (300 km/h).
- If your tire code ④ includes "ZR" and there is no speed rating ⑦, find out what the maximum speed is from the tire manufacturer.
- If load-bearing index ⑥ and speed rating ⑦ are in brackets, the maximum speed rating of your tire is above 186 mph (300 km/h). To find out the maximum speed, ask the tire manufacturer.

<sup>1</sup> "ZR" stated in the tire code.

<sup>2</sup> Or "M+S"  for winter tires.

### All-weather tires and winter tires

Index	Speed rating
Q M+S <sup>2</sup>	up to 100 mph (160 km/h)
T M+S <sup>2</sup>	up to 118 mph (190 km/h)
H M+S <sup>2</sup>	up to 130 mph (210 km/h)
V M+S <sup>2</sup>	up to 149 mph (240 km/h)

Winter tires bear the  snowflake symbol and fulfill the requirements of the Rubber Manufacturers Association (RMA) and the Rubber Association of Canada (RAC) regarding the tire traction on snow.

### Load index ⑧:

- No specification given: standard load (SL) tire
- "XL" or "Extra Load": extra load tire or reinforced tire
- "Light Load": light load tire

- "C", "D", "E": a load range that depends on the maximum load that the tire can carry at a certain pressure

### Definition of terms for tires and loading

**Tire structure and characteristics:** describes the number of layers or the number of rubber-coated belts in the tire contact surface and the tire wall. These are made of steel, nylon, polyester and other materials.

**Bar:** metric unit for tire pressure. 14.5038 pounds per square inch (psi) and 100 kilopascal (kPa) is the equivalent of one bar.

**DOT (Department of Transportation):** DOT-marked tires fulfill the requirements of the US Department of Transportation.

**Average weight of the vehicle occupants:** the number of vehicle occupants for which the vehicle is designed, multiplied by 150 lb (68 kg).

**Uniform Tire Quality Grading Standards:** a uniform standard to grade the quality of tires with regard

to tread quality, tire traction and temperature characteristics. The quality grading assessment is made by the manufacturer following specifications from the U.S. government. The quality grade of a tire is imprinted on the side wall of the tire.

**Recommended tire pressure:** the recommended tire pressure is the tire pressure specified for the tires mounted to the vehicle at the factory.

The tire and information table contains the recommended tire pressures for cold tires, the maximum permissible load and the maximum permissible vehicle speed.

The tire pressure table contains the recommended tire pressures for cold tires under various operating conditions, i.e. loading and/or speed of the vehicle.

**Increased vehicle weight due to optional equipment:** the combined weight of all standard and optional equipment available for the vehicle, regardless of whether it is actually installed on the vehicle or not.

**Rim:** the part of the wheel on which the tire is installed.

**GAWR (Gross Axle Weight Rating):** the GAWR is the maximum permissible axle load. The actual load on an axle must never exceed the gross axle weight rating. The gross axle weight rating can be found on the vehicle identification plate on the B-pillar on the driver's side.

**Speed rating:** the speed rating is part of the tire identification. It specifies the speed range for which a tire is approved.

**GVW (Gross Vehicle Weight):** the gross vehicle weight comprises the weight of the vehicle including fuel, tools, the spare wheel, accessories installed, occupants, luggage and the trailer drawbar noseweight, if applicable. The gross vehicle weight must not exceed the gross vehicle weight rating GVWR as specified on the vehicle identification plate on the B-pillar on the driver's side.

**GVWR (Gross Vehicle Weight Rating):** the GVWR is the maximum permitted gross weight of the fully laden vehicle (weight of the vehicle including all accessories, occupants, fuel, luggage and the trailer drawbar noseweight if applicable). The gross vehicle weight rating is specified on the vehicle identification plate on the B-pillar on the driver's side.

**Maximum weight of the laden vehicle:** the maximum weight is the sum of the curb weight of the vehicle, the weight of the accessories, the maximum load and the weight of optional equipment installed at the factory.

**Kilopascal (kPa):** metric unit for tire pressure. 6.9 kPa corresponds to 1 psi. Another unit for tire pressure is bar. 100 kilopascal (kPa) equals 1 bar.

**Load index:** in addition to the load-bearing index, the load index may also be imprinted on the side wall of the tire. This specifies the load-bearing capacity of the tire more precisely.

**Curb weight:** the weight of a vehicle with standard equipment including the maximum capacity of fuel, oil and coolant. It also includes the air conditioning system and optional equipment if these are installed on the vehicle, but does not include passengers or luggage.

**Maximum tire load:** the maximum tire load is the maximum permissible weight in kilograms or lbs for which a tire is approved.

**Maximum permissible tire pressure:** maximum permissible tire pressure for one tire.

**Maximum load on one tire:** maximum load on one tire. This is calculated by dividing the maximum axle load of one axle by two.

**PSI (pounds per square inch):** standard unit of measurement for tire pressure.

**Aspect ratio:** ratio between tire height and tire width in percent.

**Tire pressure:** pressure inside the tire applying an outward force to every square inch of the tire. The tire pressure is specified in pounds per square inch (psi), in kilopascals (kPa) or in bar. The tire pressure should only be corrected when the tires are cold.

**Cold tire pressure:** the tires are cold when the vehicle has been parked for at least 3 hours without direct sunlight on the tires or the vehicle has been driven for less than 1 mile (1.6 km).

**Tire contact surface:** the part of the tire that comes into contact with the road.

**Tire bead:** the purpose of the tire bead is to ensure that the tire sits securely on the wheel rim. There are several wire cores in the tire bead to prevent the tire from changing length on the wheel rim.

**Side wall:** the part of the tire between the tread and the tire bead.

**Weight of optional equipment:** the combined weight of the optional equipment weighing more than the replaced standard parts and more than 5 lbs (2.3 kg). This optional equipment, such as high-performance brakes, level control system, a roof luggage rack or high-performance batteries, is not included in the curb weight and the weight of the accessories.

**TIN (Tire Identification Number):** a unique identification number which can be used by a tire manufacturer to identify tires, for example, in a product recall, and thus identify the purchasers. The TIN is made up of the manufacturer's identity code, tire size, tire type code and the manufacturing date.

**Load-bearing index:** the load-bearing index is a code that contains the maximum load-bearing capacity of a tire.

**Traction:** traction is the grip resulting from friction between the tires and the road surface.

**Wear indicator:** narrow bars (tread wear bars) that are distributed over the tire contact surface. If the

tire tread is level with the bars, the wear limit of 1/16 in (1.6 mm) has been reached.

**Distribution of vehicle occupants:** distribution of vehicle occupants over designated seat positions in a vehicle.

**Maximum permissible payload weight:** nominal load and luggage load plus 150 lb (68 kg) multiplied by the number of seats in the vehicle.

### Changing a wheel

#### Notes on selecting, installing and replacing tires

**!** **NOTE** Mercedes-AMG vehicles

▶ Observe the notes in the Supplement. You could otherwise fail to recognize dangers.

**⚠** **WARNING** Risk of accident due to incorrect wheel and tire dimensions

If wheels and tires of the wrong size are installed, the service brakes or components in the

brake system and in the wheel suspension may be damaged.

- ▶ Always replace wheels and tires with ones that fulfill the specifications of the original part.

For wheels, pay attention to the following:

- Designation
- Type

For tires, pay attention to the following:

- Designation
- Manufacturer
- Type

**⚠ WARNING** Risk of injury through exceeding the specified tire load-bearing capacity or the permissible speed rating

Exceeding the specified tire load rating or the permissible speed rating may lead to tire damage and to the tires bursting.

- ▶ Therefore, only use tire types and sizes approved for your vehicle model.
- ▶ Observe the tire load rating and speed rating required for your vehicle.

**! NOTE** Vehicle and tire damage through tire types and sizes that have not been approved

For safety reasons, only use tires, wheels and accessories which have been specially approved by Mercedes-Benz for your vehicle.

These tires are specially adapted to the active safety systems, such as ABS, ESP® and 4MATIC, and marked as follows:

- MO = Mercedes-Benz Original
- MOE = Mercedes-Benz Original Extended (run-flat tire only for certain wheels)
- MO1 = Mercedes-Benz Original (only certain AMG tires)

Otherwise, certain properties, such as handling characteristics, vehicle noise emissions, consumption, etc. could be adversely affected.

Furthermore, other tire sizes could result in the tires rubbing against the body and axle components when loaded. This could result in damage to the tire or the vehicle.

Only use tires, wheels and accessories that have been checked and recommended by Mercedes-Benz.

**! NOTE** Risk to driving safety from retreaded tires

Retreaded tires are neither tested nor recommended by Mercedes-Benz, since previous damage cannot always be detected on retreaded tires.

For this reason driving safety cannot be guaranteed.

- ▶ Do not use used tires if you have no information about their previous usage.

**!** **NOTE** Possible wheel and tire damage when driving over obstacles

Large wheels have a smaller section width. As the section width decreases, the risk of wheels and tires being damaged when driving over obstacles increases.

- ▶ Avoid obstacles or drive especially carefully.
- ▶ Reduce your speed when driving over curbs, speed bumps, manhole covers and potholes.
- ▶ Avoid particularly high curbs.

**!** **NOTE** Possible wheel and tire damage when parking on curbs or in potholes

Parking on curbs or in potholes may damage the wheels and tires.

- ▶ If possible, park only on flat surfaces.
- ▶ Avoid curbs and potholes when parking.

**!** **NOTE** Damage to electronic component parts from the use of tire-mounting tools

**Vehicles with a tire pressure monitoring system:** Electronic component parts are located in the wheel. Tire-mounting tools should not be used in the area of the valve.

This could otherwise damage the electronic component parts.

- ▶ Have the tires changed at a qualified specialist workshop only.

**!** **NOTE** Damage to summer tires at low ambient temperatures

At low ambient temperatures, tears could form when driving with summer tires, causing permanent damage to the tires.

- ▶ At temperatures below 45 °F (7 °C) use  M+S tires.

Accessory parts which are not approved for your vehicle by Mercedes-Benz, or which are not used correctly, can impair the operating safety.

Before purchasing and using non-approved accessories, visit a qualified specialist workshop and inquire about:

- Suitability
- Legal stipulations
- Factory recommendations

**!** **WARNING** Risk of accident with high performance tires

The special tire tread in combination with the optimized tire compound means that the risk of skidding and hydroplaning on wet roads is increased.

In addition, the tire grip is greatly reduced at a low outside temperature and tire running temperature.

- ▶ Switch on the ESP® and adapt your driving style accordingly.
- ▶ Use  M+S tires at outside temperatures of less than 50 °F (10 °C).
- ▶ Only use the tires for their intended purpose.



Observe the following when selecting, installing and replacing tires:

- Furthermore, the use of certain tire types in certain regions and areas of operation can be highly beneficial.
- Only use tires and wheels of the same type (summer tires, winter tires, MOExtended tires) and the same make.
- Only install wheels of the same size on one axle (left and right).

It is only permissible to install a different wheel size in the event of a flat tire in order to drive to the specialist workshop.

- **Vehicles with a tire pressure monitoring system:** All installed wheels must be equipped with functioning sensors for the tire pressure monitoring system.
- At temperatures below 45 °F (7 °C) use winter tires or all-season tires marked  M+S for all wheels.

Winter tires provide the best possible grip in wintry road conditions.

- For M+S tires, only use tires with the same tread.
- Observe the maximum permissible speed for the M+S tires installed.  
If the tire's maximum speed is below that of the vehicle, this must be indicated by an appropriate label in the driver's field of vision.
- Break in new tires at moderate speeds for the first 60 miles (100 km).
- Replace the tires after six years at the latest, regardless of wear.
- **When replacing with tires that do not feature run-flat characteristics:** vehicles with MOExtended tires are not equipped with a TIREFIT kit at the factory. Equip the vehicle with a TIREFIT kit after replacing with tires that do not feature run-flat characteristics, e.g. winter tires.

For more information on wheels and tires, contact a qualified specialist workshop.

Be sure to also observe the following further related subjects:

- Notes on tire pressure (→ page 371)

- Tire and Loading Information placard (→ page 376)
- Tire size designation, load-bearing capacity, speed rating and load index (→ page 384)
- Tire pressure table (→ page 373)
- Notes on the emergency spare wheel (→ page 399)

#### Notes on rotating the wheels

 **WARNING** Risk of injury through different wheel sizes

Rotating the front and rear wheels can severely impair the driving characteristics. The wheel brakes or suspension components may also be damaged.

 Rotate front and rear wheels only if the wheels and tires are of the same dimensions.

The wear patterns on the front and rear wheels differ:

- Front wheels wear more on the tire shoulder

## 392 Wheels and tires

- Rear wheels wear more in the center of the tire

Do not drive with tires that have too little tread depth. This significantly reduces traction on wet roads (hydroplaning).

On vehicles that have the same size front and rear wheels, rotate the wheels according to the intervals in the tire manufacturer's warranty book in your vehicle documents. If this is not available, rotate the tires every 3,000 to 6,000 miles (5,000 to 10,000 km), depending on the wear. Ensure that the direction of rotation is maintained.

Observe the instructions and safety notes on "Changing a wheel" when doing so (→ page 392).

### Notes on storing wheels

When storing wheels, observe the following notes:

- After removing wheels, store them in a cool, dry and preferably dark place.
- Protect the tires from contact with oil, grease or fuel.

### Overview of the tire-change tool kit

Apart from some country-specific variants, vehicles are not equipped with a tire-change tool kit. For more information on which tools are required and approved to perform a wheel change on your vehicle, consult a qualified specialist workshop.

Required tire-changing tools may include, for example:

- Jack
- Chock
- Lug wrench

Tire-change tool kit  is located under the cargo compartment floor.

-  Depending on the model, the tire change tool kit may be located in other positions under the cargo compartment floor.

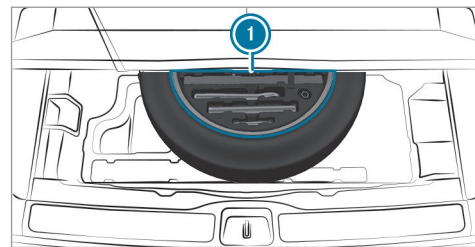

The tire-change tool kit includes the following:

- Jack
- Lug wrench
- Wheel studs
- Extension attachment for wheel studs, if necessary (depending on vehicle version)
- Folding chock
- Ratchet wrench

### Preparing the vehicle for a wheel change

#### Requirements:

- The vehicle is not on a slope.

- The vehicle is on solid, non-slippery and level ground.
- The required tire-change tool kit is available.

**i** If your vehicle is not equipped with the tire-change tool kit, consult a qualified specialist workshop to find out about suitable tools.

- ▶ Apply the electric parking brake manually.
- ▶ Move the front wheels to the straight-ahead position.
- ▶ Shift the transmission to position **P**.
- ▶ **Vehicles with level control system:** Set the normal vehicle level (→ page 249).
- ▶ Switch off the vehicle.
- ▶ Make sure that the vehicle cannot be started.
- ▶ Place chocks or other suitable items under the front and rear of the wheel that is diagonally opposite the wheel you wish to change.
- ▶ Raise the vehicle (→ page 394).

**Additionally, for Mercedes-Maybach vehicles:**

- ▶ Retract the running boards (→ page 78)

- ▶ To remove stone chipping protective covers

**2**:

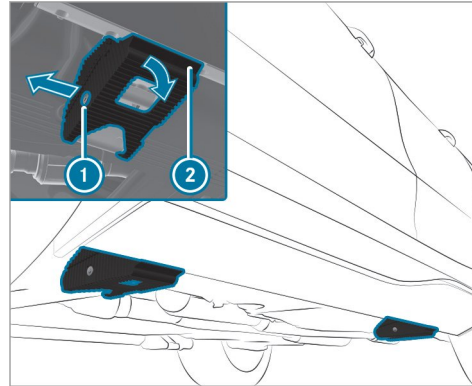

- ▶ Loosen expansion rivet **1** and pull it out.
- ▶ Fold down and remove stone chipping protective covers **2**.

**Removing and installing the wheel trim/hub caps**

**Requirements:**

- The vehicle is prepared for a wheel change (→ page 392).

**Plastic hub cap**

- ▶ **To remove:** turn the center cover of the hub cap counter-clockwise and remove the hub cap.
- ▶ **To install:** make sure that the center cover of the hub cap is turned counter-clockwise.
- ▶ Position the hub cap and turn the center cover clockwise until the hub cap engages physically and audibly.

## Aluminum hub cap

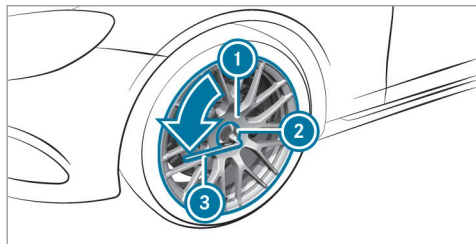

- ▶ **To remove:** position socket ② from the tire-change tool kit on hub cap ①.
- ▶ Position wheel wrench ③ on socket ②.
- ▶ Using wheel wrench ③, turn hub cap ① counter-clockwise and remove it.
- ▶ **To install:** follow the instructions above in reverse order.

**i Specified tightening torque:** 18 lb-ft (25 Nm).

## Raising the vehicle when changing a wheel

## Requirements:

- There are no persons in the vehicle.
- The vehicle has been prepared for a wheel change (→ page 392).

## Important notes on using the jack:

- Use only a vehicle-specific jack that has been approved by Mercedes-Benz to raise the vehicle.
- The jack is only designed for raising and holding the vehicle for a short time while a wheel is being changed and not for maintenance work under the vehicle.
- The jack must be placed on a firm, flat and non-slip surface. If necessary, use a large, flat, load-bearing, non-slip underlay.
- The foot of the jack must be positioned vertically under the jack support point.

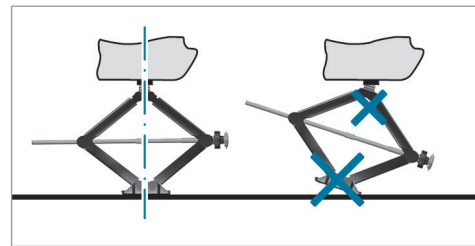

## Rules of conduct when the vehicle is raised:

- Never place your hands or feet under the vehicle.
- Never lie under the vehicle.
- Do not start the vehicle and do not release the electric parking brake.
- Do not open or close any doors or the tailgate.

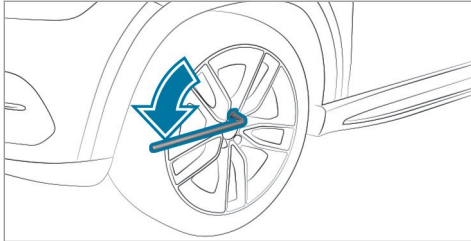

- ▶ Using the lug wrench, loosen the wheel bolts on the wheel you wish to change by about one full turn. Do not unscrew the screws completely.

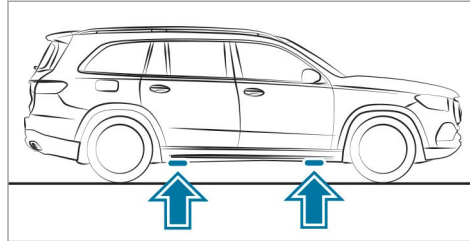

Position of jack support points

**⚠ WARNING** Risk of injury from incorrect positioning of the jack

If you do not position the jack correctly at the appropriate jacking point of the vehicle, the jack could tip with the vehicle raised.

- ▶ Only position the jack at the appropriate jacking point of the vehicle. The base of the jack must be positioned vertically under the jacking point of the vehicle.

**!** **NOTE** Vehicle damage from the jack

If you do not position the jack correctly at the appropriate jack support point of the vehicle, the jack could tip over with the vehicle raised.

- ▶ The jack is designed exclusively for jacking up the vehicle at the jack support points.

- ▶ Take the ratchet wrench out of the tire-change tool kit and place it on the hexagon nut of the jack so that the letters "AUF" are visible.

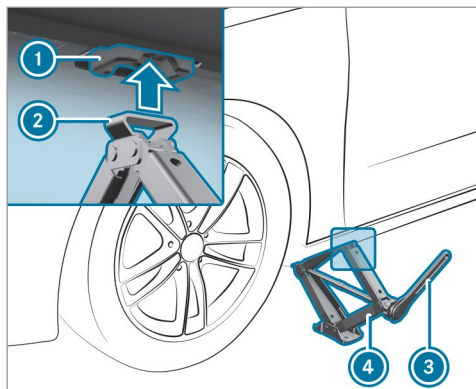

- ▶ Position support ② of jack ④ on jack support point ①.
- ▶ Turn ratchet wrench ③ clockwise until jack support ② sits completely on jacking point ① and the base of the jack lies evenly on the ground.

- ▶ Continue to turn ratchet wrench ③ until the tire is raised a maximum of 1.2 in (3 cm) off the ground.
- ▶ Loosen and remove the wheel (→ page 396).

#### Mercedes-Maybach vehicles:

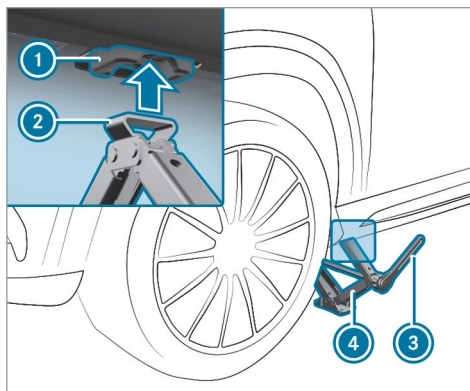

#### Requirements:

- The running boards are retracted (→ page 78)

- The stone chipping protective covers are removed (→ page 392)
- ▶ Position support ② of jack ④ on jack support point ①.
- ▶ Turn ratchet wrench ③ clockwise until jack ② sits completely on jacking point ① and the base of the jack lies evenly on the ground.
- ▶ Continue to turn ratchet wrench ③ until the tire is raised a maximum of 1.2 in (3 cm) off the ground.
- ▶ Loosen and remove the wheel (→ page 396).

#### Removing a wheel

##### Requirements:

- The vehicle is raised (→ page 394).

##### ! NOTE Mercedes-AMG vehicles

- ▶ Observe the notes in the Supplement. You could otherwise fail to recognize dangers.

##### Note on AMG vehicles:

When changing a wheel, avoid applying any force to the brake discs, as this could impair the level of comfort when braking.

**!** **NOTE** Damage to threading from dirt on wheel bolts

- ▶ Do not place wheel bolts in sand or on a dirty surface.

- ▶ Completely unscrew the wheel bolts.
- ▶ Remove the wheel.

### Installing a new wheel

#### Requirements:

- The wheel that is to be replaced is removed (→ page 396).

**!** **NOTE** Mercedes-AMG vehicles

- ▶ Observe the notes in the Supplement. You could otherwise fail to recognize dangers.

**!** **WARNING** Risk of accident from losing a wheel

Oiled, greased or damaged wheel bolt/wheel nut threads or wheel hub/wheel mounting bolt threads can cause the wheel bolts/wheel nuts to come loose.

- ▶ Never oil or grease the threads.
- ▶ In the event of damage to the threads, contact a qualified specialist workshop immediately.
- ▶ Have the damaged wheel bolts or damaged hub threads replaced.
- ▶ Do not continue driving.

- ▶ Observe the information on the choice of tires (→ page 388).

For tires with a specified direction of rotation, an arrow on the side wall of the tire indicates the correct direction of rotation. Observe the direction of rotation when installing.

#### Note on AMG vehicles:

- ▶ Place the wheel to be installed on the wheel hub and push it on.

**!** **WARNING** Risk of injury from tightening wheel bolts and nuts

If you tighten the wheel bolts or wheel nuts when the vehicle is raised, the jack could tip.

- ▶ Only tighten wheel bolts or wheel nuts when the vehicle is on the ground.

- ▶ Observe the instructions and safety notes on "Changing a wheel" (→ page 388).
- ▶ For safety reasons, only use wheel bolts which have been approved by Mercedes-Benz and for the wheel in question.

**!** **NOTE** Damage to paintwork of the wheel rim when screwing in the first wheel bolt

If the wheel has too much play when screwing in the first wheel bolt, the wheel rim paint can be damaged.

- ▶ Press the wheel firmly against the wheel hub when screwing in the first wheel bolt.

- ▶ Tighten the wheel bolts evenly in a diagonal pattern in the order indicated until they are finger-tight.
- ▶ If the collapsible spare wheel has been installed, inflate the collapsible spare wheel (→ page 402).
- ▶ Lower the vehicle (→ page 398).

### Lowering the vehicle after a wheel change

#### Requirements:

- The new wheel has been installed (→ page 397).

Observe the information on tire pressure (→ page 371).

- ▶ Place the ratchet wrench onto the hexagon nut of the jack so that the lettering "AB" is visible.

- ▶ **To lower the vehicle:** turn the ratchet wrench of the jack counter-clockwise.

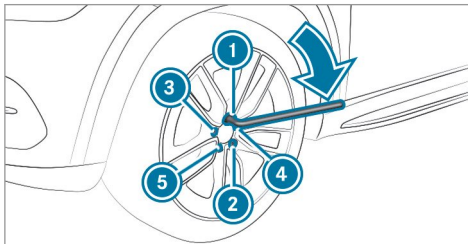

- ▶ Tighten the wheel bolts evenly in a diagonal pattern in the order indicated ① to ⑤ with a maximum of 59 lb-ft (80 Nm).
- ▶ Then tighten the wheel bolts evenly in a diagonal pattern in the order indicated ① to ⑤ to the specified tightening torque of 111 lb-ft (150 Nm).

- ▶ **WARNING** Risk of injury through incorrect tightening torque

The wheels could come loose if the wheel bolts or wheel nuts are not tightened to the prescribed tightening torque.

- ▶ Make sure the wheel bolts or wheel nuts are tightened to the prescribed tightening torque.
- ▶ If you are not sure, do not move the vehicle. Consult a qualified specialist workshop and have the tightening torque checked immediately.

- ▶ Check the tire pressure of the newly mounted wheel and adjust accordingly.

**i** The following does not apply if the new wheel is an emergency spare wheel.

- ▶ **Vehicles with a tire pressure monitoring system:** Restart the tire pressure monitoring system (→ page 376).



## Emergency spare wheel

### Notes on the emergency spare wheel

**⚠ WARNING** Risk of accident caused by incorrect wheel and tire dimensions

The wheel or tire sizes and the tire type of the emergency spare wheel or spare wheel and the wheel to be replaced may differ. The emergency spare wheel or spare wheel can significantly impair driving characteristics of the vehicle.

To prevent hazardous situations:

- ▶ Drive carefully.
- ▶ Never install more than one emergency spare wheel or spare wheel that differs in size.
- ▶ Only use an emergency spare wheel or spare wheel briefly.
- ▶ Do not deactivate ESP®.
- ▶ Have the emergency spare wheel or spare wheel of a different size replaced at the nearest qualified specialist work-

shop. The new wheel must have the correct dimensions.

- ① The emergency spare wheel is fastened in the cargo compartment under the cargo compartment floor.
  - ① Not for Mercedes-Maybach vehicles.
- Observe the following notes on installing an emergency spare wheel:
- The maximum permissible speed with an emergency spare wheel installed is 50 mph (80 km/h).
  - Do not equip the emergency spare wheel with snow chains.
  - Replace the emergency spare wheel after six years at the latest, regardless of wear.
  - Check the tire pressure of the emergency spare wheel installed. Correct the pressure as necessary.
- ① The specified tire pressure is stated on the label of the emergency spare wheel.
  - ① **Vehicles with a tire pressure monitoring system:** If an emergency spare wheel is installed,

the tire pressure monitoring system cannot function reliably. For a few minutes after an emergency spare wheel is installed, the system may still display the tire pressure of the removed wheel. Only restart the system again when the emergency spare wheel has been replaced with a new wheel.

Be sure to also observe the following further related subjects:

- Notes on tire pressure (→ page 371)
- Tire and Loading Information placard (→ page 376)
- Tire pressure table (→ page 373)
- Notes on installing tires (→ page 388)
- Installing an emergency spare wheel (→ page 392)

### Inflating the emergency spare wheel

**NOTE** Overheating due to the tire inflation compressor running too long

Do not run the tire inflation compressor for longer than ten minutes without interruption.

#### Requirements:

The emergency spare wheel has been installed correctly. (→ page 392)

Comply with the manufacturer's safety notes on the sticker of the emergency spare wheel and on the tire inflation compressor.

- ▶ Remove the sticker with the label 50 mph (80 km/h) from the tire inflation compressor housing and affix it to the instrument cluster within the driver's field of vision.
- ▶ Remove the tire inflation compressor from the stowage space under the trunk floor. (→ page 353)

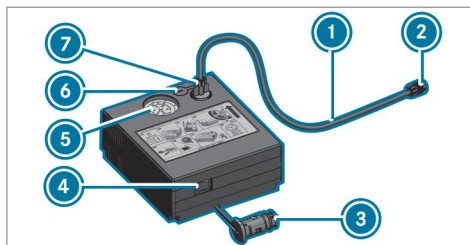

- ▶ Pull filler hose ① and plug ③ out of the tire inflation compressor housing.
- ▶ Insert plug ⑦ of filler hose ① in the socket on the tire inflation compressor and then turn it until plug ⑦ engages.
- ▶ Unscrew the cap from the valve on the emergency spare wheel.
- ▶ Screw union nut ② of filler hose ① onto the valve.
- ▶ Make sure on and off switch ④ of the tire inflation compressor is set to 0.
- ▶ Insert plug ③ in a socket in your vehicle.
  - 12 V socket: (→ page 140)

- Observe the notes on sockets: (→ page 140)
- ▶ Press the start/stop button once to switch on the power supply (→ page 173).
- ▶ Press on and off switch ④ on the tire inflation compressor to I. The tire inflation compressor is switched on. The tire is inflated. The tire pressure appears on manometer ⑤.
- ▶ Pump the tire to the specified tire pressure.
  - ⓘ The specified tire pressure is stated on the label of the emergency spare wheel.
- ▶ When the specified tire pressure has been reached, press on and off switch ④ on the tire inflation compressor to 0. The tire inflation compressor is switched off.
- ▶ Press the start/stop button to switch off the power supply.
- ▶ If the tire pressure is higher than the specified pressure, press pressure release valve button ⑥ until the correct tire pressure has been reached.

- ▶ Unscrew union nut ② of filler hose ① from the valve.
- ▶ Screw the valve cap of the emergency spare wheel onto the valve again.
- ▶ Stow filler hose ① and plug ③ in the lower section of the tire inflation compressor housing.
- ▶ Stow the tire inflation compressor in the vehicle.

### Collapsible spare wheel

#### Notes on the collapsible spare wheel

**⚠ WARNING** Risk of accident caused by incorrect wheel and tire dimensions

The wheel or tire sizes and the tire type of the emergency spare wheel or spare wheel and the wheel to be replaced may differ. The emergency spare wheel or spare wheel can significantly impair driving characteristics of the vehicle.

To prevent hazardous situations:

- ▶ Drive carefully.
- ▶ Never install more than one emergency spare wheel or spare wheel that differs in size.
- ▶ Only use an emergency spare wheel or spare wheel briefly.
- ▶ Do not deactivate ESP®.
- ▶ Have the emergency spare wheel or spare wheel of a different size replaced at the nearest qualified specialist workshop. The new wheel must have the correct dimensions.

The collapsible spare wheel is an emergency spare wheel which is only suitable for use for a limited period of time and in a restricted manner in the event of a flat tire (e.g. until the nearest workshop).

The tire sidewalls are folded when in transport mode. Before use, the collapsible spare wheel has to be inflated with the accompanying compressor.

Check the tire pressure of the collapsible spare wheel once installed. Correct the pressure as necessary.

The maximum permissible speed with a collapsible spare wheel installed is 50 mph (80 km/h).

Do not equip the collapsible spare wheel with snow chains.

Replace the collapsible spare wheel after six years at the latest, regardless of wear.

**i Vehicles with a tire pressure monitoring system:** If a collapsible spare wheel is installed the tire pressure monitoring system cannot function reliably. For a few minutes after an emergency spare wheel is installed, the system may still display the tire pressure of the removed wheel. Only restart the system again when the collapsible spare wheel has been replaced with a new wheel.

Be sure to also observe the following further related subjects:

- Notes on tire pressure (→ page 371)
- Tire pressure table (→ page 373)

### Removing the collapsible spare wheel

The collapsible spare wheel is located under the cargo compartment floor.

- ▶ Observe the information on mounting tires (→ page 388).
- ▶ Open the tailgate.
- ▶ Open the cargo compartment floor.
- ▶ Remove the collapsible spare wheel.

#### Mercedes-Maybach vehicles

**Without refrigerator box:** The collapsible spare wheel is located in the collapsible spare wheel bag on the cargo compartment floor.

- ▶ Observe the information on mounting tires (→ page 388).
- ▶ Open the cargo compartment.
- ▶ Loosen the lashing straps.
- ▶ Unhook the retaining spring hooks of the lashing straps from the brackets.
- ▶ Remove the collapsible spare wheel bag together with the collapsible spare wheel.

- ▶ Open the collapsible spare wheel bag and remove the collapsible spare wheel.

**With refrigerator box:** The collapsible spare wheel is located in the collapsible spare wheel bag inside the open cargo compartment floor.

- ▶ Observe the information on mounting tires (→ page 388).
- ▶ Open the cargo compartment.
- ▶ Loosen the lashing straps.
- ▶ Unhook the retaining spring hooks of the lashing straps from the brackets.
- ▶ Remove the collapsible spare wheel bag together with the collapsible spare wheel.
- ▶ Open the collapsible spare wheel bag and remove the collapsible spare wheel.

### Inflating the collapsible spare wheel

#### Requirements:

- Mount the collapsible spare wheel as described (→ page 397).

- Remove the tire inflation compressor from the storage space under the trunk floor (→ page 353).

**!** **NOTE** Damage to the collapsible spare wheel when lowering the vehicle

Lowering the vehicle without previously inflating the collapsible spare wheel can damage its rim.

- ▶ Inflate the collapsible spare wheel using the tire inflation compressor before lowering the vehicle.

**!** **NOTE** Overheating due to the tire inflation compressor running too long

- ▶ Do not run the tire inflation compressor for longer than ten minutes without interruption.

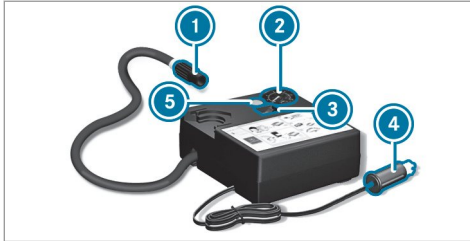

- ▶ Pull connector ④ and the hose out of the housing.
- ▶ Unscrew the cap from the valve on the collapsible spare wheel.
- ▶ Screw union nut ① of the hose onto the valve.
- ▶ Make sure on and off switch ③ of the tire inflation compressor is set to **0**.
- ▶ Insert connector ④ into the cigarette lighter socket or into a 12 V socket (→ page 140) in your vehicle.
- ▶ Switch on the power supply (→ page 173).

- ▶ Press on and off switch ③ on the tire inflation compressor to **I**.  
The tire inflation compressor is switched on. The tire is inflated. The tire pressure is shown on manometer ②.
- ▶ Pump the tire to the specified tire pressure.
- ⓘ The specified tire pressure is printed on the yellow label of the collapsible spare wheel.
- ▶ When the specified tire pressure has been reached, press on and off switch ③ on the tire inflation compressor to **0**.
- ▶ If the tire pressure is higher than the specified pressure, press pressure release valve button ⑤ until the correct tire pressure has been reached.

### Notes on technical data

#### **!** NOTE Mercedes-AMG vehicles

- ▶ Observe the notes in the Supplement. You could otherwise fail to recognize dangers.

The data stated only applies to vehicles with standard equipment. You can obtain further information from an authorized Mercedes-Benz Center.

### Vehicle electronics

#### Two-way radios

##### Notes on installing two-way radios

#### **!** WARNING Risk of accident due to improper work on two-way radios

If two-way radios are manipulated or retrofitted incorrectly, the electromagnetic radiation from the two-way radios can interfere with the vehicle electronics and jeopardize the operating safety of the vehicle.

- ▶ You should have all work on electrical and electronic components carried out at a qualified specialist workshop.

#### **!** WARNING Risk of accident due to improper operation of two-way radios

If you use two-way radios in the vehicle improperly, their electromagnetic radiation can disrupt the vehicle's electronics. This is the case in the following situations, in particular:

- The two-way radio is not connected to an exterior antenna.
- The exterior antenna is installed incorrectly or is not a low-reflection antenna.

This could jeopardize the operating safety of the vehicle.

- ▶ Have the low-reflection exterior antenna installed at a qualified specialist workshop.

- ▶ When operating two-way radios in the vehicle, always connect them to the low-reflection exterior antenna.

#### **!** NOTE Invalidation of the operating permit due to failure to comply with the instructions for installation and use

The operating permit may be invalidated if the instructions for installation and use of two-way radios are not observed.

- ▶ Only use approved frequency bands.
- ▶ Observe the maximum permissible output power in these frequency bands.
- ▶ Only use approved antenna positions.

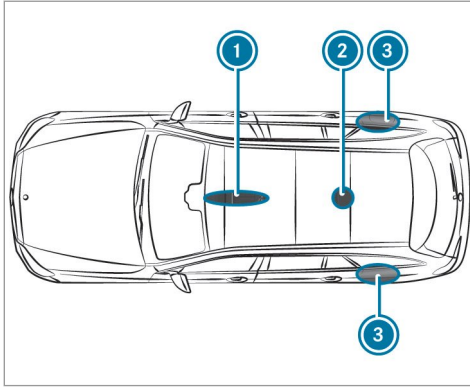

- ① Front roof area
- ② Rear roof area
- ③ Rear fenders

On vehicles with a panoramic sliding sunroof, installing an antenna to the front or rear roof area is not permitted.

On the rear fenders, it is recommended that you install the antenna on the side of the vehicle closest to the center of the road.

Use Technical Specification ISO/TS 21609 (Road Vehicles - "EMCs for installation of aftermarket radio frequency transmitting equipment") when retrofitting two-way radios. Comply with the legal requirements for detachable parts.

If your vehicle has installing for two-way radio equipment, use the power supply and antenna connectors provided in the pre-installation. Observe the manufacturer's supplements when installing.

#### Two-way radio transmission output

The maximum transmission output (PEAK) at the base of the antenna must not exceed the values in the following table.

#### Frequency band and maximum transmission output

Frequency band	Maximum transmission output
Short wave 3 - 54 MHz	100 W
4 m frequency band 74 - 88 MHz	30 W
2 m frequency band 144 - 174 MHz	50 W
Terrestrial Trunked Radio (TETRA) 380 - 460 MHz	10 W
70 cm frequency band 420 - 450 MHz	35 W
Two-way radio (2G/3G/4G)	10 W

The following can be used in the vehicle without restrictions:

- Two-way radios with a maximum transmission output of up to 100 mW
- RF transmitters with transmitter frequencies in the 380 - 410 MHz frequency band and a maximum transmission output of up to 2 W (TETRA)
- Mobile phones (2G/3G/4G)

There are no restrictions when positioning the antenna on the outside of the vehicle for the following frequency bands:

- Terrestrial Trunked Radio (TETRA)
- 70 cm frequency band
- 2G/3G/4G

### Regulatory radio identification and notes

#### Regulatory radio identification of small components

Manufacturer information about radio-based vehicle components can be found using the key phrase "Regulatory radio identification" in the Dig-

ital Operator's Manual in the vehicle, on the Internet and in the app.

#### Regulatory radio identification – Indonesia

Manufacturer information about radio-based vehicle components can be found using the key phrase "Regulatory radio identification – Indonesia" in the Digital Operator's Manual in the vehicle, on the Internet and in the app.

- ① These are not small components. Information about small components can be found using the key phrase "Regulatory radio identification of small components".

#### Information on installation clearances

Information on installation clearances of wireless vehicle components can be found using the key phrase "Installation clearances" in the Digital Operator's Manual in the vehicle, on the Internet, and in the app.

#### Further component-specific information

Further component-specific information can be found using the key phrase "further component-specific information" in the Digital Operator's Manual in the vehicle, on the Internet and in the app.



Vehicle identification plate, VIN and engine number overview

Vehicle identification plate

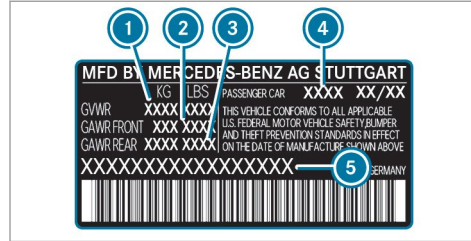
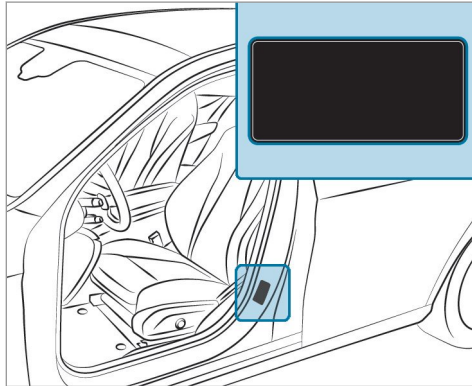

Vehicle identification plate (USA only)

- ① Maximum permissible gross vehicle weight
- ② Maximum permissible front axle load
- ③ Maximum permissible rear axle load
- ④ Paint code
- ⑤ VIN (vehicle identification number)

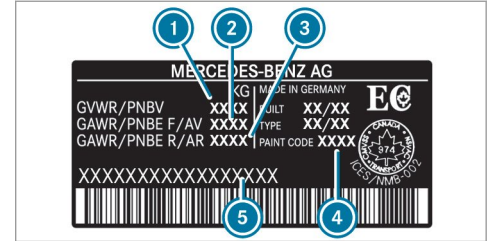

Vehicle identification plate (Canada only)

- ① Maximum permissible gross vehicle weight
- ② Maximum permissible front axle load
- ③ Maximum permissible rear axle load
- ④ Paint code
- ⑤ VIN (vehicle identification number)

The maximum permissible gross vehicle weight is made up of the vehicle weight, all vehicle occupants, the fuel and the load. The maximum gross axle weight rating is the maximum weight that can be carried on one axle (front or rear axle).

Never exceed the maximum permissible gross vehicle weight or the maximum gross axle weight rating for the front or rear axle.

### VIN in front of the front seat

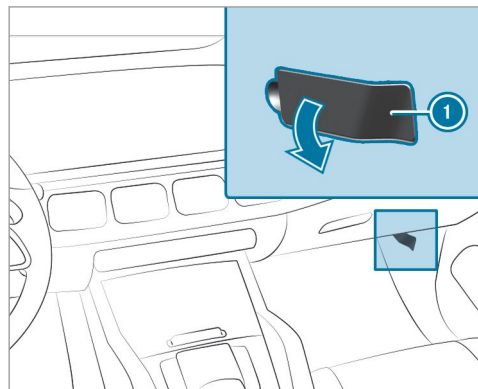

- ① VIN (vehicle identification number)

### Additional plates

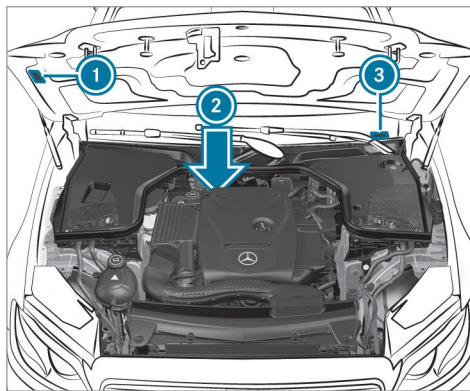

- ① Plate with information about emissions testing, including confirmation of emissions guidelines at the U.S. federal level as well as for California
- ② Engine number stamped into the crankcase
- ③ VIN (vehicle identification number) as a label at the lower edge of the windshield

### Operating fluids

#### Notes on operating fluids

##### ! NOTE Mercedes-AMG vehicles

- ▶ Observe the notes in the Supplement. You could otherwise fail to recognize dangers.

##### ⚠ WARNING Risk of injury from operating fluids harmful to your health

Operating fluids may be poisonous and harmful to your health.

- ▶ Observe the text on the original containers when using, storing or disposing of operating fluids.
- ▶ Always store operating fluids sealed in their original containers.
- ▶ Always keep children away from operating fluids.

 **ENVIRONMENTAL NOTE** Pollution of the environment due to irresponsible disposal of operating fluids

Incorrect disposal of operating fluids can cause considerable damage to the environment.

- ▶ Dispose of operating fluids in an environmentally responsible manner.

Operating fluids include the following:

- Fuels
- Lubricants
- Coolant
- Brake fluid
- Windshield washer fluid
- Climate control system refrigerant

Only use products approved by Mercedes-Benz. Damage caused by the use of products that have not been approved is not covered by the Mercedes-Benz warranty or goodwill gestures.

The operating fluids approved by Mercedes-Benz can be identified by the following inscriptions on the container:

- MB-Freigabe (e.g. MB-Freigabe 229.51)
- MB-Approval (e.g. MB-Approval 229.51)

Further information on approved operating fluids:

- In the Mercedes-Benz Specifications for Operating Fluids by entering the designation
  - At <https://bevo.mercedes-benz.com>
  - In the Mercedes-Benz BeVo app
- At a qualified specialist workshop

 **WARNING** Risk of fire or explosion from fuel

Fuels are highly flammable.

- ▶ Fire, open flames, smoking and creating sparks must be avoided.
- ▶ Before and during refueling, switch off the vehicle and, if installed, the stationary heater.

 **WARNING** Risk of injury from fuels

Fuels are poisonous and hazardous to your health.

- ▶ Do not swallow fuel or let it come into contact with skin, eyes or clothing.
- ▶ Do not inhale fuel vapor.
- ▶ Keep children away from fuel.
- ▶ Keep doors and windows closed during the refueling process.

If you or other people come into contact with fuel, observe the following:

- ▶ Immediately rinse fuel off your skin with soap and water.
- ▶ If fuel comes into contact with your eyes, immediately rinse them thoroughly with clean water. Seek medical attention immediately.
- ▶ If you swallow fuel, seek medical attention immediately. Do not induce vomiting.

- ▶ Change immediately out of clothing that has come into contact with fuel.

Flexible-fuel vehicles can be refueled with the following fuel types:

- Premium grade unleaded gasoline
- E85 fuel
- A mixture of E85 fuel and premium grade unleaded gasoline

Flexible-fuel vehicles can be identified by the **Ethanol up to E85** sticker on the inside of the fuel filler flap.

Depending on the country, the fuels you can use in your vehicle may differ from the information in the Operator's Manual. The fuels that have been approved for your vehicle can be found on the instruction label on the inside of the fuel filler flap.

## Fuel

### Notes on fuel grades for vehicles with a gasoline engine

Observe the notes on operating fluids (→ page 408).

### ! NOTE Damage caused by the wrong fuel

Even small amounts of the wrong fuel could result in damage to the fuel system, the engine and the emission control system.

- ▶ Only refuel with low-sulfur unleaded fuel.

This fuel may contain up to 10% ethanol by volume. Your vehicle is suitable for use with E10 fuel.

Never refuel with one of the following fuels:

- Diesel
- Gasoline with more than 10% ethanol by volume, e.g. E15, E85, E100
- Gasoline with more than 3% methanol by volume, e.g. M15, M30, M85, M100
- Gasoline with additives containing metal

If you have accidentally refueled with the wrong fuel:

- ▶ Do not switch on the ignition.
- ▶ Consult a qualified specialist workshop.

If the available fuel is not sufficiently low in sulfur, this can produce unpleasant odors.

Only refuel with fuel that has at least the octane number specified in the instruction label in the fuel filler flap (→ page 199). This may reduce engine output and increase fuel consumption.

**If you want maximum engine output:** only refuel with unleaded premium grade gasoline with an octane number of at least 91 AKI/95 RON.

As a temporary measure, if the recommended fuel is not available, you may also refuel with unleaded regular gasoline with at least 87 AKI/91 RON. This may reduce engine output and increase fuel consumption.

Never refuel using gasoline with an even lower RON.

### ! NOTE Premature wear caused by unleaded regular gasoline

Unleaded regular gasoline can cause the engine to wear more quickly and impair longevity and performance.

If unleaded premium grade gasoline is unavailable and you have to refuel using unleaded regular gasoline:

- ▶ Only fill the fuel tank to half full with unleaded regular gasoline and refill as soon as possible with unleaded premium grade gasoline.
- ▶ Do not drive at the maximum speed.
- ▶ Avoid sudden acceleration and engine speeds over 3,000 rpm.

Further information on fuel is available at the following locations:

- At a gas station
- At a qualified specialist workshop
- USA only: at <http://www.mbusa.com>

#### Notes on additives in gasoline (vehicles with a gasoline engine)

Note the instructions about operating fluids (→ page 408).

**!** **NOTE** Damage from use of unsuitable additives

Even small amounts of the wrong additive may lead to malfunctions occurring.

- ▶ Only add cleaning additives recommended by Mercedes-Benz to the fuel.

Mercedes-Benz recommends that you use brand-name fuels with additives.

In some countries, the fuel available may not have sufficient additives. Deposits could build up in the fuel injection system as a result. In this case, in consultation with an authorized Mercedes-Benz Center, mix the fuel with the cleaning additive recommended by Mercedes-Benz. Observe the notes and mixing ratios indicated on the tank.

#### Tank content and fuel reserve

##### Fuel tank total capacity

Model	
All models	23.8 gal (90.0 liters)

##### Fuel tank total capacity (Mercedes-Maybach)

Model	
Mercedes-Maybach GLS 600 4MATIC	23.8 gal (90.0 liters)

##### Reserve fuel tank

Model	
All models	2.4 gal (9.0 liters)

##### Fuel tank reserve (Mercedes-Maybach)

Model	
Mercedes-Maybach GLS 600 4MATIC	3.2 gal (12.0 liters)

#### Engine oil

##### Notes on engine oil

Observe the notes on operating fluids (→ page 408).



**!** **NOTE** Engine damage caused by an incorrect oil filter, incorrect oil or additives

- ▶ Do not use engine oils or oil filters other than those which meet the specifications necessary for the prescribed service intervals.
- ▶ Do not alter the engine oil or oil filter in order to achieve longer change intervals than prescribed.
- ▶ Do not use additives.
- ▶ Have the engine oil changed after the prescribed intervals.

Mercedes-Benz recommends having the oil changed at a qualified specialist workshop.

Only use engine oils approved for your vehicle by Mercedes-Benz.

### Quality and capacity of engine oil

#### Engine oil specifications

Model	MB-Freigabe or MB-Approval
GLS 450 4MATIC	229.51, 229.52, 229.61, 229.71 229.72*
GLS 580 4MATIC	229.52 229.61*

#### Engine oil specifications (Mercedes-Maybach)

Model	MB-Freigabe or MB-Approval
Mercedes-Maybach GLS 600 4MATIC	229.5

\* Recommended for lowest possible fuel consumption (lowest SAE viscosity class in each case; observe possible restrictions of the approved SAE viscosity classes).

To achieve the lowest possible fuel consumption, it is recommended to use the engine oil specifications marked in the table for the lowest SAE viscosity class. Possible restrictions of the approved SAE viscosity classes must be observed.

The following values refer to an oil change, including the oil filter.

#### Engine oil filling capacity

Model	Capacity
GLS 450 4MATIC	8.9 US qt (8.5 liters)
GLS 580 4MATIC	10.0 US qt (9.5 liters)

#### Engine oil capacity (Mercedes-Maybach)

Model	Capacity
Mercedes-Maybach GLS 600 4MATIC	10.0 US qt (9.5 liters)

### Notes on brake fluid

Note the instructions about operating fluids (→ page 408).

**⚠ WARNING** Risk of an accident due to vapor pockets forming in the brake system

The brake fluid constantly absorbs moisture from the air. This lowers the boiling point of the brake fluid. If the boiling point is too low, vapor pockets may form in the brake system when the brakes are applied hard.

This causes the braking effect to be impaired.

- ▶ Have the brake fluid renewed at the specified intervals.

Have the brake fluid replaced regularly at a qualified specialist workshop.

Only use a brake fluid approved by Mercedes-Benz according to MB-Freigabe or MB-Approval 331.0.

### Coolant

#### Notes on coolant

Observe the notes on operating fluids (→ page 408).

**⚠ WARNING** - Risk of fire and injury from antifreeze

If antifreeze comes into contact with hot component parts in the engine compartment, it may ignite.

- ▶ Allow the engine to cool down before adding antifreeze.
- ▶ Make sure that no antifreeze spills out next to the filler opening.
- ▶ Thoroughly clean off any antifreeze from component parts before starting the vehicle.

**! NOTE** Damage caused by incorrect coolant

- ▶ Only use coolant that has been premixed with the required antifreeze protection.

Information on coolant is available at the following locations:

- In the Mercedes-Benz Specification for Operating Fluids 320.1
  - At <https://bevo.mercedes-benz.com>
  - In the Mercedes-Benz BeVo app
- At a qualified specialist workshop

**! NOTE** Overheating at high outside temperatures

If an inappropriate coolant is used, the engine cooling system is not sufficiently protected against overheating and corrosion at high outside temperatures.

- ▶ Only use coolant approved by Mercedes-Benz.
- ▶ Observe the instructions in the Mercedes-Benz Specifications for Operating Fluids 320.1.

Have the coolant regularly replaced at a qualified specialist workshop.

## 414 Technical data

Proportion of antifreeze concentrate in the engine cooling system:

- A minimum of 50% (antifreeze protection down to about -35°F (-37°C))
- A maximum of 55% (antifreeze protection down to -49°F (-45°C))

### Coolant capacity

#### Engine coolant

Model	Capacity
GLS 450 4MATIC	20.0 US qt (18.9 liters)
GLS 580 4MATIC	16.6 US qt (15.7 liters)

#### Engine coolant (Mercedes-Maybach)

Model	Capacity
Mercedes-Maybach GLS 600 4MATIC	16.6 US qt (15.7 liters)

### Notes on windshield washer fluid

Observe the notes on operating fluids (→ page 408).

**⚠ WARNING** - Risk of fire and injury from windshield washer concentrate

Windshield washer concentrate is highly flammable. It could ignite if it comes into contact with hot engine component parts or the exhaust system.

- ▶ Make sure that no windshield washer concentrate spills out next to the filler opening.

**! NOTE** Damage to the exterior lighting due to unsuitable windshield washer fluid

Unsuitable windshield washer fluid may damage the plastic surface of the exterior lighting.

- ▶ Only use windshield washer fluid which is also suitable for use on plastic surfaces, e.g. MB SummerFit or MB WinterFit.

**! NOTE** Blocked spray nozzles caused by mixing windshield washer fluids

- ▶ Do not mix MB SummerFit and MB WinterFit with other windshield washer fluids.

Do not use distilled or de-ionized water. Otherwise, the fill level sensor may be triggered erroneously.

Recommended windshield washer fluid:

- Above freezing point: e.g. MB SummerFit
- Below freezing point: e.g. MB WinterFit

For the correct mixing ratio, refer to the information on the antifreeze container.

Mix washer fluid with windshield washer fluid all year round.

### Refrigerant

#### Notes on refrigerant

Observe the notes on operating fluids (→ page 408).



**! NOTE** Damage due to incorrect refrigerant

If a non-approved refrigerant is used, the climate control system may be damaged.

- ▶ **USA:** use only R-134a refrigerant.
- ▶ **Canada:** use only R-1234yf refrigerant.

**! NOTE** Damage to the climate control system due to incorrect refrigerant compressor oil

- ▶ Only use refrigerant compressor oil that has been approved by Mercedes-Benz.
- ▶ Do not mix the approved refrigerant compressor oil with a different refrigerant compressor oil.

Work on the climate control system may be carried out only by a qualified specialist workshop. All applicable regulations, as well as SAE standard J639, must be adhered to.

The information label for the climate control system regarding the refrigerant type and the refrigerant compressor oil (PAG oil) is located on the inside of the hood.

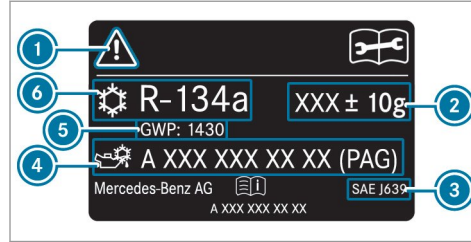

Information label (example - USA/China)

- ① Hazard and service warning symbols
- ② Refrigerant filling capacity
- ③ Applicable standards
- ④ PAG oil part number
- ⑤ GWP (global warming potential) of the refrigerant used
- ⑥ Refrigerant type

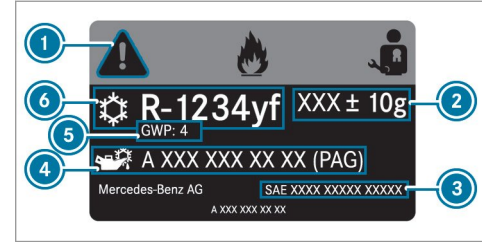

Information label (example - Canada)

- ① Hazard and service warning symbols
- ② Refrigerant filling capacity
- ③ Applicable standards
- ④ PAG oil part number
- ⑤ GWP (global warming potential) of the refrigerant used
- ⑥ Refrigerant type

Symbols ① indicate the following:

- Possible dangers
- The need to have service work carried out at a qualified specialist workshop only

## Filling capacity for refrigerant and PAG oil

## Refrigerant filling capacity

Model	
All models	34.6 ± 0.4 oz (980 ± 10 g)

## Refrigerant filling capacity (Mercedes-Maybach)

Model	
Mercedes-Maybach GLS 600 4MATIC	34.6 ± 0.4 oz (980 ± 10 g)

## Filling capacity for PAG oil

Model	
GLS 450 4MATIC	5.0 ± 0.4 oz (140 ± 10 g)
GLS 580 4MATIC	5.0 ± 0.4 oz (140 ± 10 g)

## Filling capacity for PAG oil (Mercedes-Maybach)

Model	
Mercedes-Maybach GLS 600 4MATIC	2.9 ± 0.4 oz (80 ± 10 g)

## Vehicle data

## Vehicle dimensions

The heights specified may vary as a result of the following factors:

- Tires
- Load
- Condition of the suspension
- Optional equipment

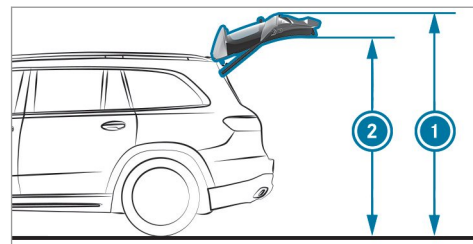

## Height when opened and headroom

Model	① Height when opened*	② Head-room*
Vehicles with AIR-MATIC	84.4 in (2144 mm) - 87.9 in (2234 mm)	75.9 in (1929 mm) - 79.4 in (2019 mm)
Vehicles with Off-road package	84.4 in (2144 mm) - 89.5 in (2274 mm)	75.9 in (1929 mm) - 81.0 in (2059 mm)

**Height when opened and headroom (Mercedes-Maybach)**

Model	① Height when opened*	② Headroom*
Mercedes-Maybach GLS 600 4MATIC	85.0 in (2159 mm) - 87.9 in (2234 mm)	76.5 in (1944 mm) - 79.4 in (2019 mm)

\*When the rear-end lowering is activated, the values are correspondingly lower.

**Vehicle dimensions**

All models	
Vehicle length	205.0 in (5207 mm)
Vehicle length, AMG Styling	205.2 in (5213 mm)
Vehicle width including outside mirrors	84.9 in (2157 mm)

**All models**

Maximum vehicle height (AIR-MATIC)	74.3 in (1888 mm)
Maximum vehicle height (Off-road package)	75.9 in (1928 mm)
Minimum vehicle height (highway driving level)	71.7 in (1823 mm) - 72.3 in (1838 mm)
Wheelbase	123.4 in (3135 mm)
Maximum ground clearance (AIRMATIC)	10.1 in (259 mm)
Maximum ground clearance (Off-road package)	11.3 in (289 mm)
Minimum ground clearance (AIRMATIC/Off-road package)	6.8 in (174 mm)
Turning radius	41.1 ft (12.52 m)

**Vehicle dimensions (Mercedes-Maybach)**

Mercedes-Maybach GLS 600 4MATIC	
Vehicle length	204.9 in (5205 mm)
Vehicle width including outside mirrors	84.9 in (2157 mm)
Maximum vehicle height	74.3 in (1888 mm)
Minimum vehicle height (highway driving level)	72.3 in (1838 mm)
Wheelbase	123.4 in (3135 mm)
Maximum ground clearance	8.2 in (210 mm)
Minimum ground clearance	5.3 in (135 mm)
Turning radius	41.1 ft (12.52 m)

## Weights and loads

Please note that for the specified vehicle data:

- Items of optional equipment increase the curb weight and reduce the payload.
- Vehicle-specific weight information can be found on the vehicle identification plate (→ page 407).

### Roof load

#### All models

Maximum roof load	220 lb (100 kg)
-------------------	-----------------

### Running board

#### All models

Maximum load	440 lb (200 kg)
--------------	-----------------

## Off-road driving

### Fording depth

**!** **NOTE** Damage caused by water when fording

In the following cases water can penetrate into the engine compartment and vehicle interior:

- The maximum permissible fording depth is exceeded when driving through standing water.
- When driving through the water a bow wave forms.
- Water accumulates when driving through running water.

▶ Do not exceed the maximum permissible fording depth and drive slowly through the water.

The specified value indicates the maximum permissible fording depth for:

- Vehicles that are ready to drive
- slow driving through standing water

Driving through flowing water reduces the permissible fording depth due to the accumulation of water.

Observe the notes on off-road driving and fording (→ page 182).

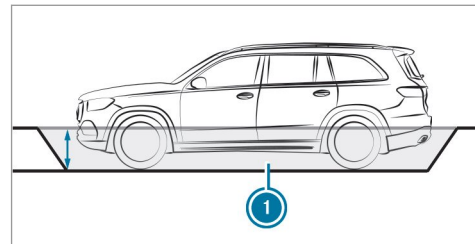

### Fording depth

Model	① Fording depth
<b>Vehicles with AIRMATIC</b>	
Raised level	19.7 in (50 cm)
<b>Vehicles with Off-road package</b>	

Model	1 Fording depth
Off-road level 1	19.7 in (50 cm)
Off-road level 2	19.7 in (50 cm)
Off-road level 3	23.6 in (60 cm)

#### Fording depth (Mercedes-Maybach)

Mercedes-Maybach GLS 600 4MATIC	1 Fording depth
Raised level	19.7 in (50 cm)

#### Angle of approach/departure

The specified values are maximum values for vehicles that are ready to drive.

Observe the notes on driving in mountainous terrain (→ page 182).

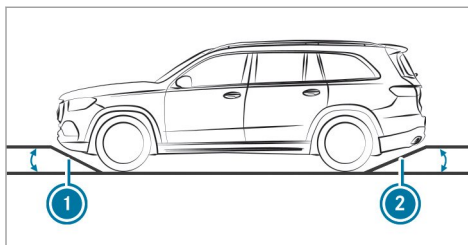

#### Angle of approach/departure (vehicles without AMG Styling)

All models	1 Front	2 Rear
<b>Vehicles with AIR-MATIC*</b>		
Normal level	23°	20°
Raised level	27°	24°
<b>Vehicles with Off-road package</b>		
Normal level	23°	20°

All models	1 Front	2 Rear
Off-road level 1	25°	22°
Off-road level 2	27°	24°
Off-road level 3	29°	26°

#### Angle of approach/departure (vehicles with AMG Styling)

All models	1 Front	2 Rear
<b>Vehicles with AIR-MATIC</b>		
Normal level	21° - 22°	20° - 21°
Raised level	25°	24°
<b>Vehicles with Off-road package</b>		
Normal level	21° - 22°	20° - 21°
Off-road level 1	23° - 24°	22° - 23°

All models	① Front	② Rear
Off-road level 2	25°	24°
Off-road level 3	27° - 28°	25° - 26°

#### Angle of approach/departure (Mercedes-Maybach)

Mercedes-Maybach GLS 600 4MATIC	① Front	② Rear
Normal level	24°	21°
Raised level	27°	25°

\*Depending on the tire size.

#### Maximum gradient climbing ability

The vehicle's gradient climbing ability depends on the weight distribution in the vehicle, the terrain conditions and the road surface conditions.

The specified value applies when:

- The vehicle is ready to drive
- The **LOW RANGE** off-road gear of the transfer case is engaged

- The road surface conditions and thus the traction are good

A gradient climbing ability of 100% corresponds to an incline of 45°.

Observe the notes on driving in mountainous terrain (→ page 182).

#### Gradient climbing ability

Model	Maximum gradient climbing ability
<b>Vehicles without Off-road package</b>	80%
<b>Vehicles with Off-road package</b>	100%
When LOW RANGE off-road gear is engaged	

#### Gradient climbing ability (Mercedes-Maybach)

Model	Maximum gradient climbing ability
Mercedes-Maybach GLS 600 4MATIC	80%

#### Trailer hitch

##### General notes on the trailer hitch

Modifications to the engine cooling system may be necessary, depending on the vehicle model. The retrofitting of a trailer hitch is only permissible if a towing capacity is specified in your vehicle documents.

Further information can be obtained at a qualified specialist workshop.

##### Towing capacity

The tongue weight is not included in the towing capacity.

Missing values were not available at the time of going to press.

#### Towing capacity, braked

Model	Towing capacity
All models	

#### Towing capacity, braked (Mercedes-Maybach)

Model	Towing capacity
Mercedes-Maybach GLS 600 4MATIC	

#### Maximum tongue weight and load capacity

**!** NOTE Damage caused by the trailer coming loose

If the tongue weight used is too low, the trailer may come loose.

▶ The tongue weight must not be below 110.2 lbs (50 kg).

▶ Use a tongue weight that is as close as possible to the maximum permissible tongue weight.

**!** NOTE Damage caused by the bicycle rack coming loose

When using a bicycle rack, both the maximal tongue weight and the maximal load capacity should be observed.

▶ Do not exceed the permissible load capacity.

Observe the additional notes on load capacity .

#### Tongue weight

Model	Maximum tongue weight
All models	617.3 lbs (280 kg)

#### Tongue weight (Mercedes-Maybach)

Model	Maximum tongue weight
Mercedes-Maybach GLS 600 4MATIC	617.3 lbs (280 kg)

#### Load capacity

All models	Maximum load
When attaching the bicycle rack to the ball head	165.3 lbs (75 kg)
When attaching the bicycle rack to the ball head and additionally to the guide pin	220.5 lbs (100 kg)

## 422 Technical data

---

### Load capacity (Mercedes-Maybach)

Mercedes-Maybach GLS 600 4MATIC	Maximum load
When attaching the bicycle rack to the ball head	165.3 lbs (75 kg)
When attaching the bicycle rack to the ball head and additionally to the guide pin	220.5 lbs (100 kg)

### Permissible rear axle load (trailer operation)

#### Trailer operation axle load

Model	Axle load
All models	4078.5 lbs (1850 kg)

#### Trailer operation axle load (Mercedes-Maybach)

Model	Axle load
Mercedes-Maybach GLS 600 4MATIC	4078.5 lbs (1850 kg)



## Display messages

### Introduction



#### Notes about display messages

Display messages appear on the instrument display.

Display messages with graphic symbols are simplified in the Operator's Manual and may differ from the symbols on the instrument display. The instrument display shows high-priority display messages in red. Certain display messages are accompanied by a warning tone.

Please act in accordance with the display messages and follow the additional notes in the Operator's Manual.

For some display messages, symbols will also be shown:

-  Further information
-  Hide display message

With the left-hand Touch Control, you can select the respective symbol by swiping to the left or right. Pressing  displays further information on

the media display. Press the  symbol to hide the display message.

You can hide low-priority display messages by pressing the back button  or the left-hand Touch Control. The display messages will then be stored in the message memory.

Rectify the cause of a display message as quickly as possible.

High-priority display messages cannot be hidden. The instrument display will show these display messages permanently until the cause of the display message has been rectified.



#### Calling up saved display messages

On-board computer:



 **Service**  **1 Message**

If there are no display messages, **No Messages** will appear on the instrument display.

 Scroll through the display messages by swiping upwards or downwards on the left-hand Touch Control.

 **To exit the message memory:** press the back button .

## Occupant safety

Display messages	Possible causes/consequences and ► Solutions
 <p data-bbox="144 381 395 433">SRS Malfunction Service Required</p>	<p data-bbox="476 288 1005 313">* The restraint system is malfunctioning (→ page 39).</p> <div data-bbox="500 332 1648 446" style="border: 1px solid gray; padding: 5px;"> <p data-bbox="506 339 1212 365">▲ <b>WARNING</b> Risk of injury due to malfunctions in the restraint system</p> <p data-bbox="513 381 1578 407">Components in the restraint system may be activated unintentionally or not deploy as planned in an accident.</p> <p data-bbox="513 417 1474 443">► Have the restraint system checked and repaired immediately at a qualified specialist workshop.</p> </div>
 <p data-bbox="144 557 417 609">Front Left Malfunction Service Required (example)</p>	<p data-bbox="476 464 1153 490">* The corresponding restraint system is malfunctioning (→ page 39).</p> <div data-bbox="500 508 1648 622" style="border: 1px solid gray; padding: 5px;"> <p data-bbox="506 515 1212 541">▲ <b>WARNING</b> Risk of injury due to malfunctions in the restraint system</p> <p data-bbox="513 557 1578 583">Components in the restraint system may be activated unintentionally or not deploy as planned in an accident.</p> <p data-bbox="513 593 1474 619">► Have the restraint system checked and repaired immediately at a qualified specialist workshop.</p> </div>
 <p data-bbox="144 733 388 811">Left Side Curtain Airbag Malfunction Service Required (example)</p>	<p data-bbox="476 640 1153 666">* The corresponding restraint system is malfunctioning (→ page 39).</p> <div data-bbox="500 684 1648 826" style="border: 1px solid gray; padding: 5px;"> <p data-bbox="506 692 1411 717">▲ <b>WARNING</b> Risk of injury or fatal injury due to a malfunction in the window curtain airbag</p> <p data-bbox="513 733 1578 780">The window curtain airbag might be triggered unintentionally or might not be triggered at all in the event of an accident.</p> <p data-bbox="513 790 1530 816">► Have the window curtain airbag checked and repaired immediately at a qualified specialist workshop.</p> </div>

Display messages	Possible causes/consequences and ► Solutions
<p>Front Passenger Airbag Disabled See Operator's Manual</p>	<p>* The front passenger airbag has been disabled even though an adult or a person of adult build is on the front passenger seat. If additional forces are applied to the seat, the weight the system detects may be too low.</p> <div data-bbox="545 315 1690 523" style="border: 1px solid gray; padding: 5px;"> <p><b>▲ WARNING</b> Risk of injury or fatal injury due to a disabled front passenger airbag</p> <p>If the front passenger airbag is disabled, the front passenger airbag will not be deployed in the event of an accident and cannot perform its intended protective function.</p> <p>A person in the front passenger seat could then, for example, come into contact with the vehicle's interior, especially if the person is sitting too close to the cockpit.</p> <p>► Make sure, both before and during the journey, that the status of the front passenger airbag is correct.</p> </div> <p>► Stop the vehicle immediately in accordance with the traffic conditions.</p> <p>► Make sure that no objects are trapped under the front passenger seat.</p> <p>► Check the status of automatic front passenger airbag shutoff (→ page 49).</p> <p>► If necessary, consult a qualified specialist workshop immediately.</p>
<p>Front Passenger Airbag Enabled See Operator's Manual</p>	<p>* The front passenger airbag will be enabled while the vehicle is in motion in the following situations:</p> <ul style="list-style-type: none"> <li>• Even when a child, a person of smaller stature or an object weighing less than the system weight threshold is located on the front passenger seat</li> <li>• Even when the front passenger seat is not occupied</li> </ul> <p>The system may detect objects or forces that are adding to the weight applied to the seat.</p>

Display messages	Possible causes/consequences and ► Solutions
	<p><b>▲ WARNING</b> Risk of injury or death when using a child restraint system while the front passenger airbag is enabled</p> <p>If you secure a child in a child restraint system on the front passenger seat and the front passenger airbag is enabled, the front passenger airbag can deploy in the event of an accident.</p> <p>The child could be struck by the airbag.</p> <ul style="list-style-type: none"> <li>► Ensure, both before and during the journey, that the status of the front passenger airbag is correct.</li> </ul> <p>NEVER use a rearward facing child restraint on a seat protected by an ACTIVE AIRBAG in front of it, DEATH or SERIOUS INJURY to the CHILD can occur.</p> <ul style="list-style-type: none"> <li>► Stop the vehicle immediately in accordance with the traffic conditions.</li> <li>► Make sure that no objects are trapped under the front passenger seat.</li> <li>► Check the status of automatic front passenger airbag shutoff (→ page 49).</li> <li>► If necessary, consult a qualified specialist workshop immediately.</li> </ul>
PRE-SAFE Inoperative See Operator's Manual	<ul style="list-style-type: none"> <li>* The PRE-SAFE® functions are malfunctioning.</li> <li>► Consult a qualified specialist workshop.</li> </ul>
PRE-SAFE Impulse Side Inoperative See Operator's Manual	<ul style="list-style-type: none"> <li>* The PRE-SAFE® Impulse Side system is malfunctioning or inoperative after having already been triggered.</li> <li>► Consult a qualified specialist workshop.</li> </ul>

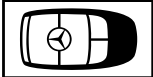
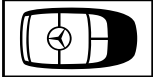
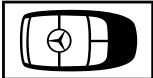

## SmartKey

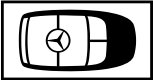
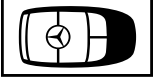
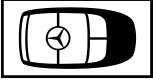



Display messages	Possible causes/consequences and ► Solutions
 <p data-bbox="195 381 376 407">Obtain a New Key</p>	<ul style="list-style-type: none"> <li data-bbox="519 291 827 317">* Have the SmartKey replaced.</li> <li data-bbox="543 324 962 350">► Consult a qualified specialist workshop.</li> </ul>
 <p data-bbox="195 523 399 549">Replace Key Battery</p>	<ul style="list-style-type: none"> <li data-bbox="519 433 898 458">* The SmartKey battery is discharged.</li> <li data-bbox="543 466 911 492">► Replace the battery (→ page 72).</li> </ul>
 <p data-bbox="195 663 439 717">Key Not Detected (white display message)</p>	<ul style="list-style-type: none"> <li data-bbox="519 572 916 598">* The SmartKey is currently undetected.</li> <li data-bbox="543 606 1079 631">► Change the location of the SmartKey in the vehicle.</li> <li data-bbox="543 639 1677 665">► If the SmartKey is still not recognized, place it in the marked space for starting with the SmartKey (→ page 175).</li> </ul>

Display messages	Possible causes/consequences and ► Solutions
 <p data-bbox="144 342 413 394">Key Not Detected (red display message)</p>	<p data-bbox="473 249 1184 306">* The SmartKey cannot be detected and may no longer be in the vehicle. The SmartKey is no longer in the vehicle and you switch off the vehicle:</p> <ul data-bbox="500 317 892 373" style="list-style-type: none"><li data-bbox="500 317 874 342">• You can no longer start the vehicle.</li><li data-bbox="500 348 892 373">• You cannot centrally lock the vehicle.</li></ul> <p data-bbox="491 389 944 415">► Ensure that the SmartKey is in the vehicle.</p> <p data-bbox="491 441 1360 467">If the SmartKey detection function has a malfunction due to a strong radio signal source:</p> <ul data-bbox="491 477 1483 534" style="list-style-type: none"><li data-bbox="491 477 1215 503">► Stop the vehicle immediately in accordance with the traffic conditions.</li><li data-bbox="491 508 1483 534">► Place the SmartKey in the marked space for starting the engine with the SmartKey (→ page 175).</li></ul>
 <p data-bbox="144 651 371 677">Don't Forget Your Key</p>	<p data-bbox="473 558 1641 584">* A warning tone will also sound. This message reminds you to take your SmartKey with you when you leave the vehicle.</p>
 <p data-bbox="144 791 421 843">Key Being Initialized Please Wait</p>	<p data-bbox="473 698 1119 724">* The vehicle is processing in order to teach in the new SmartKey.</p> <ul data-bbox="491 729 861 755" style="list-style-type: none"><li data-bbox="491 729 861 755">► Wait until processing is complete.</li></ul>

Display messages	Possible causes/consequences and ► Solutions
<p>Place the Key in the Marked Space See Operator's Manual</p>	<ul style="list-style-type: none"> <li>* SmartKey detection is malfunctioning.               <ul style="list-style-type: none"> <li>► Change the location of the SmartKey in the vehicle.</li> <li>► Place the SmartKey in the marked space for starting the engine with the SmartKey (→ page 175).</li> </ul> </li> </ul>

## Lights

Display messages	Possible causes/consequences and ► Solutions
<div style="text-align: center;">  </div> <p>Check Left Low Beam (example)</p>	<ul style="list-style-type: none"> <li>* The corresponding light source is defective.               <ul style="list-style-type: none"> <li>► Drive on carefully.</li> <li>► Visit a qualified specialist workshop immediately.</li> </ul> </li> <li>ⓘ LED light sources: the display message for the corresponding light appears only when all the light-emitting diodes in the light are faulty.</li> </ul>
<div style="text-align: center;">  </div> <p>Malfunction See Operator's Manual</p>	<ul style="list-style-type: none"> <li>* The exterior lighting is malfunctioning.               <ul style="list-style-type: none"> <li>► Consult a qualified specialist workshop.</li> </ul> </li> </ul>

Display messages	Possible causes/consequences and ► Solutions
 <p data-bbox="144 339 421 391">Automatic Headlamp Mode Inoperative</p>	<ul style="list-style-type: none"> <li>* The light sensor for automatic driving lights is malfunctioning.                             <ul style="list-style-type: none"> <li>► Consult a qualified specialist workshop.</li> </ul> </li> </ul>
 <p data-bbox="144 508 421 560">Active Headlamps Inoperative</p>	<ul style="list-style-type: none"> <li>* The active headlamps are malfunctioning.                             <ul style="list-style-type: none"> <li>► Consult a qualified specialist workshop.</li> </ul> </li> </ul>
 <p data-bbox="144 677 369 702">Switch On Headlamps</p>	<ul style="list-style-type: none"> <li>* You are driving without low-beam headlamps.                             <ul style="list-style-type: none"> <li>► Turn the light switch to the  or <b>AUTO</b> position.</li> </ul> </li> </ul>
 <p data-bbox="144 815 317 840">Switch Off Lights</p>	<ul style="list-style-type: none"> <li>* You are leaving the vehicle and the lights are still switched on.                             <ul style="list-style-type: none"> <li>► Turn the light switch to the <b>AUTO</b> position.</li> </ul> </li> </ul>





Display messages	Possible causes/consequences and ► Solutions
 <p data-bbox="195 342 469 389">Intell. Light System Inoperative</p>	<ul style="list-style-type: none"> <li>* The Intelligent Light System is malfunctioning. The lighting system continues to function properly without the functions of the Intelligent Light System.               <ul style="list-style-type: none"> <li>► Consult a qualified specialist workshop.</li> </ul> </li> </ul>
<p data-bbox="195 417 462 493">Adaptive Highbeam Assist Currently Unavailable See Operator's Manual</p>	<ul style="list-style-type: none"> <li>* Adaptive Highbeam Assist is temporarily unavailable. The system limits have been reached (→ page 151). Once the cause of the problem is no longer present, the system will be available again. The <a href="#">Adaptive Highbeam Assist Now Available</a> display message will appear.               <ul style="list-style-type: none"> <li>► Drive on.</li> <li>► Operate the high beam manually until Adaptive High Beam Assist is available again.</li> </ul> </li> </ul>
<p data-bbox="195 624 462 676">Adaptive Highbeam Assist Inoperative</p>	<ul style="list-style-type: none"> <li>* Adaptive Highbeam Assist is malfunctioning.               <ul style="list-style-type: none"> <li>► Drive on.</li> <li>or</li> <li>► Stop the vehicle in accordance with the traffic conditions and restart the vehicle.</li> <li>► If the display message does not disappear: consult a qualified specialist workshop.</li> <li>► Until then, operate the high beam manually.</li> </ul> </li> </ul>
<p data-bbox="195 831 449 883">Hazard Warning Flashers Malfunctioning</p>	<ul style="list-style-type: none"> <li>* The hazard warning lamp switch is malfunctioning.               <ul style="list-style-type: none"> <li>► Consult a qualified specialist workshop.</li> </ul> </li> </ul>

## Vehicle

Display messages	Possible causes/consequences and ► Solutions
Update Successfully Completed	* Installation of the software update has been successfully completed (→ page 298).
Update Failed Software Remains Unchanged	* An error occurred during installation of the software update (→ page 298). The previous software release remains in place.
Update Failed	* An error occurred during installation of the software update (→ page 298). Make a Mercedes me call via the overhead control panel (→ page 316).
 Vehicle Ready to Drive Switch the Ignition Off Before Exiting	* You are leaving the vehicle in a ready-to-drive state. <ul style="list-style-type: none"> <li>► Get out of the vehicle, secure it against rolling away and take the SmartKey with you.</li> <li>► If you do not leave the vehicle, switch off the electrical consumers, e.g. the seat heating. Otherwise, the 12-V battery may discharge and starting the engine may be possible only with the help of a second battery (jump start).</li> </ul>
Running Boards Not Retracted Pay Attention to Excess Width of Vehicle	* Mercedes-Maybach vehicles: the running boards are not retracted. <ul style="list-style-type: none"> <li>• The running boards can be retracted via the multimedia system only when the vehicle is stationary (→ page 78).</li> <li>• The running boards and the side skirt must be free of dirt, ice and snow. Otherwise, they are unable to retract.</li> </ul> ► Clean the running boards (→ page 346).

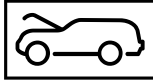
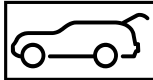

Display messages	Possible causes/consequences and ► Solutions
	<ul style="list-style-type: none"> <li>► Repeat the retraction of the running boards (→ page 77). If the running boards cannot be retracted again, consult a qualified specialist workshop.</li> <li>► If the running boards are not retracted, check the excess width of the vehicle.</li> </ul>
<div style="border: 1px solid black; padding: 5px; width: fit-content; margin-bottom: 5px;">  </div> <p>Running Board Not Extended</p>	<ul style="list-style-type: none"> <li>* Mercedes-Maybach vehicles: the running boards are not extended. <ul style="list-style-type: none"> <li>• The running boards extend only when the vehicle is stationary.</li> <li>• The running boards and the side skirt must be free of dirt, ice and snow. Otherwise, they are unable to extend.</li> </ul> </li> <li>► Clean the running boards (→ page 346).</li> <li>► Repeat the extension of the running boards (→ page 77). If the running boards fail to extend again, consult a qualified specialist workshop.</li> <li>► If the running boards are not extended, be particularly careful when getting in or out.</li> </ul>
<p>Head-up Display Currently Unavailable See Operator's Manual</p>	<ul style="list-style-type: none"> <li>* The Head-up Display is temporarily unavailable. Possible causes: <ul style="list-style-type: none"> <li>• Malfunctions in the power supply</li> <li>• Signal interference</li> </ul> </li> <li>► Stop in accordance with the traffic conditions and switch the vehicle off and on again.</li> <li>► If the display message still appears, consult a qualified specialist workshop.</li> </ul>
<p>Head-up Display Inoperative</p>	<ul style="list-style-type: none"> <li>* The Head-up Display has an internal error. <ul style="list-style-type: none"> <li>► Consult a qualified specialist workshop.</li> </ul> </li> </ul>

Display messages	Possible causes/consequences and ► Solutions
 <p>Steering Malfunction Increased Physical Effort See Operator's Manual</p>	<p>* The power steering assistance is malfunctioning.</p> <div style="background-color: #f0f0f0; padding: 5px;"> <p><b>⚠ WARNING</b> Risk of an accident due to altered steering characteristics</p> <p>If the power assistance of the steering fails partially or completely, you will need to use more force to steer.</p> <ul style="list-style-type: none"> <li>► If safe steering is possible, drive on carefully.</li> <li>► Visit or consult a qualified specialist workshop immediately.</li> </ul> </div>
 <p>Steering Malfunction Stop Immediately See Operator's Manual</p>	<p>* The steering is malfunctioning. Steering capability is significantly impaired.</p> <div style="background-color: #f0f0f0; padding: 5px;"> <p><b>⚠ WARNING</b> Risk of accident if steering capability is impaired</p> <p>If the steering does not function as intended, the vehicle's operating safety is jeopardized.</p> <ul style="list-style-type: none"> <li>► Pull over and stop the vehicle safely as soon as possible, paying attention to road and traffic conditions. Do not continue driving under any circumstances.</li> <li>► Consult a qualified specialist workshop.</li> </ul> </div>
	<p>* At least one door is open.</p> <ul style="list-style-type: none"> <li>► Close all doors.</li> </ul>

Display messages	Possible causes/consequences and ► Solutions
	<p>* The hood is open.</p> <p><b>⚠ WARNING</b> Risk of accident due to driving with the hood unlocked</p> <p>The hood may open and block your view.</p> <ul style="list-style-type: none"> <li>► Never release the hood when driving.</li> <li>► Before every trip, ensure that the hood is locked.</li> </ul> <p>► Stop the vehicle immediately in accordance with the traffic conditions.</p> <p>► Close the hood.</p>
	<p>* The tailgate is open.</p> <p><b>⚠ DANGER</b> Risk of poisoning from exhaust gases</p> <p>Combustion engines emit poisonous exhaust gases, such as carbon monoxide. Exhaust gases can enter the vehicle interior if the tailgate is open when the vehicle is running, especially if the vehicle is in motion.</p> <ul style="list-style-type: none"> <li>► Always switch off the vehicle before opening the tailgate.</li> <li>► Never drive with the tailgate open.</li> </ul> <p>► Close the tailgate.</p>
<p>LOW RANGE Only When Vehicle Is Stationary</p>	<p>* One or more shifting conditions have not been met.</p> <p>► Stop the vehicle.</p>

Display messages	Possible causes/consequences and ► Solutions
	<ul style="list-style-type: none"> <li>► Engage neutral <b>[N]</b>.</li> <li>► Repeat the gear change.</li> </ul>
LOW RANGE Shift to Position N Briefly	<ul style="list-style-type: none"> <li>* One or more shifting conditions have not been met.               <ul style="list-style-type: none"> <li>► Engage neutral <b>[N]</b>.</li> <li>► Repeat the gear change.</li> </ul> </li> </ul>
LOW RANGE Not in Drive Program "Sport"	<ul style="list-style-type: none"> <li>* You will not be able to select the LOW RANGE off-road gear if the drive program <b>[S]</b> or <b>[S']</b> is switched on. The drive program therefore automatically switches to <b>[C]</b>.               <ul style="list-style-type: none"> <li>► Select the LOW RANGE off-road gear (→ page 198).</li> </ul> </li> </ul>
LOW RANGE Malfunction To Park, Apply Brake	<ul style="list-style-type: none"> <li>* The transfer case is malfunctioning.               <ul style="list-style-type: none"> <li>► Do not shift the transfer case!</li> <li>► Use the electric parking brake to secure the vehicle against rolling away.</li> <li>► Consult a qualified specialist workshop.</li> </ul> </li> </ul>
LOW RANGE Shifting Canceled Please Reactivate	<ul style="list-style-type: none"> <li>* The transfer case did not perform the gear change.               <ul style="list-style-type: none"> <li>► Repeat the gear change.</li> <li>► Ensure that all shifting conditions are met (→ page 198).</li> </ul> </li> </ul>
LOW RANGE Malfunction	<ul style="list-style-type: none"> <li>* The transfer case is malfunctioning.               <ul style="list-style-type: none"> <li>► Do not shift the transfer case!</li> </ul> </li> </ul>



Display messages	Possible causes/consequences and ► Solutions
	<ul style="list-style-type: none"> <li>► Use the electric parking brake to secure the vehicle against rolling away.</li> <li>► Consult a qualified specialist workshop.</li> </ul>
LOW RANGE Stop Apply Parking Brake	<ul style="list-style-type: none"> <li>* The transfer case is malfunctioning.               <ul style="list-style-type: none"> <li>► Stop the vehicle in accordance with the traffic conditions.</li> <li>► Apply the electric parking brake.</li> <li>► Where necessary, also secure the vehicle against rolling away.</li> <li>► Engage park position <b>P</b>.</li> </ul> </li> </ul>
LOW RANGE Max. Speed 6 mph	<ul style="list-style-type: none"> <li>* The maximum speed of 6 mph (10 km/h) for the gear change has been exceeded.               <ul style="list-style-type: none"> <li>► Drive more slowly.</li> <li>► Repeat the gear change.</li> </ul> </li> </ul>
LOW RANGE Max. Speed 25 mph	<ul style="list-style-type: none"> <li>* The maximum speed of 25 mph (40 km/h) for the gear change has been exceeded.               <ul style="list-style-type: none"> <li>► Drive more slowly.</li> <li>► To deactivate the gear change, press the <b>LOW RANGE</b> button again.</li> <li>► Repeat the gear change.</li> </ul> </li> </ul>
Gearbox Protection Limit 18 mph Disable LOW RANGE	<ul style="list-style-type: none"> <li>* The oil temperature in the transfer case is too high.               <ul style="list-style-type: none"> <li>► In the on-road position, shift to HIGH RANGE.</li> </ul> </li> </ul>



Display messages	Possible causes/consequences and ► Solutions
 <p data-bbox="144 339 413 391">Cannot Fold 2nd Seat Row See Operator's Manual</p>	<p data-bbox="473 249 1206 270">* The seat backrests on the second row of seats cannot be folded forward.</p> <ul style="list-style-type: none"> <li data-bbox="491 280 1557 308">► Check the requirements for folding forward the seat backrests on the second row of seats (→ page 104).</li> </ul>
 <p data-bbox="144 508 343 529">Check Washer Fluid</p>	<p data-bbox="473 418 1308 439">* The washer fluid level in the washer fluid reservoir has dropped below the minimum.</p> <ul style="list-style-type: none"> <li data-bbox="491 449 842 477">► Add washer fluid (→ page 340).</li> </ul>
<p data-bbox="144 557 358 578">Wiper Malfunctioning</p>	<p data-bbox="473 557 901 578">* The windshield wipers are malfunctioning.</p> <ul style="list-style-type: none"> <li data-bbox="491 588 717 616">► Restart the vehicle.</li> </ul> <p data-bbox="491 643 842 664">If the display message still appears:</p> <ul style="list-style-type: none"> <li data-bbox="491 674 912 702">► Consult a qualified specialist workshop.</li> </ul>



## Engine

Display messages	Possible causes/consequences and ► Solutions
To switch engine off, press and hold Start/Stop button for at least 3 seconds or press 3 times.	<ul style="list-style-type: none"> <li>* You have pressed the start/stop button while the vehicle is in motion.               <ul style="list-style-type: none"> <li>► Information about switching off the vehicle while driving (→ page 174).</li> </ul> </li> </ul>
Cannot Start Engine See Operator's Manual	<ul style="list-style-type: none"> <li>* The vehicle cannot be started.               <ul style="list-style-type: none"> <li>► Switch the vehicle off and switch it back on</li> <li>► If the display message still appears, consult a qualified specialist workshop.</li> </ul> </li> </ul>
 <p>Check Coolant Level See Operator's Manual</p>	<ul style="list-style-type: none"> <li>* The coolant level is too low.               <div style="border: 1px solid black; padding: 5px; margin-top: 10px;"> <p><b>!</b> <b>NOTE</b> Engine damage due to insufficient coolant</p> <ul style="list-style-type: none"> <li>► Avoid long journeys with insufficient coolant.</li> </ul> </div> <ul style="list-style-type: none"> <li>► Add coolant (→ page 339).</li> <li>► Have the engine cooling system checked at a qualified specialist workshop.</li> </ul> </li> </ul>

Display messages	Possible causes/consequences and ► Solutions
 <p data-bbox="144 339 421 391">Coolant Too Hot Stop Vehicle Turn Engine Off</p>	<p data-bbox="476 249 717 270">* The coolant is too hot.</p> <ul style="list-style-type: none"> <li data-bbox="495 280 1356 306">► Stop immediately in accordance with the traffic conditions and switch off the vehicle.</li> </ul> <div data-bbox="495 332 1648 588" style="border: 1px solid gray; padding: 5px;"> <p data-bbox="506 339 1023 365"><b>⚠ WARNING</b> Risk of burns when opening the hood</p> <p data-bbox="506 381 1604 433">If you open the hood in the event of an overheated engine or fire in the engine compartment, the following situations may occur:</p> <ul style="list-style-type: none"> <li data-bbox="519 443 968 464">• You may come into contact with hot gases.</li> <li data-bbox="519 474 1208 495">• You may come into contact with other escaping hot operating fluids.</li> </ul> <ul style="list-style-type: none"> <li data-bbox="506 519 1097 539">► Before opening the hood, allow the engine to cool down.</li> <li data-bbox="506 550 1474 570">► In the event of a fire in the engine compartment, keep the hood closed and call the fire service.</li> </ul> </div> <ul style="list-style-type: none"> <li data-bbox="495 601 907 622">► Wait until the engine has cooled down.</li> <li data-bbox="495 632 1134 653">► Make sure that the air supply to the radiator is not obstructed.</li> <li data-bbox="495 664 1622 715">► Avoiding high loads on the engine, drive to the nearest qualified specialist workshop. In doing so, ensure that the coolant temperature display remains below the red marking.</li> </ul>
	<p data-bbox="476 743 999 764">* There is a malfunction in the engine cooling system.</p> <ul style="list-style-type: none"> <li data-bbox="495 774 1622 826">► Avoiding high loads on the engine, drive to the nearest qualified specialist workshop. In doing so, ensure that the coolant temperature display remains below the red marking.</li> </ul>

Display messages	Possible causes/consequences and ► Solutions
 <p>Fuel Level Low</p>	<ul style="list-style-type: none"> <li>* The fuel supply has dropped into the reserve range.               <ul style="list-style-type: none"> <li>► Refuel.</li> </ul> </li> </ul>
 <p>Gas Cap Loose</p>	<ul style="list-style-type: none"> <li>* The fuel filler cap is not closed correctly or the fuel system is leaking.               <ul style="list-style-type: none"> <li>► Close the fuel filler cap.</li> <li>► <b>If the fuel filler cap was already properly closed:</b> consult a qualified specialist workshop.</li> </ul> </li> </ul>

### Transmission

Display messages	Possible causes/consequences and ► Solutions
<p>Only Shift to 'P' when Vehicle is Stationary</p>	<ul style="list-style-type: none"> <li>* It is possible to select the park position <b>P</b> only if the vehicle is stationary.               <ul style="list-style-type: none"> <li>► Depress the brake pedal to stop.</li> <li>► Shift the transmission to park position <b>P</b> when the vehicle is stationary.</li> </ul> </li> </ul>
<p>Apply Brake to Shift from 'P'</p>	<ul style="list-style-type: none"> <li>* You have attempted to shift the transmission out of park position <b>P</b> and into another transmission position.               <ul style="list-style-type: none"> <li>► Depress the brake pedal.</li> <li>► Select transmission position <b>D</b>, <b>R</b> or neutral <b>N</b>.</li> </ul> </li> </ul>

## 442 Display messages and warning/indicator lamps

Display messages	Possible causes/consequences and ► Solutions
<p>To Deselect P or N, Depress Brake and Start Engine</p>	<p>* You have attempted to shift the transmission out of park position <b>P</b> or neutral <b>N</b> and into another transmission position.</p> <ul style="list-style-type: none"> <li>► Depress the brake pedal.</li> <li>► Start the vehicle.</li> <li>► Change the transmission position.</li> </ul>
<p>Apply Brake to Shift to D or R</p>	<p>* You have attempted to select transmission position <b>D</b> or <b>R</b>.</p> <ul style="list-style-type: none"> <li>► Depress the brake pedal.</li> <li>► Select transmission position <b>D</b> or <b>R</b>.</li> </ul>
<p>Apply Brake to Shift to 'R'</p>	<p>* You have attempted to select transmission position <b>R</b>.</p> <ul style="list-style-type: none"> <li>► Depress the brake pedal.</li> <li>► Select transmission position <b>R</b>.</li> </ul>
<p>Driver's Door Open &amp; Transmission Not in P Risk of Vehicle Rolling Away</p>	<p>* The driver's door is not fully closed and transmission position <b>D</b>, <b>R</b> or neutral <b>N</b> is selected.</p> <p>The vehicle may roll away.</p> <ul style="list-style-type: none"> <li>► Select park position <b>P</b> when switching off the vehicle.</li> </ul>
<p>N Permanently Active Risk of Rolling Away</p>	<p>* While the vehicle is rolling or while you are driving, neutral <b>N</b> has been engaged.</p> <ul style="list-style-type: none"> <li>► Depress the brake pedal to stop.</li> <li>► Shift the transmission to park position <b>P</b> when the vehicle is stationary.</li> <li>► To continue driving, select transmission position <b>D</b> or <b>R</b>.</li> </ul>





Display messages	Possible causes/consequences and ► Solutions
Service Required Do Not Shift Gears Visit Dealer	<ul style="list-style-type: none"> <li>* The transmission is malfunctioning. It is no longer possible to change the transmission position.               <ul style="list-style-type: none"> <li>► If transmission position <b>D</b> is selected, consult a qualified specialist workshop and do not change the transmission position.</li> <li>► For all other transmission positions, park the vehicle safely.</li> <li>► Consult a qualified specialist workshop or breakdown service.</li> </ul> </li> </ul>
Reversing Not Possible Service Required	<ul style="list-style-type: none"> <li>* The transmission is malfunctioning. It is not possible to select transmission position <b>R</b>.               <ul style="list-style-type: none"> <li>► Consult a qualified specialist workshop.</li> </ul> </li> </ul>
Transmission Malfunction Stop	<ul style="list-style-type: none"> <li>* The transmission is malfunctioning. The transmission shifts to neutral <b>N</b> automatically.               <ul style="list-style-type: none"> <li>► Stop the vehicle immediately in accordance with the traffic conditions.</li> <li>► Depress the brake pedal.</li> <li>► Engage park position <b>P</b>.</li> <li>► Consult a qualified specialist workshop.</li> </ul> </li> </ul>
Stop Vehicle Leave Engine Running Wait Transmission Cooling	<ul style="list-style-type: none"> <li>* The transmission is overheating. Pulling away may be temporarily impaired or not possible.               <ul style="list-style-type: none"> <li>► Stop the vehicle immediately in accordance with the traffic conditions. Do not continue driving.</li> <li>► Leave the engine running.</li> <li>► Wait until the display message disappears before pulling away.</li> </ul> </li> </ul>
Auxiliary Battery Malfunction (white display message)	<ul style="list-style-type: none"> <li>* The auxiliary battery for the automatic transmission is no longer being charged.               <ul style="list-style-type: none"> <li>► Visit a qualified specialist workshop.</li> </ul> </li> </ul>









#### 444 Display messages and warning/indicator lamps

---

Display messages	Possible causes/consequences and ► Solutions
	<ul style="list-style-type: none"><li>► Until then, always select park position <b>P</b> manually before you switch off the vehicle.</li><li>► Before leaving the vehicle, apply the electric parking brake.</li></ul>
Auxiliary Battery Malfunction (red display message)	<ul style="list-style-type: none"><li>* <b>Vehicles with automatic transmission:</b> The auxiliary battery for the transmission is no longer being charged.</li><li>► Consult a qualified specialist workshop.</li><li>► <b>Vehicles with automatic transmission:</b> Until then, always select park position <b>P</b> before you switch off the vehicle.</li><li>► Before leaving the vehicle, apply the electric parking brake.</li></ul>





## Brakes







Display messages	Possible causes/consequences and ► Solutions
<div data-bbox="203 290 360 372" data-label="Image"> </div> <p data-bbox="203 378 304 409">(USA only)</p> <div data-bbox="203 419 360 502" data-label="Image"> </div> <p data-bbox="203 507 341 538">(Canada only)</p> <p data-bbox="194 543 462 595">Parking Brake See Operator's Manual</p>	<ul style="list-style-type: none"> <li data-bbox="526 290 1339 315">* The yellow  indicator lamp is lit. The electric parking brake is malfunctioning. <ul style="list-style-type: none"> <li data-bbox="545 326 637 352"><b>To apply:</b></li> <li data-bbox="545 357 1007 383">► Switch the vehicle off and switch it back on</li> <li data-bbox="545 388 1136 419">► Apply the electric parking brake manually (→ page 207).</li> </ul> <p data-bbox="545 445 1071 471">If it is not possible to apply the electric parking brake:</p> <ul style="list-style-type: none"> <li data-bbox="545 476 970 502">► Consult a qualified specialist workshop.</li> <li data-bbox="545 507 1256 538">► Where necessary, also secure the parked vehicle against rolling away.</li> </ul> </li> <li data-bbox="526 549 1690 600">* The yellow  indicator lamp and the red  (USA only) or  (Canada only) indicator lamp are lit. The electric parking brake is malfunctioning. <ul style="list-style-type: none"> <li data-bbox="545 611 656 637"><b>To release:</b></li> <li data-bbox="545 642 1007 668">► Switch the vehicle off and switch it back on</li> <li data-bbox="545 673 1155 704">► Release the electric parking brake manually (→ page 207).</li> </ul> <p data-bbox="545 714 572 740">or</p> <ul style="list-style-type: none"> <li data-bbox="545 745 1201 777">► Release the electric parking brake automatically (→ page 207).</li> </ul> <p data-bbox="545 777 1127 802">If it is still not possible to release the electric parking brake:</p> <ul style="list-style-type: none"> <li data-bbox="545 808 1210 839">► Do not continue driving. Consult a qualified specialist workshop.</li> </ul> </li> </ul>

Display messages	Possible causes/consequences and ► Solutions
	<p>* The yellow  indicator lamp is lit and the red  (USA only) or  (Canada only) indicator lamp is flashing. The electric parking brake is malfunctioning.</p> <p>The electric parking brake could not be applied or released.</p> <ul style="list-style-type: none"><li>► Switch the vehicle off and switch it back on</li></ul> <p><b>To apply:</b></p> <ul style="list-style-type: none"><li>► Release and then apply the electric parking brake manually (→ page 207).</li></ul> <p><b>To release:</b></p> <ul style="list-style-type: none"><li>► Apply and then release the electric parking brake manually.</li></ul> <p>If the electric parking brake cannot be applied or the red  (USA only) or  (Canada only) indicator lamp continues to flash:</p> <ul style="list-style-type: none"><li>► Do not continue driving. Consult a qualified specialist workshop.</li><li>► Where necessary, also secure the parked vehicle against rolling away.</li></ul> <p>* The yellow  indicator lamp is lit and the red  (USA only) or  (Canada only) indicator lamp flashes for approximately ten seconds after the electric parking brake has been applied or released. It then remains lit or goes out. The electric parking brake is malfunctioning.</p> <p><b>If the state of charge is too low:</b></p> <ul style="list-style-type: none"><li>► Charge the 12 V battery.</li></ul>



Display messages	Possible causes/consequences and ► Solutions
	<p><b>To apply:</b></p> <ul style="list-style-type: none"><li>► Switch off the vehicle. The electric parking brake will be applied automatically.</li></ul> <p>If you do not want the electric parking brake to be applied, e.g. at an automatic car wash or when the vehicle is being towed, leave the vehicle switched on. This does not include having the vehicle towed with the rear axle raised.</p> <p>If the electric parking brake is not applied automatically:</p> <ul style="list-style-type: none"><li>► Switch the vehicle off and switch it back on</li><li>► Release and then apply the electric parking brake manually (→ page 207).</li></ul> <p>If it is still not possible to apply the electric parking brake:</p> <ul style="list-style-type: none"><li>► Consult a qualified specialist workshop.</li><li>► Where necessary, also secure the parked vehicle against rolling away.</li></ul> <p><b>To release:</b></p> <ul style="list-style-type: none"><li>► If the conditions for automatic release are fulfilled and the electric parking brake is not released automatically, release the electric parking brake manually (→ page 207).</li></ul> <p>If it is still not possible to release the electric parking brake:</p> <ul style="list-style-type: none"><li>► Do not continue driving. Consult a qualified specialist workshop.</li></ul>



Display messages	Possible causes/consequences and ► Solutions
 <p>(USA only)</p>  <p>(Canada only)</p> <p>Please Release Parking Brake</p>	<p>* The red  indicator lamp (USA only) or  indicator lamp (Canada only) is flashing.</p> <p>The electric parking brake is applied while you are driving:</p> <ul style="list-style-type: none"><li>• A condition for automatic release of the electric parking brake has not been fulfilled (→ page 207).</li><li>• You are performing emergency braking using the electric parking brake (→ page 207).</li></ul> <p>► Check the conditions for automatic release of the electric parking brake.</p> <p>► Release the electric parking brake manually.</p>



Display messages	Possible causes/consequences and ► Solutions
<div data-bbox="205 249 362 332"></div> <div data-bbox="199 339 306 366">(USA only)</div> <div data-bbox="205 377 362 459"></div> <div data-bbox="199 467 340 494">(Canada only)</div> <div data-bbox="192 501 462 553">Turn On the Ignition to Release the Parking Brake</div>	<p>* The red  (USA only) or  (Canada only) indicator lamp is lit. You have attempted to release the electric parking brake with the vehicle switched off.</p> <ul style="list-style-type: none"> <li>► Switch on the vehicle.</li> </ul>
<div data-bbox="205 581 362 664"></div> <div data-bbox="192 671 303 698">(USA only)</div> <div data-bbox="205 708 362 791"></div> <div data-bbox="192 798 332 825">(Canada only)</div> <div data-bbox="192 832 439 853">Check Brake Fluid Level</div>	<p>* There is insufficient brake fluid in the brake fluid reservoir.</p> <div data-bbox="550 622 1696 660" style="background-color: #e0e0e0; padding: 5px;"> <p> <b>WARNING</b> Risk of an accident due to low brake fluid level</p> </div> <p>If the brake fluid level is too low, the braking effect and the braking characteristics may be impaired.</p> <ul style="list-style-type: none"> <li>► Pull over and stop the vehicle safely as soon as possible, paying attention to road and traffic conditions. Do not continue driving under any circumstances.</li> <li>► Consult a qualified specialist workshop.</li> <li>► Do not add brake fluid.</li> </ul>



## 450 Display messages and warning/indicator lamps



Display messages	Possible causes/consequences and ► Solutions
<a href="#">Check Brake Pads See Operator's Manual</a>	<ul style="list-style-type: none"><li>* The brakepads have reached the wear limit.<ul style="list-style-type: none"><li>► Consult a qualified specialist workshop.</li></ul></li></ul>

### Driving systems

Display messages	Possible causes/consequences and ► Solutions
 <p>Off</p>	<ul style="list-style-type: none"><li>* The HOLD function is deactivated because the vehicle is slipping or a condition for activation is not fulfilled.<ul style="list-style-type: none"><li>► Reactivate the HOLD function later or check the activation conditions for the HOLD function (→ page 215).</li></ul></li></ul>
 <p>ATTENTION ASSIST Inoperative</p>	<ul style="list-style-type: none"><li>* ATTENTION ASSIST is malfunctioning.<ul style="list-style-type: none"><li>► Visit a qualified specialist workshop.</li></ul></li></ul>

Display messages	Possible causes/consequences and ► Solutions
 <p data-bbox="195 342 473 389">ATTENTION ASSIST: Take a Break!</p>	<ul style="list-style-type: none"> <li>* ATTENTION ASSIST has detected fatigue or an increasing lack of concentration on the part of the driver (→ page 216).               <ul style="list-style-type: none"> <li>► If necessary, take a break.</li> </ul> </li> </ul>
 <p data-bbox="195 511 282 532">--- mph</p>	<ul style="list-style-type: none"> <li>* Cruise control cannot be activated as not all activation conditions are fulfilled.               <ul style="list-style-type: none"> <li>► Observe the activation conditions for cruise control (→ page 219).</li> </ul> </li> </ul>
<p data-bbox="195 557 463 581">Cruise Control Inoperative</p>	<ul style="list-style-type: none"> <li>* Cruise control is malfunctioning.               <ul style="list-style-type: none"> <li>► Visit a qualified specialist workshop.</li> </ul> </li> </ul>
<p data-bbox="195 632 380 656">Cruise Control Off</p>	<ul style="list-style-type: none"> <li>* Cruise control has been deactivated.               <ul style="list-style-type: none"> <li>If there is an additional warning tone, cruise control has been deactivated automatically (→ page 218).</li> </ul> </li> </ul>
 <p data-bbox="195 801 282 822">--- mph</p>	<ul style="list-style-type: none"> <li>* Active Distance Assist DISTRONIC cannot be activated as not all activation conditions are fulfilled.               <ul style="list-style-type: none"> <li>► Comply with the activation conditions of Active Distance Assist DISTRONIC (→ page 222).</li> </ul> </li> </ul>

Display messages	Possible causes/consequences and ► Solutions
 <p>Suspended</p>	<p>* If you depress the accelerator pedal beyond the setting of Active Distance Assist DISTRONIC, the system will switch to passive mode (→ page 220).</p>
 <p>Off</p>	<p>* Active Distance Assist DISTRONIC was deactivated. If a warning tone also sounds, Active Distance Assist DISTRONIC has deactivated automatically (→ page 222).</p>
<p>Active Distance Assist Currently Unavailable See Operator's Manual</p>	<p>* Active Distance Assist DISTRONIC is temporarily unavailable. The ambient conditions are outside the system limits (→ page 220). As soon as the ambient conditions are within the system limits, the system will become available again.</p> <p>► Drive on.</p> <p>or</p> <p>► If the display message does not disappear, stop the vehicle in accordance with the traffic conditions and restart the vehicle.</p>
<p>Active Distance Assist Inoperative</p>	<p>* Active Distance Assist DISTRONIC is malfunctioning. Other driving systems and driving safety systems may also be malfunctioning.</p> <p>► Drive on.</p>

Display messages	Possible causes/consequences and ► Solutions
	<p>or</p> <ul style="list-style-type: none"> <li>► Stop the vehicle in accordance with the traffic conditions and restart the vehicle.</li> <li>► If the display message does not disappear: consult a qualified specialist workshop.</li> </ul>
Active Distance Assist Now Available	<ul style="list-style-type: none"> <li>* Active Distance Assist DISTRONIC is operational again. <ul style="list-style-type: none"> <li>► Switch on Active Distance Assist DISTRONIC (→ page 222).</li> </ul> </li> </ul>
 <p>Inoperative</p>	<ul style="list-style-type: none"> <li>* The Downhill Speed Regulation is malfunctioning. <ul style="list-style-type: none"> <li>► Consult a qualified specialist workshop.</li> </ul> </li> </ul>
 <p>Not in the Current Drive Program</p>	<ul style="list-style-type: none"> <li>* The Downhill Speed Regulation is not available in the currently selected drive program. <ul style="list-style-type: none"> <li>► Change the drive program (→ page 188).</li> </ul> </li> </ul>
 <p>Max. Speed 25 mph</p>	<ul style="list-style-type: none"> <li>* The maximum speed of 25 mph (40 km/h) for the Downhill Speed Regulation has been exceeded. <ul style="list-style-type: none"> <li>► Drive more slowly.</li> </ul> </li> </ul>

Display messages	Possible causes/consequences and ► Solutions
<p>Active Steering Assist Currently Unavailable See Operator's Manual</p>	<p>* Active Steering Assist is temporarily unavailable. The ambient conditions are outside the system limits (→ page 229). As soon as the ambient conditions are within the system limits, the system will become available again.</p> <ul style="list-style-type: none"> <li>► Drive on</li> <li>► Check the tire pressure if necessary.</li> </ul>
<p>Active Steering Assist Inoperative</p>	<p>* Active Steering Assist is malfunctioning. Active Distance Assist DISTRONIC remains available.</p> <ul style="list-style-type: none"> <li>► Drive on</li> </ul> <p>or</p> <ul style="list-style-type: none"> <li>► Stop the vehicle in accordance with the traffic conditions and restart the vehicle.</li> <li>► If the display message does not disappear: consult a qualified specialist workshop.</li> </ul>
<p>Active Steering Asst. Currently Unavailable Due to Multiple Emergency Stops</p>	<p>* Active Steering Assist is temporarily unavailable due to multiple emergency stops.</p> <ul style="list-style-type: none"> <li>► Take over the steering and stop in accordance with the traffic conditions.</li> <li>► Switch the vehicle off and switch it back on Active Steering Assist is available once more.</li> </ul>
<p>Beginning Emergency Stop</p>	<p>* Your hands are not on the steering wheel. An emergency stop is being initiated (→ page 231).</p> <ul style="list-style-type: none"> <li>► Put your hands back on the steering wheel.</li> </ul> <p>You can cancel the deceleration at any time by performing one of the following actions:</p> <ul style="list-style-type: none"> <li>• Steering</li> </ul>



Display messages	Possible causes/consequences and ► Solutions
	<ul style="list-style-type: none"> <li>• Braking or accelerating</li> <li>• Deactivating Active Distance Assist DISTRONIC</li> </ul>
	<p>* Active Steering Assist has reached the system limits (→ page 229). You have not steered independently for a considerable period of time.</p> <p>► Take over the steering and drive on in accordance with the traffic conditions.</p>
<p>Active Stop &amp; Go Assist Currently Unavailable See Operator's Manual</p>	<p>* Active Stop-and-Go Assist is temporarily unavailable. Active Distance Assist DISTRONIC and Active Steering Assist are still available. The ambient conditions are outside the system limits (→ page 226). As soon as the ambient conditions are within the system limits, the system will become available again.</p> <p>► Drive on.</p>
<p>Active Stop &amp; Go Assist Inoperative See Operator's Manual</p>	<p>* Active Stop-and-Go Assist is malfunctioning. Active Stop-and-Go Assist has been deactivated. Active Distance Assist DISTRONIC and Active Steering Assist are still available.</p> <p>► Drive on. or ► Stop the vehicle in accordance with the traffic conditions and restart the vehicle. ► If the display message does not disappear, consult a qualified specialist workshop.</p>

Display messages	Possible causes/consequences and ► Solutions
Traffic Sign Assist Currently Unavailable See Operator's Manual	<p>* Traffic Sign Assist is temporarily unavailable. Once the cause of the problem is no longer present, the system will be available again.</p> <p>► Drive on</p>
Traffic Sign Assist Inoperative	<p>* Traffic Sign Assist is malfunctioning.</p> <p>► Drive on or</p> <p>► Stop the vehicle in accordance with the traffic conditions and restart the vehicle. ► If the display message does not disappear: consult a qualified specialist workshop.</p>
Blind Spot Assist Currently Unavailable See Operator's Manual	<p>* Blind Spot Assist is temporarily unavailable. The system limits have been reached (→ page 242). Once the cause of the problem is no longer present, the system will be available again.</p> <p>► Drive on or</p> <p>► If the display message does not disappear, stop the vehicle in accordance with the traffic conditions and restart the vehicle.</p>
Blind Spot Assist Inoperative	<p>* Blind Spot Assist is malfunctioning.</p> <p>► Drive on or</p>

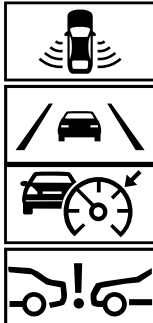

Display messages	Possible causes/consequences and ► Solutions
	<ul style="list-style-type: none"> <li>► Stop the vehicle in accordance with the traffic conditions and restart the vehicle.</li> <li>► If the display message does not disappear: consult a qualified specialist workshop.</li> </ul>
Blind Spot Assist Not Available When Towing a Trailer See Operator's Manual	<p>* When you establish the electrical connection to the trailer, Blind Spot Assist will be unavailable.</p> <ul style="list-style-type: none"> <li>► Press the left-hand Touch Control and acknowledge the display message.</li> </ul>
Active Blind Spot Assist Currently Unavailable See Operator's Manual	<p>* Active Blind Spot Assist is temporarily unavailable. The system limits have been reached (→ page 242). Once the cause of the problem is no longer present, the system will be available again.</p> <ul style="list-style-type: none"> <li>► Drive on</li> <li>or</li> <li>► If the display message does not disappear, stop the vehicle in accordance with the traffic conditions and restart the vehicle.</li> </ul>
Active Blind Spot Assist Inoperative	<p>* Active Blind Spot Assist is malfunctioning.</p> <ul style="list-style-type: none"> <li>► Drive on</li> <li>or</li> <li>► Stop the vehicle in accordance with the traffic conditions and restart the vehicle.</li> <li>► If the display message does not disappear: consult a qualified specialist workshop.</li> </ul>

Display messages	Possible causes/consequences and ► Solutions
Active Blind Spot Asst. Not Available When Towing a Trailer See Operator's Manual	* When you establish the electrical connection to the trailer, Active Blind Spot Assist will be unavailable. ► Press the left-hand Touch Control and acknowledge the display message.
Active Lane Keeping Assist Currently Unavailable See Operator's Manual	* Active Lane Keeping Assist is temporarily unavailable. The ambient conditions are outside the system limits (→ page 244). As soon as the ambient conditions are within the system limits, the system will become available again. ► Drive on
Active Lane Keeping Assist Inoperative	* Active Lane Keeping Assist is malfunctioning. ► Drive on or ► Stop the vehicle in accordance with the traffic conditions and restart the vehicle. ► If the display message does not disappear: consult a qualified specialist workshop.

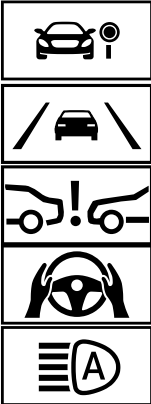
Display messages	Possible causes/consequences and ► Solutions
 <p data-bbox="194 595 443 647">Temporarily Unavailable Sensors are Dirty</p>	<p data-bbox="526 248 1413 274">* Front and corner radar sensors (hereafter "sensors") are malfunctioning. Possible causes:</p> <ul data-bbox="545 284 1201 378" style="list-style-type: none"> <li>• The sensors are dirty</li> <li>• Heavy rain or snow</li> <li>• Extended country driving without other traffic, e.g. in the desert</li> </ul> <p data-bbox="545 393 1690 445">Driving systems and driving safety systems may be malfunctioning or temporarily unavailable. The brake system, steering and drive system will continue to function normally.</p> <p data-bbox="545 455 674 481">► Drive on.</p> <p data-bbox="545 502 1690 554">Once the causes of the problem are no longer present, the driving systems and driving safety systems will be available again and the corresponding symbols will be switched off.</p> <p data-bbox="545 564 960 590">If the display message does not disappear:</p> <ul data-bbox="545 600 1145 694" style="list-style-type: none"> <li>► Stop the vehicle in accordance with the traffic conditions.</li> <li>► Clean all sensor covers from outside (→ page 209).</li> <li>► Restart the vehicle.</li> </ul>

Display messages	Possible causes/consequences and ► Solutions
 <p data-bbox="144 681 389 731">Temporarily Unavailable Camera View Restricted</p>	<p data-bbox="476 249 1147 270">* The view of the multifunction camera is restricted. Possible causes:</p> <ul data-bbox="500 283 1633 401" style="list-style-type: none"> <li data-bbox="500 283 1215 304">• Dirt on the windshield in the field of vision of the multifunction camera</li> <li data-bbox="500 318 759 338">• Heavy rain, snow or fog</li> <li data-bbox="500 352 1633 401">• Condensation on the inside of the windshield: in certain weather conditions, condensation can form on the inside of the windshield during cold times of year in particular.</li> </ul> <p data-bbox="495 418 1646 468">ⓘ This condensation on the windshield will be removed automatically within a short time with the aid of a heater. The restriction is temporary.</p> <p data-bbox="495 481 1646 531">Driving systems and driving safety systems may be malfunctioning or temporarily unavailable. The brake system, steering and drive system will continue to function normally.</p> <p data-bbox="495 544 617 565">► Drive on.</p> <p data-bbox="495 592 1646 642">Once the causes of the problem are no longer present, the driving systems and driving safety systems will be available again and the corresponding symbols will be switched off.</p> <p data-bbox="495 655 911 676">If the display message does not disappear:</p> <ul data-bbox="495 689 1411 780" style="list-style-type: none"> <li data-bbox="495 689 1092 710">► Stop the vehicle in accordance with the traffic conditions.</li> <li data-bbox="495 724 1411 744">► Clean the windshield, especially in the position of the multifunction camera (→ page 209).</li> <li data-bbox="495 758 718 779">► Restart the vehicle.</li> </ul>

Display messages	Possible causes/consequences and ► Solutions
 <p data-bbox="195 339 458 391">Malfunction Drive at Max. 50 mph</p>	<p data-bbox="524 249 1554 273">* AIRMATIC is functioning only to a limited extent. The vehicle's handling characteristics may be affected.</p> <ul style="list-style-type: none"> <li data-bbox="543 283 1452 307">► Drive in a manner appropriate for the current level, but do not exceed 50 mph (80 km/h).</li> <li data-bbox="543 318 935 341">► Visit a qualified specialist workshop.</li> </ul>
<p data-bbox="195 418 473 491">E-ACTIVE BODY CONTROL Function Limited See Operator's Manual</p>	<p data-bbox="524 418 1587 511">* At least one main function of the E-ACTIVE BODY CONTROL system is malfunctioning. The system is outside the operating temperature range or the on-board electrical system voltage is too low. Once the cause of the problem is no longer present, the system will be available again.</p> <div data-bbox="550 526 1696 708" style="border: 1px solid black; padding: 5px;"> <p data-bbox="561 539 1641 588"><b>!</b> <b>NOTE</b> The vehicle's suspension and damping behavior is restricted. The vehicle body may tilt heavily to the side during cornering.</p> <ul style="list-style-type: none"> <li data-bbox="561 605 774 628">► Drive on carefully.</li> <li data-bbox="561 639 1079 663">► Reduce speed considerably before taking a bend.</li> <li data-bbox="561 673 938 697">► Avoid sudden steering movements.</li> </ul> </div> <ul style="list-style-type: none"> <li data-bbox="543 726 759 750">► Drive on carefully.</li> <li data-bbox="543 760 1068 784">► Reduce speed considerably before taking a curve.</li> <li data-bbox="543 794 924 818">► Avoid sudden steering movements.</li> </ul>

Display messages	Possible causes/consequences and ► Solutions
 <p data-bbox="144 339 408 391">Malfunction Drive at Max. 50 mph</p>	<p data-bbox="476 249 1332 308">* At least one main function of the E-ACTIVE BODY CONTROL system is malfunctioning. The system is deactivated.</p> <div data-bbox="500 325 1646 505" style="border: 1px solid gray; padding: 5px;"> <p data-bbox="506 335 1578 387"><b>!</b> <b>NOTE</b> The vehicle's suspension and damping behavior has changed significantly, the vehicle body may tilt heavily to the side during cornering.</p> <ul style="list-style-type: none"> <li data-bbox="506 401 949 428">► Reduce vehicle speed. Drive on carefully.</li> <li data-bbox="506 436 1147 463">► Reduce the vehicle speed considerably before taking a curve.</li> <li data-bbox="506 470 888 497">► Avoid sudden steering movements.</li> </ul> </div> <ul style="list-style-type: none"> <li data-bbox="495 522 1160 549">► Continue driving carefully and do not exceed 50 mph (80 km/h).</li> <li data-bbox="495 556 1474 583">► If possible, stop in accordance with the traffic conditions and switch the vehicle off and on again.</li> <li data-bbox="495 590 1264 617">► If the display message still appears, consult a qualified specialist workshop.</li> </ul>
 <p data-bbox="144 725 319 752">Malfunction Stop</p>	<p data-bbox="476 632 1430 692">* There is a serious malfunction affecting the hydraulics of the E-ACTIVE BODY CONTROL system. The system is deactivated.</p> <div data-bbox="500 708 1646 822" style="border: 1px solid gray; padding: 5px;"> <p data-bbox="506 718 1230 745"><b>!</b> <b>NOTE</b> The vehicle's driving characteristics have changed significantly.</p> <ul style="list-style-type: none"> <li data-bbox="506 759 1572 811">► Pull over and stop the vehicle safely as soon as possible in accordance with the traffic conditions. Do not continue driving under any circumstances.</li> </ul> </div>



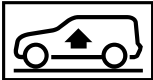
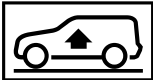

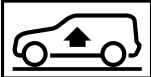
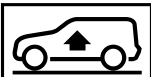
Display messages	Possible causes/consequences and ► Solutions
	<ul style="list-style-type: none"> <li>► Stop the vehicle immediately in accordance with the traffic conditions. Do not continue driving under any circumstances.</li> <li>► Consult a qualified specialist workshop.</li> </ul>
 <p data-bbox="195 443 288 467">Lowering</p>	<ul style="list-style-type: none"> <li>* The vehicle level will lower for the following reasons:               <ul style="list-style-type: none"> <li>• You have selected a different drive program.</li> <li>• You have exceeded the speed limit.</li> <li>• You have changed the vehicle level by pressing the button.</li> <li>• <b>Operation with a trailer or bicycle rack:</b> if an electrical connection has been correctly made, you have exceeded the speed limit.</li> <li>• You have switched on the rear fog lamp in the off-road level +3.</li> </ul> </li> </ul>
 <p data-bbox="195 681 340 705">Vehicle Rising</p>	<ul style="list-style-type: none"> <li>* Your vehicle is adjusting to the level you have selected.</li> </ul>
 <p data-bbox="195 822 463 846">Vehicle Rising Please Wait</p>	<ul style="list-style-type: none"> <li>* The vehicle level is too low. The vehicle will be raised to the selected vehicle level.               <ul style="list-style-type: none"> <li>► Wait until the display message disappears before pulling away.</li> </ul> </li> </ul>

Display messages	Possible causes/consequences and ► Solutions
 <p data-bbox="144 339 328 363">Drive More Slowly</p>	<ul style="list-style-type: none"> <li data-bbox="476 249 1007 273">* You are driving too fast for the selected vehicle level.               <ul style="list-style-type: none"> <li data-bbox="495 283 1164 307">► Drive more slowly and then select the desired vehicle level again.</li> </ul> </li> <li data-bbox="476 335 1609 359">* You are driving too quickly with a trailer or the trailer hitch socket is being used, e.g. for a rear-mounted cycle rack.               <ul style="list-style-type: none"> <li data-bbox="495 369 875 393">► Read the notes on trailer operation.</li> </ul> </li> </ul>
 <p data-bbox="144 498 375 522">Compressor Is Cooling</p>	<ul style="list-style-type: none"> <li data-bbox="476 411 1646 459">* Due to frequent level changes within a short space of time, the compressor first needs to cool down in order to set the selected vehicle level. When the compressor has cooled down, the vehicle will continue rising to the selected vehicle level.               <ul style="list-style-type: none"> <li data-bbox="495 501 1563 525">► Drive on in a manner appropriate for the current level. Make sure that there is sufficient ground clearance.</li> </ul> </li> </ul>
<p data-bbox="144 550 408 625">Selected Level Not Available When Rear Fog Lamp On</p>	<ul style="list-style-type: none"> <li data-bbox="476 553 838 577">* You cannot select off-road level +3.               <ul style="list-style-type: none"> <li data-bbox="495 587 807 611">► Switch off the rear fog lamp.</li> </ul> </li> </ul>
<p data-bbox="144 650 399 726">Parking Assist and PARKTRONIC Inoperative See Operator's Manual</p>	<ul style="list-style-type: none"> <li data-bbox="476 653 1563 712">* <b>Vehicles with Active Parking Assist:</b> Active Parking Assist and Parking Assist PARKTRONIC are malfunctioning. <b>Vehicles without Active Parking Assist:</b> Parking Assist PARKTRONIC is malfunctioning.               <ul style="list-style-type: none"> <li data-bbox="495 723 1317 746">► Stop the vehicle in accordance with the traffic conditions and restart the vehicle.</li> <li data-bbox="495 757 1262 781">► If the display message still appears, consult a qualified specialist workshop.</li> </ul> </li> </ul>

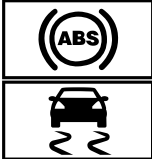
## Driving safety systems

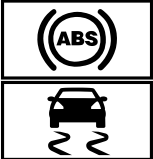
Display messages	Possible causes/consequences and ► Solutions
 <p data-bbox="195 467 458 515">Currently Unavailable See Operator's Manual</p>	<p data-bbox="528 291 1692 386">* ABS and ESP® are temporarily unavailable. Other driving systems and driving safety systems (e.g. BAS) may also be temporarily unavailable. The brake system will continue to operate normally. Braking distance may increase in an emergency braking situation.</p> <div data-bbox="550 405 1698 448" style="background-color: #f0f0f0; padding: 5px;"> <p data-bbox="559 415 1215 441">▲ <b>WARNING</b> Risk of skidding if ABS and ESP® are malfunctioning</p> </div> <p data-bbox="565 456 1650 541">The wheels may lock during braking and ESP® does not perform any vehicle stabilization. The steerability and braking characteristics are heavily impaired and the braking distance may increase. In addition, other driving safety systems are switched off.</p> <ul data-bbox="565 552 1633 664" style="list-style-type: none"> <li data-bbox="565 552 1615 601">► Drive carefully on a suitable stretch of road, making slight steering movements at a speed above 19 mph (30 km/h).</li> <li data-bbox="565 612 1633 664">► If the display message does not disappear, consult a qualified specialist workshop immediately. Drive carefully.</li> </ul>

Display messages	Possible causes/consequences and ► Solutions
 <p data-bbox="144 425 417 474">Inoperative See Operator's Manual</p>	<p data-bbox="476 249 1641 346">* ABS and ESP® are malfunctioning. Other driving systems and driving safety systems (e.g. BAS) may also be malfunctioning. The brake system will continue to operate normally. Braking distance may increase in an emergency braking situation.</p> <div data-bbox="500 363 1646 581" style="border: 1px solid black; padding: 5px;"> <p data-bbox="506 370 1166 399"><b>▲ WARNING</b> Risk of skidding if ABS and ESP® are malfunctioning</p> <p data-bbox="513 415 1387 439">The wheels may block during braking and ESP® does not perform any vehicle stabilization.</p> <p data-bbox="513 449 1600 498">The steerability and braking characteristics are heavily impaired and the braking distance may increase. In addition, other driving safety systems are switched off.</p> <ul data-bbox="513 508 1289 570" style="list-style-type: none"> <li data-bbox="513 508 722 532">► Drive on carefully.</li> <li data-bbox="513 542 1289 570">► Have ABS and ESP® checked immediately at a qualified specialist workshop.</li> </ul> </div>
 <p data-bbox="144 692 408 740">Currently Unavailable See Operator's Manual</p>	<p data-bbox="476 598 1350 660">* ESP® is temporarily unavailable. Other driving systems and driving safety systems (e.g. BAS) may also be malfunctioning.</p> <div data-bbox="500 678 1646 854" style="border: 1px solid black; padding: 5px;"> <p data-bbox="506 685 1060 714"><b>▲ WARNING</b> Risk of skidding if ESP is malfunctioning®</p> <p data-bbox="513 730 1618 779">If ESP® is malfunctioning, ESP® cannot carry out vehicle stabilization. In addition, other driving safety systems are switched off.</p> <ul data-bbox="513 789 1563 841" style="list-style-type: none"> <li data-bbox="513 789 1563 841">► Drive carefully on a suitable stretch of road, making slight steering movements at a speed above 19 mph (30 km/h).</li> </ul> </div>

Display messages	Possible causes/consequences and ► Solutions
	<ul style="list-style-type: none"> <li>► If the display message does not disappear, consult a qualified specialist workshop immediately. Drive carefully.</li> </ul>
 <p data-bbox="194 424 471 476">Inoperative See Operator's Manual</p>	<p data-bbox="526 336 776 362">* ESP® is malfunctioning.</p> <p data-bbox="545 367 1404 398">Other driving systems and driving safety systems (e.g. BAS) may also be malfunctioning.</p> <p data-bbox="545 404 1690 429">The brake system will continue to operate normally. Braking distance may increase in an emergency braking situation.</p> <div data-bbox="545 445 1700 492" style="background-color: #cccccc; padding: 5px;"> <p data-bbox="554 455 1118 486"><b>▲ WARNING</b> Risk of skidding if ESP® is malfunctioning</p> </div> <p data-bbox="563 497 1672 554">If ESP® is malfunctioning, ESP® cannot carry out vehicle stabilization. In addition, other driving safety systems are switched off.</p> <ul style="list-style-type: none"> <li>► Drive on carefully.</li> <li>► Have ESP® checked at a qualified specialist workshop.</li> </ul>

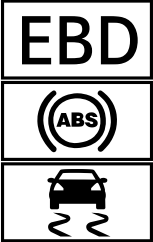
Display messages	Possible causes/consequences and ► Solutions
 <p data-bbox="144 511 417 560">Inoperative See Operator's Manual</p>	<p data-bbox="476 249 1350 311">* EBD, ABS and ESP® are malfunctioning. Other driving systems and driving safety systems (e.g. BAS) may also be malfunctioning.</p> <div data-bbox="500 329 1646 547" style="border: 1px solid gray; padding: 5px;"> <p data-bbox="510 337 1221 365"><b>▲ WARNING</b> Risk of skidding if EBD, ABS and ESP® are malfunctioning</p> <p data-bbox="510 381 1391 407">The wheels may block during braking and ESP® does not perform any vehicle stabilization.</p> <p data-bbox="510 415 1600 467">The steerability and braking characteristics are heavily impaired and the braking distance may increase. In addition, other driving safety systems are switched off.</p> <ul style="list-style-type: none"> <li data-bbox="510 477 722 503">► Drive on carefully.</li> <li data-bbox="510 511 1313 537">► Have the brake system checked immediately at a qualified specialist workshop.</li> </ul> </div>
<p data-bbox="144 588 417 664">Active Brake Assist Functions Currently Limited See Operator's Manual</p>	<p data-bbox="476 588 1646 640">* <b>Vehicles with the Driving Assistance Package:</b> Active Brake Assist with cross-traffic function, Evasive Steering Assist or PRE-SAFE® PLUS are temporarily unavailable or only partially available.</p> <p data-bbox="491 648 1419 674"><b>Vehicles without the Driving Assistance Package:</b> Active Brake Assist is temporarily unavailable.</p> <ul style="list-style-type: none"> <li data-bbox="491 684 1535 736">► Drive on. As soon as the ambient conditions are within the system limits, the system will become available again.</li> <li data-bbox="491 746 519 772">or</li> <li data-bbox="491 781 1618 832">► If the display message does not disappear, stop the vehicle in accordance with the traffic conditions and restart the vehicle.</li> </ul>

Display messages	Possible causes/consequences and ► Solutions
<p data-bbox="194 248 452 326">Active Brake Assist Functions Limited See Operator's Manual</p>	<p data-bbox="526 248 1690 300">* For vehicles with the Driving Assistance Package, the following functions may be temporarily unavailable or only partially available:</p> <ul data-bbox="545 310 1025 404" style="list-style-type: none"> <li data-bbox="545 310 1025 336">• Active Brake Assist with cross-traffic function</li> <li data-bbox="545 341 803 367">• Evasive Steering Assist</li> <li data-bbox="545 372 748 404">• PRE-SAFE® PLUS</li> </ul> <p data-bbox="545 419 1690 471"><b>Vehicles without the Driving Assistance Package:</b> Active Brake Assist is temporarily unavailable or only partially available.</p> <p data-bbox="545 481 665 543">► Drive on or</p> <p data-bbox="545 554 1367 580">► Stop the vehicle in accordance with the traffic conditions and restart the vehicle.</p> <p data-bbox="545 585 1386 606">► If the display message does not disappear: consult a qualified specialist workshop.</p>

### Mercedes-Benz emergency call system

Display messages	Possible causes/consequences and ► Solutions
 <p data-bbox="194 839 314 865">Inoperative</p>	<p data-bbox="526 745 1690 797">* The Mercedes-Benz emergency call system is malfunctioning. The Mercedes me connect system is also malfunctioning.</p> <p data-bbox="545 808 970 833">► Consult a qualified specialist workshop.</p>

## 470 Display messages and warning/indicator lamps

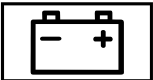

Display messages	Possible causes/consequences and ► Solutions
<a href="#">Device Detected at Diagnostics Connection See Operator's Manual</a>	<ul style="list-style-type: none"><li>* The vehicle functions for malfunction detection are restricted. At least one of the main functions of the Mercedes me connect system is malfunctioning.<ul style="list-style-type: none"><li>► Observe the notes on the diagnostics connection (→ page 28).</li><li>► Consult a qualified specialist workshop.</li></ul></li></ul>

## Battery

Display messages	Possible causes/consequences and ► Solutions
 <p data-bbox="144 612 393 660"><a href="#">12 V Battery See Operator's Manual</a></p>	<ul style="list-style-type: none"><li>* The vehicle is off and the condition of charge of the 12 V battery is too low.<ul style="list-style-type: none"><li>► Switch off electrical consumers that are not required.</li><li>► Drive for 30–60 minutes.</li></ul>or<ul style="list-style-type: none"><li>► Charge the 12 V battery when stationary (→ page 360).</li></ul></li><li>* If the message appears while the vehicle is switched on, this indicates an on-board electrical system malfunction.<ul style="list-style-type: none"><li>► Visit a qualified specialist workshop.</li></ul></li></ul>
 <p data-bbox="144 850 376 876"><a href="#">See Operator's Manual</a></p>	<ul style="list-style-type: none"><li>* The 12 V battery is not being charged.</li></ul>

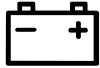

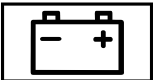

Display messages	Possible causes/consequences and ► Solutions
	<div data-bbox="547 249 1692 368" style="border: 1px solid gray; padding: 5px;"> <p><b>!</b> <b>NOTE</b> Possible engine damage if you continue driving</p> <ul style="list-style-type: none"> <li>▶ Do not continue driving under any circumstances.</li> <li>▶ Consult a qualified specialist workshop.</li> </ul> </div> <ul style="list-style-type: none"> <li>▶ Stop immediately in accordance with the traffic conditions and switch off the vehicle.</li> <li>▶ Consult a qualified specialist workshop.</li> </ul>
<div data-bbox="205 464 362 547" style="border: 1px solid black; padding: 5px; text-align: center;">  </div> <p data-bbox="195 553 445 601">Stop Vehicle See Operator's Manual</p>	<p data-bbox="524 462 1350 487">* The 12 V battery is no longer being charged and the condition of charge is too low.</p> <div data-bbox="547 503 1692 622" style="border: 1px solid gray; padding: 5px;"> <p><b>!</b> <b>NOTE</b> Possible engine damage if you continue driving</p> <ul style="list-style-type: none"> <li>▶ Do not continue driving under any circumstances.</li> <li>▶ Consult a qualified specialist workshop.</li> </ul> </div> <ul style="list-style-type: none"> <li>▶ Stop the vehicle immediately in accordance with the traffic conditions. Do not continue driving.</li> <li>▶ Switch off the vehicle.</li> <li>▶ Consult a qualified specialist workshop.</li> </ul>



Display messages	Possible causes/consequences and ► Solutions
 <p data-bbox="144 339 413 391">Stop Vehicle Leave Engine Running</p>	<ul style="list-style-type: none"> <li>* The 12 V battery charge level is too low.               <ul style="list-style-type: none"> <li>► Stop the vehicle immediately in accordance with the traffic conditions. Do not continue driving.</li> <li>► Leave the vehicle running</li> <li>► If the display message disappears: drive on.</li> <li>► If the display message does not disappear: consult a qualified specialist workshop.</li> </ul> </li> </ul>
 <p data-bbox="144 519 391 570">48 V Battery See Operator's Manual</p>	<ul style="list-style-type: none"> <li>* The 48 V on-board electrical system has function restrictions. Comfort functions may be restricted.               <ul style="list-style-type: none"> <li>► Visit a qualified specialist workshop immediately.</li> </ul> </li> </ul>
 <p data-bbox="144 687 413 739">Please Wait Charging 48 V Battery...</p>	<ul style="list-style-type: none"> <li>* The 48 V battery is discharged. You have switched on the vehicle while the 12 V battery was being charged with a suitable charger or while another vehicle was providing starting assistance. The discharged 48 V battery is charged automatically via the voltage converter. After a few minutes, the <b>Engine Can Now Be Started</b> display message will be shown on the instrument display.               <ul style="list-style-type: none"> <li>► Start the vehicle.</li> <li>► Drive the vehicle for a while to charge the 12 V battery and the 48 V battery after disconnecting the charger from the vehicle.</li> </ul> <p>If the <b>Engine Can Now Be Started</b> display message does not appear after a few minutes:</p> </li> </ul>

Display messages	Possible causes/consequences and ► Solutions
	<ul style="list-style-type: none"> <li>► Try to start the vehicle.</li> <li>► If the vehicle does not start, consult a qualified specialist workshop.</li> </ul>
Cannot Start Engine See Operator's Manual	<ul style="list-style-type: none"> <li>* The state of charge of the 48 V battery is too low. You can no longer start the vehicle.</li> <li>► Switch off electrical consumers that are not required.</li> <li>► Connect a suitable charger approved for Mercedes-Benz with sufficient charge output to the jump-start connection point of the 12 V battery (→ page 360). The 48 V battery is charged via the voltage converter in the vehicle.</li> </ul>
Engine Can Now Be Started	<ul style="list-style-type: none"> <li>* The 48 V battery has been charged automatically via the voltage converter.</li> <li>► Start the vehicle and drive for a while to charge the 12 V battery and the 48 V battery.</li> </ul>

### Tire pressure monitor



Display messages	Possible causes/consequences and ► Solutions
Tire Press. Monitor Currently Unavailable	<ul style="list-style-type: none"> <li>* There is interference from a powerful radio signal source. As a result, no signals from the tire pressure sensors are being received. The tire pressure monitoring system is temporarily unavailable. The tire pressure monitoring system will restart automatically as soon as the cause has been rectified.</li> <li>► Drive on.</li> </ul>
Tire Press. Monitor Inoperative	<ul style="list-style-type: none"> <li>* The tire pressure monitoring system is malfunctioning.</li> </ul>



Display messages	Possible causes/consequences and ► Solutions
	<p><b>▲ WARNING</b> There is a risk of an accident if the tire pressure monitoring system is malfunctioning</p> <p>The tire pressure monitoring system cannot issue a warning if there is pressure loss in one or more of the tires. Tires with insufficient tire pressure may impair the driving characteristics as well as steering and braking.</p> <p>► Have the tire pressure monitoring system checked at a qualified specialist workshop.</p>
<p>Tire Pressure Monitor Inoperative No Wheel Sensors</p>	<p>* The wheels installed do not have suitable tire pressure sensors. The tire pressure monitoring system is deactivated.</p> <p>► Install wheels with suitable tire pressure sensors.</p>
 <p>Wheel Sensor(s) Missing</p>	<p>* There is no signal from the tire pressure sensor of one or more wheels. No pressure value is displayed for the affected tire.</p> <p>► Have the faulty tire pressure sensor replaced at a qualified specialist workshop.</p>
 <p>Check Tires</p>	<p>* The tire pressure in one or more tires has dropped significantly. The wheel position is displayed. A warning tone will also sound.</p> <p><b>▲ WARNING</b> Risk of an accident due to insufficient tire pressure</p> <ul style="list-style-type: none"> <li>• The tires can burst.</li> <li>• The tires can wear excessively and/or unevenly.</li> <li>• The driving characteristics as well as the steering and braking may be greatly impaired.</li> </ul>

Display messages	Possible causes/consequences and ► Solutions
	<p>You could then lose control of the vehicle.</p> <ul style="list-style-type: none"> <li>► Observe the recommended tire pressures.</li> <li>► Adjust the tire pressure if necessary.</li> </ul> <ul style="list-style-type: none"> <li>► Stop the vehicle in accordance with the traffic conditions.</li> <li>► Check the tire pressure (→ page 371) and the tires.</li> </ul>
 <p data-bbox="195 547 445 594">Please Correct Tire Pressure</p>	<p>* The tire pressure is too low in at least one of the tires, or the difference in tire pressure between the individual wheels is too great.</p> <ul style="list-style-type: none"> <li>► Check the tire pressure and add air, if necessary.</li> <li>► When the tire pressure is correct, restart the tire pressure monitor (→ page 376).</li> </ul>
 <p data-bbox="195 715 445 738">Warning Tire Malfunction</p>	<p>* The tire pressure in one or more tires has dropped suddenly. The wheel position will be displayed.</p> <div style="background-color: #cccccc; padding: 5px; margin-bottom: 10px;"> <p><b>⚠ WARNING</b> Risk of an accident from driving with a flat tire</p> <ul style="list-style-type: none"> <li>• The tires can overheat and be damaged.</li> <li>• The driving characteristics as well as the steering and braking characteristics may be greatly impaired.</li> </ul> </div> <p>You could then lose control of the vehicle.</p> <ul style="list-style-type: none"> <li>► Do not drive with a flat tire.</li> </ul>

Display messages	Possible causes/consequences and ► Solutions
	<ul style="list-style-type: none"> <li>► Do not exceed the maximum permissible driving distance in emergency mode and the maximum permissible speed with a flat MOExtended tire.</li> <li>► Observe the notes on flat tires.</li> </ul> <p>Notes in the event of a flat tire (→ page 351).</p> <ul style="list-style-type: none"> <li>► Stop the vehicle in accordance with the traffic conditions.</li> <li>► Check the tires.</li> </ul>
Tires Overheated	<p>* At least one tire is overheating. The affected tires are displayed in red. At temperatures close to the limit value, the tires are displayed in yellow.</p> <div style="background-color: #f0f0f0; padding: 5px; border: 1px solid #ccc;"> <p><b>⚠ WARNING</b> Risk of an accident from driving with overheated tires</p> <p>Overheated tires can burst.</p> <ul style="list-style-type: none"> <li>► Reduce speed so that the tires cool down.</li> </ul> </div>
Decrease Speed	<p>* At least one tire is overheating. The affected tires are displayed in red. At temperatures close to the limit value, the tires are displayed in yellow.</p> <div style="background-color: #f0f0f0; padding: 5px; border: 1px solid #ccc;"> <p><b>⚠ WARNING</b> Risk of an accident from driving with overheated tires</p> <p>Overheated tires can burst.</p> <ul style="list-style-type: none"> <li>► Reduce speed so that the tires cool down.</li> </ul> </div>

## Engine oil

Display messages	Possible causes/consequences and ► Solutions
 <p data-bbox="194 404 425 455">Check Engine Oil Level (Add 1 quart)</p>	<p data-bbox="526 310 1071 336">* The engine oil level has dropped to the minimum level.</p> <div data-bbox="545 357 1690 398" style="border: 1px solid gray; padding: 5px;"> <p data-bbox="554 362 1256 388"><b>!</b> <b>NOTE</b> Engine damage caused by driving with insufficient engine oil</p> </div> <div data-bbox="545 404 1690 440" style="border: 1px solid gray; padding: 5px;"> <p data-bbox="554 409 1053 429">► Avoid long journeys with insufficient engine oil.</p> </div> <p data-bbox="545 455 1247 481">► When next refueling, add 1.1 US qt (1 l) of engine oil (→ page 338).</p> <p data-bbox="545 497 887 523">Notes on engine oil (→ page 411).</p>
 <p data-bbox="194 631 471 657">Engine Oil Reduce Oil Level</p>	<p data-bbox="526 538 850 564">* The engine oil level is too high.</p> <div data-bbox="545 585 1690 626" style="border: 1px solid gray; padding: 5px;"> <p data-bbox="554 590 1210 616"><b>!</b> <b>NOTE</b> Engine damage caused by driving with excess engine oil</p> </div> <div data-bbox="545 631 1690 668" style="border: 1px solid gray; padding: 5px;"> <p data-bbox="554 637 1016 657">► Avoid long journeys with excess engine oil.</p> </div> <p data-bbox="545 683 1459 709">► Consult a qualified specialist workshop immediately and have the engine oil level reduced.</p>
 <p data-bbox="194 818 452 870">Engine Oil Level Low Stop Vehicle Turn Engine Off</p>	<p data-bbox="526 725 840 751">* The engine oil level is too low.</p> <div data-bbox="545 771 1690 813" style="border: 1px solid gray; padding: 5px;"> <p data-bbox="554 777 1256 802"><b>!</b> <b>NOTE</b> Engine damage caused by driving with insufficient engine oil</p> </div> <div data-bbox="545 818 1690 854" style="border: 1px solid gray; padding: 5px;"> <p data-bbox="554 823 1053 844">► Avoid long journeys with insufficient engine oil.</p> </div>

Display messages	Possible causes/consequences and ► Solutions
	<ul style="list-style-type: none"> <li>► Stop the vehicle immediately in accordance with the traffic conditions. Do not continue driving.</li> <li>► Switch off the vehicle.</li> <li>► Add 1.1 US qt (1 l) of engine oil (→ page 338).</li> <li>► Check the engine oil level.</li> </ul> <p>Notes on engine oil (→ page 411).</p>
 <p>Engine Oil Pressure Stop Switch Off Engine</p>	<p>* The oil pressure is too low.</p> <div style="border: 1px solid black; padding: 5px; margin: 5px 0;"> <p><b>!</b> <b>NOTE</b> Engine damage caused by driving with insufficient oil pressure</p> <p>► Avoid driving with insufficient oil pressure.</p> </div> <ul style="list-style-type: none"> <li>► Stop the vehicle immediately in accordance with the traffic conditions. Do not continue driving.</li> <li>► Switch off the vehicle.</li> <li>► Consult a qualified specialist workshop.</li> </ul>
 <p>Engine Oil Level Cannot Be Measured</p>	<p>* The electrical connection to the oil level sensor has been interrupted or the oil level sensor is faulty.</p> <ul style="list-style-type: none"> <li>► Consult a qualified specialist workshop.</li> </ul>



## Warning and indicator lamps

### Overview of indicator and warning lamps





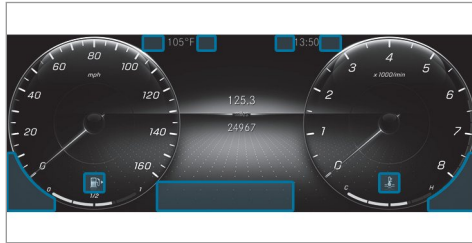

Some systems will perform a self-test when the vehicle is switched on. Some indicator and warning lamps may briefly light up or flash. This behavior is non-critical. These indicator and warning lamps indicate a malfunction only if they light up or flash after the vehicle has been started or during a journey.













### Instrument display





Depending on the display setting, the positions of the indicator lamps on the instrument display may differ from the example shown.

### Indicator and warning lamps:

-  Restraint system (→ page 480)
-  Seat belt (→ page 480)
-  Power steering (→ page 481)
-  Coolant temperature (→ page 482)
-  Engine diagnostics (→ page 482)
-  Electrical malfunction (→ page 482)
-  Reserve fuel with fuel filler flap location indicator (→ page 482)
- PARK** USA: electric parking brake (red) (→ page 486)
- (P)** Canada: electric parking brake (red) (→ page 486)
- (P)** Electric parking brake (yellow) (→ page 486)
- RBS** USA: Recuperative Brake System (→ page 486)
- (D)** Canada: brakes (yellow) (→ page 486)
- BRAKE** USA: brakes (red) (→ page 486)
- (D)** Canada: brakes (red) (→ page 486)

-  Distance warning (→ page 489)
-  Active Brake Assist (→ page 489)
-  Active Brake Assist (→ page 489)
-  AIRMATIC/E-ACTIVE BODY CONTROL (→ page 489)
-  ABS (→ page 491)
-  ESP® (→ page 491)
-  ESP® OFF (→ page 491)
-  Tire pressure monitoring system (→ page 493)
-  Parking lights (→ page 148)
-  Low beam (→ page 148)
-  High beam (→ page 149)
-  Turn signal lights (→ page 149)
-  Rear fog light (→ page 148)

Occupant safety

Warning/indicator lamp	Possible causes/consequences and ► Solutions
 <p data-bbox="144 381 395 433">Restraint system warning lamp</p>	<p data-bbox="463 288 1123 339">* The restraint system red warning lamp is lit while the vehicle is on. The restraint system is malfunctioning (→ page 39).</p> <div data-bbox="482 360 1646 474" style="border: 1px solid gray; padding: 5px;"> <p data-bbox="491 365 1193 391"><b>▲ WARNING</b> Risk of injury due to malfunctions in the restraint system</p> <p data-bbox="495 407 1559 433">Components in the restraint system may be activated unintentionally or not deploy as planned in an accident.</p> <p data-bbox="495 438 1456 464">► Have the restraint system checked and repaired immediately at a qualified specialist workshop.</p> </div> <ul data-bbox="476 490 1018 588" style="list-style-type: none"> <li data-bbox="476 490 689 515">► Drive on carefully.</li> <li data-bbox="476 521 957 547">► Note the messages on the instrument display.</li> <li data-bbox="476 552 1018 588">► Consult a qualified specialist workshop immediately.</li> </ul>
 <p data-bbox="144 695 371 746">Seat belt warning lamp flashes</p>	<p data-bbox="463 601 1387 653">* The red seat belt warning lamp flashes and an intermittent warning tone sounds. The driver or front passenger has not fastened his/her seat belt while the vehicle is in motion.</p> <ul data-bbox="476 658 1009 746" style="list-style-type: none"> <li data-bbox="476 658 855 684">► Fasten your seat belt (→ page 43).</li> <li data-bbox="476 689 929 715">There are objects on the front passenger seat.</li> <li data-bbox="476 721 1009 746">► Remove the objects from the front passenger seat.</li> </ul>

Warning/indicator lamp	Possible causes/consequences and ► Solutions
 <p data-bbox="194 341 425 393">Seat belt warning lamp lights up</p>	<p data-bbox="508 248 1358 274">* The red seat belt warning lamp lights up for six seconds once the vehicle has started.</p> <p data-bbox="526 284 1044 310">In addition, an intermittent warning tone may sound.</p> <p data-bbox="526 310 1469 336">The red seat belt warning lamp reminds the driver and front passenger to fasten their seat belts.</p> <ul style="list-style-type: none"> <li data-bbox="526 341 914 367">► Fasten your seat belt (→ page 43).</li> </ul> <p data-bbox="526 383 1524 409">If you have placed objects on the front passenger seat, the red seat belt warning lamp may remain lit.</p>



## Vehicle

Warning/indicator lamp	Possible causes/consequences and ► Solutions
 <p data-bbox="194 646 425 698">Power steering warning lamp (red)</p>	<p data-bbox="508 553 1210 579">* The red power steering warning lamp is lit while the vehicle is running.</p> <p data-bbox="526 579 1118 605">The power assistance or the steering itself is malfunctioning.</p> <div style="background-color: #f0f0f0; padding: 5px; margin: 10px 0;"> <p data-bbox="535 630 1164 656"><b>⚠ WARNING</b> Risk of accident if steering capability is impaired</p> <p data-bbox="545 667 1422 693">If the steering does not function as intended, the vehicle's operating safety is jeopardized.</p> <ul style="list-style-type: none"> <li data-bbox="545 703 1663 760">► Pull over and stop the vehicle safely as soon as possible, paying attention to road and traffic conditions. Do not continue driving under any circumstances.</li> <li data-bbox="545 765 970 791">► Consult a qualified specialist workshop.</li> </ul> </div> <ul style="list-style-type: none"> <li data-bbox="526 817 1007 843">► Note the messages on the instrument display.</li> </ul>

## Engine

Warning/indicator lamp	Possible causes/consequences and ► Solutions
 <p data-bbox="144 381 413 407">Coolant warning lamp (red)</p>	<p data-bbox="463 288 1086 313">* The red coolant warning lamp is lit while the engine is running.</p> <p data-bbox="476 324 643 344">Possible causes:</p> <ul data-bbox="482 360 925 521" style="list-style-type: none"> <li>• The temperature sensor is malfunctioning</li> <li>• The coolant level is too low</li> <li>• The air supply to the radiator is obstructed</li> <li>• The radiator fan is faulty</li> <li>• The engine coolant pump is faulty</li> </ul> <p data-bbox="476 536 1609 562">If there is an additional warning tone, the coolant temperature has exceeded the maximum permissible temperature.</p> <div data-bbox="482 581 1646 837" style="border: 1px solid gray; padding: 5px;"> <p data-bbox="491 588 1005 614"><b>⚠ WARNING</b> Risk of burns when opening the hood</p> <p data-bbox="495 629 1628 681">If you open the hood in the event of an overheated engine or fire in the engine compartment, the following situations may occur:</p> <ul data-bbox="500 692 1193 749" style="list-style-type: none"> <li>• You may come into contact with hot gases.</li> <li>• You may come into contact with other escaping hot operating fluids.</li> </ul> <ul data-bbox="495 764 1456 826" style="list-style-type: none"> <li>► Before opening the hood, allow the engine to cool down.</li> <li>► In the event of a fire in the engine compartment, keep the hood closed and call the fire service.</li> </ul> </div> <p data-bbox="476 852 1581 878">► Stop immediately in accordance with the traffic conditions and switch off the vehicle. Do not continue driving.</p>

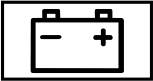
Warning/indicator lamp	Possible causes/consequences and ► Solutions
	<p>► Note the messages on the instrument display.</p> <p><b>If the coolant temperature display is at the lower end of the temperature scale:</b></p> <p>► Consult a qualified specialist workshop.</p> <p><b>If the coolant temperature display is at the upper end of the temperature scale:</b></p> <p>► Exit the vehicle and keep a safe distance from it until the engine has cooled down.</p> <p>► Check the coolant level (→ page 339).</p> <p>► Make sure that the air supply to the radiator is not obstructed.</p> <p>► Avoiding high loads on the engine, drive to the nearest qualified specialist workshop. In doing so, ensure that the coolant temperature display remains below the red area.</p>
 <p>Coolant warning lamp (yellow)</p>	<p>* The yellow coolant warning lamp is lit while the engine is running.</p> <p>Possible causes:</p> <ul style="list-style-type: none"> <li>• The temperature sensor is malfunctioning</li> <li>• The charge air, transmission oil or battery cooling is faulty</li> <li>• The radiator shutters are blocked or defective</li> </ul> <p>► Avoiding high loads on the engine, drive to the nearest qualified specialist workshop.</p>

Warning/indicator lamp	Possible causes/consequences and ► Solutions
 <p data-bbox="144 342 395 391">Engine diagnosis warning lamp</p>	<p data-bbox="463 249 1631 394">* The yellow Check Engine warning lamp is lit while the engine is running. A malfunction has occurred in the engine, the exhaust system or the fuel system. The emission limit values may be exceeded and the engine may be in emergency mode. In some states, legal requirements stipulate that you must immediately consult a qualified specialist workshop as soon as the yellow Check Engine warning lamp lights up.</p> <p data-bbox="476 405 1291 428">► Have the vehicle checked as soon as possible at a qualified specialist workshop.</p>
 <p data-bbox="144 539 421 588">Electrical malfunction warning lamp</p>	<p data-bbox="463 446 959 495">* The red electrical malfunction warning lamp is lit. There is a malfunction in the electrics.</p> <p data-bbox="476 505 959 529">► Note the messages on the instrument display.</p>
 <p data-bbox="144 698 404 746">Fuel reserve warning lamp flashes</p>	<p data-bbox="463 605 1628 653">* The yellow fuel reserve warning lamp lights up while you are driving. There has been pressure loss in the fuel system. The fuel filler cap is not closed correctly or the fuel system is leaking.</p> <p data-bbox="476 664 744 687">► Close the fuel filler cap.</p> <p data-bbox="476 715 999 739">If the fuel filler cap has already been closed correctly:</p> <p data-bbox="476 750 898 773">► Consult a qualified specialist workshop.</p>

**Warning/indicator lamp**



Fuel reserve warning lamp  
lights up

**Possible causes/consequences and ► Solutions**





\* The yellow fuel reserve warning lamp lights up while the engine is running.  
The fuel supply has dropped into the reserve range.

► Refuel.

## Brakes



Warning/indicator lamp	Possible causes/consequences and ► Solutions
 <p>Electric parking brake indicator lamp (red) (USA only)</p>  <p>Electric parking brake indicator lamp (red) (Canada only)</p>  <p>The electric parking brake (yellow) indicator lamp</p>	<p>* The red electric parking brake indicator lamp flashes or is lit. The yellow electric parking brake indicator lamp is also lit in the event of a malfunction.</p> <ul style="list-style-type: none"><li>► Note the messages on the instrument display.</li></ul>





Warning/indicator lamp	Possible causes/consequences and ► Solutions
 <p>Recuperative Brake System warning lamp (USA only)</p>  <p>Brakes warning lamp (yellow) (Canada only)</p>	<p>*The yellow  warning lamp (USA only) or the yellow  brake warning lamp (Canada only) is lit while the vehicle is running.</p> <p><b>▲ WARNING</b> Risk of an accident due to a brake system malfunction</p> <p>If the brake system is malfunctioning, braking characteristics may be impaired.</p> <ul style="list-style-type: none"><li>▶ Drive on carefully.</li><li>▶ Have the brake system checked immediately at a qualified specialist workshop.</li></ul> <p>► Adjust your speed and drive on carefully, leaving a suitable distance to the vehicle in front.</p> <p>► If the instrument display shows a display message, observe it.</p> <p>► Consult a qualified specialist workshop.</p>



Warning/indicator lamp	Possible causes/consequences and ► Solutions
<div data-bbox="155 251 312 332" data-label="Image"> </div> <p data-bbox="144 342 395 391">Brake warning lamp (USA only)</p> <div data-bbox="155 397 312 478" data-label="Image"> </div> <p data-bbox="144 488 413 537">Brake system warning lamp (Canada only)</p>	<p data-bbox="458 249 1068 273">* The red brake warning lamp is lit while the vehicle is running.</p> <p data-bbox="476 283 639 307">Possible causes:</p> <ul data-bbox="482 318 1402 373" style="list-style-type: none"> <li data-bbox="482 318 1402 341">• The brake force boosting is malfunctioning and the braking characteristics may be affected.</li> <li data-bbox="482 350 1073 373">• There is insufficient brake fluid in the brake fluid reservoir.</li> </ul> <p data-bbox="476 392 959 416">► Note the messages on the instrument display.</p> <div data-bbox="482 439 1646 477" data-label="Section-Header"> <p><b>▲ WARNING</b> Risk of accident and injury if brake force boosting is malfunctioning</p> </div> <p data-bbox="495 484 1591 533">If brake force boosting is malfunctioning, increased brake pedal force may be necessary for braking. The braking characteristics may be impaired. The braking distance can increase in emergency braking situations.</p> <ul data-bbox="495 543 1116 605" style="list-style-type: none"> <li data-bbox="495 543 1116 567">► Stop in a safe location immediately. Do not continue driving.</li> <li data-bbox="495 576 916 605">► Consult a qualified specialist workshop.</li> </ul> <div data-bbox="482 632 1646 671" data-label="Section-Header"> <p><b>▲ WARNING</b> Risk of an accident due to low brake fluid level</p> </div> <p data-bbox="495 678 1467 702">If the brake fluid level is too low, the braking effect and the braking characteristics may be impaired.</p> <ul data-bbox="495 712 1609 832" style="list-style-type: none"> <li data-bbox="495 712 1609 761">► Pull over and stop the vehicle safely as soon as possible, paying attention to road and traffic conditions. Do not continue driving under any circumstances.</li> <li data-bbox="495 769 916 793">► Consult a qualified specialist workshop.</li> <li data-bbox="495 801 753 825">► Do not add brake fluid.</li> </ul>



## Driving systems

Warning/indicator lamp	Possible causes/consequences and ► Solutions
 <p data-bbox="195 384 454 433">Warning lamp for distance warning function</p>	<p data-bbox="513 291 1212 339">* The red distance warning lamp lights up while the vehicle is in motion. The distance to the vehicle in front is too small for the speed selected.</p> <p data-bbox="528 353 1411 373">If there is an additional warning tone, you are approaching an obstacle at too high a speed.</p> <ul style="list-style-type: none"> <li data-bbox="528 387 898 408">► Be prepared to brake immediately.</li> <li data-bbox="528 421 781 442">► Increase the distance.</li> </ul> <p data-bbox="528 463 981 483">Function of Active Brake Assist (→ page 233).</p>
 <p data-bbox="195 599 463 648">Active Brake Assist warning lamp</p>	<p data-bbox="513 506 1535 555">* The Active Brake Assist warning lamp is on. Due to dirty sensors or a malfunction, the system is not available or the range of functions is restricted.</p> <ul style="list-style-type: none"> <li data-bbox="528 568 1009 589">► Note the messages on the instrument display.</li> </ul>
 <p data-bbox="195 760 463 809">Active Brake Assist warning lamp</p>	<p data-bbox="513 667 1548 750">* The Active Brake Assist warning lamp is on. The system is switched off or the range of functions has been automatically restricted. This may be the case if the driver is not wearing a seat belt or another driving system has been activated.</p> <ul style="list-style-type: none"> <li data-bbox="528 763 1116 784">► Observe the notes on Active Brake Assist (→ page 233).</li> </ul>

Warning/indicator lamp	Possible causes/consequences and ► Solutions
 <p data-bbox="144 342 397 391">Suspension warning lamp (yellow)</p>	<p data-bbox="463 249 1153 298">* The yellow AIRMATIC/E-ACTIVE BODY CONTROL warning lamp is lit. A malfunction has occurred in AIRMATIC/E-ACTIVE BODY CONTROL.</p> <ul data-bbox="476 308 962 335" style="list-style-type: none"><li data-bbox="476 308 962 335">► Note the messages on the instrument display.</li></ul>
 <p data-bbox="144 503 397 552">Suspension warning lamp (red)</p>	<p data-bbox="463 410 1153 458">* The red AIRMATIC/E-ACTIVE BODY CONTROL warning lamp is lit. A malfunction has occurred in AIRMATIC/E-ACTIVE BODY CONTROL.</p> <div data-bbox="482 477 1644 562" style="border: 1px solid black; padding: 5px;"><p data-bbox="491 484 1252 511"><b>!</b> <b>NOTE</b> The vehicle's driving characteristics will have changed significantly.</p><ul data-bbox="491 526 916 553" style="list-style-type: none"><li data-bbox="491 526 916 553">► Consult a qualified specialist workshop.</li></ul></div> <ul data-bbox="476 578 981 638" style="list-style-type: none"><li data-bbox="476 578 981 605">► Note the messages on the multifunction display.</li><li data-bbox="476 615 864 638">► Visit a qualified specialist workshop.</li></ul>

## Driving safety systems

Warning/indicator lamp	Possible causes/consequences and ► Solutions
 <p data-bbox="195 381 375 407">ABS warning lamp</p>	<p data-bbox="513 288 1136 339">* The yellow ABS warning lamp is lit while the vehicle is running. ABS is malfunctioning.</p> <p data-bbox="526 350 1112 376">If an additional warning tone sounds, EBD is malfunctioning.</p> <p data-bbox="526 386 1278 412">Other driving systems and driving safety systems may also be malfunctioning.</p> <p data-bbox="526 422 1009 448">► Note the messages on the instrument display.</p> <div data-bbox="532 464 1707 676" style="border: 1px solid black; padding: 5px;"> <p data-bbox="541 469 1252 495"><b>⚠ WARNING</b> There is a risk of skidding if EBD or ABS is malfunctioning</p> <p data-bbox="541 510 901 536">The wheels may lock during braking.</p> <p data-bbox="541 547 1666 593">The steerability and braking characteristics are heavily impaired and the braking distance may increase. In addition, other driving safety systems are switched off.</p> <ul style="list-style-type: none"> <li data-bbox="541 603 759 629">► Drive on carefully.</li> <li data-bbox="541 640 1350 666">► Have the brake system checked immediately at a qualified specialist workshop.</li> </ul> </div>
 <p data-bbox="195 785 463 811">ESP® warning lamp flashes</p>	<p data-bbox="513 692 1193 743">* The yellow ESP® warning lamp flashes while the vehicle is in motion. One or more wheels have reached their grip limit (→ page 212).</p> <p data-bbox="526 754 1184 780">► Adapt your driving style to suit the road and weather conditions.</p>

Warning/indicator lamp	Possible causes/consequences and ► Solutions
 <p>ESP® warning lamp lights up</p>	<p>* The yellow ESP® warning lamp is lit while the vehicle is running. ESP® is malfunctioning. Other driving systems and driving safety systems (e.g. BAS) may also be malfunctioning.</p> <ul style="list-style-type: none"> <li>► Note the messages on the instrument display.</li> </ul> <div style="background-color: #f0f0f0; padding: 5px; margin-top: 10px;"> <p><b>▲ WARNING</b> Risk of skidding if ESP® is malfunctioning</p> <p>If ESP® is malfunctioning, ESP® cannot carry out vehicle stabilization. In addition, other driving safety systems are switched off.</p> <ul style="list-style-type: none"> <li>► Drive on carefully.</li> <li>► Have ESP® checked at a qualified specialist workshop.</li> </ul> </div>
 <p>ESP® OFF warning lamp</p>	<p>* The yellow ESP® OFF warning lamp is lit while the vehicle is running. ESP® is deactivated. Other driving systems and driving safety systems may also be inoperative.</p> <div style="background-color: #f0f0f0; padding: 5px; margin-top: 10px;"> <p><b>▲ WARNING</b> Risk of skidding when driving with ESP® deactivated</p> <p>ESP® does not act to stabilize the vehicle. The availability of further driving safety systems is also limited.</p> <ul style="list-style-type: none"> <li>► Drive on carefully.</li> <li>► Deactivate ESP® only for as long as the situation requires.</li> </ul> </div>

Warning/indicator lamp	Possible causes/consequences and ► Solutions
	<p>If ESP® cannot be activated, ESP® is malfunctioning.</p> <ul style="list-style-type: none"> <li>► Have ESP® checked immediately at a qualified specialist workshop.</li> </ul> <p>► Observe the notes on deactivating ESP® (→ page 212).</p>

### Tire pressure monitor

Warning/indicator lamp	Possible causes/consequences and ► Solutions
 <p>Tire pressure monitoring system warning lamp flashes</p>	<p>*The yellow tire pressure monitor warning lamp (pressure loss/malfunction) flashes for approximately one minute and then remains lit. The tire pressure monitor is malfunctioning.</p> <p><b>▲ WARNING</b> There is a risk of an accident if the tire pressure monitoring system is malfunctioning</p> <p>The tire pressure monitoring system cannot issue a warning if there is pressure loss in one or more of the tires. Tires with insufficient tire pressure may impair the driving characteristics as well as steering and braking.</p> <ul style="list-style-type: none"> <li>► Have the tire pressure monitoring system checked at a qualified specialist workshop.</li> </ul>

Warning/indicator lamp



Tire pressure monitoring system warning lamp lights up

Possible causes/consequences and ► Solutions

\* The yellow tire pressure monitoring system warning lamp (pressure loss/malfunction) is lit. The tire pressure monitoring system has detected tire pressure loss in at least one of the tires.

**▲ WARNING** Risk of an accident due to insufficient tire pressure

- The tires can burst.
- The tires can wear excessively and/or unevenly.
- The driving characteristics as well as the steering and braking may be greatly impaired.

You could then lose control of the vehicle.

- Observe the recommended tire pressures.
- Adjust the tire pressure if necessary.

- Stop the vehicle in accordance with the traffic conditions.
- Check the tire pressure and the tires.



**1, 2, 3 ...****4MATIC**

Function..... 198

**12 V battery**

see On-board electrical system battery (12 V)

**12 V socket**

see Socket (12 V)

**48 V on-board electrical system**

Operating safety..... 25

**115 V socket**

see Socket (115 V)

**360° Camera**

Function..... 264

**A****A/C function**

Activating/deactivating (control panel)... 165

Activating/deactivating (MBUX multi-media system)..... 166

**ABS (Anti-lock Braking System)..... 211****Acceleration**

see Kickdown

**Accident and Breakdown Management**

Mercedes me connect..... 319

**Acoustic locking verification signal**

Activating/deactivating..... 71

**Active Blind Spot Assist**

Brake application..... 243

Function..... 242

System limitations..... 242

Trailer operation..... 243

**Active Brake Assist**

Function/notes..... 233

Setting..... 237

**Active Distance Assist DISTRONIC**

Active Emergency Stop Assist..... 231

Active Lane Change Assist..... 232

Calling up a speed..... 222

Function..... 220

Increasing/decreasing the speed..... 222

Route-based speed adaptation..... 225

Storing a speed..... 222

Switching off/deactivating..... 222

Switching on/activating..... 222

System limitations..... 220

**Active Emergency Stop Assist..... 231****Active headlamps..... 151****Active Lane Change Assist**

Activating/deactivating..... 233

Function..... 232

**Active Lane Keeping Assist**

Activating/deactivating..... 246

Activating/deactivating the warning..... 246

Function..... 244

Setting the sensitivity..... 246

System limits..... 244

Trailer operation..... 244

**Active Parking Assist**

Exiting a parking space..... 275

Function..... 272

Parking..... 274

System limitations..... 272

**Active Service System PLUS**

see ASSYST PLUS

**Active Speed Limit Assist**

Display..... 224

Function..... 224

**Active Steering Assist**

Activating/deactivating..... 231

Active Emergency Stop Assist..... 231

- Active Lane Change Assist..... 232  
 Function..... 229  
 System limits..... 229
- Active Traffic Jam Assist**  
 Activating/deactivating..... 227  
 Function..... 226
- Adaptive cruise control**  
 see Active Distance Assist DISTRONIC
- Adaptive Highbeam Assist**  
 Activating/deactivating..... 152  
 Function..... 151
- Additional cushion**  
 Leg rest..... 104  
 Rear passenger compartment head restraint..... 111
- Additives**  
 Engine oil..... 411  
 Fuel..... 411
- Additives (engine oil)**  
 see Additives
- Additives (fuel)**  
 see Fuel
- ADS PLUS damping system**  
 see AIRMATIC
- After-sales service**  
 see ASSYST PLUS
- Air bag**  
 Reduced protection..... 47
- Air conditioning menu**  
 Calling up..... 165
- Air distribution**  
 Setting..... 164  
 Setting (MBUX multimedia system)..... 166
- Air freshener system**  
 see Fragrance system
- Air inlet**  
 see Air-water duct
- Air pressure**  
 see Tire pressure
- Air suspension**  
 see AIRMATIC
- Air vents**  
 Adjusting (front)..... 169  
 Adjusting (rear)..... 170  
 Glove box..... 171
- Air vents**  
 see Air vents
- Air-conditioning system**  
 see Climate control
- Air-recirculation mode (with fine particle prefilter)..... 167**
- Air-water duct**  
 Keeping free..... 341
- Airbag**  
 Activation..... 39  
 Cushionbag..... 44  
 Front airbag (driver, front passenger)..... 44  
 Installation locations..... 44  
 Knee airbag..... 44  
 Overview..... 44  
 PASSENGER AIR BAG indicator lamps..... 49  
 Protection..... 45  
 Side airbag..... 44  
 Window curtain airbag..... 44
- Airflow**  
 Setting..... 164
- AIRMATIC**  
 Setting..... 249  
 Suspension..... 246

















- Alarm**  
see Panic alarm
- Alarm system**  
see ATA (anti-theft alarm system)
- All-wheel drive**  
see 4MATIC
- Ambient lighting**  
Setting (MBUX multimedia system)..... 154
- Android Auto**  
see Smartphone integration
- Animals**  
Pets in the vehicle..... 69
- Anti-lock braking system**  
see ABS (Anti-lock Braking System)
- Anti-skid chains**  
see Snow chains
- Anti-theft protection**  
Immobilizer..... 93
- Anti-theft protection**  
see ATA (anti-theft alarm system)
- Anticipatory occupant protection**  
see PRE-SAFE® (anticipatory occupant protection)
- see PRE-SAFE® PLUS (anticipatory occupant protection plus)
- Apple CarPlay®**  
see Smartphone integration
- Assistance systems**  
see Driving safety system
- ASSYST PLUS**  
Battery disconnection periods..... 335  
Displaying the service due date..... 334  
Function/notes..... 334  
Regular maintenance work..... 334  
Special service requirements..... 334
- ATA (anti-theft alarm system)**  
Activating/deactivating the interior motion sensor..... 96  
Arming/disarming the tow-away alarm.... 95  
Deactivating the alarm..... 94  
Function..... 94  
Interior motion sensor function..... 95  
The tow-away alarm function..... 94
- ATTENTION ASSIST**  
Function..... 216  
Setting..... 218  
System limitations..... 216
- Attention assistant**  
see ATTENTION ASSIST
- Authorized Mercedes-Benz Center**  
see Qualified specialist workshop
- Authorized workshop**  
see Qualified specialist workshop
- Automatic car wash mode**  
Activating..... 343
- Automatic distance control**  
see Active Distance Assist DISTRONIC
- Automatic driving lights**..... 149
- Automatic engine start**  
see ECO start/stop function
- Automatic engine stop**  
see ECO start/stop function
- Automatic front passenger airbag shutoff**  
Function of the front passenger airbag shutoff..... 48  
PASSENGER AIR BAG indicator lamps..... 49
- Automatic measures after an accident**..... 53
- Automatic mirror folding function**  
Activating/deactivating..... 163

- Automatic seat adjustment**  
 Setting..... 112
- Automatic transmission**  
 DIRECT SELECT lever..... 192  
 Drive programs..... 188  
 DYNAMIC SELECT switch..... 188  
 Engaging drive position..... 194  
 Engaging reverse gear..... 193  
 Kickdown..... 196  
 Manual gearshifting..... 195  
 Selecting park position..... 194  
 Steering wheel paddle shifters..... 195  
 Transmission position display..... 192  
 Transmission positions..... 192
- Axle load**  
 Towing a trailer..... 422
- B**
- Back seat**  
 see Seats
- Bag hook**..... 136
- Ball neck**  
 Installing..... 279
- BAS (Brake Assist System)**..... 212
- Battery (SmartKey)**  
 Replacing..... 72
- Battery (vehicle)**  
 Charging (Remote Online)..... 176  
 Notes..... 357  
 Notes (starting assistance and charging)..... 358
- Belt**  
 see Seat belt
- Bicycle rack**  
 Load capacity..... 421
- Blind**  
 see Roller sunblind
- Blind Spot Assist**  
 Activating/deactivating..... 244  
 Function..... 242  
 System limitations..... 242
- Blower**  
 see Climate control
- Brake Assist System**  
 see BAS (Brake Assist System)
- Brake fluid**  
 Notes..... 413
- Brake force distribution**  
 EBD (electronic brake force distribution)..... 215
- Brakes**  
 ABS (Anti-lock Braking System)..... 211  
 Active Brake Assist..... 233  
 BAS (Brake Assist System)..... 212  
 Breaking-in notes..... 177  
 Driving tips..... 178  
 EBD (electronic brake force distribution)..... 215  
 HOLD function..... 215  
 Limited braking effect (salt-treated roads)..... 178  
 New/replaced brake linings/brake discs..... 177  
 Post-collision brake..... 53
- Braking assistance**  
 see BAS (Brake Assist System)
- Breakdown**  
 Assistance overview..... 18  
 Changing a wheel..... 392  
 Roadside Assistance..... 25  
 Tow-starting..... 367  
 Towing away..... 363







































- Transporting the vehicle..... 365
- Breakdown**  
see Flat tire
- Breaking-in notes**..... 177
- Buttons**  
Steering wheel..... 284
- C**
- Calls**  
Mercedes me..... 316
- Camera**  
Information..... 209
- Camera**  
see 360° Camera  
see Dashcam  
see Rear view camera
- Car key**  
see SmartKey
- Car wash**  
see Care
- Car wash (care)**..... 341
- Car-to-X-Communication**  
Displaying hazard warnings..... 309
- Care**  
Air-water duct..... 341  
Automatic car wash..... 341  
Carpet..... 347  
Decorative foil..... 345  
Display..... 347  
Exterior lighting..... 346  
Head-up Display..... 347  
Headliner..... 347  
Paint..... 344  
Plastic trim..... 347  
Power washer..... 343  
Real wood/trim elements..... 347  
Rear view camera..... 346  
Running boards..... 346  
Seat belt..... 347  
Seat cover..... 347  
Sensors..... 346  
Steering wheel..... 347  
Surround view camera..... 346  
Tailpipes..... 346  
Trailer hitch..... 346  
Washing by hand..... 344  
Wheels/rims..... 346  
Windows..... 346  
Wiper blades..... 346
- Cargo compartment cover**  
Extending/retracting..... 133  
Notes..... 133  
Removing/installing..... 133
- Cargo compartment floor**  
Locking/unlocking..... 137
- Cargo tie-down rings**..... 136
- Carpet (Care)**..... 347
- Change of address**..... 25
- Change of ownership**..... 25
- Changing a wheel**  
Installing a new wheel..... 397  
Preparation..... 392  
Raising the vehicle..... 394  
Removing a wheel..... 396
- Changing a wheel**  
see Emergency spare wheel
- Changing gears**  
Manually..... 195
- Changing hub caps**..... 393
- Charging**  
Notes on wireless charging..... 144

- On-board electrical system battery (12 V)..... 360
- USB port..... 142
- Child safety lock**
  - Rear door..... 67
  - Rear side windows..... 68
- Child seat**
  - Attaching (notes)..... 57
  - Basic instructions..... 53
  - Front-passenger seat (notes)..... 65
  - LATCH-type (ISOFIX) (installing)..... 59
  - Notes on risks and dangers..... 54
  - Securing on the front passenger seat..... 66
  - Securing on the rear seat..... 64
  - Top Tether..... 62
- Children**
  - Avoiding dangers in the vehicle..... 54
  - Basic instructions..... 53
  - Special seat belt retractor..... 58
- Chock**
  - Storage location..... 392
- Chock**
  - see Chock
- Cleaning**
  - see Care
- Cleaning fluid**
  - see Windshield washer fluid
- Climate control**
  - Activating/deactivating..... 165
  - Activating/deactivating (rear operating unit)..... 165
  - Activating/deactivating the A/C function (control panel)..... 165
  - Activating/deactivating the A/C function (MBUX multimedia system)..... 166
  - Activating/deactivating the synchronization function (control panel)..... 167
  - Activating/deactivating the synchronization function (MBUX multimedia system)..... 167
  - Air-recirculation mode (with fine particle prefilter)..... 167
  - Automatic control..... 166
  - Automatically controlling (rear operating unit)..... 166
  - Calling up the air conditioning menu..... 165
  - Control panel for 3-zone automatic climate control..... 164
  - Control panel for dual-zone automatic climate control..... 164
  - Defrosting the windshield..... 164
  - Filling capacity for refrigerant and PAG oil..... 416
  - Front air vents..... 169
  - Glove box air vent..... 171
  - Information on the windshield heater..... 169
  - Inserting/removing the flacon (fragrance system)..... 168
  - Ionization..... 168
  - Note..... 164
  - Rear air vents..... 170
  - Rear operating unit..... 165
  - Refrigerant..... 414
  - Removing condensation from the windows..... 167
  - Residual heat..... 167
  - Residual heat (rear operating unit)..... 167
  - Setting (MBUX multimedia system)..... 165
  - Setting the air distribution..... 164
  - Setting the airflow..... 164
  - Setting the fragrance system..... 168
  - Setting the vehicle interior temperature..... 164

- Switching the rear window heater on/off..... 164  
 Ventilating the vehicle (convenience opening)..... 86
- Coat hook**..... 137
- Cockpit**  
 Overview..... 6
- Coffee cup symbol**  
 see ATTENTION ASSIST
- Collapsible spare wheel**  
 Inflating..... 402  
 Notes..... 401  
 Removing..... 402
- Collision detection (parked vehicle)**  
 Information..... 208
- Combination switch**..... 149
- Component-specific information**..... 406
- Computer**  
 see On-board computer
- Convenience closing**..... 87
- Convenience opening**..... 86
- Coolant (engine)**  
 Capacity..... 414  
 Level check..... 339  
 Notes..... 413
- Cooling**  
 see Climate control
- Copyrights**  
 License..... 36  
 Trademarks..... 37
- Cornering light**..... 151
- Cross traffic (warning)**  
 see Maneuvering assistance
- Cross Traffic Alert**..... 277
- Crosswind Assist**  
 Function/notes..... 213
- Cruise control**  
 Activating..... 219  
 Buttons..... 219  
 Calling up a speed..... 219  
 Deactivating..... 219  
 Function..... 218  
 Requirements:..... 219  
 Selecting..... 219  
 Setting a speed..... 219
- Storing a speed..... 219  
 System limitations..... 218
- Cup holder**  
 Switching the cooling/heating function on/off..... 139
- Cushionbag**..... 44
- Customer Assistance Center (CAC)**..... 31
- Customer Relations Department**..... 31
- D**
- Dashboard**  
 see Cockpit
- Dashcam**  
 Notes..... 311  
 Selecting a USB device..... 311  
 Starting/stopping a video recording..... 311
- Data acquisition**  
 Vehicle..... 32
- Data protection rights**  
 Data storage..... 35
- Data storage**  
 Data protection rights..... 35  
 Electronic control units..... 32

- Online services..... 34  
 Vehicle..... 32
- Daytime running lamp mode**  
 see Daytime running lamps
- Daytime running lamps**  
 Activating/deactivating..... 153
- Deactivating the alarm (ATA)**..... 94
- Dealership**  
 see Qualified specialist workshop
- Declaration of conformity**  
 Wireless vehicle components..... 27
- Decorative foil (cleaning instructions)**..... 345
- Definitions (tires and loading)**..... 386
- Destination entry**  
 Entering a POI or address..... 306
- Detecting inattentiveness**  
 see ATTENTION ASSIST
- Diagnostics connection**..... 28
- Digital Operator's Manual**..... 20
- Dinghy towing**  
 see Tow-bar system
- DIRECT SELECT lever**  
 Engaging drive position..... 194  
 Engaging neutral..... 193  
 Engaging park position automatically..... 194  
 Engaging reverse gear..... 193  
 Function..... 192  
 Selecting park position..... 194
- Display (care)**..... 347
- Display (MBUX multimedia system)**  
 Home screen..... 290  
 Operating..... 291
- Display (on-board computer)**  
 Displays on the instrument display..... 286
- Display in the windshield**  
 see Head-up Display
- Display message**  
 Calling up (on-board computer)..... 423  
 Notes..... 423
- Display messages**  
 --- mph..... 451  
 --- mph..... 451  
 12 V Battery See Operator's Manual..... 470
-  48 V Battery See Operator's Manual..... 472
-  Active Headlamps Inoperative..... 430
-  ATTENTION ASSIST Inoperative..... 450
-  ATTENTION ASSIST: Take a Break!..... 451
-  Automatic Headlamp Mode Inoperative..... 430
-  Cannot Fold 2nd Seat Row See Operator's Manual..... 438
-  Check Brake Fluid Level..... 449
-  Check Coolant Level See Operator's Manual..... 439
-  Check Engine Oil Level (Add 1 quart)..... 477
-  Check Left Low Beam (example)... 429
-  Check Tires..... 474
-  Check Washer Fluid..... 438
-  Compressor Is Cooling..... 464



- |   |   |  |
|---|---|--|
|  Coolant Too Hot Stop Vehicle<br>Turn Engine Off..... 440        |  Inoperative See Operator's<br>Manual..... 466                                 |  Malfunction See Operator's<br>Manual..... 429        |
|  Currently Unavailable See Oper-<br>ator's Manual..... 465       |  Inoperative See Operator's<br>Manual..... 467                                 |  Malfunction Stop..... 462                            |
|  Currently Unavailable See Oper-<br>ator's Manual..... 466       |  EBD Inoperative See Operator's<br>Manual..... 468                             |  Max. Speed 25 mph..... 453                           |
|  Don't Forget Your Key..... 428                                  |  Inoperative..... 469  |  Not in the Current Drive Program.. 453               |
|  Drive More Slowly..... 464                                      |  Inoperative..... 453  |  Obtain a New Key..... 427                            |
|  Engine Oil Level Cannot Be<br>Measured..... 478                 |  Intell. Light System Inoperative..... 431                                     |  Off..... 452   |
|  Engine Oil Level Low Stop Vehi-<br>cle Turn Engine Off..... 477 |  Key Being Initialized Please Wait... 428                                      |  HOLD Off..... 450                                    |
|  Engine Oil Pressure Stop Switch<br>Off Engine..... 478          |  Key Not Detected (red display<br>message)..... 428                            |  PARK Parking Brake See Operator's<br>Manual..... 445 |
|  Engine Oil Reduce Oil Level..... 477                            |  Key Not Detected (white display<br>message)..... 427                          |  Please Correct Tire Pressure..... 475                |
|  Front Left Malfunction Service<br>Required (example)..... 424   |  Left Side Curtain Airbag Mal-<br>function Service Required (example)..... 424 |  PARK Please Release Parking Brake..... 448           |
|  Fuel Level Low..... 441   |  Lowering..... 463   |  Please Wait Charging 48 V Bat-<br>tery..... 472      |
|  Gas Cap Loose..... 441  |  Malfunction Drive at Max. 50<br>mph..... 461, 462                             |  Replace Key Battery..... 427                         |
|   |   |  Running Board Not Extended..... 433                  |
|   |   |  See Operator's Manual..... 470                       |
|   |   |  SRS Malfunction Service<br>Required..... 424         |

-  Steering Malfunction Increased  
Physical Effort See Operator's Manual.... 434
-  Steering Malfunction Stop  
Immediately See Operator's Manual..... 434
-  Stop Vehicle Leave Engine Running..... 472
-  Stop Vehicle See Operator's Manual..... 471
-  Suspended..... 452
-  Switch Off Lights..... 430
-  Switch On Headlamps..... 430
-  Temporarily Unavailable Camera  
View Restricted..... 460
-  Temporarily Unavailable Sensors are Dirty..... 459
-  Turn On the Ignition to Release the Parking Brake..... 449
-  Vehicle Ready to Drive Switch  
the Ignition Off Before Exiting..... 432
-  Vehicle Rising Please Wait..... 463
-  Vehicle Rising..... 463
-  Warning Tire Malfunction..... 475
-  Wheel Sensor(s) Missing..... 474
- Active Blind Spot Assist Currently  
Unavailable See Operator's Manual..... 457
- Active Blind Spot Assist Inoperative..... 457
- Active Blind Spot Asst. Not Available  
When Towing a Trailer See Operator's  
Manual..... 458
- Active Brake Assist Functions Currently Limited See Operator's Manual..... 468
- Active Brake Assist Functions Limited  
See Operator's Manual..... 469
- Active Distance Assist Currently  
Unavailable See Operator's Manual..... 452
- Active Distance Assist Inoperative..... 452
- Active Distance Assist Now Available..... 453
- Active Lane Keeping Assist Currently  
Unavailable See Operator's Manual..... 458
- Active Lane Keeping Assist Inoperative... 458
- Active Steering Assist Currently  
Unavailable See Operator's Manual..... 454
- Active Steering Assist Inoperative..... 454
- Active Steering Asst. Currently  
Unavailable Due to Multiple Emergency Stops..... 454
- Active Stop & Go Assist Currently  
Unavailable See Operator's Manual..... 455
- Active Stop & Go Assist Inoperative  
See Operator's Manual..... 455
- Adaptive Highbeam Assist Currently  
Unavailable See Operator's Manual..... 431
- Adaptive Highbeam Assist Inoperative... 431
- Apply Brake to Shift from 'P'..... 441
- Apply Brake to Shift to 'R'..... 442
- Apply Brake to Shift to D or R..... 442
- Auxiliary Battery Malfunction (red display message)..... 444
- Auxiliary Battery Malfunction (white display message)..... 443

Beginning Emergency Stop.....	454	Front Passenger Airbag Enabled See Operator's Manual.....	425	LOW RANGE Shifting Canceled Please Reactivate.....	436
Blind Spot Assist Currently Unavaila- ble See Operator's Manual.....	456	Gearbox Protection Limit 18 mph Dis- able LOW RANGE.....	437	LOW RANGE Stop Apply Parking Brake... N Permanently Active Risk of Rolling Away.....	437 442
Blind Spot Assist Inoperative.....	456	Hazard Warning Flashers Malfunction- ing.....	431	Only Shift to 'P' when Vehicle is Sta- tionary.....	441
Blind Spot Assist Not Available When Towing a Trailer See Operator's Manual..	457	Head-up Display Currently Unavaila- ble See Operator's Manual.....	433	Parking Assist and PARKTRONIC Inop- erative See Operator's Manual.....	464
Cannot Start Engine See Operator's Manual.....	439, 473	Head-up Display Inoperative.....	433	Place the Key in the Marked Space See Operator's Manual.....	429
Check Brake Pads See Operator's Manual.....	450	LOW RANGE Malfunction.....	436	PRE-SAFE Impulse Side Inoperative See Operator's Manual.....	426
Cruise Control Inoperative.....	451	LOW RANGE Malfunction To Park, Apply Brake.....	436	PRE-SAFE Inoperative See Operator's Manual.....	426
Cruise Control Off.....	451	LOW RANGE Max. Speed 6 mph.....	437	REVERSING Not Possible Service Required.....	443
Decrease Speed.....	476	LOW RANGE Max. Speed 25 mph.....	437	Running Boards Not Retracted Pay Attention to Excess Width of Vehicle.....	432
Device Detected at Diagnostics Con- nection See Operator's Manual.....	470	LOW RANGE Not in Drive Program "Sport".....	436		
Driver's Door Open & Transmission Not in P Risk of Vehicle Rolling Away.....	442	LOW RANGE Only When Vehicle Is Stationary.....	435		
Engine Can Now Be Started.....	473	LOW RANGE Shift to Position N Briefly....	436		
Front Passenger Airbag Disabled See Operator's Manual.....	425				

- Service Required Do Not Shift Gears  
Visit Dealer..... 443
- Stop Vehicle Leave Engine Running  
Wait Transmission Cooling..... 443
- Tire Press. Monitor Currently Unavailable..... 473
- Tire Press. Monitor Inoperative..... 473
- Tire Pressure Monitor Inoperative No Wheel Sensors..... 474
- Tires Overheated..... 476
- To Deselect P or N, Depress Brake and Start Engine..... 442
- To switch engine off, press and hold Start/Stop button for at least 3 seconds or press 3 times..... 439
- Traffic Sign Assist Currently Unavailable See Operator's Manual..... 456
- Traffic Sign Assist Inoperative..... 456
- Transmission Malfunction Stop..... 443
- Update Failed..... 432
- Update Failed Software Remains Unchanged..... 432
- Update Successfully Completed..... 432
- Wiper Malfunctioning..... 438
- Distance control**  
see Active Distance Assist DISTRONIC
- DISTRONIC**  
see Active Distance Assist DISTRONIC
- Door**  
Child safety lock (rear door)..... 67  
Locking/unlocking (emergency key)..... 76  
Opening (from inside)..... 74  
Power closing function..... 76  
Unlocking (from inside)..... 74
- Door control panel**..... 14
- Door control panel (rear passenger compartment)**..... 16
- DOT, Tire Identification Number (TIN)**..... 382
- Downhill driving assistance**  
see DSR
- Drawbar**  
see Tow-bar system
- Drinking and driving**..... 178
- Drive Away Assist**..... 276
- Drive position**  
Inserting..... 194
- Drive program display**..... 190
- Drive programs**  
see DYNAMIC SELECT
- Driver's seat**  
see Seat
- Driving safety system**  
ABS (Anti-lock Braking System)..... 211  
Active Brake Assist..... 233  
BAS (Brake Assist System)..... 212  
Cameras..... 209  
EBD (electronic brake force distribution)..... 215  
ESP® Crosswind Assist..... 213  
ESP® trailer stabilization..... 213  
Off-road ABS..... 211  
Overview..... 210  
Radar and ultrasonic sensors..... 209  
Responsibility..... 209  
STEER CONTROL..... 215

**Driving system**

- see 360° Camera
- see Active Blind Spot Assist
- see Active Distance Assist DISTRONIC
- see Active Emergency Stop Assist
- see Active Lane Change Assist
- see Active Lane Keeping Assist
- see Active Parking Assist
- see Active Speed Limit Assist
- see Active Steering Assist
- see AIRMATIC
- see ATTENTION ASSIST
- see Blind Spot Assist
- see Cruise control
- see Driving safety system
- see DSR
- see E-ACTIVE BODY CONTROL
- see HOLD function
- see Parking Assist PARKTRONIC
- see Rear view camera
- see Traffic Sign Assist

**Driving tips**

- Breaking-in notes..... 177
- Drinking and driving..... 178
- General driving tips..... 178

- Optimized acceleration..... 177

**Drowsiness detection**

- see ATTENTION ASSIST

**DSR**

- Activating/deactivating..... 228
- Changing the target speed..... 229
- Function..... 227
- Notes..... 227
- Switching on/off..... 228

**Dynamic handling control system**

- see ESP® (Electronic Stability Program)

**DYNAMIC SELECT**

- Calling up the fuel consumption indicator..... 191
- Configuring drive program I..... 191
- Displaying engine data..... 191
- Displaying vehicle data..... 191
- Drive program display..... 190
- Drive programs..... 188
- Function..... 188
- Operating..... 190
- Selecting the drive program..... 190

**E****E-ACTIVE BODY CONTROL**

- Individual wheel control..... 257
- Recovery mode..... 256
- Setting the level..... 257
- Suspension..... 253

- E10**..... 410

**Easy entry feature**

- Function/notes..... 118

**Easy exit feature**

- Function/notes..... 118

**EBD (electronic brake force distribution)**

- Function/notes..... 215

**ECO Assist**

- Function/notes..... 187

**ECO display**

- Function..... 186

**ECO start/stop function**

- Switching off/on..... 186

**Electric parking brake**

- Applying automatically..... 206
- Applying/releasing manually..... 207
- Emergency braking..... 207

- Releasing automatically..... 207
- Electrohydraulic suspension**  
see E-ACTIVE BODY CONTROL
- Electronic Stability Program**  
see ESP® (Electronic Stability Program)
- Emergency**  
Assistance overview..... 18  
First-aid kit (soft sided)..... 351  
Reflective safety vest..... 350  
Removing the warning triangle..... 350  
Setting up the warning triangle..... 351
- Emergency braking**..... 207
- Emergency braking**  
see BAS (Brake Assist System)
- Emergency call**  
see Mercedes-Benz emergency call system
- Emergency key**  
Locking/unlocking the doors..... 76
- Emergency operation mode**  
Starting the vehicle..... 175
- Emergency release**  
Tailgate..... 83
- Emergency spare wheel**  
Inflating..... 400  
Notes..... 399
- Emergency Tensioning Devices**  
Activation..... 39
- Engine**  
Engine number..... 407  
Starting (emergency operation mode).... 175  
Starting (Remote Online)..... 176
- Engine data**  
Displaying..... 191
- Engine number**..... 407
- Engine oil**  
Additives..... 411  
Capacity..... 412  
Checking the oil level using the on-board computer..... 337  
MB-Freigabe or MB-Approval..... 412  
Quality..... 412  
Refilling..... 338
- Entering/exiting level**  
Setting..... 252
- Error message**  
see Display message
- ESC (Electronic Stability Control)**  
see ESP® (Electronic Stability Program)
- ESP®**  
Crosswind Assist..... 213  
Trailer stabilization..... 213
- ESP® (Electronic Stability Program)**  
Activating/deactivating..... 214  
Function/notes..... 212
- Extendable running boards**..... 77
- Extendable step**  
see Running boards
- Exterior lighting**  
Care..... 346
- Exterior lighting**  
see Lights
- Exterior mirrors**  
Automatic mirror folding function..... 163  
Operating the memory function..... 120  
Parking position..... 162
- F**
- Fatigue detection**  
see ATTENTION ASSIST

- First-aid kit (soft sided)**..... 351
- Flacon**  
Inserting/removing..... 168
- Flat tire**  
Changing a wheel..... 392  
MOExtended tires..... 352  
Notes..... 351  
TIREFIT kit..... 353
- Flat towing**  
see Tow-bar system
- Floor mats**..... 147
- Foil covering**  
Radar and ultrasonic sensors..... 209
- Folding table**..... 127
- Fragrance**  
see Fragrance system
- Fragrance system**  
Inserting/removing the flacon..... 168
- Free driving mode**  
Starting..... 260
- Free software**..... 36
- Frequencies**  
Two-way radio..... 405
- Front airbag (driver, front passenger)**..... 44
- Front passenger airbag shutoff**  
see Automatic front passenger airbag shutoff
- Front passenger seat**  
Adjusting from the driver's seat..... 100  
Adjusting from the rear passenger compartment..... 101
- Front passenger seat**  
see Seat
- Fuel**  
Additives..... 411  
E10..... 410  
Fuel reserve..... 411  
Gasoline..... 410  
Quality (gasoline)..... 410  
Refueling..... 199  
Sulfur content..... 410  
Tank content..... 411
- Fuel consumption indicator**  
Calling up..... 191
- Function seat**  
see Door control panel
- Function seat (rear passenger compartment)**  
see Seat (rear passenger compartment)
- Fuses**  
Before replacing a fuse..... 367  
Dashboard fuse box..... 369  
Fuse assignment diagram..... 367  
Fuse box in the cargo compartment..... 369  
Fuse box in the engine compartment..... 368  
Fuse box in the front-passenger footwell..... 369  
Notes..... 367
- Fuses**  
see Fuses
- G**
- Garage door opener**  
Clearing the memory..... 205
- Garage door openers**  
Opening/closing the door..... 205  
Programming buttons..... 203  
Resolving problems..... 205  
Synchronizing the rolling code..... 205
- Gasoline**..... 410

- Gearshift recommendation**..... 195
- Genuine parts**..... 22
- Glide mode**..... 196
- Glove box**  
Air vent..... 171
- H**
- Handbrake**  
see Electric parking brake
- Handling (unusual)**..... 370
- HANDS-FREE ACCESS**..... 82
- Handset**  
Stowage compartment..... 128
- Hazard warning lights**..... 150
- Hazardous substances**  
Information..... 25
- Head restraint**  
Attaching/removing the supplementary cushion..... 111  
EASY ADJUST luxury head restraint (front)..... 109  
Front (adjusting mechanically)..... 107  
Front (luxury head restraint)..... 108
- Rear (adjusting)..... 109  
Rear (removing/installing)..... 110  
Rear passenger compartment (luxury head restraint)..... 110
- Head-up Display**  
Adjusting brightness (on-board computer)..... 287  
Adjusting display elements (on-board computer)..... 287  
Care..... 347  
Function..... 286  
Menu (on-board computer)..... 287  
Operating the memory function..... 120  
Setting the position (on-board computer)..... 287  
Switching on/off..... 288
- Headlamps**  
see Automatic driving lights
- Headliner (care)**..... 347
- Heating**  
see Climate control
- Help call**  
see Mercedes-Benz emergency call system
- High beam**  
Activating/deactivating..... 149
- High beam**  
see Adaptive Highbeam Assist
- HIGH RANGE**  
Shifting..... 198
- High-beam flasher**..... 149
- Hill start assist**..... 216
- HOLD function**  
Function/notes..... 215  
Switching on/off..... 215
- Home screen (media display)**  
Overview..... 290
- Hood**  
Opening/closing..... 335
- I**
- Identification plate**  
Engine..... 407  
Refrigerant..... 414  
vehicle..... 407
- Ignition key**  
see SmartKey



- Immobilizer**..... 93
- Indicator lamp**  
see Warning/indicator lamp
- Individual drive program**  
Configuring..... 191  
Selecting..... 190
- Inside rearview mirror**  
Anti-glare mode (automatic)..... 161
- Inside rearview mirror**  
see Outside mirrors
- Inspection**  
see ASSYST PLUS
- Instrument cluster**  
Function/notes..... 282, 283
- Instrument display**  
Function/notes..... 283  
Instrument cluster..... 10  
Overview of displays..... 286  
Warning/indicator lamps..... 479
- Instrument display and on-board computer**  
Function/notes..... 282
- Intelligent Light System**  
Active headlamps..... 151  
Adaptive Highbeam Assist..... 151  
Cornering light..... 151
- Interior lighting**  
Adjusting..... 153  
Ambient lighting..... 154  
Reading lamp..... 153  
Switch-off delay time..... 155
- Interior motion sensor**  
Activating/deactivating..... 96  
Function..... 95
- Internet radio**  
see TuneIn
- Ionization**  
Activating/deactivating (MBUX multi-media system)..... 168
- iPhone®**  
see Smartphone integration
- J**
- Jack**  
Storage location..... 392
- Jump-start connection**  
General notes..... 358
- K**
- KEYLESS-GO**  
Deactivating a function..... 71  
Locking/unlocking the vehicle..... 74  
Problem..... 75  
Unlocking setting..... 71
- Kickdown**  
Using..... 196
- Knee airbag**..... 44
- L**
- Labeling (tires)**  
see Tire labeling
- Lamp**  
see Interior lighting
- Lamp (instrument display)**  
see Warning/indicator lamp
- Lane detection (automatic)**  
see Active Lane Keeping Assist

- Lane Keeping Assist**  
see Active Lane Keeping Assist
- Language**  
Notes..... 301  
Setting..... 301
- LATCH-type (ISOFIX) child seat anchor**  
Installing..... 59
- Leg rest**  
Attaching/removing the additional  
cushion..... 104
- Level control system**  
see AIRMATIC  
see E-ACTIVE BODY CONTROL
- Light switch**  
Overview..... 148
- Lighting**  
see Interior lighting  
see Lights
- Lights**  
Active headlamps..... 151  
Adaptive Highbeam Assist..... 151  
Automatic driving lights..... 149  
Combination switch..... 149  
Cornering light..... 151  
Hazard warning lights..... 150  
High beam..... 149  
High-beam flasher..... 149  
Light switch..... 148  
Low beam..... 148  
Parking lights..... 148  
Rear fog light..... 148  
Responsibility for lighting systems..... 148  
Setting the exterior lighting switch-off  
delay time..... 153  
Standing lights..... 148  
Switching the surround lighting on/off... 153  
Turn signal light..... 149
- Limited Warranty**  
Vehicle..... 32
- Limiting the opening angle (tailgate)..... 83**
- Live Traffic Information**  
Switching the traffic information dis-  
play on..... 309
- Load index (tires)..... 384**
- Load protection net**  
Attaching..... 135
- Load-bearing capacity (tires)..... 384**
- Loading**  
Bag hook..... 136  
Cargo tie-down rings..... 136  
Coat hook..... 137  
Definitions..... 386  
Notes..... 124  
Roof luggage rack..... 138
- Loading guidelines..... 124**
- Loading information table..... 376**
- Loads**  
Fixing..... 124
- Locking/unlocking**  
Emergency key..... 76  
KEYLESS-GO..... 74  
Opening the tailgate..... 78  
Switching the automatic locking fea-  
ture on/off..... 76  
Unlocking/opening the doors from  
the inside..... 74
- Low beam**  
Activating/deactivating..... 148
- LOW RANGE**  
Shifting..... 198

<b>Lowering the vehicle</b>	
Rear of the vehicle.....	252
<b>Lubricant additives</b>	
see Additives	
<b>Luggage</b>	
Securing.....	124
<b>Lumbar support</b>	
see Lumbar support (4-way)	
<b>Lumbar support (4-way).....</b>	101
<b>M</b>	
<b>MAGIC VISION CONTROL</b>	
Windshield wipers.....	158
<b>Maintenance</b>	
Vehicle.....	25
<b>Maintenance</b>	
see ASSYST PLUS	
<b>Malfunction</b>	
Restraint system.....	39
<b>Maneuvering aid</b>	
see Maneuvering assistance	
<b>Maneuvering assistance</b>	
Activating/deactivating.....	277

Cross Traffic Alert.....	277
Drive Away Assist.....	276
<b>Map</b>	
Displaying online map contents.....	309
Displaying weather information.....	309
Moving.....	308
Selecting the map orientation.....	308
Setting the map scale.....	308
Switching freeway information on/off.....	308
<b>Massage programs</b>	
Overview.....	113
Resetting the settings.....	113
Selecting the front seats.....	113
<b>Maximum load rating.....</b>	383
<b>Maximum permissible load</b>	
Calculation example.....	378
Determining.....	377
<b>Maximum tire pressure.....</b>	383
<b>MBUX Interior Assistant</b>	
Overview.....	294
Switching the reading light on/off (contactless).....	295
Switching the search light on/off (contactless).....	295

<b>MBUX multimedia system</b>	
Activating/deactivating standby mode...	209
Collision detection (parked vehicle).....	208
Configuring drive program I.....	191
Home screen.....	290
Notes.....	289
Operating the touchscreen.....	291
Overview.....	289
Restoring (factory settings).....	302
Setting route-based speed adaptation....	226
Setting the air distribution.....	166
Setting the fragrance system.....	168
Setting the rear climate control.....	166
Standby mode function.....	208
Switching ionization on/off.....	168
<b>MBUX multimedia system</b>	
see Display (MBUX multimedia system)	
see MBUX Interior Assistant	
<b>Mechanical key</b>	
Inserting/removing.....	72
Unlocking the tailgate.....	84
<b>Media</b>	
Overview of the functions and symbols...	326

- Media mode**  
 Connecting Bluetooth® audio equipment..... 327
- Medical aids**..... 30
- Memory function**  
 Function..... 119  
 Head-up Display – Calling up stored settings..... 120  
 Head-up Display – Storing settings..... 120  
 Operating..... 120  
 Outside mirrors – Calling up stored settings..... 120  
 Outside mirrors – Storing settings..... 120  
 Seat – Calling up stored settings..... 120  
 Seat – Storing settings..... 120
- Memory function in the rear passenger compartment**  
 Function..... 120  
 Operating rear seats..... 121  
 Operating the front passenger seat and rear seats..... 122
- Menu (on-board computer)**  
 Head-up Display..... 287  
 Overview..... 284
- Mercedes me app**  
 Information..... 320  
 Notes..... 24  
 On-demand feature..... 24
- Mercedes me calls**  
 Arranging a service appointment..... 317  
 Calling the Mercedes-Benz customer center..... 316  
 Calling the Mercedes-Benz Customer Center after automatic accident or breakdown detection..... 317  
 Information..... 316  
 Making a call via the overhead control panel..... 316  
 Transferred data..... 318
- Mercedes me connect**  
 Accident and Breakdown Management... 319  
 Information..... 319  
 Transferred data..... 320
- Mercedes-AMG vehicles**  
 Notes..... 173
- Mercedes-Benz emergency call system**  
 Automatic emergency call..... 324  
 Information..... 323
- Information about data transfer..... 325  
 Manual emergency call..... 324  
 Overview..... 323
- Message (instrument display)**  
 see Display message
- Message memory**..... 423
- Mirrors**  
 see Outside mirrors
- Mobile phone**  
 Notes on wireless charging..... 144  
 Wireless charging (rear passenger compartment)..... 146
- Mobile phone**  
 see Smartphone integration  
 see Telephone
- Model type**  
 see Vehicle identification plate
- MOExtended tires**..... 352
- Multifunction camera**  
 ROAD SURFACE SCAN..... 256
- Multifunction steering wheel**  
 Overview of buttons..... 284

**Multifunction steering wheel**

see Steering wheel

**Multimedia system**

Activating/deactivating DSR..... 228

Extending/retracting the running boards..... 78

**Multimedia system**

see MBUX multimedia system

**N****Navigation**

Activating..... 303

Notes..... 302

Overview..... 304

Showing/hiding the menu..... 303

**Navigation**

see Destination entry

see Map

see Route

**Neutral**

Engaging..... 193

**O****Occupant safety**

see Airbag

see Automatic front passenger airbag shutoff

see Automatic measures after an accident

see Child seat

see Pets in the vehicle

see Post-collision brake

see PRE-SAFE® (anticipatory occupant protection)

see PRE-SAFE® Impulse Side

see PRE-SAFE® PLUS (anticipatory occupant protection plus)

see Restraint system

see Seat belt

**Off-road Assist**

Setting..... 260

**Off-road driving**..... 182**Off-road driving**

see Off-road driving

**Off-road ESP® (Electronic Stability Program)**

Switching on/off..... 214

**Offroad Score**

Displaying..... 192

**Oil**

see Engine oil

**On-board computer**

Displaying the service due date..... 334

Head-up Display menu..... 287

Instrument display..... 286

Menu overview..... 284

Operating..... 284

**On-board diagnostics interface**

see Diagnostics connection

**On-board electrical system battery (12 V)**

Charging..... 360

Replacing..... 361

Starting assistance..... 360

**On-board electronics**

Notes..... 404

Two-way radios..... 404

**On-demand feature**

Activating..... 24

Notes..... 24

**Online services**

Data storage..... 34

- Open-source software**..... 36
- Opening the tailgate using your foot**  
HANDS-FREE ACCESS..... 82
- Operating fluids**  
Additives (fuel)..... 411  
Brake fluid..... 413  
Coolant (engine)..... 413  
Engine oil..... 411  
Fuel (gasoline)..... 410  
Notes..... 408  
Refrigerant (air conditioning system)..... 414  
Windshield washer fluid..... 414
- Operating safety**  
48 V on-board electrical system..... 25  
Declaration of conformity (wireless  
vehicle components)..... 27  
Information..... 25
- Operating system**  
see On-board computer
- Operator's Manual**  
Vehicle equipment..... 23
- Operator's Manual (digital)**..... 20
- Optimized acceleration**  
Activating..... 177
- Outside mirrors**  
Anti-glare mode (automatic)..... 161  
Folding in/out..... 160  
Setting..... 160
- Overhead control panel**  
Overview..... 12
- Overview**  
Toll system..... 304
- P**
- Paint (cleaning instructions)**..... 344
- Paint code**..... 407
- Panel heating**  
Setting..... 115
- Panic alarm**  
Arming/disarming..... 71
- Panorama roof with power tilt/sliding  
panel**  
see Sliding sunroof
- Park position**  
Engaging..... 194  
Selecting automatically..... 194
- Parking**  
see Electric parking brake
- Parking aid**  
see Parking Assist PARKTRONIC
- Parking Assist PARKTRONIC**  
Activating..... 271  
Adjusting warning tones..... 272  
Function..... 267  
Side impact protection..... 270  
Switching off..... 271  
System limitations..... 267
- Parking assistance systems**  
see Active Parking Assist
- Parking brake**  
see Electric parking brake
- Parking for an extended period**..... 208
- Parking lights**..... 148
- Parking option**  
Selecting..... 309
- Parking position**  
Exterior mirrors..... 162

- Storing the position of the front-passenger outside mirror using reverse gear..... 162
- Parking service**  
Selecting parking options..... 309
- PASSENGER AIR BAG status display**  
see Automatic front passenger airbag shutoff
- Payload**  
Calculation example..... 378  
Determining the maximum..... 377
- Perfume**  
see Fragrance system
- Perfume atomizer**  
Setting..... 168
- Perfume vial**  
see Fragrance system
- Period out of use**  
Activating/deactivating standby mode... 209  
Standby mode function..... 208
- Permissible towing methods**..... 362
- Pets in the vehicle**..... 69
- Plastic trim (Care)**..... 347
- Post-collision brake**..... 53
- Power closing function**  
Door..... 76
- Power supply**  
Switching on (start/stop button)..... 173
- Power washer (care)**..... 343
- PRE-SAFE® (anticipatory occupant protection)**  
Function..... 52  
PRE-SAFE® Sound..... 52  
Reversing measures..... 52
- PRE-SAFE® Impulse Side**  
Activation..... 39  
Function..... 53
- PRE-SAFE® PLUS (anticipatory occupant protection plus)**  
Function..... 52  
Reversing measures..... 52
- Preventative occupant protection system**  
see PRE-SAFE® (anticipatory occupant protection)  
see PRE-SAFE® PLUS (anticipatory occupant protection plus)
- Profile**  
Creating a new profile..... 297  
Notes..... 296  
Selecting profile options..... 297
- Programs**  
see DYNAMIC SELECT
- Protecting the environment**  
Notes..... 22
- Pulling away**  
see Driving tips
- Q**
- QR code**  
Rescue card..... 32
- Qualified specialist workshop**..... 29
- R**
- Radar and ultrasonic sensors**  
Damage..... 209
- Radio**  
Overview of the functions and symbols... 328
- Rain-closing feature**  
Sliding sunroof..... 91

- Raising the vehicle**  
Rear of the vehicle..... 252
- Reading lamp**  
see Interior lighting
- Reading light**  
Switching on/off (contactless)..... 295
- Real wood (Care)**..... 347
- Rear climate control**  
Setting (MBUX multimedia system)..... 166
- Rear door (child safety lock)**..... 67
- Rear fog lamp**  
Switching on/off..... 149
- Rear of the vehicle**  
Lowering..... 252  
Raising..... 252
- Rear passenger compartment seat**  
Seats..... 102
- Rear seat**  
see Seats  
see Third row of seats
- Rear view camera**  
Care..... 346  
Function..... 261
- Rear window**  
Replacing wiper blade..... 159
- Rear window heater**..... 164
- Rear window wipers**  
Activating/deactivating..... 156
- Reflective safety vest**..... 350
- Refrigerant (air conditioning system)**  
Notes..... 414
- Refrigerator box**  
Using..... 143
- Refueling**  
Refueling the vehicle..... 199
- Regulatory radio identification**  
Indonesia..... 406  
Small components..... 406
- Regulatory radio information**  
Installation clearances..... 406
- Remote Online**  
Charging the starter battery..... 176  
Cooling/heating the vehicle interior..... 175  
Starting the vehicle..... 176
- Reporting safety defects**..... 31
- Rescue card**..... 32
- Reserve**  
Fuel..... 411
- Reset function (MBUX multimedia system)**.... 302
- Residual heat**  
Rear operating unit..... 167
- Restoring (factory settings)**  
see Reset function (MBUX multimedia system)
- Restraint system**  
Basic instructions for children..... 53  
Function in an accident..... 39  
Functionality..... 39  
Limited protection..... 38  
Malfunction..... 39  
Protection..... 38  
Self-test..... 39  
Warning lamp..... 39
- Reverse gear**  
Engaging..... 193
- Reversing camera**  
Opening the camera cover (surround  
view camera)..... 267
- Rims (care)**..... 346



- ROAD SURFACE SCAN**  
Multifunction camera..... 256
- ROAD SURFACE SCAN**  
see Camera
- Roadside Assistance (breakdown)**..... 25
- Roll away protection**  
see HOLD function
- Roller sunblind**  
Side windows (electric)..... 93  
Sliding sunroof..... 88
- Rollover crash**..... 30
- Roof load**..... 418
- Roof load display**  
Information..... 190
- Roof luggage rack**  
Loading..... 138  
Securing..... 138
- Route**  
Calculating..... 307  
Selecting options..... 307
- Route guidance with augmented reality**  
Activating..... 307  
Displaying street names and house numbers..... 307
- Route-based speed adaptation**  
Function..... 225  
Setting..... 226
- Run-flat characteristics**  
MOExtended tires..... 352
- Running boards**  
Care..... 346  
Extending/retracting..... 78  
Function..... 77
- S**
- Safety systems**  
see Driving safety system
- Satellite radio**  
Logging in..... 332  
Setting music and sport alerts..... 332
- Search light**  
Switching on/off (contactless)..... 295
- Seat**  
4-way lumbar support..... 101  
Adjusting (electrically)..... 97  
Adjusting a reclining rear seat..... 102  
Adjusting the front passenger seat from the rear passenger compartment... 101  
Automatic adjustment..... 112  
Configuring settings..... 111  
Correct driver's seat position..... 97  
Folding back the backrest (rear passenger compartment)..... 104, 130  
Folding back the backrest on the third row of seats..... 132  
Folding the backrest (rear passenger compartment) forwards to get in (third row of seats)..... 104  
Folding the backrest on the third row of seats forwards..... 131  
Massage program overview..... 113  
Mechanically unlocking the backrest (rear passenger compartment)..... 104  
Operating the memory function..... 120  
Panel heating..... 115  
Rear (seat comfort)..... 102  
Resetting the settings..... 113  
Setting options..... 14  
Setting the fully reclined position..... 103  
Workout program overview..... 113

- Seat (rear passenger compartment)**  
Setting options..... 16
- Seat belt**  
Adjusting the height..... 43  
Care..... 347  
Fastening..... 43  
Protection..... 40  
Warning lamp..... 44
- Seat belt adjustment**  
Activating/deactivating..... 44  
Function..... 43
- Seat belt warning**  
see Seat belt
- Seat belts**  
Activating/deactivating seat belt  
adjustment..... 44  
Reduced protection..... 41  
Releasing..... 44  
Seat belt adjustment (function)..... 43
- Seat cover (Care)**..... 347
- Seat heating**  
Activating/deactivating..... 113
- Seat ventilation**  
Activating/deactivating..... 115
- Seats**  
Folding the backrest forwards (rear  
passenger compartment)..... 129  
Rear passenger compartment (adjust-  
ing electrically)..... 102
- Selecting a gear**  
see Changing gears
- Selector lever**  
see DIRECT SELECT lever
- Self-test**  
Automatic front passenger airbag shut  
off..... 49
- Sensors (care)**..... 346
- Service**  
see ASSYST PLUS
- Service Center**  
see Qualified specialist workshop
- Service interval display**  
see ASSYST PLUS
- Setting a speed**  
see Cruise control
- Setting the map scale**  
see Map
- Shift paddles**  
see Steering wheel paddle shifters
- Shifting gears**  
Gearshift recommendation..... 195
- Side airbag**..... 44
- Side impact protection**..... 270
- Side windows**  
Child safety lock in the rear  
passenger compartment..... 68  
Closing using the SmartKey..... 87  
Convenience closing..... 87  
Convenience opening..... 86  
Opening with the SmartKey..... 86  
Opening/closing..... 85  
Problem..... 87  
Roller sunblind (electric)..... 93
- Size designation (tires)**..... 384
- Sliding sunroof**  
Automatic functions..... 91  
Closing..... 88  
Closing using the SmartKey..... 87  
Opening..... 88  
Opening with the SmartKey..... 86  
Problem..... 92

- Rain-closing feature..... 91
- SmartKey**
- Acoustic locking verification signal..... 71
  - Battery..... 72
  - Deactivating a function..... 71
  - Energy consumption..... 71
  - Function overview..... 70
  - Key ring attachment..... 72
  - Mechanical key..... 72
  - Panic alarm..... 71
  - Problem..... 73
  - Unlocking setting..... 71
- SmartKey**
- see SmartKey
- Smartphone**
- see Smartphone integration
  - see Telephone
- Smartphone integration**
- Overview..... 321
- Snow chains**..... 371
- Socket (12 V)**
- Using..... 140
- Socket (115 V)**
- Rear passenger compartment..... 141
- Software update**
- System updates..... 298
- Sound**
- PRE-SAFE® Sound..... 52
  - Wheels and tires..... 370
  - Wheels/tires..... 370
- Sound menu**
- Functions overview..... 333
- Spare wheel**
- see Collapsible spare wheel
  - see Emergency spare wheel
- Special seat belt retractor**..... 58
- Specialist workshop**
- see Qualified specialist workshop
- Speed index (tires)**..... 384
- Sport Utility Vehicle**..... 30
- Standby mode**
- Activating/deactivating..... 209
  - Function..... 208
- Standing lights**..... 148
- Start-off assist**
- see Optimized acceleration
- Start/stop button**
- Parking the vehicle..... 201
  - Starting the vehicle..... 174
  - Switching on the power supply/vehicle.. 173
- Start/stop function**
- see ECO start/stop function
- Starter battery**
- Charging (Remote Online)..... 176
- Starting**
- see Vehicle
- Starting assistance**
- see Jump-start connection
- Starting-off aid**
- see Hill start assist
- STEER CONTROL**
- Function/notes..... 215
- Steering wheel**
- Adjusting (electrically)..... 117
  - Adjusting (manually)..... 116
  - Buttons..... 284
  - Care..... 347
  - Steering wheel heater..... 117

- Steering wheel heater**  
 Activating/deactivating..... 117
- Steering wheel paddle shifters**..... 195
- Step**  
 see Running boards
- Storage areas**  
 see Storage space
- Storage compartments**  
 see Storage space
- Storage space**  
 Armrest..... 127  
 Center console..... 127  
 Door..... 127  
 Glove box..... 127
- Stowage areas**  
 see Loading
- Stowage compartment**  
 Folding table..... 127  
 Handset (rear passenger compartment)..... 128  
 Rear seat backrest..... 128
- Stowage compartments**  
 see Loading
- Street names and house numbers**  
 Displaying..... 307
- Suggestions**  
 Configuring..... 297
- Sulfur content**..... 410
- Surround lighting**  
 Switching on/off..... 153
- Surround View**  
 see 360° Camera
- Surround view camera**  
 Care..... 346  
 Opening the camera cover (reversing camera)..... 267  
 Selecting a view..... 267
- Suspension**  
 Individual wheel control (E-ACTIVE BODY CONTROL)..... 257  
 Rocking free mode (E-ACTIVE BODY CONTROL)..... 256  
 Setting the suspension level (AIRMATIC)..... 249  
 Setting the suspension level (E-ACTIVE BODY CONTROL)..... 257
- Suspension**  
 see AIRMATIC  
 see E-ACTIVE BODY CONTROL
- Suspension level (AIRMATIC)**  
 Setting..... 249
- Suspension level (E-ACTIVE BODY CONTROL)**  
 Setting..... 257
- Switch-off delay time**  
 Exterior..... 153  
 Interior..... 155
- Switching on the ignition**  
 see Vehicle
- Synchronization function**  
 Activating/deactivating (control panel)... 167  
 Activating/deactivating (MBUX multimedia system)..... 167
- System settings**  
 Overview of the system settings menu.... 298  
 Reset function (MBUX multimedia system)..... 302
- System settings**  
 see Language















- T**
- Table**  
see Folding table
- Tailgate**  
Closing..... 79  
Emergency release..... 83  
HANDS-FREE ACCESS..... 82  
Limiting the opening angle..... 83  
Opening..... 78  
Opening dimensions..... 416  
Unlocking (mechanical key)..... 84
- Tailpipes (care)**..... 346
- Tank content**  
Fuel..... 411  
Reserve (fuel)..... 411
- Technical data**  
Axle load (trailer operation)..... 422  
Component-specific information..... 406  
Information..... 404  
Notes (trailer hitch)..... 420  
Regulatory radio identification (Indonesia)..... 406  
Regulatory radio identification of small components..... 406  
Regulatory radio information..... 406  
Tongue weight..... 421  
Towing capacity (trailer operation)..... 420
- Telephone**  
Connecting a mobile phone (Passkey).... 315  
Connecting a mobile phone (Secure Simple Pairing)..... 315  
Functions in the telephone menu..... 315  
Notes..... 312  
Notes on wireless charging (mobile phone)..... 144  
Operating modes..... 314  
Telephone menu overview..... 314  
Wireless charging (mobile phone in the rear passenger compartment)..... 146  
Wireless charging (mobile phone)..... 145
- Telephony operating modes**  
Bluetooth® telephony..... 314
- Temperature**  
Setting the vehicle interior temperature..... 164
- Temperature grade**..... 381
- Themes**  
Fastening..... 297
- Third row of seats**  
Folding back the backrest on the third row of seats..... 132  
Folding the backrest on the third row of seats forwards..... 131  
Getting in/out..... 104
- Through-loading feature**  
see Seats  
see Third row of seats
- TIN (Tire Identification Number)**..... 382
- Tire and Loading Information placard**..... 376
- Tire characteristics**..... 384
- Tire inflation compressor**  
see TIREFIT kit
- Tire information table**..... 376
- Tire labeling**  
Characteristics..... 384  
DOT, Tire Identification Number (TIN).... 382  
Load index..... 384  
Load-bearing capacity..... 384  
Maximum tire load..... 383  
Maximum tire pressure..... 383  
Overview..... 381  
Speed rating..... 384













- Temperature grade..... 381
- Tire Quality Grading..... 381
- Tire size designation..... 384
- Traction grade..... 381
- Tread wear grade..... 381
- Tire load (maximum)**..... 383
- Tire pressure**
  - Checking (manually)..... 374
  - Checking (tire pressure monitoring system)..... 375
  - Maximum..... 383
  - Notes..... 371
  - Restarting the tire pressure monitoring system..... 376
  - Tire pressure monitoring system (function)..... 374
  - Tire pressure table..... 373
  - TIREFIT kit..... 353
- Tire pressure monitor**
  - Checking the tire pressure..... 375
  - Checking the tire temperature..... 375
  - Function..... 374
  - Restarting..... 376
- Tire pressure table**..... 373
- Tire Quality Grading**..... 381
- Tire temperature**
  - Checking (tire pressure monitoring system)..... 375
  - Tire pressure monitoring system (function)..... 374
- Tire tread**..... 370
- Tire-change tool kit**
  - Overview..... 392
- TIREFIT kit**
  - Storage location..... 353
  - Using..... 353
- Tires**
  - Characteristics..... 384
  - Checking..... 370
  - Checking the tire pressure (manually)..... 374
  - Checking the tire pressure (tire pressure monitoring system)..... 375
  - Definitions..... 386
  - DOT, Tire Identification Number (TIN)..... 382
  - Flat tire..... 351
  - Installing..... 397
  - Load index..... 384
  - Load-bearing capacity..... 384
  - Maximum tire load..... 383
  - Maximum tire pressure..... 383
  - MOExtended tires..... 352
  - Noise generation..... 370
  - Notes on installing..... 388
  - Overview of tire labeling..... 381
  - Removing..... 396
  - Replacing..... 388, 392
  - Replacing the wheel trim..... 393
  - Restarting the tire pressure monitoring system..... 376
  - Rotating..... 391
  - Selection..... 388
  - Snow chains..... 371
  - Speed rating..... 384
  - Storing..... 392
  - Temperature grade..... 381
  - Tire and Loading Information placard..... 376
  - Tire pressure (notes)..... 371
  - Tire pressure monitoring system (function)..... 374
  - Tire pressure table..... 373
  - Tire Quality Grading..... 381
  - Tire size designation..... 384
  - TIREFIT kit..... 353
  - Traction grade..... 381

- Tread wear grade..... 381  
 Unfamiliar handling..... 370
- Toll system**  
 Windshield..... 163
- Tongue weight**..... 421
- Tool**  
 see Vehicle tool kit
- Top Tether**..... 62
- Touch Control**  
 On-board computer..... 284  
 Operating..... 291
- Touchpad**  
 Operating..... 291
- Touchscreen**  
 Operating..... 291
- Tow-away alarm**  
 Activating/deactivating..... 95  
 Function..... 94
- Tow-bar system**..... 281
- Tow-starting**..... 367
- Towing away**..... 363
- Towing eye**  
 Installing..... 366  
 Storage location..... 366
- Towing methods**..... 362
- Traction grade**..... 381
- Traffic information**  
 Switching on the display..... 309
- Traffic light data service**  
 Display in the Instrument Display..... 239  
 Turning the display on/off..... 241
- Traffic Sign Assist**  
 Function/notes..... 238  
 Setting..... 239  
 System limits..... 238
- Trailer hitch**  
 Attaching the ball neck..... 279  
 Care..... 346  
 Coupling up/uncoupling a trailer..... 280  
 General notes..... 420  
 Notes..... 277
- Trailer operation**  
 Active Blind Spot Assist..... 243  
 Active Lane Keeping Assist..... 244  
 Attaching the ball neck..... 279
- Coupling up/uncoupling a trailer..... 280  
 Notes..... 277
- Trailer stabilization**  
 Function/notes..... 213
- Trailer tow hitch**  
 Axle load..... 422  
 Tongue weight..... 421  
 Towing capacity..... 420
- Transfer case**  
 HIGH RANGE..... 197  
 LOW RANGE..... 197  
 Shifting..... 198
- Transmission**  
 Engaging neutral..... 193
- Transmission position display**..... 192
- Transporting**  
 vehicle..... 365
- Tread wear grade**..... 381
- Trim element (Care)**..... 347
- Trunk lid**  
 see Tailgate
- Tuneln**  
 Calling up..... 331

- Turn signal indicator**..... 149
- Turn signal light**  
 Activating/deactivating..... 149
- Two-way radios**  
 Frequencies..... 405  
 Notes on installation..... 404  
 Transmission output (maximum)..... 405
- U**
- Unlocking**  
 see Locking/unlocking
- Updates**  
 Important system updates..... 298
- USB port**  
 Front storage compartment..... 127  
 Rear passenger compartment..... 142
- V**
- Vehicle**  
 Activating/deactivating standby mode... 209  
 Correct use..... 29  
 Data acquisition..... 32  
 Data storage..... 32  
 Diagnostics connection..... 28
- Equipment..... 23  
 Limited Warranty..... 32  
 Locking (automatically)..... 76  
 Locking/unlocking (emergency key)..... 76  
 Locking/unlocking (from inside)..... 74  
 Locking/unlocking (KEYLESS-GO)..... 74  
 Lowering..... 398  
 Maintenance..... 25  
 Medical aids..... 30  
 Parking for an extended period..... 208  
 Problem notification..... 31  
 QR code rescue card..... 32  
 Qualified specialist workshop..... 29  
 Raising..... 394  
 Setting collision detection (parked vehicle)..... 208  
 Standby mode function..... 208  
 Starting (emergency operation mode).... 175  
 Starting (Remote Online)..... 176  
 Starting (start/stop button)..... 174  
 Switching off (start/stop button)..... 201  
 Switching on (start/stop button)..... 173  
 Towing..... 281  
 Ventilating (convenience opening)..... 86
- Vehicle battery**  
 see On-board electrical system battery (12 V)
- Vehicle camera**  
 Information..... 209
- Vehicle data**  
 Angle of approach/departure..... 418  
 Displaying (DYNAMIC SELECT)..... 191  
 Maximum gradient-climbing capability... 418  
 Roof load..... 418  
 Turning circle..... 416  
 Vehicle height..... 416  
 Vehicle length..... 416  
 Vehicle width..... 416  
 Wheelbase..... 416
- Vehicle data storage**  
 Event data recorders..... 35  
 MBUX multimedia system/Mercedes me connect..... 35
- Vehicle dimensions**..... 416
- Vehicle emergency start**..... 367
- Vehicle identification number**  
 see VIN
- Vehicle identification plate**  
 Paint code..... 407



- VIN..... 407
- Vehicle interior**  
Cooling or heating (Remote Online)..... 175
- Vehicle level**  
Setting individual wheel control..... 260
- Vehicle maintenance**  
see ASSYST PLUS
- Vehicle operation**  
Outside the USA or Canada..... 24
- Vehicle sensors**  
Information..... 209
- Vehicle tool kit**  
TIREFIT kit..... 353  
Towing eye..... 366
- Vehicle with a high center of gravity**..... 30
- Ventilating**  
Convenience opening..... 86
- Ventilation**  
see Climate control
- Vents**  
see Air vents
- VIN**  
Identification plate..... 407  
Seat..... 407  
Windshield..... 407
- Vision**  
Removing condensation from the windows..... 167  
Windshield heater..... 169
- Voice Control System**  
Function..... 293  
Starting..... 293
- W**
- Warning lamp**  
see Warning/indicator lamp
- Warning system**  
see ATA (anti-theft alarm system)
- Warning triangle**  
Removing..... 350  
Setting up..... 351
- Warning/indicator lamp**  
 ABS warning lamp..... 491  
 Active Brake Assist warning lamp.. 489
-  Brake system warning lamp  
(Canada only)..... 488
-  Brake warning lamp (USA only).... 488
-  Brakes warning lamp (yellow)  
(Canada only)..... 487
-  Coolant warning lamp (red)..... 482
-  Coolant warning lamp (yellow)..... 483
-  Electric parking brake indicator  
lamp (red) (Canada only)..... 486
-  Electric parking brake indicator  
lamp (red) (USA only)..... 486
-  Electrical malfunction warning  
lamp..... 484
-  Engine diagnosis warning lamp..... 484
-  ESP® OFF warning lamp..... 492
-  ESP® warning lamp flashes..... 491
-  ESP® warning lamp lights up..... 492
-  Fuel reserve warning lamp flashes..... 484

-  Fuel reserve warning lamp lights up..... 485
-  Power steering warning lamp (red)..... 481
-  Recuperative Brake System warning lamp (USA only)..... 487
-  Restraint system warning lamp..... 480
-  Seat belt warning lamp flashes..... 480
-  Seat belt warning lamp lights up.... 481
-  Suspension warning lamp (red)..... 490
-  Suspension warning lamp (yellow)..... 490
-  The electric parking brake (yellow) indicator lamp..... 486
-  Tire pressure monitoring system warning lamp flashes..... 493
-  Tire pressure monitoring system warning lamp lights up..... 494
-  Warning lamp for distance warning function..... 489
- Overview..... 479
- PASSENGER AIR BAG..... 49
- Warranty**..... 32
- Washing by hand (care)**..... 344
- Water tank**  
see Air-water duct
- Weather information**..... 309
- Web browsers**  
Overview..... 321
- Wheel change**  
Lowering the vehicle..... 398  
Removing/installing hub caps..... 393
- Wheel rotation**..... 391
- Wheels**  
Care..... 346  
Checking..... 370  
Checking the tire pressure (manually).... 374  
Checking the tire pressure (tire pressure monitoring system)..... 375  
Definitions..... 386  
DOT, Tire Identification Number (TIN).... 382  
Flat tire..... 351  
Installing..... 397
- Load index..... 384
- Load-bearing capacity..... 384
- Maximum tire load..... 383
- Maximum tire pressure..... 383
- MOExtended tires..... 352
- Noise generation..... 370
- Notes on installing..... 388
- Overview of tire labeling..... 381
- Removing..... 396
- Replacing..... 388, 392
- Replacing the hub cap..... 393
- Restarting the tire pressure monitoring system..... 376
- Rotating..... 391
- Selection..... 388
- Snow chains..... 371
- Speed rating..... 384
- Storing..... 392
- Temperature grade..... 381
- Tire and Loading Information placard.... 376
- Tire characteristics..... 384
- Tire pressure (notes)..... 371
- Tire pressure monitoring system (function)..... 374
- Tire pressure table..... 373
- Tire Quality Grading..... 381

- Tire size designation..... 384
- TIREFIT kit..... 353
- Traction grade..... 381
- Tread wear grade..... 381
- Unfamiliar handling..... 370
- Wi-Fi**
  - Setting..... 299
- Window curtain airbag**..... 44
- Window lifter**
  - see Side windows
- Windows**
  - Care..... 346
- Windows**
  - see Side windows
- Windshield**
  - Defrosting..... 164
  - Infrared reflective..... 163
  - Radio waves..... 163
  - Replacing the wiper blades..... 156
  - Replacing the wiper blades (MAGIC VISION CONTROL)..... 158
- Windshield**
  - see Windshield
- Windshield heater**..... 169
- Windshield heater**
  - see Windshield heater
- Windshield washer fluid**
  - Notes..... 414
- Windshield washer system**
  - Refilling..... 340
- Windshield wipers**
  - Activating/deactivating..... 155
  - Replacing the wiper blades..... 156
  - Replacing the wiper blades (MAGIC VISION CONTROL)..... 158
- Winter operation**
  - Snow chains..... 371
- Wiper blades**
  - Care..... 346
  - Replacing (MAGIC VISION CONTROL)..... 158
  - Replacing (windshield)..... 156
- Wireless charging**
  - Function/notes..... 144
  - Mobile phone..... 145
  - Mobile phone (rear passenger compartment)..... 146
- Wireless vehicle components**
  - Declaration of conformity..... 27
- Workout program**
  - Overview..... 113
- Workshop**
  - see Qualified specialist workshop





