

<b>Pictorial index</b>	Search by illustration	
<b>For safety and security</b>	Make sure to read through them (Main topics: Child seat, theft deterrent system)	1
<b>Vehicle status information and indicators</b>	Reading driving-related information (Main topics: Meters, multi-information display)	2
<b>Before driving</b>	Opening and closing the doors and windows, adjustment before driving (Main topics: Keys, doors, seats)	3
<b>Driving</b>	Operations and advice which are necessary for driving (Main topics: Starting engine, refueling)	4
<b>Interior features</b>	Usage of the interior features (Main topics: Air conditioner, storage features)	5
<b>Maintenance and care</b>	Caring for your vehicle and maintenance procedures (Main topics: Interior and exterior, light bulbs)	6
<b>When trouble arises</b>	What to do in case of malfunction and emergency (Main topics: Battery discharge, flat tire)	7
<b>Vehicle specifications</b>	Vehicle specifications, customizable features (Main topics: Fuel, oil, tire inflation pressure)	8
<b>For owners</b>	Reporting safety defects for U.S. owners, and seat belt, SRS airbag and headlight aim instructions for Canadian owners	9
<b>Index</b>	Search by symptom	
	Search alphabetically	

## 2 TABLE OF CONTENTS

For your information .....	6
Reading this manual .....	10
How to search .....	11
Pictorial index .....	12

### 1 For safety and security

<b>1-1. For safe use</b>	
Before driving .....	24
For safe driving .....	25
Seat belts .....	26
SRS airbags .....	30
Front passenger occupant classification system .....	39
Exhaust gas precautions .....	44
<b>1-2. Child safety</b>	
Riding with children .....	45
Child restraint systems .....	45
<b>1-3. Lexus Enform</b>	
Lexus Enform Safety Connect ..	60
<b>1-4. Theft deterrent system</b>	
Engine immobilizer system .....	66
Alarm .....	68

### 2 Vehicle status information and indicators

<b>2-1. Instrument cluster</b>	
Warning lights and indicators .....	72
Gauges and meters .....	77
Multi-information display .....	81
Head-up display .....	88
Fuel consumption information .....	92

### 3 Before driving

<b>3-1. Key information</b>	
Keys .....	96
<b>3-2. Opening, closing and locking the doors</b>	
Side doors .....	99
Power back door .....	103
Smart access system with push-button start .....	115
<b>3-3. Adjusting the seats</b>	
Front seats .....	121
Rear seats .....	122
Driving position memory .....	133
Head restraints .....	136
<b>3-4. Adjusting the steering wheel and mirrors</b>	
Steering wheel .....	139
Inside rear view mirror .....	140
Outside rear view mirrors .....	141
<b>3-5. Opening, closing the windows and moon roof</b>	
Power windows .....	144
Moon roof .....	146
Panoramic moon roof .....	149

### 4 Driving

<b>4-1. Before driving</b>	
Driving the vehicle .....	154
Cargo and luggage .....	159
Vehicle load limits .....	162
Trailer towing (vehicles without towing package) .....	163

Trailer towing (vehicles with towing package).....	163		
Dinghy towing .....	173		
<b>4-2. Driving procedures</b>			
Engine (ignition) switch .....	174		
Automatic transmission.....	178		
Turn signal lever.....	182		
Parking brake .....	183		
Brake Hold.....	186		
<b>4-3. Operating the lights and wipers</b>			
Headlight switch.....	188		
AHB (Automatic High Beam) .....	191		
Fog light switch .....	194		
Windshield wipers and washer .....	194		
Rear window wiper and washer .....	199		
<b>4-4. Refueling</b>			
Opening the fuel tank cap.....	200		
<b>4-5. Using the driving support systems</b>			
Lexus Safety System + 2.0.....	203		
PCS (Pre-Collision System)....	209		
LTA (Lane Tracing Assist).....	216		
RSA (Road Sign Assist).....	225		
Dynamic radar cruise control with full-speed range.....	227		
BSM (Blind Spot Monitor).....	236		
PKSA (Parking Support Alert) .....	242		
Intuitive parking assist .....	244		
RCTA (Rear cross traffic alert) function.....	250		
PKSB (Parking Support Brake) .....	255		
Parking Support Brake function (static objects).....	261		
Parking Support Brake function (rear-crossing vehicles).....	267		
Driving mode select switch .....	271		
All-wheel drive lock switch.....	273		1
Driving assist systems .....	274		
<b>4-6. Driving tips</b>			
Winter driving tips.....	280		2
Utility vehicle precautions.....	282		
<b>5 Interior features</b>			3
<b>5-1. Remote Touch/Display</b>			
Remote Touch.....	286		4
Center Display.....	288		
<b>5-2. Lexus Climate Concierge</b>			
Lexus Climate Concierge.....	291		5
<b>5-3. Using the air conditioning system and defogger</b>			
Front automatic air conditioning system.....	292		6
Rear automatic air conditioning system.....	303		7
Heated steering wheel/seat heat- ers/seat ventilators.....	306		8
<b>5-4. Using the interior lights</b>			
Interior lights list .....	309		9
<b>5-5. Using the storage features</b>			
List of storage features .....	312		
Luggage compartment features .....	317		
<b>5-6. Using the other interior features</b>			
Other interior features .....	322		
Garage door opener .....	334		
Compass .....	340		

**6** Maintenance and care

**6-1. Maintenance and care**  
 Cleaning and protecting the vehicle exterior ..... **344**  
 Cleaning and protecting the vehicle interior ..... **347**

**6-2. Maintenance**  
 Maintenance requirements ..... **350**  
 General maintenance ..... **351**  
 Emission inspection and maintenance (I/M) programs ..... **354**

**6-3. Do-it-yourself maintenance**  
 Do-it-yourself service precautions ..... **355**  
 Hood ..... **357**  
 Positioning a floor jack ..... **357**  
 Engine compartment ..... **359**  
 Tires ..... **365**  
 Tire inflation pressure ..... **373**  
 Wheels ..... **374**  
 Air conditioning filter ..... **376**  
 Windshield wiper inserts ..... **378**  
 Electronic key battery ..... **379**  
 Checking and replacing fuses ..... **381**  
 Headlight aim ..... **382**  
 Light bulbs ..... **384**

**7** When trouble arises

**7-1. Essential information**  
 Emergency flashers ..... **394**  
 If your vehicle has to be stopped in an emergency ..... **394**

If the vehicle is trapped in rising water ..... **395**

**7-2. Steps to take in an emergency**  
 If your vehicle needs to be towed ..... **397**  
 If you think something is wrong ..... **401**  
 Fuel pump shut off system ..... **402**  
 If a warning light turns on or a warning buzzer sounds ..... **403**  
 If a warning message is displayed ..... **412**  
 If you have a flat tire ..... **416**  
 If the engine will not start ..... **428**  
 If you lose your keys ..... **430**  
 If the fuel filler door cannot be opened ..... **430**  
 If the electronic key does not operate properly ..... **431**  
 If the vehicle battery is discharged ..... **433**  
 If your vehicle overheats ..... **437**  
 If the vehicle becomes stuck ... **439**

**8** Vehicle specifications

**8-1. Specifications**  
 Maintenance data (fuel, oil level, etc.) ..... **442**  
 Fuel information ..... **450**  
 Tire information ..... **452**

**8-2. Customization**  
 Customizable features ..... **461**

**8-3. Initialization**  
 Items to initialize ..... **474**

**9 For owners**

**9-1. For owners**

- Reporting safety defects for U.S. owners ..... **476**
- Seat belt instructions for Canadian owners (in French)..... **476**
- SRS airbag instructions for Canadian owners (in French)..... **478**
- Headlight aim instructions for Canadian owners (in French) ..... **486**

**Index**

- What to do if... (Troubleshooting) ..... **490**
- Alphabetical Index..... **493**

1
2
3
4
5
6
7
8
9

## For your information

### Main Owner's Manual

Please note that this manual applies to all models and explains all equipment, including options. Therefore, you may find some explanations for equipment not installed on your vehicle.

All specifications provided in this manual are current at the time of printing. However, because of the Lexus policy of continual product improvement, we reserve the right to make changes at any time without notice.

Depending on specifications, the vehicle shown in the illustrations may differ from your vehicle in terms of color and equipment.

### Noise from under vehicle after turning off the engine

Approximately five hours after the engine is turned off, you may hear sound coming from under the vehicle for several minutes. This is the sound of a fuel evaporation leakage check and, it does not indicate a malfunction.

### Accessories, spare parts and modification of your Lexus

A wide variety of non-genuine spare parts and accessories for Lexus vehicles are currently available in the market. You should know that Toyota does not warrant these products and is not responsible for their performance,

repair, or replacement, or for any damage they may cause to, or adverse effect they may have on, your Lexus vehicle.

This vehicle should not be modified with non-genuine Lexus products. Modification with non-genuine Lexus products could affect its performance, safety or durability, and may even violate governmental regulations. In addition, damage or performance problems resulting from the modification may not be covered under warranty.

### Installation of a mobile two-way radio system

The installation of a mobile two-way radio system in your vehicle could affect electronic systems such as:

- Multiport fuel injection system/sequential multiport fuel injection system
- Lexus Safety System + 2.0
- Anti-lock brake system
- Vehicle dynamics integrated management
- SRS airbag system
- Seat belt pretensioner system

Be sure to check with your Lexus dealer for precautionary measures or special instructions regarding installation of a mobile two-way radio system.

### Vehicle data recording

The vehicle is equipped with sophisti-

cated computers that will record certain data, such as:

- Engine speed/Electric motor speed (traction motor speed)
  - Accelerator status
  - Brake status
  - Vehicle speed
  - Operation status of the driving assist systems
  - Images from the cameras
- Your vehicle is equipped with cameras. Contact your Lexus dealer for the location of recording cameras.

The recorded data varies according to the vehicle grade level and options with which it is equipped.

These computers do not record conversations or sounds, and only record images outside of the vehicle in certain situations.

#### ● Data Transmission

Your vehicle may transmit the data recorded in these computers to Lexus without notification to you.

#### ● Data usage

Lexus may use the data recorded in this computer to diagnose malfunctions, conduct research and development, and improve quality.

Lexus will not disclose the recorded data to a third party except:

- With the consent of the vehicle owner or with the consent of the lessee if the vehicle is leased
- In response to an official request by the police, a court of law or a government agency
- For use by Lexus in a lawsuit
- For research purposes where the data is

not tied to a specific vehicle or vehicle owner

- Recorded image information can be erased by your Lexus dealer.

The image recording function can be disabled. However, if the function is disabled, data from when the system operates will not be available.

- To learn more about the vehicle data collected, used and shared by Lexus, please visit [www.lexus.com/privacyvts/](http://www.lexus.com/privacyvts/).

### Usage of data collected through Lexus Enform (U.S. mainland only)

If your Lexus has Lexus Enform and if you have subscribed to those services, please refer to the Lexus Enform Telematics Subscription Service Agreement for information on data collected and its usage.

To learn more about the vehicle data collected, used and shared by Lexus, please visit [www.lexus.com/privacyvts/](http://www.lexus.com/privacyvts/).

### Event data recorder

This vehicle is equipped with an event data recorder (EDR). The main purpose of an EDR is to record, in certain crash or near crash-like situations, such as an air bag deployment or hitting a road obstacle, data that will assist in understanding how a vehicle's systems performed. The EDR is designed to record data related to vehicle dynamics and safety systems for a short

period of time, typically 30 seconds or less.

The EDR in this vehicle is designed to record such data as:

- How various systems in your vehicle were operating;
- Whether or not the driver and passenger safety belts were buckled/fastened;
- How far (if at all) the driver was depressing the accelerator and/or brake pedal; and,
- How fast the vehicle was traveling.

These data can help provide a better understanding of the circumstances in which crashes and injuries occur.

NOTE: EDR data are recorded by your vehicle only if a non-trivial crash situation occurs; no data are recorded by the EDR under normal driving conditions and no personal data (e.g., name, gender, age, and crash location) are recorded. However, other parties, such as law enforcement, could combine the EDR data with the type of personally identifying data routinely acquired during a crash investigation.

To read data recorded by an EDR, special equipment is required, and access to the vehicle or the EDR is needed. In addition to the vehicle manufacturer, other parties, such as law enforcement, that have the special equipment, can read the information if they have access to the vehicle or the EDR.

- Disclosure of the EDR data

Lexus will not disclose the data recorded in an EDR to a third party except when:

- An agreement from the vehicle's owner (or the lessee for a leased vehicle) is obtained
- In response to an official request by the police, a court of law or a government agency
- For use by Lexus in a lawsuit

However, if necessary, Lexus may:

- Use the data for research on vehicle safety performance
- Disclose the data to a third party for research purposes without disclosing information about the specific vehicle or vehicle owner

### Scrapping of your Lexus

The SRS airbag and seat belt pretensioner devices in your Lexus contain explosive chemicals. If the vehicle is scrapped with the airbags and seat belt pretensioners left as they are, this may cause an accident such as fire. Be sure to have the systems of the SRS airbag and seat belt pretensioner removed and disposed of by a qualified service shop or by your Lexus dealer before you scrap your vehicle.

### Perchlorate Material

Special handling may apply, See [www.dtsc.ca.gov/hazardouswaste/perchlorate](http://www.dtsc.ca.gov/hazardouswaste/perchlorate).

Your vehicle has components that may contain perchlorate. These components may include the airbags, seat belt pretensioners, wireless remote control batteries, and the batteries in the tire pressure warning valve and transmit-



ters.



#### WARNING

##### ■ General precautions while driving

**Driving under the influence:** Never drive your vehicle when under the influence of alcohol or drugs that have impaired your ability to operate your vehicle. Alcohol and certain drugs delay reaction time, impair judgment and reduce coordination, which could lead to an accident that could result in death or serious injury.

**Defensive driving:** Always drive defensively. Anticipate mistakes that other drivers or pedestrians might make and be ready to avoid accidents.

**Driver distraction:** Always give your full attention to driving. Anything that distracts the driver, such as adjusting controls, talking on a cellular phone or reading can result in a collision with resulting death or serious injury to you, your occupants or others.

##### ■ General precaution regarding children's safety



Never leave children unattended in the vehicle, and never allow children to have or use the key.

Children may be able to start the vehicle or shift the vehicle into neutral. There is also a danger that children may injure themselves by playing with the windows, the moon roof or panoramic moon roof, or other features of the vehicle. In addition, heat build-up or extremely cold temperatures inside the vehicle can be fatal to children.

### Reading this manual



Explains symbols used in this manual.

### Symbols in this manual

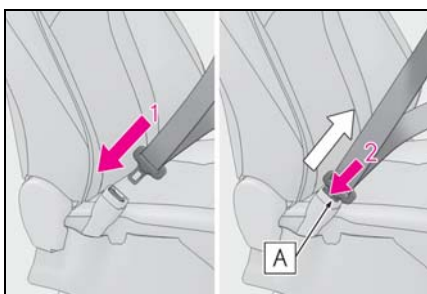

Symbols	Meanings
	<b>WARNING:</b> Explains something that, if not obeyed, could cause death or serious injury to people.
	<b>NOTICE:</b> Explains something that, if not obeyed, could cause damage to or a malfunction in the vehicle or its equipment.
	Indicates operating or working procedures. Follow the steps in numerical order.

### Symbols in illustrations

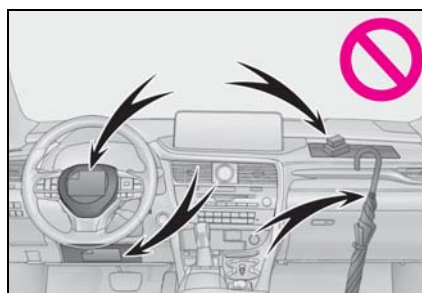

Symbols	Meanings
	Indicates the action (pushing, turning, etc.) used to operate switches and other devices.
	Indicates the outcome of an operation (e.g. a lid opens).



Symbols	Meanings
	Indicates the component or position being explained.
	Means <b>Do not, Do not do this, or Do not let this happen.</b>

## How to search

### ■ Searching by name

- Alphabetical index: →P.493

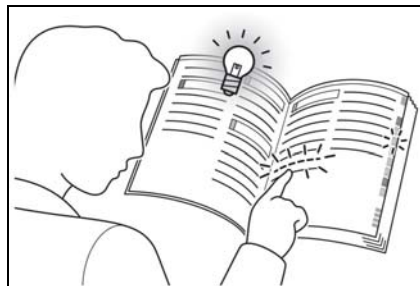
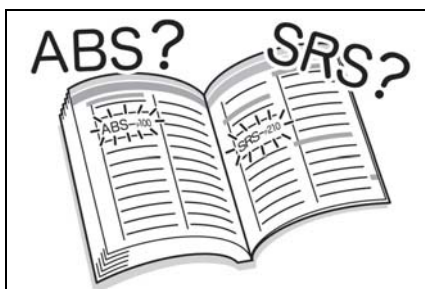

### ■ Searching by installation position

- Pictorial index: →P.12

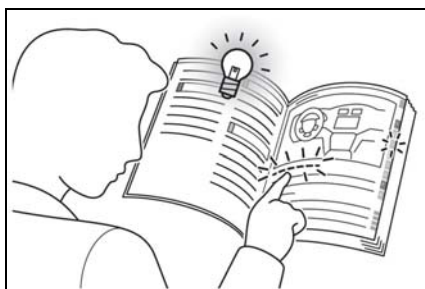

### ■ Searching by symptom or sound

- What to do if... (Troubleshooting):  
→P.490



### ■ Searching by title

- Table of contents: →P.2

## Pictorial index

### ■ Exterior

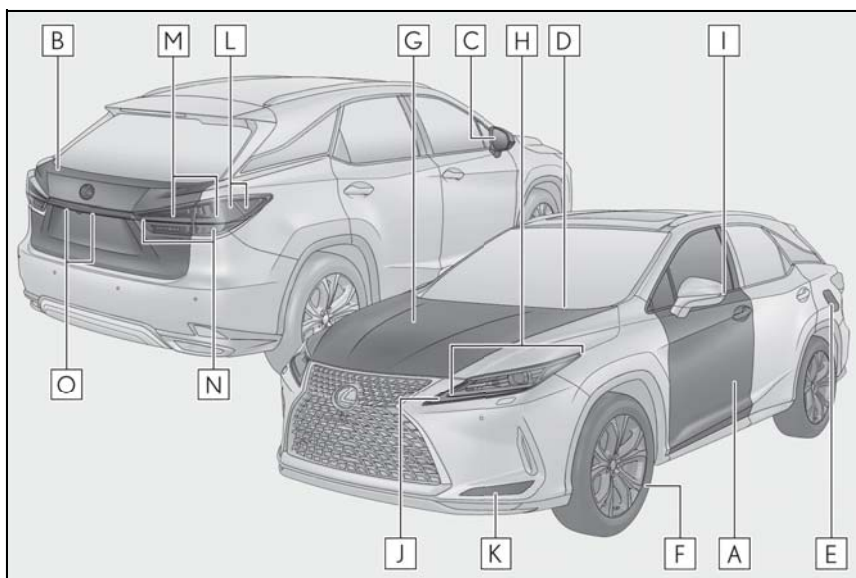

The shape of the lights may differ depending on the grade, etc.

<b>A</b>	<b>Side doors</b> .....	<b>P.99</b>
	Locking/unlocking .....	P.99
	Opening/closing the side windows .....	P.144
	Locking/unlocking by using the mechanical key .....	P.431
	Warning lights/warning messages .....	P.403, 412
<b>B</b>	<b>Back door</b> .....	<b>P.103</b>
	Opening from inside the cabin .....	P.105
	Opening from outside .....	P.105
	Warning lights/warning messages .....	P.403, 412
<b>C</b>	<b>Outside rear view mirrors</b> .....	<b>P.141</b>
	Adjusting the mirror angle .....	P.141
	Folding the mirrors .....	P.142, 142
	Driving position memory * .....	P.133
	Defogging the mirrors .....	P.294
<b>D</b>	<b>Windshield wipers</b> .....	<b>P.194</b>

	Precautions for winter season .....	P.280
	To prevent freezing (windshield wiper de-icer)* .....	P.299
	Precautions for car wash .....	P.345
<b>E</b>	<b>Fuel filler door</b> .....	<b>P.200</b>
	Refueling method .....	P.200
	Fuel type/fuel tank capacity .....	P.444
<b>F</b>	<b>Tires</b> .....	<b>P.365</b>
	Tire size/inflation pressure .....	P.365, 448
	Winter tires/tire chains .....	P.280
	Checking/rotation/tire pressure warning system .....	P.365
	Coping with flat tires .....	P.416
<b>G</b>	<b>Hood</b> .....	<b>P.357</b>
	Opening .....	P.357
	Engine oil .....	P.444
	Coping with overheating .....	P.437
	Warning messages .....	P.412

#### Light bulbs of the exterior lights for driving (Replacing method: P.384, Watts: P.449)

<b>H</b>	<b>Headlights/front turn signal lights/front side marker lights</b> .....	<b>P.182, 188</b>
<b>I</b>	<b>Side turn signal lights</b> .....	<b>P.182</b>
<b>J</b>	<b>Parking lights/daytime running lights</b> .....	<b>P.188</b>
<b>K</b>	<b>Fog lights/cornering lights</b> * .....	<b>P.188, 194</b>
<b>L</b>	<b>Rear side marker lights</b> .....	<b>P.188</b>
<b>M</b>	<b>Stop/tail lights</b> .....	<b>P.188</b>
<b>N</b>	<b>Back-up lights/rear turn signal lights</b> .....	<b>P.182, 188</b>
	Shifting the shift lever to R .....	P.178
<b>O</b>	<b>License plate lights</b> .....	<b>P.188</b>

\*: If equipped

■ Instrument panel

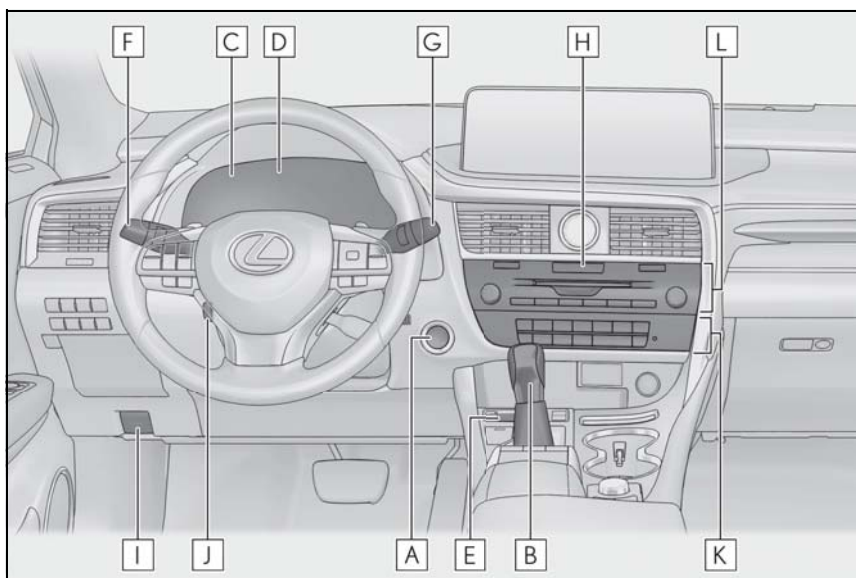

<b>A</b>	<b>Engine switch</b> .....	<b>P.174</b>
	Starting the engine/changing the modes .....	P.174
	Emergency stop of the engine .....	P.394
	When the engine will not start.....	P.428
	Warning messages .....	P.412
<b>B</b>	<b>Shift lever</b> .....	<b>P.178</b>
	Changing the shift position .....	P.179
	Precautions for towing .....	P.397
	When the shift lever does not move .....	P.179
<b>C</b>	<b>Meters</b> .....	<b>P.77</b>
	Reading the meters/adjusting the instrument panel light.....	P.77, 80
	Warning lights/indicator lights .....	P.72
	When a warning light turns on .....	P.403
<b>D</b>	<b>Multi-information display</b> .....	<b>P.81</b>
	Display .....	P.81
	When the warning messages are displayed.....	P.412

<b>E</b>	<b>Parking brake switch</b> .....	P.183
	Applying/releasing .....	P.183
	Precautions for winter season .....	P.281
	Warning buzzer/messages .....	P.412
<b>F</b>	<b>Turn signal lever</b> .....	P.182
	<b>Headlight switch</b> .....	P.188
	Headlights/side marker lights/parking lights/tail lights/license plate lights/daytime running lights .....	P.188
	Fog lights <sup>*1</sup> .....	P.194
<b>G</b>	<b>Windshield wiper and washer switch</b> .....	P.194, 199
	Usage.....	P.194, 199
	Adding washer fluid.....	P.364
	Warning messages .....	P.412
<b>H</b>	<b>Emergency flasher switch</b> .....	P.394
<b>I</b>	<b>Hood lock release lever</b> .....	P.357
<b>J</b>	<b>Tilt and telescopic steering control switch</b> .....	P.139
	Adjustment .....	P.139
	Driving position memory <sup>*1</sup> .....	P.133
<b>K</b>	<b>Air conditioning system</b> .....	P.292
	Usage.....	P.292
	Rear window defogger.....	P.292
<b>L</b>	<b>Audio system</b> <sup>*2</sup>	

<sup>\*1</sup>: If equipped

<sup>\*2</sup>: Refer to "NAVIGATION AND MULTIMEDIA SYSTEM OWNER'S MANUAL".

■ Switches

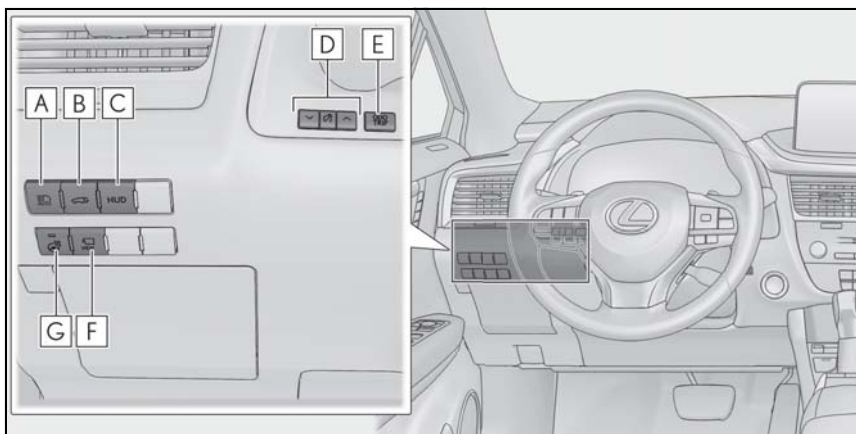

- A** Automatic High Beam switch..... P.191
- B** Power back door switch.....P.105
- C** HUD (Head-up display) switch<sup>\*1</sup>..... P.89
- D** Instrument panel light control switches..... P.80
- E** “ODO TRIP” switch..... P.80
- F** Camera switch<sup>\*1,2</sup>
- G** Heated steering wheel switch<sup>\*1</sup>.....P.306

<sup>\*1</sup>: If equipped

<sup>\*2</sup>: Refer to “NAVIGATION AND MULTIMEDIA SYSTEM OWNER’S MANUAL”.

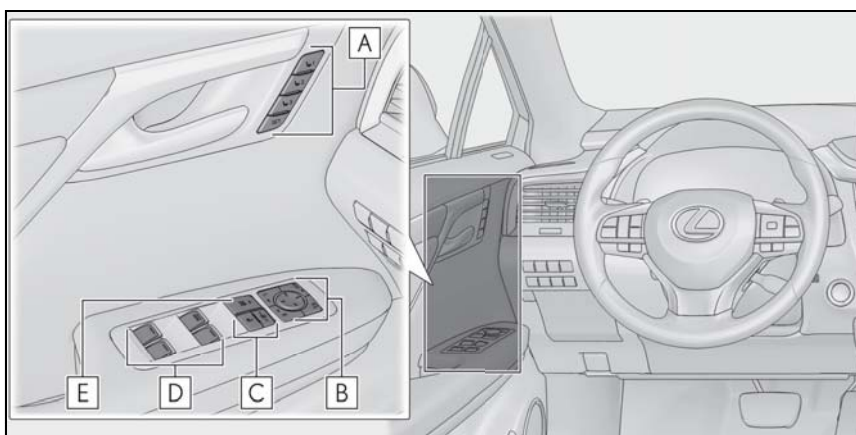



- A** Driving position memory switches \* .....P.133
- B** Outside rear view mirror switches ..... P.141
- C** Door lock switches .....P.101
- D** Power window switches ..... P.144
- E** Window lock switch .....P.146

\* : If equipped

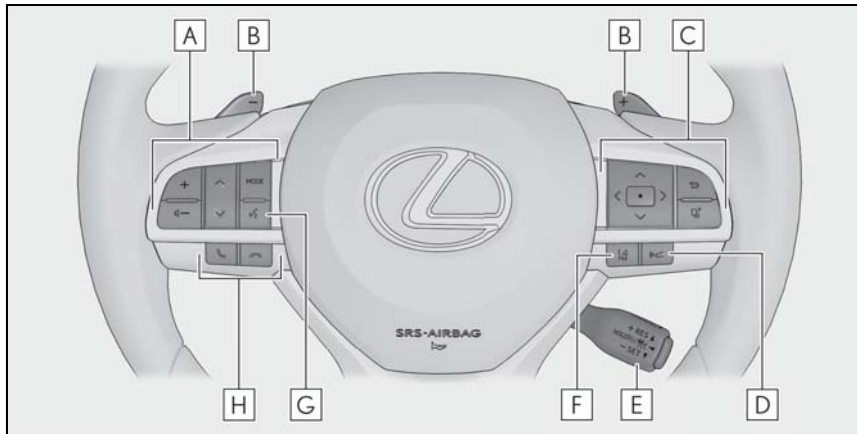

- A** Audio remote control switches \* ..... P.180
- B** Paddle shift switches ..... P.82
- C** Meter control switches ..... P.232
- D** Vehicle-to-vehicle distance switch ..... P.227
- E** Cruise control switch ..... P.220
- F** LTA (Lane Tracing Assist) switch ..... P.220
- G** Talk switch \*
- H** Phone switch \*

\* : Refer to "NAVIGATION AND MULTIMEDIA SYSTEM OWNER'S MANUAL".

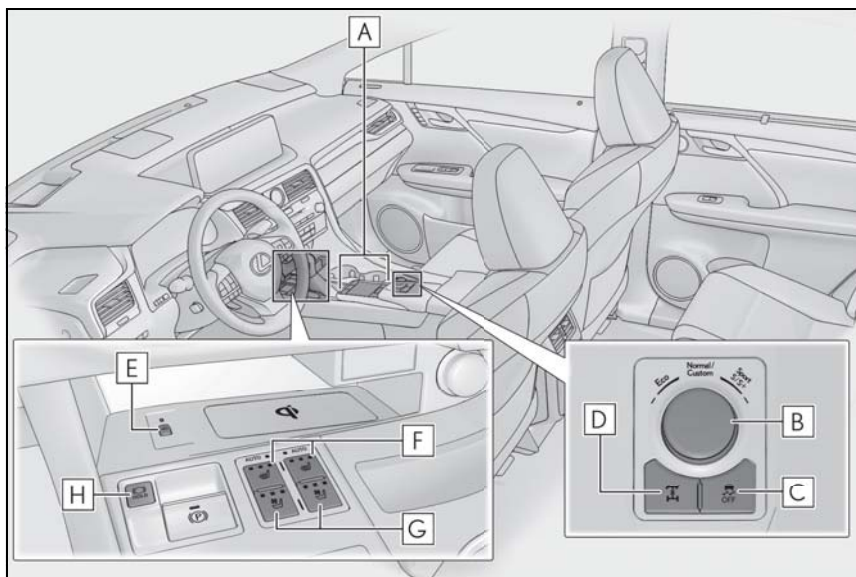

- A** Remote Touch<sup>\*1</sup> ..... P.286
- B** Driving mode select switch ..... P.271
- C** VSC OFF switch ..... P.276
- D** All-wheel drive lock switch<sup>\*2</sup> ..... P.273
- E** Wireless charger switch<sup>\*2</sup> ..... P.323
- F** Front seat heater switches<sup>\*2</sup> ..... P.306
- G** Seat ventilator switches<sup>\*2</sup> ..... P.308
- H** Brake hold switch ..... P.186

<sup>\*1</sup>: Refer to "NAVIGATION AND MULTIMEDIA SYSTEM OWNER'S MANUAL".

<sup>\*2</sup>: If equipped

## ■ Interior

### ► RX350

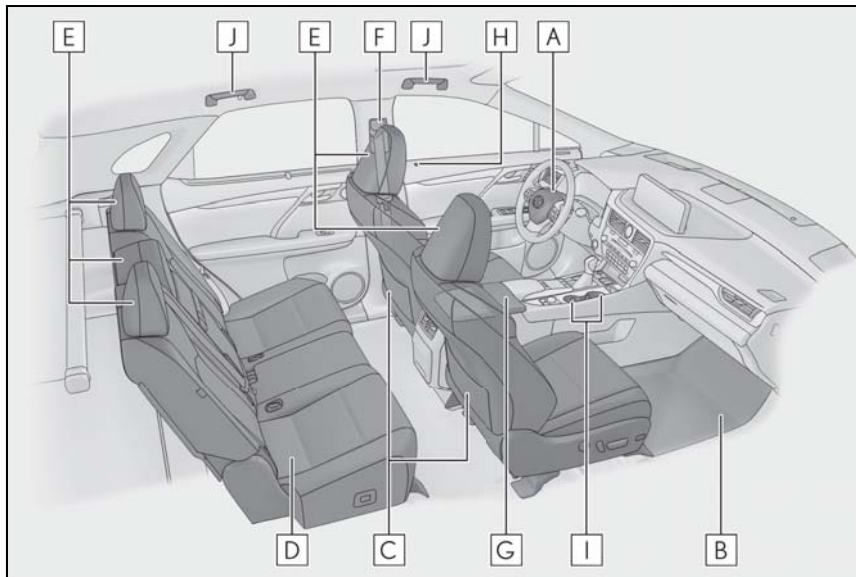

<b>A</b>	SRS airbags.....	P.30
<b>B</b>	Floor mats.....	P.24
<b>C</b>	Front seats.....	P.121
<b>D</b>	Rear seats.....	P.122
<b>E</b>	Head restraints.....	P.136
<b>F</b>	Seat belts.....	P.26
<b>G</b>	Console box.....	P.314
<b>H</b>	Inside lock buttons.....	P.101
<b>I</b>	Cup holders.....	P.315
<b>J</b>	Assist grips.....	P.330

► RX350L (vehicles with separate-type second-row seats)

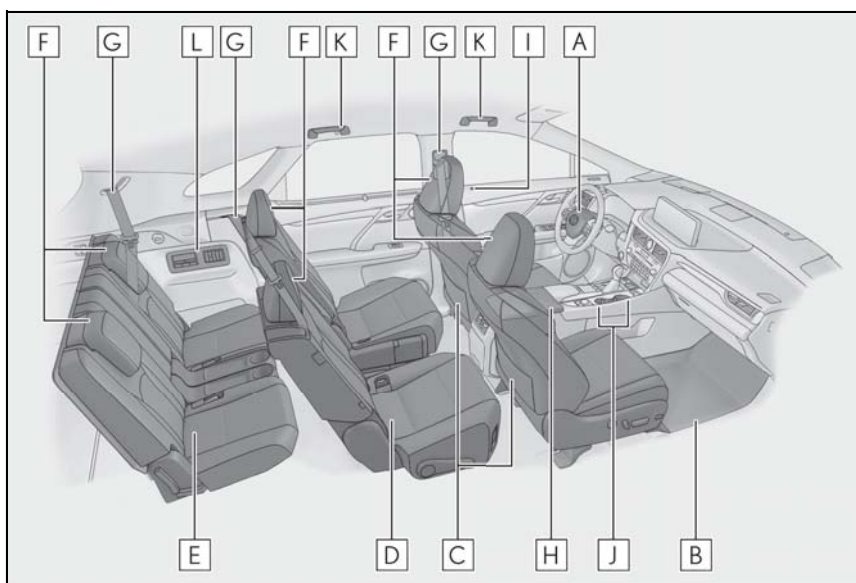

<b>A</b>	SRS airbags.....	P.30
<b>B</b>	Floor mats.....	P.24
<b>C</b>	Front seats.....	P.121
<b>D</b>	Second-row seats.....	P.122
<b>E</b>	Third-row seats.....	P.122
<b>F</b>	Head restraints.....	P.136
<b>G</b>	Seat belts.....	P.26
<b>H</b>	Console box.....	P.314
<b>I</b>	Inside lock buttons.....	P.101
<b>J</b>	Cup holders.....	P.315
<b>K</b>	Assist grips.....	P.330
<b>L</b>	Rear automatic air conditioning system.....	P.303

► RX350L (vehicles with bench-type second-row seats)

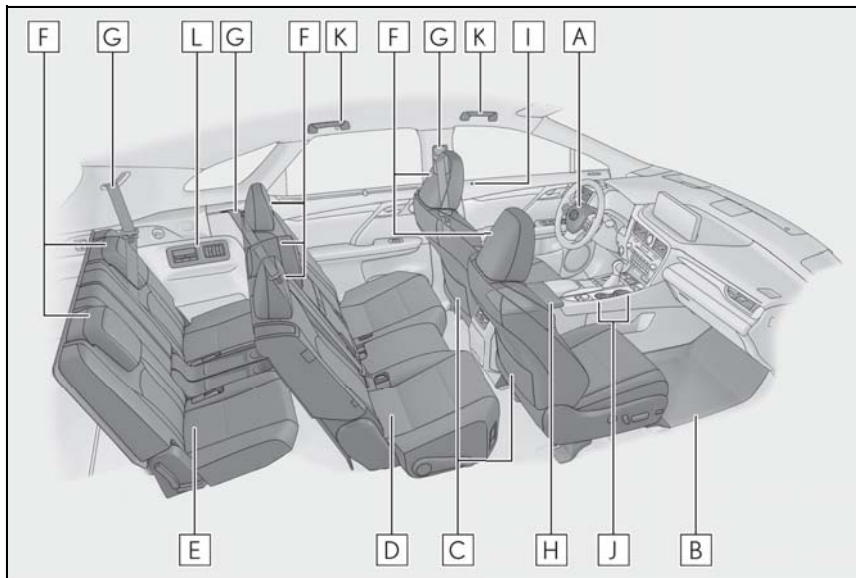

<b>A</b>	SRS airbags.....	P.30
<b>B</b>	Floor mats.....	P.24
<b>C</b>	Front seats.....	P.121
<b>D</b>	Second-row seats.....	P.122
<b>E</b>	Third-row seats.....	P.122
<b>F</b>	Head restraints.....	P.136
<b>G</b>	Seat belts.....	P.26
<b>H</b>	Console box.....	P.314
<b>I</b>	Inside lock buttons.....	P.101
<b>J</b>	Cup holders.....	P.315
<b>K</b>	Assist grips.....	P.330
<b>L</b>	Rear automatic air conditioning system.....	P.303

■ Ceiling

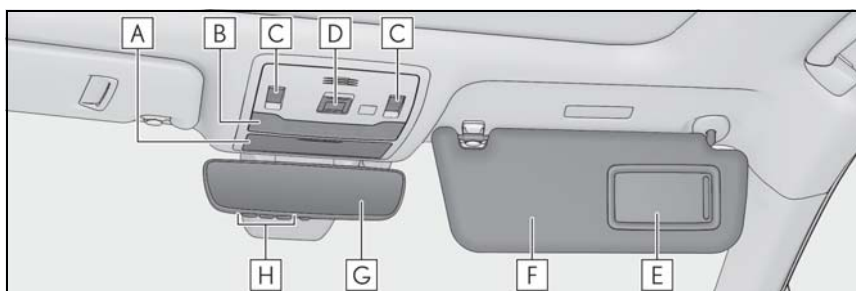

- A** Auxiliary box..... P.317
- B** Interior light <sup>\*1</sup>..... P.309  
     Personal lights <sup>\*1</sup>..... P.310
- C** Moon roof switches <sup>\*2</sup>..... P.146  
     Panoramic moon roof switches <sup>\*2</sup>..... P.149
- D** "SOS" button <sup>\*2</sup>..... P.60
- E** Vanity mirrors ..... P.333
- F** Sun visors..... P.332
- G** Inside rear view mirror ..... P.140
- H** Garage door opener switches ..... P.334

<sup>\*1</sup>: The illustration shows the front, but they are also equipped in the rear.

<sup>\*2</sup>: If equipped

**For safety and security**

1

23

- 1-1. For safe use**
  - Before driving .....24
  - For safe driving..... 25
  - Seat belts ..... 26
  - SRS airbags ..... 30
  - Front passenger occupant classification system ..... 39
  - Exhaust gas precautions ..... 44
- 1-2. Child safety**
  - Riding with children..... 45
  - Child restraint systems ..... 45
- 1-3. Lexus Enform**
  - Lexus Enform Safety Connect ..... 60
- 1-4. Theft deterrent system**
  - Engine immobilizer system ..... 66
  - Alarm..... 68

1

For safety and security

### Before driving

Observe the following before starting off in the vehicle to ensure safety of driving.

### Installing floor mats

Use only floor mats designed specifically for vehicles of the same model and model year as your vehicle. Fix them securely in place onto the carpet.

- 1 Insert the retaining hooks (clips) into the floor mat eyelets.

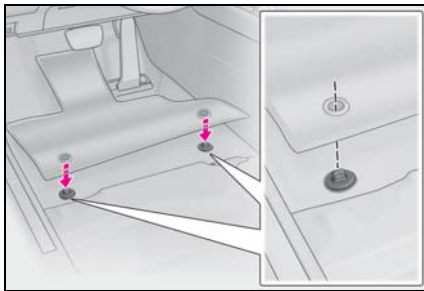

- 2 Turn the upper knob of each retaining hook (clip) to secure the floor mats in place.

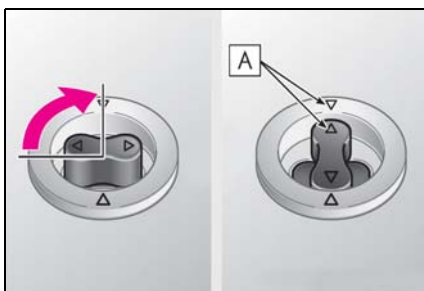

Always align the  $\triangle$  marks **A**.

The shape of the retaining hooks (clips) may differ from that shown in the illustration.

### ⚠ WARNING

Observe the following precautions. Failure to do so may cause the driver's floor mat to slip, possibly interfering with the pedals while driving. An unexpectedly high speed may result or it may become difficult to stop the vehicle. This could lead to an accident, resulting in death or serious injury.

#### ■ When installing the driver's floor mat

- Do not use floor mats designed for other models or different model year vehicles, even if they are Lexus Genuine floor mats.
- Only use floor mats designed for the driver's seat.
- Always install the floor mat securely using the retaining hooks (clips) provided.
- Do not use two or more floor mats on top of each other.
- Do not place the floor mat bottom-side up or upside-down.

#### ■ Before driving

- Check that the floor mat is securely fixed in the correct place with all the provided retaining hooks (clips). Be especially careful to perform this check after cleaning the floor.

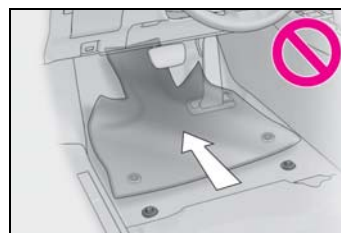

- With the engine stopped and the shift lever in P, fully depress each pedal to the floor to make sure it does not interfere with the floor mat.



### For safe driving

For safe driving, adjust the seat and mirror to an appropriate position before driving.

### Correct driving posture

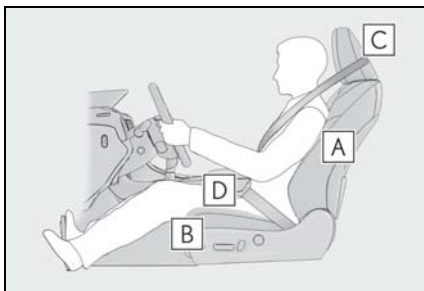

- A** Adjust the angle of the seatback so that you are sitting straight up and so that you do not have to lean forward to steer. (→P.121)
- B** Adjust the seat so that you can depress the pedals fully and so that your arms bend slightly at the elbow when gripping the steering wheel. (→P.121)
- C** Lock the head restraint in place with the center of the head restraint closest to the top of your ears. (→P.136)
- D** Wear the seat belt correctly. (→P.26)

### WARNING

#### ■ For safe driving

Observe the following precautions. Failure to do so may result in death or serious injury.

- Do not adjust the position of the driver's seat while driving. Doing so could cause the driver to lose control of the vehicle.
- Do not place a cushion between the driver or passenger and the seatback. A cushion may prevent correct posture from being achieved, and reduce the effectiveness of the seat belt and head restraint.
- Do not place anything under the front seats. Objects placed under the front seats may become jammed in the seat tracks and stop the seat from locking in place. This may lead to an accident and the adjustment mechanism may also be damaged.
- Always observe the legal speed limit when driving on public roads.
- When driving over long distances, take regular breaks before you start to feel tired. Also, if you feel tired or sleepy while driving, do not force yourself to continue driving and take a break immediately.

### Correct use of the seat belts

Make sure that all occupants are wearing their seat belts before driving the vehicle. (→P.26)

Use a child restraint system appropriate for the child until the child becomes large enough to properly wear the vehicle's seat belt. (→P.45)

### Adjusting the mirrors

Make sure that you can see backward clearly by adjusting the inside and outside rear view mirrors properly. (→P.140, 141)

## Seat belts

**Make sure that all occupants are wearing their seat belts before driving the vehicle.**

### WARNING

Observe the following precautions to reduce the risk of injury in the event of sudden braking, sudden swerving or an accident. Failure to do so may cause death or serious injury.

#### ■ Wearing a seat belt

- Ensure that all passengers wear a seat belt.
- Always wear a seat belt properly.
- Each seat belt should be used by one person only. Do not use a seat belt for more than one person at once, including children.
- Lexus recommends that children be seated in the rear seat and always use a seat belt and/or an appropriate child restraint system.
- To achieve a proper seating position, do not recline the seat more than necessary. The seat belt is most effective when the occupants are sitting up straight and well back in the seats.
- Do not wear the shoulder belt under your arm.
- Always wear your seat belt low and snug across your hips.

- RX350L: Do not let third-row seat passengers to use second-row seat belts.



#### ■ Pregnant women

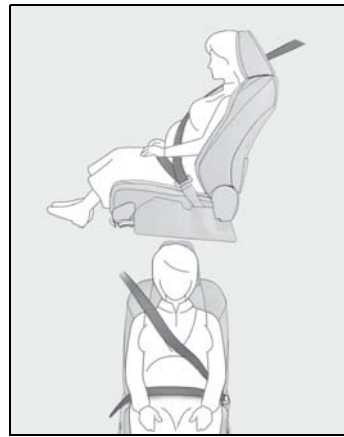

Obtain medical advice and wear the seat belt in the proper way. (→P.27)

Women who are pregnant should position the lap belt as low as possible over the hips in the same manner as other occupants, extending the shoulder belt completely over the shoulder and avoiding belt contact with the rounding of the abdominal area.

If the seat belt is not worn properly, not only the pregnant woman, but also the fetus could suffer death or serious injury as a result of sudden braking or a collision.

#### ■ People suffering illness

Obtain medical advice and wear the seat belt in the proper way. (→P.27)

#### ■ When children are in the vehicle

→P.54

**⚠ WARNING****■ Seat belt damage and wear**

- Do not damage the seat belts by allowing the belt, plate, or buckle to be jammed in the door.
- Inspect the seat belt system periodically. Check for cuts, fraying, and loose parts. Do not use a damaged seat belt until it is replaced. Damaged seat belts cannot protect an occupant from death or serious injury.
- Ensure that the belt and plate are locked and the belt is not twisted. If the seat belt does not function correctly, immediately contact your Lexus dealer.
- Replace the seat assembly, including the belts, if your vehicle has been involved in a serious accident, even if there is no obvious damage.
- Do not attempt to install, remove, modify, disassemble or dispose of the seat belts. Have any necessary repairs carried out by your Lexus dealer. Inappropriate handling may lead to incorrect operation.

**Correct use of the seat belts**

- Extend the shoulder belt so that it comes fully over the shoulder, but does not come into contact with the neck or slide off the shoulder.
- Position the lap belt as low as possi-

ble over the hips.

- Adjust the position of the seatback. Sit up straight and well back in the seat.
- Do not twist the seat belt.

**■ Child seat belt usage**

The seat belts of your vehicle were principally designed for persons of adult size.

- Use a child restraint system appropriate for the child, until the child becomes large enough to properly wear the vehicle's seat belt. (→P.45)
- When the child becomes large enough to properly wear the vehicle's seat belt, follow the instructions regarding seat belt usage. (→P.26)

**■ Seat belt extender**

If your seat belts cannot be fastened securely because they are not long enough, a personalized seat belt extender is available from your Lexus dealer free of charge.

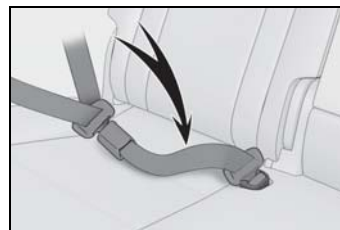
**⚠ WARNING****■ Using a seat belt extender**

Observe the following precautions to reduce the risk of injury in the event of sudden braking, sudden swerving or an accident.

Failure to do so may cause death or serious injury.

- Do not wear the seat belt extender if you can fasten the seat belt without the extender.

**⚠ WARNING**

- Do not use the seat belt extender when installing a child restraint system because the belt will not securely hold the child restraint system, increasing the risk of death or serious injury in the event of an accident.
- The personalized extender may not be safe on another vehicle, when used by another person, or at a different seating position other than the one originally intended.

**⚠ NOTICE**

- **When using a seat belt extender**  
When releasing the seat belt, press on the buckle release button on the extender, not on the seat belt. This helps prevent damage to the vehicle interior and the extender itself.

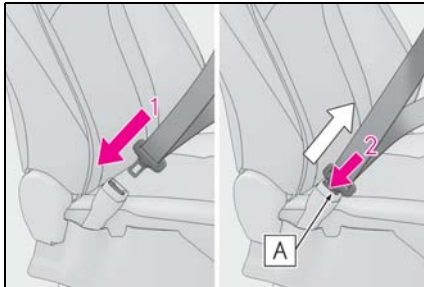
**Fastening and releasing the seat belt**

- 1 To fasten the seat belt, push the plate into the buckle until a click sound is heard.
- 2 To release the seat belt, press the release button **A**.

**■ Emergency locking retractor (ELR)**

The retractor will lock the belt during a sudden stop or on impact. It may also lock if you lean forward too quickly. A slow, easy

motion will allow the belt to extend so that you can move around fully.

**■ Automatic locking retractor (ALR)**

When a passenger's shoulder belt is completely extended and then retracted even slightly, the belt is locked in that position and cannot be extended. This feature is used to hold the child restraint system (CRS) firmly. To free the belt again, fully retract the belt and then pull the belt out once more. (→P.45)

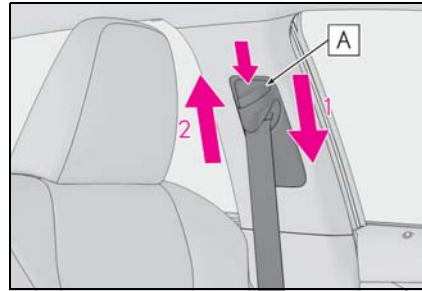
**Adjusting the seat belt shoulder anchor height (front seats)**

- 1 Push the seat belt shoulder anchor down while pressing the release button **A**.
- 2 Push the seat belt shoulder anchor up while pressing the release button **A**.

Move the height adjuster up and down as needed until you hear a click.

**⚠ WARNING****■ Adjustable shoulder anchor**

Always make sure the shoulder belt is positioned across the center of your shoulder. The belt should be kept away from your neck, but not falling off your shoulder. Failure to do so could reduce the amount of protection in an accident and cause death or serious injuries in the event of a sudden stop, sudden swerve or accident.

### Seat belt pretensioners (front seats and outboard second-row seats)

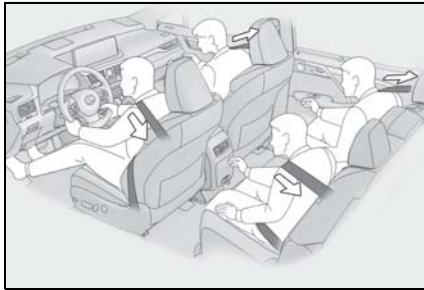

The pretensioners help the seat belts to quickly restrain the occupants by retracting the seat belts when the vehicle is subjected to certain types of severe frontal or side collision or a vehicle rollover.

The pretensioners do not activate in the event of a minor frontal impact, a minor side impact or a rear impact.

#### ■ Replacing the belt after the pretensioner has been activated

If the vehicle is involved in multiple collisions, the pretensioner will activate for the first collision, but will not activate for the second or subsequent collisions.

#### WARNING

##### ■ Seat belt pretensioners

Observe the following precautions to reduce the risk of injury in the event of sudden braking, sudden swerving or an accident. Failure to do so may cause death or serious injury.

- Do not place anything, such as a cushion, on the front passenger's seat. Doing so will disperse the passenger's weight, which prevents the sensor from detecting the passenger's weight properly. As a result, the seat belt pretensioner for the front passenger's seat may not activate in the event of a collision.
- If the pretensioner has activated, the SRS warning light will come on. In that case, the seat belt cannot be used again and must be replaced at your Lexus dealer.

## SRS airbags

The SRS airbags inflate when the vehicle is subjected to certain types of severe impacts that may cause significant injury to the occupants. They work together with the seat belts to help reduce the risk of death or serious injury.

### SRS airbag system

#### ■ Location of the SRS airbags

##### ► RX350

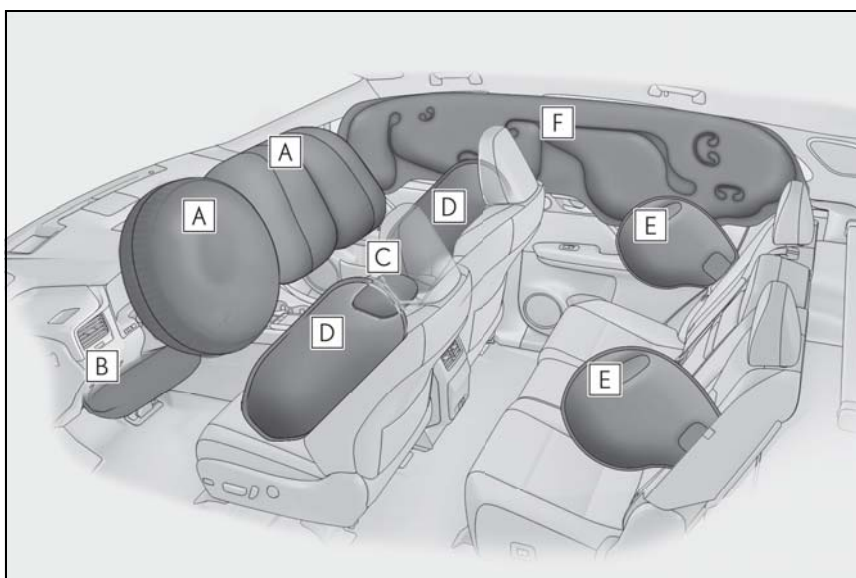

##### ► SRS front airbags

#### **A** SRS driver airbag/front passenger airbag

Can help protect the head and chest of the driver and front passenger from impact with interior components

#### **B** SRS knee airbag

Can help provide driver protection

#### **C** SRS seat cushion airbag

Can help restrain the front passenger

##### ► SRS side and curtain shield airbags

#### **D** SRS front side airbags

Can help protect the torso of the front seat occupants

**E** SRS rear side airbags

Can help protect the torso of occupants in the rear outer seats

**F** SRS curtain shield airbags

- Can help protect primarily the head of occupants in the outer seats
- Can help prevent the occupants from being thrown from the vehicle in the event of vehicle rollover

## ▶ RX350L

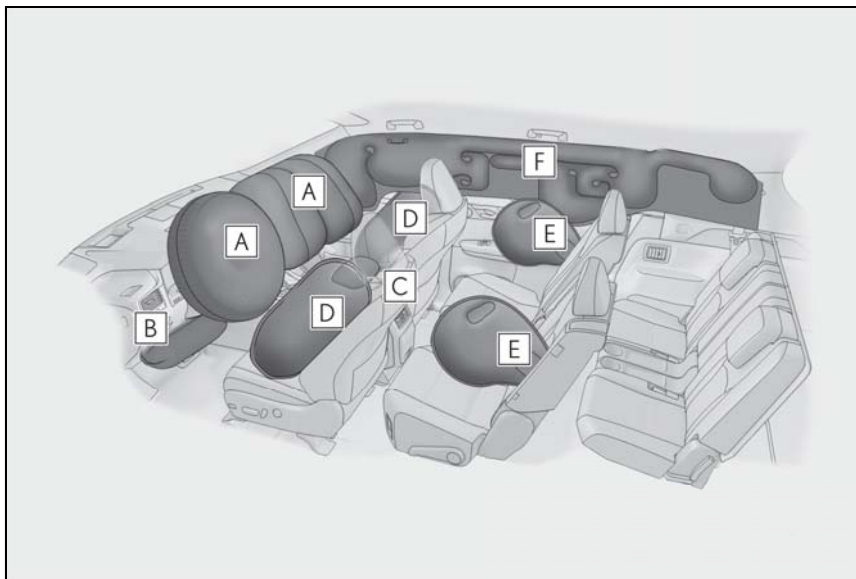

## ▶ SRS front airbags

**A** SRS driver airbag/front passenger airbag

Can help protect the head and chest of the driver and front passenger from impact with interior components

**B** SRS knee airbag

Can help provide driver protection

**C** SRS seat cushion airbag

Can help restrain the front passenger

## ▶ SRS side and curtain shield airbags

**D** SRS front side airbags

Can help protect the torso of the front seat occupants

**E** SRS rear side airbags

Can help protect the torso of occupants in the outboard second-row seats

**F** SRS curtain shield airbags

- Can help protect primarily the head of occupants in the outer seats
- Can help prevent the occupants from being thrown from the vehicle in the event of vehicle rollover

**■ SRS airbag system components**

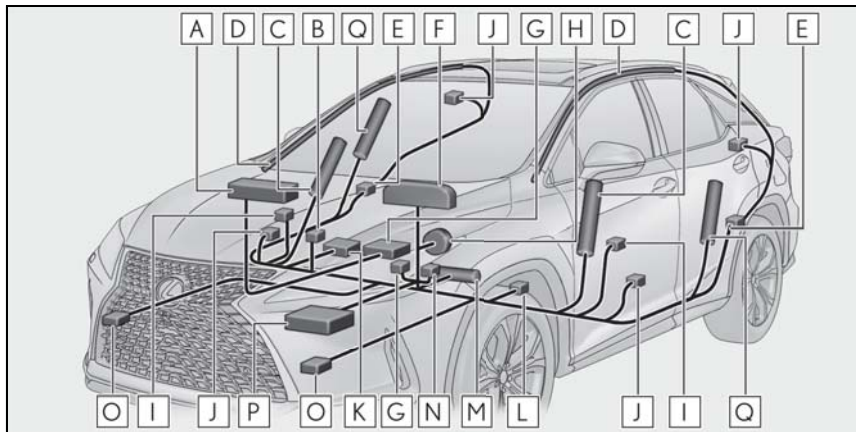

**A** Front passenger airbag

**B** "AIR BAG ON" and "AIR BAG OFF" indicator lights

**C** Front side airbags

**D** Curtain shield airbags

**E** Side impact sensors (rear)

**F** SRS warning light

**G** Front passenger occupant classification system (ECU and sensors)

**H** Driver airbag

**I** Side impact sensors (front door)

**J** Seat belt pretensioners and force limiters

**K** Passenger seat cushion airbag

**L** Driver's seat position sensor

**M** Driver's knee airbag

**N** Driver's seat belt buckle switch

**O** Front impact sensors

**P** Airbag sensor assembly

**Q** RX350: Rear side airbags



### RX350L: Rear side airbags (outboard second-row seats)

Your vehicle is equipped with ADVANCED AIRBAGS designed based on the US motor vehicle safety standards (FMVSS208). The airbag sensor assembly (ECU) controls airbag deployment based on information obtained from the sensors etc. shown in the system components diagram above. This information includes crash severity and occupant information. As the airbags deploy, a chemical reaction in the inflators quickly fills the airbags with non-toxic gas to help restrain the motion of the occupants.

#### ■ If the SRS airbags deploy (inflate)

- Slight abrasions, burns, bruising etc., may be sustained from SRS airbags, due to the extremely high speed deployment (inflation) by hot gases.
- A loud noise and white powder will be emitted.
- Parts of the airbag module (steering wheel hub, airbag cover and inflator) as well as the front seats, parts of the front and rear pillars, and roof side rails, may be hot for several minutes. The airbag itself may also be hot.
- The windshield may crack.
- All of the doors will be unlocked. (→P.100)
- The brakes and stop lights will be controlled automatically. (→P.275)
- The interior lights will turn on automatically. (→P.310)
- The emergency flashers will turn on automatically. (→P.394)
- Fuel supply to the engine will be stopped. (→P.402)
- For Lexus Enform Safety Connect subscribers, if any of the following situations occur, the system is designed to send an emergency call to the response center, notifying them of the vehicle's location (without needing to push the "SOS" button) and an agent will attempt to speak with the occupants to ascertain the level of emergency and assistance required. If the occupants are unable to communicate, the agent automatically treats the call as an emergency and helps to dispatch the necessary emergency services.

(→P.60)

- An SRS airbag is deployed.
- A seat belt pretensioner is activated.
- The vehicle is involved in a severe rear-end collision.

#### ■ SRS airbag deployment conditions (SRS front airbags)

- The SRS front airbags will deploy in the event of an impact that exceeds the set threshold level (the level of force corresponding to an approximately 12 - 18 mph [20 - 30 km/h] frontal collision with a fixed wall that does not move or deform).

However, this threshold velocity will be considerably higher in the following situations:

- If the vehicle strikes an object, such as a parked vehicle or sign pole, which can move or deform on impact
- If the vehicle is involved in an underride collision, such as a collision in which the front of the vehicle "underrides", or goes under, the bed of a truck
- Depending on the type of collision, it is possible that only the seat belt pretensioners will activate.

- The SRS seat cushion airbag on the front passenger seat will not operate if the occupant is not wearing a seat belt.

#### ■ SRS airbag deployment conditions (SRS side and curtain shield airbags)

- The SRS side and curtain shield airbags will deploy in the event of an impact that exceeds the set threshold level (the level of force corresponding to the impact force produced by an approximately 3300 lb. [1500 kg] vehicle colliding with the vehicle cabin from a direction per-

pendicular to the vehicle orientation at an approximate speed of 12 - 18 mph [20 - 30 km/h]).

- Both SRS curtain shield airbags will deploy in the event of vehicle rollover.
- All SRS side and curtain shield airbags will deploy in the event of a severe frontal collision.

■ **Conditions under which the SRS airbags may deploy (inflate), other than a collision**

The SRS front airbags and SRS side and curtain shield airbags may also deploy if a serious impact occurs to the underside of your vehicle. Some examples are shown in the illustration.

- Hitting a curb, edge of pavement or hard surface
- Falling into or jumping over a deep hole
- Landing hard or falling

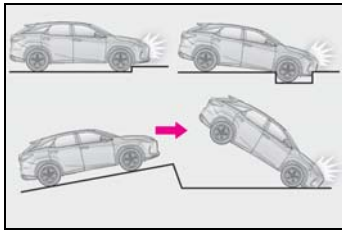

The SRS curtain shield airbags may also deploy under the situations shown in the illustration.

- The angle of vehicle tip-up is marginal.
- The vehicle skids and hits a curb stone.

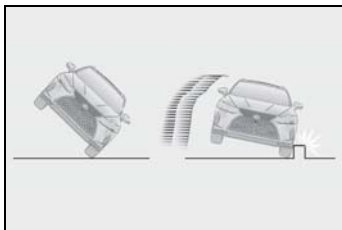

■ **Types of collisions that may not deploy the SRS airbags (SRS front airbags)**

The SRS front airbags do not generally inflate if the vehicle is involved in a side or rear collision, if it rolls over, or if it is involved in a low-speed frontal collision. But, when-

ever a collision of any type causes sufficient forward deceleration of the vehicle, deployment of the SRS front airbags may occur.

- Collision from the side
- Collision from the rear
- Vehicle rollover

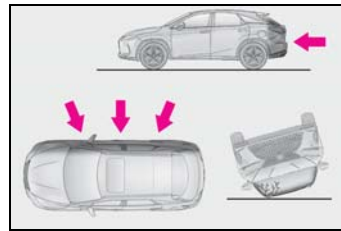

■ **Types of collisions that may not deploy the SRS airbags (SRS side and curtain shield airbags)**

The SRS side and curtain shield airbags may not activate if the vehicle is subjected to a collision from the side at certain angles, or a collision to the side of the vehicle body other than the passenger compartment.

- Collision from the side to the vehicle body other than the passenger compartment
- Collision from the side at an angle



The SRS side airbags do not generally inflate if the vehicle is involved in a frontal or rear collision, if it rolls over, or if it is involved in a low-speed side or low-speed frontal collision.

- Collision from the rear
- Vehicle rollover

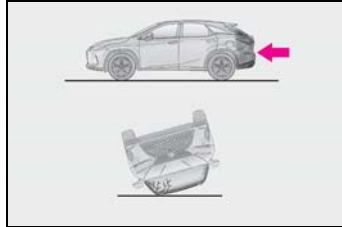

The SRS curtain shield airbags do not generally inflate if the vehicle is involved in a rear collision, if it pitches end over end, or if it is involved in a low-speed side or low-speed frontal collision.

- Collision from the rear
- Pitching end over end

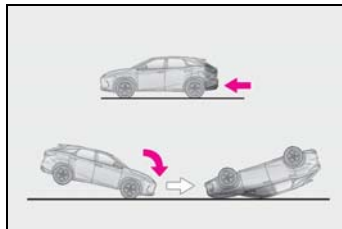

#### ■ When to contact your Lexus dealer

In the following cases, the vehicle will require inspection and/or repair. Contact your Lexus dealer as soon as possible.

- Any of the SRS airbags have been inflated.
- The front of the vehicle is damaged or deformed, or was involved in an accident that was not severe enough to cause the SRS front airbags to inflate.

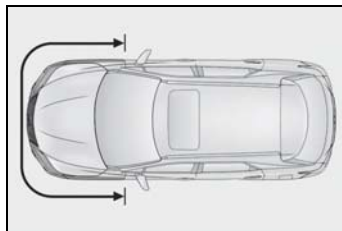

- A portion of a door or its surrounding area is damaged, deformed or has had a hole made in it, or the vehicle was involved in an accident that was not severe enough to cause the SRS side and curtain shield airbags to inflate.

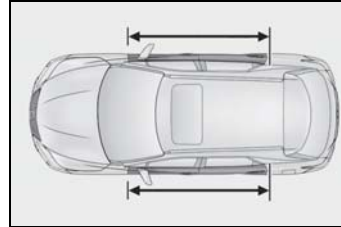

- The pad section of the steering wheel, dashboard near the front passenger airbag or lower portion of the instrument panel is scratched, cracked, or otherwise damaged.

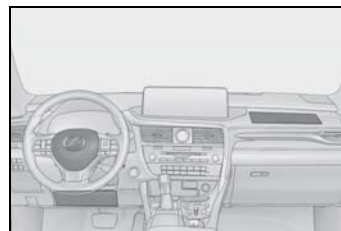

- The front passenger's seat cushion surface is scratched, cracked, or otherwise damaged.



- The surface of the seats with the SRS side airbag is scratched, cracked, or otherwise damaged.

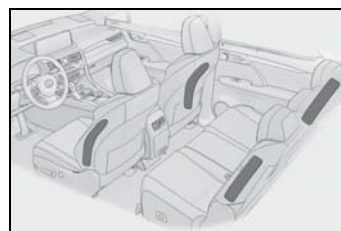

- The portion of the front pillars, rear pillars or roof side rail garnishes (padding) containing the SRS curtain shield airbags inside is scratched, cracked, or otherwise damaged.

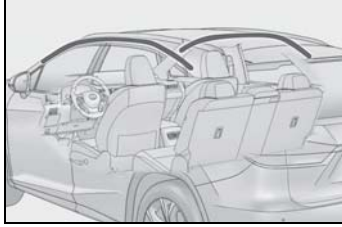

**⚠ WARNING**

**■ SRS airbag precautions**

Observe the following precautions regarding the SRS airbags. Failure to do so may cause death or serious injury.

- The driver and all passengers in the vehicle must wear their seat belts properly. The SRS airbags are supplemental devices to be used with the seat belts.
- The SRS driver airbag deploys with considerable force, and can cause death or serious injury especially if the driver is very close to the airbag. The National Highway Traffic Safety Administration (NHTSA) advises: Since the risk zone for the driver's airbag is the first 2 - 3 in. (50 - 75 mm) of inflation, placing yourself 10 in. (250 mm) from your driver airbag provides you with a clear margin of safety. This distance is measured from the center of the steering wheel to your breastbone. If you sit less than 10 in. (250 mm) away now, you can change your driving position in several ways:
  - Move your seat to the rear as far as you can while still reaching the pedals comfortably.

- Slightly recline the back of the seat. Although vehicle designs vary, many drivers can achieve the 10 in. (250 mm) distance, even with the driver seat all the way forward, simply by reclining the back of the seat somewhat. If reclining the back of your seat makes it hard to see the road, raise yourself by using a firm, non-slippery cushion, or raise the seat if your vehicle has that feature.
- If your steering wheel is adjustable, tilt it downward. This points the airbag toward your chest instead of your head and neck.

The seat should be adjusted as recommended by NHTSA above, while still maintaining control of the foot pedals, steering wheel, and your view of the instrument panel controls.

- If the seat belt extender has been connected to the front seat belt buckles but the seat belt extender has not also been fastened to the latch plate of the seat belt, the SRS front airbags will judge that the driver and front passenger are wearing the seat belt even though the seat belt has not been connected. In this case, the SRS front airbags may not activate correctly in a collision, resulting in death or serious injury in the event of a collision. Be sure to wear the seat belt with the seat belt extender.



**⚠ WARNING**

- The SRS front passenger airbag also deploys with considerable force, and can cause death or serious injury especially if the front passenger is very close to the airbag. The front passenger seat should be as far from the airbag as possible with the seatback adjusted, so the front passenger sits upright.
- Improperly seated and/or restrained infants and children can be killed or seriously injured by a deploying airbag. An infant or child who is too small to use a seat belt should be properly secured using a child restraint system. Lexus strongly recommends that all infants and children be placed in the rear seats of the vehicle and properly restrained. The rear seats are safer for infants and children than the front passenger seat. (→P.45)
- Do not sit on the edge of the seat or lean against the dashboard.

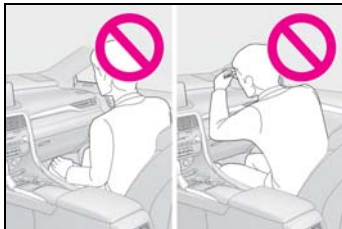

- Do not allow a child to stand in front of the SRS front passenger airbag unit or sit on the knees of a front passenger.

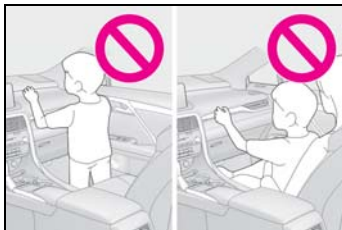

- Do not allow the front seat occupants to hold items on their knees.

- Do not lean against the door, the roof side rail or the front, side and rear pillars.



- Do not allow anyone to kneel on the passenger seats toward the door or put their head or hands outside the vehicle.



- Do not attach anything to or lean anything against areas such as the dashboard, steering wheel pad and lower portion of the instrument panel. These items can become projectiles when the SRS driver, front passenger and knee airbags deploy.

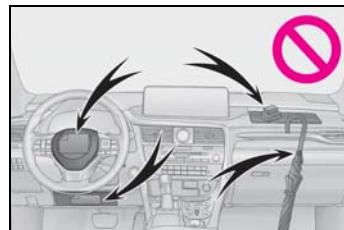

**⚠ WARNING**

- Do not attach anything to areas such as a door, windshield, side windows, front or rear pillar, roof side rail and assist grip.



- Do not hang coat hangers or other hard objects on the coat hooks. All of these items could become projectiles and may cause death or serious injury, should the SRS curtain shield airbags deploy.
- If a vinyl cover is put on the area where the SRS knee airbag will deploy, be sure to remove it.
- Do not use seat accessories which cover the parts where the SRS side airbags and SRS seat cushion airbag inflate as they may interfere with inflation of the SRS airbags. Such accessories may prevent the side airbags and SRS seat cushion airbag from activating correctly, disable the system or cause the side airbags and SRS seat cushion airbag to inflate accidentally, resulting in death or serious injury.
- Do not strike or apply significant levels of force to the area of the SRS airbag components or the front doors. Doing so can cause the SRS airbags to malfunction.
- Do not touch any of the component parts immediately after the SRS airbags have deployed (inflated) as they may be hot.

- If breathing becomes difficult after the SRS airbags have deployed, open a door or window to allow fresh air in, or leave the vehicle if it is safe to do so. Wash off any residue as soon as possible to prevent skin irritation.

- If the areas where the SRS airbags are stored, such as the steering wheel pad and front and rear pillar garnishes, are damaged or cracked, have them replaced by your Lexus dealer.

- Do not place anything, such as a cushion, on the front passenger's seat. Doing so will disperse the passenger's weight, which prevents the sensor from detecting the passenger's weight properly. As a result, the SRS front airbags for the front passenger may not deploy in the event of a collision.

**■ Modification and disposal of SRS airbag system components**

Do not dispose of your vehicle or perform any of the following modifications without consulting your Lexus dealer. The SRS airbags may malfunction or deploy (inflate) accidentally, causing death or serious injury.

- Installation, removal, disassembly and repair of the SRS airbags
- Repairs, modifications, removal or replacement of the steering wheel, instrument panel, dashboard, seats or seat upholstery, front, side and rear pillars, roof side rails, front door panels, front door trims or front door speakers
- Modifications to the front door panel (such as making a hole in it)
- Repairs or modifications of the front fender, front bumper, or side of the occupant compartment
- Installation of a grille guard (bull bars, kangaroo bar, etc.), snow plows, winches or roof luggage carrier
- Modifications to the vehicle's suspension system

**⚠ WARNING**

- Installation of electronic devices such as mobile two-way radios and CD players
- Modifications to your vehicle for a person with a physical disability

**Front passenger occupant classification system**

Your vehicle is equipped with a front passenger occupant classification system. This system detects the conditions of the front passenger seat and activates or deactivates the devices for the front passenger.

1

For safety and security

## System components



**A** SRS warning light

**B** Driver's and front passenger's seat belt reminder light

► For the U.S.A.

**C** "AIR BAG OFF" indicator light

**D** "AIR BAG ON" indicator light

► For Canada

**E** "AIR BAG OFF" indicator light

**F** "AIR BAG ON" indicator light

### ⚠ WARNING

#### ■ Front passenger occupant classification system precautions

Observe the following precautions regarding the front passenger occupant classification system. Failure to do so may cause death or serious injury.

- Wear the seat belt properly.
- Make sure the front passenger's seat belt plate has not been left inserted into the buckle before someone sits in the front passenger seat.

- Make sure the "AIR BAG OFF" indicator light is not illuminated when using the seat belt extender for the front passenger seat. If the "AIR BAG OFF" indicator light is illuminated, disconnect the extender tongue from the seat belt buckle, and reconnect the seat belt. Reconnect the seat belt extender after making sure the "AIR BAG ON" indicator light is illuminated. If you use the seat belt extender while the "AIR BAG OFF" indicator light is illuminated, the SRS airbags for the front passenger will not activate, which could cause death or serious injury in the event of a collision.

- Do not apply a heavy load to the front passenger seat or equipment (e.g. seatback pocket).



**⚠ WARNING**

- Do not put weight on the front passenger seat by putting your hands or feet on the front passenger seat seatback from the rear passenger seat.
- Do not let a rear passenger lift the front passenger seat with their feet or press on the seatback with their legs.
- Do not put objects under the front passenger seat.
- Do not recline the front passenger seatback so far that it touches a rear seat. This may cause the "AIR BAG OFF" indicator light to be illuminated, which indicates that the SRS airbags for the front passenger will not activate in the event of a severe accident. If the seatback touches the rear seat, return the seatback to a position where it does not touch the rear seat. Keep the front passenger seatback as upright as possible when the vehicle is moving. Reclining the seatback excessively may lessen the effectiveness of the seat belt system.
- If an adult sits in the front passenger seat, the "AIR BAG ON" indicator light is illuminated. If the "AIR BAG OFF" indicator is illuminated, ask the passenger to sit up straight, well back in the seat, feet on the floor, and with the seat belt worn correctly. If the "AIR BAG OFF" indicator still remains illuminated, either ask the passenger to move to the rear seat, or if that is not possible, move the front passenger seat fully rearward.
- When it is unavoidable to install a forward-facing child restraint system on the front passenger seat, install the child restraint system on the front passenger seat in the proper order. (→P.46)
- Do not modify or remove the front seats.
- Do not kick the front passenger seat or subject it to severe impact. Otherwise, the SRS warning light may come on to indicate a malfunction of the front passenger occupant classification system. In this case, contact your Lexus dealer immediately.
- Child restraint systems installed on the rear seat should not contact the front seatbacks.
- Do not use a seat accessory, such as a cushion and seat cover, that covers the seat cushion surface.
- Do not modify or replace the upholstery of the front seat.

### Condition and operation in the front passenger occupant classification system

#### ■ Adult<sup>\*1</sup>

Indicator/warning light	"AIRBAG ON" and "AIRBAG OFF" indicator lights	"AIR BAG ON"
	SRS warning light	Off
	Driver's and front passenger's seat belt reminder light	Off <sup>*2</sup> or flashing <sup>*3</sup>
Devices	Front passenger airbag	Activated
	Seat cushion airbag in the front passenger side	Activated <sup>*2</sup> or deactivated <sup>*3</sup>

#### ■ Child<sup>\*4</sup>

Indicator/warning light	"AIRBAG ON" and "AIRBAG OFF" indicator lights	"AIR BAG OFF" or "AIR BAG ON" <sup>*4</sup>
	SRS warning light	Off
	Driver's and front passenger's seat belt reminder light	Off <sup>*2</sup> or flashing <sup>*3</sup>
Devices	Front passenger airbag	Deactivated or activated <sup>*4</sup>
	Seat cushion airbag in the front passenger side	Deactivated or activated <sup>*4,2</sup>

#### ■ Child restraint system with infant<sup>\*5</sup>

Indicator/warning light	"AIRBAG ON" and "AIRBAG OFF" indicator lights	"AIR BAG OFF" <sup>*6</sup>
	SRS warning light	Off
	Driver's and front passenger's seat belt reminder light	Off <sup>*2</sup> or flashing <sup>*3</sup>
Devices	Front passenger airbag	Deactivated
	Seat cushion airbag in the front passenger side	

### ■ Unoccupied

Indicator/warning light	"AIRBAG ON" and "AIRBAG OFF" indicator lights	"AIR BAG OFF"
	SRS warning light	Off
	Driver's and front passenger's seat belt reminder light	
Devices	Front passenger airbag	Deactivated
	Seat cushion airbag in the front passenger side	

### ■ There is a malfunction in the system

Indicator/warning light	"AIRBAG ON" and "AIRBAG OFF" indicator lights	"AIR BAG OFF"
	SRS warning light	On
	Driver's and front passenger's seat belt reminder light	Off
Devices	Front passenger airbag	Deactivated
	Seat cushion airbag in the front passenger side	

\*1: The system judges a person of adult size as an adult. When a smaller adult sits in the front passenger seat, the system may not recognize him/her as an adult depending on his/her physique and posture.

\*2: In the event the front passenger is wearing a seat belt.

\*3: In the event the front passenger does not wear a seat belt.

\*4: For some children, child in seat, child in booster seat or child in convertible seat, the system may not recognize him/her as a child. Factors which may affect this can be the physique or posture.

\*5: Never install a rear-facing child restraint system on the front passenger seat. A forward-facing child restraint system should only be installed on the front passenger seat when it is unavoidable. (→P.45)

\*6: In case the indicator light is not illuminated, consult this manual on how to install the child restraint system properly. (→P.46)

### Exhaust gas precautions

**Harmful substance to the human body is included in exhaust gases if inhaled.**

#### WARNING

Exhaust gases include harmful carbon monoxide (CO), which is colorless and odorless. Observe the following precautions.

Failure to do so may cause exhaust gases enter the vehicle and may lead to an accident caused by light-headedness, or may lead to death or a serious health hazard.

#### ■ Important points while driving

- Keep the back door closed.
- If you smell exhaust gases in the vehicle even when the back door is closed, open the windows and have the vehicle inspected at your Lexus dealer as soon as possible.

#### ■ When parking

- If the vehicle is in a poorly ventilated area or a closed area, such as a garage, stop the engine.
- Do not leave the vehicle with the engine running for a long time. If such a situation cannot be avoided, park the vehicle in an open space and ensure that exhaust fumes do not enter the vehicle interior.
- Do not leave the engine running in an area with snow build-up, or where it is snowing. If snowbanks build up around the vehicle while the engine is running, exhaust gases may collect and enter the vehicle.

#### ■ Exhaust pipe

The exhaust system needs to be checked periodically. If there is a hole or crack caused by corrosion, damage to a joint or abnormal exhaust noise, be sure to have the vehicle inspected and repaired by your Lexus dealer.

## Riding with children

Observe the following precautions when children are in the vehicle. Use a child restraint system appropriate for the child, until the child becomes large enough to properly wear the vehicle's seat belt.

- It is recommended that children sit in the rear seats to avoid accidental contact with the shift lever, wiper switch, etc.
- Use the rear door child-protector lock or the window lock switch to avoid children opening the door while driving or operating the power window accidentally. (→P.102, 146)
- Do not let small children operate equipment which may catch or pinch body parts, such as the power window, hood, back door, seats etc.

### WARNING

#### ■ When children are in the vehicle

Never leave children unattended in the vehicle, and never allow children to have or use the key.

Children may be able to start the vehicle or shift the vehicle into neutral. There is also a danger that children may injure themselves by playing with the windows, the moon roof or panoramic moon roof, or other features of the vehicle. In addition, heat build-up or extremely cold temperatures inside the vehicle can be fatal to children.

## Child restraint systems

Before installing a child restraint system in the vehicle, there are precautions that need to be observed, different types of child restraint systems, as well as installation methods, etc., written in this manual.

Use a child restraint system when riding with a small child that cannot properly use a seat belt. For the child's safety, install the child restraint system to a second-row seat. Be sure to follow the installation method that is in the operation manual enclosed with the restraint system.

### Table of contents

Points to remember: P.45

Child restraint system: P.46

When using a child restraint system: P.48

Child restraint system installation method

- Fixed with a seat belt: P.50
- Fixed with a child restraint LATCH anchor: P.54
- Using an anchor bracket (for top tether strap): P.57

### Points to remember

The laws of all 50 states of the U.S.A. as well as Canada now require the use of child restraint systems.

- Prioritize and observe the warn-

ings, as well as the laws and regulations for child restraint systems.

- Use a child restraint system until the child becomes large enough to properly wear the vehicle's seat belt.
- Choose a child restraint system that suits your vehicle and is appropriate to the age and size of the child.

 **WARNING**

■ **When a child is riding**

Observe the following precautions. Failure to do so may result in death or serious injury.

- For effective protection in automobile accidents and sudden stops, a child must be properly restrained, using a seat belt or child restraint system which is correctly installed. For installation details, refer to the operation manual enclosed with the child restraint system. General installation instruction is provided in this manual.
- Lexus strongly urges the use of a proper child restraint system that conforms to the weight and size of the child, installed on the second-row seat. According to accident statistics, the child is safer when properly restrained in the second-row seat than in the front seat.

- Holding a child in your or someone else's arms is not a substitute for a child restraint system. In an accident, the child can be crushed against the windshield or between the holder and the interior of the vehicle.

■ **Handling the child restraint system**

If the child restraint system is not properly fixed in place, the child or other passengers may be seriously injured or even killed in the event of sudden braking, sudden swerving, or an accident.

- If the vehicle were to receive a strong impact from an accident, etc., it is possible that the child restraint system has damage that is not readily visible. In such cases, do not reuse the restraint system.
- Make sure you have complied with all installation instructions provided with the child restraint system manufacturer and that the system is properly secured.
- Keep the child restraint system properly secured on the seat even if it is not in use. Do not store the child restraint system unsecured in the passenger compartment.
- If it is necessary to detach the child restraint system, remove it from the vehicle or store it securely in the luggage compartment.

**Child restraint system**

■ **Types of child restraint system installation methods**

Confirm with the operation manual enclosed with the child restraint system about the installation of the child restraint system.

Installation method		Page
Seat belt attachment		P.50
Child restraint LATCH anchors attachment		P.54

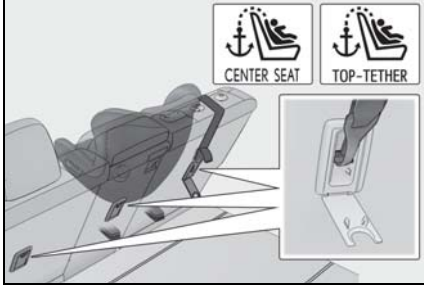
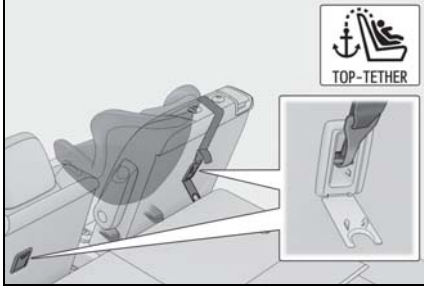
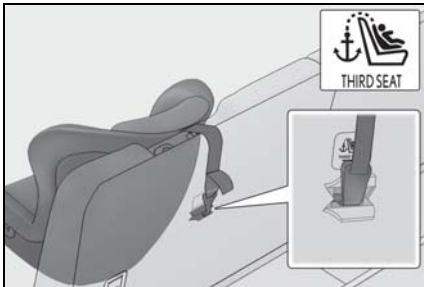
	Installation method	Page
<p>Anchor brackets (for top tether strap) attachment</p>	<p>Bench-type second-row seats:</p> 	<p>P.57</p>
	<p>Separate-type second-row seats:</p> 	
	<p>Third-row seats *</p> 	

\* : The third-row seats are not equipped with Child restraint LATCH anchors.

**When using a child restraint system**

■ **When installing a child restraint system to a front passenger seat**

For the safety of a child, install child

restraint systems to second-row seats. When installing child restraint system to a front passenger seat is unavoidable, adjust the seat as follows and install the child restraint system.

- Move the seat to the rearmost posi-



tion

- Raise the seatback as much as possible
- Raise the seat to the highest position
- If the head restraint interferes with the installation of the child restraint system, and the head restraint can be removed, remove the head restraint

If the head restraint cannot be removed, raise it to the uppermost position.

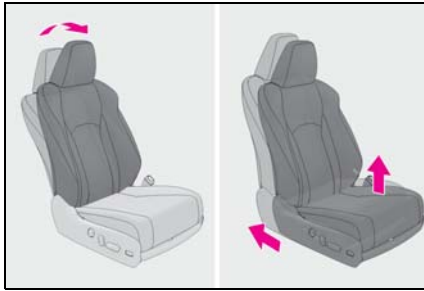

### WARNING

#### ■ When using a child restraint system

Observe the following precautions. Failure to do so may result in death or serious injury.

- Never install a rear-facing child restraint system on the front passenger seat even if the "AIR BAG OFF" indicator light is illuminated. In the event of an accident, the force of the rapid inflation of the front passenger airbag can cause death or serious injury to the child if the rear-facing child restraint system is installed on the front passenger seat.

- A forward-facing child restraint system may be installed on the front passenger seat only when it is unavoidable. A child restraint system that requires a top tether strap should not be used in the front passenger seat since there is no top tether strap anchor for the front passenger seat.
- A forward-facing child restraint system may be installed on the front passenger seat only when it is unavoidable. When installing a forward-facing child restraint system on the front passenger seat, raise the seatback as much as possible, move the seat to the rear-most position, and raise the seat to the highest position, even if the "AIR BAG OFF" indicator light is illuminated.

If the head restraint interferes with the installation of the child restraint system, and the head restraint can be removed, remove the head restraint.

If the head restraint cannot be removed, raise it to the uppermost position.



**⚠ WARNING**

- Do not allow the child to lean his/her head or any part of his/her body against the door or the area of the seat, front or rear pillars, or roof side rails from which the SRS side airbags or SRS curtain shield airbags deploy even if the child is seated in the child restraint system. It is dangerous if the SRS side airbags and curtain shield airbags inflate, and the impact could cause death or serious injury to the child.



- When a booster seat is installed, always ensure that the shoulder belt is positioned across the center of the child's shoulder. The belt should be kept away from the child's neck, but not so that it could fall off the child's shoulder.
- Use child restraint system suitable to the age and size of the child and install it to the rear seat.
- If the driver's seat interferes with the child restraint system and prevents it from being attached correctly, attach the child restraint system to the right-hand rear seat.

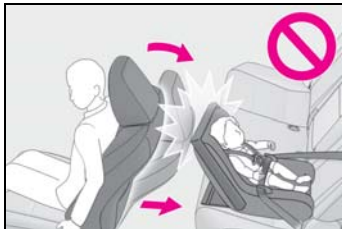

- Adjust the front passenger seat so that it does not interfere with the child restraint system.

**Child restraint system fixed with a seat belt**

A child restraint system for a small child or baby must itself be properly restrained on the seat with the lap portion of the lap/shoulder belt.

- **Installing child restraint system using a seat belt (child restraint lock function belt)**

Install the child restraint system in accordance to the operation manual enclosed with the child restraint system.

- **Rear-facing— Infant seat/convertible seat**

- 1 Adjust the rear seat

If there is a gap between the child seat and the seatback, adjust the seatback angle until good contact is achieved.

- 2 Place the child restraint system on the rear seat facing the rear of the vehicle.

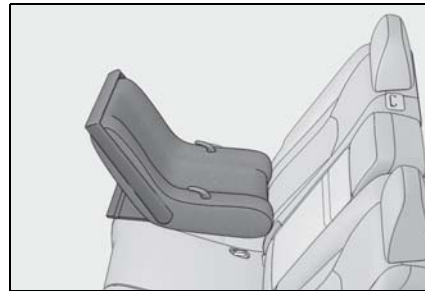

- 3 Run the seat belt through the child restraint system and insert the plate

into the buckle. Make sure that the belt is not twisted.

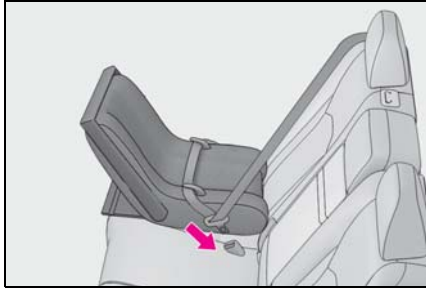

- 4** Fully extend the shoulder belt and allow it to retract to put it in lock mode. In lock mode, the belt cannot be extended.

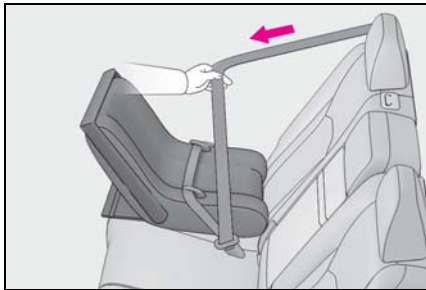

- 5** While pushing the child restraint system down into the rear seat, allow the shoulder belt to retract until the child restraint system is securely in place.

After the shoulder belt has retracted to a point where there is no slack in the belt, pull the belt to check that it cannot be extended.

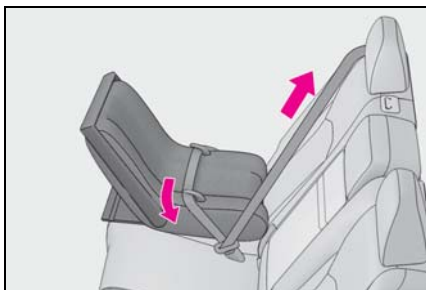

- 6** After installing the child restraint system, rock it back and forth to ensure that it is installed securely. (→P.54)

#### ■ Forward-facing—Convertible seat

- 1** Adjust the seat

- ▶ When using the front passenger seat

If installing the child restraint system to the front passenger seat is unavoidable, refer to P.48 for the front passenger seat adjustment.

- ▶ When using the rear seat

If there is a gap between the child seat and the seatback, adjust the seatback angle until good contact is achieved.

- 2** Remove the head restraint if it interferes with your child restraint system. (→P.136)

If the head restraint cannot be removed, raise it to the uppermost position.

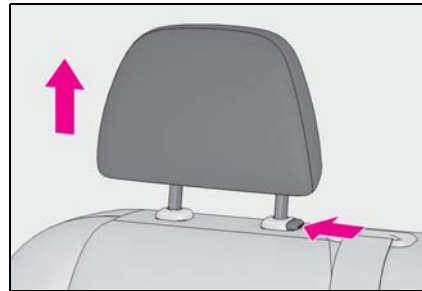

- Place the child restraint system on the seat facing the front of the vehicle.



- Run the seat belt through the child restraint system and insert the plate into the buckle. Make sure that the belt is not twisted.



- Fully extend the shoulder belt and allow it to retract to put it in lock mode. In lock mode, the belt cannot be extended.

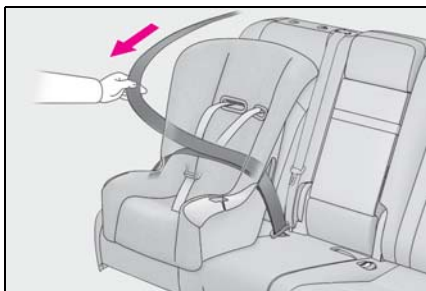

- While pushing the child restraint system into the rear seat, allow the shoulder belt to retract until the

child restraint system is securely in place.

After the shoulder belt has retracted to a point where there is no slack in the belt, pull the belt to check that it cannot be extended.



- If the child restraint has a top tether strap, follow the child restraint manufacturer's operation manual regarding the installation, using the top tether strap to latch onto the top tether strap anchor. (→P.57)
- After installing the child restraint system, rock it back and forth to ensure that it is installed securely. (→P.54)

■ **Booster seat**

- If installing the child restraint system to the front passenger seat is unavoidable, refer to P.48 for the front passenger seat adjustment.
- High back type: Remove the head restraint if it interferes with your child restraint system. (→P.136)

If the head restraint cannot be removed,

raise it to the uppermost position.

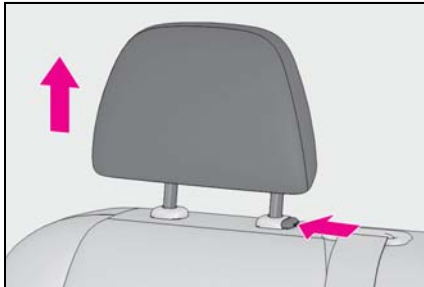

- 3** Place the child restraint system on the seat facing the front of the vehicle.

► Booster type



► High back type

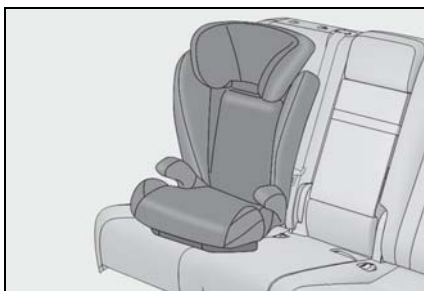

- 4** Sit the child in the child restraint system. Fit the seat belt to the child restraint system according to the manufacturer's instructions and insert the plate into the buckle. Make sure that the belt is not twisted.

Check that the shoulder belt is correctly positioned over the child's shoulder and that the lap belt is as low as possible. (→P.26)



■ **Removing a child restraint system installed with a seat belt**

Press the buckle release button and fully retract the seat belt.

When releasing the buckle, the child restraint system may spring up due to the rebound of the seat cushion. Release the buckle while holding down the child restraint system.

Since the seat belt automatically reels itself, slowly return it to the stowing position.

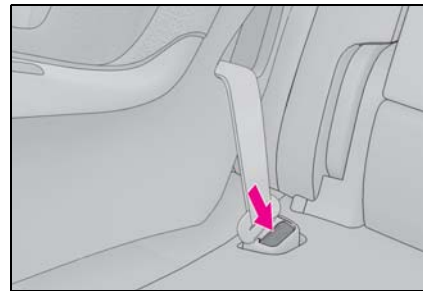

**⚠ WARNING**

■ **When installing a child restraint system**

Observe the following precautions. Failure to do so may result in death or serious injury.

### WARNING

- Do not allow children to play with the seat belt. If the seat belt becomes twisted around a child's neck, it may lead to choking or other serious injuries that could result in death. If this occurs and the buckle cannot be unfastened, scissors should be used to cut the belt.
- Ensure that the belt and plate are securely locked and the seat belt is not twisted.
- Shake the child restraint system left and right, and forward and backward to ensure that it has been securely installed.
- After securing a child restraint system, never adjust the seat.
- When a booster seat is installed, always ensure that the shoulder belt is positioned across the center of the child's shoulder. The belt should be kept away from the child's neck, but not so that it could fall off the child's shoulder.
- Follow all installation instructions provided by the child restraint system manufacturer.
- When securing some types of child restraint systems in rear seats, it may not be possible to properly use the seat belts in positions next to the child restraint without interfering with it or affecting seat belt effectiveness. Be sure your seat belt fits snugly across your shoulder and low on your hips. If it does not, or if it interferes with the child restraint, move to a different position. Failure to do so may result in death or serious injury.

- When installing a child restraint system in the rear center seat, adjust both seat cushions to the same position and align both seatbacks at the same angle. The seatbacks must be adjusted to the same angle. Otherwise, the child restraint system cannot be securely restrained and this may cause death or serious injuries in the event of sudden braking, sudden swerving or an accident.

#### ■ When installing a booster seat

To prevent the belt from going into ALR lock mode, do not fully extend the shoulder belt. ALR mode causes the belt to tighten only. This could cause injury or discomfort to the child. (→P.28)

#### ■ Do not use a seat belt extender

If a seat belt extender is used when installing a child restraint system, the seat belt will not securely hold the child restraint system, which could cause death or serious injury to the child or other passengers in the event of sudden braking, sudden swerving or an accident.

### Child restraint system fixed with a child restraint LATCH anchor

#### ■ Child restraint LATCH anchors

LATCH anchors are provided for the outboard second-row seats. (Buttons displaying the location of the anchors are attached to the seats.)

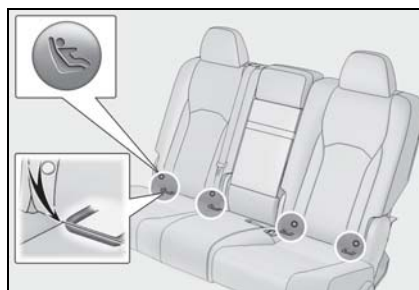

### ■ When installing in the rear out-board seats

Install the child restraint system in accordance to the operation manual enclosed with the child restraint system.

#### 1 Adjust the seat

If there is a gap between the child seat and the seatback, adjust the seatback angle until good contact is achieved.

#### 2 Remove the head restraint if it interferes with your child restraint system. (→P.136)

If the head restraint cannot be removed, raise it to the uppermost position.

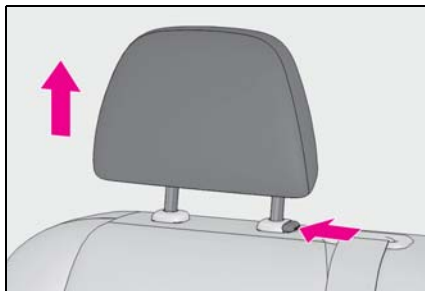

#### 3 Widen the gap between the seat cushion and seatback slightly.

▶ With flexible lower attachments

#### 4 Latch the hooks of the lower attachments onto the LATCH anchors.

For owners in Canada:

The symbol on a child restraint sys-

tem indicates **A** the presence of a lower connector system.

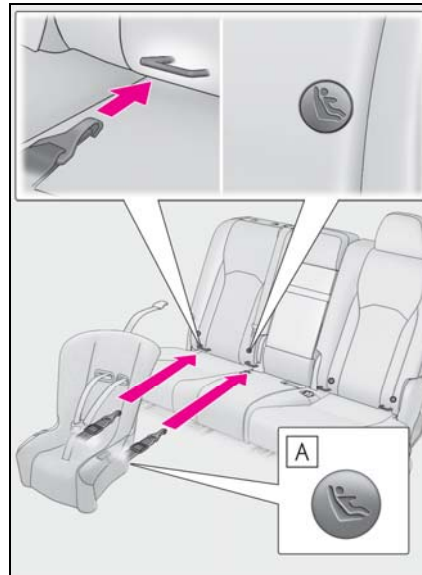

#### **A** Canada only

▶ With rigid lower attachments

#### 4 Latch the buckles onto the LATCH anchors.

For owners in Canada:

The symbol on a child restraint sys-

tem indicates **A** the presence of a lower connector system.

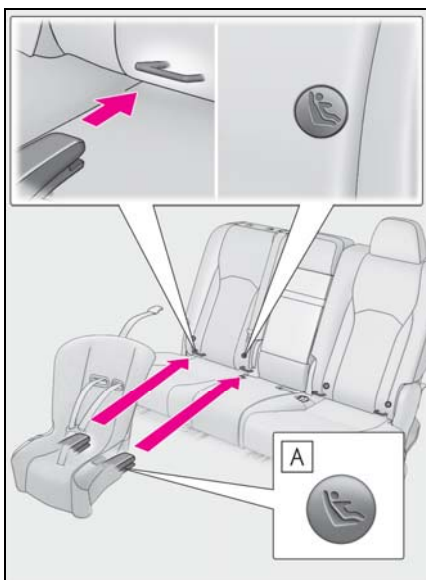

**A** Canada only

- 5 If the child restraint has a top tether strap, follow the child restraint manufacturer's operation manual regarding the installation, using the top tether strap to latch onto the top tether strap anchor. (→P.57)
- 6 After installing the child restraint system, rock it back and forth to ensure that it is installed securely. (→P.54)

#### ■ When installing in the rear center seat

There are no LATCH anchors behind the rear center seat. However, the inboard LATCH anchors of the outboard seats, which are 18.1 in. (460 mm) apart, can be used if the child restraint system manufacturer's instructions permit use of those

anchors with the anchor spacing stated.

Child restraint systems with rigid lower attachments cannot be installed in the center seat. This type of child restraint system can only be installed in the outboard seat.

#### ■ Laws and regulations pertaining to anchors

The LATCH system conforms to FMVSS225 or CMVSS210.2.

Child restraint systems conforming to FMVSS213 or CMVSS213 specifications can be used.

This vehicle is designed to conform to SAE J1819.

#### ⚠ WARNING

##### ■ When installing a child restraint system

Observe the following precautions. Failure to do so may result in death or serious injury.

- When using the LATCH anchors, be sure that there are no foreign objects around the anchors and that the seat belt is not caught behind the child restraint system.
- Follow all installation instructions provided by the child restraint system manufacturer.
- Never attach two child restraint system attachments to the same anchor. In a collision, one anchor may not be strong enough to hold two child restraint system attachments and may break.  
If the LATCH anchors are already in use, use the seat belt to install a child restraint system in the center seat.



**⚠ WARNING**

- When securing some types of child restraint systems in rear seats, it may not be possible to properly use the seat belts in positions next to the child restraint without interfering with it or affecting seat belt effectiveness. Be sure your seat belt fits snugly across your shoulder and low on your hips. If it does not, or if it interferes with the child restraint, move to a different position. Failure to do so may result in death or serious injury.
- When installing a child restraint system in the rear center seat, adjust both seat cushions to the same position and align both seatbacks at the same angle. The seatbacks must be adjusted to the same angle. Otherwise, the child restraint system cannot be securely restrained and this may cause death or serious injuries in the event of sudden braking, sudden swerving or an accident.
- If the seat is adjusted, reconfirm the security of the child restraint system.

**Using an anchor bracket (for top tether strap)****■ Anchor brackets (for top tether strap)**

Anchor brackets are provided for the following seats:

Use anchor brackets when fixing the top tether strap.

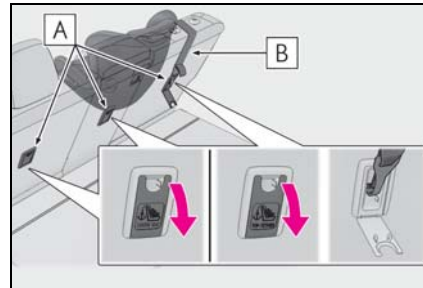
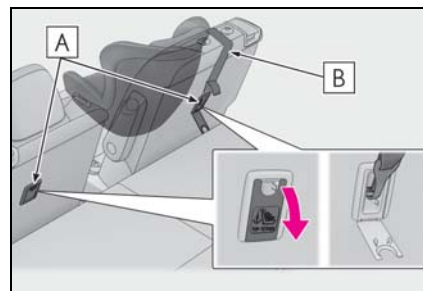
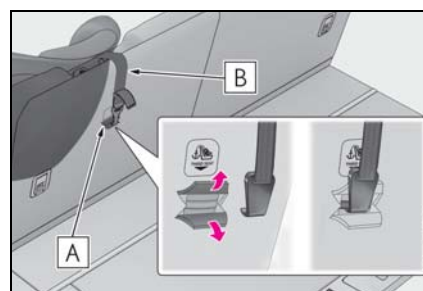
**▶ Bench-type second-row seats****A** Anchor brackets**B** Top tether strap**▶ Separate-type second-row seats****A** Anchor brackets**B** Top tether strap**▶ Third-row left side seat\*****A** Anchor brackets**B** Top tether strap

\*: The third-row seats are not equipped with Child restraint LATCH anchors.

### ■ Fixing the top tether strap to the anchor bracket (second-row seats)

Install the child restraint system in accordance to the operation manual enclosed with the child restraint system.

- 1 Remove the head restraint if it interferes with your child restraint system. (→P.136)

If the head restraint cannot be removed, raise it to the uppermost position.

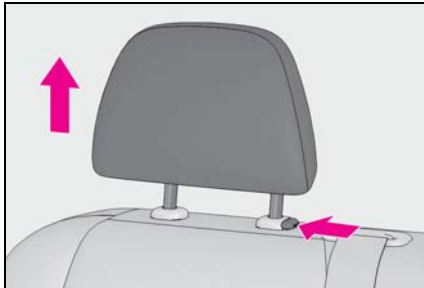

- 2 Open the anchor bracket cover, latch the hook onto the anchor bracket and tighten the top tether strap.

Make sure the top tether strap is securely latched. (→P.54)

When installing the child restraint system with the head restraint being raised, be sure to have the top tether strap pass underneath the head restraint.

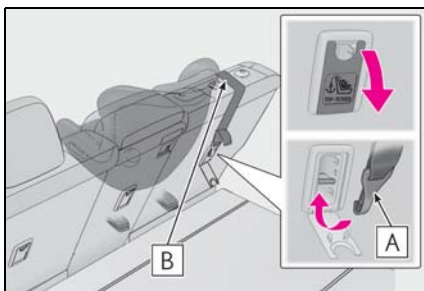

**A** Hook

**B** Top tether strap

### ■ Fixing the top tether strap to the anchor bracket (third-row left side seat)

Install the child restraint system in accordance to the operation manual enclosed with the child restraint system.

- 1 Remove the head restraint if it interferes with your child restraint system. (→P.136)

If the head restraint cannot be removed, raise it to the uppermost position.

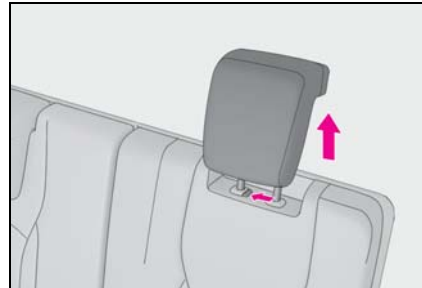

- 2 Latch the hook onto the anchor bracket and tighten the top tether strap.

Make sure the top tether strap is securely latched. (→P.54)

When installing the child restraint system with the head restraint being raised, be sure to have the top tether strap pass underneath the head restraint.

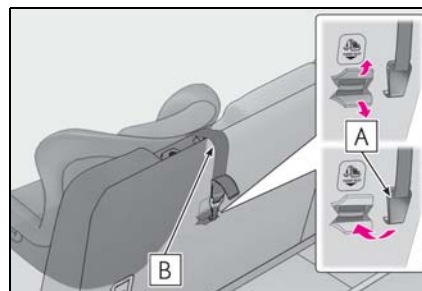

**A** Hook

**B** Top tether strap

#### ■ Laws and regulations pertaining to anchors

The LATCH system conforms to FMVSS225 or CMVSS210.2.

Child restraint systems conforming to FMVSS213 or CMVSS213 specifications can be used.

This vehicle is designed to conform to SAE J1819.



#### NOTICE

##### ■ Anchor brackets (for top tether strap)

When not in use, make certain to close the lid. If it remains open, the lid may be damaged.



#### WARNING

##### ■ When installing a child restraint system

Observe the following precautions. Failure to do so may result in death or serious injury.

- Firmly attach the top tether strap and make sure that the belt is not twisted.
- Do not attach the top strap to anything other than the anchor bracket of the seat the child restraint system is installed to.
- Follow all installation instructions provided by the child restraint system manufacturer.
- When installing the child restraint system with the head restraint being raised, after the head restraint has been raised and then the anchor bracket has been fixed, do not lower the head restraint.
- When installing a child restraint system in the rear center seat, adjust both seat cushions to the same position and align both seatbacks at the same angle. The seatbacks must be adjusted to the same angle. Otherwise, the child restraint system cannot be securely restrained and this may cause death or serious injuries in the event of sudden braking, sudden swerving or an accident.
- If the seat is adjusted, reconfirm the security of the child restraint system.

## Lexus Enform Safety Connect\*

\*: If equipped

Safety Connect is a subscription-based telematics service that uses Global Positioning System (GPS) data and embedded cellular technology to provide safety and security features to subscribers.

Safety Connect is supported by Lexus' designated response center, which operates 24 hours per day, 7 days per week.

Safety Connect service is available by subscription on select, telematics hardware-equipped vehicles.

By using the Safety Connect service, you are agreeing to be bound by the Telematics Subscription Service Agreement and its Terms and Conditions, as in effect and amended from time to time, a current copy of which is available at [Lexus.com](http://Lexus.com). All use of the Safety Connect service is subject to such then-applicable Terms and Conditions.

## System components

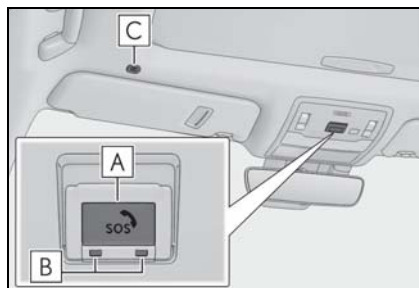

- A** "SOS" button
- B** LED light indicators
- C** Microphone

---

■ Certification for Lexus Enform

FCC ID: JOYDA39

**NOTE**

This device complies with part 15 of the FCC Rules. Operation is subject to the following two conditions: (1) This device may not cause harmful interference, and (2) this device must accept any interference received, including interference that may cause undesired operation.

**FCC WARNING**

Changes or modifications not expressly approved by the party responsible for compliance could void the user's authority to operate the equipment.

**Co-location:** This transmitter must not be co-located or operated in conjunction with any other antenna or transmitter.

**CAUTION : Radio Frequency Radiation Exposure**

This equipment complies with FCC radiation exposure limits set forth for an uncontrolled environment and meets the FCC radio frequency (RF) Exposure Guidelines. This equipment should be installed and operated keeping the radiator at least 20cm or more away from person's body.

IC: 574B-DA39

**NOTE**

This device contains licence-exempt transmitter(s)/receiver(s) that comply with Innovation, Science and Economic Development Canada's licence-exempt RSS(s). Operation is subject to the following two conditions:

(1) This device may not cause interference.

(2) This device must accept any interference, including interference that may cause undesired operation of the device.

The antenna cannot be removed (and changed) by user.

**Co-location:** This transmitter must not be co-located or operated in conjunction with any other antenna or transmitter.

**CAUTION: Radio Frequency Radiation Exposure**

This equipment complies with ISED radiation exposure limits set forth for an uncontrolled environment and meets RSS-102 of the ISED radio frequency (RF) Exposure rules. This equipment should be installed and operated keeping the radiator at least 20 cm or more away from person's body.

**NOTE**

L'émetteur/récepteur exempt de licence contenu dans le présent appareil est conforme aux CNR d'Innovation, Sciences et Développement économique Canada applicables aux appareils radio exempts de licence. L'exploitation est autorisée aux deux conditions suivantes :

- (1) L'appareil ne doit pas produire de brouillage;
- (2) L'appareil doit accepter tout brouillage radioélectrique subi, même si le brouillage est susceptible d'en compromettre le fonctionnement.

L'utilisateur n'est pas autorisé à retirer (ou modifier) l'antenne.

Emplacement: Cet émetteur ne doit pas être installé ou utilisé conjointement avec d'autres antennes ou émetteurs.

**ATTENTION** : exposition aux radiofréquences

Cet équipement est conforme aux limites d'exposition aux rayonnements ISDE établies pour un environnement non contrôlé et satisfait à la norme CNR-102 de la réglementation ISDE sur l'exposition aux radiofréquences (RF). Cet équipement doit être installé et utilisé avec un minimum de 20 cm de distance entre la source de rayonnement et le corps.

**Services**

Subscribers have the following Safety Connect services available:

- Automatic Collision Notification \*

Helps drivers receive necessary response from emergency service providers. (→P.63)

\* : U.S. Patent No. 7,508,298 B2

- Stolen Vehicle Location

Helps drivers in the event of vehicle theft. (→P.63)

- Emergency Assistance Button ("SOS")

Connects drivers to response-center support. (→P.63)

- Enhanced Roadside Assistance

Provides drivers various on-road assistance. (→P.63)

**Subscription**

After you have signed the Telematics Subscription Service Agreement and are enrolled, you can begin receiving services.

A variety of subscription terms is available for purchase. Contact your Lexus dealer, call the following or push the "SOS" button in your vehicle for further subscription details.

- The United States  
1-800-25-LEXUS (1-800-255-3987)
- Canada  
1-800-26-LEXUS (1-800-265-3987)
- Puerto Rico  
1-877-539-8777

**■ Safety Connect Services Information**

- Phone calls using the vehicles Bluetooth® technology will not be possible during Safety Connect.

- Safety Connect is available beginning Fall 2009 on select Lexus models (in the contiguous United States only). Contact with the Safety Connect response center is dependent upon the telematics device being in operative condition, cellular connection availability, and GPS satellite signal reception, which can limit the ability to reach the response center or receive emergency service support. Enrollment and Telematics Subscription Service Agreement required. A variety of subscription terms is available; charges vary by subscription term selected and location.
- Automatic Collision Notification, Emergency Assistance and Stolen Vehicle Location will function in the United States, including Hawaii and Alaska, Puerto Rico and in Canada, and Enhanced Roadside Assistance will function in the United States, Puerto Rico and in Canada.
- Automatic Collision Notification, Emergency Assistance, Stolen Vehicle and Enhanced Road Assistance will not function in the United States Virgin Islands. For vehicles first sold in the USVI, no Safety Connect services will function in and outside the United States Virgin Islands.
- Safety Connect services are not subject to section 255 of the Telecommunications Act and the device is not TTY compatible.

#### ■ Languages

The Safety Connect response center will offer support in multiple languages. The Safety Connect system will offer voice prompts in English, Spanish, and French. Please indicate your language of choice when enrolling.

#### ■ When contacting the response center

You may be unable to contact the response center if the network is busy.

### Safety Connect LED light Indicators

When the engine switch is turned to IGNITION ON mode, the red indicator light comes on for 2 seconds then turns off. Afterward, the green indicator light comes on, indicating that the service is active.

The following indicator light patterns indicate specific system usage conditions:

- Green indicator light on = Active service
- Green indicator light flashing = Safety Connect call in process
- Red indicator light (except at vehicle start-up) = System malfunction (contact your Lexus dealer)
- No indicator light (off) = Safety Connect service not active

### Safety Connect services

#### ■ Automatic Collision Notification

In case of either airbag deployment or severe rear-end collision, the system is designed to automatically call the response center. The responding agent receives the vehicle's location and attempts to speak with the vehicle occupants to assess the level of emergency. If the occupants are unable to communicate, the agent automatically treats the call as an emergency, contacts the nearest emergency services provider to describe the situation, and requests that assistance be sent to the

location.

#### ■ Stolen Vehicle Location

If your vehicle is stolen, Safety Connect can work with local authorities to assist them in locating and recovering the vehicle. After filing a police report, call the Safety Connect response center at 1-800-25-LEXUS

(1-800-255-3987) in the United States, 1-877-539-8777 in Puerto Rico or 1-800-265-3987 in Canada, and follow the prompts for Safety Connect to initiate this service.

In addition to assisting law enforcement with recovery of a stolen vehicle, Safety-Connect-equipped vehicle location data may, under certain circumstances, be shared with third parties to locate your vehicle. Further information is available at Lexus.com.

#### ■ Emergency Assistance Button (“SOS”)

In the event of an emergency on the road, push the “SOS” button to reach the Safety Connect response center. The answering agent will determine your vehicle’s location, assess the emergency, and dispatch the necessary assistance required.

If you accidentally press the “SOS” button, tell the response-center agent that you are not experiencing an emergency.

#### ■ Enhanced Roadside Assistance

Enhanced Roadside Assistance adds GPS data to the already included warranty-based Lexus roadside service.

Subscribers can press the “SOS” button to reach a Safety Connect

response-center agent, who can help with a wide range of needs, such as: towing, flat tire, fuel delivery, etc. For a description of the Roadside Assistance services and their limitations, please see the Safety Connect Terms and Conditions, which are available at Lexus.com.

### Safety information for Safety Connect

Important! Read this information about exposure to radio frequency signals before using Safety Connect;

The Safety Connect system installed in your vehicle is a low-power radio transmitter and receiver. It receives and also sends out radio frequency (RF) signals.

In August 1996, the Federal Communications Commission (FCC) adopted RF exposure guidelines with safety levels for mobile wireless phones. Those guidelines are consistent with the safety standards previously set by the following U.S. and international standards bodies.

- ANSI (American National Standards Institute) C95.1 [1992]
- NCRP (National Council on Radiation Protection and Measurement) Report 86 [1986]
- ICNIRP (International Commission on Non-Ionizing Radiation Protection) [1996]

Those standards were based on comprehensive and periodic evaluations of the relevant scientific literature. Over



120 scientists, engineers, and physicians from universities, and government health agencies and industries reviewed the available body of research to develop the ANSI Standard (C95.1).

The design of Safety Connect complies with the FCC guidelines in addition to those standards.

### Engine immobilizer system

The vehicle's keys have built-in transponder chips that prevent the engine from starting if a key has not been previously registered in the vehicle's on-board computer.

Never leave the keys inside the vehicle when you leave the vehicle.

This system is designed to help prevent vehicle theft but does not guarantee absolute security against all vehicle thefts.

### Operating the system

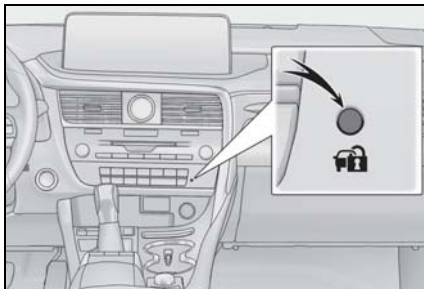

#### ■ Certification for the engine immobilizer system

- ▶ Except for vehicles sold in Canada

FCC ID: N14TMIMB-3

This device complies with part 15 of the FCC Rules. Operation is subject to the following two conditions: (1) This device may not cause harmful interference, and (2) this device must accept any interference received, including interference that may cause undesired operation.

Changes or modifications not expressly approved by the party responsible for compliance could void the user's authority to operate the equipment.

The indicator light flashes after the engine switch has been turned off to indicate that the system is operating.

The indicator light stops flashing after the engine switch has been turned to ACCESSORY or IGNITION ON mode to indicate that the system has been canceled.

#### ■ System maintenance

The vehicle has a maintenance-free type engine immobilizer system.

#### ■ Conditions that may cause the system to malfunction

- If the grip portion of the key is in contact with a metallic object
- If the key is in close proximity to or touching a key registered to the security system (key with a built-in transponder chip) of another vehicle

- For vehicles sold in Canada

This device complies with Industry Canada's licence-exempt RSSs. Operation is subject to the following two conditions: (1) This device may not cause interference; and (2) This device must accept any interference, including interference that may cause undesired operation of the device.

Le présent appareil est conforme aux CNR d'Industrie Canada applicables aux appareils radio exempts de licence. L'exploitation est autorisée aux deux conditions suivantes : 1) l'appareil ne doit pas produire de brouillage; 2) l'utilisateur de l'appareil doit accepter tout brouillage radioélectrique subi, même si le brouillage est susceptible d'en compromettre le fonctionnement.

**WARNING****■ Certifications for the engine immobilizer system**

Changes or modifications not expressly approved by the party responsible for compliance could void the user's authority to operate the equipment.

**NOTICE****■ To ensure the system operates correctly**

Do not modify or remove the system. If modified or removed, the proper operation of the system cannot be guaranteed.

## Alarm

The alarm uses light and sound to give an alert when an intrusion is detected.

The alarm is triggered in the following situations when the alarm is set:

- Except for Canada: A locked door is unlocked or opened in any way other than using the entry function, wireless remote control or mechanical key. (The doors will lock again automatically.)
- For Canada: A locked door is unlocked or opened in any way other than using the entry function or wireless remote control. (The doors will lock again automatically.)
- The hood is opened.

## Setting/canceling/stopping the alarm system

### ■ Items to check before locking the vehicle

To prevent unexpected triggering of the alarm and vehicle theft, make sure of the following:

- Nobody is in the vehicle.
- The windows, moon roof (if equipped) and panoramic moon roof (if equipped) are closed before the alarm is set.
- No valuables or other personal items are left in the vehicle.

### ■ Setting

Close the doors and hood, and lock all the doors. The system will be set automatically after 30 seconds.

The indicator light changes from being on to flashing when the system is set.

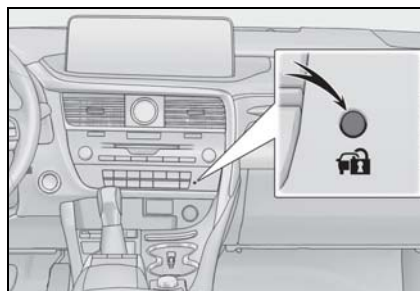

### ■ Canceling or stopping

Do one of the following to deactivate or stop the alarm:

- Unlock the doors.
- Turn the engine switch to ACCESSORY or IGNITION ON mode, or start the engine. (The alarm will be deactivated or stopped after a few seconds.)

### ■ System maintenance

The vehicle has a maintenance-free type alarm system.

### ■ Triggering of the alarm

The alarm may be triggered in the following situations: (Stopping the alarm deactivates the alarm system.)

- For Canada: The doors are unlocked using the mechanical key.

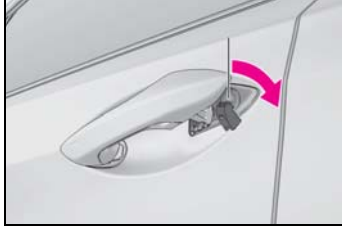

- A person inside the vehicle opens a door or hood, or unlocks the vehicle.



- The battery is recharged or replaced when the vehicle is locked. (→P.435)

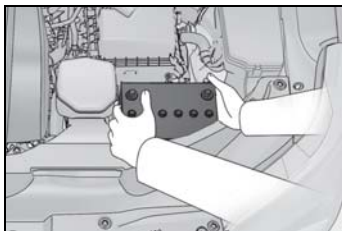

#### ■ Alarm-operated door lock

In the following cases, depending on the situation, the door may automatically lock to prevent improper entry into the vehicle:

- When a person remaining in the vehicle unlocks the door and the alarm is activated.
- While the alarm is activated, a person remaining in the vehicle unlocks the door.
- When recharging or replacing the battery

#### ⚠ NOTICE

##### ■ To ensure the system operates correctly

Do not modify or remove the system. If modified or removed, the proper operation of the system cannot be guaranteed.



**Vehicle status information  
and indicators**

**2**

**71**

**2-1. Instrument cluster**  
Warning lights and indicators ..... **72**  
Gauges and meters ..... **77**  
Multi-information display ..... **81**  
Head-up display ..... **88**  
Fuel consumption information  
..... **92**

**2**

Vehicle status information and indicators

### Warning lights and indicators

The warning lights and indicators on the instrument cluster, center panel and outside rear view mirrors inform the driver of the status of the vehicle's various systems.

### Warning lights and indicators displayed on the instrument cluster

For the purpose of explanation, the following illustrations display all warning lights and indicators illuminated.

- ▶ Except F SPORT models















- ▶ F SPORT models







## Warning lights

Warning lights inform the driver of malfunctions in the indicated vehicle's systems.

	Brake system warning light <sup>*1</sup> (U.S.A.) (→P.403)
	Brake system warning light <sup>*1</sup> (red) (→P.403) (Canada)
	Brake system warning light <sup>*1</sup> (yellow) (→P.403)
	High coolant temperature warning light <sup>*2</sup> (→P.403)
	Charging system warning light <sup>*3</sup> (→P.404)
	Low engine oil pressure warning light <sup>*2</sup> (→P.404)
	Malfunction indicator lamp <sup>*1</sup> (U.S.A.) (→P.404)
	Malfunction indicator lamp <sup>*1</sup> (Canada) (→P.404)
	SRS warning light <sup>*1</sup> (→P.404)
	ABS warning light <sup>*1</sup> (→P.405) (U.S.A.)
	ABS warning light <sup>*1</sup> (→P.405) (Canada)
	Brake Override System warning light/Drive-Start Control warning light <sup>*2</sup> (→P.405)
	Electric power steering system warning light <sup>*1</sup> (→P.405) (red)

 Electric power steering system warning light<sup>\*1</sup> (→P.405)  
(yellow)

 Low fuel level warning light  
(→P.406)

 Driver's and front passenger's seat belt reminder light  
(→P.406)

 Rear passengers' seat belt reminder light<sup>\*4</sup>  
(RX350) (→P.406)

 Rear passengers' seat belt reminder light<sup>\*4</sup> (→P.406)  
(RX350L)

 Tire pressure warning light<sup>\*1</sup>  
(→P.407)

 LTA indicator (→P.407)  
(orange)

 Intuitive parking assist OFF indicator<sup>\*1</sup> (if equipped) (→P.407)  
(flashes)

 RCTA OFF indicator<sup>\*1</sup> (if equipped) (→P.407)  
(flashes)

 PKSB OFF indicator<sup>\*1</sup> (if equipped) (→P.408)  
(flashes)

 PCS warning light<sup>\*1</sup> (→P.408)  
(flashes or illuminates)

 Slip indicator<sup>\*1</sup> (→P.408)

 Parking brake indicator  
(flashes) (→P.409)  
(U.S.A.)

 Parking brake indicator  
(flashes) (→P.409)  
(Canada)

 Brake hold operated indicator <sup>\*1</sup>  
(flashes) (→P.409)

 Master warning light <sup>\*1</sup>  
(→P.409)

<sup>\*1</sup>: These lights turn on when the engine switch is turned to IGNITION ON mode to indicate that a system check is being performed. They will turn off after the engine is started, or after a few seconds. There may be a malfunction in a system if a light does not come on, or turn off. Have the vehicle inspected by your Lexus dealer.

<sup>\*2</sup>: This light illuminates on the multi-information display.

<sup>\*3</sup>: Except F SPORT models: This light illuminates on the multi-information display.  
F SPORT models: This light illuminates on the meter.

<sup>\*4</sup>: This light illuminates on the center panel.

 **WARNING**

**■ If a safety system warning light does not come on**

Should a safety system light such as the ABS and SRS warning lights not come on when you start the engine, this could mean that these systems are not available to help protect you in an accident, which could result in death or serious injury. Have the vehicle inspected by your Lexus dealer immediately if this occurs.

**Indicators**

The indicators inform the driver of the operating state of the vehicle's various systems.

 Turn signal indicator (→P.182)

 Headlight indicator (→P.188)  
(U.S.A.)

 Tail light indicator (→P.188)  
(Canada)

 Headlight high beam indicator  
(→P.189)

 Automatic High Beam indicator <sup>\*1</sup> (→P.191)

 Fog light indicator (if equipped)  
(→P.194)

 PCS warning light <sup>\*1,2</sup> (→P.211)

 Cruise control indicator  
(→P.234)

 Dynamic radar cruise control indicator (→P.227)

 Cruise control "SET" indicator  
(→P.227)

 LTA indicator (→P.220)  
(white)

 LTA indicator (→P.220)  
(green)















 LTA indicator (→P.220)  
(orange)  
(flashes)

 BSM outside rear view mirror indicators <sup>\*3,4</sup> (if equipped)  
(→P.236, 250)



 BSM indicator (if equipped)  
(→P.236)

 Intuitive parking assist OFF indicator <sup>\*1,2</sup> (if equipped)  
(→P.245)





 RCTA OFF indicator <sup>\*1,2</sup> (if equipped)  
(→P.250)

-  PKSB OFF indicator<sup>\*1,2</sup> (if equipped) (→P.256)
-  All-wheel drive lock indicator<sup>\*1</sup> (AWD models only) (→P.273)
-  Slip indicator<sup>\*1</sup> (→P.275) (flashes)
-  VSC OFF indicator<sup>\*1,2</sup> (→P.276)
-  Smart access system with push-button start indicator<sup>\*5</sup> (→P.174)
-  Parking brake indicator (→P.183) (U.S.A.)
-  Parking brake indicator (→P.183) (Canada)
-  Brake hold standby indicator<sup>\*1</sup> (→P.186)
-  Brake hold operated indicator<sup>\*1</sup> (→P.186)
-  Eco Driving Indicator Light<sup>\*1</sup> (→P.83)
-  Low outside temperature indicator<sup>\*6</sup> (→P.77)
-  Security indicator<sup>\*7</sup> (→P.66, 68)
-  "AIR BAG ON/OFF" indicator<sup>\*1,7</sup> (→P.40) (U.S.A.)
-  "AIR BAG ON/OFF" indicator<sup>\*1,7</sup> (→P.40) (Canada)

- Drive mode indicators
- ▶ Except F SPORT models

-  Eco drive mode indicator (→P.271)
-  Sport mode indicator (if equipped) (→P.271)



▶ F SPORT models

-  Custom mode indicator (→P.271)
-  Eco drive mode indicator (→P.271)
-  Sport mode indicator (if equipped) (→P.271)
-  Sport S mode indicator (→P.271)
-  Sport S+ mode indicator (→P.271)

<sup>\*1</sup>: These lights turn on when the engine switch is turned to IGNITION ON mode to indicate that a system check is being performed. They will turn off after the engine is started, or after a few seconds. There may be a malfunction in a system if a light does not come on, or turn off. Have the vehicle inspected by your Lexus dealer.

<sup>\*2</sup>: This light comes on when the system is turned off.

<sup>\*3</sup>: In order to confirm operation, the BSM outside rear view mirror indicators illuminate in the following situations:

- When the BSM function is enabled on  of the multi-information display, the engine switch is turned to IGNITION ON mode.
- When the engine switch is in IGNITION ON mode, the BSM function is enabled on  of the multi-information display.

If the system is functioning correctly, the BSM outside rear view mirror indicators will turn off after a few seconds. If the BSM outside rear view mirror indicators do not illuminate or do not turn off, there may be a malfunction in

the system. If this occurs, have the vehicle inspected by your Lexus dealer.

\*4: This light illuminates on the outside rear view mirrors.

\*5: This light illuminates on the multi-information display.

\*6: When the outside temperature is approximately 37°F (3°C) or lower, this indicator will flash for approximately 10 seconds, then stay on.

\*7: This light illuminates on the center panel.

## Gauges and meters

### Meter display

#### ■ Locations of gauges and meters

- ▶ Except F SPORT models

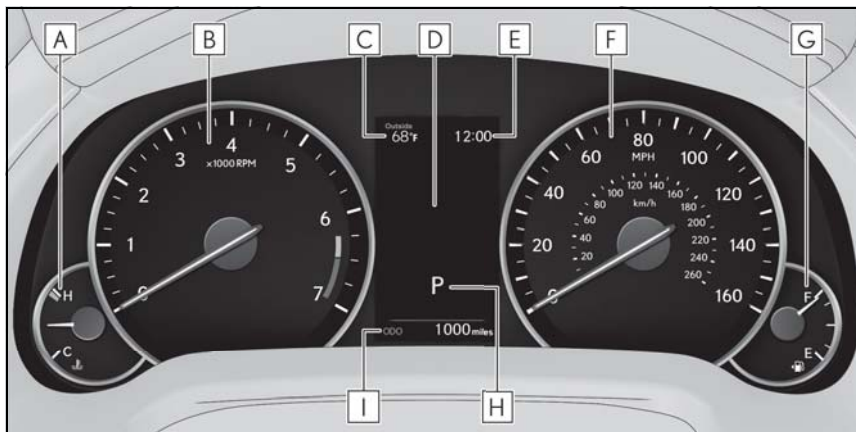

The units used on the meters may differ depending on the target region.

#### **A** Engine coolant temperature gauge

Displays the engine coolant temperature

#### **B** Tachometer

Displays the engine speed in revolutions per minute

#### **C** Outside temperature

Displays the outside temperature within the range of  $-40^{\circ}\text{F}$  ( $-40^{\circ}\text{C}$ ) to  $122^{\circ}\text{F}$  ( $50^{\circ}\text{C}$ ). Low outside temperature indicator comes on when the ambient temperature is  $37^{\circ}\text{F}$  ( $3^{\circ}\text{C}$ ) or lower.

#### **D** Multi-information display

Presents the driver with a variety of vehicle data (→P.81)

Displays warning messages in case of a malfunction (→P.412)

#### **E** Clock

Time displayed is linked to the analog clock on the instrument panel. (→P.331)

#### **F** Speedometer

#### **G** Fuel gauge

Displays the quantity of fuel remaining in the tank

#### **H** Shift position display (→P.178)

**I** Odometer and trip meter display (→P.80)

▶ F SPORT models

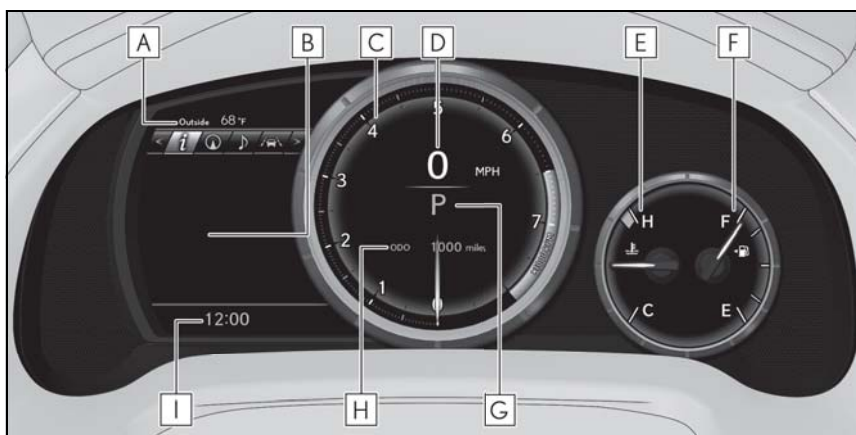

The units used on the meters may differ depending on the target region.

**A** Outside temperature

Displays the outside temperature within the range of -40°F (-40°C) to 122°F (50°C). Low outside temperature indicator comes on when the ambient temperature is 37°F (3°C) or lower.

**B** Multi-information display

Presents the driver with a variety of vehicle data (→P.81)

Displays warning messages in case of a malfunction (→P.412)

**C** Tachometer

Displays the engine speed in revolutions per minute

When sport mode is selected for the driving mode, the periphery of the tachometer will change color and the scale of the tachometer will be emphasized.

**D** Speedometer

**E** Engine coolant temperature gauge

Displays the engine coolant temperature

**F** Fuel gauge

Displays the quantity of fuel remaining in the tank

**G** Shift position display (→P.178)

**H** Odometer and trip meter display (→P.80)

**I** Clock

Time displayed is linked to the analog clock on the instrument panel. (→P.331)

■ **Rev indicator (F SPORT models)** When the engine speed reaches a set

speed, a ring-shaped indicator will be displayed on the tachometer.

The desired engine speed at which the Rev indicator will begin to be displayed can be set on  of the multi-information display. (→P.81)



#### ■ Rev peak (F SPORT models)

The engine speed reaches or exceeds 5000 rpm, an afterimage of the tachometer will be displayed at the highest engine speed for approximately 1 second.



#### ■ The meters and display illuminate when

The engine switch is in IGNITION ON mode.

#### ■ Outside temperature display

- In the following situations, the correct outside temperature may not be displayed, or the display may take longer than normal to change:
  - When stopped, or driving at low speeds (less than 12 mph [20 km/h])
  - When the outside temperature has

changed suddenly (at the entrance/exit of a garage, tunnel, etc.)

- When "--" or "E" is displayed, the system may be malfunctioning. Take your vehicle to your Lexus dealer.

#### ■ Liquid crystal display

Small spots or light spots may appear on the display. This phenomenon is characteristic of liquid crystal displays, and there is no problem continuing to use the display.

#### ■ Customization

The gauges and meters can be customized on  of the multi-information display. (→P.85)

#### ⚠ WARNING

##### ■ The information display at low temperatures

Allow the interior of the vehicle to warm up before using the liquid crystal information display. At extremely low temperatures, the information display monitor may respond slowly, and display changes may be delayed.

For example, there is a lag between the driver's shifting and the new gear number appearing on the display. This lag could cause the driver to downshift again, causing rapid and excessive engine braking and possibly an accident resulting in death or injury.

#### ⚠ NOTICE

##### ■ To prevent damage to the engine and its components

- Do not let the indicator needle of the tachometer enter the red zone, which indicates the maximum engine speed.
- The engine may be overheating if the engine coolant temperature gauge is in the red zone (H). In this case, immediately stop the vehicle in a safe place, and check the engine after it has cooled completely. (→P.437)

### Odometer and trip meter display

#### ■ Display items

##### ● Odometer

Displays the total distance the vehicle has been driven.

##### ● Trip meter A/trip meter B

Displays the distance the vehicle has been driven since the meter was last reset. Trip meters A and B can be used to record and display different distances independently.

##### ● Distance until next engine oil change

Displays the distance the vehicle can be driven until an oil change is necessary.

#### ■ Changing the display

Each time the "ODO TRIP" switch is pressed, the displayed item will be changed. When the trip meter is displayed, pressing and holding the switch will reset the trip meter.

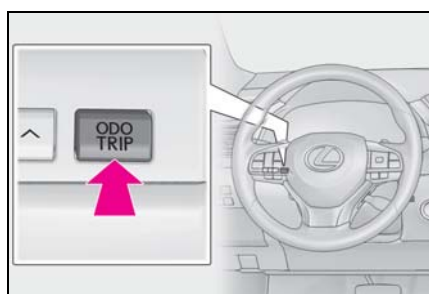

#### ■ Pop-up display

Distance until next engine oil change

Displays the distance until the next engine oil change. This display will be displayed in the following situations:

- When the engine switch is turned to IGNITION ON mode.

- When a warning message indicating that oil maintenance should be performed soon or is required is displayed.

### Changing the instrument panel light brightness

The brightness of the instrument panel lights can be adjusted.

If the brightness is adjusted when the surroundings are bright and the tail lights are on (day mode brightness adjustment), the brightness level of night mode will be adjusted at the same time.

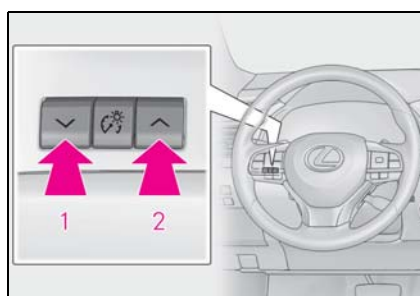

- 1 Darker
- 2 Brighter

#### ■ Brightness of the meters (day mode and night mode)

The brightness of the meters is changed between day mode and night mode.

- Day mode: When the tail lights are off or when the tail lights are on but the surrounding area is bright
- Night mode: When the tail lights are on and the surrounding area is dark



## Multi-information display

### Display and menu icons

#### ■ Display

- ▶ Except F SPORT models

By selecting menu icons on the multi-information display, a variety of driving-related information can be displayed. The multi-information display can also be used to change display settings and other vehicle settings.

Warning or suggestion/advice pop-up displays are also displayed in certain situations.

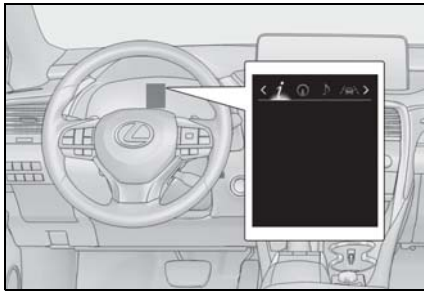

- ▶ F SPORT models





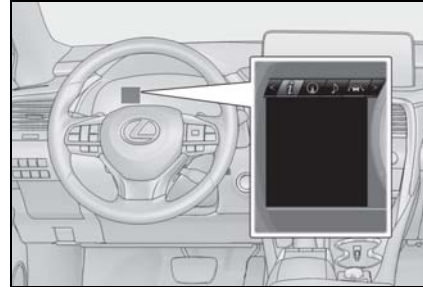

By selecting menu icons on the multi-information display, a variety of driving-related information can be displayed. The multi-information display can also be used to change display settings and other vehicle settings.

Warning or suggestion/advice pop-up displays are also displayed in certain situations.



#### ■ Menu icons

Select a menu icon to display its content.

-  Driving information (→P.82)
-  Navigation system-linked display (if equipped) (→P.85)
-  Audio system-linked display (→P.85)
-  Driving assist system information (→P.85)
-  Warning message display (→P.412)
-  Settings display (→P.85)

#### ■ Liquid crystal display

→P.79

### WARNING

#### ■ Caution for use while driving

- When operating the multi-information display while driving, pay extra attention to the safety of the area around the vehicle.
- Do not look continuously at the multi-information display while driving as you may fail to see pedestrians, objects on the road, etc. ahead of the vehicle.

**⚠ WARNING**

■ The information display at low temperatures  
→P.79

**Changing the meter display**

The multi-information display is operated using the meter control switches.

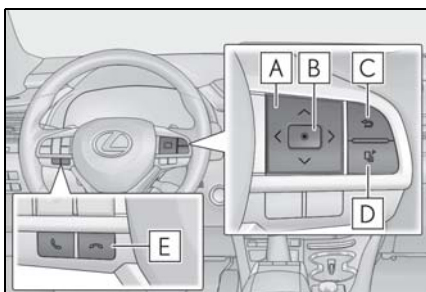

**A** < > : Select menu icons  
^ v : Change displayed content, scroll up/down the screen and move the cursor

**B** Press: Enter/Set  
Press and hold: Reset

**C** Return to the previous screen  
Pressing and holding the switch will display the first screen of the selected menu icon.

**D** Press: Display the top screen  
Press and hold: Register current screen as the top screen

**E** Call sending/receiving and history display

Linked with the hands-free system, sending or receiving call is displayed. For details regarding the hands-free system, refer to the "NAVIGATION AND MULTIMEDIA SYSTEM OWNER'S MANUAL".

**■ Registering a top screen**

The displayed top screen can be changed to a registered screen of your choice. To register a screen as the top screen, display the desired screen and press and hold .

- A message asking to confirm if registration is desired will be displayed. If the selected screen cannot be registered, a registration failure message will be displayed.
- When no screen has been registered, the drive information screen will be displayed.

**Drive information****■ Content displayed as drive information**

Displays drive information such as the following:

- Drive information 1
  - Current fuel consumption
  - Average fuel economy (after reset)
- Drive information 2
  - Distance (driving range)
  - Average vehicle speed (after reset)
- Drive information 3
  - Average fuel economy (after refuel)
  - Elapsed time (after start)

Displayed items (listed below) can be changed on . (→P.85)

- Current fuel consumption

Displays instantaneous current fuel consumption

- Average fuel economy

After reset: Displays average fuel consumption since the display was reset<sup>\*1,2</sup>

After start: Displays average fuel consumption since engine start<sup>\*2</sup>

After refuel: Displays average fuel consumption since refuel<sup>\*2,3</sup>

- Average vehicle speed

After reset: Displays average vehicle speed since the display was reset<sup>\*1</sup>

After start: Displays average vehicle speed since engine start

- Elapsed time

After reset: Displays elapsed time since the display was reset<sup>\*1</sup>

After start: Displays elapsed time since engine start

- Distance

Driving range: Displays driving range with remaining fuel<sup>\*3,4</sup>

After start: Displays drive distance since vehicle start

- Other

Blank: No item

<sup>\*1</sup>: To reset, display the desired item and press and hold  of the meter control switch.

If both of the displayed items are resettable, a message will be displayed asking which item(s) to reset.

<sup>\*2</sup>: Use the displayed fuel consumption as a reference.

<sup>\*3</sup>: When only a small amount of fuel is added to the tank, the display may not be updated.  
When refueling, turn the engine switch off. If the vehicle is refueled without

turning the engine switch off, the display may not be updated.

<sup>\*4</sup>: This distance is computed based on your average fuel consumption. As a result, the actual distance that can be driven may differ from that displayed.

### ■ Eco Driving Indicator

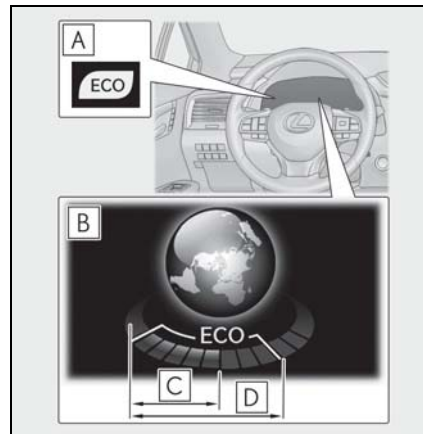

#### **A** Eco Driving Indicator Light

During Eco-friendly acceleration (Eco driving), the Eco Driving Indicator Light will turn on. When the acceleration exceeds the Zone of Eco driving, or when the vehicle is stopped, the light turns off.

#### **B** Eco Driving Indicator Zone Display

Suggests the Zone of Eco driving with current Eco driving ratio based on acceleration.

#### **C** Eco driving ratio based on acceleration

If the acceleration exceeds the Zone of Eco driving, the right side of the Eco Driving Indicator Zone Display will illuminate.

#### **D** Zone of Eco driving

### ■ AWD Control (if equipped)

Displays the driving force applied to each wheel using segments.

The greater the number of segments displayed, the greater the driving force applied.

#### ■ G-force (if equipped)

Displays lateral G-forces on the vehicle. Also displays, around the periphery of the G-force display, the left and right steering amount, accelerator pedal input, and brake fluid pressure.

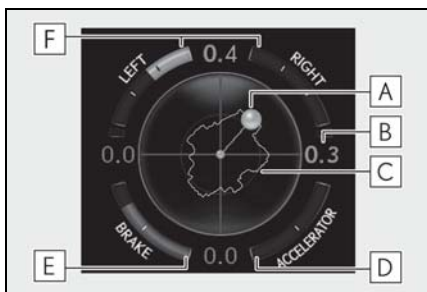

- A** Acceleration G-force on the vehicle
- B** Current G-force value (analyzed value of front/rear and left/right G-forces)
- C** Record of the maximum G-forces
- D** Accelerator pedal input
- E** Brake fluid pressure
- F** Steering amount

This display is intended for use as a guideline. Depending on factors such as the road surface condition, temperature and vehicle speed, the display may not show the actual condition of the vehicle.

- Resetting the record of maximum G-forces

Press and hold  of the meter control switch to reset the record.

- Peak hold function

If lateral G-forces of 0.5 G or greater are generated, the G-force value display will turn amber and be held for 2 seconds.

#### ■ Tire pressure

→P.367

#### ■ Units (if equipped)

The units of measure used can be changed while driving.

Unlike the units setting performed on the settings display, the units setting performed on the drive information display can be changed while driving.

#### ■ Blank (No items)

Displays no drive information contents.

#### ■ Eco Driving Indicator

Eco Driving Indicator will not operate under the following conditions:

- The shift lever is in any position other than D.
- A paddle shift switch is operated.
- Sport mode is selected.
- The driving mode is set to customized mode and the powertrain control is set to power (→P.271)
- The vehicle speed is approximately 80 mph (130 km/h) or higher.

#### ■ G-force display (if equipped)

- The G-force values may not be zero even when the vehicle is parked, such as when it is parked on an incline.
- Depending on the vehicle usage conditions, the brake fluid pressure display may not reach its maximum reading even though the brake pedal is fully depressed.
- If a battery terminal is disconnected and reconnected, the steering amount display may be disabled temporarily. After driving the vehicle for a while, the display will be enabled.

#### ■ Tire pressure

- It may take a few minutes to display the

tire inflation pressure after the engine switch is turned to IGNITION ON mode. It may also take a few minutes to display the tire inflation pressure after inflation pressure has been adjusted.

- “---” may be displayed if the tire position information cannot be determined due to unfavorable radio wave conditions.
- Tire inflation pressure changes with temperature. The displayed values may also be different from the values measured using a tire pressure gauge.

### Navigation system-linked display (if equipped)

Select to display the following navigation system-linked information.

- Route guidance
- Compass display (heading-up display)

### Audio system-linked display

Select to enable selection of an audio source or track on the meter using the meter control switches.

### Driving assist system information

Select to display the operational status of the following systems:

- LTA (Lane Tracing Assist) (→P.216)
- RSA (Road Sign Assist) (if equipped) (→P.225)
- Dynamic radar cruise control with full-speed range (→P.227)

### Settings display

#### ■ Meter display settings that can be changed

- Clock

Select to switch between 12-hour display and 24-hour display.

- Language

Select to change the language displayed.

- Units

Select to change the units of measure displayed.

-  Eco Driving Indicator Light (→P.83)

Select to enable/disable the Eco Driving Indicator Light.

-  Switch settings

Select to display how to change the top screen.

- Drive information 1/Drive information 2/Drive information 3

Select to select up to 2 items (→P.82) that will be displayed on each Drive information screen (Drive information 1 screen, Drive information 2 screen, and Drive information 3 screen) respectively.

- Pop-up display

Select to enable/disable the pop-up display.

- Intersection guidance (if equipped)
- Incoming calls
- Brightness adjustment

- Color (except F SPORT models)

Select to set the color of the cursor on the multi-information display.

- Needle (F SPORT models)

Select to set the tachometer needle color.

- Rev indicator (F SPORT models) (→P.78)
- Select to enable/disable the Rev indicator.
- Select to set the desired engine speed at which the Rev indicator will begin to be displayed.

Selectable engine speed range:

2000 rpm to 6500 rpm

- Rev peak (F SPORT models) (→P.79)

Select to enable/disable the Rev peak.

- Default setting

Select to reset the meter display settings to the default setting.

#### ■ Vehicle functions and settings that can be changed

→P.461

#### ■ Background color of the indicator/shift position display area (except F SPORT models)

The background color of the indicator/shift position display area is changed according to the driving mode as follows (→P.271):

- Eco drive mode: Blue
- Sport mode: Red

#### ■ Suspension of the settings display

- Some settings cannot be changed while driving. When changing settings, park the vehicle in a safe place.
- If a warning message is displayed, operation of the settings display will be suspended.

#### WARNING

##### ■ Cautions during setting up the display

As the engine needs to be running during setting up the display, ensure that the vehicle is parked in a place with adequate ventilation. In a closed area such as a garage, exhaust gases including harmful carbon monoxide (CO) may collect and enter the vehicle. This may lead to death or a serious health hazard.

#### NOTICE

##### ■ While setting up the display

To prevent battery discharge, ensure that the engine is running while setting up the display features.

#### Suggestion function

Displays suggestions to the driver in the following situations. To select a response to a displayed suggestion, use the meter control switches.

#### ■ Suggestion to enable the power back door

If the power back door system is disabled (setting on  set to off) and the power back door switch on the instrument panel is operated, a suggestion message will be displayed asking if you wish to enable the power back door system.

To enable the power back door system, select "Yes".

After enabling the power back door system, press the power back door switch again to open or close the power back door.

---

**■ Suggestion to turn off the headlights**

If the headlights are left on for a certain amount of time after the engine switch has been turned off, a suggestion message will be displayed asking if you wish to turn the headlights off.

To turn the headlights off, select "Yes".

If a front door is opened after the engine switch is turned off, this suggestion message will not be displayed.

---

**■ Customization**

Some functions can be customized.  
(→P.461)

## Head-up display\*

\*: If equipped

The head-up display is linked to the meters and navigation system (if equipped) and projects a variety of information in front of the driver, such as the current vehicle speed and route guidance to a set destination.

### System components

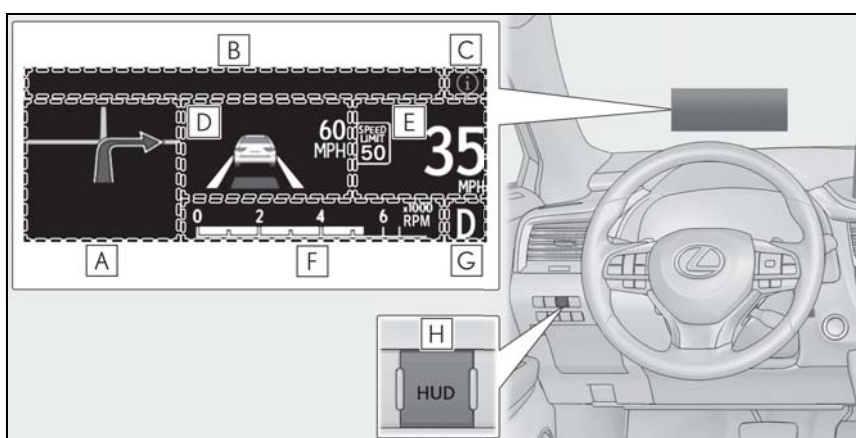

Illustrations used in this text are intended as examples, and may differ from the image that is actually displayed by the head-up display.

**A** Navigation system-linked display area (if equipped) (→P.91)

**B** Message display area (→P.91)

Displays the following items:

- Warning/Message (if equipped)
- Audio system operation status
- Outside temperature

Displays the following item, which are linked to the navigation system:

- Street name

**C**  /  icon (→P.90)

**D** Driving assist system status display area (if equipped)

Displays the operational status of the following systems:

- Dynamic radar cruise control with full-speed range (→P.227)
- LTA (Lane Tracing Assist) (→P.216)
- Intuitive parking assist (→P.244)
- Parking Support Brake function (for static objects) (→P.261)

Displayed content is the same as that displayed on the multi-information display. For details,



refer to the explanations of each system.

#### **E** Vehicle speed display area

Displays the following items:

- Vehicle speed
- Speed limit (vehicles with a navigation system) (U.S.A. only)
- Road sign icons recognized by the RSA (→P.225)

#### **F** Eco Driving Indicator/Tachometer (→P.92)

#### **G** Shift position display (→P.178)

#### **H** HUD (Head-up display) switch (→P.89)

#### ■ Head-up display

The head-up display may seem dark or hard to see when viewed through sunglasses, especially polarized sunglasses. Adjust the brightness of the head-up display or remove your sunglasses.

#### **!** WARNING

##### ■ Before using the head-up display

- Check that the position and brightness of the head-up display image does not interfere with safe driving. Incorrect adjustment of the image's position or brightness may obstruct the driver's view and lead to an accident, resulting in death or serious injury.
- Do not continuously look at the head-up display while driving as you may fail to see pedestrians, objects on the road, etc. ahead of the vehicle.

#### **!** NOTICE

##### ■ To prevent damage to components

- Do not place any drinks near the head-up display projector. If the projector gets wet, electrical malfunctions may result.

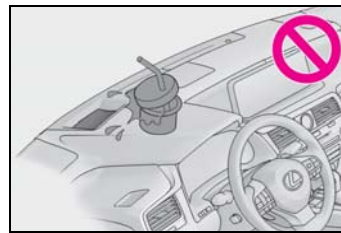

- Do not place anything on or put stickers onto the head-up display projector. Doing so could interrupt head-up display indications.
- Do not touch the inside of the head-up display projector or thrust sharp edges or the like into the projector. Doing so could cause mechanical malfunctions.

#### Using the head-up display

##### ■ Enabling/Disabling the head-up display

Press the HUD (Head-up display) switch.

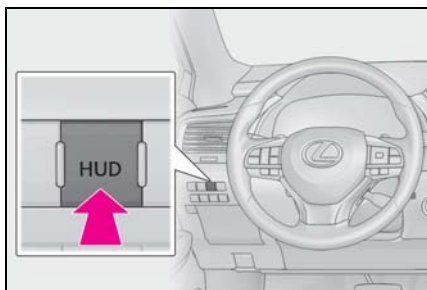

### ■ Changing settings of the head-up display

Select  on the multi-information display (→P.461) to change the following settings:

- Display brightness/position

Select to adjust the brightness and position of the head-up display.

- Display content

Select to enable/disable the following items:

- Route guidance to destination (if equipped)
- Driving assist system status (if equipped)
- Compass (if equipped)
- Audio system operation status
- Eco Driving Indicator/Tachometer

Select to display Eco Driving Indicator/tachometer/no content.

- Display angle

Select to adjust the angle of the head-up display.

### ■ Enabling/disabling of the head-up display

If the head-up display is disabled, it will remain disabled when the engine switch is turned off then back to IGNITION ON mode.

### ■ Display brightness

The brightness of the head-up display can be adjusted on  of the multi-information display. Also, it is automatically adjusted according to the ambient brightness.

### ■ Automatic adjustment of the head-up display position (if equipped)

A desired head-up display position can be entered to memory and recalled automatically by the driving position memory system. (→P.133)

### ■ When the battery is disconnected

The customize settings of the head-up display will be reset.

### WARNING

#### ■ Caution for changing settings of the head-up display

As the engine needs to be running while changing the settings of the head-up display, ensure that the vehicle is parked in a place with adequate ventilation. In a closed area such as a garage, exhaust gases including harmful carbon monoxide (CO) may collect and enter the vehicle. This may lead to death or a serious health hazard.

### NOTICE

#### ■ When changing the settings of the head-up display

To prevent battery discharge, ensure that the engine is running while the changing the settings of the head-up display.

### Information icon/Master warning icon

Displays the following multi-information display linked icons:

 : Master warning icon

Displayed when a warning message is displayed on the multi-information display.

(→P.412)

**i**: Information icon

Displayed when a suggestion/advice pop-up display is displayed on the multi-information display. (→P.86)

### Message display area

Displays the following items in the appropriate situation:

■ **Warning/Message (if equipped)**

Displays the following system warning/messages:

- PCS (Pre-Collision System) (→P.209)
- Parking Support Brake function (for static objects) (→P.261)
- Dynamic radar cruise control with full-speed range (→P.227)
- Brake Override System (→P.155)
- Drive-Start Control (→P.155)

Details of content displayed on the head-up display may differ from that displayed on the multi-information display. For details, refer to the explanation of each system.

■ **Audio system operation status**

Displayed when the audio system is operated.

■ **Outside temperature**

Displayed in the following situations:

- When the engine switch is turned to IGNITION ON mode
- When the low outside temperature indicator is flashing

Displayed content is the same as that

displayed on the multi-information display. For details, refer to the explanation of the outside temperature display on the multi-information display. (→P.79)

Displays the following items which are linked to the navigation system:

■ **Street name**

The name of the street that the vehicle is currently driving on is displayed on the bottom of the display area.

When the navigation system is performing route guidance, the name of the next street will be displayed on the top of the display area.

■ **Street name display (vehicles with a navigation system)**

Only street names which are included in the map data will be displayed.

### Navigation system-linked display area (if equipped)

Displays the following items which are linked to the navigation system:

■ **Route guidance to destination**

Displayed when the navigation system is performing route guidance. When approaching an intersection, an arrow will be displayed to indicate the suggested direction of travel.

■ **Compass**

Displays the direction of travel.

## Eco Driving Indicator/Tachometer

### ■ Eco Driving Indicator

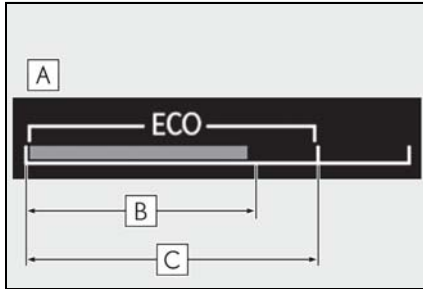

**A** Eco Driving Indicator Zone Display

**B** Eco driving ratio based on acceleration

**C** Zone of Eco driving

Displayed content is the same as that displayed on the multi-information display (Eco Driving Indicator). For details, refer to P.83.

### ■ Tachometer

Displays the engine speed in revolutions per minute.

## Fuel consumption information

Fuel consumption information can be displayed on the Center Display.

Vehicles with a 12.3-inch display: The fuel consumption information can be displayed and operated on the side display.

## System components

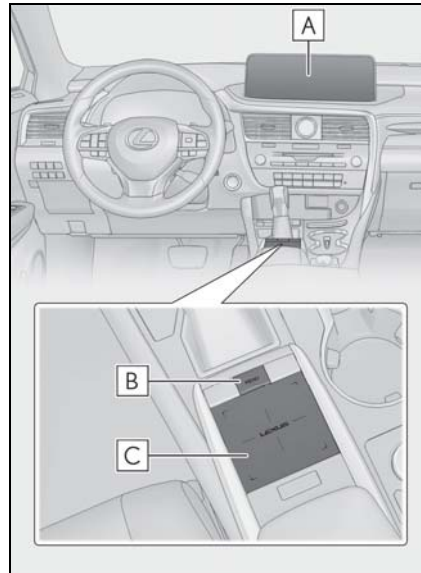

**A** Center Display

**B** "MENU" button

**C** Touchpad

## Consumption

### ■ Trip information

Press the "MENU" button on the Remote Touch, then select  on the

menu screen.

If a screen other than “Trip Information” is displayed, select “Trip Information”.

This system can also be operated by the touch screen.

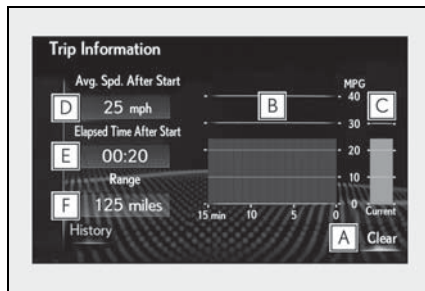

- A** Resetting the consumption data
- B** Fuel consumption in the past 15 minutes
- C** Current fuel consumption
- D** Average vehicle speed since the engine was started.
- E** Elapsed time since the engine was started.
- F** Cruising range

Average fuel consumption for the past 15 minutes is divided by color into past averages and averages attained since the engine switch was last turned to IGNITION ON mode. Use the displayed average fuel consumption as a reference.

The image is an example only, and may vary slightly from actual conditions.

#### ■ History

Press the “MENU” button on the Remote Touch, then select  on the menu screen.

If a screen other than “History” is displayed, select “History”.

This system can also be operated by the touch screen.

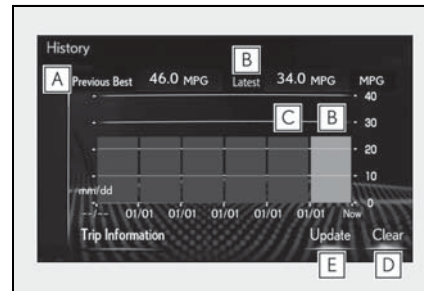

- A** Best recorded fuel consumption
- B** Latest fuel consumption
- C** Previous fuel consumption record
- D** Resetting the history data
- E** Updating the latest fuel consumption data

The average fuel consumption history is divided by color into past averages and the average fuel consumption since the last updated. Use the displayed average fuel consumption as a reference.

The image is an example only, and may vary slightly from actual conditions.

#### ■ Updating the history data

Update the latest fuel consumption by selecting “Update” to measure the current fuel consumption again.

#### ■ Resetting the data

The fuel consumption data can be deleted by selecting “Clear”.

#### ■ Cruising range

Displays the estimated maximum distance that can be driven with the quantity of fuel remaining.

This distance is computed based on your average fuel consumption. As a result, the actual distance that can be driven may differ from that displayed.

**Using the side display (vehicles with a 12.3-inch display)**

Display the vehicle information on the side display (→P.289), and then select **<** or **>** to display the desired screen.

The image is an example only, and may vary slightly from actual conditions.

**■ Trip information (type A)**

Displays the average fuel consumption for the past 10 minutes in 1 minute intervals, as well as the cruising range.

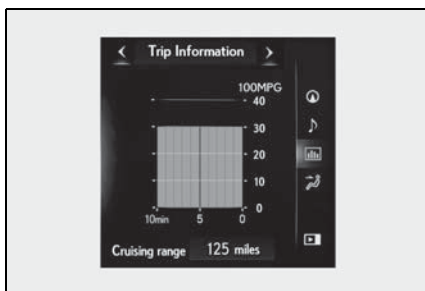

Use the displayed average fuel consumption as a reference.

**■ Trip information (type B)**

Displays the cruising range, latest fuel consumption and the amount of time elapsed since the engine was started.

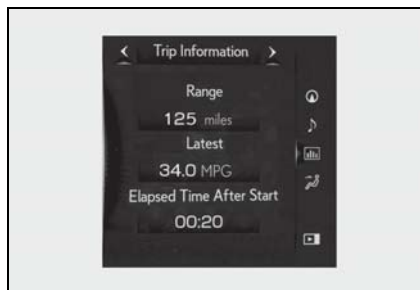

Use the displayed average fuel consumption as a reference.

**■ History**

Displays the average fuel consumption and highest fuel consumption.

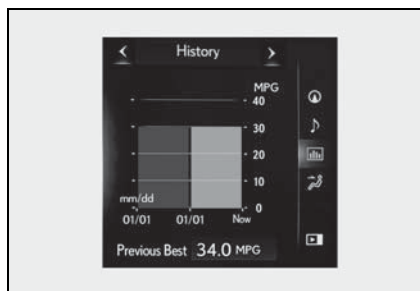

Use the displayed average fuel consumption as a reference.

- 3-1. Key information**
  - Keys ..... 96
- 3-2. Opening, closing and locking the doors**
  - Side doors ..... 99
  - Power back door ..... 103
  - Smart access system with push-button start ..... 115
- 3-3. Adjusting the seats**
  - Front seats ..... 121
  - Rear seats ..... 122
  - Driving position memory ..... 133
  - Head restraints ..... 136
- 3-4. Adjusting the steering wheel and mirrors**
  - Steering wheel ..... 139
  - Inside rear view mirror ..... 140
  - Outside rear view mirrors ..... 141
- 3-5. Opening, closing the windows and moon roof**
  - Power windows ..... 144
  - Moon roof ..... 146
  - Panoramic moon roof ..... 149

## Keys

### The keys

The following keys are provided with the vehicle.

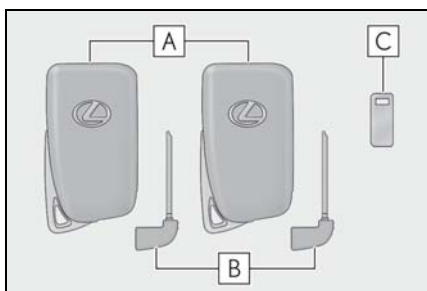

#### A Electronic keys

- Operating the smart access system with push-button start (→P.115)
- Operating the wireless remote control function (→P.97)

#### B Mechanical keys

#### C Key number plate

#### ■ When riding in an aircraft

When bringing an electronic key onto an aircraft, make sure you do not press any buttons on the electronic key while inside the aircraft cabin. If you are carrying an electronic key in your bag, etc., ensure that the buttons are not likely to be pressed accidentally. Pressing a button may cause the electronic key to emit radio waves that could interfere with the operation of the aircraft.

#### ■ Electronic key battery depletion

- The standard battery life is 1 to 2 years.
- If the battery becomes low, an alarm will sound in the cabin when the engine is stopped.
- To reduce key battery depletion when the electronic key is to not be used for long periods of time, set the electronic key to the battery-saving mode. (→P.116)

- As the electronic key always receives radio waves, the battery will become depleted even if the electronic key is not used. The following symptoms indicate that the electronic key battery may be depleted. Replace the battery when necessary.

- The smart access system with push-button start or the wireless remote control does not operate.
- The detection area becomes smaller.
- The LED indicator on the key surface does not turn on.

- To avoid serious deterioration, do not leave the electronic key within 3 ft. (1 m) of the following electrical appliances that produce a magnetic field:

- TVs
- Personal computers
- Cellular phones, cordless phones and battery chargers
- Recharging cellular phones or cordless phones
- Table lamps
- Induction cookers

#### ■ Replacing the battery

→P.379

#### ■ Confirmation of the registered key number

The number of keys already registered to the vehicle can be confirmed. Ask your Lexus dealer for details.

#### ■ If "A New Key has been Registered Contact Your Dealer for Details" is shown on the multi-information display

This message will be displayed each time the driver's door is opened when the doors are unlocked from the outside for approximately one week after a new electronic key has been registered.

If this message is displayed but you have not had a new electronic key registered, ask your Lexus dealer to check if an unknown electronic key (other than those in your possession) has been registered.



 NOTICE

**■ To prevent key damage**

- Do not drop the keys, subject them to strong shocks or bend them.
- Do not expose the keys to high temperatures for long periods of time.
- Do not get the keys wet or wash them in an ultrasonic washer, etc.
- Do not attach metallic or magnetic materials to the keys or place the keys close to such materials.
- Do not disassemble the keys.
- Do not attach a sticker or anything else to the surface of the electronic key.
- Do not place the keys near objects that produce magnetic fields, such as TVs, audio systems and induction cookers, or medical electrical equipment, such as low-frequency therapy equipment.

**■ Carrying the electronic key on your person**

Carry the electronic key 3.9 in. (10 cm) or more away from electric appliances that are turned on. Radio waves emitted from electric appliances within 3.9 in. (10 cm) of the electronic key may interfere with the key, causing the key to not function properly.

**■ In case of a smart access system with push-button start malfunction or other key-related problems**

→P.431

**■ When an electronic key is lost**

→P.430

**Wireless remote control**

The electronic keys are equipped with the following wireless remote control:

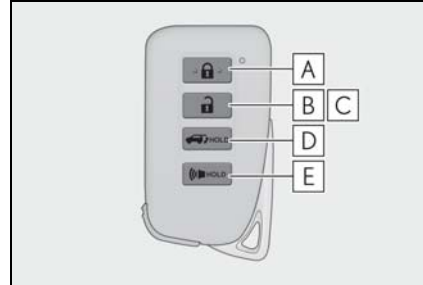

- A** Locks all the doors (→P.99)
- B** Unlocks all the doors (→P.99)
- C** Opens the windows<sup>\*2</sup> and the moon roof<sup>\*1,2</sup> or panoramic moon roof<sup>\*1,2</sup> (→P.99)
- D** Opens and closes the power back door (→P.104)
- E** Sounds the alarm

<sup>\*1</sup>: If equipped

<sup>\*2</sup>: These settings must be customized at your Lexus dealer.

**■ Theft deterrent panic mode**

When  is pressed for longer than about one second, an alarm will sound intermittently and the vehicle lights will flash to deter any person from trying to break into or damage your vehicle.

To stop the alarm, press any button on the electronic key.



**Using the mechanical key**

To take out the mechanical key, push

the release button and take the key out.

The mechanical key can only be inserted in one direction, as the key only has grooves on one side. If the key cannot be inserted in a lock cylinder, turn it over and re-attempt to insert it.

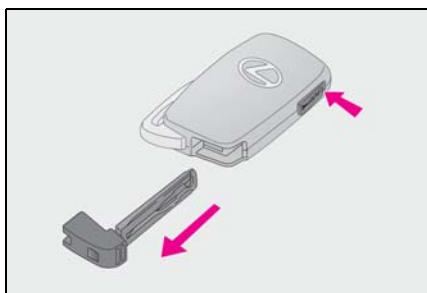
After using the mechanical key, store it in the electronic key. Carry the mechanical key together with the electronic key. If the electronic key battery is depleted or the entry function does not operate properly, you will need the mechanical key.  
(→P.431)



■ **When required to leave the vehicle's key with a parking attendant**

Lock the glove box as circumstances demand. (→P.314)

Remove the mechanical key for your own use and provide the attendant with the electronic key only.

■ **If you lose your mechanical keys**

→P.430

■ **If a wrong key is used**

The key cylinder rotates freely, isolated from the internal mechanism.

### Side doors

The vehicle can be locked and unlocked using the entry function, wireless remote control or door lock switches.

### Unlocking and locking the doors from the outside

#### Smart access system with push-button start

Carry the electronic key to enable this function.

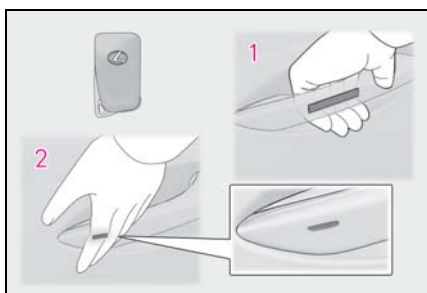

- 1 Grip the driver's door handle to unlock the door. Grip any passenger door handle to unlock all the doors.\*

Make sure to touch the sensor on the back of the handle.

The doors cannot be unlocked for 3 seconds after the doors are locked.

\*: The door unlock settings can be changed.

- 2 Touch the lock sensor (indentation on the surface of the door handle) to lock all the doors.

Check that the door is securely locked.

#### Wireless remote control

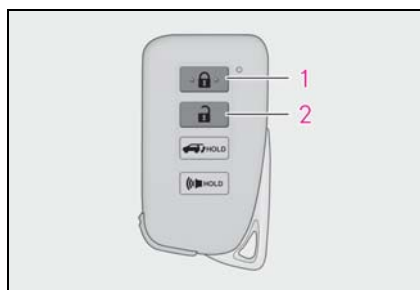

- 1 Locks all the doors

Check that the door is securely locked.

- 2 Unlocks all the doors

Pressing the button unlocks the driver's door. Pressing the button again within 3 seconds unlocks the other doors.





Press and hold to open the windows\*<sup>2</sup> and the moon roof\*<sup>1,2</sup> or panoramic moon roof\*<sup>1,2</sup>

\*<sup>1</sup>: If equipped

\*<sup>2</sup>: This setting must be customized at your Lexus dealer.

#### Switching the door unlock function



It is possible to set which doors the entry function unlocks using the wireless remote control.

- 1 Turn the engine switch off.
- 2 When the indicator light on the key surface is not on, press and hold ,  HOLD or  HOLD for approximately 5 seconds while pressing and holding .

The setting changes each time an operation is performed, as shown below. (When changing the setting continuously, release the buttons, wait for at least 5 seconds, and repeat step 2.)

3

Before driving

Multi-information display/Beep	Unlocking function
 Exterior: Beeps 3 times Interior: Pings once	Holding the driver's door handle unlocks only the driver's door. Holding any of the passenger door handles unlocks all the doors.
 Exterior: Beeps twice Interior: Pings once	Holding a door handle unlocks all the doors.

To prevent unintended triggering of the alarm, unlock the doors using the wireless remote control and open and close a door once after the settings have been changed. (If a door is not opened within 60 seconds after  is pressed, the doors will be locked again and the alarm will automatically be set.)

In a case that the alarm is triggered, immediately stop the alarm. (→P.68)

#### ■ Impact detection door lock release system

In the event that the vehicle is subject to a strong impact, all the doors are unlocked. Depending on the force of the impact or the type of accident, however, the system may not operate.

#### ■ Operation signals

Doors:

A buzzer sounds and the emergency flashers flash to indicate that the doors have been locked/unlocked. (Locked: Once; Unlocked: Twice)

Windows and moon roof or panoramic moon roof:

A buzzer sounds.

#### ■ Security feature

If a door is not opened within approximately 60 seconds after the vehicle is unlocked, the security feature automatically locks the vehicle again.

#### ■ When the door cannot be locked by the lock sensor on the surface of the door handle

When the door cannot be locked even if the lock sensor on the surface of the door handle is touched by a finger, touch the lock sensor with the palm.

When gloves are being worn, remove the gloves.

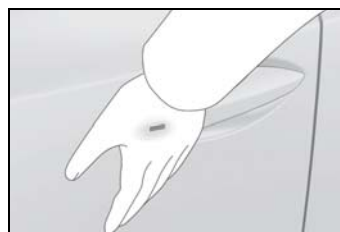

#### ■ Door lock buzzer

If an attempt to lock the doors using the smart key system is made when a door is not fully closed, a buzzer will sound continuously for 5 seconds. Fully close the door to stop the buzzer, and lock the doors again.

#### ■ Setting the alarm

Locking the doors will set the alarm system. (→P.68)

#### ■ Conditions affecting the operation of the smart access system with push-button start or wireless remote control

→P.116

#### ■ If the smart access system with push-button start or the wireless remote control does not operate properly

Use the mechanical key to lock and unlock the doors. (→P.431)

Replace the key battery with a new one if it is depleted. (→P.379)

#### ■ If the battery is discharged

The doors cannot be locked and unlocked using the smart access system with push-button start or wireless remote control. Lock or unlock the doors using the

mechanical key. (→P.431)

#### ■ Customization

Some functions can be customized.  
(→P.461)

### ⚠ WARNING

#### ■ To prevent an accident

Observe the following precautions while driving the vehicle. Failure to do so may result in a door opening and an occupant falling out, resulting in death or serious injury.

- Ensure that all doors are properly closed and locked.
- Do not pull the inside handle of the doors while driving.

Be especially careful for the front doors, as the doors may be opened even if the inside lock buttons are in locked position.

- Set the rear door child-protector locks when children are seated in the rear seats.

#### ■ When opening or closing a door

Check the surroundings of the vehicle such as whether the vehicle is on an incline, whether there is enough space for a door to open and whether a strong wind is blowing. When opening or closing the door, hold the door handle tightly to prepare for any unpredictable movement.

### Unlocking and locking the doors from the inside

#### ■ Door lock switches (to lock/unlock)

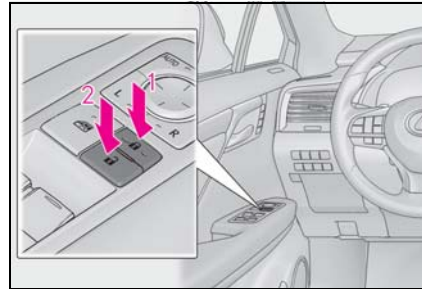

- 1 Locks all the doors
- 2 Unlocks all the doors

#### ■ Inside lock buttons (to lock)

Push down the inside lock button to lock the door.

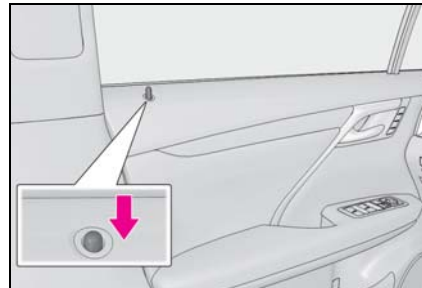

#### ■ Inside door handles (to unlock)

- ▶ For the front doors

Pull the handle to unlock and open the door.

When the door is unlocked, the inside lock button will pop up.

- ▶ For the rear doors

Pull the handle to unlock the door. Pull the handle a second time to open the door.

3

Before driving

When the door is unlocked, the inside lock button will pop up.

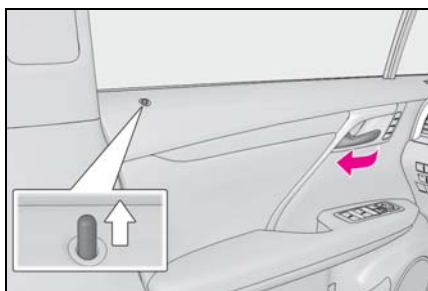

■ **Locking the doors from the outside without a key**

- 1 Push down the inside lock button.
- 2 Close the door.

The door cannot be locked if the engine switch is in ACCESSORY or IGNITION ON mode, or the electronic key is left inside the vehicle. However, the key may not be detected correctly and the door may be locked.

■ **Open door warning buzzer**

If the vehicle speed reaches 3 mph (5 km/h), the master warning light flashes and a buzzer sounds to indicate that door(s) or the hood is not fully closed. The open door(s) or hood is displayed on the multi-information display.

**Rear door child-protector lock**

The door cannot be opened from inside the vehicle when the lock is set.

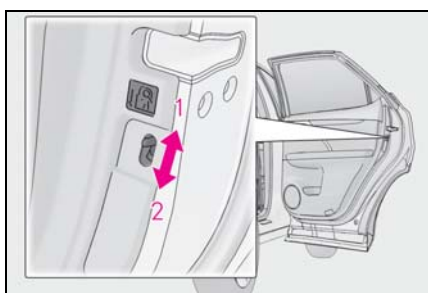

- 1 Unlock

2 Lock

These locks can be set to prevent children from opening the rear doors. Push down on each rear door switch to lock both rear doors.

**Automatic door locking and unlocking systems**

The following functions can be set or canceled:

For instructions on customizing, refer to P.461.

Function	Operation
Speed linked door locking function	All doors are automatically locked when vehicle speed is approximately 12 mph (20 km/h) or higher.
Shift position linked door locking function	All doors are automatically locked when shifting the shift lever out of P.
Shift position linked door unlocking function	All doors are automatically unlocked when shifting the shift lever to P.
Driver's door linked door unlocking function	All doors are automatically unlocked when driver's door is opened.

## Power back door

The power back door can be opened using the power back door opener switch, smart access system with push-button start or wireless remote control.

### WARNING

Observe the following precautions. Failure to do so may result in death or serious injury.

#### ■ Before driving the vehicle

Before driving the vehicle, make sure that the power back door is fully closed. If the power back door is not fully closed, it may open unexpectedly while driving, causing an accident.

#### ■ Caution while driving

- Keep the power back door closed while driving.

If the power back door is left open, it may hit nearby objects while driving or luggage may be unexpectedly thrown out, causing an accident.

In addition, exhaust gases may enter the vehicle, causing death or a serious health hazard. Make sure to close the power back door before driving.

- Never let anyone sit in the luggage compartment. In the event of sudden braking, sudden swerving or a collision, they are susceptible to death or serious injury.

#### ■ When children are in the vehicle

Observe the following precautions. Failure to do so may result in death or serious injury.

- Do not allow children to play in the luggage compartment.

If a child is accidentally locked in the luggage compartment, they could have heat exhaustion or other injuries.

- Do not allow a child to open or close the power back door.

Doing so may cause the power back door to move unexpectedly, or cause the child's hands, arms, head, or neck to be caught by the closing power back door.

#### ■ Operating the power back door

Observe the following precautions. Failure to do so may cause parts of the body to be caught, resulting in death or serious injury.

- Remove any heavy loads, such as snow and ice, from the power back door before opening it. Failure to do so may cause the power back door to suddenly shut again after it is opened.
- When opening or closing the power back door, thoroughly check to make sure the surrounding area is safe.
- If anyone is in the vicinity, make sure they are safe and let them know that the power back door is about to open or close.
- Use caution when opening or closing the power back door in windy weather as it may move abruptly in strong wind.
- The power back door may suddenly shut if it is not opened fully. It is more difficult to open or close the back door on an incline than on a level surface, so beware of the back door unexpectedly opening or closing by itself. Make sure that the back door is fully open and secure before using the luggage compartment.



**⚠ WARNING**

- When closing the power back door, take extra care to prevent your fingers, etc., from being caught.



- When closing the power back door, make sure to press it lightly on its outer surface. If the back door handle is used to fully close the power back door, it may result in hands or arms being caught.
- Do not pull on the back door spindle (→P.112) to close the power back door, and do not hang on the back door spindle.

Doing so may cause hands to be caught or the back door spindle to break, causing an accident.

- If a bicycle carrier or similar heavy object is attached to the power back door, it may suddenly shut again after being opened, causing someone's hands, arms, head or neck to be caught and injured. When installing an accessory part to the power back door, using a genuine Lexus part is recommended.

**Unlocking and locking the power back door from the outside****■ Smart access system with push-button start**

Carry the electronic key to enable this function.

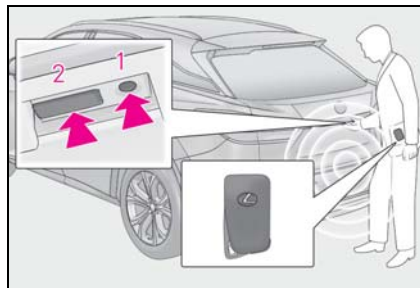
**1 Locks all the doors**

Check that the door is securely locked.

**2 Unlocks all the doors**

The doors cannot be unlocked for 3 seconds after the doors are locked.

**■ Wireless remote control**

→P.97

**Unlocking and locking the power back door from the inside****■ Door lock switch**

→P.101

**Opening/closing the power back door****■ Opening/closing the power back door using the wireless remote control**

Press and hold the switch for approximately 1 second.

The power back door can be operated whether it is locked\* or unlocked.

Pressing the switch while the power back door is opening/closing will stop the operation.

Pressing and holding the switch again for approximately 1 second will operate the power back door in the opposite direction.



\*: Opening of the power back door when it is locked can be disabled by a customized setting.



■ Opening/closing the power back door from the inside

Press and hold the switch for approximately 1 second.

A buzzer will sound and the power back door will automatically open or close. However, if the power back door is locked, it will not open.

Pressing the switch while the power back door is opening/closing will stop the operation.

Pressing and holding the switch again for approximately 1 second will operate the power back door in the opposite direction.

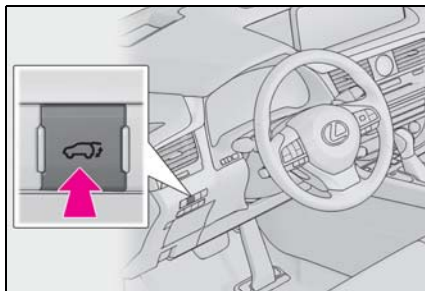

■ Back door opener switch

● Open

When the power back door is unlocked: Press the back door opener switch.

When the power back door is locked:

While carrying an electronic key, press and hold the back door opener switch.

A buzzer will sound and the power back door will automatically open.

Pressing the switch while the power back door is opening/closing will stop the operation.

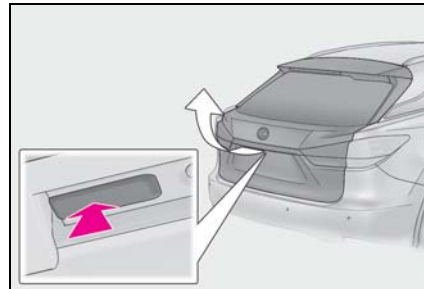

● Close

Press the switch.

A buzzer will sound and the power back door will automatically close.

Pressing the switch while the power back door is closing will stop the operation. Pressing the switch again will open the power back door automatically.

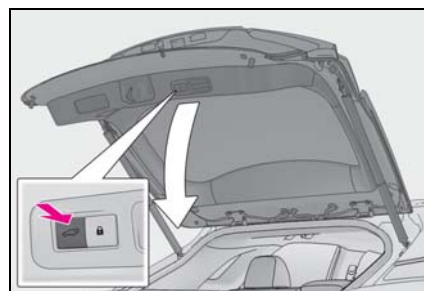

● Close the back door and lock all doors (close & lock function)

Press the switch.

The power back door will close and all of the doors will be locked at the same time.

A different buzzer than the normal one will

sound and the power back door will begin closing automatically. When the power back door is closed, all of the doors will lock simultaneously and operation signals will indicate that all of the doors have been locked.

If the  switch is pressed while the power back door is closing, the operation will stop.

Pressing the switch again will open the power back door automatically.

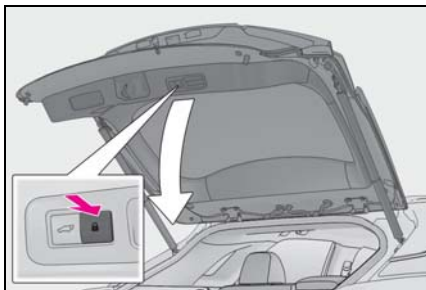

#### ■ Closing the power back door using the back door handle

Lower the power back door using the back door handle, then a buzzer will sound and the power back door will automatically close.

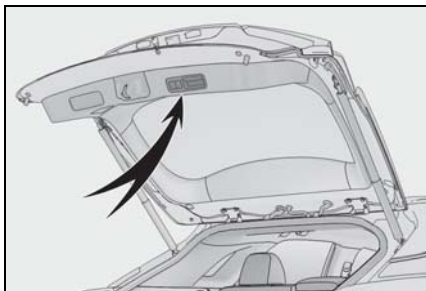

#### ■ Hands Free Power Back Door (if equipped)

- 1 While carrying an electronic key, stand within the smart access system with push-button start opera-

tion range, approximately 19.7 to 23.6 in. (50 to 60 cm) from the rear bumper.

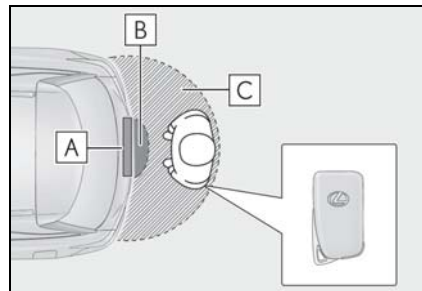

**A** Kick sensor

**B** Hands Free Power Back Door operation detection area

**C** Smart access system with push-button start operation detection area (→P.115)

- 2 Perform a kick operation by moving your foot to within approximately 3.9 in. (10 cm) of the rear bumper and then pulling it back.
  - Perform the entire kick operation within 1 second.
  - The Hands Free Power Back Door will not start operating while a foot is detected under the rear bumper.
  - Operate the Hands Free Power Back Door without contacting the rear bumper with your foot.
  - If another electronic key is in the cabin or luggage compartment, it may take slightly longer than normal

for the operation to occur.

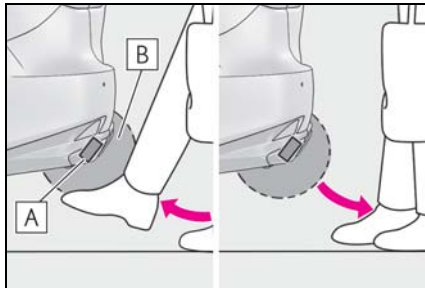

- A** Kick sensor
  - B** Hands Free Power Back Door operation detection area
- 3** When the kick sensor detects that your foot is pulled back, a buzzer will sound and the power back door will automatically fully open/close.

If kick operation is performed again in the middle of back door operating, the operation will stop.

■ **Hands free close & lock function\* (vehicles with Hands Free Power Back Door)**

\*: This setting can be customized by your Lexus dealer.

If the power back door is closed using a Hands Free Power Back Door close operation, all of the doors will be locked at the same time.

A different buzzer than the normal one will sound before the power back door begins to close. The door lock operation signals will operate to indicate that the power back door has closed and all of the doors have locked simultaneously.

If a Hands Free Power Back Door operation is performed while the power back door is operating, the power back door will stop.

If a Hands Free Power Back Door opera-

tion is performed again, the power back door will open.

■ **Luggage compartment lights**

- The luggage compartment lights turn on when the back door is opened.
- When the engine switch is turned off, the lights will go off automatically after 20 minutes.

■ **Power back door operating conditions**

If the following conditions are met with the power back door operation enabled, the power back door can be opened and closed automatically.

- When an electronic key is being carried and the back door opener switch is pressed\*
- When the wireless remote control is used\*
- When the engine switch is in IGNITION ON mode, the vehicle speed must be lower than 2 mph (3 km/h) and one of the following conditions must be met in addition to the above conditions:
  - The parking brake is engaged.
  - The brake pedal is depressed.
  - The shift lever is in P.

\*: When the operation of the power back door when it is locked has been disabled by a customized setting, operate the power back door after it has been unlocked.

■ **Close & lock function operating conditions**

This function can be operated when all of the following conditions are met:

- An electronic key is not detected within the vehicle.
- All of the doors other than the power back door are closed.
- The engine switch is off.

■ **Hands Free Power Back Door operating conditions (if equipped)**

- The Hands Free Power Back Door (kick sensor) setting is on.

- When an electronic key is carried within the operation range.

#### ■ Hands free close & lock function operating conditions (vehicles with Hands Free Power Back Door)

This function can be operated when all of the following conditions are met:

- The hands free close & lock function setting is on.
- The Hands Free Power Back Door operating conditions are met.
- An electronic key is not detected within the vehicle.
- All of the doors other than the power back door are closed.
- The engine switch is off.

#### ■ Back door closer

In the event that the power back door is left slightly open, the back door closer will automatically close it to the fully closed position.

- The back door closer can function when the engine switch is in any mode.
- The power back door can be opened using the back door opener switch even if the back door closer is operating.

#### ■ Operation of the power back door

- When the power back door begins to operate, the emergency flashers will flash and a buzzer will sound.
- When the power back door is disabled, the power back door will not operate but can be opened and closed manually.
- The power back door turns to manual operation when the back door opener switch is pressed while the power back door is in an automatic opening/closing operation.
- If anything obstructs the power back door while opening, a buzzer will sound and the power back door will stop immediately. If anything obstructs the power back door while closing, a buzzer will sound and the power back door will automatically move slightly in the opposite direction and then stop.

#### ■ Back door reserve lock function



This function reserves the locking of the power back door when the power back door is open. If the following operations are performed, all of the doors except the power back door will lock and then the power back door will lock when it is completely closed.

- 1 Close all of the doors, except the power back door.
- 2 Perform an automatic closing operation of the power back door and lock the doors using the wireless remote control (→P.97) or smart access system with push-button start (→P.99) while the power back door is closing.

Also, if the back door does not fully close due to the operation of the jam protection function, etc., while the back door is automatically closing after a reserve lock operation is performed, the reserve lock function is canceled and all the doors will unlock.

#### ■ Situations in which the close & lock function may not operate properly

In the following situations, the close & lock function may not operate properly:

- If the  switch on the lower part of the power back door (→P.105) is pressed by a hand which is holding an electronic key
- If the  switch on the lower part of the power back door (→P.105) is pressed when the electronic key is in a bag, etc. that is placed on the ground
- If the  switch on the lower part of the power back door (→P.105) is pressed with the electronic key not near the vehicle.

#### ■ Situations in which the Hands Free Power Back Door may not operate properly (if equipped)

In the following situations, the Hands Free Power Back Door may not operate properly:

- When a foot remains under the rear bumper
- If the rear bumper is strongly hit with a foot or is touched for a while

If the rear bumper has been touched for a while, wait for a short time before attempting to operate the Hands Free Power Back Door again.

- When standing excessively close to the rear bumper
- When an external radio wave source interferes with the communication between the electronic key and the vehicle (→P.116)
- When the vehicle is parked near metal, or an external radio wave or electrical noise source which affects the sensitivity of the Hands Free Power Back Door, such as a pay parking spot, gas station, electrically heated road, fluorescent light, or metal plate
- When the vehicle is near a TV tower, electric power plant, radio station, large display, airport or other facility that generates strong radio waves or electrical noise
- When a large amount of water is applied to the rear bumper, such as when the vehicle is being washed or in heavy rain
- When mud, snow, ice, etc. is attached to the rear bumper
- When the vehicle has been parked for a while near objects that may move and contact the rear bumper, such as plants
- When an accessory is installed to the rear bumper

If an accessory has been installed, turn the Hands Free Power Back Door (kick sensor) operation setting off.

- RX350L: When a tire other than the spare tire is stored in the spare tire storage area

#### ■ Preventing unintentional operation of the Hands Free Power Back Door (if equipped)

When an electronic key is in the operation detection area, the Hands Free Power Back Door may operate unintentionally, so be careful in the following situations:

- When a large amount of water is applied to the rear bumper, such as when the vehicle is being washed or in heavy rain

- When dirt is wiped off the rear bumper
- When a small animal or small object, such as a ball, moves under the rear bumper
- When an object is moved from under the rear bumper
- If someone is swinging their legs while sitting on the rear bumper
- If the legs or another part of someone's body contacts the rear bumper while passing by the vehicle
- When the vehicle is parked near an electrical noise source which affects the sensitivity of the Hands Free Power Back Door, such as a pay parking spot, gas station, electrically heated road, or fluorescent light
- When the vehicle is near a TV tower, electric power plant, radio station, large display, airport or other facility that generates strong radio waves or electrical noise
- When the vehicle is parked in a place where objects such as plants are near the rear bumper
- If luggage, etc. is set near the rear bumper
- If accessories or a vehicle cover is installed/removed near the rear bumper
- When the vehicle is being towed

To prevent unintentional operation, turn the Hands Free Power Back Door (kick sensor) operation setting off.

#### ■ When reconnecting the battery

To enable the power back door to operate properly, close the power back door manually.

#### ■ Jam protection function

Sensors are installed in the right and left sides of the power back door. When the door is automatically closing and the sensors are pushed due to an object being caught, etc., the jam protection function will operate.

From that position the door will automatically move a little in the opposite direction and then the function will stop.

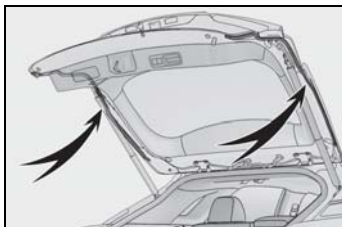

#### ■ If the power back door opener is inoperative

The power back door can be unlocked from the inside

- 1 Remove the cover.

To protect the cover, place a rag between the flathead screwdriver and cover as shown in the illustration.

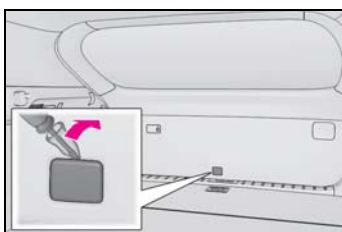

- 2 Move the lever.



#### ■ Customization

Some functions can be customized.  
(→P.461)

#### ⚠ WARNING

##### ■ Back door closer

- In the event that the power back door is left slightly open, the back door closer will automatically close it to the fully closed position. It takes several seconds before the back door closer begins to operate. Be careful not to get fingers caught or anything else in the power back door, as this may cause bone fractures or other serious injuries.



- Use caution when using the back door closer as it still operates when the power back door system is disabled.

##### ■ Power back door

Observe the following precautions when operating the power back door. Failure to do so may cause death or serious injury.

- Check the safety of the surrounding area to make sure there are no obstacles or anything that could cause any of your belongings to get caught.
- If anyone is in the vicinity, make sure they are safe and let them know that the power back door is about to open or close.
- If the power back door system is disabled while the power back door is operating, the power back door will stop operating. The power back door must then be operated manually. Take extra care in this situation, as the power back door may open or close suddenly.

**⚠ WARNING**

- If the operating conditions of the power back door (→P.107) are no longer met, a buzzer may sound and the power back door may stop opening or closing. The power back door must then be operated manually. Take extra care on an incline in this situation, as the power back door may move suddenly.
- On an incline, the power back door may suddenly shut after it opens. Make sure the power back door is fully open and secure.
- In the following situations, the power back door may detect an abnormality and automatic operation may be stopped. In this case, the power back door must then be operated manually. Take extra care in this situation, as the stopped power back door may suddenly open or close, causing an accident.
  - When the power back door contacts an obstacle
  - When the battery voltage suddenly drops, such as when the engine switch is turned to IGNITION ON mode or the engine is started during automatic operation
- If a bicycle carrier or similar heavy object is attached to the power back door, the power back door may not operate, causing a malfunction, or the power back door may suddenly shut again after being opened, causing someone's hands, arms, head or neck to be caught and injured. When installing an accessory part to the power back door, using a genuine Lexus part is recommended.

**■ Jam protection function**

Observe the following precautions. Failure to do so may cause death or serious injury.

- Never use any part of your body to intentionally activate the jam protection function.
  - The jam protection function may not work if something gets caught just before the power back door fully closes. Be careful not to get fingers caught or anything else.
  - The jam protection function may not work depending on the shape of the object that is caught. Be careful not to catch fingers or anything else.
- Hands Free Power Back Door (if equipped)**
- Observe the following precautions. Failure to do so may cause death or serious injury.
- Check the safety of the surrounding area to make sure there are no obstacles or anything that could cause any of your belongings to get caught.
  - Exhaust gasses cause the exhaust pipes to become quite hot. When operating the Hands Free Power Back Door, be careful not to touch the exhaust pipe.
  - Do not operate the Hands Free Power Back Door if there is little space under the rear bumper.

 NOTICE

■ **Back door spindles**

The power back door is equipped with spindles **A** that hold the power back door in place.

Observe the following precautions.

Failure to do so may cause damage to the back door spindle **A**, resulting in malfunction.

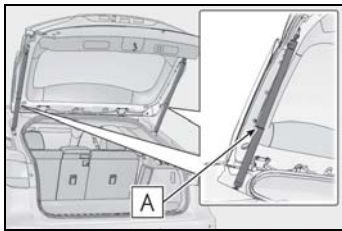

- Do not attach any foreign objects, such as stickers, plastic sheets, or adhesives to the spindle rod.
- Do not attach any accessories other than genuine Lexus parts to the power back door.
- Do not place your hand on the spindle or apply lateral forces to it.

■ **To prevent back door closer malfunction**

- Do not apply excessive force to the power back door while the back door closer is operating. Applying excessive force may cause the back door closer to malfunction.
- If the power back door is opened and closed repeatedly in a short amount of time, the back door closer may stop operating. In this case, manually open the power back door once and wait for a while before attempting to close it again.

■ **To prevent malfunction of the power back door**

- Make sure that there is no ice between the power back door and frame that would prevent movement of the power back door. Operating the power back door when excessive load is present on the power back door may cause a malfunction.
- Do not apply excessive force to the power back door while the power back door is operating.
- Take care not to damage the sensors installed on the right and left edges of the power back door (→P.109) with a knife or other sharp object. If a sensor is disconnected, the power back door will not close automatically.

■ **Close & lock function/Hands free close & lock function**

When closing the power back door using the close & lock function/hands free close & lock function, a different buzzer than the normal one will sound before the operation begins.

To check that the operation has started correctly, check that a different buzzer than the normal one has sounded.

Additionally, when the power back door is fully closed and locked, operation signals will indicate that all of the doors have been locked.

Before leaving the vehicle, make sure that the operational signals have operated and that all of the doors are locked.

■ **Hands Free Power Back Door precautions (if equipped)**

The kick sensor is located behind lower center part of the rear bumper. Observe the following to ensure that the Hands Free Power Back Door function operates properly:



 NOTICE

- Keep the lower center part of the rear bumper clean at all times.

If the lower center part of the rear bumper is dirty or covered with snow, the Hands Free Power Back Door may not operate. In this situation, clean off the dirt or snow, move the vehicle from the current position and then check if the Hands Free Power Back Door operates. If it does not operate, have the vehicle inspected by your Lexus dealer.

- Do not apply coatings that have a rain clearing (hydrophilic) effect, or other coatings, to the lower center part of the rear bumper.
- Do not park the vehicle near objects that may move and contact the lower center part of the rear bumper, such as grass or trees.

If the vehicle has been parked for a while near objects that may move and contact the lower center part of the rear bumper, such as grass or trees, the Hands Free Power Back Door may not operate. In this situation, move the vehicle from the current position and then check if the Hands Free Power Back Door operates. If it does not operate, have the vehicle inspected by your Lexus dealer.

- Do not subject the rear bumper or its surrounding area to a strong impact.

If the rear bumper or its surrounding area has been subjected to a strong impact, the Hands Free Power Back Door may not operate properly.

If the Hands Free Power Back Door does not operate in the following situations, have the vehicle inspected by your Lexus dealer.





- The kick sensor or its surrounding area has been subjected to a strong impact.
- The lower center part of the rear bumper is scratched or damaged.

- Do not disassemble the rear bumper.

- Do not attach stickers to the rear bumper.
- Do not paint the rear bumper.
- If a bicycle carrier or similar heavy object is attached to the power back door, disable the Hands Free Power Back Door (kick sensor).

### Canceling the power back door system

The power back door system can be enabled/disabled on the multi-information display. (→P.81)

- 1 Press < or > of the meter control switches and select .
- 2 Press ^ or v of the meter control switches, select the "Vehicle Settings" and then press .
- 3 Press ^ or v of the meter control switches, select  and then press .
- 4 Press ^ or v of the meter control switches, and then select "PBD".
- 5 ON and OFF will be switched over with presses of  on the meter control switches.





When OFF is selected and the operations of the power back door is made to stop from the  of multi-information display, unless it is set to ON, the operation of the power back door will not return. (No return in the engine switch operation)

3

Before driving

### Canceling the Hands Free Power Back Door (if equipped)

The Hands Free Power Back Door (kick sensor) can be enabled/disabled on the multi-information display. (→P.81)

- 1 Press < or > of the meter control switches and select .
- 2 Press ^ or v of the meter control switches, select the "Vehicle Settings" and then press .
- 3 Press ^ or v of the meter control switches, select  and then press .
- 4 Press ^ or v of the meter control switches, and then select "Kick Sensor".
- 5 ON and OFF will be switched over with presses of  on the meter control switches.

When OFF is selected and the operations of the Hands Free Power Back Door is made to stop from the  of multi-information display, unless it is set to ON, the operation of the Hands Free Power Back Door will not return. (No return in the engine switch operation)

### Adjusting the open position of the power back door

The open position of the power back door can be adjusted.

- 1 Stop the power back door at the desired position. (→P.105)

- 2 Press and hold the  switch on the lower part of the power back door for 2 seconds.

- When setting is complete, a buzzer will sound 4 times.
- The next time the power back door is opened, it will stop at that position.

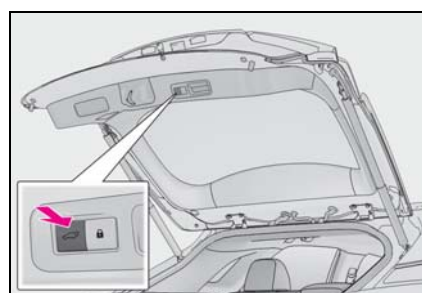

### Returning the power back door opening position to the default setting

Press and hold the  switch on the lower part of the power back door for 7 seconds.

A buzzer will sound twice. The next time the power back door is opened, it will open to the default position.

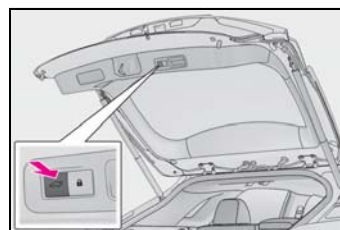

### Customization

The opening position can be set with the navigation system or multimedia system. Priority for the stop position is given to the last position set by either the  switch, navigation system or multimedia system. (Customizable features:→P.461)

### Smart access system with push-button start

The following operations can be performed simply by carrying the electronic key on your person, for example in your pocket. The driver should always carry the electronic key.

- Locks and unlocks the doors (→P.99)
- Locks and unlocks the back door (→P.104)
- Starts and stops the engine (→P.174)

#### Antenna location

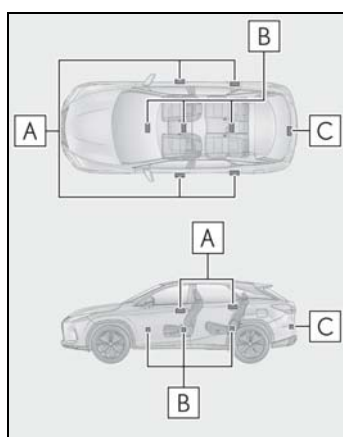

- A** Antennas outside the cabin
- B** Antennas inside the cabin
- C** Antenna outside the luggage compartment

#### Effective range (areas within which the electronic key is detected)

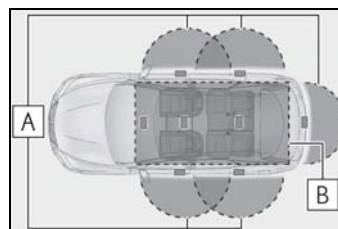

##### **A** When locking or unlocking the doors

The system can be operated when the electronic key is within about 2.3 ft. (0.7 m) of an outside door handle. (Only the doors detecting the key can be operated.)

##### **B** When starting the engine or changing engine switch modes

The system can be operated when the electronic key is inside the vehicle.

#### Alarms and warning messages

An alarm sounds and warning messages are displayed on the multi-information display to protect against unexpected accidents or theft of the vehicle resulting from erroneous operation. When a warning message is displayed, take appropriate measures based on the displayed message. (→P.412)

When only an alarm sounds, circumstances and correction procedures are as follows.

- When an exterior alarm sounds once for 5 seconds

Situation	Correction procedure
An attempt was made to lock the vehicle while a door was open.	Close all of the doors and lock the doors again.

- When an interior alarm sounds continuously

Situation	Correction procedure
The engine switch was turned to ACCESSORY mode while the driver's door was open (The driver's door was opened when the engine switch was in ACCESSORY mode).	Turn the engine switch off and close the driver's door.

#### ■ If "Key Left inside Vehicle" is shown on the multi-information display

An attempt was made to lock the doors using the smart access system with push-button start while the electronic key was still inside the vehicle. Retrieve the electronic key from the vehicle and lock the doors again.



#### ■ Battery-saving function

The battery-saving function will be activated in order to prevent the electronic key battery and the battery from being discharged while the vehicle is not in operation for a long time.

- In the following situations, the smart access system with push-button start may take some time to unlock the doors.
  - The electronic key has been left in an area of approximately 6 ft. (2 m) of the outside of the vehicle for 10 minutes or longer.
  - The smart access system with push-button start has not been used for 5 days or longer.
- If the smart access system with push-button start has not been used for 14 days or longer, the doors cannot be unlocked at any doors except the driver's door. In this case, take hold of the driver's door handle, or use the wireless remote control or the mechanical key, to unlock the doors.

#### ■ Turning an electronic key to battery-saving mode

When battery-saving mode is set, battery depletion is minimized by stopping the electronic key from receiving radio waves.

Press  twice while pressing and holding . Confirm that the electronic key indicator flashes 4 times.

While the battery-saving mode is set, the smart access system with push-button start cannot be used. To cancel the function, press any of the electronic key buttons.



#### ■ Conditions affecting operation

The smart access system with push-button start, wireless remote control and engine immobilizer system use weak radio waves. In the following situations, the communication between the electronic key and the vehicle may be affected, preventing the smart access system with push-button start, wireless remote control and engine immobilizer system from operating properly. (Ways of coping:→P.431)

- When the electronic key battery is depleted
- Near a TV tower, electric power plant, gas station, radio station, large display, airport or other facility that generates strong radio waves or electrical noise
- When the electronic key is in contact with, or is covered by the following metallic objects
  - Cards to which aluminum foil is attached
  - Cigarette boxes that have aluminum foil inside
  - Metallic wallets or bags
  - Coins
  - Hand warmers made of metal
  - Media such as CDs and DVDs
- When other wireless keys (that emit radio waves) are being used nearby
- When carrying the electronic key together with the following devices that emit radio waves
  - Portable radio, cellular phone, cordless phone or other wireless communication

- devices
- Another vehicle's electronic key, another electronic key of your vehicle, or a wireless key that emits radio waves
  - Personal computers or personal digital assistants (PDAs)
  - Digital audio players
  - Portable game systems
- If window tint with a metallic content or metallic objects are attached to the rear window
  - When the electronic key is placed near a battery charger or electronic devices
  - When the vehicle is parked in a pay parking spot where radio waves are emitted
- **Note for the entry function**
- Even when the electronic key is within the effective range (detection areas), the system may not operate properly in the following cases:
    - The electronic key is too close to the window or outside door handle, near the ground, or in a high place when the doors are locked or unlocked.
    - The electronic key is near the ground or in a high place, or too close to the rear bumper center when the back door is opened.
    - The electronic key is on the instrument panel, luggage compartment, floor, or in the door pockets or glove box when the engine is started or engine switch modes are changed.
  - Do not leave the electronic key on top of the instrument panel or near the door pockets when exiting the vehicle. Depending on the radio wave reception conditions, it may be detected by the antenna outside the cabin and the door will become lockable from the outside, possibly trapping the electronic key inside the vehicle.
  - As long as the electronic key is within the effective range, the doors may be locked or unlocked by anyone.
  - Even if the electronic key is not inside the vehicle, it may be possible to start the engine if the electronic key is near the window.
  - The doors may unlock if a large amount of water splashes on the door handle, such as in the rain or in a car wash when the electronic key is within the effective range. (The door will automatically be locked after approximately 60 seconds if the doors are not opened and closed.)
  - If the wireless remote control is used to lock the doors when the electronic key is near the vehicle, there is a possibility that the door may not be unlocked by the entry function. (Use the wireless remote control to unlock the doors.)
  - Touching the door lock sensor while wearing gloves may delay or prevent lock operation. Remove the gloves and touch the lock sensor again.
  - When the lock operation is performed using the lock sensor, recognition signals will be shown up to two consecutive times. After this, no recognition signals will be given.
  - If the door handle becomes wet while the electronic key is within the effective range, the door may lock and unlock repeatedly. In that case, follow the following correction procedures to wash the vehicle:
    - Place the electronic key in a location 6 ft. (2 m) or more away from the vehicle. (Take care to ensure that the key is not stolen.)
    - Set the electronic key to battery-saving mode to disable the smart access system with push-button start. (→P.116)
  - If the electronic key is inside the vehicle and a door handle becomes wet during a car wash, a message may be shown on the multi-information display and a buzzer will sound outside the vehicle. To turn off the alarm, lock all the doors.
  - The lock sensor may not work properly if it comes into contact with ice, snow, mud, etc. Clean the lock sensor and attempt to operate it again.
  - A sudden approach to the effective range or door handle may prevent the doors from being unlocked. In this case, return the door handle to the original position and check that the doors unlock before pulling the door handle again.
  - If there is another electronic key in the

detection area, it may take slightly longer to unlock the doors after the door handle is gripped.

- Fingernails may scrape against the door during operation of the door handle. Be careful not to injure fingernails or damage the surface of the door.

#### ■ When the vehicle is not driven for extended periods

- To prevent theft of the vehicle, do not leave the electronic key within 6 ft. (2 m) of the vehicle.
- The smart access system with push-button start can be deactivated in advance.
- Setting the electronic key to battery-saving mode helps to reduce key battery depletion. (→P.116)

#### ■ To operate the system properly

Make sure to carry the electronic key when operating the system. Do not get the electronic key too close to the vehicle when operating the system from the outside of the vehicle.

Depending on the position and holding condition of the electronic key, the key may not be detected correctly and the system may not operate properly. (The alarm may go off accidentally, or the door lock prevention may not operate.)

#### ■ If the smart access system with push-button start does not operate properly

- If the doors cannot be locked or unlocked and the back door cannot be opened, perform the following.
  - Bring the electronic key close to the door handle and perform a lock or unlock operation.
  - Bring the electronic key close to the button on the back door (→P.104) and press the button.
  - Use the wireless remote control.

If the doors cannot be locked or unlocked by perform the above, use the mechanical key. (→P.431) However, if the mechanical key is used while the alarm system is set, the warning will sound. (→P.68)

- If the engine cannot be started, refer to →P.432

#### ■ Customization

Some functions can be customized. (→P.461)

#### ■ If the smart access system with push-button start has been deactivated in a customized setting

- Locking and unlocking the doors: Use the wireless remote control or mechanical key. (→P.99, 104, 431)
- Starting the engine and changing engine switch modes: →P.432
- Stopping the engine: →P.176

**■ Certification for the smart access system with push-button start**

- Except for vehicles sold in Canada

FCC ID:HYQ23ABL  
FCC ID:HYQ14FLB

**NOTE:**

This device complies with part 15 of the FCC Rules. Operation is subject to the following two conditions: (1) This device may not cause harmful interference, and (2) this device must accept any interference received, including interference that may cause undesired operation.

**FCC WARNING:**

Changes or modifications not expressly approved by the party responsible for compliance could void the user's authority to operate the equipment.

FCC ID:NI4TMLF15-2

This device complies with part 15 of the FCC Rules. Operation is subject to the following two conditions: (1) This device may not cause harmful interference, and (2) this device must accept any interference received, including interference that may cause undesired operation.

Changes or modifications not expressly approved by the party responsible for compliance could void the user's authority to operate the equipment.

- For vehicles sold in Canada

**NOTE:**

This device contains licence-exempt transmitter(s)/receiver(s) that comply with Innovation, Science and Economic Development Canada's licence-exempt RSS(s).

Operation is subject to the following two conditions:

- (1) This device may not cause interference.
- (2) This device must accept any interference, including interference that may cause undesired operation of the device.

**NOTE:**

L'émetteur/récepteur exempt de licence contenu dans le présent appareil est conforme aux CNR d'Innovation, Sciences et Développement économique Canada applicables aux appareils radio exempts de licence.

L'exploitation est autorisée aux deux conditions suivantes :

- (1) L'appareil ne doit pas produire de brouillage;
- (2) L'appareil doit accepter tout brouillage radioélectrique subi, même si le brouillage est susceptible d'en compromettre le fonctionnement.

This device complies with Industry Canada's licence-exempt RSSs. Operation is subject to the following two conditions: (1) This device may not cause interference; and (2) This device must accept any interference, including interference that may cause undesired operation of the device.

Le présent appareil est conforme aux CNR d'Industrie Canada applicables aux appareils radio exempts de licence. L'exploitation est autorisée aux deux conditions suivantes : 1) l'appareil ne doit pas produire de brouillage; 2) l'utilisateur de l'appareil doit accepter tout brouillage radioélectrique subi, même si le brouillage est susceptible d'en compromettre le fonctionnement.

 **WARNING**

■ **Caution regarding interference with electronic devices**

- People with implantable cardiac pacemakers, cardiac resynchronization therapy-pacemakers or implantable cardioverter defibrillators should keep away from the smart access system with push-button start antennas. (→P.115)

The radio waves may affect the operation of such devices. If necessary, the entry function can be disabled. Ask your Lexus dealer for details, such as the frequency of radio waves and timing of the emitted radio waves. Then, consult your doctor to see if you should disable the entry function.

- Users of any electrical medical device other than implantable cardiac pacemakers, cardiac resynchronization therapy-pacemakers or implantable cardioverter defibrillators should consult the manufacturer of the device for information about its operation under the influence of radio waves. Radio waves could have unexpected effects on the operation of such medical devices.

Ask your Lexus dealer for details on disabling the entry function.



## Front seats

### ⚠ WARNING

#### ■ When adjusting the seat position

- Take care when adjusting the seat position to ensure that other passengers are not injured by the moving seat.
- Do not put your hands under the seat or near the moving parts to avoid injury. Fingers or hands may become jammed in the seat mechanism.
- Make sure to leave enough space around the feet so they do not get stuck.

#### ■ Seat adjustment

To reduce the risk of sliding under the lap belt during a collision, do not recline the seat more than necessary.

If the seat is too reclined, the lap belt may slide past the hips and apply restraint forces directly to the abdomen, or your neck may contact the shoulder belt, increasing the risk of death or serious injury in the event of an accident.

Adjustments should not be made while driving as the seat may unexpectedly move and cause the driver to lose control of the vehicle.

## Adjustment procedure

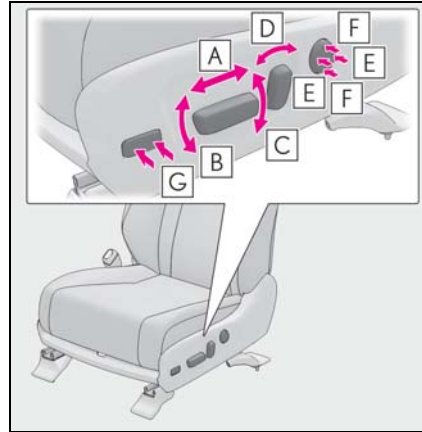

- A** Seat position adjustment switch
- B** Seat cushion (front) angle adjustment switch
- C** Vertical height adjustment switch
- D** Seatback angle adjustment switch
- E** Lumbar support firmness adjustment switch
- F** Lumbar support height adjustment switch (if equipped)
- G** Seat cushion length adjustment switch (if equipped)

#### ■ Power easy access system

The driver's seat (on some models) and steering wheel move in accordance with engine switch mode and the driver's seat belt condition. (→P.133)

## Rear seats

### WARNING

#### ■ When a rear seatback is folded

Observe the following precautions. Failure to do so may result in death or serious injury.

- Do not fold down the rear seatbacks while driving.
- Stop the vehicle on level ground, apply the parking brake and shift the shift lever to P.
- Do not allow anyone to sit on a folded rear seatback or in the luggage compartment while driving.
- Do not allow children to enter the luggage compartment.

#### ■ When operating the rear seatback

Observe the following precautions. Failure to do so may result in death or serious injury.

- Make sure that passengers are clear of the rear seatback before operating it.
- To prevent hands and other body parts from being caught, keep them away from the gaps in the seats and the moving parts of the seats when operating a rear seatback.
- Power seat: Do not let children operate the rear seatback. Other passengers may get caught in the seat.
- Power seat: Make sure that all passengers are clear of a seat before folding it. Do not let passengers sit in the seat while it is being folded.

#### ■ Seat adjustment

Second-row seats: To reduce the risk of sliding under the lap belt during a collision, do not recline the seat more than necessary.

If the seat is reclined excessively, the lap belt may slide past the hips and apply restraint forces directly to the abdomen, or your neck may contact the shoulder belt, increasing the risk of death or serious injury in the event of an accident.

#### ■ After adjusting the rear seats

Observe the following precautions. Failure to do so may result in death or serious injury.

- Make sure that the rear seatback is securely locked in position by lightly pushing it back and forth.
- Check that the seat belts are not twisted or caught between or behind in the rear seatback.
- Arrange the seat belts in the proper positions for ready use.

#### ■ Jam protection function (power seat)

Observe the following precautions. Failure to do so may result in death or serious injury.

- Never use any part of your body to intentionally activate the jam protection function.
- The jam protection function may not operate if something is caught just before the fully folded position. Be careful so that fingers, etc. do not get caught.
- The jam protection function may not operate depending on the shape or position of the obstruction. Be careful so that fingers, etc. do not get caught.

 NOTICE

- **Before folding a rear seat seatback**
- Second-row seats: Make sure to stow the center seat seat belt buckle and armrest before folding the second-row seat seatbacks. (→P.330)

- Third-row seats: Make sure that the third-row seats and trays are free of obstructions before folding the seatbacks. Otherwise the seat or tray may be damaged.

**Adjustment procedure (RX350)**

## ▶ Manual seat

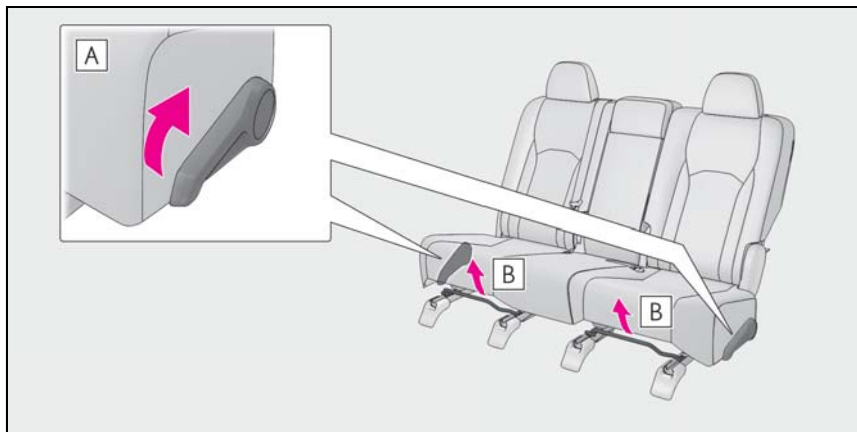
**A** Seatback angle adjustment lever**B** Seat position adjustment lever

3

Before driving

▶ Power seat

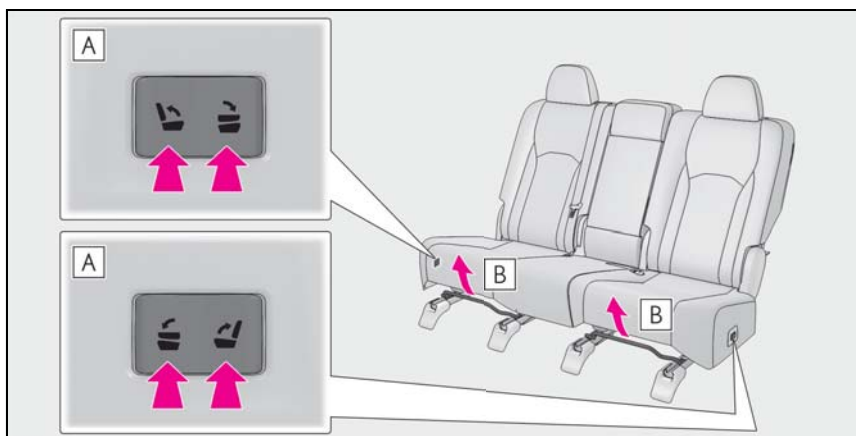

**A** Seatback angle adjustment switch

**B** Seat position adjustment lever

■ The rear seatbacks can be adjusted when (power seat)

When the rear seatback is in a position within the range **A** shown in the illustration, the rear seat operation switch (rear seat) can be used to adjust the rear seatback.

**B** is where the rear seatback is at its most upright position.

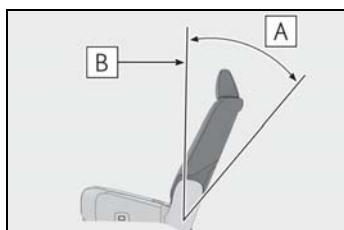
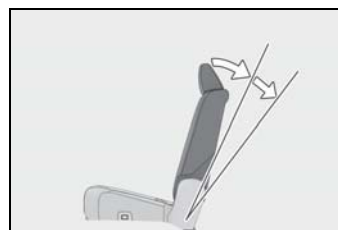

■ Fully reclining the rear seatback (power seat)

Operate the rear seat operation switch (rear seat) to recline the rear seatback and stop it partway. To set the rear seatback to the rearmost position, press the button again.

### Adjustment procedure (RX350L)

▶ Second-row seats (Separate seat)

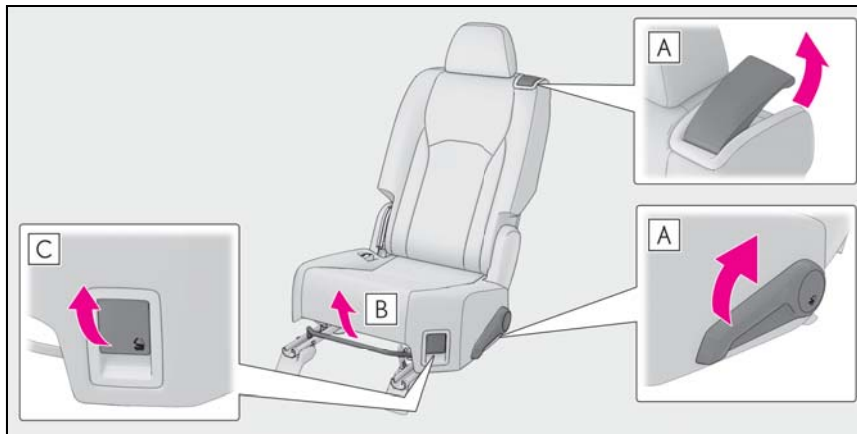

- A** Seatback angle adjustment lever
- B** Seat position adjustment lever
- C** Seatback folding lever

▶ Second-row seats (Bench seat)

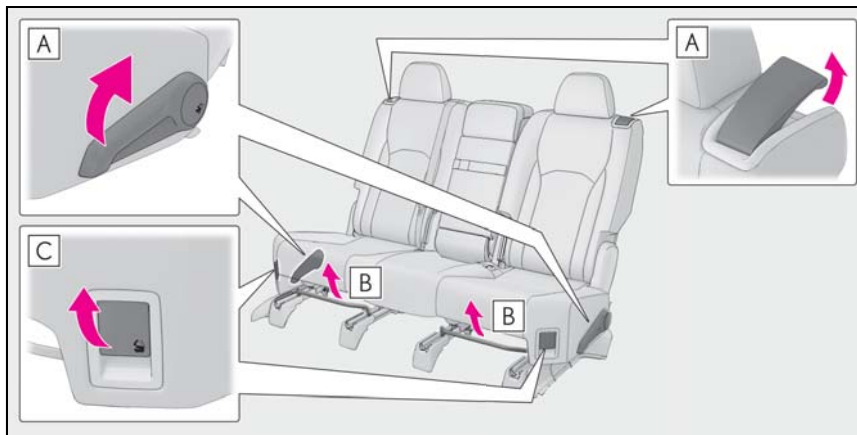

- A** Seatback angle adjustment lever
- B** Seat position adjustment lever
- C** Seatback folding lever

▶ Third-row seats

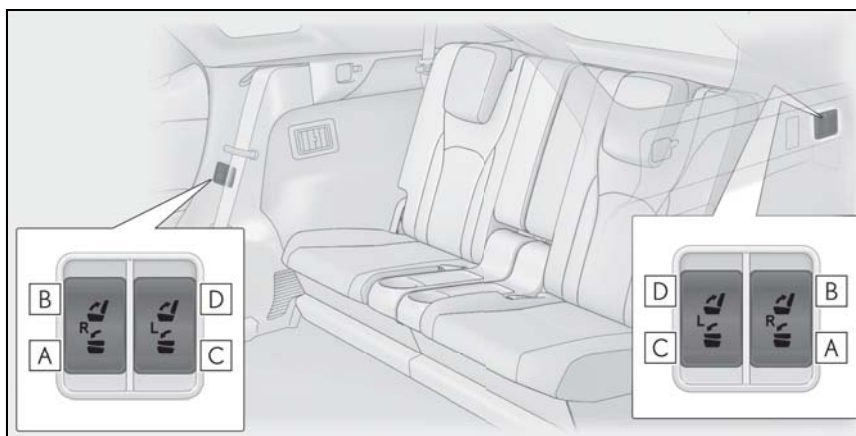

- A** Right seat fold switch (→P.132)
- B** Right seat return switch (→P.132)
- C** Left seat fold switch (→P.132)
- D** Left seat return switch (→P.132)

**Folding the second-row seat seatbacks (RX350)**

- **Before folding the rear seatbacks**
  - 1** Stow the center seat seat belt buckle.
  - 2** Lower the rear seat head restraints to the lowest position. (→P.136)
- **Folding the rear seatbacks (manual seat)**
  - ▶ Using the seatback angle adjustment lever
 

Pull the lever and fold the rear seatback.

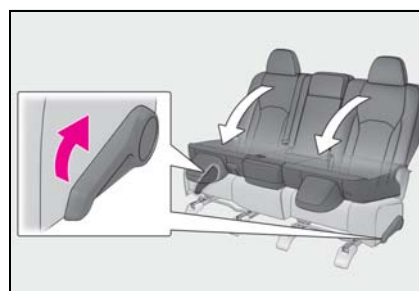

- ▶ Using the lever in the luggage compartment
 

Pull the lever and fold the rear seatback.

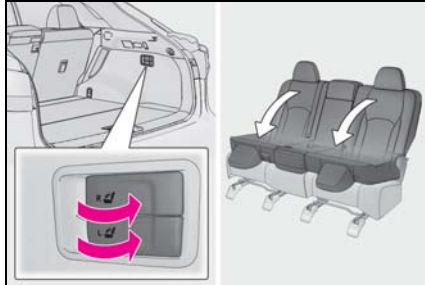

#### ■ Folding the rear seatbacks (power seat)

Press and hold the fold switch until the rear seatback begins to operate.

A buzzer will sound and then the operation will start. When the operation is completed, the buzzer will sound again.

To stop the operation partway, press either side of the switch for the operating seat.

Any rear seat operation switch for the operating seat, regardless of location, can be used to stop the operation. (A buzzer may sound depending on the position that the rear seatback is stopped.)

#### ► Using the seatback angle adjustment switch

If the rear seatback is reclined, adjust it to the most upright position and then press the switch again.

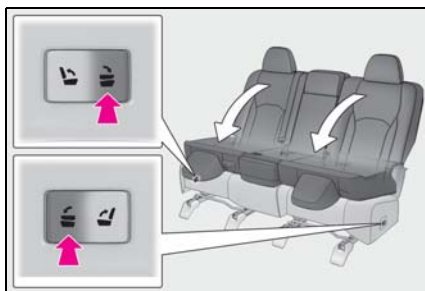

#### ► Using the switch in the luggage compartment

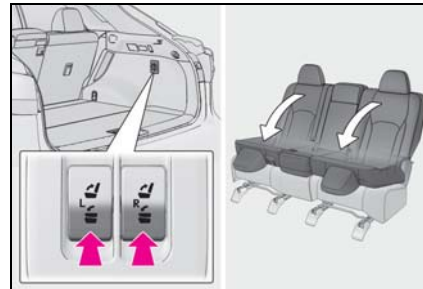

#### ■ Returning the rear seatbacks (manual seat)

- 1 Lift the rear seatback until it locks in position.



- 2 Check that the plate of the seat belt is on the front side of the seatback.

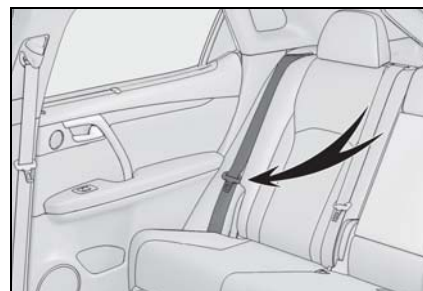

#### ■ Returning the rear seatbacks (power seat)

- 1 Press and hold the return switch until the rear seatback begins to operate.

A buzzer will sound and then the operation will start. When the operation is completed, the buzzer will sound twice again.

To stop the operation partway, press either side of the switch for the operating seat. Any rear seat operation switch for the operating seat, regardless of location, can be used to stop the operation. (A buzzer may sound depending on the position that the rear seatback is stopped.)

- ▶ Using the seatback angle adjustment switch

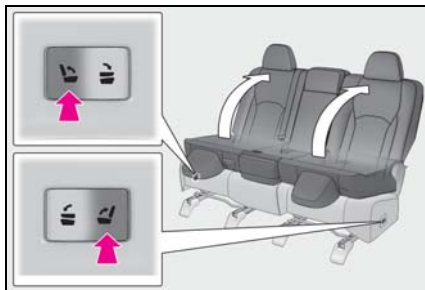

- ▶ Using the switch in the luggage compartment

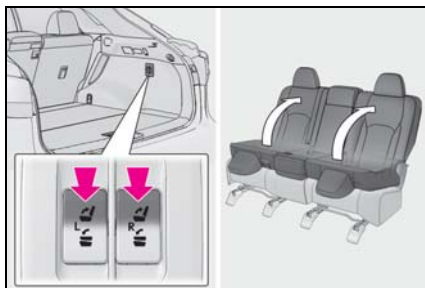

- 2 Check that the plate of the seat belt is on the front side of the seatback.

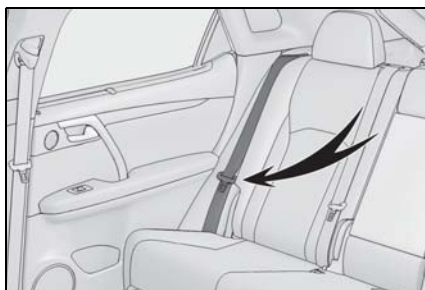

### ■ Folding the rear center seatback only

Pull the lock release lever on the back side of the seatback and fold the center seatback.

To return the rear center seatback to its original position, lift it until it locks in position.



### ■ Engine switch mode conditions under which the rear seatbacks can be folded down or raised (power seat)

The rear seatbacks can be folded down or raised when the engine switch is in either of the following modes:

- When the engine switch is turned off or in ACCESSORY mode
- When the engine switch is in IGNITION ON mode and any of the following conditions are met:
  - The parking brake is engaged.
  - The brake pedal is depressed.
  - The shift lever is in P.

### ■ The rear seatbacks can be folded down when (power seat)

When all of the following conditions are met, a rear seat operation switch can be used to fold down the rear seatback:

- When using the rear seat operation switch (rear seat): The rear seatback is in a position within the range **A** shown in the illustration with the rear door nearest to the seat to be operated open (**C** is where the rear seatback is at its most upright position)
- When using the rear seat operation



switch (luggage compartment): The rear seatback is in a position within the range **B** shown in the illustration with the back door open

- The other seat operation switch for the seat to be operated is not being pressed.

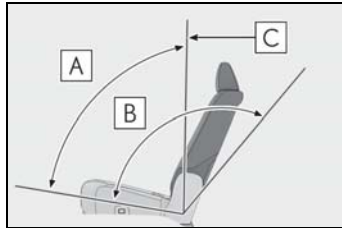

■ **The rear seatbacks can be raised when (power seat)**

When all of the following conditions are met, a rear seat operation switch can be used to return the rear seatback:

- When using the rear seat operation switch (rear seat): The rear seatback is in a position within the range **A** shown in the illustration with the back door open (**B** is where the rear seatback is at its most upright position)
- When using the rear seat operation switch (rear seat): The rear door nearest to the seat to be operated is open
- The other seat operation switch for the seat to be operated is not being pressed.

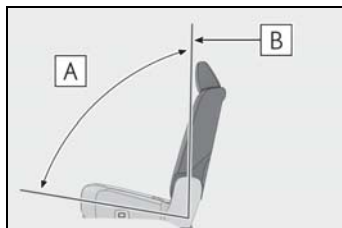

■ **Precautions for power seats (if equipped)**

If a seat cover or seat cushion is used on a power seat, the power seat may not operate properly.

Before folding the seatback of a power seat, make sure that the seat and area around the seat is free of obstructions which may interfere the operation.

■ **Rear seatback jam protection function (power seat)**

When folding or returning the seatback of a power seat, if an object is detected between the seatback and seat cushion or behind the seatback, the seatback may stop or move in the opposite direction slightly.

A buzzer will sound continuously when the seatback stops and intermittently when moving in the opposite direction.

**Folding the second-row seat seatbacks (RX350L)**

■ **Before folding the second-row seat seatbacks**

- 1 To prevent the seat belt from being damaged, hook it to the seat belt hanger.

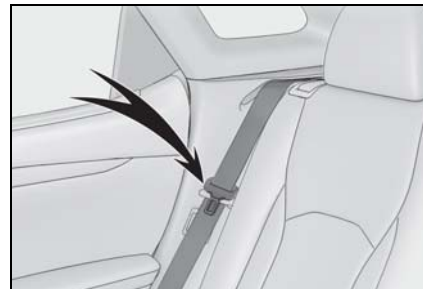

- 2 Stow the center seat seat belt buckle.
- 3 Lower the second-row seat head restraints to the lowest position. (→P.136)

**3**

Before driving

■ **Folding the second-row seat seatbacks**

► Separate seat

- 1 Pull the seatback angle adjustment lever and tilt the seatback forward.

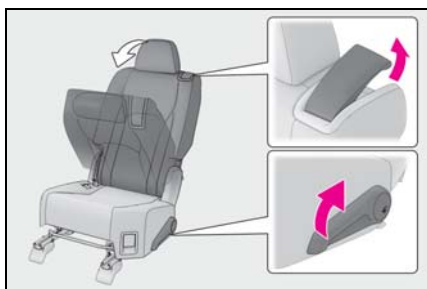

- 2 Pull the seatback folding lever and fold the seatback.

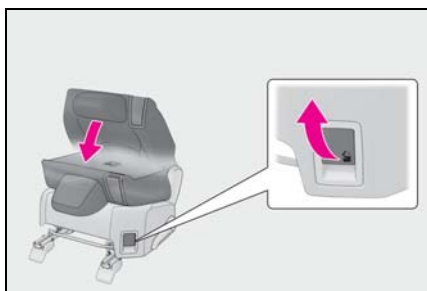

► Bench seat

- 1 Pull the seatback angle adjustment lever and tilt the seatback forward.

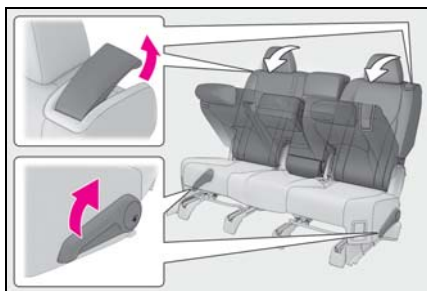

- 2 Pull the seatback folding lever and fold the seatback.

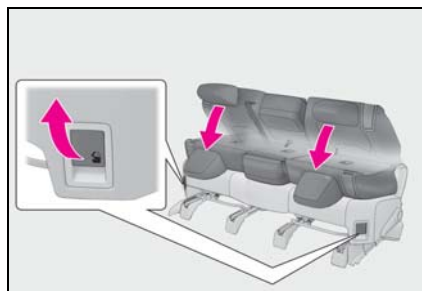

■ **Returning the second-row seat seatbacks**

Lift the second-row seat seatback until it locks in position.

Remove the secured seat belts from the seat belt hangers.



■ **Folding the second-row center seatback only (Bench seat)**

Pull the lock release lever on the back side of the seatback and fold the center seatback.

To return the second-row center seatback to its original position, lift it until it locks in position.



### Moving the second-row seat for third-row seat access (RX350L)

#### ■ Before moving the second-row seat

To prevent the seat belt from being damaged, hook it to the seat belt hanger.

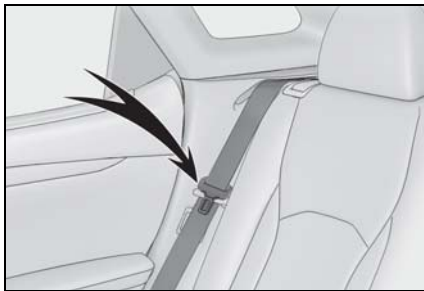

#### ■ When entering/exiting the vehicle

Pull the seatback angle adjustment lever **A** or **B** to tilt the seatback forward and then slide the seat forward.

Make sure that the second-row seat is free of passengers and obstructions before operating the seatback tilt lever.

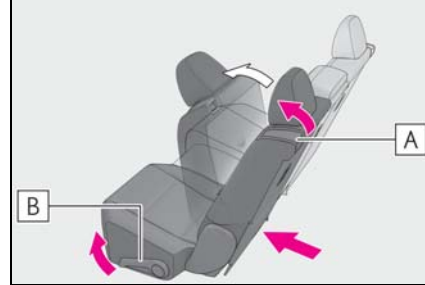

#### ■ After passengers have entered/exited the vehicle

Tilt back and slide the second-row seat until it locks in position.

Remove the secured seat belts from the seat belt hangers.

#### ⚠ NOTICE

#### ■ When moving the second-row seat for third-row seat access

Do not slide the second-row seat forward if an electronic device is connected to the USB charging port on the rear console. Otherwise, the second-row seat may contact the electronic device, possibly resulting in damage to the device.

### Folding the third-row seat seatbacks (RX350L)

#### ■ Before folding the third-row seat seatbacks

- 1 To prevent the seat belt from being damaged, hook it to the seat belt hanger.

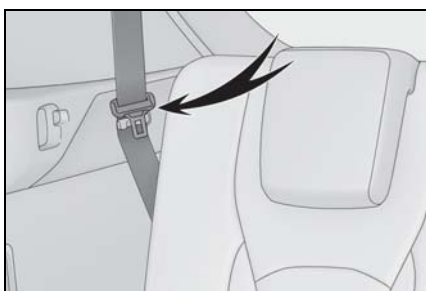

- 2 Lower the third-row seat head restraints to the lowest position. (→P.136)

#### ■ Folding the third-row seat seatbacks

Press and hold the  side of the switch until the seatback is folded completely.

A buzzer will sound twice before the operation begins and twice when the operation is complete.

If the switch is released while the seatback is operating, the seatback will stop and a buzzer will sound continuously.

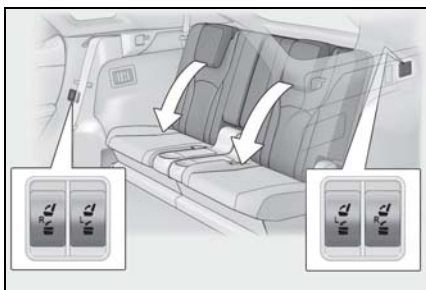

#### ■ Returning the third-row seat seatbacks

Press and hold the  side of the switch until the seatback is fully upright.

A buzzer will sound twice before the operation begins and twice when the operation is complete.

If the switch is released while the seatback is operating, the seatback will stop and a buzzer will sound continuously.

Remove the secured seat belts from the seat belt hangers.



#### ■ The third-row seats can be folded when

- The vehicle is stopped.
- The back door is open. (When using the switches in the luggage compartment)
- A seat side switch and switch in the luggage compartment are not being operated simultaneously.



#### ■ Precautions for third-row seats

If a seat cover or seat cushion is used on a seat, the seat may not operate properly. Before folding the seatback of a seat, make sure that the seat and area around the seat is free of obstructions which may interfere the operation.

#### ■ If a buzzer sounds continuously after a third-row seat seatback is completely folded

The power seat system may be malfunctioning or it may need to be initialized. To initialize the system, perform the following procedure. (It is necessary to perform this

procedure with two people.)

- 1 Check that the seat is free of obstructions.
- 2 Press and hold the  side switch of the luggage compartment side switch for the seat which the buzzer is sounding.
- 3 Within 10 seconds of the performing the above step, press the  side switch of the seat side switch 5 times.
- 4 When a buzzer sounds 3 times, release the luggage compartment side switch.
- 5 Press the  side switch of the seat side switch until the seatback is folded completely.

A buzzer will sound twice when the operation is complete.

If the buzzer does not stop sounding even though the above procedure has been performed, have the vehicle inspected by your Lexus dealer.

#### WARNING

##### ■ Precautions for third-row seat

When operating a third-row seat, make sure to press and hold the switch until the third-row seat seatback is completely folded/upright. Do not use a third-row seat in a position other than the completely upright position, as doing so may lead to death or serious injury in an accident. (If the switch is released while the seatback is still moving, a buzzer will sound continuously until the seatback is completely folded/upright.)

#### NOTICE

##### ■ Before returning the third-row seat seatbacks to the upright position

If the luggage cover is installed in the luggage compartment, make sure to remove it before returning the third-row seat seatbacks. (→P.318) Otherwise, the luggage cover may be damaged.

### Driving position memory\*

\*: If equipped

This feature automatically adjusts the driver's seat (on some models), steering wheel, outside rear view mirrors and head-up display (if equipped) to make entering and exiting the vehicle easier or to suit your preferences.

Up to 3 different driving positions can be recorded.

Each electronic key can be registered to recall your preferred driving position.

### Power easy access system (driver's side only)

The seat and steering wheel are automatically adjusted to allow the driver to enter and exit the vehicle easily.

When all of the following have been performed, the seat and steering wheel are automatically adjusted to a position that allows driver to enter and exit the vehicle easily.

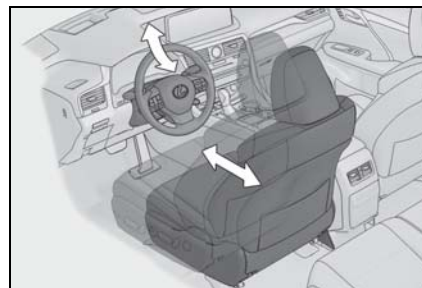

- The shift lever has been shifted to P.
- The engine switch has been turned off.

3

Before driving

- The driver's seat belt has been unfastened.

When any of the following has been performed, the seat and steering wheel automatically return to their original positions.

- The engine switch has been turned to ACCESSORY mode or IGNITION ON mode.
- The driver's seat belt has been fastened.

**■ Operation of the power easy access system**

When exiting the vehicle, the power easy access system may not operate if the seat is already close to the rearmost position, etc.

**■ Customization**

Some functions can be customized. (→P.461)

**Recording a driving position into memory**

- 1 Check that the shift lever is in P.
- 2 Turn the engine switch to IGNITION ON mode.
- 3 Adjust the driver's seat, steering wheel, outside rear view mirrors and head-up display (if equipped) to the desired positions.
- 4 While pressing the "SET" button, or within 3 seconds after the "SET" button is pressed, press button "1", "2" or "3" until the buzzer sounds.

If the selected button has already been preset, the previously recorded position

will be overwritten.

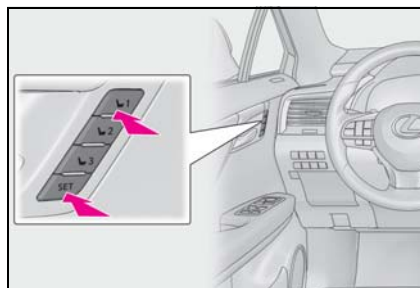

**■ Seat positions that can be memorized (→P.121)**

The adjusted positions other than the position adjusted by lumbar support switch can be recorded.

**■ In order to correctly use the driving position memory function**

If a seat position is already in the furthest possible position and the seat is operated in the same direction, the recorded position may be slightly different when it is recalled.

**⚠ WARNING**

**■ Seat adjustment caution**

Take care during seat adjustment so that the seat does not strike the rear passenger or squeeze your body against the steering wheel.

**Recalling a driving position**

- 1 Check that the shift lever is in P.
- 2 Turn the engine switch to IGNITION ON mode.

- 3 Press one of the buttons for the driving position you want to recall until the buzzer sounds.

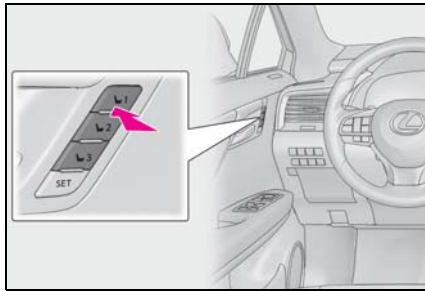

■ **To stop the position recall operation part-way through**

Perform any of the following operations:

- Press the "SET" button.
- Press button "1", "2" or "3".
- Operate any of the seat adjustment switches (only cancels seat position recall).
- Operate the tilt and telescopic steering control switch (only cancels steering wheel position recall).

■ **Operating the driving position memory after turning the engine switch off**

Recorded seat positions can be activated up to 180 seconds after the driver's door is opened and another 60 seconds after it is closed again.

**Registering/canceling/recall a driving position to an electronic key (memory recall function) (driver's side only)**

■ **Registering procedure**

Record your driving position to button "1", "2" or "3" before performing the following:

Carry only the key you want to register, and then close the driver's door.

If 2 or more keys are in the vehicle, the driving position cannot be recorded properly.

- 1 Check that the shift lever is in P.
- 2 Turn the engine switch to IGNITION ON mode.
- 3 Recall the driving position that you want to record.
- 4 While pressing the recalled button, press and hold the door lock switch (either lock or unlock) until the buzzer sounds.

If the button could not be registered, the buzzer sounds continuously for approximately 3 seconds.

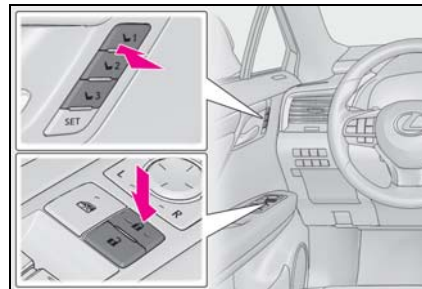

■ **Cancelation procedure**

Carry only the key you want to cancel and then close the driver's door.

If 2 or more keys are in the vehicle, the driving position cannot be canceled properly.

- 1 Turn the engine switch to IGNITION ON mode.
- 2 While pressing the "SET" button, press and hold the door lock switch (either lock or unlock) until the buzzer sounds twice.

If it button could not be canceled, the buzzer sounds continuously for approximately 3 seconds.

■ Recall procedure

- 1 Make sure that the doors are locked before recalling the driving position. Carry the electronic key that has been registered to the driving position, and then unlock and open the driver's door using the smart access system with push-button start or wireless remote control.

The driving position will move to the recorded position (not including the steering wheel and head-up display [if equipped]). However, the seat will move to a position slightly behind the recorded position in order to make entering the vehicle easier.

If the driving position is in a position that has already been recorded, the seat and outside rear view mirrors will not move.

- 2 Turn the engine switch to ACCESSORY mode or IGNITION ON mode, or fasten a seat belt.

The seat, steering wheel and head-up display (if equipped) will move to the recorded position.

■ Recalling the driving position using the memory recall function

- Different driving positions can be registered for each electronic key. Therefore, the driving position that is recalled may be different depending on the key being carried.
- If a door other than the driver's door is unlocked with the smart access system with push-button start, the driving position cannot be recalled. In this case, press the driving position button which has been set.

■ Customization

Some functions can be customized. (→P.461)

**Head restraints**

Head restraints are provided for all seats.

**! WARNING**

■ Head restraint precautions

Observe the following precautions regarding the head restraints. Failure to do so may result in death or serious injury.

- Use the head restraints designed for each respective seat.
- Adjust the head restraints to the correct position at all times.
- After adjusting the head restraints, push down on them and make sure they are locked in position.
- Do not drive with the head restraints removed.

**Adjusting a head restraint vertically**

■ Front seats

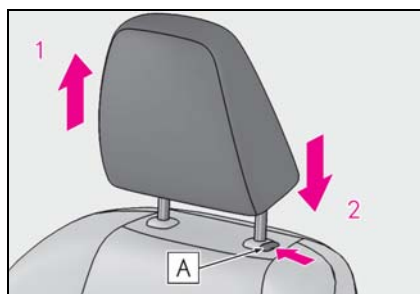

- 1 Up

Pull the head restraints up.

- 2 Down

Push the head restraint down while pressing the lock release button **A**.



■ **Second-row seats**

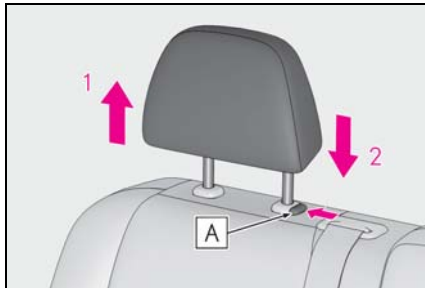

- 1 Up**  
Pull the head restraints up.
- 2 Down**  
Push the head restraint down while pressing the lock release button **A**.

■ **Third-row seats (RX350L)**

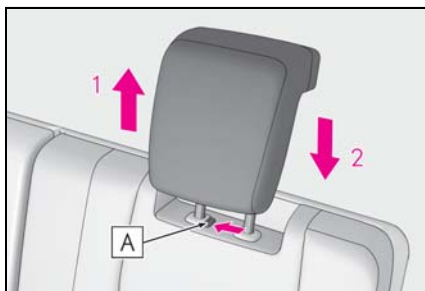

- 1 Up**  
Pull the head restraints up.
- 2 Down**  
Push the head restraint down while pressing the lock release button **A**.

■ **Adjusting the height of the head restraints**

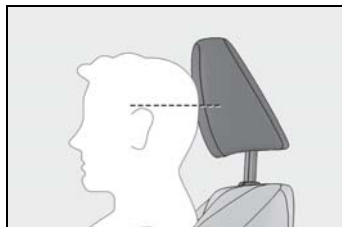

Make sure that the head restraints are adjusted so that the center of the head restraint is closest to the top of your ears.

■ **Adjusting the second-row center and third-row seat head restraints**

Always raise the head restraint one level from the stowed position when using.

**Adjusting a head restraint horizontally (if equipped)**

The position of the head restraint can be adjusted forward in 4 stages.

If the head restraint is pulled forward from the foremost position, it will return to the rearmost position.

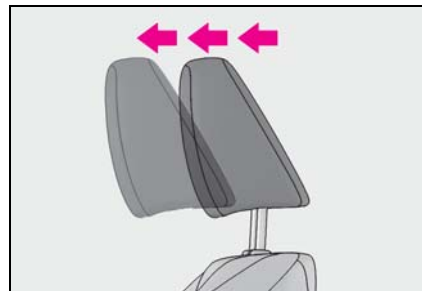

**Removing the head restraints**

■ **Front and second-row seats**

Pull the head restraint up while pressing the lock release button **A**.

If the head restraint touches the ceiling, making the removal difficult, change the seat height or angle. (→P.121, 122)

**3**

Before driving

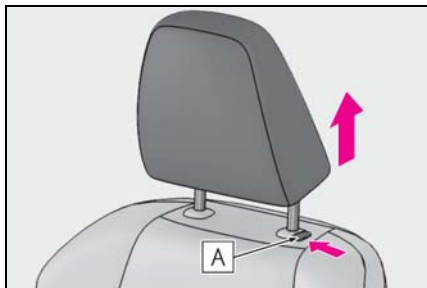

#### ■ Third-row seats (RX350L)

Pull the head restraint up while pressing the lock release button **A**.

If the head restraint touches the ceiling, making the removal difficult, change the seat angle. (→P.122)

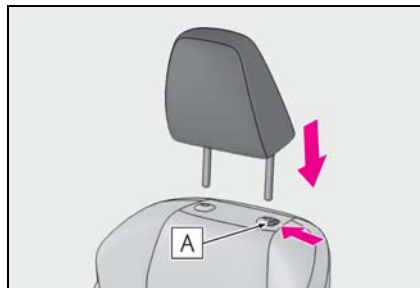

#### ■ Third-row seats (RX350L)

Align the head restraint with the installation holes and push it down to the lock position.

Press and hold the lock release button **A** when lowering the head restraint.

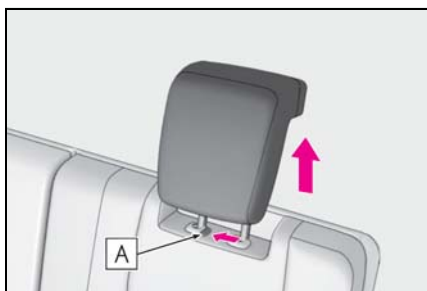

### Installing the head restraints

#### ■ Front and second-row seats

Align the head restraint with the installation holes and push it down to the lock position.

Press and hold the lock release button **A** when lowering the head restraint.

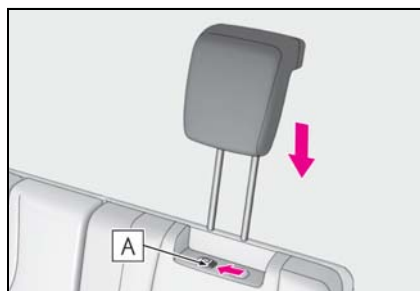

## Steering wheel

### Adjustment procedure

Operating the switch moves the steering wheel in the following directions:

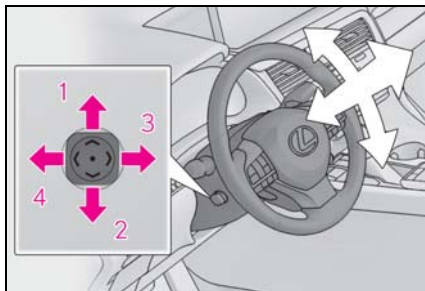

- 1 Up
- 2 Down
- 3 Toward the driver
- 4 Away from the driver

#### ■ The steering wheel can be adjusted when

The engine switch is in ACCESSORY or IGNITION ON mode\*.

\*: If the driver's seat belt is fastened, the steering wheel can be adjusted regardless of engine switch mode.

#### ■ Automatic adjustment of the steering position (if equipped)

A desired steering position can be entered to memory and recalled automatically by the driving position memory system. (→P.133)

#### ■ Power easy access system

The steering wheel and driver's seat (on some models) move in accordance with engine switch mode and the driver's seat belt condition. (→P.133)

#### ■ Customization

Some functions can be customized. (→P.461)

### ⚠ WARNING

#### ■ Caution while driving

Do not adjust the steering wheel while driving. Doing so may cause the driver to mishandle the vehicle and cause an accident, resulting in death or serious injury.

### Auto tilt away

When the engine switch is turned off, the steering wheel returns to its stowed position by moving up and away to enable easier driver entry and exit.

Turning the engine switch to ACCESSORY or IGNITION ON mode will return the steering wheel to the original position.

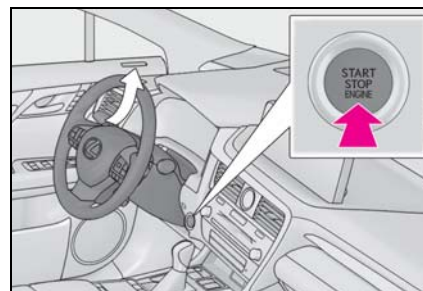

### Sounding the horn

Press on or close to the  mark.

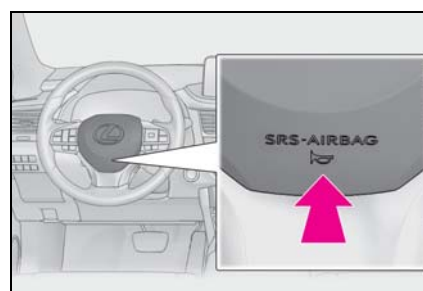

3

Before driving

### Inside rear view mirror

The rear view mirror's position can be adjusted to enable sufficient confirmation of the rear view.

### Adjusting the height of rear view mirror

The height of the rear view mirror can be adjusted to suit your driving posture.

Adjust the height of the rear view mirror by moving it up and down.

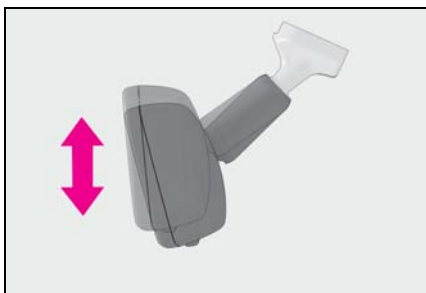

### ⚠ WARNING

#### ■ Caution while driving

Do not adjust the position of the mirror while driving. Doing so may lead to mishandling of the vehicle and cause an accident, resulting in death or serious injury.

### Anti-glare function

Responding to the level of brightness of the headlights of vehicles behind, the reflected light is automatically reduced.

Turn the automatic anti-glare function mode on/off

When the automatic anti-glare function is in ON mode, the indicator **A** illuminates. The function will set to ON mode each time the engine switch is turned to IGNITION ON mode.

Pressing the button turns the function to OFF mode. (The indicator **A** also turns off.)

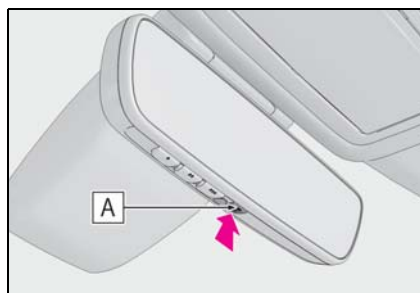

### ■ To prevent sensor error

To ensure that the sensors operate properly, do not touch or cover them.

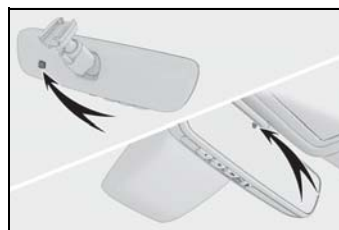

## Outside rear view mirrors

The rear view mirror's position can be adjusted to enable sufficient confirmation of the rear view.

### ⚠ WARNING

#### ■ Important points while driving

Observe the following precautions while driving.

Failing to do so may result in loss of control of the vehicle and cause an accident, resulting in death or serious injury.

- Do not adjust the mirrors while driving.
- Do not drive with the mirrors folded.
- Both the driver and passenger side mirrors must be extended and properly adjusted before driving.

### Adjustment procedure

- 1 To select a mirror to adjust, press the switch.

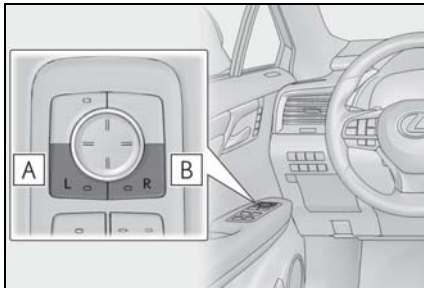

- A** Left
- B** Right

Pressing the same switch again will put the switch in neutral.

- 2 To adjust the mirror, press the switch.

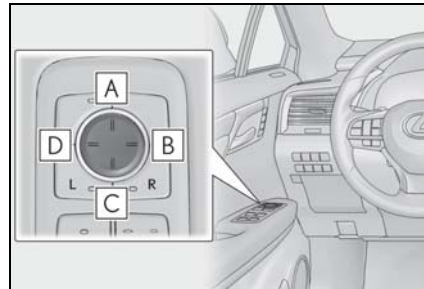

- A** Up
- B** Right
- C** Down
- D** Left

#### ■ Mirror angle can be adjusted when

The engine switch is in ACCESSORY or IGNITION ON mode.

#### ■ Defogging the mirrors

The outside rear view mirrors can be cleared using the mirror defoggers. Turn on the rear window defogger to turn on the outside rear view mirror defoggers. (→P.294)

#### ■ Automatic adjustment of the mirror angle (if equipped)

A desired mirror face angle can be entered to memory and recalled automatically by the driving position memory. (→P.133)

#### ■ Auto anti-glare function (if equipped)

When the anti-glare inside rear view mirror is set to automatic mode, the outside rear view mirrors will activate in conjunction with the anti-glare inside rear view mirror to reduce reflected light. (→P.140)

#### ■ Linked mirror function when reversing

When either "L" or "R" of the mirror select switch is selected, the outside rear view mirrors will automatically angle downwards when the vehicle is reversing in order to give a better view of the ground.

To disable this function, select neither "L"

nor "R".

To set the mirror angle used when the vehicle is reversing, adjust the mirror angle at a desired position with the shift lever in R.

The adjusted angle will be memorized and the mirror will automatically tilt to the memorized angle whenever the shift lever is shifted to R from next time.

The memorized downward tilt position of the mirror is linked to the normal position (angle adjusted with the shift lever in other than R). Therefore, if the normal position is changed after adjustment, the tilt position will also change.

When the normal position is changed, readjust the angle in reversing.



#### WARNING

##### ■ When the mirror defoggers are operating

Do not touch the rear view mirror surfaces, as they can become very hot and burn you.

#### Folding the mirrors (manual type)

Push the mirror back in the direction of the vehicle's rear.

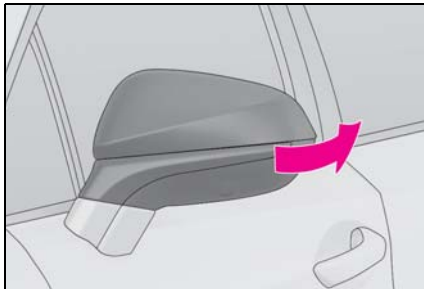

#### Folding and extending the mirrors (power type)

##### ■ Using the switch

Press the switch to fold the mirrors.

Press it again to extend them to the original position.

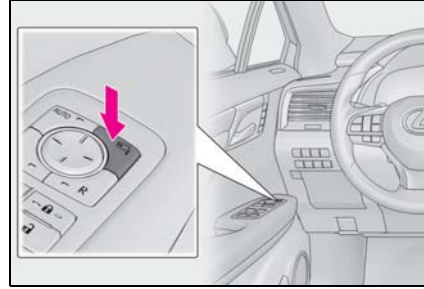

##### ■ Setting automatic mode

Automatic mode allows the folding or extending of the mirrors to be linked to locking/unlocking of the doors.

Press the "AUTO" switch to set automatic mode.

The indicator **A** will come on.

Pressing the switch once more will return to manual mode.

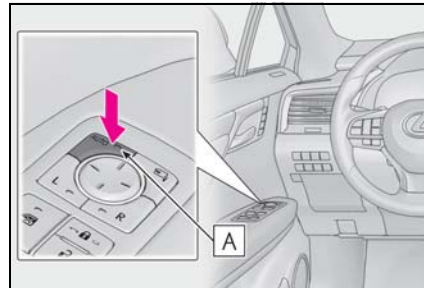

##### ■ When disconnecting and reconnecting battery terminals (power type)

The automatic folding/extending mirror function will return to off as default. To turn the function on, press the switch again to select on.

##### ■ Using automatic mode in cold weather (if equipped)

When automatic mode is used in cold weather, the door mirror could freeze up and automatic stowing and return may not be possible. In this case, remove any ice and

snow from the door mirror, then either operate the mirror using manual mode or move the mirror by hand.

#### ■ Customization

Some functions can be customized.  
(→P.461)



#### WARNING

##### ■ When a mirror is moving

To avoid personal injury and mirror malfunction, be careful not to get your hand caught by the moving mirror.

## Power windows

### Opening and closing the power windows

The power windows can be opened and closed using the switches.

Operating the switch moves the windows as follows:

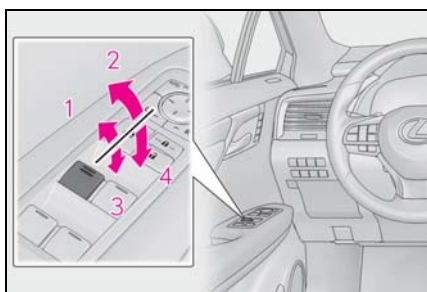

- 1 Closing
- 2 One-touch closing \*
- 3 Opening
- 4 One-touch opening \*

\* : To stop the window partway, operate the switch in the opposite direction.

#### ■ The power windows can be operated when

The engine switch is in IGNITION ON mode.

#### ■ Operating the power windows after turning the engine off

The power windows can be operated for approximately 45 seconds even after the engine switch is turned to ACCESSORY mode or turned off. They cannot, however, be operated once either front door is opened.

#### ■ Jam protection function

If an object becomes jammed between the window and the window frame while the window is closing, window movement is stopped and the window is opened slightly.

#### ■ Catch protection function

If an object becomes caught between the door and window while the window is opening, window movement is stopped.

#### ■ When the window cannot be opened or closed

When the jam protection function or catch protection function operates unusually and the door window cannot be opened or closed, perform the following operations with the power window switch of that door.

- Stop the vehicle. With the engine switch in IGNITION ON mode, within 4 seconds of the jam protection function or catch protection function activating, continuously operate the power window switch in the one-touch closing direction or one-touch opening direction so that the door window can be opened and closed.

- If the door window cannot be opened and closed even when performing the above operations, perform the following procedure for function initialization.

- 1 Turn the engine switch to IGNITION ON mode.
- 2 Pull and hold the power window switch in the one-touch closing direction and completely close the door window.
- 3 Release the power window switch for a moment, resume pulling the switch in the one-touch closing direction, and hold it there for approximately 6 seconds or more.
- 4 Press and hold the power window switch in the one-touch opening direction. After the door window is completely opened, continue holding the switch for an additional 1 second or more.
- 5 Release the power window switch for a moment, resume pushing the switch in the one-touch opening direction, and hold it there for approximately 4 seconds or more.
- 6 Pull and hold the power window switch in the one-touch closing direction again. After the door window is completely closed, continue holding the switch for a further 1 second or more.



If you release the switch while the window is moving, start again from the beginning. If the window reverses and cannot be fully closed or opened, have the vehicle inspected by your Lexus dealer.

#### ■ Door lock linked window operation

- The power windows can be opened and closed using the mechanical key.\* (→P.432)
- The power windows can be opened using the wireless remote control.\* (→P.99)

\*: These settings must be customized at your Lexus dealer.

#### ■ Alarm

The alarm may be triggered if the alarm is set and a power window is closed using the door lock linked power window operation function. (→P.68)

#### ■ Power windows open warning buzzer

A buzzer sounds and a message is shown on the multi-information display in the instrument cluster when the engine switch is turned off and the driver's door is opened with the power windows open.

#### ■ Customization

Some functions can be customized. (→P.461)

### ⚠ WARNING

Observe the following precautions. Failing to do so may result in death or serious injury.

#### ■ Closing the windows

- The driver is responsible for all the power window operations, including the operation for the passengers. In order to prevent accidental operation, especially by a child, do not let a child operate the power windows. It is possible for children and other passengers to have body parts caught in the power window. Also, when riding with a child, it is recommended to use the window lock switch. (→P.146)

- Check to make sure that all passengers do not have any part of their body in a position where it could be caught when a window is being operated.

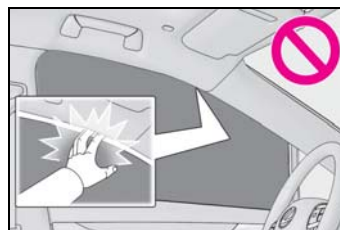

- When using the wireless remote control or mechanical key and operating the power windows, operate the power window after checking to make sure that there is no possibility of any passenger having any of their body parts caught in the window. Also do not let a child operate window by the wireless remote control or mechanical key. It is possible for children and other passengers to get caught in the power window.

- When exiting the vehicle, turn the engine switch off, carry the key and exit the vehicle along with the child. There may be accidental operation, due to mischief, etc., that may possibly lead to an accident.

#### ■ Jam protection function

- Never use any part of your body to intentionally activate the jam protection function.
- The jam protection function may not work if something gets jammed just before the window is fully closed. Be careful not to get any part of your body jammed in the window.

#### ■ Catch protection function

- Never use any part of your body or clothing to intentionally activate the catch protection function.

**⚠ WARNING**

- The catch protection function may not work if something gets caught just before the window is fully opened. Be careful not to get any part of your body or clothing caught in the window.

**Preventing accidental operation (window lock switch)**

This function can be used to prevent children from accidentally opening or closing a passenger window.

Press the switch.

The indicator **A** will come on and the passenger windows will be locked.

The passenger windows can still be opened and closed using the driver's switch even if the lock switch is on.

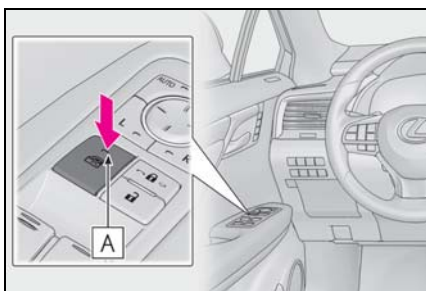
**■ The power windows can be operated when**

The engine switch is in IGNITION ON mode.

**■ When the battery is disconnected**

The window lock switch is disabled. If necessary, press the window lock switch after reconnecting the battery.

**Moon roof\***

\*: If equipped

Use the overhead switches to open and close the moon roof and tilt it up and down.

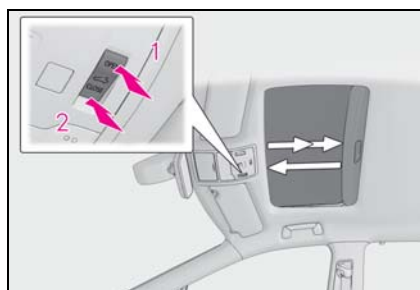
**Operating the moon roof****■ Opening and closing****1 Opens the moon roof\***

The moon roof stops slightly before the fully open position to reduce wind noise. Press the switch again to fully open the moon roof.

**2 Closes the moon roof\***

\*: Lightly press either side of the moon roof switch to stop the moon roof partway.

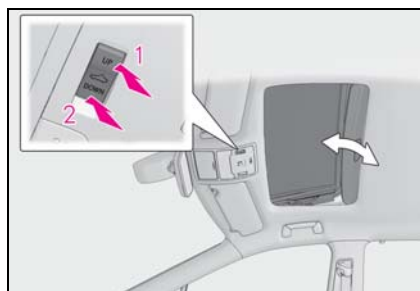
**■ Tilting up and down****1 Tilts the moon roof up\*****2 Tilts the moon roof down\***

\*: Lightly press either side of the moon roof switch to stop the moon roof partway.

#### ■ The moon roof can be operated when

The engine switch is in IGNITION ON mode.

#### ■ Operating the moon roof after turning the engine off

The moon roof can be operated for approximately 45 seconds after the engine switch is turned to ACCESSORY mode or turned off. It cannot, however, be operated once the driver's door is opened.

#### ■ Jam protection function

If an object is detected between the moon roof and the frame while the moon roof is closing or tilting down, travel is stopped and the moon roof opens slightly.

#### ■ Sunshade

The sunshade can be opened and closed manually. However, the sunshade will open automatically when the moon roof is opened.

#### ■ Door lock linked moon roof operation

- The moon roof can be opened and closed using the mechanical key.\* (→P.432)
- The moon roof can be opened using the wireless remote control.\* (→P.99)
- The alarm may be triggered if the alarm is set and the moon roof is closed using the door lock linked moon roof operation function. (→P.68)

\*: These settings must be customized at your Lexus dealer.

#### ■ When the moon roof does not close normally

Perform the following procedure:

- ▶ If the moon roof closes but then re-opens slightly

- 1 Stop the vehicle.
- 2 Press and hold the "CLOSE" switch.\*<sup>1</sup>

The moon roof will close, reopen and pause for approximately 10 seconds.\*<sup>2</sup> Then it will

close again, tilt up and pause for approximately 1 second. Finally, it will tilt down, open and close.

- 3 Check to make sure that the moon roof is completely closed and then release the switch.

- ▶ If the moon roof tilts down but then tilts back up

- 1 Stop the vehicle.
- 2 Press and hold the "UP" switch\*<sup>1</sup> until the moon roof moves into the tilt up position and stops.
- 3 Release the "UP" switch once and then press and hold the "UP" switch again.\*<sup>1</sup>The moon roof will pause for approximately 10 seconds in the tilt up position.\*<sup>2</sup> Then it will adjust slightly and pause for approximately 1 second. Finally, it will tilt down, open and close.
- 4 Check to make sure that the moon roof is completely closed and then release the switch.

\*<sup>1</sup>: If the switch is released at the incorrect time, the procedure will have to be performed again from the beginning.

\*<sup>2</sup>: If the switch is released after the above mentioned 10 second pause, automatic operation will be disabled. In that case, press and hold the "CLOSE" or "UP" switch, and the moon roof will tilt up and pause for approximately 1 second. Then it will tilt down, open and close. Check to make sure that the moon roof is completely closed and then release the switch.

If the moon roof does not fully close even after performing the above procedure correctly, have the vehicle inspected by your Lexus dealer.

#### ■ Moon roof open warning buzzer

A buzzer sounds and a message is shown on the multi-information display in the instrument cluster when the engine switch is turned off and the driver's door is opened with the moon roof open.

### ■ Customization

Some functions can be customized.  
(→P.461)

### ⚠ WARNING

Observe the following precautions.  
Failing to do so may cause death or serious injury.

#### ■ Opening the moon roof

- Do not allow any passengers to put their hands or heads outside the vehicle while it is moving.
- Do not sit on top of the moon roof.

#### ■ Opening and closing the moon roof

- The driver is responsible for moon roof opening and closing operations. In order to prevent accidental operation, especially by a child, do not let a child operate the moon roof. It is possible for children and other passengers to have body parts caught in the moon roof.
- Check to make sure that all passengers do not have any part of their body in a position where it could be caught when the moon roof is being operated.

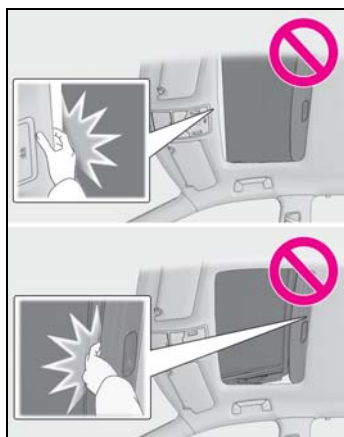

- When using the wireless remote control or mechanical key and operating the moon roof, operate the moon roof after checking to make sure that there is no possibility of any passenger having any of their body parts caught in the moon roof. Also, do not let a child operate moon roof by the wireless remote control or mechanical key. It is possible for children and other passengers to get caught in the moon roof.

- When exiting the vehicle, turn the engine switch off, carry the key and exit the vehicle along with the child. There may be accidental operation, due to mischief, etc., that may possibly lead to an accident.

#### ■ Jam protection function

- Never use any part of your body to intentionally activate the jam protection function.
- The jam protection function may not work if something gets caught just before the moon roof is fully closed. Also, the jam protection function is not designed to operate while the switch is being pressed. Take care so that your fingers, etc. do not get caught.

### Panoramic moon roof\*

\*: If equipped

Use the overhead switches to operate the panoramic moon roof and electronic sunshade.

### Operating the panoramic moon roof

#### ■ Opening and closing the electronic sunshade

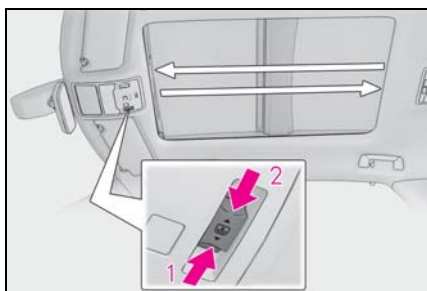

#### 1 Opens the electronic sunshade

Slide and hold the  switch backward. The electronic sunshade will fully open automatically.\*

#### 2 Closes the electronic sunshade

Slide and hold the  switch forward. The electronic sunshade will fully close automatically.\*

\*: Quickly slide and release the  switch in either direction to stop the electronic sunshade partway.

#### ■ Tilting the panoramic moon roof up and down

Tilts the panoramic moon roof up (press)\*

When the panoramic moon roof is tilted

up, the electronic sunshade will open to the half-open position of the roof.

\*: Lightly press the  switch again to stop the panoramic moon roof partway.

Tilts the panoramic moon roof down (press and hold)

The panoramic moon roof can be tilted down only when it is in the tilt-up position.

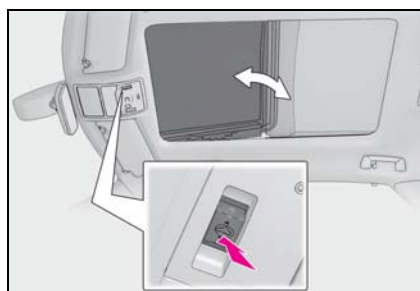

#### ■ Opening and closing the panoramic moon roof

Opens the panoramic moon roof\*

Slide and hold the  switch backward. The panoramic moon roof and electronic sunshade will open automatically.

The panoramic moon roof can be opened from the tilt-up position.

\*: Quickly slide and release the  switch in either direction to stop the panoramic moon roof partway.

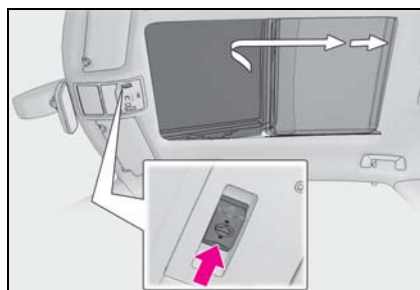

3

Before driving

Closes the panoramic moon roof

Slide and hold the  switch forward. The panoramic moon roof will fully close automatically.

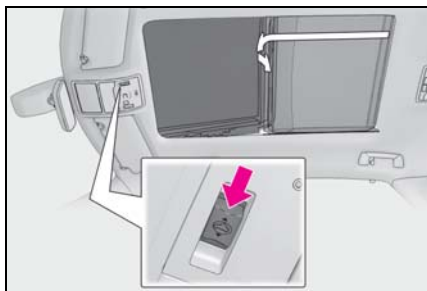

#### ■ The panoramic moon roof can be operated when

The engine switch is in IGNITION ON mode.

#### ■ Operating the panoramic moon roof after turning the engine off

The panoramic moon roof and electronic sunshade can be operated for approximately 45 seconds after the engine switch is turned to ACCESSORY mode or turned off. They cannot, however, be operated once the driver's door is opened.

#### ■ Jam protection function

If an object is detected between the panoramic moon roof and the frame in the following situations, travel is stopped and the panoramic moon roof opens slightly:

- The panoramic moon roof is closing or tilting down.
- The electronic sunshade is closing.

#### ■ Door lock linked panoramic moon roof operation

- The panoramic moon roof can be opened and closed using the mechanical key.\* (→P.432)
- The panoramic moon roof can be opened using the wireless remote control.\* (→P.99)

\* : These settings must be customized at your Lexus dealer.



#### ■ Closing both the panoramic moon roof and electronic sunshade

Slide the  switch forward.

The electronic sunshade will close to the half-open position and pause. The panoramic moon roof will then fully close. Then the electronic sunshade will fully close.

#### ■ When the panoramic moon roof or electronic sunshade does not close normally

Perform the following procedure:

- 1 Stop the vehicle.
- 2 Turn the engine switch to IGNITION ON mode.
- 3 Slide and hold the  switch or  switch forward. Continue pressing the switch for approximately 10 seconds after the panoramic moon roof or electronic sunshade closes and reopens. The panoramic moon roof and electronic sunshade will start to close.\*
- 4 Check that the panoramic moon roof and electronic sunshade are fully closed and release the switch.

\* : If the switch is released at the incorrect time, the procedure will have to be performed again from the beginning.

If the panoramic moon roof or electronic sunshade does not fully close even after performing the above procedure correctly, have the vehicle inspected by your Lexus dealer.

#### ■ Alarm

The alarm may be triggered if the alarm is set and the panoramic moon roof is closed using the door lock linked panoramic moon roof operation function. (→P.69)

#### ■ Panoramic moon roof open warning buzzer

A buzzer sounds and a message is shown on the multi-information display in the instrument cluster when the engine switch is turned off and the driver's door is opened with the panoramic moon roof open.

#### ■ Customization

Some functions can be customized. (→P.461)

**⚠ WARNING**

Observe the following precautions. Failing to do so may cause death or serious injury.

**■ Opening and closing the electronic sunshade**

- Check to make sure that all passengers do not have any part of their body in a position where it could be caught when the electronic sunshade is being operated.



- Do not let a child operate the electronic sunshade. Closing the electronic sunshade on someone can cause death or serious injury.

**■ Opening and closing the panoramic moon roof**

- The driver is responsible for panoramic moon roof opening and closing operations. In order to prevent accidental operation, especially by a child, do not let a child operate the panoramic moon roof. It is possible for children and other passengers to have body parts caught in the panoramic moon roof.

- Check to make sure that all passengers do not have any part of their body in a position where it could be caught when the panoramic moon roof is being operated.

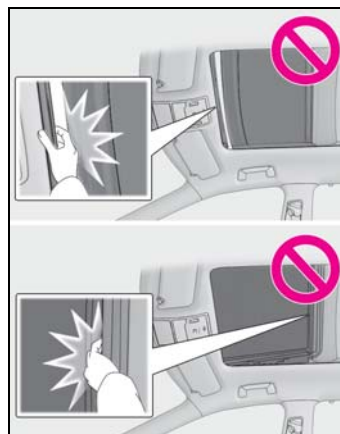

- When using the wireless remote control or mechanical key and operating the panoramic moon roof, operate the panoramic moon roof after checking to make sure that there is no possibility of any passenger having any of their body parts caught in the panoramic moon roof. Also, do not let a child operate panoramic moon roof by the wireless remote control or mechanical key. It is possible for children and other passengers to get caught in the panoramic moon roof.
- When exiting the vehicle, turn the engine switch off, carry the key and exit the vehicle along with the child. There may be accidental operation, due to mischief, etc., that may possibly lead to an accident.

**■ Jam protection function**

- Never use any part of your body to intentionally activate the jam protection function.

**WARNING**

- The jam protection function may not work if something gets caught just before the panoramic moon roof or electronic sunshade is fully closed. Also, the jam protection function is not designed to operate while the switch is being pressed. Take care so that your fingers, etc. do not get caught.

**■ To prevent burns or injuries**

Do not touch the area between the underside of the panoramic moon roof and the electronic sunshade. Your hand may get caught and you could injure yourself. Also, if the vehicle is left in direct sunlight for a long time, the underside of the panoramic moon roof could become very hot and could cause burns.

**NOTICE****■ To prevent damage to the panoramic moon roof**

- Before opening the panoramic moon roof, make sure that there are no foreign objects, such as stones or ice, around the opening.
- Do not hit the surface or edge of the panoramic moon roof with hard objects.
- Do not continuously press the  switch after the panoramic moon roof has been fully opened or closed.

**■ After the vehicle has been washed or rained on**

Before opening the panoramic moon roof, wipe any water off the panoramic moon roof. Otherwise, water may enter the cabin when the panoramic moon roof is opened.



- 4-1. Before driving**
  - Driving the vehicle..... **154**
  - Cargo and luggage..... **159**
  - Vehicle load limits..... **162**
  - Trailer towing (vehicles without towing package)..... **163**
  - Trailer towing (vehicles with towing package)..... **163**
  - Dinghy towing ..... **173**
- 4-2. Driving procedures**
  - Engine (ignition) switch ..... **174**
  - Automatic transmission..... **178**
  - Turn signal lever..... **182**
  - Parking brake ..... **183**
  - Brake Hold..... **186**
- 4-3. Operating the lights and wipers**
  - Headlight switch..... **188**
  - AHB (Automatic High Beam) ..... **191**
  - Fog light switch ..... **194**
  - Windshield wipers and washer ..... **194**
  - Rear window wiper and washer ..... **199**
- 4-4. Refueling**
  - Opening the fuel tank cap..... **200**
- 4-5. Using the driving support systems**
  - Lexus Safety System + 2.0..... **203**
  - PCS (Pre-Collision System) ..... **209**
  - LTA (Lane Tracing Assist) ..... **216**
  - RSA (Road Sign Assist)..... **225**
  - Dynamic radar cruise control with full-speed range..... **227**
  - BSM (Blind Spot Monitor).... **236**
  - PKSA (Parking Support Alert) ..... **242**
  - Intuitive parking assist ..... **244**
  - RCTA (Rear cross traffic alert) function..... **250**
  - PKSB (Parking Support Brake) ..... **255**
  - Parking Support Brake function (static objects)..... **261**
  - Parking Support Brake function (rear-crossing vehicles) ..... **267**
  - Driving mode select switch .... **271**
  - All-wheel drive lock switch... **273**
  - Driving assist systems..... **274**
- 4-6. Driving tips**
  - Winter driving tips ..... **280**
  - Utility vehicle precautions..... **282**

## Driving the vehicle

The following procedures should be observed to ensure safe driving:

### Driving procedure

#### ■ Starting the engine

→P.174

#### ■ Driving

- 1 With the brake pedal depressed, shift the shift lever to D. (→P.178)
- 2 Release the parking brake. (→P.183)

If the parking brake is in automatic mode, the parking brake is released automatically when shifting the shift lever to any position other than P. (→P.184)

- 3 Gradually release the brake pedal and gently depress the accelerator pedal to accelerate the vehicle.

#### ■ Stopping

- 1 With the shift lever in D, depress the brake pedal.
- 2 If necessary, set the parking brake. (→P.183)

If the vehicle is to be stopped for an extended period of time, shift the shift lever to P or N. (→P.178)

#### ■ Parking the vehicle

- 1 With the shift lever in D, depress the brake pedal.
- 2 Set the parking brake (→P.183), and shift the shift lever to P (→P.178).
- 3 Press the engine switch to stop the engine.

- 4 Lock the door, making sure that you have the electronic key on your person.

If parking on a hill, block the wheels as needed.

#### ■ Starting off on a steep uphill

- 1 With the brake pedal depressed, shift the shift lever to D. (→P.179)
- 2 Pull the parking brake switch and parking brake is set manually. (→P.183)
- 3 Release the brake pedal and gently depress the accelerator pedal to accelerate the vehicle.
- 4 Press the parking brake switch and parking brake is released manually.

#### ■ When starting off on a uphill

The hill-start assist control will activate. (→P.275)

#### ■ Driving in the rain

- Drive carefully when it is raining, because visibility will be reduced, the windows may become fogged-up, and the road will be slippery.
- Drive carefully when it starts to rain, because the road surface will be especially slippery.
- Refrain from high speeds when driving on an expressway in the rain, because there may be a layer of water between the tires and the road surface, preventing the steering and brakes from operating properly.

#### ■ Engine speed while driving

In the following conditions, the engine speed may become high while driving. This is due to automatic up-shifting control or down-shifting implementation to meet driving conditions. It does not indicate sudden acceleration.

- The vehicle is judged to be driving uphill or downhill

- When the accelerator pedal is released
- When the brake pedal is depressed while sport mode is selected

■ **Restraining the engine output (Brake Override System)**

- When the accelerator and brake pedals are depressed at the same time, the engine output may be restrained.
- A warning message is displayed on the multi-information display and head-up display (if equipped) while the system is operating.

■ **Restraining sudden start (Drive-Start Control)**

- When the following unusual operation is performed, the engine output may be restrained.
  - When the shift lever is shifted from R to D, D to R, N to R, P to D, or P to R (D includes M) with the accelerator pedal depressed, a warning message appears on the multi-information display and head-up display (if equipped). If a warning message is shown on the multi-information display and head-up display (if equipped), read the message and follow the instructions.
  - When the accelerator pedal is depressed too much while the vehicle is in reverse.
- While Drive-Start Control is being activated, your vehicle may have trouble escaping from the mud or fresh snow. In such case, deactivate TRAC (→P.276) to cancel Drive-Start Control so that the vehicle may become able to escape from the mud or fresh snow.

■ **Breaking in your new Lexus**

To extend the life of the vehicle, observing the following precautions is recommended:

- For the first 200 miles (300 km):  
Avoid sudden stops.
- For the first 500 miles (800 km):  
Do not tow a trailer.
- For the first 1000 miles (1600 km):
  - Do not drive at extremely high speeds.
  - Avoid sudden acceleration.
  - Do not drive continuously in low gears.
  - Do not drive at a constant speed for

extended periods.

■ **Operating your vehicle in a foreign country**

Comply with the relevant vehicle registration laws and confirm the availability of the correct fuel. (→P.444)

■ **Eco-friendly driving**

→P.83

 **WARNING**

Observe the following precautions. Failure to do so may result in death or serious injury.

■ **When starting the vehicle**

Always keep your foot on the brake pedal while stopped the engine running. This prevents the vehicle from creeping.

■ **When driving the vehicle**

- Do not drive if you are unfamiliar with the location of the brake and accelerator pedals to avoid depressing the wrong pedal.
  - Accidentally depressing the accelerator pedal instead of the brake pedal will result in sudden acceleration that may lead to an accident.
  - When backing up, you may twist your body around, leading to a difficulty in operating the pedals. Make sure to operate the pedals properly.
  - Make sure to keep a correct driving posture even when moving the vehicle only slightly. This allows you to depress the brake and accelerator pedals properly.
  - Depress the brake pedal using your right foot. Depressing the brake pedal using your left foot may delay response in an emergency, resulting in an accident.

**WARNING**

- Do not drive the vehicle over or stop the vehicle near flammable materials. The exhaust system and exhaust gases can be extremely hot. These hot parts may cause a fire if there is any flammable material nearby.
- During normal driving, do not turn off the engine. Turning the engine off while driving will not cause loss of steering or braking control, but the power assist to these systems will be lost. This will make it more difficult to steer and brake, so you should pull over and stop the vehicle as soon as it is safe to do so. However, in the event of an emergency, such as if it becomes impossible to stop the vehicle in the normal way: →P.394
- Use engine braking (downshift) to maintain a safe speed when driving down a steep hill. Using the brakes continuously may cause the brakes to overheat and lose effectiveness. (→P.178)
- Do not adjust the positions of the steering wheel, the seat, or the inside or outside rear view mirrors while driving. Doing so may result in a loss of vehicle control.
- Always check that all passengers' arms, heads or other parts of their body are not outside the vehicle.
- AWD models: Do not drive the vehicle off-road. This is not an AWD vehicle designed for off-road driving. Proceed with all due caution if it becomes unavoidable to drive off-road.
- Do not drive across a river or through other bodies of water. This may cause electric/electronic components to short circuit, damage the engine or cause other serious damage to the vehicle.

- Do not drive in excess of the speed limit. Even if the legal speed limit permits it, do not drive over 85 mph (140 km/h) unless your vehicle has high-speed capability tires. Driving over 85 mph (140 km/h) may result in tire failure, loss of control and possible injury. Be sure to consult a tire dealer to determine whether the tires on your vehicle are high-speed capability tires or not before driving at such speeds.

**■ When driving on slippery road surfaces**

- Sudden braking, acceleration and steering may cause tire slippage and reduce your ability to control the vehicle.
- Sudden acceleration, engine braking due to shifting, or changes in engine speed could cause the vehicle to skid.
- After driving through a puddle, lightly depress the brake pedal to make sure that the brakes are functioning properly. Wet brake pads may prevent the brakes from functioning properly. If the brakes on only one side are wet and not functioning properly, steering control may be affected.

**■ When shifting the shift lever**

- Do not let the vehicle roll backward while the shift lever is in a driving position, or roll forward while the shift lever is in R. Doing so may cause the engine to stall or lead to poor brake and steering performance, resulting in an accident or damage to the vehicle.
- Do not shift the shift lever to P while the vehicle is moving. Doing so can damage the transmission and may result in a loss of vehicle control.
- Do not shift the shift lever to R while the vehicle is moving forward. Doing so can damage the transmission and may result in a loss of vehicle control.

**⚠ WARNING**

- Do not shift the shift lever to a driving position while the vehicle is moving backward. Doing so can damage the transmission and may result in a loss of vehicle control.
- Shifting the shift lever to N while the vehicle is moving will disengage the engine. Engine braking is not available when N is selected.
- Be careful not to shift the shift lever with the accelerator pedal depressed. Shifting the shift lever to any position other than P or N may lead to unexpected rapid acceleration of the vehicle that may cause an accident and result in death or serious injury.

**■ If you hear a squealing or scraping noise (brake pad wear limit indicators)**

Have the brake pads checked and replaced by your Lexus dealer as soon as possible. Rotor damage may result if the pads are not replaced when needed.

It is dangerous to drive the vehicle when the wear limits of the brake pads and/or those of the brake discs are exceeded.

**■ When the vehicle is stopped**

- Do not race the engine. If the shift lever is in any position other than P or N, the vehicle may accelerate suddenly and unexpectedly, causing an accident.
- In order to prevent accidents due to the vehicle rolling away, always keep depressing the brake pedal while the engine is running, and apply the parking brake as necessary.
- If the vehicle is stopped on an incline, in order to prevent accidents caused by the vehicle rolling forward or backward, always depress the brake pedal and securely apply the parking brake as needed.

- Avoid revving or racing the engine. Running the engine at high speed while the vehicle is stopped may cause the exhaust system to overheat, which could result in a fire if combustible material is nearby.

**■ When the vehicle is parked**

- Do not leave glasses, cigarette lighters, spray cans, or soft drink cans in the vehicle when it is in the sun. Doing so may result in the following:
  - Gas may leak from a cigarette lighter or spray can, and may lead to a fire.
  - The temperature inside the vehicle may cause the plastic lenses and plastic material of glasses to deform or crack.
  - Soft drink cans may fracture, causing the contents to spray over the interior of the vehicle, and may also cause a short circuit in the vehicle's electrical components.
- Do not leave cigarette lighters in the vehicle. If a cigarette lighter is in a place such as the glove box or on the floor, it may be lit accidentally when luggage is loaded or the seat is adjusted, causing a fire.
- Do not attach adhesive discs to the windshield or windows. Do not place containers such as air fresheners on the instrument panel or dashboard. Adhesive discs or containers may act as lenses, causing a fire in the vehicle.
- Do not leave a door or window open if the curved glass is coated with a metallized film such as a silver-colored one. Reflected sunlight may cause the glass to act as a lens, causing a fire.

 **WARNING**

- Always apply the parking brake, shift the shift lever to P, stop the engine and lock the vehicle.  
Do not leave the vehicle unattended while the engine is running.  
If the vehicle is parked with the shift lever in P but the parking brake is not set, the vehicle may start to move, possibly leading to an accident.

- Do not touch the exhaust pipes while the engine is running or immediately after turning the engine off.  
Doing so may cause burns.

■ **When taking a nap in the vehicle**

Always turn the engine off. Otherwise, if you accidentally move the shift lever or depress the accelerator pedal, this could cause an accident or fire due to engine overheating. Additionally, if the vehicle is parked in a poorly ventilated area, exhaust gases may collect and enter the vehicle, leading to death or a serious health hazard.

■ **When braking**

- When the brakes are wet, drive more cautiously.  
Braking distance increases when the brakes are wet, and this may cause one side of the vehicle to brake differently than the other side. Also, the parking brake may not securely hold the vehicle.
- If the brake booster device does not operate, do not follow other vehicles closely and avoid hills or sharp turns that require braking.  
In this case, braking is still possible, but the brake pedal should be depressed more firmly than usual. Also, the braking distance will increase. Have your brakes fixed immediately.
- Do not pump the brake pedal if the engine stalls.  
Each push on the brake pedal uses up the reserve for the power-assisted brakes.

- The brake system consists of 2 individual hydraulic systems; if one of the systems fails, the other will still operate. In this case, the brake pedal should be depressed more firmly than usual and the braking distance will increase.  
Have your brakes fixed immediately.

■ **If the vehicle becomes stuck (AWD models)**

Do not spin the wheels excessively when any of the tires is up in the air, or the vehicle is stuck in sand, mud, etc. This may damage the driveline components or propel the vehicle forward or backward, causing an accident.

 **NOTICE**

■ **When driving the vehicle**

- Do not depress the accelerator and brake pedals at the same time during driving, as this may restrain the engine output.
- Do not use the accelerator pedal or depress the accelerator and brake pedals at the same time to hold the vehicle on a hill.

■ **When parking the vehicle**

Always set the parking brake and shift the shift lever to P. Failure to do so may cause the vehicle to move or the vehicle may accelerate suddenly if the accelerator pedal is accidentally depressed.

■ **Avoiding damage to vehicle parts**

- Do not turn the steering wheel fully in either direction and hold it there for an extended period of time.  
Doing so may damage the power steering motor.
- When driving over bumps on the road, drive as slowly as possible to avoid damaging the wheels, underside of the vehicle, etc.

**NOTICE****■ If you get a flat tire while driving**

A flat or damaged tire may cause the following situations. Hold the steering wheel firmly and gradually depress the brake pedal to slow down the vehicle.

- It may be difficult to control your vehicle.
- The vehicle will make abnormal sounds or vibrations.
- The vehicle will lean abnormally.

Information on what to do in case of a flat tire (→P.416)

**■ When encountering flooded roads**

Do not drive on a road that has flooded after heavy rain etc. Doing so may cause the following serious damage to the vehicle:

- Engine stalling
- Short in electrical components
- Engine damage caused by water immersion

In the event that you drive on a flooded road and the vehicle is flooded, be sure to have your Lexus dealer check the following:

- Brake function
- Changes in quantity and quality of oil and fluid used for the engine, transaxle, transfer (AWD models), rear differential (AWD models), etc.
- Lubricant condition for the propeller shaft (AWD models), bearings and suspension joints (where possible), and the function of all joints, bearings, etc.

**Cargo and luggage**

**Take notice of the following information about storage precautions, cargo capacity and load.**

**Capacity and distribution**

Cargo capacity depends on the total weight of the occupants.

(Cargo capacity) = (Total load capacity) – (Total weight of occupants)

Steps for Determining Correct Load Limit –

(1) Locate the statement “The combined weight of occupants and cargo should never exceed XXX kg or XXX lbs.” on your vehicle’s placard.

(2) Determine the combined weight of the driver and passengers that will be riding in your vehicle.

(3) Subtract the combined weight of the driver and passengers from XXX kg or XXX lbs.

(4) The resulting figure equals the available amount of cargo and luggage load capacity.

For example, if the “XXX” amount equals 1400 lbs. and there will be five 150 lb passengers in your vehicle, the amount of available cargo and luggage load capacity is 650 lbs. (1400 – 750 (5 × 150) = 650 lbs.)

(5) Determine the combined weight of luggage and cargo being loaded on the vehicle. That weight may not safely exceed the available cargo and lug-

gage load capacity calculated in Step 4.

(6) If your vehicle will be towing a trailer, load from your trailer will be transferred to your vehicle. Consult this manual to determine how this reduces the available cargo and luggage load capacity of your vehicle. (→P.162)

Vehicles without towing package: Lexus does not recommend towing a trailer with your vehicle. Your vehicle is not designed for trailer towing.

**Calculation formula for your vehicle**

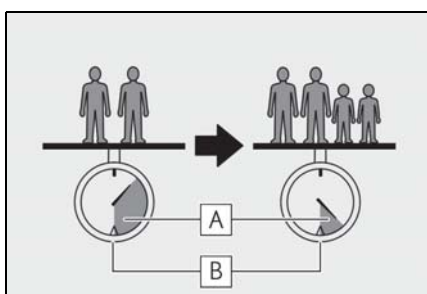

- A** Cargo capacity
- B** Total load capacity (vehicle capacity weight) (→P.442)

When 2 people with the combined weight of A lb. (kg) are riding in your vehicle, which has a total load capacity (vehicle capacity weight) of B lb. (kg), the available amount of cargo and luggage load capacity will be C lb. (kg) as follows:

$$B^{*2} \text{ lb. (kg)} - A^{*1} \text{ lb. (kg)} = C^{*3} \text{ lb. (kg)}$$

\*1: A =Weight of people

\*2: B =Total load capacity

\*3: C =Available cargo and luggage load

In this condition, if 3 more passengers with the combined weight of D lb. (kg) get on, the available cargo and luggage load will be reduced E lb. (kg) as follows:

$$C \text{ lb. (kg)} - D^{*4} \text{ lb. (kg)} = E^{*5} \text{ lb. (kg)}$$

\*4: D =Additional weight of people

\*5: E =Available cargo and luggage load

As shown in the example above, if the number of occupants increases, the cargo and luggage load will be reduced by an amount that equals the increased weight due to the additional occupants. In other words, if an increase in the number of occupants causes an excess of the total load capacity (combined weight of occupants plus cargo and luggage load), you must reduce the cargo and luggage on your vehicle.

**WARNING**

**Things that must not be carried in the luggage compartment**

The following things may cause a fire if loaded in the luggage compartment:

- Receptacles containing gasoline
- Aerosol cans

**Storage precautions**

Observe the following precautions. Failure to do so may prevent the pedals from being depressed properly, may block the driver's vision, or may result in items hitting the driver or passengers, possibly causing an accident.

- Stow cargo and luggage in the luggage compartment whenever possible.



**⚠ WARNING**

- Do not stack cargo and luggage in the luggage compartment higher than the seatbacks.
- When you fold down the rear seats, long items should not be placed directly behind the front seats.
- Never allow anyone to ride in the luggage compartment. It is not designed for passengers. They should ride in their seats with their seat belts properly fastened.
- Do not place cargo or luggage in or on the following locations.
  - At the feet of the driver
  - On the front passenger or rear seats (when stacking items)
  - On the luggage cover
  - On the instrument panel
  - On the dashboard
- Secure all items in the occupant compartment.
- **Capacity and distribution**
  - Do not exceed the maximum axle weight rating or the total vehicle weight rating.
  - Even if the total load of occupant's weight and the cargo load is less than the total load capacity, do not apply the load unevenly. Improper loading may cause deterioration of steering or braking control which may cause death or serious injury.
- **Roof luggage carrier precautions**

Observe the following precautions:

  - Place the cargo so that its weight is distributed evenly between the front and rear axles.
  - If loading long or wide cargo, never exceed the vehicle overall length or width. (→P.442)

- Before driving, make sure the cargo is securely fastened on the roof luggage carrier.
- Loading cargo on the roof luggage carrier will make the center of gravity of the vehicle higher. Avoid high speeds, sudden starts, sharp turns, sudden braking or abrupt maneuvers, otherwise it may result in loss of control or vehicle rollover due to failure to operate this vehicle correctly and result in death or serious injury.
- If driving for a long distance, on rough roads, or at high speeds, stop the vehicle now and then during the trip to make sure the cargo remains in its place.
- Do not exceed 165 lb. (75 kg) cargo weight on the roof luggage carrier.

**⚠ NOTICE**

- **When loading cargo (vehicles with a moon roof or panoramic moon roof)**  
Be careful not to scratch the surface of the moon roof or panoramic moon roof.

## Vehicle load limits

Vehicle load limits include total load capacity, seating capacity, trailer weight rating and cargo capacity.

- Total load capacity (vehicle capacity weight): →P.442

Total load capacity means the combined weight of occupants, cargo and luggage.

- Seating capacity (RX350): →P.443

Seating capacity means the maximum number of occupants whose estimated average weight is 150 lb. (68 kg) per person.

- Seating capacity (RX350L): →P.443

Seating capacity means the maximum number of occupants whose estimated average weight is 150 lb. (68 kg) per person.

- TWR (Trailer Weight Rating) (vehicles with towing package): →P.168, 442

TWR means the maximum gross trailer weight (trailer weight plus its cargo weight) that your vehicle is able to tow.

- TWR (Trailer Weight Rating) (vehicles without towing package)

Lexus does not recommend towing a trailer with your vehicle.

- Cargo capacity

Cargo capacity may increase or decrease depending on the weight and the number of occupants.

### ■ Total load capacity and seating capacity

These details are also described on the tire and loading information label. (→P.373)

### WARNING

#### ■ Overloading the vehicle

Do not overload the vehicle. It may not only cause damage to the tires, but also degrade steering and braking ability, resulting in an accident.

### Trailer towing (vehicles without towing package)

Lexus does not recommend towing a trailer with your vehicle. Lexus also does not recommend the installation of a tow hitch or the use of a tow hitch carrier for a wheelchair, scooter, bicycle, etc. Your vehicle is not designed for trailer towing or for the use of tow hitch mounted carriers.



### Trailer towing (vehicles with towing package)

Your vehicle is designed primarily as a passenger-and-load-carrying vehicle. Towing a trailer can have an adverse impact on handling, performance, braking, durability, and fuel consumption. For your safety and the safety of others, you must not overload your vehicle or trailer. You must also ensure that you are using appropriate towing equipment, that the towing equipment has been installed correctly and used properly, and that you employ the requisite driving habits.

Vehicle-trailer stability and braking performance are affected by trailer stability, brake performance and setting, trailer brakes, the hitch and hitch systems (if equipped).

To tow a trailer safely, use extreme care and drive the vehicle in accordance with your trailer's characteristics and operating conditions.

Lexus warranties do not apply to damage or malfunction caused by towing a trailer for commercial purposes.

Contact your Lexus dealer for further information about additional requirements such as a towing kit, etc.

#### ■ Matching trailer ball height to trailer coupler height

No matter which class of tow hitch applies,

for a more safe trailer hookup, the trailer ball setup must be the proper height for the coupler on the trailer.

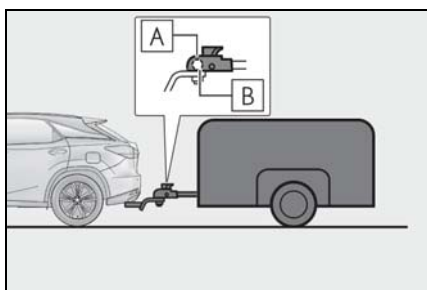
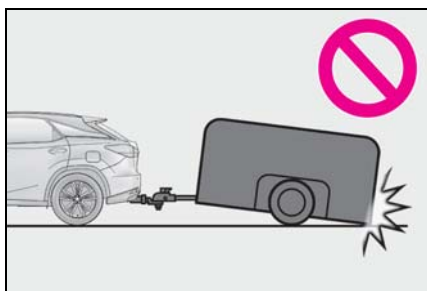

**A** Coupler

**B** Trailer ball

■ **Before towing**

Check that the following conditions are met:

- Ensure that your vehicle's tires are properly inflated. (→P.448)
- Trailer tires are inflated according to the trailer manufacturer's recommendation.
- All trailer lights work as required by law.
- All lights work each time you connect them.
- The trailer ball is set at the proper height for the coupler on the trailer.
- The trailer is level when it is hitched. Do not drive if the trailer is not level, and check for improper tongue weight, overloading, worn suspension, or other possible causes.
- The trailer cargo is securely loaded.
- The rear view mirrors conform to all applicable federal, state/provincial or

local regulations. If they do not, install rear view mirrors appropriate for towing purposes.

■ **Adaptive Variable Suspension System (if equipped)**

The suspension can be switched for improvement in driveability. (→P.275)

■ **Break-in schedule**

If your vehicle is new or equipped with any new power train components (such as an engine, transaxle, transfer [AWD models], rear differential [AWD models] or wheel bearing), Lexus recommends that you do not tow a trailer until the vehicle has been driven for over 500 miles (800 km).

After the vehicle has been driven for over 500 miles (800 km), you can start towing. However, for the next 500 miles (800 km), drive the vehicle at a speed of less than 50 mph (80 km/h) when towing a trailer, and avoid full throttle acceleration.

■ **Maintenance**

- If you tow a trailer, your vehicle will require more frequent maintenance due to the additional load. (See "Warranty and Services Guide", "Owner's Manual Supplement" or "Scheduled Maintenance".)
- Retighten the fixing bolts of the towing ball and bracket after approximately 600 miles (1000 km) of trailer towing.

■ **If trailer sway occurs**

One or more factors (crosswinds, passing vehicles, rough roads, etc.) can adversely affect handling of your vehicle and trailer, causing instability.

- If trailer swaying occurs:
  - Firmly grip the steering wheel. Steer straight ahead. Do not try to control trailer swaying by turning the steering wheel.
  - Begin releasing the accelerator pedal immediately but very gradually to reduce speed. Do not increase speed. Do not apply vehicle brakes.

If you make no extreme correction with the steering or brakes, your vehicle and trailer should stabilize. (if enabled, Trailer Sway

Control can also help to stabilize the vehicle and trailer.)

- After the trailer swaying has stopped:
  - Stop in a safe place. Get all occupants out of the vehicle.
  - Check the tires of the vehicle and the trailer.
  - Check the load in the trailer. Make sure the load has not shifted. Make sure the tongue weight is appropriate, if possible.
  - Check the load in the vehicle. Make sure the vehicle is not overloaded after occupants get in.

If you cannot find any problems, the speed at which trailer swaying occurred is beyond the limit of your particular vehicle-trailer combination. Drive at a lower speed to prevent instability. Remember that swaying of the towing vehicle-trailer increases as speed increases.

 **WARNING**

■ **Trailer towing precautions**

To tow a trailer safely, use extreme care and drive the vehicle in accordance with the trailer's characteristics and operating conditions. Failure to do so could cause an accident resulting in death or serious injury. Vehicle stability and braking performance are affected by trailer stability, brake setting and performance, and the hitch. Your vehicle will handle differently when towing a trailer.

■ **To avoid accident or injury**

- Do not exceed the TWR, unbraked TWR, GCWR, GVWR or GAWR.
- If the gross trailer weight is over 2000 lb. (907 kg), a sway control device with sufficient capacity is required.
- Adjust the tongue weight within the appropriate range. Place heavier loads as close to the trailer axle as possible.

- Do not exceed 65 mph (104 km/h), the posted towing speed limit or the speed limit for your trailer as set forth in your trailer owner's manual, whichever is lowest. Slow down sufficiently before making a turn, in cross winds, on wet or slippery surface, etc. to help avoid an accident. If you experience a vehicle-trailer instability from reducing a certain speed, slow down and make sure you keep your vehicle speed under the speed of which you experience the instability.
- Do not make jerky, abrupt or sharp turns.
- Do not apply the brakes suddenly as you may skid, resulting in jackknifing and loss of vehicle control. This is especially true on wet or slippery surfaces.
- Do not exceed the trailer hitch assembly weight, gross vehicle weight, gross axle weight and trailer tongue weight capacities.
- Do not use the following systems when trailer towing.
  - Dynamic radar cruise control with full-speed range
  - LTA (Lane Tracing Assist)
  - PCS (Pre-Collision System)
  - BSM (Blind Spot Monitor) (if equipped)
- Slow down and downshift before descending steep or long downhill grades. Do not make sudden downshifts while descending steep or long downhill grades.

**⚠ WARNING**

- Vehicle-trailer instability is more likely on steep long downhills. Before descending steep or long downhill grades, slow down and downshift. Do not make sudden downshifts when descending steep or long downhill grades. Avoid holding the brake pedal down too long or applying the brakes too frequently. This could cause the brakes to overheat and result in reduced braking efficiency.

- Do not tow a trailer when the compact spare tire is installed on your vehicle.

**■ When towing a trailer**

Lexus recommends trailers with brakes that conform to any applicable federal and state/provincial regulations.

- If the gross trailer weight exceeds unbraked TWR, trailer brakes are required. Lexus recommends trailers with brakes that conform to all applicable federal and state/provincial regulations.

- Never tap into your vehicle's hydraulic system, as this will lower the vehicle's braking effectiveness.

- Never tow a trailer without using a safety chain securely attached to both the trailer and the vehicle. If damage occurs to the coupling unit or hitch ball, there is danger of the trailer wandering into another lane.

**⚠ NOTICE****■ When installing a trailer hitch**

Use only the position recommended by your Lexus dealer. Do not install the trailer hitch on the bumper; this may cause body damage.

**■ Do not directly splice trailer lights**

Do not directly splice trailer lights. Directly splicing trailer lights may damage your vehicle's electrical system and cause a malfunction.

**Towing related terms****■ GCWR (Gross Combination Weight Rating)**

The maximum allowable gross combination weight. The gross combination weight is the sum of the total vehicle weight (including the occupants, cargo and any optional equipment installed on the vehicle) and the weight of the trailer being towed (including the cargo in the trailer).

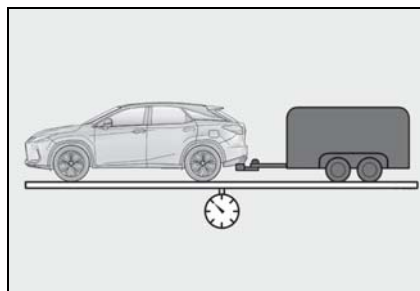
**■ GVWR (Gross Vehicle Weight Rating)**

The maximum allowable gross vehicle weight. The gross vehicle weight is the total weight of the vehicle. When towing a trailer, it is the sum of the vehicle weight (including the occupants, cargo and any optional equipment installed on the vehicle) and the tongue weight.

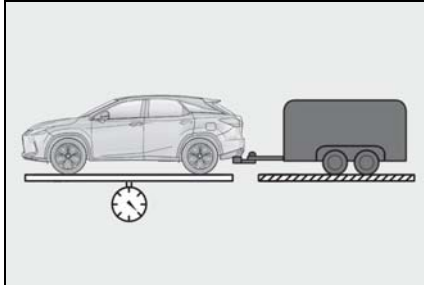

■ **GAWR (Gross Axle Weight Rating)**

The maximum allowable gross axle weight. The gross axle weight is the load placed on each axle (front and rear).

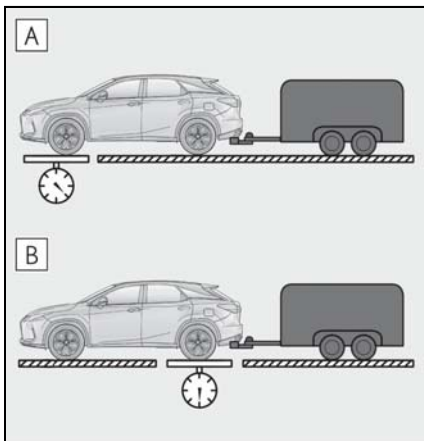

**A** Front GAWR

**B** Rear GAWR

■ **TWR (Trailer Weight Rating)**

The maximum allowable gross trailer weight. The gross trailer weight is the sum of the trailer weight and the weight of the cargo in the trailer.

TWR is calculated assuming base vehicle with one driver, one front passenger, towing package (if available), hitch and hitch systems (if required).

Additional optional equipment, passengers and cargo in the vehicle will reduce the trailer weight rating so as not to exceed GCWR, GVWR and GAWR.

If the gross trailer weight exceeds 3000 lb. (1360 kg), it is recommended to use a trailer with 2 or more axles.

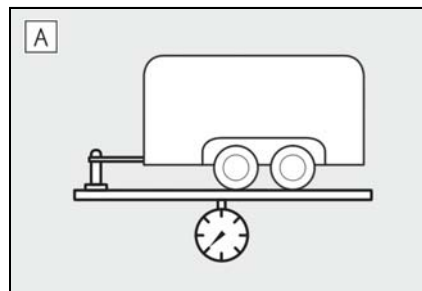

**A** With brakes

■ **Unbraked TWR (Unbraked Trailer Weight Rating)**

The trailer weight rating for towing a trailer without a trailer service brake system.

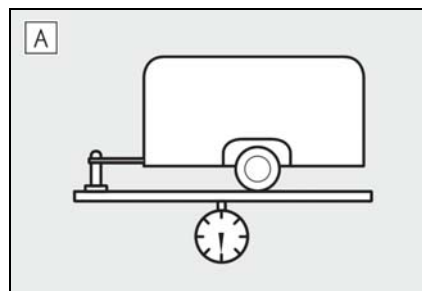

**A** Without brakes

■ **Tongue Weight**

The load placed on the trailer hitch ball. (→P.168)

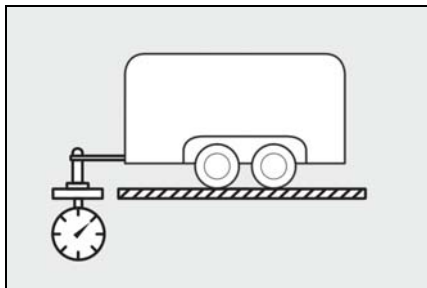

### Weight limits

- The gross trailer weight must never exceed 3500 lb. (1585 kg).
- The gross combination weight must never exceed the following:
  - ▶ RX350  
2WD models: 9165 lb. (4157 kg)  
AWD models: 9360 lb. (4246 kg)
  - ▶ RX350L  
2WD models: 9400 lb. (4263 kg)  
AWD models: 9485 lb. (4302 kg)
- The gross vehicle weight must never exceed the GVWR indicated on the Certification Label. (→P.443)
- The gross axle weight on each axle must never exceed the GAWR indicated on the Certification Label. (→P.443)
- If the gross trailer weight is over the unbraked TWR, trailer service brakes are required.
- If the gross trailer weight is over 2000 lb. (907 kg), a sway control device with sufficient capacity is required.

### GCWR, TWR and Unbraked TWR

Confirm that the gross trailer weight, gross combination weight, gross vehicle weight, gross axle weight and tongue weight are all within the limits.

#### ■ GCWR\*

##### ▶ RX350

2WD models: 9165 lb. (4157 kg)

AWD models: 9360 lb. (4246 kg)

##### ▶ RX350L

2WD models: 9400 lb. (4263 kg)

AWD models: 9485 lb. (4302 kg)

#### ■ TWR\*

3500 lb. (1585 kg)

#### ■ Unbraked TWR\*

1000 lb. (453 kg)

\*: This models meet the tow-vehicle trailering requirement of SAE International per SAE J2807.

### Trailer Tongue Weight

- A recommended tongue weight varies in accordance with the types of trailers or towing as described below.
- To ensure the recommended values shown below, the trailer must be loaded by referring to the following instructions.
  - Tongue Weight

The gross trailer weight should be distributed so that the tongue weight is 9% to 11%.



(Tongue weight/Gross trailer weight x 100 = 9% to 11%)

The gross trailer weight, gross axle weight and tongue weight can be measured with platform scales found at a highway weighing station, building supply company, trucking company, junk yard, etc.

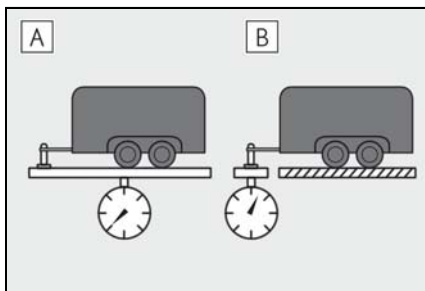

**A** Gross trailer weight

**B** Tongue weight

### Hitch

Trailer hitch assemblies have different weight capacities. Lexus recommends the use of Lexus hitch/bracket for your vehicle. For details, contact your Lexus dealer.

- If you wish to install a trailer hitch, contact your Lexus dealer.
- Use only a hitch that conforms to the gross trailer weight requirement of your vehicle.
- Follow the directions supplied by the hitch manufacturer.
- Lubricate the hitch ball with a light coating of grease.
- Remove the hitch ball whenever you are not towing a trailer. Remove the trailer hitch if you do not need it. After removing the hitch, seal any

mounting hole in the vehicle body to prevent entry of any substances into the vehicle.

### **WARNING**

#### Hitches

Trailer hitch assemblies have different weight capacities established by the hitch manufacturer. Even though the vehicle may be physically capable of towing a higher weight, the operator must determine the maximum weight rating of the particular hitch assembly and never exceed the maximum weight rating specified for the trailer-hitch. Exceeding the maximum weight rating set by the trailer-hitch manufacturer can cause an accident resulting in death or serious personal injuries.

### Selecting trailer ball

Use the correct trailer ball for your application.

Trailer class	Typical trailer ball size
IV	2 5/16 in.
II and III	2 in.
I	1 7/8 in.

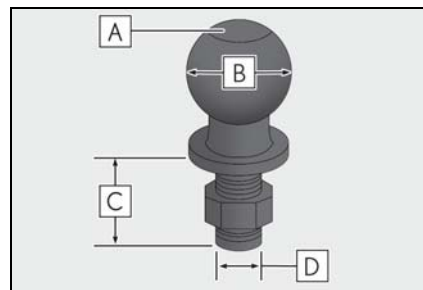

**A** Trailer ball load rating

Matches or exceeds the gross trailer weight rating of the trailer.

**B** Ball diameter

Matches the size of the trailer coupler. Most couplers are stamped with the required trailer ball size.

**C** Shank length

Protrudes beyond the bottom of the lock washer and nut by at least 2 threads.

**D** Shank diameter

Matches the ball mount hole diameter size.

### Positions for towing hitch receiver and hitch ball

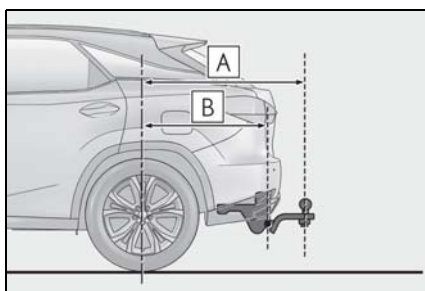
**A** Weight carrying ball position

- RX350 : 44.96 in. (1142 mm)
- RX350L : 49.72 in. (1263 mm)

**B** Hitch receiver pin hole position

- RX350 : 35.94 in. (913 mm)
- RX350L : 45.08 in. (1145 mm)

### Connecting trailer lights

Use the wire harness stored in the rear end under body.

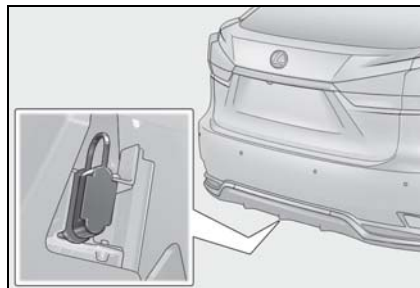
**Auto current cut-off function**

In case of over current, the auto cut-off function stops the power flowing to the trailer lights to prevent damage to the vehicle's electrical system.

This function is activated when the rated current of any of the following trailer light circuit components is exceeded:

- Tail lights: maximum 7.8 A
- Stop/turn signal light (right): maximum 4.5 A
- Stop/turn signal light (left): maximum 4.5 A

**When the auto current cut function is activated**

If a trailer light does not come on due to the activation of the auto current cut function, the light system will need to be reset.

Follow the reset procedure shown below.

- If a tail light does not come on, turn off the headlight switch.
- If the right-side stop/turn signal light does not come on, put the turn signal in the off position or remove foot from the brake pedal.
- If the left-side stop/turn signal light does not come on, put the turn signal in the off position or remove foot from the brake pedal.

If the emergency flashers do not operate, press the emergency flasher switch to turn them off.

After the light system is reset, operate the light switches again to see if the lights operate normally.

If the lights do not operate normally, have

the vehicle inspected by your Lexus dealer.

### Trailer towing tips

Your vehicle will handle differently when towing a trailer. Help to avoid an accident, death or serious injury, keep the following in mind when towing:

- Speed limits for towing a trailer vary by state or province. Do not exceed the posted towing speed limit.
- Lexus recommends that the vehicle-trailer speed limit is 65 mph (104 km/h) on a flat, straight, dry road. Do not exceed this limit, the posted towing speed limit or the speed limit for your trailer as set forth in your trailer owner's manual, whichever is lowest. Instability of the towing vehicle-trailer combination (trailer sway) increases as speed increases. Exceeding speed limits may cause loss of control.
- Before starting out, check the trailer lights, tires and the vehicle-trailer connections. Recheck after driving a short distance.
- Practice turning, stopping and reversing with the trailer attached in an area away from traffic until you become accustomed to the feel of the vehicle-trailer combination.
- Reversing with a trailer attached is difficult and requires practice. Grip the bottom of the steering wheel and move your hand to the left to move the trailer to the left. Move your hand to the right to move the trailer to right. (This is generally opposite to reversing without a trailer attached.) Avoid sharp or prolonged turning. Have someone guide you when reversing to reduce the risk of an accident.
- As stopping distance is increased when towing a trailer, vehicle-to-vehicle distance should be increased. For each 10 mph (16 km/h) of speed, allow at least one vehicle and trailer length.
- Avoid sudden braking as you may skid, resulting in the trailer jackknifing and a loss of vehicle control. This is especially true on wet or slippery surfaces.
- Avoid jerky starts or sudden acceleration.
- Avoid jerky steering and sharp turns, and slow down before making turn.
- Note that when making a turn, the trailer wheels will be closer than the vehicle wheels to the inside of the turn. Compensate by making a wider than normal turning radius.
- Slow down before making a turn, in cross winds, on wet or slippery surfaces, etc. Increasing vehicle speed can destabilize the trailer.
- Take care when passing other vehicles. Passing requires considerable distance. After passing a vehicle, do not forget the length of your trailer, and be sure you have plenty of room before changing lanes.
- To maintain engine braking efficiency and charging system perfor-

mance when using engine braking, do not put the transmission in D. If in the M mode, the transmission shift range position must be in 6 or lower. (→P.178)

- Instability happens more frequently when descending steep or long downhill grades. Before descending, slow down and downshift. Do not make sudden downshifts while descending steep or long downhill grades.
  - Avoid holding the brake pedal down too long or applying the brakes too frequently. This could cause the brakes to overheat and result in reduced braking efficiency.
  - Due to the added load of the trailer, your vehicle's engine may overheat on hot days (at temperatures over 85°F [30°C]) when driving up a long or steep grade. If the engine coolant temperature gauge indicates overheating, immediately turn off the air conditioning (if in use), pull your vehicle off the road and stop in a safe spot. (→P.437)
  - Always place wheel blocks under both the vehicle's and the trailer's wheels when parking. Put the transmission in P and apply the parking brake. Avoid parking on a slope, but if unavoidable, do so only after performing the following:
    - 1 Apply the brakes and keep them applied.
    - 2 Have someone place wheel blocks under both the vehicle's and trailer's wheels.
    - 3 When the wheel blocks are in place, release the brakes slowly until the blocks absorb the load.
    - 4 Shift into P and apply the parking brake.
    - 5 Turn off the engine.
- When restarting after parking on a slope:
    - 1 With the transmission in P, start the engine. Be sure to keep the brake pedal depressed.
    - 2 Shift into a forward gear. If reversing, shift into R.
    - 3 If the parking brake is in manual mode, release the parking brake. (→P.183)
    - 4 Release the brake pedal, and slowly pull or back away from the wheel blocks. Stop and apply the brakes.
    - 5 Have someone retrieve the blocks.

**Dinghy towing**

Your vehicle is not designed to be dinghy towed (with 4 wheels on the ground) behind a motor home.

 NOTICE

■ To avoid serious damage to your vehicle

Do not tow your vehicle with the four wheels on the ground.

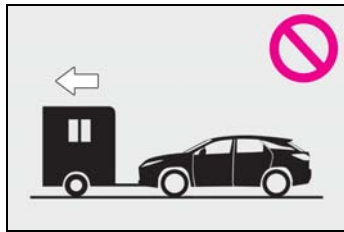

■ To prevent causing serious damage to the transmission and Dynamic Torque Control AWD system (AWD models)

2WD models: Never tow this vehicle from the rear with the front wheels on the ground.

This may cause serious damage to the transmission.

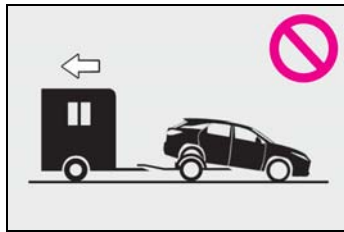

AWD models: Never tow this vehicle with any of the wheels on the ground. This may cause serious damage to the transmission and Dynamic Torque Control AWD system.

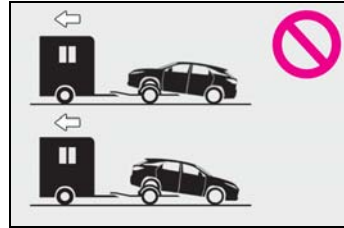

## Engine (ignition) switch

Performing the following operations when carrying the electronic key on your person starts the engine or changes engine switch modes.

### Starting the engine

- 1 Check that the parking brake is set.
- 2 Check that the shift lever is in P.
- 3 Firmly depress the brake pedal.

 and a message will be displayed on the multi-information display. If it is not displayed, the engine cannot be started.

- 4 Press the engine switch shortly and firmly.

When operating the engine switch, one short, firm press is enough. It is not necessary to press and hold the switch.

The engine will crank until it starts or for up to 30 seconds, whichever is less.

Continue depressing the brake pedal until the engine is completely started.

The engine can be started from any engine switch mode.

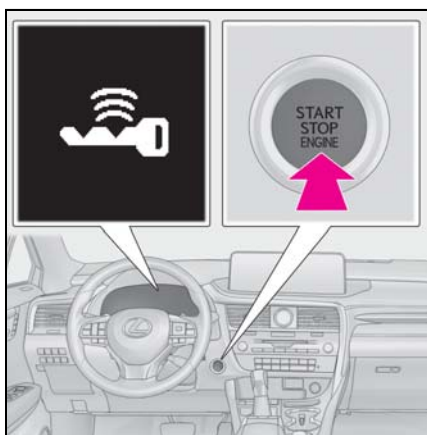

### ■ Engine switch illumination

According to the situation, the engine switch illumination operates as follows.

- When a door is opened, or the engine switch mode is changed from ACCESSORY or IGNITION ON mode to off, the engine switch illumination slowly blinks.
- When depressing the brake pedal with carrying the electronic key on your person, the engine switch illumination rapidly blinks.
- When the engine switch is in ACCESSORY or IGNITION ON mode, the engine switch illumination illuminates.

### ■ If the engine does not start

- The engine immobilizer system may not have been deactivated. (→P.66)  
Contact your Lexus dealer.
- Check that the shift lever is securely set in P. The engine may not start if the shift lever is displaced out of P. "To Start Vehicle, Put Shift Lever into P" will be displayed on the multi-information display.
- If the door is unlocked with the mechanical key, the engine cannot be started using the smart access system with push-button start. Refer to P.432 to start the engine. However, if the electronic key is carried inside the vehicle and the doors are locked (→P.101), the engine can be started.

### ■ Electronic key battery depletion

→P.96

### ■ Conditions affecting operation

→P.116

### ■ Note for the entry function

→P.117

### ■ Steering lock function

- After turning the engine switch off and opening and closing the doors, the steering wheel will be locked due to the steering lock function. Operating the engine switch again automatically cancels the steering lock.
- When the steering lock cannot be

released, "Steering Wheel Lock Press Engine Switch while Turning Wheel" will be displayed on the multi-information display.

Check that the shift lever is in P. Press the engine switch shortly and firmly while turning the steering wheel left and right.

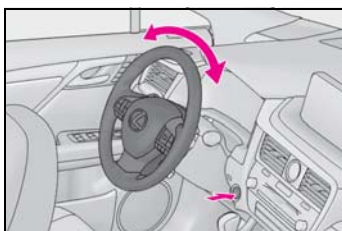

- To prevent the steering lock motor from overheating, operation of the motor may be suspended if the engine is turned on and off repeatedly in a short period of time. In this case, refrain from operating the engine switch. After about 10 seconds, the steering lock motor will resume functioning.

■ **When "Access System with Elec. Key Malfunction See Owner's Manual" is displayed on the multi-information display**

The system may be malfunctioning. Have the vehicle inspected by your Lexus dealer immediately.

■ **Electronic key battery**

→P.379

■ **Operation of the engine switch**

- If the switch is not pressed shortly and firmly, the engine switch mode may not change or the engine may not start.
- If attempting to restart the engine immediately after turning the engine switch off, the engine may not start in some cases. After turning the engine switch off, please wait a few seconds before restarting the engine.

■ **Customization**

If the smart access system with push-button start has been deactivated in a customized setting, refer to P.431.

**! WARNING**

■ **When starting the engine**

Always start the engine while sitting in the driver's seat. Do not depress the accelerator pedal while starting the engine under any circumstances. Doing so may cause an accident resulting in death or serious injury.

■ **Caution while driving**

If engine failure occurs while the vehicle is moving, do not lock or open the doors until the vehicle reaches a safe and complete stop. Activation of the steering lock in this circumstance may lead to an accident, resulting in death or serious injury.

**! NOTICE**

■ **When starting the engine**

- Do not race a cold engine.
- If the engine becomes difficult to start or stalls frequently, have your vehicle checked by your Lexus dealer immediately.

■ **Symptoms indicating a malfunction with the engine switch**

If the engine switch seems to be operating somewhat differently than usual, such as the switch sticking slightly, there may be a malfunction. Contact your Lexus dealer immediately.

**Stopping the engine**

- 1 Stop the vehicle completely.
- 2 Set the parking brake (→P.183), and shift the shift lever to P.
- 3 Press the engine switch.
- 4 Release the brake pedal and check that the display on the meters is off.

■ **Automatic engine shut off feature**

- The vehicle is equipped with a feature

that automatically shuts off the engine when the shift lever is in P with the engine running for an extended period.

- The engine will automatically shut off after approximately 1 hour if it has been left running while the shift lever is in P.
- The timer for the automatic engine shut off feature will reset if the brake pedal is depressed or if the shift lever is in a position other than P.
- After the vehicle is parked, if the door is locked with the door lock switch (→P.101) from the inside or the mechanical key from the outside, the automatic engine shut off feature will be disabled. The timer for the automatic engine shut off feature will be re-enabled if the driver's door is opened.

#### ■ Locking the door from outside with the engine running

- 1 With the driver's door open, pull the driver's door handle and insert the mechanical key.

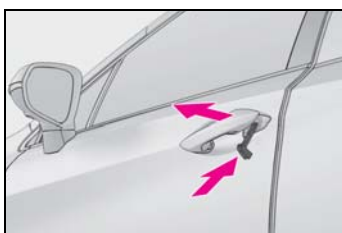

- 2 Turn the mechanical key counterclockwise.



- 3 Pull out the mechanical key and close the door.

#### ⚠ WARNING

##### ■ Stopping the engine in an emergency

If you want to stop the engine in an emergency while driving the vehicle, press and hold the engine switch for more than 2 seconds, or press it briefly 3 times or more in succession. (→P.394)

However, do not touch the engine switch while driving except in an emergency. Turning the engine off while driving will not cause loss of steering or braking control, but the power assist to these systems will be lost. This will make it more difficult to steer and brake, so you should pull over and stop the vehicle as soon as it is safe to do so.

##### ■ When parking

Exhaust gases include harmful carbon monoxide (CO), which is colorless and odorless. Observe the following precautions.

Failure to do so may cause exhaust gases to enter the vehicle and may lead to an accident caused by light-headedness, or may lead to death or a serious health hazard.

- If the vehicle is in a poorly ventilated area or a closed area, such as a garage, stop the engine.

#### ⚠ WARNING

- Do not leave the vehicle with the engine running for a long time. If such a situation cannot be avoided, park the vehicle in an open space and ensure that exhaust fumes do not enter the vehicle interior.

- Do not leave the engine running in an area with snow build-up, or where it is snowing. If snowbanks build up around the vehicle while the engine is running, exhaust gases may collect and enter the vehicle.

### Changing engine switch modes

Modes can be changed by pressing



the engine switch with brake pedal released. (The mode changes each time the switch is pressed.)

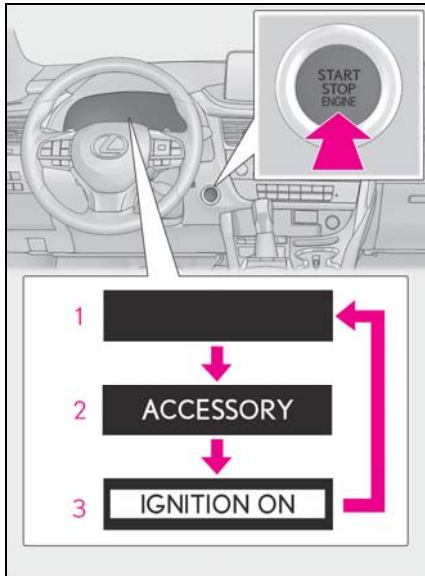

**1 Off\***

The emergency flashers can be used.

**2 ACCESSORY mode**

Some electrical components such as the audio system can be used. "ACCESSORY" will be displayed on the meters.

**3 IGNITION ON mode**

All electrical components can be used. "IGNITION ON" will be displayed on the meters.

\*: If the shift lever is in a position other than P when turning off the engine, the engine switch will be turned to ACCESSORY mode, not to off.

**■ Auto power off function**

If the vehicle is left in ACCESSORY mode for more than 20 minutes or IGNITION ON mode (with the engine not running) for more than an hour with the shift lever in P,

the engine switch will automatically turn off. However, this function cannot entirely prevent battery discharge. Do not leave the vehicle with the engine switch in ACCESSORY or IGNITION ON mode for long periods of time when the engine is not running.

**NOTICE**

**■ To prevent battery discharge**

- Do not leave the engine switch in ACCESSORY or IGNITION ON mode for long periods of time without the engine running.
- If "ACCESSORY" or "IGNITION ON" is displayed on the meters while the engine is not running, the engine switch is not off. Exit the vehicle after turning the engine switch off.

**When stopping the engine with the shift lever in a position other than P**

If the engine is stopped with the shift lever in a position other than P, the engine switch will not be turned off but instead be turned to ACCESSORY mode. Perform the following procedure to turn the switch off:

- 1** Check that the parking brake is set.
- 2** Shift the shift lever to P.
- 3** Check that "Turn Off Vehicle" is displayed on the multi-information display and then press the engine switch once.
- 4** Check that "Turn Off Vehicle" on the multi-information display is off.

**NOTICE****■ To prevent battery discharge**

Do not stop the engine when the shift lever is in a position other than P. If the engine is stopped in another shift lever position, the engine switch will not be turned off but instead be turned to ACCESSORY mode. If the vehicle is left in ACCESSORY mode, battery discharge may occur.

**Automatic transmission**

Select the shift position depending on your purpose and situation.

**Shift position purpose and functions**

Shift position	Objective or function
P	Parking the vehicle/starting the engine
R	Reversing
N	Condition in which the power is not transmission
D	Normal driving <sup>*1</sup>
M	M mode driving <sup>*2</sup> (→P.181)

<sup>\*1</sup>: Shifting to the D position allows the system to select a gear suitable for the driving conditions. Setting the shift lever to the D position is recommended for normal driving.

<sup>\*2</sup>: Selecting gears using M mode fixes the gear step, controls engine braking force, and prevents unnecessary upshifting.

**■ To protect the automatic transmission**

If the automatic transmission fluid temperature is high, "Transmission Fluid Temp High See Owner's Manual" will be displayed on the multi-information display and the vehicle will go into transmission protection mode automatically. Have the vehicle inspected by your Lexus dealer.

**■ When driving with dynamic radar cruise control with full-speed range activated**

Even when performing the following actions with the intent of enabling engine braking, engine braking will not occur

because dynamic radar cruise control with full-speed range will not be canceled.

- While driving in D position, downshifting to 7, 6, 5 or 4. (→P.227)
- When switching the driving mode to sport mode while driving in the D position (→P.271)

#### ■ Restraining sudden start (Drive-Start Control)

→P.155

#### ■ AI-SHIFT

- The AI-SHIFT automatically selects the suitable gear according to driver performance and driving conditions.

The AI-SHIFT automatically operates when the shift lever is in D. (Shifting the shift lever to the M position cancels the function.)

- G AI-SHIFT automatically selects a suitable gear for sporty driving according to driver's input and driving conditions. G AI-SHIFT operates automatically when the shift lever is in D and sport mode is selected for the driving mode. (Selecting normal mode with the driving mode select switch or shifting the shift lever to the M position cancels this function.)

#### ⚠ WARNING

##### ■ When driving on slippery road surfaces

Be careful of downshifting and sudden acceleration, as this could result in the vehicle skidding to the side or spinning.

### Shifting the shift lever

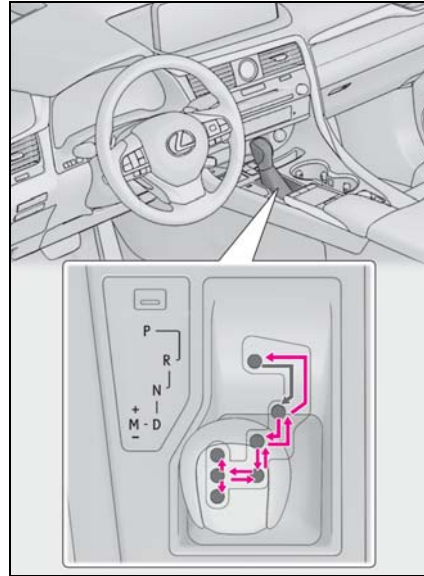

← While the engine switch is in IGNITION ON mode, move the shift lever with the brake pedal depressed.

When shifting the shift lever between P and D, make sure that the vehicle is completely stopped.

#### ■ Shift lock system

The shift lock system is a system to prevent accidental operation of the shift lever in starting.

The shift lever can be shifted from P only when the engine switch is in IGNITION ON mode and the brake pedal is being depressed.

#### ■ If the shift lever cannot be shifted from P

First, check whether the brake pedal is being depressed.

If the shift lever cannot be shifted with your foot on the brake pedal, there may be a problem with the shift lock system. Have the vehicle inspected by your Lexus dealer immediately.

The following steps may be used as an

emergency measure to ensure that the shift lever can be shifted.

Releasing the shift lock:

- 1 Turn the engine switch to IGNITION ON mode and check that the parking brake is set. (→P.177, 183)
- 2 Turn the engine switch to off.
- 3 Depress the brake pedal.
- 4 Pry the cover up with a flathead screwdriver or equivalent tool.

To prevent damage to the cover, cover the tip of the screwdriver with a rag.

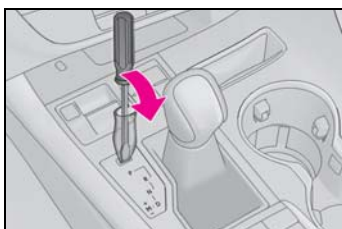

- 5 Press the shift lock override button.

The shift lever can be shifted while the button is pressed.

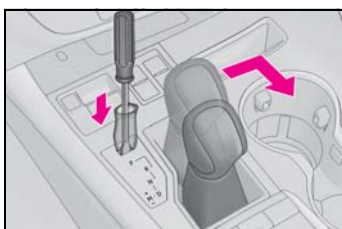

### ⚠ WARNING

#### ■ To prevent an accident when releasing the shift lock

Before pressing the shift lock override button, make sure to set the parking brake and depress the brake pedal.

If the accelerator pedal is accidentally depressed instead of the brake pedal when the shift lock override button is pressed and the shift lever is shifted out of P, the vehicle may suddenly start, possibly leading to an accident resulting in death or serious injury.

### Selecting the driving mode

→P.271

### Selecting shift ranges in the D position

To drive using temporary shift range selection, operate the “-” or “+” paddle shift switch.

When the “-” paddle shift switch is operated, the shift range will be downshifted to a range that enables engine braking force that is suitable to driving conditions. When the “+” paddle shift switch is operated, the shift range will be one gear higher than the gear in use during normal D position driving.

Changing the shift range allows restriction of the highest gear, preventing unnecessary upshifting and enabling the level of engine braking force to be selected.

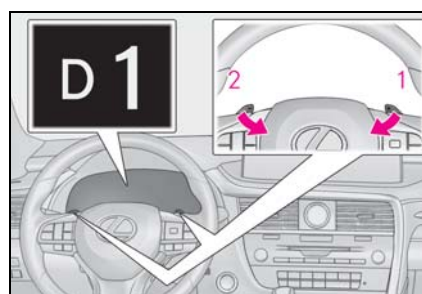

1 Upshifting

2 Downshifting

The selected shift range, from D1 to D8, will be displayed on the meters.

### ■ Shift ranges and their functions

Meter display	Function
D2 - D8	A gear in the range between 1 and the selected gear is automatically chosen depending on vehicle speed and driving conditions
D1	Setting the gear at 1

A lower shift range will provide greater engine braking forces than a higher shift range.

### ■ Automatic deactivation of shift range selection in the D position

Shift range selection in the D position will be deactivated in the following situations:

- When the vehicle comes to a stop
- If the accelerator pedal is depressed for more than a certain period of time
- When the shift lever is shifted to a position other than D
- The "+" paddle shift switch is held down for a period of time

### ■ Downshifting restriction warning buzzer

To help ensure safety and driving performance, downshifting operation may sometimes be restricted. In some circumstances, downshifting may not be possible even when the shift lever or paddle shift switch is operated. (A buzzer will sound twice.)

### Selecting gears in the M position

To enter M mode, shift the shift lever to M. Gears can then be selected by operating the shift lever or paddle shift switches, allowing you to drive in the gear of your choosing.

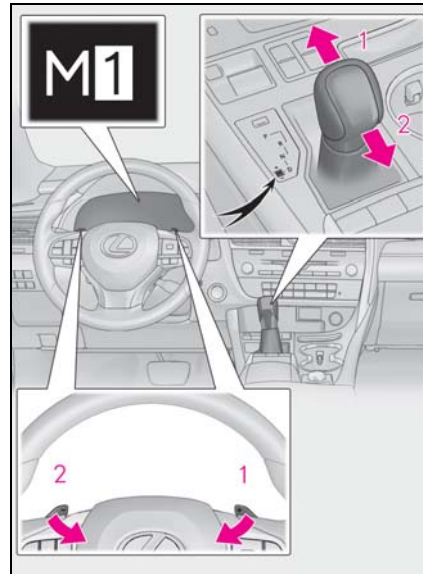

**1** Upshifting

**2** Downshifting

The gear changes once every time the shift lever or paddle shift switch is operated.

The selected gear, from M1 to M8, will be fixed and displayed on the meters.

When in the M position, the gear will not change unless the shift lever or paddle shift switches are operated.

However, even when in the M position, the gears will be automatically changed in the following situation:

- When vehicle speed drops (downshift only).
- When the automatic transmission fluid or engine coolant temperature is low.
- When automatic transmission fluid temperature is high (upshift only).
- When the needle of the tachometer is in the red zone (the range which exceeds the allowable revs of the

engine).

In the following situations, the gear will not shift even if the shift lever or paddle shift switches are operated.

- The vehicle speed is low (upshift only).

■ **Downshifting restriction warning buzzer**

To help ensure safety and driving performance, downshifting operation may sometimes be restricted. In some circumstances, downshifting may not be possible even when the paddle shift switch is operated. (A buzzer will sound twice.)

**Turn signal lever**

**Operating instructions**

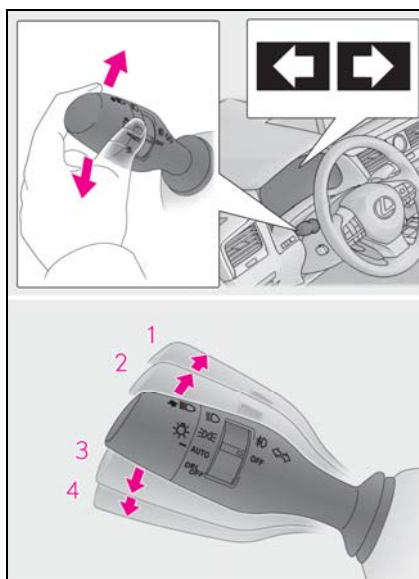

- 1 Right turn
- 2 Lane change to the right (move the lever partway and release it)  
The right hand signals will flash 3 times.
- 3 Lane change to the left (move the lever partway and release it)  
The left hand signals will flash 3 times.
- 4 Left turn

■ **Turn signals can be operated when**

The engine switch is in IGNITION ON mode.

■ **If the indicator flashes faster than usual**

Check that a light bulb in the front or rear turn signal lights has not burned out.

■ **If the turn signals stop flashing before a lane change has been performed**

Operate the lever again.

### ■ Customization

Some functions can be customized.  
(→P.461)

## Parking brake

The parking brake can be set or released automatically or manually.

In automatic mode, the parking brake can be set or released automatically according to the shift lever operation. Also, even in automatic mode, the parking brake can be set or released manually.

## Operating instructions

### ■ Using the manual mode

The parking brake can be set and released manually.

4

Driving

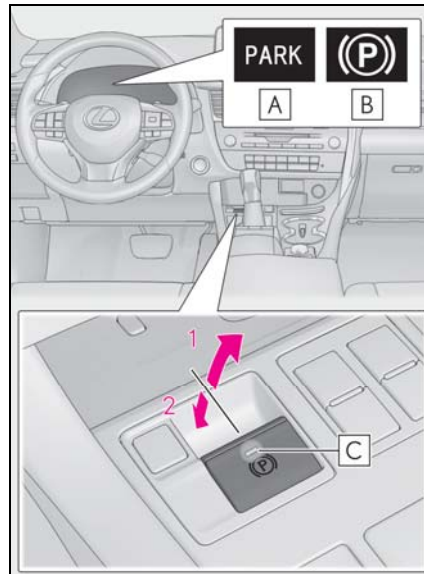

**A** U.S.A.

**B** Canada

**C** Parking brake light

- 1** Pull the parking brake switch to set the parking brake

The parking brake indicator light and parking brake light will turn on.

Pull and hold the parking brake switch if an emergency occurs and it is necessary to operate the parking brake while driving.

**2** Push the parking brake switch to release the parking brake

Operate the switch while depressing the brake pedal or slowly depressing the accelerator pedal.

Make sure that the parking brake indicator light and parking brake light turn off.

If the parking brake indicator light and parking brake light flashes, operate the switch again. (→P.409)

■ **Turns automatic mode on**

While the vehicle is stopped, pull and hold the parking brake switch until “Automatic Mode On” will be displayed on the multi-information display.

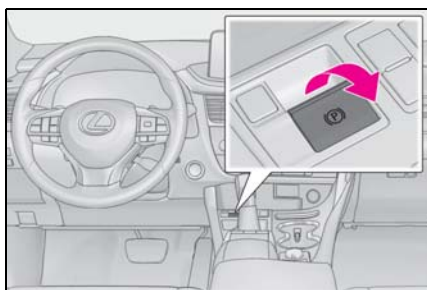

When the automatic mode is turned on, the parking brake operates as follows.

- When the shift lever is moved out of P, the parking brake will be released, and the parking brake indicator light and parking brake light turn off.
- When the shift lever is moved into P, the parking brake will be set, and the

parking brake indicator light and parking brake light turn on.

Operate the shift lever with the brake pedal depressed.

■ **Turns automatic mode off**

While the vehicle is stopped, press and hold the parking brake switch until “Automatic Mode Off” will be displayed on the multi-information display.

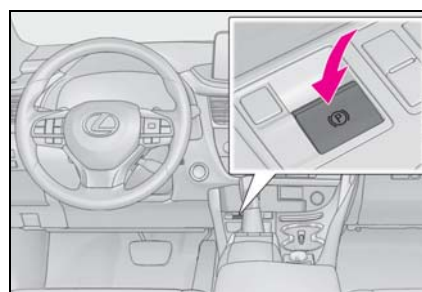

■ **Parking brake operation**

- When the engine switch is not in IGNITION ON mode, the parking brake cannot be released using the parking brake switch.
- When the engine switch is not in IGNITION ON mode, automatic mode (automatic brake setting and releasing) is not available.

■ **Parking brake automatic release function**

The parking brake is automatically released when slowly depress the accelerator pedal.

The parking brake will be released automatically under the following conditions:

- The driver’s door is closed.
- The driver’s seatbelt is fastened.
- Shift the shift lever is in a forward or reverse position.
- The malfunction indicator lamp or brake system warning light is not illuminated.

If the automatic release function does not



operate, manually release the parking brake.

■ **If “Parking Brake Overheated Parking Brake Unavailable” is displayed on the multi-information display**

If the parking brake is operated repeatedly over a short period of time, the system may restrict operation to prevent overheating. If this happens, refrain from operating the parking brake. Normal operation will return after about 1 minute.

■ **If “EPB Activation Stopped Incompletely” or “Parking Brake Unavailable” is displayed on the multi-information display**

Operate the parking brake switch. If the message does not disappear after operating the switch several times, the system may be malfunctioning. Have the vehicle inspected by your Lexus dealer immediately.

■ **Parking brake operation sound**

When the parking brake operates, a motor sound (whirring sound) may be heard. This does not indicate a malfunction.

■ **Parking brake indicator light and parking brake light**

- Depending on the engine switch mode, the parking brake indicator light and parking brake light will turn on and stay on as described below:  
IGNITION ON mode: Comes on until the parking brake is released.  
Not in IGNITION ON mode: Stays on for approximately 15 seconds.
- When the engine switch is turned off with the parking brake set, the parking brake indicator light and parking brake light will stay on for about 15 seconds. This does not indicate a malfunction.

■ **Changing the mode**

When changing the automatic mode on/off, the message will be shown on the multi-information display and the buzzer sounds.

■ **Parking the vehicle**

→P.154

■ **Parking brake engaged warning buzzer**

A buzzer will sound if the vehicle is driven with the parking brake engaged. “Release Parking Brake” is displayed on the multi-information display.

■ **Warning messages and buzzers**

Warning messages and buzzers are used to indicate a system malfunction or to inform the driver of the need for caution. If a warning message is shown on the multi-information display, read the message and follow the instructions.

■ **If the brake system warning light comes on**

→P.403

■ **Usage in winter time**

→P.282

 **WARNING**

■ **When parking the vehicle**

Do not leave a child in the vehicle alone. The parking brake may be released unintentionally and there is the danger of the vehicle moving that may lead to an accident resulting in death or serious injury.

■ **Parking brake switch**

Do not set any objects near the parking brake switch. Objects may interfere with the switch and may lead the parking brake to unexpectedly operate.

 **NOTICE**

■ **When parking the vehicle**

Before you leave the vehicle, shift the shift lever to P, set the parking brake and make sure that the vehicle does not move.

■ **When the system malfunctions**

Stop the vehicle in a safe place and check the warning messages.



## NOTICE

■ **When the parking brake cannot be released due to a malfunction**

Driving the vehicle with the parking brake set will lead to brake components overheating, which may affect braking performance and increase brake wear.

Have the vehicle inspected by your Lexus dealer immediately if this occurs.

## Brake Hold

The brake hold system keeps the brake applied when the shift lever is in D, M or N with the system on and the brake pedal has been depressed to stop the vehicle. The system releases the brake when the accelerator pedal is depressed with the shift lever in D or M to allow smooth start off.

### Enabling the system

Turns the brake hold system on

The brake hold standby indicator (green)

**A** comes on. While the system is holding the brake, the brake hold operated indicator (yellow) **B** comes on.

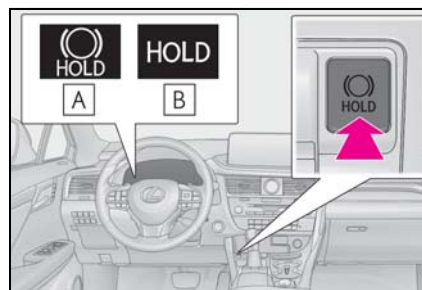

### ■ Brake hold system operating conditions

The brake hold system cannot be turned on in the following conditions:

- The driver's door is not closed.
- The driver is not wearing the seat belt.

If any of the conditions above are detected when the brake hold system is enabled, the system will turn off and the brake hold standby indicator light will go off. In addition, if any of the conditions are detected while the system is holding the brake, a warning buzzer will sound and a message will be shown on the multi-information dis-

play. The parking brake will then be set automatically.

#### ■ Brake hold function

- If the brake pedal is left released for a period of about 3 minutes after the system has started holding the brake, the parking brake will be set automatically. In this case, a warning buzzer sounds and a message is shown on the multi-information display.
- To turn the system off while the system is holding the brake, firmly depress the brake pedal and press the button again.
- The brake hold function may not hold the vehicle when the vehicle is on a steep incline. In this situation, it may be necessary for the driver to apply the brakes. A warning buzzer will sound and the multi-information display will inform the driver of this situation. If a warning message is shown on the multi-information display, read the message and follow the instructions.

#### ■ When the parking brake is set automatically while the system is holding the brakes

Perform any of the following operations to release the parking brake.

- Depress the accelerator pedal. (The parking brake will not be released automatically if the seat belt is not fastened.)
- Operate the parking brake switch with the brake pedal depressed.

Make sure that the parking brake indicator light goes off. (→P.183)

#### ■ When an inspection at your Lexus dealer is necessary

When the brake hold standby indicator (green) does not illuminate even when the brake hold switch is pressed with the brake hold system operating conditions met, the system may be malfunctioning. Have the vehicle inspected at your Lexus dealer.

#### ■ If “Brake Hold Fault Depress Brake to Deactivate Visit Your Dealer” or “Brake Hold Malfunction Visit Your Dealer” is displayed on the multi-information display

The system may be malfunctioning. Have the vehicle inspected by your Lexus dealer.

#### ■ Warning messages and buzzers

Warning messages and buzzers are used to indicate a system malfunction or to inform the driver of the need for caution. If a warning message is shown on the multi-information display, read the message and follow the instructions.

#### ■ If the brake hold operated indicator flashes

→P.409

### WARNING

#### ■ When the vehicle is on a steep incline

When using the brake hold system on a steep incline exercise caution. The brake hold function may not hold the vehicle in such a situation.

#### ■ When stopped on a slippery road

The system cannot stop the vehicle when the gripping ability of the tires has been exceeded. Do not use the system when stopped on a slippery road.

### NOTICE

#### ■ When parking the vehicle

The brake hold system is not designed for use when parking the vehicle for a long period of time. Turning the engine switch off while the system is holding the brake may release the brake, which would cause the vehicle to move. When operating the engine switch, depress the brake pedal, shift the shift lever to P and set the parking brake.

## Headlight switch

The headlights can be operated manually or automatically.

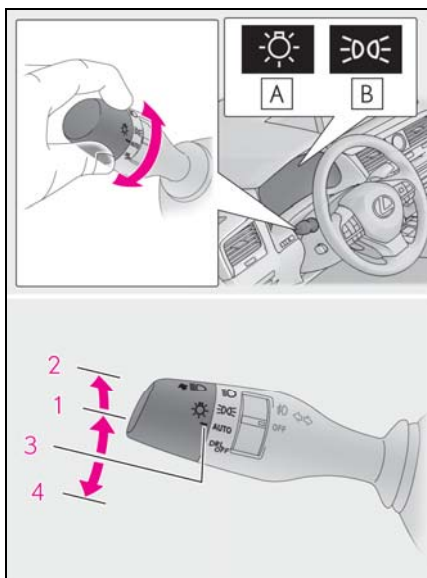

## Operating instructions

Operating the  switch turns on the lights as follows:



**A** U.S.A.

**B** Canada

- 1**  The side marker, parking, tail, license plate, instrument panel lights, and daytime running lights (→P.188) turn on.
- 2**  The headlights and all lights listed above (except daytime running lights) turn on.
- 3** **AUTO** The headlights, daytime running lights (→P.188) and all the

lights listed above turn on and off automatically.

(When the engine switch is in IGNITION ON mode.)

**4**  (U.S.A.) Off

## Daytime running light system

- The daytime running lights illuminate using the same lights as the parking lights and illuminate brighter than the parking lights.
- To make your vehicle more visible to other drivers during daytime driving, the daytime running lights turn on automatically when all of the following conditions are met. (The daytime running lights are not designed for use at night.)
  - The engine is running
  - The parking brake is released
  - The headlight switch is in the  or **AUTO** position

\* : When the surroundings are bright

The daytime running lights remain on after they illuminate, even if the parking brake is set again.

- For the U.S.A.: Daytime running lights can be turned off by operating the switch.
- Compared to turning on the headlights, the daytime running light system offers greater durability and consumes less electricity, so it can help improve fuel economy.

## Headlight control sensor

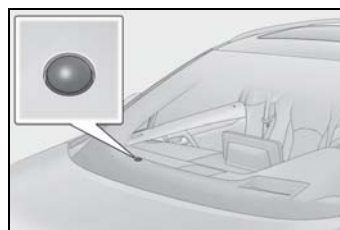



The sensor may not function properly if an object is placed on the sensor, or anything that blocks the sensor is affixed to the windshield.

Doing so interferes with the sensor detecting the level of ambient light and may cause the automatic headlight system to malfunction.

#### ■ Automatic light off system

- When the headlights come on: The headlights and tail lights turn off 30 seconds after a door is opened and closed if the engine switch is turned to ACCESSORY mode or turned off. (The lights turn off immediately if  on the key is pressed after all the doors are locked.)
- When only the tail lights are on: The tail lights turn off automatically if the engine switch is turned to ACCESSORY mode or turned off and the driver's door is opened.

To turn the lights on again, turn the engine switch to IGNITION ON mode, or turn the light switch off once and then back to  or .

#### ■ Automatic headlight leveling system (if equipped)

The level of the headlights is automatically adjusted according to the number of passengers and the loading condition of the vehicle to ensure that the headlights do not interfere with other road users.

#### ■ Light reminder buzzer

A buzzer sounds when the engine switch is turned off or turned to ACCESSORY mode and the driver's door is opened while the lights are turned on.

#### ■ Welcome lighting

If the headlight switch is turned to AUTO and the surrounding area is dark, unlocking the doors using the smart access system with push-button start or wireless remote control will turn the parking lights and tail lights on automatically.

#### ■ Windshield wiper linked headlight illumination

When driving during daytime with the headlight switch turned to AUTO, if the windshield wipers are used, the headlights will

turn on automatically after several seconds to help enhance the visibility of your vehicle.

#### ■ Battery-saving function

In order to prevent the battery of the vehicle from discharging, if the headlights and/or tail lights are on when the engine switch is turned off the battery saving function will operate and automatically turn off all the lights after approximately 20 minutes. When the engine switch is turned to IGNITION ON mode, the battery-saving function will be disabled.

When any of the following are performed, the battery-saving function is canceled once and then reactivated. All the lights will turn off automatically 20 minutes after the battery-saving function has been reactivated:

- When the headlight switch is operated
- When a door is opened or closed

#### ■ Customization

Some functions can be customized. (→P.461)

#### NOTICE

##### ■ To prevent battery discharge

Do not leave the lights on longer than necessary when the engine is off.

#### Turning on the high beam headlights

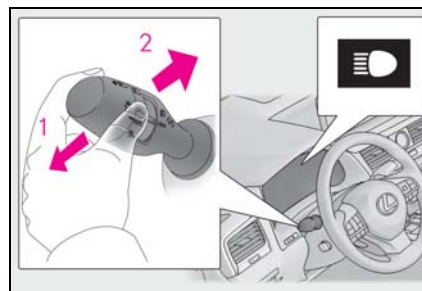

- 1 With the headlights on, push the lever away from you to turn on the high beams.

Pull the lever toward you to the center position to turn the high beams off.

- 2 Pull the lever toward you and release it to flash the high beams once.

You can flash the high beams with the headlights on or off.

### AFS (Adaptive Front-lighting System) (if equipped)

AFS (Adaptive Front-lighting System) secures excellent visibility at intersections and on curves by automatically adjusting the direction of the light axis of the headlights according to vehicle speed and the degree of the tire's angle as controlled by steering input.

AFS operates at speeds of 6 mph (10 km/h) or higher.

#### ■ Customization

Some functions can be customized. (→P.461)

### Cornering lights (if equipped)

- When the steering wheel or turn signal lever is operated while the headlights are on (low beam), a cornering light will turn on and light up the direction of movement of the vehicle. The cornering lights are designed to ensure excellent visibility when making a turn at an intersection.

However, when vehicle speed is approximately 22 mph (35 km/h) or higher, the cornering lights will not turn on.

- When the shift lever is in R while the

headlights are on (low beam), both cornering lights will turn on. This is designed to enhance visibility when parking.

#### ■ Cornering lights (if equipped)

When the cornering lights are on for more than 30 minutes, they will turn off automatically.

## AHB (Automatic High Beam)

The Automatic High Beam uses a camera sensor located behind the upper portion of the windshield to assess the brightness of the lights of vehicles ahead, streetlights, etc., and automatically turns the high beams on or off as necessary.

### ⚠ WARNING

#### ■ Limitations of the Automatic High Beam

Do not overly rely on the Automatic High Beam. Always drive safely, taking care to observe your surroundings and turning the high beams on or off manually if necessary.

#### ■ To prevent incorrect operation of the Automatic High Beam system

Do not overload the vehicle.

## Activating the Automatic High Beam

- 1 Press the Automatic High Beam switch.

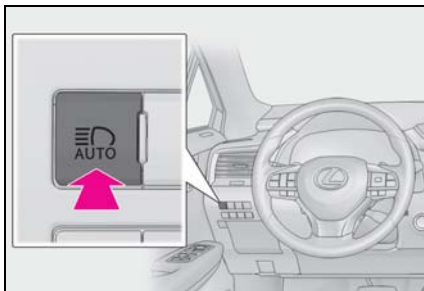

- 2 Turn the headlight switch to the AUTO or  position.

The Automatic High Beam indicator will

come on when the system is operating.



### ■ Conditions to turn the high beams on/off automatically

- When all of the following conditions are met, the high beams will be turned on automatically (after approximately 1 second):
  - The vehicle speed is approximately 21 mph (34 km/h) or more.
  - The area ahead of the vehicle is dark.
  - There are no vehicles ahead with headlights or tail lights turned on.
  - There are few streetlights on the road ahead.
- If any of the following conditions is met, the high beams will turn off automatically:
  - The vehicle speed is below approximately 17 mph (27 km/h).
  - The area ahead of the vehicle is not dark.
  - Vehicles ahead have their headlights or tail lights turned on.
  - There are many streetlights on the road ahead.

### ■ Camera sensor detection information

- The high beams may not be automatically turned off in the following situations:
  - When a vehicle suddenly appears from around a curve
  - When the vehicle is cut in front of by another vehicle
  - When vehicles ahead cannot be detected due to repeated curves, road dividers or roadside trees
  - When vehicles ahead appear in a far-away lane on a wide road
  - When the lights of vehicles ahead are not on
- The high beams may be turned off if a vehicle ahead that is using fog lights with-

out its headlights turned on is detected.

- House lights, street lights, traffic signals, and illuminated billboards or signs and other reflective objects may cause the high beams to change to the low beams, or the low beams to remain on.
- The following factors may affect the amount of time taken for the high beams to turn on or off:
  - The brightness of the headlights, fog lights, and tail lights of vehicles ahead
  - The movement and direction of vehicles ahead
  - When a vehicle ahead only has operational lights on one side
  - When a vehicle ahead is a two-wheeled vehicle
  - The condition of the road (gradient, curve, condition of the road surface, etc.)
  - The number of passengers and amount of luggage in the vehicle
- The high beams may turn on or off unexpectedly.
- Bicycles or similar vehicles may not be detected.
- In the following situations the system may not be able to correctly detect the surrounding brightness level. This may cause the low beams to remain on or the high beams to flash or dazzle pedestrians or vehicles ahead. In such a case, it is necessary to manually switch between the high and low beams.
  - When driving in inclement weather (heavy rain, snow, fog, sandstorms, etc.)
  - When the windshield is obscured by fog, mist, ice, dirt, etc.
  - When the windshield is cracked or damaged
  - When the camera sensor is deformed or dirty
  - When the temperature of the camera sensor is extremely high
  - When the surrounding brightness level is equal to that of headlights, tail lights or fog lights
  - When headlights or tail lights of vehicles ahead are turned off, dirty, changing color, or not aimed properly
  - When the vehicle is hit by water, snow, dust, etc. from a preceding vehicle
  - When driving through an area of inter-

mittently changing brightness and darkness

- When frequently and repeatedly driving ascending/descending roads, or roads with rough, bumpy or uneven surfaces (such as stone-paved roads, gravel roads, etc.)
- When frequently and repeatedly taking curves or driving on a winding road
- When there is a highly reflective object ahead of the vehicle, such as a sign or mirror
- When the back of a preceding vehicle is highly reflective, such as a container on a truck
- When the vehicle's headlights are damaged or dirty, or are not aimed properly
- When the vehicle is listing or tilting due to a flat tire, a trailer being towed, etc.
- When the headlights are changed between the high beams and low beams repeatedly in an abnormal manner
- When the driver believes that the high beams may be flashing or dazzling pedestrians or other drivers

#### ■ Temporarily lowering sensor sensitivity

The sensitivity of the sensor can be temporarily lowered.

- 1 Turn the engine switch off while the following conditions are met.
  - The headlight switch is in  or AUTO.
  - The headlight switch lever is in high beam position.
  - Automatic High Beam switch is on.
- 2 Turn the engine switch to IGNITION ON mode.
- 3 Within 60 seconds after step 2, repeat pulling the headlight switch lever to the original position then pushing it to the high beam position quickly 10 times, then leave the lever in high beam position.
- 4 If the sensitivity is changed, the Automatic High Beam indicator is turn on and off 3 times.

Automatic High Beam (headlights) may turn on even when the vehicle is stopped.



### Turning the high beams on/off manually

#### ■ Switching to the high beams

Push the lever away from you.

The Automatic High Beam indicator will turn off and the high beam indicator will turn on.

Pull the lever to its original position to activate the Automatic High Beam system again.

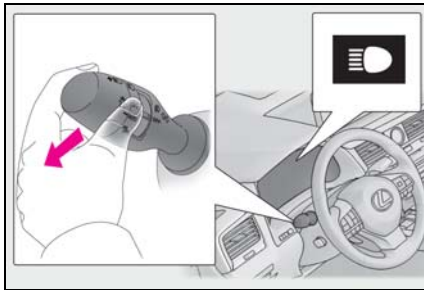

#### ■ Switching to the low beams

Press the Automatic High Beam switch.

The Automatic High Beam indicator will turn off.

Press the switch to activate the Automatic High Beam system again.

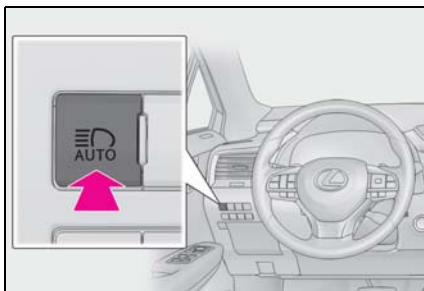

#### ■ Temporarily switching to the low beams

Pull the lever toward you and then

return it to its original position.

The high beams are on while the lever is pulled toward you, however, after the lever is returned to its original position, the low beams remain on for a certain amount of time. Afterwards, the Automatic High Beam will be activated again.

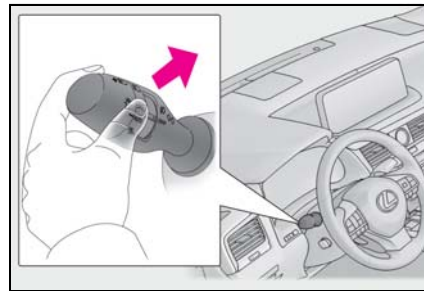

#### ■ Temporarily switching to the low beams

It is recommended to switch to the low beams when the high beam may cause problems or distress to other drivers or pedestrians nearby.

### Fog light switch\*

\*: If equipped

The fog lights secure excellent visibility in difficult driving conditions, such as in rain and fog.

### Operating instructions

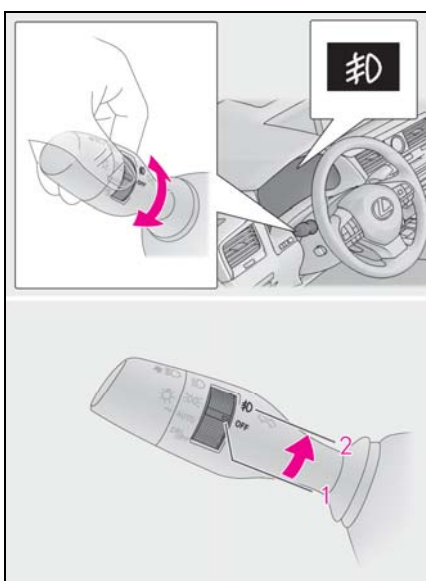

- 1** OFF (U.S.A.) or ○ (Canada)  
Turns the fog lights off
- 2** ☁ Turns the fog lights on

■ Fog lights can be used when  
The headlights are on in low beam.

### Windshield wipers and washer

Operating the lever can switch between automatic operation and manual operation, or can use the washer.

#### ⚠ NOTICE

#### ■ When the windshield is dry

Do not use the wipers, as they may damage the windshield.

### Operating the wiper lever

Operate the  lever operates the wipers or washer as follows.

- ▶ Intermittent windshield wipers with interval adjuster

Wiper intervals can be adjusted when intermittent operation is selected.

The interval of intermittent operation varies according to vehicle speed.

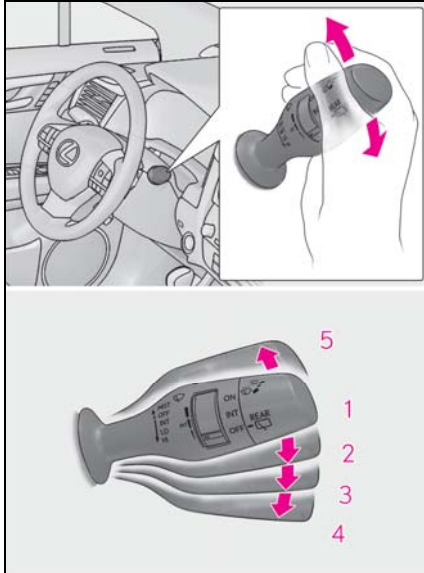

- 1** OFF (U.S.A.) or ○ (Canada)  
Off
- 2** INT (U.S.A.) or ▽ (Canada) Inter-  
mittent operation  
The intermittent windshield wiper operates  
more frequently as vehicle speed becomes  
higher.
- 3** LO (U.S.A.) or ▼ (Canada)  
Low speed operation
- 4** HI (U.S.A.) or ▾ (Canada)  
High speed operation
- 5** MIST (U.S.A.) or △ (Canada)  
Temporary operation

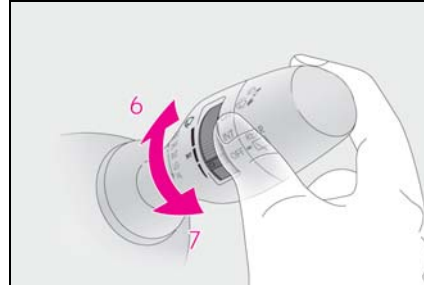

- 6** Increases the intermittent wind-  
shield wiper frequency
- 7** Decreases the intermittent wind-  
shield wiper frequency

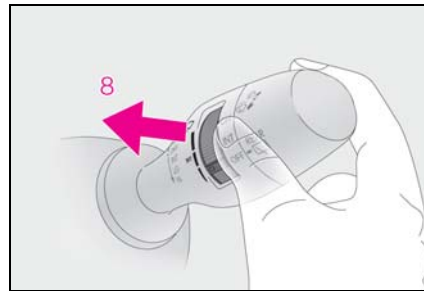

- 8**  Washer/wiper dual opera-  
tion

Pulling the lever operates the wipers and  
washer.

The wipers will automatically operate a  
couple of times after the washer squirts.

Vehicles with headlight cleaners:

When the engine switch is in IGNITION  
ON mode and the headlights are on, if the  
lever is pulled, the headlight cleaners will  
operate once. After this, the headlight  
cleaners will operate every 5th time the  
lever is pulled.

► Rain-sensing windshield wipers

When "AUTO" is selected, the wipers  
will operate automatically when the  
sensor detects falling rain. The system  
automatically adjusts wiper timing in

accordance with rain volume and vehicle speed.

The sensor sensitivity can be adjusted when "AUTO" is selected.

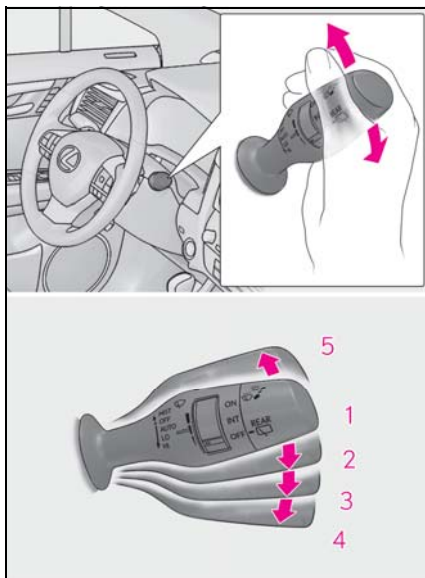

- 1** OFF (U.S.A.) or ○ (Canada)  
Off
- 2** AUTO Rain-sensing wiper operation
- 3** LO (U.S.A.) or ▼ (Canada)  
Low speed operation
- 4** HI (U.S.A.) or ▼ (Canada)  
High speed operation
- 5** MIST (U.S.A.) or △ (Canada)  
Temporary operation

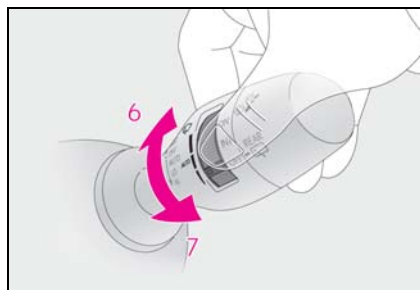

- 6** Increases the sensitivity
- 7** Decreases the sensitivity

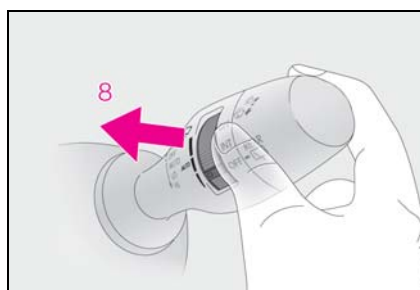

- 8**  Washer/wiper dual operation

Pulling the lever operates the wipers and washer.

The wipers will automatically operate a couple of times after the washer squirts.

Vehicles with headlight cleaners:  
When the engine switch is in IGNITION ON mode and the headlights are on, if the lever is pulled, the headlight cleaners will operate once. After this, the headlight cleaners will operate every 5th time the lever is pulled.

■ **The windshield wipers and washer can be operated when**

The engine switch is in IGNITION ON mode.

■ **Dripping prevention wiper sweep (vehicles with rain-sensing windshield wipers)**

After washing and wiping operation several

times, the wipers operate one more time after a short delay to prevent dripping. However, this function will not operate while driving.

■ **Effects of vehicle speed on wiper operation**

Vehicle speed affects the intermittent wiper interval.

■ **Raindrop sensor (vehicles with rain-sensing windshield wipers)**

- The raindrop sensor judges the amount of raindrops.  
An optical sensor is adopted. It may not operate properly when sunlight from the rising or setting of the sun intermittently strikes the windshield, or if bugs, etc. are present on the windshield

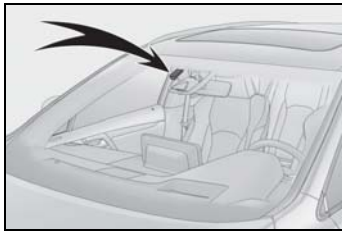

- If the wiper switch is turned to the "AUTO" position while the engine switch is in IGNITION ON mode, the wipers will operate once to show that AUTO mode is activated.
- When the sensor sensitivity ring is turned toward high while in "AUTO" position, the wipers will operate once to indicate that the sensor sensitivity is enhanced.
- If the temperature of the raindrop sensor is 194°F (90°C) or higher, or 5°F (-15°C) or lower, automatic operation may not occur. In this case, operate the wipers in any mode other than AUTO mode.

■ **If no windshield washer fluid sprays**

Check that the washer nozzles are not blocked, if there is washer fluid in the washer fluid tank.

■ **Front door opening linked windshield wiper stop function (vehicles with rain-sensing windshield wipers)**

When "AUTO" is selected and the windshield wipers are operating, if a front door is

opened, the operation of the windshield wipers will be stopped to prevent anyone near the vehicle from being sprayed by water from the wipers, provided the vehicle is stopped with the parking brake applied or the shift lever in P. When the front door is closed, wiper operation will resume.

■ **Customization**

Some functions can be customized. (→P.461)

**WARNING**

■ **Caution regarding the use of windshield wipers in AUTO mode (vehicles with rain-sensing windshield wipers)**

The windshield wipers may operate unexpectedly if the sensor is touched or the windshield is subject to vibration in AUTO mode. Take care that your fingers, etc. do not become caught in the windshield wipers.

■ **Caution regarding the use of washer fluid**

When it is cold, do not use the washer fluid until the windshield becomes warm. The fluid may freeze on the windshield and cause low visibility. This may lead to an accident, resulting in death or serious injury.

**NOTICE**

■ **When the washer fluid tank is empty**

Do not operate the switch continually as the washer fluid pump may overheat.

■ **When a nozzle becomes blocked**

In this case, contact your Lexus dealer. Do not try to clear it with a pin or other object. The nozzle will be damaged.

**Changing the windshield wiper rest position/Lifting the windshield wipers**

When the windshield wipers are not

being used, they retract to below the hood. To enable the windshield wipers to be lifted when parking in cold conditions or when replacing a windshield wiper insert, change the rest position of the windshield wipers to the service position using the wiper lever.

■ **Raising the wipers to the service position**

Within approximately 40 seconds of turning the engine switch off, move the wiper lever to the MIST (U.S.A.) or Δ (Canada) position and hold it for approximately 2 seconds or more.

The wipers will move to the service position.

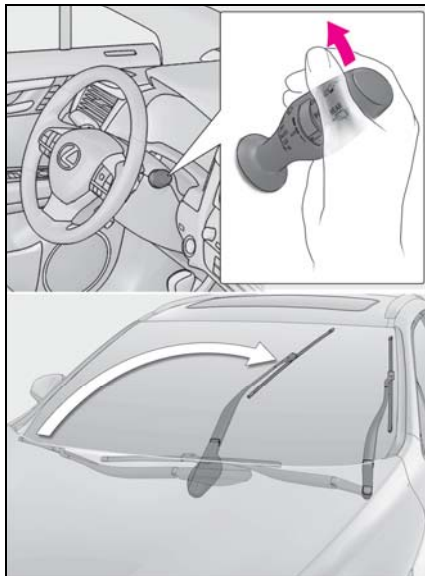

■ **Lifting the windshield wipers**

While holding the hook portion of the wiper arm, lift the windshield wiper from the windshield.

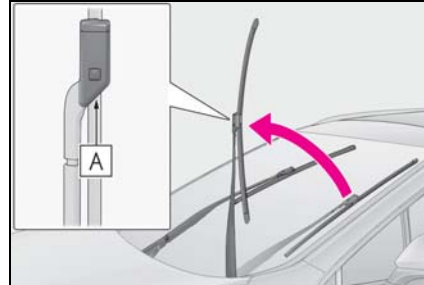

A Hook portion

■ **Lowering the windshield wipers to the retracted position**

With the windshield wipers placed on the windshield, turn the engine switch to IGNITION ON mode and then move the wiper lever to an operating position. When the wiper switch is turned off, the windshield wipers will stop at the retracted position.

⚠ NOTICE

■ **When lifting the windshield wipers**

- Do not lift the windshield wipers when they are in the retracted position below the hood. Otherwise, they may contact the hood, possibly resulting in damage to a windshield wiper and/or the hood.
- Do not lift a windshield wiper by the wiper blade. Otherwise, the wiper blade may be deformed.

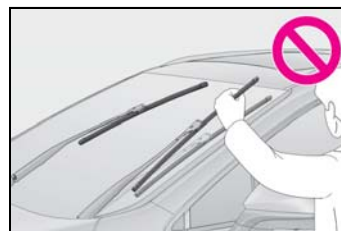

- Do not operate the wiper lever when the windshield wipers are lifted. Otherwise, the windshield wipers may contact the hood, possibly resulting in damage to the windshield wipers and/or hood.

## Rear window wiper and washer

### NOTICE

■ **When the rear window is dry**  
Do not use the wiper, as it may damage the rear window.

## Operating the wiper lever

Operating the  switch operates the rear wiper as follows.

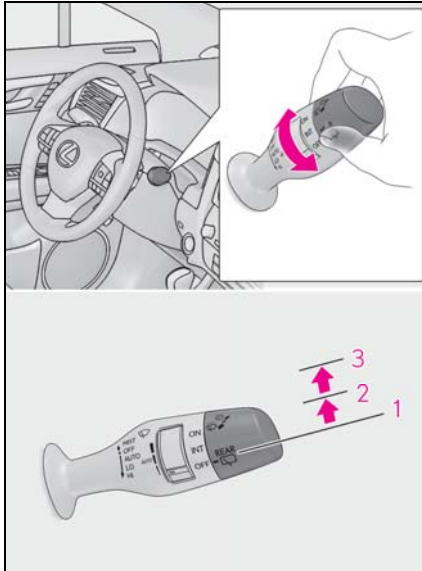

- 1** OFF (U.S.A.) or ○ (Canada)  
Off
- 2** INT (U.S.A.) or --- (Canada) Inter-  
mittent operation
- 3** ON (U.S.A.) or — (Canada) Nor-  
mal operation

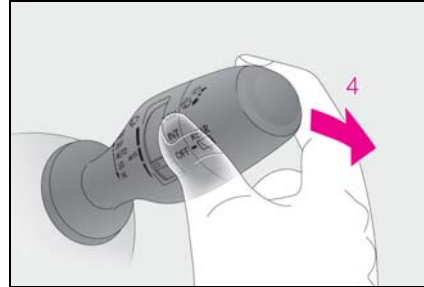

### 4 Washer/wiper dual operation

Pushing the lever operates the wiper and washer.

The wiper will automatically operate a couple of times after the washer squirts.

### ■ The rear window wiper and washer can be operated when

The engine switch is in IGNITION ON mode.

### ■ If no washer fluid sprays

Check that the washer nozzle is not blocked if there is washer fluid in the washer fluid tank.

### NOTICE

#### ■ When the washer fluid tank is empty

Do not operate the switch continually as the washer fluid pump may overheat.

#### ■ When a nozzle becomes blocked

In this case, contact your Lexus dealer. Do not try to clear it with a pin or other object. The nozzle will be damaged.

### Opening the fuel tank cap

Perform the following steps to open the fuel tank cap:

#### Before refueling the vehicle

- Close all the doors and windows, and turn the engine switch off.
- Confirm the type of fuel.

#### ■ Fuel types

→P.450

#### ■ Fuel tank opening for unleaded gasoline

To help prevent incorrect fueling, your vehicle has a fuel tank opening that only accommodates the special nozzle on unleaded fuel pumps.

#### ■ If the malfunction indicator lamp illuminates

The malfunction indicator lamp may illuminate erroneously if refueling is performed repeatedly when the fuel tank is nearly full.

### WARNING

#### ■ When refueling the vehicle

Observe the following precautions while refueling the vehicle. Failure to do so may result in death or serious injury.

- After exiting the vehicle and before opening the fuel door, touch an unpainted metal surface to discharge any static electricity. It is important to discharge static electricity before refueling because sparks resulting from static electricity can cause fuel vapors to ignite while refueling.

- Always hold the grips on the fuel tank cap and turn it slowly to remove it. A whooshing sound may be heard when the fuel tank cap is loosened. Wait until the sound cannot be heard before fully removing the cap. In hot weather, pressurized fuel may spray out of the filler neck and cause injury.

- Do not allow anyone that has not discharged static electricity from their body to come close to an open fuel tank.

- Do not inhale vaporized fuel. Fuel contains substances that are harmful if inhaled.

- Do not smoke while refueling the vehicle. Doing so may cause the fuel to ignite and cause a fire.

- Do not return to the vehicle or touch any person or object that is statically charged. This may cause static electricity to build up, resulting in a possible ignition hazard.

#### ■ When refueling

Observe the following precautions to prevent fuel overflowing from the fuel tank:

- Securely insert the fuel nozzle into the fuel filler neck.
- Stop filling the tank after the fuel nozzle automatically clicks off.
- Do not top off the fuel tank.

### NOTICE

#### ■ Refueling

Do not spill fuel during refueling. Doing so may damage the vehicle, such as causing the emission control system to operate abnormally or damaging fuel system components or the vehicle's painted surface.



**Opening the fuel tank cap**

- 1 With the doors unlocked, press the center of the rear edge of the fuel filler door.

Push inward and take your hand away to slightly open the fuel filler door. Then open the door fully by hand.

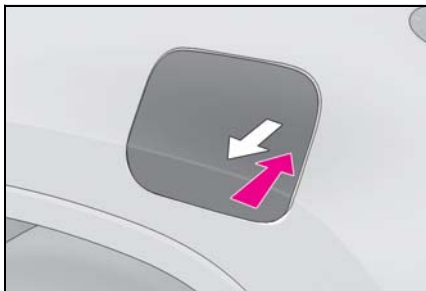

- 2 Open the fuel filler door until it is securely locked.
- 3 Turn the fuel tank cap slowly and remove it, then put it into the holder on the fuel filler door.

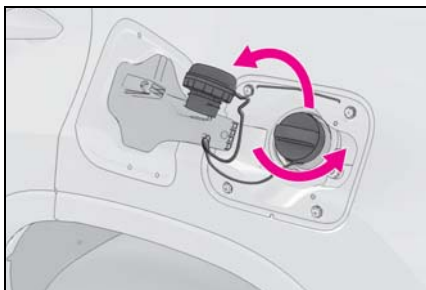

■ **If the fuel filler door cannot be opened**  
→P.430

**Closing the fuel tank cap**

- 1 After refueling, turn the fuel tank cap until you hear a click. Once the

cap is released, it will turn slightly in the opposite direction.

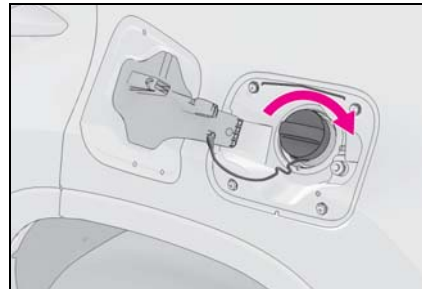

- 2 Close the fuel filler door, and press the center of the rear edge of the fuel filler door.

When you lock the doors, the fuel filler door will lock also.

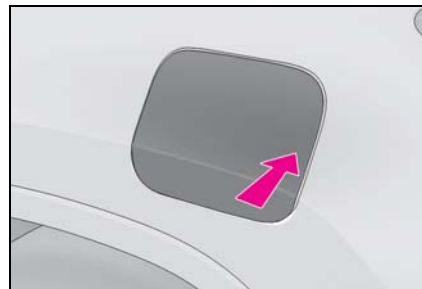

■ **Fuel filler door lock condition**

The fuel filler door may not be locked even when the vehicle's doors are locked in the following conditions:

- When operating the door lock button inside the vehicle
- When the automatic door locking system is operated (→P.102)
- When the fuel filler door is closed after the vehicle's doors are locked

**WARNING****■ When replacing the fuel tank cap**

Do not use anything but a genuine Lexus fuel tank cap designed for your vehicle. Doing so may cause a fire or other incident which may result in death or serious injury.

**Lexus Safety System + 2.0**

The Lexus Safety System + 2.0 consists of the following drive assist systems and contributes to a safe and comfortable driving experience:

**Driving assist system**

- **PCS (Pre-Collision System)**  
→P.209
- **LTA (Lane Tracing Assist)**  
→P.216
- **AHB (Automatic High Beam)**  
→P.191
- **RSA (Road Sign Assist)\***  
→P.225  
\*: If equipped
- **Dynamic radar cruise control with full-speed range**  
→P.227

**⚠ WARNING**

■ **Lexus Safety System + 2.0**  
The Lexus Safety System + 2.0 is designed to operate under the assumption that the driver will drive safely, and is designed to help reduce the impact to the occupants and the vehicle in the case of a collision or assist the driver in normal driving conditions.  
As there is a limit to the degree of recognition accuracy and control performance that this system can provide, do not overly rely on this system. The driver is always responsible for paying attention to the vehicle's surroundings and driving safely.

**Sensors**

Two types of sensors, located behind the front grille and windshield, detect information necessary to operate the drive assist systems.

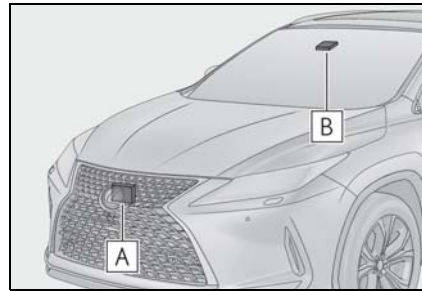

- A** Radar sensor
- B** Front camera

**⚠ WARNING**

■ **To avoid malfunction of the radar sensor**  
Observe the following precautions.  
Otherwise, the radar sensor may not operate properly, possibly leading to an accident resulting in death or serious injury.

**⚠ WARNING**

- Keep the radar sensor and the radar sensor cover clean at all times.

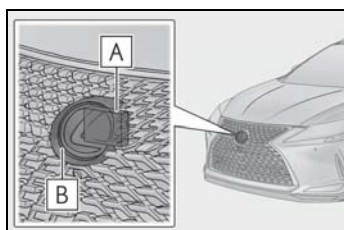

**A** Radar sensor

**B** Radar sensor cover

If the front of the radar sensor or the front or back of the radar sensor cover is dirty or covered with water droplets, snow, etc., clean it.

Clean the radar sensor and radar sensor cover with a soft cloth to avoid damaging them.

- Do not attach accessories, stickers (including transparent stickers) or other items to the radar sensor, radar sensor cover or surrounding area.
- Do not subject the radar sensor or its surrounding area to a strong impact. If the radar sensor, front grille, or front bumper has been subjected to a strong impact, have the vehicle inspected by your Lexus dealer.
- Do not disassemble the radar sensor.
- Do not modify or paint the radar sensor or radar sensor cover.
- In the following cases, the radar sensor must be recalibrated. Contact your Lexus dealer.
  - When the radar sensor or front grille are removed and installed, or replaced
  - When the front bumper is replaced

**■ To avoid malfunction of the front camera**

Observe the following precautions.

Otherwise, the front camera may not operate properly, possibly leading to an accident resulting in death or serious injury.

- Keep the windshield clean at all times.
  - If the windshield is dirty or covered with an oily film, water droplets, snow, etc., clean the windshield.
  - If a glass coating agent is applied to the windshield, it will still be necessary to use the windshield wipers to remove water droplets, etc. from the area of the windshield in front of the front camera.
  - If the inner side of the windshield where the front camera is installed is dirty, contact your Lexus dealer.
- Do not attach objects, such as stickers, transparent stickers, etc., to the outer side of the windshield in front of the front camera (shaded area in the illustration).

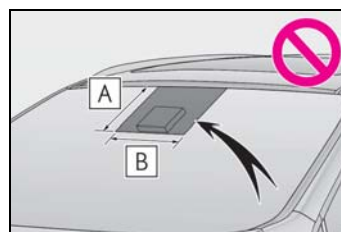

**A** From the top of the windshield to approximately 0.4 in. (1 cm) below the bottom of the front camera

**B** Approximately 7.9 in. (20 cm) (Approximately 4.0 in. [10 cm] to the right and left from the center of the front camera)

**WARNING**

- If the part of the windshield in front of the front camera is fogged up or covered with condensation, or ice, use the windshield defogger to remove the fog, condensation, or ice. (→P.292)
  - If water droplets cannot be properly removed from the area of the windshield in front of the front camera by the windshield wipers, replace the wiper insert or wiper blade.
  - Do not attach window tint to the windshield.
  - Replace the windshield if it is damaged or cracked.  
After replacing the windshield, the front camera must be recalibrated. Contact your Lexus dealer.
  - Do not allow liquids to contact the front camera.
  - Do not allow bright lights to shine into the front camera.
  - Do not dirty or damage the front camera.  
When cleaning the inside of the windshield, do not allow glass cleaner to contact the lens of the front camera. Also, do not touch the lens. If the lens is dirty or damaged, contact your Lexus dealer.
  - Do not subject the front camera to a strong impact.
  - Do not change the installation position or direction of the front camera or remove it.
  - Do not disassemble the front camera.
  - Do not modify any components of the vehicle around the front camera (inside rear view mirror, etc.) or ceiling.
  - Do not attach any accessories to the hood, front grille or front bumper that may obstruct the front camera. Contact your Lexus dealer for details.
- If a surfboard or other long object is to be mounted on the roof, make sure that it will not obstruct the front camera.
  - Do not modify the headlights or other lights.

■ **Certification**

- ▶ Except for vehicles sold in Canada

FCC ID: HYQDNMWR009

**NOTE:**

This device complies with part 15 of the FCC Rules. Operation is subject to the following two conditions: (1) This device may not cause harmful interference, and (2) this device must accept any interference received, including interference that may cause undesired operation.

**FCC WARNING:**

Changes or modifications not expressly approved by the party responsible for compliance could void the user's authority to operate the equipment.

**Radiofrequency radiation exposure Information:**

This equipment complies with FCC radiation exposure limits set forth for an uncontrolled environment. This equipment should be installed and operated with minimum distance of 20 cm between the radiator (antenna) and your body. This transmitter must not be co-located or operating in conjunction with any other antenna or transmitter.

- ▶ For vehicles sold in Canada

**NOTE:**

This device contains licence-exempt transmitter(s)/receiver(s) that comply with Innovation, Science and Economic Development Canada's licence-exempt RSS(s). Operation is subject to the following two conditions:

- (1) This device may not cause interference.
- (2) This device must accept any interference, including interference that may cause undesired operation of the device.

This equipment complies with IC radiation exposure limits set forth for an uncontrolled environment and meets RSS-102 of the IC radio frequency (RF) Exposure rules. This equipment should be installed and operated keeping the radiator at least 20 cm or more away from person's body.

**NOTE:**

L'émetteur/récepteur exempt de licence contenu dans le présent appareil est conforme aux CNR d'Innovation, Sciences et Développement économique Canada applicables aux appareils radio exempts de licence.

L'exploitation est autorisée aux deux conditions suivantes :

- 1) L'appareil ne doit pas produire de brouillage;
- 2) L'appareil doit accepter tout brouillage radioélectrique subi, même si le brouillage est susceptible d'en compromettre le fonctionnement.

Cet équipement est conforme aux limites d'exposition aux rayonnements énoncées pour un environnement non contrôlé et respecte les règles d'exposition aux fréquences radioélectriques (RF) CNR-102 de l'IC.

Cet équipement doit être installé et utilisé en gardant une distance de 20 cm ou plus entre le dispositif rayonnant et le corps.

■ **If a warning message is displayed on the multi-information display**

A system may be temporarily unavailable or there may be a malfunction in the system.

- In the following situations, perform the actions specified in the table. When the normal operating conditions are detected, the message will disappear and the system will become operational.

If the message does not disappear, contact your Lexus dealer.

Situation	Actions
When the area around a sensor is covered with dirt, moisture (fogged up, covered with condensation, ice, etc.), or other foreign matter	To clean the part of the windshield in front of the front camera, use the windshield wipers or the windshield defogger of the air conditioning system (→P.292).

Situation	Actions
When the temperature around the front camera is outside of the operational range, such as when the vehicle is in the sun or in an extremely cold environment	<p>If the front camera is hot, such as after the vehicle had been parked in the sun, use the air conditioning system to decrease the temperature around the front camera.</p> <p>If a sunshade was used when the vehicle was parked, depending on its type, the sunlight reflected from the surface of the sunshade may cause the temperature of the front camera to become excessively high.</p>
	<p>If the front camera is cold, such after the vehicle is parked in an extremely cold environment, use the air conditioning system to increase the temperature around the front camera.</p>
The area in front of the front camera is obstructed, such as when the hood is open or a sticker is attached to the part of the windshield in front of the front camera.	Close the hood, remove the sticker, etc. to clear the obstruction.

- In the following situations, if the situation has changed (or the vehicle has been driven for some time) and the normal operating conditions are detected, the message will disappear and the system will become operational.
  - If the message does not disappear, contact your Lexus dealer.
  - When the temperature around the radar sensor is outside of the operational range, such as when the vehicle is in the sun or in an extremely cold environment
  - When the front camera cannot detect objects in front of the vehicle, such as when driving in the dark, snow, or fog, or when bright lights are shining into the front camera



## PCS (Pre-Collision System)

The pre-collision system uses a radar sensor and front camera to detect objects (→P.209) in front of the vehicle. When the system determines that the possibility of a frontal collision with an object is high, a warning operates to urge the driver to take evasive action and the potential brake pressure is increased to help the driver avoid the collision. If the system determines that the possibility of a frontal collision with an object is extremely high, the brakes are automatically applied to help avoid the collision or help reduce the impact of the collision.

The pre-collision system can be disabled/enabled and the warning timing can be changed. (→P.211)

### Detectable objects

The system can detect the following:

- Vehicles
- Bicyclists
- Pedestrians

### System functions

#### ■ Pre-collision warning

When the system determines that the possibility of a frontal collision is high, a buzzer will sound and a warning message will be displayed on the multi-information display to urge the

driver to take evasive action.

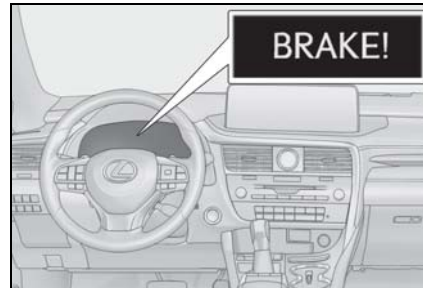

#### ■ Pre-collision brake assist

When the system determines that the possibility of a frontal collision is high, the system applies greater braking force in relation to how strongly the brake pedal is depressed.

#### ■ Pre-collision braking

If the system determines that the possibility of a frontal collision is extremely high, the brakes are automatically applied to help avoid the collision or reduce the impact of the collision.

#### ■ Suspension control (if equipped)

When the system determines that the possibility of a frontal collision is high, the Adaptive Variable Suspension System (→P.275) will control the damping force of the shock absorbers to help maintain an appropriate vehicle posture.

**WARNING****■ Limitations of the pre-collision system**

- The driver is solely responsible for safe driving. Always drive safely, taking care to observe your surroundings. Do not use the pre-collision system instead of normal braking operations under any circumstances. This system will not prevent collisions or lessen collision damage or injury in every situation. Do not overly rely on this system. Failure to do so may lead to an accident, resulting in death or serious injury.
  - Although this system is designed to help avoid a collision or help reduce the impact of the collision, its effectiveness may change according to various conditions, therefore the system may not always be able to achieve the same level of performance. Read the following conditions carefully. Do not overly rely on this system and always drive carefully.
    - Conditions under which the system may operate even if there is no possibility of a collision: →P.213
    - Conditions under which the system may not operate properly: →P.214
  - Do not attempt to test the operation of the pre-collision system yourself. Depending on the objects used for testing (dummies, cardboard objects imitating detectable objects, etc.), the system may not operate properly, possibly leading to an accident.
- Pre-collision braking**
- When the pre-collision braking function is operating, a large amount of braking force will be applied.
  - If the vehicle is stopped by the operation of the pre-collision braking function, the pre-collision braking function operation will be canceled after approximately 2 seconds. Depress the brake pedal as necessary.

- The pre-collision braking function may not operate if certain operations are performed by the driver. If the accelerator pedal is being depressed strongly or the steering wheel is being turned, the system may determine that the driver is taking evasive action and possibly prevent the pre-collision braking function from operating.

- In some situations, while the pre-collision braking function is operating, operation of the function may be canceled if the accelerator pedal is depressed strongly or the steering wheel is turned and the system determines that the driver is taking evasive action.

- If the brake pedal is being depressed, the system may determine that the driver is taking evasive action and possibly delay the operation timing of the pre-collision braking function.

**■ When to disable the pre-collision system**

In the following situations, disable the system, as it may not operate properly, possibly leading to an accident resulting in death or serious injury:

- When the vehicle is being towed
- When your vehicle is towing another vehicle
- When transporting the vehicle via truck, boat, train or similar means of transportation
- When the vehicle is raised on a lift with the engine running and the tires are allowed to rotate freely
- When inspecting the vehicle using a drum tester such as a chassis dynamometer or speedometer tester, or when using an on vehicle wheel balancer
- When a strong impact is applied to the front bumper or front grille, due to an accident or other reasons

**⚠ WARNING**

- If the vehicle cannot be driven in a stable manner, such as when the vehicle has been in an accident or is malfunctioning
- When the vehicle is driven in a sporty manner or off-road
- When the tires are not properly inflated
- When the tires are very worn
- When tires of a size other than specified are installed
- When tire chains are installed
- When a compact spare tire or an emergency tire puncture repair kit is used
- If equipment (snow plow, etc.) that may obstruct the radar sensor or front camera is temporarily installed to the vehicle

**Changing settings of the pre-collision system****■ Enabling/disabling the pre-collision system**

The pre-collision system can be enabled/disabled on  (→P.81) of the multi-information display.

The system is automatically enabled each time the engine switch is turned to IGNITION ON mode.

If the system is disabled, the PCS warning light will turn on and a message will be displayed on the multi-information display.

**■ Operational conditions**

The pre-collision system is enabled and the system determines that the possibility of a frontal

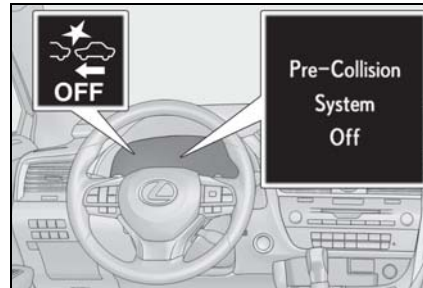
**■ Changing the pre-collision warning timing**

The pre-collision warning timing can be changed on  (→P.81) of the multi-information display.

The warning timing setting is retained when the engine switch is turned off. However, if the pre-collision system is disabled and re-enabled, the operation timing will return to the default setting (middle).

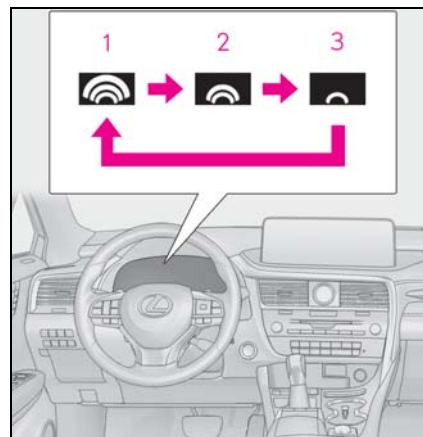

**1** Early

**2** Middle

This is the default setting.

**3** Late

collision with a detected object is high.  
Each function is operational at the following speed

● Pre-collision warning

Detectable objects	Vehicle speed	Relative speed between your vehicle and object
Vehicles	Approx. 7 to 110 mph (10 to 180 km/h)	Approx. 7 to 110 mph (10 to 180 km/h)
Bicyclists and pedestrians	Approx. 7 to 50 mph (10 to 80 km/h)	Approx. 7 to 50 mph (10 to 80 km/h)

● Pre-collision brake assist

Detectable objects	Vehicle speed	Relative speed between your vehicle and object
Vehicles	Approx. 20 to 110 mph (30 to 180 km/h)	Approx. 20 to 110 mph (30 to 180 km/h)
Bicyclists and pedestrians	Approx. 20 to 50 mph (30 to 80 km/h)	Approx. 20 to 50 mph (30 to 80 km/h)

● Pre-collision braking

Detectable objects	Vehicle speed	Relative speed between your vehicle and object
Vehicles	Approx. 7 to 110 mph (10 to 180 km/h)	Approx. 7 to 110 mph (10 to 180 km/h)
Bicyclists and pedestrians	Approx. 7 to 50 mph (10 to 80 km/h)	Approx. 7 to 50 mph (10 to 80 km/h)

The system may not operate in the following situations:

- If a battery terminal has been disconnected and reconnected and then the vehicle has not been driven for a certain amount of time
- If the shift lever is in R
- When the VSC OFF indicator is illuminated (only the pre-collision warning function will be operational)

■ Object detection function

The system detects objects based on their size, profile, motion, etc. However, an object may not be detected depending on the surrounding brightness and the motion, posture, and angle of the detected object, preventing the system from operating properly. (→P.214)

The illustration shows an image of detectable objects.



### ■ Cancellation of the pre-collision braking

If either of the following occur while the pre-collision braking function is operating, it will be canceled:

- The accelerator pedal is depressed strongly.
- The steering wheel is turned sharply or abruptly.

### ■ Conditions under which the system may operate even if there is no possibility of a collision

- In some situations such as the following, the system may determine that there is a possibility of a frontal collision and operate.
  - When passing a detectable object, etc.
  - When changing lanes while overtaking a detectable object, etc.
  - When approaching a detectable object in an adjacent lane or on the roadside, such as when changing the course of travel or driving on a winding road

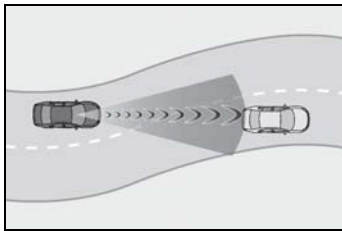

- When rapidly closing on a detectable object, etc.
- When approaching objects on the roadside, such as detectable objects, guardrails, utility poles, trees, or walls
- When there is a detectable object or other object by the roadside at the entrance of a curve

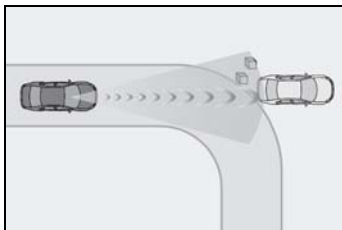

- When there are patterns or paint in front of your vehicle that may be mistaken for a detectable object

- When the front of your vehicle is hit by water, snow, dust, etc.
- When overtaking a detectable object that is changing lanes or making a right/left turn

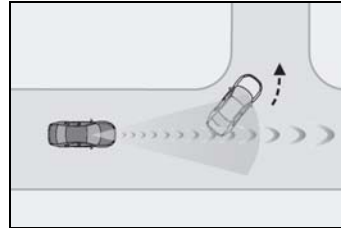

- When passing a detectable object in an oncoming lane that is stopped to make a right/left turn

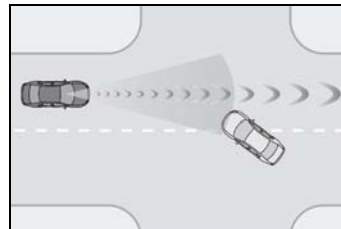

- When a detectable object approaches very close and then stops before entering the path of your vehicle
- If the front of your vehicle is raised or lowered, such as when on an uneven or undulating road surface
- When driving on a road surrounded by a structure, such as in a tunnel or on an iron bridge
- When there is a metal object (manhole cover, steel plate, etc.), steps, or a protrusion in front of your vehicle
- When passing under an object (road sign, billboard, etc.)

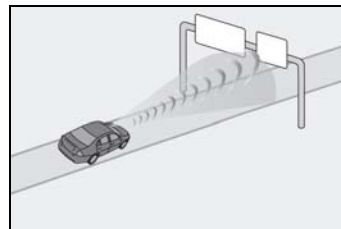

- When approaching an electric toll gate barrier, parking area barrier, or other barrier that opens and closes

- When using an automatic car wash
- When driving through or under objects that may contact your vehicle, such as thick grass, tree branches, or a banner

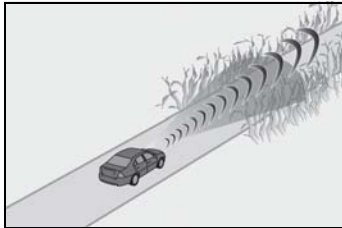

- When driving through steam or smoke
- When driving near an object that reflects radio waves, such as a large truck or guardrail
- When driving near a TV tower, broadcasting station, electric power plant, or other location where strong radio waves or electrical noise may be present

■ **Situations in which the system may not operate properly**

- In some situations such as the following, an object may not be detected by the radar sensor and front camera, preventing the system from operating properly:
  - When a detectable object is approaching your vehicle
  - When your vehicle or a detectable object is wobbling
  - If a detectable object makes an abrupt maneuver (such as sudden swerving, acceleration or deceleration)
  - When your vehicle approaches a detectable object rapidly
  - When a detectable object is not directly in front of your vehicle

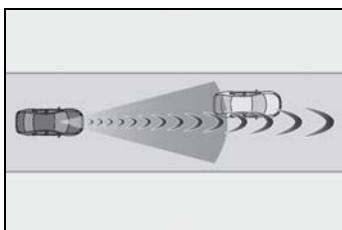

- When a detectable object is near a wall, fence, guardrail, manhole cover, vehicle, steel plate on the road, etc.
- When a detectable object is under a structure

- When part of a detectable object is hidden by an object, such as large baggage, an umbrella, or guardrail
- When multiple detectable objects are close together
- If the sun or other light is shining directly on a detectable object
- When a detectable object is a shade of white and looks extremely bright
- When a detectable object appears to be nearly the same color or brightness as its surroundings
- If a detectable object cuts or suddenly emerges in front of your vehicle
- When the front of your vehicle is hit by water, snow, dust, etc.
- When a very bright light ahead, such as the sun or the headlights of oncoming traffic, shines directly into the front camera
- When approaching the side or front of a vehicle ahead
  - If a vehicle ahead is a motorcycle
  - If a vehicle ahead is narrow, such as a personal mobility vehicle
  - If a preceding vehicle has a small rear end, such as an unloaded truck
  - If a preceding vehicle has a low rear end, such as a low bed trailer



- If a vehicle ahead has extremely high ground clearance

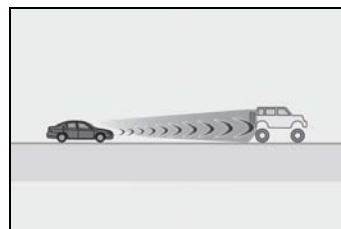

- If a vehicle ahead is carrying a load which protrudes past its rear bumper
- If a vehicle ahead is irregularly shaped, such as a tractor or side car

- If a vehicle ahead is a child sized bicycle, a bicycle that is carrying a large load, a bicycle ridden by more than one person, or a uniquely shaped bicycle (bicycle with a child seat, tandem bicycle, etc.)
- If a pedestrian/or the riding height of a bicyclist ahead is shorter than approximately 3.2 ft. (1 m) or taller than approximately 6.5 ft. (2 m)
- If a pedestrian/bicyclist is wearing oversized clothing (a rain coat, long skirt, etc.), making their silhouette obscure
- If a pedestrian is bending forward or squatting or bicyclist is bending forward
- If a pedestrian/bicyclist is moving fast
- If a pedestrian is pushing a stroller, wheelchair, bicycle or other vehicle
- When driving in inclement weather such as heavy rain, fog, snow or a sandstorm
- When driving through steam or smoke
- When the surrounding area is dim, such as at dawn or dusk, or while at night or in a tunnel, making a detectable object appear to be nearly the same color as its surroundings
- When driving in a place where the surrounding brightness changes suddenly, such as at the entrance or exit of a tunnel
- After the engine has started the vehicle has not been driven for a certain amount of time
- While making a left/right turn and for a few seconds after making a left/right turn
- While driving on a curve and for a few seconds after driving on a curve
- If your vehicle is skidding
- If the front of the vehicle is raised or lowered
- If the radar sensor or front camera is misaligned
- In some situations such as the following, sufficient braking force may not be obtained, preventing the system from performing properly:
  - If the braking functions cannot operate to their full extent, such as when the brake parts are extremely cold, extremely hot, or wet
  - If the vehicle is not properly maintained (brakes or tires are excessively worn, improper tire inflation pressure, etc.)
- When the vehicle is being driven on a gravel road or other slippery surface

#### ■ If VSC is disabled

- If VSC is disabled (→P.276), the pre-collision brake assist and pre-collision braking functions are also disabled.
- The PCS warning light will turn on and “VSC Turned Off Pre-Collision Brake System Unavailable” will be displayed on the multi-information display.

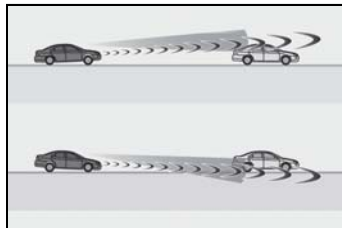

- If the wheels are misaligned
- If a wiper blade is blocking the front camera
- The vehicle is being driven at extremely high speeds
- When driving on a hill

### LTA (Lane Tracing Assist)

When driving on highways and freeways with white (yellow) lane lines, this function alerts the driver when the vehicle might depart from its lane or course\* and provides assistance by operating the steering wheel to keep the vehicle in its lane or course\*. Furthermore, the system provides steering assistance when dynamic radar cruise control with full-speed range is operating to keep the vehicle in its lane.

The LTA system recognizes white (yellow) lane lines or a course\* using the front camera. Additionally, it detects preceding vehicles using the front camera and radar.

\*: Boundary between asphalt and the side of the road, such as grass, soil, or a curb

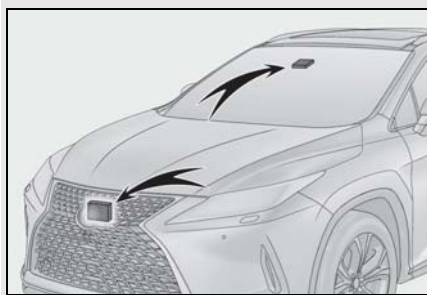

### ⚠ WARNING

#### ■ Before using LTA system

- Do not rely solely upon the LTA system. The LTA system does not automatically drive the vehicle or reduce the amount of attention that must be paid to the area in front of the vehicle. The driver must always assume full responsibility for driving safely by paying careful attention to the surrounding conditions and operating the steering wheel to correct the path of the vehicle. Also, the driver must take adequate breaks when fatigued, such as from driving for a long period of time.
- Failure to perform appropriate driving operations and pay careful attention may lead to an accident, resulting in death or serious injury.
- When not using the LTA system, use the LTA switch to turn the system off.

#### ■ Situations unsuitable for LTA system

In the following situations, use the LTA switch to turn the system off. Failure to do so may lead to an accident, resulting in death or serious injury.

- Vehicle is driven on a road surface which is slippery due to rainy weather, fallen snow, freezing, etc.
- Vehicle is driven on a snow-covered road.
- White (yellow) lines are difficult to see due to rain, snow, fog, dust, etc.
- Vehicle is driven in a temporary lane or restricted lane due to construction work.
- Vehicle is driven in a construction zone.
- A spare tire, tire chains, etc. are equipped.
- When the tires have been excessively worn, or when the tire inflation pressure is low.



**⚠ WARNING**

- When your vehicle is towing a trailer (vehicles with towing package) or during emergency towing.
- **Preventing LTA system malfunctions and operations performed by mistake**
- Do not modify the headlights or place stickers, etc. on the surface of the lights.
- Do not modify the suspension etc. If the suspension etc. needs to be replaced, contact your Lexus dealer.
- Do not install or place anything on the hood or grille. Also, do not install a grille guard (bull bars, kangaroo bar, etc.).
- If your windshield needs repairs, contact your Lexus dealer.

■ **Conditions in which functions may not operate properly**

In the following situations, the functions may not operate properly and the vehicle may depart from its lane. Drive safely by always paying careful attention to your surroundings and operate the steering wheel to correct the path of the vehicle without relying solely on the functions.

- When the follow-up cruising display is displayed (→P.221) and the preceding vehicle changes lanes. (Your vehicle may follow the preceding vehicle and also change lanes.)

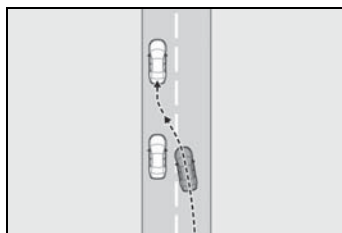

- When the follow-up cruising display is displayed (→P.221) and the preceding vehicle is swaying. (Your vehicle may sway accordingly and depart from the lane.)

- When the follow-up cruising display is displayed (→P.221) and the preceding vehicle departs from its lane. (Your vehicle may follow the preceding vehicle and depart from the lane.)
- When the follow-up cruising display is displayed (→P.221) and the preceding vehicle is being driven extremely close to the left/right lane line. (Your vehicle may follow the preceding vehicle and depart from the lane.)
- Vehicle is being driven around a sharp curve.
- Objects or patterns that could be mistaken for white (yellow) lines are present on the side of the road (guardrails, reflective poles, etc.).

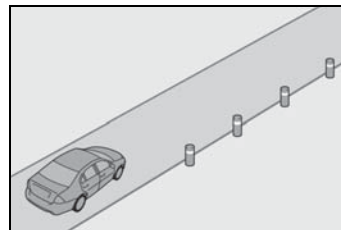

- Vehicle is driven where the road diverges, merges, etc.

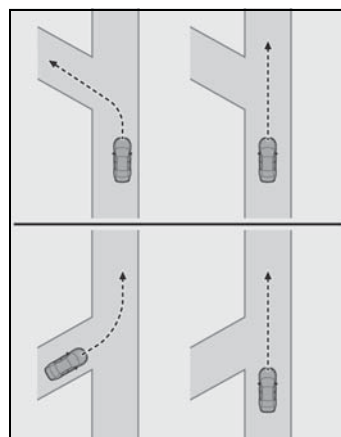

**⚠ WARNING**

- Repair marks of asphalt, white (yellow) lines, etc. are present due to road repair.

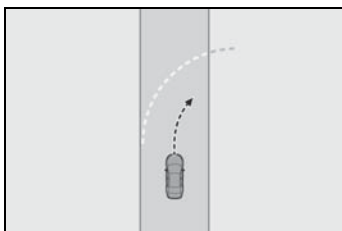

- There are shadows on the road that run parallel with, or cover, the white (yellow) lines.
- The vehicle is driven in an area without white (yellow) lines, such as in front of a tollgate or checkpoint, or at an intersection, etc.
- The white (yellow) lines are cracked, "Botts' dots", "Raised pavement marker" or stones are present.
- The white (yellow) lines cannot be seen or are difficult to see due to sand, etc.
- The vehicle is driven on a road surface that is wet due to rain, puddles, etc.
- The traffic lines are yellow (which may be more difficult to recognize than lines that are white).
- The white (yellow) lines cross over a curb, etc.
- The vehicle is driven on a bright surface, such as concrete.
- If the edge of the road is not clear or straight.
- The vehicle is driven on a surface that is bright due to reflected light, etc.
- The vehicle is driven in an area where the brightness changes suddenly, such as at the entrances and exits of tunnels, etc.

- Light from the headlights of an oncoming vehicle, the sun, etc. enters the camera.
- The vehicle is driven on a slope.
- The vehicle is driven on a road which tilts left or right, or a winding road.
- The vehicle is driven on an unpaved or rough road.
- The traffic lane is excessively narrow or wide.
- The vehicle is extremely tilted due to carrying heavy luggage or having improper tire pressure.
- The distance to the preceding vehicle is extremely short.
- The vehicle is moving up and down a large amount due to road conditions during driving (poor roads or road seams).
- When driving in a tunnel or at night with the headlights off or when a headlight is dim due to its lens being dirty or it being misaligned.
- The vehicle is struck by a crosswind.
- The vehicle is affected by wind from a vehicle driven in a nearby lane.
- The vehicle has just changed lanes or crossed an intersection.
- Tires which differ by structure, manufacturer, brand or tread pattern are used.
- When tires of a size other than specified are installed.
- Snow tires, etc. are equipped.
- The vehicle is being driven at extremely high speeds.

### Functions included in LTA system

#### ■ Lane departure alert function

When the system determines that the vehicle might depart from its lane or course<sup>\*</sup>, a warning is displayed on the multi-information display, and either a warning buzzer will sound or the steering wheel will vibrate to alert the driver.

When the warning buzzer sounds or the steering wheel vibrates, check the area around your vehicle and carefully operate the steering wheel to move the vehicle back to the center of the lane.

Vehicle with BSM: When the system determines that the vehicle might depart from its lane and that the possibility of a collision with an overtaking vehicle in the adjacent lane is high, the lane departure alert will operate even if the turn signals are operating.

\* : Boundary between asphalt and the side of the road, such as grass, soil, or a curb

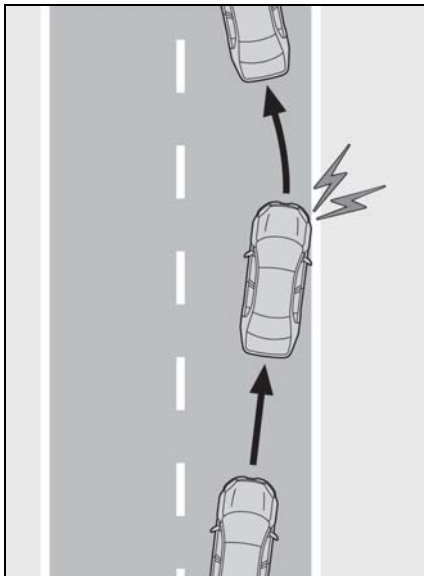

#### ■ Steering assist function

When the system determines that the vehicle might depart from its lane or course<sup>\*</sup>, the system provides assistance as necessary by operating the steering wheel in small amounts for a short period of time to keep the vehicle in its lane.

If the system detects that the steering wheel has not been operated for a fixed amount of time or the steering wheel is not being firmly gripped, a warning is displayed on the multi-information display and the function is temporarily canceled.

Vehicle with BSM: When the system determines that the vehicle might depart from its lane and that the possibility of a collision with an overtaking vehicle in the adjacent lane is high, the steering assist function will operate even if the turn signals are operating.

\* : Boundary between asphalt and the side of the road, such as grass, soil, or a curb

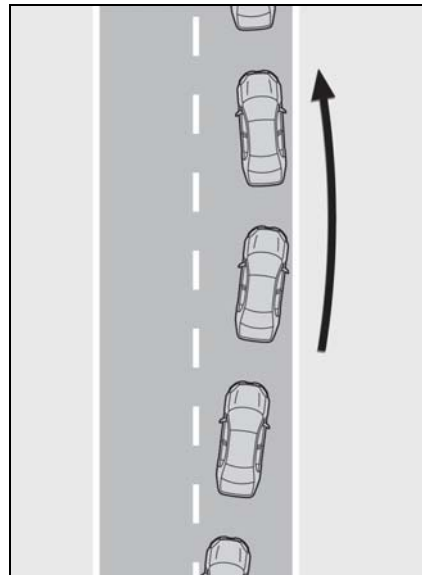

### ■ Vehicle sway warning function

When the vehicle is swaying within a lane, the warning buzzer will sound and a message will be displayed on the multi-information display to alert the driver.

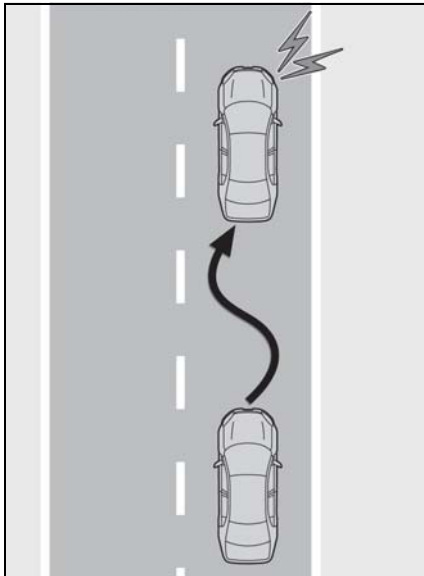

### ■ Lane centering function

This function is linked with dynamic radar cruise control with full-speed range and provides the required assistance by operating the steering wheel to keep the vehicle in its current lane.

When dynamic radar cruise control with full-speed range is not operating, the lane centering function does not operate.

In situations where the white (yellow) lane lines are difficult to see or are not visible, such as when in a traffic jam, this function will operate to help follow a preceding vehicle by monitoring the position of the preceding vehicle.

If the system detects that the steering wheel has not been operated for a fixed

amount of time or the steering wheel is not being firmly gripped, a warning is displayed on the multi-information display and the function is temporarily canceled.

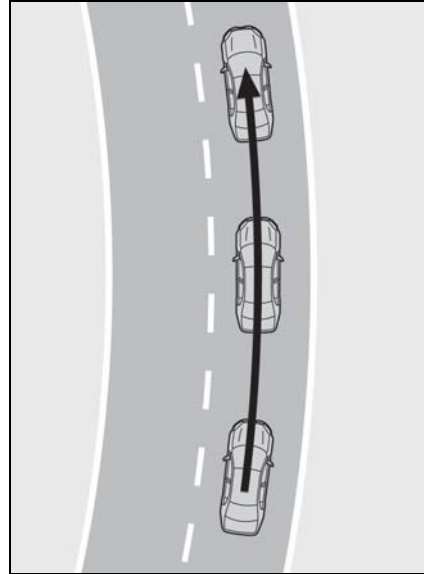

### Turning LTA system on

Press the LTA switch to turn the LTA system on.

The LTA indicator illuminates and a message is displayed on the multi-information display.

Press the LTA switch again to turn the LTA system off.

When the LTA system is turned on or off, operation of the LTA system continues in the same condition the next time the engine is started.

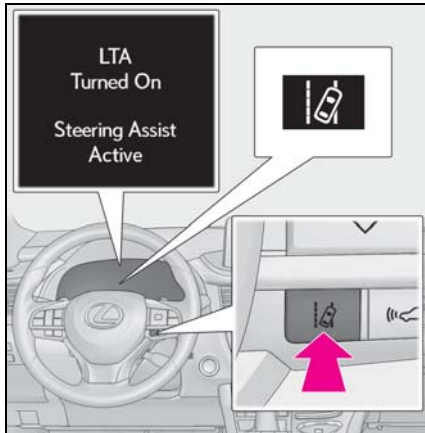

**Indications on multi-information display**

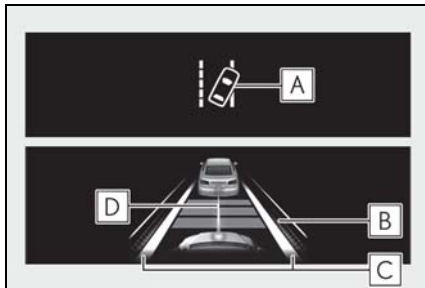

**A** LTA indicator

The illumination condition of the indicator informs the driver of the system operation status.

Illuminated in white: LTA system is operating.

Illuminated in green: Steering wheel assistance of the steering assist function or lane centering function is operating.

Flashing in orange: Lane departure alert function is operating.

**B** Operation display of steering wheel operation support

Displayed when the multi-information display is switched to the driving assist system information screen.

Indicates that steering wheel assistance of the steering assist function or lane centering function is operating.

Both outer sides of the lane are displayed: Indicates that steering wheel assist of the lane centering function is operating.

One outer side of the lane is displayed: Indicates that steering wheel assist of the steering assist function is operating.

Both outer sides of the lane are flashing: Alerts the driver that their input is necessary to stay in the center of the lane (lane centering function).

**C** Lane departure alert function display

Displayed when the multi-information display is switched to the driving assist system information screen.

► Inside of displayed lines is white



Indicates that the system is recognizing white (yellow) lines or a course\*. When the vehicle departs from its lane, the white line displayed on the side the vehicle departs from flashes orange.

- ▶ Inside of displayed white lines is black



Indicates that the system is not able to recognize white (yellow) lines or a course<sup>\*</sup> or is temporarily canceled.

<sup>\*</sup>: Boundary between asphalt and the side of the road, such as grass, soil, or a curb

#### **D** Follow-up cruising display

Displayed when the multi-information display is switched to the driving assist system information screen.

Indicates that steering assist of the lane centering function is operating by monitoring the position of a preceding vehicle.

When the follow-up cruising display is displayed, if the preceding vehicle moves, your vehicle may move in the same way. Always pay careful attention to your surroundings and operate the steering wheel as necessary to correct the path of the vehicle and ensure safety.

#### ■ Operation conditions of each function

##### ● Lane departure alert function

This function operates when all of the following conditions are met.

- LTA is turned on.
- Vehicle speed is approximately 32 mph (50 km/h) or more.<sup>\*1</sup>
- System recognizes white (yellow) lane lines or a course<sup>\*2</sup>. (When a white [yellow] line or course<sup>\*2</sup> is recognized on only one side, the system will operate

only for the recognized side.)

- Width of traffic lane is approximately 9.8 ft. (3 m) or more.
- Turn signal lever is not operated. (Vehicle with BSM: Except when another vehicle is in the lane on the side where the turn signal was operated)
- Vehicle is not being driven around a sharp curve.
- No system malfunctions are detected. (→P.224)

<sup>\*1</sup>: The function operates even if the vehicle speed is less than approximately 32 mph (50 km/h) when the lane centering function is operating.

<sup>\*2</sup>: Boundary between asphalt and the side of the road, such as grass, soil, or a curb

##### ● Steering assist function

This function operates when all of the following conditions are met in addition to the operation conditions for the lane departure alert function.

- Setting for "Steering Assist" in  of the multi-information display is set to "On". (→P.81)
- Vehicle is not accelerated or decelerated by a fixed amount or more.
- Steering wheel is not operated with a steering force level suitable for changing lanes.
- ABS, VSC, TRAC and PCS are not operating.
- TRAC or VSC is not turned off.
- Hands off steering wheel warning is not displayed. (→P.223)

##### ● Vehicle sway warning function

This function operates when all of the following conditions are met.

- Setting for "Sway Warning" in  of the multi-information display is set to "On". (→P.81)
- Vehicle speed is approximately 32 mph (50 km/h) or more.
- Width of traffic lane is approximately 9.8 ft. (3 m) or more.
- No system malfunctions are detected. (→P.224)

##### ● Lane centering function

This function operates when all of the fol-

lowing conditions are met.

- LTA is turned on.
- Setting for “Steering Assist” and “Lane Center” in  of the multi-information display are set to “On”. (→P.81)
- This function recognizes white (yellow) lane lines or the position of a preceding vehicle (except when the preceding vehicle is small, such as a motorcycle).
- The dynamic radar cruise control with full-speed range is operating in vehicle-to-vehicle distance control mode.
- Width of traffic lane is approximately 10 to 13 ft. (3 to 4 m).
- Turn signal lever is not operated.
- Vehicle is not being driven around a sharp curve.
- No system malfunctions are detected. (→P.224)
- Vehicle does not accelerate or decelerate by a fixed amount or more.
- Steering wheel is not operated with a steering force level suitable for changing lanes.
- ABS, VSC, TRAC and PCS are not operating.
- TRAC or VSC is not turned off.
- Hands off steering wheel warning is not displayed. (→P.223)
- The vehicle is being driven in the center of a lane.
- Steering assist function is not operating.

#### ■ Temporary cancelation of functions

- When operation conditions are no longer met, a function may be temporarily canceled. However, when the operation conditions are met again, operation of the function is automatically restored. (→P.222)
- If the operation conditions (→P.222) are no longer met while the lane centering function is operating, the steering wheel may vibrate and the buzzer may sound to indicate that the function has been temporarily canceled. However, if the “Alert” customization setting is set to , the system will notify the driver by vibrating the steering wheel instead of sounding the buzzer.

#### ■ Steering assist function/lane centering function

- Depending on the vehicle speed, lane departure situation, road conditions, etc., the driver may not feel the function is operating or the function may not operate at all.
- The steering control of the function is overridden by the driver’s steering wheel operation.
- Do not attempt to test the operation of the steering assist function.

#### ■ Lane departure alert function

- The warning buzzer may be difficult to hear due to external noise, audio playback, etc. Also, it may be difficult to feel steering wheel vibrations due to the road conditions, etc.
- If the edge of the course\* is not clear or straight, the lane departure alert function may not operate.
- Vehicle with BSM: It may not be possible for the system to determine if there is a danger of a collision with a vehicle in an adjacent lane.
- Do not attempt to test the operation of the lane departure alert function.

\*: Boundary between asphalt and the side of the road, such as grass, soil, or a curb

#### ■ Hands off steering wheel warning

In the following situations, a warning message urging the driver to hold the steering wheel and the symbol shown in the illustration are displayed on the multi-information display to warn the driver. The warning stops when the system determines that the driver holds the steering wheel. Always keep your hands on the steering wheel when using this system, regardless of warnings.

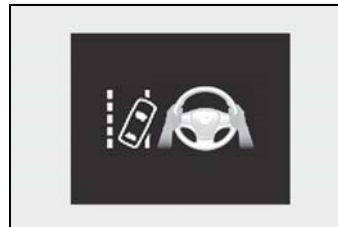

- When the system determines that the driver is driving without holding the steering wheel while the system is operating

If the driver continues to keep their hands off of the steering wheel, the buzzer sounds, the driver is warned and the function is temporarily canceled. This warning also operates in the same way when the driver continuously operates the steering wheel only a small amount.

The buzzer also sounds even if the alert type is set to .

- When the system determines that the vehicle may deviate from the lane while driving around a curve while the lane centering function is operating.

Depending on the vehicle condition and road conditions, the warning may not operate. Also, if the system determines that the vehicle is driving around a curve, warnings will occur earlier than during straight-lane driving.

- When the system determines that the driver is driving without holding the steering wheel while the steering wheel assist of the steering assist function is operating.

If the driver continues to keep their hands off of the steering wheel and the steering wheel assist is operating, the buzzer sounds and the driver is warned. Each time the buzzer sounds, the continuing time of the buzzer becomes longer.

The buzzer also sounds even if the alert type is set to .

■ **Vehicle sway warning function**

When the system determines that the vehicle is swaying while the vehicle sway warning function is operating, a buzzer sounds and a warning message urging the driver to rest and the symbol shown in the illustration are simultaneously displayed on the multi-information display.



Depending on the vehicle and road conditions, the warning may not operate.

■ **Warning message**

If the following warning message is displayed on the multi-information display and the LTA indicator illuminates in orange, follow the appropriate troubleshooting procedure. Also, if a different warning message is displayed, follow the instructions displayed on the screen.

- “LTA Malfunction Visit Your Dealer”

The system may not be operating properly. Have the vehicle inspected by your Lexus dealer.

- “LTA Unavailable”

The system is temporarily canceled due to a malfunction in a sensor other than the front camera. Turn the LTA system off, wait for a little while, and then turn the LTA system back on.

- “LTA Unavailable at Current Speed”

The function cannot be used as the vehicle speed exceeds the LTA operation range. Drive slower.

■ **Customization**

Function settings can be changed. (Customizable features:→P.461)



**RSA (Road Sign Assist)\***

\*: If equipped

The RSA system recognizes specific road signs using the front camera to provide information to the driver via the display.

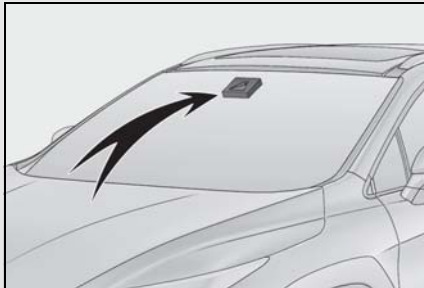

If the system judges that the vehicle is being driven over the speed limit, performing prohibited actions, etc. according to the recognized road signs, it notifies the driver through a visual notification and notification buzzer.

**⚠ WARNING**

**■ Before using the RSA**

Do not rely solely upon the RSA system. RSA is a system which supports the driver by providing information, but it is not a replacement for a driver's own vision and awareness. Drive safely by always paying careful attention to the traffic rules.

**Indication on the multi-information display**

When the front camera recognizes a sign, the sign will be displayed on the multi-information display.

- When the driving assist system

information is selected, a maximum of 3 signs can be displayed. (→P.81)

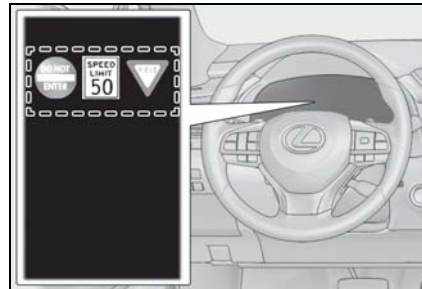

- When a tab other than the driving assist system information is selected, the following types of road signs will be displayed (→P.81)
  - Speed limit sign
  - Do Not Enter sign (when notification is necessary)

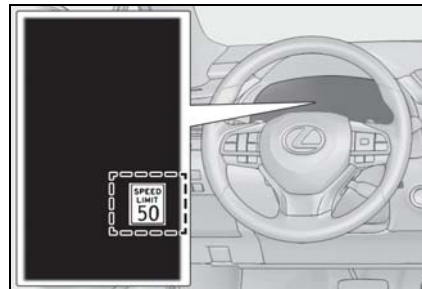

If signs other than speed limit signs are recognized, they will be displayed in an overlapping stack under the current speed limit sign.

**Supported types of road signs**

The following types of road signs, including electronic signs and blinking signs, are recognized.

A non-official or a recently introduced traffic sign may not be recognized.







### Notification function

In the following situations, the RSA system will notify the driver.

- When the vehicle speed exceeds the speed notification threshold of the speed limit sign displayed, the sign display will be emphasized and a buzzer will sound.
- When the RSA system recognizes a do not enter sign and determines that your vehicle has entered a no-entry area, the displayed sign will flash and a buzzer will sound.

Depending on the situation, a notification function may not operate properly.

### Setting procedure

- 1 Press < or > of the meter control switches and select .
- 2 Press ^ or v of the meter control switches and select , then press .
- 3 Press ^ or v of the meter control switches and select "RSA", then press .

### Automatic turn-off of RSA sign display

In the following situations, a displayed speed limit sign and/or do not enter sign will stop being displayed automatically:

- No sign has been recognized for a certain distance.
- The road changes due to a left or right turn, etc.

In the following situations, stop and yield signs will stop being displayed automatically:

- The system determines that your vehicle has passed the sign.
- The road changes due to a left or right turn, etc.

### Conditions in which the function may not operate or detect correctly

In the following situations, RSA does not operate normally and may not recognize signs, display the incorrect sign, etc. However, this does not indicate a malfunction.

- The front camera is misaligned due to a strong impact being applied to the sensor, etc.
- Dirt, snow, stickers, etc. are on the windshield near the front camera.
- In inclement weather such as heavy rain, fog, snow or sand storms.
- Light from an oncoming vehicle, the sun, etc. enters the front camera.
- The sign is dirty, faded, tilted or bent.
- The contrast of electronic sign is low.
- All or part of the sign is hidden by the leaves of a tree, a pole, etc.
- The sign is only visible to the front camera for a short amount of time.
- The driving scene (turning, lane change, etc.) is judged incorrectly.
- If a sign not appropriate for the currently traveled lane, but the sign exists directly after a freeway branches, or in an adjacent lane just before merging.
- Stickers are attached to the rear of the preceding vehicle.
- A sign resembling a system compatible sign is recognized.

- Side road speed signs may be detected and displayed (if positioned in sight of the front camera) while the vehicle is traveling on the main road.
- Roundabout exit road speed signs may be detected and displayed (if positioned in sight of the front camera) while traveling on a roundabout.
- The front of the vehicle is raised or lowered due to the carried load.
- The surrounding brightness is not sufficient or changes suddenly.
- When a sign intended for trucks, etc. is recognized.
- The speed information displayed on the meter and on the navigation system may be different due to the navigation system using map data.

#### ■ Speed limit sign display

If the engine switch was last turned off while a speed limit sign was displayed on the multi-information display, the same sign displays again when the engine switch is turned to IGNITION ON mode.

#### ■ Customization

Some functions can be customized. (Customizable features: →P.461)

### Dynamic radar cruise control with full-speed range

In vehicle-to-vehicle distance control mode, the vehicle automatically accelerates, decelerates and stops to match the speed changes of the preceding vehicle even if the accelerator pedal is not depressed. In constant speed control mode, the vehicle runs at a fixed speed.

Use the dynamic radar cruise control with full-speed range on freeways and highways.

- Vehicle-to-vehicle distance control mode (→P.229)
- Constant speed control mode (→P.234)

4

Driving

### System Components

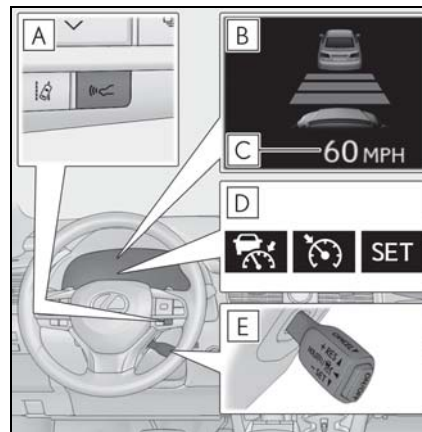

- A** Vehicle-to-vehicle distance switch
- B** Multi-information display
- C** Set speed
- D** Indicators

### E Cruise control switch

#### WARNING

##### ■ Before using dynamic radar cruise control with full-speed range

- Driving safely is the sole responsibility of the driver. Do not rely solely on the system, and drive safely by always paying careful attention to your surroundings.
- The dynamic radar cruise control with full-speed range provides driving assistance to reduce the driver's burden. However, there are limitations to the assistance provided. Read the following conditions carefully. Do not overly rely on this system and always drive carefully.
  - When the sensor may not be correctly detecting the vehicle ahead: →P.235
  - Conditions under which the vehicle-to-vehicle distance control mode may not function correctly: →P.236
- Set the speed appropriately depending on the speed limit, traffic flow, road conditions, weather conditions, etc. The driver is responsible for checking the set speed.
- Even when the system is functioning normally, the condition of the preceding vehicle as detected by the system may differ from the condition observed by the driver. Therefore, the driver must always remain alert, assess the danger of each situation and drive safely. Relying solely on this system or assuming the system ensures safety while driving can lead to an accident, resulting in death or serious injury.
- Switch the dynamic radar cruise control with full-speed range setting to off, using the "ON/OFF" button when not in use.

##### ■ Cautions regarding the driving assist systems

Observe the following precautions, as there are limitations to the assistance provided by the system. Failure to do so may cause an accident resulting in death or serious injury.

##### ● Assisting the driver to measure following distance

The dynamic radar cruise control with full-speed range is only intended to help the driver in determining the following distance between the driver's own vehicle and a designated vehicle traveling ahead. It is not a mechanism that allows careless or inattentive driving, and it is not a system that can assist the driver in low-visibility conditions.

It is still necessary for driver to pay close attention to the vehicle's surroundings.

##### ● Assisting the driver to judge proper following distance

The dynamic radar cruise control with full-speed range determines whether the following distance between the driver's own vehicle and a designated vehicle traveling ahead is within a set range. It is not capable of making any other type of judgement. Therefore, it is absolutely necessary for the driver to remain vigilant and to determine whether or not there is a possibility of danger in any given situation.

##### ● Assisting the driver to operate the vehicle

The dynamic radar cruise control with full-speed range does not include functions which will prevent or avoid collisions with vehicles ahead of your vehicle. Therefore, if there is ever any possibility of danger, the driver must take immediate and direct control of the vehicle and act appropriately in order to ensure the safety of all involved.

 **WARNING****■ Situations unsuitable for dynamic radar cruise control with full-speed range**

Do not use dynamic radar cruise control with full-speed range in any of the following situations. Doing so may result in inappropriate speed control and could cause an accident resulting in death or serious injury.

- Roads where there are pedestrians, cyclists, etc.
- In heavy traffic
- On roads with sharp bends
- On winding roads
- On slippery roads, such as those covered with rain, ice or snow
- On steep downhill, or where there are sudden changes between sharp up and down gradients  
Vehicle speed may exceed the set speed when driving down a steep hill.
- At entrances to freeways and highways
- When weather conditions are bad enough that they may prevent the sensors from detecting correctly (fog, snow, sandstorm, heavy rain, etc.)
- When there is rain, snow, etc. on the front surface of the radar or front camera
- In traffic conditions that require frequent repeated acceleration and deceleration
- When your vehicle is towing a trailer or during emergency towing
- When an approach warning buzzer is heard often

**Driving in vehicle-to-vehicle distance control mode**

This mode employs a radar to detect the presence of vehicles up to approximately

328 ft. (100 m) ahead, determines the current vehicle-to-vehicle following distance, and operates to maintain a suitable following distance from the vehicle ahead. The desired vehicle-to-vehicle distance can also be set by operating the vehicle-to-vehicle distance switch.

When driving on downhill slopes, the vehicle-to-vehicle distance may become shorter.

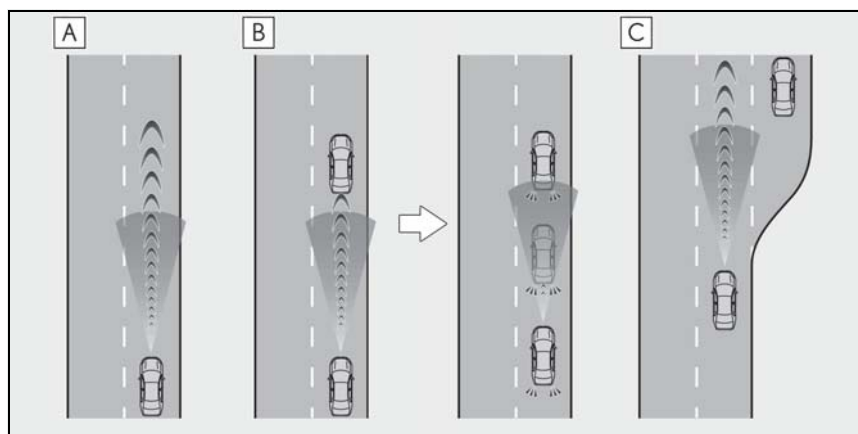

**A** Example of constant speed cruising

When there are no vehicles ahead

The vehicle travels at the speed set by the driver.

**B** Example of deceleration cruising and follow-up cruising

When a preceding vehicle driving slower than the set speed appears

When a vehicle is detected running ahead of you, the system automatically decelerates your vehicle. When a greater reduction in vehicle speed is necessary, the system applies the brakes (the stop lights will come on at this time). The system will respond to changes in the speed of the vehicle ahead in order to maintain the vehicle-to-vehicle distance set by the driver. Approach warning warns you when the system cannot decelerate sufficiently to prevent your vehicle from closing in on the vehicle ahead.

When the vehicle ahead of you stops, your vehicle will also stop (vehicle is stopped by system control). After the vehicle ahead starts off, pushing the cruise control lever up or depressing the accelerator pedal (start-off operation) will resume follow-up cruising. If the start-off operation is not performed, system control continues to keep your vehicle stopped.

When the turn signal lever is operated and your vehicle moves to an overtaking lane while driving at 50 mph (80 km/h) or more, the vehicle will accelerate to help to overtake a passing vehicle.

The system's identification of what is an overtaking lane may be determined solely based on the location of the steering wheel in the vehicle (left side driver position versus right side driver position.) If the vehicle is driven to a region where the overtaking lane is on a different side from where the vehicle is normally driven, the vehicle may accelerate when the turn

signal lever is operated in the opposite direction to the overtaking lane (e.g., if the driver normally operates the vehicle in a region where the overtaking lane is to the right but then drives to a region where the overtaking lane is to the left, the vehicle may accelerate when the right turn signal is activated).

**C** Example of acceleration

When there are no longer any preceding vehicles driving slower than the set speed

The system accelerates until the set speed is reached. The system then returns to constant speed cruising.

**Setting the vehicle speed (vehicle-to-vehicle distance control mode)**

- 1 Press the "ON/OFF" button to activate the cruise control.

Dynamic radar cruise control indicator will come on and a message will be displayed on the multi-information display. Press the button again to deactivate the cruise control.

If the "ON/OFF" button is pressed and held for 1.5 seconds or more, the system turns on in constant speed control mode. (→P.234)

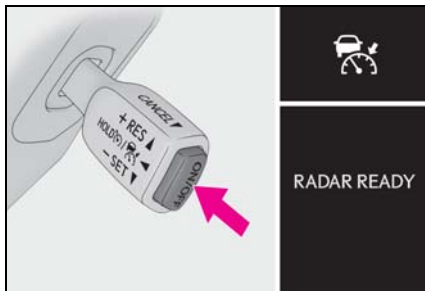

- 2 Accelerate or decelerate, with accelerator pedal operation, to the desired vehicle speed (at or above approximately 20 mph [30 km/h]) and push the lever down to set the speed.

Cruise control "SET" indicator will come on.

The vehicle speed at the moment the lever is released becomes the set speed.

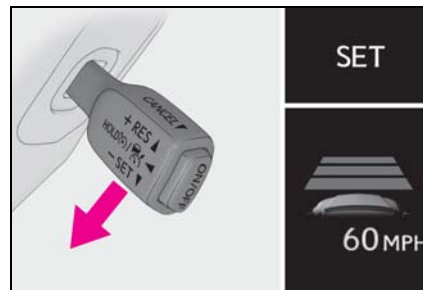

**Adjusting the set speed**

To change the set speed, operate the lever until the desired set speed is displayed.

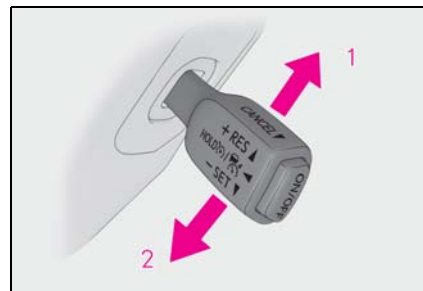

- 1 Increases the speed (Except when the vehicle has been stopped by system control in vehicle-to-vehicle distance control mode)
- 2 Decreases the speed

Fine adjustment: Momentarily move the

lever in the desired direction.

Large adjustment: Hold the lever up or down to change the speed, and release when the desired speed is reached.

In the vehicle-to-vehicle distance control mode, the set speed will be increased or decreased as follows:

- ▶ For the U.S. mainland, Hawaii

Fine adjustment: By 1 mph (1.6 km/h)<sup>\*1</sup> or 1 km/h (0.6 mph)<sup>\*2</sup> each time the lever is operated

Large adjustment: Increases or decreases in 1 mph (1.6 km/h)<sup>\*1</sup> or 1 km/h (0.6 mph)<sup>\*2</sup> increments for as long as the lever is held

- ▶ For Canada, Guam, Puerto Rico and Saipan

Fine adjustment: By 1 mph (1.6 km/h)<sup>\*1</sup> or 1 km/h (0.6 mph)<sup>\*2</sup> each time the lever is operated

Large adjustment: Increases or decreases in 5 mph (8 km/h)<sup>\*1</sup> or 5 km/h (3.1 mph)<sup>\*2</sup> increments for as long as the lever is held

In the constant speed control mode (→P.234), the set speed will be increased or decreased as follows:

Fine adjustment: By 1 mph (1.6 km/h)<sup>\*1</sup> or 1 km/h (0.6 mph)<sup>\*2</sup> each time the lever is operated

Large adjustment: The speed will continue to change while the switch is held.

<sup>\*1</sup>: When the set speed is shown in "MPH"

<sup>\*2</sup>: When the set speed is shown in "km/h"

**Changing the vehicle-to-vehicle distance (vehicle-to-vehicle distance control mode)**

Pressing the switch changes the vehi-

cle-to-vehicle distance as follows:

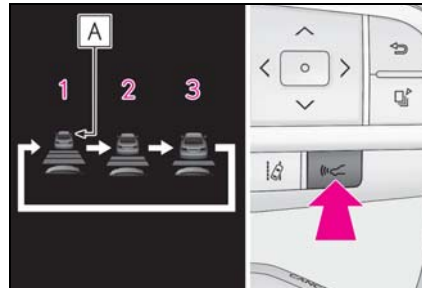

- 1 Long
- 2 Medium
- 3 Short

If a vehicle is running ahead of you, the preceding vehicle mark **A** will also be displayed.

**Vehicle-to-vehicle distance settings (vehicle-to-vehicle distance control mode)**

Select a distance from the table below. Note that the distances shown correspond to a vehicle speed of 50 mph (80 km/h). Vehicle-to-vehicle distance increases/decreases in accordance with vehicle speed. When the vehicle is stopped by system control, the vehicle stops at a certain vehicle-to-vehicle distance depending on the situation.

Distance options	Vehicle-to-vehicle distance
Long	Approximately 160 ft. (50 m)
Medium	Approximately 130 ft. (40 m)
Short	Approximately 100 ft. (30 m)



### Resuming follow-up cruising when the vehicle has been stopped by system control (vehicle-to-vehicle distance control mode)

After the vehicle ahead of you starts off, push the lever up.

Your vehicle will also resume follow-up cruising if the accelerator pedal is depressed after the vehicle ahead of you starts off.

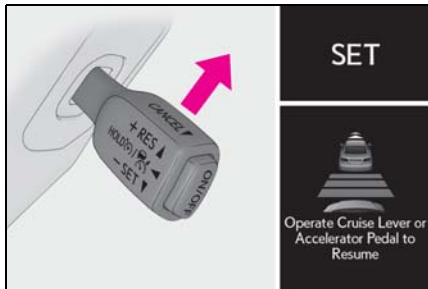

### Canceling and resuming the speed control

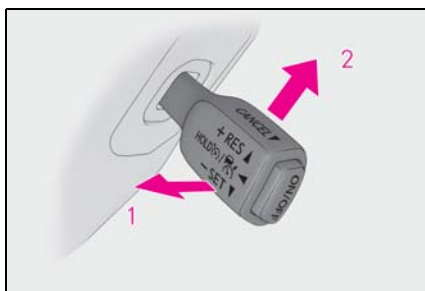

- 1 Pulling the lever toward you cancels the speed control.

The speed control is also canceled when the brake pedal is depressed. (When the vehicle has been stopped by system control, depressing the brake pedal does not cancel the setting.)

- 2 Pushing the lever up resumes the cruise control and returns vehicle speed to the set speed.

### Approach warning (vehicle-to-vehicle distance control mode)

When your vehicle is too close to a vehicle ahead, and sufficient automatic deceleration via the cruise control is not possible, the display will flash and the buzzer will sound to alert the driver. An example of this would be if another driver cuts in front of you while you are following a vehicle. Depress the brake pedal to ensure an appropriate vehicle-to-vehicle distance.

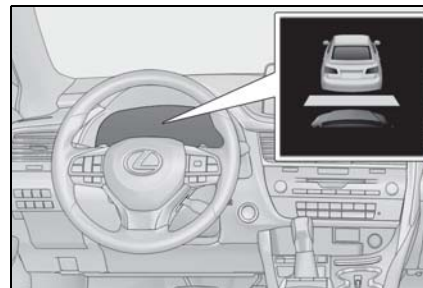

#### ■ Warnings may not occur when

In the following instances, warnings may not occur even when the vehicle-to-vehicle distance is small.

- When the speed of the preceding vehicle matches or exceeds your vehicle speed
- When the preceding vehicle is traveling at an extremely slow speed
- Immediately after the cruise control speed was set
- When depressing the accelerator

pedal

### Selecting constant speed control mode

When constant speed control mode is selected, your vehicle will maintain a set speed without controlling the vehicle-to-vehicle distance. Select this mode only when vehicle-to-vehicle distance control mode does not function correctly due to a dirty radar, etc.

- 1 With the cruise control off, press and hold the "ON/OFF" button for 1.5 seconds or more.

Immediately after the "ON/OFF" button is pressed, the dynamic radar cruise control indicator will come on. Afterwards, it switches to the cruise control indicator.

Switching to constant speed control mode is only possible when operating the lever with the cruise control off.

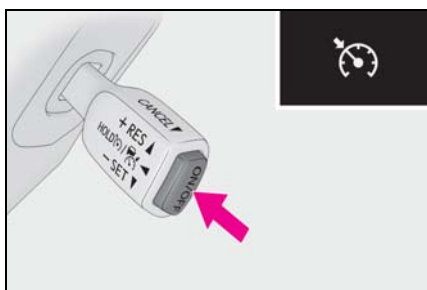

- 2 Accelerate or decelerate, with accelerator pedal operation, to the desired vehicle speed (at or above approximately 20 mph [30 km/h]) and push the lever down to set the speed.

Cruise control "SET" indicator will come on.

The vehicle speed at the moment the lever is released becomes the set speed.

Adjusting the speed setting: →P.231

Canceling and resuming the speed setting:  
→P.233

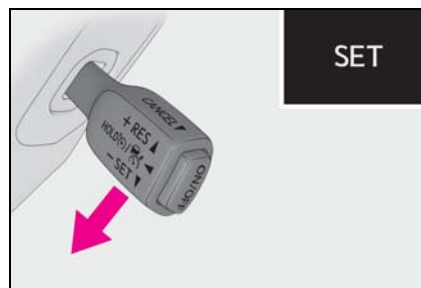

### Dynamic radar cruise control with full-speed range can be set when

- The shift lever is in D.
- The desired set speed can be set when the vehicle speed is approximately 20 mph (30 km/h) or more. (However, when the vehicle speed is set while driving at below approximately 20 mph [30 km/h], the set speed will be set to approximately 20 mph [30 km/h].)

### Accelerating after setting the vehicle speed

The vehicle can accelerate by operating the accelerator pedal. After accelerating, the set speed resumes. However, during vehicle-to-vehicle distance control mode, the vehicle speed may decrease below the set speed in order to maintain the distance to the preceding vehicle.

### When the vehicle stops while follow-up cruising

- Pushing the lever up while the vehicle ahead stops will resume follow-up cruising if the vehicle ahead starts off within approximately 3 seconds after the lever is pushed up.
- If the vehicle ahead starts off within 3 seconds after your vehicle stops, follow-up cruising will be resumed.

### Automatic cancelation of vehicle-to-vehicle distance control mode

Vehicle-to-vehicle distance control mode is automatically canceled in the following situations.

- VSC is activated.

- TRAC is activated for a period of time.
- When the VSC or TRAC system is turned off.
- The sensor cannot detect correctly because it is covered in some way.
- Pre-collision braking is activated.
- The parking brake is operated.
- The vehicle is stopped by system control on a steep incline.
- The following are detected when the vehicle has been stopped by system control:
  - The driver is not wearing a seat belt.
  - The driver's door is opened.
  - The vehicle has been stopped for about 3 minutes.

If vehicle-to-vehicle distance control mode is automatically canceled for any reasons other than the above, there may be a malfunction in the system. Contact your Lexus dealer.

#### ■ Automatic cancelation of constant speed control mode

Constant speed control mode is automatically canceled in the following situations:

- Actual vehicle speed is more than approximately 10 mph (16 km/h) below the set vehicle speed.
- Actual vehicle speed falls below approximately 20 mph (30 km/h).
- VSC is activated.
- TRAC is activated for a period of time.
- When the VSC or TRAC system is turned off.
- Pre-collision braking is activated.

If constant speed control mode is automatically canceled for any reasons other than the above, there may be a malfunction in the system. Contact your Lexus dealer.

#### ■ Brake operation

A brake operation sound may be heard and the brake pedal response may change, but these are not malfunctions.

#### ■ Warning messages and buzzers for dynamic radar cruise control with full-speed range

Warning messages and buzzers are used to indicate a system malfunction or to inform the driver of the need for caution while driving. If a warning message is shown on the multi-information display, read the message and follow the instructions. (→P.207,412)

#### ■ When the sensor may not be correctly detecting the vehicle ahead

In the case of the following and depending on the conditions, operate the brake pedal when deceleration of the system is insufficient or operate the accelerator pedal when acceleration is required. As the sensor may not be able to correctly detect these types of vehicles, the approach warning (→P.233) may not be activated.

- Vehicles that cut in suddenly
- Vehicles traveling at low speeds
- Vehicles that are not moving in the same lane
- Vehicles with small rear ends (trailers with no load on board, etc.)



- Motorcycles traveling in the same lane
- When water or snow thrown up by the surrounding vehicles hinders the detecting of the sensor
- When your vehicle is pointing upwards (caused by a heavy load in the luggage compartment, etc.)

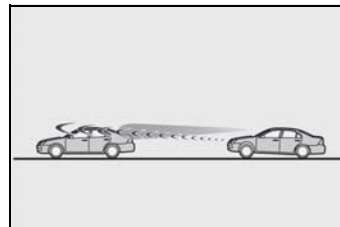

- Preceding vehicle has an extremely high ground clearance

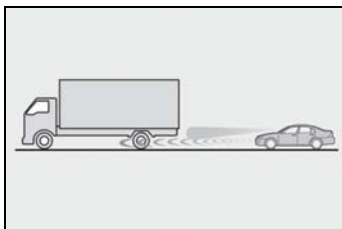

- Conditions under which the vehicle-to-vehicle distance control mode may not function correctly

In the case of the following conditions, operate the brake pedal (or accelerator pedal, depending on the situation) as necessary.

As the sensor may not be able to correctly detect vehicles ahead, the system may not operate properly.

- When the road curves or when the lanes are narrow

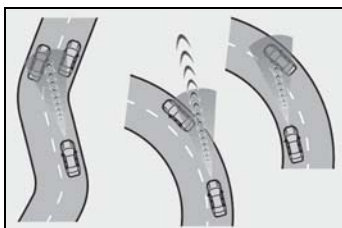

- When steering wheel operation or your position in the lane is unstable

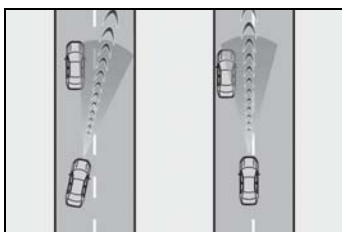

- When the vehicle ahead of you decelerates suddenly
- When driving on a road surrounded by a structure, such as in a tunnel or on a bridge
- While the vehicle speed is decreasing to the set speed after the vehicle accelerates by depressing the accelerator pedal

## BSM (Blind Spot Monitor)\*

\*: If equipped

The Blind Spot Monitor is a system that uses rear side radar sensors installed on the inner side of the rear bumper on the left and right side to assist the driver in confirming safety when changing lanes.

### ! WARNING

#### ■ Cautions regarding the use of the system

The driver is solely responsible for safe driving. Always drive safely, taking care to observe your surroundings.

The Blind Spot Monitor is a supplementary function which alerts the driver that a vehicle is in a blind spot of the outside rear view mirrors or is approaching rapidly from behind into a blind spot. Do not overly rely on the Blind Spot Monitor. As the function cannot judge if it is safe to change lanes, over reliance could lead to an accident resulting in death or serious injury.

As the system may not function correctly under certain conditions, the driver's own visual confirmation of safety is necessary.

## System components

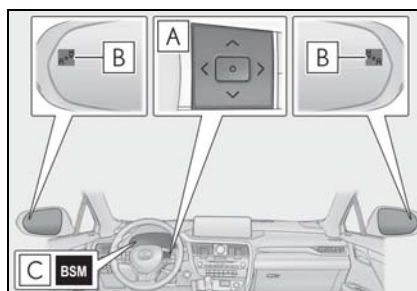

### A Meter control switches

Turning the Blind Spot Monitor on/off.

**B** Outside rear view mirror indicators

When a vehicle is detected in a blind spot of the outside rear view mirrors or approaching rapidly from behind into a blind spot, the outside rear view mirror indicator on the detected side will illuminate. If the turn signal lever is operated toward the detected side, the outside rear view mirror indicator flashes.

**C** BSM indicator

Illuminates when the Blind Spot Monitor is enabled

■ **Outside rear view mirror indicator visibility**

In strong sunlight, the outside rear view mir-

■ **Certification**

▶ Except for vehicles sold in Canada

FCC ID : OAYSRR3A

This device complies with part 15 of the FCC Rules. Operation is subject to the following two conditions:

- (1) This device may not cause harmful interference, and
- (2) this device must accept any interference received, including interference that may cause undesired operation.

FCC Warning

Changes or modifications not expressly approved by the party responsible for compliance could void the user's authority to operate the equipment.

ror indicator may be difficult to see.

■ **When "Blind Spot Monitor Unavailable" is shown on the multi-information display**

Ice, snow, mud, etc., may be attached to the rear bumper around the sensors. (→P.238) The system should return to normal operation after removing the ice, snow, mud, etc. from the rear bumper. Additionally, the sensors may not operate normally when driving in extremely hot or cold environments.

■ **Customization**

Some functions can be customized. (→P.461)

► For vehicles sold in Canada

This device contains licence-exempt transmitter(s)/receiver(s) that comply with Innovation, Science and Economic Development Canada's licence-exempt RSS(s). Operation is subject to the following two conditions:

1. This device may not cause interference.
2. This device must accept any interference, including interference that may cause undesired operation of the device.

Radiofrequency radiation exposure information:

This equipment complies with radiation exposure limits set forth for an uncontrolled environment. This equipment should be installed and operated with minimum distance of 20 cm between the radiator and your body.

L'émetteur/récepteur exempt de licence contenu dans le présent appareil est conforme aux CNR d'Innovation, Sciences et Développement économique Canada applicables aux appareils radio exempts de licence. L'exploitation est autorisée aux deux conditions suivantes:

1. L'appareil ne doit pas produire de brouillage;
2. L'appareil doit accepter tout brouillage radioélectrique subi, même si le brouillage est susceptible d'en compromettre le fonctionnement.

Informations sur l'exposition aux rayonnements radiofréquences:

Cet équipement est conforme aux limites d'exposition aux rayonnements définies pour un environnement non contrôlé. Cet équipement doit être installé et utilisé avec un minimum de 20 cm de distance entre la source de rayonnement et votre corps.

 **WARNING**

■ **Handling the rear side radar sensor**

Blind Spot Monitor sensors are installed behind the left and right sides of the rear bumper respectively. Observe the following to ensure the Blind Spot Monitor can operate correctly.

**⚠ WARNING**

- Keep the sensors and the surrounding areas on the rear bumper clean at all times.

If a sensor or its surrounding area on the rear bumper is dirty or covered with snow, the Blind Spot Monitor may not operate and a warning message (→P.237) will be displayed. In this situation, clear off the dirt or snow and drive the vehicle with the operation conditions of the BSM function (→P.241) satisfied for approximately 10 minutes. If the warning message does not disappear, have the vehicle inspected by your Lexus dealer.

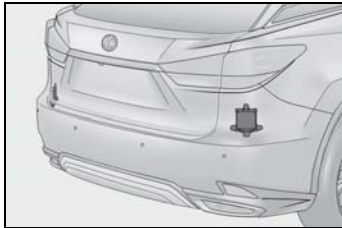



- Do not attach stickers to the sensor or surrounding area on the rear bumper.
- Do not subject a sensor or its surrounding area on the rear bumper to a strong impact.  
If a sensor is moved even slightly off position, the system may malfunction and vehicles may not be detected correctly.  
In the following situations, have your vehicle inspected by your Lexus dealer.
  - A sensor or its surrounding area is subject to a strong impact.
  - If the surrounding area of a sensor is scratched or dented, or part of them has become disconnected.
- Do not disassemble the sensor.
- Do not modify the sensor or surrounding area on the rear bumper.

- If a sensor or the rear bumper needs to be removed/installed or replaced, contact your Lexus dealer.

- Do not paint the rear bumper any color other than an official Lexus color.

**Turning the Blind Spot Monitor on/off**

Use the meter control switches to turn on/off the function.

- 1 Press < or > to select .
- 2 Press ^ or v to select  and then press .

### Blind Spot Monitor operation

#### ■ Vehicles that can be detected by the Blind Spot Monitor

The Blind Spot Monitor uses rear side radar sensors to detect the following vehicles traveling in adjacent lanes and advises the driver of the presence of such vehicles via the indicators on the outside rear view mirrors.

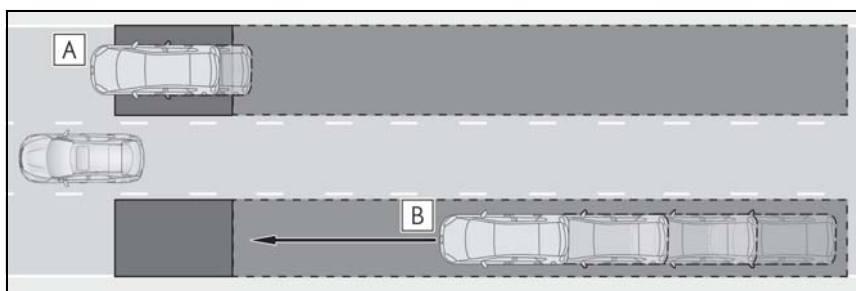

- A** Vehicles that are traveling in areas that are not visible using the outside rear view mirrors (the blind spots)
- B** Vehicles that are approaching rapidly from behind in areas that are not visible using the outside rear view mirrors (the blind spots)

#### ■ The Blind Spot Monitor detection areas

The areas that vehicles can be detected in are outlined below.

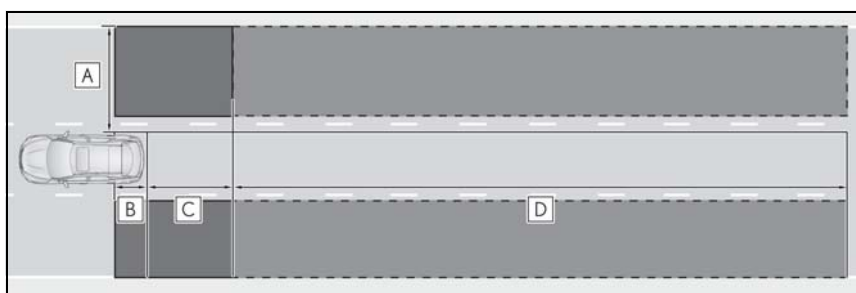

The range of each detection area is:

- A** Approximately 1.6 ft. (0.5 m) to 11.5 ft. (3.5 m) from either side of the vehicle <sup>\*1</sup>
- B** Approximately 3.3 ft. (1 m) forward of the rear bumper
- C** Approximately 9.8 ft. (3 m) from the rear bumper
- D** Approximately 9.8 ft. (3 m) to 197 ft. (60 m) from the rear bumper <sup>\*2</sup>

<sup>\*1</sup>: The area between the side of the vehicle and 1.6 ft. (0.5 m) from the side of the vehicle cannot be detected.

<sup>\*2</sup>: The greater the difference in speed between your vehicle and the detected vehicle is,



the farther away the vehicle will be detected, causing the outside rear view mirror indicator to illuminate or flash.

#### ■ The Blind Spot Monitor is operational when

The Blind Spot Monitor is operational when all of the following conditions are met:

- The Blind Spot Monitor is on.
- The shift lever is in a position other than R.
- The vehicle speed is greater than approximately 10 mph (16 km/h).

#### ■ The Blind Spot Monitor will detect a vehicle when

The Blind Spot Monitor will detect a vehicle present in the detection area in the following situations:

- A vehicle in an adjacent lane overtakes your vehicle.
- You overtake a vehicle in an adjacent lane slowly.
- Another vehicle enters the detection area when it changes lanes.

#### ■ Conditions under which the Blind Spot Monitor will not detect a vehicle

The Blind Spot Monitor is not designed to detect the following types of vehicles and/or objects:

- Small motorcycles, bicycles, pedestrians, etc.\*
- Vehicles traveling in the opposite direction
- Guardrails, walls, signs, parked vehicles and similar stationary objects\*
- Following vehicles that are in the same lane\*
- Vehicles traveling 2 lanes away from your vehicle\*
- Vehicles which are being overtaken rapidly by your vehicle\*

\*: Depending on the conditions, detection of a vehicle and/or object may occur.

#### ■ Conditions under which the Blind Spot Monitor may not function correctly

- The Blind Spot Monitor may not detect vehicles correctly in the following situations:
  - When the sensor is misaligned due to a strong impact to the sensor or its surrounding area
  - When mud, snow, ice, a sticker, etc. is covering the sensor or surrounding area on the rear bumper
  - When driving on a road surface that is wet with standing water during bad weather, such as heavy rain, snow, or fog
  - When multiple vehicles are approaching with only a small gap between each vehicle
  - When the distance between your vehicle and a following vehicle is short
  - When there is a significant difference in speed between your vehicle and the vehicle that enters the detection area
  - When the difference in speed between your vehicle and another vehicle is changing
  - When a vehicle enters a detection area traveling at about the same speed as your vehicle
  - As your vehicle starts from a stop, a vehicle remains in the detection area
  - When driving up and down consecutive steep inclines, such as hills, dips in the road, etc.
  - When driving on roads with sharp bends, consecutive curves, or uneven surfaces
  - When vehicle lanes are wide, or when driving on the edge of a lane, and the vehicle in an adjacent lane is far away from your vehicle
  - When an accessory (such as a bicycle carrier) is installed to the rear of the vehicle
  - When there is a significant difference in height between your vehicle and the vehicle that enters the detection area
  - Immediately after the Blind Spot Monitor is turned on
- Instances of the Blind Spot Monitor unnecessarily detecting a vehicle and/or object may increase in the following situ-

ations:

- When the sensor is misaligned due to a strong impact to the sensor or its surrounding area
- When the distance between your vehicle and a guardrail, wall, etc. that enters the detection area is short
- When driving up and down consecutive steep inclines, such as hills, dips in the road, etc.
- When vehicle lanes are narrow, or when driving on the edge of a lane, and a vehicle traveling in a lane other than the adjacent lanes enters the detection area
- When driving on roads with sharp bends, consecutive curves, or uneven surfaces
- When the tires are slipping or spinning
- When the distance between your vehicle and a following vehicle is short
- When an accessory (such as a bicycle carrier) is installed to the rear of the vehicle

### PKSA (Parking Support Alert)\*

\*: If equipped

The Parking Support Alert system consists of the following functions that operate when driving at a low speed or backing up, such as when parking. When the system determines that the possibility of a collision with a detected object or such as a wall is high, a warning operates to urge the driver to take evasive action.

### PKSA (Parking Support Alert) system

#### ■ Intuitive parking assist (if equipped)

Ultrasonic sensors are used to detect static objects in the detection area when driving at a low speed or backing up. (→P.244)

#### ■ RCTA (Rear Cross Traffic Alert) function (if equipped)

Rear side radar sensors are used to detect approaching vehicles in the detection areas behind the vehicle when backing up. (→P.250)

### Setting the buzzer volume





#### ■ Adjusting the buzzer volume

The buzzer volume can be adjusted on the multi-information display. The volume of buzzers for the intuitive parking assist and RCTA function will be

adjusted simultaneously.





Use the meter control switches to change settings. (→P.82)

▶ Vehicles without the Intuitive parking assist

- 1 Press < or > to select .
- 2 Press ^ or v to select "Vehicle Settings" and then press .
- 3 Press ^ or v to select  and then press .

Each time the switch is pressed, the volume level will change between 1, 2, and 3.

▶ Vehicles with the Intuitive parking assist

- 1 Press < or > to select .
- 2 Press ^ or v to select "PKSA" and then press .
- 3 Press ^ or v to select  and then press .

Each time the switch is pressed, the volume level will change between 1, 2, and 3.

#### ■ Muting a buzzer temporarily

▶ Vehicles without the Intuitive parking assist

A mute button will be displayed on the multi-information display when an object is detected. To mute the buzzer, press .

Mute will be canceled automatically in the following situations:

- When the shift lever is changed.
- When the vehicle speed exceeds a certain speed.

- When the operating function is temporarily canceled.
  - When the operating function is disabled manually.
  - When the engine switch is turned off.
- ▶ Vehicles with the Intuitive parking assist

A mute button will be displayed on the multi-information display when an object is detected. To mute the buzzer, press .

The buzzers for the intuitive parking assist and RCTA function will be muted simultaneously.

Mute will be canceled automatically in the following situations:

- When the shift lever is changed.
- When the vehicle speed exceeds a certain speed.
- When there is malfunction in a sensor or the system is temporarily unavailable.
- When the operating function is disabled manually.
- When the engine switch is turned off.

### Intuitive parking assist\*

\*: If equipped

The distance from your vehicle to objects, such as a wall, when parallel parking or maneuvering into a garage is measured by the sensors and communicated via the multi-information display, head-up display (if equipped), Center Display (if equipped), and a buzzer. Always check the surrounding area when using this system.

### System components

#### ■ Types of sensors

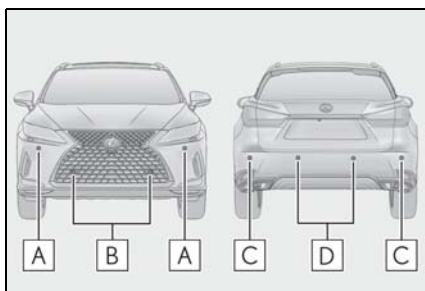

**A** Front corner sensors

**B** Front center sensors

**C** Rear corner sensors

**D** Rear center sensors

#### ■ Display

When the sensors detect an object, such as a wall, a graphic is shown on the multi-information display, head-up display (if equipped) and Center Display depending on the position and distance to the object.

- Multi-information display and

#### head-up display

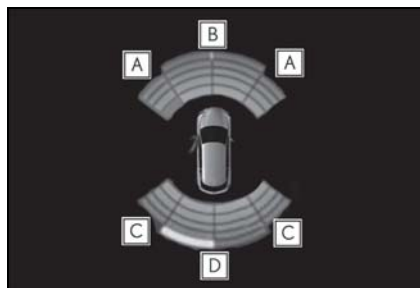

**A** Front corner sensor detection

**B** Front center sensor detection

**C** Rear corner sensor detection

**D** Rear center sensor detection

- Center Display (vehicles with a Lexus parking assist monitor)

When the R shift lever is selected, a simplified image is displayed on the Center Display.

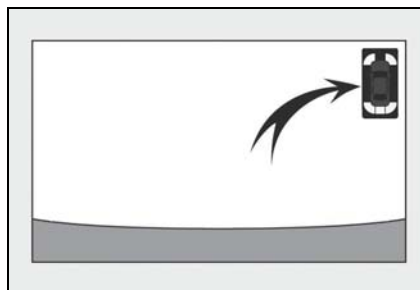

- Vehicles with a 12.3-inch display

When the N, M or D shift lever is selected (vehicle moving forward), a graphic will be displayed on the Center Display.

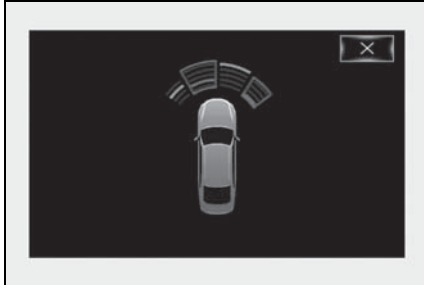



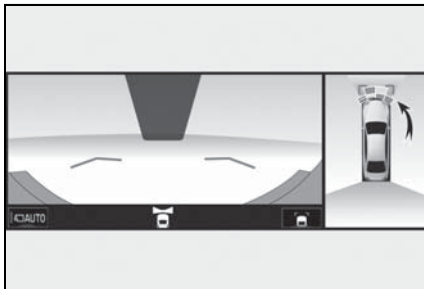

- Center Display (vehicles with a Panoramic view monitor)

A graphic will be displayed on the Center Display.





### Turning intuitive parking assist on/off

Use the meter control switches to enable/disable the Lexus parking assist-sensor. (→P.82)

- 1 Press < or > to select .
- 2 Press ^ or v to select "PKSA" and then press .
- 3 Press ^ or v to select  and then press .

When the intuitive parking assist function is disabled, the intuitive parking assist OFF indicator (→P.72) illuminates.

To re-enable the system, select  on the multi-information display, select  and turn it on. If the system is disabled, it will remain off even if the engine switch is turned to IGNITION ON mode after the engine switch has been turned off.

### WARNING

#### ■ When using the intuitive parking assist

Observe the following precautions. Failing to do so may result in the vehicle being unable to be driven safely and possibly cause an accident.

- Do not use the sensor at speeds in excess of 6 mph (10 km/h).
- The sensors' detection areas and reaction times are limited. When moving forward or reversing, check the areas surrounding the vehicle (especially the sides of the vehicle) for safety, and drive slowly, using the brake to control the vehicle's speed.
- Do not install accessories within the sensors' detection areas.
- The area directly under the bumpers is not detected. Thin posts or objects lower than the sensor may not be detected when approached, even if they have been detected once.

#### ■ When to disable the function

In the following situations, disable the function as it may operate even though there is no possibility of a collision.

- The vehicle is equipped with a fender pole, wireless antenna or fog lights.
- The front or rear bumper or a sensor receives a strong impact.
- A non-genuine Lexus suspension (lowered suspension, etc.) is installed.

**WARNING**

- Towing eyelets are installed.
- A backlit licence plate is installed.
- **When using intuitive parking assist**  
In the following situations, the system may not function correctly due to a sensor malfunction, etc. Have the vehicle checked by your Lexus dealer.
  - The intuitive parking assist operation display flashes or shows continuously, and a buzzer sounds when no objects are detected.
  - If the area around a sensor collides with something, or is subjected to strong impact.
  - If the bumper or grille collides with something.
  - If the display flashes or is displayed continuously and a buzzer does not sound, except when the mute function has been turned on.
  - If a display error occurs, first check the sensor.  
If the error occurs even when there is no ice, snow or mud on the sensor, it is likely that the sensor is malfunctioning.
- **Notes when washing the vehicle**  
Do not apply intensive bursts of water or steam to the sensor area.  
Doing so may result in the sensor malfunctioning.
  - When using a high pressure washer to wash the vehicle, do not spray the sensors directly, as doing so may cause a sensor to malfunction.
  - When using steam to clean the vehicle, do not direct steam too close to the sensors as doing so may cause a sensor to malfunction.

■ **The system can be operated when**

- The engine switch is in IGNITION ON

mode.

- Intuitive parking assist function is on.
- The vehicle speed is less than about 6 mph (10 km/h).
- A shift lever other than P.

■ **Setting the buzzer volume**

The buzzer volume can be adjusted on the multi-information display. (→P.242)

■ **If “Parking Assist Unavailable” is displayed on the multi-information display**

- Water may be continuously flowing over the sensor surface, such as in a heavy rain. When the system determines that it is normal, the system will return to normal.
- Initialization may not have been performed after a battery terminal was disconnected and reconnected. Initialize the system. (→P.246) If this message continues to be displayed even after initialization, have the vehicle inspected by your Lexus dealer.

■ **If “Parking Assist Unavailable Clean Parking Assist Sensor” is displayed on the multi-information display**

A sensor may be covered with ice, snow, dirt, etc. Remove the ice, snow, dirt, etc., from the sensor to return the system to normal.

Also, due to ice forming on a sensor at low temperatures, a warning message may be displayed or the sensor may not be able to detect an object. Once the ice melts, the system will return to normal.

■ **If a battery terminal has been disconnected and reconnected**

The system needs to be initialized. To initialize the system, drive the vehicle straight ahead for 5 seconds or more at a speed of approximately 22 mph (35 km/h) or more.

■ **Sensor detection information**

- The following situations may occur during use.
  - The sensor's detection areas are limited to the areas around the vehicle front and rear bumpers.
  - Depending on the shape of the object

and other factors, the detection distance may shorten, or detection may be impossible.

- There will be a short delay between object detection and display. Even at low speeds, there is a possibility that the object will come within the sensor's detection areas before the display is shown and the warning beep sounds.
- It might be difficult to hear the buzzer due to the volume of the audio system or air flow noise of the air conditioning system.
- It may be difficult to hear the buzzer if buzzers for other systems are sounding.

#### ■ Conditions under which the function may not function correctly

Certain vehicle conditions and the surrounding environment may affect the ability of a sensor to correctly detect objects. Particular instances where this may occur are listed below.

- There is dirt, snow or ice on a sensor. (Cleaning the sensors will resolve this problem.)
- A sensor is frozen. (Thawing the area will resolve this problem.)  
In especially cold weather, if a sensor is frozen the sensor display may be displayed abnormally, or objects, such as a wall, may not be detected.
- A sensor is covered in any way.
- When a sensor or the area around a sensor is extremely hot or cold.
- On an extremely bumpy road, on an incline, on gravel, or on grass.
- The vicinity of the vehicle is noisy due to vehicle horns, motorcycle engines, air brakes of large vehicles, or other loud noises producing ultrasonic waves.
- There is another vehicle equipped with parking assist sensors in the vicinity.
- A sensor is coated with a sheet of spray or heavy rain.
- If a sensor is hit by a large amount of water, such as when driving on a flooded road.
- If the vehicle is significantly tilted.
- The vehicle is approaching a tall or curved curb.

- If objects draw too close to the sensor.

#### ■ Objects which may not be properly detected

The shape of the object may prevent the sensor from detecting it. Pay particular attention to the following objects:

- Wires, fences, ropes, etc.
- Cotton, snow and other materials that absorb sound waves
- Sharply-angled objects
- Low objects
- Tall objects with upper sections projecting outwards in the direction of your vehicle

People may not be detected if they are wearing certain types of clothing.

### Sensor detection display, object distance

#### ■ Detection range of the sensors

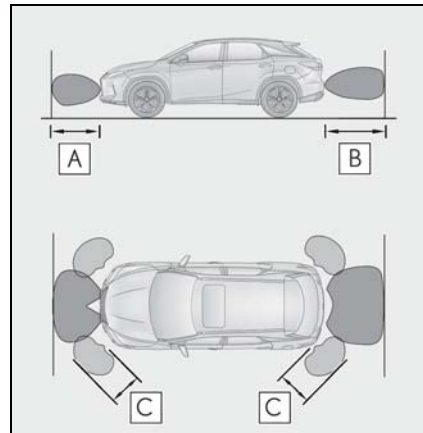

**A** Approximately 3.3 ft. (100 cm)

**B** Approximately 4.9 ft. (150 cm)

**C** Approximately 2.0 ft. (60 cm)



The diagram shows the detection range of the sensors. Note that the sensors cannot detect objects that are extremely close to the vehicle.

The range of the sensors may change depending on the shape of the object, etc.

■ **Multi-information display, head-up display (if equipped) and Center Display**



When an object is detected by a sensor, the approximate distance to the object will be displayed on the multi-information display, Center Display, and head-up display (if equipped). (As the distance to the object becomes short, the distance segments may blink.)

- Approximate distance to object: 4.9 ft. (150 cm) to 2.0 ft. (60 cm)\* (Rear center sensor)

Multi-information display	Center Display	Head-up display
		



\*: Automatic buzzer mute function is enabled. (→P.249)

- Approximate distance to object: 3.3 ft. (100 cm) to 2.0 ft. (60 cm)\* (Front center sensor)

Multi-information display	Center Display	Head-up display
		

\*: Automatic buzzer mute function is enabled. (→P.249)



- Approximate distance to object: 2.0 ft. (60 cm) to 1.5 ft. (45 cm)\*

Multi-information display	Center Display	Head-up display
		

\*: Automatic buzzer mute function is enabled. (→P.249)



- Approximate distance to object: 1.5 ft. (45 cm) to 1.0 ft. (30 cm)\*



Multi-information display	Center Display	Head-up display
		

\*: Automatic buzzer mute function is enabled. (→P.249)



- Approximate distance to object: 1.0 ft. (30 cm) to 0.5 ft. (15 cm)<sup>\*1</sup>

Multi-information display <sup>*2</sup>	Center Display <sup>*2</sup>	Head-up display
		

<sup>\*1</sup>: Automatic buzzer mute function is disabled. (→P.249)

<sup>\*2</sup>: The distance segments will blink slowly.

- Approximate distance to object: Less than 0.5 ft. (15 cm)<sup>\*1</sup>

Multi-information display <sup>*2</sup>	Center Display <sup>*2</sup>	Head-up display
		

<sup>\*1</sup>: Automatic buzzer mute function is disabled. (→P.249)

<sup>\*2</sup>: The distance segments will blink rapidly.

■ **Buzzer operation and distance to an object**

A buzzer sounds when the sensors are operating.

- The buzzer beeps faster as the vehicle approaches an object. When the vehicle comes within the following distance of the object, the buzzer sounds continuously:

Approximately 1.0 ft. (30 cm)

- When 2 or more objects are detected simultaneously, the buzzer

sounds for the nearest object. If one or more objects come within approximately 1.0 ft. (30 cm) of the vehicle, the buzzer will repeat a long tone, followed by fast beeps.

- Automatic buzzer mute function: After a buzzer begins sounding, if the distance between the vehicle and the detected object does not become shorter, the buzzer will be muted automatically. (However, if the distance between the vehicle and object is 1.0 ft. (30 cm) or less,

this function will not operate.)  
 The buzzer sounds volume can be adjusted. (→P.242)

### RCTA (Rear cross traffic alert) function\*

\*: If equipped

The RCTA function uses the BSM rear side radar sensors installed behind the rear bumper. This function is intended to assist the driver in checking areas that are not easily visible when backing up.

### System components

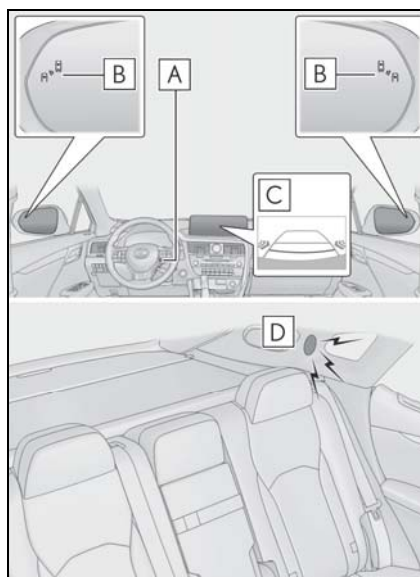

**A** Meter control switches

Turning the RCTA function on/off.  
 When the RCTA function is disabled, the RCTA OFF indicator illuminates.

**B** Outside rear view mirror indicators

When a vehicle approaching from the right or left at the rear of the vehicle is detected, both outside rear view mirror indicators will flash.

**C** Center Display

If a vehicle approaching from the right or left at the rear of the vehicle is detected, the RCTA icon (→P.252) for the detected side will be displayed on the Center Display. This illustration shows an example of a vehicle approaching from both sides of the vehicle.



#### **D** RCTA buzzer

If a vehicle approaching from the right or left at the rear of the vehicle is detected, a buzzer will sound.

### Turning the RCTA function on/off



Use the meter control switches to enable/disable the RCTA function. (→P.82)

- ▶ Vehicles without the Intuitive parking assist

- 1 Press < or > to select .
- 2 Press ^ or v to select "RCTA" and then press .

When the RCTA function is disabled, the RCTA OFF indicator (→P.72) illuminates on the multi-information display. (Each time the engine switch is turned off then changed to IGNITION ON mode, the RCTA function will be enabled automatically.)

- ▶ Vehicles with the Intuitive parking assist

- 1 Press < or > to select .
- 2 Press ^ or v to select "PKSA" and then press .
- 3 Press ^ or v to select "RCTA" and then press .

When the RCTA function is disabled, the RCTA OFF indicator (→P.72) illuminates on the multi-information display. (Each time the engine switch is turned off then changed to IGNITION ON mode, the RCTA function will be enabled automatically.)

#### WARNING

##### ■ Cautions regarding the use of the function

The driver is solely responsible for safe driving. Always drive safely, taking care to observe your surroundings.

The RCTA function is only a supplementary function which alerts the driver that a vehicle is approaching from the right or left at the rear of the vehicle. As the RCTA function may not function correctly under certain conditions, the driver's own visual confirmation of safety is necessary. Over reliance on this function may lead to an accident resulting death or serious injury.

#### NOTICE

##### ■ Before using the RCTA function

Do not place objects near the sensors.

#### ■ Outside rear view mirror indicator visibility

In strong sunlight, the outside rear view mirror indicator may be difficult to see.

#### ■ Hearing the RCTA buzzer

The RCTA buzzer may be difficult to hear over loud noises, such as if the audio system volume is high.

#### ■ When "Rear Cross Traffic Alert Unavailable" is shown on the multi-information display

Water, ice, snow, mud, etc., may be attached to the rear bumper around the sensors. (→P.239) Removing the water, ice, snow, mud, etc., from the attached to the rear bumper around the sensors to return the function to normal.

Additionally, the function may not operate normally when driving in extremely hot or cold environments.

■ **Rear side radar sensors**  
→P.239

### RCTA function

#### ■ Operation of the RCTA function

The RCTA function uses rear side radar sensors to detect vehicles approaching from the right or left at the rear of the vehicle and alerts the driver of the presence of such vehicles by flashing the outside rear view mirror indicators and sounding a buzzer.

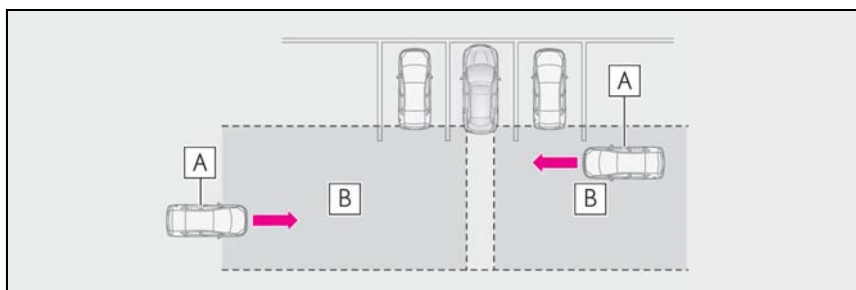

**A** Approaching vehicles

**B** Detection areas of approaching vehicles

#### ■ RCTA icon display

When a vehicle approaching from the right or left at the rear of the vehicle is detected, the following will be displayed on the Center Display.

- Example (Lexus parking assist monitor) (if equipped): Vehicles are approaching from both sides of the vehicle

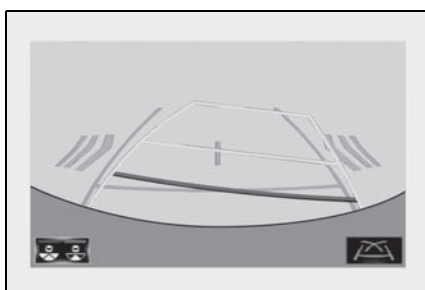

- Example (Panoramic view monitor) (if equipped): Vehicles are approaching from both sides of the vehicle

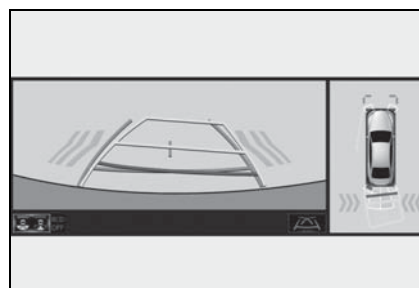

■ RCTA function detection areas

The areas that vehicles can be detected in are outlined below.

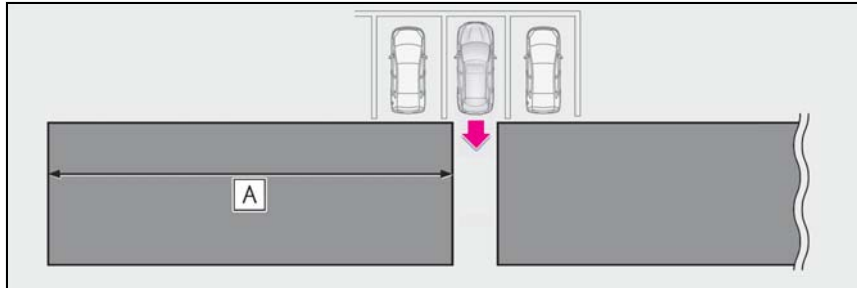

The buzzer can alert the driver of faster vehicles approaching from farther away.

Example:

Approaching vehicle speed	A Approximate alert distance
18 mph (28 km/h) (fast)	65 ft. (20 m)
5 mph (8 km/h) (slow)	18 ft. (5.5 m)

■ The RCTA function is operational when

The RCTA function operates when all of the following conditions are met:

- The engine switch is in IGNITION ON mode.
- The RCTA function is on.
- The shift lever is in R.
- The vehicle speed is less than approximately 5 mph (8 km/h).
- The approaching vehicle speed is between approximately 5 mph (8 km/h) and 18 mph (28 km/h).

■ Setting the buzzer volume

The buzzer volume can be adjusted on the multi-information display. (→P.242)

Use the meter control switches to change settings. (→P.82)

■ Conditions under which the RCTA function will not detect a vehicle

The RCTA function is not designed to detect the following types of vehicles and/or objects:

- Vehicles approaching from directly behind
- Vehicles backing up in a parking space next to your vehicle
- Vehicles that the sensors cannot detect due to obstructions

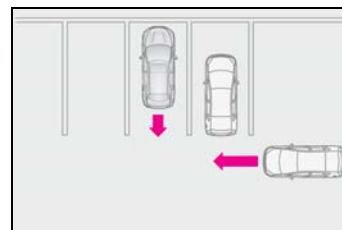

- Guardrails, walls, signs, parked vehicles and similar stationary objects\*
- Small motorcycles, bicycles, pedestrians, etc.\*
- Vehicles moving away from your vehicle
- Vehicles approaching from the parking spaces next to your vehicle\*

\*: Depending on the conditions, detection of a vehicle and/or object may occur.

■ Conditions under which the RCTA function may not function correctly

- The RCTA function may not detect vehicles correctly in the following situations:

- When a sensor is misaligned due to a strong impact to the sensor or its surrounding area
- When mud, snow, ice, a sticker, etc. is covering a sensor or its surrounding area on the rear bumper
- When driving on a road surface that is wet with standing water during bad weather, such as heavy rain, snow, or fog
- When multiple vehicles are approaching with only a small gap between each vehicle
- If a vehicle is approaching the rear of your vehicle rapidly
- When a towing eyelet is installed to the rear of the vehicle.
- When backing up on a slope with a sharp change in grade

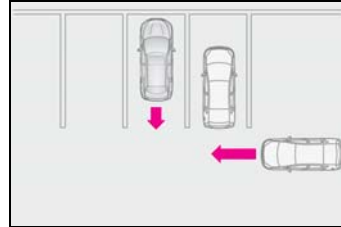

- Instances of the RCTA function unnecessarily detecting a vehicle and/or object may increase in the following situations:
  - When a vehicle passes by the side of your vehicle
  - When the parking space faces a street and vehicles are being driven on the street

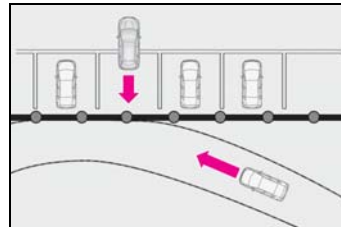
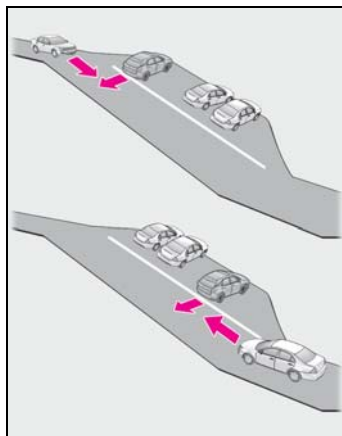

- When the distance between your vehicle and metal objects, such as a guardrail, wall, sign, or parked vehicle, which may reflect electrical waves toward the rear of the vehicle, is short
- When a towing eyelet is installed to the rear of the vehicle

- When backing out of a shallow angle parking spot

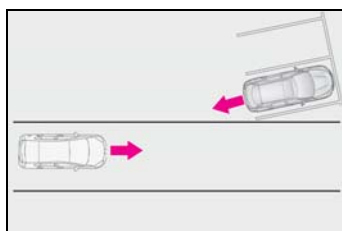

- Immediately after the RCTA function is turned on
- Immediately after the engine is started with the RCTA function on
- When the sensors cannot detect a vehicle due to obstructions

## PKSB (Parking Support Brake)\*

\*: If equipped

The Parking Support Brake system consists of the following functions that operate when driving at a low speed or backing up, such as when parking. When the system determines that the possibility of a collision with a detected object is high, a warning operates to urge the driver to take evasive action. If the system determines that the possibility of a collision with a detected object is extremely high, the brakes are automatically applied to help avoid the collision or help reduce the impact of the collision.

### PKSB (Parking Support Brake) system

#### ■ Parking Support Brake function (static objects) (if equipped)

Ultrasonic sensors are used to detect static objects, such as a wall, in the detection area when driving at a low speed or backing up. (→P.261)

#### ■ Parking Support Brake function (rear-crossing vehicles) (if equipped)

Rear radar sensors are used to detect approaching vehicles in the detection area behind the vehicle when backing up. (→P.267)

### WARNING

#### ■ Limitations of the Parking Support Brake system

Do not overly rely on the system, as doing so may lead to an accident.

- The driver is solely responsible for safe driving. Always drive carefully, taking care to observe your surroundings. The Parking Support Brake system is designed to provide support to lessen the severity of collisions. However, it may not operate in some situations.
- The Parking Support Brake system is not designed to stop the vehicle completely. Additionally, even if the system has stopped the vehicle, it is necessary to depress the brake pedal immediately as brake control will be canceled after approximately 2 seconds.

### NOTICE



#### ■ If “Parking Support Brake Unavailable” is displayed on the multi-information display and the PKSB OFF indicator is flashing

If this message is displayed immediately after the engine switch is changed to IGNITION ON mode, operate the vehicle carefully, paying attention to your surroundings. It may be necessary to drive the vehicle for a certain amount of time before the system returns to normal. (If the system is not return to normal after driving for a while, clean the sensors and their surrounding area on the bumpers.)



### Enabling/Disabling the Parking Support Brake

The Parking Support Brake can be enabled/disabled on the multi-information display. All of the Parking Support Brake functions (static objects and rear-crossing vehicles) are enabled/disabled simultaneously.

Use the meter control switches to enable/disable the parking support brake. (→P.82)

- 1 Press < or > to select .
- 2 Press ^ or v to select  and then press .

When the Parking Support Brake is disabled, the PKSB OFF indicator (→P.72) illuminates on the multi-information display.

To re-enable the system when it was disabled, select  on the multi-information display, select  and turn it on. If the system is disabled, it will remain off even if the engine switch is turned to IGNITION ON mode after the engine switch has been turned off.

**Displays and buzzers for engine output restriction control and brake control**

If the engine output restriction control or brake control operates, a buzzer will sound and a message will be displayed on the Center Display and multi-information display, to alert the driver. On vehicles with a head-up display, the head-up display (if equipped) will display the same message as the multi-information display.

Depending on the situation, engine output restriction control will operate to either limit acceleration or restrict output as much as possible.

- Engine output restriction control is operating (acceleration restriction)

Acceleration greater than a certain amount is restricted by the system.

Center Display (Panoramic view monitor) (If equipped): No warning displayed

Multi-information display: "Object

Detected Acceleration Reduced"

PKSB OFF indicator: Not illuminated

Buzzer: Does not sound

- Engine output restriction control is operating (output restricted as much as possible)

The system has determined that stronger-than-normal brake operation is necessary.

Center Display (Panoramic view monitor) (If equipped): "BRAKE!"

Multi-information display: "BRAKE!"

PKSB OFF indicator: Not illuminated

Buzzer: Short beep

- Brake control is operating

The system determined that emergency braking is necessary.

Center Display (Panoramic view monitor) (If equipped): "BRAKE!"

Multi-information display: "BRAKE!"

PKSB OFF indicator: Not illuminated

Buzzer: Short beep

- Vehicle stopped by system operation

The vehicle has been stopped by brake control operation.

Center Display (Panoramic view monitor) (If equipped): "Press Brake Pedal"

Multi-information display: "Switch to Brake" (If the accelerator pedal is not depressed, "Press Brake Pedal" will be displayed.)

PKSB OFF indicator: Illuminated

Buzzer: Short beep



**System overview**

If the Parking Support Brake determines that a collision with a detected object is possible, the engine output will be restricted to restrain any increase in the vehicle speed. (Engine output restriction control: See figure 2.)

Additionally, if the accelerator pedal continues to be depressed, the brakes will be applied automatically to reduce the vehicle speed. (Brake control: See figure 3.)

- Figure 1 When the PKSB (Parking Support Brake) is disabled

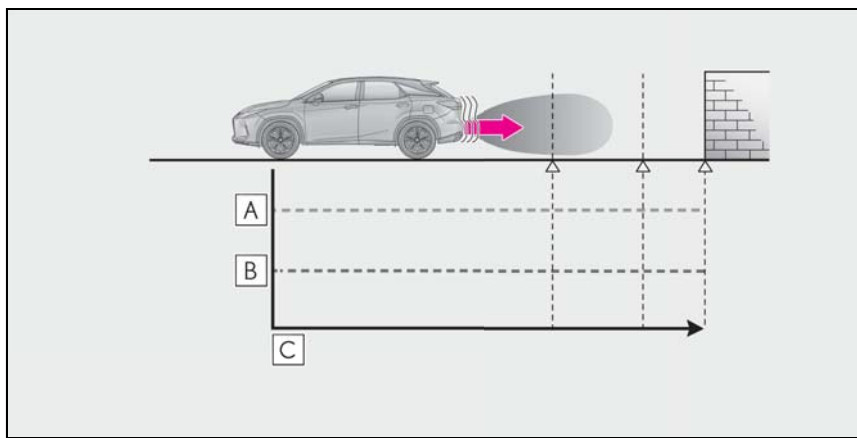

- A** Engine output
- B** Braking force
- C** Time

- Figure 2 When engine output restriction control operates

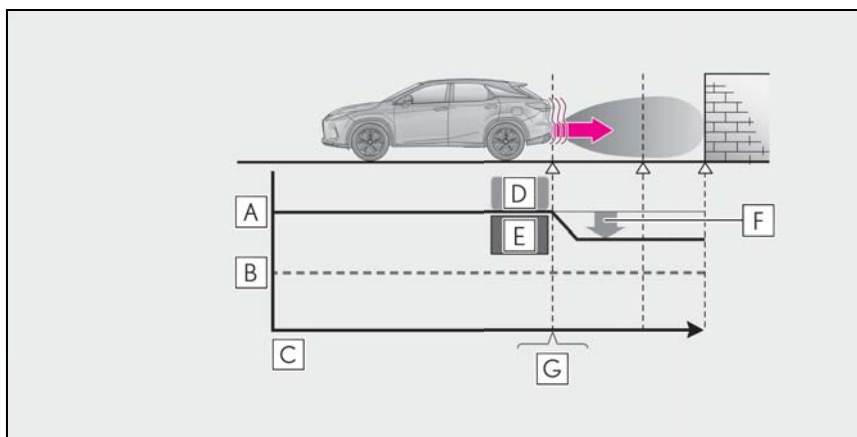

- A** Engine output

- B** Braking force
  - C** Time
  - D** Engine output restriction control begins operating
  - E** System determines that possibility of collision with detected object is high
  - F** Engine output reduced
  - G** Example: Multi-information display: "BRAKE!"
- Figure 3 When brake control operates

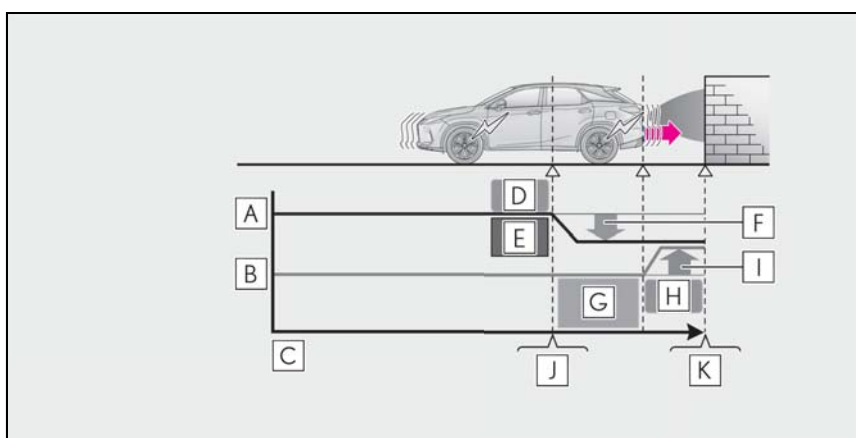

- A** Engine output
- B** Braking force
- C** Time
- D** Engine output restriction control begins operating
- E** System determines that possibility of collision with detected object is high
- F** Engine output reduced
- G** System determines that possibility of collision with detected object is extremely high
- H** Brake control begins operating
- I** Brake control strength increased
- J** Example: Multi-information display: "BRAKE!"
- K** Example: Multi-information display: "Switch to Brake"

■ **If the Parking Support Brake has operated**  
 If the vehicle is stopped due to operation of

the Parking Support Brake, the Parking Support Brake will be disabled and the PKSB OFF indicator will illuminate. If the Parking Support Brake operates unneces-

sarily, brake control can be canceled by depressing the brake pedal or waiting for approximately 2 seconds for it to automatically be canceled. Then, the vehicle can be operated by depressing the accelerator pedal.

#### ■ Re-enabling the Parking Support Brake

To re-enable the Parking Support Brake when it has been disabled due to system operation perform any of the following operations.

At this time, the PKSB OFF indicator will turn off. (→P.74)

- Turn the PKSB (Parking Support Brake) on (→P.256)
- The shift lever is in P.
- Drive with no operation targets in the traveling direction of the vehicle
- Change the traveling direction of the vehicle

#### ■ If “Parking Support Brake Unavailable” is displayed on the multi-information display and the PKSB OFF indicator is flashing

- If this message is displayed only when the shift lever is in any position other than R, a sensor on the front or rear bumper may be dirty. Clean the sensors and their surrounding area on the bumpers.
- Initialization may not have been performed after a battery terminal was disconnected and reconnected. Initialize the system. (→P.260)  
If this message continues to be displayed even after initialization, have the vehicle inspected by your Lexus dealer.

#### ■ If “Parking Assist Unavailable” and “Parking Assist Unavailable Clean Parking Assist Sensor” are displayed on the multi-information display and the PKSB OFF indicator is flashing

- A sensor may be covered with ice, snow, dirt, etc. Remove the ice, snow, dirt, etc., from the sensor to return the system to normal.  
If this message is shown even after removing dirt from the sensor, or shown when the sensor was not dirty to begin with, have the vehicle inspected by your

Lexus dealer.

- A sensor may be frozen. Once the ice melts, the system will return to normal.
- Water may be continuously flowing over the sensor surface, such as in a heavy rain. When the system determines that it is normal, the system will return to normal.

#### ■ If a battery terminal has been disconnected and reconnected

The system needs to be initialized. To initialize the system, drive the vehicle straight ahead for 5 seconds or more at a speed of approximately 22 mph (35 km/h) or more. Additionally, for vehicles with the Parking Support Brake function, turn the steering wheel fully to the left and right with the vehicle stopped.

**Parking Support Brake function (static objects)\***

\*: If equipped

If the sensors detect a static object, such as a wall, in the travelling direction of the vehicle and the system determines that a collision may occur due to the vehicle suddenly moving forward due to an accidental accelerator pedal operation, the vehicle moving the unintended direction due to the wrong shift lever position, or while parking or traveling at low speeds, the system will operate to lessen the impact with the detected static object and reduce the resulting damage.

**Examples of function operation**

This function will operate in situations such as the following if an object is detected in the traveling direction of the vehicle.

- **When traveling at a low speed and the brake pedal is not depressed, or is depressed late**

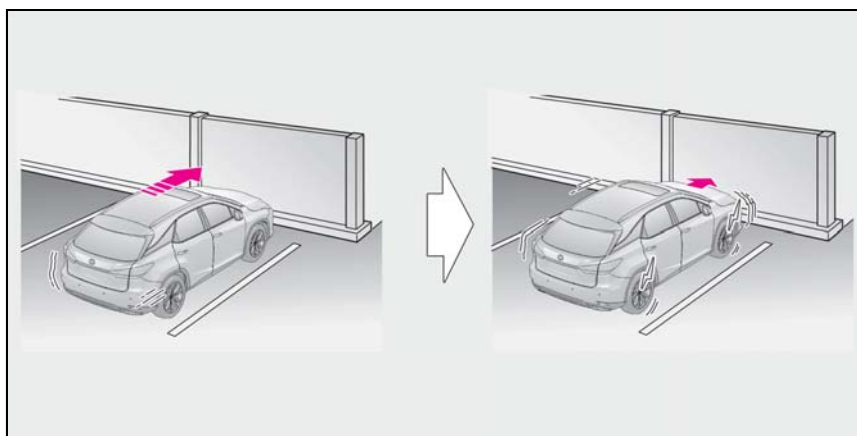

■ When the accelerator pedal is depressed excessively

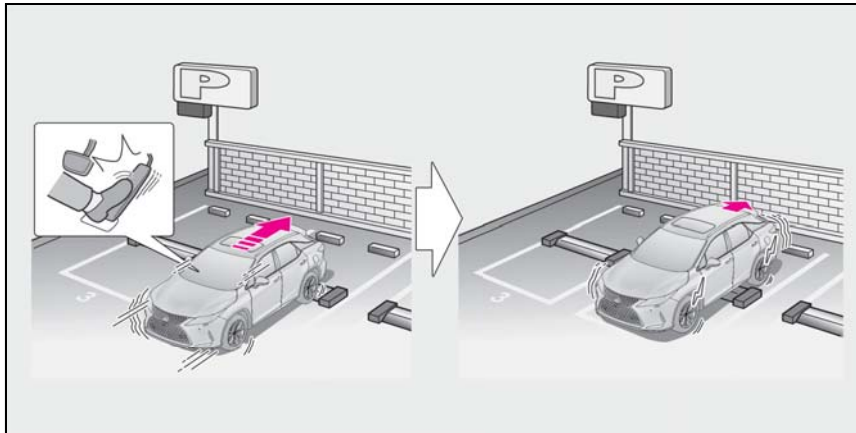

■ When the vehicle moves in the unintended direction due to the wrong shift lever position

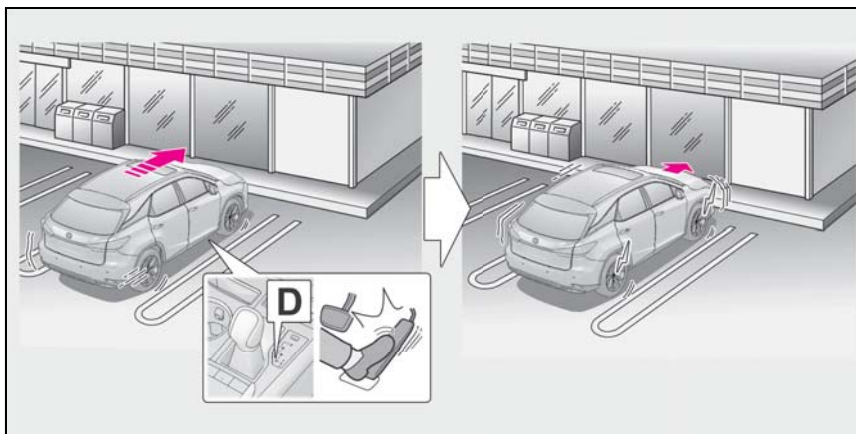

**Types of sensors**

→P.244

**⚠ WARNING**

■ **To ensure the Parking Support Brake can operate properly**

Observe the following precautions regarding the sensors (→P.244). Failure to do so may cause a sensor to not operate properly, and may cause an accident.

- Do not modify, disassemble or paint the sensors.
- Do not replace a sensor with a part other than a genuine part.
- Do not subject a sensor or its surrounding area to a strong impact.
- Do not damage the sensors, and always keep them clean.

**WARNING****■ Handling the suspension**

Do not modify the suspension, as changes to the height or inclination of the vehicle may prevent the sensors from detecting objects correctly or cause the system to not operate or operate unnecessarily.

**■ If the Parking Support Brake function (static objects) operates unnecessarily, such as at a railroad crossing**

In the event that the Parking Support Brake function (static objects) operates unnecessarily, such as at a railroad crossing, brake control will be canceled after approximately 2 seconds, allowing you to proceed forward and leave the area, brake control can also be canceled by depressing the brake pedal. Depressing the accelerator pedal after brake control is canceled will allow you to proceed forward and leave the area.

**■ Notes when washing the vehicle**

Do not apply intensive bursts of water or steam to the sensor area.

Doing so may result in the sensor malfunctioning.

- When using a high pressure washer to wash the vehicle, do not spray the sensors directly, as doing so may cause a sensor to malfunction.
- When using steam to clean the vehicle, do not direct steam too close to the sensors as doing so may cause a sensor to malfunction.

**■ When to disable the Parking Support Brake**

In the following situations, disable the Parking Support Brake as the system may operate even though there is no possibility of a collision.

- When inspecting the vehicle using a chassis roller, chassis dynamo or free roller

- When loading the vehicle onto a boat, truck or other transport vessel
- If the suspension has been modified or tires of a size other than specified are installed
- If the front of the vehicle is raised or lowered due to the carried load
- When equipment that may obstruct a sensor is installed, such as a towing eyelet, bumper protector (an additional trim strip, etc.), bicycle carrier, or snow plow
- When using an automatic car wash

**■ The Parking Support Brake function (static object) will operate when**

The function will operate when the PKSB OFF indicator is not illuminated or flashing (→P.73, 74) and all of the following conditions are met:

- Engine output restriction control
  - The Parking Support Brake is enabled.
  - The vehicle speed is 9 mph (15 km/h) or less.
- There is a static object in the traveling direction of the vehicle and 6 to 13 ft. (2 to 4 m) away.
- The Parking Support Brake determines that a stronger-than-normal brake operation is necessary to avoid a collision.
- Brake control
  - Engine output restriction control is operating.
  - The Parking Support Brake determines that an immediate brake operation is necessary to avoid a collision.

**■ The Parking Support Brake function (static objects) will stop operating when**

The function will stop operating if any of the following conditions are met:

- Engine output restriction control
  - The Parking Support Brake is disabled.
  - The system determines that the collision has become avoidable with normal brake operation.
- The static object is no longer 6 to 13 ft. (2 to 4 m) away from the vehicle or in the

traveling direction of the vehicle.

- Brake control
- The Parking Support Brake is disabled.
- Approximately 2 seconds have elapsed since the vehicle was stopped by brake control.
- The brake pedal is depressed after the vehicle is stopped by brake control.
- The static object is no longer 6 to 13 ft. (2 to 4 m) away from the vehicle or in the traveling direction of the vehicle.

#### ■ Re-enabling the Parking Support Brake function (static objects)

→P.259

#### ■ Detection range of the Parking Support Brake function (static objects)

The detection range of the Parking Support Brake function (static objects) differs from the detection range of the intuitive parking assist. (→P.247) Therefore, even if the intuitive parking assist detects an object and provides a warning, the Parking Support Brake function (static objects) may not start operating.

#### ■ Objects that the Parking Support Brake function (static objects) may not detect

The sensors may not be able to detect certain objects, such as the following:

- Pedestrian
- Cotton cloth, snow, and other materials that are poor reflectors of ultrasonic waves
- Objects which are not perpendicular to the ground, are not perpendicular to the traveling direction of the vehicle, are uneven or are waving
- Low objects
- Thin objects such as wires, fences, ropes and signposts
- Objects that are extremely close to the bumper
- Sharply-angled objects
- Tall objects with upper sections projecting outwards in the direction of your vehicle

#### ■ Situation in which the Parking Support Brake function (static objects) may not operate

When driving with the shift lever in N.

#### ■ Intuitive parking assist buzzer

Regardless of whether the intuitive parking assist system is enabled or not (→P.245), if the Parking Support Brake function (static objects) is enabled (→P.256), the front or rear sensors detect an object and brake control is performed, the intuitive parking assist buzzer will sound to notify the driver of the approximate distance to the object.

#### ■ Situations in which the Parking Support Brake function (static objects) may operate even if there is no possibility of a collision

In some situations, such as the following, the Parking Support Brake function (static objects) may operate even though there is no possibility of a collision.

- Vehicle surroundings
- When driving on a narrow road

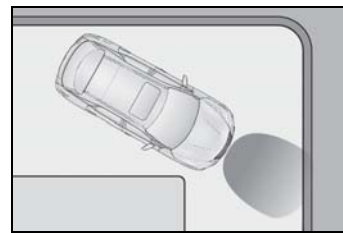

- When driving on a gravel road or in an area with tall grass

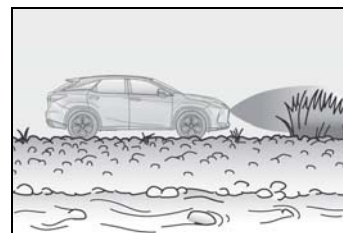

- When driving toward a banner, flag, low-hanging branch or boom barrier (such as those used at railroad crossings, toll gates and parking lots)
- When driving on a narrow path surrounded by a structure, such as in a tunnel or on an iron bridge

- When parallel parking
- When there is a rut or hole in the surface of the road
- When driving on a metal cover (grating), such as those used for drainage ditches
- When driving on a steep slope
- If a sensor is hit by a large amount of water, such as when driving on a flooded road

- Weather

- If a sensor is covered with ice, snow, dirt, etc. (when cleared, the system will return to normal)
- If heavy rain or water strikes a sensor
- When driving in inclement weather such as fog, snow or a sandstorm
- When strong winds are blowing

- Other ultrasonic wave sources

- When vehicle horns, vehicle detectors, motorcycle engines, air brakes of large vehicles, the clearance sonar of other vehicles or other devices which produce ultrasonic waves are near the vehicle
- If a sticker or an electronic component, such as a backlit license plate (especially fluorescent type), fog lights, fender pole or wireless antenna is installed near a sensor

- Changes in the vehicle posture

- If the vehicle is significantly tilted
- If the front of the vehicle is raised or lowered due to the carried load
- If the orientation of a sensor has been changed due to a collision or other impact

- Situations in which the Parking Support Brake function (static objects) may not operate properly

In some situations, such as the following, this function may not operate properly.

- Weather

- When a sensor or the area around a sensor is extremely hot or cold

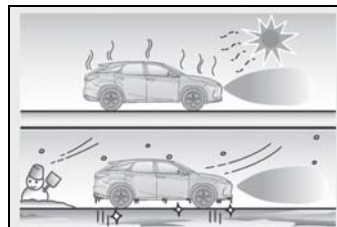

- When strong winds are blowing

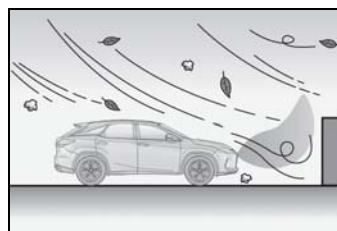

- If a sensor is covered with ice, snow, dirt, etc. (when cleared, the system will return to normal)
- If heavy rain or water strikes a sensor
- When driving in inclement weather such as fog, snow or a sandstorm
- When the sensor is frozen (Once the sensor thaws, the system will return to normal)

- Vehicle surroundings

- When an object that cannot be detected is between the vehicle and a detected object
- If an object such as a vehicle, motorcycle, bicycle or pedestrian cuts in front of the vehicle or runs out from the side of the vehicle
- The vehicle is approaching a tall or curved curb.
- On an extremely bumpy road, on an incline, on gravel, or on grass.
- If objects draw too close to the sensor.

- Other ultrasonic wave sources

- When vehicle horns, vehicle detectors, motorcycle engines, air brakes of large vehicles, the clearance sonar of other vehicles or other devices which produce ultrasonic waves are near the vehicle
- If a sticker or an electronic component, such as a backlit license plate (especially fluorescent type), fog lights, fender pole or wireless antenna is installed near a sensor



- Changes in the vehicle posture
  - If the vehicle is significantly tilted
  - If the front of the vehicle is raised or lowered due to the carried load
  - If the orientation of a sensor has been changed due to a collision or other impact
  - When equipment that may obstruct a sensor is installed, such as a bumper protector (an additional trim strip, etc.), bicycle carrier, or snow plow
  - If the suspension has been modified or tires of a size other than specified are installed
  - If a sensor has been painted or covered with a sticker, etc.

### Parking Support Brake function (rear-crossing vehicles)\*

\*: If equipped

If a rear radar sensor detects a vehicle approaching from the right or left at the rear of the vehicle and the system determines that the possibility of a collision is high, this function will perform brake control to reduce the likelihood of an impact with the approaching vehicle.

#### Examples of function operation

This function will operate in situations such as the following if a vehicle is detected in the traveling direction of the vehicle.

- When reversing, a vehicle is approaching and the brake pedal is not depressed, or is depressed late

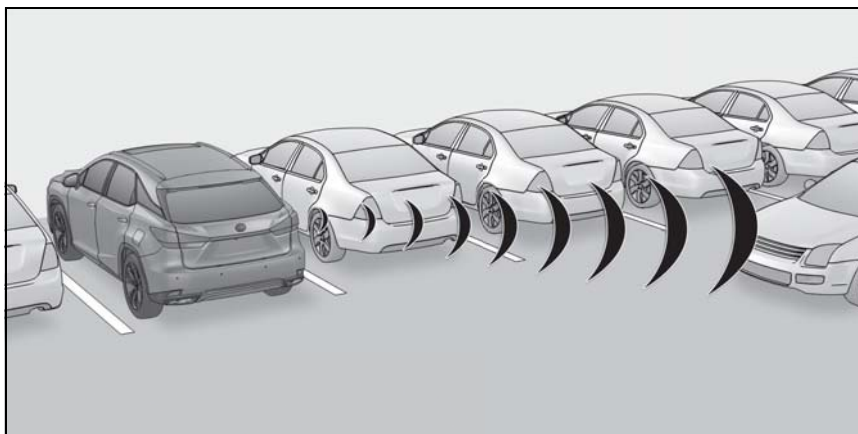

#### Types of sensors

→P.238

#### ⚠ WARNING

- To ensure the Parking Support Brake function (rear-crossing vehicles) can operate properly

Observe the following precautions regarding the rear side radar sensors (→P.238). Failure to do so may cause a sensor to not operate properly, and may cause an accident.

- Do not modify, disassemble or paint the sensors.
- Do not replace a rear side radar sensor with a part other than a genuine part.
- Do not damage the rear side radar sensors, and always keep the radar sensors and their surrounding area on the bumper clean.

**⚠ WARNING**

- If the area around a rear side radar sensor is subjected to an impact, the system may not operate properly due to a sensor malfunction. Have the vehicle inspected by your Lexus dealer.

**■ The Parking Support Brake function (rear-crossing vehicles) will operate when**

The function will operate when the PKSB OFF indicator is not illuminated or flashing (→P.73, 74) and all of the following conditions are met:

- Engine output restriction control
  - The Parking Support Brake is enabled.
  - The vehicle speed is 9 mph (15 km/h) or less.
- Vehicles which are approaching from the right or left at the rear of the vehicle at a traveling speed of less than approximately 5 mph (8 km/h)
- The shift lever is in R.
- The Parking Support Brake determines that a stronger than normal brake operation is necessary to avoid a collision with an approaching vehicle.
- Brake control
  - Engine output restriction control is operating.
  - The Parking Support Brake determines that an emergency brake operation is necessary to avoid a collision with an approaching vehicle.

**■ The Parking Support Brake function (rear-crossing vehicles) will stop operating when**

The function will stop operating if any of the following conditions are met:

- Engine output restriction control
  - The Parking Support Brake is disabled.
  - The collision becomes avoidable with normal brake operation.
  - A vehicle is no longer approaching from the right or left at the rear of the vehicle.
- Brake control
  - The Parking Support Brake is disabled.
  - Approximately 2 seconds have elapsed since the vehicle was stopped by brake

- control.
  - The brake pedal is depressed after the vehicle is stopped by brake control.
  - A vehicle is no longer approaching from the right or left at the rear of the vehicle.

**■ Re-enabling the Parking Support Brake function (rear-crossing vehicles)**  
→P.259

**■ Detection area of the Parking Support Brake function (rear-crossing vehicles)**

The detection area of the Parking Support Brake function (rear-crossing vehicles) differs from the detection area of the RCTA function (→P.253). Therefore, even if the RCTA function detects a vehicle and provides an alert, the Parking Support Brake function (rear-crossing vehicles) may not start operating.

**■ Conditions under which the Parking Support Brake function (rear-crossing vehicles) will not detect a vehicle**

The Parking Support Brake function (rear-crossing vehicles) is not designed to detect the following types of vehicles and/or objects:

- Vehicles approaching from directly behind
- Vehicles backing up in a parking space next to your vehicle
- Vehicles that the sensors cannot detect due to obstructions

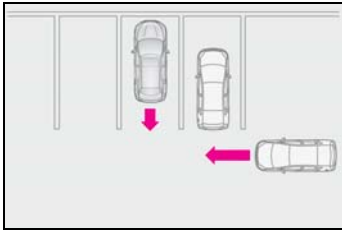

- Vehicles which suddenly accelerate or decelerate near your vehicle
- Guardrails, walls, signs, parked vehicles and similar stationary objects
- Small motorcycles, bicycles, pedestrians, etc.\*
- Vehicles moving away from your vehicle
- Vehicles approaching from the parking

spaces next to your vehicle \*

- Objects which are extremely close to a radar sensor\*
- Vehicles which are approaching from the right or left at the rear of the vehicle at a traveling speed of less than approximately 5 mph (8 km/h)
- Vehicles which are approaching from the right or left at the rear of the vehicle at a traveling speed of more than approximately 15 mph (24 km/h)

\*: Depending on the conditions, detection of a vehicle and/or object may occur.

■ PKSB buzzer

If the Parking Support Brake is enabled and brake control is performed, a buzzer will sound to notify the driver.

■ Situations in which the system may operate even though there is no possibility of a collision

In some situations such as the following, the Parking Support Brake function (rear-crossing vehicles) may operate even though there is no possibility of a collision.

- When the parking space faces a street and vehicles are being driven on the street

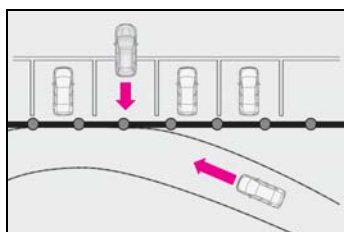

- When a detected vehicle turns while approaching the vehicle

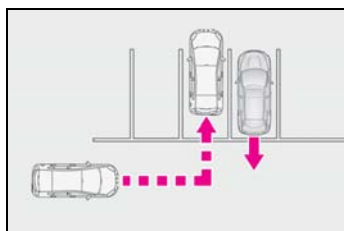

- When a vehicle passes by the side of your

vehicle

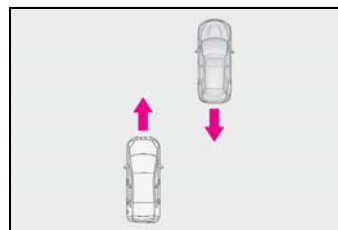

- When the distance between your vehicle and metal objects, such as a guardrail, wall, sign, or parked vehicle, which may reflect electrical waves toward the rear of the vehicle, is short

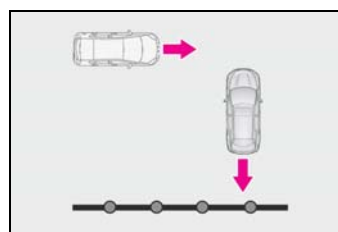

- When there are spinning objects near your vehicle such as the fan of an air conditioning unit
- When water is splashed or sprayed toward the rear bumper, such as from a sprinkler

■ Situations in which the Parking Support Brake function (rear-crossing vehicles) may not operate properly

In some situations, such as the following, the radar sensors may not detect an object and this function may not operate properly

- Stationary objects
- When a sensor or the area around a sensor is extremely hot or cold
- If the rear bumper is covered with ice, snow, dirt, etc.
- When it is raining heavily or water strikes the vehicle
- If the vehicle is significantly tilted
- When equipment that may obstruct a sensor is installed, such as a towing eyelet, bumper protector (an additional trim strip, etc.), bicycle carrier, or snow plow
- If the suspension has been modified or

tires of a size other than specified are installed

- If the front of the vehicle is raised or lowered due to the carried load
- If an electronic component, such as a backlit license plate (especially fluorescent type), fog lights, fender pole or wireless antenna is installed near a radar sensor
- If the orientation of a radar sensor has been changed
- When multiple vehicles are approaching with only a small gap between each vehicle
- If a vehicle is approaching the rear of your vehicle rapidly
- Situations in which the radar sensor may not detect a vehicle
  - When a vehicle approaches from the right or left at the rear of the vehicle while you are turning while backing up
  - When turning while backing up

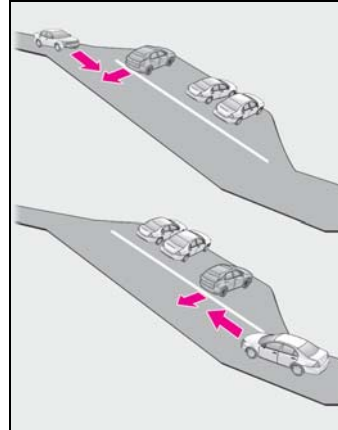

- When a vehicle turns into the detection area

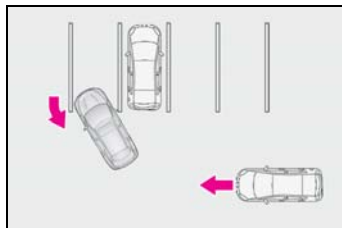
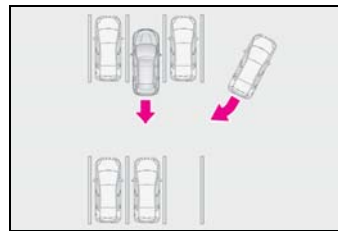

- When backing out of a shallow angle parking spot

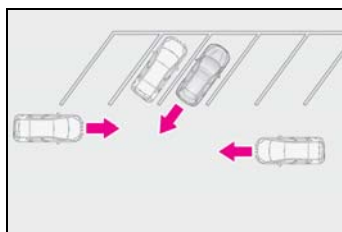

- When backing up on a slope with a sharp change in grade

### Driving mode select switch

The driving modes can be selected to suit driving conditions.

### Selecting a drive mode

► Except F SPORT models

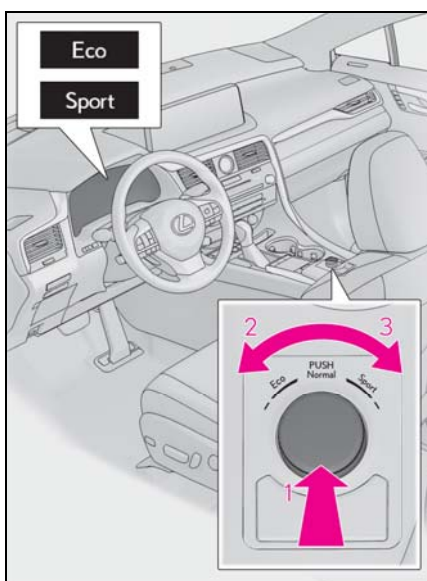

#### 1 Normal mode

Provides an optimal balance of fuel economy, quietness, and dynamic performance. Suitable for city driving.

Press the switch to change the driving mode to normal mode when Eco drive mode or sport mode is selected.

#### 2 Eco drive mode

Helps the driver accelerate in an eco-friendly manner and improve fuel economy through moderate throttle characteristics and by controlling the operation of the air conditioning system (heating/cooling).

When not in Eco drive mode, if the driving

mode select switch is turned to the left, the Eco drive mode indicator will come on.

#### 3 Sport mode

Controls the transmission and engine to provide quick, powerful acceleration. This mode also changes the steering feel, making it suitable for when agile driving response is desired, such as when driving on roads with many curves.

When not in sport mode, if the driving mode select switch is turned to the right, the "Sport" indicator will come on.

► F SPORT models (vehicles with Adaptive Variable Suspension System)

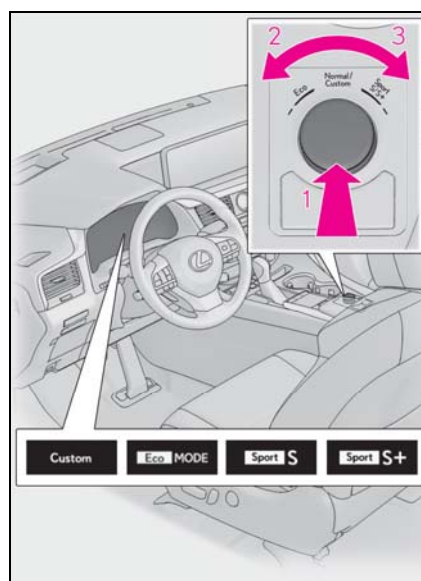

#### 1 Normal mode/Custom mode

Normal mode and custom mode are selected by pressing the driving mode select switch. Each time the switch is pressed, the driving mode changes between normal mode and custom mode. When custom mode is selected, the "Custom" indicator will be illuminated.

When Eco drive mode or sport mode is

selected, pressing the switch changes the driving mode to normal mode.

- Normal mode

Provides an optimal balance of fuel economy, quietness, and dynamic performance. Suitable for city driving.

- Custom mode

Allows you to drive with the following functions set to your preferred settings. Custom mode settings can only be changed on the drive mode customization display of the Center Display. (→P.288)

Function	Setting
Powertrain	Normal
	Power
	Eco
Chassis	Normal
	Sport
Air conditioning system	Normal
	Eco

**2 Eco drive mode**

Helps the driver accelerate in an eco-friendly manner and improve fuel economy through moderate throttle characteristics and by controlling the operation of the air conditioning system (heating/cooling).

When not in Eco drive mode, if the driving mode select switch is turned to the left, the Eco drive mode indicator will come on.

**3 Sport mode**

- Sport S mode

Controls the transmission and engine to provide quick, powerful acceleration. This mode is suitable for when agile driving response is desired, such as when driving on roads with many curves.

When not in Sport S mode, if the driving

mode select switch is turned to the right, the “Sport S” indicator will come on.

- Sport S+ mode

Helps to ensure steering performance and driving stability by simultaneously controlling the steering and suspension in addition to the transmission and engine. Suitable for sportier driving.

When in Sport S mode, if the driving mode select switch is turned to the right, the “Sport S+” indicator will come on.

- ▶ F SPORT models (vehicles without Adaptive Variable Suspension System)

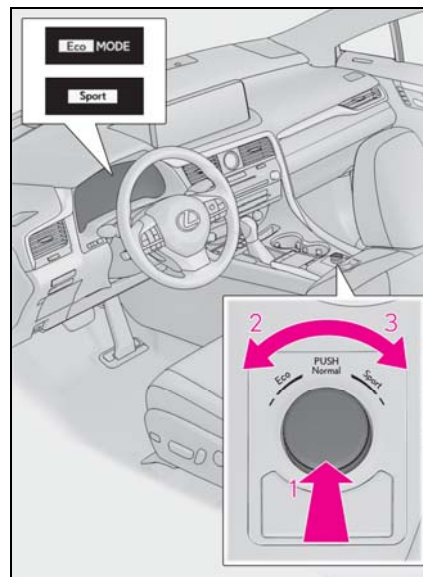

**1 Normal mode**

Provides an optimal balance of fuel economy, quietness, and dynamic performance. Suitable for city driving.

Press the switch to change the driving mode to normal mode when Eco drive mode or sport mode is selected.

**2 Eco drive mode**

Helps the driver accelerate in an eco-friendly manner and improve fuel

economy through moderate throttle characteristics and by controlling the operation of the air conditioning system (heating/cooling).

When not in Eco drive mode, if the driving mode select switch is turned to the left, the Eco drive mode indicator will come on.

### 3 Sport mode

Controls the transmission and engine to provide quick, powerful acceleration. This mode also changes the steering feel, making it suitable for when agile driving response is desired, such as when driving on roads with many curves.

When not in sport mode, if the driving mode select switch is turned to the right, the "Sport" indicator will come on.

#### ■ Operation of the air conditioning system in Eco drive mode

Eco drive mode controls the heating/cooling operations and fan speed of the air conditioning system to enhance fuel efficiency. To improve air conditioning performance, adjust the fan speed or turn off Eco drive mode.

#### ■ Automatic deactivation of sport mode and custom mode

If the engine switch is turned off after driving in sport mode or custom mode, the drive mode will be changed to normal mode.

#### ■ Driving mode pop-up display (12.3-inch display only)

When the driving mode is changed, the selected driving mode will be temporarily displayed on the side display. (→P.288)

### All-wheel drive lock switch (AWD models)

All-wheel drive lock mode can be used when a large amount of drive power needs to be applied to all the wheels, such as when the vehicle gets stuck in mud and you need to free it.

#### Using All-wheel drive lock mode

Press the switch.

The torque of the engine is distributed to the rear wheels to the maximum extent possible in accordance with driving conditions.

Pressing the switch again cancels all-wheel drive lock mode and returns the Dynamic Torque Control AWD system to normal mode. (→P.275)

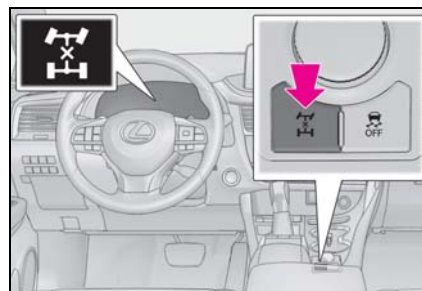

#### ■ All-wheel drive lock mode can be operated when

The engine switch is in IGNITION ON mode.

#### ■ Automatic release for the all-wheel drive lock mode

- All-wheel drive lock mode is canceled when the brakes are applied to ensure the ABS and VSC systems operate effectively.



- All-wheel drive lock mode is canceled when the vehicle speed exceeds 25 mph (40 km/h).

### Driving assist systems

To keep driving safety and performance, the following systems operate automatically in response to various driving situations. Be aware, however, that these systems are supplementary and should not be relied upon too heavily when operating the vehicle.

#### Summary of the driving assist systems

##### ■ ABS (Anti-lock Brake System)

Helps to prevent wheel lock when the brakes are applied suddenly, or if the brakes are applied while driving on a slippery road surface

##### ■ Brake assist

Generates an increased level of braking force after the brake pedal is depressed when the system detects a panic stop situation

##### ■ VSC (Vehicle Stability Control)

Helps the driver to control skidding when swerving suddenly or turning on slippery road surfaces

##### ■ Enhanced VSC (Enhanced Vehicle Stability Control)

Provides cooperative control of the ABS, TRAC, VSC and EPS.  
Helps to maintain directional stability when swerving on slippery road surfaces by controlling steering performance.

■ **Trailer Sway Control (if equipped)**

Helps the driver to control trailer sway by selectively applying brake pressure for individual wheels and reducing driving torque when trailer sway is detected.

■ **TRAC (Traction Control)**

Helps to maintain drive power and prevent the drive wheels from spinning when starting the vehicle or accelerating on slippery roads

■ **Active Cornering Assist (ACA)**

Helps to prevent the vehicle from drifting to the outer side by performing inner wheel brake control when attempting to accelerate while turning

■ **Hill-start assist control**

Helps to reduce the backward movement of the vehicle when starting on an uphill

■ **EPS (Electric Power Steering)**

Employs an electric motor to reduce the amount of effort needed to turn the steering wheel

■ **Dynamic Torque Control AWD system (AWD models)**

Automatically switches from front-wheel drive to all-wheel drive (AWD) according to the driving conditions, helping to ensure reliable handling and stability. Examples of conditions where the system will switch to AWD are when cornering, going uphill, starting off or accelerating, and when the road surface is slippery due to snow, rain, etc.

■ **Adaptive Variable Suspension System (if equipped)**

Controls the damping force of the shock absorber of each wheel according to the road and driving conditions, helping achieve a comfortable ride, excellent driveability and a high level of stability.

If Sport S+ mode is selected using the driving mode select switch, the damping force will become more suitable for sporty driving. (→P.271)

■ **VDIM (Vehicle Dynamics Integrated Management) (if equipped)**

Provides integrated control of the ABS, brake assist, TRAC, VSC, hill-start assist control and EPS systems. Helps to maintain vehicle stability when swerving on slippery road surfaces by controlling the brakes, engine output and steering assist.

■ **The Secondary Collision Brake**

When the SRS airbag sensor detects a collision and the system operates, the brakes and brake lights are automatically controlled to reduce the vehicle speed and help reduce the possibility of further damage due to a secondary collision.

---

■ **When the TRAC/VSC/Trailer Sway Control systems are operating**

The slip indicator light will flash while the TRAC/VSC/Trailer Sway Control systems are operating.

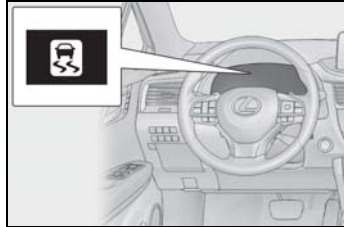

■ **Disabling the TRAC system**

If the vehicle gets stuck in mud, dirt or snow, the TRAC system may reduce power from the engine to the wheels. Pressing the  switch to turn the system off may make it easier for you to rock the vehicle in order to free it.

To turn the TRAC system off, quickly press and release the  switch.

The “Traction Control Turned Off” will be shown on the multi-information display.

Press the  switch again to turn the system back on.

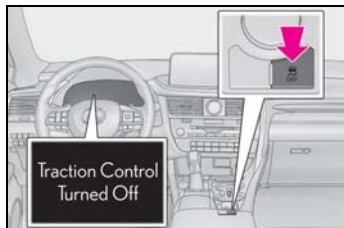

■ **Turning off both TRAC, VSC and Trailer Sway Control systems**

To turn the TRAC, VSC and Trailer Sway Control systems off, press and hold the  switch for more than 3 seconds while the vehicle is stopped.

The VSC OFF indicator light will come on and the “Traction Control Turned Off” will be shown on the multi-information display.\*

Press the  switch again to turn the system back on.

\* : On vehicles with PCS (Pre-Collision

System), PCS will also be disabled (only Pre-Collision warning is available). The PCS warning light will come on and a message will be displayed on the multi-information display. (→P.209)

■ **When the message is displayed on the multi-information display showing that TRAC has been disabled even if the**

 switch has not been pressed

TRAC is temporary deactivated. If the information continues to show, contact your Lexus dealer.

■ **Operating conditions of hill-start assist control**

When the following four conditions are met, the hill-start assist control will operate:

- The shift lever is in a position other than P or N (when starting off forward/backward on an upward incline)
- The vehicle is stopped
- The accelerator pedal is not depressed
- The parking brake is not engaged

■ **Automatic system cancellation of hill-start assist control**

The hill-start assist control will turn off in any of the following situations:

- The shift lever is shifted to P or N
- The accelerator pedal is depressed
- The parking brake is engaged
- 2 seconds at maximum elapsed after the brake pedal is released

■ **Sounds and vibrations caused by the ABS, brake assist, VSC, Trailer Sway Control, TRAC and hill-start assist control systems**

- A sound may be heard from the engine compartment when the brake pedal is depressed repeatedly, when the engine is started or just after the vehicle begins to move. This sound does not indicate that a malfunction has occurred in any of these systems.
- Any of the following conditions may occur when the above systems are operating. None of these indicates that a mal-

- function has occurred.
- Vibrations may be felt through the vehicle body and steering.
- A motor sound may be heard also after the vehicle comes to a stop.
- The brake pedal may pulsate slightly after the ABS is activated.
- The brake pedal may move down slightly after the ABS is activated.

■ **Active Cornering Assist operation sounds and vibrations**

When the Active Cornering Assist is operated, operation sounds and vibrations may be generated from the brake system, but this is not a malfunction.

■ **EPS operation sound**

When the steering wheel is operated, a motor sound (whirring sound) may be heard. This does not indicate a malfunction.

■ **Reduced effectiveness of the EPS system**

The effectiveness of the EPS system is reduced to prevent the system from overheating when there is frequent steering input over an extended period of time. The steering wheel may feel heavy as a result. Should this occur, refrain from excessive steering input or stop the vehicle and turn the engine off. The EPS system should return to normal within 10 minutes.

■ **Automatic reactivation of TRAC, Trailer Sway Control and VSC systems**

After turning the TRAC, Trailer Sway Control and VSC systems off, the systems will be automatically re-enabled in the following situations:

- When the engine switch is turned off
  - If only the TRAC system is turned off, the TRAC will turn on when vehicle speed increases
- If both the TRAC and VSC systems are turned off, automatic re-enabling will not occur when vehicle speed increases.

■ **Operating conditions of Active Cornering Assist**

The system operates when the following occurs.

- TRAC/VSC can operate

- The driver is attempting to accelerate while turning
- The system detects that the vehicle is drifting to the outer side
- The brake pedal is released

■ **Secondary Collision Brake operating conditions**

The system operates when the SRS airbag sensor detects a collision while the vehicle is in motion.

However, the system does not operate in any of the following situations.

- The vehicle speed is below 6 mph (10 km/h)
- Components are damaged

■ **Secondary Collision Brake automatic cancellation**

The system is automatically canceled in any of the following situations.

- The vehicle speed drops below approximately 6 mph (10 km/h)
- A certain amount of time elapses during operation
- The accelerator pedal is depressed a large amount

 **WARNING**

■ **The ABS does not operate effectively when**

- The limits of tire gripping performance have been exceeded (such as excessively worn tires on a snow covered road).
- The vehicle hydroplanes while driving at high speed on wet or slick roads.

■ **Stopping distance when the ABS is operating may exceed that of normal conditions**

The ABS is not designed to shorten the vehicle's stopping distance. Always maintain a safe distance from the vehicle in front of you, especially in the following situations:

- When driving on dirt, gravel or snow-covered roads

**⚠ WARNING**

- When driving with tire chains
- When driving over bumps in the road
- When driving over roads with potholes or uneven surfaces

**■ TRAC/VSC may not operate effectively when**

Directional control and power may not be achievable while driving on slippery road surfaces, even if the TRAC/VSC system is operating. Drive the vehicle carefully in conditions where stability and power may be lost.

**■ Active Cornering Assist does not operate effectively when**

- Do not overly rely on Active Cornering Assist. Active Cornering Assist may not operate effectively when accelerating down slopes or driving on slippery road surfaces.
- When Active Cornering Assist frequently operates, Active Cornering Assist may temporarily stop operating to ensure proper operation of the brakes, TRAC and VSC.

**■ Hill-start assist control does not operate effectively when**

- Do not overly rely on hill-start assist control. Hill-start assist control may not operate effectively on steep inclines and roads covered with ice.
- Unlike the parking brake, hill-start assist control is not intended to hold the vehicle stationary for an extended period of time. Do not attempt to use hill-start assist control to hold the vehicle on an incline, as doing so may lead to an accident.

**■ When the TRAC/VSC/Trailer Sway Control is activated**

The slip indicator light flashes. Always drive carefully. Reckless driving may cause an accident. Exercise particular care when the indicator light flashes.

**■ When the TRAC/VSC/Trailer Sway Control systems are turned off**

- Be especially careful and drive at a speed appropriate to the road conditions. As these are the systems to help ensure vehicle stability and driving force, do not turn the TRAC/VSC/Trailer Sway Control systems off unless necessary.
- Trailer Sway Control is part of the VSC system and will not operate if VSC is turned off or experiences a malfunction.

**■ Replacing tires**

Make sure that all tires are of the specified size, brand, tread pattern and total load capacity. In addition, make sure that the tires are inflated to the recommended tire inflation pressure level.

The ABS, TRAC, Trailer Sway Control and VSC systems will not function correctly if different tires are installed on the vehicle.

Contact your Lexus dealer for further information when replacing tires or wheels.

**■ Handling of tires and the suspension**

Using tires with any kind of problem or modifying the suspension will affect the driving assist systems, and may cause a system to malfunction.

**■ Trailer Sway Control precaution**

The Trailer Sway Control system is not able to reduce trailer sway in all situations. Depending on many factors such as the conditions of the vehicle, trailer, road surface and driving environment, the Trailer Sway Control system may not be effective. Refer to your trailer owner's manual for information on how to tow your trailer properly.

**WARNING****■ If trailer sway occurs**

Observe the following precautions. Failing to do so may cause death or serious injury.

- Firmly grip the steering wheel. Steer straight ahead. Do not try to control trailer sway by turning the steering wheel.
- Begin releasing the accelerator pedal immediately but very gradually to reduce speed. Do not increase speed. Do not apply vehicle brakes.

If you make no extreme correction with the steering or brakes, your vehicle and trailer should stabilize.

**■ Secondary Collision Brake**

Do not rely solely upon the Secondary Collision Brake. This system is designed to help reduce the possibility of further damage due to a secondary collision, however, that effect changes according to various conditions. Overly relying on the system may result in death or serious injury.

**Winter driving tips**

**Carry out the necessary preparations and inspections before driving the vehicle in winter. Always drive the vehicle in a manner appropriate to the prevailing weather conditions.**

**Pre-winter preparations**

- Use fluids that are appropriate to the prevailing outside temperatures.
  - Engine oil
  - Engine coolant
  - Washer fluid
- Have a service technician inspect the condition of the battery.
- Have the vehicle fitted with four snow tires or purchase a set of tire chains for the front tires.

Ensure that all tires are of the specified size and the same brand, and that chains match the size of the tires.

**⚠ WARNING**

**■ Driving with snow tires**

Observe the following precautions to reduce the risk of accidents. Failure to do so may result in a loss of vehicle control and cause death or serious injury.

- Use tires of the specified size.
- Maintain the recommended level of air pressure.
- Do not drive in excess of 75 mph (120 km/h), regardless of the type of snow tires being used.

- Use snow tires on all, not just some wheels.

**■ Driving with tire chains**

Observe the following precautions to reduce the risk of accidents. Failure to do so may result in the vehicle being unable to be driven safely, and may cause death or serious injury.

- Do not drive in excess of the speed limit specified for the tire chains being used, or 30 mph (50 km/h), whichever is lower.
- Avoid driving on bumpy road surfaces or over potholes.
- Avoid sudden acceleration, abrupt steering, sudden braking and shifting operations that cause sudden engine braking.
- Slow down sufficiently before entering a curve to ensure that vehicle control is maintained.
- Do not use the LTA (Lane Tracing Assist) system.

**⚠ NOTICE**

**■ Repairing or replacing snow tires**

Request repairs or replacement of snow tires from your Lexus dealer or legitimate tire retailers. This is because the removal and attachment of snow tires affects the operation of the tire pressure warning valves and transmitters.

**Before driving the vehicle**

Perform the following according to the driving conditions:

- Do not try to forcibly open a window or move a wiper that is frozen. Pour warm water over the frozen area to melt the ice. Wipe away the water

immediately to prevent it from freezing.

- To ensure proper operation of the climate control system fan, remove any snow that has accumulated on the air inlet vents in front of the windshield.
- Check for and remove any excess ice or snow that may have accumulated on the exterior lights, vehicle's roof, chassis, around the tires or on the brakes.
- Remove any snow or mud from the bottom of your shoes before getting in the vehicle.

#### When driving the vehicle

Accelerate the vehicle slowly, keep a safe distance between you and the vehicle ahead, and drive at a reduced speed suitable to road conditions.

#### When parking the vehicle

- Park the vehicle and move the shift lever to P without setting the parking brake. The parking brake may freeze up, preventing it from being released. If the vehicle is parked without setting the parking brake, make sure to block the wheels. Failure to do so may be dangerous because it may cause the vehicle to move unexpectedly, possibly leading to an accident.

When the parking brake is in automatic mode, release the parking brake after shifting the shift lever to P. (→P.184)

- If the vehicle is parked without setting the parking brake, confirm that the shift lever cannot be moved out of P\*.

\*: The shift lever will be locked if it is attempted to be shifted from P to any other position without depressing the brake pedal. If the shift lever can be shifted from P, there may be a problem with the shift lock system. Have the vehicle inspected by your Lexus dealer immediately.

#### Selecting tire chains

Use the correct tire chain size when mounting the tire chains.

Chain size is regulated for each tire size.

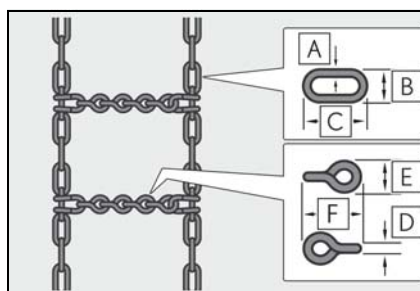

- A** Side chain (0.12 in. [3 mm] in diameter)
- B** Side chain (0.43 in. [10.8 mm] in width)
- C** Side chain (0.98 in. [25 mm] in length)
- D** Cross chain (0.15 in. [3.9 mm] in diameter)
- E** Cross chain (0.54 in. [13.8 mm] in width)
- F** Cross chain (1.00 in. [25.3 mm] in length)



length)

**Regulations on the use of tire chains**

Regulations regarding the use of tire chains vary depending on location and type of road. Always check local regulations before installing chains.

**Tire chain installation**

Observe the following precautions when installing and removing chains:

- Install and remove tire chains in a safe location.
- Install tire chains on the front tires only. Do not install tire chains on the rear tires.
- Install tire chains on front tires as tightly as possible. Retighten chains after driving 1/4—1/2 mile (0.5—1.0 km).
- Install tire chains following the instructions provided with the tire chains.



**NOTICE**

**Fitting tire chains**

The tire pressure warning valves and transmitters may not function correctly when tire chains are fitted.

**Windshield wipers**

To enable the windshield wipers to be lifted when heavy snow or icy conditions are expected, change the rest position of the windshield wipers from the retracted position below the hood to the service position using the wiper lever. (→P.197)

**Utility vehicle precautions**

This vehicle belongs to the utility vehicle class, which has higher ground clearance and narrower tread in relation to the height of its center of gravity.

**Utility vehicle feature**

- Specific design characteristics give it a higher center of gravity than ordinary passenger cars. This vehicle design feature causes this type of vehicle to be more likely to roll-over. And, utility vehicles have a significantly higher rollover rate than other types of vehicles.
- An advantage of the higher ground clearance is a better view of the road allowing you to anticipate problems.
- It is not designed for cornering at the same speeds as ordinary passenger cars any more than low-slung sports cars are designed to perform satisfactorily under off-road conditions. Therefore, sharp turns at excessive speeds may cause the vehicle to rollover.



**WARNING**

**Utility vehicle precautions**

Always observe the following precautions to minimize the risk of death, serious injury or damage to your vehicle:

**⚠ WARNING**

- In a rollover crash, an unbelted person is significantly more likely to die than a person wearing a seat belt. Therefore, the driver and all passengers should always fasten their seat belts.
- Avoid sharp turns or abrupt maneuvers, if at all possible. Failure to operate this vehicle correctly may result in loss of control or vehicle rollover causing death or serious injury.
- Loading cargo on the roof luggage carrier will make the center of the vehicle gravity higher. Avoid high speeds, sudden starts, sharp turns, sudden braking or abrupt maneuvers, otherwise it may result in loss of control or vehicle rollover due to failure to operate this vehicle correctly.
- Always slow down in gusty crosswinds. Because of its profile and higher center of gravity, your vehicle is more sensitive to side winds than an ordinary passenger car. Slowing down will allow you to have better control.
- Do not drive horizontally across steep slopes. Driving straight up or straight down is preferred. Your vehicle (or any similar off-road vehicle) can tip over sideways much more easily than forward or backward.

**Off-road driving**

Your vehicle is not designed to be driven off-road. However, in the event that off-road driving cannot be avoided, please observe the following precautions to help avoid the areas prohibited to vehicles.

- Drive your vehicle only in areas where off-road vehicles are permitted to travel.
- Respect private property. Get owner's permission before entering private property.
- Do not enter areas that are closed. Honor gates, barriers and signs that restrict travel.
- Stay on established roads. When conditions are wet, driving techniques should be changed or travel delayed to prevent damage to roads.

**■ Additional information for off-road driving**

- ▶ For owners in U.S. mainland, Hawaii and Puerto Rico:

To obtain additional information pertaining to driving your vehicle off-road, consult the following organizations.

- State and Local Parks and Recreation Departments
- State Motor Vehicle Bureau
- Recreational Vehicle Clubs
- U.S. Forest Service and Bureau of Land Management

**⚠ WARNING****■ Off-road driving precautions**

Always observe the following precautions to minimize the risk of death, serious injury or damage to your vehicle:

- Drive carefully when off the road. Do not take unnecessary risks by driving in dangerous places.
- Do not grip the steering wheel spokes when driving off-road. A bad bump could jerk the wheel and injure your hands. Keep both hands and especially your thumbs on the outside of the rim.
- Always check your brakes for effectiveness immediately after driving in sand, mud, water or snow.

**⚠ WARNING**

- After driving through tall grass, mud, rock, sand, rivers, etc., check that there is no grass, bush, paper, rags, stone, sand, etc. adhering or trapped on the underbody. Clear off any such matter from the underbody. If the vehicle is used with these materials trapped or adhering to the underbody, a breakdown or fire could occur.
- When driving off-road or in rugged terrain, do not drive at excessive speeds, jump, make sharp turns, strike objects, etc. This may cause loss of control or vehicle rollover causing death or serious injury. You are also risking expensive damage to your vehicle's suspension and chassis.

**⚠ NOTICE****■ To prevent water damage**

Take all necessary safety measures to ensure that water damage to the engine or other components does not occur.

- Water entering the engine air intake will cause severe engine damage.
- Water entering the automatic transmission will cause deterioration in shift quality, locking up of your transmission accompanied by vibration, and ultimately damage.
- Water can wash the grease from wheel bearings, causing rusting and premature failure, and may also enter the differential, transmission and transfer (AWD models only) case, reducing the gear oil's lubricating qualities.

**■ When you drive through water**

If driving through water, such as when crossing shallow streams, first check the depth of the water and the bottom of the riverbed for firmness. Drive slowly and avoid deep water.

**■ Inspection after off-road driving**

- Sand and mud that has accumulated around brake discs may affect braking efficiency and may damage brake system components.
- Always perform a maintenance inspection after each day of off-road driving that has taken you through rough terrain, sand, mud, or water. For scheduled maintenance information, refer to the "Warranty and Services Guide/Owner's Manual Supplement/Scheduled Maintenance".



- 5-1. Remote Touch/Display**
  - Remote Touch.....286
  - Center Display.....288
- 5-2. Lexus Climate Concierge**
  - Lexus Climate Concierge..... 291
- 5-3. Using the air conditioning system and defogger**
  - Front automatic air conditioning system ..... 292
  - Rear automatic air conditioning system ..... 303
  - Heated steering wheel/seat heaters/seat ventilators.....306
- 5-4. Using the interior lights**
  - Interior lights list.....309
- 5-5. Using the storage features**
  - List of storage features..... 312
  - Luggage compartment features ..... 317
- 5-6. Using the other interior features**
  - Other interior features ..... 322
  - Garage door opener..... 334
  - Compass..... 340

### Remote Touch

The Remote Touch can be used to operate the Center Display.

For details on the Remote touch, refer to “NAVIGATION AND MULTIMEDIA SYSTEM OWNER’S MANUAL”.

### Remote Touch operation

#### ■ Switches

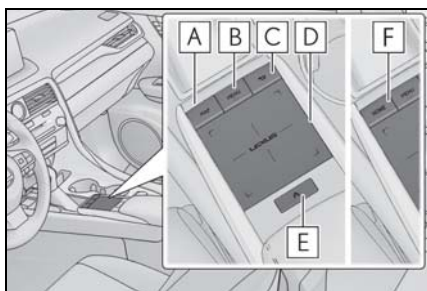

**A** Vehicles with a 12.3-inch display: “MAP” button

Vehicles with navigation function:  
Press this button to display the vehicle’s current position.

Vehicles without navigation function:  
Press this button to display the compass mode screen.

**B** “MENU” button

Press this button to display the menu screen.

**C** Back button

Press this button to display the previous screen.

**D** Touchpad

Slide your finger on the touchpad and move the pointer to select a function, letter and screen button.

Press the touchpad to enter the selected function, letter or screen button. Certain finger movements on the touchpad can perform functions, such as changing map scalings and scrolling list screens.

**E** Sub function button

When  is displayed on the screen, a function screen assigned to the screen can be displayed.

**F** Vehicles with a 8-inch display: “HOME” button

Press this button to display the compass mode screen.

#### ■ Using the touchpad

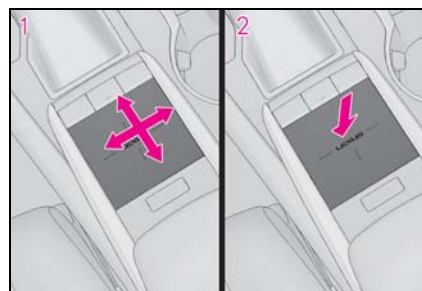

- 1** Select: Touch the touchpad to select the desired button on the screen.
- 2** Enter: Buttons on the screen can be selected by either depressing or double tapping the touchpad. Once a button has been selected, the screen will change.

#### ■ Touch operation

Operations are performed by touching the touchpad with your finger.

#### ● Trace

Trace the pad surface while maintaining contact with the touchpad. Moving the cursor and the pointer.

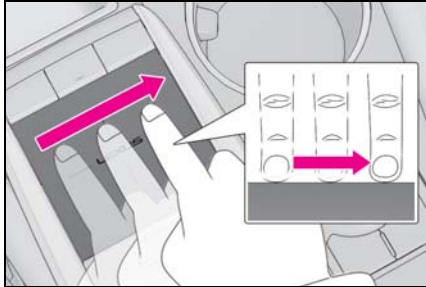

● Double tap

Tap the touchpad twice, quickly. Select the button on the screen.

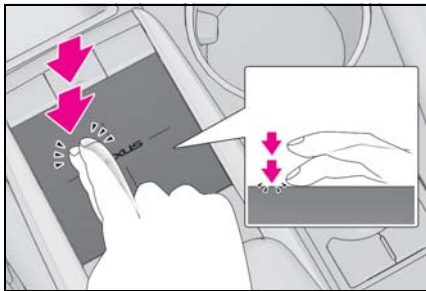

● Flick

Quick and short movement along the touchpad with you finger. Move the list screen.

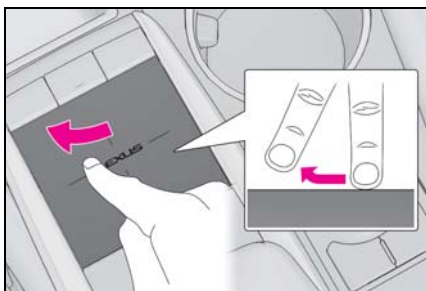

● Pinch in/Pinch out

Slide fingers toward each other or apart on the touchpad. Change the scale of the map.

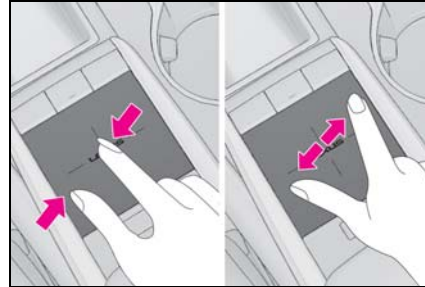

 NOTICE

■ To prevent damage to the Remote Touch

Observe the following precautions. Failure to do so may cause damage to the Remote Touch.

- Do not allow food, liquid, stickers or lit cigarettes to contact the Remote Touch.
- Do not subject the Remote Touch to excessive pressure or strong impact.
- Do not push the touchpad with a strong force or use a sharp pointed object to operate the pad.

## Center Display

### Center Display overview

#### ■ Menu screen

Press the "MENU" button on the Remote Touch to display the menu screen.

This system can also be operated by the touch screen.

For details, refer to "NAVIGATION AND MULTIMEDIA SYSTEM OWNER'S MANUAL".





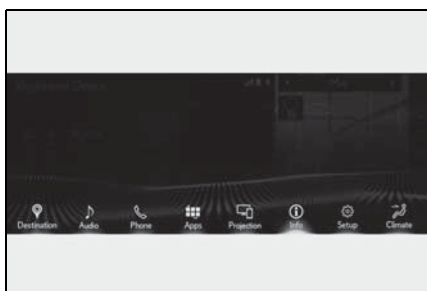





The displays shown in the illustrations are used for example only and may differ from the actual vehicle.

#### ▶ Vehicles with a 12.3-inch display



#### ▶ Vehicles with a 8-inch display



Switch	Function
	Select to display the "Destination" screen. *1
	Select to display the audio control screen. *1
	Select to display the hands-free control screen. *1
	Select to display the "Apps" screen. *1, 2
 /  / 	When an Apple CarPlay/Android Auto connection is established and this button displays "Apple CarPlay"/"Android Auto", select to display the home screen of Apple CarPlay/Android Auto. *1, 2
	Select to display the information screen. *1 (→P.92)
	Select to display the setup screen. *1
	Select to display the air conditioning control screen. (→P.292)
	Select to adjust the contrast and brightness of the screens, turn the screen off, etc. *1, 2



\*1: Refer to "NAVIGATION AND MULTIMEDIA SYSTEM OWNER'S MANUAL".

\*2: This function is not made available in some models or areas.

■ **Split-screen display (vehicles with a 12.3-inch display)**

Different information can be displayed on the left and right sides of the screen. For example, air conditioning system screen can be displayed and operated while the fuel consumption information screen is being displayed. The large screen on the left of the display is called the main display, and the small screen to the right is called the side display.

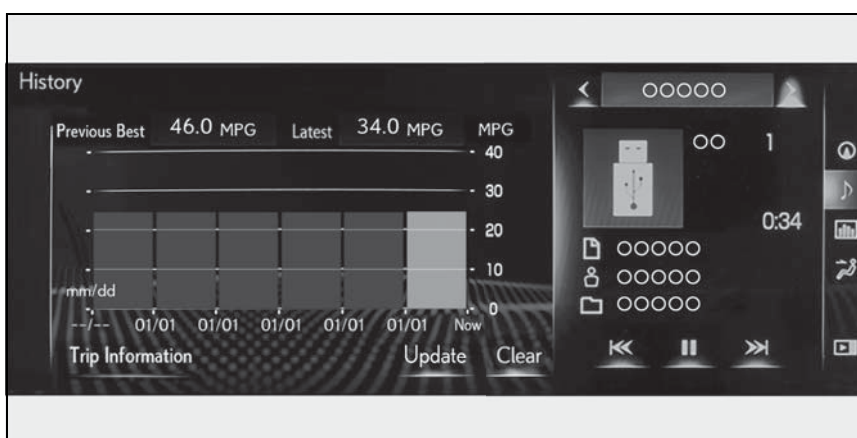

■ **Main display (vehicles with a 12.3-inch display)**

For details about the functions and operation of the main display, refer to the respective section and "NAVIGATION AND MULTIMEDIA SYSTEM OWNER'S MANUAL".

■ **Side display (vehicles with a 12.3-inch display)**

The following functions can be displayed and operated on the side display.

Select **<** or **>** to display the desired screen.

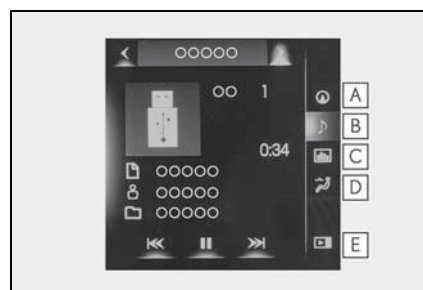

- A** Navigation system \*
- B** Audio \*
- C** Vehicle information (→P.94)
- D** Air conditioning system (→P.292)
- E** Show/hide the side display \*

\*: Refer to "NAVIGATION AND MULTIMEDIA SYSTEM OWNER'S MANUAL".

**■ Screen display during low temperatures**

When the ambient temperature is extremely low, screen response may be delayed even if the Remote Touch is operated.

## Lexus Climate Concierge\*

\*: If equipped

The climate control seats are automatically controlled according to the set temperature of the air conditioning system, outside temperature, cabin temperature, etc. Lexus Climate Concierge allows a comfortable condition to be maintained without adjusting each system.

## Turning on Lexus Climate Concierge

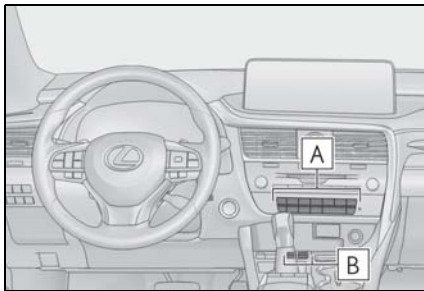

### **A** Front automatic air conditioning system (→P.292)

Set the air conditioning system to automatic mode.

The temperature for the driver's seat and front passenger's seat can be adjusted individually.

### **B** Seat heaters and ventilators (→P.306)

Select "AUTO" mode on each seat.

Seat heater or ventilation is automatically selected according to the set temperature of the air conditioning system, outside temperature, etc.

### Front automatic air conditioning system

Air outlets and fan speed are automatically adjusted according to the temperature setting.

Press the “MENU” button on the Remote Touch, then select  to display the air conditioning control screen.

Vehicles with a 12.3-inch display: The air conditioning system can be displayed and operated on the side display.

### Air conditioning controls

#### ► RX350

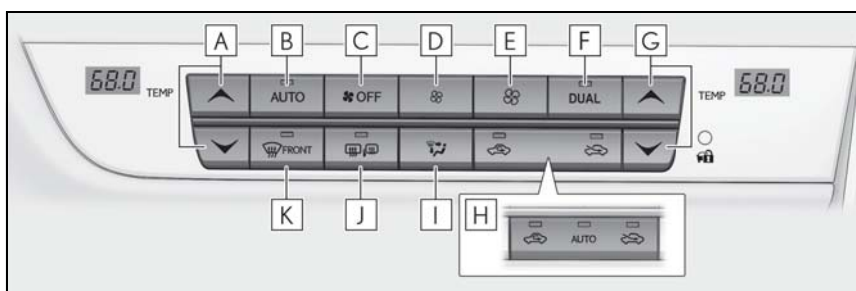

- A** Left-hand side temperature control switch
- B** Automatic mode switch
- C** Off switch
- D** Fan speed decreases switch
- E** Fan speed increases switch
- F** DUAL switch
- G** Right-hand side temperature control switch
- H** Outside/recirculated air mode switch
- I** Air flow mode switch
- J** Rear window defogger and outside rear view mirror defoggers switch
- K** Windshield defogger switch

## ► RX350L

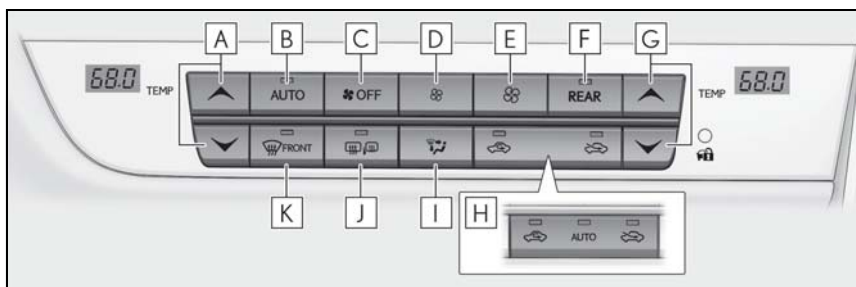

- A** Left-hand side temperature control switch
- B** Automatic mode switch
- C** Off switch
- D** Fan speed decreases switch
- E** Fan speed increases switch
- F** REAR switch
- G** Right-hand side temperature control switch
- H** Outside/recirculated air mode switch
- I** Air flow mode switch
- J** Rear window defogger and outside rear view mirror defoggers switch
- K** Windshield defogger switch

#### ■ Adjusting the temperature

Press ▲ to increase the temperature and ▼ to decrease the temperature.

#### ■ Setting the fan speed

Operate the ⏪ switch to increase the fan speed and the ⏩ switch to decrease the fan speed.

Press the off switch to turn the fan off.



#### ■ Changing the air flow mode

→P.296

#### ■ Switching between outside air and recirculated air modes

##### ► Type A

Press .

The mode switches between  (recirculated air mode) and  (outside air mode) modes each time the button is pressed.

##### ► Type B

Press .

The mode switches between  (recirculated air mode), automatic and



(outside air mode) modes each time the button is pressed.

When the system is switched to automatic mode, the air conditioning system operates automatically.

#### ■ Defogging the windshield

Defoggers are used to defog the windshield and front side windows.

Press the windshield defogger switch.

Set the outside/recirculated air mode button to outside air mode if the recirculated air mode is used. (It may switch automatically.)

To defog the windshield and the side windows early, turn the air flow and temperature up.

To return to the previous mode, press the windshield defogger switch again when the windshield is defogged.

#### ■ Defogging the rear window and outside rear view mirrors

Defoggers are used to defog the rear window, and to remove raindrops, dew and frost from the outside rear view mirrors.

Press the rear window and outside rear view mirror defoggers switch.

The defoggers will automatically turn off after a period of time.

#### ■ Windshield wiper de-icer (if equipped)

→P.299

#### ■ When the outside temperature exceeds 75°F (24°C) and the air conditioning system is on

- In order to reduce the air conditioning power consumption, the air conditioning system may switch to recirculated air

mode automatically. This may also reduce fuel consumption.

- Recirculated air mode is selected as a default mode when the engine switch is turned to IGNITION ON mode.
- It is possible to switch to outside air mode at any time by pressing the outside/recirculated air mode switch.

#### ■ Fogging up of the windows

The windows will easily fog up when the humidity in the vehicle is high. Selecting "A/C" on will dehumidify the air from the outlets and defog the windshield effectively.

- If you turn "A/C" off, the windows may fog up more easily.
- The windows may fog up if the recirculated air mode is used.

#### ■ When driving on dusty roads

Close all windows. If dust thrown up by the vehicle is still drawn into the vehicle after closing the windows, it is recommended that the air intake mode be set to outside air mode and the fan speed to any setting except off.

#### ■ Outside/recirculated air mode

- Setting to the recirculated air mode temporarily is recommended in preventing dirty air from entering the vehicle interior and helping to cool the vehicle when the outside air temperature is high.
- Outside/recirculated air mode may automatically switch depending on the temperature setting or the inside temperature.

#### ■ Registering air conditioning settings to electronic keys (vehicles with driving position memory)

- Unlocking the vehicle using an electronic key and turning the engine switch to IGNITION ON mode will recall that key's registered air conditioning settings.
- When the engine switch is turned off, the current air conditioning settings will automatically be registered to the electronic key that was used to unlock the vehicle.
- The system may not operate correctly if more than one electronic key is in the vicinity or if the smart access system with

push-button start is used to unlock a passenger door.

- The doors that can recall the air conditioning setting when unlocked using the smart access system with push-button start can be changed.\* For details, contact your Lexus dealer.

\* : The doors that can recall the driving position memory are changed at the same time.

■ **Operation of the air conditioning system in Eco drive mode**

In Eco drive mode, the air conditioning system is controlled as follows to prioritize fuel efficiency:

- Engine speed and compressor operation controlled to restrict heating/cooling capacity
- Fan speed restricted when automatic mode is selected

To improve air conditioning performance, perform the following operations:

- Adjust the fan speed
- Turn off Eco drive mode (→P.271)

■ **When the outside temperature falls to nearly 32°F (0°C)**

The dehumidification function may not operate even when "A/C" is selected.

■ **Ventilation and air conditioning odors**

- To let fresh air in, set the air conditioning system to the outside air mode.
- During use, various odors from inside and outside the vehicle may enter into and accumulate in the air conditioning system. This may then cause odor to be emitted from the vents.
- To reduce potential odors from occurring:
  - It is recommended that the air conditioning system be set to outside air mode prior to turning the vehicle off.
  - The start timing of the blower may be delayed for a short period of time immediately after the air conditioning system is started in automatic mode or with the micro dust and pollen filter on.

■ **Using the voice command system**

Air conditioning system can be operated using voice commands. For details, refer to "NAVIGATION AND MULTIMEDIA SYSTEM OWNER'S MANUAL".

■ **Air conditioning filter**

→P.376

■ **Air conditioning system refrigerant**

- A label regarding the refrigerant of the air conditioning system is attached to the hood at the location shown in the following illustration.



- The meaning of each symbol on the label are as follows:

	Caution
	Air conditioning system
	Air conditioning system lubricant type
	Requires registered technician to service air conditioning system
	Flammable refrigerant

■ **Customization**

Some functions can be customized. (→P.461)

**⚠ WARNING**

■ **To prevent the windshield from fogging up**

Do not use the windshield defogger switch during cool air operation in extremely humid weather. The difference between the temperature of the outside air and that of the windshield can cause the outer surface of the windshield to fog up, blocking your vision.

■ **When the outside rear view mirror defoggers are operating**

Do not touch the outside rear view mirror surfaces, as they can become very hot and burn you.

**⚠ NOTICE**

■ **To prevent battery discharge**

Do not leave the air conditioning system on longer than necessary when the engine is off.

■ **When repairing/replacing parts of the air conditioning system**

Have repair/replacement performed by your Lexus dealer.  
When a part of the air conditioning system, such as the evaporator, is to be replaced, it must be replaced with a new one.

**Air conditioning control screen**

■ **Main control screen**

Using the touchpad of the Remote Touch, select the button on the screen.

This system can also be operated by the touch screen.

▶ **Vehicles with DUAL-ZONE climate control**

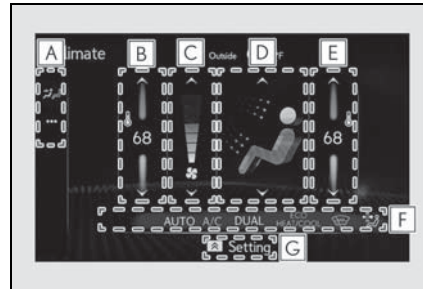

**A** Sub menu

Selecting the sub menu item to switch the main screen.



: Display the air conditioning control screen



: Display the option control screen

**B** Adjust the left side seat temperature setting

**C** Adjust the fan speed setting

**D** Select the air flow mode



: Air flows to the upper body



: Air flows to the upper body and feet



: Air flows to the feet



: Air flows to the feet and the windshield defogger operates

**E** Adjust the right side seat temperature setting

**F** Function on/off indicators

When the function is on, the indicator illuminates on the control screen.

**G** Sub function menu

When the sub function button on the



Remote Touch is pressed, the following functions can be switched on and off.

“AUTO”: Set automatic mode on/off (→P.300)

“OFF”: Turn the fan off

“A/C”: Set cooling and dehumidification function

If the “A/C” display is turned off, the system will blow ambient temperature air or heated air.

“DUAL”: Adjust the temperature for driver and passenger seats separately (“DUAL” mode) (→P.301)

**ECO HEAT/COOL**: Set eco air conditioning mode

▶ Vehicles with 3-ZONE climate control

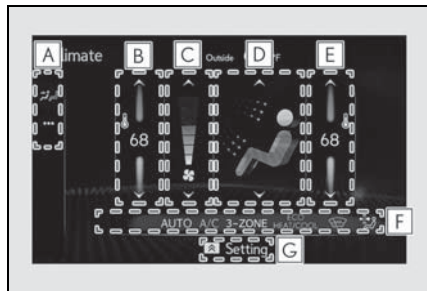

**A** Sub menu

Selecting the sub menu item to switch the main screen.

: Display the air conditioning control screen

: Display the option control screen

**B** Adjust the left side seat temperature setting

**C** Adjust the fan speed setting

**D** Select the air flow mode

: Air flows to the upper body

: Air flows to the upper body and feet

: Air flows to the feet

: Air flows to the feet and the windshield defogger operates

**E** Adjust the right side seat temperature setting

**F** Function on/off indicators

When the function is on, the indicator illuminates on the control screen.

**G** Sub function menu

When the sub function button on the Remote Touch is pressed, the following functions can be switched on and off.

“AUTO”: Set automatic mode on/off (→P.300)

“OFF”: Turn the fan off

“A/C”: Set cooling and dehumidification function

If the “A/C” display is turned off, the system will blow ambient temperature air or heated air.

“3-ZONE”: Adjust the temperature for the driver, front passenger and rear passenger seats separately (“3-ZONE” mode) (→P.301)

**ECO HEAT/COOL**: Set eco air conditioning mode

**Option control screen**

Select on the sub menu to display the option control screen.

The functions can be switched on and off.

When the function is on, the indicator illuminates on the screen.

- ▶ Vehicles with DUAL-ZONE climate control

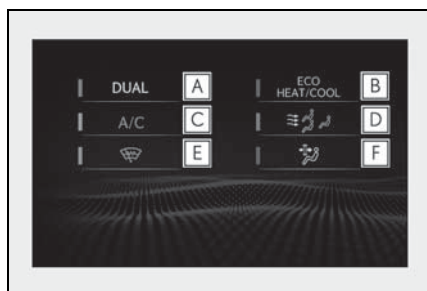

- A** Adjusting the temperature for driver and passenger seats separately (“DUAL” mode) (→P.301)
- B** Set eco air conditioning mode  
Air conditioning and heater output is limited to prioritize fuel economy.
- C** Cooling and dehumidification function  
If the “A/C” indicator is turned off, the system will blow ambient temperature air or heated air.
- D** Select the front seat concentrated airflow mode (S-FLOW) (→P.300)
- E** Prevent ice from building up on the windshield and wiper blades (Windshield wiper de-icer) (if equipped)
- F** Removing pollen from the air (Micro dust and pollen filter)

- ▶ Vehicles with 3-ZONE climate control

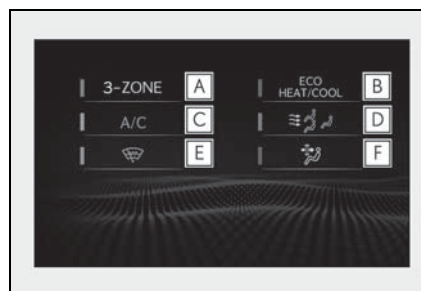

- A** Adjust the temperature for driver, passenger and rear seats separately (“3-ZONE” mode) (→P.301)
- B** Set eco air conditioning mode  
Air conditioning and heater output is limited to prioritize fuel economy.
- C** Cooling and dehumidification function  
If the “A/C” indicator is turned off, the system will blow ambient temperature air or heated air.
- D** Select the front seat concentrated airflow mode (S-FLOW) (→P.300)
- E** Prevent ice from building up on the windshield and wiper blades (Windshield wiper de-icer) (if equipped)
- F** Removing pollen from the air (Micro dust and pollen filter)

### ■ Side display

- ▶ Vehicles with DUAL-ZONE climate control

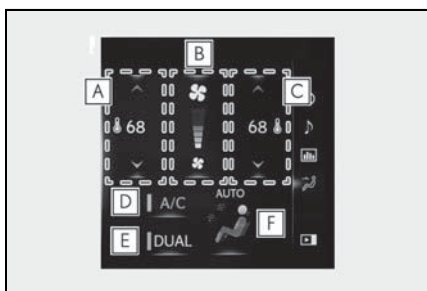

- A** Adjust the left side seat temperature setting
- B** Adjust the fan speed setting
- C** Adjust the right side seat temperature setting
- D** Set cooling and dehumidification function on/off
- E** Adjusting the temperature for driver and passenger seats separately ("DUAL" mode) (→P.301)
- F** Select the air flow mode

- ▶ Vehicles with 3-ZONE climate control

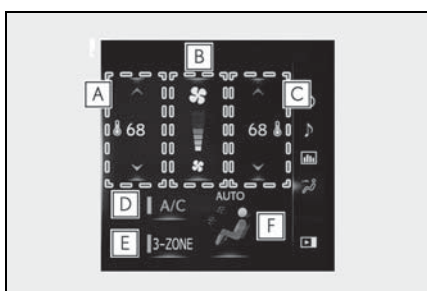

- A** Adjust the left side seat temperature setting
- B** Adjust the fan speed setting

- C** Adjust the right side seat temperature setting

- D** Set cooling and dehumidification function on/off

- E** Adjust the temperature for driver, passenger and rear seats separately ("3-ZONE" mode) (→P.301)

- F** Select the air flow mode

### ■ Windshield wiper de-icer (if equipped)

This feature is used to prevent ice from building up on the windshield and wiper blades.

The windshield de-icer will automatically turn off after a while.

### ■ Micro dust and pollen filter

Outside air mode switches to  (recirculated air) mode. Pollen is removed from the air and the air flows to the upper part of the body.

Usually the system will automatically turn off after a while.

In order to prevent the windshield from fogging up when the outside air is cold, the dehumidification function may operate or the outside/recirculated air mode may not switch to  (recirculated air) mode.

Pollen is filtered even if the micro dust and pollen filter is turned off.

### ⚠ WARNING

#### ■ To prevent burns (vehicles with windshield wiper de-icer)

Do not touch the glass at lower part of the windshield or to the side of the front pillars when the windshield wiper de-icer is on.

### Using automatic mode

- 1 Press the automatic mode switch or select "AUTO" on the sub function menu. (→P.296)
  - 2 Press the outside/recirculated air mode switch to switch to automatic air intake mode. (if equipped)
- The air conditioning system automatically switches between outside air and recirculated air modes.
- 3 Adjust the temperature setting.
  - 4 To stop the operation, press the off switch or select "OFF" on the sub function menu. (→P.296)

If the fan speed setting or air flow modes are operated, the automatic mode indicator goes off. However, automatic mode for functions other than that operated is maintained.

### Using automatic mode

Fan speed is adjusted automatically according to the temperature setting and the ambient conditions.

Therefore, the fan may stop for a while until warm or cool air is ready to flow immediately after the automatic mode switch is pressed or "AUTO" is selected.

Cool air may blow around the upper body even when the heater is on due to sunlight.

### Automatic mode for air intake control (if equipped)

In automatic mode, the system detects exhaust gas and other pollutants and automatically switches between outside air and recirculated air modes.

When the dehumidification function is off, and the fan is operating, turning automatic mode on will activate the dehumidification function.

### Front seat concentrated airflow mode (S-FLOW)

This function automatically controls the air conditioning airflow so that priority is given to the front seats. When the front passenger seat is not occupied, airflow may switch to only the driver's seat. Unnecessary air conditioning is suppressed, contributing to increased fuel efficiency.

Front seat concentrated airflow mode operates in the following situations.

- No passengers are detected in the rear seats
- The windshield defogger is not operating
- Pollen removal mode is not operating

While operating,  illuminates.

### Manually turning front seat concentrated airflow mode on/off

In front seat concentrated airflow mode, directing airflow to the front seats only and to all seats can be switched via switch operation. When the mode has been switched manually, automatic airflow control stops operating.

Select  on the center display and switch the airflow.

- Indicator illuminated: Airflow to the front seats only
- Indicator off: Airflow to all the seats

#### ■ Operation of automatic airflow control

- In order to maintain a comfortable interior, airflow may be directed to seats without passengers immediately after the engine is started and at other times depending on the outside temperature.
- After the engine is started, if passengers move around inside or enter/exit the vehicle, the system cannot accurately detect the presence of passengers and automatic airflow control will not operate.

#### ■ Operation of manual airflow control

Even if the function is manually switched to directing airflow to only the front seats, when a rear seat is occupied, it may automatically direct airflow to all seats.

#### ■ To return to automatic airflow control

- 1 With the indicator off, turn the engine switch off.
- 2 After 60 minutes or more elapse, turn the engine switch to ON.

### Adjusting the temperature for the driver and passenger seats separately

- ▶ Vehicles with DUAL-ZONE climate control

To turn on the "DUAL" mode, perform any of the following procedures:

- Select "DUAL" on the sub function menu. (→P.296)
- Select "DUAL" on the option control screen.
- Adjust the passenger's side temperature setting.

The indicator on the main control screen comes on when the "DUAL" mode is on.

- ▶ Vehicles with 3-ZONE climate control

To turn on the "3-ZONE" mode, per-

form any of the following procedures:

- Select "3-ZONE" on the sub function menu. (→P.296)
- Select "3-ZONE" on the option control screen.
- Adjust a passenger seat temperature setting.

The indicator on the main control screen comes on when the "3-ZONE" mode is on.

### Air outlet layout and operations

#### ■ Location of air outlets

The air outlets and air volume changes according to the selected air flow mode.

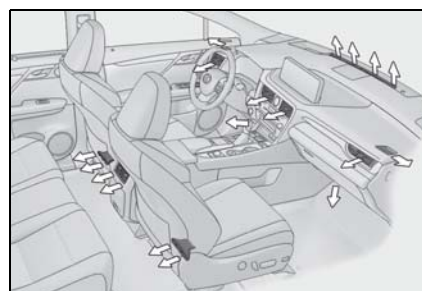

#### ■ Adjusting the position of and opening and closing the air outlets

- ▶ Front center

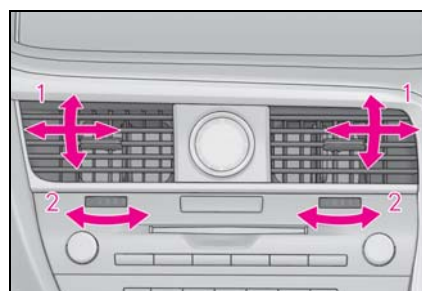

- 1 Direct air flow to the left or right, up or down

- 2** Turn the knob to open or close the vent

► Front side

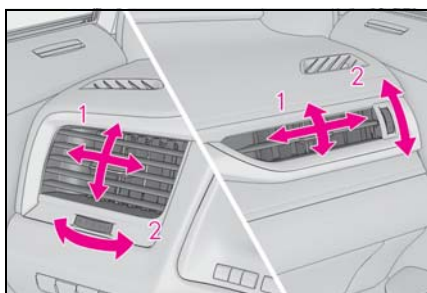

- 1** Direct air flow to the left or right, up or down

- 2** Turn the knob to open or close the vent

► Rear

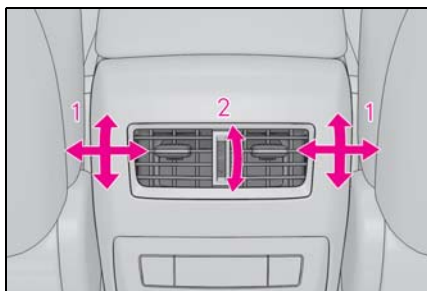

- 1** Direct air flow to the left or right, up or down

- 2** Turn the knob to open or close the vent

**! WARNING**

**■ To prevent the windshield defogger from operating improperly**

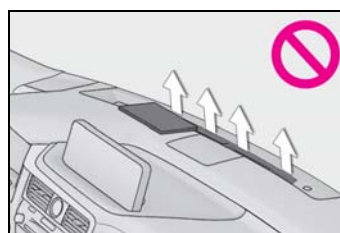

Do not place anything on the instrument panel which may cover the air outlets. Otherwise, air flow may be obstructed, preventing the windshield defoggers from defogging.



### Rear automatic air conditioning system (RX350L)

The air outlets and fan speed are automatically adjusted according to the temperature setting.

The rear air conditioning system can be operated using the Center Display and rear air conditioning system control panel.

Press the "MENU" button on the Remote Touch to display the main menu and move the cursor to  to display the climate control shortcut buttons. Then, select  to display the rear air conditioning control screen.

### Rear air conditioning control operation

#### ■ Center Display

Using the touchpad of the Remote Touch, select the button on the screen.

This system can also be operated by the touch screen.

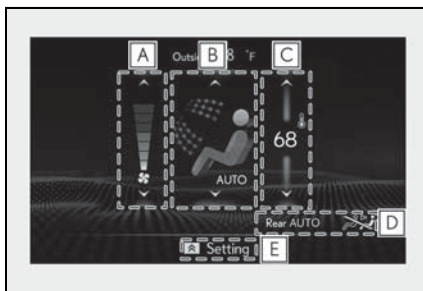

**A** Adjust the rear seats fan speed setting

**B** Select the rear seats air flow mode



: Air flows to the upper body



: Air flows to the upper body and feet



: Air flows to the feet

**C** Adjust the rear seats temperature setting

**D** Function on/off indicators

When the function is on, the indicator illuminates on the control screen.

**E** Sub function menu

When the sub function button on the Remote Touch is pressed, the following functions can be switched on and off.

"Rear off": Turn the rear seats fan off

"Rear AUTO": Set the rear seats automatic mode on/off (→P.304)



: Disables operation of the rear air conditioning system using the Rear air conditioning system control panel

■ Rear air conditioning system control panel

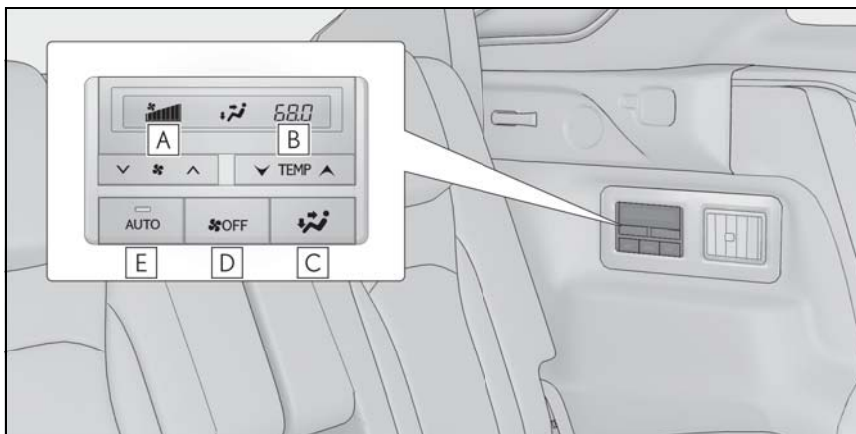

**A** Adjust the rear seats fan speed setting

Press to increase the fan speed and to decrease the fan speed.

Press the OFF switch to turn the fan off.

**B** Adjust the rear seats temperature setting

Press to increase the temperature and to decrease the temperature.

**C** Select the air flow mode

**D** OFF switch

**E** AUTO button

When the function is on, the indicator illuminates on the control screen.

**Using automatic mode**

► Center Display

- 1 Select "Rear AUTO" on the sub function menu. (→P.303)
- 2 To stop the operation, select "Rear off" on the sub function menu. (→P.303)

If the fan speed setting or air flow modes are operated, the automatic mode indicator goes off. However, automatic mode for functions other

than that operated is maintained.

► Rear air conditioning system control panel

- 1 Press "AUTO" on the rear air conditioning system control panel.
- 2 To stop the operation, select "OFF" on the rear air conditioning system control panel.

If the fan speed setting or air flow modes are operated, the automatic mode indicator goes off. However, automatic mode for functions other



than that operated is maintained.

#### ■ Using automatic mode

Fan speed is adjusted automatically according to the temperature setting and the ambient conditions.

Therefore, the fan may stop for a while until warm or cool air is ready to flow immediately after "Rear AUTO" is selected or "AUTO" is touched.

Cool air may blow around the upper body even when the heater is on due to sunlight.

### Adjusting the temperature setting of the rear seats

The temperature setting of the rear seats can be adjusted using the following methods:

- When the "3-ZONE" indicator is off: Adjust the driver's seat temperature.

Adjust the temperature setting of each rear seat using the Center Display or rear air conditioning system control panel.

- Adjust the temperature setting of rear seats using the Center Display (rear air conditioning control screen) or rear air conditioning system control panel.

### Air outlets

#### ■ Location of air outlets

The air outlets and air volume changes according to the selected air flow mode.

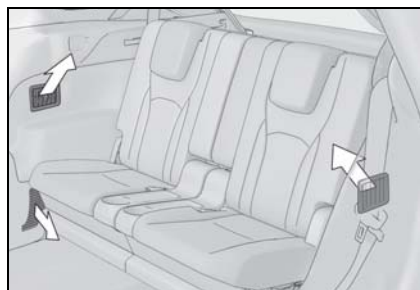

#### ■ Adjusting the position of and opening and closing the air outlets

Adjusting the position of and opening and closing the air outlets

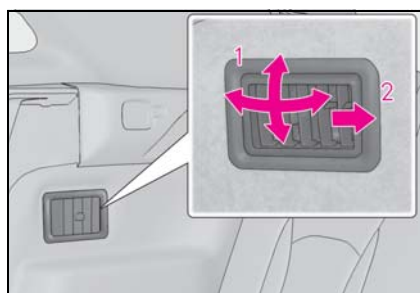

- 1 Direct air flow to the left or right, up or down
- 2 Turn the knob fully to the back of the vehicle to close the vent

#### ⚠ NOTICE

##### ■ To prevent battery discharge

Do not leave the air conditioning system on longer than necessary when the engine is off.

### Heated steering wheel<sup>\*</sup> / seat heaters<sup>\*</sup> / seat ventilators<sup>\*</sup>

<sup>\*</sup>: If equipped

- Heated steering wheel

Warms up the grip of the steering wheel

- Seat heaters

Warm up the seat upholstery

- Seat ventilators

Maintain good ventilation using a fan built into the seat

#### WARNING

##### ■ To prevent minor burn injuries

Care should be taken if anyone in the following categories comes in contact with the steering wheel or seats when the heater is on:

- Babies, small children, the elderly, the sick and the physically challenged
- Persons with sensitive skin
- Persons who are fatigued
- Persons who have taken alcohol or drugs that induce sleep (sleeping drugs, cold remedies, etc.)

#### NOTICE

##### ■ To prevent damage to the seat heaters

Do not put heavy objects that have an uneven surface on the seat and do not stick sharp objects (needles, nails, etc.) into the seat.

##### ■ To prevent battery discharge

Do not use the functions when the engine is off.

### Heated steering wheel

Turns the heated steering wheel on/off

The indicator light comes on when the heated steering wheel is operating.

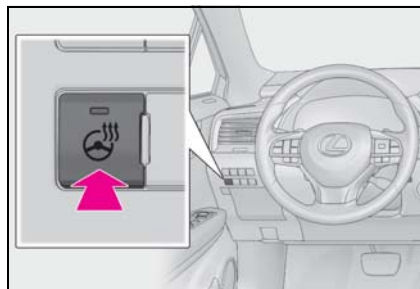

#### ■ Operation condition

The engine switch is in IGNITION ON mode.

#### ■ Timer function

The heated steering wheel will automatically turn off after about 30 minutes.

### Seat heaters

#### ■ Front seats

##### ▶ Vehicles without seat ventilators

Each time the switch is pressed, the operation condition changes as follows.

Hi (3 segments lit) → Mid (2 segments lit) → Lo (1 segment lit) → Off

The level indicator (amber)  lights up during operation.

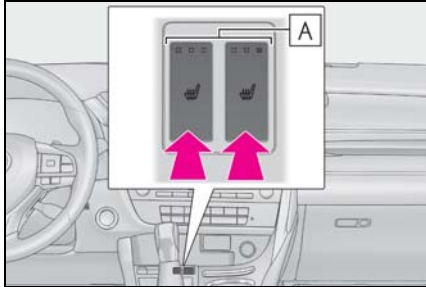

► Vehicles with seat ventilators

When any switch is pressed, the system is set to automatic mode and the "AUTO" indicator (green) **A** lights up. Each time the switch is pressed, the operation condition changes as follows.

Hi (3 segments lit)→Mid (2 segments lit)→Lo (1 segment lit)→Off

The level indicator (amber) **B** lights up during operation.

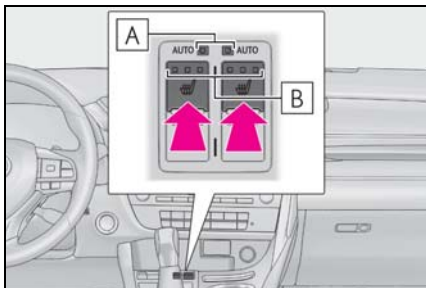

■ Second-row seats

Each time the switch is pressed, the operation condition changes as follows.

Hi (3 segments lit)→Mid (2 segments lit)→Lo (1 segment lit)→Off

The level indicator (amber) **A** lights up during operation.

► Type A

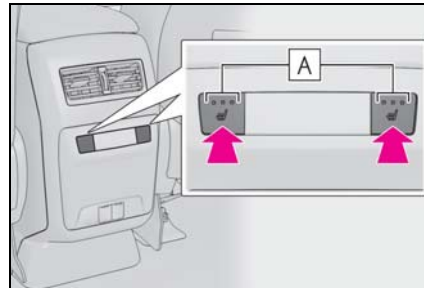

► Type B

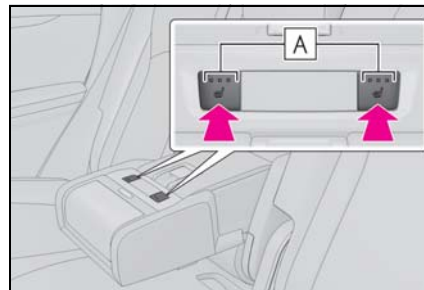

■ Operation condition

The engine switch is in IGNITION ON mode.

■ When the air conditioning system is operating in front seat concentrated air-flow mode (S-FLOW)

If a passenger is not detected in the front passenger seat, the seat heater of the front passenger's seat will be turned off if on. (→P.300)

■ Customization

Some functions can be customized. (→P.461)

**! WARNING**

■ To prevent overheating and minor burn injuries

Observe the following precautions when using the seat heaters.

- Do not cover the seat with a blanket or cushion when using the seat heater.

**⚠ WARNING**

- Do not use seat heater more than necessary.

**Seat ventilators (front seats)**

When any switch is pressed, the system is set to automatic mode and the "AUTO" indicator (green) **A** lights up.

Each time the switch is pressed, the operation condition changes as follows.

Hi (3 segments lit)→Mid (2 segments lit)→Lo (1 segment lit)→Off

The level indicator (green) **B** lights up during operation.

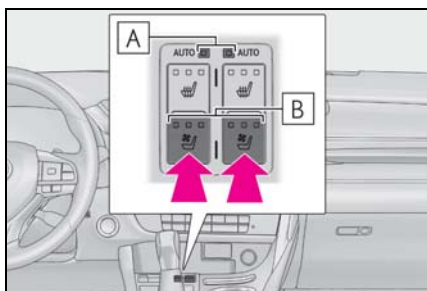
**■ Operation condition**

The engine switch is in IGNITION ON mode.

**■ When the air conditioning system is operating in front seat concentrated air-flow mode (S-FLOW)**

If a passenger is not detected in the front passenger seat, the seat ventilator of the front passenger's seat will be turned off if on. (→P.300)

**■ Customization**

Some functions can be customized. (→P.461)

**Interior lights list**

**Location of the interior lights**

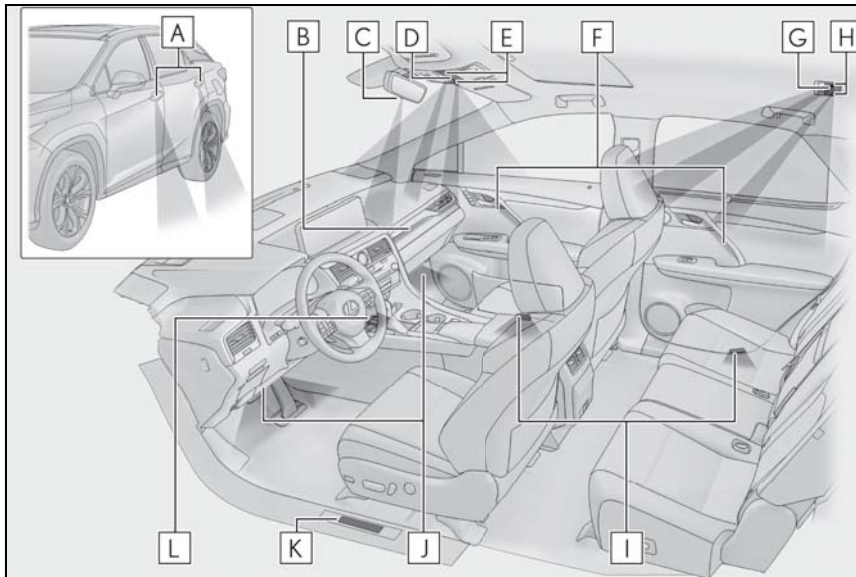

- A** Outer foot lights
- B** Instrument panel ornament light (if equipped)
- C** Shift lever light
- D** Front interior light (→P.309)
- E** Front personal lights (→P.310)
- F** Door trim ornament lights (if equipped)
- G** Rear interior light (→P.309)
- H** Rear personal lights (→P.310)
- I** Door courtesy lights
- J** Footwell lights
- K** Scuff lights (if equipped)
- L** Front center console light

**Operating the interior lights**

Turns the lights on/off (touch the light)

- **Front interior light**

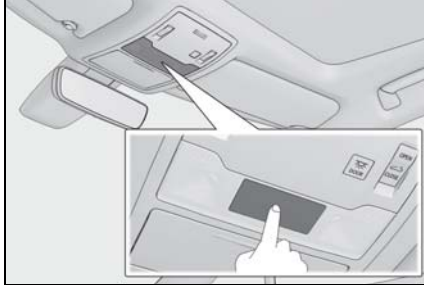

Turns the door position on/off

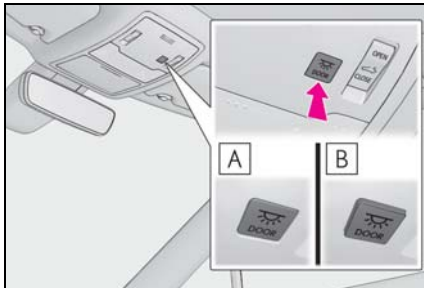

**A** On

**B** Off

#### ■ Rear interior light

The rear interior light turns on/off together with the front interior light.

### Operating the personal lights

#### ■ Front personal lights

Turns the lights on/off (touch the lights)

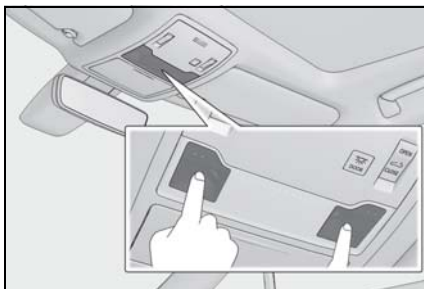

#### ■ Rear personal lights

Turns the lights on/off

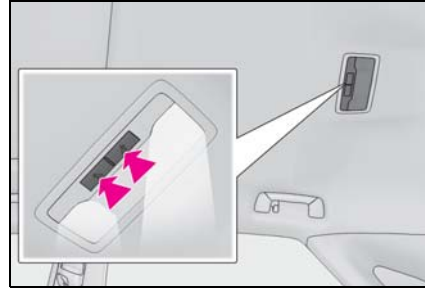

#### ■ Illuminated entry system

The lights automatically turn on/off according to the engine switch mode, the presence of the electronic key, whether the doors are locked/unlocked, and whether the doors are opened/closed.

#### ■ To prevent the battery from being discharged

If the interior lights remain on when the engine switch is turned off, the lights will go off automatically after 20 minutes.

#### ■ When front interior light or front personal lights do not respond as normal

In the following cases, the interior lights and front personal lights may not respond as normal.

- When water, dirt, etc., have adhered to the lens surface
- When operated with a wet hand
- When wearing gloves, etc.

#### ■ The interior lights may turn on automatically when

If any of the SRS airbags deploy (inflate) or in the event of a strong rear impact, the interior lights will turn on automatically.

The interior lights will turn off automatically after approximately 20 minutes.

The interior lights can be turned off manually. However, in order to help prevent further collisions, it is recommended that they be left on until safety can be ensured.

(The interior lights may not turn on automatically depending on the force of the

impact and conditions of the collision.)

■ **Customization**

Some functions can be customized.  
(→P.461)



**NOTICE**

■ **Removing light lenses**

Never remove the lens for the front interior light and front personal lights. Otherwise, the lights will be damaged. If the lens need to remove, contact your Lexus dealer.

■ **To prevent battery discharge**

Do not leave the lights on longer than necessary when the engine is not running.

### List of storage features

#### Location of the storage features

- ▶ Vehicles with bench-type second-row seats

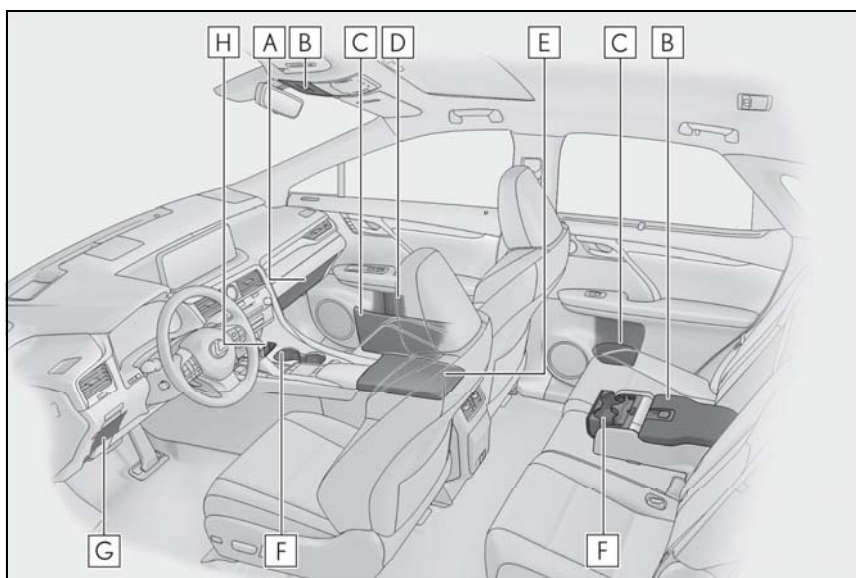

- A** Glove box (→P.314)
- B** Auxiliary boxes (if equipped) (→P.317)
- C** Door pockets (→P.316)
- D** Bottle holders (→P.316)
- E** Console box (→P.314)
- F** Cup holders (→P.315)
- G** Coin box (→P.316)
- H** Smartphone holder (→P.314)



## ▶ Vehicles with separate-type second-row seats

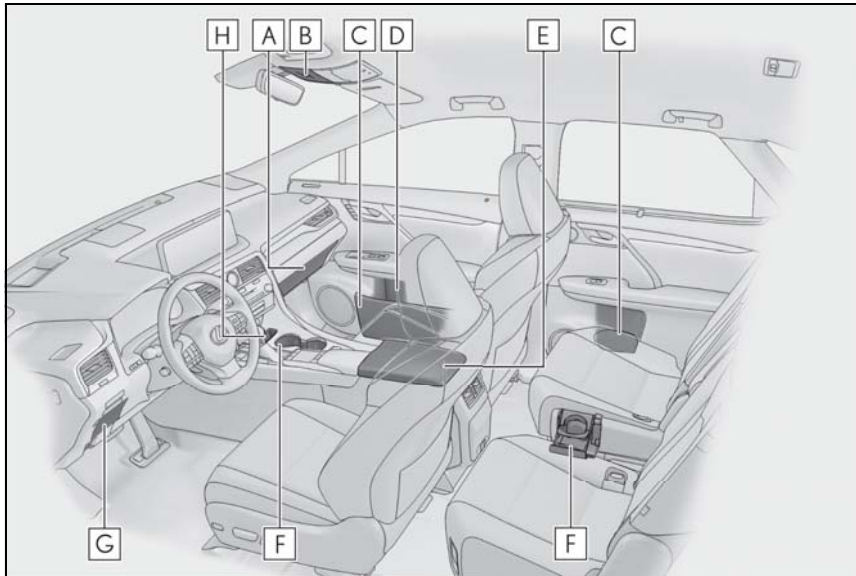

- A** Glove box (→P.314)
- B** Auxiliary boxes (→P.317)
- C** Door pockets (→P.316)
- D** Bottle holders (→P.316)
- E** Console box (→P.314)
- F** Cup holders (→P.315)
- G** Coin box (→P.316)
- H** Smartphone holder (→P.314)

**⚠ WARNING**

**■ Items that should not be left in the storage spaces**

Do not leave glasses, lighters or spray cans in the storage spaces, as this may cause the following when cabin temperature becomes high:

- Glasses may be deformed by heat or cracked if they come into contact with other stored items.

- Lighters or spray cans may explode. If they come into contact with other stored items, the lighter may catch fire or the spray can may release gas, causing a fire hazard.

**⚠ WARNING**

■ **When storage compartments are not in use**

When driving or when the storage compartments are not in use, keep the lids closed.

In the event of sudden braking or sudden swerving, an accident may occur due to an occupant being struck by an open lid or the items stored inside.

**Glove box**

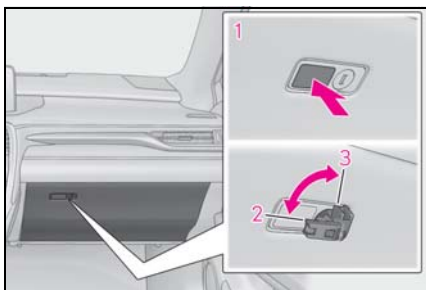

- 1 Open (press the button)
- 2 Unlock with the mechanical key
- 3 Lock with the mechanical key

■ **Glove box light**

The glove box light turns on when the tail lights are on.

**Smartphone holder**



■ **When cleaning the interior**

Remove **A** to clean it.

When installing **A**, engage the left and right claws and then engage the center claw.

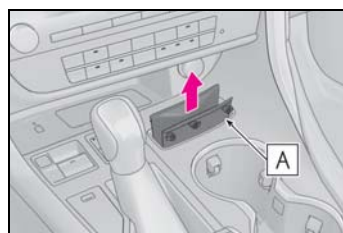

**Console box**

Push the knob.

Lift by hand to fully open the console box.

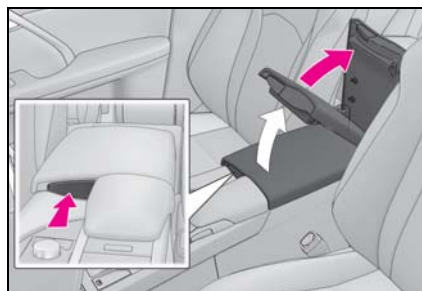

■ **Console box light**

The console box light turns on when the tail lights are on.

■ **Pen holder**

A pen can be stored in the pen holder on the underside of the lid.

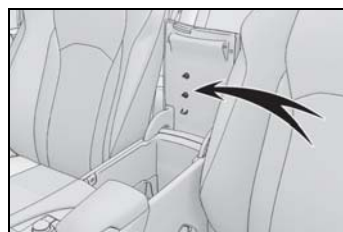

■ **Tray in the console box**

Remove the tray to access a storage space under the tray.

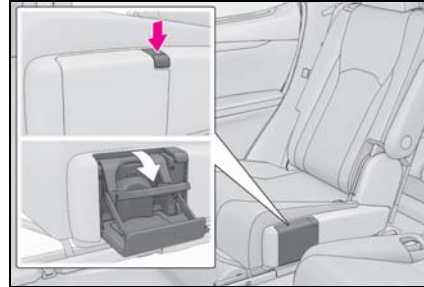
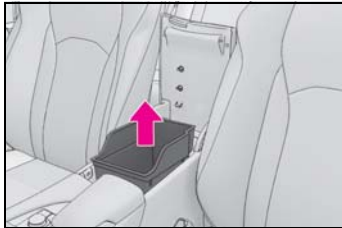

**Cup holders**

► **Front seats**

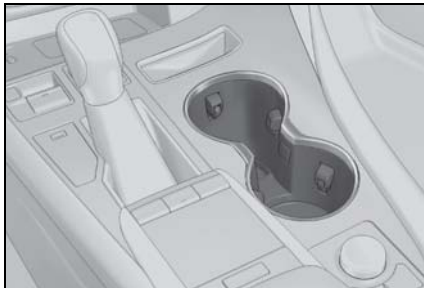

■ **The depth of the front cup holder can be changed.**

- 1 To store a water bottle, push down the bottom of the cup holder.

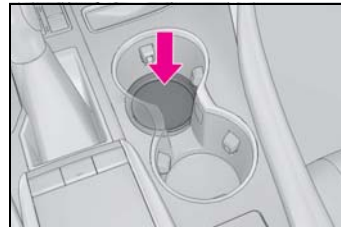

- 2 To return the bottom to its original position, press the button.

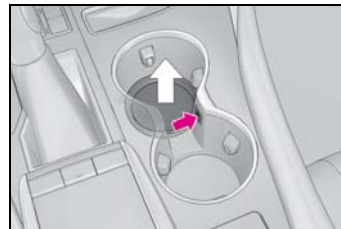

► **Bench-type second-row seats**

Pull down the armrest and then press down the button.

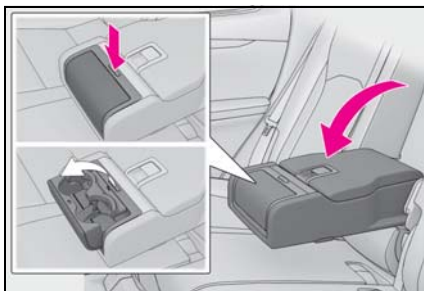

► **Separate-type second-row seats**

Press in the button.

**⚠ WARNING**

■ **Items unsuitable for the cup holder**

- Do not place anything other than cups, aluminum cans, or water bottles in the cup holders. Other items may be thrown out of the holders in the event of an accident or sudden braking, possibly causing injury. If possible, cover hot drinks to prevent burns.
- Rear cup holder: When not in use, keep the cup holders are closed. Injuries may result in the event of an accident or sudden braking.

 **NOTICE**  
■ **To prevent damage to the rear cup holder**  
Stow the cup holder before stowing the armrest.

### Door pockets

► Front

The door pockets can be opened and closed.

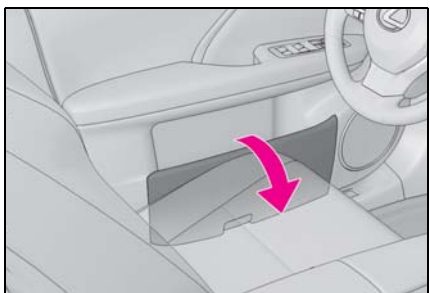

► Rear



 **WARNING**  
■ **Caution while driving**  
Front door pockets: Keep the door pockets closed while driving. Injuries may result in the event of an accident or sudden braking.

### Bottle holders

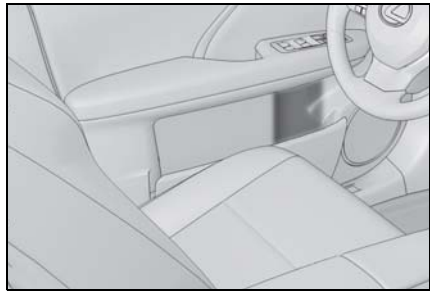

- **Bottle holders**
- When storing a bottle, close the cap.
  - The bottle may not be stored depending on its size or shape.

 **NOTICE**  
■ **Items unsuitable for the bottle holders**  
Do not place open bottle, glass or paper cups containing liquid in the bottle holders. Otherwise, contained liquid may be spilled. Glass cups may break if used in the bottle holders.

### Coin box

Press in the button.

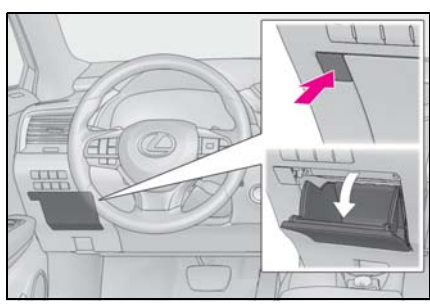

**⚠ WARNING**

■ **Caution while driving**  
 Keep the coin box closed while driving. Injuries may result in the event of an accident or sudden braking.

**Auxiliary boxes**

- ▶ Type A  
 Press in the lid.

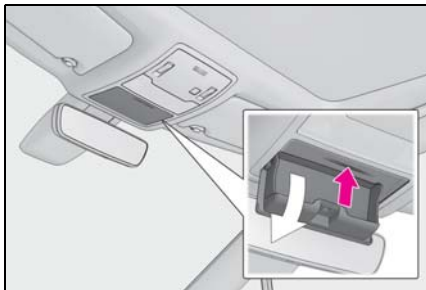

- ▶ Type B (if equipped)  
 Pull up the lever to release the lock, and lift the lid.

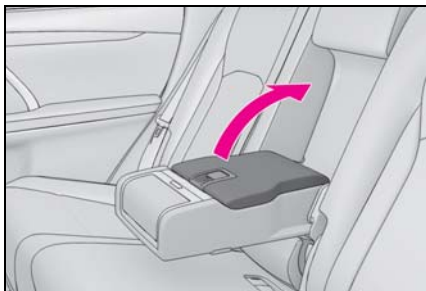

**⚠ WARNING**

■ **Items unsuitable for storing (Type A)**  
 Do not store items heavier than 0.44 lb. (200 g). Doing so may cause the auxiliary box to open and the items inside may fall out, resulting in an accident.

**Luggage compartment features**

**Cargo hooks**

Pull down the hook to use.  
 The cargo hooks are provided for securing loose items.

- ▶ RX350

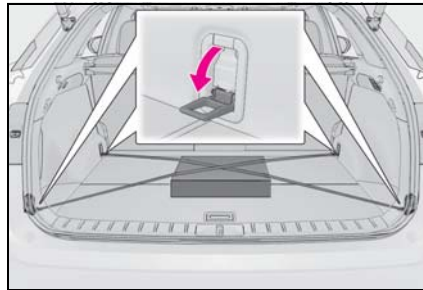

- ▶ RX350L

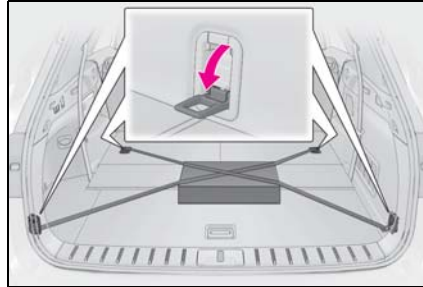

**⚠ WARNING**

■ **When cargo hooks are not in use**  
 To avoid injury, always return the hooks to their stowed positions when not in use.

**Cargo net hooks**

To hang the cargo net, use the cargo net hooks and rear cargo hooks.

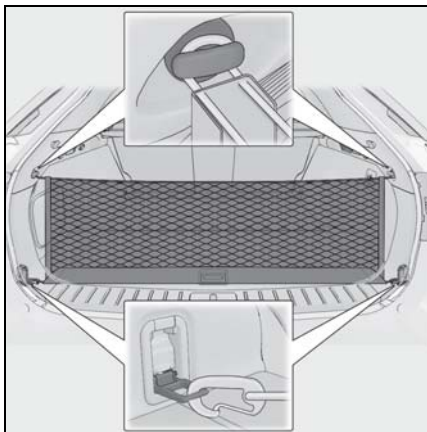

**⚠ WARNING**  
**■ When the cargo net is not in use**  
 To avoid injury, always return the hooks to their stowed positions when not in use.

**Grocery bag hooks**

To use the grocery bag hook, push it in.  
 ▶ RX350

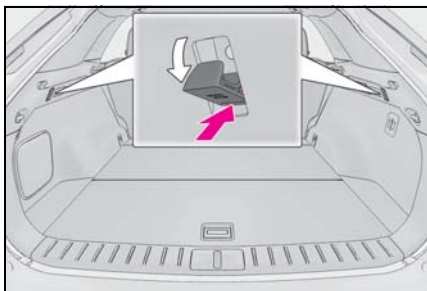

▶ RX350L

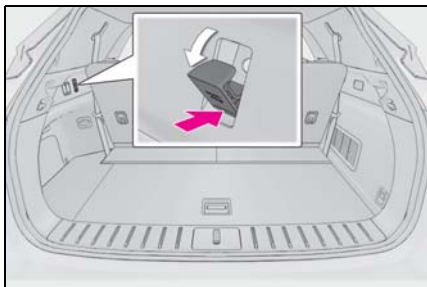

**⚠ NOTICE**  
**■ To prevent damage to the grocery bag hooks**  
 Do not hang any object heavier than 8.8 lb. (4 kg) on the grocery bag hooks.

**Luggage cover**

**■ Removing the luggage cover unit (RX350L)**

Remove the deck board and side auxiliary box cover and take out the luggage cover unit. (→P.319)

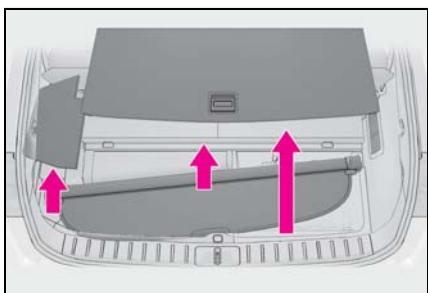

**■ Using the luggage cover**

RX350L: Before installing the luggage cover, fold down the third-row seats. (→P.122)

- 1 Insert either end of the luggage cover into the recess, then com-

press the other end of the luggage cover and insert it into the recess.

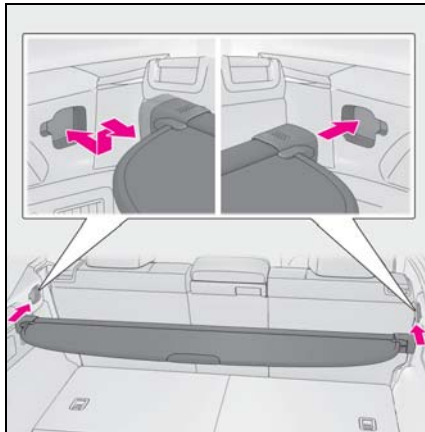

- 2 Pull out the luggage cover and hook it onto the anchors.

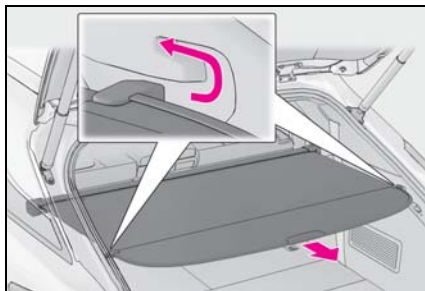

**■ Removing the luggage cover**

- 1 Release the cover from the left and right anchors and allow it to retract.

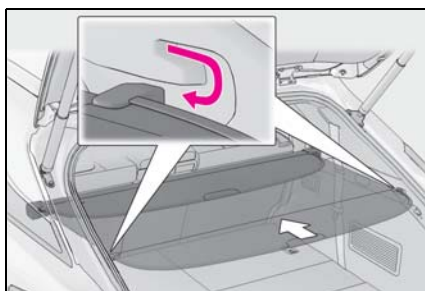

- 2 Compress the end of the luggage cover and lift the luggage cover up.

RX350: After removing the luggage cover, place it somewhere other than the passenger compartment.

RX350L: Stow the luggage cover under the deck board and side auxiliary box cover.

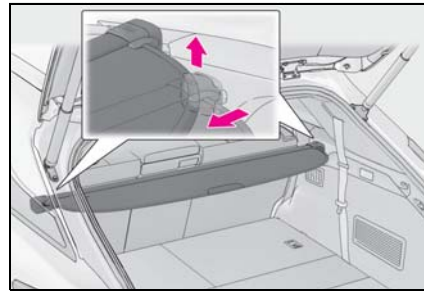

**⚠ WARNING**

**■ Luggage cover**

- Do not place anything on the luggage cover. In the event of sudden braking or turning, the item may go flying and strike an occupant. This could lead to an unexpected accident, resulting in death or serious injury.
- Do not allow children to climb on the luggage cover. Climbing on the luggage cover could result in damage to the luggage cover, possibly causing death or serious injury to the child.

**Auxiliary boxes (RX350)**

- 1 Pull the lever up and fold the flap of the deck board.

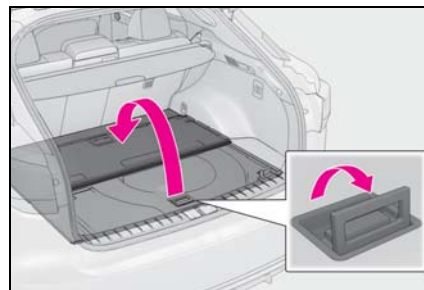

- 2 Lift the deck board and disengage the hook on the underside of the deck board.

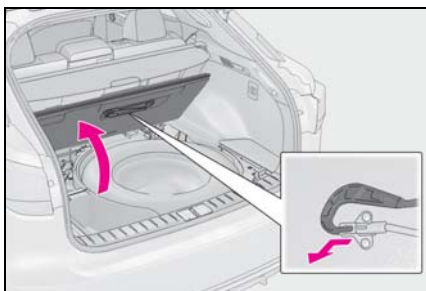

- 3 Attach the hook to the upper edge of the back door opening as shown.

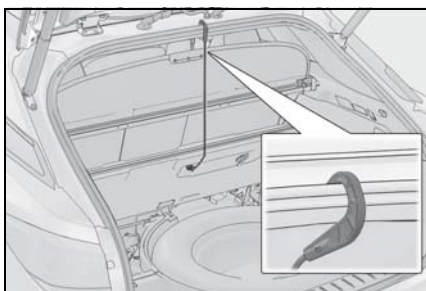

► Deck floor box

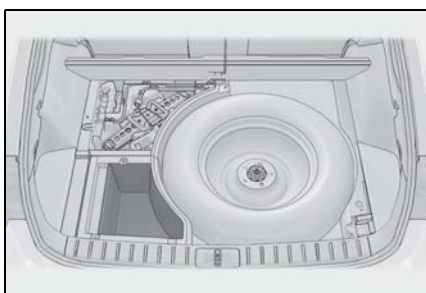

► Deck side box

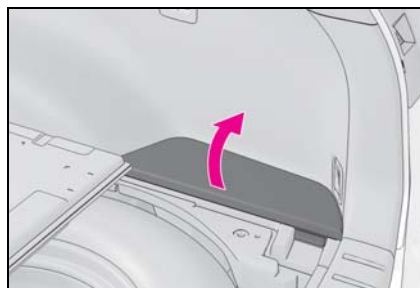

**⚠ WARNING**

- If the deck board is folded or removed

Return it to its original position before driving. In the event of sudden braking, an accident may occur due to an occupant being struck by the deck board or the items stored in the deck under tray.

**⚠ NOTICE**

- When closing the back door

Do not leave the deck board hook hooked on the edge of the back door opening. The deck board hook may get damaged.

**Auxiliary boxes (RX350L)**

- 1 Pull up the lever, lift the deck board and pull out the hook from the underside of the deck board.

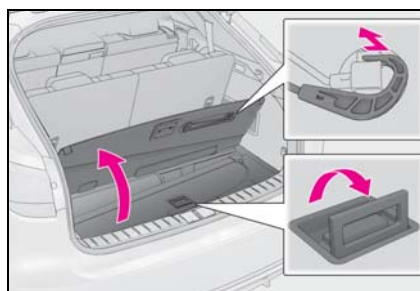



2 Attach the hook to the upper edge of the back door opening as shown.

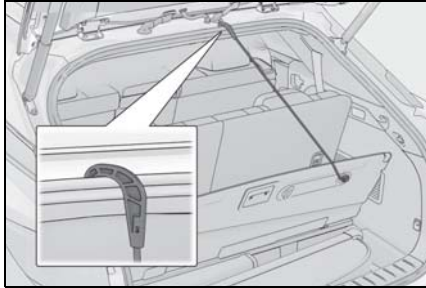

▶ Deck floor box (if equipped)

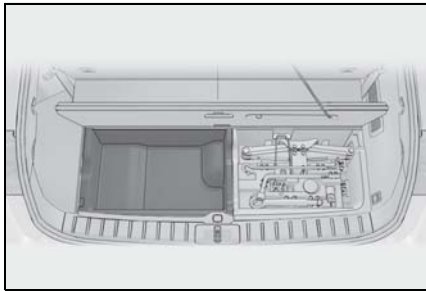

▶ Side auxiliary box

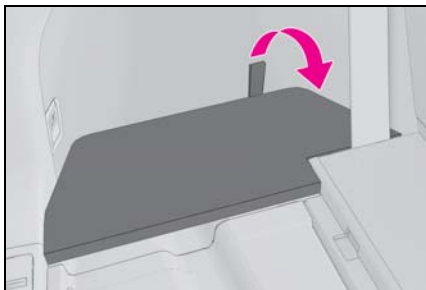

**⚠ WARNING**

■ If the deck board is folded or removed

Return it to its original position before driving. In the event of sudden braking, an accident may occur due to an occupant being struck by the deck board or the items stored in the deck under tray.

■ When installing the deck side box and side auxiliary box cover

Make sure that the third-row seat seatbelt is positioned correctly. If the seatbelt is positioned incorrectly, the seatbelt may be damaged when a passenger uses the seatbelt. Also, in the case of sudden braking, the side auxiliary box cover may come off and things stored in the deck side box may fly about and strike an occupant, possibly resulting in death or serious injury.

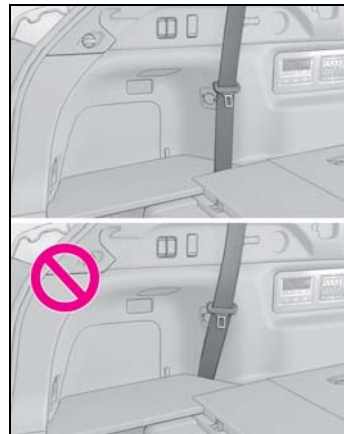

**⚠ NOTICE**

■ When closing the back door

Do not leave the deck board hook hooked on the edge of the back door opening. The deck board hook may get damaged.

## Other interior features

### USB charging ports

The USB charging ports are used to supply 2.1 A of electricity at 5 V to external devices.

The USB charging ports are for charging only. They are not designed for data transfer or other purposes. Depending on the external device, it may not charge properly. Refer to the manual included with the device before using a USB charging port.

#### ■ Using the USB charging ports

- ▶ On the instrument panel



- ▶ On the rear console

Open the lid.

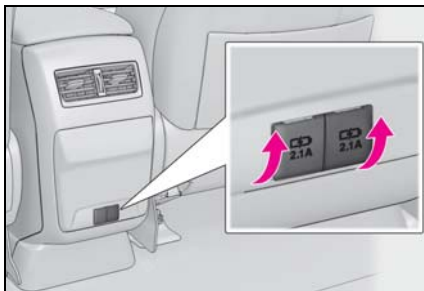

- ▶ Armrest (RX350L with bench-type second-row seats)



#### ■ The USB charging ports can be used when

The engine switch is in ACCESSORY or IGNITION ON mode.

#### ■ Situations in which the USB charging ports may not operate correctly

- If a device which consumes more than 2.1 A at 5 V is connected
- If a device designed to communicate with a personal computer, such as a USB memory device, is connected
- If the connected external device is turned off (depending on device)
- If the temperature inside the vehicle is high, such as after the vehicle has been parked in the sun

#### ■ About connected external devices

Depending on the connected external device, charging may occasionally be suspended and then start again. This is not a malfunction.

#### ⚠ NOTICE

##### ■ To prevent damage to the USB charging ports

- Do not insert foreign objects into the ports.
- Do not spill water or other liquids into the ports.

 NOTICE

- Rear console: When the USB charging ports are not in use, close the lids. If a foreign object or liquid enters a port may cause a short circuit.
- Do not apply excessive force to or impact the USB charging ports.
- Do not disassemble or modify the USB charging ports.
- **To prevent damage to external devices**
  - Do not leave external devices in the vehicle. The temperature inside the vehicle may become high, resulting in damage to an external device.
  - Do not push down on or apply unnecessary force to an external device or the cable of an external device while it is connected.
- **To prevent battery discharge**

Do not use the USB charging ports for a long period of time with the engine stopped.

### Wireless charger (if equipped)

A portable device, such as a smartphone or mobile battery, can be charged by just placing it on the charging area, provided the device is compatible with the Qi wireless charging standard created by the Wireless Power Consortium.

The wireless charger cannot be used with a portable device that is larger than the charging area. Additionally, depending on the portable device, the wireless charger may not operate properly. Refer to the operation manual of the portable device.

### ■ The “Qi” symbol

The “Qi” symbol is a trademark of the Wireless Power Consortium.



### ■ Name for all parts

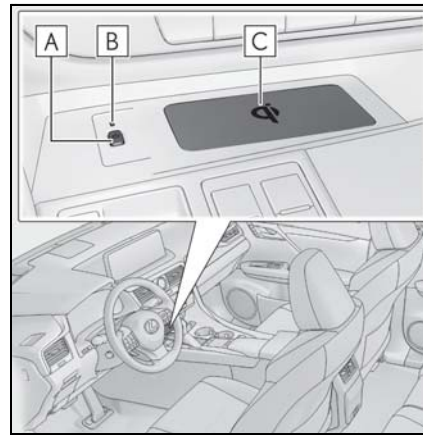

- A** Power supply switch
- B** Operation indicator light
- C** Charge area

### ■ Using the wireless charger

- 1 Press the power supply switch of the wireless charger.

Pressing the switch again turns the wireless charger off.

When turned on, the operation indicator light (green) comes on.

When the engine switch is turned off, the on/off state of the wireless charger will be

memorized.



- Place a portable device on the charging area with its charging surface facing down.

While charging, the operation indicator light (orange) will be illuminated.

If charging does not begin, move the portable device as close to the center of the charging area as possible.

When charging is complete, the operation indicator light (green) will illuminate.

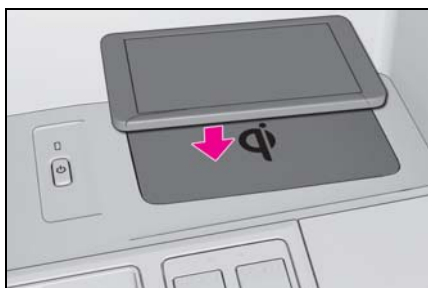

#### ■ Recharging function

- If a certain amount of time has elapsed since charging completed and the portable device has not been moved, the wireless charger will restart charging.
- If the portable device is moved within the charging area, charging will stop temporarily then restart.

#### ■ Operation indicator light status

Operation indicator light	State
Off	The Wireless charger is off
Green (illuminated)	Standby (charging is possible)
	Charging is complete*
Orange (illuminated)	A portable device has been placed on the charging area (identifying the portable device)
	Charging in progress

\*: Depending on the portable device, the operation indicator light may stay illuminated (orange) after charging has completed.

#### ■ If the operation indicator light blinks

If an error is detected, the operation indicator light will blink (orange). Take the appropriate measures according to the table below.

- Blinks (orange) at a one second interval continuously

Suspected causes	Measure
Vehicle to charger communication failure.	Contact your Lexus dealer.

- Blinks (orange) 3 times repeatedly

Suspected causes	Measure
A foreign object exists between the portable device and charging area.	Remove the foreign object.
Portable device is not positioned properly on the charging area.	Move the portable device toward the center of the charging area.

- Blinks (orange) 4 times repeatedly

Suspected causes	Measure
The temperature of the wireless charger is excessively high.	Stop charging immediately and continue charging after a while.

■ **The wireless charger can be operated when**

The engine switch is in ACCESSORY or IGNITION ON mode.

■ **Portable devices that can be charged**

- Portable devices compatible with the Qi wireless charging standard can be charged by the wireless charger. However, compatibility with all devices which meet the Qi wireless charging standard is not guaranteed.
- The wireless charger is designed to supply low power electricity (5 W or less) to a cellular phone, smartphone, or other portable device.

■ **If a cover or accessory is attached to the portable device**

Do not charge a portable device if a cover or accessory which is not Qi compatible is attached. Depending on the type of cover and/or accessory attached, it may not be possible to charge the portable device. If the portable device is placed on the charging area and does not charge, remove the cover and/or accessories.

■ **If interference is heard in AM radio broadcasts while charging**

Turn off the wireless charger and check if the noise is reduced. If noise is reduced, press and hold the power supply switch of the wireless charger for 2 seconds. The frequency of the wireless charger is changed and noise may be reduced. When the frequency is changed, the operation indicator light will blink (orange) 2 times.

■ **Charging precautions**

- If the electronic key cannot be detected in the cabin, charging cannot be performed. When a door is opened and closed, charging may be temporarily suspended.
- While charging, the wireless charger and the portable device will become warm. This is not a malfunction. If a portable device becomes warm while charging and charging stops due to the protection function of the portable device, wait until the portable device cools down and charge it again.

■ **Sound generated during operation**

When the power supply switch is turned on or while a portable device is being identified, operation sounds may be heard. This is not a malfunction.

■ **Cleaning the wireless charger**

→P.347

■ Certification for the wireless charger

FCC Provided Information:

This equipment has been tested and found to comply with Part 18 of the FCC Rules. These limits are designed to provide reasonable protection against harmful interference in a residential installation. Any changes or modifications not expressly approved by the party responsible for compliance could void the user's authority to operate this equipment.

This device complies with Part 18 of the FCC Rules. Operation is subject to the following two conditions:

(1) This device may not cause harmful interference, and (2) this device must accept any interference received, including interference that may cause undesired operation.

Declaration of Conformity

Trade Name: Panasonic  
Model Numbers: AT1701 contains CA-QS03J1AJ  
Responsible Party: Panasonic Corporation of North America  
Two Riverfront Plaza, Newark, NJ 07102-5490  
Support Contact: <http://shop.panasonic.com/support/>



PRODUCT SAFETY AND COMPLIANCE DEPARTMENT . PANASONIC CORPORATION OF NORTH AMERICA . TWO RIVERFRONT PLAZA, 9<sup>TH</sup> FLOOR, NEWARK, NJ 07102-5490

### FCC Declaration of Conformity Summary

Product Name	In-Vehicle Wireless Charger	
Model Number	AT1701	
Brand Name	Panasonic	
Size and Mass	<ul style="list-style-type: none"> <li>245mm (w), 136mm (l) and 48mm (h) and mass is 515grams</li> </ul>	
Purpose Updated DoC	Added similarity variant model/ AT1701 contains CA-QS03J1AJ	
Compliance Information	<ul style="list-style-type: none"> <li>47 CFR, FCC Part 18, Subpart C for ISM Equipment FCC's KDB 680106 D01 RF Exposure Wireless Charging Apps v02</li> <li>Industry Canada RSS-216, Issue 1, dated August 2014 For Wireless Power Transfer Devices (Wireless Chargers)</li> </ul>	
Responsible Applicant	Panasonic Corporation Automotive & Industrial Systems Company Automotive Infotainment Systems Business Division 4261, Ikonobe-cho, Tsuzuki-ku, Yokohama-shi, 224-8520, Japan	
Responsible Factories	<ul style="list-style-type: none"> <li>Panasonic Corporation, Automotive &amp; Industrial Systems Company                              Automotive Infotainment / Systems Business Division                              Global Manufacturing Innovation Center, Matsumoto Factory                              5652 Sasaga, Matsumoto city, Nagano 399-8730, Japan</li> <li>Panasonic Automotive Systems Czech, s.r.o.                              U Panasonicu 266, 530 06 Pardubice-Stare Covice, Czech Republic</li> <li>Panasonic Automotive Systems Asia Pacific (Thailand) Co.,Ltd.                              101 Moo 2 Teprarak Road, T.Bangsaothong Ging A.Bangsaothong Samutprakarn 10540 Thailand</li> <li>Panasonic Automotive Systems Dalian Co., Ltd.                              No.300, HongGang Road, GanJingZi District, Dalian, Liaoning Province, 116033 China</li> </ul>	
Responsible Sales Company	Panasonic Consumer Electronics Company Division of Panasonic Corporation of North America Two Riverfront Plaza, Newark, NJ 07102-5490 General Contact: <a href="http://shop.panasonic.com/support">http://shop.panasonic.com/support</a>	
Special Conditions For Compliance	In-Vehicle Wireless Charger will be installed and used exclusively within transportation vehicle and as such, it is exempt from the following requirements: (1) Part 15 digital device technical rules in accordance with §15.103(a); and (2) §15.105(b) full text information to user to appear in User Manual in accordance with §18.213.	
EMI Test Report	TCB	UL Japan
	Test Report	10120384-R2
	Model Tested	AT1701 contains CA-QS03J1AJ
	Date Issued	12/14/2015
	Methodology	FCC-OET MP-4



PRODUCT SAFETY AND COMPLIANCE DEPARTMENT . PANASONIC CORPORATION OF NORTH AMERICA . TWO RIVERFRONT PLAZA, 9<sup>TH</sup> FLOOR, NEWARK, NJ 07102-5490



PRODUCT SAFETY AND COMPLIANCE DEPARTMENT . PANASONIC CORPORATION OF NORTH AMERICA . TWO RIVERFRONT PLAZA, 9<sup>TH</sup> FLOOR, NEWARK, NJ 07102-5499

## FCC Declaration of Conformity Summary

RF Exposure Evaluation	TCB	UL Japan
	MPE	10197157S-E-R1
	Test Report	
	Model Tested	AT1701 contains CA-QS03J1AJ
	Date Issued	12/14/2015
	Methodology	KDB 680106 D01 RF Exposure Wireless Charging Apps v02
Importation	The subject In-Vehicle Wireless Charger can be imported on behalf of Panasonic affiliated sales companies by PNA's Logistics Import Customs, or their authored brokers, by electrically filing FCC Form 740 while declaring Box 2 with no reference to any FCC ID.	

This DoC is granted for the subject In-Vehicle Wireless Charger on the basis of the manufacturer's attested compliance with the above described conditions and in accordance with FCC Part 18 and FCC's KDB 0680106 D01 RF Exposure Wireless Charging Apps v02.

Certificate Number: DoC 2014-008C  
Applicant Ref No.: PAS-16-F001

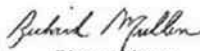
  
 Issued by: Richard Mullen  
 Issue Date: January 14, 2016

PRODUCT SAFETY AND COMPLIANCE DEPARTMENT . PANASONIC CORPORATION OF NORTH AMERICA . TWO RIVERFRONT PLAZA, 9<sup>TH</sup> FLOOR, NEWARK, NJ 07102-5499



**WARNING****■ Caution while driving**

When charging a portable device while driving, for safety reasons, the driver should not operate the portable device.

**■ Caution regarding interference with electronic devices**

People with implantable cardiac pacemakers, cardiac resynchronization therapy pacemakers or implantable cardioverter defibrillators, as well as any other electrical medical device, should consult their physician about the usage of the wireless charger.

Operations of the wireless charger may have an affect on medical devices.

**■ To prevent damage or burns**

Observe the following precautions.

Failure to do so may result in the possibility of fire, equipment failure or damage, or burns due to heat.

- Do not put any metallic objects between the charging area and the portable device while charging.
- Do not attach metallic objects, such as aluminum stickers, to the charging area.
- Do not cover the wireless charger with a cloth or other object while charging.
- Do not attempt to charge portable devices which are not compatible with the Qi wireless charging standard.
- Do not disassemble, modify or remove the wireless charger.
- Do not apply force or impact to the wireless charger.

**NOTICE****■ Conditions in which the wireless charger may not operate correctly**

In the following situations, the wireless charger may not operate correctly:

- When a portable device is fully charged
- When there is a foreign object between the charging area and portable device
- When a portable device becomes hot while charging
- When a portable device is placed on the wireless area with its charging surface facing up
- When a portable device is not centered on the charging area
- When the vehicle is near a TV tower, electric power plant, gas station, radio station, large display, airport or other facility that generates strong radio waves or electrical noise
- When the portable device is in contact with, or is covered by any of the following metallic objects:
  - Cards to which aluminum foil is attached
  - Cigarette boxes that have aluminum foil inside
  - Metallic wallets or bags
  - Coins
  - Metal hand warmers
  - Media such as CDs and DVDs
- When wireless keys (that emit radio waves) other than those of your vehicle are being used nearby.

If in situations other than above the wireless charger does not operate properly or the operation indicator light is blinking, the wireless charger may be malfunctioning. Contact your Lexus dealer.

 NOTICE

■ **To prevent failure or damage to data**

- Do not bring magnetic cards, such as a credit card, or magnetic recording media, close to the wireless charger while charging. Otherwise, data may be erased due to the influence of magnetism. Additionally, do not bring precision instruments such as wrist watches, close to the wireless charger, as such objects may malfunction.
- Do not leave portable devices in the cabin. The temperature inside the cabin may become high when parked in the sun, and cause damage to the device.

■ **To prevent battery discharge**

Do not use the wireless charger for a long period of time with the engine is stopped.

### Armrest

- ▶ RX350/RX350L with bench-type second-row seats

Pull the armrest down for use.



- ▶ RX350L with separate-type second-row seats

To adjust the armrest angle, raise the armrest to the highest position and then lower the armrest to the lowest position.

Raise the armrest again to the desired

position and the armrest will be locked at that position.

When the armrest is locked, the armrest cannot be lowered.

To lower the armrest, raise the armrest to the highest position again.

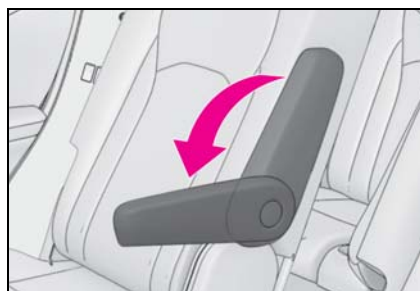

 NOTICE

■ **To prevent damage to the armrest**

Do not apply too much load on the armrest.

### Assist grips

An assist grip installed on the ceiling can be used to support your body while sitting on the seat.

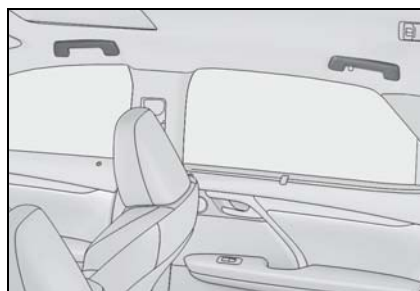

 WARNING

■ **Assist grip**

Do not use the assist grip when getting in or out of the vehicle or rising from your seat.

**NOTICE****■ To prevent damage to the assist grip**

Do not hang any heavy object or put a heavy load on the assist grip.

**Coat hooks**

The coat hooks are provided with the rear assist grips.

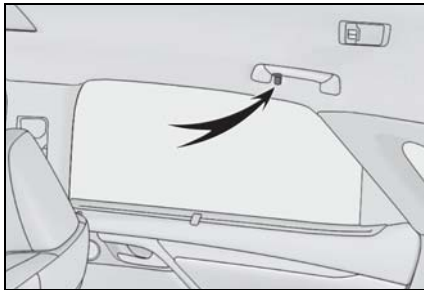
**WARNING****■ Items that must not be hung on the hook**

Do not hang coat hangers or other hard or sharp objects on the hook. If the SRS curtain shield airbags deploy, these items may become projectiles, causing death or serious injury.

**Clock**

The GPS clock's time is automatically adjusted by utilizing GPS time information.

For details, refer to "NAVIGATION AND MULTIMEDIA SYSTEM OWNER'S MANUAL".

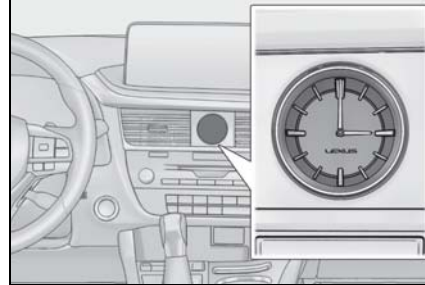
**Power outlets**

Please use as a power supply for electronic goods that use less than 12 VDC/10 A (power consumption of 120 W).

Observe the following when using electronic goods:

- Make sure that the power consumption of all the connected power outlets on the instrument panel and in the luggage compartment is less than 120 W.
- Make sure that the power consumption of all the connected power outlets inside the console box is less than 120 W.

- ▶ On the instrument panel

Remove the cap.

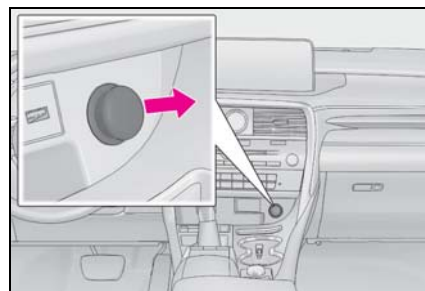

- ▶ Inside the console box

Open the lid.

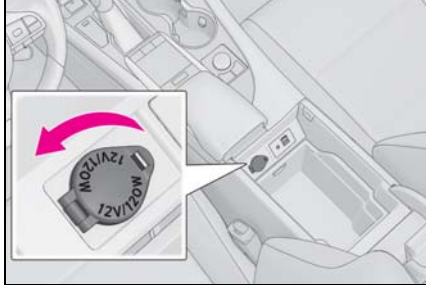

- ▶ In the luggage compartment (RX350)

Open the lid.

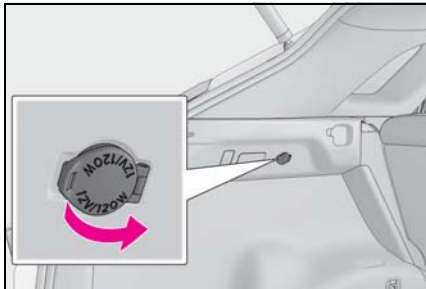

- ▶ In the luggage compartment (RX350L)

Open the lid.

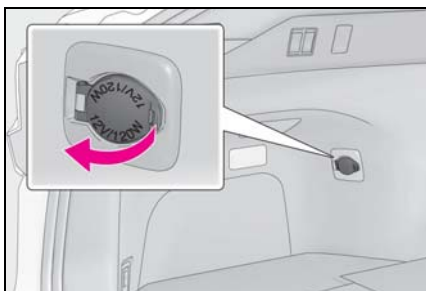

#### ■ The power outlet can be used when

The engine switch is in ACCESSORY or IGNITION ON mode.

#### ■ Using the power outlet

The shape of the console box rim allows power cables to be passed through when the console box lid is closed.

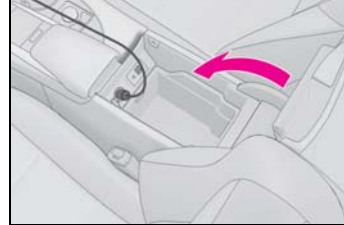

#### ■ When turning the engine switch off

Disconnect electrical devices with charging functions, such as mobile battery packs. If such devices are left connected, the engine switch may not be turned off normally.

#### ⚠ NOTICE

##### ■ To avoid damaging the power outlet

Install the cap or close the lid when the power outlets is not in use.

Foreign objects or liquids that enter the power outlet may cause a short circuit.

##### ■ To prevent the battery from being discharged

Do not use the power outlet longer than necessary when the engine is not running.

#### Sun visors

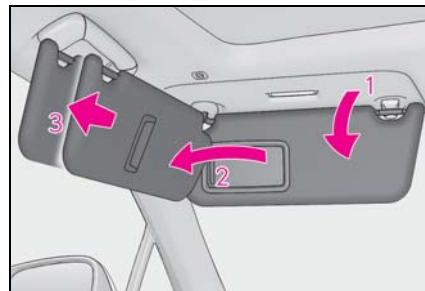

- 1 To set the visor in the forward position, flip it down.

- 2 To set the visor in the side position, flip down, unhook, and swing it to the side.

- 3 To use the side extender, place the visor in the side position, then slide it backward.

**Vanity mirrors**

Slide the cover to open.

The light turns on when the cover is opened.

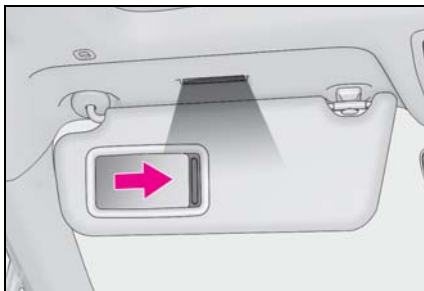

**To prevent battery discharge**

If the vanity lights remain on when the engine switch is turned off, the lights will go off automatically after 20 minutes.

**NOTICE**

**To prevent the battery from being discharged**

Do not leave the vanity lights on for extended periods while the engine is off.

**Front passenger footwell hooks**

Use the front passenger footwell hooks to help support and prevent objects placed on the floor, such as a grocery bag, from overturning.

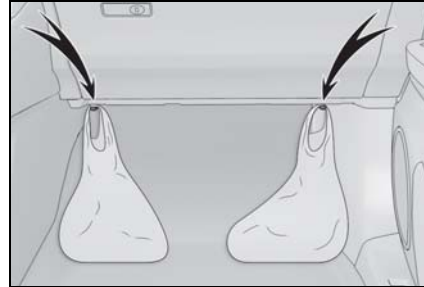

**NOTICE**

**To prevent damage to the hooks**

Do not hang anything from a hook or apply excessive force to it.

**Rear door sunshades (if equipped)**

Pull the sunshade up using the tab and hook the sunshade on to the anchors.

To lower the sunshade, pull it up slightly using the tab, unhook it from the anchors, and lower it slowly.

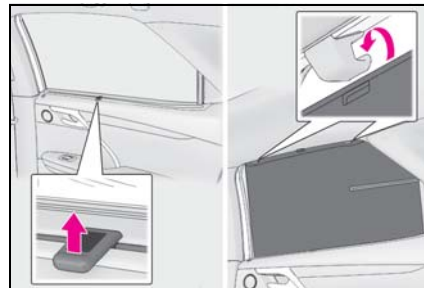

**WARNING**

**Closing the rear door sunshade**

When a rear door sunshade is in use, do not put fingers, etc. on the anchors or in the groove of the rear door sunshade. Otherwise, a finger, etc. may get caught, possibly causing an injury.

**NOTICE**

- **To ensure normal operation of the sunshade**
- Do not put anything in an area where it may interfere with the operation of a rear door sunshade.
- To prevent damage to the rear door sunshades, do not apply excessive load or attach items to the rear door sunshades.

## Garage door opener

The garage door opener can be programmed using the HomeLink<sup>®</sup> to operate garage doors, gates, entry doors, door locks, home lighting systems, security systems, and other devices.

## System components

The HomeLink<sup>®</sup> wireless control system in your vehicle has 3 buttons which can be programmed to operate 3 different devices. Refer to the programming methods on the following pages to determine the method which is appropriate for the device.

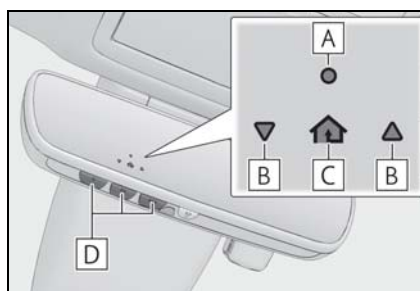

- A** HomeLink<sup>®</sup> indicator light
  - B** Garage door operation indicators
  - C** HomeLink<sup>®</sup> icon
- Illuminates while HomeLink<sup>®</sup> is operating.
- D** Buttons

### ■ Codes stored in the HomeLink<sup>®</sup> memory

- The registered codes are not erased even if the battery cable is disconnected.
- If learning failed when registering a dif-

ferent code to a HomeLink® button that already has a code registered to it, the already registered code will not be erased.

■ **Certification for the garage door opener**

► **Except for vehicles sold in Canada**

This device complies with FCC rules part 15 and Innovation, Science, and Economic Development Canada RSS-210. Operation is subject to the following two conditions: (1) This device may not cause harmful interference, and (2) This device must accept any interference that may be received including interference that may cause undesired operation. **WARNING:** The transmitter has been tested and complies with FCC and ISSED rules. Changes or modifications not expressly approved by the party responsible for compliance could void the user's authority to operate the device.

This equipment complies with FCC and ISSED radiation exposure limits set forth for an uncontrolled environment. End Users must follow the specific operating instructions for satisfying RF exposure compliance. This transmitter must be at least 20 cm from the user and must not be co-located or operating in conjunction with any other antenna or transmitter.

► **For vehicles sold in Canada**

This device complies with FCC rules part 15 and Innovation, Science, and Economic Development Canada RSS-210. Operation is subject to the following two conditions: (1) This device may not cause harmful interference, and (2) This device must accept any interference that may be received including interference that may cause undesired operation. **WARNING:** The transmitter has been tested and complies with FCC and ISSED rules. Changes or modifications not expressly approved by the party responsible for compliance could void the user's authority to operate the device.

This equipment complies with FCC and ISSED radiation exposure limits set forth for an uncontrolled environment. End Users must follow the specific operating instructions for satisfying RF exposure compliance. This transmitter must be at least 20 cm from the user and must not be co-located or operating in conjunction with any other antenna or transmitter.

Cet appareil est conforme aux règlements de la FCC, section 15, et au CNR-210 d'Innovation, Sciences et Développement économique Canada. Le fonctionnement est assujéti aux deux conditions suivantes : (1) cet appareil ne doit pas causer d'interférences nuisibles et (2) cet appareil doit accepter toute interférence reçue, y compris celle qui pourrait entraîner un dysfonctionnement. **MISE EN GARDE :** L'émetteur a subi des tests et est conforme aux règlements de la FCC et d'ISDE. Les changements ou modifications non approuvés explicitement par la partie responsable de la conformité pourraient rendre caduque l'autorisation de l'utilisateur de se servir du dispositif.

Cet appareil est conforme aux limites d'exposition aux radiations de la FCC et d'ISDE établies pour un environnement non contrôlé. Les utilisateurs finaux doivent respecter les instructions d'utilisation spécifiques pour satisfaire aux exigences de conformité aux expositions de RF. L'émetteur doit se trouver à 20 cm au minimum de l'utilisateur et ne doit pas être situé au même endroit que tout autre émetteur ou antenne ni fonctionner avec un autre émetteur ou antenne.

■ **When support is necessary**

Visit on the web at [www.homelink.com/lexus](http://www.homelink.com/lexus) or call 1-800-355-3515.

**⚠ WARNING**

■ **When programming a garage door or other remote control device**

The garage door or other device may operate, so ensure people and objects are out of danger to prevent potential harm.

■ **Conforming to federal safety standards**

Do not use the HomeLink® compatible transceiver with any garage door opener or device that lacks safety stop and reverse features as required by federal safety standards.

This includes any garage door that cannot detect an interfering object. A door or device without these features increases the risk of death or serious injury.

**⚠ WARNING****■ When operating or programming HomeLink®**

Never allow a child to operate or play with the HomeLink® buttons.

**Programming the HomeLink®****■ Before programming HomeLink®**

- During programming, it is possible that garage doors, gates, or other devices may operate. For this reason, make sure that people and objects are clear of the garage door or other devices to prevent injury or other potential harm.
- It is recommended that a new battery be placed in the remote control transmitter for more accurate programming.
- Garage door opener motors manufactured after 1995 may be equipped with rolling code protection. If this is the case, you may need a stepladder or other sturdy, safe device to reach the “Learn” or “Smart” button on the garage door opener motor.

**■ Programming HomeLink®**

Steps **1** through **3** must be performed within 60 seconds, otherwise the indicator light will stop flashing and programming will not be able to be completed.

- 1** Press and release the HomeLink® button you want to program and

check that the HomeLink® indicator light flashes (orange).

- 2** Point the remote control transmitter for the device at the rear view mirror, 1 to 3 in. (25 to 75 mm) from the HomeLink® buttons.

Keep the HomeLink® indicator light in view while programming.



- 3** Program a device.

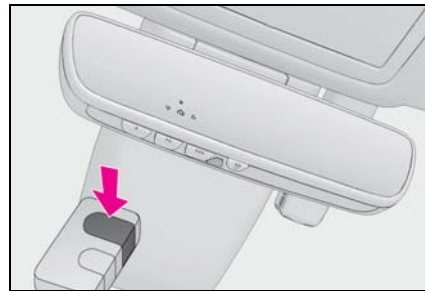

- ▶ Programming a device other than an entry gate (for U.S.A. owners)

Press and hold the handheld transmitter button until the HomeLink® indicator light changes from slowly flashing orange to rapidly flashing green (rolling code) or continuously lit green (fixed code), then release the button.

- ▶ Programming an entry gate (for U.S.A. owners)/Programming a device in the Canadian market

Press and release the remote control



transmitter button at 2 second intervals, repeatedly, until the HomeLink<sup>®</sup> indicator light changes from slowly flashing (orange) to rapidly flashing (green) (rolling code) or continuously lit (green) (fixed code).

**4** Test the HomeLink<sup>®</sup> operation by pressing the newly programmed button and observing the indicator light:

- Indicator light illuminates: Programming of a fixed code device has completed. The garage door or other device should operate when a HomeLink<sup>®</sup> button is pressed and released.
- Indicator light flashes rapidly: The garage door opener motor or other device is equipped with a rolling code. To complete programming, firmly press and hold the HomeLink<sup>®</sup> button for 2 seconds then release it.
- If the garage door or other device does not operate, proceed to “Programming a rolling code system”.

**5** Repeat the steps above to program another device for any of the remaining HomeLink<sup>®</sup> buttons.

■ **Programming a rolling code system**

2 or more people may be necessary to complete rolling code programming.

**1** Locate the “Learn” or “Smart” button on the garage door opener motor in the garage.

This button can usually be found where the

hanging antenna wire is attached to the unit. The name and color of the button may vary by manufacturer. Refer to the owner’s manual supplied with the garage door opener motor for details.

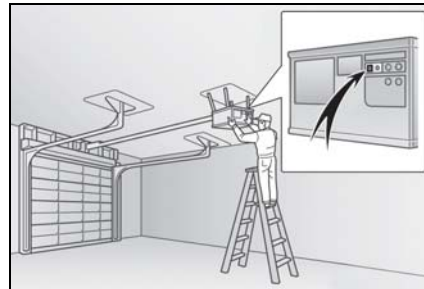

**2** Press and release the “Learn” or “Smart” button. Perform **3** within 30 seconds after performing **2**.

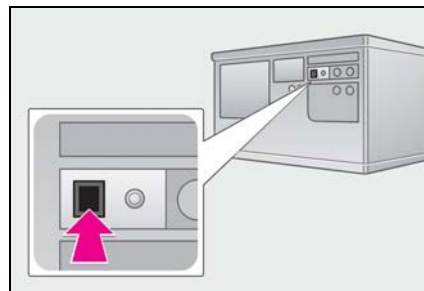

**3** Press and hold the desired HomeLink<sup>®</sup> button (inside the vehicle) for 2 seconds and release it. Repeat this sequence (press/hold/release) up to 3 times to complete programming. If the garage door opener motor operates when the HomeLink<sup>®</sup> button is pressed, the garage door

opener motor recognizes the HomeLink<sup>®</sup> signal.



■ **Enabling 2-way communication with a garage door (only available for compatible devices)**

When enabled, 2-way communication allows you to check the status of the opening and closing of a garage door through indicators in your vehicle.

2-way communication is only available if the garage door opener motor used is a compatible device. (To check device compatibility, refer to [www.homelink.com](http://www.homelink.com).)

- 1 Within 5 seconds after programming the garage door opener has been completed, if the garage door opener motor is trained to HomeLink<sup>®</sup>, both garage door operation indicators will flash rapidly (green) and the light on the garage door opener motor will blink twice, indicating that 2-way communication is enabled.

If the indicators do not flash, perform **2** and **3** within the first 10 presses of the HomeLink<sup>®</sup> button after programming has been completed.

- 2 Press a programmed HomeLink<sup>®</sup> button to operate a garage door.

- 3 Within 1 minute of pressing the HomeLink<sup>®</sup> button, after the garage door operation has stopped, press the “Learn” or “Smart” button on the garage door opener motor. Within 5 seconds of the establishment of 2-way communication with the garage door opener, both garage door operation indicators in the vehicle will flash rapidly (green) and the light on the garage door opener motor will blink twice, indicating that 2-way communication is enabled.

■ **Reprogramming a single HomeLink<sup>®</sup> button**

When the following procedure is performed, buttons which already have devices registered to them can be overwritten:

- 1 With one hand, press and hold the desired HomeLink<sup>®</sup> button.
- 2 When the HomeLink<sup>®</sup> indicator starts flashing (orange), continue to hold the HomeLink<sup>®</sup> button and perform “Programming HomeLink<sup>®</sup>” **1** (it takes 20 seconds for the HomeLink<sup>®</sup> indicator to start flashing).

■ **Before programming**

- Install a new battery in the transmitter.
- The battery side of the transmitter must be pointed away from the HomeLink<sup>®</sup>.

**Operating HomeLink®**

Press the appropriate HomeLink® button. The HomeLink® indicator light should turn on.

The status of the opening and closing of a garage door is shown by the indicators.

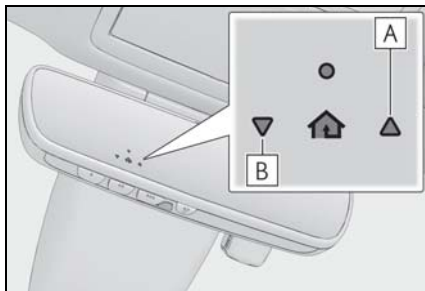

**A** Opening

**B** Closing



This function is only available if the garage door opener motor used is a compatible device. (To check device compatibility, refer to [www.homelink.com](http://www.homelink.com).)

Color	Status
Orange (flashing)	Currently opening/closing
Green	Opening/closing has completed
Red (flashing)	Feedback signals cannot be received

The indicators can operate within approximately 820 ft. (250 m) of the garage door. However, if there are obstructions between the garage door and the vehicle, such as houses and trees, feedback signals from the garage door may not be received.

To recall the previous door operation status, press and release either Home-

Link® buttons  and  or

 and  simultaneously. The last recorded status will be displayed for 3 seconds.

**Erasing the entire HomeLink® memory (all three codes)**

Press and hold the 2 outside buttons for 10 seconds until the HomeLink® indicator light changes from continuously lit (orange) to rapidly flashing (green).

If you sell your vehicle, be sure to erase the programs stored in the HomeLink® memory.



### Compass\*

\*: If equipped

The compass on the inside rear view mirror indicates the direction in which the vehicle is heading.

### Operation and displays

To turn the compass on or off, press and hold the switch for 3 seconds.

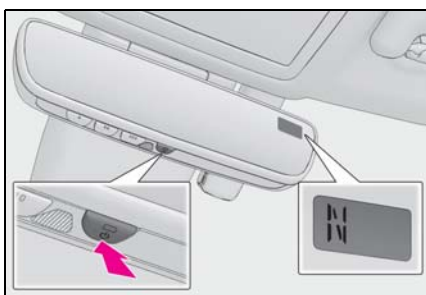

Directions are displayed as follows:

Display	Direction
"N"	North
"NE"	Northeast
"E"	East
"SE"	Southeast
"S"	South
"SW"	Southwest
"W"	West
"NW"	Northwest

### ■ Conditions unfavorable to correct operation

The compass may not show the correct direction in the following conditions:

- The vehicle is stopped immediately after turning.

- The vehicle is on an inclined surface.
- The vehicle is in a place where the earth's magnetic field is subject to interference by artificial magnetic fields (underground car park/parking lot, under a steel tower, between buildings, roof car park/parking lot, near an intersection, near a large vehicle, etc.).
- The vehicle has become magnetized. (There is a magnet or metal object near the inside rear view mirror.)
- The battery has been disconnected.
- A door is open.

### ⚠ WARNING

#### ■ While driving the vehicle

Do not adjust the display. Adjust the display only when the vehicle is stopped.

### ⚠ NOTICE

#### ■ To avoid compass malfunctions

Do not place magnets or any metal objects near the inside rear view mirror. Doing this may cause the compass sensor to malfunction.

#### ■ To ensure normal operation of the compass

- Do not perform a circling calibration of the compass in a place where the earth's magnetic field is subject to interference by artificial magnetic fields.
- During calibration, do not operate electric systems (moon roof, panoramic moon roof, power windows, etc.) as they may interfere with the calibration.

## Calibrating the compass

### ■ Deviation

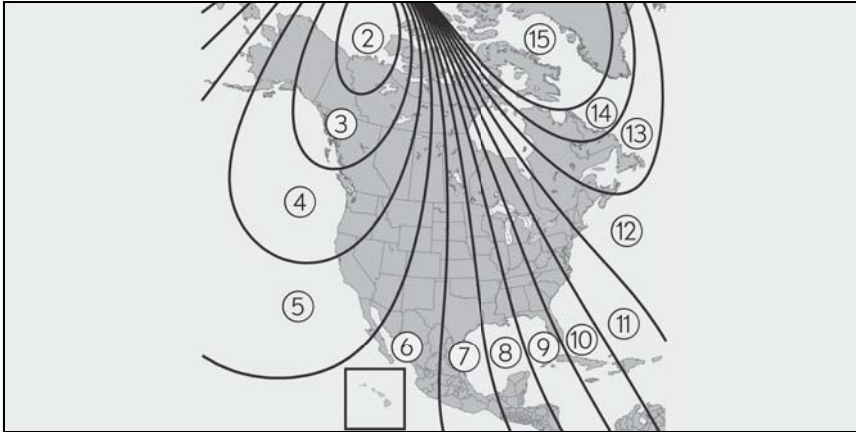

The direction display deviates from the true direction determined by the earth's magnetic field. The amount of deviation varies according to the geographic position of the vehicle.

If you cross over a map boundary shown in illustration, the compass will deviate.

To obtain higher precision or perfect calibration, refer to the following.

### ■ Deviation calibration

- 1 Stop the vehicle.
- 2 Press and hold the switch for 6 seconds. A number (1 to 15) appears on the compass display.

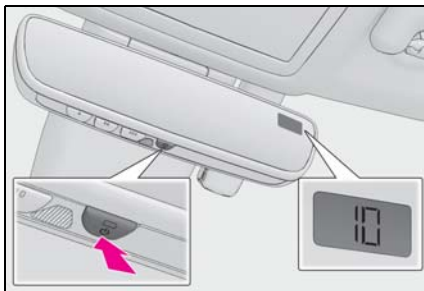

- 3 Press the switch and, referring to the map above, select the number of the zone where you are.

If the direction is displayed several seconds

after adjustment, the calibration is complete.

### ■ Circling calibration

- 1 Stop the vehicle in a place where it is safe to drive in a circle.
- 2 Press and hold the button for 9 seconds.

"C" appears on the compass display.

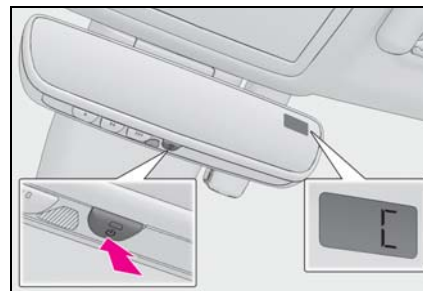

- 3 Drive the vehicle at 5 mph (8 km/h) or less in a circle until a direction is displayed.

If there is not enough space to drive in a circle, drive around the block until a direction is displayed.

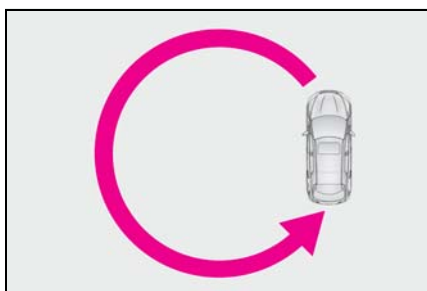

**⚠ WARNING**

■ **When doing the circling calibration**

Secure a wide space, and watch out for people and vehicles in the vicinity. Do not violate any local traffic rules while performing circling calibration.

**6-1. Maintenance and care**

Cleaning and protecting the vehicle exterior ..... **344**

Cleaning and protecting the vehicle interior ..... **347**

**6-2. Maintenance**

Maintenance requirements ..... **350**

General maintenance ..... **351**

Emission inspection and maintenance (I/M) programs ..... **354**

**6-3. Do-it-yourself maintenance**

Do-it-yourself service precautions ..... **355**

Hood..... **357**

Positioning a floor jack..... **357**

Engine compartment..... **359**

Tires ..... **365**

Tire inflation pressure..... **373**

Wheels..... **374**

Air conditioning filter..... **376**

Windshield wiper inserts..... **378**

Electronic key battery ..... **379**

Checking and replacing fuses ..... **381**

Headlight aim..... **382**

Light bulbs..... **384**

## Cleaning and protecting the vehicle exterior

Perform cleaning in a manner appropriate to each component and its material.

### Cleaning instructions

- Working from top to bottom, liberally apply water to the vehicle body, wheel wells and underside of the vehicle to remove any dirt and dust.
- Wash the vehicle body using a sponge or soft cloth, such as a chamois.
- For hard-to-remove marks, use car wash soap and rinse thoroughly with water.
- Wipe away any water.
- Wax the vehicle when the water-proof coating deteriorates.

If water does not bead on a clean surface, apply wax when the vehicle body is cool.

### Self-restoring coat

The vehicle body has a self-restoring coating that is resistant to small surface scratches caused in a car wash etc.

- The coating lasts for 5 to 8 years from when the vehicle is delivered from the plant.
- The restoration time differs depending on the depth of the scratch and outside temperature. The restoration time may become shorter when the coating is warmed by applying warm water.
- Deep scratches caused by keys, coins, etc. cannot be restored.
- Do not use wax that contains abrasives.

### Automatic car washes

- Before washing the vehicle:
  - Fold the mirrors
  - Turn off the power back door

Start washing from the front of the vehicle. Extend the mirrors before driving.

- Brushes used in automatic car washes may scratch the vehicle surface, parts (wheel, etc.) and harm your vehicle's paint.
- Rear spoiler may not be washable in some automatic car washes. There may also be an increased risk of damage to vehicle.

### High pressure car washes

As water may enter the cabin, do not bring the nozzle tip near the gaps around the doors or perimeter of the windows, or spray these areas continuously.

### When using a car wash

If the door handle becomes wet while the electronic key is within the effective range, the door may lock and unlock repeatedly. In that case, follow the following correction procedures to wash the vehicle:

- Place the key in a position 6 ft. (2 m) or more separate from the vehicle while the vehicle is being washed. (Take care to ensure that the key is not stolen.)
- Set the electronic key to battery-saving mode to disable the smart access system with push-button start. (→P.116)

### Wheels and wheel ornaments

- Remove any dirt immediately by using a neutral detergent.
- Wash detergent off with water immediately after use.
- To protect the paint from damage, make sure to observe the following precautions.
  - Do not use acidic, alkaline or abrasive detergent
  - Do not use hard brushes
  - Do not use detergent on the wheels when they are hot, such as after driving or parking in hot weather



### ■ Bumpers

Do not scrub with abrasive cleaners.

### ■ Front side windows water-repellent coating

- The following precautions can extend the effectiveness of the water-repellent coating.
  - Remove any dirt, etc. from the front side windows regularly.
  - Do not allow dirt and dust to accumulate on the windows for a long period. Clean the windows with a soft, damp cloth as soon as possible.
  - Do not use wax or glass cleaners that contain abrasives when cleaning the windows.
  - Do not use any metallic objects to remove condensation build up.
- When the water-repellent performance has become insufficient, the coating can be repaired. Contact your Lexus dealer.

### ■ Plated portions

If dirt cannot be removed, clean the parts as follows:

- Use a soft cloth dampened with an approximately 5% solution of neutral detergent and water to clean the dirt off.
- Wipe the surface with a dry, soft cloth to remove any remaining moisture.
- To remove oily deposits, use alcohol wet wipes or a similar product.



### WARNING

#### ■ When washing the vehicle

Do not apply water to the inside of the engine compartment. Doing so may cause the electrical components, etc. to catch fire.

### ■ When cleaning the windshield (vehicles with rain-sensing windshield wipers)

Set the wiper switch to off. If the switch is in "AUTO", the wipers may operate unexpectedly in the following situations, and may result in hands being caught or other serious injuries and cause damage to the wiper blades.

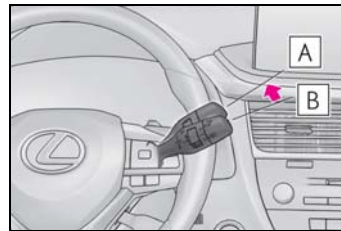

**A** Off

**B** AUTO

- When the upper part of the windshield where the raindrop sensor is located is touched by hand
- When a wet rag or similar is held close to the raindrop sensor
- If something bumps against the windshield
- If you directly touch the raindrop sensor body or if something bumps into the raindrop sensor

### ■ Precautions regarding the exhaust pipes and rear bumper diffusers

Exhaust gasses cause the exhaust pipes and rear bumper diffusers to become quite hot.

When washing the vehicle, be careful not to touch the pipes and diffusers until they have cooled sufficiently, as touching hot exhaust pipes and rear bumper diffusers can cause burns.

### ■ Precaution regarding the rear bumper

If the paint of the rear bumper is chipped or scratched, the following systems may not function correctly. If this occurs, consult your Lexus dealer.

 **WARNING**

- Lexus Safety System + 2.0
- BSM (if equipped)
- RCTA (if equipped)
- PKSB (if equipped)

 **NOTICE**

- **To prevent paint deterioration and corrosion on the body and components (aluminum wheels, etc.)**
  - Wash the vehicle immediately in the following cases:
    - After driving near the sea coast
    - After driving on salted roads
    - If coal tar or tree sap is present on the paint surface
    - If dead insects, insect droppings or bird droppings are present on the paint surface
    - After driving in an area contaminated with soot, oily smoke, mine dust, iron powder or chemical substances
    - If the vehicle becomes heavily soiled with dust or mud
    - If liquids such as benzene and gasoline are spilled on the paint surface
  - If the paint is chipped or scratched, have it repaired immediately.
  - To prevent the wheels from corroding, remove any dirt and store in a place with low humidity when storing the wheels.
- **Cleaning the exterior lights**
  - Wash carefully. Do not use organic substances or scrub with a hard brush. This may damage the surfaces of the lights.

- Do not apply wax to the surfaces of the lights.  
Wax may cause damage to the lenses.

■ **When using an automatic car wash (vehicles with rain-sensing windshield wipers)**

Set the wiper switch to the off position. If the wiper switch is in "AUTO", the wipers may operate and the wiper blades may be damaged.

■ **When using a high pressure car wash**

- When washing the vehicle, do not let water of the high pressure washer hit directly or the vicinity of the camera. Due to the shock from the high pressure water, it is possible the device may not operate as normal.
- Do not bring the nozzle tip close to boots (rubber or resin manufactured cover), connectors or the following parts. The parts may be damaged if they come into contact with high-pressure water.
  - Traction related parts
  - Steering parts
  - Suspension parts
  - Brake parts
- Keep the cleaning nozzle at least 11.9 in. (30 cm) away from the vehicle body. Otherwise resin section, such as moldings and bumpers, may be deformed and damaged.

Also, do not continuously hold the nozzle in the same place.

- Do not spray the lower part of the windshield continuously.

If water enters the air conditioning system intake located near the lower part of the windshield, the air conditioning system may not operate correctly.

- Do not wash the underside of the vehicle using a high pressure car washer.

 NOTICE

- Vehicles with towing package: Do not point the nozzle of a high pressure washer at the areas shown in the illustration, as high pressure water may damage the oil cooler.

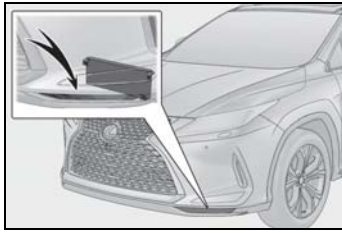

## Cleaning and protecting the vehicle interior

Perform cleaning in a manner appropriate to each component and its material.

### Protecting the vehicle interior

- Remove dirt and dust using a vacuum cleaner. Wipe dirty surfaces with a cloth dampened with lukewarm water.
- If dirt cannot be removed, wipe it off with a soft cloth dampened with neutral detergent diluted to approximately 1%.  
Wring out any excess water from the cloth and thoroughly wipe off remaining traces of detergent and water.

### Shampooing the carpets

There are several commercial foaming-type cleaners available. Use a sponge or brush to apply the foam. Rub in overlapping circles. Do not use water. Wipe dirty surfaces and let them dry. Excellent results are obtained by keeping the carpet as dry as possible.

### Handling the seat belts

Clean with mild soap and lukewarm water using a cloth or sponge. Also check the belts periodically for excessive wear, fraying or cuts.

 WARNING

### Water in the vehicle

- Do not splash or spill liquid in the vehicle.  
Doing so may cause electrical components, etc. to malfunction or catch fire.

**⚠ WARNING**

- Do not get any of the SRS components or wiring in the vehicle interior wet. (→P.30)

An electrical malfunction may cause the airbags to deploy or not function properly, resulting in death or serious injury.

- Vehicles with wireless charger: Do not let the wireless charger (→P.323) get wet. Failure to do so may cause the charger to become hot and cause burns or could cause electric shock resulting in death or serious injury.

■ **Cleaning the interior (especially instrument panel)**

Do not use polish wax or polish cleaner. The instrument panel may reflect off the windshield, obstructing the driver's view and leading to an accident, resulting in death or serious injury.

**⚠ NOTICE**

■ **Cleaning detergents**

- Do not use the following liquids, as they may discolor the vehicle interior or cause streaks or damage to painted surfaces:
  - Center Display: Organic substances such as benzine or gasoline, alkaline solutions, and alcohol
  - Seats: Alkaline solutions, organic substances such as thinner or benzine, and alcohol
  - Other parts: Organic substances such as benzine or gasoline, alkaline or acidic solutions, dye, and bleach
- Do not use polish wax or polish cleaner. The instrument panel's or other interior part's painted surface may be damaged.

■ **Preventing damage to leather surfaces**

Observe the following precautions to avoid damage to and deterioration of leather surfaces:

- Remove any dust or dirt from leather surfaces immediately.
- Do not expose the vehicle to direct sunlight for extended periods of time. Park the vehicle in the shade, especially during summer.
- Do not place items made of vinyl, plastic, or containing wax on the upholstery, as they may stick to the leather surface if the vehicle interior heats up significantly.

■ **Water on the floor**

Do not wash the vehicle floor with water. Vehicle systems such as the audio system may be damaged if water comes into contact with electrical components such as the audio system above or under the floor of the vehicle. Water may also cause the body to rust.

■ **When cleaning the inside of the windshield**

Do not allow glass cleaner to contact the lens. Also, do not touch the lens. (→P.203)

■ **Cleaning the inside of the rear window**

- Do not use glass cleaner to clean the rear window, as this may cause damage to the rear window defogger heater wires or antenna. Use a cloth dampened with lukewarm water to gently wipe the window clean. Wipe the window in strokes running parallel to the heater wires or antenna.
- Be careful not to scratch or damage the heater wires or antenna.

### Cleaning the leather areas

- Remove dirt and dust using a vac-

uum cleaner.

- Wipe off any excess dirt and dust with a soft cloth dampened with diluted detergent.

Use a diluted water solution of approximately 5% neutral wool detergent.

- Wring out any excess water from the cloth and thoroughly wipe off all remaining traces of detergent.
- Wipe the surface with a dry, soft cloth to remove any remaining moisture. Allow the leather to dry in a shaded and ventilated area.

#### ■ Caring for leather areas

Lexus recommends cleaning the interior of the vehicle at least twice a year to maintain the quality of the vehicle's interior.

#### Cleaning the synthetic leather areas

- Remove dirt and dust using a vacuum cleaner.
- Wipe it off with a soft cloth dampened with neutral detergent diluted to approximately 1%.
- Wring out any excess water from the cloth and thoroughly wipe off remaining traces of detergent and water.

## Maintenance requirements

To ensure safe and economical driving, day-to-day care and regular maintenance are essential. It is the owner's responsibility to perform regular checks. Lexus recommends the following maintenance:

### ■ Repair and replacement

It is recommended that genuine Lexus parts be used for repairs to ensure performance of each system. If non-Lexus parts are used in replacement or if a repair shop other than a Lexus dealer performs repairs, confirm the warranty coverage.

### ■ Allow inspection and repairs to be performed by a Lexus dealer

- Lexus technicians are well-trained specialists and are kept up to date with the latest service information. They are well informed about the operation of all systems on your vehicle.
- Keep a copy of the repair order. It proves that the maintenance that has been performed is under warranty coverage. If any problem should arise while your vehicle is under warranty, your Lexus dealer will promptly take care of it.

### ⚠ WARNING

#### ■ If your vehicle is not properly maintained

Improper maintenance could result in serious damage to the vehicle and possible death or serious injury.

#### ■ Handling of the battery

- Engine exhaust, some of its constituents, and a wide variety of automobile components contain or emit chemicals known to the State of California to cause cancer and birth defects and other reproductive harm. Work in a well ventilated area.

- Oils, fuels and fluids contained in vehicles as well as waste produced by component wear contain or emit chemicals known to the State of California to cause cancer and birth defects or other reproductive harm. Avoid exposure and wash any affected area immediately.

- Battery posts, terminals and related accessories contain lead and lead compounds which are known to cause brain damage. Wash your hands after handling. (→P.363)

## General maintenance

General maintenance should be performed on a daily basis. This can be done by yourself or by a Lexus dealer.



## Scheduled maintenance

Scheduled maintenance should be performed at specified intervals according to the maintenance schedule.

For details about maintenance items and schedules, refer to the "Warranty and Service Guide", "Owner's Manual Supplement" or "Scheduled Maintenance".

### ■ Resetting the message indicating maintenance is required (U.S.A. only)

After the required maintenance is performed according to the maintenance schedule, please reset the message. To reset the message, follow the procedures described below:

- 1 Press < or > of the meter control switch to select .
- 2 Press ^ or v of the meter control switch, select the "Scheduled Maintenance" screen and then press and hold the .

- 3 Select the "Yes" and press .
- 4 A message will be displayed on the multi-information display when the reset procedure has been completed.

### Do-it-yourself maintenance

You can perform some maintenance procedures by yourself. Please be aware that do-it-yourself maintenance may affect warranty coverage.

The use of Lexus repair manuals is recommended.

For details about warranty coverage, refer to the separate "Owner's Guide", "Warranty and Service Guide", "Owner's Manual Supplement" or "Warranty Booklet".

### General maintenance

Listed below are the general maintenance items that should be performed at the intervals specified in the "Warranty and Service Guide" or "Owner's Manual Supplement". It is recommended that any problem you notice should be brought to the attention of your Lexus dealer or qualified service shop for advice.

#### WARNING

##### If the engine is running

Turn the engine off and ensure that there is adequate ventilation before performing maintenance checks.

### Engine compartment

Items	Check points
Battery	Check the connections. (→P.363)
Brake fluid	Is the brake fluid at the correct level? (→P.362)
Engine coolant	Is the engine coolant at the correct level? (→P.361)
Engine oil	Is the engine oil at the correct level? (→P.359)
Exhaust system	There should not be any fumes or strange sounds.

Items	Check points
Radiator/condenser	The radiator and condenser should be free from foreign objects. (→P.362)
Washer fluid	Is there sufficient washer fluid? (→P.364)

### Vehicle interior

Items	Check points
Accelerator pedal	<ul style="list-style-type: none"> <li>The accelerator pedal should move smoothly (without uneven pedal effort or catching).</li> </ul>
Automatic transmission "Park" mechanism	<ul style="list-style-type: none"> <li>When parked on a slope and the shift lever is in P, is the vehicle securely stopped?</li> </ul>
Brake pedal	<ul style="list-style-type: none"> <li>Does the brake pedal move smoothly?</li> <li>Does the brake pedal have appropriate clearance from the floor?</li> <li>Does the brake pedal have the correct amount of free play?</li> </ul>

Items	Check points
Brakes	<ul style="list-style-type: none"> <li>The vehicle should not pull to one side when the brakes are applied.</li> <li>The brakes should work effectively.</li> <li>The brake pedal should not feel spongy.</li> <li>The brake pedal should not get too close to the floor when the brakes are applied.</li> </ul>
Head restraints	<ul style="list-style-type: none"> <li>Do the head restraints move smoothly and lock securely?</li> </ul>
Indicators/buzzers	<ul style="list-style-type: none"> <li>Do the indicators and buzzers function properly?</li> </ul>
Lights	<ul style="list-style-type: none"> <li>Do all the lights come on?</li> <li>Are the headlights aimed correctly? (→P.382)</li> </ul>
Parking brake	<ul style="list-style-type: none"> <li>Does the parking brake switch operate normally?</li> <li>When parked on a slope and the parking brake is on, is the vehicle securely stopped?</li> </ul>
Seat belts	<ul style="list-style-type: none"> <li>Do the seat belts operate smoothly?</li> <li>The seat belts should not be damaged.</li> </ul>



Items	Check points
Seats	<ul style="list-style-type: none"> <li>• Do the seat controls operate properly?</li> </ul>
Steering wheel	<ul style="list-style-type: none"> <li>• Does the steering wheel rotate smoothly?</li> <li>• Does the steering wheel have the correct amount of free play?</li> <li>• There should not be any strange sounds coming from the steering wheel.</li> </ul>

**Vehicle exterior**

Items	Check points
Doors	<ul style="list-style-type: none"> <li>• Do the doors operate smoothly?</li> </ul>
Engine hood	<ul style="list-style-type: none"> <li>• Does the engine hood lock system work properly?</li> </ul>
Fluid leaks	<ul style="list-style-type: none"> <li>• There should not be any signs of fluid leakage after the vehicle has been parked.</li> </ul>

Items	Check points
Tires	<ul style="list-style-type: none"> <li>• Is the tire inflation pressure correct?</li> <li>• The tires should not be damaged or excessively worn.</li> <li>• Have the tires been rotated according to the maintenance schedule?</li> <li>• The wheel nuts should not be loose.</li> </ul>
Windshield wipers/rear window wiper	<ul style="list-style-type: none"> <li>• The wiper blades should not show any signs of cracking, splitting, wear, contamination or deformation.</li> <li>• The wiper blades should clear the windshield/rear window without streaking or skipping.</li> </ul>

### **Emission inspection and maintenance (I/M) programs**

Some states have vehicle emission inspection programs which include OBD (On Board Diagnostics) checks. The OBD system monitors the operation of the emission control system.

### **If the malfunction indicator lamp comes on**

The OBD system determines that a problem exists somewhere in the emission control system. Your vehicle may not pass the I/M test and may need to be repaired. Contact your Lexus dealer to service the vehicle.

### **Your vehicle may not pass the I/M test in the following situations:**

- When the battery is disconnected or discharged

Readiness codes that are set during ordinary driving are erased.

Also, depending on your driving habits, the readiness codes may not be completely set.

- When the fuel tank cap is loose

The malfunction indicator lamp comes on indicating a temporary malfunction and your vehicle may not pass the I/M test.

### **When the malfunction indicator lamp still remains on after several driving trips**

The error code in the OBD system will not be cleared unless the vehicle is driven 40 or more times.

### **If your vehicle does not pass the I/M test**

Contact your Lexus dealer to prepare the vehicle for re-testing.

### Do-it-yourself service precautions

If you perform maintenance by yourself, be sure to follow the correct procedure as given in these sections.

### Maintenance

Items	Parts and tools
Battery condition (→P.363)	<ul style="list-style-type: none"> <li>• Warm water</li> <li>• Baking soda</li> <li>• Grease</li> <li>• Conventional wrench (for terminal clamp bolts)</li> </ul>
Brake fluid level (→P.362)	<ul style="list-style-type: none"> <li>• FMVSS No.116 DOT 3 or SAE J1703 brake fluid</li> <li>• Rag or paper towel</li> <li>• Funnel (used only for adding brake fluid)</li> </ul>

Items	Parts and tools
Engine coolant level (→P.361)	<ul style="list-style-type: none"> <li>• "Toyota Super Long Life Coolant" or a similar high quality ethylene glycol-based non-silicate, non-amine, non-nitrite and non-borate coolant with long-life hybrid organic acid technology</li> <li>For the U.S.A.: "Toyota Super Long Life Coolant" is pre-mixed with 50% coolant and 50% deionized water.</li> <li>For Canada: "Toyota Super Long Life Coolant" is pre-mixed with 55% coolant and 45% deionized water.</li> <li>• Funnel (used only for adding engine coolant)</li> </ul>
Engine oil level (→P.359)	<ul style="list-style-type: none"> <li>• "Toyota Genuine Motor Oil" or equivalent</li> <li>• Rag or paper towel</li> <li>• Funnel (used only for adding engine oil)</li> </ul>
Fuses (→P.381)	<ul style="list-style-type: none"> <li>• Fuse with same amperage rating as original</li> </ul>
Headlight aim (→P.382)	<ul style="list-style-type: none"> <li>• Phillips-head screwdriver</li> </ul>

Items	Parts and tools
Light bulbs (→P.384)	<ul style="list-style-type: none"> <li>• Bulb with same number and wattage rating as original</li> <li>• Flathead screwdriver</li> <li>• Wrench</li> </ul>
Radiator and condenser (→P.362)	—
Tire inflation pressure (→P.373)	<ul style="list-style-type: none"> <li>• Tire pressure gauge</li> <li>• Compressed air source</li> </ul>
Washer fluid (→P.364)	<ul style="list-style-type: none"> <li>• Water or washer fluid containing anti-freeze (for winter use)</li> <li>• Funnel (used only for adding water or washer fluid)</li> </ul>

### WARNING

The engine compartment contains many mechanisms and fluids that may move suddenly, become hot, or become electrically energized. To avoid death or serious injury, observe the following precautions.

- **When working on the engine compartment**
  - Keep hands, clothing and tools away from the moving fan and engine drive belt.
  - Be careful not to touch the engine, radiator, exhaust manifold, etc. right after driving as they may be hot. Oil and other fluids may also be hot.
  - Do not leave anything that may burn easily, such as paper and rags, in the engine compartment.
  - Do not smoke, cause sparks or expose an open flame to fuel or the battery. Fuel and battery fumes are flammable.

- Be extremely cautious when working on the battery. It contains poisonous and corrosive sulfuric acid.

### ■ When working near the electric cooling fan or radiator grille

Be sure the engine switch is off. With the engine switch in IGNITION ON mode, the electric cooling fan may automatically start to run if the air conditioning is on and/or the coolant temperature is high. (→P.362)

### ■ Safety glasses

Wear safety glasses to prevent flying or falling material, fluid spray, etc. from getting in your eyes.

### NOTICE

### ■ If you remove the air cleaner filter

Driving with the air cleaner filter removed may cause excessive engine wear due to dirt in the air.

## Hood

### Opening the hood

- 1 Pull the hood lock release lever.  
The hood will pop up slightly.

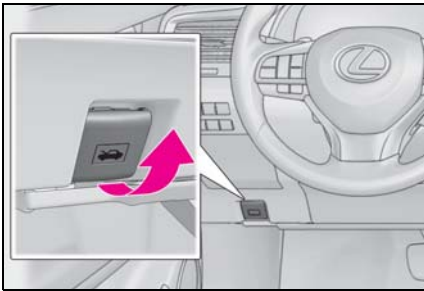

- 2 Pull up the auxiliary catch lever and lift the hood.

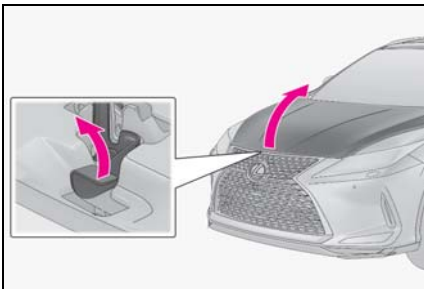

### WARNING

#### Pre-driving check

Check that the hood is fully closed and locked.  
If the hood is not locked properly, it may open while the vehicle is in motion and cause an accident, which may result in death or serious injury.

## Positioning a floor jack

When using a floor jack, follow the instructions in the manual provided with the jack and perform the operation safely.

When raising your vehicle with a floor jack, position the jack correctly. Improper placement may damage your vehicle or cause injury.

### Location of the jack point

#### ■ Front

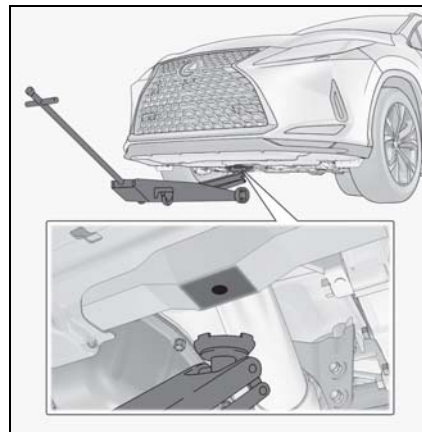

■ Rear



## Engine compartment

### Components

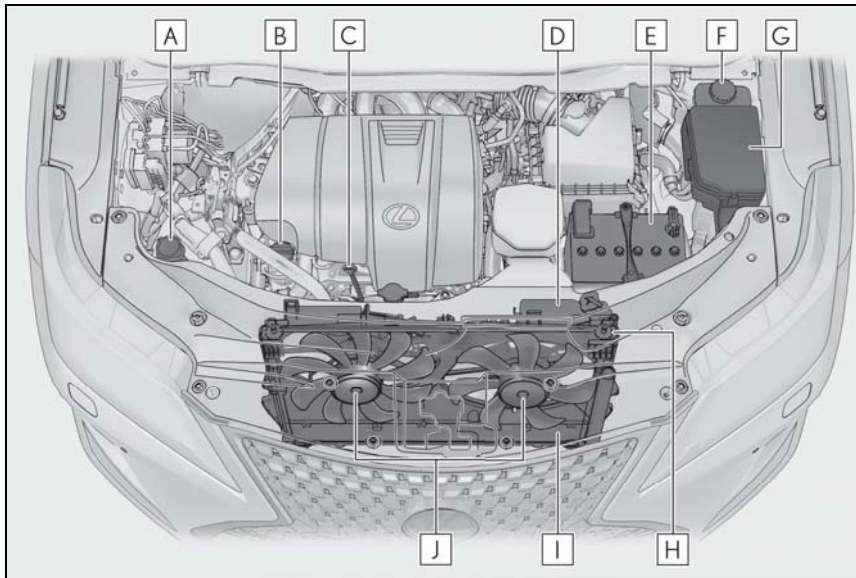

- A** Washer fluid tank (→P.364)
- B** Engine oil filler cap (→P.360)
- C** Engine oil level dipstick (→P.359)
- D** Engine coolant reservoir (→P.361)
- E** Battery (→P.363)
- F** Brake fluid reservoir (→P.362)
- G** Fuse box (→P.381)
- H** Radiator (→P.362)
- I** Condenser (→P.362)
- J** Electric cooling fans

### Checking and adding the engine oil

With the engine at operating temperature and turned off, check the oil level on the dipstick.

#### ■ Checking the engine oil

- 1** Park the vehicle on level ground. After warming up the engine and turning off the engine, wait more

than 5 minutes for the oil to drain back into the bottom of the engine.

- 2 Holding a rag under the end, pull the dipstick out.

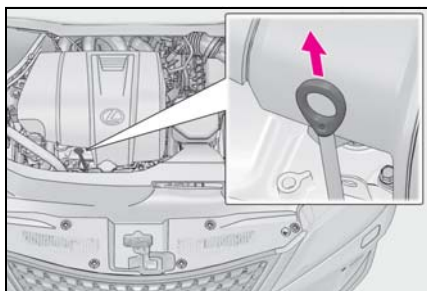

- 3 Wipe the dipstick clean.
- 4 Reinsert the dipstick fully.
- 5 Holding a rag under the end, pull the dipstick out and check the oil level.

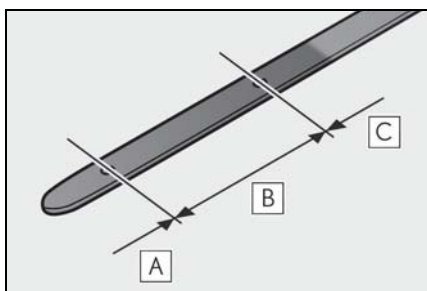

- A** Low
- B** Normal
- C** Excessive

The shape of the dipstick may differ depending on the type of vehicle or engine.

- 6 Wipe the dipstick and reinsert it fully.

**■ Checking the oil type and preparing the item needed**

Make sure to check the oil type and

prepare the items needed before adding oil.

- Engine oil selection  
→P.445
- Oil quantity (Low → Full)  
1.9 qt. (1.8 L, 1.6 Imp. qt.)
- Item  
Clean funnel

**■ Adding engine oil**

If the oil level is below or near the low level mark, add engine oil of the same type as that already in the engine.

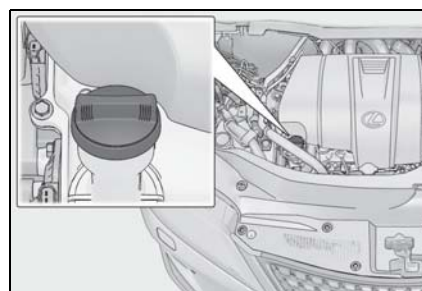

- 1 Remove the oil filler cap by turning it counterclockwise.
- 2 Add engine oil slowly, checking the dipstick.
- 3 Install the oil filler cap by turning it clockwise.

**■ Engine oil consumption**

A certain amount of engine oil will be consumed while driving. In the following situations, oil consumption may increase, and engine oil may need to be refilled in between oil maintenance intervals.

- When the engine is new, for example directly after purchasing the vehicle or after replacing the engine
- If low quality oil or oil of an inappropriate viscosity is used
- When driving at high engine speeds or





with a heavy load, when towing, or when driving while accelerating or decelerating frequently

- When leaving the engine idling for a long time, or when driving frequently through heavy traffic

#### ■ After changing the engine oil

The engine oil maintenance data should be reset. Perform the following procedures:

- 1 Press < or > of the meter control switch to select  on the multi-information display.
- 2 Press ^ or v of the meter control switch, select the "Vehicle Settings" then "Oil Maintenance". (To confirm setting, press )
- 3 Select the "Yes" and press .
- 4 A message is displayed on the multi-information display.

#### ⚠ WARNING

##### ■ Used engine oil

- Used engine oil contains potentially harmful contaminants which may cause skin disorders such as inflammation and skin cancer, so care should be taken to avoid prolonged and repeated contact. To remove used engine oil from your skin, wash thoroughly with soap and water.
- Dispose of used oil and filters only in a safe and acceptable manner. Do not dispose of used oil and filters in household trash, in sewers or onto the ground. Call your Lexus dealer, service station or auto parts store for information concerning recycling or disposal.
- Do not leave used engine oil within the reach of children.

#### ⚠ NOTICE

##### ■ To prevent serious engine damage

Check the oil level on a regular basis.

#### ■ When replacing the engine oil

- Be careful not to spill engine oil on the vehicle components.
- Avoid overfilling, or the engine could be damaged.
- Check the oil level on the dipstick every time you refill the vehicle.
- Be sure the engine oil filler cap is properly tightened.

#### Checking the coolant

The coolant level is satisfactory if it is between the "FULL" and "LOW" lines on the reservoir when the engine is cold.

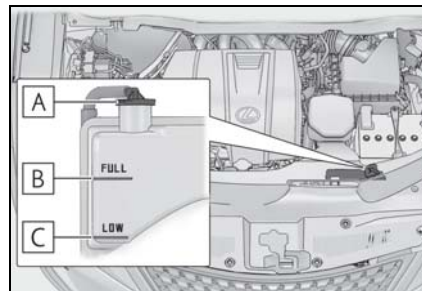

**A** Reservoir cap

**B** "FULL" line

**C** "LOW" line

If the level is on or below the "LOW" line, add coolant up to the "FULL" line. (→P.437)

#### ■ Coolant selection

Only use "Toyota Super Long Life Coolant" or a similar high quality ethylene glycol based non-silicate, non-amine, non-nitrite, and non-borate coolant with long-life hybrid organic acid technology.

U.S.A.:

"Toyota Super Long Life Coolant" is a mixture of 50% coolant and 50% deionized

water. (Minimum temperature: -31°F [-35°C])

Canada:

“Toyota Super Long Life Coolant” is a mixture of 55% coolant and 45% deionized water. (Minimum temperature: -44°F [-42°C])

For more details about coolant, contact your Lexus dealer.

■ **If the coolant level drops within a short time of replenishing**

Visually check the radiator, hoses, engine coolant reservoir cap, drain cock and water pump.

If you cannot find a leak, have your Lexus dealer test the cap and check for leaks in the cooling system.

**! WARNING**

■ **When the engine is hot**

Do not remove the engine coolant reservoir cap and radiator cap.

The cooling system may be under pressure and may spray hot coolant if the cap is removed, causing serious injuries, such as burns.

**! NOTICE**

■ **When adding coolant**

Coolant is neither plain water nor straight antifreeze. The correct mixture of water and antifreeze must be used to provide proper lubrication, corrosion protection and cooling. Be sure to read the antifreeze or coolant label.

■ **If you spill coolant**

Be sure to wash it off with water to prevent it from damaging parts or paint.

**Checking the radiator and condenser**

Check the radiator and condenser and clear away any foreign objects.

If either of the above parts is extremely dirty or you are not sure of their condition, have your vehicle inspected by your Lexus dealer.

**! WARNING**

■ **When the engine is hot**

Do not touch the radiator or condenser as they may be hot and cause serious injuries, such as burns.

**Checking and adding the brake fluid**

■ **Checking fluid level**

The brake fluid level should be between the “MAX” and “MIN” lines on the tank.

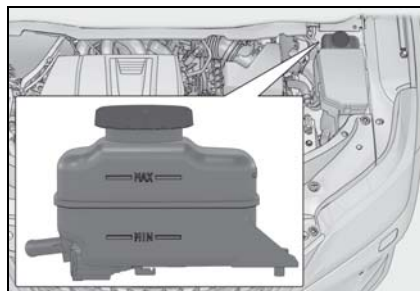

■ **Adding fluid**

Make sure to check the fluid type and prepare the necessary item.

● **Fluid type**

FMVSS No.116 DOT 3 or SAE J1703 brake fluid

● **Item**

Clean funnel

■ **Brake fluid can absorb moisture from the air**

Excess moisture in the brake fluid can cause a dangerous loss of braking efficiency. Use

only newly opened brake fluid.

### WARNING

#### ■ When filling the reservoir

Take care as brake fluid can harm your hands and eyes and damage painted surfaces.

If fluid gets on your hands or in your eyes, flush the affected area with clean water immediately.

If you still experience discomfort, see a doctor.

### NOTICE

#### ■ If the fluid level is low or high

It is normal for the brake fluid level to go down slightly as the brake pads wear out or when the fluid level in the accumulator is high.

If the reservoir needs frequent refilling, there may be a serious problem.

## Battery

Check the battery as follows.

### ■ Battery exterior

Make sure that the battery terminals are not corroded and that there are no loose connections, cracks, or loose clamps.

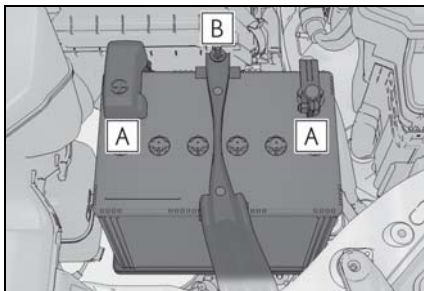

**A** Terminals

**B** Hold-down clamp

### ■ Before recharging

When recharging, the battery produces hydrogen gas which is flammable and explosive. Therefore, observe the following precautions before recharging:

- If recharging with the battery installed on the vehicle, be sure to disconnect the ground cable.
- Make sure the power switch on the charger is off when connecting and disconnecting the charger cables to the battery.

### ■ After recharging/reconnecting the battery

- The engine may not start. Follow the procedure below to initialize the system.

- 1 Shift the shift lever to P.
  - 2 Open and close any of the doors.
  - 3 Restart the engine.
- Unlocking the doors using the smart access system with push-button start may not be possible immediately after reconnecting the battery. If this happens, use the wireless remote control or the mechanical key to lock/unlock the doors.
  - Start the engine with the engine switch in ACCESSORY mode. The engine may not start with the engine switch turned off. However, the engine will operate normally from the second attempt.
  - The engine switch mode is recorded by the vehicle. If the battery is reconnected, the vehicle will return the engine switch mode to the status it was in before the battery was disconnected. Make sure to turn off the power before disconnect the battery. Take extra care when connecting the battery if the engine switch mode prior to discharge is unknown.

If the system will not start even after multiple attempts at all the methods above, contact your Lexus dealer.

### WARNING

#### ■ Chemicals in the battery

Batteries contain poisonous and corrosive sulfuric acid and may produce hydrogen gas which is flammable and explosive. To reduce the risk of death or serious injury, take the following precautions while working on or near the battery:

- Do not cause sparks by touching the battery terminals with tools.
- Do not smoke or light a match near the battery.
- Avoid contact with eyes, skin and clothes.
- Never inhale or swallow electrolyte.
- Wear protective safety glasses when working near the battery.
- Keep children away from the battery.

#### ■ Where to safely charge the battery

Always charge the battery in an open area. Do not charge the battery in a garage or closed room where there is insufficient ventilation.

#### ■ How to recharge the battery

Only perform a slow charge (5 A or less). The battery may explode if charged at a quicker rate.

#### ■ Emergency measures regarding electrolyte

- If electrolyte gets in your eyes  
Flush your eyes with clean water for at least 15 minutes and get immediate medical attention. If possible, continue to apply water with a sponge or cloth while traveling to the nearest medical facility.
- If electrolyte gets on your skin  
Wash the affected area thoroughly. If you feel pain or burning, get medical attention immediately.

- If electrolyte gets on your clothes  
It can soak through clothing on to your skin. Immediately take off the clothing and follow the procedure above if necessary.

- If you accidentally swallow electrolyte  
Drink a large quantity of water or milk. Get emergency medical attention immediately.

#### ■ When there is insufficient battery fluid

Do not use if there is insufficient fluid in the battery. There is a possible danger that the battery may explode.

### NOTICE

#### ■ When recharging the battery

Never recharge the battery while the engine is running. Also, be sure all accessories are turned off.

#### ■ When adding distilled water

Avoid overfilling. Water spilled during battery recharging may cause corrosion.

### Washer fluid

If any washer does not work or the warning message appears on the multi-information display, the washer tank may be empty. Add washer fluid.

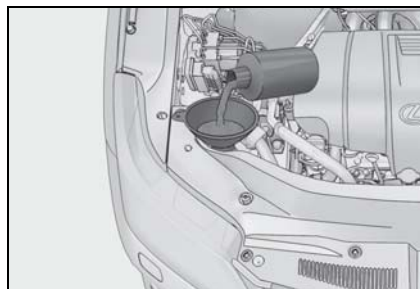

**⚠ WARNING****■ When adding washer fluid**

Do not add washer fluid when the engine is hot or running as washer fluid contains alcohol and may catch fire if spilled on the engine, etc.

**⚠ NOTICE****■ Do not use any fluid other than washer fluid**

Do not use soapy water or engine anti-freeze instead of washer fluid.

Doing so may cause streaking on the vehicle's painted surfaces, as well as damaging the pump leading to problems of the washer fluid not spraying.

**■ Diluting washer fluid**

Dilute washer fluid with water as necessary.

Refer to the freezing temperatures listed on the label of the washer fluid bottle.

**Tires**

**Replace or rotate tires in accordance with maintenance schedules and treadwear.**

**Checking tires**

Check if the treadwear indicators are showing on the tires. Also check the tires for uneven wear, such as excessive wear on one side of the tread.

Check the spare tire condition and pressure if not rotated.

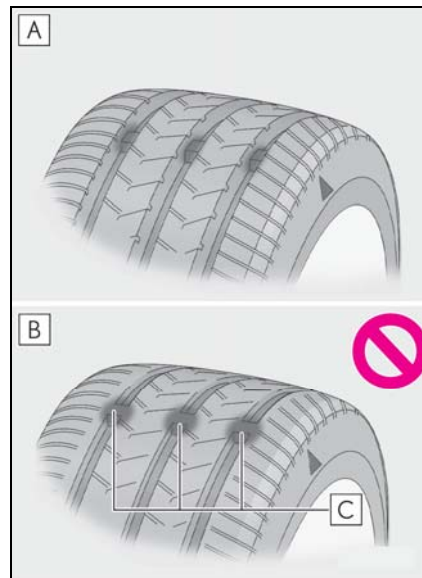

**A** New tread

**B** Worn tread

**C** Treadwear indicator

The location of treadwear indicators is shown by a "TWI" or "△" mark, etc., molded into the sidewall of each tire. Replace the tires if the treadwear indicators are showing on a tire.

■ **When to replace your vehicle's tires**

Tires should be replaced if:

- The treadwear indicators are showing on a tire.
- You have tire damage such as cuts, splits, cracks deep enough to expose the fabric, and bulges indicating internal damage.
- A tire goes flat repeatedly or cannot be properly repaired due to the size or location of a cut or other damage.

If you are not sure, consult with your Lexus dealer.

■ **Tire life**

Any tire over 6 years old must be checked by a qualified technician even if it has seldom or never been used or damage is not obvious.

■ **Proper storage of the spare tire (RX350L)**

As an improperly stored spare tire may cause damage to the wire cable that holds it, check that the spare tire is stored properly on a daily basis.

- If the stored spare tire appears to be slanted or rattles while driving, the spare tire may not be properly stored. Store the spare tire again by performing the following tire change procedure correctly:

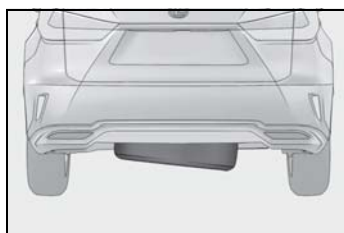

- 1 If the spare tire is slanted, the hoist assembly may be stuck in the wheel opening. If the spare tire rattles while driving, it may not be fully raised. Lower the spare tire to the ground and make sure that the hoist assembly is perpendicular to the wheel opening.
- 2 Raise the tire slowly and steadily until a click is heard and the jack handle skips.

If the spare tire cannot be lowered, the wire cable may be severed. Have the vehicle

inspected at your Lexus dealer.

■ **Maximum load of tire**

Check that the maximum load of the replacement tire is greater than 1/2 of the Gross Axle Weight Ratings (GAWR) of either the front axle or the rear axle, whichever is greater.

For the GAWR, see the Certification Label. For the maximum load of the tire, see the load limit at maximum cold tire inflation pressure mentioned on the sidewall of the tire. (→P.452)

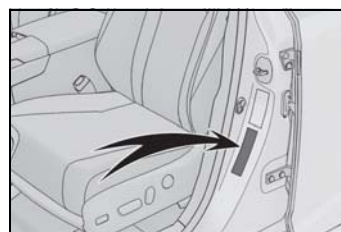

■ **Tire types**

● **Summer tires**

Summer tires are high-speed performance tires best suited to highway driving under dry conditions. Since summer tires do not have the same traction performance as snow tires, summer tires are inadequate for driving on snow-covered or icy roads. For driving on snow-covered roads or icy roads, the use of snow tires is recommended. When installing snow tires, be sure to replace all four tires.

● **All season tires**

All season tires are designed to provide better traction in snow and to be adequate for driving in most winter conditions as well as for use year-round. All season tires, however, do not have adequate traction performance compared with snow tires in heavy or loose snow. Also, all season tires fall short in acceleration and handling performance compared with summer tires in highway driving.

● **Snow tires**

For driving on snow-covered roads or icy

roads, we recommend using snow tires. If you need snow tires, select tires of the same size, construction and load capacity as the originally installed tires. Since your vehicle has radial tires as original equipment, make sure your snow tires also have radial construction. Do not install studded tires without first checking local regulations for possible restrictions. Snow tires should be installed on all wheels. (→P.280)

■ **If the tread on snow tires wears down below 0.16 in. (4 mm)**

The effectiveness of the tires as snow tires is lost.

**! WARNING**

■ **When inspecting or replacing tires**

Observe the following precautions to prevent accidents. Failure to do so may cause damage to parts of the drive train as well as dangerous handling characteristics, which may lead to an accident resulting in death or serious injury.

- Do not mix tires of different makes, models or tread patterns. Also, do not mix tires of remarkably different treadwear.
- Do not use tire sizes other than those recommended by Lexus.
- Do not mix differently constructed tires (radial, bias-belted or bias-ply tires).
- Do not mix summer, all season and snow tires.
- Do not use tires that have been used on another vehicle. Do not use tires if you do not know how they were used previously.
- Do not tow if your vehicle has a compact spare tire installed.

**! NOTICE**

■ **Driving on rough roads**

Take particular care when driving on roads with loose surfaces or potholes. These conditions may cause losses in tire inflation pressure, reducing the cushioning ability of the tires. In addition, driving on rough roads may cause damage to the tires themselves, as well as the vehicle's wheels and body.

■ **If tire inflation pressure of each tire becomes low while driving**

Do not continue driving, or your tires and/or wheels may be ruined.

**Tire rotation**

Rotate the tires in the order shown.

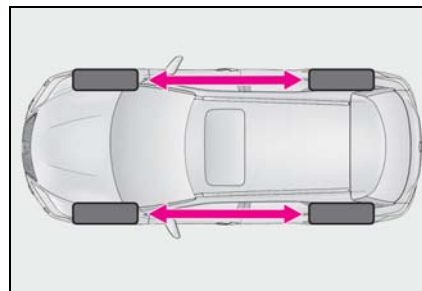

To equalize tire wear and extend tire life, Lexus recommends that tire rotation is carried out at the same interval as tire inspection.

Do not fail to initialize the tire pressure warning system after tire rotation.

**Tire pressure warning system**

Your vehicle is equipped with a tire pressure warning system that uses tire pressure warning valves and transmitters to detect low tire inflation pressure before serious problems arise.

- The tire pressure detected by the

tire pressure warning system can be displayed on the multi-information display. (→P.81)

The illustration used is intended as an example, and may differ from the image that is actually displayed on the multi-information display.

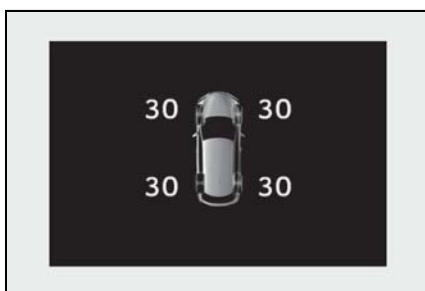

- If the tire pressure drops below a predetermined level, the driver is warned by a screen display and a warning light. (→P.407)

The illustration used is intended as an example, and may differ from the image that is actually displayed on the multi-information display.



■ **Routine tire inflation pressure checks**

The tire pressure warning system does not replace routine tire inflation pressure checks. Make sure to check tire inflation pressure as part of your routine of daily vehicle checks.

■ **Situations in which the tire pressure warning system may not operate properly**

- In the following cases, the tire pressure warning system may not operate properly.
  - If non-genuine Lexus wheels are used.
  - A tire has been replaced with a tire that is not an OE (Original Equipment) tire.
  - A tire has been replaced with a tire that is not of the specified size.
  - Tire chains, etc. are equipped.
  - If a window tint that affects the radio wave signals is installed.
  - If there is a lot of snow or ice on the vehicle, particularly around the wheels or wheel housings.
  - If the tire inflation pressure is extremely higher than the specified level.
  - If wheel without the tire pressure warning valve and transmitter is used.
  - If the ID code on the tire pressure warning valves and transmitters is not registered in the tire pressure warning computer.
- Performance may be affected in the following situations.
  - Near a TV tower, electric power plant, gas station, radio station, large display, airport or other facility that generates strong radio waves or electrical noise
  - When carrying a portable radio, cellular phone, cordless phone or other wireless communication device

If tire position information is not correctly displayed due to the radio wave conditions, the display may be corrected by driving and changing the radio wave conditions.

- When the vehicle is parked, the time taken for the warning to start or go off could be extended.
- When tire inflation pressure declines rapidly for example when a tire has burst, the warning may not function.

■ **Warning performance of the tire pressure warning system**

The warning of the tire pressure warning system will change in accordance with the conditions under which it was initialized. For this reason, the system may give a warning even if the tire pressure does not reach a



low enough level, or if the pressure is higher than the pressure that was adjusted to when the system was initialized.

■ **Tire pressure warning system certification**

► Except for vehicles sold in Canada

**FCC ID: PAXPMVE000**

**NOTE**

This device complies with part 15 of the FCC Rules. Operation is subject to the following two conditions: (1) This device may not cause harmful interference, and (2) this device must accept any interference received, including interference that may cause undesired operation.

**FCC WARNING**

Changes or modifications not expressly approved by the party responsible for compliance could void the user's authority to operate the equipment.

**FCC ID: PAXPMVE100**

**NOTE**

This device complies with part 15 of the FCC Rules. Operation is subject to the following two conditions: (1) This device may not cause harmful interference, and (2) this device must accept any interference received, including interference that may cause undesired operation.

**FCC WARNING**

Changes or modifications not expressly approved by the party responsible for compliance could void the user's authority to operate the equipment.

"Perchlorate Material – special handling may apply, See [www.dtsc.ca.gov/hazardouswaste/perchlorate](http://www.dtsc.ca.gov/hazardouswaste/perchlorate)."

► For vehicles sold in Canada

**NOTE**

This device complies with Industry Canada licence-exempt RSS standard(s). Operation is subject to the following two conditions: (1) this device may not cause interference, and (2) this device must accept any interference, including interference that may cause undesired operation of the device.

**NOTE**

Le présent appareil est conforme aux CNR d'Industrie Canada applicables aux appareils radio exempts de licence. L'exploitation est autorisée aux deux conditions suivantes : (1) l'appareil ne doit pas produire de brouillage, et (2) l'utilisateur de l'appareil doit accepter tout brouillage radioélectrique subi, même si le brouillage est susceptible d'en compromettre le fonctionnement.

**Installing tire pressure warning valves and transmitters**

When replacing tires or wheels, tire pressure warning valves and transmitters must also be installed.

When new tire pressure warning valves and transmitters are installed, new ID codes must be registered in the tire pressure warning computer and the tire pressure warning system must be initialized. Have tire pressure warning valve and transmitter ID codes registered by your Lexus dealer. (→P.372)

**Replacing tires and wheels**

If the ID code of the tire pressure warning valve and transmitter is not registered, the tire pressure warning system will not work properly. After driving for about 20 minutes, the tire pressure warning light blinks for 1 minute and stays on to indicate a system malfunction.

 NOTICE

- **Repairing or replacing tires, wheels, tire pressure warning valves, transmitters and tire valve caps**
- When removing or fitting the wheels, tires or the tire pressure warning valves and transmitters, contact your Lexus dealer as the tire pressure warning valves and transmitters may be damaged if not handled correctly.
- Make sure to install the tire valve caps. If the tire valve caps are not installed, water could enter the tire pressure warning valves and the tire pressure warning valves could be bound.
- When replacing tire valve caps, do not use tire valve caps other than those specified. The cap may become stuck.

 NOTICE

■ **To avoid damage to the tire pressure warning valves and transmitters**

When a tire is repaired with liquid sealants, the tire pressure warning valve and transmitter may not operate properly. If a liquid sealant is used, contact your Lexus dealer or other qualified service shop as soon as possible. Make sure to replace the tire pressure warning valve and transmitter when replacing the tire. (→P.370)

**Initializing the tire pressure warning system**

■ **The tire pressure warning system must be initialized in the following circumstances:**

- When the tire inflation pressure is changed such as when changing traveling speed.
- When the tire inflation pressure is changed such as when the tire size is changed.
- When rotating the tires.

When the tire pressure warning system is initialized, the current tire inflation pressure is set as the benchmark pressure.

■ **How to initialize the tire pressure warning system**







- 1** Park the vehicle in a safe place and turn the engine switch off.

Initialization cannot be performed while the vehicle is moving.

- 2** Adjust the tire inflation pressure to the specified cold tire inflation pressure level.

Make sure to adjust the tire pressure to the specified cold tire inflation pressure level.

The tire pressure warning system will operate based on this pressure level.

- 3** Turn the engine switch to IGNITION ON mode.
- 4** Select  on the multi-information display.
- 5** Press  or  of the meter control switch, select the "Vehicle Settings" screen and then press the .
- 6** Press  or  of the meter control switch, select the "TPMS" screen and then press and hold the  until the tire pressure warning light blinks slowly 3 times.

"- -" will be displayed for inflation pressure of each tire on the multi-information display while the tire pressure warning system determines the position of each tire.

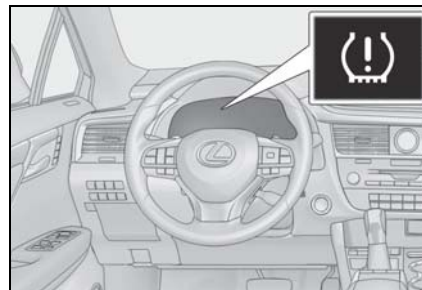

- 7** Drive the vehicle at approximately 25 mph (40 km/h) or more for approximately 10 to 30 minutes until the inflation pressure of each tire is displayed on the multi-information display.

When position of each tire is determined, the inflation pressure of each tire will be displayed on the multi-information display.

If tire inflation pressure becomes low before the inflation pressure is displayed, the tire pressure warning light will come

on.

Depending on the vehicle and driving conditions, initialization may take up to approximately 1 hour to complete.

■ **Initializing the tire pressure warning system**

Initialize the system with the tire inflation pressure adjusted to the specified level.

■ **If you press the tire pressure warning reset switch accidentally**

If initialization is performed, adjust the tire inflation pressure to the specified level and initialize the tire pressure warning system again.

■ **Initialization procedure**

- Make sure to carry out initialization after adjusting the tire inflation pressure. Also, make sure the tires are cold before carrying out initialization or tire inflation pressure adjustment.
- If you have accidentally turned the engine switch off during initialization, it is not necessary to press the reset switch again as initialization will restart automatically when the engine switch has been turned to IGNITION ON mode for the next time.
- If you accidentally press the reset switch when initialization is not necessary, adjust the tire inflation pressure to the specified level when the tires are cold, and conduct initialization again.
- While the position of each tire is being determined and the inflation pressures are not being displayed on the multi-information display, if the inflation pressure of a tire drops, the tire pressure warning light will come on.

■ **When initialization of the tire pressure warning system has failed**

Initialization may take longer to complete if the vehicle is driven on an unpaved road. When performing initialization, drive on a paved road if possible. Depending on the driving environment and condition of the tires, initialization will be completed in approximately 10 to 30 minutes. If initialization is not complete after driving approxi-

mately 10 to 30 minutes, continue driving for a while.

If the inflation pressure of each tire is not displayed after driving for approximately 1 hour, perform the following procedure.

- Park the vehicle in a safe place for approximately 20 minutes. Then drive straight (with occasional left and right turns) at approximately 25 mph (40 km/h) or more for approximately 10 to 30 minutes.

However, in the following situations, the tire inflation pressure will not be recorded and the system will not operate properly. Perform initialization again.

- When operating the tire pressure warning reset switch, the tire pressure warning light does not blink 3 times.
- After performing initialization, the tire pressure warning light blinks for 1 minute then stays on while driving.

If the inflation pressure of each tire is still not displayed, have the vehicle inspected by your Lexus dealer.

 **WARNING**

■ **When initializing the tire pressure warning system**

Do not initialize tire inflation pressure without first adjusting the tire inflation pressure to the specified level. Otherwise, the tire pressure warning light may not come on even if the tire inflation pressure is low, or it may come on when the tire inflation pressure is actually normal.

**Registering ID codes**

The tire pressure warning valve and transmitter is equipped with a unique ID code. When replacing a tire pressure warning valve and transmitter, it is necessary to register the ID code.

Have the ID code registered by your Lexus dealer.

**Tire inflation pressure**

**Checking the specified tire inflation pressure**

The recommended cold tire inflation pressure and tire size are displayed on the tire and loading information label. (→P.443)

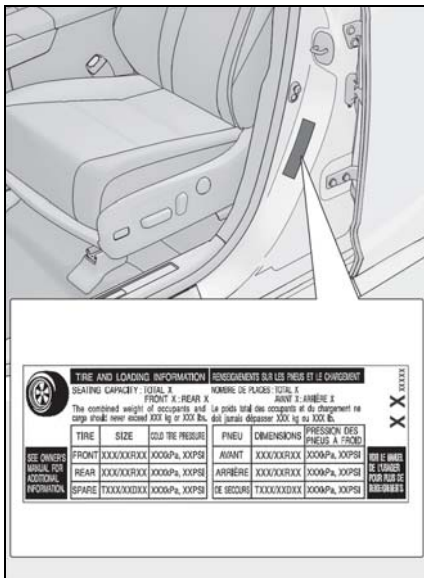

**Inspection and adjustment procedure**

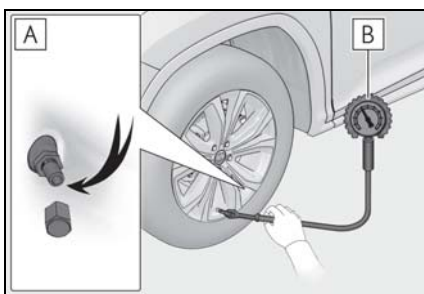

- A** Tire valve
- B** Tire pressure gauge

- 1** Remove the tire valve cap.
- 2** Press the tip of the tire pressure gauge onto the tire valve.
- 3** Read the pressure using the gauge gradations.
- 4** If the tire inflation pressure is not at the recommended level, adjust the pressure.  
If you add too much air, press the center of the valve to deflate.
- 5** After completing the tire inflation pressure measurement and adjustment, apply soapy water to the valve and check for leakage.
- 6** Put the tire valve cap back on.

**■ Tire inflation pressure check interval**

You should check tire inflation pressure every two weeks, or at least once a month. Do not forget to check the spare.

**■ Effects of incorrect tire inflation pressure**

Driving with incorrect tire inflation pressure may result in the following:

- Reduced fuel economy
- Reduced driving comfort and poor handling
- Reduced tire life due to wear
- Reduced safety
- Damage to the drive train

If a tire needs frequent inflating, have it checked by your Lexus dealer.

**■ Instructions for checking tire inflation pressure**

When checking tire inflation pressure, observe the following:

- Check only when the tires are cold.  
If your vehicle has been parked for at least 3 hours or has not been driven for more than 1 mile or 1.5 km, you will get an accurate cold tire inflation pressure read-

ing.

- Always use a tire pressure gauge. It is difficult to judge if a tire is properly inflated based only on its appearance.
- It is normal for the tire inflation pressure to be higher after driving as heat is generated in the tire. Do not reduce tire inflation pressure after driving.
- Never exceed the vehicle capacity weight. Passengers and luggage weight should be placed so that the vehicle is balanced.

 **WARNING**

■ **Proper inflation is critical to save tire performance**

Keep your tires properly inflated. If the tires are not properly inflated, the following conditions may occur which could lead to an accident resulting in death or serious injury:

- Excessive wear
- Uneven wear
- Poor handling
- Possibility of blowouts resulting from overheated tires
- Air leaking from between tire and wheel
- Wheel deformation and/or tire damage
- Greater possibility of tire damage while driving (due to road hazards, expansion joints, sharp edges in the road, etc.)

 **NOTICE**

■ **When inspecting and adjusting tire inflation pressure**

Be sure to put the tire valve caps back on. If a valve cap is not installed, dirt or moisture may get into the valve and cause an air leak, resulting in decreased tire inflation pressure.

**Wheels**

**If a wheel is bent, cracked or heavily corroded, it should be replaced. Otherwise, the tire may separate from the wheel or cause a loss of handling control.**

**Wheel selection**

When replacing wheels, care should be taken to ensure that they are equivalent to those removed in load capacity, diameter, rim width and inset\*.

Replacement wheels are available at your Lexus dealer.

\*: Conventionally referred to as offset.

Lexus does not recommend using the following:

- Wheels of different sizes or types
- Used wheels
- Bent wheels that have been straightened

■ **When replacing wheels**

The wheels of your vehicle are equipped with tire pressure warning valves and transmitters that allow the tire pressure warning system to provide advance warning in the event of a loss in tire inflation pressure. Whenever wheels are replaced, tire pressure warning valves and transmitters must be installed. (→P.370)

 **WARNING**

■ **When replacing wheels**

- Do not use wheels that are a different size from those recommended in the Owner's Manual, as this may result in a loss of handling control.

**⚠ WARNING**

- Never use an inner tube in a leaking wheel which is designed for a tubeless tire. Doing so may result in an accident, causing death or serious injury.

**■ Use of defective wheels prohibited**

Do not use cracked or deformed wheels. Doing so could cause the tire to leak air during driving, possibly causing an accident.

**⚠ NOTICE****■ Replacing tire pressure warning valves and transmitters**

- Because tire repair or replacement may affect the tire pressure warning valves and transmitters, make sure to have tires serviced by your Lexus dealer or other qualified service shop. In addition, make sure to purchase your tire pressure warning valves and transmitters at your Lexus dealer.
- Ensure that only genuine Lexus wheels are used on your vehicle. Tire pressure warning valves and transmitters may not work properly with non-genuine wheels.

**Aluminum wheel precautions**

- Use only Lexus wheel nuts and wrenches designed for use with your aluminum wheels.
- When rotating, repairing or changing your tires, check that the wheel nuts are still tight after driving 1000 miles (1600 km).
- Be careful not to damage the aluminum wheels when using tire chains.
- Use only Lexus genuine balance weights or equivalent and a plastic

or rubber hammer when balancing your wheels.

### Air conditioning filter

The air conditioning filter must be changed regularly to maintain air conditioning efficiency.

### Removing the air conditioning filter

- 1 Turn the engine switch off.
- 2 Open the glove box. Slide off the damper.

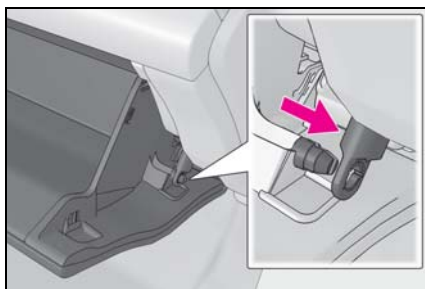

- 3 Push in the glove box on the vehicle's outer side to disconnect the claws. Then pull out the glove box and disconnect the lower claws.

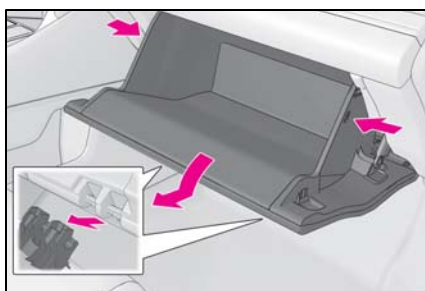

- 4 Remove the cover.

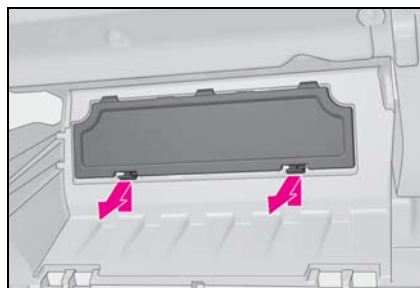

- 5 Unlock the filter cover (A), pull the filter cover out of the claws (B), and remove the filter cover.

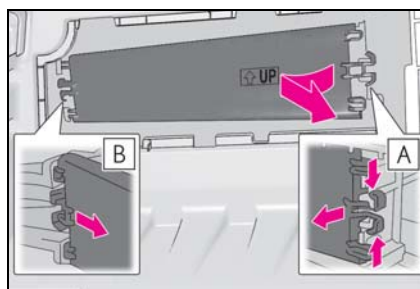

- 6 Remove the filter case.

There may be foreign objects on top of the air conditioning filter.

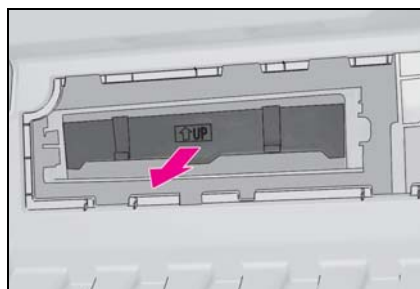

- 7 Remove the air conditioning filter from the filter case and replace it with a new one.

The "↑ UP" marks shown on the filter



and the filter case should be pointing up.

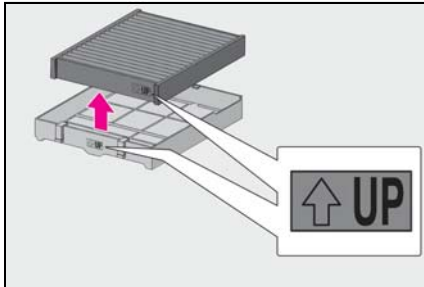

■ **Checking interval**

Inspect and replace the air conditioning filter according to the maintenance schedule. In dusty areas or areas with heavy traffic flow, early replacement may be required. (For scheduled maintenance information, please refer to the “Owner’s Manual Supplement” or “Scheduled Maintenance.”)

■ **If air flow from the vents decreases dramatically**

The filter may be clogged. Check the filter and replace if necessary.

■ **Air conditioning filter with deodorizing function**

When fragrances are placed in your vehicle, the deodorizing effect may become significantly weakened in a short period. When an air conditioning odor comes out continuously, replace the air conditioning filter.

 **NOTICE**

■ **When using the air conditioning system**

Make sure that a filter is always installed. Using the air conditioning system without a filter may cause damage to the system.

■ **To prevent damage to the filter cover**

When moving the filter cover in the direction of arrow to release the fitting, pay attention not to apply excessive force to the claws. Otherwise, the claws may be damaged.

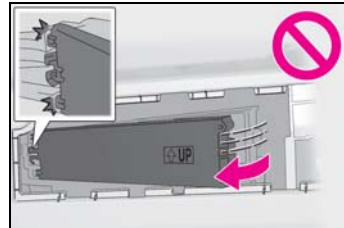

## Windshield wiper inserts

### Replacing a windshield wiper insert

- 1 Change the rest position of the windshield wipers to the service position using the wiper lever and then lift a windshield wiper. (→P.198)
- 2 While pressing and holding the wiper blade lock release button, remove the wiper blade.

When performing this operation, make sure to hold the hook portion of the wiper arm securely.

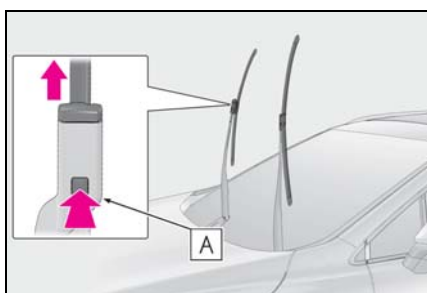

**A** Hook portion

- 3 While disengaging the cap lock, using a tool such as a flathead screwdriver if necessary, remove the wiper insert.

Hold the cap on the end of the wiper insert when removing the wiper insert. (The cap is integrated into the wiper insert.)

If using a screwdriver, make sure to wrap its

tip with tape to protect the wiper blade.

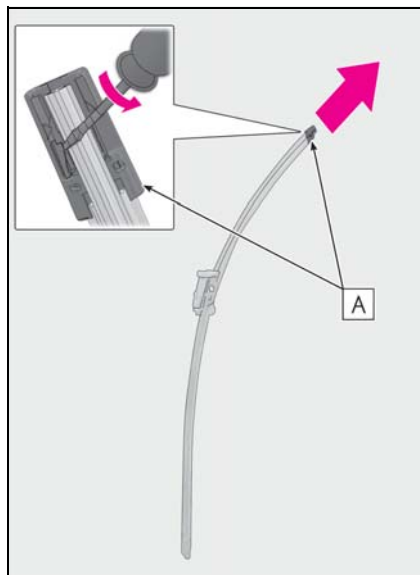

**A** Cap lock

- 4 Install a new wiper insert.

Make sure to push the wiper insert firmly until the cap lock is engaged.

After installation, check that the cap lock is locked securely.

- 5 Install the wiper blade to the wiper arm.

Make sure to push the wiper blade until it is locked.

When performing this operation, make sure to hold the hook portion of the wiper arm securely.

After installation, check that the wiper blade is locked securely.

- 6 After replacing the wiper inserts, place the windshield wipers on the windshield and lower them to the retracted position. (→P.198)

Do not drive the vehicle with the windshield wipers lifted.

#### ■ Replacing the rear wiper insert

Have the rear wiper insert replaced by your Lexus dealer.

#### ■ Handling of the windshield wiper blades and inserts

Improper handling of the windshield wiper blades and inserts may cause them to be damaged. If it is difficult to follow the wiper blade and insert replacement procedure precisely, contact your Lexus dealer.

### Electronic key battery

#### Replace the battery with a new one if it is depleted.

#### ■ If the electronic key battery is depleted

The following symptoms may occur:

- The smart access system with push-button start and wireless remote control will not function properly.
- The operational range will be reduced.

#### You will need the following items:

- Flathead screwdriver
- Lithium battery CR2032

#### ■ Use a CR2032 lithium battery

- Batteries can be purchased at your Lexus dealer, local electrical appliance shops or camera stores.
- Replace only with the same or equivalent type recommended by the manufacturer.
- Dispose of used batteries according to the local laws.

### Replacing the battery

- 1 Take out the mechanical key.

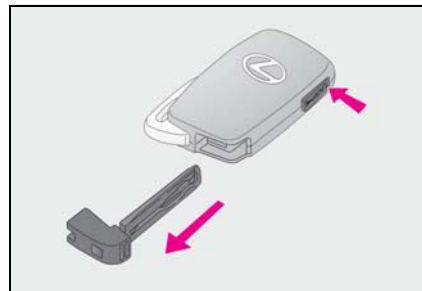

- 2 Remove the cover.

To prevent damage to the key, cover the tip

of the flathead screwdriver with a tape.

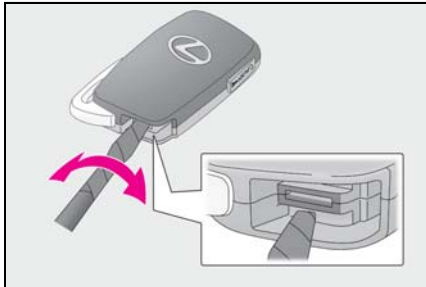

**3** Remove the depleted battery.

When removing the cover, the electronic key module may stick to the cover and the battery may not be visible. In this case, remove the electronic key module in order to remove the battery.

Insert a new battery with the “+” terminal facing up.

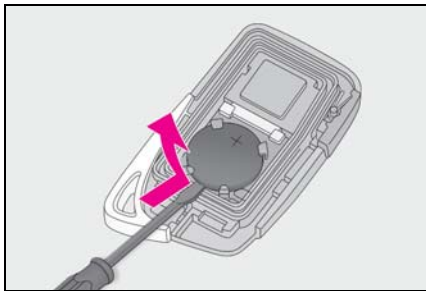

**⚠ WARNING**

■ **Battery precautions**

Observe the following precautions. Failure to do so may result in death or serious injury.

- Do not swallow the battery. Doing so may cause chemical burns.
- A coin battery or button battery is used in the electronic key. If a battery is swallowed, it may cause severe chemical burns in as little as 2 hours and may result in death or serious injury.
- Keep away new and removed batteries from children.

- If the cover cannot be firmly closed, stop using the electronic key and stow the key in the place where children cannot reach, and then contact your Lexus dealer.

- If you accidentally swallow a battery or put a battery into a part of your body, get emergency medical attention immediately.

■ **To prevent battery explosion or leakage of flammable liquid or gas**

- Replace the battery with a new battery of the same type. If a wrong type of battery is used, it may explode.

- Do not expose batteries to extremely low pressure due to high altitude or extremely high temperatures.

- Do not burn, break or cut a battery.

**⚠ NOTICE**

■ **For normal operation after replacing the battery**

Observe the following precautions to prevent accidents:

- Always work with dry hands. Moisture may cause the battery to rust.
- Do not touch or move any other component inside the remote control.
- Do not bend either of the battery terminals.

### Checking and replacing fuses

If any of the electrical components do not operate, a fuse may have blown. If this happens, check and replace the fuses as necessary.

### Checking and replacing fuses

- 1 Turn the engine switch off.
- 2 Open the fuse box cover.
  - ▶ Engine compartment
 Push the tab in and lift the lid off.

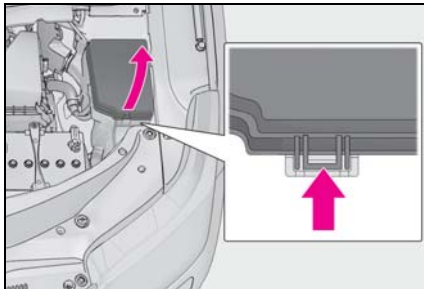

- ▶ Driver's side instrument panel
- Remove the lid.

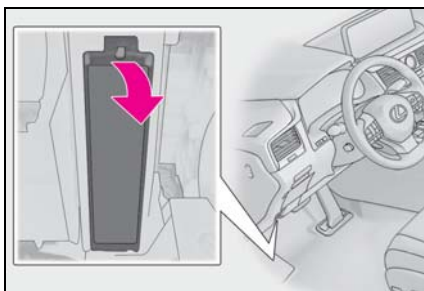

- 3 Remove the fuse with the pullout tool.

Only some fuses can be removed using the pullout tool.

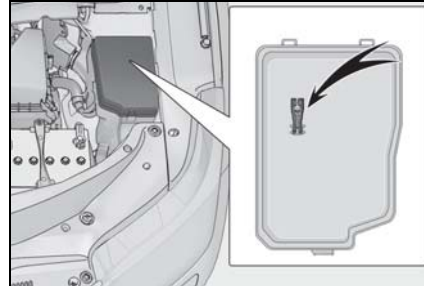

- 4 Check if the fuse is blown.

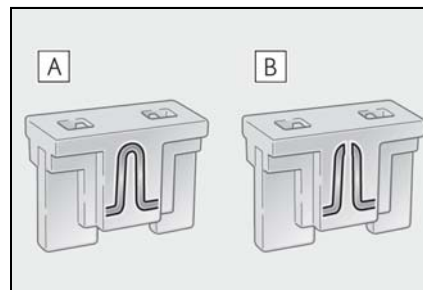

- A Normal fuse
- B Blown fuse

Replace the blown fuse with a new fuse of an appropriate amperage rating. The amperage rating can be found on the fuse box lid.

Many types of fuse are used on this vehicle. This illustration shows a common type of fuse used on this vehicle.

#### ■ After a fuse is replaced

- If the lights do not turn on even after the fuse has been replaced, a bulb may need replacement. (→P.384)
- If the replaced fuse blows again, have the vehicle inspected by your Lexus dealer.

#### ■ If there is an overload in a circuit

The fuses are designed to blow, protecting the wiring harness from damage.

■ **When replacing light bulbs**

Lexus recommends that you use genuine Lexus products designed for this vehicle. Because certain bulbs are connected to circuits designed to prevent overload, non-genuine parts or parts not designed for this vehicle may be unusable.

**⚠ WARNING**

■ **To prevent system breakdowns and vehicle fire**

Observe the following precautions. Failure to do so may cause damage to the vehicle, and possibly a fire or injury.

- Never use a fuse of a higher amperage rating than that indicated, or use any other object in place of a fuse.
- Always use a genuine Lexus fuse or equivalent. Never replace a fuse with a wire, even as a temporary fix.
- Do not modify the fuses or fuse boxes.

**⚠ NOTICE**

■ **Before replacing fuses**

Have the cause of electrical overload determined and repaired by your Lexus dealer as soon as possible.

**Headlight aim**

**Vertical movement adjusting bolts**

- ▶ Vehicles without single-beam headlights

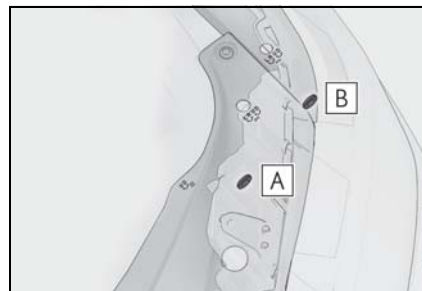

- A** Adjustment bolt A
- B** Adjustment bolt B

- ▶ Vehicles with single-beam headlights

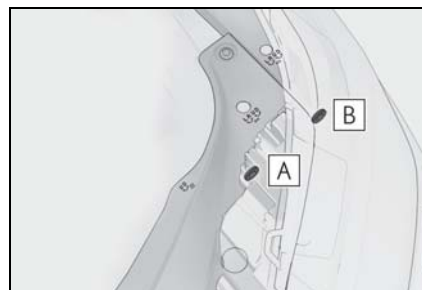

- A** Adjustment bolt A
- B** Adjustment bolt B

**Before checking the headlight aim**

- 1 Make sure the vehicle has a full tank of gasoline and the area around the headlight is not deformed.

- 2 Park the vehicle on level ground.
- 3 Sit in the driver's seat.
- 4 Bounce the vehicle several times.

### Adjusting the headlight aim

- 1 Using a phillips-head screwdriver, turn bolt A in either direction.

Remember the turning direction and the number of turns.

- ▶ Vehicles without single-beam headlights

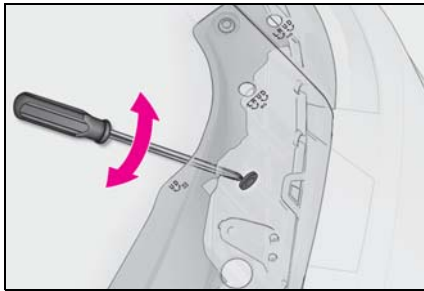

- ▶ Vehicles with single-beam headlights

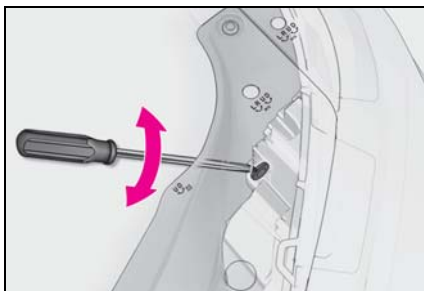

- 2 Turn bolt B the same number of turns and in the same direction as step 1.

If the headlight cannot be adjusted using this procedure, take the vehicle to your Lexus dealer to adjust the headlight aim.

- ▶ Vehicles without single-beam headlights

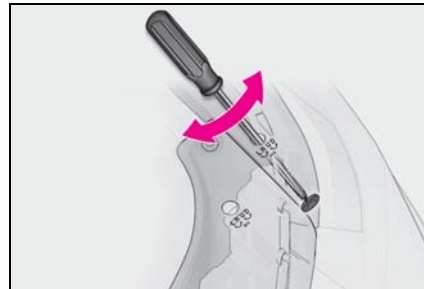

- ▶ Vehicles with single-beam headlights

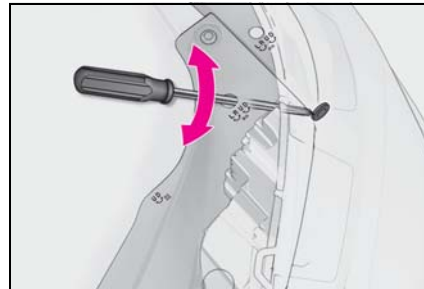

### Light bulbs

You may replace the following bulbs by yourself. The difficulty level of replacement varies depending on the bulb. If necessary bulb replacement seems difficult to perform, contact your Lexus dealer.

For more information about replacing other light bulbs, contact your Lexus dealer.

### Preparing for light bulb replacement

Check the wattage of the light bulb to be replaced. (→P.449)

### Canceling the power back door system

→P.113

### Bulb locations

#### ■ Front

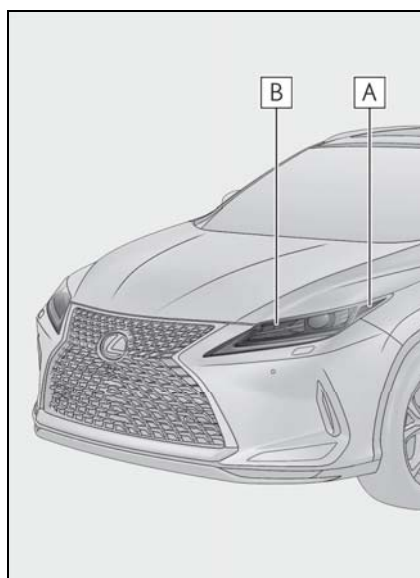

- A** Front side marker light (vehicles with single-beam headlights)
- B** Front turn signal light (vehicles with single-beam headlights)



### ■ Rear



**A** Back-up light (bulb type)

**B** Rear turn signal light (bulb type)

### ■ Replacing the following bulbs

If any of the lights listed below has burnt out, have it replaced by your Lexus dealer.

- Headlight
- Parking lights and daytime running lights
- Front turn signal lights (vehicles without single-beam headlights)
- Front side marker lights (vehicles without single-beam headlights)
- Front fog lights (if equipped)
- Cornering lights (if equipped)
- Side turn signal lights
- Stop/tail lights
- Back-up lights (LED type)

- Rear turn signal light (LED type)
- Rear side marker lights
- High mounted stoplight
- License plate lights
- Outer foot lights

### ■ LED Lights

The lights other than the front turn signal lights (vehicles with single-beam headlights), front side marker lights (vehicles with single-beam headlights), rear turn signal lights (bulb type) and back-up lights (bulb type) each consist of a number of LEDs. If any of the LEDs burn out, take your vehicle to your Lexus dealer to have the light replaced.

### ■ Condensation build-up on the inside of the lens

Temporary condensation build-up on the inside of the headlight lens does not indicate a malfunction. Contact your Lexus dealer for more information in the following situations:

- Large drops of water have built up on the inside of the lens.
- Water has built up inside the headlight.

### ■ When replacing light bulbs

→P.382

## Replacing light bulbs

### ■ Front side marker lights (vehicles with single-beam headlights)

- 1 To ensure enough space to perform work, turn the steering wheel to rotate the front wheel away from the bulb to be replaced.  
Remove the 3 fender liner clips.

Turn the steering wheel to the left when replacing the right side light bulb, and turn the steering wheel to the right when replacing the left side light bulb.

When removing a fender liner clip, use a

flathead screwdriver to pry the center portion out and then remove the whole clip.

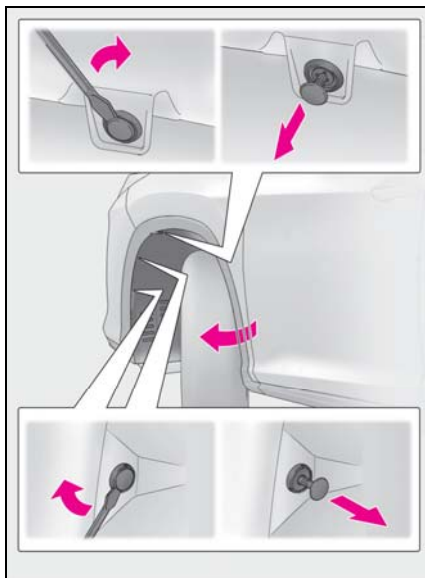

2 Pull back the fender liner until the connector is visible.

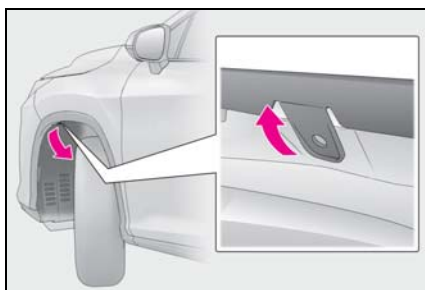

3 Partially remove the fender liner and turn the bulb base counter-clockwise and remove it.

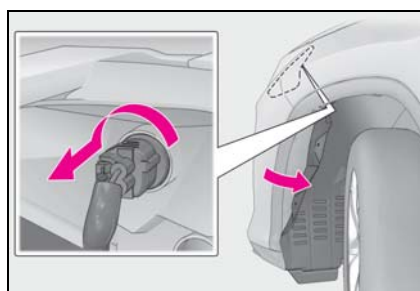

4 Remove the light bulb.

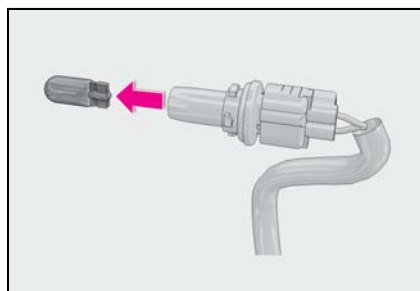

5 Install a new light bulb and then install the bulb base to the light unit by inserting it and turning it clockwise.

After installing the bulb base, wiggle it lightly to make sure it is securely installed and turn the lights on to visually check that there is no light leaking from between the bulb base and light unit.

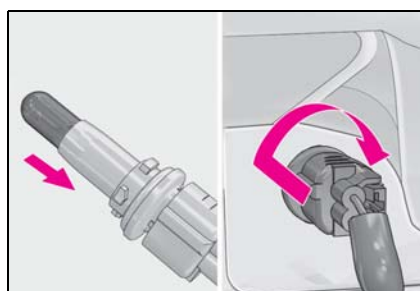

- 6** Reinstall the fender liner and install the 3 fender liner clips.

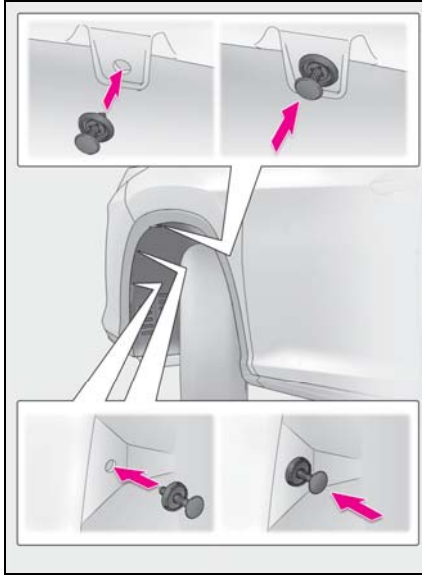

■ **Front turn signal lights (vehicles with single-beam headlights)**

- 1** Removing the engine compartment cover.

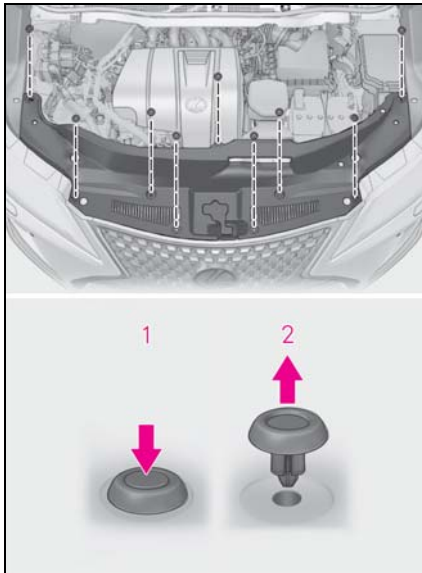

- 1** Push the center of the clip.  
**2** Remove the clip.  
**2** For the right side only: Remove the bolt, and move the washer fluid inlet.

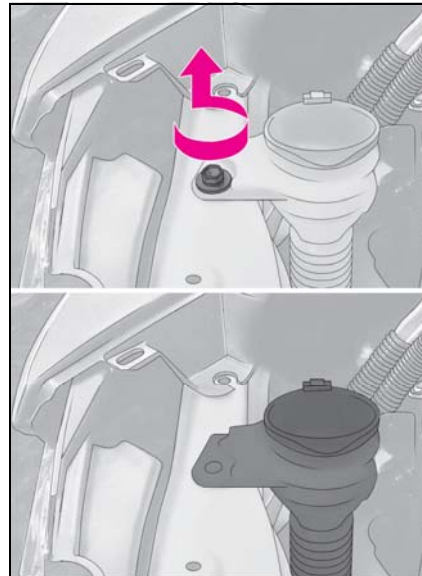

- 3** Turn the bulb base counterclockwise and remove it.

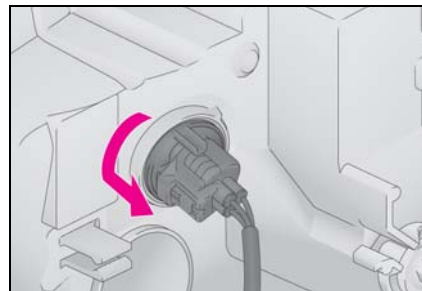

- 4 Remove the light bulb.

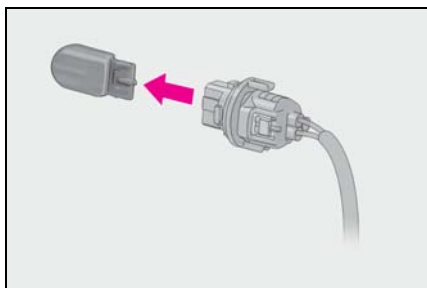

- 5 Install a new light bulb and then install the bulb base to the light unit by inserting it and turning it clockwise.

After installing the bulb base, wiggle it lightly to make sure it is securely installed and turn the lights on to visually check that there is no light leaking from between the bulb base and light unit.

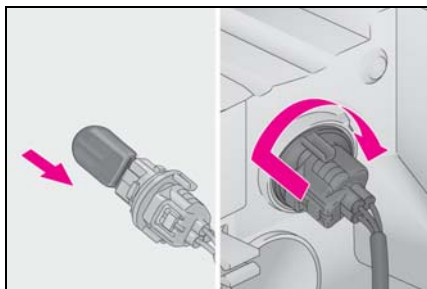

- 6 For the right side only: Fix the washer fluid inlet.

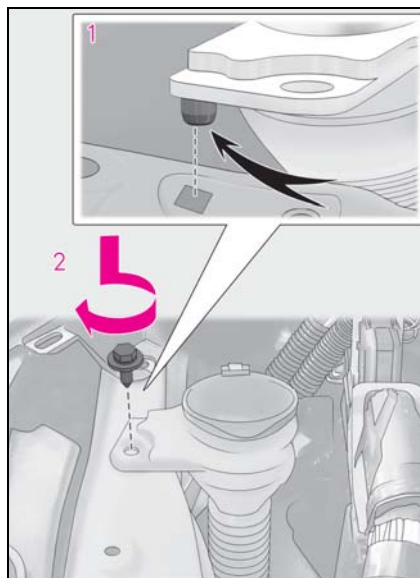

- 1 Align the tab position and install washer fluid inlet.  
2 Fasten the bolt.

- 7** Install the engine compartment cover.

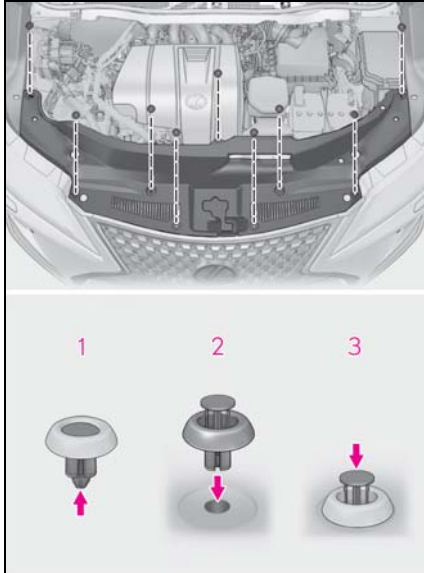

- 1** Push up center portion  
**2** Insert  
**3** Press

■ **Rear turn signal lights (bulb type)**

- 1** Open the back door and apply protective tape to the vehicle body around the taillight.

Use masking tape, etc. Do not use duct tape, as it may leave residue or damage the paint when removed.

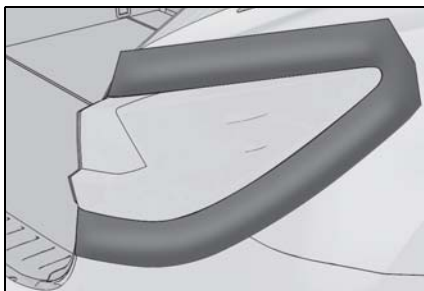

- 2** Using a flathead screwdriver, remove the cover.

To prevent scratching the vehicle, wrap the tip of the flathead screwdriver with a cloth, etc.

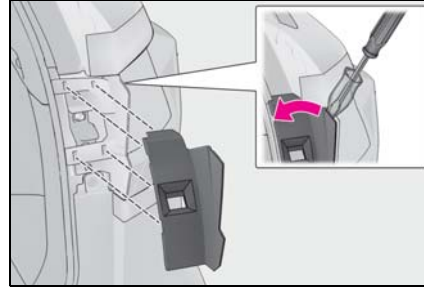

- 3** Remove the 2 screws.

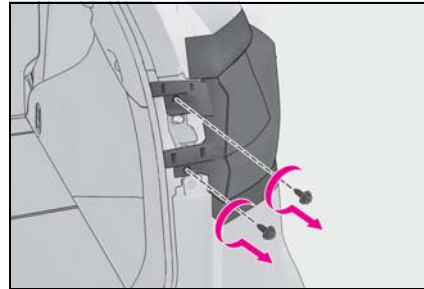

- 4** Remove the taillight unit.

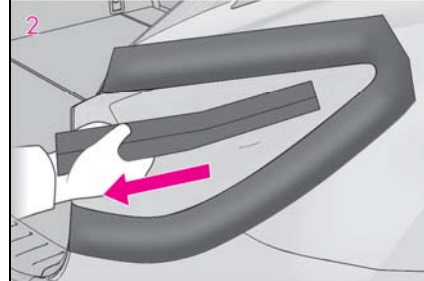
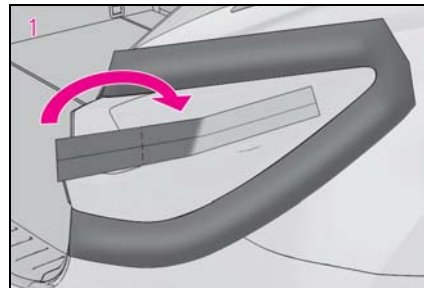

- 1** Attach 2 long pieces of masking

tape to the taillight unit and fold the excess in half.

- 2 Hold the folded portion and pull it toward the rear of the vehicle to remove the light unit.
- 5 Turn the bulb base counterclockwise and remove it.

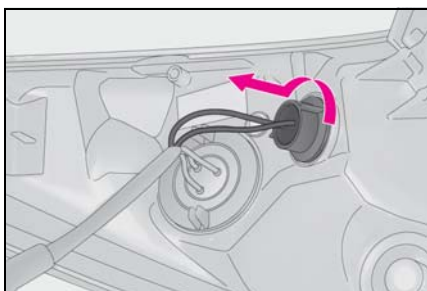

- 6 Remove the light bulb.

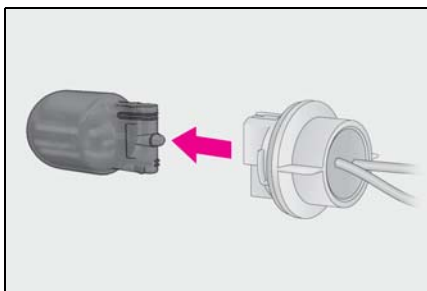

- 7 Install a new light bulb and then install the bulb base to the light unit by inserting it and turning it clockwise.

After installing the bulb base, wiggle it lightly to make sure it is securely installed and turn on the rear turn signal lights to visually check that there is no light leaking

from between the bulb base and light unit.

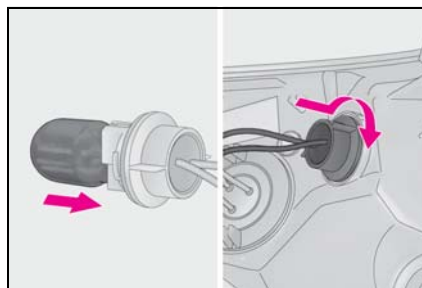

- 8 Install the light unit.

Align the tabs and push the light unit toward the front of the vehicle to install it.

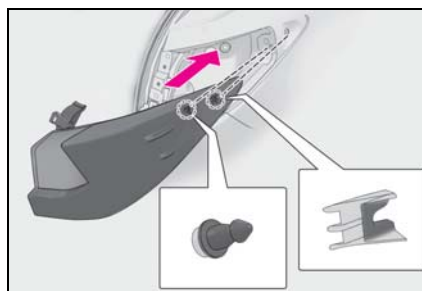

- 9 Install the 2 screws.

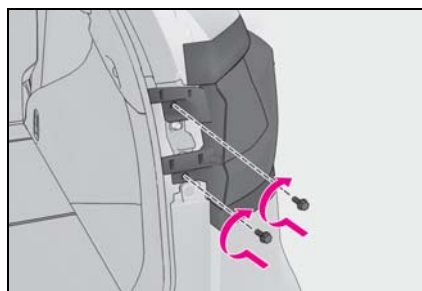

**10** Install the cover.

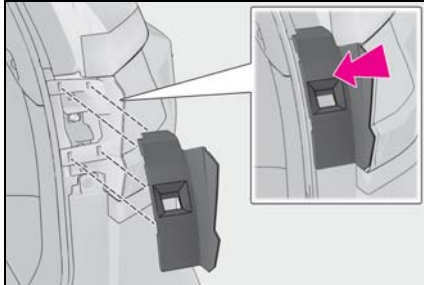

**11** Remove the protective tape.

■ **Back-up lights (bulb type)**

**1** Open the back door and remove the cover.

Using a flathead screwdriver, remove the cover.

To prevent scratching to the vehicle, wrap the tip of the flathead screwdriver with a cloth, etc.

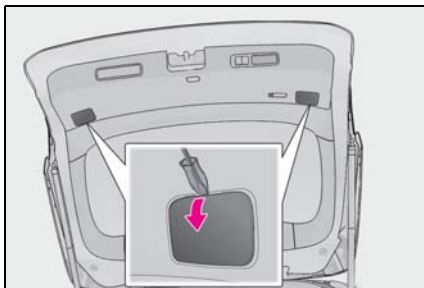

**2** Turn the bulb base counterclockwise and remove it.

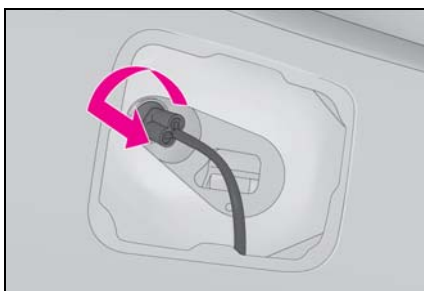

**3** Remove the light bulb.

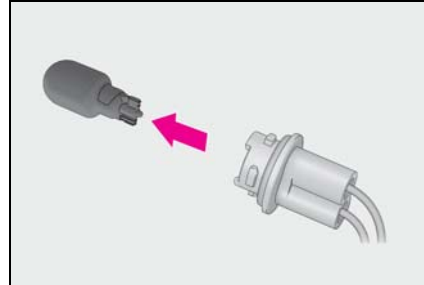

**4** Install a new light bulb and then install the bulb base to the light unit by inserting it and turning it clockwise.

After installing the bulb base, wiggle it lightly to make sure it is securely installed and turn on the back-up lights to visually check that there is no light leaking from between the bulb base and light unit.

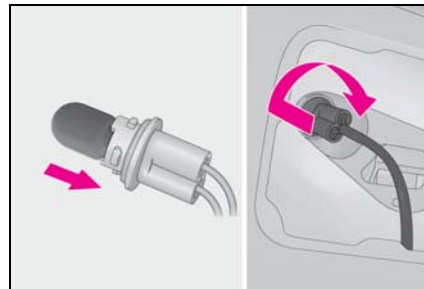

**5** Install the cover.

Align the tabs of the cover with the grooves and install the cover.

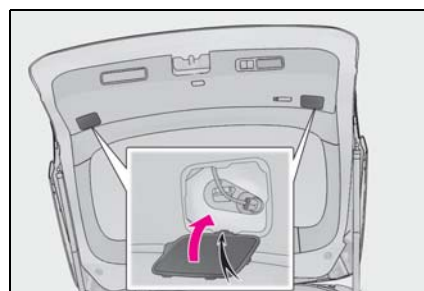

**WARNING****■ To prevent injury**

Before performing any light bulb replacement procedure, be sure to turn the engine switch off. Failure to do so may result in burns from hot components or a part of your body may get caught on an operating component, possibly causing serious injury.

**■ Replacing light bulbs**

- Turn off the lights. Do not attempt to replace the bulb immediately after turning off the lights.  
The bulbs become very hot and may cause burns.
  - Do not touch the glass portion of the light bulb with bare hands. When it is unavoidable to hold the glass portion, use and hold with a clean dry cloth to avoid getting moisture and oils on the bulb.  
Also, if the bulb is scratched or dropped, it may blow out or crack.
  - Fully install light bulbs and any parts used to secure them. Failure to do so may result in heat damage, fire, or water entering the headlight unit. This may damage the headlights or cause condensation to build up on the lens.
  - Do not attempt to repair or disassemble the light bulbs, connectors, electric circuits or component parts.  
Doing so may result in death or serious injury due to electric shock.
- To prevent damage or fire**
- Make sure bulbs are fully seated and locked.
  - Check the wattage of the bulb before installing to prevent heat damage.



## When trouble arises

## 7

## 7-1. Essential information

Emergency flashers..... 394

If your vehicle has to be stopped in  
an emergency..... 394

If the vehicle is trapped in rising  
water..... 395

## 7-2. Steps to take in an emergency

If your vehicle needs to be towed  
..... 397

If you think something is wrong  
..... 401

Fuel pump shut off system ..... 402

If a warning light turns on or a  
warning buzzer sounds ..... 403

If a warning message is displayed  
..... 412

If you have a flat tire..... 416

If the engine will not start ..... 428

If you lose your keys..... 430

If the fuel filler door cannot be  
opened..... 430

If the electronic key does not  
operate properly ..... 431

If the vehicle battery is discharged  
..... 433

If your vehicle overheats ..... 437

If the vehicle becomes stuck  
..... 439

### Emergency flashers

The emergency flashers are used to warn other drivers when the vehicle has to be stopped on the road due to a breakdown, etc.

### Operating instructions

Press the switch.

All the turn signal lights will flash. To turn them off, press the switch once again.

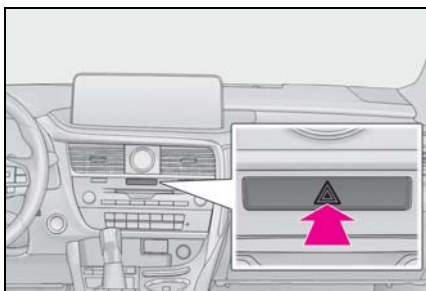

### Emergency flashers

- If the emergency flashers are used for a long time while the engine is not operating, the battery may discharge.
- If any of the SRS airbags deploy (inflate) or in the event of a strong rear impact, the emergency flashers will turn on automatically. The emergency flashers will turn off automatically after operating for approximately 20 minutes. To manually turn the emergency flashers off, press the switch twice. (The emergency flashers may not turn on automatically depending on the force of the impact and conditions of the collision.)

### If your vehicle has to be stopped in an emergency

Only in an emergency, such as if it becomes impossible to stop the vehicle in the normal way, stop the vehicle using the following procedure:

### Stopping the vehicle

- 1 Steadily step on the brake pedal with both feet and firmly depress it.

Do not pump the brake pedal repeatedly as this will increase the effort required to slow the vehicle.

- 2 Shift the shift lever to N.
  - ▶ If the shift lever is shifted to N
- 3 After slowing down, stop the vehicle in a safe place by the road.
- 4 Stop the engine.
  - ▶ If the shift lever cannot be shifted to N
- 3 Keep depressing the brake pedal with both feet to reduce vehicle speed as much as possible.
- 4 To stop the engine, press and hold the engine switch for 2 consecutive

seconds or more, or press it briefly 3 times or more in succession.

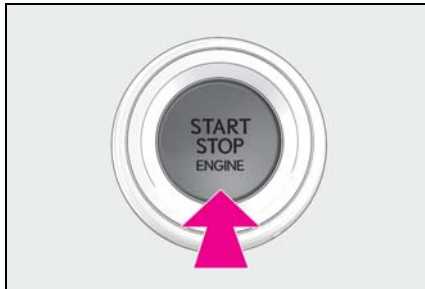

- 5 Stop the vehicle in a safe place by the road.

**⚠ WARNING**

■ **If the engine has to be turned off while driving**

Power assist for the brakes and steering wheel will be lost, making the brake pedal harder to depress and the steering wheel heavier to turn. Decelerate as much as possible before turning off the engine.

**If the vehicle is trapped in rising water**

**In the event the vehicle is submerged in water, remain calm and perform the following.**

- Remove the seat belt first.
- If the door can be opened, open the door and exit the vehicle.
- If the door can not be opened, open the window using the power window switch and exit the vehicle through the window.
- If the window can not be opened using the power window switch, remain calm, wait until the water level inside the vehicle rises to the point that the water pressure inside of the vehicle equals the water pressure outside of the vehicle, and then open the door and exit the vehicle.

**⚠ WARNING**

■ **Using an emergency hammer\* for emergency escape**

The rear side windows and rear window of this vehicle can be shattered by an emergency hammer\* used for emergency escape, however, since the windshield and front side windows are laminated glass they can not be shattered by an emergency hammer\*.

\*: Contact your Lexus dealer or after-market accessory manufacturer for further information about an emergency hammer.

**WARNING****■ Escaping the vehicle from the window**

There are cases where escaping the vehicle from the window is not possible due to seating position, passenger body type, etc.

When using an emergency hammer, consider your seat location and the size of the window opening to ensure that the opening is accessible and large enough to escape.

### If your vehicle needs to be towed

If towing is necessary, we recommend having your vehicle towed by your Lexus dealer or commercial towing service, using a wheel-lift type truck or flatbed truck.

Use a safety chain system for all towing, and abide by all state/provincial and local laws.

2WD models: If towing your vehicle with a wheel-lift type truck from the front, the vehicle's rear wheels and axles must be in good conditions. (→P.398, 397)

If they are damaged, use a towing dolly or flatbed truck.

AWD models: If towing your vehicle with a wheel-lift type truck, use a towing dolly. (→P.398, 397)

#### WARNING

Observe the following precautions. Failure to do so may result in death or serious injury.

#### When towing the vehicle

##### ▶ 2WD models

Be sure to transport the vehicle with the front wheels raised or with all four wheels raised off the ground. If the vehicle is towed with the front wheels contacting the ground, the drivetrain and related parts may be damaged.

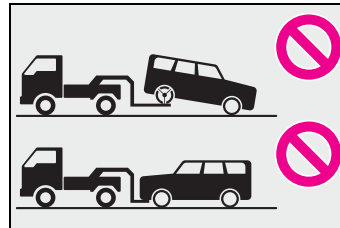

##### ▶ AWD models

Be sure to transport the vehicle with all four wheels raised off the ground. If the vehicle is towed with the tires contacting the ground, the drivetrain or related parts may be damaged, the vehicle may fly off the truck.

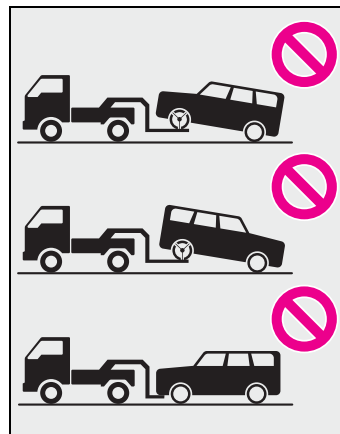

#### While towing

- When towing using cables or chains, avoid sudden starts, etc. which place excessive stress on the towing eyelets, cables or chains. The towing eyelets, cables or chains may become damaged, broken debris may hit people, and cause serious damage.

**⚠ WARNING**

- Do not turn the engine switch off. There is a possibility that the steering wheel is locked and cannot be operated.

- **Installing towing eyelets to the vehicle**

Make sure that towing eyelets are installed securely. If not securely installed, towing eyelets may come loose during towing.

**⚠ NOTICE**

- **To prevent damage to the vehicle when towing using a wheel-lift type truck**

- Do not tow the vehicle from the rear when the engine switch is off. The steering lock mechanism is not strong enough to hold the front wheels straight.
- When raising the vehicle, ensure adequate ground clearance for towing at the opposite end of the raised vehicle. Without adequate clearance, the vehicle could be damaged while being towed.

- **To prevent damage to the vehicle when towing with a sling-type truck**

Do not tow with a sling-type truck, either from the front or rear.

- **To prevent damage to the vehicle during emergency towing**

Do not secure cables or chains to the suspension components.

- **Recreational towing (behind motor home, etc.)**

Never dinghy tow your vehicle to prevent causing serious damage to the Dynamic Torque Control AWD system (AWD models) and transmission. (→P.173)

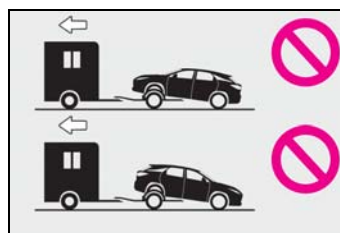

**Situations when it is necessary to contact dealers before towing**

The following may indicate a problem with your transmission. Contact your Lexus dealer or commercial towing service before towing.

- The engine is running but the vehicle does not move.
- The vehicle makes an abnormal sound.

**Towing with a wheel-lift type truck**

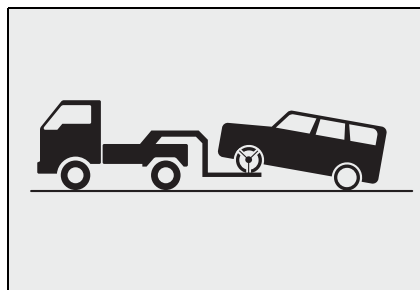
- ▶ From the front (2WD models)



Release the parking brake.

Turn automatic mode off. (→P.184)

- ▶ From the front (AWD models)

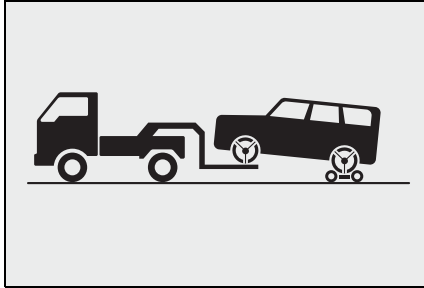

Use a towing dolly under the rear wheels.

- ▶ From the rear

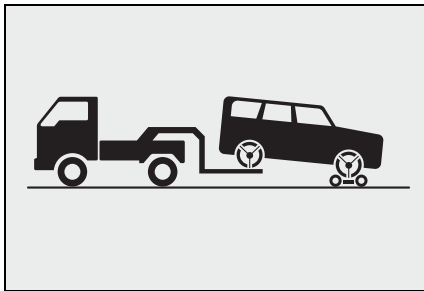

Use a towing dolly under the front wheels.



#### NOTICE

##### ■ Towing with a sling-type truck

Do not tow with a sling-type truck to prevent body damage.

- ▶ 2WD models

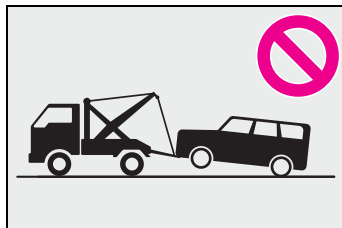

- ▶ AWD models

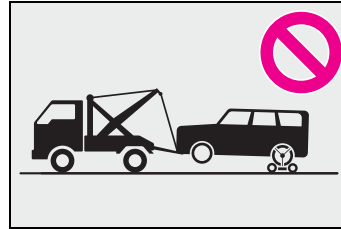

#### Using a flatbed truck

When using a flat-bed truck to transport the vehicle, use tire strapping belts. Refer to the owner's manual of the flat-bed truck for the tire strapping method.

In order to suppress vehicle movement during transportation, set the parking brake and turn the engine switch off.

#### Emergency towing (vehicles with towing eyelets)

If a tow truck is not available in an emergency, your vehicle may be temporarily towed using cables or chains secured to the emergency towing eyelets. This should only be attempted on hard surfaced roads for at most 50 miles (80 km) at under 18 mph (30 km/h).

A driver must be in the vehicle to steer and operate the brakes. The vehicle's wheels, drive train, axles, steering and brakes must be in good condition.

#### Emergency towing procedure (vehicles with towing eyelets)

To have your vehicle towed by another

vehicle, the towing eyelet must be installed to your vehicle. Install the towing eyelet using the following procedure.

- 1 Take out the towing eyelet. (→P.417)
- 2 Remove the eyelet cover.
  - ▶ Except F SPORT models

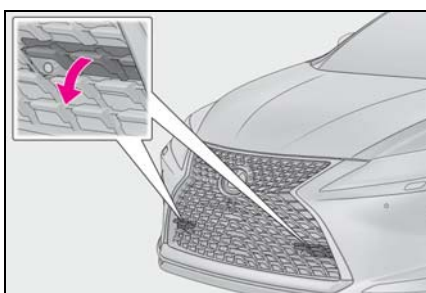

- ▶ F SPORT models

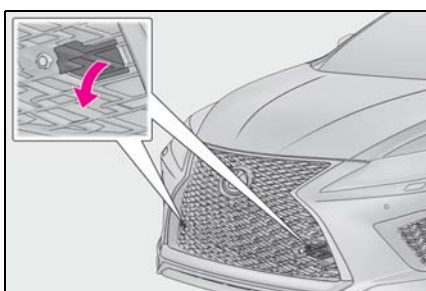

- 3 Insert the towing eyelet into the hole and tighten partially by hand.

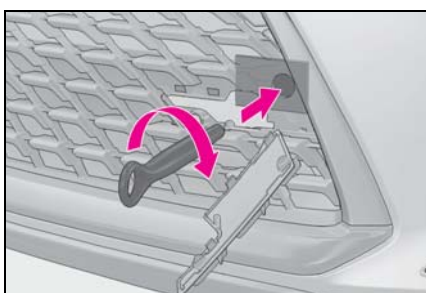

- 4 Tighten down the towing eyelet securely using a wheel nut wrench or hard metal bar.

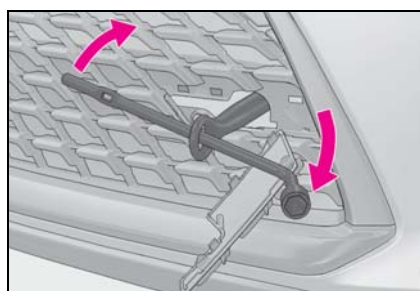

- 5 Securely attach cables or chains to the towing eyelet.

Take care not to damage the vehicle body.

- 6 Enter the vehicle being towed and start the engine.

If the engine does not start, turn the engine switch to ON.

- 7 Shift the shift lever to N and release the parking brake.

Turn automatic mode off. (→P.184)

When the shift lever cannot be shifted:  
→P.179

#### ■ While towing

If the engine is not running, the power assist for the brakes and steering will not function, making steering and braking more difficult.

#### ■ Wheel nut wrench

Wheel nut wrench is installed in luggage compartment. (→P.417)



**If you think something is wrong**

If you notice any of the following symptoms, your vehicle probably needs adjustment or repair. Contact your Lexus dealer as soon as possible.

**Visible symptoms**

- Fluid leaks under the vehicle (Water dripping from the air conditioning after use is normal.)
- Flat-looking tires or uneven tire wear
- Engine coolant temperature gauge needle continually points higher than normal

**Audible symptoms**

- Changes in exhaust sound
- Excessive tire squeal when cornering
- Strange noises related to the suspension system
- Pinging or other noises related to the engine

**Operational symptoms**

- Engine missing, stumbling or running roughly
- Appreciable loss of power
- Vehicle pulls heavily to one side when braking

- Vehicle pulls heavily to one side when driving on a level road
- Loss of brake effectiveness, spongy feeling, pedal almost touches the floor

### Fuel pump shut off system

To minimize the risk of fuel leakage when the engine stalls or when an airbag inflates upon collision, the fuel pump shut off system stops the supply of fuel to the engine.

### Restarting the engine

Follow the procedure below to restart the engine after the system is activated.

- 1 Turn the engine switch to ACCESSORY mode or turn it off.
- 2 Restart the engine.

 NOTICE

■ **Before starting the engine**



Inspect the ground under the vehicle. If you find that fuel has leaked onto the ground, the fuel system has been damaged and is in need of repair. Do not restart the engine.

### If a warning light turns on or a warning buzzer sounds

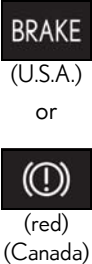

Calmly perform the following actions if any of the warning lights comes on or flashes. If a light comes on or flashes, but then goes off, this does not necessarily indicate a malfunction in the system. However, if this continues to occur, have the vehicle inspected by your Lexus dealer.

#### Actions to the warning lights or warning buzzers



##### ■ Brake system warning light

Warning light	Details/Actions
 <p><b>BRAKE</b> (U.S.A.) or  (red) (Canada)</p>	<p>Indicates that:</p> <ul style="list-style-type: none"> <li>● The brake fluid level is low; or</li> <li>● The brake system is malfunctioning</li> </ul> <p>→ <b>Immediately stop the vehicle in a safe place and contact your Lexus dealer. Continuing to drive the vehicle may be dangerous.</b></p>

##### ■ Brake system warning light

Warning light	Details/Actions
 <p> (yellow)</p>	<p>Indicates a malfunction in the electric parking brake</p> <p>→ <b>Have the vehicle inspected by your Lexus dealer immediately.</b></p>

##### ■ High coolant temperature warning light\* (warning buzzer)

Warning light	Details/Actions
 <p></p>	<p>Indicates that the engine coolant temperature is too high</p> <p>→ <b>Immediately stop the vehicle in a safe place.</b> Handling method (→P.437)</p>

\*: This light illuminates on the multi-information display.

■ Charging system warning light\*

Warning light	Details/Actions
	Indicates a malfunction in the vehicle's charging system → <b>Immediately stop the vehicle in a safe place and contact your Lexus dealer. Continuing to drive the vehicle may be dangerous.</b>



\* : Except F SPORT models: This light illuminates on the multi-information display.  
F SPORT models: This light illuminates on the meter.

■ Low engine oil pressure warning light\* (warning buzzer)

Warning light	Details/Actions
	Indicates that the engine oil pressure is too low → <b>Immediately stop the vehicle in a safe place and contact your Lexus dealer.</b>

\* : This light illuminates on the multi-information display.



■ Malfunction indicator lamp

Warning light	Details/Actions
 (U.S.A.) or  (Canada)	Indicates a malfunction in: <ul style="list-style-type: none"> <li>● The electronic engine control system;</li> <li>● The electronic throttle control system; or</li> <li>● The electronic automatic transmission control system</li> </ul> → <b>Have the vehicle inspected by your Lexus dealer immediately.</b>

■ SRS warning light

Warning light	Details/Actions
	Indicates a malfunction in: <ul style="list-style-type: none"> <li>● The SRS airbag system;</li> <li>● The front passenger occupant classification system; or</li> <li>● The seat belt pretensioner system</li> </ul> → <b>Have the vehicle inspected by your Lexus dealer immediately.</b>

### ■ ABS warning light



Warning light	Details/Actions
 (U.S.A.) or  (Canada)	Indicates a malfunction in: <ul style="list-style-type: none"> <li>● The ABS; or</li> <li>● The brake assist system</li> </ul> → <b>Have the vehicle inspected by your Lexus dealer immediately.</b>

### ■ Brake Override System warning light/Drive-Start Control warning light\* (warning buzzer)

Warning light	Details/Actions
	When a buzzer sounds: <ul style="list-style-type: none"> <li>● Brake Override System is malfunctioning;</li> <li>● Drive-Start Control is operating;</li> <li>● Drive-Start Control is malfunctioning; or</li> <li>● PKSB (Parking Support Brake) (if equipped) is operating</li> </ul> → <b>Follow the instructions displayed on the multi-information display.</b>  When a buzzer does not sound: Brake Override System is operating → <b>Release the accelerator pedal and depress the brake pedal.</b>

\*: This light illuminates on the multi-information display.

### ■ Electric power steering system warning light (warning buzzer)

Warning light	Details/Actions
 (red) or  (yellow)	Indicates a malfunction in the EPS (Electric Power Steering) system → <b>Have the vehicle inspected by your Lexus dealer immediately.</b>

■ Low fuel level warning light

Warning light	Details/Actions
	Indicates that remaining fuel is approximately 2.8 gal. (10.8 L, 2.3 Imp. gal.) or less → <b>Refuel the vehicle.</b>

■ Driver's and front passenger's seat belt reminder light (warning buzzer)\*

Warning light	Details/Actions
	Warns the driver and/or front passenger to fasten their seat belts → <b>Fasten the seat belt.</b> If the front passenger's seat is occupied, the front passenger's seat belt also needs to be fastened to make the warning light (warning buzzer) turn off.



\*: Driver's seat belt warning buzzer:

The driver's seat belt warning buzzer sounds to alert the driver that his or her seat belt is not fastened. Once the engine switch is turned to IGNITION ON mode, the buzzer sounds. If the seat belt is still unfastened, the buzzer sounds intermittently for a certain period of time after the vehicle reaches a certain speed.

Front passenger's seat belt warning buzzer:

The front passenger's seat belt warning buzzer sounds to alert the front passenger that his or her seat belt is not fastened. If the seat belt is unfastened, the buzzer sounds intermittently for a certain period of time after the vehicle reaches a certain speed.

■ Rear passengers' seat belt reminder light \*1(warning buzzer)\*2

Warning light	Details/Actions
 (RX350) or  (RX350L)	Warns the rear passengers to fasten their seat belts → <b>Fasten the seat belt.</b>

\*1: This light illuminates on the center panel.

Regardless of whether or not a rear passenger is present, if the engine switch is turned to IGNITION ON mode with the rear seat belts unfastened, this light will also illuminate for a certain period of time.

\*2: Rear passengers' seat belt warning buzzer:

The rear passengers' seat belt warning buzzer sounds to alert the rear passenger that his or

her seat belt is not fastened. If the seat belt is unfastened, the buzzer sounds intermittently for a certain period of time, after the seat belt is fastened and unfastened and the vehicle reaches a certain speed.

#### ■ Tire pressure warning light

Warning light	Details/Actions
	<p>Indicates the following:</p> <ul style="list-style-type: none"> <li>● Low tire pressure due to flat tire;</li> <li>● Low tire pressure due to natural causes; or</li> <li>● The tire pressure warning system is malfunctioning</li> </ul> <p>→ <b>Immediately stop the vehicle in a safe place.</b> Handling method (→P.410)</p>

#### ■ LTA indicator (warning buzzer)

Warning light	Details/Actions
 (orange)	<p>Indicates a malfunction in the LTA (Lane Tracing Assist)</p> <p>→ <b>Follow the instructions displayed on the multi-information display.</b> (→P.224)</p>

#### ■ Intuitive parking assist OFF indicator (warning buzzer)

Warning light	Details/Actions
 (flashes) (if equipped)	<p>Indicates a malfunction in the intuitive parking assist function</p> <p>→ <b>Have the vehicle inspected by your Lexus dealer immediately.</b></p> <p>Indicates that the system is temporarily unavailable, possibly due to a sensor being dirty or covered with ice, etc.</p> <p>→ <b>Follow the instructions displayed on the multi-information display.</b> (→P.246)</p>

#### ■ RCTA OFF indicator (warning buzzer)

Warning light	Details/Actions
 (flashes) (if equipped)	<p>Indicates a malfunction in the RCTA (Rear Cross Traffic Alert) function</p> <p>→ <b>Have the vehicle inspected by your Lexus dealer immediately.</b></p> <p>Indicates that the rear bumper around the radar sensor is covered with dirt, etc. (→P.238)</p> <p>→ <b>Follow the instructions displayed on the multi-information display.</b> (→P.251)</p>

■ PKSB OFF indicator (warning buzzer)

Warning light	Details/Actions
 <p>(flashes) (if equipped)</p>	<p>When a buzzer sounds: Indicates a malfunction in the PKSB (Parking Support Brake) system → <b>Have the vehicle inspected by your Lexus dealer immediately.</b></p> <p>When a buzzer does not sound: Indicates that the system is temporarily unavailable, possibly due to a sensor being dirty or covered with ice, etc. → <b>Follow the instructions displayed on the multi-information display.</b> (→P.260, 412)</p>

■ PCS warning light

Warning light	Details/Actions
 <p>(flashes or illuminates)</p>	<p>When a buzzer sounds simultaneously: Indicates a malfunction has occurred in the PCS (Pre-Collision System). → <b>Have the vehicle inspected by your Lexus dealer immediately.</b></p> <p>When a buzzer does not sound: The PCS (Pre-Collision System) has become temporarily unavailable, corrective action may be necessary. → <b>Follow the instructions displayed on the multi-information display.</b> (→P.207, 415)</p> <p>If the PCS (Pre-Collision System) or VSC (Vehicle Stability Control) system is disabled, the PCS warning light will illuminate. → P.215</p>

■ Slip indicator

Warning light	Details/Actions
	<p>When the warning light is illuminated: Indicates a malfunction in: ● The VSC system; ● The TRAC system; ● The Trailer Sway Control; or ● The hill-start assist control system; → <b>Have the vehicle inspected by your Lexus dealer immediately.</b></p> <p>When the warning light flashes: Indicates that the VSC, TRAC or Trailer Sway Control system is operating</p>

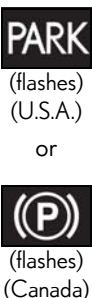

■ **Parking brake indicator**

Warning light	Details/Actions
 <p>(flashes) (U.S.A.) or (flashes) (Canada)</p>	<p>It is possible that the parking brake is not fully engaged or released → <b>Operate the parking brake switch once again.</b></p> <p>This light comes on when the parking brake is not released. If the light turns off after the parking brake is fully released, the system is operating normally.</p>

■ **Brake hold operated indicator**

Warning light	Details/Actions
 <p>(flashes)</p>	<p>Indicates a malfunction in the brake hold system → <b>Have the vehicle inspected by your Lexus dealer immediately.</b></p>

■ **Master warning light**

Warning light	Details/Actions
	<p>A buzzer sounds and the warning light comes on and flashes to indicate that the master warning system has detected a malfunction. → P.412</p>

■ **Warning buzzer**

In some cases, the buzzer may not be heard due to being in a noisy location or audio sound.

■ **Front passenger detection sensor, seat belt reminder and warning buzzer**

- If luggage is placed on the front passenger seat, the front passenger detection sensor may cause the warning light to flash and the warning buzzer to sound even if a passenger is not sitting in the seat.
- If a cushion is placed on the seat, the sensor may not detect a passenger, and the warning light may not operate properly.

■ **SRS warning light**

This warning light system monitors the air-

bag sensor assembly, front impact sensors, side impact sensors (front door), side impact sensors (rear), driver's seat position sensor, driver's seat belt buckle switch, front passenger occupant classification system (ECU and sensors), "AIR BAG ON" indicator light, "AIR BAG OFF" indicator light, front passenger's seat belt buckle switch, driver's seat belt pretensioner, front passenger's seat belt pretensioner and force limiter, airbags, interconnecting wiring and power sources. (→P.30)

■ **If the malfunction indicator lamp comes on while driving**

First check the following:

- Is the fuel tank empty?  
If it is, fill the fuel tank immediately.
- Is the fuel tank cap loose?  
If it is, tighten it securely.

The light will go off after several driving trips.

If the light does not go off even after several trips, contact your Lexus dealer as soon as possible.

■ **Electric power steering system warning light (warning buzzer)**

When the battery charge becomes insufficient or the voltage temporarily drops, the electric power steering system warning light may come on and the warning buzzer may sound.

■ **When the tire pressure warning light comes on**

Inspect the tires to check if a tire is punctured.

If a tire is punctured: →P.416

If none of the tires are punctured: Turn the engine switch off then turn it to IGNITION ON mode. Check if the tire pressure warning light comes on or blinks.

- ▶ If the tire pressure warning light blinks for 1 minute then stays on

There may be a malfunction in the tire pressure warning system. Have the vehicle inspected by your Lexus dealer immediately.

- ▶ If the tire pressure warning light comes on
  - 1 After the temperature of the tires has lowered sufficiently, check the inflation pressure of each tire and adjust them to the specified level.
  - 2 If the warning light does not turn off even after several minutes have elapsed, check that the inflation pressure of each tire is at the specified level and perform initialization. (→P.371)

If the warning light does not turn off several minutes after the initialization has been performed, have the vehicle inspected by your Lexus dealer immediately.

■ **The tire pressure warning light may come on due to natural causes**

The tire pressure warning light may come on due to natural causes such as natural air leaks and tire inflation pressure changes caused by temperature. In this case, adjust-

ing the tire inflation pressure will turn off the warning light (after a few minutes).

■ **When a tire is replaced with a spare tire**

The compact spare tire is not equipped with a tire pressure warning valve and transmitter. If a tire goes flat, the tire pressure warning light will not turn off even though the flat tire has been replaced with the spare tire. Replace the spare tire with the repaired tire and adjust the tire inflation pressure. The tire pressure warning light will go off after a few minutes.

■ **Conditions that the tire pressure warning system may not function properly**

→P.368

■ **Customization**

Some functions can be customized. (→P.461)

 **WARNING**

■ **If both the ABS and the brake system warning lights remain on**

Stop your vehicle in a safe place immediately and contact your Lexus dealer. The vehicle will become extremely unstable during braking, and the ABS system may fail, which could cause an accident resulting in death or serious injury.

■ **When the electric power steering system warning light comes on**

When the light comes on yellow, the assist to the power steering is restricted. When the light comes on red, the assist to the power steering is lost and handling operations of the steering wheel become extremely heavy. When steering wheel operations are heavier than usual, grip the steering wheel firmly and operate it using more force than usual.

**⚠ WARNING****■ If the tire pressure warning light comes on**

Be sure to observe the following precautions.

Failure to do so could cause a loss of vehicle control and result in death or serious injury.

- Stop your vehicle in a safe place as soon as possible. Adjust the tire inflation pressure immediately.
- If the tire pressure warning light comes on even after tire inflation pressure adjustment, it is probable that you have a flat tire. Check the tires. If a tire is flat, change it with the spare tire and have the flat tire repaired by the nearest Lexus dealer.
- Avoid abrupt maneuvering and braking. If the vehicle tires deteriorate, you could lose control of the steering wheel or the brakes.

**■ If a blowout or sudden air leakage should occur**

The tire pressure warning system may not activate immediately.

**■ Maintenance of the tires**

Each tire, including the spare (if provided), should be checked monthly when cold and inflated to the inflation pressure recommended by the vehicle manufacturer on the vehicle placard or tire inflation pressure label (tire and load information label). (If your vehicle has tires of a different size than the size indicated on the vehicle placard or tire inflation pressure label [tire and load information label], you should determine the proper tire inflation pressure for those tires.)

As an added safety feature, your vehicle has been equipped with a tire pressure monitoring system (TPMS-tire pressure warning system) that illuminates a low tire pressure telltale (tire pressure warning light) when one or more of your tires is significantly under-inflated. Accordingly, when the low tire pressure telltale (tire pressure warning light) illuminates, you should stop and check your tires as soon as possible, and inflate them to the proper pressure. Driving on a significantly under-inflated tire causes the tire to overheat and can lead to tire failure. Under-inflation also reduces fuel efficiency and tire tread life, and may affect the vehicle's handling and stopping ability.

Please note that the TPMS (tire pressure warning system) is not a substitute for proper tire maintenance, and it is the driver's responsibility to maintain correct tire pressure, even if under-inflation has not reached the level to trigger illumination of the TPMS low tire pressure telltale (tire pressure warning light).

Your vehicle has also been equipped with a TPMS (tire pressure warning system) malfunction indicator to indicate when the system is not operating properly. The TPMS (tire pressure warning system) malfunction indicator is combined with the low tire pressure telltale (tire pressure warning light). When the system detects a malfunction, the telltale will flash for approximately one minute and then remain continuously illuminated. This sequence will continue upon subsequent vehicle start-ups as long as the malfunction exists. When the malfunction indicator is illuminated, the system may not be able to detect or signal low tire pressure as intended.

**⚠ WARNING**

TPMS (tire pressure warning system) malfunctions may occur for a variety of reasons, including the installation of replacement or alternate tires or wheels on the vehicle that prevent the TPMS (tire pressure warning system) from functioning properly. Always check the TPMS (tire pressure warning system) malfunction telltale after replacing one or more tires or wheels on your vehicle to ensure that the replacement or alternate tires and wheels allow the TPMS (tire pressure warning system) to continue to function properly.

**⚠ NOTICE**

**■ To ensure the tire pressure warning system operates properly**

Do not install tires with different specifications or makers, as the tire pressure warning system may not operate properly.

**If a warning message is displayed**

The multi-information display shows warnings of system malfunctions, incorrectly performed operations, and messages that indicate a need for maintenance. When a message is shown, perform the correction procedure appropriate to the message.

Except F SPORT models:

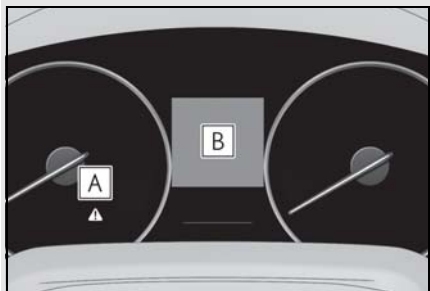

- A** Master warning light  
The master warning light also comes on or flashes in order to indicate that a message is currently being displayed on the multi-information display.
- B** Multi-information display  
Follow the instructions of the message on the multi-information display.  
If any of the warning messages are shown again after the appropriate actions have been performed, contact your Lexus dealer.

F SPORT models:

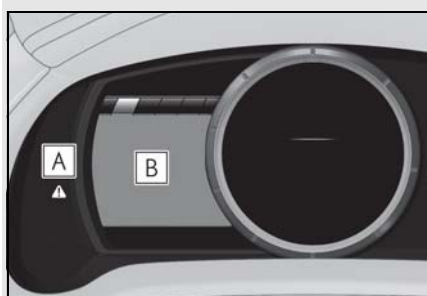

**A** Master warning light

The master warning light also comes on or flashes in order to indicate that a message is currently being displayed on the multi-information display.

**B** Multi-information display

Follow the instructions of the message on the multi-information display.

If any of the warning messages are shown again after the appropriate actions have been performed, contact your Lexus dealer.

### Messages and warnings

The master warning light and warning buzzers operate as follows depending on the content of the message. If a message indicates the need for inspection by a dealer, have the vehicle inspected by your Lexus dealer immediately.

	Warning buzzer *	Warning
Comes on	Sounds	Indicates an important situation, such as when a system related to driving is malfunctioning or that danger may result if the correction procedure is not performed
Flashes	Sounds	Indicates a situation, such as when damage to the vehicle or danger may result

	Warning buzzer *	Warning
Comes on	Does not sound	Indicates a condition, such as malfunction of electrical components, their condition, or indicates the need for maintenance
Flashes	Does not sound	Indicates a situation, such as when an operation has been performed incorrectly, or indicates how to perform an operation correctly

- In some situations, the master warning light and warning buzzer may not operate as specified. In this case, follow the instructions displayed in the warning message.
- If a warning light comes on or flashes at the same time that a warning message is displayed, take corrective action according to the warning light. (→P.403)

\* : A buzzer sounds the first time a message is shown on the multi-information display.

■ **Warning messages**

The warning messages explained below may differ from the actual messages according to operation conditions and vehicle specifications.

■ **Warning buzzer**

In some cases, the buzzer may not be heard due to being in a noisy location or audio sound.

■ **If “Shift to P Before Exiting Vehicle” is displayed**

Message is displayed when the driver’s door is opened without turning the engine switch off with the shift lever in any position other than P.

Shift the shift lever to P.

■ **If “Power Turned Off to Save Battery” is displayed**

This message is displayed when the power was cut off due to the automatic power off function. The next time the engine is started, increase the engine speed slightly and maintain it at that speed for approximately 5 minutes to recharge the battery.

■ **If “AWD System Overheated Switching to 2WD Mode” or “AWD System Overheated 2WD Mode Engaged” is displayed (AWD models)**

This message may be displayed when driving under extremely high load conditions.

Drive the vehicle at low speeds or stop the vehicle in a safe place with the engine running until the message is cleared.

If the message is not cleared, have the vehicle inspected by your Lexus dealer.

■ **If “Headlight System Malfunction Visit Your Dealer” is displayed**

The following systems may be malfunctioning. Have the vehicle inspected by your Lexus dealer immediately.

- The LED headlight system
- AFS (Adaptive Front-lighting System) (if equipped)
- The automatic headlight leveling system
- Automatic High Beam

■ **If “Radar Cruise Control Unavailable See Owner's Manual” is displayed**

The dynamic radar cruise control with full-speed range system is suspended temporarily or until the problem shown in the message is resolved. (causes and coping methods: →P.207)

■ **If “Radar Cruise Control Unavailable” is displayed**

The dynamic radar cruise control with full-speed range system cannot be used temporarily. Use the system when it becomes available again.

■ **If a message that indicates the malfunction of front camera is displayed**

The following systems may be suspended until the problem shown in the message is resolved. (→P.207, 408)

- PCS (Pre-Collision system)
- LTA (Lane Tracing Assist)
- Automatic High Beam
- RSA (Road Sign Assist) (if equipped)
- Dynamic radar cruise control with full-speed range

■ **If “Check Fuel Cap” is displayed (if equipped)**

The fuel tank cap is not properly installed. Correctly install the fuel tank cap.

■ **If “Maintenance Required Soon” is displayed (U.S.A. only)**

Indicates that all maintenance according to the driven distance on the maintenance schedule\* should be performed soon.

Comes on approximately 4500 miles (7200 km) after the message has been reset. If necessary, perform maintenance. Please reset the message after the maintenance is performed. (→P.350)

\*: Refer to the separate “Scheduled Maintenance” or “Owner’s Manual Supplement” for the maintenance interval applicable to your vehicle.

■ **If “Maintenance Required Visit Your Dealer” is displayed (U.S.A. only)**

Indicates that all maintenance is required to correspond to the driven distance on the maintenance schedule\*.

Comes on approximately 5000 miles (8000 km) after the message has been reset. (The indicator will not work properly unless the message has been reset.) Perform the necessary maintenance. Please

reset the message after the maintenance is performed. (→P.350)

\*: Refer to the separate “Scheduled Maintenance” or “Owner’s Manual Supplement” for the maintenance interval applicable to your vehicle.

■ **If “Oil Maintenance Required Soon” is displayed**

Indicates that the engine oil should be scheduled to be changed.

Check the engine oil and change it if necessary. After changing the engine oil, make sure to reset the message. (→P.361)

■ **If “Oil Maintenance Required” is displayed**

Indicates that the engine oil should be changed.

Check and change the engine oil, and oil filter by your Lexus dealer. After changing the engine oil, make sure to reset the message. (→P.361)

■ **If a message that indicates the need for visiting your Lexus dealer is displayed**

The system or part shown on the multi-information display is malfunctioning. Have the vehicle inspected by your Lexus dealer immediately.

■ **If a message that indicates the need for referring to Owner’s Manual is displayed**

● “Engine Coolant Temp High” is shown on the multi-information display, follow the instructions. (→P.437)

● “Transmission Fluid Temp High” is shown on the multi-information display, the automatic transmission fluid temperature may be too high. Immediately stop the vehicle in a safe place, shift the shift lever to P with the engine running and wait until the message is cleared. If the message is not cleared, contact your Lexus dealer.

● If the following message is shown on the multi-information display, it may indicate a malfunction. Have the vehicle inspected by your Lexus dealer immediately.

- “Access System with Elec. Key Malfunction”

- If any of the following messages are shown on the multi-information display, it may indicate a malfunction. Immediately stop the vehicle and contact your Lexus dealer.
  - “Braking Power Low”
  - “Charging System Malfunction”
  - “Oil Pressure Low”

 NOTICE

■ If “High Power Consumption Partial Limit On AC/Heater Operation” is displayed frequently

There is a possible malfunction relating to the charging system or the battery may be deteriorating. Have the vehicle inspected by your Lexus dealer.

**If you have a flat tire**

Your vehicle is equipped with a spare tire. The flat tire can be replaced with the spare tire.

For details about tires: →P.365

 WARNING

■ If you have a flat tire

Do not continue driving with a flat tire. Driving even a short distance with a flat tire can damage the tire and the wheel beyond repair, which could result in an accident.

**Before jacking up the vehicle**

- Stop the vehicle in a safe place on a hard, flat surface.
- Set the parking brake.
- Shift the shift lever to P.
- Stop the engine.
- Turn on the emergency flashers. (→P.394)



**Location of the spare tire, jack and tools**

## ▶ RX350

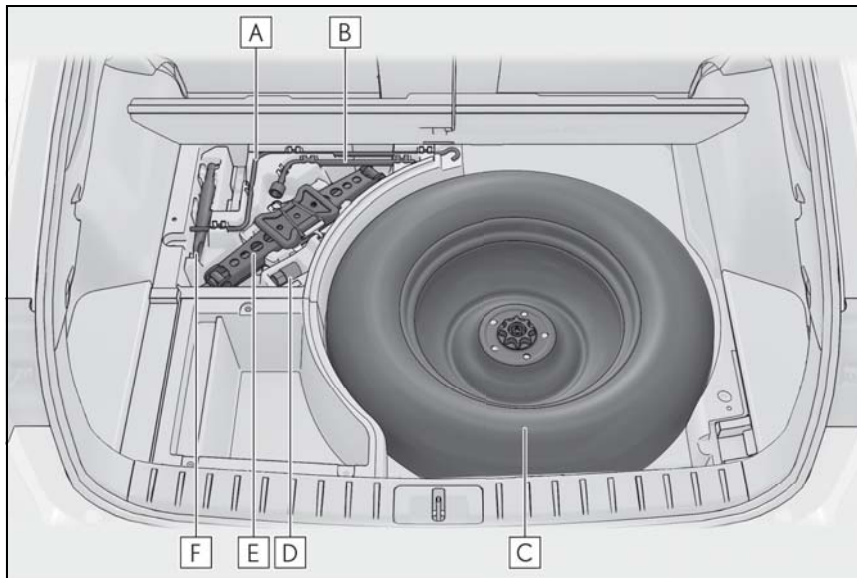

- A** Jack handle
- B** Wheel nut wrench
- C** Spare tire
- D** Wheel lock key\* (if equipped)
- E** Jack
- F** Towing eyelet (if equipped)

\*: Documentation relating to the wheel lock key, such as the registration and I.D. card, is inside the glove box.

► RX350L

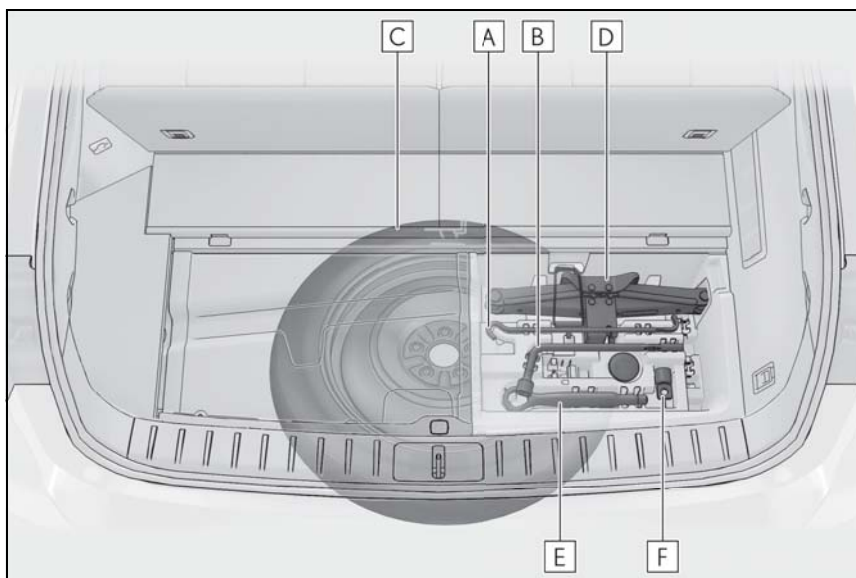

- A** Jack handle
- B** Wheel nut wrench
- C** Spare tire
- D** Jack
- E** Towing eyelet
- F** Adapter socket

**⚠ WARNING**

■ **Using the tire jack**

Observe the following precautions. Improper use of the tire jack may cause the vehicle to suddenly fall off the jack, leading to death or serious injury.

- Do not use the tire jack for any purpose other than replacing tires or installing and removing tire chains.
- Only use the tire jack that comes with this vehicle for replacing a flat tire. Do not use it on other vehicles, and do not use other tire jacks for replacing tires on this vehicle.

- Put the jack properly in its jack point.

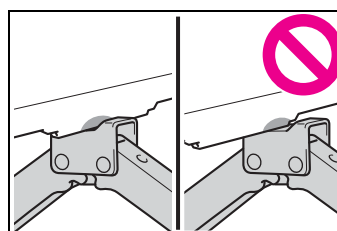

- Do not put any part of your body under the vehicle while it is supported by the jack.
- Do not start the engine or drive the vehicle while the vehicle is supported by the jack.

**⚠ WARNING**

- Do not raise the vehicle while someone is inside.
- When raising the vehicle, do not put an object on or under the jack.
- Do not raise the vehicle to a height greater than that required to replace the tire.
- Use a jack stand if it is necessary to get under the vehicle.
- When lowering the vehicle, make sure that there is no-one near the vehicle. If there are people nearby, warn them vocally before lowering.

**Wheel lock nut (if equipped)**

When replacing tires on a vehicle with wheel lock nuts, use the following procedures to remove and install the wheel lock nuts. The wheel lock key is stored in the tray inside the luggage compartment. Always return the wheel lock key to its original position after use, so that it does not get lost.

**■ Removal**

For ease of removal, the wheel lock nut should always be the first one loosened.

- 1** Place the wheel lock key on top of the wheel lock nut, turning until the wheel lock key and wheel lock nut patterns engage.
- 2** Place the wheel nut wrench on the wheel lock key, and while applying pressure on the wheel lock key, loosen the wheel lock nut.

**■ Installation**

For ease of installation, the wheel lock

nut should always be the last one tightened.

- 1** By hand, install a wheel lock nut on each wheel.
- 2** Place the wheel lock key on top of the wheel lock nut, turning until the wheel lock key and wheel lock nut patterns engage.
- 3** Place the wheel nut wrench on the wheel lock key, and while applying pressure on the wheel lock key, tighten the wheel lock nut to the recommended torque.

**⚠ NOTICE**

Do not use an impact wrench. Using an impact wrench may cause permanent damage to wheel lock nut and wheel lock key. If in doubt about wheel lock application, contact your Lexus dealer.

**Taking out the jack**

- 1** Secure the deck board using the hook. (→P.319)
- 2** Disengage the hook and take out the jack.

RX350: Remove the wheel nut wrench and then the jack.

RX350L: Remove the jack handle and then the jack.

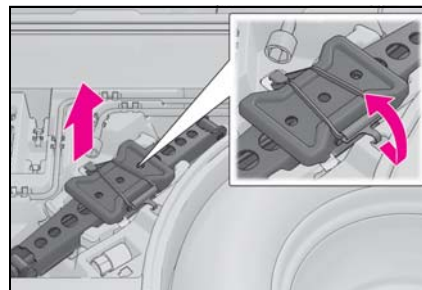

**Taking out the spare tire**

▶ RX350

- 1 Secure the deck board using the hook. (→P.319)
- 2 Loosen the center fastener that secures the spare tire.

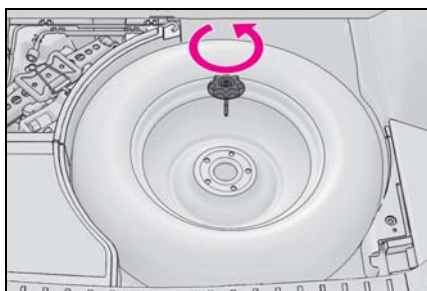

▶ RX350L

- 1 Remove the deck board.
- 2 Remove the cover.

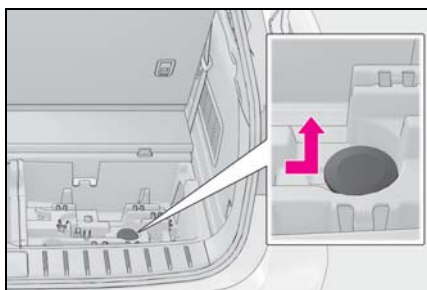

- 3 Attach the adapter socket to the spare tire clamp bolt.

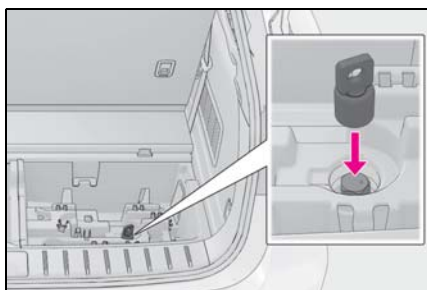

- 4 Assemble the jack handle extension.

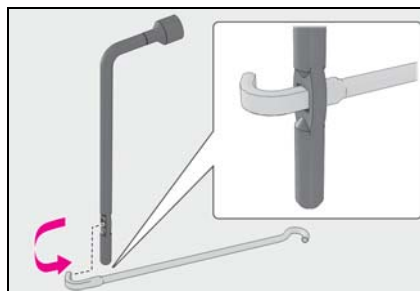

- 5 Connect the jack handle to the adapter socket. Turn the jack handle counterclockwise.

The tire will be lowered completely to the ground.

Turn the jack handle slowly to lower the spare tire. If the handle is turned quickly, the wire cable may come off the shaft inside the unit and the tire may not be lowered.

If the spare tire cannot be lowered:  
→P.422

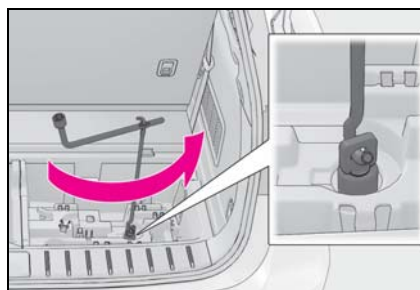

- 6 Pull out the spare tire and stand it against the bumper.

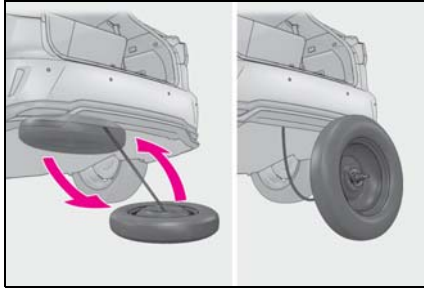

- 7 Fully depress the secondary latch **A** and remove the holding bracket **B** from the hoist assembly **C**.

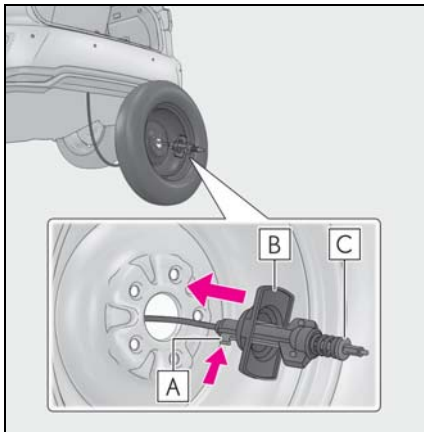

- 8 Tilt the bracket **B** and pass it through the wheel opening. Then remove the hoist assembly **C**.

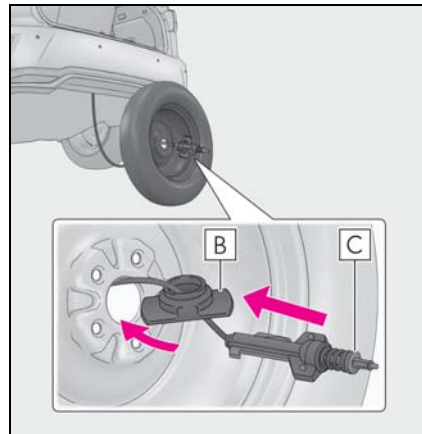

#### ⚠ WARNING

##### ■ When storing the spare tire

Be careful not to catch fingers or other body parts between the spare tire and the body of the vehicle.

#### Replacing a flat tire

- 1 Check the tires.

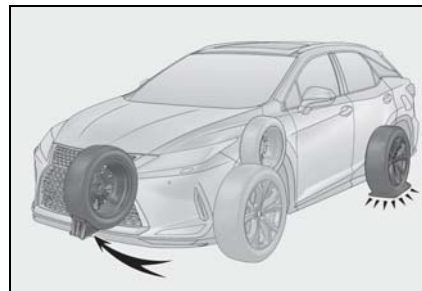

Flat tire	Wheel chock positions
Front left-hand side	Behind the rear right-hand side tire
Front right-hand side	Behind the rear left-hand side tire
Rear left-hand side	In front of the front right-hand side tire
Rear right-hand side	In front of the front left-hand side tire

**2** Slightly loosen the wheel nuts (one turn).

For vehicles with wheel lock nuts, loosen the wheel lock nut first.

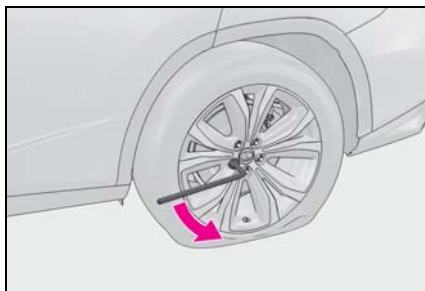

**3** Turn the tire jack portion **A** by hand until the notch of the jack is in contact with the jack point.

The jack point guides are located under the rocker panel. They indicate the jack point positions.

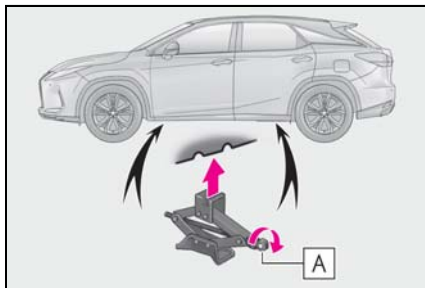

**4** Raise the vehicle until the tire is slightly raised off the ground.

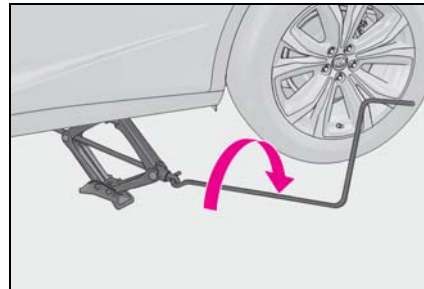

**5** Remove all the wheel nuts and the tire.

When resting the tire on the ground, place the tire so that the wheel design faces up to avoid scratching the wheel surface.

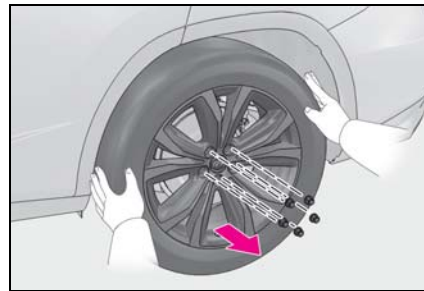

**■ If the spare tire cannot be lowered (RX350L)**

If the spare tire cannot be lowered, it may not have been stowed properly. Perform the following procedure:

**1** Fully tighten the spare tire clamp bolt by turning the jack handle clockwise until two clicks are heard and the jack handle skips.

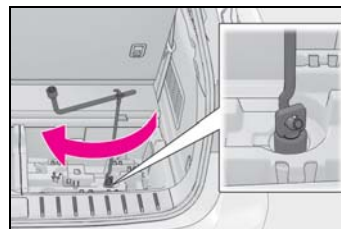

- 2** Turn the jack handle counterclockwise to lower the spare tire.

If the spare tire still cannot be lowered, attempt to fully tighten the spare tire clamp bolt again by turning the jack handle clockwise. Then turn it counterclockwise at least 2 turns to lower the spare tire.

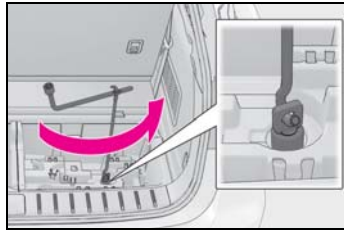

If the spare tire still cannot be lowered, the wire cable may be severed. Have the vehicle inspected by your Lexus dealer.

### **!** WARNING

#### ■ Replacing a flat tire

- Do not touch the disc wheels or the area around the brakes immediately after the vehicle has been driven. After the vehicle has been driven the disc wheels and the area around the brakes will be extremely hot. Touching these areas with hands, feet or other body parts while changing a tire, etc. may result in burns.
- Failure to follow these precautions could cause the wheel nuts to loosen and the tire to fall off, resulting in death or serious injury.
- Never use oil or grease on the wheel bolts or wheel nuts. Oil and grease may cause the wheel nuts to be excessively tightened, leading to bolt or disc wheel damage. In addition, the oil or grease can cause the wheel nuts to loosen and the wheel may fall off, causing an accident and resulting in death or serious injury. Remove any oil or grease from the wheel bolts or wheel nuts.

- Have the wheel nuts tightened with a torque wrench to 76 ft•lb (103 N•m, 10.5 kgf•m) as soon as possible after changing wheels.
- When installing a tire, only use wheel nuts that have been specifically designed for that wheel.
- If there are any cracks or deformations in the bolt screws, nut threads or bolt holes of the wheel, have the vehicle inspected by your Lexus dealer.
- Observe the following precautions. (RX350L)  
Failure to do so may result in serious injury:
- Do not try to remove the wheel ornament by hand. Take due care in handling the ornament to avoid unexpected personal injury.
- Lower the spare tire completely to the ground before removing it from under the vehicle.

#### ■ Replacing a flat tire for vehicles with power back door

In cases such as when replacing tires, make sure to turn off the power back door main switch (→P.461). Failure to do so may cause the back door to operate unintentionally if the power back door switch is accidentally touched, resulting in hands and fingers being caught and injured.

### Installing the spare tire

- 1** Remove any dirt or foreign matter from the wheel contact surface.

If foreign matter is on the wheel contact surface, the wheel nuts may loosen while the vehicle is in motion, causing the tire to

come off.

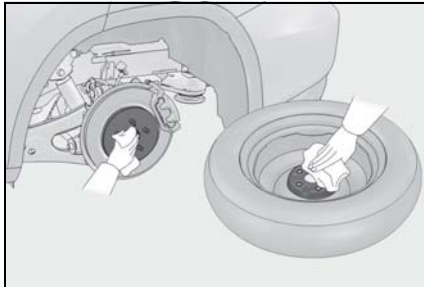

- 2 Install the spare tire and loosely tighten each wheel nut by hand by approximately the same amount.

Tighten the wheel nuts until the tapered portion comes into loose contact with the disc wheel seat.

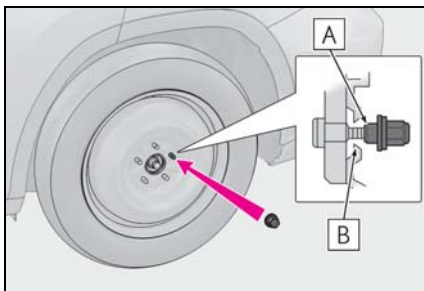

**A** Tapered portion

**B** Disc wheel seat

- 3 Lower the vehicle.

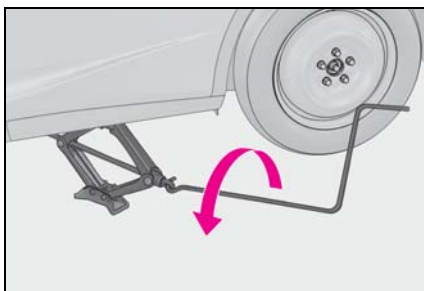

- 4 Firmly tighten each wheel nut two or three times in the order shown in the illustration.

For vehicles with wheel lock nuts, tighten

the wheel lock nut last.

Tightening torque:  
76 ft•lb (103 N•m, 10.5 kgf•m)

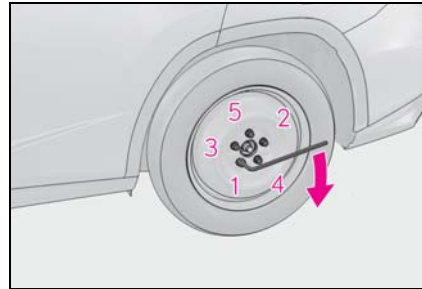

- 5 RX350: Stow the flat tire, tire jack and all tools.  
RX350L: →P.424

**! WARNING**

**■ Stowing the flat tire**

Failure to follow steps listed under stowing the tire may result in damage to the spare tire carrier and loss of the tire, which could result in serious injury or death.

**Stowing the flat tire, jack and all tools (RX350L)**

- 1 Remove the center wheel ornament by pushing from the reverse side.

Be careful not to lose the wheel ornament.

- 2 Stand the tire against the bumper with the inner surface facing toward you. Pass the hoist assembly



**C** and holding bracket **B** through the wheel opening.

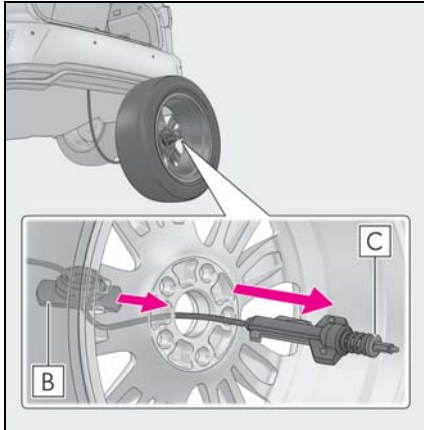

- 3** Fully depress the secondary latch **A** and install the bracket **B** to the hoist assembly **C**.

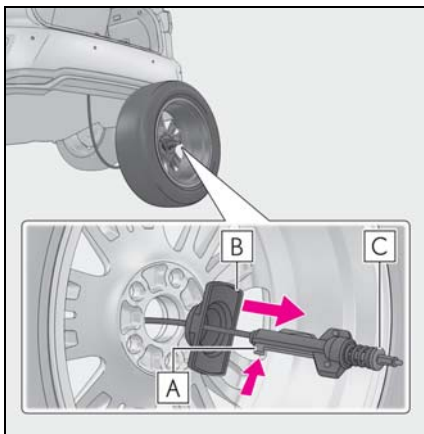

- 4** Lay the tire on the ground with the outer surface (valve stem) facing up.

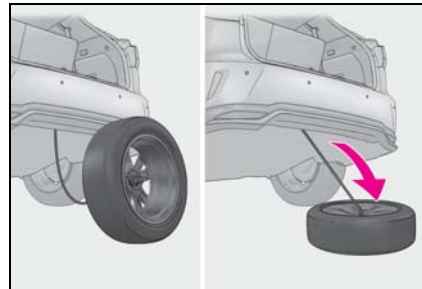

- 5** Before raising the tire, make sure that the hoist assembly is perpendicular to the wheel opening. (Try to place the tire directly beneath the vehicle, near where the wire cable is hanging from.)

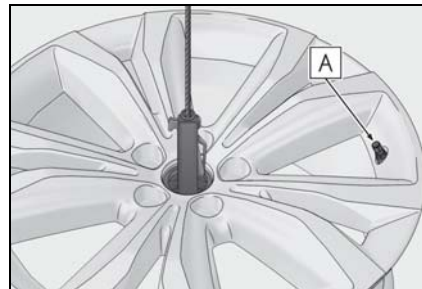

- A** Valve stem
- 6** Using the jack handle and adapter socket, tighten the tire clamp bolt by turning it clockwise until the tire is in the correct position and two clicks are heard as the jack handle skips.

7 Confirm it is not loose after tightening:

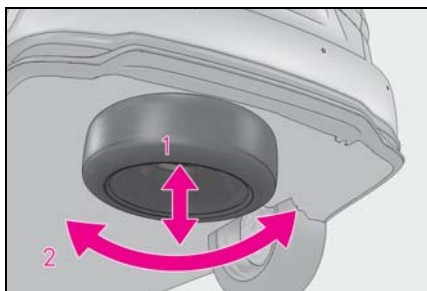

- 1 Push and pull the tire
- 2 Try rotating

Visually check to ensure tire is not hung on surrounding parts. If looseness or misassembly exists, repeat steps 2 to 7.

- 8 Repeat step 7, any time the tire is lowered or disturbed.
- 9 Stow the jack and all tools.

■ **The compact spare tire**

- The compact spare tire is identified by the label "TEMPORARY USE ONLY" on the tire sidewall. Use the compact spare tire temporarily, and only in an emergency.
- Make sure to check the tire inflation pressure of the compact spare tire. (→P.448)

■ **When using the compact spare tire**

As the compact spare tire is not equipped with a tire pressure warning valve and transmitter, low inflation pressure of the spare tire will not be indicated by the tire pressure warning system. Also, if you replace the compact spare tire after the tire pressure warning light comes on, the light remains on.

■ **When the compact spare tire is equipped**

When driving with the compact spare tire installed, the vehicle height will be different than when driving with standard tires.

■ **If you have a flat front tire on a road covered with snow or ice**

Install the compact spare tire on one of the rear wheels of the vehicle. Perform the following steps and fit tire chains to the front tires:

- 1 Replace a rear tire with the compact spare tire.
- 2 Replace the flat front tire with the tire removed from the rear of the vehicle.
- 3 Fit tire chains to the front tires.

▲ **WARNING**

■ **When using the compact spare tire**

- Remember that the compact spare tire provided is specifically designed for use with your vehicle. Do not use your compact spare tire on another vehicle.
- Do not use more than one compact spare tire simultaneously.
- Replace the compact spare tire with a standard tire as soon as possible.
- Avoid sudden acceleration, abrupt steering, sudden braking and shifting operations that cause sudden engine braking.

■ **When the compact spare tire is attached**

The vehicle speed may not be correctly detected, and the following systems may not operate correctly:

- ABS & Brake assist
- VSC
- TRAC
- Trailer Sway Control
- EPS
- VDIM (if equipped)
- Adaptive Variable Suspension System (if equipped)
- Dynamic radar cruise control with full-speed range

**⚠ WARNING**

- PCS (Pre-Collision System)
- LTA (Lane Tracing Assist)
- RSA (Road Sign Assist) (if equipped)
- Automatic High Beam
- AFS (Adaptive Front-lighting System) (if equipped)
- Tire pressure warning system
- Intuitive parking assist (if equipped)
- PKSB (Parking Support Brake) (if equipped)
- Lexus parking assist monitor (if equipped)
- Panoramic view monitor (if equipped)
- BSM (Blind Spot Monitor) (if equipped)
- Navigation system (if equipped)

Also, not only can the following system not be utilized fully, but it may even negatively affect the drive-train components:

- AWD system (AWD models)

**■ Speed limit when using the compact spare tire**

Do not drive at speeds in excess of 50 mph (80 km/h) when a compact spare tire is installed on the vehicle.

The compact spare tire is not designed for driving at high speeds. Failure to observe this precaution may lead to an accident causing death or serious injury.

**■ After using the tools and jack**

Before driving, make sure all the tools and jack are securely in place in their storage location to reduce the possibility of personal injury during a collision or sudden braking.

**⚠ NOTICE****■ Be careful when driving over bumps with the compact spare tire installed on the vehicle**

The vehicle becomes lower when driving with the compact spare tire compared to when driving with standard tires. Be careful when driving over uneven road surfaces.

**■ Driving with tire chains and the compact spare tire**

Do not fit tire chains to the compact spare tire. Tire chains may damage the vehicle body and adversely affect driving performance.

**■ When replacing the tires**

When removing or fitting the wheels, tires or the tire pressure warning valve and transmitter, contact your Lexus dealer as the tire pressure warning valve and transmitter may be damaged if not handled correctly.

**■ When stowing the flat tire (RX350L)**

- Ensure that there is no object caught between the tire and the vehicle underbody.
- Securely tighten the spare tire clamp bolt to hold the spare wheel carrier by the hook.
- Stow the flat tire in the spare tire location. Failure to do so may cause damage to the spare tire carrier. Proper storage reduces the possibility of injury in a collision or during sudden braking.
- Have the flat tire repaired and the spare tire replaced with it as soon as possible.

 NOTICE

■ Proper storage of the spare tire (RX350L)

- If the hoist assembly is slanted when stowing a tire, the hoist assembly may become stuck in the wheel opening and the tire may not be raised properly, causing damage to the wheel or the wire cable.



- If the spare tire clamp bolt is turned without a tire on the hoist assembly, the wire cable may not be able to be lowered. If the wire cable cannot be lowered, contact your Lexus dealer.

### If the engine will not start

If the engine will not start even though correct starting procedures are being followed (→P.174), consider each of the following points:

#### The engine will not start even though the starter motor operates normally.

One of the following may be the cause of the problem:

- There may not be sufficient fuel in the vehicle's tank.  
Refuel the vehicle.
- The engine may be flooded.  
Try to restart the engine again following correct starting procedures. (→P.174)
- There may be a malfunction in the engine immobilizer system. (→P.66)

#### The starter motor turns over slowly, the interior lights and headlights are dim, or the horn does not sound or sounds at a low volume.

One of the following may be the cause of the problem:

- The battery may be discharged. (→P.433)
- The battery terminal connections may be loose or corroded. (→P.363)

**The starter motor does not turn over**

The engine starting system may be malfunctioning due to an electrical problem such as electronic key battery depletion or a blown fuse. However, an interim measure is available to start the engine. (→P.429)

**The starter motor does not turn over, the interior lights and headlights do not turn on, or the horn does not sound.**

One of the following may be the cause of the problem:

- One or both of the battery terminals may be disconnected. (→P.363)
- The battery may be discharged. (→P.433)
- There may be a malfunction in the steering lock system.

Contact your Lexus dealer if the problem cannot be repaired, or if repair procedures are unknown.

**Starting the engine in an emergency**

When the engine does not start, the following steps can be used as an interim measure to start the engine if the engine switch is functioning normally.

Do not use this starting procedure except in cases of emergency.

- 1 Turn the engine switch to IGNITION ON mode and check that

the parking brake is set. (→P.177, 183)

- 2 Shift the shift lever to P.
- 3 Turn the engine switch to ACCESSORY mode.
- 4 Press and hold the engine switch for about 15 seconds while depressing the brake pedal firmly.

Even if the engine can be started using the above steps, the system may be malfunctioning. Have the vehicle inspected by your Lexus dealer.

### If you lose your keys

New genuine mechanical keys can be made by your Lexus dealer using another mechanical key and the key number stamped on your key number plate.

Keep the plate in a safe place such as your wallet, not in the vehicle.

 NOTICE

■ When an electronic key is lost

If the electronic key remains lost, the risk of vehicle theft increases significantly. Visit your Lexus dealer immediately with all remaining electronic keys that were provided with your vehicle.

### If the fuel filler door cannot be opened

If the fuel filler door cannot be opened by pressing the center of the rear edge of the fuel filler door with the doors unlocked, contact your Lexus dealer to service the vehicle. In case where refueling is urgently necessary, the following procedure can be used to open the fuel filler door.

#### Opening the fuel filler door

► RX350

If the fuel filler door cannot be opened by pressing the rear edge of the fuel filler door with the doors unlocked, remove the cover inside the luggage compartment and pull the lever to open the fuel filler door.

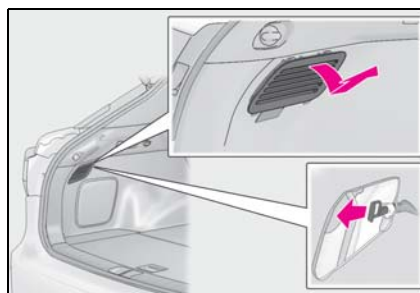

► RX350L

If the fuel filler door cannot be opened by pressing its rear edge with the doors unlocked, remove the cover inside the luggage compartment using a tool, such as a flathead screwdriver, and pull the lever to open the fuel filler door.

When using a screwdriver, make sure to

wrap its tip with tape to protect the cover.

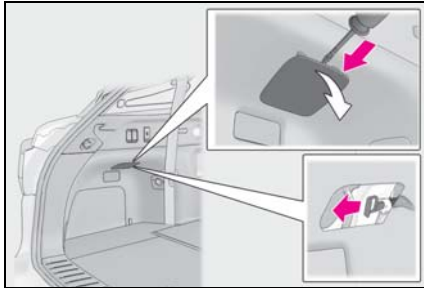

### If the electronic key does not operate properly

If communication between the electronic key and vehicle is interrupted (→P.116) or the electronic key cannot be used because the battery is depleted, the smart access system with push-button start and wireless remote control cannot be used. In such cases, the doors can be opened and the engine can be started by following the procedure below.

- **When the electronic key does not work properly**
  - Make sure that the smart access system with push-button start has not been disabled at your Lexus dealer. If it has been disabled, re-enable it.
  - Check if battery-saving mode is set. If it is set, cancel the function. (→P.116)

#### NOTICE

#### ■ In case of a smart access system with push-button start malfunction or other key-related problems

Take your vehicle with all the electronic keys provided with your vehicle to your Lexus dealer.

### Locking and unlocking the doors

#### ■ Unlocking the door

Use the mechanical key (→P.97) in order to perform the following operations:

- 1 Insert the mechanical key while pulling on the driver's door handle.

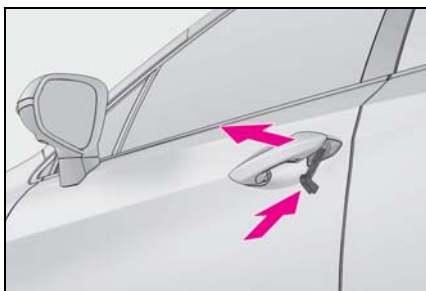

- 2 Unlock the door.

Turning the key rearward unlocks the driver's door. Turning the key again unlocks the other doors.



- 3 Remove the key, return the handle, and then pull the handle again.

#### ■ Locking the door

- 1 With the door open, push down the inside lock button.



- 2 Close the door.

#### ■ Key linked functions

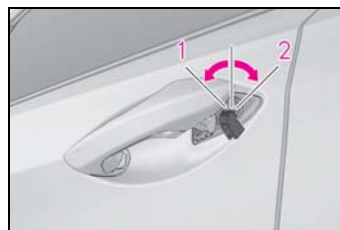

- 1 Closes the windows and the moon roof\* or panoramic moon roof\* (turn and hold)
- 2 Opens the windows and the moon roof\* or panoramic moon roof\* (turn and hold)

These settings must be customized at your Lexus dealer.

\*: If equipped

#### ⚠ WARNING

##### ■ When using the mechanical key and operating the power windows or the moon roof or panoramic moon roof

Operate the power window or the moon roof or panoramic moon roof after checking to make sure that there is no possibility of any passenger having any of their body parts caught in the window or the moon roof or panoramic moon roof. Also, do not allow children to operate the mechanical key. It is possible for children and other passengers to get caught in the power window or the moon roof or panoramic moon roof.

#### Starting the engine

- 1 Ensure that the shift lever is in P and depress the brake pedal.
- 2 Touch the Lexus emblem side of the electronic key to the engine switch.

When the electronic key is detected, a buzzer sounds and the engine switch will turn to IGNITION ON mode.



When the smart access system with push-button start is deactivated in customization setting, the engine switch will turn to ACCESSORY mode.



- 3 Firmly depress the brake pedal and check that  is shown on the multi-information display.
- 4 Press the engine switch shortly and firmly.

In the event that the engine still cannot be started, contact your Lexus dealer.

#### ■ Stopping the engine

Shift the shift lever to P, set the parking brake, and press the engine switch as you normally do when stopping the engine.

#### ■ Replacing the key battery

As the above procedure is a temporary measure, it is recommended that the electronic key battery be replaced immediately when the battery is depleted. (→P.379)

#### ■ Alarm (For Canada)

Using the mechanical key to lock the doors will not set the alarm system.

If a door is unlocked using the mechanical key when the alarm system is set, the alarm may be triggered. (→P.68)

#### ■ Changing engine switch modes

Release the brake pedal and press the engine switch in step 3 above. The engine does not start and modes will be changed each time the switch is pressed. (→P.177)

### If the vehicle battery is discharged

The following procedures may be used to start the engine if the vehicle's battery is discharged. You can also call your Lexus dealer or a qualified repair shop.

### Restarting the engine

(→P.69)

If you have a set of jumper (or booster) cables and a second vehicle with a battery, you can jump start your vehicle by following the steps below.

- 1 Confirm that the electronic key is being carried.

When connecting the jumper (or booster) cables, depending on the situation, the alarm may activate and doors locked.



- 2 Open the hood. (→P.357)

- 3 Connect a positive jumper cable clamp to **A** on your vehicle and connect the clamp on the other end of the positive cable to **B** on the second vehicle. Then, connect a negative cable clamp to **C** on the second vehicle and connect the clamp at the other end of the negative cable to **D**.

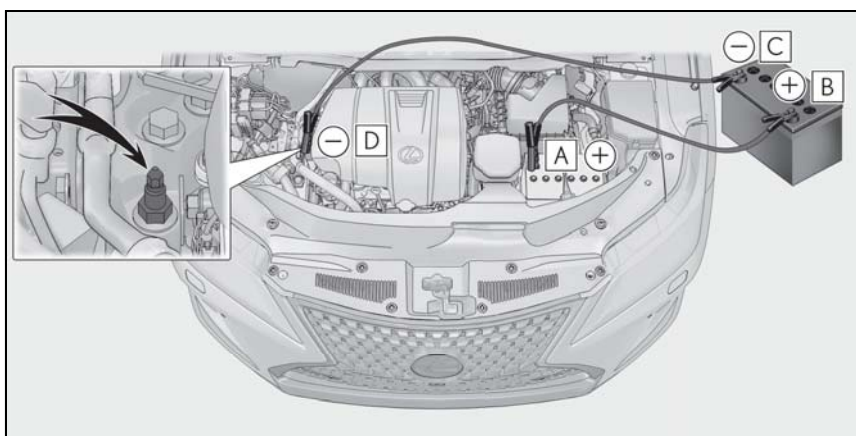

- A** Positive (+) battery terminal (your vehicle)
  - B** Positive (+) battery terminal (second vehicle)
  - C** Negative (-) battery terminal (second vehicle)
  - D** Solid, stationary, unpainted metallic point away from the battery and any moving parts as shown in the illustration
- 4 Start the engine of the second vehicle. Increase the engine speed slightly and maintain at that level for approximately 5 minutes to recharge the battery of your vehicle.
  - 5 Open and close any of the doors of your vehicle with the engine switch off.

- 6 Maintain the engine speed of the second vehicle and start the engine of your vehicle by turning the engine switch to IGNITION ON mode.
- 7 Once the vehicle's engine has started, remove the jumper cables in the exact reverse order from which they were connected.

Once the engine starts, have the vehicle inspected at your Lexus dealer as soon as possible.

#### ■ Starting the engine when the battery is discharged

The engine cannot be started by push-starting.

#### ■ To prevent battery discharge

- Turn off the headlights and the audio system while the engine is off.
- Turn off any unnecessary electrical components when the vehicle is running at a low speed for an extended period, such as in heavy traffic.

#### ■ When removing the battery terminals

When the battery terminals are removed, the information stored in the ECU is cleared. Before removing the battery terminals, contact your Lexus dealer.

#### ■ Charging the battery

The electricity stored in the battery will discharge gradually even when the vehicle is not in use, due to natural discharge and the draining effects of certain electrical appliances. If the vehicle is left for a long time, the battery may discharge, and the engine may be unable to start. (The battery recharges automatically during driving.)

#### ■ When the battery is removed or discharged

- In some cases, it may not be possible to unlock the doors using the smart access system with push-button start when the battery is discharged. Use the wireless

remote control or the mechanical key to lock or unlock the doors.

- The engine may not start on the first attempt after the battery has recharged but will start normally after the second attempt. This is not a malfunction.
- The engine switch mode is memorized by the vehicle. When the battery is reconnected, the system will return to the mode it was in before the battery was discharged. Before disconnecting the battery, turn the engine switch off. If you are unsure what mode the engine switch was in before the battery discharged, be especially careful when reconnecting the battery.
- The power back door must be initialized. (→P.109)

#### ■ Replacing the battery

- Use a battery with the same case size as the previous battery and an equivalent 20 hour rate capacity (20HR) or greater.
  - If the sizes differ, the battery cannot be properly secured.
  - If the 20 hour rate capacity is low, even if the time period where the vehicle is not used is a short time, the battery may discharge and the engine may not be able to start.
- For details, consult your Lexus dealer.

#### WARNING

##### ■ When removing the battery terminals

Always remove the negative (-) terminal first. If the positive (+) terminal contacts any metal in the surrounding area when the positive (+) terminal is removed, a spark may occur, leading to a fire in addition to electrical shocks and death or serious injury.

##### ■ Avoiding battery fires or explosions

Observe the following precautions to prevent accidentally igniting the flammable gas that may be emitted from the battery:

**⚠ WARNING**

- Make sure each jumper cable is connected to the correct terminal and that it is not unintentionally in contact with any other than the intended terminal.
- Do not allow the other end of the jumper cable connected to the “+” terminal to come into contact with any other parts or metal surfaces in the area, such as brackets or unpainted metal.
- Do not allow the + and - clamps of the jumper cables to come into contact with each other.
- Do not smoke, use matches, cigarette lighters or allow open flame near the battery.

**■ Battery precautions**

The battery contains poisonous and corrosive acidic electrolyte, while related parts contain lead and lead compounds. Observe the following precautions when handling the battery:

- When working with the battery, always wear safety glasses and take care not to allow any battery fluids (acid) to come into contact with skin, clothing or the vehicle body.
- Do not lean over the battery.
- In the event that battery fluid comes into contact with the skin or eyes, immediately wash the affected area with water and seek medical attention. Place a wet sponge or cloth over the affected area until medical attention can be received.
- Always wash your hands after handling the battery support, terminals, and other battery-related parts.
- Do not allow children near the battery.

**■ When replacing the battery**

- When the vent plug and indicator are close to the hold down clamp, the battery fluid (sulfuric acid) may leak.

- For information regarding battery replacement, contact your Lexus dealer.

**⚠ NOTICE****■ When handling jumper cables**

When connecting the jumper cables, ensure that they do not become entangled in the cooling fans or engine drive belt.

### If your vehicle overheats

The following may indicate that your vehicle is overheating.

- The needle of the engine coolant temperature gauge (→P.77) enters the red zone, or a loss of engine power is experienced. (For example, the vehicle speed does not increase.)
- “Engine Coolant Temp High Stop in a Safe Place See Owner’s Manual” is shown on the multi-information display.
- Steam comes out from under the hood.

### Correction procedures

- 1 Stop the vehicle in a safe place and turn off the air conditioning system, and then stop the engine.
- 2 If you see steam:  
Carefully lift the hood after the steam subsides.  
If you do not see steam:  
Carefully lift the hood.
- 3 After the engine has cooled down sufficiently, inspect the hoses and

radiator core (radiator) for any leaks.

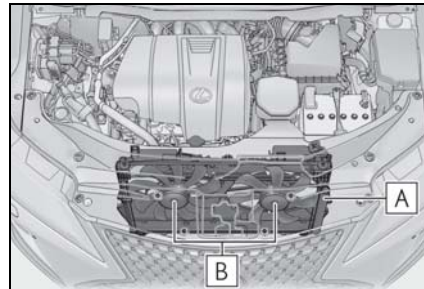

- A** Radiator
- B** Cooling fans

If a large amount of coolant leaks, immediately contact your Lexus dealer.

- 4 The coolant level is satisfactory if it is between the “FULL” and “LOW” lines on the reservoir.

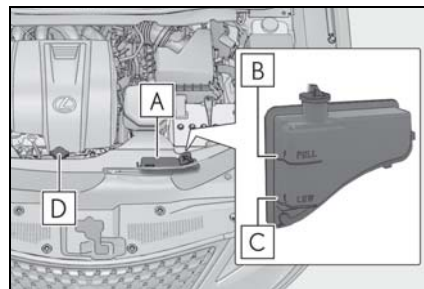

- A** Reservoir
- B** “FULL” line
- C** “LOW” line
- D** Radiator cap

- 5 Add coolant if necessary.

Water can be used in an emergency if

coolant is unavailable.

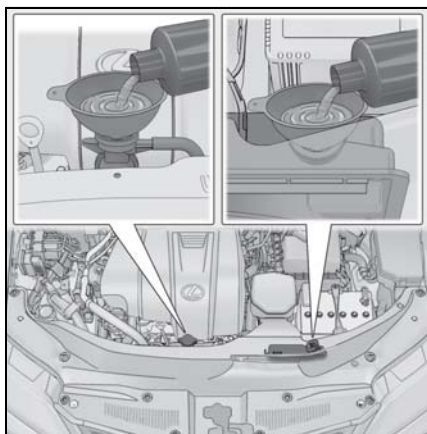

- 6 Start the engine and turn the air conditioning system on to check that the radiator cooling fans operate and to check for coolant leaks from the radiator or hoses.

The fans operate when the air conditioning system is turned on immediately after a cold start. Confirm that the fans are operating by checking the fan sound and air flow. If it is difficult to check these, turn the air conditioning system on and off repeatedly. (The fans may not operate in freezing temperatures.)

- 7 If the fans are not operating:  
Stop the engine immediately and contact your Lexus dealer.  
If the fans are operating:  
Have the vehicle inspected at the nearest Lexus dealer.
- 8 Check if “Engine Coolant Temp High Stop in a Safe Place See Owner's Manual” is shown on the multi-information display.

If the message does not disappear:  
Stop the engine and contact your Lexus dealer.  
If the message is not displayed:  
Have the vehicle inspected at the nearest

Lexus dealer.

**! WARNING**

**When inspecting under the hood of your vehicle**

Observe the following precautions. Failure to do so may result in serious injury such as burns.

- If steam is seen coming from under the hood, do not open the hood until the steam has subsided. The engine compartment may be very hot.
- Keep hands and clothing (especially a tie, a scarf or a muffler) away from the fans and belts. Failure to do so may cause the hands or clothing to be caught, resulting in serious injury.
- Do not loosen the radiator cap and the coolant reservoir cap while the engine and radiator are hot. High temperature steam or coolant could spray out.

**! NOTICE**

**When adding engine coolant**

Add coolant slowly after the engine has cooled down sufficiently. Adding coolant to a hot engine too quickly can cause damage to the engine.

**To prevent damage to the cooling system**

Observe the following precautions:

- Avoid contaminating the coolant with foreign matter (such as sand or dust, etc.).
- Do not use any coolant additive.

**If the vehicle becomes stuck**

Carry out the following procedures if the tires spin or the vehicle becomes stuck in mud, dirt or snow:

**Recovering procedure**

- 1 Stop the engine. Shift the shift lever to P and set the parking brake.
- 2 Remove the mud, snow or sand from around the front wheels.
- 3 Place wood, stones or some other material under the front wheels to help provide traction.
- 4 Restart the engine.
- 5 AWD models: Activate all-wheel drive lock mode. (→P.273)
- 6 Shift the shift lever to D or R and release the parking brake. Then, while exercising caution, depress the accelerator pedal.

**■ When it is difficult to free the vehicle**

Press  to turn off TRAC.

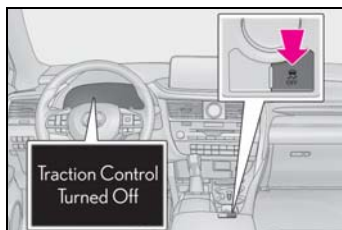
**⚠ WARNING****■ When attempting to free a stuck vehicle**

If you choose to push the vehicle back and forth to free it, make sure the surrounding area is clear to avoid striking other vehicles, objects or people. The vehicle may also lunge forward or lunge back suddenly as it becomes free. Use extreme caution.

**■ When shifting the shift lever**

Be careful not to shift the shift lever with the accelerator pedal depressed. This may lead to unexpected rapid acceleration of the vehicle that may cause an accident resulting in death or serious injury.

**⚠ NOTICE****■ To avoid damage to the transmission and other components**

- Avoid spinning the front wheels and depressing the accelerator pedal more than necessary.
- If the vehicle remains stuck even after these procedures are performed, the vehicle may require towing to be freed.





## Vehicle specifications

8

441

### 8-1. Specifications

Maintenance data (fuel, oil level,  
etc.) ..... 442

Fuel information ..... 450

Tire information ..... 452

### 8-2. Customization

Customizable features ..... 461

### 8-3. Initialization

Items to initialize ..... 474

8

Vehicle specifications

**Maintenance data (fuel, oil level, etc.)**

**Dimensions and weight**

Overall length	192.5 in. (4890 mm) <sup>*1</sup> 196.9 in. (5000 mm) <sup>*2</sup>
Overall width	74.6 in. (1895 mm)
Overall height <sup>*3</sup>	67.7 in. (1720 mm)
Wheelbase	109.8 in. (2790 mm)
Tread	Front 64.4 in. (1635 mm) <sup>*1</sup> 64.5 in. (1640 mm) <sup>*2</sup>
	Rear 64.0 in. (1625 mm) <sup>*1</sup> 64.1 in. (1630 mm) <sup>*2</sup>
Vehicle capacity weight (Occupants + luggage)	1050 lb. (480 kg) <sup>*1,4</sup> 920 lb. (420 kg) <sup>*1,5</sup> 1140 lb. (520 kg) <sup>*2,6</sup> 1235 lb. (560 kg) <sup>*2,7</sup>
Trailer Weight Rating <sup>*8</sup> (Trailer weight + cargo weight)	3500 lb. (1585 kg)

\*1: RX350

\*2: RX350L

\*3: Unladen vehicle

\*4: For GGL25L-BWZGBA models<sup>\*9</sup>

\*5: Except for GGL25L-BWZGBA models<sup>\*9</sup>

\*6: Vehicles with separate-type second-row seats

\*7: Vehicles with bench-type second-row seats

\*8: Vehicles with towing package

\*9: The model code is indicated on the Certification Label. (→P.443)

### Seating capacity

Seating capacity	5 (Front 2, Rear 3) <sup>*1</sup> 6 (Front 2, Rear 4) <sup>*2,3</sup> 7 (Front 2, Rear 5) <sup>*2,4</sup>
------------------	---

\*1: RX350

\*2: RX350L

\*3: Vehicles with separate-type second-row seats

\*4: Vehicles with bench-type second-row seats

### Vehicle identification

#### ■ Vehicle identification number

The vehicle identification number (VIN) is the legal identifier for your vehicle. This is the primary identification number for your Lexus. It is used in registering the ownership of your vehicle.

This number is stamped on the top left of the instrument panel.

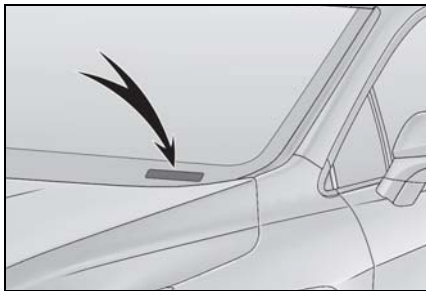

On some models, this number is also stamped under the right-hand front seat.

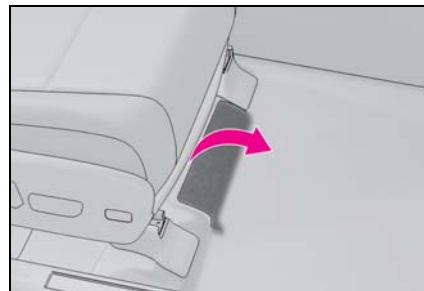

This number is also on the Certification Label.

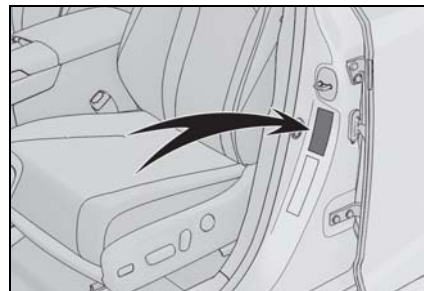

#### ■ Engine number

The engine number is stamped on the engine block as shown.

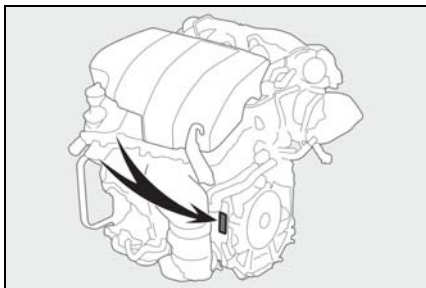

### Engine

Model	3.5 L 6-cylinder (2GR-FKS)
Type	6-cylinder V type, 4-cycle, gasoline
Bore and stroke	3.70 x 3.27 in. (94.0 x 83.0 mm)
Displacement	210.9 cu. in. (3456 cm <sup>3</sup> )
Valve clearance (engine cold)	Automatic adjustment
Drive belt tension	Automatic adjustment

### Fuel

Fuel type	Unleaded gasoline only
Octane Rating	87 (Research Octane Number 91) or higher
Fuel tank capacity (Reference)	19.2 gal. (72.5 L, 15.9 Imp. gal.)

### Lubrication system

■ Oil capacity (Drain and refill—reference<sup>\*</sup>)

With filter	▶ Vehicles with towing package 5.8 qt. (5.5 L, 4.8 Imp. qt.)
	▶ Vehicles without towing package 5.7 qt. (5.4 L, 4.8 Imp. qt.)
Without filter	5.6 qt. (5.3 L, 4.7 Imp. qt.)

\*: The engine oil capacity is a reference

quantity to be used when changing the engine oil. Warm up and turn off the engine, wait more than 5 minutes, and check the oil level on the dipstick.

■ **Engine oil selection**

“Toyota Genuine Motor Oil” is used in your Lexus vehicle. Use Lexus approved “Toyota Genuine Motor Oil” or equivalent to satisfy the following grade and viscosity.

Oil grade: ILSAC GF-5 multigrade engine oil

Recommended viscosity: SAE OW-20  
SAE OW-20 is the best choice for good fuel economy and good starting in cold weather.

If SAE OW-20 is not available, SAE 5W-20 oil may be used. However, it must be replaced with SAE OW-20 at the next oil change.

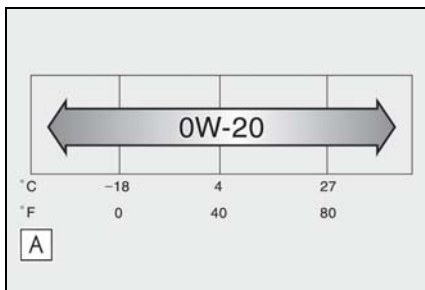

**A** Outside temperature

Oil viscosity (OW-20 is explained here as an example):

- The OW in OW-20 indicates the characteristic of the oil which allows cold startability. Oils with a lower value before the W allow for easier starting of the engine in cold weather.

- The 20 in OW-20 indicates the viscosity characteristic of the oil when the oil is at high temperature. An oil with a higher viscosity (one with a higher value) may be better suited if the vehicle is operated at high speeds, or under extreme load conditions.

How to read oil container label:

The International Lubricant Specification Advisory Committee (ILSAC) Certification Mark is added to some oil containers to help you select the oil you should use.



### Cooling system

Capacity *	<ul style="list-style-type: none"> <li>▶ RX350 (Vehicles without towing package) 9.5 qt. (9.0 L, 7.9 Imp. qt.)</li> <li>▶ RX350 (Vehicles with towing package) 10.5 qt. (9.9 L, 8.7 Imp. qt.)</li> <li>▶ RX350L 13.1 qt. (12.4 L, 11 Imp. qt.)</li> </ul>
Coolant type	<p>Use either of the following:</p> <ul style="list-style-type: none"> <li>• “Toyota Super Long Life Coolant”</li> <li>• Similar high-quality ethylene glycol-based non-silicate, non-amine, non-nitrite, and non-borate coolant with long-life hybrid organic acid technology</li> </ul> <p>Do not use plain water alone.</p>

\* : The coolant capacity is a reference quantity.  
If replacement is necessary, contact your Lexus dealer.

### Ignition system (spark plug)

Make	DENSO FK20HBR8
Gap	0.03 in. (0.8 mm)



#### NOTICE

#### ■ Iridium-tipped spark plugs

Use only iridium-tipped spark plugs. Do not adjust the spark plug gap.

### Electrical system (battery)

Open voltage at 68°F (20°C):	<p>12.6 V or higher: Fully charged 12.2 — 12.4 V: Half charged 12.0 V or lower: Discharged</p> <p>(Turn the engine switch off and turn on the headlights for 20 to 30 seconds.)</p>
Charging rates	5 A max.

**Automatic transmission**

Fluid capacity *	7.2 qt. (6.8 L, 6.0 Imp. qt.)
Fluid type	Toyota Genuine ATF WS

\*: The fluid capacity is a reference quantity.  
If replacement is necessary, contact your Lexus dealer.

 **NOTICE****Transmission fluid type**

Using transmission fluid other than the above type may cause abnormal noise or vibration, or damage the transmission of your vehicle.

**Transfer (AWD models)**

Oil capacity	0.8 qt. (0.8 L, 0.7 Imp. qt.)
Oil type and viscosity	Toyota Genuine Differential gear oil LT 75W-85 GL-5 or equivalent

Your Lexus vehicle is filled with “Toyota Genuine Differential Gear Oil” at the factory. Use Lexus approved “Toyota Genuine Differential Gear Oil” or an equivalent of matching quality to satisfy the above specification. Please contact your Lexus dealer for further details.

**Rear differential (AWD models)**

Oil capacity	0.5 qt. (0.5 L, 0.4 Imp. qt.)
Oil type and viscosity	Toyota Genuine Differential gear oil LT 75W-85 GL-5 or equivalent

Your Lexus vehicle is filled with “Toyota Genuine Differential Gear Oil” at the factory. Use Lexus approved “Toyota Genuine Differential Gear Oil” or an equivalent of matching quality to satisfy the above specification. Please contact your Lexus dealer for further details.

**Brakes**

Pedal clearance *	3.4 in. (86 mm) Min.
Pedal free play	0.04—0.24 in. (1.0—6.0 mm)

Brake pad wear limit	0.04 in. (1.0 mm)
Fluid type	FMVSS No. 116 DOT 3 or SAE J1703 FMVSS No. 116 DOT 4 or SAE J1704

\* : Minimum pedal clearance when depressed with a force of 110 lbf (490 N, 50 kgf) while the engine is running.

### Steering

Free play	Less than 1.2 in. (30 mm)
-----------	---------------------------

### Tires and wheels

► Type A

Tire size	235/65R18 106V, T165/90D18 107M (spare)
Tire inflation pressure (Recommended cold tire inflation pressure)	<p>► Front tire 33 psi (230 kPa, 2.3 kgf/cm<sup>2</sup> or bar)</p> <p>► Rear tire 33 psi (230 kPa, 2.3 kgf/cm<sup>2</sup> or bar)</p> <p>► Spare tire 60 psi (420 kPa, 4.2 kgf/cm<sup>2</sup> or bar)</p> <p>Driving at high speeds (above 100 mph [160 km/h]) (in countries where such speeds are permitted by law)</p> <p>Add 5 psi (30 kPa, 0.3 kgf/cm<sup>2</sup> or bar) to the front and rear tires. Never exceed the maximum cold tire inflation pressure indicated on the tire sidewall.</p>
Wheel size	18 × 8J, 18 × 4T (spare)
Wheel nut torque	76 ft•lbf (103 N•m, 10.5 kgf•m)



## ► Type B

Tire size	235/55R20 102V, T165/90D18 107M (spare)
Tire inflation pressure (Recommended cold tire inflation pressure)	<p>► Front tire 33 psi (230 kPa, 2.3 kgf/cm<sup>2</sup> or bar)</p> <p>► Rear tire 33 psi (230 kPa, 2.3 kgf/cm<sup>2</sup> or bar)</p> <p>► Spare tire 60 psi (420 kPa, 4.2 kgf/cm<sup>2</sup> or bar)</p> <p>Driving at high speeds (above 100 mph [160 km/h]) (in countries where such speeds are permitted by law)</p> <p>Add 11 psi (70 kPa, 0.7 kgf/cm<sup>2</sup> or bar) to the front and rear tires. Never exceed the maximum cold tire inflation pressure indicated on the tire sidewall.</p>
Wheel size	20 × 8J, 18 × 4T (spare)
Wheel nut torque	76 ft•lbf (103 N•m, 10.5 kgf•m)

**Light bulbs**

	Light bulbs	Bulb No.	W	Type
Exterior	Front side marker lights <sup>*1</sup>	W5W	5	B
	Front turn signal lights <sup>*1</sup>	7444NA	28/8	A
	Rear turn signal lights <sup>*1</sup>	WY21W	21	A
	Back-up lights <sup>*1</sup>	921	16	B
Interior	Door courtesy lights <sup>*2</sup>	—	5	B
	Vanity lights	—	8	B

A: Wedge base bulbs (amber)

B: Wedge base bulbs (clear)

<sup>\*1</sup>: Vehicles with single-beam headlights<sup>\*2</sup>: Vehicles without door trim ornament lights

## Fuel information

You must only use unleaded gasoline.

Select octane rating 87 (Research Octane Number 91) or higher. Use of unleaded gasoline with an octane rating lower than 87 may result in engine knocking. Persistent knocking can lead to engine damage.

At minimum, the gasoline you use should meet the specifications of ASTM D4814 in the U.S.A.

### Gasoline quality

In very few cases, driveability problems may be caused by the brand of gasoline you are using. If driveability problems persist, try changing the brand of gasoline. If this does not correct the problem, consult your Lexus dealer.

### Recommendation of the use of gasoline containing detergent additives

- Lexus recommends the use of gasoline that contains detergent additives to avoid the build-up of engine deposits.
- All gasoline sold in the U.S.A. contains minimum detergent additives to clean and/or keep clean intake systems, per EPA's lowest additives concentration program.
- Lexus strongly recommends the use of Top Tier Detergent Gasoline. For more information on Top Tier Detergent Gasoline and a list of marketers, please go to the official website [www.toptiergas.com](http://www.toptiergas.com).

### Recommendation of the use of low emissions gasoline

Gasolines containing oxygenates such as ethers and ethanol, as well as reformulated gasolines, are available in some cities. These fuels are typically acceptable for use, providing they meet other fuel require-

ments.

Lexus recommends these fuels, since the formulations allow for reduced vehicle emissions.

### Non-recommendation of the use of blended gasoline

- Use only gasoline containing up to 15% ethanol. DO NOT use any flex-fuel or gasoline that could contain more than 15% ethanol, including from any pump labeled E30 (30% ethanol [**A**]), E50 (50% ethanol [**B**]), E85 (85% ethanol [**C**]) (which are only some examples of fuel containing more than 15% ethanol).

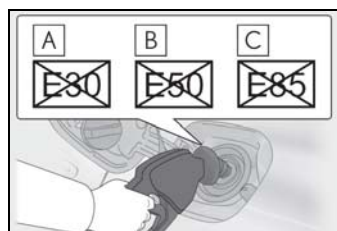

- If you use gasohol in your vehicle, be sure that it has an octane rating no lower than 87.
- Lexus does not recommend the use of gasoline containing methanol.

### Non-recommendation of the use of gasoline containing MMT

Some gasoline contains an octane enhancing additive called MMT (Methylcyclopentadienyl Manganese Tricarbonyl).

Lexus does not recommend the use of gasoline that contains MMT. If fuel containing MMT is used, your emission control system may be adversely affected.

The malfunction indicator lamp on the instrument cluster may come on. If this happens, contact your Lexus dealer for service.

### If your engine knocks

- Consult your Lexus dealer.
- You may occasionally notice light knocking for a short time while accelerating or driving uphill. This is normal and there is no need for concern.

 NOTICE**■ Notice on fuel quality**

- Do not use improper fuels. If improper fuels are used, the engine will be damaged.
- Do not use leaded gasoline. Leaded gasoline can cause damage to your vehicle's three-way catalytic converters causing the emission control system to malfunction.
- Do not use gasohol other than the type previously stated. Other gasohol may cause fuel system damage or vehicle performance problems.
- Using unleaded gasoline with an octane number or rating lower than the level previously stated will cause persistent heavy knocking. At worst, this will lead to engine damage.

**■ When refueling with gasohol**

Take care not to spill gasohol. It can damage your vehicle's paint.

**■ Fuel-related poor driveability**

If poor driveability (poor hot starting, vaporization, engine knocking, etc.) is encountered after using a different type of fuel, discontinue the use of that type of fuel.

**Tire information**

**Typical tire symbols**

► Full-size tire

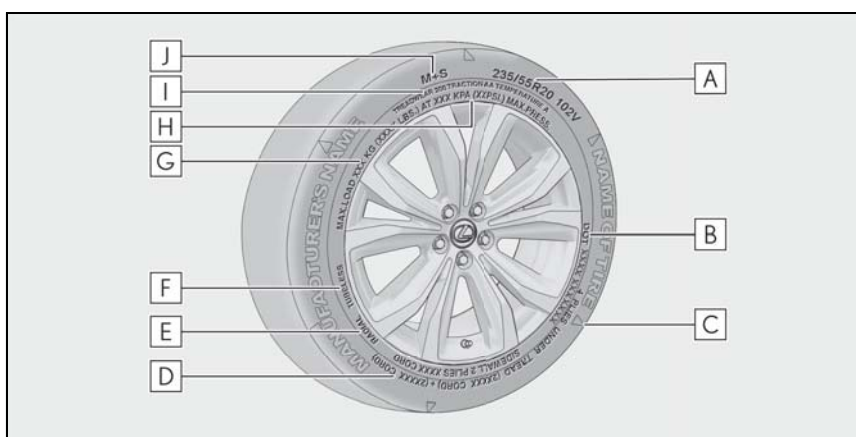

► Compact spare tire

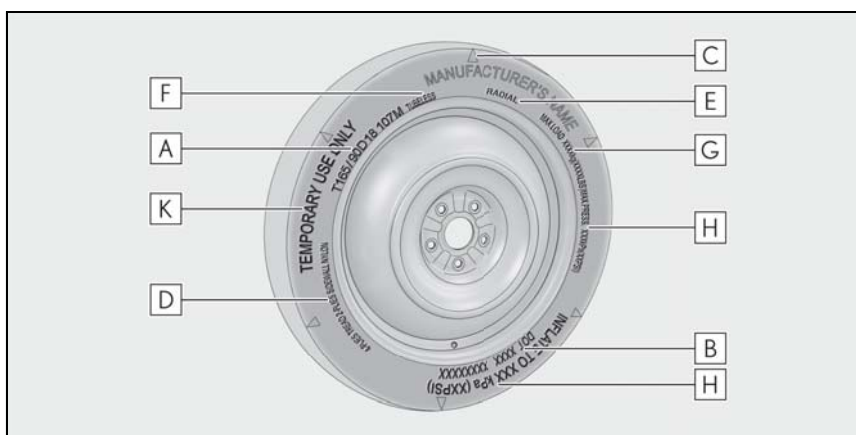

- A** Tire size (→P.454)
  - B** DOT and Tire Identification Number (TIN) (→P.453)
  - C** Location of treadwear indicators (→P.365)
  - D** Tire ply composition and materials
- Plyes are layers of rubber-coated parallel cords. Cords are the strands which form the plyes in a tire.
- E** Radial tires or bias-ply tires

A radial tire has "RADIAL" on the sidewall. A tire not marked "RADIAL" is a bias-ply tire.

**F** TUBELESS or TUBE TYPE

A tubeless tire does not have a tube and air is directly put into the tire. A tube type tire has a tube inside the tire and the tube maintains the air pressure.

**G** Load limit at maximum cold tire inflation pressure (→P.366)

**H** Maximum cold tire inflation pressure (→P.448)

This means the pressure to which a tire may be inflated.

**I** Uniform tire quality grading

For details, see "Uniform Tire Quality Grading" that follows.

**J** Summer tires or all season tires (→P.366)

An all season tire has "M+S" on the sidewall. A tire not marked "M+S" is a summer tire.

**K** "TEMPORARY USE ONLY"

A compact spare tire is identified by the phrase "TEMPORARY USE ONLY" molded on its sidewall. This tire is designed for temporary emergency use only.

**Typical DOT and Tire Identification Number (TIN)**

► Type A

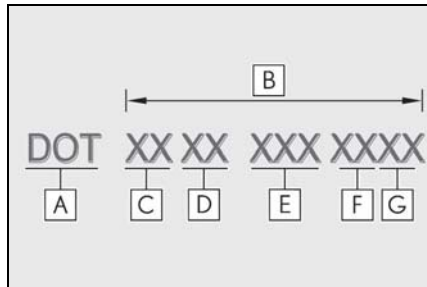

- A** DOT symbol\*
- B** Tire Identification Number (TIN)
- C** Tire manufacturer's identification mark
- D** Tire size code
- E** Manufacturer's optional tire type code (3 or 4 letters)
- F** Manufacturing week
- G** Manufacturing year

\*: The DOT symbol certifies that the tire conforms to applicable Federal Motor Vehicle Safety Standards.

► Type B

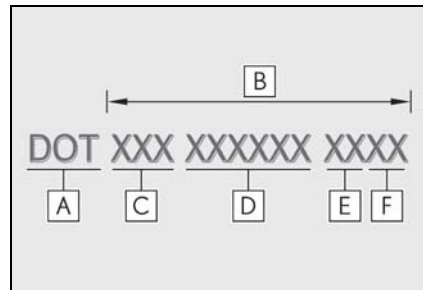

- A** DOT symbol\*
- B** Tire Identification Number (TIN)
- C** Tire manufacturer's identification mark
- D** Manufacturer's code
- E** Manufacturing week
- F** Manufacturing year

\*: The DOT symbol certifies that the tire conforms to applicable Federal Motor

Vehicle Safety Standards.

**Tire size**

■ **Typical tire size information**

The illustration indicates typical tire size.

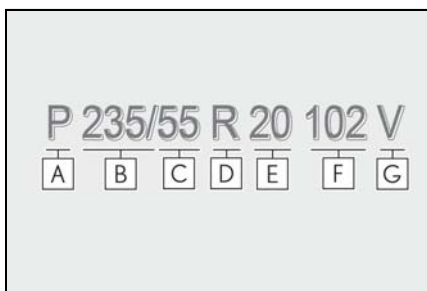

- A** Tire use (P = Passenger car, T = Temporary use)
- B** Section width (millimeters)
- C** Aspect ratio (tire height to section width)
- D** Tire construction code (R = Radial, D = Diagonal)
- E** Wheel diameter (inches)
- F** Load index (2 digits or 3 digits)
- G** Speed symbol (alphabet with one letter)

■ **Tire dimensions**

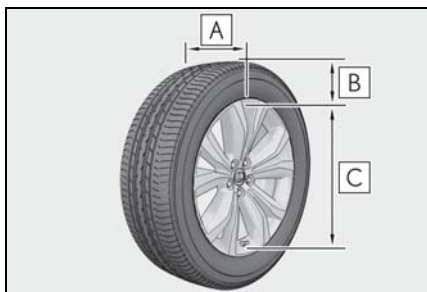

- A** Section width

- B** Tire height
- C** Wheel diameter

**Tire section names**

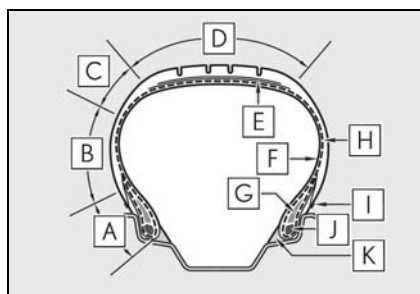

- A** Bead
- B** Sidewall
- C** Shoulder
- D** Tread
- E** Belt
- F** Inner liner
- G** Reinforcing rubber
- H** Carcass
- I** Rim lines
- J** Bead wires
- K** Chafer

**Uniform Tire Quality Grading**

This information has been prepared in accordance with regulations issued by the National Highway Traffic Safety Administration of the U.S. Department of Transportation.

It provides the purchasers and/or prospective purchasers of Lexus vehicles with information on uniform tire quality grading.

Your Lexus dealer will help answer any questions you may have as you read this information.

#### ■ DOT quality grades

All passenger vehicle tires must conform to Federal Safety Requirements in addition to these grades. Quality grades can be found where applicable on the tire sidewall between tread shoulder and maximum section width.

For example: Treadwear 200 Traction AA Temperature A

#### ■ Treadwear

The treadwear grade is a comparative rating based on the wear rate of the tire when tested under controlled conditions on a specified government test course.

For example, a tire graded 150 would wear one and a half (1 - 1/2) times as well on the government course as a tire graded 100. The relative performance of tires depends upon the actual conditions of their use. Performance may differ significantly from the norm due to variations in driving habits, service practices and differences in road characteristics and climate.

#### ■ Traction AA, A, B, C

The traction grades, from highest to lowest, are AA, A, B and C, and they represent the tire's ability to stop on wet pavement as measured under controlled conditions on specified government test surfaces of asphalt and concrete.

A tire marked C may have poor traction performance.

Warning: The traction grade assigned to this tire is based on braking (straight

ahead) traction tests and does not include cornering (turning) traction.

#### ■ Temperature A, B, C

The temperature grades are A (the highest), B, and C, representing the tire's resistance to the generation of heat and its ability to dissipate heat when tested under controlled conditions on a specified indoor laboratory test wheel.

Sustained high temperature can cause the material of the tire to degenerate and reduce tire life, and excessive temperature can lead to sudden tire failure.

Grade C corresponds to a level of performance which all passenger car tires must meet under the Federal Motor Vehicle Safety Standard No. 109.

Grades B and A represent higher levels of performance on the laboratory test wheel than the minimum required by law.

Warning: The temperature grades of a tire assume that it is properly inflated and not overloaded.

Excessive speed, underinflation, or excessive loading, either separately or in combination, can cause heat buildup and possible tire failure.

**Glossary of tire terminology**

Tire related term	Meaning
Cold tire inflation pressure	Tire pressure when the vehicle has been parked for three hours or more, or has not been driven more than 1 mile or 1.5 km under that condition
Maximum inflation pressure	The maximum cold inflated pressure to which a tire may be inflated, shown on the sidewall of the tire
Recommended inflation pressure	Cold tire inflation pressure recommended by a manufacturer
Accessory weight	The combined weight (in excess of those standard items which may be replaced) of automatic transmission, power steering, power brakes, power windows, power seats, radio and heater, to the extent that these items are available as factory-installed equipment (whether installed or not)
Curb weight	The weight of a motor vehicle with standard equipment, including the maximum capacity of fuel, oil and coolant, and if so equipped, air conditioning and additional weight optional engine
Maximum loaded vehicle weight	The sum of: (a) Curb weight (b) Accessory weight (c) Vehicle capacity weight (d) Production options weight
Normal occupant weight	150 lb. (68 kg) times the number of occupants specified in the second column of Table 1* that follows
Occupant distribution	Distribution of occupants in a vehicle as specified in the third column of Table 1* below
Production options weight	The combined weight of installed regular production options weighing over 5 lb. (2.3 kg) in excess of the standard items which they replace, not previously considered in curb weight or accessory weight, including heavy duty brakes, ride levelers, roof rack, heavy duty battery, and special trim



Tire related term	Meaning
Rim	A metal support for a tire or a tire and tube assembly upon which the tire beads are seated
Rim diameter (Wheel diameter)	Nominal diameter of the bead seat
Rim size designation	Rim diameter and width
Rim type designation	The industry manufacturer's designation for a rim by style or code
Rim width	Nominal distance between rim flanges
Vehicle capacity weight (Total load capacity)	The rated cargo and luggage load plus 150 lb. (68 kg) times the vehicle's designated seating capacity
Vehicle maximum load on the tire	The load on an individual tire that is determined by distributing to each axle its share of the maximum loaded vehicle weight, and dividing by two
Vehicle normal load on the tire	The load on an individual tire that is determined by distributing to each axle its share of curb weight, accessory weight, and normal occupant weight (distributed in accordance with Table 1* below), and dividing by two
Weather side	The surface area of the rim not covered by the inflated tire
Bead	The part of the tire that is made of steel wires, wrapped or reinforced by ply cords and that is shaped to fit the rim
Bead separation	A breakdown of the bond between components in the bead
Bias ply tire	A pneumatic tire in which the ply cords that extend to the beads are laid at alternate angles substantially less than 90 degrees to the centerline of the tread
Carcass	The tire structure, except tread and sidewall rubber which, when inflated, bears the load
Chunking	The breaking away of pieces of the tread or sidewall
Cord	The strands forming the plies in the tire
Cord separation	The parting of cords from adjacent rubber compounds

Tire related term	Meaning
Cracking	Any parting within the tread, sidewall, or innerliner of the tire extending to cord material
CT	A pneumatic tire with an inverted flange tire and rim system in which the rim is designed with rim flanges pointed radially inward and the tire is designed to fit on the underside of the rim in a manner that encloses the rim flanges inside the air cavity of the tire
Extra load tire	A tire designed to operate at higher loads and at higher inflation pressures than the corresponding standard tire
Groove	The space between two adjacent tread ribs
Innerliner	The layer(s) forming the inside surface of a tubeless tire that contains the inflating medium within the tire
Innerliner separation	The parting of the innerliner from cord material in the carcass
Intended outboard sidewall	(a) The sidewall that contains a whitewall, bears white lettering, or bears manufacturer, brand, and/or model name molding that is higher or deeper than the same molding on the other sidewall of the tire, or (b) The outward facing sidewall of an asymmetrical tire that has a particular side that must always face outward when mounted on a vehicle
Light truck (LT) tire	A tire designated by its manufacturer as primarily intended for use on lightweight trucks or multipurpose passenger vehicles
Load rating	The maximum load that a tire is rated to carry for a given inflation pressure
Maximum load rating	The load rating for a tire at the maximum permissible inflation pressure for that tire
Maximum permissible inflation pressure	The maximum cold inflation pressure to which a tire may be inflated
Measuring rim	The rim on which a tire is fitted for physical dimension requirements
Open splice	Any parting at any junction of tread, sidewall, or innerliner that extends to cord material

Tire related term	Meaning
Outer diameter	The overall diameter of an inflated new tire
Overall width	The linear distance between the exteriors of the sidewalls of an inflated tire, including elevations due to labeling, decorations, or protective bands or ribs
Passenger car tire	A tire intended for use on passenger cars, multipurpose passenger vehicles, and trucks, that have a gross vehicle weight rating (GVWR) of 10,000 lb. or less.
Ply	A layer of rubber-coated parallel cords
Ply separation	A parting of rubber compound between adjacent plies
Pneumatic tire	A mechanical device made of rubber, chemicals, fabric and steel or other materials, that, when mounted on an automotive wheel, provides the traction and contains the gas or fluid that sustains the load
Radial ply tire	A pneumatic tire in which the ply cords that extend to the beads are laid at substantially 90 degrees to the centerline of the tread
Reinforced tire	A tire designed to operate at higher loads and at higher inflation pressures than the corresponding standard tire
Section width	The linear distance between the exteriors of the sidewalls of an inflated tire, excluding elevations due to labeling, decoration, or protective bands
Sidewall	That portion of a tire between the tread and bead
Sidewall separation	The parting of the rubber compound from the cord material in the sidewall
Snow tire	A tire that attains a traction index equal to or greater than 110, compared to the ASTM E-1136 Standard Reference Test Tire, when using the snow traction test as described in ASTM F-1805-00, Standard Test Method for Single Wheel Driving Traction in a Straight Line on Snow-and Ice-Covered Surfaces, and which is marked with an Alpine Symbol (  ) on at least one sidewall

Tire related term	Meaning
Test rim	The rim on which a tire is fitted for testing, and may be any rim listed as appropriate for use with that tire
Tread	That portion of a tire that comes into contact with the road
Tread rib	A tread section running circumferentially around a tire
Tread separation	Pulling away of the tread from the tire carcass
Treadwear indicators (TWI)	The projections within the principal grooves designed to give a visual indication of the degrees of wear of the tread
Wheel-holding fixture	The fixture used to hold the wheel and tire assembly securely during testing

\*: Table 1 -Occupant loading and distribution for vehicle normal load for various designated seating capacities

Designated seating capacity, Number of occupants	Vehicle normal load, Number of occupants	Occupant distribution in a normally loaded vehicle
2 through 4	2	2 in front
5 through 10	3	2 in front, 1 in second seat
11 through 15	5	2 in front, 1 in second seat, 1 in third seat, 1 in fourth seat
16 through 20	7	2 in front, 2 in second seat, 2 in third seat, 1 in fourth seat

**Customizable features**

Your vehicle includes a variety of electronic features that can be personalized to suit your preferences. The settings of these features can be changed by using the meter control switches, the Remote Touch, or at your Lexus dealer.

**Customizing vehicle features**

■ **Changing by using the Remote Touch**

- 1 Press the "MENU" button on the Remote Touch.
- 2 Select "Setup" on the menu screen and select "Vehicle".
- 3 Select "Vehicle Customization" or "Drive Mode Customization".



Various setting can be changed. Refer to the list of settings that can be changed for details.

This system can also be operated by the touch screen.

For details on the Remote Touch, refer to the "NAVIGATION AND MULTIMEDIA SYSTEM OWNER'S MAN-

UAL".

■ **Changing by using the meter control switches**

- 1 Press < or > to select .
- 2 Operate the meter control switches to select the desired item to be customized.
- 3 According to the display, select the desired setting and then press .

To go back to the previous screen or exit the customize mode, press .

**! WARNING**

■ **During customization**

As the engine needs to be running during customization, ensure that the vehicle is parked in a place with adequate ventilation. In a closed area such as a garage, exhaust gases including harmful carbon monoxide (CO) may collect and enter the vehicle. This may lead to death or a serious health hazard.

**! NOTICE**

■ **During customization**

To prevent battery discharge, ensure that the engine is running while customizing features.

**Customizable Features**

Some function settings are changed simultaneously with other functions being customized. Contact your Lexus dealer for further details.

- A** Settings that can be changed using the Remote Touch
- B** Settings that can be changed using the meter control switches
- C** Settings that can be changed by your Lexus dealer

Definition of symbols: ○ = Available, – = Not available

■ Gauges, meters and multi-information display (→P.72, 77, 81)

Function <sup>*1</sup>	Default setting	Customized setting	A	B	C
Language	English	French	○	○	–
		Spanish			
Units <sup>*2</sup>	miles (MPG)	km (km/L)	○	○	–
		km (L/100km)			
		miles (MPG Imperial)			
Drive information 1	Current fuel consumption	Customizable items: →P.82	–	○	–
	Average fuel economy (after reset)				
Drive information 2	Distance (driving range)				
	Average vehicle speed (after reset)				
Drive information 3	Average fuel economy (after refuel)				
	Elapsed time (after start)				
Clock	12-hour display				
Pop-up display	On	Off	–	○	–
Accent color <sup>*3</sup>	Color 1	Color 2	○	○	–
Needle <sup>*4</sup>	Color 1	Color 2	–	○	–
		Color 3			
Rev indicator <sup>*4</sup>	5000 r/min.	2000 - 6500 r/min.	–	○	–
		Off			
Rev peak <sup>*4</sup>	On	Off	–	○	–
Eco Driving Indicator Light	On	Off	–	○	–
Suggestion function	On	Off	–	–	○

\*1: For details about each function: →P.85

\*2: The default setting varies according to country.

\*3: Except F SPORT models

\*4: F SPORT models

### ■ Head-up Display\* (→P.88)

Function	Default setting	Customized setting	A	B	C
Gauge information	No content	Eco Driving Indicator	-	○	-
		Tachometer	-	○	-
Route guidance to destination/street name	On	Off	-	○	-
Driving support system display	On	Off	-	○	-
Compass	On	Off	-	○	-
Audio system operation status	On	Off	-	○	-

\*: If equipped

### ■ Door lock (→P.99, 431)

Function	Default setting	Customized setting	A	B	C
Unlocking using a mechanical key	Driver's door unlocked in one step, all doors unlocked in two step	All doors unlocked in one step	-	-	○
Automatic door locking function	Shift position linked door locking operation	Off	-	-	○
		Speed linked door locking operation	○	-	○
Automatic door unlocking function	Shift position linked door unlocking operation	Off	-	-	○
		Driver's door linked door unlocking operation	○	-	○

■ Power back door (→P.103)

Function	Default setting	Customized setting	A	B	C
Power back door	On	Off	-	○	-
Power back door opening position	5	1 to 5	○	-	-
Buzzer volume	Level 3	Level 1	-	○	-
		Level 2	-	○	-
Kick sensor*	On	Off	-	○	-
Hands free close & lock function*	Off	On	-	-	○

\* : If equipped

■ Smart access system with push-button start and wireless remote control (→P.99, 115)

Function	Default setting	Customized setting	A	B	C
Operation buzzer volume	5	Off	○	-	○
		1 to 7			
Operation signal (Emergency flashers)	On	Off	○	-	○
Time elapsed before automatic door lock function is activated if door is not opened after being unlocked	60 seconds	Off			
		30 seconds	○	-	○
		120 seconds			
Open door warning buzzer	Off	On	-	-	○
Reservation lock	On	Off	-	-	○

■ Smart access system with push-button start (→P.99, 115)



Function	Default setting	Customized setting	A	B	C
Smart access system with push-button start	On	Off	-	-	○



Function	Default setting	Customized setting	A	B	C
The doors that are unlocked using the smart access system with push-button start can be selected	Driver's door	All the doors	<input type="radio"/>	-	<input type="radio"/>
Number of consecutive door lock operations	2 times	As many as desired	-	-	<input type="radio"/>

■ **Wireless remote control (→P.97, 99, 103)**

Function	Default setting	Customized setting	A	B	C
Wireless remote control	On	Off	-	-	<input type="radio"/>
Unlocking operation	Driver's door unlocked in one step, all doors unlocked in two step	All doors unlocked in one step	<input type="radio"/>	-	<input type="radio"/>
Panic function	On	Off	-	-	<input type="radio"/>

Function	Default setting	Customized setting	A	B	C
Opening/closing of the power back door using the  switch of the wireless remote control	Open: Press for 1 second <sup>*1</sup> Close: Press for 1 second	Off			
		Open: Press for 1 second with the back door unlocked Close: Press for 1 second			
		Open: One short press with the back door unlocked Close: One short press	-	-	○
		Open: Press twice with the back door unlocked Close: Press twice			
		Open: Press twice <sup>*1</sup> Close: Press twice			
Door unlocked when the power back door is opened using the  switch of the wireless remote control <sup>*2</sup>	All the doors	Back door	-	-	○

<sup>\*1</sup>: This setting enables opening of the power back door when it is locked or unlocked.

<sup>\*2</sup>: This function is available only when a customized setting that enables opening of the power back door when it is either locked or unlocked is selected. (See <sup>\*1</sup> above.)

#### ■ Driving position memory\* (→P.133)

Function	Default setting	Customized setting	A	B	C
Driver's seat movement when exiting the vehicle	Standard	Off	○	-	○
		Partial			
Selecting doors linked to the memory recall function	Driver's door	All doors	-	-	○

\*: If equipped

### ■ Steering wheel (→P.139)

Function	Default setting	Customized setting	A	B	C
Auto tilt away function	On	Off	-	-	○

### ■ Outside rear view mirrors (→P.141)

Function	Default setting	Customized setting	A	B	C
Automatic mirror folding and extending operation *	Linked to the locking/unlocking of the doors	Off	-	-	○
		Linked to operation of the engine switch	-	-	○

\*: If equipped

### ■ Power windows, and moon roof\* or panoramic moon roof\* (→P.144, 146, 149)

Function	Default setting	Customized setting	A	B	C
Mechanical key linked operation	Off	On	-	-	○
Wireless remote control linked operation	Off	On (open only)	-	-	○
Wireless remote control linked operation signal (buzzer)	On	Off	-	-	○

\*: If equipped

### ■ Moon roof\* (→P.146)

Function	Default setting	Customized setting	A	B	C
Linked operation of components when mechanical key is used (open only)	Slide only	Tilt only	-	-	○
Linked operation of components when wireless remote control is used	Slide only	Tilt only	-	-	○

\*: If equipped

■ Turn signal lever (→P.182)

Function	Default setting	Customized setting	A	B	C
The number of times the turn signal lights flash automatically when the turn signal lever is moved to the first position during a lane change	3	5	-	-	○
		7			
		Off			

■ Automatic light control system (→P.188)

Function	Default setting	Customized setting	A	B	C
Light sensor sensitivity	Standard	-2 to 2	○	-	○
Time elapsed before headlights automatically turn off after doors are closed	30 seconds	Off	○	-	○
		60 seconds			
		90 seconds			

■ Lights (→P.188)

Function	Default setting	Customized setting	A	B	C
Daytime running lights	On	Off <sup>*1</sup>	○	-	○
Welcome lighting	On	Off	-	-	○
AFS (Adaptive Front-lighting System) <sup>*2</sup>	On	Off	-	-	○
Windshield wiper linked headlight illumination	On	Off	-	-	○

<sup>\*1</sup>: Except for Canada

<sup>\*2</sup>: If equipped

■ Rain-sensing windshield wipers\* (→P.194)

Function	Default setting	Customized setting	A	B	C
Wiper operation when the wiper switch is in the "AUTO" position	Rain-sensing operation	Intermittent operation linked to vehicle speed (with interval adjuster)	-	-	○

\*: If equipped

## ■ PCS (Pre-Collision System) (→P.209)

Function	Default setting	Customized setting	A	B	C
PCS (Pre-Collision System)	On	Off	-	○	-
Adjust alert timing	Middle	Early	-	○	-
		Late	-	○	-

## ■ LTA (Lane Tracing Assist) (→P.216)

Function	Default setting	Customized setting	A	B	C
Lane centering function	On	Off	-	○	-
Steering assist function	On	Off	-	○	-
Alert type	Steering wheel vibration	Buzzer	-	○	-
Alert sensitivity	High	Standard	-	○	-
Vehicle sway warning function	On	Off	-	○	-
Vehicle sway warning sensitivity	Standard	High	-	○	-
		Low	-	○	-

## ■ RSA (Road Sign Assist)\* (→P.225)

Function	Default setting	Customized setting	A	B	C
RSA (Road Sign Assist)	On	Off	-	○	-
Excess speed notification method	Display only	No notification	-	○	-
		Display and buzzer	-	○	-
Excess speed notification level	1 mph (2 km/h)	3 mph (5 km/h)	-	○	-
		5 mph (10 km/h)	-	○	-
Other notifications method (No-entry notification)	Display only	No notification	-	○	-
		Display and buzzer	-	○	-

\* : If equipped

■ BSM (Blind Spot Monitor)\* (→P.236)

Function	Default setting	Customized setting	A	B	C
BSM (Blind Spot Monitor)	On	Off	-	○	-
Outside rear view mirror indicator brightness	Bright	Dim	-	○	-
Alert timing for presence of approaching vehicle (sensitivity)	Intermediate	Early	-	○	-
		Late			
		Only when vehicle detected in blind spot			

\*: If equipped

■ PKSA (Parking support alert)\* (→P.242)

Function	Default setting	Customized setting	A	B	C
Buzzer volume	Level 2	Level 1	-	○	-
		Level 3			

\*: If equipped

■ Intuitive parking assist\* (→P.244)

Function	Default setting	Customized setting	A	B	C
Intuitive parking assist	On	Off	-	○	-

\*: If equipped

■ RCTA (Rear cross traffic alert) function\* (→P.250)

Function	Default setting	Customized setting	A	B	C
RCTA (Rear cross traffic alert) function	On	Off	-	○	-
RCTA buzzer volume	Level 2	Level 1	-	○	-
		Level 3			

\*: If equipped

■ PKSB (Parking Support Brake)\* (→P.255)

Function	Default setting	Customized setting	A	B	C
PKSB (Parking Support Brake) function	On	Off	-	○	-

\*: If equipped

■ Driving mode select switch (→P.271)

Function	Default setting	Customized setting	A	B	C
Powertrain control in customized mode*	Normal	Power	○	-	-
		Eco			
Chassis control in customized mode*	Normal	Sport	○	-	-
Air conditioning operation in customized mode*	Normal	Eco	○	-	-

\*: If equipped

■ Front automatic air conditioning system (→P.292)

Function	Default setting	Customized setting	A	B	C
A/C auto switch operation	On	Off	○	-	○
Exhaust gas sensor sensitivity*	Standard	-3 to 3	○	-	○

\*: If equipped

■ Seat heaters\*/seat ventilators\* (→P.306)

Function	Default setting	Customized setting	A	B	C
Driver's seat temperature preference in automatic mode	Standard	-2 (cooler) to 2 (warmer)	○	-	○
Front passenger's seat temperature preference in automatic mode	Standard	-2 (cooler) to 2 (warmer)	○	-	○

\*: If equipped

■ Illumination (→P.309)

Function	Default setting	Customized setting	A	B	C
Time elapsed before the interior lights turn off	15 seconds	Off	○	-	○
		7.5 seconds			
		30 seconds			
Operation after the engine switch is turned off	On	Off	-	-	○
Operation when the doors are unlocked	On	Off	-	-	○
Operation when you approach the vehicle with the electronic key on your person	On	Off	-	-	○
Footwell lights and front center console light	On	Off	-	-	○
Instrument panel ornament light* and door trim ornament lights*	On	Off	-	-	○
Time elapsed before the outer foot lights turn off	15 seconds	Off	○	-	○
		7.5 seconds			
		30 seconds			
Operation of the outer foot lights when you approach the vehicle with the electronic key on your person	On	Off	-	-	○
Operation of the outer foot lights when the doors are unlocked with the power door lock switch	On	Off	-	-	○
Operation of the outer foot lights when a door is opened	On	Off	-	-	○
Fading out of the outer foot lights when they turn off	Long	Short	-	-	○

\* : If equipped



### ■ Seat belt reminder (→P.403)

Function	Default setting	Customized setting	A	B	C
Vehicle speed linked seat belt reminder buzzer	On	Off	-	-	○

### ■ Vehicle customization

- When the smart access system with push-button start is off, the entry unlock function cannot be customized.
- When the doors remain closed after unlocking the doors and the timer activated automatic door lock function activates, signals will be generated in accordance with the operation buzzer volume and operational signal (Emergency flashers) function settings.
- Some settings can be changed using a switch or the Remote Touch. If a setting is changed using a switch, the changed setting will not be reflected on the Remote Touch until the engine switch is turned off and then to IGNITION ON mode.

### ■ Clock settings screen

If the clock adjustment screen is displayed continuously when attempting to change the clock settings, the system may be malfunctioning. Have the vehicle inspected by your Lexus dealer.

**Items to initialize**

The following items must be initialized for normal system operation after such cases as the battery being reconnected, or maintenance being performed on the vehicle:

**List of items to initialize**

Item	When to initialize	Reference
Message indicating maintenance is required (U.S.A. only)	<ul style="list-style-type: none"> <li>• After the maintenance is performed</li> </ul>	P.350
Tire pressure warning system	<ul style="list-style-type: none"> <li>• When changing the tire inflation pressure by changing traveling speed</li> <li>• When changing the tire size</li> <li>• When rotating the tires</li> </ul>	P.371
Oil maintenance	<ul style="list-style-type: none"> <li>• After the maintenance is performed</li> </ul>	P.361
PKSB (Parking Support Brake)*	<ul style="list-style-type: none"> <li>• After reconnecting or changing the battery</li> </ul>	P.260
Power back door	<ul style="list-style-type: none"> <li>• After reconnecting or changing the battery</li> </ul>	P.109

\*: If equipped

9-1. For owners

Reporting safety defects for U.S. owners ..... 476

Seat belt instructions for Canadian owners (in French)..... 476

SRS airbag instructions for Canadian owners (in French)..... 478

Headlight aim instructions for Canadian owners (in French) ..... 486

### Reporting safety defects for U.S. owners

If you believe that your vehicle has a defect which could cause a crash or could cause injury or death, you should immediately inform the National Highway Traffic Safety Administration (NHTSA) in addition to notifying the Lexus Division of Toyota Motor Sales, U.S.A., Inc. (Toll-free: 1-800-25-LEXUS).

If NHTSA receives similar complaints, it may open an investigation, and if it finds that a safety defect exists in a group of vehicles, it may order a recall and remedy campaign. However, NHTSA cannot become involved in individual problems between you, your dealer, or Lexus Division of Toyota Motor Sales, U.S.A., Inc.

To contact NHTSA, you may call the Vehicle Safety Hotline toll-free at 1-888-327-4236 (TTY: 1-800-424-9153); go to <http://www.safercar.gov>; or write to: Administrator, NHTSA, 1200 New Jersey Ave. SE., Washington, DC 20590. You can also obtain other information about motor vehicle safety from <http://www.safercar.gov>.

### Seat belt instructions for Canadian owners (in French)

The following is a French explanation of seat belt instructions extracted from the seat belt section in this manual.

See the seat belt section for more detailed seat belt instructions in English.

### Utilisation correcte des ceintures de sécurité



- Déroulez la sangle diagonale de telle sorte qu'elle passe bien sur l'épaule, sans pour autant être en contact avec le cou ou glisser de l'épaule.
- Placez la sangle abdominale le plus bas possible sur les hanches.
- Réglez la position du dossier de siège. Asseyez-vous le dos droit et calez-vous bien dans le siège.
- Ne vrillez pas la ceinture de sécurité.

## Entretien et soin

### ■ Traitement des ceintures de sécurité

Nettoyez avec un chiffon ou une éponge humidifiés avec de l'eau savonneuse tiède. Vérifiez régulièrement que les ceintures ne sont pas usées, effilochées ou entaillées excessivement.



### WARNING

#### ■ Détérioration et usure des ceintures de sécurité

Inspectez le système de ceintures de sécurité régulièrement. Contrôlez l'absence de coupures, d'effilochages et de pièces desserrées. N'utilisez pas une ceinture de sécurité endommagée avant qu'elle ne soit remplacée. Une ceinture de sécurité endommagée ne permet pas de protéger un occupant de blessures graves ou mortelles.

### SRS airbag instructions for Canadian owners (in French)

The following is a French explanation of SRS airbag instructions extracted from the SRS airbag section in this manual.

See the SRS airbag section for more detailed SRS airbag instructions in English.

### Système de coussins gonflables SRS

#### ■ Emplacement des coussins gonflables SRS

##### ► RX350

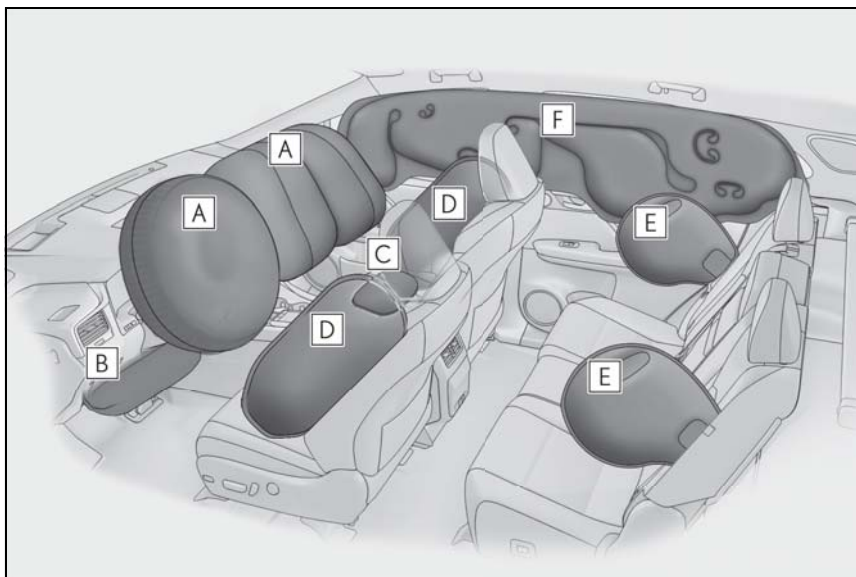

##### ► Coussins gonflables frontaux SRS

#### **A** Coussin gonflable conducteur/coussin gonflable du passager avant SRS

Participe à la protection de la tête et du thorax du conducteur et du passager avant contre les chocs contre les éléments de l'habitacle

#### **B** Coussin gonflable de genoux SRS

Participe à la protection du conducteur

#### **C** Coussin gonflable de coussin de siège SRS

Contribue à retenir le passager avant

##### ► Coussins gonflables latéraux et rideaux SRS

#### **D** Coussins gonflables latéraux avant SRS

Participent à la protection du torse des occupants de siège avant

**E** Coussins gonflables latéraux arrière SRS

Participent à la protection du torse des occupants des sièges latéraux arrière

**F** Coussins gonflables rideaux SRS

- Participent principalement à la protection de la tête des occupants des sièges latéraux
- Peut contribuer à empêcher les occupants d'être éjectés du véhicule en cas de tonneau

► RX350L

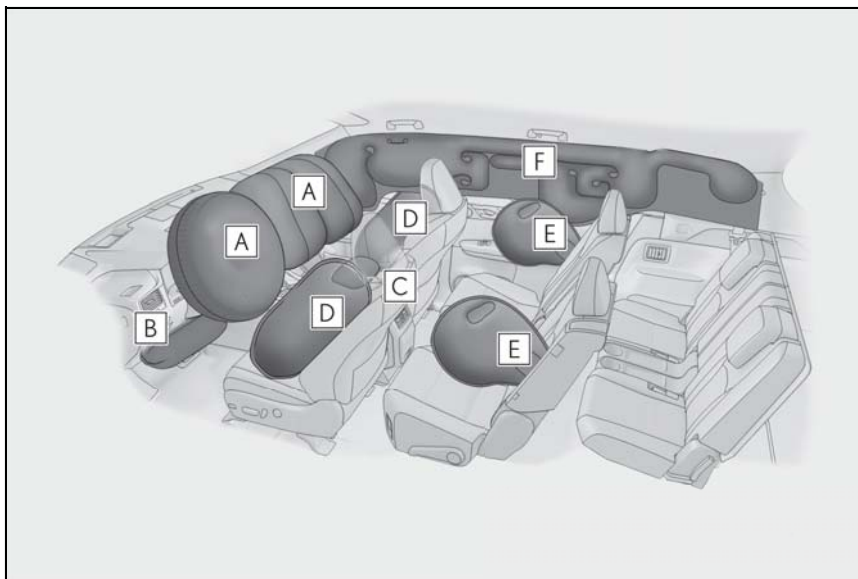

► Coussins gonflables frontaux SRS

**A** Coussin gonflable conducteur/coussin gonflable du passager avant SRS

Participe à la protection de la tête et du thorax du conducteur et du passager avant contre les chocs contre les éléments de l'habitacle

**B** Coussin gonflable de genoux SRS

Participe à la protection du conducteur

**C** Coussin gonflable de coussin de siège SRS

Contribue à retenir le passager avant

► Coussins gonflables latéraux et rideaux SRS

**D** Coussins gonflables latéraux avant SRS

Participent à la protection du torse des occupants de siège avant

**E** Coussins gonflables latéraux arrière SRS

Participent à la protection du torse des occupants des sièges latéraux de deuxième rangée

### **F** Coussins gonflables rideaux SRS

- Participent principalement à la protection de la tête des occupants des sièges latéraux
- Peut contribuer à empêcher les occupants d'être éjectés du véhicule en cas de tonneau

### ■ Composants du système de coussins gonflables SRS

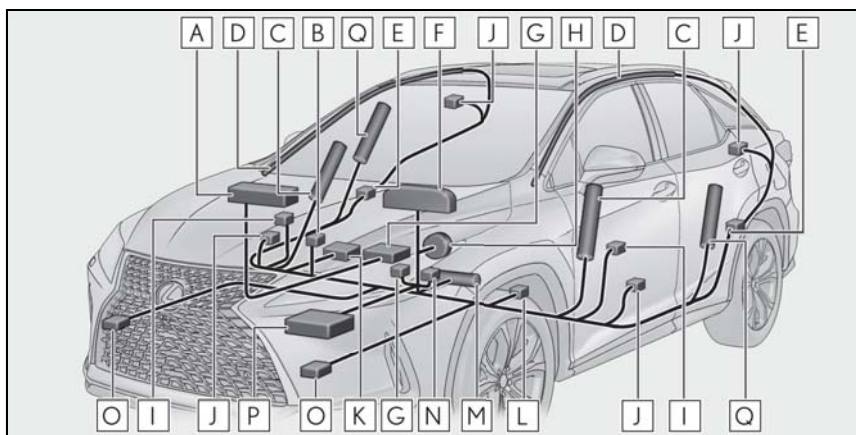

- A** Coussin gonflable passager avant
- B** Témoins indicateurs "AIR BAG ON" et "AIR BAG OFF"
- C** Coussins gonflables latéraux avant
- D** Coussins gonflables rideaux
- E** Capteurs d'impact latéral (arrière)
- F** Témoin d'avertissement SRS
- G** Système de classification de l'occupant du siège passager avant (ECU et capteurs)
- H** Coussin gonflable conducteur
- I** Capteurs d'impact latéral (porte avant)
- J** Prétensionneurs de ceintures de sécurité et limiteurs de force
- K** Coussin gonflable de coussin de siège passager
- L** Capteur de position du siège conducteur
- M** Coussin gonflable de genoux du conducteur
- N** Contact de boucle de ceinture de sécurité conducteur
- O** Capteurs d'impact avant
- P** Ensemble de capteurs de coussins gonflables
- Q** RX350: Coussins gonflables latéraux arrière



RX350L: Coussins gonflables latéraux arrière (sièges latéraux de deuxième rangée)

Votre véhicule est équipé de COUSSINS GONFLABLES INTELLIGENTS conçus selon les normes de sécurité américaines applicables aux véhicules à moteur (FMVSS208). L'ensemble de capteurs de coussins gonflables (ECU) régule le déploiement des coussins gonflables sur la base des informations qu'il reçoit des capteurs, etc., indiqués ci-dessus dans le schéma illustrant les composants du système. Parmi ces informations figurent la gravité du choc et l'occupation du véhicule par les passagers. Le déploiement rapide des coussins gonflables est obtenu au moyen d'une réaction chimique dans les dispositifs pyrotechniques, qui produit un gaz inoffensif permettant d'amortir le mouvement des occupants.

**WARNING****■ Précautions relatives aux coussins gonflables SRS**

Respectez les précautions suivantes concernant les coussins gonflables SRS. Le non-respect de ces précautions peut occasionner des blessures graves, voire mortelles.

- Le conducteur et tous les passagers du véhicule doivent porter correctement leur ceinture de sécurité. Les coussins gonflables SRS sont des dispositifs supplémentaires à utiliser avec les ceintures de sécurité.

- Le coussin gonflable conducteur SRS se déploie avec une force considérable, pouvant occasionner des blessures graves, voire mortelles, si le conducteur se trouve très près du coussin gonflable.

L'autorité fédérale chargée de la sécurité routière aux États-Unis (NHTSA) conseille: La zone à risque du coussin gonflable conducteur se situant dans les premiers 2 à 3 in. (50 à 75 mm) de déploiement, vous placer à 10 in. (250 mm) de votre coussin gonflable conducteur vous garantit une marge de sécurité suffisante. Cette distance est à mesurer entre le centre du volant et le sternum. Si vous êtes assis à moins de 10 in. (250 mm), vous pouvez changer votre position de conduite de plusieurs façons:

- Reculez votre siège le plus possible, de manière à pouvoir encore atteindre confortablement les pédales.

**⚠ WARNING**

- Inclinez légèrement le dossier du siège.  
Bien que les véhicules aient une conception différente, un grand nombre de conducteurs peuvent s'asseoir à une distance de 10 in. (250 mm), même avec le siège conducteur complètement avancé, simplement en inclinant un peu le dossier de siège. Si vous avez des difficultés à voir la route après avoir incliné le dossier de votre siège, utilisez un coussin ferme et antidérapant pour vous rehausser ou remontez le siège si votre véhicule est équipé de cette fonction.
- Si votre volant est réglable, inclinez-le vers le bas. Cela a pour effet d'orienter le coussin gonflable en direction de votre poitrine plutôt que de votre tête et de votre cou.

Réglez votre siège selon les recommandations de la NHTSA ci-dessus, tout en conservant le contrôle des pédales, du volant et la vue des commandes du tableau de bord.

- Si vous attachez une rallonge de ceinture de sécurité aux boucles de ceinture de sécurité avant, sans l'attacher au pêne de la ceinture de sécurité, les coussins gonflables frontaux SRS déterminent que le conducteur et le passager avant ont attaché leur ceinture de sécurité, bien que la ceinture de sécurité ne soit pas attachée. Dans ce cas, les coussins gonflables frontaux SRS peuvent ne pas se déployer correctement en cas de collision, pouvant occasionner des blessures graves, voire mortelles. Veillez à porter la ceinture de sécurité avec la rallonge de ceinture de sécurité.



- Le coussin gonflable passager avant SRS se déploie également avec une force considérable, pouvant occasionner des blessures graves, voire mortelles, si le passager avant se trouve très près du coussin gonflable. Le siège du passager avant doit être éloigné le plus possible du coussin gonflable en réglant le dossier de siège de façon à ce que le passager avant soit assis bien droit dans le siège.

**⚠ WARNING**

- Les nourrissons et les enfants qui ne sont pas correctement assis et/ou attachés peuvent être grièvement blessés ou tués par le déploiement d'un coussin gonflable. Un nourrisson ou un enfant trop petit pour utiliser une ceinture de sécurité doit être correctement attaché au moyen d'un siège de sécurité enfant. Lexus recommande vivement d'installer tous les nourrissons et enfants sur les sièges arrière du véhicule et de prévoir pour eux des systèmes de retenue adaptés. Les sièges arrière sont plus sûrs pour les nourrissons et les enfants que le siège du passager avant.
- N'installez jamais un siège de sécurité enfant type dos à la route sur le siège passager avant, même si le témoin indicateur "AIR BAG OFF" est allumé. En cas d'accident, la force engendrée par le déploiement rapide du coussin gonflable du passager avant peut blesser grièvement, voire tuer l'enfant si le siège de sécurité enfant type dos à la route est installé sur le siège du passager avant.
- Ne vous asseyez pas sur le bord du siège et ne vous appuyez pas contre la planche de bord.

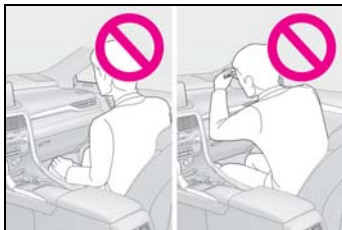

- Ne laissez pas un enfant rester debout devant le coussin gonflable passager avant SRS ou s'asseoir sur les genoux du passager avant.

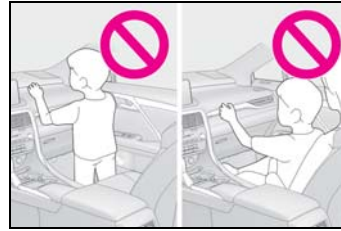

- Ne laissez pas les occupants des sièges avant voyager avec un objet sur les genoux.
- Ne vous appuyez pas contre la porte, le rail latéral de toit ou les montants avant, latéraux et arrière.



- Ne laissez personne s'agenouiller sur les sièges passagers en appui contre la porte ou sortir la tête ou les mains à l'extérieur du véhicule.



 **WARNING**

- Ne fixez rien et ne posez rien sur des emplacements tels que la planche de bord, la garniture du volant et la partie inférieure du tableau de bord. Ces éléments peuvent se transformer en projectiles lorsque les coussins gonflables conducteur, passager avant et genoux SRS se déploient.

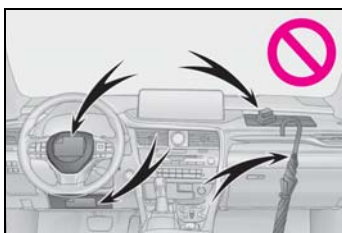

- Ne fixez rien aux portes, à la vitre du pare-brise, aux vitres latérales, aux montants avant et arrière, au rail latéral de toit et à la poignée de maintien.

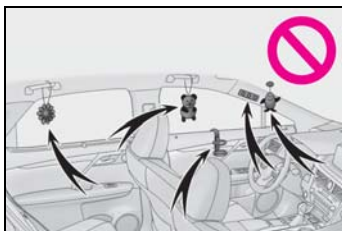

- Ne suspendez aucun cintre ou objet dur aux crochets à vêtements. Tous ces objets pourraient se transformer en projectiles et causer des blessures graves, voire mortelles en cas de déploiement des coussins gonflables rideaux SRS.
- Si un cache en vinyle est placé sur la zone où le coussin gonflable de genoux SRS se déploie, assurez-vous de le retirer.

- N'utilisez aucun accessoire de siège recouvrant les zones de déploiement des coussins gonflables latéraux SRS et du coussin gonflable de coussin de siège SRS, car il risque de gêner le déploiement des coussins gonflables SRS. De tels accessoires peuvent empêcher les coussins gonflables latéraux et le coussin gonflable de coussin de siège SRS de s'activer correctement, désactiver le système ou entraîner le déploiement accidentel des coussins gonflables latéraux et du coussin gonflable de coussin de siège SRS, occasionnant des blessures graves, voire mortelles.
- Évitez de faire subir des chocs ou des pressions excessives aux parties renfermant les composants de coussins gonflables SRS ou aux portes avant. En effet, cela pourrait entraîner un dysfonctionnement des coussins gonflables SRS.
- Ne touchez aucun composant immédiatement après le déploiement (gonflage) des coussins gonflables SRS, car ils peuvent être chauds.
- Si vous avez des difficultés à respirer après le déploiement des coussins gonflables SRS, ouvrez une porte ou une vitre pour faire entrer de l'air frais, ou bien descendez du véhicule si cela ne présente pas de danger. Essayez tout résidu dès que possible afin d'éviter d'éventuelles irritations de la peau.
- Si les parties renfermant les coussins gonflables SRS, comme les garnitures du volant et des montants avant et arrière, sont endommagées ou craquelées, faites-les remplacer par votre concessionnaire Lexus.

 **WARNING**

- Ne placez rien sur le siège du passager avant, comme un coussin par exemple. Cela a pour conséquence de répartir le poids du passager sur toute la surface du siège, ce qui empêche le capteur de détecter correctement le poids du passager. En conséquence, les coussins gonflables frontaux SRS du passager avant risquent de ne pas se déployer en cas de collision.

**■ Modification et mise au rebut des composants du système de coussins gonflables SRS**

Ne mettez pas votre véhicule au rebut et ne procédez à aucune des modifications suivantes sans consulter votre concessionnaire Lexus. Les coussins gonflables SRS peuvent ne pas fonctionner correctement ou se déployer (se gonfler) accidentellement, provoquant la mort ou de graves blessures.

- Installation, dépose, démontage et réparation des coussins gonflables SRS
- Réparations, modifications, démontage ou remplacement du volant, du tableau de bord, de la planche de bord, des sièges ou de leur garnissage, des montants avant, latéraux et arrière, des rails latéraux de toit, des panneaux de porte avant, des garnitures de porte avant ou des haut-parleurs de porte avant
- Modifications du panneau de porte avant (par exemple, perçage d'un trou dans le panneau)
- Réparations ou modifications des ailes avant, du pare-chocs avant ou des flancs de l'habitacle
- Installation d'un protège-calandre (pare-buffle, pare-kangourou, etc.), de chasse-neige, de treuils ou d'un porte-bagages de toit
- Modifications du système de suspension du véhicule

- Installation d'appareils électroniques tels que les émetteurs/récepteurs radios mobiles et les lecteurs CD
- Modifications de votre véhicule pour une personne atteinte d'un handicap physique

### Headlight aim instructions for Canadian owners (in French)

The following is a French explanation of headlight aim instructions from the headlight aim section in this manual.

#### Boulons de réglage du mouvement vertical

- ▶ Véhicules sans phares à faisceau unique

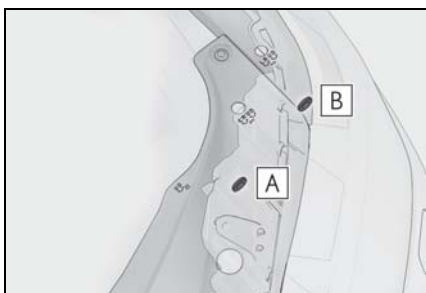

**A** Boulon de réglage A

**B** Boulon de réglage B

- ▶ Véhicules avec phares à faisceau unique

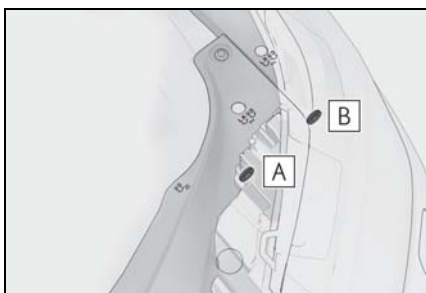

**A** Boulon de réglage A

**B** Boulon de réglage B

### Avant de vérifier le réglage des phares

- 1 Vérifiez que le réservoir de carburant du véhicule est plein et que la zone autour des phares n'est pas déformée.
- 2 Stationnez le véhicule sur une surface plane.
- 3 Installez-vous dans le siège conducteur.
- 4 Balancez le véhicule plusieurs fois.

### Réglage du faisceau des phares

- 1 À l'aide d'un tournevis cruciforme, tournez le boulon A dans n'importe quel sens.

Mémo­risez le sens dans lequel vous avez tourné et le nombre de tours.

- ▶ Véhicules sans phares à faisceau unique

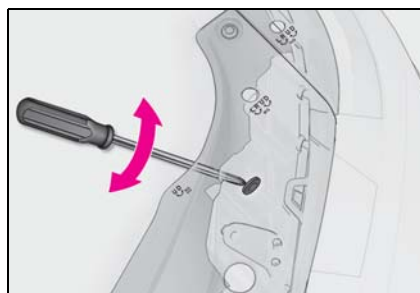

- ▶ Véhicules avec phares à faisceau unique

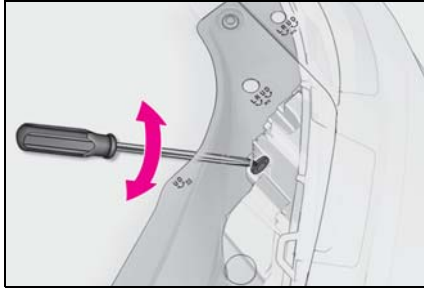

- 2 Tournez le boulon B du même nombre de tours dans le même sens qu'à l'étape 1.

Si vous n'arrivez pas à régler le phare en procédant de la sorte, confiez le véhicule à votre concessionnaire Lexus pour qu'il règle le faisceau des phares.

- ▶ Véhicules sans phares à faisceau unique

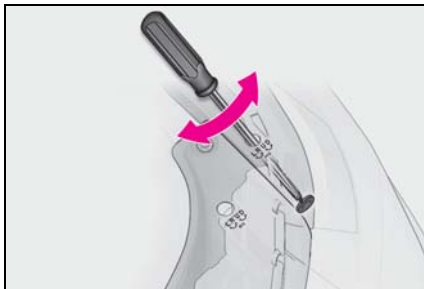

- ▶ Véhicules avec phares à faisceau unique

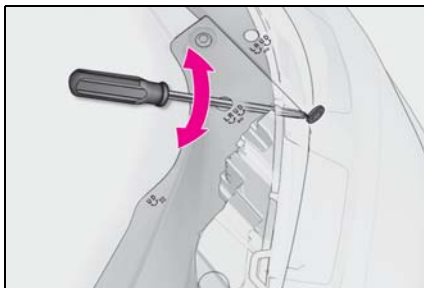





**Index**

**489**

What to do if... (Troubleshooting)

.....**490**

Alphabetical Index.....**493**

## What to do if... (Troubleshooting)

If you have a problem, check the following before contacting your Lexus dealer.

### The doors cannot be locked, unlocked, opened or closed



#### You lose your keys

- If you lose your mechanical keys, new genuine mechanical keys can be made by your Lexus dealer. (→P.430)
- If you lose your electronic keys, the risk of vehicle theft increases significantly. Contact your Lexus dealer immediately. (→P.430)



#### The electronic key does not operate properly

- Is the electronic key battery weak or depleted? (→P.379)



#### The doors cannot be locked or unlocked

- Is the engine switch in IGNITION ON mode?

When locking the doors, turn the engine switch off. (→P.177)

- Is the electronic key left inside the vehicle?

When locking the doors, make sure that you have the electronic key on your person.

- The function may not operate properly due to the condition of the radio wave. (→P.116)



#### The rear door cannot be opened

- Is the child-protector lock set?

The rear door cannot be opened from inside the vehicle when the lock is set.

Open the rear door from outside and then unlock the child-protector lock. (→P.102)

### If you think something is wrong



#### The engine does not start

- Did you press the engine switch while firmly depressing the brake pedal? (→P.174)
- Is the shift lever in P? (→P.174)
- Is the electronic key anywhere detectable inside the vehicle? (→P.115)
- Is the steering wheel unlocked? (→P.175)
- Is the electronic key battery weak or depleted?

In this case, the engine can be started in a temporary way. (→P.432)

- Is the battery discharged? (→P.433)



#### The shift lever cannot be shifted from P even if you depress the brake pedal

- Is the engine switch in IGNITION ON mode?

If you cannot release the shift lever by depressing the brake pedal with the engine switch in IGNITION ON mode (→P.179)



**The steering wheel cannot be turned after the engine is stopped**

- It is locked automatically to prevent theft of the vehicle. (→P.175)



**The windows do not open or close by operating the power window switches**

- Is the window lock switch pressed?

The power window except for the one at the driver's seat cannot be operated if the window lock switch is pressed. (→P.146)



**The engine switch is turned off automatically**

- The auto power off function will be operated if the vehicle is left in ACCESSORY or IGNITION ON mode (the engine is not running) for a period of time. (→P.177)



**A warning buzzer sounds during driving**

- The seat belt reminder light is flashing

Are the driver and the passengers wearing the seat belts? (→P.406)

- The parking brake indicator is on
- Is the parking brake released? (→P.183)

Depending on the situation, other types of warning buzzer may also sound. (→P.403, 412)



**An alarm is activated and the horn sounds**

- Did anyone inside the vehicle open a door during setting the alarm?

The sensor detects it and the alarm sounds. (→P.68)

Do one of the following to stop the alarms:

- Unlock the doors.
- Turn the engine switch to ACCESSORY or IGNITION ON mode, or start the engine.



**A warning buzzer sounds when leaving the vehicle**

- Is the message displayed on the multi-information display?

Check the message on the multi-information display. (→P.412)



**A warning light turns on or a warning message is displayed**

- When a warning light turns on or a warning message is displayed, refer to P.403, 412.

### When a problem has occurred



**If you have a flat tire**

- Stop the vehicle in a safe place and replace the flat tire with the spare tire. (→P.416)

**The vehicle becomes stuck**

- Try the procedure for when the vehicle becomes stuck in mud, dirt, or snow. (→P.439)

## Alphabetical Index

### A

**A/C**  
 Air conditioning filter .....376  
 Front automatic air conditioning system  
 .....292  
 Front seat concentrated airflow mode  
 (S-FLOW).....300  
 Micro dust and pollen filter.....299  
 Rear automatic air conditioning system  
 .....303  
**ABS (Anti-lock Brake System)**.....274  
 Warning light.....405  
**ACA (Active Cornering Assist)**.....275  
**Active Cornering Assist (ACA)**.....275  
**Adaptive Front-lighting System (AFS)** 190  
**Adaptive Variable Suspension System**275  
**AFS (Adaptive Front-lighting System)** 190  
**AHB (Automatic High Beam)** .....191  
**Air conditioning filter** .....376  
**Air conditioning system**  
 Air conditioning filter .....376  
 Front automatic air conditioning system  
 .....292  
 Front seat concentrated airflow mode  
 (S-FLOW).....300  
 Micro dust and pollen filter.....299  
 Rear automatic air conditioning system  
 .....303  
**Airbags**  
 Airbag operating conditions.....33  
 Airbag precautions for your child.....36  
 Correct driving posture.....25  
 Curtain shield airbag operating condi-  
 tions.....33  
 Curtain shield airbag precautions .....36  
 Front passenger occupant classification  
 system .....39  
 General airbag precautions .....36  
 Locations of airbags.....30  
 Modification and disposal of airbags.38  
 Side airbag operating conditions.....33

Side airbag precautions .....36  
 Side and curtain shield airbags operating  
 conditions.....33  
 Side and curtain shield airbags precau-  
 tions .....36  
 SRS airbags.....30  
 SRS warning light.....404  
**Alarm**.....68  
 Warning buzzer .....403  
**Anchor brackets**.....46, 57  
**Antennas (smart access system with  
 push-button start)**.....115  
**Anti-lock Brake System (ABS)**.....274  
 Warning light .....405  
**Approach warning**.....233  
**Armrest**.....330  
**Assist grips** .....330  
**Audio system-linked display**.....85  
**Automatic headlight leveling system**...189  
**Automatic High Beam** .....191  
**Automatic light control system**.....188  
**Automatic transmission** .....178  
 M mode .....181  
 Paddle shift switches .....180, 181  
**Auxiliary boxes**.....317, 319  
**Average fuel economy**.....82  
**Average vehicle speed** .....82  
**AWD Control**.....83

### B

**Back door** .....103  
**Back-up light**  
 Wattage.....449  
**Back-up lights**  
 Replacing light bulbs.....385, 391  
**Battery**  
 Battery checking .....363  
 If the battery is discharged .....433  
 Preparing and checking before winter  
 .....280  
 Warning light .....404  
**Blind Spot Monitor (BSM)**.....236

Bottle holders.....316

**Brake**

    Brake hold.....186

    Fluid.....362, 447

    Parking brake.....183

    Warning light.....403

**Brake assist**.....274

**Break-in tips**.....155

**Brightness control**

    Instrument panel light control.....80

**BSM (Blind Spot Monitor)**.....236

**Buzzer**

    Hands off steering wheel warning (LTA)  
    .....223

**C**

**Care**

    Exterior.....344

    Interior.....347

    Seat belts.....347

    Wheels and wheel ornaments.....344

**Cargo capacity**.....159, 162

**Cargo hooks**.....317

**Cargo net hooks**.....317

**Center Display**.....288

**Chains**.....281

**Child restraint system**

    Fixed with a LATCH system.....54

    Fixed with a seat belt.....50

    Front passenger occupant classification  
    system.....39

    Points to remember.....45

    Riding with children.....45

    Types of child restraint system installation  
    method.....46

    Using an anchor bracket.....57

**Child safety**

    Airbag precautions.....36

    Battery precautions.....364, 436

    Child restraint system.....46

    Heated steering wheel and seat heater  
    precautions.....306

    How your child should wear the seat belt  
    .....27

    Moon roof precautions.....148

    Panoramic moon roof precautions.....151

    Power back door precautions.....103

    Power window lock switch.....146

    Power window precautions.....145

    Rear door child-protectors.....102

    Seat belt extender precautions.....27

    Seat belt precautions.....45

**Child-protectors**.....102

**Cleaning**

    Exterior.....344

    Interior.....347

    Radar sensor.....203

    Seat belts.....347

    Wheels and wheel ornaments.....344

**Clock**.....77, 331

**Coat hooks**.....331

**Coin box**.....316

**Compass**.....340

**Condenser**.....362

**Console box**.....314

**Consumption screen**.....92

**Cooling system**.....361

    Engine overheating.....437

**Cornering lights**.....190

    Replacing light bulbs.....385

**Cruise control**

    Dynamic radar cruise control with  
    full-speed range.....227

**Cup holders**.....315

**Current fuel consumption**.....82

**Curtain shield airbags**.....30

**Customizable features**.....461

**D**

**Daytime running light system**.....188

**Defogger**

    Outside rear view mirrors.....294

    Rear window.....294

    Windshield.....294

**Differential**  
 Rear differential oil ..... 447

**Dimension** ..... 442

**Dinghy towing**..... 173

**Display**  
 Center Display.....288  
 Dynamic radar cruise control with  
 full-speed range.....227  
 Head-up display .....88  
 Intuitive parking assist.....244  
 LTA (Lane Tracing Assist).....221  
 Multi-information display.....81  
 RCTA .....250  
 Warning message.....412

**Distance until next engine oil change**...80

**Do-it-yourself maintenance** .....351

**Door courtesy lights**.....309  
 Wattage.....449

**Door lock**  
 Power back door.....103  
 Side doors.....99  
 Smart access system with push-button  
 start.....115  
 Wireless remote control.....97

**Door pockets** .....316

**Doors**  
 Automatic door locking and unlocking  
 system .....102  
 Door glasses .....144  
 Door lock warning buzzer .....100  
 Open door warning buzzer .....102  
 Outside rear view mirrors .....141  
 Rear door child-protectors .....102  
 Side doors.....99

**Drive distance**..... 82

**Driver's seat position memory**  
 Driving position memory.....133  
 Memory recall function .....135  
 Power easy access system.....133

**Drive-start control** ..... 155

**Driving**  
 Break-in tips ..... 155

Correct driving posture .....25  
 Driving mode select switch .....271  
 Procedures .....154  
 Winter drive tips.....280

**Driving assist system information** .....85

**Driving information display** .....82

**Driving position memory**.....133  
 Memory recall function.....135  
 Power easy access system .....133

**Driving range** .....82

**Dynamic radar cruise control with**  
 full-speed range .....227  
 Warning message.....235

**Dynamic Torque Control AWD system**  
 ..... 275

**E**

**Eco Driving Indicator** .....83, 92

**Eco Driving Indicator Light** ..... 83

**EDR (Event data recorder)**.....7

**Elapsed time** .....82

**Electric Power Steering (EPS)** ..... 275  
 Warning light .....405

**Electronic key** ..... 96  
 Battery-saving function.....116  
 If the electronic key does not operate  
 properly .....431  
 Replacing the battery.....379

**Electronic sunshade**  
 Jam protection function .....150  
 Operation.....149

**Emergency flashers**..... 394

**Emergency, in case of**  
 If a warning buzzer sounds..... 403  
 If a warning light turns on..... 403  
 If a warning message is displayed.....412  
 If the battery is discharged.....433  
 If the electronic key does not operate  
 properly .....431  
 If the engine will not start.....428  
 If the fuel filler door cannot be opened  
 ..... 430

If the vehicle is trapped in rising water .....395

If you have a flat tire.....416

If you lose your keys.....430

If you think something is wrong ..... 401

If your vehicle becomes stuck.....439

If your vehicle has to be stopped in an emergency .....394

If your vehicle needs to be towed....397

If your vehicle overheats.....437

**Engine**

    ACCESSORY mode .....177

    Compartment .....359

    Engine switch.....174

    Fuel pump shut off system .....402

    Hood.....357

    How to start the engine.....174

    Identification number .....443

    If the engine will not start .....428

    If your vehicle has to be stopped in an emergency .....394

    Ignition switch (engine switch) .....174

    Overheating.....437

    Tachometer .....77

**Engine coolant**

    Capacity.....446

    Checking .....361

    Preparing and checking before winter .....280

**Engine coolant temperature gauge .....77**

**Engine immobilizer system ..... 66**

**Engine oil**

    Capacity.....444

    Checking .....359

    Preparing and checking before winter .....280

    Warning light.....404

**Engine oil maintenance data .....361**

**Engine switch .....174**

    Auto power off function .....177

    Changing the engine switch modes..177

If your vehicle has to be stopped in an emergency.....394

**EPS (Electric Power Steering) ..... 275**

    Warning light .....405

**Event data recorder (EDR).....7**

**F**

**Flat tire**

    Tire pressure warning system .....367

    Vehicles with a spare tire.....416

**Floor mats ..... 24**

**Fluid**

    Automatic transmission .....447

    Brake.....447

    Washer .....364

**Fog lights**

    Switch.....194

**Footwell light .....309**

**Front automatic air conditioning system .....292**

**Front fog lights**

    Replacing light bulbs.....385

**Front passenger footwell hooks .....333**

**Front passenger occupant classification system ..... 39**

**Front seats**

    Adjustment.....121

    Cleaning.....347

    Correct driving posture .....25

    Driving position memory .....133

    Head restraints.....136

    Memory recall function.....135

    Power easy access system .....133

    Seat heaters .....306

    Seat position memory .....133

    Seat ventilators .....306

**Front side marker light**

    Light switch .....188

    Replacing light bulbs.....385

**Front side marker lights**

    Replacing light bulbs.....385

    Wattage.....449



**Front turn signal lights**  
 Replacing light bulbs..... 385, 387  
 Turn signal lever .....182  
 Wattage.....449

**Fuel**  
 Capacity.....444  
 Fuel gauge .....77  
 Fuel pump shut off system .....402  
 Information.....450  
 Refueling.....200  
 Type.....444  
 Warning light.....406

**Fuel consumption**  
 Average fuel economy.....82  
 Current fuel consumption.....82

**Fuel filler door**  
 If the fuel filler door cannot be opened  
 .....430  
 Refueling.....200

**Fuel gauge.....77**

**Fuel pump shut off system.....402**

**Fuses.....381**

**G**

**Garage door opener .....334**

**Gauges.....77**

**G-force.....84**

**Glove box.....314**

**Glove box light.....314**

**Grocery bag hooks .....318**

**H**

**Hands Free Power Back Door .....106**

**Head restraints.....136**

**Headlight aim.....382**

**Headlights**  
 Adaptive Front-lighting System (AFS)  
 .....190  
 Automatic High Beam system.....191  
 Light switch.....188  
 Replacing light bulbs.....385

**Head-up display.....88**  
 Driving information display area.....88  
 Eco Driving Indicator.....92  
 HUD (Head-up display) switch.....89  
 Navigation system-linked display .....91  
 Settings.....90

**Heated steering wheel.....306**

**Heaters**  
 Front automatic air conditioning system  
 .....292  
 Heated steering wheel.....306  
 Outside rear view mirrors.....294  
 Rear automatic air conditioning system  
 .....303  
 Seat heaters.....306

**High mounted stoplight**  
 Replacing light bulbs.....385

**Hill-start assist control.....275**

**Hood**  
 Open.....357

**Hooks**  
 Cargo hooks.....317  
 Cargo net hooks.....317  
 Coat hooks .....331  
 Front passenger footwell hooks.....333  
 Grocery bag hooks.....318  
 Retaining hooks (floor mat).....24

**Horn.....139**

**HUD (Head-up display) switch.....89**

**I**

**I/M test .....354**

**Identification**  
 Engine.....443  
 Vehicle.....443

**If your vehicle has to be stopped in an  
 emergency .....394**

**Ignition switch (engine switch).....174**  
 Auto power off function.....177  
 Changing the engine switch modes..177  
 If your vehicle has to be stopped in an  
 emergency.....394

**Indicators** .....74

**Initialization**

- Items to initialize ..... 474
- Maintenance .....350, 361
- Power windows.....144
- Tire pressure warning system.....371

**Inside rear view mirror** .....140

**Instrument panel light control** ..... 80

**Intercooler coolant**

- Capacity.....446

**Interior lights**.....309

- Front interior light .....309
- Rear interior light .....309

**Intuitive parking assist**..... 242, 244

- Function.....244
- Warning message.....246

**J**

**Jack**

- Positioning a floor jack..... 357
- Vehicle-equipped jack .....417

**Jack handle** .....417

**Jam protection function**

- Electronic sunshade.....150
- Moon roof.....147
- Panoramic moon roof.....150
- Power back door.....109
- Power windows.....144
- Rear seats .....122

**K**

**Keyless entry**

- Smart access system with push-button start..... 115
- Wireless remote control..... 97

**Keys**

- Battery-saving function ..... 116
- Electronic key .....96
- Engine switch.....174
- If the electronic key does not operate properly.....431

- If you lose your keys ..... 430
- Key number plate .....96
- Keyless entry ..... 97, 115
- Mechanical key.....96
- Replacing the battery.....379
- Warning buzzer .....115
- Wireless remote control.....97

**Knee airbags** .....30

**L**

**Lane Tracing Assist (LTA)**

- Operation.....216
- Warning messages.....224

**Language (multi-information display) ...85**

**LATCH anchors** ..... 54

**Lever**

- Auxiliary catch lever .....357
- Hood lock release lever .....357
- Shift lever.....178
- Turn signal lever .....182
- Wiper lever .....194

**Lexus climate concierge** .....291

**Lexus Enform Safety Connect**..... 60

**Lexus Safety System + 2.0**

- AHB (Automatic High Beam).....191
- Dynamic radar cruise control with full-speed range ..... 227
- LTA (Lane Tracing Assist).....216
- PCS (Pre-Collision System).....209
- RSA (Road Sign Assist).....225

**License plate lights**

- Light switch .....188
- Replacing light bulbs.....385

**Light bulbs**

- Replacing ..... 384

**Lights**

- Automatic High Beam system.....191
- Fog light switch .....194
- Front interior lights .....309
- Front personal lights.....310
- Headlight switch.....188
- Interior lights.....309

Interior lights list.....309  
 Rear interior lights.....309  
 Rear personal lights..... 310  
 Replacing light bulbs..... 385  
 Turn signal lever.....182  
 Vanity lights.....333  
 Wattage.....449  
**Lock steering column.....175**  
**LTA (Lane Tracing Assist)**  
     Operation.....216  
     Warning messages.....224  
**Luggage cover.....318**

**M**

**Maintenance**  
     Do-it-yourself maintenance.....355  
     General maintenance.....351  
     Maintenance data.....442  
     Maintenance requirements.....350  
**Malfunction indicator lamp.....404**  
**Master warning light.....409**  
**Menu icons.....81**  
**Meter**  
     Clock.....77  
     Indicators.....74  
     Instrument panel light control.....80  
     Meter control switches.....82  
     Meters.....77  
     Multi-information display.....81  
     Settings.....85  
     Units.....84  
     Warning lights.....403  
     Warning message.....412  
**Micro dust and pollen filter.....299**  
**Mirrors**  
     Inside rear view mirror.....140  
     Outside rear view mirror defoggers.....294  
     Outside rear view mirrors.....141  
     Vanity mirrors.....333  
**Moon roof**  
     Door lock linked moon roof operation  
         .....147

Door lock linked panoramic moon roof  
     operation.....150  
 Jam protection function.....147  
 Operation.....146  
**Multi-information display.....81**  
     Audio system-linked display.....85  
     AWD Control.....83  
     Drive information.....82  
     Driving assist system information.....85  
     Driving information display.....82  
     Dynamic radar cruise control with  
         full-speed range.....227  
     Eco Driving Indicator.....83  
     G-force.....84  
     LTA (Lane Tracing Assist).....221  
     Menu icons.....81  
     Meter control switches.....82  
     Navigation system-linked display.....85  
     Pop-up display.....81  
     Settings.....85  
     Suggestion function.....86  
     Tire pressure.....367  
     Units.....84  
     Warning message.....412

**N**

**Navigation system-linked display.....85, 91**  
**Noise from under vehicle.....6**

**O**

**“ODO TRIP” switch.....80**  
**Odometer.....80**  
**Odometer and trip meter display**  
     Display items.....80  
     “ODO TRIP” switch.....80  
     Pop-up display.....80  
**Oil**  
     Engine oil.....444  
     Rear differential oil.....447  
**Opener**  
     Fuel filler door.....200

Hood.....357

**Outer foot lights**

  Location.....309

**Outside door handle lights.....309**

**Outside rear view mirrors**

  Adjustment.....141

  BSM (Blind Spot Monitor) .....236

  Folding .....142

  Linked mirror function when reversing  
    .....141

  Mirror position memory.....133

  Outside rear view mirror defoggers294

  RCTA function.....250

**Outside temperature.....77**

**Overheating .....437**

**P**

**Paddle shift switches .....180, 181**

**Panic mode .....97**

**Panoramic moon roof**

  Jam protection function.....150

  Operation.....149

**Parking assist sensors (intuitive parking  
assist).....244**

**Parking brake**

  Operation.....183

  Parking brake engaged warning buzzer  
    .....185

  Warning light.....409

  Warning message.....185

**Parking lights**

  Light switch.....188

  Replacing light bulbs.....385

**Parking Support Brake function (for  
rear-crossing vehicles) .....267**

  Function.....267

**Parking Support Brake function (static  
objects).....261**

  Function.....261

**PCS (Pre-Collision System)**

  Function.....209

  PCS OFF switch.....211

  Warning light .....408

**Personal lights.....309**

**PKSA (Parking Support Alert).....242**

**PKSB (Parking Support Brake).....255**

  Warning message.....260

**Power back door .....103**

  Hands Free Power Back Door .....106

  Smart access system with push-button  
  start .....104

**Power easy access system .....133**

**Power outlets .....331**

**Power steering (Electric power steering  
system).....275**

  Warning light .....405

**Power windows**

  Door lock linked window operation .145

  Jam protection function.....144

  Operation.....144

  Window lock switch.....146

**Pre-Collision System (PCS)**

  Function .....209

  PCS OFF switch .....211

  Warning light .....408

**R**

**Radar cruise control (dynamic radar cruise  
control with full-speed range).....227**

**Radiator .....362**

**RCTA**

  Function .....250

  Warning message.....251

**RCTA (Rear Cross Traffic Alert) .....242**

**RCTA function .....252**

**Rear automatic air conditioning system  
.....303**

**Rear Cross Traffic Alert (RCTA) .....250**

**Rear door sunshades .....333**

**Rear fog lights**

  Switch.....194

**Rear seats .....122**

  Adjustment.....123

  Folding down the rear seatbacks.....123

Head restraints .....136  
 Seat heaters.....306  
**Rear side marker lights**  
 Light switch.....188  
 Replacing light bulbs..... 385  
**Rear turn signal lights**  
 Replacing light bulbs.....385, 389  
 Turn signal lever .....182  
 Wattage.....449  
**Rear view mirror**  
 Inside rear view mirror..... 140  
 Outside rear view mirrors .....141  
**Rear window defogger .....294**  
**Rear window wiper.....199**  
**Refueling**  
 Capacity.....444  
 Fuel types.....444  
 If the fuel filler door cannot be opened  
 .....430  
 Opening the fuel tank cap.....200  
**Remote Touch .....286**  
**Replacing**  
 Electronic key battery.....379  
 Fuses .....381  
 Light bulbs.....384  
 Tires.....416  
**Resetting the message indicating maintenance is required.....350**  
**Rev indicator .....78**  
**Rev peak.....79**  
**Road Sign Assist .....225**  
**RSA (Road Sign Assist) .....225**

**S**

**Seat belt reminder light.....406**  
**Seat belts.....26**  
 Automatic Locking Retractor .....28  
 Child restraint system installation.....46  
 Cleaning and maintaining the seat belt  
 .....347  
 Emergency Locking Retractor.....28  
 How to wear your seat belt.....27

How your child should wear the seat belt  
 .....27  
 Pregnant women, proper seat belt use  
 .....26  
 Reminder light and buzzer .....406  
 Seat belt extender.....27  
 Seat belt pretensioners .....29  
 SRS warning light.....404  
**Seat heaters .....306**  
**Seat position memory.....133**  
**Seat ventilators .....306**  
**Seating capacity.....162**  
**Seats**  
 Adjustment.....121, 123  
 Adjustment precautions .....121, 122  
 Child seats/child restraint system installation .....45  
 Cleaning.....347  
 Driving position memory .....133  
 Folding down the rear seatbacks.....123  
 Head restraints.....136  
 Power easy access system .....133  
 Properly sitting in the seat .....25  
 Seat heaters .....306  
 Seat position memory .....133  
 Seat ventilators .....306  
**Sensor**  
 Automatic headlight system.....188  
 Automatic High Beam system.....191  
 Inside rear view mirror .....140  
 Intuitive parking assist .....244  
 LTA (Lane Tracing Assist).....216  
 Parking Support Brake function  
 (rear-crossing vehicles) .....267  
 Parking Support Brake function (static  
 objects).....262  
 Radar sensor .....203, 238  
 Rain-sensing windshield wipers.....197  
 RCTA.....252  
**Service reminder message .....350**  
**Shift lever**  
 Automatic transmission .....178

Shift lever light .....	309	Storage features .....	312
Side airbags .....	30	Stuck	
Side doors.....	99	If the vehicle becomes stuck.....	439
Side marker lights		Suggestion function.....	86
Light switch.....	188	Sun visors.....	332
Replacing light bulbs.....	385	Sunshade	
Side mirrors		Panoramic moon roof.....	149
Adjustment.....	141	Roof.....	147
BSM (Blind Spot Monitor) .....	236	Switches	
Folding .....	142	Automatic High Beam switch .....	191
Linked mirror function when reversing		Brake Hold switch.....	186
.....	141	Door lock switches .....	101
Mirror position memory.....	133	Driving mode select switch .....	271
RCTA function.....	250	Driving position memory switches ...	133
Side turn signal lights		Dynamic radar cruise control with	
Replacing light bulbs.....	385	full-speed range switch .....	227
Turn signal lever .....	182	Electronic sunshade switch .....	149
Side windows .....	144	Emergency flashers switch .....	394
Smart access system with push-button		Engine switch.....	174
start		Fog light switch .....	194
Antenna location.....	115	Garage door opener switches.....	334
Entry functions.....	99, 104	Heated steering wheel switch.....	306
Starting the engine .....	174	HUD (Head-up display) switch .....	89
Smartphone holder.....	314	Ignition switch.....	174
Snow tires .....	280	Instrument panel light control switches	
Spare tire.....	416	.....	80
Storage location.....	417	Intuitive parking assist switch .....	245
Spark plug .....	446	Light switches .....	188
Specifications.....	442	LTA (Lane Tracing Assist) switch ....	220
Speedometer .....	77	Meter control switches .....	82
Steering lock		Moon roof switches.....	146
Column lock release.....	175	"ODO TRIP" switch .....	80
Steering lock system warning message		Outside rear view mirror switches .....	141
.....	175	Paddle shift switches .....	180, 181
Steering wheel		Panoramic moon roof switches .....	149
Adjustment.....	139	Parking brake switch.....	183
Heated steering wheel.....	306	PCS OFF switch .....	211
Meter control switches.....	82	PKSB (Parking Support Brake) switch	
Power easy access system.....	133	.....	256
Steering wheel position memory .....	133	Power window switches .....	144
Stop lights		RCTA switch.....	251
Replacing light bulbs.....	385		

Rear window and outside rear view mirror defoggers switch ..... 292  
 Seat heater switches ..... 306  
 Seat ventilator switches ..... 306  
 “SOS” button ..... 60  
 Tilt and telescopic steering control switch ..... 139  
 Tire pressure warning reset switch ... 371  
 Vehicle-to-vehicle distance switch ... 227  
 VSC OFF switch ..... 276  
 Window lock switch ..... 146  
 Windshield wiper and washer switch 194  
 Windshield wiper de-icer switch ..... 297

**T**

**Tachometer** ..... 77  
 Rev indicator ..... 78  
 Rev peak ..... 79  
**Tail lights**  
 Light switch ..... 188  
 Replacing light bulbs ..... 385  
**The Secondary Collision Brake** ..... 275  
**Theft deterrent system**  
 Alarm ..... 68  
 Engine immobilizer system ..... 66  
**Tire inflation pressure**  
 Maintenance data ..... 448  
 Tire inflation pressure display function ..... 367  
 Warning light ..... 407  
**Tire information** ..... 452  
 Glossary ..... 456  
 Size ..... 454  
 Tire identification number ..... 453  
 Uniform Tire Quality Grading ..... 454  
**Tire pressure display** ..... 367  
**Tire pressure warning system**  
 Function ..... 367  
 Initializing ..... 371  
 Installing tire pressure warning valves and transmitters ..... 370  
 Registering ID codes ..... 372

Warning light ..... 407  
**Tires**  
 Chains ..... 281  
 Checking ..... 365  
 If you have a flat tire ..... 416  
 Inflation pressure ..... 373  
 Information ..... 452  
 Replacing ..... 416  
 Rotating tires ..... 367  
 Size ..... 448  
 Snow tires ..... 280  
 Spare tire ..... 416  
 Tire inflation pressure display function ..... 367  
 Tire pressure warning system ..... 367  
 Warning light ..... 407  
**Tools** ..... 417  
**Top tether strap** ..... 57  
**Total load capacity** ..... 442  
**Towing**  
 Dinghy towing ..... 173  
 Emergency towing ..... 397  
 Towing eyelet ..... 399  
 Trailer towing ..... 163  
**TRAC (Traction Control)** ..... 275  
**Traction Control (TRAC)** ..... 275  
**Trailer Sway Control** ..... 275  
**Trailer towing** ..... 163  
**Transmission**  
 Automatic transmission ..... 178  
 Driving mode select switch ..... 271  
 M mode ..... 181  
 Paddle shift switches ..... 180, 181  
**Trip meters** ..... 80  
**Turn signal lights**  
 Replacing light bulbs ..... 385  
 Turn signal lever ..... 182  
 Wattage ..... 449

**U**

**USB charging ports** ..... 322

**V**

Vanity lights..... 333  
     Wattage..... 449  
 Vanity mirrors ..... 333  
 VDIM (Vehicle Dynamics Integrated Management)..... 275  
 Vehicle data recording .....6  
 Vehicle Dynamics Integrated Management (VDIM)..... 275  
 Vehicle identification number ..... 443  
 Vehicle Stability Control (VSC) .....274  
 Ventilators (seat ventilators)..... 306  
 VSC (Vehicle Stability Control) .....274

**W**

**Warning buzzers**  
     Approach warning..... 233  
     Brake Override System .....405  
     Door lock.....100  
     Downshifting .....181, 182  
     Drive-Start Control .....405  
     Electric power steering .....405  
     Hands off steering wheel warning (LTA) ..... 223  
     High coolant temperature ..... 403  
     Intuitive parking assist..... 249, 407  
     Low engine oil pressure..... 404  
     LTA (Lane Tracing Assist)216, 219, 407  
     Open door.....102  
     Open window.....145  
     PKSA (Parking Support Alert) ..... 242  
     PKSB (Parking Support Brake)..... 408  
     Pre-collision braking.....210  
     RCTA (Rear Cross Traffic Alert) .....407  
     Seat belt.....406  
**Warning lights.....403**  
     ABS .....405  
     Brake hold operated indicator .....409  
     Brake Override System .....405  
     Brake system .....403  
     Charging system .....404

Drive-Start Control..... 405  
 Electric power steering.....405  
 High coolant temperature.....403  
 Intuitive parking assist OFF indicator .....407  
     .....407  
 Low engine oil pressure..... 404  
 Low fuel level .....406  
 LTA indicator .....407  
 Malfunction indicator lamp ..... 404  
 Master warning light.....409  
 Parking brake indicator .....409  
 PKSB OFF indicator .....408  
 Pre-collision system.....408  
 RCTA OFF indicator .....407  
 Seat belt reminder light..... 406  
 Slip indicator.....408  
 SRS.....404  
 Tire pressure .....407  
**Warning messages ..... 412**  
**Washer**  
     Adding.....364  
     Preparing and checking before winter .....280  
     Switch.....194  
**Washing and waxing..... 344**  
**Weight**  
     Cargo capacity .....159, 162  
     Load limits .....162  
     Weight.....442  
**Wheels..... 374**  
     Size.....448  
**Window lock switch .....146**  
**Windows**  
     Power windows.....144  
     Rear window defogger.....294  
     Washer ..... 194  
**Windshield wiper de-icer ..... 299**  
**Windshield wiper inserts..... 378**  
**Windshield wipers**  
     Position.....197  
     Rain-sensing windshield wipers..... 194  
     Replacing a windshield wiper insert.378



Winter driving tips.....280  
Wireless charger.....323  
Wireless remote control  
    Battery-Saving Function .....116  
    Locking/Unlocking.....97  
    Replacing the battery.....379

---

---

**For information regarding the equipment listed below, refer to the “NAVIGATION AND MULTI-MEDIA SYSTEM OWNER’S MANUAL”.**

- Navigation system
- Audio/visual system
- Panoramic view monitor
- Lexus parking assist monitor







## GAS STATION INFORMATION

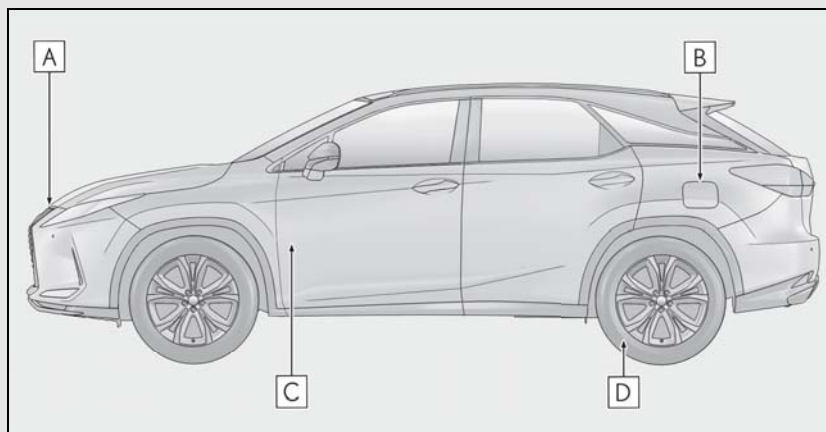

- A** Auxiliary catch lever (→P.357)
- B** Fuel filler door (→P.201)
- C** Hood lock release lever (→P.357)
- D** Tire inflation pressure (→P.448)

Fuel tank capacity (Reference)	19.2 gal. (72.5 L, 15.9 Imp. gal.)	
Fuel type	Unleaded gasoline only	P.444 P.450
Cold tire inflation pressure		P.448
Engine oil capacity (Drain and refill — reference)		P.444
Engine oil type		P.444