

2024 FORD E-SERIES Owner's Manual



The information contained in this publication was correct at the time of release. In the interest of continuous development, we reserve the right to change specifications, design or equipment at any time without notice or obligation. No part of this publication may be reproduced, transmitted, stored in a retrieval system or translated into any language in any form by any means without our written permission. Errors and omissions excepted.

© Ford Motor Company 2022

All rights reserved.

Part Number: -202210-20221028183855

California Proposition 65



WARNING: Operating, servicing and maintaining a passenger vehicle or off-highway motor vehicle can expose you to chemicals including engine exhaust, carbon monoxide, phthalates, and lead, which are known to the State of California to cause cancer and birth defects or other reproductive harm. To minimize exposure, avoid breathing exhaust, do not idle the engine except as necessary, service your vehicle in a well-ventilated area and wear gloves or wash your hands frequently when servicing your vehicle. For more information go to www.P65Warnings.ca.gov/passenger-vehicle.



WARNING: Battery posts, terminals and related accessories contain lead and lead compounds, chemicals known to the State of California to cause cancer and reproductive harm.
Wash your hands after handling.

Table of Contents

Introduction

About This Manual	7
Perchlorate	7
Ford Credit	7
Replacement Parts Recommendation	8
Special Notices	8
Mobile Communications Equipment	10

Symbols Glossary

Symbols Used on Your Vehicle	11
------------------------------------	----

Data Privacy

Data Privacy	14
Service Data	15
Event Data	15
Connected Vehicle Data	16
Emergency Call System Data	16

Environment

Protecting the Environment	17
----------------------------------	----

At a Glance

Instrument Panel	18
------------------------	----

Child Safety

General Information	20
Installing Child Restraints	22
Booster Seats	26
Child Restraint Positioning	28

Seatbelts

Principle of Operation	30
Fastening the Seatbelts	31
Seatbelt Height Adjustment	33
Seatbelt Warning Lamp and Indicator Chime	33
Child Restraint and Seatbelt Maintenance	34

Seatbelt Extensions	34
---------------------------	----

Supplementary Restraints System

Principle of Operation	35
Driver and Passenger Airbags	36
Crash Sensors and Airbag Indicator	40
Airbag Disposal	41

Keys and Remote Controls

General Information on Radio Frequencies	42
Remote Control	42
Replacing a Lost Key or Remote Control	44

Doors and Locks

Locking and Unlocking	45
-----------------------------	----

Security

Passive Anti-Theft System	47
---------------------------------	----

Steering Wheel

Adjusting the Steering Wheel	48
Cruise Control - Vehicles With: Adaptive Cruise Control	48
Cruise Control - Vehicles With: Cruise Control	48
Information Display Control	49
Horn	49

Wipers and Washers

Windshield Wipers	50
Windshield Washers	50

Lighting

General Information	51
Lighting Control	51
Autolamps	52
Instrument Lighting Dimmer	52

Table of Contents

Daytime Running Lamps - Vehicles With: Configurable Daytime Running Lamps	52	Head Restraints	76
Daytime Running Lamps - Vehicles With: Daytime Running Lamps (DRL)	53	Manual Seats	77
Direction Indicators	53	Power Seats	78
Automatic High Beam Control		Auxiliary Power Points	
What Is Automatic High Beam Control	54	Auxiliary Power Points	79
Switching Automatic High Beam Control On and Off	54	Starting and Stopping the Engine	
Automatic High Beam Control Indicators	54	General Information	81
Overriding Automatic High Beam Control	55	Ignition Switch	81
Windows and Mirrors		Starting a Gasoline Engine	82
Power Windows	56	Engine Block Heater	83
Exterior Mirrors	56	Fuel and Refueling	
Interior Mirror	57	Safety Precautions	85
Sun Visors	57	Fuel Quality - E85	85
Instrument Cluster		Fuel Quality - Gasoline	87
Gauges	58	Running Out of Fuel	87
Warning Lamps and Indicators	61	Refueling	88
Audible Warnings and Indicators	63	Fuel Consumption	89
Information Displays		Engine Emission Control	
General Information	64	Emission Law	91
Information Messages	68	Catalytic Converter	92
Climate Control		Transmission	
Manual Climate Control	73	Automatic Transmission	95
Hints on Controlling the Interior Climate	74	Brakes	
Rear Passenger Climate Controls	75	General Information	99
Seats		Hints on Driving With Anti-Lock Brakes	100
Sitting in the Correct Position	76	Parking Brake	100
		Hill Start Assist	101
		Traction Control	
		Principle of Operation	102
		Using Traction Control	102

Table of Contents

Stability Control

Principle of Operation	103
Using Stability Control	104

Parking Aids

Rear View Camera	105
------------------------	-----

Cruise Control

What Is Cruise Control	106
Switching Cruise Control On and Off	106
Setting the Cruise Control Speed	106
Canceling the Set Speed	107
Resuming the Set Speed	107
Cruise Control Indicators	107
Using Adaptive Cruise Control	107

Driving Aids

Driver Alert	114
Lane Keeping System	115
Steering	118
Pre-Collision Assist	118

Load Carrying

Load Limit	122
------------------	-----

Towing

Towing a Trailer	127
Recommended Towing Weights	128
Essential Towing Checks	129
Towing the Vehicle on Four Wheels	135

Driving Hints

Reduced Engine Performance	136
Economical Driving	136
Breaking-In	137
Driving Through Water	137
Floor Mats	137

Roadside Emergencies

Hazard Flashers	139
Jump Starting the Vehicle	139
Transporting the Vehicle	140

Crash and Breakdown Information

Roadside Assistance	142
Post-Collision Braking	143
Automatic Crash Shutoff	143

Customer Assistance

Getting the Services You Need	144
In California (U.S. Only)	145
The Better Business Bureau (BBB) Auto Line Program (U.S. Only)	146
Getting Assistance Outside the U.S. and Canada	147
Ordering Additional Owner's Literature	148
Reporting Safety Defects (U.S. Only)	148
Reporting Safety Defects (Canada Only)	149

Fuses

Fuse Specification Chart	150
Changing a Fuse	159

Maintenance

General Information	161
Opening and Closing the Hood	161
Under Hood Overview	162
Engine Oil Dipstick	163
Engine Oil Check	163
Oil Change Indicator Reset	164
Changing the Engine Air Filter	165
Engine Coolant Check	165
Automatic Transmission Fluid Check	170
Brake Fluid Check	172

Table of Contents

Power Steering Fluid Check	173
Changing the 12V Battery	173
Adjusting the Headlamps	176
Washer Fluid Check	177
Fuel Filter	178
Checking the Wiper Blades	178
Changing the Wiper Blades	178
Removing a Headlamp	179
Changing a Bulb	179

Vehicle Care

General Information	182
Cleaning Products	182
Cleaning the Exterior	183
Waxing	184
Cleaning the Engine	184
Cleaning the Windows and Wiper Blades	185
Cleaning the Interior	185
Cleaning the Instrument Panel and Instrument Cluster Lens	186
Cleaning Leather Seats	186
Repairing Minor Paint Damage	187
Cleaning the Wheels	187
Vehicle Storage	187

Wheels and Tires

General Information	190
Tire Care	191
Using Snow Chains	212
Tire Pressure Monitoring System	213
Changing a Road Wheel	218
Technical Specifications	225

Capacities and Specifications

Engine Specifications	226
Motorcraft Parts - 7.3L	227
Bulb Specification Chart	228

Engine Oil Capacity and Specification	229
Cooling System Capacity and Specification	230
Fuel Tank Capacity	231
Air Conditioning System Capacity and Specification	232
Washer Fluid Specification	232
Automatic Transmission Fluid Capacity and Specification	233
Brake Fluid Specification	234
Rear Axle Fluid Capacity and Specification	234
Hydraulic Power Steering Fluid Capacity and Specification	236

Vehicle Identification

Vehicle Identification Number	237
-------------------------------------	-----

Connected Vehicle

Connected Vehicle Requirements	238
Connected Vehicle Limitations	238
Connecting the Vehicle to a Mobile Network	238
Connected Vehicle – Troubleshooting	238

Audio System

General Information	239
Audio Unit	239
Connecting a Bluetooth® Device	242
Streaming Bluetooth Audio	242
Playing Media From a USB Device	242
USB Port	243
Using Voice Recognition	243

Accessories

Accessories	244
Auxiliary Switches	245

Table of Contents

Ford Protect

Ford Protect247

Scheduled Maintenance

General Maintenance Information249

Normal Scheduled Maintenance252

Special Operating Conditions Scheduled
Maintenance255

Customer Information

Radio Frequency Certification Labels
.....258

Warranty Information268

Appendices

Electromagnetic Compatibility270

End User License Agreement273

Introduction

ABOUT THIS MANUAL

Thank you for choosing Ford. We recommend that you take some time to get to know your vehicle by reading this manual. The more that you know about your vehicle, the greater the safety and pleasure you will get from driving it.



WARNING: Driving while distracted can result in loss of vehicle control, crash and injury. We strongly recommend that you use extreme caution when using any device that may take your focus off the road. Your primary responsibility is the safe operation of your vehicle. We recommend against the use of any hand-held device while driving and encourage the use of voice-operated systems when possible. Make sure you are aware of all applicable local laws that may affect the use of electronic devices while driving.

Note: *This manual describes product features and options available throughout the range of available models, sometimes even before they are generally available. It may describe options not fitted to the vehicle you have purchased.*

Note: *Some of the illustrations in this manual may show features as used in different models, so may appear different to you on your vehicle.*

Note: *Always use and operate your vehicle in line with all applicable laws and regulations.*

Note: *Pass on this manual when selling your vehicle. It is an integral part of your vehicle.*

This manual may qualify the location of a component as left-hand side or right-hand side. The side is determined when facing forward in the seat.

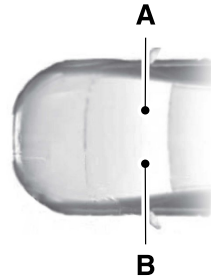

- A Right-hand side.
- B Left-hand side.

PERCHLORATE

Certain components in your vehicle such as airbag modules, seatbelt pretensioners and remote control batteries may contain perchlorate material. Special handling may apply for service or vehicle end of life disposal.

For more information visit:

Web Address
www.dtsc.ca.gov/hazardouswaste/perchlorate

FORD CREDIT

US Only

Ford Credit/Ford Pro FinSimple offers a full range of financing and lease plans to help you acquire our vehicle. If you have financed or leased your vehicle through Ford Credit/Ford Pro FinSimple, thank you for your business.

Introduction

For assistance:

- Call 1-800-727-7000.
- For more information about Ford Credit and access to the online Account Manager tool, visit www.ford.com/finance.
- For more information about Ford Pro FinSimple, visit <https://fordpro.com/en-us/financing/>.

REPLACEMENT PARTS RECOMMENDATION

We have built your vehicle to the highest standards using quality parts. We recommend that you demand the use of genuine Ford and Motorcraft parts whenever your vehicle requires scheduled maintenance or repair. You can clearly identify genuine Ford and Motorcraft parts by looking for the Ford, FoMoCo or Motorcraft branding on the parts or their packaging.

Scheduled Maintenance and Mechanical Repairs

One of the best ways for you to make sure that your vehicle provides years of service is to have it maintained in line with our recommendations using parts that conform to the specifications detailed in this Owner's Manual.

Genuine Ford and Motorcraft parts meet or exceed these specifications.

Collision Repairs

We hope that you never experience a collision, but accidents happen sometimes.

Genuine Ford replacement collision parts meet our stringent requirements for fit, finish, structural integrity, corrosion protection and dent resistance. During vehicle development we validate that these parts deliver the intended level of protection as a whole system. A great way to know for sure you are getting this level of protection is to use genuine Ford replacement collision parts.

Warranty on Replacement Parts

Genuine Ford and Motorcraft replacement parts are the only replacement parts that benefit from a Ford Warranty.

The Ford Warranty may not cover damage caused to your vehicle as a result of failed non-Ford parts.

For additional information, refer to the terms and conditions of the Ford Warranty.

SPECIAL NOTICES

New Vehicle Limited Warranty

For a detailed description of what is covered by your New Vehicle Limited Warranty, see your warranty guide that is available online. For more information, refer to our website and download your copy of the warranty guide.

Special Instructions

For your added safety, your vehicle is fitted with sophisticated electronic controls.



WARNING: You risk death, fire, or serious injury to yourself and others if you do not follow the instruction highlighted by the warning symbol.



WARNING: Never place front seat mounted rear-facing child or infant seats in front of an active passenger airbag.

Introduction

Fleet Telematics Modem (If Equipped)

The onboard modem provides access to data to support telematics services such as location, speed, idle time, fuel, vehicle diagnostics and maintenance alerts. To explore data, telematics services, third party service provider support and to manage existing telematics accounts, refer to www.commercialsolutions.ford.com or call 833-FCS-FORD.

Note: *This is not available with FordPass Connect.*

FordPass Connect (If Equipped)

With a FordPass Connect-equipped vehicle, you can use FordPass to track your vehicle's location and remotely access vehicle features such as start, lock and unlock and vehicle status including fuel level and approximate mileage. Message and data rates may apply. Services may be limited by mobile phone network coverage area. For additional information, refer to www.fordpass.com.

On Board Diagnostics Data Link Connector



WARNING: Do not connect wireless plug-in devices to the data link connector. Unauthorized third parties could gain access to vehicle data and impair the performance of safety related systems. Only allow repair facilities that follow our service and repair instructions to connect their equipment to the data link connector.

Your vehicle has an OBD Data Link Connector (DLC) that is used in conjunction with a diagnostic scan tool for vehicle diagnostics, repairs and reprogramming services. Installing an aftermarket device that uses the DLC during normal driving for purposes such as

remote insurance company monitoring, transmission of vehicle data to other devices or entities, or altering the performance of the vehicle, may cause interference with or even damage to vehicle systems. We do not recommend or endorse the use of aftermarket plug-in devices unless approved by Ford. The vehicle Warranty will not cover damage caused by an aftermarket plug-in device.

Notice to Owners of Pickup Trucks and Utility Type Vehicles



WARNING: Utility vehicles have a significantly higher rollover rate than other types of vehicles.



WARNING: Vehicles with a higher center of gravity (utility and four-wheel drive vehicles) handle differently than vehicles with a lower center of gravity (passenger cars). Avoid sharp turns, excessive speed and abrupt steering in these vehicles. Failure to drive cautiously increases the risk of losing control of your vehicle, vehicle rollover, personal injury and death.

Before you drive your vehicle, please read this Owner's Manual carefully. Your vehicle is not a passenger car. As with other vehicles of this type, failure to operate this vehicle correctly may result in loss of vehicle control, vehicle rollover, personal injury or death.

Using your Vehicle as an Ambulance

If your light truck has the Ford Ambulance Preparation Package, it may be utilized as an ambulance. Ford urges ambulance manufacturers to follow the recommendations of the Ford Incomplete Vehicle Manual, Ford Truck Body Builder's Layout Book and the Qualified Vehicle

Introduction

Modifiers (QVM) Guidelines as well as pertinent supplements. For additional information, please contact the Truck Body Builders Advisory Service at <http://www.fleet.ford.com/truckbbas/> and then by selecting Contact Us or by phone at 1-877-840-4338.

Use of your Ford light truck as an ambulance, without the Ford Ambulance Preparation Package voids the Ford New Vehicle Limited Warranty and may void the emissions warranties. In addition, ambulance usage without the preparation package could cause high underbody temperatures, over-pressurized fuel and a risk of spraying fuel, which could lead to fires.

If your vehicle has the Ford Ambulance Preparation Package, it will be indicated on the Safety Compliance Certification Label. The label is on the driver side door pillar or on the rear edge of the driver door. You can determine whether the ambulance manufacturer followed Ford's recommendations by directly contacting that manufacturer.

hand-held device while driving and encourage the use of voice-operated systems when possible. Make sure you are aware of all applicable local laws that may affect the use of electronic devices while driving.

Using mobile communications equipment is becoming increasingly important in the conduct of business and personal affairs. However, you must not compromise your own or others' safety when using such equipment. Mobile communications can enhance personal safety and security when appropriately used, particularly in emergency situations. Safety must be paramount when using mobile communications equipment to avoid negating these benefits. Mobile communication equipment includes, but is not limited to, cellular phones, pagers, portable email devices, text messaging devices and portable two-way radios.

MOBILE COMMUNICATIONS EQUIPMENT



























WARNING: Driving while distracted can result in loss of vehicle control, crash and injury. We strongly recommend that you use extreme caution when using any device that may take your focus off the road. Your primary responsibility is the safe operation of your vehicle. We recommend against the use of any

Symbols Glossary

SYMBOLS USED ON YOUR VEHICLE

These are some of the symbols you may see on your vehicle.

	Airbag		Child safety door lock or unlock
	Air conditioning system		Child seat lower anchor
	Air conditioning system lubricant type		Child seat tether anchor
	Anti-lock braking system		Cruise control
	Avoid smoking, flames or sparks		Do not open when hot
	Battery		Electric Parking brake
	Battery acid		Engine air filter
	Blower motor		Engine coolant
	Brake fluid - non petroleum based		Engine coolant temperature
	Brake system		Engine oil
	Brake system		Explosive gas
	Cabin air filter		Fan warning
	Check fuel cap		Fasten seatbelt
			Flammable
			Front fog lamps

Symbols Glossary



Fuel pump reset



Fuse compartment



Hazard flashers



Headlamp high beams



Headlamps on



Heated rear window



Hill descent control



Horn control



Interior luggage compartment release



Jack



Keep out of reach of children



Lighting control



Low fuel level



Low tire pressure warning



Maintain correct fluid level



Malfunction Indicator Lamp (MIL)



Note operating instructions



Panic alarm



Parking aid



Parking lamps



Passenger airbag activated



Passenger airbag deactivated



Power steering fluid



Power windows front/rear



Power window lockout



Requires registered technician



Safety alert



See Owner's Manual



See Service Manual



Side airbag

Symbols Glossary



Shield the eyes



Stability control



Stability control off



Trail control



Turn Signal



Windshield defrosting system



Windshield wiping system



Windshield wash and wipe

Data Privacy



WARNING: Do not connect wireless plug-in devices to the data link connector. Unauthorized third parties could gain access to vehicle data and impair the performance of safety related systems. Only allow repair facilities that follow our service and repair instructions to connect their equipment to the data link connector.

We respect your privacy and are committed to protecting it. The information contained in this publication was correct at the time of release, but as technology rapidly changes, we recommend that you visit the local Ford website for the latest information.

Your vehicle has electronic control units that have data recording functionality and the ability to permanently or temporarily store data. This data could include information on the condition and status of your vehicle, vehicle maintenance requirements, events and malfunctions. The types of data that can be recorded are described in this section. Some of the data recorded is stored in event logs or error logs.

Note: *Error logs are reset following a service or repair.*

Note: *We may provide information in response to requests from law enforcement, other government authorities and third parties acting with lawful authority or through a legal process. Such information could be used by them in legal proceedings.*

Data recorded includes, for example:

- Operating states of system components, for example fuel level, tire pressure and battery charge level.
- Vehicle and component status, for example wheel speed, deceleration, lateral acceleration and seatbelt status.

- Events or errors in essential systems, for example headlamps and brakes.
- System responses to driving situations, for example airbag deployment and stability control.
- Environmental conditions, for example temperature.

Some of this data, when used in combination with other information, for example an accident report, damage to a vehicle or eyewitness statements, could be associated with a specific person.

Services That We Provide

If you use our services, we collect and use data, for example account information, vehicle location and driving characteristics, that could identify you. We transmit this data through a dedicated, protected connection. We only collect and use data to enable your use of our services to which you have subscribed, with your consent or where permitted by law. For additional information, see the terms and conditions of the services to which you have subscribed.

For additional information about our privacy policy, refer to the local Ford website.

Services That Third Parties Provide

We recommend that you review the terms and conditions and data privacy information for any services equipped with your vehicle or to which you subscribe. We take no responsibility for services that third parties provide.

Data Privacy

SERVICE DATA

Service data recorders in your vehicle are capable of collecting and storing diagnostic information about your vehicle. This potentially includes information about the performance or status of various systems and modules in the vehicle, such as engine, throttle, steering or brake systems. In order to properly diagnose and service your vehicle, Ford Motor Company (Ford of Canada in Canada), and service and repair facilities may access or share among them vehicle diagnostic information received through a direct connection to your vehicle when diagnosing or servicing your vehicle. Additionally, Ford Motor Company (Ford of Canada, in Canada) may, where permitted by law, use vehicle diagnostic information for vehicle improvement or with other information we may have about you, for example, your contact information, to offer you products or services that may interest you. Data may be provided to our service providers such as part suppliers that may help diagnose malfunctions, and who are similarly obligated to protect data. We retain this data only as long as necessary to perform these functions or to comply with law. We may provide information where required in response to official requests to law enforcement or other government authorities or third parties acting with lawful authority or court order, and such information may be used in legal proceedings. For U.S. only (if equipped), if you choose to use connected apps and services, you consent that certain diagnostic information may also be accessed electronically by Ford Motor Company and Ford authorized service facilities, and that the diagnostic information may be used to provide services to you, personalizing your experience, troubleshoot, and to improve products and services and offer you products and services that may interest

you, where permitted by law. For Canada only, for more information, please review the Ford of Canada privacy policy at www.ford.ca, including our U.S. data storage and use of service providers in other jurisdictions who may be subject to legal requirements in Canada, the United States and other countries applicable to them, for example, lawful requirements to disclose personal information to governmental authorities in those countries.

EVENT DATA

This vehicle is equipped with an event data recorder. The main purpose of an event data recorder is to record, in certain crash or near crash-like situations, such as an airbag deployment or hitting a road obstacle; this data will assist in understanding how a vehicle's systems performed. The event data recorder is designed to record data related to vehicle dynamics and safety systems for a short period of time, typically 30 seconds or less.

The event data recorder in this vehicle is designed to record such data as:

- How various systems in your vehicle were operating.
- Whether or not the driver and passenger seatbelts were buckled/fastened.
- How far (if at all) the driver was depressing the accelerator and/or the brake pedal.
- How fast the vehicle was traveling.
- Where the driver was positioning the steering wheel.

This data can help provide a better understanding of the circumstances in which crashes and injuries occur.

Data Privacy

Note: Event data recorder data is recorded by your vehicle only if a non-trivial crash situation occurs; no data is recorded by the event data recorder under normal driving conditions and no personal data or information (for example name, gender, age, and crash location) is recorded. However, parties, such as law enforcement, could combine the event data recorder data with the type of personally identifying data routinely acquired during a crash investigation.

To read data recorded by an event data recorder, special equipment is required, and access to the vehicle or the event data recorder is needed. In addition to the vehicle manufacturer, other parties, such as law enforcement, that have such special equipment, can read the information if they have access to the vehicle or the event data recorder.

CONNECTED VEHICLE DATA



The modem has a SIM. The modem was enabled when your vehicle was built and periodically sends messages to stay connected to the cell phone network, receive automatic software updates and send vehicle-related information to us, for example diagnostic information. These messages could include information that identifies your vehicle, the SIM and the electronic serial number of the modem. Cell phone network service providers could have access to additional information, for example cell phone network tower identification. For additional information about our privacy policy, visit www.FordConnected.com or refer to your local Ford website.

Note: The modem continues to send this information unless you disable the modem or stop the modem from sharing vehicle data by changing the modem settings. See **Connected Vehicle** (page 238).

Note: The service can be unavailable or interrupted for a number of reasons, for example environmental or topographical conditions and data plan coverage.

Note: To find out if your vehicle has a modem, visit www.FordConnected.com.

EMERGENCY CALL SYSTEM DATA

When the emergency call system is active, it may disclose to emergency services that your vehicle has been in a crash involving the deployment of an airbag or activation of the fuel pump shut-off. Certain versions or updates to the emergency call system may also be capable of electronically or verbally disclosing to emergency services operators your vehicle location or other details about your vehicle or crash to assist emergency services operators to provide the most appropriate emergency services. If you do not want to disclose this information, do not activate the emergency call system.

Note: You cannot deactivate emergency call systems that are required by law.

Environment

PROTECTING THE ENVIRONMENT

Sustainability is a priority at Ford. We are constantly looking for ways to reduce our impact on the planet while providing customers with great products and delivering a strong business. You should play your part in protecting the environment. Correct vehicle usage and the authorized disposal of waste, cleaning and lubrication materials are significant steps toward this aim.

For additional information about our sustainability progress and initiatives, visit www.sustainability.ford.com.

At a Glance

INSTRUMENT PANEL

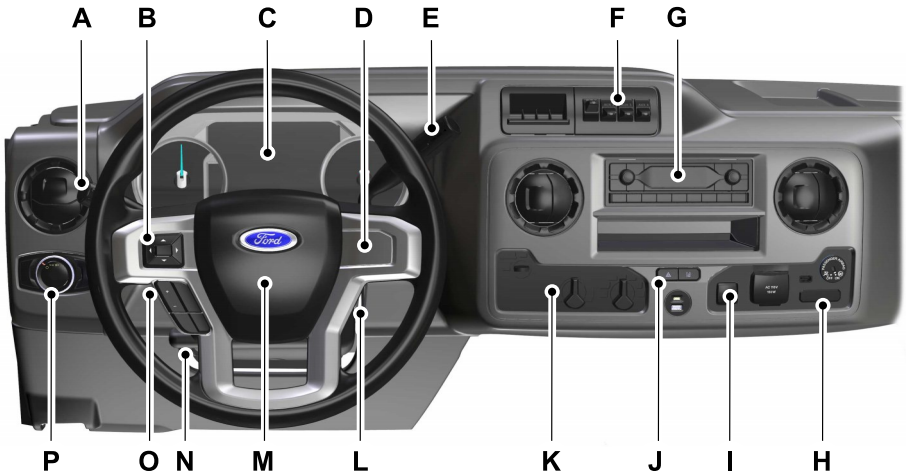

- A Direction indicators. See **Direction Indicators** (page 53). Wiper lever. See **Windshield Wipers** (page 50).
- B Information display control. See **Information Display Control** (page 49).
- C Instrument cluster. See **General Information** (page 64).
- D Audio control.
- E Gearshift lever. See **Automatic Transmission** (page 95).
- F Auxiliary switches. See **Auxiliary Switches** (page 245).
- G Audio unit. See **Audio Unit** (page 239).
- H Passenger airbag deactivation indicator. See **Driver and Passenger Airbags** (page 36).
- I Traction control switch. See **Using Traction Control** (page 102).
- J Hazard flasher switch. See **Hazard Flashers** (page 139).
- K Climate control. See **Manual Climate Control** (page 73).
- L Ignition. See **Ignition Switch** (page 81).
- M Horn.
- N Steering wheel adjustment. See **Adjusting the Steering Wheel** (page 48).

At a Glance

- O Cruise control. See **Cruise Control** (page 106).
- P Lighting control. See **Lighting Control** (page 51).

Child Safety

GENERAL INFORMATION

See the following sections for directions on how to properly use safety restraints for children.



WARNING: Always make sure your child is secured properly in a device that is appropriate for their height, age and weight. Child safety restraints must be bought separately from your vehicle. Failure to follow these instructions and guidelines may result in an increased risk of serious injury or death to your child.



WARNING: All children are shaped differently. The National Highway Traffic Safety Administration and other safety organizations, base their recommendations for child restraints on probable child height, age and weight thresholds, or on the minimum requirements of the law. We recommend that you check with a NHTSA Certified Child Passenger Safety Technician

(CPST) to make sure that you properly install the child restraint in your vehicle and that you consult your pediatrician to make sure you have a child restraint appropriate for your child. To locate a child restraint fitting station and CPST, contact NHTSA toll free at 1-888-327-4236 or go to www.nhtsa.dot.gov. In Canada, contact Transport Canada toll free at 1-800-333-0371 or go to www.tc.gc.ca to find a Child Car Seat Clinic in your area. Failure to properly restrain children in child restraints made especially for their height, age and weight, may result in an increased risk of serious injury or death to your child.



WARNING: On hot days, the temperature inside the vehicle can rise very quickly. Exposure of people or animals to these high temperatures for even a short time can cause death or serious heat related injuries, including brain damage. Small children are particularly at risk.

Child Safety

Recommendations for Safety Restraints for Children

Child	Child Size, Height, Weight, or Age	Recommended Restraint Type
Infants or toddlers	Children weighing 40 lb (18 kg) or less (generally age four or younger).	Use a child restraint (sometimes called an infant carrier, convertible seat, or toddler seat).
Small children	Children who have outgrown or no longer properly fit in a child restraint (generally children who are less than 57 in (1.45 m) tall, are greater than age four and less than age 12, and between 40 lb (18 kg) and 80 lb (36 kg) and upward to 100 lb (45 kg) if recommended by your child restraint manufacturer).	Use a belt-positioning booster seat.
Larger children	Children who have outgrown or no longer properly fit in a belt-positioning booster seat (generally children who are at least 57 in (1.45 m) tall or greater than 80 lb (36 kg) or 100 lb (45 kg) if recommended by child restraint manufacturer).	Use a vehicle seatbelt having the lap belt snug and low across the hips, shoulder belt centered across the shoulder and chest, and seat backrest upright.

- You are required by law to properly use child restraints for infants and toddlers in the United States and Canada.
- Many states and provinces require that small children use approved booster seats until they reach age eight, a height of 57 in (1.45 m) tall, or 80 lb (36 kg). Check your local and state or provincial laws for specific requirements about the safety of children in your vehicle.
- When possible, always properly restrain children 12 years of age and under in a rear seating position of your vehicle. Accident statistics suggest that children are safer when properly restrained in the rear seating positions than in a front seating position.
- When installing a rear facing child restraint, adjust the vehicle seats to avoid interference between the child restraint and the vehicle seat in front of the child restraint.

Child Safety

INSTALLING CHILD RESTRAINTS

Child Seats



E142594

Use a child restraint (sometimes called an infant carrier, convertible seat, or toddler seat) for infants, toddlers, or children weighing 40 lb (18 kg) or less (generally age four or younger).

Using Lap and Shoulder Belts

WARNING: Do not place a rearward facing child restraint in front of an active airbag. Failure to follow this instruction could result in personal injury or death.

WARNING: Properly secure children 12 years old and under in a rear seating position whenever possible. If you are unable to properly secure all children in a rear seating position, properly secure the largest child on the front seat. If you must use a forward facing child restraint on the front seat, move the seat as far back as possible. Failure to follow these instructions could result in personal injury or death.

WARNING: Depending on where you secure a child restraint, and depending on the child restraint design, you may block access to certain seatbelt buckle assemblies and LATCH lower anchors, rendering those features potentially unusable. To avoid risk of injury, make sure occupants only use seating positions where they are able to be properly restrained.

When installing a child restraint with combination lap and shoulder belts:

- Use the correct seatbelt buckle for that seating position.
- Insert the belt tongue into the proper buckle until you hear a snap and feel it latch. Make sure the tongue is securely fastened in the buckle.
- Keep the buckle release button pointing up and away from the child restraint, with the tongue between the child restraint and the release button, to prevent accidental unbuckling.
- Place the vehicle seat in the upright position before you install the child restraint.
- Put the seatbelt in the automatic locking mode. See Step 5. This vehicle does not require the use of a locking clip.

Perform the following steps when installing the child restraint with combination lap and shoulder belts:

Note: *Although the child restraint illustrated is a forward facing child restraint, the steps are the same for installing a rear facing child restraint.*

Child Safety



1. Position the child restraint in a seat with a combination lap and shoulder belt.



2. Pull down on the shoulder belt and then grasp the shoulder belt and lap belt together.

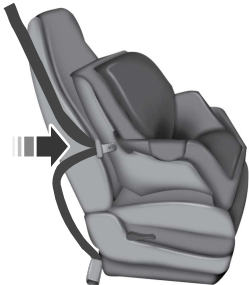

3. While holding the shoulder and lap belt portions together, route the tongue through the child restraint according to the child restraint manufacturer's instructions. Make sure that you did not twist the belt webbing.

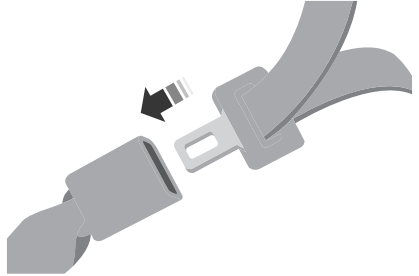

4. Insert the belt tongue into the proper buckle (the buckle closest to the direction the tongue is coming from) for that seating position until you hear a snap and feel the latch engage. Make sure the tongue is latched securely by pulling on it.



5. To put the retractor in the automatic locking mode, grasp the shoulder portion of the belt and pull downward until you pull all of the belt out.

Child Safety

6. Allow the belt to retract to remove slack. The belt clicks as it retracts to indicate it is in the automatic locking mode.
7. Try to pull the belt out of the retractor to make sure the retractor is in the automatic locking mode. You should not be able to pull more belt out. If the retractor is not locked, unbuckle the belt and repeat Steps 5 and 6.

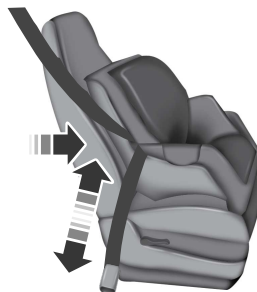
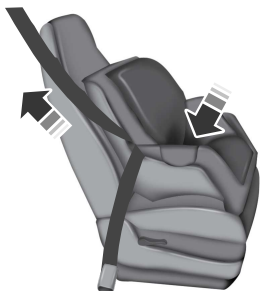

8. Remove remaining slack from the belt. Force the seat down with extra weight, for example, by pressing down or kneeling on the child restraint while pulling up on the shoulder belt in order to force slack from the belt. This is necessary to remove the remaining slack that exists once you add the extra weight of the child to the child restraint. It also helps to achieve the proper snugness of the child restraint to your vehicle. Sometimes, a slight lean toward the buckle will help to remove remaining slack from the belt.
9. If the child restraint has a tether strap, attach it.

10. Before placing the child in the seat, forcibly move the seat forward and back to make sure the seat is securely held in place.

To check this, grab the seat at the belt path and attempt to move it side to side and forward and back. There should be no more than 1 in (2.5 cm) of movement for proper installation.

We recommend checking with a NHTSA Certified Child Passenger Safety Technician to make certain the child restraint is properly installed. In Canada, check with Transport Canada for referral to a Child Car Seat Clinic.

Using Tether Straps

Many forward-facing child restraints include a tether strap which extends from the back of the child restraint and hooks to an anchoring point called the top tether anchor. Tether straps are available as an accessory for many older child restraints. Contact the manufacturer of your child restraint for information about ordering a tether strap, or to obtain a longer tether strap if the tether strap on your child restraint does not reach the appropriate top tether anchor in the vehicle.

Attach the tether strap only to the tether anchor as shown. The tether strap may not work properly if attached somewhere other than the correct tether anchor.

Child Safety

Note: Do not tighten the tether strap enough to lift the child restraint off the vehicle seat cushion when the child is seated in it. Keep the tether strap just snug without lifting the front of the child restraint. Keeping the child restraint just touching the vehicle seat gives the best protection in a severe crash.

Perform the following steps to install a child restraint with tether anchors:

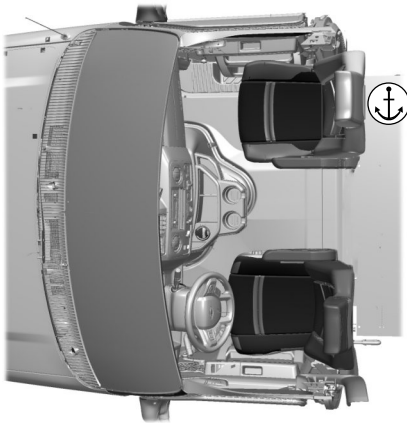

You can attach the tether directly to the rear of the front seat.

1. Adjust the front passenger seat fully forward.



E190810

2. Route the child restraint tether strap over the back of the front passenger seat as shown.

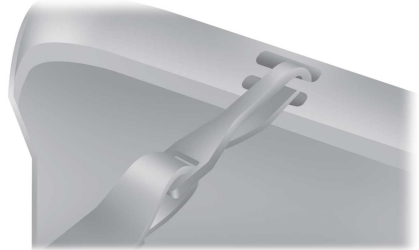

E190811

3. Clip the tether strap hook to the seat pedestal at the location shown. If the tether strap is clipped incorrectly, the child restraint may not be retained properly in the event of a crash.
4. Adjust the front passenger seat to the full rearward position.
5. Tighten the child restraint tether strap according to the manufacturer's instructions.

If you do not properly anchor the child restraint, the risk of a child being injured in a crash greatly increases.

Child Safety

BOOSTER SEATS



WARNING: Do not put the shoulder section of the seatbelt or allow the child to put the shoulder section of the seatbelt under their arm or behind their back. Failure to follow this instruction could reduce the effectiveness of the seatbelt and increase the risk of injury or death in a crash.

Use a belt-positioning booster seat for children who have outgrown or no longer properly fit in a child safety restraint (generally children who are less than 57 in (1.45 m) tall, are greater than age 4 and less than age 12, and between 40 lb (18 kg) and 80 lb (36 kg) and upward to 100 lb (45 kg) if recommended by your child restraint manufacturer). Many state and provincial laws require that children use approved booster seats until they reach age eight, a height of 57 in (1.45 m) tall, or 80 lb (36 kg).

Booster seats should be used until you can answer YES to ALL of these questions when seated without a booster seat:

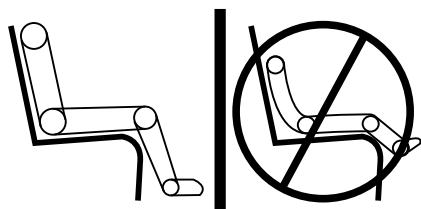

- Can the child sit all the way back against their vehicle seat backrest with knees bent comfortably at the edge of the seat cushion?
- Can the child sit without slouching?

- Does the lap belt rest low across the hips?
- Is the shoulder belt centered on the shoulder and chest?
- Can the child stay seated like this for the whole trip?

Always use booster seats in conjunction with your vehicle lap and shoulder belt.

Types of Booster Seats



- Backless booster seats

If your backless booster seat has a removable shield, remove the shield. If a vehicle seating position has a low seat backrest or no head restraint, a backless booster seat may place your child's head (as measured at the tops of the ears) above the top of the seat. In this case, move the backless booster to another seating position with a higher seat backrest or head restraint and lap and shoulder belts, or consider using a high back booster seat.

Child Safety



- High back booster seats

If, with a backless booster seat, you cannot find a seating position that adequately supports your child's head, a high back booster seat would be a better choice.

Children and booster seats vary in size and shape. Choose a booster that keeps the lap belt low and snug across the hips, never up across the stomach, and lets you adjust the shoulder belt to cross the chest and rest snugly near the center of the shoulder. The following drawings compare the ideal fit (center) to a shoulder belt uncomfortably close to the neck and a shoulder belt that could slip off the shoulder. The drawings also show how the lap belt should be low and snug across the child's hips.



Child Safety

If the booster seat slides on the vehicle seat upon which it is being used, placing a rubberized mesh sold as shelf or carpet liner under the booster seat may improve this condition. Do not introduce any item thicker than this under the booster seat. Check with the booster seat manufacturer's instructions.

CHILD RESTRAINT POSITIONING



WARNING: Do not place a rearward facing child restraint in front of an active airbag. Failure to follow this instruction could result in personal injury or death.



WARNING: Properly secure children 12 years old and under in a rear seating position whenever possible. If you are unable to properly secure all children in a rear seating position, properly secure the largest child on the front seat. If you must use a forward facing child restraint on the front seat, move the seat as far back as possible. Failure to follow these instructions could result in personal injury or death.



WARNING: Always carefully follow the instructions and warnings provided by the manufacturer of any child restraint to determine if the restraint device is appropriate for your child's size, height, weight, or age. Follow the child restraint manufacturer's instructions and warnings provided for installation and use in conjunction with the instructions

and warnings provided by your vehicle manufacturer. A safety seat that is improperly installed or utilized, is inappropriate for your child's height, age, or weight or does not properly fit the child may increase the risk of serious injury or death.



WARNING: Do not allow a passenger to hold a child on their lap when your vehicle is moving. Failure to follow this instruction could result in personal injury or death in the event of a sudden stop or crash.



WARNING: Do not use pillows, books or towels to boost your child's height. Failure to follow this instruction could result in personal injury or death.



WARNING: Properly secure child restraints or booster seats when they are not in use. They could become projectiles in a sudden stop or crash. Failure to follow this instruction could result in personal injury or death.



WARNING: Do not put the shoulder section of the seatbelt or allow the child to put the shoulder section of the seatbelt under their arm or behind their back. Failure to follow this instruction could reduce the effectiveness of the seatbelt and increase the risk of injury or death in a crash.



WARNING: Do not leave children or pets unattended in your vehicle. Failure to follow this instruction could result in personal injury or death.

Child Safety

Recommendations for Attaching Child Restraints

Restraint Type	Use Any Attachment Method as Indicated Below by X.		
	Combined Weight of Child and Child Restraint	Seatbelt and Top Tether Anchor	Seatbelt Only
Rear-facing child restraint	Up to 65 lb (29.5 kg)		X
Rear-facing child restraint	Over 65 lb (29.5 kg)		X
Forward-facing child restraint	Up to 65 lb (29.5 kg)	X	X ¹
Forward-facing child restraint	Over 65 lb (29.5 kg)	X	X ¹

¹We recommend using a top tether if the child restraint has one, and the child restraint manufacturer recommends its use.

Note: *The child restraint must rest tightly against the vehicle seat upon which it is installed. It may be necessary to lift or remove the head restraint. See **Head Restraints** (page 76).*

Seatbelts

PRINCIPLE OF OPERATION

 **WARNING:** Always drive and ride with the seat backrest upright and the lap belt snug and low across the hips.

 **WARNING:** To reduce the risk of injury, make sure children sit where they can be properly restrained.

 **WARNING:** Never let a passenger hold a child on his or her lap while your vehicle is moving. The passenger cannot protect the child from injury in a crash which may result in serious injury or death.

 **WARNING:** All occupants of the vehicle, including the driver, should always properly wear their safety belts, even when an airbag supplemental restraint system is provided. Failure to properly wear your safety belt could seriously increase the risk of injury or death.

 **WARNING:** It is extremely dangerous to ride in a cargo area, inside or outside of a vehicle. In a crash, people riding in these areas are more likely to be seriously injured or killed. Do not allow people to ride in any area of your vehicle that is not equipped with seats and safety belts. Be sure everyone in your vehicle is in a seat and using a safety belt properly.

 **WARNING:** In a rollover crash, an unbelted person is significantly more likely to die than a person wearing a safety belt.

 **WARNING:** Each seating position in your vehicle has a specific safety belt assembly which is made up of one buckle and one tongue that are designed to be used as a pair. 1) Use the shoulder belt on the outside shoulder only. Never wear the shoulder belt under the arm. 2) Never swing the safety belt around your neck over the inside shoulder. 3) Never use a single belt for more than one person.

 **WARNING:** When possible, all children 12 years old and under should be properly restrained in a rear seating position. Failure to follow this could seriously increase the risk of injury or death.

 **WARNING:** Safety belts and seats can become hot in a vehicle that has been closed up in sunny weather; they could burn a small child. Check seat covers and buckles before you place a child anywhere near them.

 **WARNING:** Front and rear seat occupants, including pregnant women, should wear safety belts for optimum protection in an accident.

All seating positions in this vehicle have lap and shoulder safety belts. All occupants of the vehicle should always properly wear their safety belts, even when an airbag supplemental restraint system is provided.

The safety belt system consists of:

- Lap and shoulder safety belts.
- Shoulder safety belt with automatic locking mode, (except driver safety belt).

Seatbelts

- Height adjuster at the front outboard seating positions.
- Safety belt pretensioner at the front outboard seating positions.



- Safety belt warning light and chime.



- Crash sensors and monitoring system with readiness indicator.

The safety belt pretensioners at the front seating positions are designed to tighten the safety belts when activated. In frontal and near-frontal crashes, the safety belt pretensioners may be activated alone or, if the crash is of sufficient severity, together with the front airbags.

FASTENING THE SEATBELTS

The front outboard safety restraints in the vehicle are combination lap and shoulder belts.

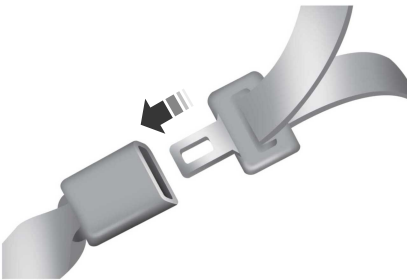

1. Insert the belt tongue into the proper buckle (the buckle closest to the direction the tongue is coming from) until you hear a snap and feel it latch. Make sure the tongue is securely fastened in the buckle.

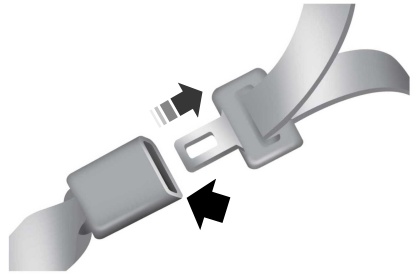

2. To unfasten, press the release button and remove the tongue from the buckle.

Using Seatbelts During Pregnancy

 **WARNING:** Always ride and drive with your seatback upright and properly fasten your seatbelt. Fit the lap portion of the seatbelt snugly and low across the hips. Position the shoulder portion of the seatbelt across your chest. Pregnant women must follow this practice. See the following figure.

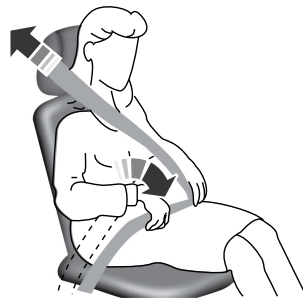

Seatbelts

Pregnant women should always wear their seatbelt. Position the lap belt portion of a combination lap and shoulder belt low across the hips below the belly and worn as tight as comfort allows. Position the shoulder belt to cross the middle of the shoulder and the center of the chest.

Seatbelt Locking Modes



WARNING: If your vehicle is involved in a crash, have the seatbelts and associated components inspected as soon as possible. Failure to follow this instruction could result in personal injury or death.

All safety restraints in the vehicle are combination lap and shoulder belts. The driver seatbelt has the first type of locking mode. The front outboard passenger seatbelt has both types of locking modes described as follows:

Vehicle Sensitive Mode

This is the normal retractor mode, which allows free shoulder belt length adjustment to your movements and locking in response to vehicle movement. For example, if the driver brakes suddenly or turns a corner sharply, or the vehicle receives an impact of about 5 mph (8 km/h) or more, the combination seatbelts lock to help reduce forward movement of the driver and passengers.

In addition, the retractor is designed to lock if you pull the webbing out too quickly. If the seatbelt retractor locks, slowly lower the height adjuster to allow the seatbelt to retract. If the retractor does not unlock, pull the seatbelt out slowly then feed a

small length of webbing back toward the stowed position. For rear seatbelts, recline the rear seat backrest or push the seat backrest cushion away from the seatbelt. Feed a small length of webbing back toward the stowed position.

Automatic Locking Mode

In this mode, the shoulder belt automatically pre-locks. The belt will still retract to remove any slack in the shoulder belt. The automatic locking mode is not available on the driver seatbelt.

When to Use the Automatic Locking Mode

Use this mode any time a child safety seat, except a booster, is installed in the passenger front seating position. See **Child Safety** (page 20).

How to Use the Automatic Locking Mode



1. Buckle the combination lap and shoulder belt.
2. Grasp the shoulder portion and pull downward until the entire belt is pulled out.
3. Allow the belt to retract. As the belt retracts, you will hear a clicking sound. This indicates the seatbelt is now in the automatic locking mode.

Seatbelts

How to Disengage the Automatic Locking Mode

Unbuckle the combination lap and shoulder belt and allow it to retract completely to disengage the automatic locking mode and activate the vehicle sensitive (emergency) locking mode.

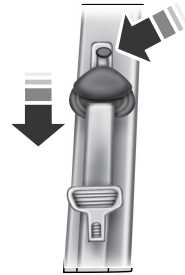

E190812

SEATBELT HEIGHT ADJUSTMENT



WARNING: Position the safety belt height adjuster so that the belt rests across the middle of your shoulder. Failure to adjust the safety belt properly could reduce the effectiveness of the safety belt and increase the risk of injury in a crash.

Adjust the height of the shoulder belt so the belt rests across the middle of your shoulder.

To adjust the shoulder belt height:

1. Press the button and slide the height adjuster up or down.
2. Release the button and pull down on the height adjuster to make sure it is locked in place.

SEATBELT WARNING LAMP AND INDICATOR CHIME



This lamp illuminates and an indicator chime will sound if the driver seatbelt has not been fastened when the vehicle's ignition is turned on.

Conditions of operation

If	Then
The driver seatbelt is not buckled before the ignition switch is turned to the on position...	The seatbelt warning lamp illuminates and the indicator chime sounds for a few seconds.
The driver seatbelt is buckled while the warning lamp is illuminated and the indicator chime is sounding...	The seatbelt warning lamp and indicator chime turn off.
The driver seatbelt is buckled before the ignition switch is turned to the on position...	The seatbelt warning lamp and indicator chime remain off.

Seatbelts

CHILD RESTRAINT AND SEATBELT MAINTENANCE

Inspect the vehicle seatbelts and child restraint systems periodically to make sure they work properly and are not damaged. Inspect the vehicle seatbelts to make sure there are no nicks, tears or cuts. Replace if necessary. All vehicle seatbelt assemblies, including retractors, buckles, front seatbelt buckle assemblies, buckle support assemblies (slide bar-if equipped), shoulder belt height adjusters (if equipped), shoulder belt guide on seatback (if equipped), rear inflatable seatbelts (if equipped), child restraint LATCH and tether anchors, and attaching hardware, should be inspected after a crash. Read the child restraint manufacturer's instructions for additional inspection and maintenance information specific to the child restraint.

We recommend that all seatbelt assemblies in use in vehicles involved in a crash be replaced. However, if the crash was minor and an authorized dealer finds that the belts do not show damage and continue to operate properly, they do not need to be replaced. Seatbelt assemblies not in use during a crash should also be inspected and replaced if either damage or improper operation is noted.

Properly care for seatbelts. See **Cleaning the Interior** (page 185).

SEATBELT EXTENSIONS



WARNING: Persons who fit into the vehicle's seatbelt should not use an extension. Unnecessary use could result in serious personal injury in the event of a crash.



WARNING: Only use extensions provided free of charge by our dealers. The dealer will provide an extension designed specifically for this vehicle, model year and seating position. The use of an extension intended for another vehicle, model year or seating position may not offer you the full protection of your vehicle's seatbelt restraint system.



WARNING: Never use seatbelt extensions to install child restraints.





WARNING: Do not use extensions to change the way the seatbelt fits across the torso, over the lap or to make the seatbelt buckle easier to reach.

If, because of body size or driving position, it is not possible to properly fasten the seatbelt over your lap and shoulder, an extension that is compatible with the seatbelts is available free of charge from our dealers. Only use our seatbelt extensions made by the original equipment seatbelt manufacturer with our seatbelts. Ask your authorized dealer if your extension is compatible with your vehicle restraint system.

Supplementary Restraints System

PRINCIPLE OF OPERATION

 **WARNING:** Airbags do not inflate slowly or gently, and the risk of injury from a deploying airbag is the greatest close to the trim covering the airbag module.

 **WARNING:** All occupants of your vehicle, including the driver, should always properly wear their seatbelts, even when an airbag supplemental restraint system is provided. Failure to properly wear your seatbelt could seriously increase the risk of injury or death.

 **WARNING:** Properly secure children 12 years old and under in a rear seating position whenever possible. If you are unable to properly secure all children in a rear seating position, properly secure the largest child on the front seat. If you must use a forward facing child restraint on the front seat, move the seat as far back as possible. Failure to follow these instructions could result in personal injury or death.

 **WARNING:** Do not place your arms on the airbag cover or through the steering wheel. Failure to follow this instruction could result in personal injury.

 **WARNING:** Do not place a rearward facing child restraint in front of an active airbag. Failure to follow this instruction could result in personal injury or death.

 **WARNING:** Do not attempt to service, repair, or modify the supplementary restraint system or associated components. Failure to follow this instruction could result in personal injury or death.

 **WARNING:** Several airbag system components get hot after inflation. To reduce the risk of injury, do not touch them after inflation.

 **WARNING:** If a supplementary restraint system component has deployed, it will not function again. Have the system and associated components inspected as soon as possible. Failure to follow this instruction could result in personal injury or death.

The airbags are a supplemental restraint system and are designed to work with the seatbelts to help protect the driver and right front passenger from certain upper body injuries. Airbags do not inflate slowly; there is a risk of injury from a deploying airbag.

Note: *You will hear a loud bang and see a cloud of harmless powdery residue if an airbag deploys. This is normal.*

The airbags inflate and deflate rapidly upon activation. After airbag deployment, it is normal to notice a smoke-like, powdery residue or smell the burnt propellant. This may consist of cornstarch, talcum powder (to lubricate the bag) or sodium compounds (for example, baking soda) that result from the combustion process that inflates the airbag. Small amounts of sodium hydroxide may be present which may irritate the skin and eyes, but none of the residue is toxic.

While the system is designed to help reduce serious injuries, contact with a deploying airbag may also cause abrasions or swelling. Temporary hearing loss is also a possibility as a result of the noise associated with a deploying airbag. Because airbags must inflate rapidly and with considerable force, there is the risk of death or serious injuries such as fractures, facial and eye injuries or internal injuries,

Supplementary Restraints System

particularly to occupants who are not properly restrained or are otherwise out of position at the time of airbag deployment. Thus, it is extremely important that occupants be properly restrained as far away from the airbag module as possible while maintaining vehicle control.

Routine maintenance of the airbags is not required.

DRIVER AND PASSENGER AIRBAGS

 **WARNING:** Do not place your arms on the airbag cover or through the steering wheel. Failure to follow this instruction could result in personal injury.

 **WARNING:** Do not place a rearward facing child restraint in front of an active airbag. Failure to follow this instruction could result in personal injury or death.

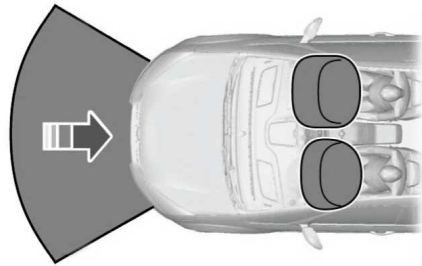

The driver and front passenger airbags deploy during significant frontal and near frontal crashes.

The driver and passenger front airbag system consists of:

- Driver and passenger airbag modules.



• Crash sensors and monitoring system with readiness indicator. See **Crash Sensors and Airbag Indicator** (page 40).

Passenger Airbag On and Off Switch (If Equipped)

 **WARNING:** Your vehicle may have an airbag deactivation switch. Before driving, always look at the switch to make sure it is in the appropriate position. Failure to put the switch in the proper position can increase the risk of serious injury or death in a crash.

Note: *The passenger airbag on and off switch may be on vehicles with no rear seats.*

Switching the Passenger Airbag Off

 **WARNING:** If the light does not illuminate when the passenger airbag switch is off and you switch the ignition on, have the passenger airbag switch serviced immediately by a qualified technician.

 **WARNING:** To avoid switching on the airbag, always remove the ignition key with the switch in the off position.

 **WARNING:** NEVER use a rearward facing child restraint on a seat protected by an ACTIVE AIRBAG in front of it, DEATH or SERIOUS INJURY to the CHILD can occur.

Supplementary Restraints System



E224283

1. Insert the ignition key into the passenger airbag on and off switch, turn the switch to off and hold it in off while removing the key.
2. When you switch the ignition on and the passenger airbag switch is in the off position, the off light illuminates briefly, momentarily shuts off and then turns back on. This indicates that the passenger airbag is deactivated.

Switching the Passenger Airbag Back On



WARNING: The seatbelts for the driver and right front passenger seating positions are specifically designed to operate together with the airbags in certain types of crashes. When you switch off your airbag, you not only lose the protection of the airbag, you also may reduce the effectiveness of your seatbelt system. If the passenger does not meet the requirements stated in the National Highway Traffic Safety Administration or Transport Canada deactivation criteria, switching off the airbag can increase the risk of serious injury or death in a crash.



WARNING: If your vehicle has rear seats, always transport children who are 12 and younger in the rear seat. Always use seatbelts and child restraints properly. Do not place a child in a rear facing infant seat in the front seat unless your vehicle is equipped with an airbag on and off switch and the passenger airbag is turned off. This is because the back of the infant seat is too close to the inflating airbag and the risk of a fatal injury to the infant when the airbag inflates is substantial.



WARNING: If the passenger airbag off light is illuminated when the passenger airbag switch is on and the ignition is on, have the passenger airbag switch serviced immediately by a qualified technician.

The passenger airbag remains off until you switch it back on.

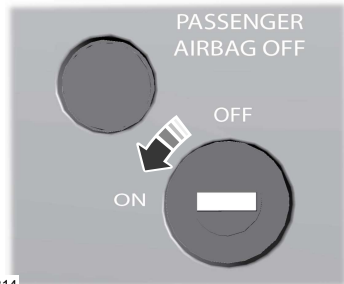

E190814

1. Insert the ignition key into the passenger airbag on and off switch and turn the switch to on.
2. The off light briefly illuminates when you switch the ignition on. This indicates that the passenger airbag is operational.

Supplementary Restraints System

The passenger side airbag should always be on (the airbag off light should not be illuminated) unless the passenger is a person who meets the requirements stated either in Category 1, 2 or 3 of the National Highway Traffic Safety Administration/Transport Canada deactivation criteria which follows.

The vast majority of drivers and passengers are much safer with an airbag than without. To do their job and reduce the risk of life threatening injuries, airbags must open with great force, and this force can pose a potentially deadly risk in some situations, particularly when a front seat occupant is not properly buckled up. The most effective way to reduce the risk of unnecessary airbag injuries without reducing the overall safety of the vehicle is to make sure all occupants are properly restrained in the vehicle, especially in the front seat. This provides the protection of seatbelts and permits the airbags to provide the additional protection they were designed to provide. If you choose to deactivate your airbag, you are losing the very significant risk reducing benefits of the airbag and you are also reducing the effectiveness of the seatbelts, because seatbelts in modern vehicles are designed to work as a safety system with the airbags.

National Highway Traffic Safety Administration Deactivation Criteria (Excluding Canada)



WARNING: This vehicle has special energy management seatbelts for the driver and right front passenger. These particular seatbelts are specifically designed to work with airbags to help reduce the risk of injury in a crash. The energy management seatbelt gives or releases additional seatbelt webbing in some accidents to reduce the

concentration of force on an occupant's chest and to reduce the risk of certain bone fractures and injuries to underlying organs. In a crash, if the airbag is off, this energy management seatbelt might permit the passenger wearing the seatbelt to move forward enough to have a serious or fatal injury. The more severe the crash, and the heavier the occupant, the greater the risk. Make sure the airbag is on for any passenger who does not qualify under the National Highway Traffic Safety Administration deactivation criteria.

1. **Infant.** An infant (less than 1 year old) must ride in the front seat because:

- The vehicle has no rear seat.
- The vehicle has a rear seat too small to accommodate a rear-facing infant seat.
- The infant has a medical condition which, according to the infant's physician, makes it necessary for the infant to ride in the front so that the driver can constantly monitor the child's condition.

2. **Child age 1 to 12.** A child age 1 to 12 must ride in the front seat because:

- The vehicle has no rear seat.
- Although children ages 1 to 12 ride in the rear seat(s) whenever possible, children ages 1 to 12 sometimes must ride in the front because no space is available in the rear seat(s) of the vehicle.
- The child has a medical condition which, according to the child's physician, makes it necessary for the child to ride in the front seat so that the driver can constantly monitor the child's condition.

Supplementary Restraints System

3. Medical condition. A passenger has a medical condition which, according to his or her physician:

- Causes the passenger airbag to pose a special risk for the passenger.
- Makes the potential harm from the passenger airbag in a crash greater than the potential harm from turning off the airbag and allowing the passenger, even if belted, to hit the dashboard or windshield in a crash.

Transport Canada Deactivation Criteria (Canada Only)



WARNING: This vehicle has special energy management seatbelts for the driver and right front passenger. These particular seatbelts are specifically designed to work with airbags to help reduce the risk of injury in a crash. The energy management seatbelt gives or releases additional seatbelt webbing in some accidents to reduce the concentration of force on an occupant's chest and to reduce the risk of certain bone fractures and injuries to underlying organs. In a crash, if the airbag is off, this energy management seatbelt might permit the passenger wearing the seatbelt to move forward enough to have a serious or fatal injury. The more severe the crash, and the heavier the occupant, the greater the risk. Make sure the airbag is on for any passenger who does not qualify under the Transport Canada deactivation criteria.

1. Infant: An infant (less than 1 year old) must ride in the front seat because:

- My vehicle has no rear seat.
- The rear seat in my vehicle cannot accommodate a rear-facing infant seat.
- The infant has a medical condition which, according to the infant's physician, makes it necessary for the infant to ride in the front seat so that the driver can monitor the infant's condition.

2. Child age 12 or under: A child age 12 or under must ride in the front seat because:

- My vehicle has no rear seat.
- Although children age 12 and under ride in the rear seat whenever possible, children age 12 and under have no option but to sometimes ride in the front seat because rear seat space is insufficient.
- The child has a medical condition that, according to the child's physician, makes it necessary for the child to ride in the front seat so that the driver can monitor the child's condition.

3. Medical condition: A passenger has a medical condition that, according to his or her physician:

- Poses a special risk for the passenger if the airbag deploys.
- Makes the potential harm from the passenger airbag deployment greater than the potential harm from turning off the airbag and experiencing a crash without the protection offered by the airbag.

Supplementary Restraints System

Proper Driver and Front Passenger Seating Adjustment

WARNING: National Highway Traffic Safety Administration (NHTSA) recommends a minimum distance of at least 10 in (25 cm) between an occupant's chest and the driver airbag module.

To properly position yourself away from the airbag:

- Move your seat to the rear as far as you can while still reaching the pedals comfortably.
- Recline the seat slightly (one or two degrees) from the upright position.

After all occupants have adjusted their seats and put on seatbelts, it is very important that they continue to sit properly. Properly seated occupants sit upright, lean against the seat back, and center themselves on the seat cushion, with their feet comfortably extended on the floor. Sitting improperly can increase the chance of injury in a crash event. For example, if an occupant slouches, lies down, turns sideways, sits forward, leans forward or sideways, or puts one or both feet up, the chance of injury during a crash is greatly increased.

Children and Airbags

WARNING: Do not place a rearward facing child restraint in front of an active airbag. Failure to follow this instruction could result in personal injury or death.



Children must always be properly restrained. Accident statistics suggest that children are safer when properly restrained in the rear seating positions than in the front seating position. Failure to follow these instructions may increase the risk of injury in a crash.

CRASH SENSORS AND AIRBAG INDICATOR

WARNING: Modifying or adding equipment to the front of your vehicle could affect the performance of the airbag system, increasing the risk of injury. This includes the hood, bumper system, frame, front body structure, tow hooks, hood pins, push bar and snowplows.

Your vehicle has a collection of crash and occupant sensors which provide information to the restraints control module. The restraints control module deploys (activates) the front seatbelt pretensioners, driver airbag and passenger airbag. Based on the type of accident, the restraints control module deploys the appropriate safety devices.

Supplementary Restraints System

The restraints control module also monitors the readiness of the above safety devices plus the crash sensors. The readiness of the safety system is indicated by a warning indicator light in the instrument cluster or by a backup tone if the warning light is not working. See **Instrument Cluster** (page 58). Routine maintenance of the airbag is not required.

A difficulty with the system is indicated by one or more of the following:



The readiness light will not illuminate immediately after you switch the ignition on.

- The readiness light either flashes or stays lit.
- You hear a series of five tones. The tone pattern repeats periodically until the problem, the light or both are repaired.

If any of these things happen, even intermittently, have the supplemental restraint system serviced at an authorized dealer immediately. Unless serviced, the system may not function properly in the event of a crash.

The seatbelt pretensioners and the airbag supplemental restraint system are designed to activate when the vehicle sustains frontal deceleration sufficient to cause the restraints control module to deploy a safety device.

The fact that the seatbelt pretensioners or airbags did not activate in a crash does not mean that something is wrong with the system. Rather, it means the restraints control module determined the accident conditions (such as crash severity, belt usage) were not appropriate to activate these safety devices.

- The design of the front airbags is to activate only in frontal and near-frontal crashes (not rollovers, side impacts or rear impacts) unless the crash causes sufficient frontal deceleration.
- The design of the seatbelt pretensioners is to activate in frontal or near-frontal crashes and deploy in rollovers.

AIRBAG DISPOSAL

Contact your authorized dealer as soon as possible. Airbags must be disposed of by qualified personnel.

Keys and Remote Controls

GENERAL INFORMATION ON RADIO FREQUENCIES

This device complies with Part 15 of the FCC Rules and with Licence exempt RSS Standards of Industry Canada. Operation is subject to the following two conditions:

- This device may not cause harmful interference.
- This device must accept any interference received, including interference that may cause undesired operation.



WARNING: Changes or modifications not expressly approved by the party responsible for compliance could void the user's authority to operate the equipment. The term "IC:" before the radio certification number only signifies that Industry Canada technical specifications were met.

The typical operating range for your transmitter is approximately 33 ft (10 m). Vehicles with the remote start feature will have a greater range. One of the following could cause a decrease in operating range:

- Weather conditions.
- Nearby radio towers.
- Structures around the vehicle.
- Other vehicles parked next to your vehicle.

Other short distance radio transmissions, for example amateur radios, medical equipment, wireless headphones, remote controls and alarm systems can also use the radio frequency used by your remote control. If the frequencies are jammed, you will not be able to use your remote control. You can lock and unlock the doors with the key.

Note: Make sure to lock your vehicle before leaving it unattended.

Note: If you are in range, the remote control will operate if you press any button unintentionally.

Note: The remote control contains sensitive electrical components. Exposure to moisture or impact may cause permanent damage.

REMOTE CONTROL (IF EQUIPPED)



E195660

Note: If there are problems with the remote entry system, make sure to take all remote entry transmitters with you to an authorized dealer in order to aid in troubleshooting the problem.

Note: If your vehicle is fitted with the E-Guard Cargo Protection System™, the remote transmitter unlock command only unlocks the front doors. The side or rear cargo doors can only be unlocked from outside your vehicle using the key.

Keys and Remote Controls

Changing the Remote Control Battery



WARNING: Keep batteries away from children to prevent ingestion. Failure to follow this instruction could result in personal injury or death. If ingested, immediately seek medical attention.



WARNING: If the battery compartment does not securely close, stop using the remote control and replace it as soon as possible. In the meantime, keep the remote control away from children. Failure to follow this instruction could result in personal injury or death.

The remote control uses one coin-type three-volt lithium battery CR2032 or equivalent.



Make sure that you dispose of old batteries in an environmentally friendly way. Seek advice from your local authority about recycling old batteries.



E195662

1. Twist a thin coin in the slot of the transmitter near the key ring to remove the battery cover.

Note: Do not remove the rubber cover and circuit board from the front housing of the remote entry transmitter.

Note: Do not wipe off any grease on the battery terminals or on the back surface of the circuit board.

2. Remove the old battery.

Keys and Remote Controls

Note: The panic alarm operates regardless of the ignition position.

REPLACING A LOST KEY OR REMOTE CONTROL

Replacement keys or remote controls can be purchased from an authorized dealer. Authorized dealers can program remote controls for your vehicle.



E195661

3. Insert the new battery. Refer to the symbols inside the transmitter for the correct orientation of the battery. Press the battery down to make sure it is fully engaged in the housing.
4. Reinstall the battery housing cover onto the transmitter.

Note: Replacing the battery does not erase the programmed key from your vehicle. The transmitter should operate normally.

Car Finder



Press the button twice within three seconds. The horn sounds and the direction indicators flash. We recommend you use this method to locate your vehicle, rather than using the panic alarm.

Sounding the Panic Alarm



Press the button to sound the panic alarm. Press the button again or switch the ignition on to turn it off.

Doors and Locks

LOCKING AND UNLOCKING

You can use the power door lock control or the remote control to lock and unlock your vehicle.

Note: Do not use the door latch assembly to attach any accessory, such as handles or steps, as this can cause damage to your vehicle.

Power Door Locks (If Equipped)

The power door lock control is on the driver and front passenger door panels.

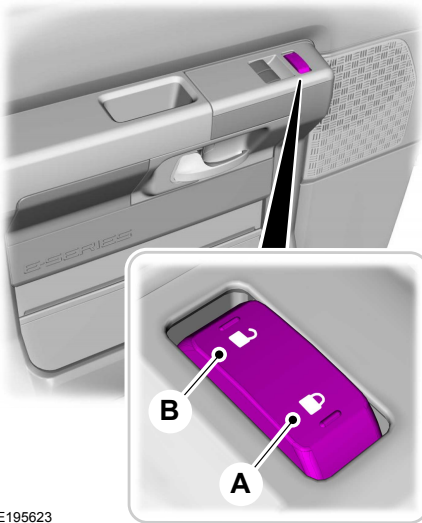

E195623

- A Lock.
- B Unlock.

Remote Control (If Equipped)

You can use the remote control at any time when the ignition is off.

Unlocking the Doors (Two-Stage Unlock)



Press the button to unlock the driver door.

Press the button again within three seconds to unlock all doors. The direction indicators flash.

Note: The driver door can be unlocked with the key if the remote control is not functioning.

Note: When you leave your vehicle unattended for several weeks, the remote control turns off. Your vehicle must be unlocked and started. Unlocking and starting your vehicle once enables the remote control.

Reprogramming the Unlocking Function

Note: When you press the unlock button, either all the doors are unlocked or only the driver door is unlocked. Pressing the unlock button again unlocks all the doors.

You can reprogram the unlocking function so that only the driver door is unlocked.

Press and hold the unlock and lock buttons on the remote control simultaneously for at least four seconds with the ignition off. The direction indicators flash twice to confirm the change.

To return to the original unlocking function, repeat the process.

Locking the Doors



Press the button to lock all doors. The direction indicators flash.

Press the button again within three seconds to confirm that all the doors are closed. The doors lock again, the horn sounds and the direction indicators flash if all the doors are closed.

Doors and Locks

Note: *If any door is open, the horn sounds twice and the direction indicators do not flash.*

Autolock

Autolock locks all the doors when all of the following occur:

- All doors are closed.
- The ignition is on.
- The vehicle reaches a speed greater than 12 mph (20 km/h).

Autolock repeats when:

- The vehicle is stopped.
- Any door opens and closes while the ignition is on.
- The vehicle reaches a speed greater than 12 mph (20 km/h).

Autounlock

Autounlock unlocks all the doors when all of the following occur:

- All the doors are closed and your vehicle is moving at a speed greater than 12 mph (20 km/h).
- Your vehicle comes to a stop.
- You open the driver door within 10 minutes of switching the ignition off or to the accessory position.

Note: *If you open the driver door after 10 minutes, autounlock does not unlock all other doors.*

Enabling or Disabling Autounlock

(If Equipped)

You can enable or disable the autounlock feature in the instrument cluster display or an authorized dealer can do it for you.

To enable or disable autounlock, do the following:

1. Switch the ignition on.

2. Press the power door unlock control three times.
3. Switch the ignition off.
4. Press the power door unlock control three times.
5. Switch the ignition on. The horn sounds indicating your vehicle is in programming mode.
6. Press the power door lock control and within five seconds, press the power door unlock control. The horn sounds once if disabled or twice if enabled.
7. Switch the ignition off. The horn sounds indicating programming is complete.

Note: *You can also switch this feature on or off using the instrument cluster display. See **Information Displays** (page 64).*

Illuminated Entry

The interior lamps and some exterior lamps illuminate when you unlock the doors with the remote control.

The lamps turn off if:

- The ignition is on.
- You press the lock button on the remote control.
- 25 seconds have elapsed.

The lamps do not turn off if:

- You switch them on with the lighting control.
- Any door is open.

PASSIVE ANTI-THEFT SYSTEM

Note: *The system is not compatible with non-Ford aftermarket remote start systems. Use of these systems could result in engine starting problems and a loss of security protection.*

Note: *Prevent these objects from touching the coded key when starting your vehicle. Metallic objects, electronic devices or a second coded key on the same key chain could result in vehicle starting problems, especially if they are too close to the key when starting your vehicle. Switch the ignition off, move all objects on the key chain away from the coded key and restart your vehicle if a problem occurs.*

Note: *Do not leave a duplicate coded key in your vehicle. Always take your keys and lock all doors when leaving your vehicle.*

SecuriLock®

The system helps prevent the engine from starting unless you use a coded key programmed to your vehicle. Using the wrong key may prevent your vehicle from starting. A message may appear in the information display.

If you are unable to start your vehicle with a coded key, it is not operating correctly. A message may appear in the information display.

Automatic Arming

The system arms when you switch the ignition off.

Automatic Disarming

The system disarms when you switch the ignition on with a coded key.

Replacement Keys

Your vehicle may have two integrated keyhead transmitters.

The integrated keyhead transmitter functions as a programmed ignition key that starts your vehicle.

If your programmed transmitters or standard SecuriLock coded keys become lost or stolen and you do not have an extra coded key, you need to have your vehicle towed to an authorized dealer. You need to erase the key codes from your vehicle and program new coded keys.

Store an extra programmed key away from your vehicle in a safe place. To purchase additional spare or replacement keys, contact an authorized dealer.

If you have a spare key, you need to program it. See **Replacing a Lost Key or Remote Control** (page 44).

Steering Wheel

ADJUSTING THE STEERING WHEEL



WARNING: Do not adjust the steering wheel when your vehicle is moving.

Note: Make sure that you are sitting in the correct position. See **Sitting in the Correct Position** (page 76).

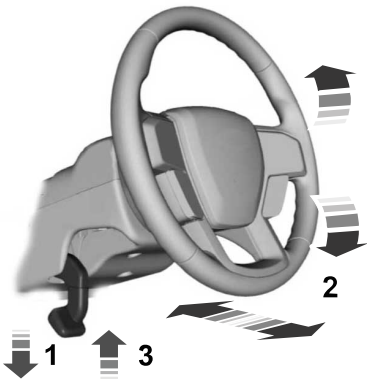

1. Unlock the steering column.
2. Adjust the steering wheel to the position you prefer.
3. Lock the steering column.

CRUISE CONTROL - VEHICLES WITH: ADAPTIVE CRUISE CONTROL



E191337

See **Using Adaptive Cruise Control** (page 107).

CRUISE CONTROL - VEHICLES WITH: CRUISE CONTROL



E191329

See **What Is Cruise Control** (page 106).

Steering Wheel

INFORMATION DISPLAY CONTROL



E191336

See **Information Displays** (page 64).

HORN



Wipers and Washers

WINDSHIELD WIPERS

Note: Fully defrost the windshield before you switch the windshield wipers on.

Note: Make sure you switch the windshield wipers off before entering a car wash.

Note: If streaks or smears appear on the windshield, clean the windshield and the wiper blades. If that does not resolve the issue, install new wiper blades.

Note: Do not operate the wipers on a dry windshield. This may scratch the glass, damage the wiper blades or cause the wiper motor to burn out. Always use the windshield washers before wiping a dry windshield.

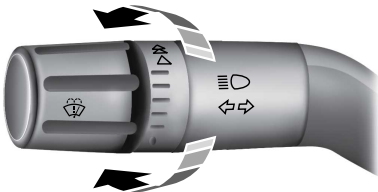

E172816

- Rotate away from you for a long wipe interval.
- Rotate toward you for a short wipe interval.

Speed Dependent Wipers

When your vehicle speed increases, the interval between wipes decreases.

WINDSHIELD WASHERS



E172818

- A brief press causes a single wipe without washer fluid.
- A brief press and hold causes the wipers to swipe three times with washer fluid.
- A long press and hold turns on the wipers and washer fluid for up to 10 seconds.

A wipe occurs a few seconds after washing to clear any remaining washer fluid. You can switch this feature on or off in the information display. See **Information Displays** (page 64).

Note: Do not operate the washers when the washer reservoir is empty. This could cause the washer pump to overheat.

Lighting

GENERAL INFORMATION

Condensation in the Exterior Front Lamps and Rear Lamps

Exterior front lamps and rear lamps have vents to accommodate normal changes in air pressure.

Condensation can be a natural by-product of this design. When moist air enters the lamp assembly through the vents, there is a possibility that condensation can occur when the temperature is cold. When normal condensation occurs, a fine mist can form on the interior of the lens. The fine mist eventually clears and exits through the vents during normal operation.

Clearing time may take as long as 48 hours under dry weather conditions.

Examples of acceptable condensation are:

- The presence of a fine mist (no streaks, drip marks or large droplets).
- A fine mist covers less than 50% of the lens.

Examples of unacceptable condensation are:

- A water puddle inside the lamp.
- Streaks, drip marks or large droplets present on the interior of the lens.

If you see any unacceptable condensation, have your vehicle checked by an authorized dealer.

LIGHTING CONTROL

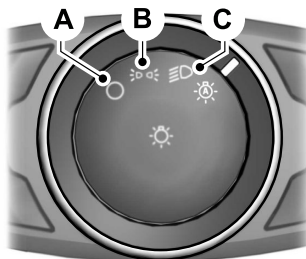

- A Lamps off.
- B Parking lamps, instrument panel lamps, license plate lamps and rear lamps.
- C Headlamps.

Headlamp High Beam

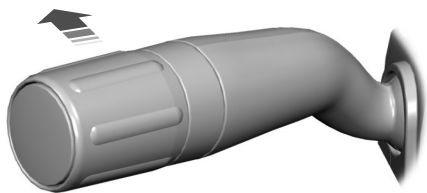

Push the lever away from you to switch the high beam on.

Push the lever forward again or pull the lever toward you to switch the high beams off.

Lighting

Flashing the Headlamp High Beam

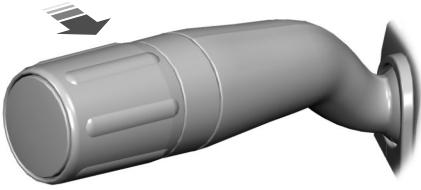

Slightly pull the lever toward you and release it to flash the headlamps.

AUTOLAMPS



WARNING: The system does not relieve you of your responsibility to drive with due care and attention. You may need to override the system if it does not turn the headlamps on in low visibility conditions, for example daytime fog.

Autolamps turn the headlamps on in low light situations or when the wipers operate.



Switch the lighting control to the autolamps position.

The headlamps remain on for a period of time after you switch the ignition off. Use the information display controls to adjust the period of time that the headlamps remain on.

Note: *If you switch the autolamps on, you cannot switch the high beams on until the system turns the low beams on.*

Windshield Wiper Activated Headlamps

When you switch the autolamps on, the headlamps turn on within 10 seconds of switching the wipers on. They turn off approximately 60 seconds after you switch the windshield wipers off.

The headlamps do not turn on with the wipers:

- During a single wipe.
- When using the windshield washers.
- If the wipers are in intermittent mode.

Note: *If you switch the autolamps and the autowipers on, the headlamps turn on when the windshield wipers continuously operate.*

INSTRUMENT LIGHTING DIMMER

The instrument lighting dimmer buttons are on the lighting control.



Repeatedly press one of the buttons to adjust the brightness.



DAYTIME RUNNING LAMPS - VEHICLES WITH: CONFIGURABLE DAYTIME RUNNING LAMPS



WARNING: The daytime running lamps system does not activate the rear lamps and may not provide adequate lighting during low visibility driving conditions. Make sure you switch the headlamps on, as appropriate, during all low visibility conditions. Failure to do so may result in a crash.

Lighting

Switch the daytime running lamps on or off using the touchscreen:

1. Select **Settings**.
2. Select **Vehicle**.
3. Select **Lighting**.

The daytime running lamps turn on when:

1. The lamps are on in the information display.
2. You switch the ignition on.
3. The transmission is not in park (P) for vehicles with automatic transmissions or you release the parking brake for vehicles with manual transmissions.
4. The lighting control is in the autolamps position.
5. The headlamps are off.

The other lighting control switch positions do not turn on the daytime running lamps.

If the daytime running lamps are off in the information display, the lamps stay off in all switch positions.

DAYTIME RUNNING LAMPS - VEHICLES WITH: DAYTIME RUNNING LAMPS (DRL)



WARNING: The daytime running lamps system does not activate the rear lamps and may not provide adequate lighting during low visibility driving conditions. Make sure you switch the headlamps on, as appropriate, during all low visibility conditions. Failure to do so may result in a crash.

The system turns the lamps on in daylight conditions.

To switch the system on, switch the lighting control to any position except headlamps.

DIRECTION INDICATORS

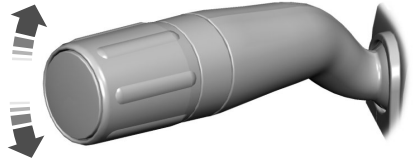

Push the lever up or down to use the direction indicators.

Note: Tap the lever up or down to make the direction indicators flash three times.

Automatic High Beam Control (If Equipped)

WHAT IS AUTOMATIC HIGH BEAM CONTROL

The system turns on high beams if it is dark enough and no other traffic is present. If it detects an approaching vehicle's headlamps or tail lamps, or street lighting ahead, the system turns the high beams off. Low beams remain on.

A camera sensor, centrally mounted behind the windshield of your vehicle, continuously monitors conditions to turn the high beams on and off.

SWITCHING AUTOMATIC HIGH BEAM CONTROL ON AND OFF

Switch the system on or off using the information display. See **General Information** (page 64).

Activating the Automatic High Beam Control



Switch the lighting control to the autolamps position to activate. See **Autolamps** (page 52).

Note: Automatic high beams are not available when you do not turn on autolamps.

When active, the high beams turn on if all of the following occur:

- The ambient light level is low enough.
- There is no traffic in front of your vehicle.
- The vehicle speed is greater than approximately 32 mph (52 km/h).

When active, the high beams turn off if any of the following occur:

- The ambient light level is high enough that it does not require high beams.
- The system detects an approaching vehicle's headlamps or tail lamps.

- The system detects severe rain, snow or fog.
- The camera is blocked.
- The vehicle speed falls below approximately 27 mph (44 km/h).

Note: The deactivation speed is lower on curves.

Note: There could be a delay in high beam reactivation in certain curvy road situations.

Note: If you have a blocked sensor, the system may not operate properly. Keep the windshield free from obstruction or damage.

Note: The system may not operate properly in cold or inclement conditions. You can switch on the high beams by overriding the system.

Note: If the system detects a blockage, for example bird droppings, bug splatter, snow or ice, the system goes into low beam mode until you clear the blockage. If you have a blocked camera, a message may appear in the information display.

Note: Using much larger tires or equipping vehicle accessories such as snowplows can modify your vehicle's ride height and degrade automatic high beam control performance.

AUTOMATIC HIGH BEAM CONTROL INDICATORS



The indicator illuminates to confirm when the system is ready to assist.

Automatic High Beam Control (If Equipped)

OVERRIDING AUTOMATIC HIGH BEAM CONTROL



WARNING: The system does not relieve you of your responsibility to drive with due care and attention. You may need to override the system if it does not turn the high beams on or off.



WARNING: You may need to override the system when approaching other road users.



WARNING: You may need to override the system during inclement weather.

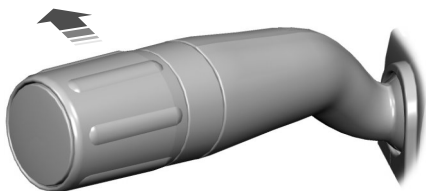

Push the lever away from you to switch between high beam and low beam.

Windows and Mirrors

POWER WINDOWS (IF EQUIPPED)

WARNING: Do not leave children unattended in your vehicle and do not let them play with the power windows. Failure to follow this instruction could result in personal injury.

WARNING: When closing the power windows, verify they are free of obstruction and make sure that children and pets are not in the proximity of the window openings.



E163056

Note: You may hear a pulsing noise when just one of the windows is open. Lower the opposite window slightly to reduce this noise.

Press the switch to open the window. Lift the switch to close the window.

One-Touch Down

Press the switch fully and release it. Press again or lift it to stop the window.

Accessory Delay

You can use the window switches for several minutes when you switch the ignition off or until you open either front door.

EXTERIOR MIRRORS (IF EQUIPPED)

Power Exterior Mirrors (If Equipped)

WARNING: Do not adjust the mirrors when your vehicle is moving.

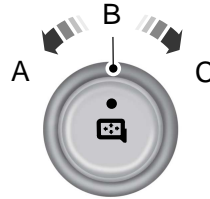

E163059

- A Left mirror.
- B Off.
- C Right mirror.

To adjust your mirrors:

1. Select the mirror you want to adjust.
2. Move the control in the direction you want to tilt the mirror.
3. Return the control to the center position to lock the mirrors in place.

Fold-Away Exterior Mirrors

Push the mirror toward the door window glass. Make sure that you fully engage the mirror in its support when returning it to its original position.

Windows and Mirrors

Telescoping Mirrors (If Equipped)

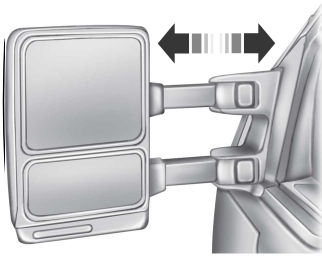

E163061

This feature lets you extend the mirror about 3 in (75 mm). It is useful when towing a trailer. You can manually pull out or push in the mirrors to the desired position.

INTERIOR MIRROR (IF EQUIPPED)



WARNING: Do not adjust the mirrors when your vehicle is moving. This could result in the loss of control of your vehicle, serious personal injury or death.

Note: Do not clean the mirror housing or glass with harsh abrasives, fuel or other petroleum-based cleaning products.

You can adjust the interior mirror to your preference. Some mirrors also have a second pivot point. This lets you move the mirror head up or down and from side to side.

Manual Dimming Mirror

Pull the tab below the mirror toward you to reduce the effect of bright light from behind.

Automatic Dimming Mirror (If Equipped)

Note: Do not block the sensors on the front and back of the mirror. A rear center passenger or raised rear center head restraint may also block light from reaching the sensor.

The mirror dims to reduce the effect of bright light from behind. It returns to normal when the bright light from behind is no longer present or if you shift into reverse (R).

SUN VISORS (IF EQUIPPED)

Illuminated Vanity Mirror (If Equipped)

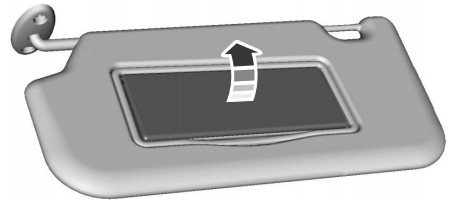

E162197

Lift the cover to switch the lamp on.

Instrument Cluster

GAUGES

2.3 Inch Display

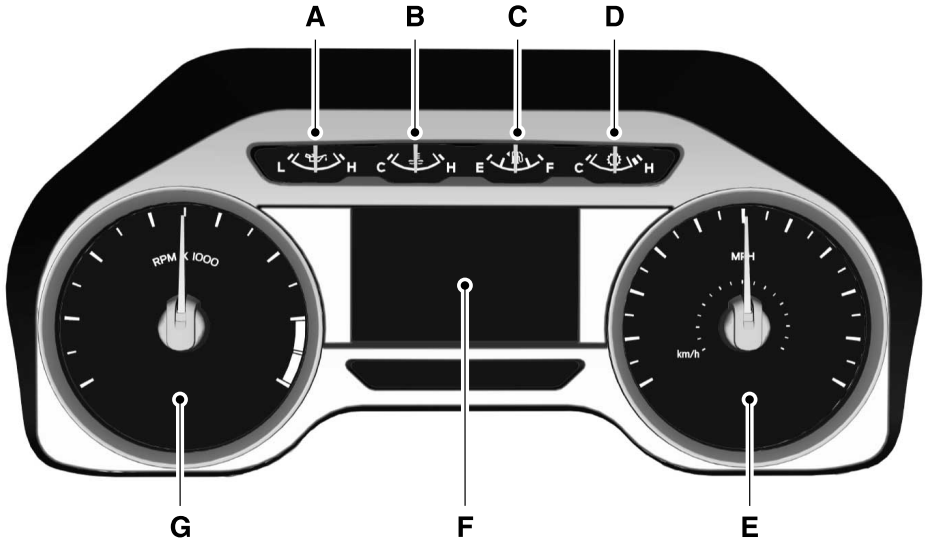

- A Engine oil pressure gauge.
- B Engine coolant temperature gauge.
- C Fuel gauge.
- D Transmission fluid temperature gauge.
- E Speedometer.
- F Information display. See **General Information** (page 64).
- G Tachometer.

Instrument Cluster

8 Inch Display

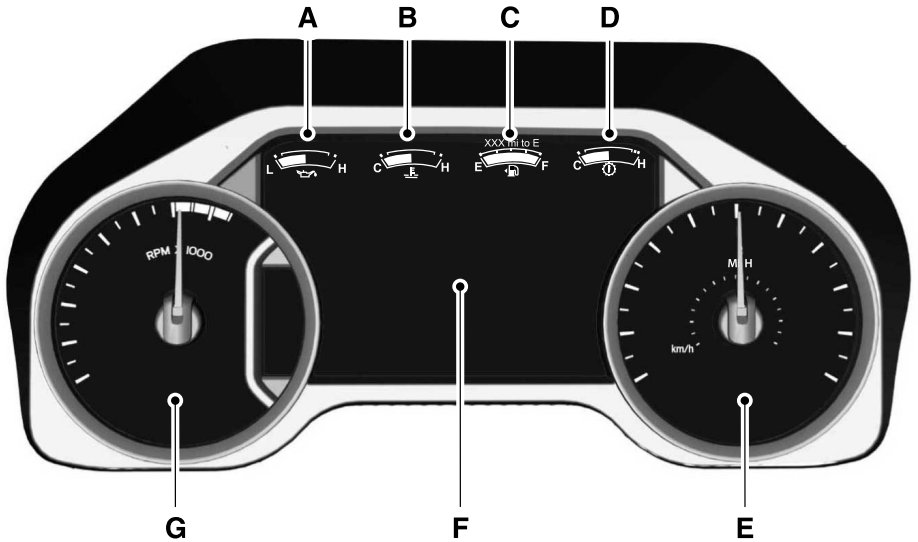

- A Engine oil pressure gauge.
- B Engine coolant temperature gauge.
- C Fuel gauge.
- D Transmission fluid temperature gauge.
- E Speedometer.
- F Information display. See **General Information** (page 64).
- G Tachometer.

Instrument Cluster

Engine Oil Pressure Gauge

Indicates engine oil pressure. At normal operating temperature, the level indicator is in the normal range. If the pressure gauge falls below the normal range, stop your vehicle, switch off the engine and check the engine oil level. Add oil if needed. If the oil level is correct, have your vehicle checked by an authorized dealer.

Engine Coolant Temperature Gauge



WARNING: Do not remove the coolant reservoir cap when the engine is on or the cooling system is hot. Wait 10 minutes for the cooling system to cool down. Cover the coolant reservoir cap with a thick cloth to prevent the possibility of scalding and slowly remove the cap. Failure to follow this instruction could result in personal injury.

Indicates engine coolant temperature. At normal operating temperature, the level indicator is in the normal range. If the engine coolant temperature exceeds the normal range, stop your vehicle as soon as possible, switch off the engine and let the engine cool.

Fuel Gauge

The fuel gauge indicates about how much fuel is in the fuel tank.

The arrow adjacent to the fuel pump symbol indicates on which side of your vehicle the fuel filler door is located.

Note: *The fuel gauge may vary slightly when your vehicle is moving or on a slope.*

Low Fuel Reminder

A low fuel level reminder displays and sounds when the distance to empty reaches 50 mi (80 km), 25 mi (40 km), 10 mi (20 km) and 0 mi (0 km) for all vehicle keys.

Note: *The low fuel reminder can appear at different fuel gauge positions depending on fuel economy conditions. This variation is normal.*

Distance to Empty

Indicates the approximate distance your vehicle can travel on the fuel remaining in the tank. Changes in driving pattern can cause the value to not only decrease but also increase or stay constant for periods of time.

Transmission Fluid Temperature Gauge

Indicates transmission fluid temperature. At normal operating temperature, the level indicator is in the normal range. If the transmission fluid temperature exceeds the normal range, stop your vehicle as soon as possible and verify the airflow is not restricted by snow or debris blocking airflow through the grille.

Special operating conditions such as snowplowing, towing, or off-road use may cause higher than normal operating temperatures. See **Special Operating Conditions Scheduled Maintenance** (page 255).

To lower the transmission temperature into the normal range, alter the severity of your driving conditions. Operating the transmission for extended periods with the gauge in the higher than normal area may cause internal transmission damage. If the gauge continues to show high temperatures, see an authorized dealer.

Instrument Cluster

WARNING LAMPS AND INDICATORS

The following warning lamps and indicators alert you to a vehicle condition that may become serious. Some lamps illuminate when you start your vehicle to make sure they work. If any lamps remain on after starting your vehicle, refer to the respective system warning lamp for further information.

Note: Some warning indicators appear in the information display and operate the same as a warning lamp but do not illuminate when you start your vehicle.

Airbag Warning Lamp



If it does not illuminate when you switch the ignition on, continues to flash or remains on when the engine is running, this indicates a malfunction. Have your vehicle checked as soon as possible.

Anti-Lock Brake System Warning Lamp



If it illuminates when you are driving, this indicates a malfunction. Your vehicle continues to have normal braking without the anti-lock brake system function. Have your vehicle checked as soon as possible.

Battery



If it illuminates while driving, it indicates a malfunction. Switch off all unnecessary electrical equipment and have an authorized dealer check the system immediately.

Brake System Warning Lamp



WARNING: Driving your vehicle with the warning lamp on is dangerous. A significant decrease in braking performance may occur. It may take you longer to stop your vehicle. Have your vehicle checked as soon as possible. Driving extended distances with the parking brake engaged can cause brake failure and the risk of personal injury.

Note: Indicators vary depending on region.

This lamp is a dual function lamp and will illuminate when:

- You apply the parking brake with the ignition on.
- Your vehicle has a brake fault or low brake fluid level, regardless of parking brake position.



If the lamp illuminates while you are moving, you may have the parking brake applied. Be sure that the parking brake is off. Have your vehicle checked as soon as possible if the lamp continues to illuminate.



Cruise Control Indicator (If Equipped)



It illuminates when you switch the system on.

See **What Is Cruise Control** (page 106).

Direction Indicator



Illuminates when you switch on the left or right direction indicator or the hazard warning flasher. If the indicators stay on or flash faster, check for a burned out bulb.

Instrument Cluster

Engine Coolant Temperature Warning Lamp



If it illuminates when your vehicle is moving, this indicates that the engine is overheating. Stop your vehicle as soon as it is safe to do so and switch the engine off. Have your vehicle checked as soon as possible.

Engine Oil



It illuminates when you switch the ignition on.

If it illuminates when the engine is running this indicates a malfunction. Stop your vehicle as soon as it is safe to do so and switch the engine off. Check the engine oil level. If the oil level is sufficient, this indicates a system malfunction. Have your vehicle checked as soon as possible.

See **Engine Oil Check** (page 163).

Fasten Seatbelt Warning Lamp



It illuminates and a tone sounds until you fasten the seatbelts.

Headlamp High Beam Indicator



It illuminates when you switch the headlamp high beam on.

Low Fuel Level Warning Lamp



If it illuminates when you are driving, refuel as soon as possible.

Low Tire Pressure Warning Lamp

(If Equipped)



It illuminates if the tire pressure in one or more tires is below the correct tire pressure.

It also illuminates momentarily when you switch the ignition on to confirm the lamp is functional. If it does not illuminate when you switch the ignition on, or begins to flash at any time, have the system checked by your authorized dealer.

Powertrain Malfunction/Electronic Throttle Control



Illuminates when the system detects a powertrain fault, have an authorized dealer check the system as soon as possible.

Service Engine Soon



If it illuminates when the engine is running this indicates a malfunction. The On Board Diagnostics system has detected a malfunction of the vehicle emission control system.

If it flashes, engine misfire may be occurring. Increased exhaust gas temperatures could damage the catalytic converter or other vehicle components. Avoid heavy acceleration and deceleration and have your vehicle serviced immediately.

It illuminates when you switch the ignition on prior to engine start to check the bulb and to indicate whether your vehicle is ready for Inspection and Maintenance (I/M) testing.

Normally, it illuminates until the engine is cranked and automatically turns off if no malfunctions are present. However, if after 15 seconds it flashes eight times, this indicates that your vehicle is not ready for Inspection and Maintenance (I/M) testing. See **Emission Law** (page 91).

Instrument Cluster

Traction Control Indicator



It flashes during a traction control event.

If it does not illuminate when you switch the ignition on, or remains on when the engine is running, this indicates a malfunction. Have your vehicle checked as soon as possible.

Traction Control System Off



It will illuminate when the driver disables traction control.

Tow Haul Indicator



Illuminates when the driver activates the tow/haul feature. If the light flashes steadily, have an authorized dealer check the system immediately, damage to the transmission could occur.

AUDIBLE WARNINGS AND INDICATORS

Headlamps On Warning Chime

Sounds when you remove the key from the ignition and open the driver's door and you have left the headlamps or parking lamps on.

Key in Ignition Warning Chime

Sounds when you open the driver's door and you have left the key in the ignition.

Parking Brake On Warning Chime

Sounds when you have left the parking brake on and drive your vehicle. If the warning chime remains on after you have released the parking brake, have the system checked by your authorized dealer immediately.

Information Displays

GENERAL INFORMATION



WARNING: Driving while distracted can result in loss of vehicle control, crash and injury. We strongly recommend that you use extreme caution when using any device that may take your focus off the road. Your primary responsibility is the safe operation of your vehicle. We recommend against the use of any hand-held device while driving and encourage the use of voice-operated systems when possible. Make sure you are aware of all applicable local laws that may affect the use of electronic devices while driving.

Note: Trailer options are not available if your vehicle speed is greater than 3 mph (5 km/h).

Information Display Controls



- Press the up and down arrow buttons to scroll through and highlight the options within a menu.
- Press the right arrow button to enter a sub-menu.
- Press the left arrow button to exit a menu.
- Press the **OK** button to choose and confirm settings or messages.



This icon shows the features on or off status. A check in the box indicates the feature is on, and unchecked indicates the feature is off.

2.3 Inch Display Menu

Note: Some options could appear slightly different or not at all if the items are optional.

Main Menu
Trip 1
Trip 2
Fuel Economy
Driver Assist
Settings

Information Displays

Trip 1 or 2

Displays the following of an individual journey.

- Digital speed.
- Distance.
- Time.
- Distance to empty.
- Average fuel economy.

Note: Hold **OK** to reset fuel history and average fuel economy.

Fuel Economy

Displays the following:

- Instant fuel economy.
- Average fuel economy.
- Average speed.
- Distance to empty.

Note: Hold **OK** to reset fuel history and average fuel economy.

Driver Assist

Displays the following:

- Progressive range select.
- Engine hours.
- Maintenance monitor.

Settings

Settings		
Vehicle	Lighting	Select Your Setting
	Locks	
	FordPass	
	Windows	
	Wiper Controls	
Displ. Settings	Units	Select Your Setting
	Temperature	
	Language	

8 Inch Display Menu

Note: Some options could appear slightly different or not at all if the items are optional.

Information Displays

Main Menu
MyView
Trip/Fuel
Vehicle Info
Settings

MyView

MyView	
Trip 1	
Fuel Economy	
Configure MyView	For more options, press the OK button.

Trip/Fuel

Trip/Fuel
Trip 1
Trip 2
Fuel Economy
Fuel History

Trip 1 or 2

Displays the following of an individual journey.

- Trip timer.
- Distance to empty.
- Trip odometer.
- Average fuel economy.

Note: Hold **OK** to reset fuel history and average fuel economy.

Fuel Economy

Displays your instantaneous fuel usage as a bar graph and average mpg.

Fuel History

Displays your fuel usage based on time. The graph is updated each minute with the fuel economy that you achieved during 30 minutes of driving.

Information Displays

Vehicle Info

Vehicle Info
Gauge View
Digital Speedometer
Engine Information
Maintenance Monitor
Transmission Temp

- Engine Information - Shows engine hours, engine idle hours and engine oil temp and oil life.

Settings

Settings			
Driver Alert		Turn On or Off	
Pre-Collision		Select Your Setting	
Cruise Control		Select Your Setting	
Gauge Selection		Select Your Setting	
Advanced Settings	Vehicle	Lighting	Select Your Setting
		Locks	
		FordPass	
		Windows	
		Wiper Controls	
	Displ. Settings	Units	Select Your Setting
		Temperature	
		Tire Pressure	
		Language	

Information Displays

INFORMATION MESSAGES

Note: *Not all messages will display or be available depending on your vehicle options and instrument cluster type. The information display may abbreviate or shorten certain messages.*

Press the **OK** button to acknowledge and remove some messages from the information display. The information display will automatically remove other messages after a short period of time.

You need to confirm certain messages before you can access the menus.



Battery and Charging System

Message	Action
Check Charging System	The charging system needs servicing. If the warning stays on or continues to come on, contact an authorized dealer as soon as possible.
Low Battery Features Temporarily Turned Off	The battery management system detects an extended low-voltage condition. Your vehicle will disable various features to help preserve the battery. Turn off as many of the electrical loads as soon as possible to improve system voltage. If the system voltage has recovered, the disabled features will operate again as normal.
Turn Power Off To Save Battery	The battery management system determines that the battery is at a low state of charge. Turn your ignition off as soon as possible to protect the battery. This message will clear once you restart your vehicle and the battery state of charge has recovered. Turning off unnecessary electrical loads will allow faster battery state-of-charge recovery.

Information Displays

Doors and Locks

Message	Action
Driver Door Ajar	The driver door is not completely closed.
Passenger Door Ajar	The passenger door is not completely closed.

Driver Alert

Message	Action
Driver Alert Warning Rest Now	Stop and rest as soon as it is safe to do so.
Driver Alert Warning Rest Suggested	Take a rest soon.

Engine

Message	Action
Power Reduced to Lower Engine Temp	The engine has reduced power to help reduce high engine temperature.

Fuel

Message	Action
Fuel Level Low	An early reminder of a low fuel condition.
Check Fuel Fill Inlet	The fuel fill inlet may not be properly closed.

Information Displays

Lane Departure Warning System

Message	Action
Front Camera Temporarily Not Available	The system detects a condition that causes the system to be temporarily unavailable.
Front Camera Low Visibility Clean Screen	The system detects a condition that requires you to clean the windshield in order for it to operate properly.
Front Camera Malfunction Service Required	Have the system checked as soon as possible.
Keep Hands on Steering Wheel	The system requests you to keep your hands on the steering wheel.

Maintenance

Message	Action
Low Engine Oil Pressure	Stop your vehicle as soon as safely possible and turn off the engine. Check the oil level. If the warning stays on or continues to come on with your engine running, contact an authorized dealer as soon as possible.
Change Engine Oil Soon	The engine oil life remaining is 10% or less.
Oil Change Required	The oil life left is at 0%.
Brake Fluid Level Low	The brake fluid level is low, inspect the brake system immediately. See Brake Fluid Check (page 172).
Check Brake System	The brake system needs servicing. Stop your vehicle in a safe place. Contact an authorized dealer.
Transport / Factory Mode Contact Dealer	Your vehicle is still in Transport or Factory mode. This may not allow some features to operate properly. See an authorized dealer.
See Manual	The powertrain needs service due to a powertrain malfunction.

Information Displays

Pre-Collision Assist

Message	Action
Pre-Collision Assist Not Available Sensor Blocked	You have a blocked sensor due to bad weather, ice, mud or water in front of the radar sensor. You can typically clean the sensor to resolve.
Pre-Collision Assist Not Available	There is a condition preventing the system from being available. Have the system checked as soon as possible.

Power Steering

Message	Action
Steering Fault Service Now	The power steering system detects a condition that requires service. See an authorized dealer.
Steering Loss Stop Safely	The power steering system is not working. Stop your vehicle in a safe place. Contact an authorized dealer.
Steering Assist Fault Service Required	The power steering system detects a condition within the power steering system or passive entry or passive start system requires service. Contact an authorized dealer.
Steering Lock Malfunction Service Now	The steering lock system detects a condition that requires service. See an authorized dealer.

Traction Control

Message	Action
Traction Control Off	The status of the traction control system after you switched it off. See Using Traction Control (page 102).
Traction Control On	The status of the traction control system after you switched it on. See Using Traction Control (page 102).

Information Displays

Transmission

Message	Action
Shift to Park	You switched the engine off and shift select lever is in any position other than park (P).
Press Brake Pedal	Displays when the brake pedal needs to be pressed.
Transmission Over Temperature Stop Safely	The transmission is overheating and needs to cool. Stop in a safe place as soon as it is possible.
Transmission Service Required	See an authorized dealer.
Transmission Too Hot Press Brake	The transmission is overheating and needs to cool. Stop in a safe place as soon as it is possible.
Transmission Limited Function See Manual	The transmission has limited functionality. See an authorized dealer.
Transmission Not in Park	A reminder to shift into park. In addition, this message is typical after reconnecting or recharging the battery until you cycle the ignition to the on mode. See Changing the 12V Battery (page 173).
Transmission Fault Service Now	Have your vehicle checked as soon as possible.
Transmission Adjusted	Displays when the transmission has adjusted the shift strategy.
Transmission Adapt-Mode	Displays when the transmission is adjusting the shift strategy.
Transmission Warming Up Please Wait	Transmission is too cold. Wait for it to warm up before you drive.
Transmission Indicat-Mode Lockup On	Displays when the transmission shift lever is locked and unable to select gears.
Transmission Indicat-Mode Lockup Off	Displays when the transmission shift lever is unlocked and free to select gears.
Transmission Overheating Stop Safely	The transmission is overheating and needs to cool. Stop in a safe place as soon as it is possible.

Climate Control

MANUAL CLIMATE CONTROL

Heater Only System (If Equipped)



Note: Depending on your vehicle option package, the controls may look different from what you see here.

Directing the Air

Turn the control to direct the air.

VENT Direct air to the instrument panel air vents.

FLR Direct air to the footwell air vents.

MIX Direct air to the instrument panel and footwell air vents.

 Direct air to the windshield air vents. You can also use this setting to defog and clear the windshield of a thin covering of ice.

Setting the Blower Motor Speed

 Turn the control to adjust the volume of air circulated in the vehicle.

Setting the Temperature

COOL

WARM

Turn the control to set the temperature.

Switching the Heater On and Off

OFF

Turn the control.

Manual Climate Control (If Equipped)



Note: Depending on your vehicle option package, the controls may look different from what you see here.

Directing the Air

Turn the control to direct the air.

VENT Direct air to the instrument panel air vents.

FLR Direct air to the footwell air vents.

MIX Direct air to the instrument panel and footwell air vents.

Climate Control



Direct air to the windshield air vents. You can also use this setting to defog and clear the windshield of a thin covering of ice.

Switching the Air Conditioning On and Off



Turn to switch the air conditioning on or off.

Switching Maximum Air Conditioning On and Off



Turn the control for maximum cooling.

Recirculated air flows through the instrument panel vents and air conditioning turns on.

Setting the Blower Motor Speed



Turn the control to adjust the volume of air circulated in the vehicle.

Setting the Temperature



Turn the control to set the temperature.

Switching the Climate Control On and Off



Turn the control.

HINTS ON CONTROLLING THE INTERIOR CLIMATE

General Hints

Note: Prolonged use of recirculated air may cause the windows to fog up.

Note: You may feel a small amount of air from the footwell air vents regardless of the air distribution setting.

Note: To reduce humidity build-up inside your vehicle, do not drive with the system switched off or with recirculated air always switched on.

Note: To reduce fogging of the windshield during humid weather, adjust the air distribution control to the windshield air vents position.

Note: Do not place objects under the front seats as this may interfere with the airflow to the rear seats.

Note: Remove any snow, ice or leaves from the air intake area at the base of the windshield.

Note: To improve the time to reach a comfortable temperature in hot weather, drive with the windows open until you feel cold air through the air vents.

Quickly Heating the Interior

1. Adjust the fan speed to the highest speed setting.
2. Adjust the temperature control to the full heat setting.
3. Direct air to the footwell air vents.

Recommended Settings for Heating

1. Adjust the fan speed to the center setting.
2. Adjust the temperature control to the midway point of the hot settings.

Climate Control

3. Direct air to the footwell air vents.

Quickly Cooling the Interior

1. Switch **MAX A/C** on.
2. Drive with the windows open until you feel cold air through the air vents.

Recommended Settings for Cooling

1. Adjust the fan speed to the center setting.
2. Adjust the temperature control to the midway point of the cold settings.
3. Direct air to the instrument panel air vents.

Vehicle Stationary for Extended Periods During Extreme High Ambient Temperatures

1. Apply the parking brake.
2. Place your vehicle in park (P) or neutral (N).
3. Switch **MAX A/C** on.
4. Adjust the fan speed to the lowest speed setting.

Defogging the Side Windows in Cold Weather

1. Direct air to the instrument panel and windshield vents.
2. Turn to **NORM A/C**.
3. Adjust the temperature control to the desired setting.
4. Adjust the fan speed to the highest setting.
5. Direct air toward the side windows.
6. Close the instrument panel vents.

REAR PASSENGER CLIMATE CONTROLS

Setting the Blower Motor Speed

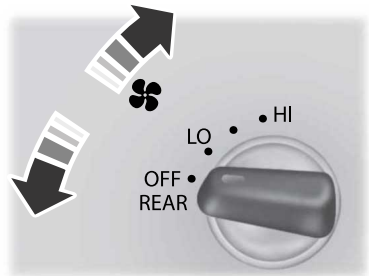

Turn the control to adjust the volume of air circulated in the vehicle.

Note: Depending on your vehicle option package, the controls may look different from what you see here.

Switching the Rear Climate Control On and Off



Turn the control.

Seats

SITTING IN THE CORRECT POSITION



WARNING: Sitting improperly, out of position or with the seatback reclined too far can take weight off the seat cushion and affect the decision of the passenger sensing system, resulting in serious injury or death in the event of a crash. Always sit upright against your seat back, with your feet on the floor.



WARNING: Do not recline the seat backrest too far as this can cause the occupant to slide under the seatbelt, resulting in personal injury in the event of a crash.



WARNING: Do not place objects higher than the top of the seat backrest. Failure to follow this instruction could result in personal injury or death in the event of a sudden stop or crash.

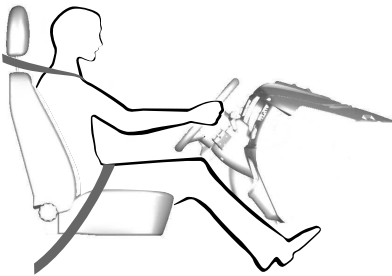

When you use them properly, the seat, head restraint, seatbelt and airbags will provide optimum protection in the event of a crash.

We recommend that you follow these guidelines:

- Sit in an upright position with the base of your spine as far back as possible.
- Do not recline the seat backrest so that your torso is more than 30 degrees from the upright position.
- Adjust the head restraint so that the top of it is level with the top of your head and as far forward as possible. Make sure that you remain comfortable.
- Keep sufficient distance between yourself and the steering wheel. We recommend a minimum of 10 in (25 cm) between your breastbone and the airbag cover.
- Hold the steering wheel with your arms slightly bent.
- Bend your legs slightly so that you can press the pedals fully.
- Position the shoulder strap of the seatbelt over the center of your shoulder and position the lap strap tightly across your hips.

Make sure that your driving position is comfortable and that you can maintain full control of your vehicle.

HEAD RESTRAINTS



E190815

Seats

The front row outboard non-adjustable head restraints consist of a trimmed foam covering over the upper structure of the seatback. Properly adjust the seatback to an upright driving or riding position, so that the head restraint is positioned as close as possible to the back of your head.

MANUAL SEATS (IF EQUIPPED)

WARNING: Make sure the seat fully locks into place by rocking it backward and forward. Not securing the seat into the locked position can be dangerous in a crash and could cause serious personal injury or death.

Moving the Seat Backward and Forward

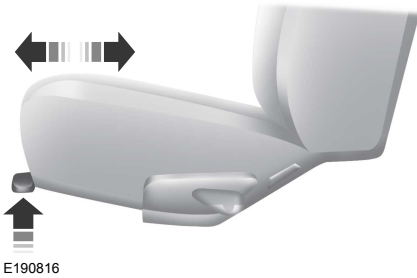

Recline Adjustment (If Equipped)

WARNING: Do not place cargo or any objects behind the seat backrest before returning it to the original position. Pull on the seat backrest to make sure that it has fully latched after returning the seat backrest to its original position. An unlatched seat may become dangerous if you stop suddenly or have a crash.

WARNING: Always drive and ride with your seatback upright and the lap belt snug and low across the hips.

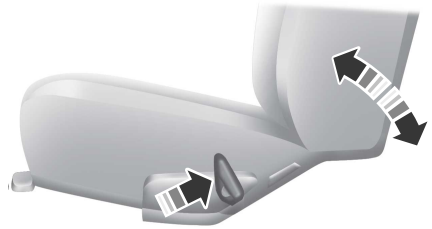

E190817

Manual Lumbar (If Equipped)

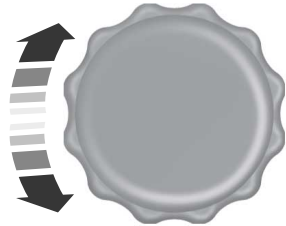

E166702

Seats

The lumbar control is on the inboard side of the driver seat. Turn the control to adjust your support.

POWER SEATS (IF EQUIPPED)



WARNING: Do not adjust the driver seat or seat backrest when your vehicle is moving. This may result in sudden seat movement, causing the loss of control of your vehicle.

The control is on the outermost side of the seat cushion.

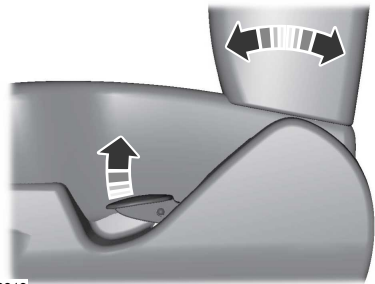

E190819

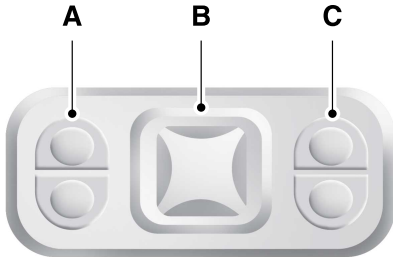

E190818

- Press A to raise or lower the front portion of the seat cushion.
- Press B to move the seat forward, backward, up or down.
- Press C to raise or lower the rear portion of the seat cushion.

Recline Adjustment (If Equipped)



WARNING: Always drive and ride with your seatback upright and the lap belt snug and low across the hips.

Auxiliary Power Points

12 Volt DC Power Point



WARNING: Do not plug optional electrical accessories into the cigar lighter socket. Incorrect use of the cigar lighter can cause damage not covered by the vehicle warranty, and can result in fire or serious injury.

Note: When you switch the ignition on, you can use the socket to power 12 volt appliances with a maximum current rating of 15 amps.

Note: If the power supply does not work after you switch the ignition off, switch the ignition on.

Note: Do not hang any accessory from the accessory plug.

Note: Do not use the power point over the vehicle capacity of 12 volt DC 180 watts or a fuse may blow.

Note: Always keep the power point caps closed when not in use.

Do not insert objects other than an accessory plug into the power point. This damages the power point and may blow the fuse.

Run the vehicle for full capacity use of the power point.

To prevent the battery from running out of charge:

- Do not use the power point longer than necessary when the vehicle is not running.
- Do not leave devices plugged in overnight or when you park your vehicle for extended periods.

Locations

Power points could be in the following locations:

- On the instrument panel.
- Inside the glove box.
- Behind the driver's seat, upper trim panel.

110 Volt AC Power Point (If Equipped)



WARNING: Do not keep electrical devices plugged into the power outlet whenever the device is not in use. The outlet provides power when the vehicle is on. Failure to follow this instruction could result in personal injury.



WARNING: Do not use an extension cord or connect multiple devices to the power outlet. Doing so could result in overloading the power outlet. Failure to follow this instruction could result in fire, personal injury or property damage.

Note: The power point turns off when you switch the ignition off, or when the battery voltage drops below 11 volts.

You can use the power point for electric devices that require up to 150 watts. It is on the instrument panel.



E194174

Auxiliary Power Points

To gain access to the outlet contacts, press the plug against the outlet and rotate clockwise.

When the indicator light on the power point is:

- **On:** The power point is working, the ignition is on and a device is plugged in.
- **Off:** The power point is off, the ignition is off or no device is plugged in.
- **Flashing:** The power point is in fault mode.

The power outlet temporarily turns off power when in fault mode if the device exceeds the 150 watt limit. Unplug your device and switch the ignition off. Switch the ignition back on, but do not plug your device back in. Let the system cool off and switch the ignition off to reset the fault mode. Switch the ignition back on and make sure the indicator light remains on.

Do not use the power point for certain electric devices, including:

- Cathode-ray, tube-type televisions.
- Motor loads, such as vacuum cleaners, electric saws and other electric power tools or compressor-driven refrigerators.
- Measuring devices, which process precise data, such as medical equipment or measuring equipment.
- Other appliances requiring an extremely stable power supply such as microcomputer-controlled electric blankets or touch-sensor lamps.

Starting and Stopping the Engine

GENERAL INFORMATION

WARNING: Extended idling at high engine speeds can produce very high temperatures in the engine and exhaust system, creating the risk of fire or other damage.

WARNING: Do not park, idle or drive your vehicle on dry grass or other dry ground cover. The emission system heats up the engine compartment and exhaust system, creating the risk of fire.

WARNING: Do not start the engine in a closed garage or in other enclosed areas. Exhaust fumes are toxic. Always open the garage door before you start the engine. Failure to follow this instruction could result in personal injury or death.

WARNING: Exhaust leaks may result in entry of harmful and potentially lethal fumes into the passenger compartment. If you smell exhaust fumes inside your vehicle, have your vehicle inspected immediately. Do not drive if you smell exhaust fumes.

The powertrain control system meets all Canadian interference-causing equipment standard requirements regulating the impulse electrical field or radio noise.

Note: *If you use your vehicle regularly above the altitude of 7,500 ft (2,286 m) and under the temperature of -4.0°F (-20°C), it is recommended to use the alternative engine oil. See **Capacities and Specifications** (page 226).*

If you disconnect the battery, your vehicle may exhibit some unusual driving characteristics for approximately 6 mi (10 km) after you reconnect it. This is because the engine management system must realign itself with the engine. You can disregard any unusual driving characteristics during this period.

When you start the engine, avoid pressing the accelerator pedal before and during operation. Only use the accelerator pedal when you have difficulty starting the engine.

IGNITION SWITCH

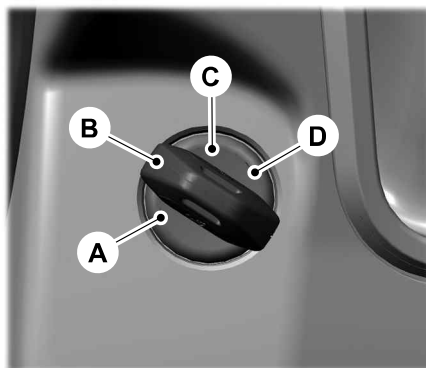

A (lock) - Locks the gearshift lever and allows key removal.

B (accessory) - Allows the electrical accessories, such as the radio, to operate while the engine is not running.

Note: *Do not leave the ignition key in this position for too long. This could cause your vehicle battery to lose charge.*

C (on) - All electrical circuits are operational and the warning lamps and indicators illuminate.

D (start) - Cranks the engine.

Starting and Stopping the Engine

STARTING A GASOLINE ENGINE

When you start the engine, the idle speed increases helping to warm up the engine. If the engine idle speed does not slow down, have your vehicle checked as soon as possible.

Before starting the engine check the following:

- Make sure all occupants fasten their seatbelts.
- Make sure the headlamps and electrical accessories are off.
- Make sure the parking brake is on.
- Make sure the transmission is in park (P) or neutral (N).
- Turn the ignition key to the on position.

Note: Do not press the accelerator pedal.

1. Fully press the brake pedal.
2. Turn the key to the start position to start the engine. Release the key when the engine starts.

Note: The engine may continue cranking for up to 15 seconds or until it starts.

Note: If you cannot start the engine on the first try, wait for a short period and try again.

Failure to Start

If you cannot start the engine after three attempts, wait 10 seconds and follow this procedure:

1. Fully press the brake pedal.
2. Shift into park (P).
3. Fully press and hold the accelerator pedal.
4. Attempt to start your vehicle and wait until the engine stops cranking.
5. Release the accelerator pedal.
6. Start the engine.

Stopping the Engine When Your Vehicle is Stationary

1. Shift into park (P) or neutral (N).
2. Turn the key to the off position.
3. Apply the parking brake.

Stopping the Engine When Your Vehicle is Moving



WARNING: Switching off the engine when your vehicle is still moving results in a significant decrease in braking assistance. Higher effort is required to apply the brakes and to stop your vehicle. A significant decrease in steering assistance could also occur. The steering does not lock, but higher effort could be required to steer your vehicle. When you switch the ignition off, some electrical circuits, for example airbags, also turn off. If you unintentionally switch the ignition off, shift into neutral (N) and restart the engine.

1. Switch the ignition off to stop the engine.
2. Put the transmission into neutral (N) and use the brakes to bring your vehicle to a safe stop.
3. When your vehicle has stopped, shift into park (P).
4. Apply the parking brake.

Guarding Against Exhaust Fumes



WARNING: Exhaust leaks may result in entry of harmful and potentially lethal fumes into the passenger compartment. If you smell exhaust fumes inside your vehicle, have your vehicle inspected immediately. Do not drive if you smell exhaust fumes.

Starting and Stopping the Engine

Important Ventilating Information

If you stop your vehicle and leave the engine idling for long periods of time, we recommend you either open the windows at least 1 in (3 cm) or set the climate control to outside air.

ENGINE BLOCK HEATER (IF EQUIPPED)



WARNING: Failure to follow engine block heater instructions could result in property damage or serious personal injury.



WARNING: Do not use your heater with ungrounded electrical systems or two-pronged adapters. There is a risk of electrical shock.



WARNING: Do not fully close the hood, or allow it to drop under its own weight when using the engine block heater. This could damage the power cable and may cause an electrical short resulting in fire, injury and property damage.

Note: *The heater is most effective when outdoor temperatures are below 0°F (-18°C).*

The heater acts as a starting aid by warming the engine coolant. This allows the climate control system to respond quickly. The equipment includes a heater element, installed in the engine block and a wire harness. You can connect the system to a grounded 120-volt AC electrical source.

We recommend that you do the following for a safe and correct operation:

- Use a 16-gauge outdoor extension cord that is product certified by Underwriter's Laboratory (UL) or Canadian Standards Association (CSA). This extension cord must be suitable for use outdoors, in cold temperatures, and be clearly marked Suitable for Use with Outdoor Appliances. Do not use an indoor extension cord outdoors. This could result in an electric shock or become a fire hazard.
- Use as short an extension cord as possible.
- Do not use multiple extension cords.
- Make sure that when in operation, the extension cord plug and heater cord plug connections are free and clear of water. This could cause an electric shock or fire.
- If the block heater cord is under the hood, Do Not remove the wiring from its original location. Do Not close the hood on the extension wiring.
- Make sure your vehicle is parked in a clean area, clear of combustibles.
- Make sure the heater, heater cord and extension cord are firmly connected.
- Check for heat anywhere in the electrical hookup once the system has been operating for approximately 30 minutes.
- Make sure the system is unplugged and properly stowed before starting and driving your vehicle. Make sure the protective cover seals the prongs of the block heater cord plug when not in use.
- Make sure the heater system is checked for proper operation before winter.

Starting and Stopping the Engine

Using the Engine Block Heater

Make sure the receptacle terminals are clean and dry prior to use. Clean them with a dry cloth if necessary.

The heater uses 0.4 to 1.0 kilowatt-hours of energy per hour of use. The system does not have a thermostat. It achieves maximum temperature after approximately three hours of operation. Using the heater longer than three hours does not improve system performance and unnecessarily uses electricity.

Fuel and Refueling

SAFETY PRECAUTIONS



WARNING: Do not overfill the fuel tank. The pressure in an overfilled tank may cause leakage and lead to fuel spray and fire.



WARNING: The fuel system may be under pressure. If you hear a hissing sound near the fuel filler inlet, do not refuel until the sound stops. Otherwise, fuel may spray out, which could cause serious personal injury.



WARNING: Fuels can cause serious injury or death if misused or mishandled.



WARNING: Fuel may contain benzene, which is a cancer-causing agent.



WARNING: When refueling always shut the engine off and never allow sparks or open flames near the fuel tank filler valve. Never smoke or use a cell phone while refueling. Fuel vapor is extremely hazardous under certain conditions. Avoid inhaling excess fumes.

Follow these guidelines when refueling:

- Extinguish all smoking materials and any open flames before refueling your vehicle.
- Always switch the engine off before refueling.
- Automotive fuels can be harmful or fatal if swallowed. Fuel is highly toxic and if swallowed can cause death or permanent injury. If fuel is swallowed immediately call a physician, even if no symptoms are immediately apparent. The toxic effects of fuel may not be apparent for hours.

- Avoid inhaling fuel vapors. Inhaling fuel vapor can lead to eye and respiratory tract irritation. In severe cases, excessive or prolonged breathing of fuel vapor can cause serious illness and permanent injury.
- Avoid getting fuel in your eyes. If you splash fuel in your eyes, immediately remove contact lenses (if worn), flush with water for 15 minutes and seek medical attention. Failure to seek proper medical attention could lead to permanent injury.
- Fuels can be harmful if absorbed through the skin. If you splash fuel on your skin, clothing or both, promptly remove contaminated clothing and thoroughly wash your skin with soap and water. Repeated or prolonged skin contact causes skin irritation.
- Be particularly careful if you are taking Antabuse or other forms of Disulfiram for the treatment of alcoholism. Breathing fuel vapors could cause an adverse reaction, serious personal injury or sickness. Immediately call a physician if you experience any adverse reactions.

FUEL QUALITY - E85

Choosing the Right Fuel - Flex Fuel Vehicles

Flex fuel vehicles have one of the following identifiers:

- Yellow fuel filler cap.
- Yellow bezel around the fuel filler inlet.
- Yellow fuel filler housing.
- Yellow E85 label on the fuel tank filler door.

Fuel and Refueling

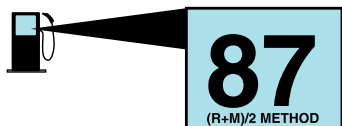

Your vehicle is designed to operate on regular unleaded gasoline with a minimum pump (R+M)/2 octane rating of 87 or regular unleaded gasoline blended with a maximum of 85% ethanol (E85).

Some fuel stations, particularly those in high altitude areas, offer fuels posted as regular unleaded gasoline with an octane rating below 87. The use of these fuels could result in engine damage that will not be covered by the vehicle warranty.

For best overall vehicle and engine performance, premium fuel with an octane rating of 91 or higher is recommended. The performance gained by using premium fuel is most noticeable in hot weather as well as other conditions, for example when towing a trailer. See **Towing** (page 127).

Do not be concerned if the engine sometimes knocks lightly. However, if the engine knocks heavily while using fuel with the recommended octane rating, contact an authorized dealer to prevent any engine damage.

We recommend Top Tier detergent gasolines, where available to help minimize engine deposits and maintain optimal vehicle and engine performance. For additional information, refer to www.toptiergas.com.

Note: *Use of any fuel for which the vehicle was not designed can impair the emission control system, cause loss of vehicle performance, and cause damage to the engine which may not be covered by the vehicle Warranty.*

Do not use:

- Diesel fuel.
- Fuels containing kerosene or paraffin.
- Fuels containing more than 85% ethanol or E100 fuel.
- Fuels containing methanol.
- Fuels containing metallic-based additives, including manganese-based compounds.
- Fuels containing the octane booster additive, methylcyclopentadienyl manganese tricarbonyl (MMT).
- Leaded fuel, using leaded fuel is prohibited by law.

The use of fuels with metallic compounds such as methylcyclopentadienyl manganese tricarbonyl (commonly known as MMT), which is a manganese-based fuel additive, will impair engine performance and affect the emission control system.

Switching Between E85 and Gasoline

We do not recommend repeatedly alternating between E85 and gasoline. If you switch from using E85 to gasoline, or from gasoline to E85, add as much fuel as possible, at least half a tank. Drive your vehicle immediately for a minimum of 5 mi (8 km) to allow it to adapt to the change in ethanol concentration. If you use E85 exclusively, we recommend that you fill the fuel tank with regular unleaded gasoline at each scheduled oil change.

Fuel and Refueling

FUEL QUALITY - GASOLINE

Choosing the Right Fuel



Your vehicle is designed to operate on regular unleaded gasoline with a minimum pump (R+M)/2 octane rating of 87.

Some fuel stations, particularly those in high altitude areas, offer fuels posted as regular unleaded gasoline with an octane rating below 87. The use of these fuels could result in engine damage that will not be covered by the vehicle warranty.

For best overall vehicle and engine performance, premium fuel with an octane rating of 91 or higher is recommended. The performance gained by using premium fuel is most noticeable in hot weather as well as other conditions, for example when towing a trailer. See **Towing** (page 127).

Do not be concerned if the engine sometimes knocks lightly. However, if the engine knocks heavily while using fuel with the recommended octane rating, contact an authorized dealer to prevent any engine damage.

We recommend Top Tier detergent gasolines, where available to help minimize engine deposits and maintain optimal vehicle and engine performance. For additional information, refer to www.toptiergas.com.

Note: Use of any fuel for which the vehicle was not designed can impair the emission control system, cause loss of vehicle performance, and cause damage to the engine which may not be covered by the vehicle Warranty.

Do not use:

- Diesel fuel.
- Fuels containing kerosene or paraffin.
- Fuel containing more than 15% ethanol or E85 fuel.
- Fuels containing methanol.
- Fuels containing metallic-based additives, including manganese-based compounds.
- Fuels containing the octane booster additive, methylcyclopentadienyl manganese tricarbonyl (MMT).
- Leaded fuel, using leaded fuel is prohibited by law.

The use of fuels with metallic compounds such as methylcyclopentadienyl manganese tricarbonyl (commonly known as MMT), which is a manganese-based fuel additive, will impair engine performance and affect the emission control system.

RUNNING OUT OF FUEL

Avoid running out of fuel. Running out of fuel can cause damage not covered by the vehicle Warranty.

Fuel and Refueling

If your vehicle runs out of fuel:

- Normally, adding 1.3 gal (5 L) of fuel is enough to restart the engine. If your vehicle is on a steep grade, more fuel may be required.
- You may need to cycle the ignition from off to on several times after refueling to allow the fuel system to pump the fuel from the tank to the engine. On restarting, cranking time will take a few seconds longer than normal.

Filling a Portable Fuel Container



WARNING: Flow of fuel through a fuel pump nozzle can produce static electricity. This can cause a fire if you are filling an ungrounded fuel container.

Use the following guidelines to avoid electrostatic charge build-up, which can produce a spark, when filling an ungrounded fuel container:

- Only use an approved fuel container to transfer fuel to your vehicle. Place the container on the ground when filling.
- Do not fill a fuel container while it is inside your vehicle (including the cargo area).
- Keep the fuel pump nozzle in contact with the fuel container while filling.
- Do not use a device that holds the fuel pump nozzle lever in the fill position.

REFUELING



WARNING: Fuel vapor burns violently and a fuel fire can cause severe injuries.



WARNING: Read and follow all the instructions on the pump island.



WARNING: When refueling always shut the engine off and never allow sparks or open flames near the fuel tank filler valve. Never smoke or use a cell phone while refueling. Fuel vapor is extremely hazardous under certain conditions. Avoid inhaling excess fumes.



WARNING: Stay outside your vehicle and do not leave the fuel pump unattended when refueling your vehicle.



WARNING: Keep children away from the fuel pump. Never let children pump fuel.



WARNING: Wait at least five seconds before removing the fuel pump nozzle to allow any residual fuel to drain into the fuel tank.



WARNING: Stop refueling after the fuel pump nozzle automatically shuts off for the second time. Failure to follow this will fill the expansion space in the fuel tank and could lead to fuel overflowing.



WARNING: Do not remove the fuel pump nozzle from its fully inserted position when refueling.

Use the following guidelines to avoid electrostatic charge build-up when filling an ungrounded fuel container:

- Place approved fuel container on the ground.
- Do not fill a fuel container while it is in the vehicle (including the cargo area).
- Keep the fuel pump nozzle in contact with the fuel container while filling.
- Do not use a device that would hold the fuel pump handle in the fill position.

Fuel and Refueling

Fuel Filler Cap



WARNING: The fuel system may be under pressure. If you hear a hissing sound near the fuel filler inlet, do not refuel until the sound stops. Otherwise, fuel may spray out, which could cause serious personal injury.

Note: If you must replace the fuel filler cap, replace it with a fuel filler cap that is designed for your vehicle. The customer warranty may be void for any damage to the fuel tank or fuel system if the correct genuine Ford, Motorcraft or other certified fuel filler cap is not used.

Your vehicle has a threaded fuel filler cap. When fueling your vehicle:

1. Put your vehicle in park (P).
2. Switch the engine off.
3. Carefully turn the fuel filler cap counterclockwise until it spins off.
4. Pull to remove the cap from the fuel filler pipe and place on the fuel door hanging hook if equipped.
5. When the nozzle shuts off, wait at least five seconds, then slightly raise the fuel pump nozzle and slowly remove it.
6. Install the fuel filler cap by rotating it clockwise until it clicks.

If the Check Fuel Cap light or a Check Fuel Cap message appears in the instrument cluster and stays on after you start the engine, you may not have installed the fuel filler properly.

If the fuel cap light remains on, at the next opportunity, safely pull off of the road, remove the fuel filler cap, align the cap properly and reinstall it. The check fuel cap light or Check fuel cap message may not reset immediately. It may take several driving cycles for the indicators to turn off. A driving cycle consists of an engine start-up (after four or more hours with the engine off) followed by normal city and highway driving.

FUEL CONSUMPTION

Advertised Capacity

The advertised capacity is the maximum amount of fuel that you can add to the fuel tank after running out of fuel. Included in the advertised capacity is an empty reserve. The empty reserve is an unspecified amount of fuel that remains in the fuel tank when the fuel gauge indicates empty.

Note: The amount of fuel in the empty reserve varies and should not be relied upon to increase driving range.

Fuel Economy

Your vehicle calculates fuel economy figures through the trip computer average fuel function. See **General Information** (page 64).

The first 1,000 mi (1,500 km) of driving is the break-in period of the engine. A more accurate measurement is obtained after 2,000 mi (3,000 km).

Impacting Fuel Economy

- Incorrect tire inflation pressures.
- Fully loading your vehicle.
- Carrying unnecessary weight.

Fuel and Refueling

- Adding certain accessories to your vehicle such as bug deflectors, rollbars or light bars, running boards and ski racks.
- Using fuel blended with alcohol. See **Fuel Quality** (page 85).
- Fuel economy may decrease with lower temperatures.
- Fuel economy may decrease when driving short distances.
- You may get better fuel economy when driving on flat terrain than when driving on hilly terrain.

Engine Emission Control

EMISSION LAW



WARNING: Do not remove or alter the original equipment floor covering or insulation between it and the metal floor of the vehicle. The floor covering and insulation protect occupants of the vehicle from the engine and exhaust system heat and noise. On vehicles with no original equipment floor covering insulation, do not carry passengers in a manner that permits prolonged skin contact with the metal floor. Failure to follow these instructions may result in fire or personal injury.

U.S. federal laws and certain state laws prohibit removing or rendering inoperative emission control system components. Similar federal or provincial laws may apply in Canada. We do not approve of any vehicle modification without first determining applicable laws.



Tampering with emissions control systems including related sensors or the Diesel Exhaust Fluid system can result in reduced engine power and the illumination of the service engine soon light.

Tampering With a Noise Control System

Federal laws prohibit the following acts:

- Removal or rendering inoperative by any person other than for purposes of maintenance.
- Repair or replacement of any device or element of the design incorporated into a new vehicle for the purpose of noise control prior to its sale or delivery to the ultimate purchaser or while it is in use.
- The use of the vehicle after any person removes or renders inoperative any device or element of the design.

The U.S. Environmental Protection Agency may presume to constitute tampering as follows:

- Removal of hood blanket, fender apron absorbers, fender apron barriers, underbody noise shields or acoustically absorptive material.
- Tampering or rendering inoperative the engine speed governor, to allow engine speed to exceed manufacturer specifications.

If the engine does not start, runs rough, experiences a decrease in engine performance, experiences excess fuel consumption or produces excessive exhaust smoke, check for the following:

- A plugged or disconnected air inlet system hose.
- A plugged engine air filter element.
- Water in the fuel filter and water separator.
- A clogged fuel filter.
- Contaminated fuel.
- Air in the fuel system, due to loose connections.
- An open or pinched sensor hose.
- Incorrect engine oil level.

Engine Emission Control

- Incorrect fuel for climatic conditions.
- Incorrect engine oil viscosity for climactic conditions.

Note: *Some vehicles have a lifetime fuel filter that is integrated with the fuel tank. Regular maintenance or replacement is not needed.*

Note: *If these checks do not help you correct the concern, have your vehicle checked as soon as possible.*

Noise Emissions Warranty, Prohibited Tampering Acts and Maintenance

On January 1, 1978, Federal regulation became effective governing the noise emission on trucks over 10,000 lb (4,536 kg) Gross Vehicle Weight Rating (GVWR). The preceding statements concerning prohibited tampering acts and maintenance, and the noise warranty found in the Warranty Guide, are applicable to complete chassis cabs over 10,000 lb (4,536 kg) GVWR.

CATALYTIC CONVERTER



WARNING: Do not park, idle or drive your vehicle on dry grass or other dry ground cover. The emission system heats up the engine compartment and exhaust system, creating the risk of fire.



WARNING: The normal operating temperature of the exhaust system is very high. Never work around or attempt to repair any part of the exhaust system until it has cooled. Use special care when working around the catalytic converter. The catalytic converter heats up to a very high temperature after only a short period of engine operation and stays hot after the engine is switched off.



WARNING: Exhaust leaks may result in entry of harmful and potentially lethal fumes into the passenger compartment. If you smell exhaust fumes inside your vehicle, have your vehicle inspected immediately. Do not drive if you smell exhaust fumes.

Your vehicle has various emission control components and a catalytic converter that enables it to comply with applicable exhaust emission standards.

To make sure that the catalytic converter and other emission control components continue to work properly:

- Do not crank the engine for more than 10 seconds at a time.
- Do not run the engine with a spark plug lead disconnected.
- Do not push-start or tow-start your vehicle. Use booster cables. See **Jump Starting the Vehicle** (page 139).
- Use only the specified fuel listed.
- Do not switch the ignition off when your vehicle is moving.
- Avoid running out of fuel.
- Have the items listed in scheduled maintenance information performed according to the specified schedule.

Note: *Resulting component damage may not be covered by the vehicle Warranty.*

The scheduled maintenance items listed in scheduled maintenance information are essential to the life and performance of your vehicle and to its emissions system.

If you use anything other than Ford, Motorcraft or Ford-authorized parts for maintenance replacements or for service of components affecting emission control, such non-Ford parts should be equivalent to genuine Ford Motor Company parts in performance and durability.

Engine Emission Control

Illumination of the service engine soon indicator, charging system warning light or the temperature warning light, fluid leaks, strange odors, smoke or loss of engine power could indicate that the emission control system is not working properly.

An improperly operating or damaged exhaust system may allow exhaust to enter the vehicle. Have a damaged or improperly operating exhaust system inspected and repaired immediately.

Do not make any unauthorized changes to your vehicle or engine. By law, vehicle owners and anyone who manufactures, repairs, services, sells, leases, trades vehicles, or supervises a fleet of vehicles are not permitted to intentionally remove an emission control device or prevent it from working. Information about your vehicle's emission system is on the Vehicle Emission Control Information Decal located on or near the engine. This decal also lists engine displacement.

Please consult your warranty information for complete details.

On-Board Diagnostics (OBD-II)

Your vehicle has a computer known as the on-board diagnostics system (OBD-II) that monitors the engine's emission control system. The system protects the environment by making sure that your vehicle continues to meet government emission standards. The OBD-II system also assists a service technician in properly servicing your vehicle.



When the service engine soon indicator illuminates, the OBD-II system has detected a malfunction. Temporary malfunctions may cause the service engine soon indicator to illuminate. Examples are:

1. Your vehicle has run out of fuel—the engine may misfire or run poorly.
2. Poor fuel quality or water in the fuel—the engine may misfire or run poorly.
3. The fuel fill inlet may not have closed properly. See **Refueling** (page 88).
4. Driving through deep water—the electrical system may be wet.

You can correct these temporary malfunctions by filling the fuel tank with good quality fuel, properly closing the fuel fill inlet or letting the electrical system dry out. After three driving cycles without these or any other temporary malfunctions present, the service engine soon indicator should stay off the next time you start the engine. A driving cycle consists of a cold engine startup followed by mixed city and highway driving. No additional vehicle service is required.

If the service engine soon indicator remains on, have your vehicle serviced at the first available opportunity. Although some malfunctions detected by the OBD-II may not have symptoms that are apparent, continued driving with the service engine soon indicator on can result in increased emissions, lower fuel economy, reduced engine and transmission smoothness and lead to more costly repairs.

Readiness for Inspection and Maintenance (I/M) Testing

Some state and provincial and local governments may have Inspection/Maintenance (I/M) programs to inspect the emission control equipment on your vehicle. Failure to pass this inspection could prevent you from getting a vehicle registration.



If the service engine soon indicator is on or the bulb does not work, your vehicle may need service. See On-Board Diagnostics.

Engine Emission Control

Your vehicle may not pass the I/M test if the service engine soon indicator is on or not working properly (bulb is burned out), or if the OBD-II system has determined that some of the emission control systems have not been properly checked. In this case, the vehicle is not ready for I/M testing.

If the vehicle's engine or transmission has just been serviced, or the battery has recently run down or been replaced, the OBD-II system may indicate that the vehicle is not ready for I/M testing. To determine if the vehicle is ready for I/M testing, turn the ignition key to the on position for 15 seconds without cranking the engine. If the service engine soon indicator blinks eight times, it means that the vehicle is not ready for I/M testing; if the service engine soon indicator stays on solid, it means that your vehicle is ready for I/M testing.

The OBD-II system checks the emission control system during normal driving. A complete check may take several days.

If the vehicle is not ready for I/M testing, you can perform the following driving cycle consisting of mixed city and highway driving:

1. 15 minutes of steady driving on an expressway or highway followed by 20 minutes of stop-and-go driving with at least four 30-second idle periods.
2. Allow your vehicle to sit for at least eight hours with the ignition off. Then, start the vehicle and complete the above driving cycle. The vehicle must warm up to its normal operating temperature. Once started, do not turn off the vehicle until the above driving cycle is complete.

If the vehicle is still not ready for I/M testing, you need to repeat the above driving cycle.

Transmission

AUTOMATIC TRANSMISSION



WARNING: Apply the parking brake, shift into park (P), switch the ignition off and remove the key before you leave your vehicle. Failure to follow this instruction could result in personal injury or death.

P R N D M 2 1

Putting your vehicle in or out of gear:

1. Fully press down the brake pedal.
2. Move the gearshift lever into the preferred gear.
3. When you finish driving, come to a complete stop.
4. Move the gearshift lever and securely latch it in park (P).
5. Release the brake pedal and the transmission remains in the selected gear.

Park (P)

This position locks the transmission and prevents the wheels from turning.

Reverse (R)

With the transmission in reverse (R), your vehicle moves backward. Always come to a complete stop before shifting into and out of reverse (R).

Neutral (N)

With the transmission in neutral (N), you can start your vehicle and it is free to roll. Hold the brake pedal down when in this position.

Drive (D)

Drive (D) is the normal driving position for the best fuel economy. The overdrive function allows automatic upshifts and downshifts through gears one through six.

Manual (M)

Moving the gearshift lever to the manual (M) position allows you to manually select the gear you prefer. Only the current gear displays. Use the buttons on the gearshift lever to manually select gears. Press the + button to upshift or the – button to downshift. Return the transmission to a different gearshift position to deactivate manual control.

Second (2)

Transmission operates in second (2) gear only. Use second (2) gear to start-up on slippery roads.

First (1)

- Transmission operates in first (1) gear only.
- Provides maximum engine braking.
- Allows upshifts by moving gearshift lever.
- Does not downshift into first (1) gear at high speeds; allows for first (1) gear when vehicle reaches slower speeds.

Forced downshifts

- Allowed in drive (D) with the tow/haul feature on or off.
- Press the accelerator to the floor.
- Allows transmission to select an appropriate gear.

Transmission

Tow/Haul Mode

TOW HAUL To activate tow/haul, press the button on the gearshift lever. The TOW HAUL indicator light illuminates in the instrument cluster.

The tow/haul feature:

- Delays upshifts to reduce the frequency of transmission shifting.
- Provides engine braking in all forward gears, which slows your vehicle and assists you in controlling your vehicle when descending a slope.
- Depending on driving conditions and load conditions, may downshift the transmission, slow your vehicle and control your vehicle speed when descending a hill, without pressing the accelerator pedal. The amount of downshift braking provided varies based upon the amount you press the brake pedal.

The tow/haul feature improves transmission operation when towing a trailer or a heavy load. All transmission gear ranges are available when using tow/haul.

To deactivate the tow/haul feature and return to normal driving mode, press the button on the gearshift lever again. The TOW HAUL light deactivates. Tow/haul also deactivates when you power down your vehicle.



WARNING: Do not use tow/haul when the road surface is slippery. Failure to follow this instruction could result in the loss of control of your vehicle.

Understanding Your SelectShift Automatic™ Transmission



Note: When pressing the button on the gearshift lever, you can cycle through the available drive modes.

Your vehicle has a SelectShift Automatic™ transmission gearshift lever. The SelectShift Automatic transmission gives you the ability to change gears up or down without a clutch.

To prevent the engine from running at too low an RPM, which may cause it to stall, SelectShift still makes some downshifts if it has determined that you have not downshifted in time. Although SelectShift makes some downshifts for you, it still allows you to downshift at any time if the SelectShift determines that damage to the engine does not occur from over-revving.

SelectShift does not upshift, even if the engine is approaching the RPM limit. Shift manually by pressing the + button.

Note: Engine damage may occur if you maintain excessive engine revving without shifting.

SelectShift does not automatically upshift, even if the engine is approaching the RPM limit. Shift manually by pressing the (+) paddle.

Transmission

Progressive Range Selection - PRS

(If Equipped)

Progressive Range Selection gives you the ability to lockout gears from the automatic shifting range. This may provide you with an improved driving experience. For example, in slippery conditions or when experiencing a steep grade.

With the gearshift lever in drive (D), press the – button to active PRS. The instrument cluster indicates the available and selected gears.

All available gears display with the current gear indicated. Press the – button again to lock out gears beginning with the highest gear. Example: press the – button twice to lock out 6th and 5th gears. Only the available gears display, and the transmission automatically shifts between the available gears. Press the + button to unlock gears to allow the transmission to shift to higher gears. The transmission shifts within the gear range you select.

Automatic Transmission Adaptive Learning

This feature may increase durability and provide consistent shift feel over the life of your vehicle. A new vehicle or transmission may have firm shifts, soft shifts, or both. This is normal and does not affect function or durability of the transmission. Over time, the adaptive learning process fully updates transmission operation.

Brake-Shift Interlock



WARNING: Do not drive your vehicle until you verify that the stoplamps are working.



WARNING: When doing this procedure, you need to take the transmission out of park (P) which means your vehicle can roll freely. To avoid unwanted vehicle movement, apply the parking brake prior to doing this procedure. Use wheel chocks if appropriate.



WARNING: If the parking brake is fully released, but the brake warning lamp remains illuminated, the brakes may not be working properly. Have your vehicle checked as soon as possible.

Your vehicle has a brake-shift interlock feature that prevents the gearshift lever from moving from park (P) when the ignition is in the 3 (on) position and the brake pedal is not pressed.

If you cannot move the gearshift lever out of park (P) position with the ignition in the 3 (on) position and the brake pedal pressed, a malfunction may have occurred. It is possible that a fuse has blown or your vehicle's brake lamps are not operating properly. See **Fuse Specification Chart** (page 150).

If the fuse is not blown and the brake lamps are working properly, the following procedure allows you to move the gearshift lever from park (P):

1. Apply the parking brake. Switch the ignition key to 1 (off), then remove the key.
2. Move the steering column to the full down and full rearward position, toward the driver seat.
3. Remove the gearshift lever boot.

Transmission

- Place your fingers into the hole where you removed the gearshift lever boot and pull the top half of the shroud up and forward to separate it from the lower half of the shroud. There is a hinge at the forward edge of the top of the shroud. Roll the top half of the shroud upward on the hinge point, then pull straight rearward toward the driver seat to remove.
- Remove the top half of the shroud.
- Remove the three fasteners under the column that secure the lower shroud half to the column.

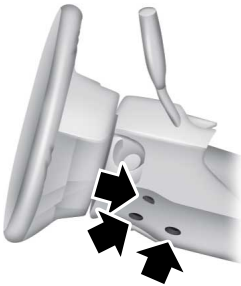

- Pull the lock lever into the full unlocked position and remove the lower shroud cover by pulling the lever handle through the slot in the cover.
- Apply the brake. Gently lift the override disk and move the gearshift lever into neutral (N).

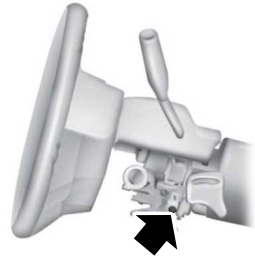

- Start your vehicle.

Perform Steps 4 through 8 in reverse order, making sure to engage the hinge pivots between the upper and lower halves of the shroud. Keep slight pressure in the forward direction as you rotate the halves together.

If Your Vehicle Gets Stuck in Mud or Snow

Note: Do not rock your vehicle if the engine is not at normal operating temperature or damage to the transmission may occur.

Note: Do not rock your vehicle for more than a minute or damage to the transmission and tires may occur, or the engine may overheat.

If your vehicle is stuck in mud or snow, you may rock it out by shifting between forward and reverse gears, stopping between shifts in a steady pattern. Press lightly on the accelerator in each gear.

Brakes

GENERAL INFORMATION

Note: Occasional brake noise is normal. If a metal-to-metal, continuous grinding or continuous squeal sound is present, the brake linings may be worn-out, have the system checked. If the vehicle has continuous vibration or shudder in the steering wheel while braking, have the system checked as soon as possible.

Note: Brake dust may accumulate on the wheels, even under normal driving conditions. Some dust is inevitable as the brakes wear and does not contribute to brake noise. See **Cleaning the Wheels** (page 187).

BRAKE See **Warning Lamps and Indicators** (page 61).



Wet brakes result in reduced braking efficiency. Gently press the brake pedal a few times when driving from a car wash or standing water to dry the brakes.

Brake Over Accelerator

In the event the accelerator pedal becomes stuck or entrapped, apply steady and firm pressure to the brake pedal to slow the vehicle and reduce engine power. If you experience this condition, apply the brakes and bring your vehicle to a safe stop. Move the transmission to park (P), switch the engine off and apply the parking brake. Inspect the accelerator pedal for any interference. If none are found and the condition persists, have the system checked.

Anti-lock Brake System

This system helps you maintain steering control during emergency stops by keeping the brakes from locking.



If it illuminates when you are driving, your vehicle requires service. Your vehicle continues to have normal braking without the anti-lock brake system function. Have your vehicle checked as soon as possible.

It also momentarily illuminates when you switch the ignition on to confirm the lamp is functional. If it does not illuminate when you switch the ignition on, or begins to flash at any time, have the system checked.



It illuminates when you engage the parking brake and the ignition is on.



If it illuminates when your vehicle is moving, make sure the parking brake is disengaged. If the parking brake is disengaged, this indicates low brake fluid level or a brake system fault. Have your vehicle checked as soon as possible.

It also momentarily illuminates when you switch the ignition on to confirm the lamp is functional. If it does not illuminate when you switch the ignition on, or begins to flash at any time, have the system checked.

Hydraulic brake booster system (Hydroboost or Hydromax)

The Hydroboost and Hydromax systems receive fluid pressure from the power steering pump to provide power assist during braking.

The Hydromax booster receives backup pressure from the reserve system electric pump whenever the fluid in the power steering system is not flowing. When the engine is off, the pump turns on if you apply the brake pedal, or if you switch the ignition to the on position.

Brakes

The sound of the pump operating may be heard by the driver. This is a normal characteristic of the system.

The reserve system provides reduced braking power, so the vehicle should be operated under these conditions with caution, and only to seek service repair and removal of the vehicle from the roadway.

Note: *For vehicles with the Hydromax system operating under normal conditions, the noise of the fluid flowing through the booster may be heard whenever you apply the brake. This condition is normal. Vehicle service is not required.*

If braking performance or pedal response becomes very poor, even when you strongly press the pedal, it may indicate the presence of air in the hydraulic system or leakage of fluid. Stop your vehicle as soon as it is safe to do so. Have the system checked as soon as possible.

HINTS ON DRIVING WITH ANTI-LOCK BRAKES

The anti-lock brake system does not eliminate the risks when:

- You drive too closely to the vehicle in front of you.
- Your vehicle is hydroplaning.
- You take corners too fast.
- The road surface is poor.

Note: *If the system activates, the brake pedal could pulse and may travel further. Maintain pressure on the brake pedal. You may also hear a noise from the system. This is normal.*

PARKING BRAKE



WARNING: Apply the parking brake, shift into park (P), switch the ignition off and remove the key before you leave your vehicle. Failure to follow this instruction could result in personal injury or death.

Apply the parking brake whenever you park your vehicle.

- For vehicles with a foot operated parking brake, press the pedal down.
- For vehicles with a hand operated parking brake, pull the parking brake lever up.



It illuminates when you switch the ignition on and apply the parking brake. It also illuminates momentarily when you switch the ignition on to confirm the lamp is functional. If it does not illuminate when you switch the ignition on or begins to flash at any time, have the system checked by an authorized dealer.

If it illuminates when your vehicle is moving, make sure you disengage the parking brake.

If the parking brake is disengaged, this indicates a low brake fluid level or a brake system fault. Have your vehicle checked as soon as possible.

To release the parking brake:

- For vehicles with a foot operated parking brake, pull the parking brake release lever.
- For vehicles with a hand operated parking brake, push the parking brake lever down.

Brakes

HILL START ASSIST



WARNING: The system does not replace the parking brake. When you leave your vehicle, always apply the parking brake.



WARNING: You must remain in your vehicle when the system turns on. At all times, you are responsible for controlling your vehicle, supervising the system and intervening, if required. Failure to take care may result in the loss of control of your vehicle, serious personal injury or death.



WARNING: The system will turn off if a malfunction is apparent or if you rev the engine excessively. Failure to take care may result in the loss of control of your vehicle, serious personal injury or death.

The system makes it easier to pull away when your vehicle is on a slope without the need to use the parking brake.

When the system is active, your vehicle remains stationary on the slope for two to three seconds after you release the brake pedal. This allows time to move your foot from the brake to the accelerator pedal. The system releases the brakes automatically once the engine has developed sufficient torque to prevent your vehicle from rolling down the slope. This is an advantage when pulling away on a slope, for example from a car park ramp, traffic lights or when reversing uphill into a parking space.

The system activates on any slope that causes your vehicle to roll.

Note: *There is no warning light to indicate the system is either on or off.*

Using Hill Start Assist

1. Press the brake pedal to bring your vehicle to a complete standstill. Keep the brake pedal pressed and shift into first gear when facing uphill or reverse (R) when facing downhill.
2. If the sensors detect that your vehicle is on a slope, the system activates automatically.
3. When you remove your foot from the brake pedal, your vehicle remains on the slope without rolling away for about two to three seconds. This hold time automatically extends if you are in the process of driving off.
4. Drive off in the normal manner. The system releases the brakes automatically.

Note: *When you remove your foot from the brake pedal and press the pedal again when the system is active, you will experience significantly reduced brake pedal travel. This is normal.*

Switching the System On and Off

Vehicles with Manual Transmission

You can switch this feature on or off in the information display. The system remembers the last setting when you start your vehicle.

Vehicles with Automatic Transmission

You cannot turn the system on or off. When you switch the ignition on, the system automatically turns on.

Traction Control

PRINCIPLE OF OPERATION

The traction control system helps avoid drive wheel spin and loss of traction.

If your vehicle begins to slide, the system applies the brakes to individual wheels and, when needed, reduces engine power at the same time. If the wheels spin when accelerating on slippery or loose surfaces, the system reduces engine power in order to increase traction.

USING TRACTION CONTROL



WARNING: Operating your vehicle with the traction control disabled could lead to an increased risk of loss of vehicle control, vehicle rollover, personal injury and death.

The system automatically turns on each time you switch the ignition on.

If your vehicle is stuck in mud or snow, switch traction control off to allow the wheels to spin.

Switching the System Off



The button for the traction control system is located on the instrument panel.

When you switch the system off, the TCS off lamp illuminates in the instrument cluster.

Use the switch again to return the traction control system to normal operation.

System Indicator Lights and Messages



The traction control light temporarily illuminates on engine start-up and flashes when a driving condition activates the system.



The traction control off light temporarily illuminates on engine start-up and stays on when the traction control system is switched off or a problem occurs in the system.

Stability Control

PRINCIPLE OF OPERATION



WARNING: Vehicle modifications involving braking system, aftermarket roof racks, suspension, steering system, tire construction and wheel and tire size may change the handling characteristics of your vehicle and may adversely affect the performance of the electronic stability control system. In addition, installing any stereo loudspeakers may interfere with and adversely affect the electronic stability control system. Install any aftermarket stereo loudspeaker as far as possible from the front center console, the tunnel, and the front seats in order to minimize the risk of interfering with the electronic stability control sensors. Reducing the effectiveness of the electronic stability control system could lead to an increased risk of loss of vehicle control, vehicle rollover, personal injury and death.



WARNING: Remember that even advanced technology cannot defy the laws of physics. It's always possible to lose control of a vehicle due to inappropriate driver input for the conditions. Aggressive driving on any road condition can cause you to lose control of your vehicle increasing the risk of personal injury or property damage. Activation of the electronic stability control system is an indication that at least some of the tires have exceeded their ability to grip the road; this could reduce the operator's ability to control the vehicle potentially resulting in a loss of vehicle control, vehicle rollover, personal injury and death. If your electronic stability control system activates, SLOW DOWN.

The system automatically turns on each time you switch the ignition on.

If a fault occurs in either the stability control or the traction control system, you may experience the following conditions:

- The stability and traction control light illuminates steadily.
- The stability control and traction control systems do not enhance your vehicle's ability to maintain traction of the wheels.

If a driving condition activates either the stability control or the traction control system you may experience the following conditions:

- The stability and traction control light flashes.
- Your vehicle slows down.
- Reduced engine power.
- A vibration in the brake pedal.
- The brake pedal is stiffer than usual.
- If the driving condition is severe and your foot is not on the brake, the brake pedal may move as the system applies higher brake force.

The stability control system has several features built into it to help you maintain control of your vehicle:

Electronic Stability Control

The system enhances your vehicle's ability to prevent skids or lateral slides by applying brakes to one or more of the wheels individually and, if necessary, reducing engine power.

Traction Control

The system enhances your vehicle's ability to maintain traction of the wheels by detecting and controlling wheel spin. See **Using Traction Control** (page 102).

Stability Control

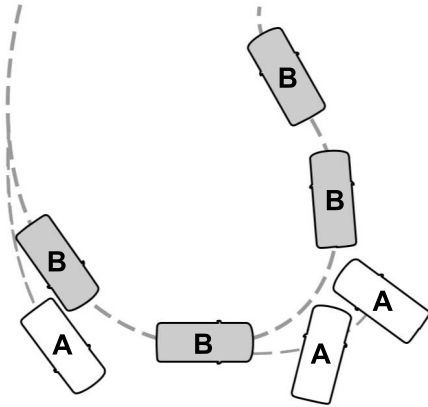

- A Vehicle without stability control skidding off its intended route.
- B Vehicle with stability control maintaining control on a slippery surface.

USING STABILITY CONTROL

The system automatically turns on each time you switch the ignition on.

You cannot switch the stability control system off, but when you shift into reverse (R), the system deactivates.

You can switch the traction control system off or on. See **Using Traction Control** (page 102).

Parking Aids

REAR VIEW CAMERA (IF EQUIPPED)



WARNING: The rear view camera system is a reverse aid supplement device that still requires the driver to use it in conjunction with the interior and exterior mirrors for maximum coverage.



WARNING: Objects that are close to either corner of the bumper or under the bumper, might not be seen on the screen due to the limited coverage of the camera system.



WARNING: Use caution when the rear cargo door is ajar. If the rear cargo door is ajar, the camera will be out of position and the video image could be incorrect. All guide lines disappear when the rear cargo door is ajar. Failure to follow this instruction could result in personal injury.



WARNING: Reverse your vehicle slowly. Failure to follow this instruction could result in the loss of control of your vehicle, personal injury or death.



WARNING: Use caution when turning camera features on or off when the transmission is not in park (P). Make sure your vehicle is not moving.

The rear view camera system provides a video image of the area behind your vehicle.

Example



The camera is located on the rear of your vehicle.

Note: Camera location may vary depending on the configuration of your vehicle.

Using the Rear View Camera System

The rear view camera system displays what is behind your vehicle when you place the transmission in reverse (R).

Note: When towing, the camera only sees what you are towing behind your vehicle. This might not provide adequate coverage as it usually provides in normal operation and you might not see some objects.

The camera may not operate correctly under the following conditions:

- Mud, water or debris obstructs the camera's view. Clean the lens with a soft, lint-free cloth and non-abrasive cleaner.
- The camera is misaligned due to damage to the rear of your vehicle.

Cruise Control (If Equipped)

WHAT IS CRUISE CONTROL

Cruise control lets you maintain a set speed without keeping your foot on the accelerator pedal.

Requirements

Use cruise control when the vehicle speed is greater than 20 mph (30 km/h).

SWITCHING CRUISE CONTROL ON AND OFF



WARNING: Do not use cruise control on winding roads, in heavy traffic or when the road surface is slippery. This could result in loss of vehicle control, serious injury or death.

The cruise controls are on the steering wheel. See **Cruise Control** (page 48).

Switching Cruise Control On

ON

Press the button.

Switching Cruise Control Off

OFF

Press the button when the system is in standby mode.

The system also turns off when you switch the ignition off.

Note: *The set speed erases when you switch the system off.*

SETTING THE CRUISE CONTROL SPEED



WARNING: When you are going downhill, your vehicle speed could increase above the set speed. The system does not apply the brakes.

Drive to the speed you prefer.

SET+

Press either button to set the current speed.

SET-

Take your foot off the accelerator pedal.

Note: *The indicator changes color in the information display.*

Changing the Set Speed

SET+

Press and release the button to increase the set speed in small increments.

Press and hold the button to accelerate. Release the button when you reach your preferred speed.

SET-

Press and release the button to decrease the set speed in small increments.

Press and hold the button to decelerate. Release the button when you reach your preferred speed.

Note: *If you accelerate by pressing the accelerator pedal, the set speed does not change. When you release the accelerator pedal, your vehicle returns to the speed that you previously set.*

Cruise Control (If Equipped)

CANCELING THE SET SPEED



Press the button, or tap the brake pedal to cancel the set speed.

Note: *The system remembers the set speed.*

Note: *The system cancels if the vehicle speed drops below 10 mph (16 km/h) under the set speed when driving uphill.*

RESUMING THE SET SPEED



Press the button.

CRUISE CONTROL INDICATORS



Illuminates when you switch the system on.

USING ADAPTIVE CRUISE CONTROL



WARNING: You are responsible for controlling your vehicle at all times. The system is designed to be an aid and does not relieve you of your responsibility to drive with due care and attention. Failure to follow this instruction could result in the loss of control of your vehicle, personal injury or death.



WARNING: Do not use adaptive cruise control on winding roads, in heavy traffic or when the road surface is slippery. This could result in loss of vehicle control, serious injury or death.



WARNING: Pay close attention to changing road conditions such as entering or leaving a highway, on roads with intersections or roundabouts, roads without visible lanes of travel, roads that are unpaved, or steep slopes. Failure to follow this instruction could result in the loss of control of your vehicle, personal injury or death.



WARNING: Do not use the system in poor visibility, for example fog, heavy rain, spray or snow.



WARNING: Do not use the system when towing a trailer that has aftermarket electronic trailer brake controls. Failure to follow this instruction could result in the loss of control of your vehicle, personal injury or death.



WARNING: Do not use tire sizes other than those recommended because this can affect the normal operation of the system. Failure to do so may result in a loss of vehicle control, which could result in serious injury.



WARNING: The system may not detect stationary or slow moving vehicles below 6 mph (10 km/h).



WARNING: The system does not detect pedestrians or objects in the road.



WARNING: The system does not detect oncoming vehicles in the same lane.



WARNING: The system is not a crash warning or avoidance system.



WARNING: Do not use the system with a snow plow blade installed.

Cruise Control (If Equipped)

The system adjusts your vehicle speed to maintain the set gap between you and the vehicle in front of you in the same lane. You can select four gap settings.

The system uses a radar sensor that projects a beam directly in front of your vehicle.



E262918

The adaptive cruise controls are on the steering wheel.

Switching Adaptive Cruise Control On



Press and release the button.



The indicator, current gap setting and set speed appear in the information display.



Setting the Adaptive Cruise Speed

Drive to your preferred speed.



Press and release either button.

Take your foot off the accelerator pedal.

The indicator, current gap setting and set speed appear in the information display.

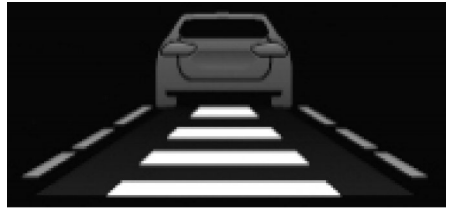

A vehicle graphic illuminates if there is a vehicle detected in front of you.

Note: *When adaptive cruise control is active, the speedometer may vary slightly from the set speed displayed in the information display.*

Following a Vehicle



WARNING: When following a vehicle that is braking, your vehicle does not always decelerate quickly enough to avoid a crash without driver intervention. Apply the brakes when necessary. Failure to follow this instruction could result in personal injury or death.

Cruise Control (If Equipped)



WARNING: The system only warns of vehicles detected by the radar sensor. In some cases there may be no warning or a delayed warning. Apply the brakes when necessary. Failure to follow this instruction could result in personal injury or death.

Note: When you are following a vehicle and you switch on a direction indicator, adaptive cruise control may provide a small temporary acceleration to help you pass.

Note: The brakes may emit noise when applied by the system.

When a vehicle ahead of you enters the same lane or a slower vehicle is ahead in the same lane, the vehicle speed adjusts to maintain a preset gap distance. A vehicle graphic illuminates in the instrument cluster.

Your vehicle maintains a consistent gap from the vehicle ahead until any of the following occur:

- The vehicle in front of you accelerates to a speed above the set speed.
- The vehicle in front of you moves out of the lane you are in.
- Your vehicle speed falls below 12 mph (20 km/h).
- You set a new gap distance.

The system applies the brakes to slow your vehicle to maintain a safe gap distance from the vehicle in front. The system only applies limited braking. You can override the system by applying the brakes.

If the system determines that its maximum braking level is not sufficient, an audible warning sounds, a message appears in the information display and an indicator flashes when the system continues to brake. Take immediate action.

Setting the Gap Distance

You can decrease or increase the distance between your vehicle and the vehicle in front by pressing the gap control.



Press and release to decrease the gap distance.



Press and release to increase the gap distance.



The selected gap appears in the information display as shown by the bars in the image.

Note: The gap setting is time dependent and therefore the distance adjusts with your vehicle speed.

Note: It is your responsibility to select a gap appropriate to the driving conditions.

Cruise Control (If Equipped)

Adaptive Cruise Control Gap Settings

Graphic Display, Bars Indicated Between Vehicles	Distance Gap	Dynamic Behavior
1	Closest.	Sport.
2	Close.	Normal.
3	Medium.	Normal.
4	Far.	Comfort.

Each time you switch the system on, it selects the last chosen gap setting.

Overriding the Set Speed



WARNING: If you override the system by pressing the accelerator pedal, it does not automatically apply the brakes to maintain a gap from any vehicle ahead.

When you press the accelerator pedal, you override the set speed and gap distance.



Use the accelerator pedal normally to intentionally exceed the set speed limit.

When you override the system, the green indicator light illuminates and the vehicle image does not appear in the information display.

The system tunes the engine, transmission controls and the stability and traction control modes to normal mode. The vehicle speed decreases to the set speed, or a lower speed if following a slower vehicle.

Changing the Set Speed

SET+

Press and release to increase the set speed in small increments.

SET-

Press and release to decrease the set speed in small increments.

Press and hold either button to change the set speed in large increments. Release the button when the set speed has reached the desired speed.

The system may apply the brakes to slow the vehicle to the new set speed. The set speed displays continuously in the information display when the system is active.

Canceling the Set Speed

CNCL

Press and release the button or tap the brake pedal.

The set speed does not erase.

Resuming the Set Speed

RES

Press and release the button.

Your vehicle speed returns to the previously set speed and gap setting. The set speed displays continuously in the information display when the system is active.

Note: Only use resume if you are aware of the set speed and intend to return to it.

Automatic Cancellation

The system is not functional at vehicle speeds below 12 mph (20 km/h). An audible alarm sounds and the automatic braking releases if the vehicle drops below this speed.

Cruise Control (If Equipped)

Automatic cancellation can occur when the tires lose traction or you apply the parking brake.

Hilly Condition and Trailer Tow Usage

You should select a lower gear when the system is active in situations such as prolonged downhill driving on steep grades, for example in mountainous areas. The system needs additional engine braking in these situations to reduce the load on the vehicle's regular brake system to prevent it from overheating.

Note: An audible alarm sounds and the system shuts down if it applies the brakes for an extended period of time. This allows the brakes to cool. The system functions normally again after the brakes cool.

Note: When towing with adaptive cruise control, switch on Tow/Haul Mode.

Switching Adaptive Cruise Control Off

OFF

Press and release the button when the system is in standby mode, or switch the ignition off.

Note: The set speed and gap setting is erased when you switch the system off.

Detection Issues



WARNING: On rare occasions, detection issues can occur due to the road infrastructures, for example bridges, tunnels and safety barriers. In these cases, the system may brake late or unexpectedly. At all times, you are responsible for controlling your vehicle, supervising the system and intervening, if required.



WARNING: If the system malfunctions, have your vehicle checked as soon as possible.

The radar sensor has a limited field of view. It may not detect vehicles at all or detect a vehicle later than expected in some situations. The lead vehicle graphic does not illuminate if the system does not detect a vehicle in front of you.

A

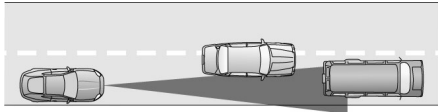

B

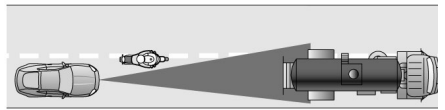

C

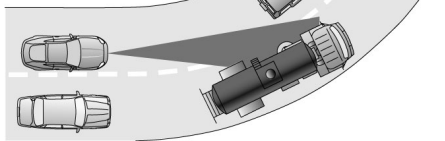

Cruise Control (If Equipped)

Detection issues can occur:

- A When driving on a different line than the vehicle in front.
- B With vehicles that edge into your lane. The system can only detect these vehicles once they move fully into your lane.
- C There may be issues with the detection of vehicles in front when driving into and coming out of a bend or curve in the road.

In these cases, the system may brake late or unexpectedly. You should stay alert and take action when necessary.

If something hits the front end of your vehicle or damage occurs, the radar-sensing zone may change. This could cause missed or false vehicle detection.

Optimal system performance requires a clear view of the road by the windshield-mounted camera.

Optimal performance may not occur if:

- The camera is blocked.
- There is poor visibility or lighting conditions.
- There are bad weather conditions.

System Not Available

Conditions that can cause the system to deactivate or prevent the system from activating when requested include:

- A blocked sensor.
- High brake temperature.
- A failure in the system or a related system.

Blocked Sensor

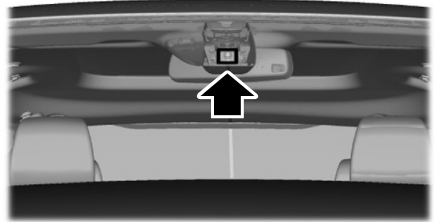

E249505

The camera is mounted on the windshield behind the interior mirror.



E183741

A message displays if something obstructs the radar signals from the sensor. The sensor is in the lower grille. The system cannot detect a vehicle ahead and does not function when something blocks the sensor.

Note: *You cannot see the sensor. It is behind a fascia panel.*

Keep the front of your vehicle free of dirt, metal badges or objects. Vehicle front protectors and aftermarket lights may also block the sensor.

Cruise Control (If Equipped)

Possible causes and actions for the blocked sensor message displaying:

Cause	Action
The surface of the radar is dirty or obstructed	Clean the grille surface in front of the radar or remove the object causing the obstruction.
The surface of the radar is clean but the message remains in the display.	Wait a short time. It may take several minutes for the radar to detect that it is free from obstruction.
Heavy rain or snow is interfering with the radar signals	Do not use the system in these conditions because it may not detect any vehicles ahead.
Water, snow or ice on the surface of the road may interfere with the radar signals.	Do not use the system in these conditions because it may not detect any vehicles ahead.
You are in a desert or remote area with no other vehicles and no roadside objects.	Wait a short time or switch to normal cruise control.

Due to the nature of radar technology, it is possible to get a blockage warning with no actual block. A false blocked condition either self-clears, or clears after you restart your vehicle.

Switching to Normal Cruise Control



WARNING: Normal cruise control will not brake when your vehicle is approaching slower vehicles. Always be aware of which mode you have selected and apply the brakes when necessary.



The cruise control indicator light replaces the adaptive cruise control indicator light if you select normal cruise control. The gap setting does not display, and the system does not respond to lead vehicles. Automatic braking remains active to maintain set speed.

You can change from adaptive cruise control to normal cruise control through the information display.

Driving Aids

DRIVER ALERT (IF EQUIPPED)



WARNING: You are responsible for controlling your vehicle at all times. The system is designed to be an aid and does not relieve you of your responsibility to drive with due care and attention. Failure to follow this instruction could result in the loss of control of your vehicle, personal injury or death.



WARNING: The system may not function if the sensor is blocked.



WARNING: Take regular rest breaks if you feel tired. Do not wait for the system to warn you.



WARNING: Certain driving styles may result in the system warning you even if you are not feeling tired.



WARNING: In cold and severe weather conditions the system may not function. Rain, snow and spray can all limit sensor performance.



WARNING: The system will not operate if the sensor cannot track the road lane markings.



WARNING: If damage occurs in the immediate area surrounding the sensor, have your vehicle checked as soon as possible.



WARNING: The system may not correctly operate if your vehicle is fitted with a suspension kit not approved by us.

Note: Keep the windshield free from obstructions. For example, bird droppings, insects and snow or ice.

Note: If the camera is blocked or if the windshield is damaged, the system may not function.

Note: The system remembers the last setting when you start your vehicle, unless it detects a MyKey™.

Note: If enabled in the menu, the system activates at speeds above 40 mph (64 km/h).

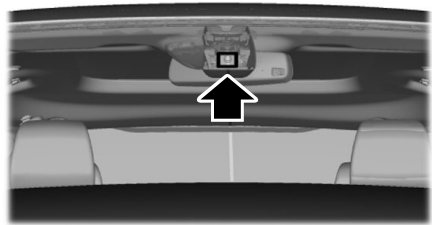

E249505

The system monitors your driving behavior using various inputs including the front camera sensor.

If the system detects reduced driving alertness below a certain threshold, the system alerts you using a tone and a message in the information display.

Using Driver Alert

Switching the system on and off

You may switch the system on or off through the information display by selecting Settings, Driver Assist and then Driver Alert in the menu. When activated, the system monitors your alertness level based upon your driving behavior in relation to the lane markings, and other factors.

System Warnings

Note: The system does not issue warnings below approximately 40 mph (64 km/h).

Driving Aids

The warning system uses two stages. At first the system issues a temporary warning that you need to take a rest. This message only appears for a short time. If the system detects further reduction in driving alertness, another warning could be issued which remains in the information display for a longer time. Press OK on the steering wheel control to clear the warning. When active the system runs in the background and only issues a warning if required.

Resetting the System

You can reset the system by either:

- Switching the ignition off and on.
- Stopping the vehicle and then opening and closing the driver door.

LANE KEEPING SYSTEM (IF EQUIPPED)

WARNING: You are responsible for controlling your vehicle at all times. The system is designed to be an aid and does not relieve you of your responsibility to drive with due care and attention. Failure to follow this instruction could result in the loss of control of your vehicle, personal injury or death.

WARNING: Always drive with due care and attention when using and operating the controls and features on your vehicle.

WARNING: In cold and severe weather conditions the system may not function. Rain, snow and spray can all limit sensor performance.

WARNING: The system will not operate if the sensor cannot track the road lane markings.

WARNING: The sensor may incorrectly track lane markings as other structures or objects. This can result in a false or missed warning.

WARNING: Large contrasts in outside lighting can limit sensor performance.

WARNING: The system may not operate properly if the sensor is blocked. Keep the windshield free from obstruction.

WARNING: If damage occurs in the immediate area surrounding the sensor, have your vehicle checked as soon as possible.

WARNING: The system may not correctly operate if your vehicle is fitted with a suspension kit not approved by us.

Note: The system works if the camera can detect one lane marking at a speed above 40 mph (64 km/h).

Note: The system may not function with a blocked camera, or if the windshield is damaged or dirty.

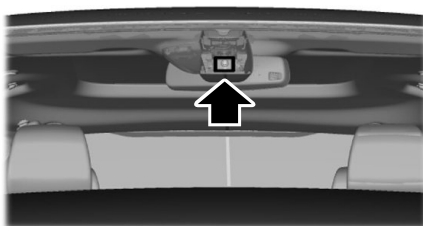

E249505

Driving Aids

When you switch the lane keeping system on and the camera detects a drift out of the travel lane, the system alerts the driver by playing a chime.

Switching the System On and Off

Note: The system stores the on or off setting until you manually change it.



Press the button to switch the system on or off. The button is above the audio unit or on the center console.

System Settings

Adjust the system sensitivity and intensity through the display screen. See **General Information** (page 64). The system remembers the last selection. You do not need to readjust the setting each time you switch on your vehicle.

Sensitivity: This setting allows you to select where you would like to receive the alert within the lane. Increasing the sensitivity setting moves the warning zones in closer to your vehicle.

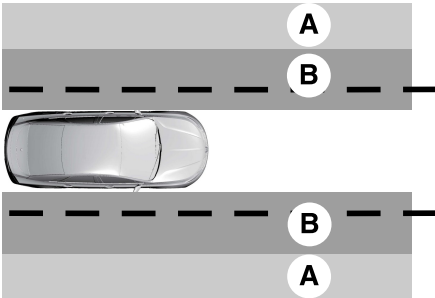

- A Normal
- B Increased

Note: The alert diagram illustrates general zone coverage. It does not provide exact zone parameters.

System Display



When you switch on the system, a graphic with lane markings appears in the display screen.

Note: The overhead vehicle graphic may still display if adaptive cruise control is enabled.

While the system is on, the color of the lane markings change to indicate the system status.

Gray: Indicates that the system is temporarily unable to provide a warning on the indicated side(s). This may be because:

- Your vehicle is below the activation speed.
- The direction indicator is active.
- Your vehicle is in a dynamic maneuver.
- The road has no or poor lane markings in the camera field-of-view.
- Certain conditions can prevent the camera from detecting the lane markings. These conditions can include any of the following: environmental, traffic, vehicle conditions, significant sun angles, shadows, snow, heavy rain or fog, following a large vehicle that is blocking or shadowing the lane, or poor headlamp illumination.

Driving Aids

See **Troubleshooting** for additional information.

Green: Indicates that the system is available or ready to provide a warning on the indicated side(s).

Red: Indicates that the system is providing or has just provided a lane keeping alert warning.

You can temporarily disable the system at any time by doing the following:

- Quick braking.
- Fast acceleration.
- Using your direction indicator.
- Evasive steering maneuver.
- Driving too close to the lane markings.

Troubleshooting

Why is the feature not available (line markings are gray) when I can see the lane markings on the road?
Your vehicle speed is outside the operational range of the feature.
The sun is shining directly into the camera lens.
A quick intentional lane change has occurred.
Your vehicle stays too close to the lane markings.
Driving at high speeds in curves.
The last feature activation occurred a short time ago.
Ambiguous lane markings, for example in construction zones.
Rapid transition from light to dark, or from dark to light.
Sudden offset in lane markings.
ABS or AdvanceTrac™ is active.
There is a camera blockage due to dirt, grime, fog, frost or water on the windshield.
You are driving too close to the vehicle in front of you.
Transitioning between no lane markings to lane markings or vice versa.
There is standing water on the road.
Faint lane markings, for example partial yellow lane markings on concrete roads.
Lane width is too narrow or too wide.
No one calibrated the camera after replacing the windshield.
Driving on tight roads or on uneven roads.
Vehicle accessories are blocking the camera, for example a snowplow.

Driving Aids

STEERING

Hydraulic Power Steering

To help prevent damage to the power steering system:

- Do not hold the steering wheel at its furthest turning points for more than three to five seconds when the engine is running.
- Avoid continuously steering back and forth with elevated engine RPM as this may overheat the system. If trying to free a stuck vehicle, pause between attempts to allow the power steering system to cool or seek assistance. Typical steering and driving maneuvers allow the system to cool.
- Do not operate the vehicle if the power steering pump fluid level is below the MIN mark on the reservoir.
- Some noise is normal during operation. If excessive, check for low power steering pump fluid level before seeking service by your dealer.
- Heavy or uneven efforts may be caused by low power steering fluid. Check for low power steering pump fluid level before seeking service by your dealer.
- Do not fill the power steering pump reservoir above the MAX mark on the reservoir, as this may result in leaks from the reservoir.

If the power steering system breaks down or if you switch the engine off, you can steer the vehicle manually, but it takes more effort.

If you have any steering components serviced or replaced, install new fasteners. Many fasteners have coatings with thread adhesive, or have prevailing torque features you cannot reuse. Do not reuse a bolt or nut. Torque fasteners to specifications.

Steering Tips

If the steering wanders or pulls, check for:

- An improperly inflated tire.
- Uneven tire wear.
- Loose or worn suspension components.
- Loose or worn steering components.
- Improper vehicle alignment.

Note: *A high crown in the road or high crosswinds may also make the steering seem to wander or pull.*

PRE-COLLISION ASSIST (IF EQUIPPED)



WARNING: You are responsible for controlling your vehicle at all times. The system is designed to be an aid and does not relieve you of your responsibility to drive with due care and attention. Failure to follow this instruction could result in the loss of control of your vehicle, personal injury or death.





WARNING: The system does not operate during hard acceleration or steering. Failure to take care may lead to a crash or personal injury.



WARNING: The system may operate with reduced function during cold and inclement weather conditions. Snow, ice, rain, spray and fog can adversely affect the system. Keep the front camera and radar free of snow and ice. Failure to follow this instruction may result in the loss of control of your vehicle, serious personal injury or death.

Driving Aids

 **WARNING:** Some situations and objects prevent hazard detection. For example low or direct sunlight, inclement weather, unconventional vehicle types, and pedestrians. Apply the brakes when necessary. Failure to follow this instruction could result in the loss of control of your vehicle, personal injury or death.

 **WARNING:** Take additional care if your vehicle is heavily loaded or you are towing a trailer. These conditions could result in reduced performance of this system. Failure to follow this instruction could result in the loss of control of your vehicle, personal injury or death.

 **WARNING:** The system cannot help prevent all crashes. Do not rely on this system to replace driver judgment and the need to maintain a safe distance and speed.

Using the Pre-Collision Assist System

The pre-collision assist system is active at speeds above 3 mph (5 km/h). Pedestrian detection functions at speeds up to 50 mph (80 km/h).



If your vehicle is rapidly approaching another stationary vehicle or a vehicle traveling in the same direction as yours, the system provides three levels of functionality:

- Alert.
- Brake support.
- Active braking.

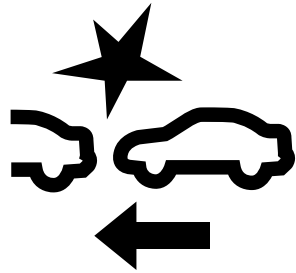

Alert: When active, a flashing visual warning appears and an audible warning tone sounds.

Brake support: Helps reduce the impact speed by preparing the brakes for rapid braking. The system does not automatically apply the brakes. If you press the brake pedal, the system could apply additional braking up to maximum braking force, even if you lightly press the brake pedal.

Active braking: May activate if the system determines that a collision is imminent. The system may help the driver reduce impact damage or avoid the crash completely.

Note: *If you perceive pre-collision assist alerts as being too frequent you can reduce the alert sensitivity, though the manufacturer recommends using the highest sensitivity setting where possible. Setting lower sensitivity would lead to fewer and later system warnings.*

Distance Indication and Alert

Provides the driver with a graphical indication of the time gap to other preceding vehicles traveling in the same direction. The distance indication and alert screen in the instrument cluster display shows one of the following graphics.

Driving Aids

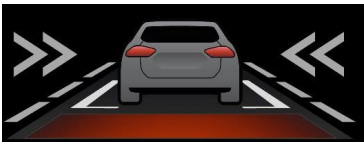
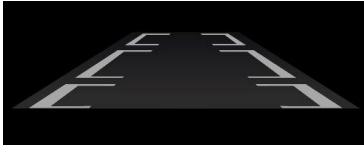

If the time gap to a preceding vehicle is small, a red visual indication displays.

Note: Distance indication and alert deactivates and the graphics do not display when adaptive cruise control is active.

Adjusting the Pre-Collision Assist Settings

You can adjust the following settings by using the instrument cluster display controls. See **General Information** (page 64).

- You can change alert and distance alert sensitivity to one of three possible settings.
- You can switch distance indication and alert on or off.

- If required, you can switch active braking on or off.
- If required, you can switch the pre-collision assist feature on or off.

Note: Active braking automatically turns on every time you switch the ignition on.

Note: Switch the system off if you install a snowplow or similar object in a way that it may block the radar sensor. Your vehicle remembers the selected setting across key cycles.

Blocked Sensors

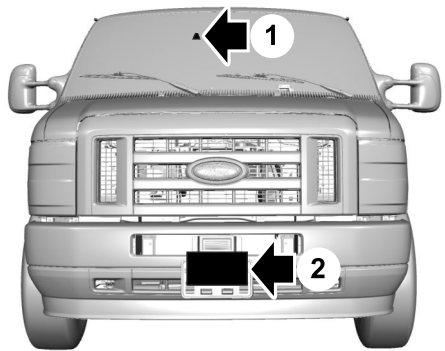

- 1 Camera.
- 2 Radar sensor.

If a message regarding a blocked sensor or camera appears in the instrument cluster display, the radar signals or camera images are obstructed. With a blocked sensor or camera, the pre-collision assist system may not function, or performance may reduce. The following table lists possible causes and actions for when this message displays.

Driving Aids

Camera Troubleshooting

Cause	Action
The windshield in front of the camera is dirty or obstructed in some way.	Clean the outside of the windshield in front of the camera.
The windshield in front of the camera is clean but the message remains in the display screen.	Wait a short time. It may take several minutes for the camera to detect that there is no obstruction.

Radar Troubleshooting

Cause	Action
The surface of the radar in the grille is dirty or obstructed in some way.	Clean the grille surface in front of the radar or remove the object causing the obstruction.
The surface of the radar in the grille is clean but the message remains in the display screen.	Wait a short time. It may take several minutes for the radar to detect that there is no obstruction.
Heavy rain, road spray, snow or fog is interfering with the radar signals.	The pre-collision assist system is temporarily disabled. Pre-collision assist automatically reactivates a short time after the weather conditions improve.
Swirling water or snow or ice on the surface of the road may interfere with the radar signals.	The pre-collision assist system is temporarily disabled. Pre-collision assist automatically reactivates a short time after the weather conditions improve.
Radar is out of alignment due to a front end impact.	Contact an authorized dealer to have the radar checked for proper coverage and operation.

Note: Proper system operation requires a clear view of the road. Repair any windshield damage in the area of the camera's field of view.

Note: If something hits the front end of your vehicle or damage occurs and your vehicle has a radar sensor, the radar sensing zone may change. This could cause missed or false vehicle detections. Contact an authorized dealer to have the radar checked for proper coverage and operation.

Note: If your vehicle detects excessive heat at the camera or a potential misalignment condition, a message may display in the instrument cluster display indicating the sensor is temporarily unavailable. When operational conditions are correct, the message deactivates. For example, when the ambient temperature around the sensor decreases or the sensor automatically recalibrates successfully.

Load Carrying

LOAD LIMIT

Vehicle Loading - with and without a Trailer

This section guides you in the proper loading of your vehicle, trailer, or both. Keep your loaded vehicle weight within its design rating capability, with or without a trailer. Properly loading your vehicle provides maximum return of vehicle design performance. Before you load your vehicle, become familiar with the following terms for determining your vehicle's weight rating, with or without a trailer, from the vehicle's Tire and Loading Information label or Safety Compliance Certification label.

Tire and Loading Label Information Example:



TIRE AND LOADING INFORMATION

SEATING CAPACITY TOTAL: 5 FRONT: 2 REAR: 3
 NOMBRE DE PLACES TOTAL: 5 AVANT: 2 ARRIERE: 3

The combined weight of occupants and cargo should never exceed: **385 kg or 850 lbs.**
 Le poids total des occupants et du chargement ne doit jamais dépasser: **385 kg ou 850 lbs.**

TIRE	SIZE	COLD TIRE PRESSURE
FRONT	235/45R18 94V	235 KPA, 34 PSI
REAR	235/45R18 94V	235 KPA, 34 PSI
SPARE	NONE	NONE

SEE OWNER'S
 MANUAL FOR
 ADDITIONAL
 INFORMATION



TIRE AND LOADING INFORMATION RENSEIGNEMENTS SUR LES PNEUS ET LE CHARGEMENT

SEATING CAPACITY TOTAL 5 FRONT 2 REAR 3
 NOMBRE DE PLACES TOTAL: 5 AVANT: 2 ARRIERE: 3

The combined weight of occupants and cargo should never exceed 396 kg or 875 lbs.
 Le poids total des occupants et du chargement ne doit jamais dépasser 396 kg ou 875 lbs.

TIRE PNEU	SIZE DIMENSIONS	COLD TIRE PRESSURE PRESSION DES PNEUS A FROID
FRONT AVANT	235/40R19 96V	255 KPA, 37 PSI
REAR ARRIERE	235/40R19 96V	255 KPA, 37 PSI
SPARE DE SECOURS	T125/80R16 97M	415 KPA, 60 PSI

SEE OWNER'S
 MANUAL FOR
 ADDITIONAL
 INFORMATION
 VOIR LE MANUEL
 DE L'USAGER
 POUR PLUS DE
 RENSEIGNEMENTS

Payload

Payload is the combined weight of cargo and passengers that your vehicle is carrying. The maximum payload for your vehicle appears on the Tire and Loading label. The label is either on the B-pillar or the edge of the driver door. Vehicles exported outside the US and Canada may not have a tire and loading label. Look for "The combined weight of occupants and cargo should never exceed XXX kg OR XXX lb" for maximum payload. The payload listed on the Tire and Loading Information label

Load Carrying

is the maximum payload for your vehicle as built by the assembly plant. If you install any additional equipment on your vehicle, you must determine the new payload. Subtract the weight of the equipment from the payload listed on the Tire and Loading label. When towing, trailer tongue weight or king pin weight is also part of payload.



WARNING: The appropriate loading capacity of your vehicle can be limited either by volume capacity (how much space is available) or by payload capacity (how much weight the vehicle should carry). Once you have reached the maximum payload of your vehicle, do not add more cargo, even if there is space available. Overloading or improperly loading your vehicle can contribute to loss of vehicle control and vehicle rollover.

GAWR (Gross Axle Weight Rating)

GAWR is the maximum allowable weight that a single axle (front or rear) can carry. These numbers are on the Safety Compliance Certification label. The label is located on the door hinge pillar, door-latch post, or the door edge that meets the door-latch post, next to the driver seating position.



The total load on each axle must never exceed its Gross Axle Weight Rating.

GVWR (Gross Vehicle Weight Rating)

GVWR is the maximum allowable weight of the fully loaded vehicle. This includes all options, equipment, passengers and cargo. It appears on the Safety Compliance Certification label. The label is located on the door hinge pillar, door-latch post, or the door edge that meets the door-latch post, next to the driver seating position.

The gross vehicle weight must never exceed the Gross Vehicle Weight Rating.

Safety Compliance Certification Label Example:

<p style="text-align: center;">MFD. BY FORD MOTOR CO.</p> <p>DATE: XXXX GVWR: XXXX(LB/KG) WITH FRONT GAWR: XXXX(LB) WITH REAR GAWR: XXXX(LB) WITH GVWR: XXXX(LB) WITH TIRE: XXXX WITH PMS: XXXX WITH PSI/COLD AT XXXX kPa/ XXX PSI/COLD</p> <p style="font-size: small;">THIS VEHICLE CONFORMS TO ALL APPLICABLE FEDERAL MOTOR VEHICLE SAFETY AND TIRES PROVISION STANDARDS IN EFFECT ON THE DATE OF MANUFACTURE SHOWN ABOVE.</p> <p>VIN: XXXXXXXXXXXXXXXXXXXX XXXXX XXXXX</p>  <p style="font-size: x-small;">EFFECTIVE DATE: 08/01/2015 EC: 01 EC: 02 EC: 03 EC: 04 EC: 05 EC: 06 EC: 07 EC: 08 EC: 09 EC: 10 EC: 11 EC: 12 EC: 13 EC: 14 EC: 15 EC: 16 EC: 17 EC: 18 EC: 19 EC: 20 EC: 21 EC: 22 EC: 23 EC: 24 EC: 25 EC: 26 EC: 27 EC: 28 EC: 29 EC: 30 EC: 31 EC: 32 EC: 33 EC: 34 EC: 35 EC: 36 EC: 37 EC: 38 EC: 39 EC: 40 EC: 41 EC: 42 EC: 43 EC: 44 EC: 45 EC: 46 EC: 47 EC: 48 EC: 49 EC: 50 EC: 51 EC: 52 EC: 53 EC: 54 EC: 55 EC: 56 EC: 57 EC: 58 EC: 59 EC: 60 EC: 61 EC: 62 EC: 63 EC: 64 EC: 65 EC: 66 EC: 67 EC: 68 EC: 69 EC: 70 EC: 71 EC: 72 EC: 73 EC: 74 EC: 75 EC: 76 EC: 77 EC: 78 EC: 79 EC: 80 EC: 81 EC: 82 EC: 83 EC: 84 EC: 85 EC: 86 EC: 87 EC: 88 EC: 89 EC: 90 EC: 91 EC: 92 EC: 93 EC: 94 EC: 95 EC: 96 EC: 97 EC: 98 EC: 99 EC: 100</p>	<p style="text-align: center;">MFD. BY FORD MOTOR CO.</p> <p>DATE: XXXX GVWR: XXXX(LB/KG) WITH FRONT GAWR: XXXX(LB) WITH REAR GAWR: XXXX(LB) WITH GVWR: XXXX(LB) WITH TIRE: XXXX WITH PMS: XXXX WITH PSI/COLD AT XXXX kPa/ XXX PSI/COLD</p> <p style="text-align: center;">EC</p> <p>AT/A kPa/PSI/LPC XXXX/XXX COLD/A FROD XXXX/XXX TIRE/RES XXXX/XXX</p> <p>VIN: XXXXXXXXXXXXXXXXXXXX XXXXX XXXXX</p>  <p style="font-size: x-small;">EFFECTIVE DATE: 08/01/2015 EC: 01 EC: 02 EC: 03 EC: 04 EC: 05 EC: 06 EC: 07 EC: 08 EC: 09 EC: 10 EC: 11 EC: 12 EC: 13 EC: 14 EC: 15 EC: 16 EC: 17 EC: 18 EC: 19 EC: 20 EC: 21 EC: 22 EC: 23 EC: 24 EC: 25 EC: 26 EC: 27 EC: 28 EC: 29 EC: 30 EC: 31 EC: 32 EC: 33 EC: 34 EC: 35 EC: 36 EC: 37 EC: 38 EC: 39 EC: 40 EC: 41 EC: 42 EC: 43 EC: 44 EC: 45 EC: 46 EC: 47 EC: 48 EC: 49 EC: 50 EC: 51 EC: 52 EC: 53 EC: 54 EC: 55 EC: 56 EC: 57 EC: 58 EC: 59 EC: 60 EC: 61 EC: 62 EC: 63 EC: 64 EC: 65 EC: 66 EC: 67 EC: 68 EC: 69 EC: 70 EC: 71 EC: 72 EC: 73 EC: 74 EC: 75 EC: 76 EC: 77 EC: 78 EC: 79 EC: 80 EC: 81 EC: 82 EC: 83 EC: 84 EC: 85 EC: 86 EC: 87 EC: 88 EC: 89 EC: 90 EC: 91 EC: 92 EC: 93 EC: 94 EC: 95 EC: 96 EC: 97 EC: 98 EC: 99 EC: 100</p>
---	--

Load Carrying



WARNING: Exceeding the Safety Compliance Certification label vehicle weight limits can adversely affect the performance and handling of your vehicle, cause vehicle damage and can result in the loss of control of your vehicle, serious personal injury or death.

Maximum Loaded Trailer Weight

Maximum loaded trailer weight is the highest possible weight of a fully loaded trailer the vehicle can tow. Consult an authorized dealer (or the RV and Trailer Towing Guide available at an authorized dealer) for more detailed information.

GCWR (Gross Combined Weight Rating)

GCWR is the maximum allowable weight of the vehicle and the loaded trailer, including all cargo and passengers, that the vehicle can handle without risking damage. (Important: The towing vehicle's braking system is rated for operation at Gross Vehicle Weight Rating, not at Gross Combined Weight Rating.) Separate functional brakes should

be used for safe control of towed vehicles and for trailers where the Gross Combined Weight of the towing vehicle plus the trailer exceed the Gross Vehicle Weight Rating of the towing vehicle.

The gross combined weight must never exceed the Gross Combined Weight Rating.

Note: For trailer towing information refer to the *RV and Trailer Towing Guide* available at an authorized dealer.



WARNING: Do not exceed the GVWR or the GAWR specified on the certification label.



WARNING: Do not use replacement tires with lower load carrying capacities than the original tires because they may lower your vehicle's GVWR and GAWR limitations. Replacement tires with a higher limit than the original tires do not increase the GVWR and GAWR limitations.



WARNING: Exceeding any vehicle weight rating can adversely affect the performance and handling of your vehicle, cause vehicle damage and can result in the loss of control of your vehicle, serious personal injury or death.

Load Carrying

Steps for determining the correct load limit:

1. Locate the statement "The combined weight of occupants and cargo should never exceed XXX kg or XXX lb." on your vehicle's placard.
2. Determine the combined weight of the driver and passengers that will be riding in your vehicle.
3. Subtract the combined weight of the driver and passengers from XXX kg or XXX lb.
4. The resulting figure equals the available amount of cargo and luggage load capacity. For example, if the "XXX" amount equals 1,400 lb. and there will be five 150 lb. passengers in your vehicle, the amount of available cargo and luggage load capacity is 650 lb.
($1400 - (5 \times 150) = 1400 - 750 = 650$ lb.)
5. Determine the combined weight of luggage and cargo being loaded on the vehicle. That weight may not safely exceed the available cargo and luggage load capacity calculated in Step 4.
6. If your vehicle will be towing a trailer, load from your trailer will be transferred to your vehicle. Consult this manual to determine how this reduces the available cargo and luggage load capacity of your vehicle.

Helpful examples for calculating the available amount of cargo and luggage load capacity

Suppose your vehicle has a 1400-pound (635-kilogram) cargo and luggage capacity. You decide to go golfing. Is there enough load capacity to carry you, four of your friends and all the golf bags? You and four friends average 220 pounds (99 kilograms) each and the golf bags weigh approximately 30 pounds (13.5 kilograms) each. The calculation would be: $1400 - (5 \times 220) - (5 \times 30) = 1400 - 1100 - 150 = 150$ pounds. Yes, you have enough load capacity in your vehicle to transport four friends and your golf bags. In metric units, the calculation would be: $635 \text{ kilograms} - (5 \times 99 \text{ kilograms}) - (5 \times 13.5 \text{ kilograms}) = 635 - 495 - 67.5 = 72.5$ kilograms.

Suppose your vehicle has a 1400-pound (635-kilogram) cargo and luggage capacity. You and one of your friends decide to pick up cement from the local home improvement store to finish that patio you have been planning for the past two years. Measuring the inside of the vehicle with the rear seat folded down, you have room for twelve 100-pound (45-kilogram) bags of cement. Do you have enough load capacity to transport the cement to your home? If you and your friend each weigh 220 pounds (99 kilograms), the calculation would be: $1400 - (2 \times 220) - (12 \times 100) = 1400 - 440$

Load Carrying

- 1200 = - 240 pounds. No, you do not have enough cargo capacity to carry that much weight. In metric units, the calculation would be: 635 kilograms - (2 x 99 kilograms) - (12 x 45 kilograms) = 635 - 198 - 540 = -103 kilograms. You will need to reduce the load weight by at least 240 pounds (104 kilograms). If you remove three 100-pound (45-kilogram) cement bags, then the load calculation would be: 1400 - (2 x 220) - (9 x 100) = 1400 - 440 - 900 = 60 pounds. Now you have the load capacity to transport the cement and your friend home. In metric units, the calculation would be: 635 kilograms - (2 x 99 kilograms) - (9 x 45 kilograms) = 635 - 198 - 405 = 32 kilograms.

handle differently than unloaded vehicles. Take extra precautions, such as slower speeds and increased stopping distance, when driving a heavily loaded vehicle.

The above calculations also assume that the loads are positioned in your vehicle in a manner that does not overload the front or the rear gross axle weight rating specified for your vehicle on the Safety Compliance Certification label.

Special Loading Instructions for Owners of Pick-up Trucks and Utility-type Vehicles



WARNING: When loading the roof racks, we recommend you evenly distribute the load, as well as maintain a low center of gravity. Loaded vehicles, with higher centers of gravity, may

Towing

TOWING A TRAILER



WARNING: Do not exceed the GVWR or the GAWR specified on the certification label.



WARNING: Towing trailers beyond the maximum recommended gross trailer weight exceeds the limit of your vehicle and could result in engine damage, transmission damage, structural damage, loss of vehicle control, vehicle rollover and personal injury.

Your vehicle may have electrical items, for example fuses or relays, related to towing. See **Fuses** (page 150).

Your vehicle's load capacity designation is by weight, not by volume, so you cannot necessarily use all available space when loading your vehicle.

Towing a trailer places an extra load on your vehicle's engine, transmission, axle, brakes, tires and suspension. Inspect these components periodically during, and after, any towing operation.

Load Placement

To help minimize how trailer movement affects your vehicle when driving:

- Load the heaviest items closest to the trailer floor.
- Load the heaviest items centered between the left and right side trailer tires.
- Load the heaviest items above the trailer axles or just slightly forward toward the trailer tongue. Do not allow the final trailer tongue weight to go above or below 10-15% of the loaded trailer weight.
- Select a draw bar with the correct rise or drop. When both the loaded vehicle and trailer are connected, the trailer frame should be level, or slightly angled down toward your vehicle, when viewed from the side.

When driving with a trailer or payload, a slight takeoff vibration or shudder may be present due to the increased payload weight. Additional information regarding correct trailer loading and setting your vehicle up for towing is located in another chapter of this Owner's Manual. See **Load Limit** (page 122). You can also find the information in the RV & Trailer Towing Guide. See an authorized dealer.

Towing

RECOMMENDED TOWING WEIGHTS

Market	Website
United States of America	https://www.fleet.ford.com/towing-guides/
Canada	https://www.fleet.ford.ca/towing-guides/

Towing

ESSENTIAL TOWING CHECKS

Follow these guidelines for safe towing:

- Do not tow a trailer until you drive your vehicle at least 1,000 mi (1,600 km).
- Consult your local motor vehicle laws for towing a trailer.
- See the instructions included with towing accessories for the proper installation and adjustment specifications.
- Service your vehicle more frequently if you tow a trailer. See your scheduled maintenance information. See **Scheduled Maintenance** (page 249).
- If you use a rental trailer, follow the instructions the rental agency gives you.

See **Load limits** in the Load Carrying chapter for load specification terms found on the tire label and Safety Compliance label and instructions on calculating your vehicle's load.

Remember to account for the trailer tongue weight as part of your vehicle load when calculating the total vehicle weight.

Trailer Towing Connector



When attaching the trailer wiring connector to your vehicle, only use a proper fitting connector that works with the vehicle and trailer functions. Some seven-position connectors may have the SAE J2863 logo, which confirms that it is the proper wiring connector and works correctly with your vehicle.

Color	Function
Yellow	Left turn signal and stop lamp
White	Ground (-)
Blue	Electric brakes
Green	Right turn signal and stop lamp
Orange	Battery (+)
Brown	Running lights
Grey	Reverse lights

Hitches

Do not use a hitch that either clamps onto the bumper or attaches to the axle. You must distribute the load in your trailer so that 10-15% of the total weight of the trailer is on the tongue.

Weight-distributing Hitches

WARNING: Do not adjust the spring bars so that your vehicle's rear bumper is higher than before attaching the trailer. Doing so will defeat the function of the weight-distributing hitch, which may cause unpredictable handling, and could result in serious personal injury.

When connecting a trailer using a weight-distributing hitch, always use the following procedure:

Towing

1. Park the loaded vehicle, without the trailer, on a level surface.
2. Measure the height to the top of your vehicle's front wheel opening on the fender. This is H1.
3. Attach the loaded trailer to your vehicle without the weight-distributing bars connected.
4. Measure the height to the top of your vehicle's front wheel opening on the fender a second time. This is H2.
5. Install and adjust the tension in the weight-distributing bars so that the height of your vehicle's front wheel opening on the fender is approximately halfway down from H2, toward H1.
6. Check that the trailer is level or slightly nose down toward your vehicle. If not, adjust the ball height accordingly and repeat Steps 2-6.

When the trailer is level or slightly nose down toward the vehicle:

- Lock the bar tension adjuster in place.
- Check that the trailer tongue securely attaches and locks onto the hitch.
- Install safety chains, lighting and trailer brake controls as required by law or the trailer manufacturer.

Safety Chains

Note: *Do not attach safety chains to the bumper.*

Always connect the safety chains to the frame or hook retainers of your vehicle hitch.

To connect the safety chains, cross the chains under the trailer tongue and allow enough slack for turning tight corners. Do not allow the chains to drag on the ground.

Trailer Brakes



WARNING: Do not connect a trailer's hydraulic brake system directly to your vehicle's brake system. Your vehicle may not have enough braking power and your chances of having a collision greatly increase.

Electric brakes and manual, automatic or surge-type trailer brakes are safe if you install them properly and adjust them to the manufacturer's specifications. The trailer brakes must meet local and federal regulations.

The rating for the tow vehicle's braking system operation is at the gross vehicle weight rating, not the gross combined weight rating.

Separate functioning brake systems are required for safe control of towed vehicles and trailers weighing more than 1500 lb (680 kg) when loaded.

Integrated Trailer Brake Controller (If Equipped)



WARNING: Use the integrated trailer brake controller to properly adjust the trailer brakes and check all connections before towing a trailer. Failure to follow this instruction could result in the loss of control of your vehicle, personal injury or death.

Note: *The Ford trailer brake controller has been verified to be compatible with trailers having electric-actuated drum brakes (one to four axles) and electric-over-hydraulic brakes. It will not activate hydraulic surge-style trailer brakes. It is the responsibility of the customer to ensure that the trailer brakes are adjusted appropriately, functioning normally and all electric connections are properly made.*

Towing

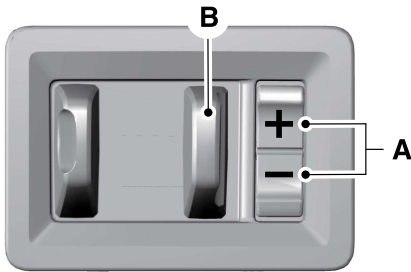

E183395

When used properly, the trailer brake controller assists in smooth and effective trailer braking by powering the trailer's electric or electric-over-hydraulic brakes with a proportional output based on the towing vehicle's brake pressure.

The controller user interface consists of the following:

A: + and - (Gain adjustment buttons): Pressing these buttons adjusts the controller's power output to the trailer brakes in 0.5 increments. You can increase the gain setting to 10.0 (maximum trailer braking) or decrease it to 0 (no trailer braking). The gain setting displays in the message center.

The controller shows gain setting, output bar graph, and trailer connectivity status in the information display. They appear in the information display as follows:

- Trailer Brake Controller Gain (without trailer connected): Shows the current gain setting during a given ignition cycle and when adjusting the gain. This also displays if you use the manual control lever or make gain adjustments with no trailer connected.
- Trailer Brake Controller Gain Output: Displays when you push your vehicle's brake pedal, or upon use of the manual control. Bar indicators illuminate in the information display to indicate the amount of power going to the trailer brakes relative to the brake pedal or manual control input. One bar indicates the least amount of output; six bars indicate maximum output.
- Trailer Connected: Displays when the system senses a correct trailer wiring connection (a trailer with electric trailer brakes) during a given ignition cycle.
- Trailer Disconnected: Displays, accompanied by a single audible tone, when the system senses a trailer connection and then a disconnection, either intentional or unintentional, during a given ignition cycle. It also displays if a truck or trailer-wiring fault occurs causing the trailer to appear disconnected. This message also displays if you use the manual control lever without a trailer connected.

B: Manual control lever: Slide the control lever to the left to switch on the trailer's electric brakes independent of the tow vehicle's. See **Procedure for Adjusting Gain** section for instructions on proper use of this feature. If you use the manual control while the brake is also applied, the greater of the two inputs determines the power sent to the trailer brakes.

Towing

- **Stoplamps:** Using the manual control lever illuminates both the trailer brake lamps and your vehicle brake lamps except the center high mounted stoplamp, if you make the proper electrical connection to the trailer. Pressing your vehicle brake pedal also illuminates both trailer and vehicle brake lamps.
- 5. In a traffic-free environment, tow the trailer on a dry, level surface at a speed of 20-25 mph (30-40 km/h) and squeeze the manual control lever completely.
- 6. If the trailer wheels lock up, indicated by squealing tires, reduce the gain setting. If the trailer wheels turn freely, increase the gain setting. Repeat Steps 5 and 6 until the gain setting is at a point just below trailer wheel lock-up. If towing a heavier trailer, trailer wheel lock-up may not be attainable even with the maximum gain setting of 10.

Procedure for Adjusting Gain

Note: Only perform this procedure in a traffic-free environment at speeds of approximately 20-25 mph (30-40 km/h).

The gain setting sets the trailer brake controller for the specific towing condition. You should change the setting as towing conditions change. Changes to towing conditions include trailer load, vehicle load, road conditions and weather.

Set the gain to provide the maximum trailer braking assistance while making sure the trailer wheels do not lock when using the brakes. Locked trailer wheels may lead to trailer instability.

1. Make sure the trailer brakes are in good working condition, functioning normally and properly adjusted. See your trailer dealer if necessary.
2. Connect the trailer and make the electrical connections according to the trailer manufacturer's instructions.
3. When you plug in a trailer with electric or electric-over-hydraulic brakes, a message confirming connection appears in the information display.
4. Use the gain adjustment (+ and -) buttons to increase or decrease the gain setting to the desired starting point. A gain setting of 6.0 is a good starting point for heavier loads.

Explanation of Information Display Warning Messages

Note: An authorized dealer can diagnose the trailer brake controller to determine exactly which trailer fault has occurred. However, your Ford warranty does not cover this diagnosis if the fault is with the trailer.

A message indicating a trailer brake module fault may display in response to faults sensed by the trailer brake controller, accompanied by a single tone. If this message appears, contact an authorized dealer as soon as possible for diagnosis and repair. The controller may still function, but performance may be degraded.

A message indicating a trailer wiring fault may display when there is a short circuit on the electric brake output wire. If this message displays, accompanied by a single tone, with no trailer connected, the problem is with your vehicle wiring between the trailer brake controller and the 7-pin connector at the bumper. If the message only displays with a trailer connected, the problem is with the trailer

Towing

wiring. Consult your trailer dealer for assistance. This can be a short to ground (such as a chaffed wire), short to voltage (such as a pulled pin on trailer emergency breakaway battery) or the trailer brakes may be drawing too much current.

Points to Remember

Note: Do not attempt removal of the trailer brake controller without consulting the Workshop Manual. Damage to the unit may result.

- Adjust gain setting before using the trailer brake controller for the first time.
 - Adjust gain setting, see **Procedure for Adjusting Gain**, whenever road, weather and trailer or vehicle loading conditions change from when the gain was initially set.
 - Only use the manual control lever for proper adjustment of the gain during trailer setup. Misuse, such as application during trailer sway, could cause instability of trailer or tow vehicle.
 - Avoid towing in adverse weather conditions. The trailer brake controller does not provide anti-lock control of the trailer wheels. Trailer wheels can lock up on slippery surfaces, resulting in reduced stability of trailer and tow vehicle.
 - The trailer brake controller is equipped with a feature that reduces output at vehicle speeds below 11 mph (18 km/h) so trailer and vehicle braking is not jerky or harsh. This feature is only available when applying the brakes using your vehicle's brake pedal, not the controller.
 - The controller interacts with the brake control system and powertrain control system of your vehicle to provide the best performance on different road conditions.
- Your vehicle's brake system and the trailer brake system work independently of each other. Changing the gain setting on the controller does not affect the operation of your vehicle's brakes whether you attach a trailer or not.
 - When you switch the engine off, the controller output is disabled and the display and module shut down. The controller module and display turn on when you switch the ignition on.
 - The trailer brake controller is only a factory-installed or dealer-installed item. Ford is not responsible for warranty or performance of the controller due to misuse or customer installation.

Trailer Lamps



WARNING: Never connect any trailer lamp wiring to the vehicle's tail lamp wiring; this may damage the electrical system resulting in fire. Contact your authorized dealer as soon as possible for assistance in proper trailer tow wiring installation. Additional electrical equipment may be required.

Trailer lamps are required on most towed vehicles. Make sure all running lights, brake lights, direction indicators and hazard lights are working.

Before Towing a Trailer

Practice turning, stopping and backing up to get the feel of your vehicle-trailer combination before starting on a trip. When turning, make wider turns so the trailer wheels clear curbs and other obstacles.

Towing

When Towing a Trailer

- Do not drive faster than 70 mph (113 km/h) during the first 500 mi (800 km).
 - Do not make full-throttle starts.
 - Check your hitch, electrical connections and trailer wheel lug nuts thoroughly after you have traveled 50 mi (80 km).
 - When stopped in congested or heavy traffic during hot weather, place the gearshift in park (P) to aid engine and transmission cooling and to help A/C performance.
 - Switch off the speed control with heavy loads or in hilly terrain. The speed control may turn off automatically when you are towing on long, steep grades.
 - Shift to a lower gear when driving down a long or steep hill. Do not apply the brakes continuously, as they may overheat and become less effective.
 - If your transmission is equipped with a Grade Assist or Tow/Haul feature, use this feature when towing. This provides engine braking and helps eliminate excessive transmission shifting for optimum fuel economy and transmission cooling.
 - If your vehicle is equipped with AdvanceTrac with roll stability control, this system may turn on during typical cornering maneuvers with a heavily loaded trailer. This is normal. Turning the corner at a slower speed while towing may reduce this tendency.
 - Allow more distance for stopping with a trailer attached. Anticipate stops and brake gradually.
 - Avoid parking on a grade. However, if you must park on a grade:
1. Turn the steering wheel to point your vehicle tires away from traffic flow.

2. Set your vehicle parking brake.
3. Place the automatic transmission in park (P).
4. Place wheel chocks in front and back of the trailer wheels. (Chocks not included with vehicle.)

Your vehicle may be equipped with a temporary or conventional spare tire. A temporary spare tire is different in size (diameter or width), tread-type (All-Season or All Terrain) or is from a different manufacturer than the road tires on your vehicle. Consult information on the tire label or Safety Compliance label for limitations when using.

Launching or Retrieving a Boat or Personal Watercraft (PWC)

Note: *Disconnect the wiring to the trailer before backing the trailer into the water.*

Note: *Reconnect the wiring to the trailer after removing the trailer from the water.*

When backing down a ramp during boat launching or retrieval:

- Do not allow the static water level to rise above the bottom edge of the rear bumper.
- Do not allow waves to break higher than 6 in (15 cm) above the bottom edge of the rear bumper.

Exceeding these limits may allow water to enter vehicle components:

- Causing internal damage to the components.
- Affecting driveability, emissions and reliability.

Replace the rear axle lubricant anytime the rear axle has been submerged in water. Water may have contaminated the rear axle lubricant, which is not normally checked or changed unless a leak is suspected or other axle repair is required.

TOWING THE VEHICLE ON FOUR WHEELS

Emergency Towing



WARNING: If your vehicle has a steering wheel lock make sure the ignition is in the accessory or on position when being towed.

You can flat-tow (all wheels on the ground, regardless of the powertrain or transmission configuration) your disabled vehicle (without access to wheel dollies or vehicle transport trailer) under the following conditions:

- Your vehicle is facing forward so you tow it in a forward direction.
- You shift into neutral (N). If you cannot shift into neutral (N), you may need to override the transmission. See **Transmission** (page 95).
- Maximum speed is 35 mph (56 km/h).
- Maximum distance is 50 mi (80 km).

Recreational Towing

Note: *Put your climate control system in recirculated air mode to prevent exhaust fumes from entering the vehicle. See **Climate Control** (page 73).*

Follow these guidelines if you have a need for recreational vehicle towing. An example of recreational towing would be towing your vehicle behind a motorhome. These guidelines are to make sure you do not damage the transmission during towing.

Do not tow your vehicle with any wheels on the ground, as vehicle or transmission damage may occur. It is recommended to tow your vehicle with all four wheels off the ground, for example when using a vehicle transport trailer. Otherwise, you cannot tow your vehicle.

Driving Hints

REDUCED ENGINE PERFORMANCE



WARNING: If you continue to drive your vehicle when the engine is overheating, the engine could stop without warning. Failure to follow this instruction could result in the loss of control of your vehicle.

If the engine coolant temperature gauge needle moves to the upper limit position, the engine is overheating. See **Gauges** (page 58).

You must only drive your vehicle for a short distance if the engine overheats. The distance you can travel depends on ambient temperature, vehicle load and terrain. The engine continues to operate with limited power for a short period of time.

If the engine temperature continues to rise, the fuel supply to the engine reduces. The air conditioning switches off and the engine cooling fan operates continually.

1. Gradually reduce your speed and stop your vehicle as soon as it is safe to do so.
2. Immediately switch the engine off to prevent severe engine damage.
3. Wait for the engine to cool down.
4. Check the coolant level. See **Engine Coolant Check** (page 165).
5. Have your vehicle checked as soon as possible.

ECONOMICAL DRIVING

Fuel economy is affected by several things such as how you drive, the conditions you drive under and how you maintain your vehicle.

There are some things to keep in mind that may improve fuel economy:

- Accelerate and slow down in a smooth, moderate fashion.
- Drive at reasonable and steady speeds.
- Anticipate stops.
- Minimize stop and go driving.
- Close the windows when driving at higher speed.
- Keep the tires properly inflated and use only the recommended size.
- Use the recommended engine oil.
- Perform all regularly scheduled maintenance.

Avoid these actions; they reduce fuel economy:

- Sudden or hard accelerations.
- Revving the engine before turning it off.
- Idle for periods longer than one minute.
- Warm up your vehicle on cold mornings.
- Using air conditioning.
- Using speed control in hilly terrain.
- Resting your foot on the brake pedal while driving.
- Driving with the wheels out of alignment.

Conditions:

- Adding certain accessories to your vehicle may reduce fuel economy. For example, bug deflectors, rollbars, light bars, running boards, ski racks or luggage racks.
- Using fuel blended with alcohol may lower fuel economy.
- Fuel economy may decrease with lower temperatures during the first 5–10 mi (12–16 km) of driving.

Driving Hints

- Driving on flat terrain offers improved fuel economy as compared to driving on hilly terrain.
- Transmissions give their best fuel economy when operated in the top cruise gear and with steady pressure on the gas pedal.

BREAKING-IN

You need to break in new tires for approximately 300 mi (480 km). During this time, your vehicle may exhibit some unusual driving characteristics.

Avoid driving too fast during the first 1,000 mi (1,600 km). Vary your speed frequently and change up through the gears early. Do not labor the engine.

Do not tow during the first 1,000 mi (1,600 km).

DRIVING THROUGH WATER



WARNING: Do not drive through flowing or deep water as you may lose control of your vehicle.

Note: *Driving through standing water can cause vehicle damage.*

Note: *Engine damage can occur if water enters the air filter.*

Before driving through standing water, check the depth. Never drive through water that is higher than the bottom of the wheel hubs.

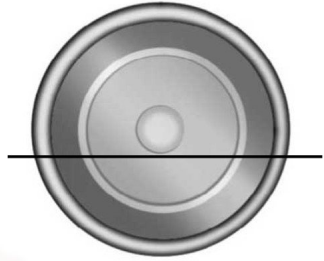

When driving through standing water, drive very slowly and do not stop your vehicle. Your brake performance and traction may be limited. After driving through water and as soon as it is safe to do so:

- Lightly press the brake pedal to dry the brakes and to check that they work.
- Check that the horn works.
- Check that the exterior lights work.
- Turn the steering wheel to check that the steering power assist works.

FLOOR MATS



WARNING: Use a floor mat designed to fit the footwell of your vehicle that does not obstruct the pedal area. Failure to follow this instruction could result in the loss of control of your vehicle, personal injury or death.



WARNING: Pedals that cannot move freely can cause loss of vehicle control and increase the risk of serious personal injury.

Driving Hints



WARNING: Secure the floor mat to both retention devices so that it cannot slip out of position and interfere with the pedals. Failure to follow this instruction could result in the loss of control of your vehicle, personal injury or death.



WARNING: Do not place additional floor mats or any other covering on top of the original floor mats. This could result in the floor mat interfering with the operation of the pedals. Failure to follow this instruction could result in the loss of control of your vehicle, personal injury or death.



WARNING: Always make sure that objects cannot fall into the driver foot well while your vehicle is moving. Objects that are loose can become trapped under the pedals causing a loss of vehicle control.

Note: Regularly check the floor mats to make sure they are secure.



To install floor mats that have eyelets, position the floor mat eyelet over the retention post and press down to lock in position. Repeat for all eyelets on the floor mat.

To remove the floor mats, reverse the installation procedure.

Roadside Emergencies

HAZARD FLASHERS

Note: If used when the vehicle is not running, the battery loses charge. As a result, there may be insufficient power to restart your vehicle.

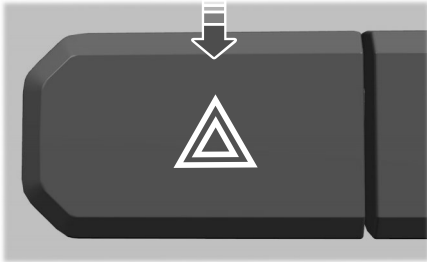

The hazard flasher control is located on the instrument panel. Use it when your vehicle is creating a safety hazard for other motorists.

- Press the flasher control and all front and rear direction indicators flash.
- Press the flasher control again to switch them off.

JUMP STARTING THE VEHICLE

WARNING: Batteries normally produce explosive gases which can cause personal injury. Therefore, do not allow flames, sparks or lighted substances to come near the battery. When working near the battery, always shield your face and protect your eyes. Always provide correct ventilation.

WARNING: Keep batteries out of reach of children. Batteries contain sulfuric acid. Avoid contact with skin, eyes or clothing. Shield your eyes when working near the battery to protect against possible splashing of acid solution. In case of acid contact with skin or eyes, flush immediately with water for a minimum of 15 minutes and get prompt medical attention. If acid is swallowed, call a physician immediately.

WARNING: Use only adequately sized cables with insulated clamps.

Preparing Your Vehicle

Do not attempt to push-start your automatic transmission vehicle.

Note: Attempting to push-start a vehicle with an automatic transmission may cause transmission damage.

Note: Use only a 12-volt supply to start your vehicle.

Note: Do not disconnect the battery of the disabled vehicle as this could damage the vehicle electrical system.

Park the booster vehicle close to the hood of the disabled vehicle, making sure the two vehicles do not touch.

Connecting the Jumper Cables

WARNING: Do not connect the negative jumper cable to any other part of your vehicle. Use the ground point.

WARNING: Make sure that the cables are clear of any moving parts and fuel delivery system parts.

Roadside Emergencies

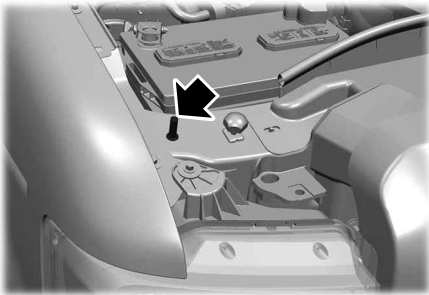

Note: See the previous image for your vehicle's assigned ground connection point.

1. Connect the positive (+) jumper cable to the positive (+) terminal of the discharged battery.
2. Connect the other end of the positive (+) cable to the positive (+) terminal of the booster vehicle battery.
3. Connect the negative (-) cable to the negative (-) terminal of the booster vehicle battery.
4. Make the final connection of the negative (-) cable to the ground connection point.

Jump Starting

1. Start the engine of the booster vehicle and rev the engine moderately, or press the accelerator gently to keep your engine speed between 2000 and 3000 RPM, as shown in your tachometer.
2. Start the engine of the disabled vehicle.
3. Once the disabled vehicle has been started, run both vehicle engines for an additional three minutes before disconnecting the jumper cables.

Removing the Jumper Cables

Remove the jumper cables in the reverse order that they were connected.

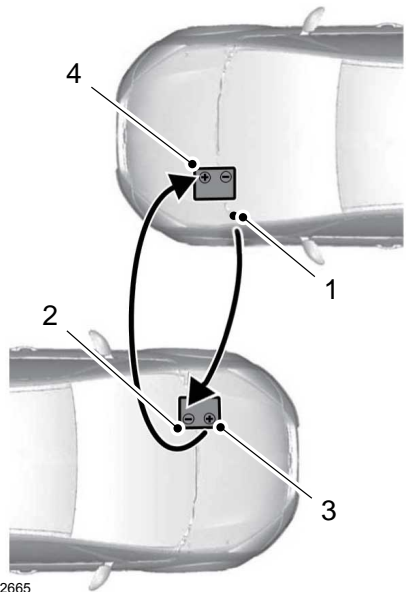

E142665

1. Remove the negative (-) jumper cable from the disabled vehicle.
2. Remove the jumper cable from the negative (-) terminal of the booster vehicle battery.
3. Remove the jumper cable from the positive (+) terminal of the booster vehicle battery.
4. Remove the jumper cable from the positive (+) terminal of the disabled vehicle battery.
5. Allow the engine to idle for at least one minute.

TRANSPORTING THE VEHICLE



WARNING: Block the wheels to help prevent the vehicle from moving.

Roadside Emergencies



WARNING: Unexpected and possibly sudden vehicle movement may occur if you do not take these precautions.

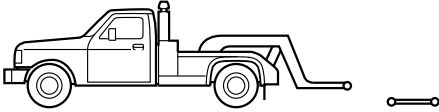

Ford Motor Company produces a towing manual for all authorized tow truck operators. Have your tow truck operator refer to this manual for proper hook-up and towing procedures for your vehicle.

It is acceptable to have your two-wheel drive vehicle towed with the front wheels on the ground (without dollies) and the rear wheels off the ground.

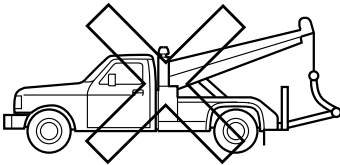
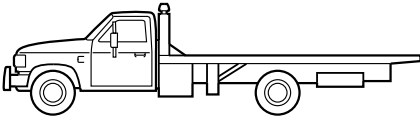

If you need to have your vehicle towed, contact a professional towing service or, if you are a member of a roadside assistance program, your roadside assistance service provider.

We recommend the use of a wheel lift and dollies or flatbed equipment to tow your vehicle. Do not tow with a slingbelt. Ford Motor Company has not approved a slingbelt towing procedure. Vehicle damage may occur if towed incorrectly, or by any other means.

Crash and Breakdown Information

ROADSIDE ASSISTANCE

Vehicles Sold in the United States: Getting Roadside Assistance

If you have a vehicle concern, Ford Motor Company offers a complimentary roadside assistance program. This program is separate from the New Vehicle Limited Warranty.

The service is available:

- 24 hours a day, seven days a week.
- For the coverage period supplied with your vehicle.

Knowing your vehicle's VIN, mileage and your specific location allows help to get to you faster.

Roadside Assistance covers:

- A flat tire change with a good spare (except vehicles supplied with a tire inflation kit).
- Battery jump start.
- Lock-out assistance (key replacement cost is the customer's responsibility).
- Fuel delivery — independent service contractors, if not prohibited by state, local or municipal law, shall deliver up to 2 gal (8 L) of gasoline or 5 gal (20 L) of diesel fuel to a disabled vehicle. Roadside assistance limits fuel delivery service to two no-charge occurrences within a 12-month period.
- Winch out — available within 100 ft (30 m) of a paved or county maintained road, no recoveries.

- Towing — independent service contractors, if not prohibited by state, local or municipal law, shall tow Ford eligible vehicles to an authorized dealer within 50 mi (80 km) of the disablement location or to the nearest authorized dealer. If a member requests a tow to an authorized dealer that is more than 50 mi (80 km) from the disablement location, the member shall be responsible for any mileage costs in excess of 50 mi (80 km). Warranty towing, non-warranty towing and collision towing are available.
- Roadside Assistance includes up to \$200 for a towed trailer if the disabled eligible vehicle requires service at the nearest authorized dealer. If the towing vehicle is operational but the trailer is not, then the trailer does not qualify for any roadside services.

Vehicles Sold in the United States: Using Roadside Assistance

United States vehicle customers who require Roadside Assistance, call 1-800-241-3673.

If you need to arrange roadside assistance on your own, Ford Motor Company reimburses a reasonable amount for towing to the nearest dealership within 50 mi (80 km). To obtain reimbursement information, United States vehicle customers call 1-800-241-3673. Customers need to submit their original receipts.

Vehicles Sold in Canada: Getting Roadside Assistance

If you have a vehicle concern, Ford Motor Company of Canada, Limited offers a complimentary roadside assistance program. This program is eligible within Canada or the continental United States.

The service is available 24 hours a day, seven days a week.

Crash and Breakdown Information

This program is separate from the New Vehicle Limited Warranty, but the coverage is concurrent with the powertrain coverage period of your vehicle. Canadian roadside coverage and benefits may differ from the U.S. coverage. For complete details, see your Warranty Guide at www.ford.com/support/warranty/.

Download the Sykes4Ford Roadside Assistance App for access to your roadside assistance services.

If you require more information, please call us in Canada at 1-800-665-2006, or visit our website at www.ford.ca.

Ford Motor Company reserves the right to modify or discontinue Roadside Assistance at any time. Certain restrictions apply to Roadside Assistance benefits.

For further details, call
1-800-241-3673 (United States)
1-800-665-2006 (Canada)

POST-COLLISION BRAKING

How Does Post-Collision Braking Work

In the event of a moderate to severe crash, the braking system reduces the vehicle's speed to prevent or reduce the impact of a potential secondary crash.

Post-Collision Braking Limitations

Post-collision braking does not activate if any of the following occur:

- The anti-lock braking system is damaged during the collision.
- Electronic stability control is disabled.

Overriding Post-Collision Braking

You can override post-collision braking by pressing the brake or accelerator pedal.

Post-Collision Braking Indicators



It flashes when a post-collision braking event is occurring.

AUTOMATIC CRASH SHUTOFF

WHAT IS AUTOMATIC CRASH SHUTOFF

The automatic crash shutoff is designed to stop the fuel going to the engine in the event of a moderate or severe crash.

Note: *Not every impact causes a shutoff.*

AUTOMATIC CRASH SHUTOFF PRECAUTIONS



WARNING: If your vehicle has been involved in a crash, have the fuel system checked. Failure to follow this instruction could result in fire, personal injury or death.

RE-ENABLING YOUR VEHICLE

1. Switch the ignition off.
2. Attempt to start your vehicle.
3. Switch the ignition off.
4. Attempt to start your vehicle.

Note: *If your vehicle does not start after the third attempt, have your vehicle checked as soon as possible.*

Customer Assistance

GETTING THE SERVICES YOU NEED

Warranty repairs to your vehicle must be performed by an authorized dealer. While any authorized dealer handling your vehicle line will provide warranty service, we recommend you return to your selling authorized dealer who wants to ensure your continued satisfaction.

Please note that certain warranty repairs require special training and equipment, so not all authorized dealers are authorized to perform all warranty repairs. This means that, depending on the warranty repair needed, you may have to take your vehicle to another authorized dealer.

A reasonable time must be allowed to perform a repair after taking your vehicle to the authorized dealer. Repairs will be made using Ford or Motorcraft® parts, or remanufactured or other parts that are authorized by Ford.

Away From Home

If you are away from home when your vehicle needs service, contact the Ford Customer Relationship Center or use the online resources listed below to find the nearest authorized dealer.

In the United States:

Mailing address

Ford Motor Company
Customer Relationship Center
P.O. Box 6248
Dearborn, MI 48126

Telephone

1-800-392-3673 (FORD)
(TDD for the hearing impaired:
1-800-232-5952)

If your vehicle is configured as a motorhome please call 1-800-444-3311 for support.

Additional information and resources are available online:

Website
www.owner.ford.com

These are some of the items that can be found online:

- U.S. dealer locator by Dealer Name, City/State or Zip Code.
- Owner Manuals.
- Maintenance Schedules.
- Recalls.
- Ford Extended Service Plans.
- Ford Genuine Accessories.
- Service specials and promotions.

In Canada:

Mailing address

Customer Relationship Centre
Ford Motor Company of Canada, Limited
P.O. Box 2000
Oakville, Ontario L6K 0C8

Telephone

1-800-565-3673 (FORD)
7-1-1 (Customer Service for Deaf and Hard-of-Hearing Customers)

Website
www.ford.ca

Additional Assistance

If you have questions or concerns, or are unsatisfied with the service you are receiving, follow these steps:

1. Contact your Sales Representative or Service Advisor at your selling or servicing authorized dealer.

Customer Assistance

2. If your inquiry or concern remains unresolved, contact the Sales Manager, Service Manager or Customer Relations Manager.
3. If you require assistance or clarification on Ford Motor Company policies, please contact the Ford Customer Relationship Center.

In order to help us serve you better, please have the following information available when contacting a Customer Relationship Center:

- Vehicle Identification Number.
- Your telephone number (home and business).
- The name of the authorized dealer and city where located.
- The vehicle's current odometer reading.

In some states within the United States, you must directly notify Ford in writing before pursuing remedies under your state's warranty laws, and Ford is also allowed a final repair attempt.

Additionally, in some states within the United States, a consumer has the option of submitting a warranty dispute to the BBB Auto Line before taking action under the Magnuson-Moss Warranty Act, or to the extent allowed by state law, before pursuing replacement or repurchase remedies provided by certain state laws. This dispute handling procedure is not required prior to enforcing state created rights or other rights which are independent of the Magnuson-Moss Warranty Act or state replacement or repurchase laws.

IN CALIFORNIA (U.S. ONLY)

California Civil Code Section 1793.2(d) requires that, if a manufacturer or its representative is unable to repair a motor vehicle to conform to the vehicle's applicable express warranty after a reasonable number of attempts, the manufacturer shall be required to either replace the vehicle with one substantially identical or repurchase the vehicle and reimburse the buyer in an amount equal to the actual price paid or payable by the consumer (less a reasonable allowance for consumer use). The consumer has the right to choose whether to receive a refund or replacement vehicle.

California Civil Code Section 1793.22(b) presumes that the manufacturer has had a reasonable number of attempts to conform the vehicle to its applicable express warranties if, within the first 18 months of ownership of a new vehicle or the first 18,000 mi (29,000 km), whichever occurs first:

1. Two or more repair attempts are made on the same non-conformity likely to cause death or serious bodily injury OR
2. Four or more repair attempts are made on the same nonconformity (a defect or condition that substantially impairs the use, value or safety of the vehicle) OR
3. The vehicle is out of service for repair of nonconformities for a total of more than 30 calendar days (not necessarily all at one time).

In the case of 1 or 2 above, the consumer must also notify the manufacturer of the need for the repair of the nonconformity at the following address:

Ford Motor Company
16800 Executive Plaza Drive
Mail Drop 3NE-B
Dearborn, MI 48126

Customer Assistance

You are required to submit your warranty dispute to BBB AUTO LINE before asserting in court any rights or remedies conferred by California Civil Code Section 1793.22(b). You are also required to use BBB AUTO LINE before exercising rights or seeking remedies created by the Federal Magnuson-Moss Warranty Act, 15 U.S.C. sec. 2301 et seq. If you choose to seek redress by pursuing rights and remedies not created by California Civil Code Section 1793.22(b) or the Magnuson-Moss Warranty Act, resort to BBB AUTO LINE is not required by those statutes.

THE BETTER BUSINESS BUREAU (BBB) AUTO LINE PROGRAM (U.S. ONLY)

Your satisfaction is important to Ford Motor Company and to your dealer. If a warranty concern has not been resolved using the three-step procedure outlined earlier in this chapter in the Getting the Services you need section, you may be eligible to participate in the BBB AUTO LINE program.

The BBB AUTO LINE program consists of two parts – mediation and arbitration. During mediation, a representative of the BBB will contact both you and Ford Motor Company to explore options for settlement of the claim. If an agreement is not reached during mediation or you do not want to participate in mediation, and if your claim is eligible, you may participate in the arbitration process. An arbitration hearing will be scheduled so that you can present your case in an informal setting before an impartial person. The arbitrator considers the testimony provided and makes a decision after the hearing.

Disputes submitted to the BBB AUTO LINE program are usually decided within 40 days after you file your claim with the BBB. You are not bound by the decision, and may reject the decision and proceed to court where all findings of the BBB Auto Line dispute, and decision, are admissible in the court action. Should you choose to accept the BBB AUTO LINE decision, Ford is then bound by the decision, and must comply with the decision within 30 days of receipt of your acceptance letter.

BBB AUTO LINE Application: Using the information that follows, please call or write to request a program application. You will be asked for your name and address, general information about your new vehicle, information about your warranty concerns, and any steps you have already taken to try to resolve them. A Customer Claim Form will be mailed that needs to be completed, signed and returned to the BBB along with proof of ownership. Upon receipt, the BBB reviews the claim for eligibility under the Program Summary Guidelines.

You can get more information by calling BBB AUTO LINE at 1-800-955-5100, or writing to:

**BBB AUTO LINE a Division of BBB National Programs, Inc.
1676 International Drive, Suite 550
McLean, VA 22102**

BBB AUTO LINE applications can also be requested by calling the Ford Motor Company Customer Relationship Center at 1-800-392-3673.

For additional information, refer to the Better Business Bureau website.

Note: *Ford Motor Company reserves the right to change eligibility limitations, modify procedures, or to discontinue this process at any time without notice and without obligation.*

Customer Assistance

GETTING ASSISTANCE OUTSIDE THE U.S. AND CANADA

Before exporting your vehicle to a foreign country, contact the appropriate foreign embassy or consulate. These officials can inform you of local vehicle registration regulations and where to find unleaded fuel or petrol/gas engines or the proper sulfur fuel for diesel engines.

If you cannot find the proper fuel recommended for your vehicle, contact our Customer Relationship Center.

The use of improper fuels in your vehicle without proper conversion may damage the effectiveness of your emission control system and may cause engine knocking or serious engine damage. Ford Motor Company or Ford of Canada is not responsible for any damage caused by use of improper fuel. Using improper fuels may also result in difficulty importing your vehicle back into the United States.

If your vehicle must be serviced while you are traveling or living in Asia-Pacific Region, Sub-Saharan Africa, U.S. Virgin Islands and/or Puerto Rico, Central America, the Caribbean, and Israel and the Middle East, contact the nearest authorized dealer. If the authorized dealer cannot help you, contact the corresponding Ford Customer Assistance Center:

FORD MOTOR COMPANY

Customer Relationship Centers in:

Customer Relationship Center	Phone	Fax	E-mail
Asia Pacific	N/A	N/A	apemcrc@ford.com
Caribbean and Central America	+1-800-841-3673	N/A	atnclien@ford.com
Middle East	Ford 80004443673	971 4 3327 266	menacac@ford.com
	Lincoln 80004441067		
	UAE 80004441066		
	Saudi Arabia 8008443673		
	Mobily and Zain cell phone users in Saudi 800850078		
Kuwait 22280384			

Customer Assistance

Customer Relationship Center	Phone	Fax	E-mail
North Africa	N/A	N/A	nafcrc@ford.com
Puerto Rico and U.S. Virgin Islands	+1-800-841-3673	N/A	atnclien@ford.com
Sub-Saharan Africa	N/A	N/A	ssacrc@ford.com
South Korea	+82-02-1600-6003	N/A	infokr1@ford.com or infokr@lincoln.com

If you buy your vehicle in North America and then relocate to any of the above locations, register your vehicle identification number (VIN) and new address with Ford Global Trade Services by emailing, expcso@ford.com.

If you are in another foreign country, contact the nearest authorized dealer. In the event your inquiry is unresolved, communicate your concern with the dealership's Sales Manager, Service Manager or Customer Relations Manager. If you require additional assistance or clarification, please contact the respective Customer Relationship Center as previously listed.

Customers in the U.S. should call 1-800-392-3673.

ORDERING ADDITIONAL OWNER'S LITERATURE

To order the publications in this portfolio, contact Helm, LLC at:

HELM, LLC
47911 Halyard Drive, Suite 200
Plymouth, Michigan 48170
Attention: Customer Service

Or to order a free publication catalog, call toll free: 1-800-782-4356

Monday-Friday 8:00 a.m. - 6:00 p.m. EST

Helm, LLC can also be reached by their website:

www.helminc.com

(Items in this catalog may be purchased by credit card, check or money order.)

Obtaining a French Owner's Manual

French Owner's Manual can be obtained from your authorized dealer or by contacting Helm, LLC using the contact information listed previously in this section.

REPORTING SAFETY DEFECTS (U.S. ONLY)

If you believe that your vehicle has a defect which could cause a crash or could cause injury or death, you should immediately inform the National Highway Traffic Safety Administration (NHTSA) in addition to notifying Ford Motor Company.

Customer Assistance

If NHTSA receives similar complaints, it may open an investigation, and if it finds that a safety defect exists in a group of vehicles, it may order a recall and remedy campaign. However, NHTSA cannot become involved in individual problems between you, your dealer, or Ford Motor Company.

To contact NHTSA, you may call the Vehicle Safety Hotline toll-free at 1-888-327-4236 (TTY: 1-800-424-9153); go to www.safercar.gov; or write to:

Administrator

1200 New Jersey Avenue,
Southeast

Washington, D.C. 20590

You can also obtain other information about motor vehicle safety from www.safercar.gov.

REPORTING SAFETY DEFECTS (CANADA ONLY)

If you believe that your vehicle has a defect which could cause a crash or could cause injury or death, you should immediately inform Transport Canada and Ford of Canada.

Transport Canada Contact Information	
Website (English)	http://tc.canada.ca/recalls
Website (French)	http://tc.canada.ca/rappels
Phone	1-800-333-0510

Website (English)	http://tc.canada.ca/recalls
Website (French)	http://tc.canada.ca/rappels
Phone	1-800-333-0510

Ford of Canada Contact Information	
Website	www.ford.ca
Phone	1-800-565-3673

Website	www.ford.ca
Phone	1-800-565-3673

Fuses

FUSE SPECIFICATION CHART

Engine Compartment Fuse Box



WARNING: Always disconnect the battery before servicing high current fuses.



WARNING: To reduce risk of electrical shock, always replace the cover to the power distribution box before reconnecting the battery or refilling fluid reservoirs.

Note: If your vehicle has dual batteries, disconnecting the primary under hood battery does not remove power from all circuits.

The engine compartment fuse box is in the engine compartment. It has high-current fuses that protect your vehicle's main electrical systems from overloads.

If you disconnect and reconnect the battery, you need to reset some features. See **Changing the 12V Battery** (page 173).

Replace fuses with the same type and rating. See **Changing a Fuse** (page 159).

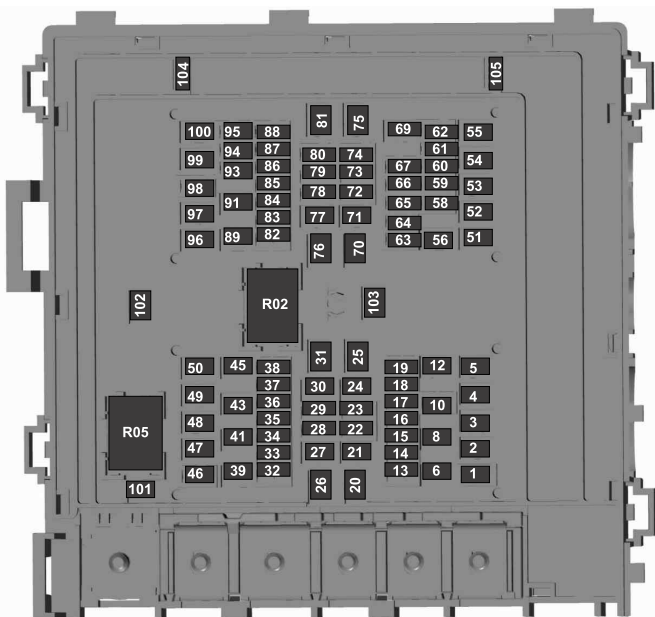

E251921

Fuses

Item	Rating	Protected Component
1	20 A	Horn.
2	50 A	Blower motor.
3	—	Not used.
4	30 A	Starter relay.
5	20 A	Power point 3.
6	20 A	Upfitter relay 4 (cutaway). Not used (spare) (stripped chassis).
8	—	Not used.
10	—	Not used.
12	20 A	Power point 4.
13	10 A	Yaw sensor (stripped chassis). Not used (spare) (cutaway).
14	10 A	Forward looking radar (cutaway). Not used (spare) (stripped chassis).
15	—	Not used.
16	—	Not used.
17	10 A	Powertrain control module run/start feed.
18	10 A	Anti-lock brake system run/start feed.
19	—	Not used.
20	30 A	Wiper power.
21	—	Not used.
22	10 A	Wiper module (stripped chassis). Not used (spare) (cutaway).
23	—	Not used.

Fuses

Item	Rating	Protected Component
24	40 A	Body control module - run power in feed 2.
25	50 A	Body control module - run power in feed 1.
26	—	Not used.
27	20 A	Body builder frame connector.
28	—	Not used.
29	10 A	B+ power 12 V (special order vehicle).
30	30 A	Power driver seat (cutaway). Not used (spare) (stripped chassis).
31	—	Not used.
32	20 A	Vehicle power 1 - Powertrain control module.
33	20 A	Vehicle power 2 - Heater exhaust gas oxygen sensor 11. Heater exhaust gas oxygen sensor 12. Heater exhaust gas oxygen sensor 21. Canister vent solenoid. Canister purge solenoid. Variable camshaft timing.
34	10 A	Vehicle power 3 - Variable oil pressure control. Fan clutch. A/C clutch relay.
35	20 A	Vehicle power 4 - Coil on plug.
36	—	Not used.
37	—	Not used.

Fuses

Item	Rating	Protected Component
38	10 A	Washer relay (stripped chassis). Not used (spare) (cutaway).
39	—	Not used.
41	30 A	Trailer brake control connector.
43	30 A	Instrument panel connector (stripped chassis). Not used (spare) (cutaway).
45	—	Not used.
46	10 A	A/C clutch.
47	40 A	Upfitter relay 1 (cutaway). Not used (spare) (stripped chassis).
48	—	Not used.
49	30 A	Pump electronics module.
50	15 A	Fuel injectors.
51	20 A	Power point 1.
52	50 A	Power at all times Auxiliary A/C prep on B-pillar vehicle connector (cutaway). Not used (spare) (stripped chassis).
53	30 A	Trailer tow park lamps.
54	40 A	Run/start feed on instrument panel connector.
55	20 A	Upfitter 3 relay (cutaway). Not used (spare) (stripped chassis).
56	20 A	Power point 2 prep B-pillar connector.
58	5 A	USB smart charger.

Fuses

Item	Rating	Protected Component
59	10 A	Parking lamps 1 (special order vehicle).
60	—	Not used.
61	—	Not used.
62	—	Not used.
63	—	Not used.
64	—	Not used.
65	—	Not used.
66	—	Not used.
67	—	Not used.
69	—	Not used.
70	40 A	Inverter.
71	30 A	Anti-lock brake system valves.
72	10 A	Brake on and off switch.
73	—	Not used.
74	—	Not used.
75	—	Not used.
76	60 A	Anti-lock brake system pump.
77	30 A	Voltage quality module power - body control module.
78	10 A	Trailer tow stoplamps.
79	—	Not used.
80	10 A	Trailer tow backup lamps.
81	—	Not used.
82	5 A	Upfitter switch (factory location for ignition power).

Fuses

Item	Rating	Protected Component
83	5 A	Upfitter switch (optional location for power at all times).
84	—	Not used.
85	—	Not used.
86	—	Not used.
87	—	Not used.
88	—	Not used.
89	—	Not used.
91	40 A	Hot at all times /B+ power on B-pillar connector (cutaway). Battery power on instrument panel connector (stripped chassis).
93	10 A	Parking lamps 3 (special order vehicle).
94	10 A	Parking lamps 2 (special order vehicle).
95	20 A	Stoplamp relay.
96	—	Not used.
97	50 A	Battery power to engine, B-pillar and instrument panel vehicle connectors.
98	30 A	Trailer tow battery charge.
99	40 A	Upfitter 2 relay (cutaway). Not used (spare) (stripped chassis).
100	—	Not used.
101	—	Not used.
102	—	Not used.
103	—	Not used.

Fuses

Item	Rating	Protected Component
104	—	Not used.
105	15 A	Trailer tow right-hand and left-hand stoplamp and direction indicator relay power.

Note: Spare fuse amperage may vary.

Passenger Compartment Fuse Box



WARNING: Always disconnect the battery before servicing high current fuses.

Note: If your vehicle has dual batteries, disconnecting the primary under hood battery does not remove power from all circuits.

The fuse panel is to the left-hand side of the brake pedal and mounted onto the lower left-hand cowl panel. Remove the fuse panel cover to access the fuses.

To remove a fuse, use the fuse puller tool provided on the inside of the fuse panel cover.

Replace fuses with the same type and rating. See **Changing a Fuse** (page 159).

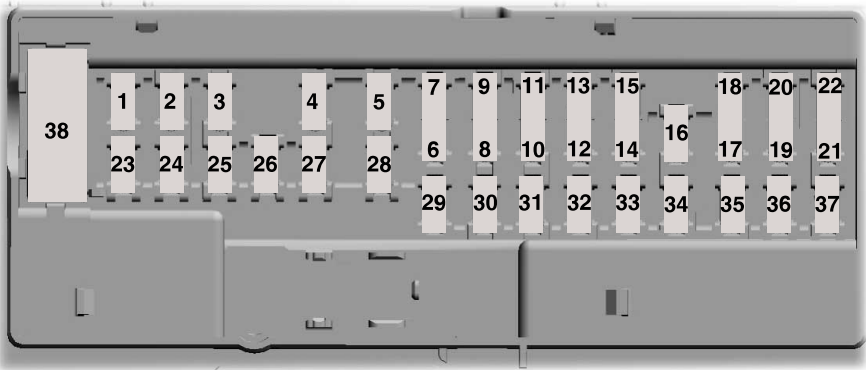

Fuses

Item	Rating	Protected Component
1	—	Not used.
2	10 A	Left-hand front and right-hand front door lock switch (cutaway). Inverter (cutaway). Connector (stripped chassis).
3	7.5 A	Power mirror switch (cutaway).
	—	Not used (stripped chassis).
4	20 A	Not used (spare).
5	20 A	Not used (spare).
6	10 A	Not used (spare).
7	10 A	Not used (spare).
8	5 A	Not used (spare).
9	5 A	Not used (spare).
10	—	Not used.
11	—	Not used.
12	7.5 A	Smart datalink connector.
13	7.5 A	Cluster. Steering column control module.
14	15 A	Not used (spare).
15	15 A	Not used (spare).
16	—	Not used.
17	7.5 A	Not used.
18	7.5 A	Run/start feed for front blend actuator/climate mode switch (cutaway). Run/start feed to stripped chassis connector (stripped chassis).

Fuses

Item	Rating	Protected Component
19	5 A	Radio transceiver module and telematics control unit (cutaway). Telematics control unit (stripped chassis).
20	5 A	Ignition switch.
21	5 A	Not used.
22	5 A	Body builder B-pillar connector (cutaway).
	5 A	Not used (stripped chassis).
23	30 A	Not used (spare).
24	30 A	Not used (spare).
25	20 A	Not used (spare).
26	30 A	Not used (spare).
27	30 A	Not used (spare).
28	30 A	Not used (spare).
29	15 A	Upfitter interface module (cutaway).
	—	Not used (stripped chassis).
30	5 A	Not used (spare).
31	10 A	Smart datalink connector.
32	20 A	Radio (cutaway).
33	—	Not used.
34	30 A	Not used (spare).
35	5 A	Tow haul switch.
36	15 A	Rear view mirror (cutaway). Camera lane departure (cutaway).
	—	Not used (stripped chassis).
37	20 A	Not used (spare).

Fuses

Item	Rating	Protected Component
38	30 A	Power window switches and motors (cutaway).
	—	Not used (stripped chassis).

Note: Spare fuse amperage may vary.

CHANGING A FUSE

Fuses



WARNING: Always replace a fuse with one that has the specified amperage rating. Using a fuse with a higher amperage rating can cause severe wire damage and could start a fire.

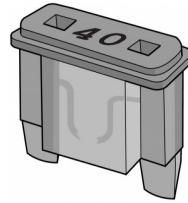

E217331

If electrical components in the vehicle are not working, a fuse may have blown. Blown fuses are identified by a broken wire within the fuse. Check the appropriate fuses before replacing any electrical components.

Fuse Types

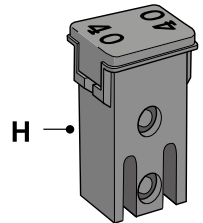
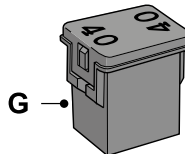
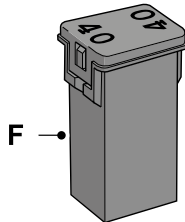
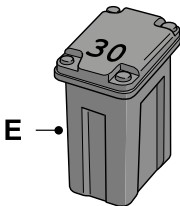
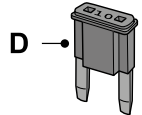
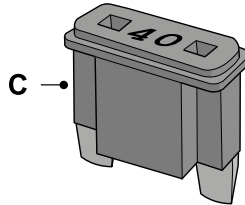
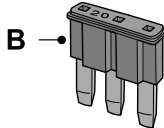
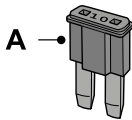

Fuses

- A Micro 2.
- B Micro 3.
- C Maxi.
- D Mini.
- E M Case.
- F J Case.
- G J Case Low Profile.
- H Slotted M Case.

Maintenance

GENERAL INFORMATION

Have your vehicle serviced regularly to help maintain its roadworthiness and resale value. There is a large network of authorized dealers that are there to help you with their professional servicing expertise. We believe that their specially trained technicians are best qualified to service your vehicle properly and expertly. They are supported by a wide range of highly specialized tools developed specifically for servicing your vehicle.

If your vehicle requires professional service, an authorized dealer can provide the necessary parts and service. Check your warranty information to find out which parts and services are covered.

Use only recommended fuels, lubricants, fluids and service parts conforming to specifications. Motorcraft® parts are designed and built to provide the best performance in your vehicle.

Precautions

- Do not work on a hot engine.
- Make sure that nothing gets caught in moving parts.
- Do not work on a vehicle with the engine running in an enclosed space, unless you are sure you have enough ventilation.
- Keep all open flames and other burning material (such as cigarettes) away from the battery and all fuel related parts.

Working with the Engine Off

1. Set the parking brake and shift the transmission to park (P).
2. Switch off the engine.
3. Block the wheels.

Working with the Engine On

WARNING: To reduce the risk of vehicle damage and personal burn injuries, do not start your engine with the air cleaner removed and do not remove it while the engine is running.

1. Set the parking brake and shift the transmission to park (P).
2. Block the wheels.

OPENING AND CLOSING THE HOOD



E196351

1. Inside the vehicle, pull the hood release handle located under the bottom left corner of the instrument panel.
2. Go to the front of the vehicle and push the auxiliary latch, located in the center of the top grille, to the left in order to release the hood.
3. Lift the hood and secure it with the prop rod.
4. To close, lower the hood and make sure that it is closed properly and fully latched.

Maintenance

UNDER HOOD OVERVIEW

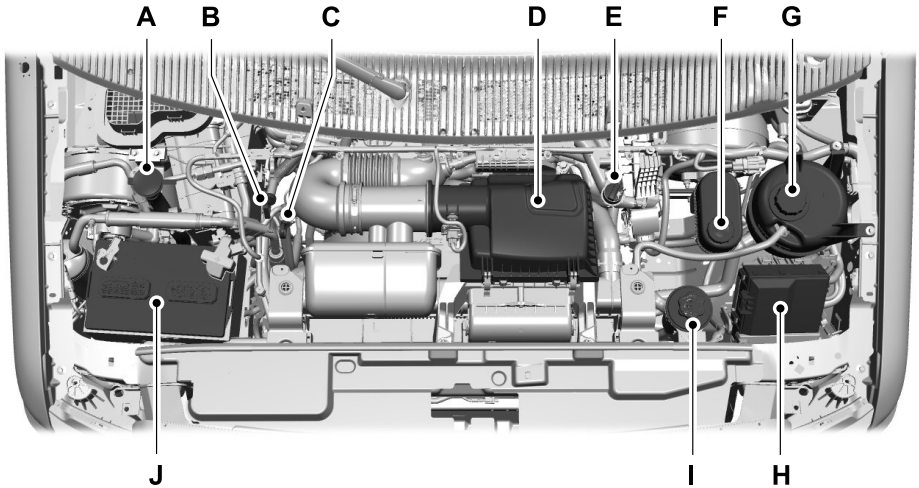

- A Windshield washer fluid reservoir. See **Washer Fluid Check** (page 177).
- B Automatic transmission fluid dipstick. See **Automatic Transmission Fluid Check** (page 170).
- C Engine oil dipstick. See **Engine Oil Dipstick** (page 163).
- D Air cleaner assembly. See **Changing the Engine Air Filter** (page 165).
- E Engine oil filler cap. See **Engine Oil Check** (page 163).
- F Brake fluid reservoir. See **Brake Fluid Check** (page 172).
- G Engine coolant reservoir. See **Engine Coolant Check** (page 165).
- H Engine compartment fuse box. See **Fuses** (page 150).
- I Power steering fluid reservoir. See **Power Steering Fluid Check** (page 173).
- J Battery. See **Changing the 12V Battery** (page 173).

Maintenance

ENGINE OIL DIPSTICK

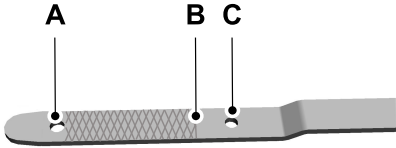

- A Minimum.
- B Nominal.
- C Maximum.

ENGINE OIL CHECK

1. Make sure that your vehicle is on level ground.
2. Check the oil level before starting the engine, or switch the engine off after warm up and wait 15 minutes for the oil to drain into the oil pan.

Note: *Checking the oil level too soon could result in an inaccurate reading.*

3. Remove the dipstick and wipe it with a clean, lint-free cloth.
4. Reinstall the dipstick and make sure it is fully seated.
5. Remove the dipstick again to check the oil level.

Note: *If the oil level is between the maximum and minimum marks, the oil level is acceptable. Do not add oil.*

6. If the oil level is at the minimum mark, immediately add oil.
7. Reinstall the dipstick. Make sure it is fully seated.

Note: *The oil consumption of new engines reaches its normal level after approximately 3,000 mi (5,000 km).*

Note: *Increases in oil level can occur from frequent short trips that do not allow the engine to get to operating temperature, as well as frequent idling or low speed driving for long periods of time.*

Note: *If oil levels are continuously noted above the maximum mark, schedule a visit to your authorized dealer.*

Adding Engine Oil



WARNING: Do not add engine oil when the engine is hot. Failure to follow this instruction could result in personal injury.



WARNING: Do not remove the filler cap when the engine is running.

Do not use supplemental engine oil additives because they are unnecessary and could lead to engine damage that the vehicle warranty may not cover.

1. Clean the area surrounding the engine oil filler cap before you remove it.
2. Remove the engine oil filler cap.
3. Add engine oil that meets our specifications. See **Capacities and Specifications** (page 226).
4. Reinstall the engine oil filler cap. Turn it clockwise until you feel a strong resistance.

Note: *Do not add oil further than the maximum mark. Oil levels above the maximum mark may cause engine damage.*

Note: *Immediately soak up any oil spillage with an absorbent cloth.*

Maintenance

Engine Oil Pressure Warning Lamp



WARNING: If it illuminates when you are driving do not continue your journey, even if the oil level is correct. Have your vehicle checked.



It illuminates when you switch the ignition on.

If it illuminates when the engine is running this indicates a malfunction. Stop your vehicle as soon as it is safe to do so and switch the engine off. Check the engine oil level. If the oil level is sufficient, this indicates a system malfunction. Have your vehicle checked as soon as possible.

OIL CHANGE INDICATOR RESET

Base Cluster

Use the information display controls on the steering wheel to reset the oil change indicator.

From the main menu scroll to:

Message	Action and Description
Driver assist	Press the right arrow button, then from this menu scroll down to the following message.
Maintenance Monitor	Press the right arrow button, then from this menu scroll down to the following message.
Oil Life % Hold to Reset	Press and hold the OK button until the instrument cluster displays the following message.

Message	Action and Description
	Reset Complete
	If the instrument cluster displays the following message, repeat the process.
	Reset Cancelled

High Series Cluster

Use the information display controls on the steering wheel to reset the oil change indicator.

From the main menu scroll to:

Message	Action and Description
Truck Info	Press the down arrow button, then from this menu scroll to the following message.
Maintenance Monitor	Press the OK button.
Oil Life: xxx%	Press the down arrow button, then from this menu scroll to the following message.
Oil Life	Press the OK button.
Oil Life Hold OK to Reset	Press and hold the OK button until the instrument cluster displays the following message. Oil Life: 100%
	When the oil change indicator resets, the instrument cluster displays 100%.
	Repeat the process if the oil change indicator does not reset.

Maintenance

CHANGING THE ENGINE AIR FILTER



WARNING: To reduce the risk of vehicle damage and personal burn injuries, do not start your engine with the air cleaner removed and do not remove it while the engine is running.

Note: Failure to use the correct air filter element may result in severe engine damage. The customer warranty may be void for any damage to the engine if the correct air filter element is not used.

When changing the air filter element, use only the air filter element listed. See **Motorcraft Parts** (page 227). The air filter element should be replaced at the appropriate intervals. See **Normal Scheduled Maintenance** (page 252).

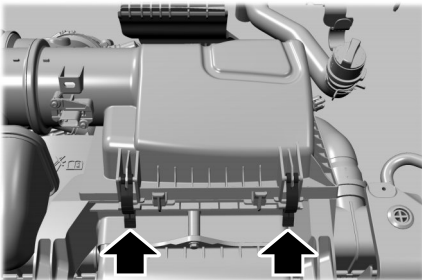

1. Release the clips (x2) that secure the two halves of the air filter housing together.

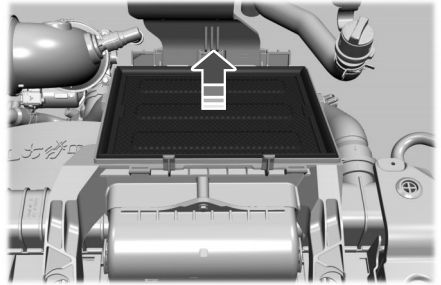

2. Carefully separate the two halves of the air filter housing.
3. Remove the air filter element from the housing.
4. Install the new filter element. Be careful to put the filter seal on top of the tray, making sure that the seal is not pushed down into the tray. This could cause filter damage and allow unfiltered air to enter the engine if not properly seated.
5. Install the air filter housing cover. Use special care to ensure that the air cleaner cover is reinstalled correctly. Verify that the tabs at the rear of the air cleaner housing cover are fully inserted into the slots at the rear of the air cleaner housing tray.
6. Secure the air filter housing clips (x2).

ENGINE COOLANT CHECK



WARNING: Do not remove the coolant reservoir cap when the engine is on or the cooling system is hot. Wait 10 minutes for the cooling system to cool down. Cover the coolant reservoir cap with a thick cloth to prevent the possibility of scalding and slowly remove the cap. Failure to follow this instruction could result in personal injury.

Maintenance

 **WARNING:** To reduce the risk of personal injury, make sure the engine is cool before unscrewing the coolant pressure relief cap. The cooling system is under pressure. Steam and hot liquid can come out forcefully when you loosen the cap slightly.

When the engine is cold, check the concentration and level of the coolant at the intervals listed in the scheduled maintenance information. See **Scheduled Maintenance** (page 249).

Note: Make sure that the coolant level is between the **MIN** and **MAX** marks on the coolant reservoir.

Note: Coolant expands when it is hot. The level may extend beyond the **MAX** mark.

Maintain coolant concentration within 48% to 50%, which equates to a freeze point between -29°F (-34°C) and -35°F (-37°C). Use a refractometer to check coolant concentration. Do not use hydrometers or coolant test strips for measuring coolant concentration.

Adding Coolant

 **WARNING:** Do not add coolant when the vehicle is on or the cooling system is hot. Failure to follow this instruction could result in personal injury.

 **WARNING:** Do not put coolant in the windshield washer reservoir. If sprayed on the windshield, coolant could make it difficult to see through the windshield.

 **WARNING:** Do not remove the coolant reservoir cap when the engine is on or the cooling system is hot. Wait 10 minutes for the cooling system to cool down. Cover the coolant reservoir cap with a thick cloth to prevent the possibility of scalding and slowly remove the cap. Failure to follow this instruction could result in personal injury.

 **WARNING:** Do not add coolant further than the **MAX** mark.

Note: Automotive fluids are not interchangeable. Do not use coolant or windshield washer fluid outside of its specified function and vehicle location.

Note: Do not use stop leak pellets, cooling system sealants, or non-specified additives as they can cause damage to the engine cooling or heating systems. Resulting component damage may not be covered by the vehicle warranty.

Always use prediluted coolant approved to the correct specification to avoid plugging the small passageways in the engine cooling system. See **Capacities and Specifications** (page 226). Do not mix different colors or types of coolant in your vehicle. Mixing of engine coolants or using an incorrect coolant may harm the engine or cooling system components and may not be covered by the vehicle warranty.

Note: If prediluted coolant is not available, use the approved concentrated coolant diluting it to 50/50 with distilled water. See **Capacities and Specifications** (page 226). Using water that has not been deionized may contribute to deposit formation, corrosion and plugging of the small cooling system passageways.

Maintenance

Note: *Coolants marketed for all makes and models may not be approved to Ford specifications and may damage the cooling system. Resulting component damage may not be covered by the vehicle warranty.*

If the coolant level is at or below the minimum mark, add prediluted coolant immediately.

Top up the coolant level as follows:

1. Unscrew the cap slowly. Any pressure escapes as you unscrew the cap.
2. Add prediluted coolant approved to the correct specification. See **Capacities and Specifications** (page 226).
3. Add enough prediluted coolant to reach the correct level.
4. Replace the coolant reservoir cap. Turn the cap clockwise until it contacts the hard stop.
5. Check the coolant level the next few times you drive your vehicle. If necessary, add enough prediluted engine coolant to bring the coolant level to the correct level.

If you have to add more than 1.1 qt (1 L) of engine coolant per month, have your vehicle checked as soon as possible. Operating an engine with a low coolant level can result in engine overheating and possible engine damage.

Note: *During normal vehicle operation, the coolant may change color, and slightly darken. As long as the coolant is clear and uncontaminated, this color change does not indicate the coolant has degraded nor does it require the coolant to be drained, the system to be flushed, or the coolant to be replaced.*

In case of emergency, you can add a large amount of water without coolant to reach a vehicle service location. In this instance, qualified personnel:

1. Must drain the cooling system.
2. Chemically clean the coolant system.
3. Refill with coolant that meets the correct specification. See **Capacities and Specifications** (page 226).

Water alone, without coolant, can cause engine damage from corrosion, overheating or freezing.

Do not use the following as a coolant substitute:

- Alcohol.
- Methanol.
- Brine.
- Any coolant mixed with alcohol or methanol antifreeze.

Alcohol and other liquids can cause engine damage from overheating or freezing.

Do not add extra inhibitors or additives to the coolant. These can be harmful and compromise the corrosion protection of the coolant.

Recycled Coolant

We do not recommend the use of recycled coolant as an approved recycling process is not yet available.

Dispose of used engine coolant in an appropriate manner.

Follow your community's regulations and standards for recycling and disposing of automotive fluids.

Maintenance

Severe Climates

If you drive in extremely cold climates:

- It may be necessary to increase the coolant concentration above 50%.
- A coolant concentration of 60% provides improved freeze point protection. Coolant concentrations above 60% decrease the overheat protection characteristics of the coolant and may cause engine damage.

If you drive in extremely hot climates:

- You can decrease the coolant concentration to 40%.
- Coolant concentrations below 40% decrease the freeze and corrosion protection characteristics of the coolant and may cause engine damage.

Vehicles driven year-round in non-extreme climates should use prediluted coolant for optimum cooling system and engine protection.

Coolant Change

Change the engine coolant at the specific mileage intervals listed in scheduled maintenance. See **Capacities and Specifications** (page 226).

Fail-Safe Cooling

Fail-safe cooling allows you to temporarily drive your vehicle before any incremental component damage occurs. The fail-safe distance depends on ambient temperature, vehicle load and terrain.

How Fail-Safe Cooling Works

If the engine begins to overheat, the coolant temperature gauge moves toward the red zone.



A warning lamp illuminates and a message may appear in the instrument cluster display.



If the engine reaches a preset over-temperature condition, it automatically switches to alternating cylinder operation. Each disabled cylinder acts as an air pump and cools the engine.

When this occurs, your vehicle still operates, however:

- Engine power is limited.
- The air conditioning system turns off.

Continued operation increases the engine temperature, causing the engine to completely shut down. Your steering and braking effort increases in this situation.

When the engine temperature cools, you can restart the engine. Have your vehicle checked as soon as possible to minimize engine damage.

When Fail-Safe Mode Is Activated



WARNING: Fail-safe mode is for use during emergencies only. Operate your vehicle in fail-safe mode only as long as necessary to bring your vehicle to rest in a safe location and seek immediate repairs. When in fail-safe mode, your vehicle will have limited power, will not be able to maintain high-speed operation, and may completely shut down without warning, potentially losing engine power, power steering assist, and power brake assist, which may increase the possibility of a crash resulting in serious injury.

Maintenance



WARNING: Do not remove the coolant reservoir cap when the engine is on or the cooling system is hot. Wait 10 minutes for the cooling system to cool down. Cover the coolant reservoir cap with a thick cloth to prevent the possibility of scalding and slowly remove the cap. Failure to follow this instruction could result in personal injury.

Your vehicle has limited engine power when in the fail-safe mode, drive your vehicle with caution. Your vehicle does not maintain high-speed operation and the engine may operate poorly.

Remember that the engine is capable of automatically shutting down to prevent engine damage. In this situation:

1. Pull off the road as soon as safely possible and switch the engine off.
2. If you are a member of a roadside assistance program, contact your roadside assistance service provider.
3. If this is not possible, wait a short period for the engine to cool.
4. Check the coolant level. If the coolant level is at or below the minimum mark, add prediluted coolant immediately.
5. When the engine temperature cools, you can restart the engine. Have your vehicle checked as soon as possible to minimize engine damage.

Note: *Driving your vehicle without repair increases the chance of engine damage.*

Engine Coolant Temperature Management (If Equipped)



WARNING: To reduce the risk of crash and injury, be prepared that the vehicle speed may reduce and the vehicle may not be able to accelerate with full power until the coolant temperature reduces.

If you tow a trailer with your vehicle, the engine may temporarily reach a higher temperature during severe operating conditions, for example ascending a long or steep slope in high ambient temperatures.

At this time, you may notice the coolant temperature gauge moves toward the red zone and a message may appear in the instrument cluster display.

You may notice a reduction in vehicle speed caused by reduced engine power to manage the engine coolant temperature. Your vehicle may enter this mode if certain high-temperature and high-load conditions take place. The amount of speed reduction depends on vehicle loading, grade and ambient temperature. If this occurs, there is no need to pull off the road. You can continue to drive your vehicle.

The air conditioning may automatically turn on and off during severe operating conditions to protect the engine from overheating. When the coolant temperature returns to the normal operating temperature, the air conditioning turns on.

If the coolant temperature gauge moves fully into the red zone, or if the coolant temperature warning or service engine soon messages appear in your instrument cluster display, do the following:

Maintenance

1. Pull off the road as soon as safely possible and shift the transmission into park (P).
2. Leave the engine running until the coolant temperature gauge needle returns to the normal position. If the temperature does not drop after several minutes, follow the remaining steps.
3. Switch the engine off and wait for it to cool. Check the coolant level.
4. If the coolant level is at or below the minimum mark, immediately add prediluted coolant.
5. If the coolant level is normal, restart the engine and continue driving.

AUTOMATIC TRANSMISSION FLUID CHECK

Have an authorized dealer check and change the transmission fluid and filter at the correct service interval. See **Scheduled Maintenance** (page 249).

Do not use supplemental transmission fluid additives, treatments or cleaning agents. The use of these materials may affect transmission operation and result in damage to internal transmission components.

Checking Automatic Transmission Fluid

For scheduled intervals of the fluid checks and changes, See **Scheduled Maintenance** (page 249). Your transmission does not consume fluid. However, if the transmission is not working properly, for example, if the transmission slips or shifts slowly, or if you notice some sign of fluid leakage, check the fluid level as soon as possible.

Automatic transmission fluid expands when warmed. Obtain an accurate reading as follows :

1. Drive the vehicle approximately 19 mi (30 km) to reach normal operating temperature via the transmission fluid temperature gauge on the instrument cluster.
2. Park the vehicle on a level surface and engage the parking brake.
3. With the engine running, parking brake engaged and your foot on the brake pedal, move the gearshift lever through all of the gear ranges. Allow sufficient time for each gear to engage.
4. Put the transmission in park (P) and leave the engine running.
5. Remove the dipstick, wiping it clean with a clean, dry, lint free rag.
6. Install the dipstick, fully seating it in the filler tube.
7. Remove the dipstick and inspect the fluid level. The fluid should be in the designated area for normal operating temperature.

Low Fluid Level



E163740

Do not drive the vehicle if there is no indication of fluid on the dipstick and the ambient temperature is above 50°F (10°C).

Maintenance

Correct Fluid Level

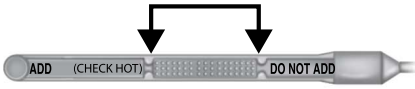

E163742

Drive the vehicle 19 mi (30 km) or until it reaches normal operating temperature. Check the fluid at the normal operating temperature of 196°F (91°C) to 215°F (102°C) on a level surface.

High Fluid Level

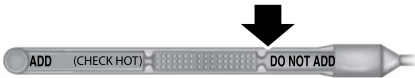

E163744

Fluid levels above the safe range may result in transmission failure. An overfill condition of transmission fluid may cause shift and engagement concerns, and possible damage.

An overheating condition can cause high fluid levels.

Adjusting Automatic Transmission Fluid Levels

Note: Use of a non-approved automatic transmission fluid may cause internal transmission component damage.

Make sure to use the correct type of fluid. You can find the type of fluid used on the transmission dipstick, or in your Owner's Manual. See **Capacities and Specifications** (page 226).

If necessary, add fluid in 8 fl oz (250 ml) increments through the filler tube until the level is correct.

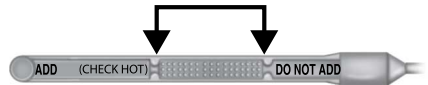

E163746

If an overfill occurs, have a qualified technician remove excess fluid.

Note: An overfill condition of transmission fluid may cause shift and engagement concerns, and possible damage.

Do not use supplemental transmission fluid additives, treatments or cleaning agents. The use of these materials may affect transmission operation and result in damage to internal transmission components.

Maintenance

Automatic Transmission Fluid Filter

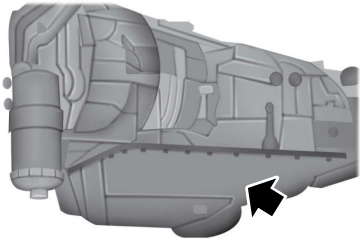

E196355

Your automatic transmission has a serviceable transmission fluid filter inside the transmission bottom pan. For service intervals for the automatic transmission fluid and transmission filter, See **Scheduled Maintenance** (page 249).

For transmission filter maintenance, see your authorized dealer.

BRAKE FLUID CHECK

WARNING: Do not use any fluid other than the recommended brake fluid as this will reduce brake efficiency. Use of incorrect fluid could result in the loss of vehicle control, serious personal injury or death.

WARNING: Only use brake fluid from a sealed container. Contamination with dirt, water, petroleum products or other materials may result in brake system damage or failure. Failure to adhere to this warning could result in the loss of vehicle control, serious personal injury or death.

WARNING: Do not allow the fluid to touch your skin or eyes. If this happens, rinse the affected areas immediately with plenty of water and contact your physician.

WARNING: The brake system could be affected if the brake fluid level is below the **MIN** mark or above the **MAX** mark on the brake fluid reservoir.



1. Park your vehicle on a level surface.
2. Look at the brake fluid reservoir to see where the brake fluid level is relative to the **MIN** and the **MAX** marks on the reservoir.

Note: If the brake fluid level is between the **MIN** and the **MAX** marks on the reservoir, it is acceptable.

Note: If the brake fluid level is below the **MIN** mark or above the **MAX** mark, have your vehicle checked as soon as possible.

Note: To avoid fluid contamination, the reservoir cap must remain in place and fully tight, unless you are adding fluid.

Maintenance

Only use fluid that meets our specifications. See **Capacities and Specifications** (page 226).

Brake Fluid Service Interval

Brake fluid absorbs water over time which degrades the effectiveness of the brake fluid. Change the brake fluid at the specified intervals to prevent degraded braking performance.

For detailed interval information, see Scheduled Maintenance in your Owner's Manual or your local maintenance guide.

POWER STEERING FLUID CHECK



WARNING: A fluid level between the MAX and MIN lines is within the normal operating range and there is no need to add fluid. A fluid level not in the normal operating range could compromise the performance of the system.



WARNING: For E-350 and E-450 vehicles with the Hydro-Boost Brake System, do not press the brake pedal after the engine has been turned off. Pressing the brake pedal after the engine has been turned off will give a false power steering fluid level reading.

Only use fluid that meets Ford specifications. See **Hydraulic Power Steering Fluid Capacity and Specification** (page 236).

To top up the power steering fluid level do the following.

1. Start the engine and let it run until it reaches normal operating temperature.
2. Make sure the fluid is within the **MIN** and **MAX** range.

3. If the fluid level is low, add fluid to be within the **MIN** and **MAX** range. Do not overfill.
4. While the engine idles, turn the steering wheel left and right several times.
5. Recheck the fluid level in the reservoir.

Note: Do not operate the vehicle with a low power steering pump fluid level.

CHANGING THE 12V BATTERY



WARNING: This vehicle may have more than one battery. Removing the battery cables from only one battery does not disconnect your vehicle electrical system. Make sure you disconnect the battery cables from all batteries when disconnecting power. Failure to do so may cause serious personal injury or property damage.



WARNING: Batteries normally produce explosive gases which can cause personal injury. Therefore, do not allow flames, sparks or lighted substances to come near the battery. When working near the battery, always shield your face and protect your eyes. Always provide correct ventilation.



WARNING: When lifting a plastic-cased battery, excessive pressure on the end walls could cause acid to flow through the vent caps, resulting in personal injury and damage to the vehicle or battery. Lift the battery with a battery carrier or with your hands on opposite corners.

Maintenance



WARNING: Keep batteries out of reach of children. Batteries contain sulfuric acid. Avoid contact with skin, eyes or clothing. Shield your eyes when working near the battery to protect against possible splashing of acid solution. In case of acid contact with skin or eyes, flush immediately with water for a minimum of 15 minutes and get prompt medical attention. If acid is swallowed, call a physician immediately.



WARNING: Battery posts, terminals and related accessories contain lead and lead compounds, chemicals known to the State of California to cause cancer and reproductive harm. **Wash your hands after handling.**

Note: *If your vehicle battery has a cover, make sure it is reinstalled after the battery has been cleaned or replaced.*

Note: *Electrical or electronic accessories or components added to the vehicle by the dealer or the owner may adversely affect battery performance and durability.*

Your vehicle is fitted with a Motorcraft® maintenance-free battery which normally does not require additional water during its life of service.

For longer, trouble-free operation, keep the top of the battery clean and dry. Also, make certain the battery cables are always tightly fastened to the battery terminals.

If you see any corrosion on the battery or terminals, remove the cables from the terminals and clean with a wire brush. You can neutralize the acid with a solution of baking soda and water.

Always dispose of automotive batteries in a responsible manner. Follow your local authorized standards for disposal. Call your local authorized recycling center to find out more about recycling automotive batteries.

Reconnecting the Battery

Because your vehicle's engine is electronically controlled by a computer, some control conditions are maintained by power from the battery. When the battery is disconnected or a new battery is installed, the engine must relearn its idle and fuel trim strategy for optimum driveability and performance. Flexible fuel vehicles must also relearn the ethanol content of the fuel for optimum driveability and performance.

To begin this process.

1. Switch off all accessories and start the engine.
2. Run the engine until it reaches normal operating temperature.
3. Allow the engine to idle for at least one minute.
4. Turn the A/C on and allow the engine to idle for at least one minute.
5. Press the brake pedal. Release the parking brake. Shift the gearshift lever to drive (D) and allow the engine to idle for at least one minute.
6. Drive the vehicle for approximately 10 mi (16 km) to complete the relearning process.

Note: *If you do not carry out the above process, the idle quality of your vehicle may be adversely affected until the idle trim is eventually relearned.*

Flexible fuel vehicles operating on E85 may experience poor starts and driveability problems until the fuel trim and ethanol content have been relearned.

Maintenance

When the battery is disconnected or a new battery installed, the transmission must relearn its adaptive strategy. As a result of this, the transmission may shift firmly. This operation is considered normal and fully updates transmission operation to its optimum shift feel.

We recommend that the negative battery cable terminal be disconnected if you plan to store your vehicle for an extended period of time. This minimizes the discharge of your battery during storage.

Dual Batteries (If Equipped)

Your vehicle may be fitted with a frame-mounted battery located on the passenger side frame rail, behind the front passenger door. This battery is connected in parallel with the battery in the engine compartment. Both batteries are used to start the vehicle.

12V Battery – Warning Lamps



If it illuminates while driving, it indicates a charging system error. Switch off all unnecessary electrical equipment and have your vehicle immediately checked.

12V Battery – Information Messages

Message	Details
Check Charging System	The charging system needs servicing. If the warning stays on or continues to come on, have your vehicle checked as soon as possible.
Charging System Service Soon	The charging system needs servicing. If the warning stays on or continues to come on, have your vehicle checked as soon as possible.
Charging System Service Now	The charging system needs servicing. Have your vehicle immediately checked.

Maintenance

Message	Details
Battery State of Charge Low	The battery management system determines that the 12V battery is at a low state of charge. Start the engine to charge the battery or charge the battery using an aftermarket battery charger. Always use the vehicle ground point when connecting the negative cable of the external battery charger. See Jump Starting the Vehicle (page 139). This message clears once you restart your vehicle and the battery state of charge has recovered. Do not switch on the ignition when a battery charger is in use to charge the battery.
Turn Power Off To Save Battery	The battery management system determines that the battery is at a low state of charge. Turn the ignition off as soon as possible to protect the battery. This message clears once the vehicle has been started and the battery state of charge has recovered. Turning off unnecessary electrical loads allows faster battery state-of-charge recovery.
Electrical Power Saver Active Some Features Turned Off See Manual	Displayed when the battery management system detects an extended low-voltage condition. Various vehicle features are disabled to help preserve the battery. Turn off as many of the electrical loads as soon as possible to improve system voltage. If the system voltage has recovered, the disabled features operate normally.

ADJUSTING THE HEADLAMPS

We properly aim the headlamps on your vehicle at the assembly plant. If your vehicle has been in an accident, have an authorized dealer check the alignment of your headlamps.

Vertical Aim Adjustment Procedure

You can only adjust the headlamps vertically. Your vehicle does not require horizontal aim adjustments.

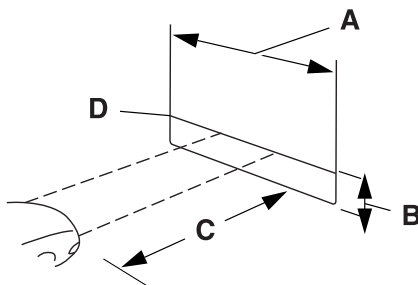

- A 8 feet (2.4 meters).
- B Center height of lamp to ground.
- C 25 feet (7.6 meters).
- D Horizontal reference line.

To adjust the headlamps:

Maintenance

1. Park the vehicle directly in front of a wall or screen on a level surface, approximately 25 ft (7.6 m) away.
2. Measure the height of the headlamp bulb center from the ground and mark an 8 ft (2.4 m) horizontal reference line on the vertical wall or screen at this height.

Note: To see a clearer light pattern for adjusting, you may want to block the light from one headlamp while adjusting the other.

3. Turn on the low beam headlamps to illuminate the wall or screen and open the hood.



4. On the wall or screen, you will observe a flat zone of high intensity light located at the top of the right hand portion of the beam pattern. If the top edge of the high intensity light zone is not at the horizontal reference line, you will need to adjust the headlamp.



5. Locate the vertical adjuster on each headlamp. Using a Phillips #2 screwdriver, turn the adjuster either clockwise or counterclockwise in order to adjust the vertical aim of the headlamp.
6. Repeat steps 3 through 5 to adjust the other headlamp.
7. Close the hood and switch off the lamps.

WASHER FLUID CHECK



WARNING: If you operate your vehicle in temperatures below 40°F (5°C), use washer fluid with antifreeze protection. Failure to use washer fluid with antifreeze protection in cold weather could result in impaired windshield vision and increase the risk of injury or accident.

Add fluid to fill the reservoir if the level is low. Only use a washer fluid that meets Ford specifications. See **Capacities and Specifications** (page 226).

Maintenance

State or local regulations on volatile organic compounds may restrict the use of methanol, a common windshield washer antifreeze additive. Washer fluids containing non-methanol antifreeze agents should be used only if they provide cold weather protection without damaging the vehicle's paint finish, wiper blades or washer system.

FUEL FILTER

Your vehicle is equipped with a lifetime fuel filter that is integrated with the fuel tank. Regular maintenance or replacement is not needed.

CHECKING THE WIPER BLADES



Run the tip of your fingers over the edge of the blade to check for roughness.

Clean the wiper blades with washer fluid or water applied with a soft sponge or cloth.

CHANGING THE WIPER BLADES

You can manually move the wiper arms when the ignition is off. This allows for ease of blade replacement and cleaning under the blades.

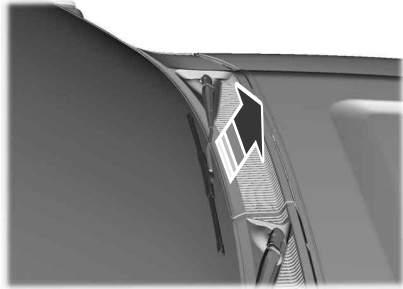

1. Pull the wiper blade and arm away from the glass.

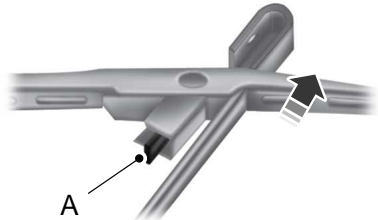

E165794

2. Release the wiper blade lock (A) and separate the wiper blade from the wiper arm.
3. Install in the reverse order.

Note: Make sure that the wiper blade locks into place. Lower the wiper arm and blade back on the windshield. The wiper arms will automatically return to their normal position when you turn the ignition on.

- Replace wiper blades at least once per year for optimum performance.
- You can improve poor wiper quality by cleaning the wiper blades and the windshield.

Maintenance

REMOVING A HEADLAMP

1. Make sure the headlamp switch is in the off position, then open the hood.



E196385

2. Remove the three screws from the headlamp assembly and pull the assembly straight out.
3. Disconnect the electrical connector by squeezing the release tab and pushing the connector forward, then pulling it rearward.
4. Remove the headlamp.

To install the new lamp, follow the removal procedures in reverse order.

CHANGING A BULB

Lamp Assembly Condensation

Exterior lamps are vented to accommodate normal changes in pressure. Condensation can be a natural by-product of this design. When moist air enters the lamp assembly through the vents, there is a possibility that condensation can occur when the temperature is cold. When normal

condensation occurs, a thin film of mist can form on the interior of the lens. The thin mist eventually clears and exits through the vents during normal operation. Clearing time may take as long as 48 hours under dry weather conditions.

Examples of acceptable condensation are:

- Presence of thin mist (no streaks, drip marks or droplets).
- Fine mist covers less than 50% of the lens.

Examples of unacceptable moisture (usually caused by a lamp water leak) are:

- Water puddle inside the lamp.
- Large water droplets, drip marks or streaks present on the interior of the lens.

Take your vehicle to a dealer for service if any of the above conditions of unacceptable moisture are present.

Replacing Headlamp Bulbs



WARNING: Make sure the bulbs have cooled down before removing them. Failure to follow this warning could result in serious personal injury.

Note: Grasp the bulb by only its plastic base and do not touch the glass. The oil from your hand could cause the bulb to break the next time the headlamps are operated.

Note: If the bulb is accidentally touched, clean it with rubbing alcohol before use.

1. Make sure the headlamp switch is in the off position, then open the hood.
2. Remove the headlamp. See **Removing a Headlamp** (page 179).
3. Disconnect the electrical connector by squeezing the release tab and pushing the connector forward, then pulling it rearward.

Maintenance



E196386

4. Remove the bulb assembly by turning it counterclockwise and pulling it straight out.

To install the new bulb, follow the removal procedures in reverse order.

Replacing Front Parking Lamp and Direction Indicator Bulbs



E196388

1. Make sure the headlamp switch is in the off position, then open the hood.
2. Remove the headlamp assembly. Refer to **Replacing Headlamp Bulbs** in this section.
3. Rotate the bulb socket counterclockwise and remove.
4. Carefully pry up the bulb straight out of the socket.

To complete installation, follow the removal procedures in reverse order.

Replacing Side Marker Bulbs



E196390

1. Make sure the headlamp switch is in the off position, then open the hood.
2. Remove the headlamp assembly. Refer to **Replacing Headlamp Bulbs** in this section.
3. Rotate the bulb socket counterclockwise and remove.
4. Carefully pry up the bulb straight out of the socket.

To complete installation, follow the removal procedures in reverse order.

Replacing Brake/Tail/Turn/Reverse Lamp Bulbs (Cut-Away Only)

1. Make sure the headlamps are off.



Maintenance

2. Remove the four screws and the lamp lens from the lamp assembly.
3. Carefully pull the bulb straight out of the socket and push in the new bulb.

Vehicle Care

GENERAL INFORMATION

Your dealer has many quality products available to clean your vehicle and protect its finishes.

CLEANING PRODUCTS

Materials

For best results, use the following products or products of equivalent quality:

For additional information and assistance, we recommend that you contact an authorized dealer.

Name	Specification
Motorcraft® Bug and Tar Remover, ZC-42 (U.S. & Canada)	
Motorcraft® Custom Bright Metal Cleaner, ZC-15 (U.S. & Canada)	ESR-M5B194-B
Motorcraft® Detail Wash, ZC-3-A (U.S. & Canada)	ESR-M14P4-A
Motorcraft® Engine Shampoo and Degreaser, ZC-20 (U.S.)	ESR-M14P3-A
Motorcraft® Engine Shampoo, CXC-66-A (Canada)	
Motorcraft® Premium Leather and Vinyl Cleaner, ZC-56 (U.S. & Canada)	
Motorcraft® Multi-Purpose Cleaner, CXC-101 (Canada)	
Motorcraft® Premium Windshield Wash Concentrate with Bitterant, ZC-32-B2 (U.S.)	WSS-M14P19-A
Motorcraft® Premium Quality Windshield Washer Fluid, CXC-37-F/M (Canada)	WSS-M14P19-A
Motorcraft® Professional Strength Carpet & Upholstery Cleaner, ZC-54 (U.S. & Canada)	
Motorcraft® Premium Glass Cleaner, CXC-100 (Canada)	ESR-M14P5-A
Motorcraft® Spot and Stain Remover, ZC-14 (U.S.)	
Motorcraft® Ultra-Clear Spray Glass Cleaner, ZC-23 (U.S.)	ESR-M14P5-A
Motorcraft® Wheel and Tire Cleaner, ZC-37-A (U.S. & Canada)	

Vehicle Care

CLEANING THE EXTERIOR

Wash your vehicle regularly with cool or lukewarm water and a neutral pH shampoo, we recommend Motorcraft Detail Wash.

- Never use strong household detergents or soap, for example dish washing or laundry liquid. These products can discolor and spot painted surfaces.
- Never wash your vehicle when it is hot to the touch, or during strong or direct sunlight.
- Dry your vehicle with a chamois or soft terry cloth towel to eliminate water spotting.
- Immediately remove fuel spillages, bird droppings, insect deposits and road tar. These may cause damage to your vehicle's paintwork or trim over time. We recommend Motorcraft Bug and Tar Remover.
- Remove any exterior accessories, for example antennas, before entering a car wash.
- When filling with AdBlue®, remove any residue on painted surfaces immediately.

Note: *Suntan lotions and insect repellents can damage painted surfaces. If these substances come in contact with your vehicle, wash the affected area as soon as possible.*

Cleaning the Exterior Precautions

Immediately remove fuel spillages, AdBlue residuals, bird droppings, insect deposits and road tar. These may cause damage to your vehicle's paintwork or trim over time.

Remove any exterior accessories, for example antennas, before entering a car wash.

Cleaning the Exterior Lamps

Note: *Do not scrape the exterior lamps lenses or use abrasives, alcoholic solvents or chemical solvents to clean them.*

Note: *Do not wipe the exterior lamps when they are dry.*

Exterior Chrome Parts

- Apply a high quality-cleaning product to bumpers and other chrome parts. Follow the manufacturer's instructions. We recommend Motorcraft Custom Bright Metal Cleaner.
- Do not apply the cleaning product to hot surfaces. Do not leave the cleaning product on chrome surfaces longer than the time recommended.
- Using non-recommended cleaners can result in severe and permanent cosmetic damage.

Note: *Never use abrasive materials, for example steel wool or plastic pads as they can scratch the chrome surface.*

Note: *Do not use chrome cleaner, metal cleaner or polish on wheels or wheel covers.*

Exterior Plastic Parts

For routine cleaning we recommend Motorcraft Detail Wash. If tar or grease spots are present, we recommend Motorcraft Bug and Tar Remover.

Stripes or Graphics (If Equipped)

Hand washing your vehicle is preferred however, pressure washing may be used under the following conditions:

- Do not use water pressure higher than 2,000 psi (14,000 kPa).
- Do not use water hotter than 179°F (82°C).

Vehicle Care

- Use a spray with a 40 degree wide spray angle pattern.
- Keep the nozzle at a 12 in (305 mm) distance and 90 degree angle to your vehicle's surface.

Note: *Holding the pressure washer nozzle at an angle to the vehicle's surface may damage graphics and cause the edges to peel away from the vehicle's surface.*

Underbody

Regularly clean the entire underside of your vehicle. This includes the chassis, body floor sheet metal and wheel wells using fresh water. Keep body and door drain holes free of debris or foreign material.

Under Hood

For removing black rubber marks from under the hood we recommend Motorcraft Wheel and Tire Cleaner or Motorcraft Bug and Tar Remover.

WAXING

Regular waxing is necessary to protect your car's paint from the elements. We recommend that you wash and wax the painted surface once or twice a year.

When washing and waxing, park your vehicle in a shaded area out of direct sunlight. Always wash your vehicle before applying wax.

- Use a quality wax that does not contain abrasives.
- Follow the manufacturer's instructions to apply and remove the wax.
- Apply a small amount of wax in a back-and-forth motion, not in circles.

- Do not allow wax to come in contact with any non-body (low-gloss black) colored trim. The wax will discolor or stain the parts over time.
 - Roof racks.
 - Bumpers.
 - Grained door handles.
 - Side moldings.
 - Mirror housings.
 - Windshield cowl area.
- Do not apply wax to glass areas.
- After waxing, your car's paint should feel smooth, and be free of streaks and smudges.

CLEANING THE ENGINE

Engines are more efficient when they are clean because grease and dirt buildup keep the engine warmer than normal.

When washing:

- Take care when using a power washer to clean the engine. The high-pressure fluid could penetrate the sealed parts and cause damage.
- Do not spray a hot engine with cold water to avoid cracking the engine block or other engine components.
- Spray Motorcraft Engine Shampoo and Degreaser on all parts that require cleaning and pressure rinse clean. In Canada, use Motorcraft Engine Shampoo.

Note: *If your vehicle has an engine cover remove the cover before application of Motorcraft Engine Shampoo and Degreaser. Immediately rinse away any over spray.*

Vehicle Care

- Never wash or rinse the engine while it is hot or running; water in the running engine may cause internal damage.
- Never wash or rinse any ignition coil, spark plug wire or spark plug well, or the area in and around these locations.
- Cover the battery, power distribution box, and air filter assembly to prevent water damage when cleaning the engine.

CLEANING THE WINDOWS AND WIPER BLADES

Car wash chemicals and environmental fallout can result in windshield and wiper blade contamination. Dirty windshield and wipers will result in poor windshield wiper operation. Keep the windshield and wiper blades clean to maintain windshield wiper performance.

To clean the windshield and wiper blades:

- Clean the windshield with a non-abrasive glass cleaner. When cleaning the interior of the windshield, avoid getting any glass cleaner on the instrument panel or door panels. Wipe any glass cleaner off these surfaces immediately.
- For windshields contaminated with tree sap, chemicals, wax or bugs, clean the entire windshield using steel wool (no greater than 0000 grade) in a circular motion and rinse with water.
- Clean the wiper blades with isopropyl rubbing alcohol or windshield washer concentrate.

Note: *Do not use razor blades or other sharp objects to clean or remove decals from the inside of the heated rear window. The vehicle warranty does not cover damage caused to the heated rear window grid lines.*

CLEANING THE INTERIOR



WARNING: Do not use cleaning solvents, bleach or dye on the vehicle's seatbelts, as these actions may weaken the belt webbing.



WARNING: On vehicles equipped with seat-mounted airbags, do not use chemical solvents or strong detergents. Such products could contaminate the side airbag system and affect performance of the side airbag in a crash.

For fabric, carpets, cloth seats and seats equipped with side airbags:

- Remove dust and loose dirt with a vacuum cleaner.
- Remove light stains and soil with Motorcraft Professional Strength Carpet & Upholstery Cleaner.
- If grease or tar is present on the material, spot-clean the area first with Motorcraft Spot and Stain Remover. In Canada, use Motorcraft Multi-Purpose Cleaner.
- If a ring forms on the fabric after spot cleaning, clean the entire area immediately (but do not oversaturate) or the ring will set.
- Do not use household cleaning products or glass cleaners, which can stain and discolor the fabric and affect the flame retardant abilities of the seat materials.

Mirrors

Do not clean the housing or glass of any mirror with harsh abrasives, fuel or other petroleum or ammonia-based cleaning products.

Vehicle Care

CLEANING THE INSTRUMENT PANEL AND INSTRUMENT CLUSTER LENS



WARNING: Do not use chemical solvents or strong detergents when cleaning the steering wheel or instrument panel to avoid contamination of the airbag system.

Note: Follow the same procedure as cleaning leather seats for cleaning leather instrument panels and leather interior trim surfaces. See **Cleaning Leather Seats** (page 186).

Clean the instrument panel and cluster lens with a clean, damp and soft cloth, then use a clean, dry and soft cloth to dry these areas.

- Avoid cleaners or polishes that increase the gloss of the upper portion of the instrument panel. The dull finish in this area helps protect you from undesirable windshield reflection.
- Do not use any household cleaning products or glass cleaners as these may damage the finish of the instrument panel, interior trim and cluster lens.
- Wash or wipe your hands clean if you have been in contact with certain products such as insect repellent and suntan lotion to avoid possible damage to the interior painted surfaces.
- Do not allow air fresheners and hand sanitizers to spill onto interior surfaces. If a spill occurs, wipe off immediately. Your warranty may not cover these damages.

If a staining liquid like coffee or juice has been spilled on the instrument panel or on interior trim surfaces:

1. Wipe up spilled liquid using a clean, soft cloth as quickly as possible.
2. Use Motorcraft Premium Leather and Vinyl Cleaner or a commercially available leather cleaning product for automotive interiors. Test any cleaner or stain remover on an inconspicuous area.
3. Alternatively, wipe the surface with a clean, soft cloth and a mild soap and water solution. Dry the area with a clean, soft cloth.
4. If necessary, apply more soap and water solution or cleaning product to a clean, soft cloth and press it onto the soiled area. Allow this to set at room temperature for 30 minutes.
5. Remove the soaked cloth, then with a clean, damp cloth, use a rubbing motion for 60 seconds on the soiled area.
6. Dry the area with a clean, soft cloth.

CLEANING LEATHER SEATS

Note: Follow the same procedure as cleaning leather seats for cleaning leather instrument panels and leather interior trim surfaces.

For routine cleaning, wipe the surface with a soft, damp cloth and a mild soap and water solution. Dry the area with a clean, soft cloth.

For cleaning and removing stains such as dye transfer, use Motorcraft Premium Leather and Vinyl Cleaner or a commercially available leather cleaning product for automotive interiors.

Note: Test any cleaner or stain remover on an inconspicuous area.

Vehicle Care

You should:

- Remove dust and loose dirt with a vacuum cleaner.
- Clean and treat spills and stains as soon as possible.

Do not use the following products as these may damage the leather:

- Oil and petroleum or silicone-based leather conditioners.
- Household cleaners.
- Alcohol solutions.
- Solvents or cleaners intended specifically for rubber, vinyl and plastics.

REPAIRING MINOR PAINT DAMAGE

We recommend that you contact an authorized dealer to identify your vehicle color code. Authorized dealers have touch-up paint to match your vehicle's color.

Before repairing minor paint damage, use a cleaner to remove particles such as bird droppings, tree sap, insect deposits, tar spots, road salt and industrial fallout.

Read the instructions before using cleaning products.

CLEANING THE WHEELS

1. Regularly clean them with a wheel cleaner. We recommend that you use Ford approved wheel cleaner if available.
2. Remove dirt and brake dust with a sponge.
3. Remove tar and grease with a bug and tar remover. We recommend that you use Ford approved bug and tar remover if available.

4. Thoroughly rinse the wheels with water after cleaning.

If you intend on parking your vehicle for an extended period after cleaning the wheels with a wheel cleaner, drive your vehicle for a few minutes before doing so. This reduces the risk of corrosion of the brake discs, brake pads and linings.

Do not clean the wheels when they are hot.

Note: *Some car washes could damage wheel rims and covers.*

Note: *Using non-recommended cleaners, harsh cleaning products, chrome wheel cleaners or abrasive materials could damage wheel rims, covers and bolts.*

VEHICLE STORAGE

If you plan on storing your vehicle for 30 days or more, read the following maintenance recommendations to make sure your vehicle stays in good operating condition.

We engineer and test all motor vehicles and their components for reliable, regular driving. Under various conditions, long-term storage may lead to degraded engine performance or failure unless you use specific precautions to preserve engine components.

General

- Store all vehicles in a dry, ventilated place.
- Protect from sunlight, if possible.
- If vehicles are stored outside, they require regular maintenance to protect against rust and damage.

Vehicle Care

Body

- Wash your vehicle thoroughly to remove dirt, grease, oil, tar or mud from exterior surfaces, rear-wheel housing and the underside of front fenders.
- Periodically wash your vehicle if it is stored in exposed locations.
- Touch-up exposed or primed metal to prevent rust.
- Cover chrome and stainless steel parts with a thick coat of auto wax to prevent discoloration. Re-wax as necessary when you wash your vehicle.
- Lubricate all hood, door and luggage compartment hinges and latches with a light grade oil.
- Cover interior trim to prevent fading.
- Keep all rubber parts free from oil and solvents.

Engine

- Change the engine oil and filter prior to storage because used engine oil contains contaminants which may cause engine damage.
- Start the engine every 15 days for a minimum of 15 minutes. Run at fast idle with the climate controls set to defrost until the engine reaches normal operating temperature.
- With your foot on the brake, shift through all the gears while the engine is running.
- We recommend that you change the engine oil before you use your vehicle again.

Fuel system

- Fill the fuel tank with high-quality fuel until the first automatic shutoff of the fuel pump nozzle.

Cooling system

- Protect against freezing temperatures.
- When removing your vehicle from storage, check coolant fluid level. Confirm that there are no cooling system leaks and that fluid is at the recommended level.

Disconnecting Your 12 Volt Battery

- Check and recharge as necessary. Keep connections clean.
- If storing your vehicle for more than 30 days without recharging the battery, we recommend that you disconnect the battery cables to maintain battery charge for quick starting.

Note: *It is necessary to reset memory features if you disconnect the battery cables.*

Brakes

- Make sure the brakes and parking brake release fully.

Tires

- Maintain recommended air pressure.

Miscellaneous

- Make sure all linkages, cables, levers and pins under your vehicle are covered with grease to prevent rust.
- Move vehicles at least 25 ft (7.5 m) every 15 days to lubricate working parts and prevent corrosion.

Vehicle Care

Removing Vehicle From Storage

When your vehicle is ready to come out of storage, do the following:

- Wash your vehicle to remove any dirt or grease film build-up on window surfaces.
- Check windshield wipers for any deterioration.
- Check under the hood for any foreign material that may have collected during storage such as mice or squirrel nests.
- Check the exhaust for any foreign material that may have collected during storage.
- Check tire pressures and set tire inflation per the Tire Label.
- Check brake pedal operation. Drive your vehicle 15 ft (4.5 m) back and forth to remove rust build-up.
- Check fluid levels (including coolant, oil and gas) to make sure there are no leaks, and fluids are at recommended levels.
- If you remove the battery, clean the battery cable ends and check for damage.

Contact an authorized dealer if you have any concerns or issues.

Wheels and Tires

GENERAL INFORMATION

Notice to Utility Vehicle, Van and Truck Owners



WARNING: Utility vehicles have a significantly higher rollover rate than other types of vehicles. To reduce the risk of serious injury or death from a rollover or other crash you must avoid sharp turns and abrupt maneuvers, drive at safe speeds for the conditions, keep tires properly inflated, never overload or improperly load your vehicle, and make sure every passenger is properly restrained.



WARNING: In a rollover crash, an unbelted person is significantly more likely to die than a person wearing a seat belt. All occupants must wear seat belts. Children and infants must use appropriate restraints to minimize the risk of injury or ejection.



E145298

Utility vehicles and trucks handle differently than passenger cars in the various driving conditions that are encountered on streets, highways and off-road. Utility vehicles and trucks are not designed for cornering at speeds as high as passenger cars any more than low-slung sports cars are designed to perform satisfactorily under off-road conditions.

How Your Vehicle Differs from Other Vehicles

Sport-utility vehicles, vans and trucks can differ from some other vehicles in a few noticeable ways. Your vehicle may be:

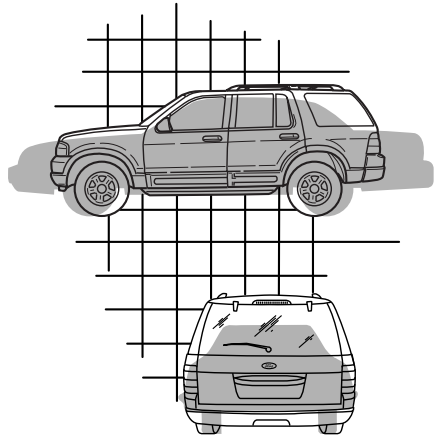

E145299

Wheels and Tires

- Higher - to allow higher load carrying capacity and to allow it to travel over rough terrain without getting hung up or damaging underbody components.
- Shorter - to give it the capability to approach inclines and drive over the crest of a hill without getting hung up or damaging underbody components. All other things held equal, a shorter wheelbase may make your vehicle quicker to respond to steering inputs than a vehicle with a longer wheelbase.
- Narrower - to provide greater maneuverability in tight spaces, particularly in off-road use.

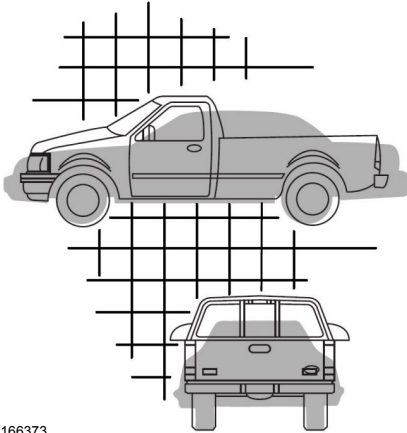

E166373

As a result of the above dimensional differences, sport-utility vehicles, vans and trucks often will have a higher center of gravity and a greater difference in center of gravity between the loaded and unloaded condition.

These differences that make your vehicle so versatile also make it handle differently than an ordinary passenger car.

TIRE CARE

Information About Uniform Tire Quality Grading



Tire Quality Grades apply to new pneumatic passenger car tires. The Quality grades can be found where applicable on the tire sidewall between tread shoulder and maximum section width. For example: **Treadwear 200 Traction AA Temperature A.**

These Tire Quality Grades are determined by standards that the United States Department of Transportation has set.

Tire Quality Grades apply to new pneumatic passenger car tires. They do not apply to deep tread, winter-type snow tires, space-saver or temporary use spare tires, light truck or LT type tires, tires with nominal rim diameters of 10 to 12 inches or limited production tires as defined in Title 49 Code of Federal Regulations Part 575.104 (c)(2).

Wheels and Tires

U.S. Department of Transportation Tire quality grades:

The U.S. Department of Transportation requires Ford Motor Company to give you the following information about tire grades exactly as the government has written it.

Treadwear

The treadwear grade is a comparative rating based on the wear rate of the tire when tested under controlled conditions on a specified government test course. For example, a tire graded 150 would wear one and one-half ($1\frac{1}{2}$) times as well on the government course as a tire graded 100. The relative performance of tires depends upon the actual conditions of their use, however, and may depart significantly from the norm due to variations in driving habits, service practices, and differences in road characteristics and climate.

Traction AA A B C



WARNING: The traction grade assigned to this tire is based on straight-ahead braking traction tests, and does not include acceleration, cornering, hydroplaning or peak traction characteristics.

The traction grades, from highest to lowest are AA, A, B, and C. The grades represent the tire's ability to stop on wet pavement as measured under controlled conditions on specified government test surfaces of asphalt and concrete. A tire marked C may have poor traction performance.

Temperature A B C



WARNING: The temperature grade for this tire is established for a tire that is properly inflated and not overloaded. Excessive speed, underinflation, or excessive loading, either separately or in combination, can cause heat buildup and possible tire failure.

The temperature grades are A (the highest), B and C, representing the tire's resistance to the generation of heat and its ability to dissipate heat when tested under controlled conditions on a specified indoor laboratory test wheel. Sustained high temperature can cause the material of the tire to degenerate and reduce tire life, and excessive temperature can lead to sudden tire failure. The grade C corresponds to a level of performance which all passenger car tires must meet under the

Wheels and Tires

Federal Motor Vehicle Safety Standard No. 139. Grades B and A represent higher levels of performance on the laboratory test wheel than the minimum required by law.

Glossary of Tire Terminology

***Tire label:** A label showing the original equipment tire sizes, recommended inflation pressure and the maximum weight the vehicle can carry.

***Tire Identification Number (TIN):** A number on the sidewall of each tire providing information about the tire brand and manufacturing plant, tire size and date of manufacture. Also referred to as DOT code.

***Inflation pressure:** A measure of the amount of air in a tire.

***Standard load:** A class of P-metric or Metric tires designed to carry a maximum load at set pressure. For example: For P-metric tires 35 psi (2.4 bar) and for Metric tires 36 psi (2.5 bar). Increasing the inflation pressure beyond this pressure does not increase the tire's load carrying capability.

***Extra load:** A class of P-metric or Metric tires designed to carry a heavier maximum load at 42 psi (2.9 bar). Increasing the inflation pressure beyond this pressure does not increase the tire's load carrying capability.

***kPa:** Kilopascal, a metric unit of air pressure.

***PSI:** Pounds per square inch, a standard unit of air pressure.

***Cold tire pressure:** The tire pressure when the vehicle has been stationary and out of direct sunlight for an hour or more and prior to the vehicle being driven for 1.0 mi (1.6 km).

***Recommended inflation pressure:** The cold inflation pressure found on the Safety Compliance Certification Label (affixed to either the door hinge pillar, door-latch post, or the door edge that meets the door-latch post, next to the driver's seating position), or Tire Label located on the B-pillar or the edge of the driver's door.

B-pillar: The structural member at the side of the vehicle behind the front door.

***Bead area of the tire:** Area of the tire next to the rim.

* **Sidewall of the tire:** Area between the bead area and the tread.

***Tread area of the tire:** Area of the perimeter of the tire that contacts the road when mounted on the vehicle.

***Rim:** The metal support (wheel) for a tire or a tire and tube assembly upon which the tire beads are seated.

Wheels and Tires

Information Contained on the Tire Sidewall

Both United States and Canada Federal regulations require tire manufacturers to place standardized information on the sidewall of all tires. This information identifies and describes the fundamental characteristics of the tire and also provides a U.S. DOT Tire Identification Number for safety standard certification and in case of a recall.

Information on P Type Tires

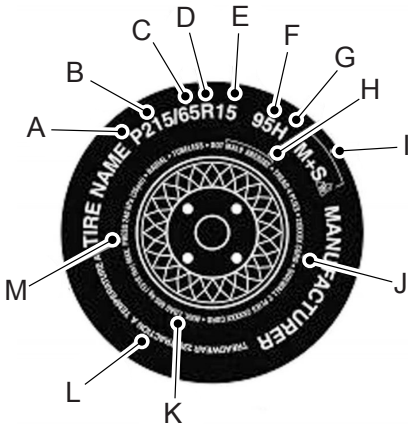

P215/65R15 95H is an example of a tire size, load index and speed rating. The definitions of these items are listed below. (Note that the tire size, load index and speed rating for your vehicle may be different from this example.)

A. P: Indicates a tire, designated by the Tire and Rim Association, that may be used for service on cars, sport utility vehicles, minivans and light trucks. **Note:** If your tire size does not begin with a letter this may mean it is designated by either the European Tire and Rim Technical Organization or the Japan Tire Manufacturing Association.

B. 215: Indicates the nominal width of the tire in millimeters from sidewall edge to sidewall edge. In general, the larger the number, the wider the tire.

C. 65: Indicates the aspect ratio which gives the tire's ratio of height to width.

D. R: Indicates a radial type tire.

E. 15: Indicates the wheel or rim diameter in inches. If you change your wheel size, you have to purchase new tires to match the new wheel diameter.

F. 95: Indicates the tire's load index. It is an index that relates to how much weight a tire can carry. You may find this information in your owner's manual. If not, contact a local tire dealer.

Note: You may not find this information on all tires because it is not required by federal law.

Wheels and Tires

G. H: Indicates the tire's speed rating. The speed rating denotes the speed at which a tire is designed to be driven for extended periods of time under a standard condition of load and inflation pressure. The tires on your vehicle may operate at different conditions for load and inflation pressure. These speed ratings may need to be adjusted for the difference in conditions. The ratings range from 81–186 mph (130–299 km/h). These ratings are listed in the following chart.

Note: You may not find this information on all tires because it is not required by federal law.

Letter rating	mph (km/h)
L	75 (120)
M	81 (130)
N	87 (140)
Q	99 (159)
R	106 (171)
S	112 (180)
T	118 (190)
U	124 (200)
H	130 (210)
V	149 (240)

Letter rating	mph (km/h)
W	168 (270)
Y	186 (299)

Note: For tires with a maximum speed capability over 149 mph (240 km/h), tire manufacturers sometimes use the letters ZR. For those with a maximum speed capability over 186 mph (299 km/h), tire manufacturers always use the letters ZR.

H. U.S. DOT Tire Identification

Number: This begins with the letters DOT and indicates that the tire meets all federal standards. The next two numbers or letters are the plant code designating where it was manufactured, the next two are the tire size code and the last four numbers represent the week and year the tire was built. For example, the numbers 317 mean the 31st week of 1997. After 2000 the numbers go to four digits. For example, 2501 means the 25th week of 2001. The numbers in between are identification codes used for traceability. This information is used to contact customers if a tire defect requires a recall.

I. M+S or M/S: Mud and Snow, or

AT: All Terrain, or

AS: All Season.

Wheels and Tires

J. Tire Ply Composition and Material Used: Indicates the number of plies or the number of layers of rubber-coated fabric in the tire tread and sidewall. Tire manufacturers also must indicate the ply materials in the tire and the sidewall, which include steel, nylon, polyester, and others.

K. Maximum Load: Indicates the maximum load in kilograms and pounds that can be carried by the tire. (affixed to either the door hinge pillar, door-latch post, or the door edge that meets the door-latch post, next to the driver's seating position), or Tire Label located on the B-pillar or the edge of the driver's door.

L. Treadwear, Traction and Temperature Grades:

***Treadwear:** The treadwear grade is a comparative rating based on the wear rate of the tire when tested under controlled conditions on a specified government test course. For example, a tire graded 150 would wear 1½ times as well on the government course as a tire graded 100.

***Traction:** The traction grades, from highest to lowest are AA, A, B, and C. The grades represent the tire's ability to stop on wet pavement as measured under controlled conditions on specified government test surfaces of asphalt and concrete. A tire marked C may have poor traction performance.

***Temperature:** The temperature grades are A (the highest), B and C, representing the tire's resistance to the generation of heat and its ability to dissipate heat when tested under controlled conditions on a specified indoor laboratory test wheel.

M. Maximum Inflation Pressure: Indicates the tire manufacturers' maximum permissible pressure or the pressure at which the maximum load can be carried by the tire. This pressure is normally higher than the vehicle manufacturer's recommended cold inflation pressure which can be found on the Safety Compliance Certification Label (affixed to either the door hinge pillar, door-latch post, or the door edge that meets the door-latch post, next to the driver's seating position), or Tire Label located on the B-pillar or the edge of the driver's door. The cold inflation pressure should never be set lower than the recommended pressure on the vehicle label.

Wheels and Tires

The tire suppliers may have additional markings, notes or warnings such as standard load or radial tubeless.

Additional Information Contained on the Tire Sidewall for LT Type Tires

Note: *Tire Quality Grades do not apply to this type of tire.*

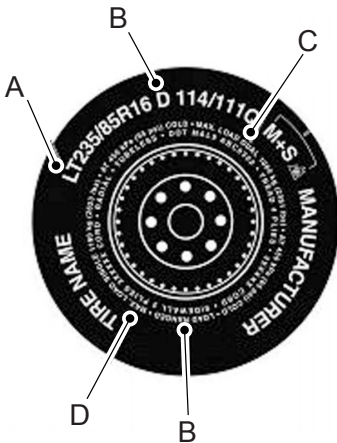

LT type tires have some additional information beyond those of P type tires. These differences are described below.

A. LT: Indicates a tire, designated by the Tire and Rim Association, that is intended for service on light trucks.

B. Load Range and Load Inflation Limits: Indicates the tire's load-carrying capabilities and its inflation limits.

C. Maximum Load Dual lb (kg) at psi (kPa) cold: Indicates the maximum load and tire pressure when the tire is used as a dual; defined as four tires on the rear axle (a total of six or more tires on the vehicle).

D. Maximum Load Single lb (kg) at psi (kPa) cold: Indicates the maximum load and tire pressure when the tire is used as a single; defined as two tires (total) on the rear axle.

Information on T Type Tires

T145/80D16 is an example of a tire size.

Note: *The temporary tire size for your vehicle may be different from this example. Tire Quality Grades do not apply to this type of tire.*

Wheels and Tires

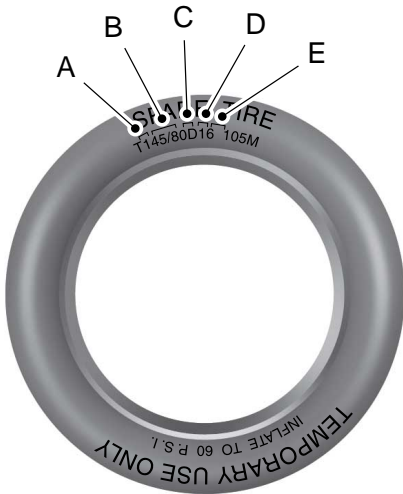

T type tires have some additional information beyond those of P type tires. These differences are described below:

A. **T:** Indicates a type of tire, designated by the Tire and Rim Association, that is intended for temporary service on cars, sport utility vehicles, minivans and light trucks.

B. **145:** Indicates the nominal width of the tire in millimeters from sidewall edge to sidewall edge. In general, the larger the number, the wider the tire.

C. **80:** Indicates the aspect ratio which gives the tire's ratio of height to width. Numbers of 70 or lower indicate a short sidewall.

D. **D:** Indicates a diagonal type tire.

R: Indicates a radial type tire.

E. **16:** Indicates the wheel or rim diameter in inches. If you change your wheel size, you have to purchase new tires to match the new wheel diameter.

Location of the Tire Label

You can find a Tire Label containing tire inflation pressure by tire size and other important information located on the B-Pillar or the edge of the driver's door.

Inflating Your Tires

Safe operation of your vehicle requires that your tires are properly inflated. Remember that a tire can lose up to half of its air pressure without appearing flat.

Every day before you drive, check your tires. If one looks lower than the others, use a tire gauge to check pressure of all tires and adjust if required.

At least once a month and before long trips, inspect each tire and check the tire pressure with a tire gauge (including spare, if equipped). Inflate all tires to the inflation pressure recommended by Ford Motor Company.

Wheels and Tires

You are strongly urged to buy a reliable tire pressure gauge, as automatic service station gauges may be inaccurate. Ford recommends the use of a digital or dial-type tire pressure gauge rather than a stick-type tire pressure gauge.

Use the recommended cold inflation pressure for optimum tire performance and wear. Under-inflation or over-inflation may cause uneven treadwear patterns



WARNING: Under-inflation is the most common cause of tire failures and may result in severe tire cracking, tread separation or blowout, with unexpected loss of vehicle control and increased risk of injury. Under-inflation increases sidewall flexing and rolling resistance, resulting in heat buildup and internal damage to the tire. It also may result in unnecessary tire stress, irregular wear, loss of vehicle control and accidents. A tire can lose up to half of its air pressure and not appear to be flat!

Always inflate your tires to the Ford recommended inflation pressure even if it is less than the maximum inflation pressure information found on the tire. The Ford recommended tire inflation pressure is found on the Safety Compliance Certification Label or

Tire Label (affixed to either the door hinge pillar, door-latch post, or the door edge that meets the door-latch post, next to the driver's seating position), or Tire Label located on the B-pillar or the edge of the driver's door. Failure to follow the tire pressure recommendations can cause uneven treadwear patterns and adversely affect the way your vehicle handles

Note: Do not reduce tire pressure to change the ride characteristics of the vehicle. If you do not maintain the inflation pressure at the levels specified by Ford, your vehicle may experience a condition known as shimmy. Shimmy is a severe vibration and oscillation in the steering wheel after the vehicle travels over a bump or dip in the road that does not dampen out by itself. Shimmy may result from significant under-inflation of the tires, improper tires (load range, size, or type), or vehicle modifications such as lift-kits. In the event that your vehicle experiences shimmy, you should slowly reduce speed by either lifting off the accelerator pedal or lightly applying the brakes. The shimmy ceases as the vehicle speed decreases.

Maximum Inflation Pressure is the tire manufacturer's maximum permissible pressure and the pressure at which the maximum load can be carried by the tire. This pressure is normally higher than

Wheels and Tires

the manufacturer's recommended cold inflation pressure which can be found on the Safety Compliance Certification Label (affixed to either the door hinge pillar, door-latch post, or the door edge that meets the door-latch post, next to the driver's seating position), or Tire Label located on the B-pillar or the edge of the driver's door. The cold inflation pressure should never be set lower than the recommended pressure on the Safety Compliance Certification Label or Tire Label.

When weather temperature changes occur, tire inflation pressures also change. A 10°F (6°C) temperature drop can cause a corresponding drop of 1 psi (7 kPa) in inflation pressure. Check your tire pressures frequently and adjust them to the proper pressure which can be found on the Safety Compliance Certification Label or Tire Label.

To check the pressure in your tire(s):

1. Make sure the tires are cool, meaning they are not hot from driving even a mile.

Note: *If you are checking tire pressure when the tire is hot, (for example, driven more than 1.0 mi (1.6 km)), never bleed or reduce air pressure. The tires are hot from driving and it is normal for pressures to increase above recommended cold pressures. A hot tire at or below recommended cold inflation pressure could be significantly under-inflated.*

Note: *If you have to drive a distance to get air for your tire(s), check and record the tire pressure first and add the appropriate air pressure when you get to the pump. It is normal for tires to heat up and the air pressure inside to go up as you drive.*

2. Remove the cap from the valve on one tire, then firmly press the tire gauge onto the valve and measure the pressure.

3. Add enough air to reach the recommended air pressure.

Note: *If you overfill the tire, release air by pressing on the metal stem in the center of the valve. Then recheck the pressure with your tire gauge.*

4. Replace the valve cap.

5. Repeat this procedure for each tire, including the spare.

Wheels and Tires

Note: Some spare tires operate at a higher inflation pressure than the other tires. For T type mini-spare tires, (see the Dissimilar spare wheel and tire assembly information for a description. Store and maintain at 60 psi (4.15 bar). For full-size and dissimilar spare tires, see the Dissimilar spare wheel and tire assembly information for a description. Store and maintain at the higher of the front and rear inflation pressure as shown on the Safety Compliance Certification Label or Tire Label.

6. Visually inspect the tires to make sure there are no nails or other objects embedded that could poke a hole in the tire and cause an air leak.

7. Check the sidewalls to make sure there are no gouges, cuts or bulges.

Checking Pressure when tires are hot:

If pressures are checked after tires have been driven for more than three minutes or more than 1 mile, (2 km) the tires become hot and the pressures will increase by approximately 4 psi (27.6 kPa). Therefore when the tire pressure is adjusted under these conditions, it should be increased to a gauge reading of 4 psi (27.6 kPa) greater than the recommended cold inflation pressure.

For Example Only

Gauge reading of hot tire	33 psi (230 kPa)
If recommended, cold inflation pressure is	32 psi (220 kPa)
The hot tire pressure is only 1 psi (10 kPa) greater than the recommended cold inflation pressure. Therefore, add 3 psi (20 kPa) more to increase the hot pressure to 4 psi (30 kPa) over the recommended cold inflation pressure.	
New hot pressure	36 psi (250 kPa)

Tire Inflation Information



WARNING: An inflated tire and rim can be very dangerous if improperly used, serviced or maintained. To reduce the risk of serious injury, never attempt to re-inflate a tire which has been run flat or seriously under-inflated without first removing the tire from the wheel assembly for inspection. Do not attempt to add air to tires or replace tires or wheels without first taking precautions to protect persons and property.

All tires with Steel Carcass Plies (if equipped):

Wheels and Tires

This type of tire utilizes steel cords in the sidewalls. As such, they cannot be treated like normal light truck tires. Tire service, including adjusting tire pressure, must be performed by personnel trained, supervised and equipped according to Federal Occupational

Safety and Health Administration regulations. For example, during any procedure involving tire inflation, the technician or individual must utilize a remote inflation device, and ensure that all persons are clear of the trajectory area.

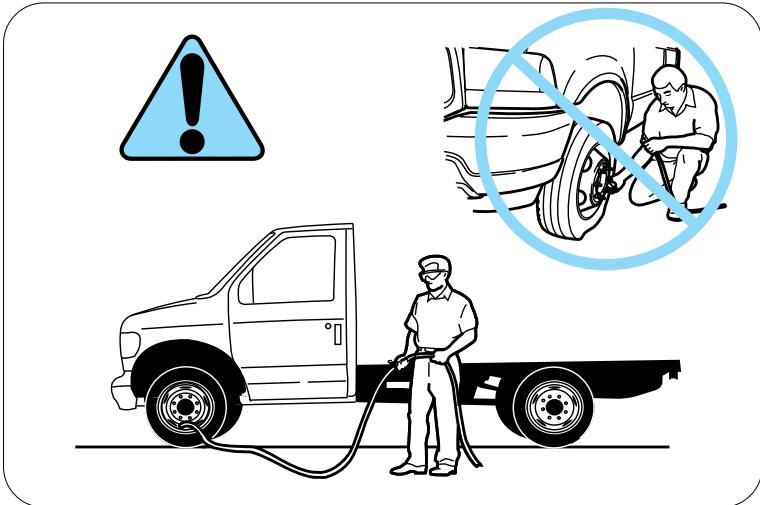

Wheels and Tires

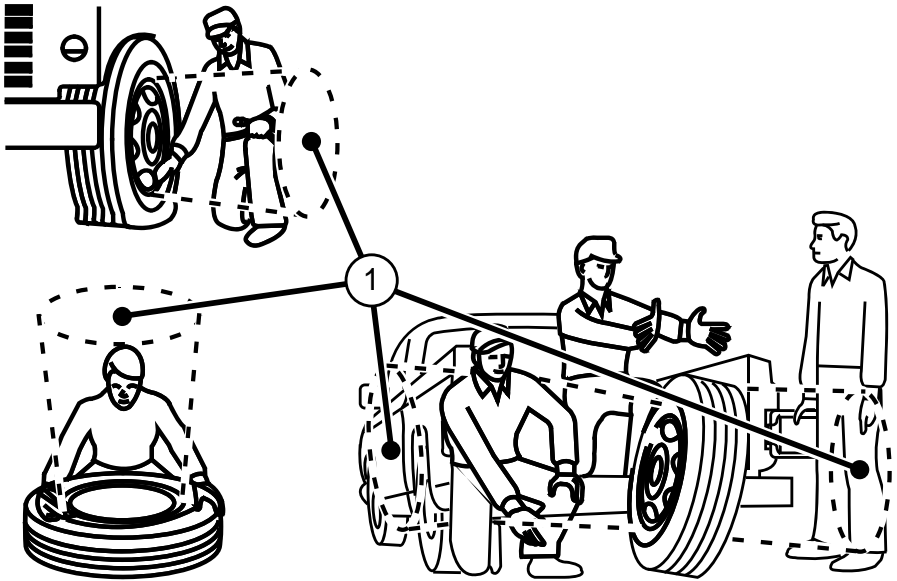

E161438

Note: *Stay out of the trajectory (1) as indicated in the illustration.*

Inspecting Your Tires and Wheel Valve Stems

Periodically inspect the tire treads for uneven or excessive wear and remove objects such as stones, nails or glass that may be wedged in the tread grooves. Check the tire and valve stems for holes, cracks, or cuts that may permit air leakage and repair or replace the tire and replace the valve stem. Inspect the tire sidewalls for cracking, cuts, bruises and other signs of damage or excessive wear. If internal damage to the tire

is suspected, have the tire demounted and inspected in case it needs to be repaired or replaced. For your safety, tires that are damaged or show signs of excessive wear should not be used because they are more likely to blow out or fail.

Improper or inadequate vehicle maintenance can cause tires to wear abnormally. Inspect all your tires, including the spare, frequently, and replace them if one or more of the following conditions exist:

Wheels and Tires

Tire Wear

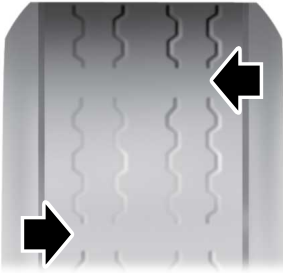

When the tread is worn down to 2/32 inch (1.6 millimeters), tires must be replaced to help prevent your vehicle from skidding and hydroplaning. Built-in treadwear indicators, or wear bars, which look like narrow strips of smooth rubber across the tread appears on the tire when the tread is worn down to 2/32 inch (1.6 millimeters).

When the tire tread wears down to the same height as these wear bars, the tire is worn out and must be replaced.

Damage

Periodically inspect the tire treads and sidewalls for damage (such as bulges in the tread or sidewalls, cracks in the tread groove and separation in the tread or sidewall). If damage is observed

or suspected have the tire inspected by a tire professional. Tires can be damaged during off-road use, so inspection after off-road use is also recommended.

Age



WARNING: Tires degrade over time depending on many factors such as weather, storage conditions, and conditions of use (load, speed, inflation pressure) the tires experience throughout their lives.

In general, tires should be replaced after six years regardless of tread wear. However, heat caused by hot climates or frequent high loading conditions can accelerate the aging process and may require tires to be replaced more frequently.

You should replace your spare tire when you replace the road tires or after six years due to aging even if it has not been used.

U.S. DOT Tire Identification Number

Both United States and Canada Federal regulations require tire manufacturers to place standardized information on the sidewall of all tires. This information identifies and

Wheels and Tires

describes the fundamental characteristics of the tire and also provides a U.S. DOT Tire Identification Number for safety standard certification and in case of a recall.

This begins with the letters DOT and indicates that the tire meets all federal standards. The next two numbers or letters are the plant code designating where it was manufactured, the next two are the tire size code and the last four numbers represent the week and year the tire was built. For example, the numbers 317 mean the 31st week of 1997. After 2000 the numbers go to four digits. For example, 2501 means the 25th week of 2001. The numbers in between are identification codes used for traceability. This information is used to contact customers if a tire defect requires a recall.

Tire Replacement Requirements

Your vehicle is equipped with tires designed to provide a safe ride and handling capability.



WARNING: Only use replacement tires and wheels that are the same size, load index, speed rating, and type as those originally provided for your vehicle. The recommended tire and wheel sizes can be found on the Tire Label on the driver side

door frame or the edge of the driver door. If this information is not found in those locations, or for additional options, contact your authorized dealer. Use of any tire or wheel not recommended, could affect the safety and performance of your vehicle, which could result in an increased risk of loss of vehicle control, vehicle rollover, personal injury and death.



WARNING: To reduce the risk of serious injury, when mounting replacement tires and wheels, you should not exceed the maximum pressure indicated on the sidewall of the tire to set the beads without additional precautions listed below. If the beads do not seat at the maximum pressure indicated, re-lubricate and try again.



WARNING: For a mounting pressure more than 20 psi (1.38 bar) greater than the maximum pressure, a Ford dealer or other tire service professional should do the mounting.



WARNING: Always inflate steel carcass tires with a remote air fill with the person inflating standing at a minimum of 12 ft (3.66 m) away from the wheel and tire assembly.

Wheels and Tires



WARNING: When inflating the tire for mounting pressures up to 20 psi (1.38 bar) greater than the maximum pressure on the tire sidewall, the following precautions must be taken to protect the person mounting the tire:

- Make sure that you have the correct tire and wheel size.
- Lubricate the tire bead and wheel bead seat area again.
- Stand at a minimum of 12 ft (3.6 m) away from the wheel and tire assembly.
- Use both eye and ear protection.

Important: Remember to replace the wheel valve stems when the road tires are replaced on your vehicle

The two front tires or two rear tires should generally be replaced as a pair.

The tire pressure sensors mounted in the wheels are not designed to be used in aftermarket wheels.

The use of wheels or tires not recommended by Ford Motor Company may affect the operation of your tire pressure monitoring system.

If the tire pressure monitoring system indicator is flashing, the system is malfunctioning. Your replacement tire might be incompatible with your tire pressure monitoring system, or some component of the system may be damaged.

Replacing a Tire That is Greenhouse Gas Certified

The tires installed on this vehicle at the factory as original equipment are certified for Greenhouse Gas and Fuel Efficiency regulations. Replacement tires must be of equal or lower rolling resistance level (TRRL or Crr). Consult with your tire supplier(s) for appropriate replacement tires.

Safety Practices



WARNING: If your vehicle is stuck in snow, mud or sand, do not rapidly spin the tires; spinning the tires can tear the tire and cause an explosion. A tire can explode in as little as three to five seconds.



WARNING: Do not spin the wheels at over 34 mph (55 km/h). The tires may fail and injure a passenger or bystander.

Wheels and Tires

HIGH SPEED DRIVING CAN BE DANGEROUS

Correct inflation pressure is especially important. However, at high speeds, even with the correct inflation pressure, a road hazard for example is more difficult to avoid and if contact is made, has a greater chance of causing tire damage than at a lower speed. Moreover, driving at high speed reduces the reaction time available to avoid accidents and bring your vehicle to a safe stop.

If you see any damage to a tire or wheel, replace it with the spare at once and visit a participating Tire Retailer.

Exceeding the maximum speeds shown on the following page for each type of tire will cause the tire to build up excessive heat which can cause tire damage that could result in sudden tire destruction and rapid air loss. Failure to control a vehicle when one or more tires experience a sudden air loss can lead to an accident.

In any case, you should not exceed reasonable speeds as indicated by the legal limits and driving conditions.

DO NOT OVERLOAD: DRIVING ON ANY OVERLOADED TIRE IS DANGEROUS

The maximum load rating of your tires is molded on the tire sidewall. Do not exceed this rating. Follow the loading instructions of the manufacturer of your vehicle and this will ensure that your tires are not overloaded. Tires which are loaded beyond their maximum allowable loads for the particular application will build up excessive heat that may result in sudden tire destruction. Do not exceed the gross axle weight rating for any axle on your vehicle.

TIRE ALTERATIONS

Do not make or allow to be made any alterations on your tires. Alterations may prevent proper performance, leading to tire damage which can result in an accident. Tires which become unserviceable due to alterations such as truing, whitewall inlays, addition of balancing or sealant liquids, or the use of tire dressing containing petroleum distillates are excluded from warranty coverage.

Wheels and Tires

REPAIRS - WHEREVER POSSIBLE, SEE YOUR TIRE RETAILER AT ONCE

If any tire sustains a puncture, have the tire demounted and thoroughly inspected by a tire retailer for possible damage that may have occurred. A tread area puncture in any passenger or light truck tire can be repaired provided that the puncture hole is not more than 1/4" in diameter, not more than one radial cable per casing ply is damaged, and the tire has not been damaged further by the puncturing object or by running underinflated. Tire punctures consistent with these guidelines should only be repaired by following the US Tire Manufacturers Association (USTMA) recommended repair procedures. Plug-only repairs done on-the-wheel are considered improper and therefore, not recommended. Such repairs are not reliable and may cause further damage to the tire.

STORAGE

Tires contain waxes and emollients to protect their outer surfaces from ozone and weather checking. As the tire rolls and flexes, the waxes and emollients continually migrate to the surface, replenishing this protection throughout the normal use of the tire. Consequently, when tires sit unused for long periods of time (a month or more) their surfaces

become dry and more susceptible to ozone and weather checking and the casing becomes susceptible to flat spotting. **For this reason, tires should always be stored in a cool, dry, clean, indoor environment. If storage is for one month or more, eliminate the weight from the tires by raising the vehicle or by removing the tires from the vehicle. Failure to store tires in accordance with these instructions could result in damage to your tires or premature aging of the tires and sudden tire failure.**

When tires are stored, be sure they are placed away from sources of heat and ozone such as direct sunlight, hot pipes and electric generators. Be sure that surfaces on which tires are stored are clean and free from grease, gasoline or other substances, which could deteriorate the rubber. Failure to store tires in accordance with these instructions could result in damage to your tires or premature aging of the tires and sudden tire failure.

Wheels and Tires

FOLLOW THESE MOUNTING RECOMMENDATIONS

Tire changing can be dangerous and must be done by professionally trained persons using proper tools and procedures as specified by the US Tire Manufacturers Association (USTMA). Single or dual assemblies must be completely deflated before demounting.

Your tires should be mounted on wheels of correct size and type and which are in good, clean condition. Wheels that are bent, chipped, rusted (steel wheels) or corroded (alloy wheels) may cause tire damage. The inside of the tire must be free from foreign material. Have your retailer check the wheels before mounting new tires. Mismatched tires and rims can explode during mounting. Also, mismatched tires and rims can result in dangerous tire failure on the road. If a tire is mounted by error on the wrong-sized rim, do not remount it on the proper rim – scrap it. It may have been damaged internally (which is not externally visible) by having been dangerously stretched and could fail on the highway.

Old valves may leak. When new tubeless tires are mounted, have new valves of the correct type installed. Tubeless tires must only be mounted on wheels designed for tubeless tires i.e., wheels which have safety humps or ledges.

It is recommended that you have your tires and wheels balanced. Tires and wheels, which are not balanced, may cause steering difficulties, a bumpy ride, and irregular tire wear.

Be sure that all your valves have suitable valve caps. The valve cap is the primary seal against air loss.

TEMPORARY SPARE TIRES

When using any temporary spare tire, be sure to follow the vehicle manufacturer's instructions.

REMEMBER... TO AVOID DAMAGE TO YOUR TIRES AND POSSIBLE ACCIDENT:

- CHECK TIRE PRESSURE AT LEAST ONCE EACH MONTH WHEN TIRES ARE COLD AND BEFORE LONG TRIPS.
- DO NOT UNDERINFLATE/OVERINFLATE.
- DO NOT OVERLOAD.
- DRIVE AT MODERATE SPEEDS, OBSERVE LEGAL LIMITS.

Wheels and Tires

- AVOID DRIVING OVER POTHoles, OBSTACLES, CURBS OR EDGES OF PAVEMENT.
- AVOID EXCESSIVE WHEEL SPINNING.
- IF YOU SEE ANY DAMAGE TO A TIRE, REPLACE WITH THE SPARE AND VISIT ANY AUTHORIZED RETAILER AT ONCE.
- IF YOU HAVE ANY QUESTIONS, CONTACT YOUR AUTHORIZED RETAILER.

Driving habits have a great deal to do with your tire mileage and safety.

- *Observe posted speed limits
- *Avoid fast starts, stops and turns
- *Avoid potholes and objects on the road
- *Do not run over curbs or hit the tire against a curb when parking

Highway Hazards

No matter how carefully you drive there's always the possibility that you may eventually have a flat tire on the highway. Drive slowly to the closest safe area out of traffic. This may further damage the flat tire, but your safety is more important.

If you feel a sudden vibration or ride disturbance when driving, or you suspect your tire or vehicle has been damaged, immediately reduce your speed. Drive with caution until you can safely pull off the road. Stop and inspect the tires for damage. If a tire is under-inflated or damaged, deflate it, remove wheel and replace it with your spare tire and wheel. If you cannot detect a cause, have the vehicle towed to the nearest repair facility or tire dealer to have the vehicle inspected.

Tire and Wheel Alignment

A bad jolt from hitting a curb or pothole can cause the front end of your vehicle to become misaligned or cause damage to your tires. If your vehicle seems to pull to one side when you're driving, the wheels may be out of alignment. Have an authorized dealer check the wheel alignment periodically.

Wheel misalignment in the front or the rear can cause uneven and rapid treadwear of your tires and should be corrected by an authorized dealer. Front-wheel drive vehicles and those with an independent rear suspension may require alignment of all four wheels.

The tires should also be balanced periodically. An unbalanced tire and wheel assembly may result in irregular tire wear.

Wheels and Tires

Tire Rotation



WARNING: If the tire label shows different tire pressures for the front and rear tires and the vehicle has a tire pressure monitoring system, then you need to update the settings for the system sensors. Always perform the system reset procedure after tire rotation. If you do not reset the system, it may not provide a low tire pressure warning when necessary.

Note: If your tires show uneven wear ask an authorized dealer to check for and correct any wheel misalignment, tire imbalance or mechanical problem involved before tire rotation.

Note: Your vehicle may be equipped with a dissimilar spare wheel and tire assembly. A dissimilar spare wheel and tire assembly is defined as a spare wheel and tire assembly that is different in brand, size or appearance from the road tires and wheels. If you have a dissimilar spare wheel and tire assembly it is intended for temporary use only and should not be used in a tire rotation.

Note: After having your tires rotated, inflation pressure must be checked and adjusted to the vehicle requirements.

Rotating your tires at the recommended interval (as indicated in the Scheduled Maintenance chapter) helps your tires wear more evenly, providing better tire performance and longer tire life. Sometime irregular tire wear can be corrected by rotating the tires.

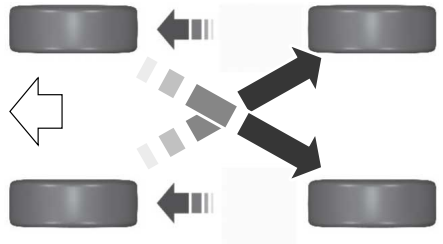

Rear-wheel drive vehicles and four-wheel drive vehicles (front tires at left of diagram).

Wheels and Tires

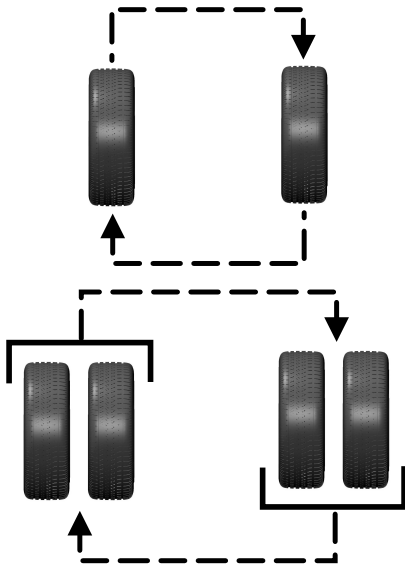

Dual rear wheel drive vehicle - six tire rotation (front tires at top of diagram).

If your vehicle is equipped with dual rear wheels it is recommended that the front and rear tires (in pairs) be rotated only side to side. We do not recommend splitting up the dual rear wheels. Rotate them side to side as a set. After tire rotation, inflation pressures must be adjusted for the tires new positions in accordance with vehicle requirements.

USING SNOW CHAINS

WARNING: Wheels and tires must be the same size, load index and speed rating as those originally fitted on the vehicle. Use of any other tire or wheel can affect the safety and performance of your vehicle. Additionally, the use of non-recommended tires and wheels can cause steering, suspension, axle, transfer case or power transfer unit failure. Follow the recommended tire inflation pressures found on the Safety Compliance Certification label, or the Tire Label on the B-Pillar or the edge of the driver door. Failure to follow this instruction could result in loss of vehicle control, vehicle rollover, or personal injury or death.

The tires on your vehicle have all-weather treads to provide traction in rain and snow. However, in some climates, you may need to use snow tires and cables. If you need to use cables, it is recommended that steel wheels (of the same size and specifications) be used, as cables may chip aluminum wheels.

Note: *The suspension insulation and bumpers help prevent vehicle damage. Do not remove these components from your vehicle when using snow tires and chains.*

Follow these guidelines when using snow tires and chains:

- If possible, avoid fully loading your vehicle.
- Install chains securely, verifying that the chains do not touch any wiring, brake lines or fuel lines.

Wheels and Tires

- Drive cautiously. If you hear the chains rub or bang against your vehicle, stop and retighten the chains. If this does not work, remove the chains to prevent damage to your vehicle.
- Remove the snow chains when they are no longer needed. Do not use snow chains on dry roads.

Please contact your upfitter for approved snow chain types/sizes and other recommendations for snow chain use.

TIRE PRESSURE MONITORING SYSTEM (IF EQUIPPED)



WARNING: The tire pressure monitoring system is not a substitute for manually checking tire pressures. You should periodically check tire pressures using a pressure gauge. Failure to correctly maintain tire pressures could increase the risk of tire failure, loss of control, vehicle rollover and personal injury.



WARNING: Changes or modifications not expressly approved by the party responsible for compliance could void the user's authority to operate the equipment. The term "IC:" before the radio certification number only signifies that Industry Canada technical specifications were met.

This device complies with Part 15 of the FCC Rules and with License exempt RSS Standards of Industry Canada. Operation is subject to the following two conditions:

1. This device may not cause harmful interference.
2. This device must accept any interference received, including interference that may cause undesired operation.



Each tire, including the spare, if provided, should be checked monthly when cold and inflated to the inflation pressure recommended by the vehicle manufacturer on the vehicle placard or tire inflation pressure label. If your vehicle has tires of a different size than the size indicated on the vehicle placard or tire inflation pressure label, you should determine the proper tire inflation pressure for those tires.

As an added safety feature, your vehicle has been equipped with a Tire Pressure Monitoring System (TPMS) that illuminates a low tire pressure telltale when one or more of your tires is significantly under-inflated. Accordingly, when the low tire pressure telltale illuminates, you should stop and check your tires as soon as possible, and inflate them to the proper pressure. Driving on a significantly under-inflated tire causes the tire to overheat and can lead to tire failure. Under-inflation also reduces fuel efficiency and tire tread life, and may affect the vehicle's handling and stopping ability.

Please note that the TPMS is not a substitute for proper tire maintenance, and it is the driver's responsibility to maintain correct tire pressure, even if under-inflation has not reached the level to trigger illumination of the TPMS low tire pressure telltale.

Your vehicle has a TPMS malfunction indicator to indicate when the system is not operating properly. The TPMS malfunction indicator is combined with the low tire pressure telltale. When the system detects a malfunction, the telltale flashes for approximately one minute and then remains continuously illuminated. This sequence continues upon subsequent vehicle start-ups as long as the malfunction exists.

Wheels and Tires

When the malfunction indicator is illuminated, the system may not be able to detect or signal low tire pressure as intended. TPMS malfunctions may occur for a variety of reasons, including the installation of replacement or alternate tires or wheels on the vehicle that prevent the TPMS from functioning properly. Always check the TPMS malfunction telltale after replacing one or more tires or wheels on your vehicle to ensure that the replacement or alternate tires and wheels allow the TPMS to continue to function properly.

Note: Only use tire sealants in roadside emergencies as they may cause damage to the tire pressure monitoring system sensor.

Note: If the tire pressure monitoring system sensor becomes damaged, it may not function.

Changing Tires With a Tire Pressure Monitoring System



Note: Each road tire is equipped with a tire pressure sensor located inside the wheel and tire assembly cavity. The pressure sensor is attached to the valve stem. The pressure sensor is covered by the tire and is not visible unless the tire is removed. Take care when changing the tire to avoid damaging the sensor.

You should always have your tires serviced by an authorized dealer.

Check the tire pressure periodically, at least monthly, using an accurate tire gauge. See *Inflating Your Tires* in this chapter.

Understanding Your Tire Pressure Monitoring System

The tire pressure monitoring system measures pressure in your four road tires and sends the tire pressure readings to your vehicle. The low tire pressure warning light turns on if the tire pressure is significantly low. Once the light is illuminated, your tires are under-inflated and need to be inflated to the manufacturer's recommended tire pressure. Even if the light turns on and a short time later turns off, your tire pressure still needs to be checked.

When Your Temporary Spare Tire is Installed

When you replace one of the road tires with the temporary spare, the system continues to identify an issue to remind you that you need to repair and put back on the damaged road wheel and tire assembly on your vehicle.

To restore the full function of the tire pressure monitoring system, have the damaged road wheel and tire assembly repaired and remounted on your vehicle.

When You Believe Your System is Not Operating Properly

The main function of the tire pressure monitoring system is to warn you when your tires need air. It can also warn you in the event the system is no longer capable of functioning as intended. See the following chart for information concerning your tire pressure monitoring system:

Wheels and Tires

Low Tire Pressure Warning Light	Possible Cause	Customer Action Required
Solid warning light	Tire(s) under-inflated	Make sure tires are at the proper pressure. See Inflating your tires in this chapter. After inflating your tires to the manufacturer's recommended pressure as shown on the Tire Label, located on the edge of driver door or the B-Pillar, the vehicle must be driven for at least two minutes over 20 mph (32 km/h) before the light turns off.
	Spare tire in use	Repair the damaged road wheel and tire assembly and reinstall it on the vehicle to restore system function. For a description on how the system functions, see When your temporary spare tire is installed in this section.
	TPMS malfunction	If the tires are properly inflated and the spare tire is not in use but the light remains on, contact your authorized dealer as soon as possible.
Flashing warning light	Spare tire in use	Repair the damaged road wheel and tire assembly and reinstall it on the vehicle to restore system function. For a description on how the system functions, see When your temporary spare tire is installed in this section.
	TPMS malfunction	If the tires are properly inflated and the spare tire is not in use but the light remains on, contact your authorized dealer as soon as possible.

When Inflating Your Tires

When putting air into your tires, such as at a gas station or in your garage, the tire pressure monitoring system may not respond immediately to the air added to your tires.

It may take up to two minutes of driving over 20 mph (32 km/h) for the light to turn off after you have filled your tires to the recommended inflation pressure.

Wheels and Tires

How Temperature Affects Your Tire Pressure

The tire pressure monitoring system monitors tire pressure in each pneumatic tire. When driving in a normal manner, a typical passenger tire inflation pressure may increase about 2–4 psi (14–28 kPa) from a cold start situation. If the vehicle is stationary overnight with the outside temperature significantly lower than the daytime temperature, the tire pressure may decrease about 3 psi (21 kPa) for a drop of 30°F (17°C) in ambient temperature. This lower pressure value may be detected by the tire pressure monitoring system as being significantly lower than the recommended inflation pressure and activate the system warning light for low tire pressure. If the low tire pressure warning light is on, visually check each tire to verify that no tire is flat. If one or more tires are flat, repair as necessary. Check the air pressure in the road tires. If any tire is under-inflated, carefully drive the vehicle to the nearest location where air can be added to the tires. Inflate all the tires to the recommended inflation pressure.

Tire Pressure Monitoring System Reset Procedure



WARNING: To determine the required pressure(s) for your vehicle, see the Safety Compliance Certification Label (on the door hinge pillar, door-latch post or the door edge that meets the door-latch post, next to the driver seat) or the Tire Label on the B-Pillar or the edge of the driver door.

Note: You need to perform the tire pressure monitoring system reset procedure after each tire rotation.

To provide the vehicle's load carrying capability, some vehicles require different recommended tire pressures in the front tires as compared to the rear tires. The tire pressure monitoring system on these vehicles illuminate the low tire pressure warning light at two different pressures: one for the front tires and one for the rear tires.

Since tires need to be rotated to provide consistent performance and maximum tire life, the tire pressure monitoring system needs to know when the tires are rotated to determine which set of tires are on the front and which are on the rear. With this information, the system can detect and properly warn of low tire pressures.

System reset tips:

- To reduce the chances of interference from another vehicle, perform the system reset procedure at least 3 ft (1 m) away from another vehicle undergoing the system reset procedure at the same time.
- Do not wait more than two minutes between resetting each tire sensor or the system can time-out and you have to repeat the entire procedure on all four wheels.
- A double horn sounds indicating the need to repeat the procedure.

Performing the System Reset Procedure - Single Rear Wheel

Read the entire procedure before attempting.

1. Drive the vehicle above 20 mph (32 km/h) for at least two minutes, then park in a safe location where you can easily get to all four tires and have access to an air pump.
2. Place the ignition in the off position and keep the key in the ignition.

Wheels and Tires

- Cycle the ignition to the on position with the engine off.
 - Turn the hazard flashers on then off three times. You must accomplish this within 10 seconds. If you successfully enter the reset mode, the horn sounds once, the system indicator flashes and a message shows in the information display. If this does not occur, please try again starting at step 2. If after repeated attempts to enter the reset mode, the horn does not sound, the system indicator does not flash and no message shows in the information display, have the system checked as soon as possible.
 - Train the tire pressure monitoring system sensors in the tires using the following system reset sequence starting with the left front tire in the following clockwise order: Left front - driver side front tire, Right front - passenger side front tire, Right rear - passenger side rear tire, Left rear - driver side rear tire.
 - Remove the valve cap from the valve stem on the left front tire. Decrease the air pressure until the horn sounds.
- Note:** *The single horn tone confirms that the sensor identification code has been learned by the module for this position. If you hear a double horn, the reset procedure was unsuccessful, and you must repeat it.*
- Remove the valve cap from the valve stem on the right front tire. Decrease the air pressure until the horn sounds.
 - Remove the valve cap from the valve stem on the right rear tire. Decrease the air pressure until the horn sounds.
 - Remove the valve cap from the valve stem on the left rear tire. Decrease the air pressure until the horn sounds. Training is complete after the horn sounds for the last tire trained, driver side rear tire, the system indicator stops flashing, and a message shows in the information display.
 - Turn the ignition off. If you hear two short tones, the reset procedure was unsuccessful and you must repeat it. If you hear two short beeps when the ignition is off after repeating the procedure, have the system checked as soon as possible.
 - Set all four tires to the recommended air pressure as indicated on the Safety Compliance Certification Label, affixed to either the door hinge pillar, door-latch post, or the door edge that meets the door-latch post, next to the driver seating position or Tire Label located on the B-Pillar or the edge of the driver door.

Performing the System Reset Procedure - Dual Rear Wheel

For further information see **Understanding Your Tire Pressure Monitoring System** and refer to **Dual Rear Wheel**, earlier in this section.

Read the entire procedure before attempting.

- Drive the vehicle above 20 mph (32 km/h) for at least two minutes, then park in a safe location where you can easily get to all six tires and have access to an air pump.
- Place the ignition in the off position and keep the key in the ignition.
- Cycle the ignition to the on position with the engine off.

Wheels and Tires

4. Turn the hazard flashers on then off three times. You must accomplish this within 10 seconds. If you successfully enter the reset mode, the horn sounds once, the system indicator flashes and a message shows in the information display. If this does not occur, please try again starting at step 2. If after repeated attempts to enter the reset mode, the horn does not sound, the system indicator does not flash and no message shows in the information display, seek service from your authorized dealer.
 5. Train the tire pressure monitoring system sensors in the tires using the following system reset sequence starting with the left front tire in the following order: Left front - driver side front tire, Right front - passenger side front tire, Right outer rear -passenger side rear outer tire, Right inner rear - passenger side rear inner tire, Left outer rear - driver side rear outer tire, Left inner rear - driver side rear inner tire.
 6. Remove the valve cap from the valve stem on the left front tire. Decrease the air pressure until the horn sounds.
- Note:** *The single horn chirp confirms that the sensor identification code has been learned by the module for this position. If a double horn is heard, the reset procedure was unsuccessful, and you must repeat it.*
7. Remove the valve cap from the valve stem on the right front tire. Decrease the air pressure until the horn sounds.
 8. Remove the valve cap from the valve stem on the right outer rear tire. Decrease the air pressure until the horn sounds.
 9. Remove the valve cap from the valve stem on the right inner rear tire. Decrease the air pressure until the horn sounds.
 10. Remove the valve cap from the valve stem on the left outer rear tire. Decrease the air pressure until the horn sounds.
 11. Remove the valve cap from the valve stem on the left inner rear tire. Decrease the air pressure until the horn sounds. Training is complete after the horn sounds for the last tire trained, the system indicator stops flashing, and a message is shown in the information display.
 12. Turn the ignition off. If two short horn beeps are heard, the reset procedure was unsuccessful and you must repeat it. If after repeating the procedure and two short beeps are heard when the ignition is turned to off, seek assistance from your authorized dealer.
 13. Set all six tires to the recommended air pressure as indicated on the Safety Compliance Certification Label, affixed to either the door hinge pillar, door-latch post, or the door edge that meets the door-latch post, next to the driver seating position or Tire Label located on the B-Pillar or the edge of the driver door.

CHANGING A ROAD WHEEL



WARNING: To determine the required pressure(s) for your vehicle, see the Safety Compliance Certification Label (on the door hinge pillar, door-latch post or the door edge that meets the door-latch post, next to the driver seat) or the Tire Label on the B-Pillar or the edge of the driver door.

Note: *You should only use tire sealants in roadside emergencies as they may cause damage to the tire pressure monitoring system sensor.*

Wheels and Tires

Note: The tire pressure monitoring system indicator light illuminates when the spare tire is in use. To restore the full function of the monitoring system, all road wheels equipped with tire pressure monitoring sensors must be mounted on the vehicle.

Note: Do not use wheels or wheel nuts different than the original equipment, as this may damage the wheel or mounting system.

If you get a flat tire when driving, do not apply the brake heavily. Instead, gradually decrease your speed. Hold the steering wheel firmly and slowly move to a safe place on the side of the road.

Have a flat serviced by an authorized dealer to prevent damage to the tire pressure monitoring system sensors. See **Tire Pressure Monitoring System** (page 213). Replace the spare tire with a road tire as soon as possible. During repairing or replacing of the flat tire, have the authorized dealer inspect the tire pressure monitoring system sensor for damage.

Dissimilar Spare Wheel and Tire Assembly Information



WARNING: Failure to follow these guidelines could result in an increased risk of loss of vehicle control, injury or death.

If you have a dissimilar spare wheel and tire, then it is intended for temporary use only. This means that if you need to use it, you should replace it as soon as possible with a road wheel and tire assembly that is the same size and type as the road tires and wheels that were originally provided by Ford. If the dissimilar spare tire or wheel is damaged, it should be replaced rather than repaired.

A dissimilar spare wheel and tire assembly is defined as a spare wheel and tire assembly that is different in brand, size or appearance from the road tires and wheels and can be one of three types:

1. **T-type mini-spares:** This spare tire begins with the letter T for tire size and may have Temporary Use Only molded in the sidewall.

2. **Full-size dissimilar spare with label on wheel:** This spare tire has a label on the wheel that states: THIS WHEEL AND TIRE ASSEMBLY FOR TEMPORARY USE ONLY.

When driving with one of the dissimilar spare tires listed above:

- Do not exceed 50 mph (80 km/h).
- Do not load the vehicle beyond maximum vehicle load rating listed on the Safety Compliance Label.
- Do not tow a trailer.
- Do not use snow chains on the end of the vehicle with the dissimilar spare tire.
- Do not use more than one dissimilar spare tire at a time.
- Do not use commercial car washing equipment.
- Do not try to repair the dissimilar spare tire.

Using a dissimilar spare wheel and tire assembly can compromise the effectiveness of the following:

- Handling, stability and braking performance.
- Comfort and noise.
- Ground clearance and parking at curbs.
- Winter weather driving capability.
- Wet weather driving capability.
- All-wheel driving capability.

Wheels and Tires

3. Full-size dissimilar spare without label on wheel

When driving with the full-size dissimilar spare wheel and tire assembly:

- Do not exceed 70 mph (113 km/h).
- Do not use more than one dissimilar spare wheel and tire assembly at a time.
- Do not use commercial car washing equipment.
- Do not use snow chains on the end of the vehicle with the dissimilar spare wheel and tire assembly.

Using a dissimilar spare wheel and tire assembly can compromise the effectiveness of the following :

- Handling, stability and braking performance.
- Comfort and noise.
- Ground clearance and parking at curbs.
- Winter weather driving capability.
- Wet weather driving capability.
- All-wheel driving capability.

When driving with the full-size dissimilar spare wheel and tire assembly additional caution should be given to:

- Towing a trailer.
- Driving vehicles equipped with a camper body.
- Driving vehicles with a load on the cargo rack.

Drive cautiously when using a full-size dissimilar spare wheel and tire assembly and seek service as soon as possible.

Tire Change Procedure (If Equipped)



WARNING: The jack supplied with this vehicle is only intended for changing a flat tire in an emergency. Do not attempt to do any other work on your vehicle when it is supported by the jack, as your vehicle could slip off the jack. Failure to follow this instruction could result in personal injury or death.



WARNING: To help prevent your vehicle from moving when changing a wheel, shift the transmission into park (P), set the parking brake and use an appropriate block or wheel chock to secure the wheel diagonally opposite to the wheel being changed. For example, when changing the front left wheel, place an appropriate block or wheel chock on the right rear wheel.



WARNING: Do not attempt to change a tire on the side of the vehicle close to moving traffic. Pull far enough off the road to not obstruct the flow of traffic and avoid the danger of being hit when operating the jack or changing the wheel.



WARNING: Only use the jack provided as original equipment with your vehicle.



WARNING: The jack supplied with this vehicle is only intended for changing a flat tire in an emergency. Do not attempt to do any other work on your vehicle when it is supported by the jack, as your vehicle could slip off the jack. Failure to follow this instruction could result in personal injury or death.



WARNING: Only use the jack provided as original equipment with your vehicle.

Wheels and Tires



WARNING: Never place anything between the vehicle jack and your vehicle.



WARNING: Never place anything between the vehicle jack and the ground.



WARNING: Only use the specified jacking points. If you use any other locations you could damage vehicle components, such as brake lines.



WARNING: Failure to follow these guidelines could result in an increased risk of loss of vehicle control, injury or death.



WARNING: Only use the spare wheel carrier to stow wheels provided with your vehicle.

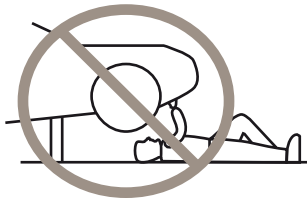

Note: *Passengers should not remain in your vehicle when the vehicle is being jacked.*

Note: *Do not use impact tools or power tools operating at over 200 RPM on the spare wheel carrier winch, which may cause it to malfunction and prevent a secure fit. Override the winch at least three times (there is an audible click each time) to make sure the wheel and tire fit securely.*

Note: *No maintenance or additional lubrication of your jack is required over the service life of your vehicle.*

1. Park the vehicle on a level firm ground and activate the hazard flashers.
2. Apply the parking brake, place the transmission in park (P), turn the engine off.

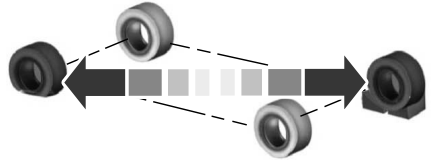

3. Block the wheel diagonally opposite the flat tire. For example, if the left front tire is flat, block the right rear wheel.

Removing the Spare Tire

1. To access the spare tire it must be lowered from its stowed position. Remove the thumb screw and anti-theft bracket as required. Use the wheel nut wrench tip to loosen it.
2. Guide the wheel nut wrench or jack handle through the hole and into the tube.
3. Turn the wrench or handle counterclockwise until the cable has slack and the tire can be slid rearward.
4. Remove the retainer from the spare tire and remove the spare tire.

Wheels and Tires

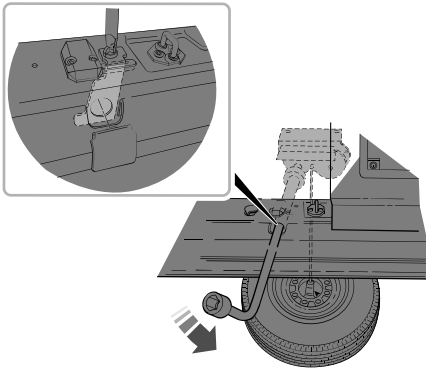

5. Use the wheel nut wrench to remove the wheel trim, if equipped.
6. Loosen each wheel nut one-half turn counterclockwise. Do not remove them until the wheel is raised off the ground.

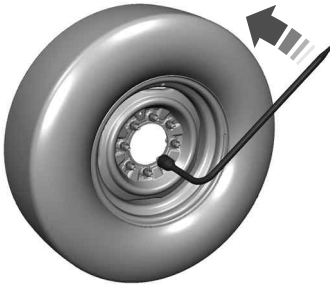

7. For E-350 dual wheel and E-450 equipped with hydraulic jacks, two handle extensions are used to operate the jack. To assemble, align the button with the hole and slide the parts together. To disconnect, press the button and pull apart.

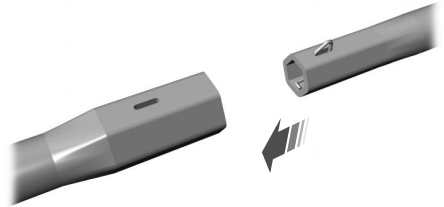

Jacking the Vehicle

Position the jack under the correct jacking points according to following pictures.

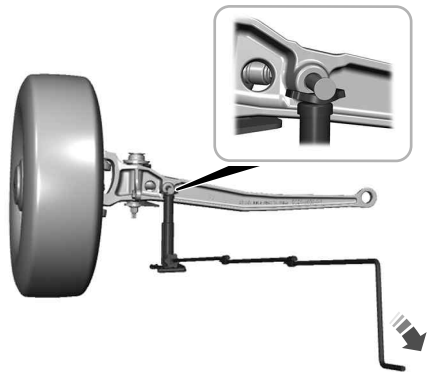

Front axle jacking point: Place the jack under the pin on the front surface of the front axle.

Note: Do not place the jack under or on the steering linkage.

Wheels and Tires

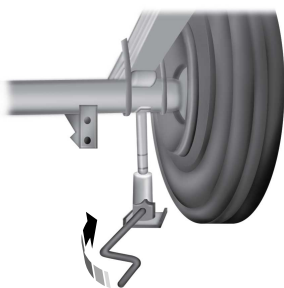

E201346

Rear axle jacking points: All models except E-350 and E-450 dual rear wheel.

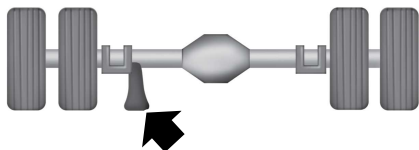

E201347

Rear axle jacking points: E-350 and E-450 dual rear wheel.

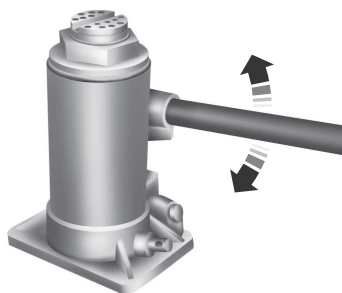

Turn the jack handle clockwise. For hydraulic jacks, operate the handle up-and-down until the wheel is completely off the ground and high enough to install the spare tire.

Installing the spare wheel and tire

1. Remove the wheel nuts with the wheel nut wrench, replace the flat tire with the spare, making sure the valve stem of the spare is facing outward when replacing a front wheel. For the rear wheel position on vehicles with single rear wheel fitments, install the spare with the valve stem facing outward. For vehicles with dual rear wheels, the valve stem of the spare must face outward when replacing an inner wheel, but must face inward when replacing an outboard wheel.
2. Install the wheel nuts and finger tighten. Do not fully tighten the wheel nuts until the wheel has been lowered.
3. Lower the vehicle completely by turning the jack handle counterclockwise.

Note: For hydraulic jacks, insert the release valve, open release valve slightly by turning the handle counterclockwise. Stop turning the release valve when vehicle start to lower. Close the valve when the vehicle is completely lowered.

Wheels and Tires

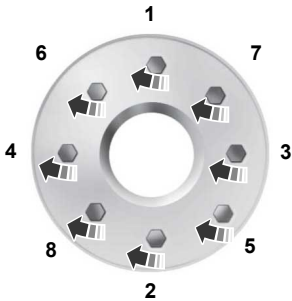

4. Install the wheel nuts in the sequence shown.



5. Remove the jack and fully tighten the wheel nuts in the sequence shown. See **Technical Specifications** (page 225).
6. Install any wheel covers or hubcaps. Make sure they snap into place.

Note: When installing the wheel center ornaments, make sure that the ornament retention towers on the back side of the ornament are aligned with the studs and wheel nuts and retain to the flange on the wheel nuts.

Stowing the Flat tire or Spare tire

1. Place the tire on end with the valve stem facing toward the front of the vehicle. Lay the tire on the ground, near the rear of the vehicle, with the valve stem side facing up.

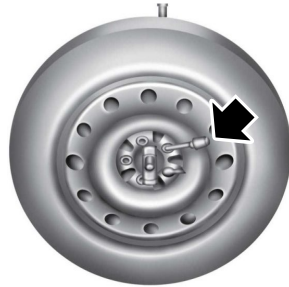

2. Slide the wheel partially under the vehicle and install the retainer through the wheel center. If equipped, you may have to remove the wheel center cap prior to pushing the retainer through the center of the wheel. To remove the center cap, press it off with the wheel nut wrench tip from the inner side of the wheel. Pull on the cable to align the components at the end of the cable.
3. Turn the wheel nut wrench clockwise until the tire is raised to its stowed position underneath the vehicle. The wrench becomes harder to turn and the spare tire winch ratchets or slips when the tire is raised to its maximum tightness. A clicking sound is heard from the winch indicating that the tire is properly stowed. Check that the tire lies flat against the frame and is properly tightened.
4. Unblock the wheel.

Wheels and Tires

TECHNICAL SPECIFICATIONS

Wheel Lug Nut Torque Specifications



WARNING: When you install a wheel, remove any corrosion, dirt or foreign materials present on the mounting surfaces of the wheel or the surface of the wheel hub, brake drum or brake disc that contacts the wheel. Make sure to secure any fasteners that attach the rotor to the hub so they do not interfere with the mounting surfaces of the wheel. Installing wheels without following these steps can cause the wheel nuts to loosen and the wheel to come off while your vehicle is in motion, resulting in loss of vehicle control, personal injury or death.

Bolt size	lb.ft (Nm) ¹
9/16 x 18 two-piece lug nut	140 lb.ft (190 Nm)

¹ Torque specifications are for nut and bolt threads free of dirt and rust. Use only Ford recommended replacement fasteners.

On vehicles equipped with single rear wheels, retighten the lug nuts to the specified torque at 100 miles (160 kilometers) after any wheel disturbance (such as tire rotation, changing a flat tire, wheel removal).

On vehicles equipped with dual rear wheels, retighten the wheel lug nuts to the specified torque at 100 miles (160 kilometers), and again at 500 miles (800 kilometers) of new vehicle operation and after any wheel disturbance (such as tire rotation, changing a flat tire, wheel removal).



E161443

On all two-piece flat wheel nuts, apply one drop of motor oil between the flat washer and the nut. Do not apply motor oil to the wheel nut threads or the wheel stud threads.



A Wheel pilot bore

Inspect the wheel pilot hole and mounting surface prior to installation. Remove any visible corrosion or loose particles.

Capacities and Specifications

ENGINE SPECIFICATIONS

Engine	7.3L V8 Engine
Displacement.	445 in ³ (7,293 cm ³)
Required fuel.	Minimum 87 octane
Firing order.	1-5-4-8-6-3-7-2
Ignition system.	Coil near spark plug with spark plug wire
Spark plug gap.	0.049 in (1.25 mm) - 0.053 in (1.35 mm)
Compression ratio.	10.5:1

Drivebelt Routing

Single Alternator

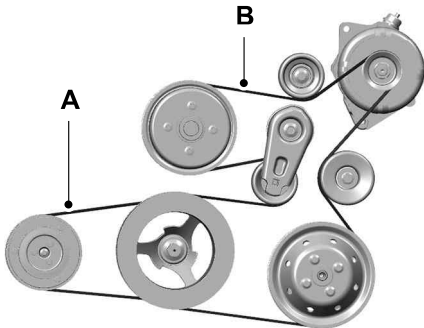

- A Drivebelt closest to the engine.
- B Drivebelt furthest from the engine.

Dual Alternator

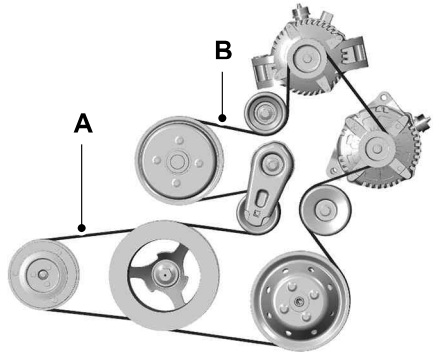

- A Drivebelt closest to the engine.
- B Drivebelt furthest from the engine.

Capacities and Specifications

MOTORCRAFT PARTS - 7.3L

Component	Motorcraft Part number
Air filter element.	FA-2042
One battery.	BXT-65-750
Two batteries (optional).	BXT-65-750
Engine oil filter. ¹	FL-820-S
Spark plug.	SP-589
Transmission fluid filter.	FT-187
Windshield wiper blade.	WW-2005

¹ If a Motorcraft oil filter is not available, use an oil filter that aligns to SAE/USCAR – 36 Performance Specifications. Filter Type D.

We recommend Motorcraft parts that are available at your authorized dealer or at www.fordparts.com. We engineer these parts for your vehicle to meet or exceed our specifications. Use of other parts could impact vehicle performance, emissions and durability. Your warranty could be void for any damage related to use of other parts.

Capacities and Specifications

BULB SPECIFICATION CHART

Replacement bulbs are specified in the chart below. Headlamp bulbs must be marked with an authorized "D.O.T." for

North America and an "E" for Europe to ensure lamp performance, light brightness and pattern and safe visibility. The correct bulbs will not damage the lamp assembly or void the lamp assembly warranty and will provide quality bulb illumination time.

Exterior Lamps

Lamp	Trade Name
Front side marker lamp.	W5W
Park lamp.	3157AK
Front direction indicator.	3157AK
Headlamp low beam.	H13
Headlamp high beam.	H13
Front clearance lamp (exterior mirror).	2825
Brake, rear and direction indicator lamp.	3157K
Reversing lamps.	3156

Interior Lamps

Lamp	Trade Name
Underhood Lamp.	906
Map lamp.	578
Dome lamp.	578
Cargo lamp.	578

To replace all instrument panel lights - see your authorized dealer.

Capacities and Specifications

ENGINE OIL CAPACITY AND SPECIFICATION

Use oil that meets the defined specification and viscosity grade.

If you do not use oil that meets the defined specification and viscosity grade, it could result in:

- Component damage that your vehicle warranty does not cover.
- Longer engine cranking periods.
- Increased emission levels.
- Reduced vehicle performance.
- Reduced fuel economy.



An oil that displays this symbol conforms to current engine, emission system and fuel economy performance standards of ILSAC.

We recommend Motorcraft motor oil for your vehicle. If Motorcraft oil is not available, use motor oils of the recommended viscosity grade that display the API Certification Mark for gasoline engines.

Do not use supplemental engine oil additives because they are unnecessary and could lead to engine damage that your vehicle warranty does not cover.

Capacities

Variant	Including the Oil Filter
All.	8.0 qt (7.57 L)

Materials

Name	Specification
Motorcraft® SAE 5W-30 Synthetic Blend Motor Oil(U.S.) Motorcraft® SAE 5W-30 Super Premium Motor Oil / Huile moteur de très haute qualité SAE 5W-30 Motorcraft®(Canada) XO-5W30-Q1SP(U.S.) CXO-5W30-LSP6(Canada)	WSS-M2C961-A1

Capacities and Specifications

Alternative Engine Oil for Extremely Cold Climates

To improve engine cold start performance,

we recommend that you use the following alternative engine oil in extremely cold climates, where the ambient temperature reaches -22°F (-30°C) or below.

Materials

Name	Specification
Engine Oil - SAE 0W-30 - Synthetic Blend	WSS-M2C963-A1

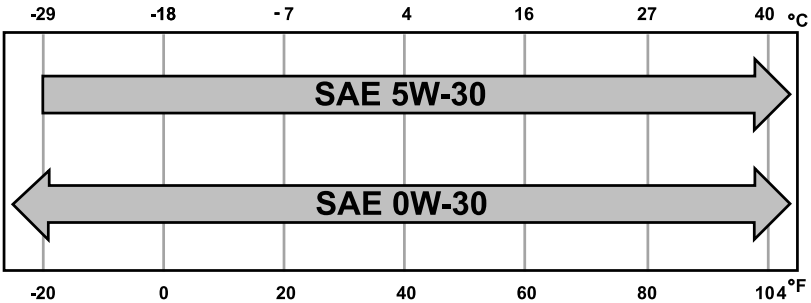

Note: If you use your vehicle regularly above the altitude of 7,500 ft (2,286 m) and under the temperature of -4.0°F (-20°C), it is recommended to use the alternative engine oil.

If you do not use coolant that meets the defined specification, it could result in:

- Component damage that your vehicle warranty does not cover.
- Reduced vehicle performance.

COOLING SYSTEM CAPACITY AND SPECIFICATION

Use coolant that meets the defined specification.

Capacities

Variant	Quantity
All.	20.3 qt (19.22 L)

Capacities and Specifications

Materials

Name	Specification
Motorcraft® Yellow Prediluted Antifreeze/ Coolant (U.S.) Motorcraft® Yellow Prediluted Antifreeze/Coolant / Antigel/liquide de refroidissement prédilué jaune Motorcraft® (Canada) VC-13DL-G (U.S.) CVC-13DL-G (Canada)	WSS-M97B57-A2

FUEL TANK CAPACITY

Capacities

Variant	Quantity
Standard.	40 gal (151 L)
Optional or E-Super Duty.	55 gal (208 L)

Capacities and Specifications

AIR CONDITIONING SYSTEM CAPACITY AND SPECIFICATION



WARNING: The air conditioning refrigerant system contains refrigerant under high pressure. Only qualified personnel should service the air conditioning refrigerant system. Opening

the air conditioning refrigerant system can cause personal injury.

Use refrigerant and oil that meets the defined specifications.

If you do not use refrigerant and oil that meets the defined specifications, it could result in:

- Component damage that your vehicle warranty does not cover.
- Reduced vehicle performance.

Capacities

Variant	Refrigerant	Refrigerant Oil
Front only.	26.98 oz (0.765 kg)	7.00 fl oz (207 ml)
With prep pack.	33.02 oz (0.936 kg)	14.00 fl oz (414 ml)

Materials

Name	Specification
Motorcraft® R-134a Refrigerant (U.S.) R-134a Refrigerant / Frigorigène R-134a (Canada) YN-19 (U.S.) CYN-19-RB (Canada)	WSH-M17B19-A
Motorcraft® PAG Refrigerant Compressor Oil (U.S.) Motorcraft® PAG Refrigerant Compressor Oil / Huile PAG pour compresseur frigorifique Motor- craft® (Canada) YN-12-D (U.S. & Canada)	WSH-M1C231-B

WASHER FLUID SPECIFICATION

Capacities

Variant	Quantity
All.	Fill as required.

Capacities and Specifications

Materials

Name	Specification
Motorcraft® Premium Windshield Wash Concentrate with Bitterant(U.S.) Motorcraft® Premium Quality Windshield Washer Fluid / Liquide lave-glace de haute qualité Motorcraft®(Canada) ZC-32-B2(U.S.) CXC-37-F/M(Canada)	WSS-M14P19-A

AUTOMATIC TRANSMISSION FLUID CAPACITY AND SPECIFICATION

Use fluid that meets the defined specification and viscosity grade.

If you do not use fluid that meets the defined specification and viscosity grade, it could result in:

- Component damage that your vehicle warranty does not cover.
- Reduced vehicle performance.
- Reduced fuel economy.

Note: Only use MERCON LV transmission fluid for automatic transmissions that require MERCON LV transmission fluid. The use of any other fluid could cause transmission damage.

Capacities

Variant	Quantity
All.	17.4 qt (16.5 L) ¹

¹ Approximate dry fill capacity. Actual amount could vary during fluid changes.

Materials

Name	Specification
Motorcraft® MERCON® LV Automatic Transmission Fluid(U.S.) Motorcraft® MERCON® LV Automatic Transmission Fluid / Huile pour boîte automatique MERCON® LV Motorcraft®(Canada) XT-10-QLVC(U.S.) CXT-10-LV6(Canada)	WSS-M2C938-AMERCON® LV,

Capacities and Specifications

BRAKE FLUID SPECIFICATION

Use fluid that meets the defined specification.

If you do not use fluid that meets the defined specification, it could result in:

- Component damage that your vehicle warranty does not cover.
- Reduced brake performance.

Note: *Keep brake fluid clean and dry. Contamination with dirt, water, petroleum products or other materials could result in brake system damage and failure.*

Capacities

Variant	Quantity
Hydroboost Brake System.	Fill as required.
Vacuum Brake System.	Fill as required.

Materials

Name	Specification
Motorcraft® DOT 4 LV High Performance Motor Vehicle Brake Fluid(U.S.) Motorcraft® DOT 4 LV High Performance Motor Vehicle Brake Fluid / Liquide de frein automobile haute performance DOT 4 LV Motorcraft®(Canada) PM-20(U.S. & Canada)	WSS-M6C65-A2

Note: *We recommend using DOT 4 Low Viscosity (LV) High Performance Brake Fluid for vehicles with vacuum brake booster systems.*

Note: *Use of any fluid other than the recommended fluid could cause reduced brake performance and not meet our performance standards.*

REAR AXLE FLUID CAPACITY AND SPECIFICATION

Use fluid that meets the defined specification and viscosity grade.

If you do not use fluid that meets the defined specification and viscosity grade, it could result in:

- Component damage that your vehicle warranty does not cover.
- Reduced vehicle performance.

Capacities and Specifications

Limited Slip Axle

Capacities

Variant	Quantity
E-350 Dana axle M70FF (M267FF).	3.28 qt (3.1 L) ¹
E-450 Dana axle M70HD (M273HD).	4.86 qt (4.6 L) ¹

¹ Fill Dana rear axles to 0.24–0.55 in (6–14 mm) below the bottom of the fill hole.

Materials

Name	Specification
Motorcraft® SAE 75W-140 Synthetic Rear Axle Lubricant(U.S.) Motorcraft® SAE 75W-140 Synthetic Rear Axle Lubricant / Lubrifiant synthétique pour pont arrière SAE 75W-140 Motorcraft®(Canada) XY-75W140-QL(U.S.) CXY-75W140-1L(Canada)	WSL-M2C192-A

Conventional Axle

Capacities

Variant	Quantity
E-350 Dana axle M70FF (M267FF).	3.28 qt (3.1 L) ¹
E-450 Dana axle M70HD (M273HD).	4.86 qt (4.6 L) ¹

¹ Fill Dana rear axles to 0.24–0.55 in (6–14 mm) below the bottom of the fill hole.

Capacities and Specifications

Materials

Name	Specification
Motorcraft® SAE 80W-90 Premium Rear Axle Lubricant(U.S.) Motorcraft® SAE 80W-90 Premium Axle Lubricant / Lubrifiant pour essieux de très haute qualité SAE 80W-90 Motorcraft®(Canada) XY-80W90-QL(U.S.) CXY-80W90-1L(Canada)	WSP-M2C197-A

HYDRAULIC POWER STEERING FLUID CAPACITY AND SPECIFICATION

Use fluid that meets the defined specification.

Capacities

Variant	Quantity
All.	Fill as required.

If you do not use fluid that meets the defined specification, it could result in:

- Component damage that your vehicle warranty does not cover.
- Reduced vehicle performance.

Materials

Name	Specification
Motorcraft® MERCON® LV Automatic Transmission Fluid(U.S.) Motorcraft® MERCON® LV Automatic Transmission Fluid / Huile pour boîte automatique MERCON® LV Motorcraft®(Canada) XT-10-QLVC(U.S.) CXT-10-LV6(Canada)	WSS-M2C938-AMERCON® LV,

Vehicle Identification

VEHICLE IDENTIFICATION NUMBER

LOCATING THE VEHICLE IDENTIFICATION NUMBER

The vehicle identification number is on the left-hand side of the instrument panel.

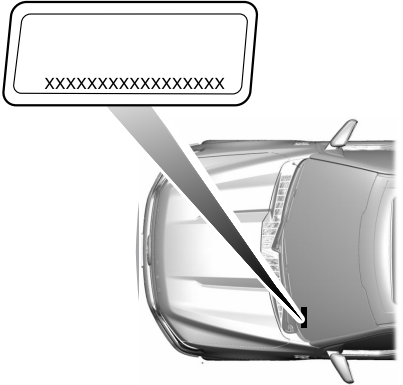

Note: In the illustration, XXXX is representative of your vehicle identification number.

VEHICLE IDENTIFICATION NUMBER OVERVIEW

The vehicle identification number contains the following information:

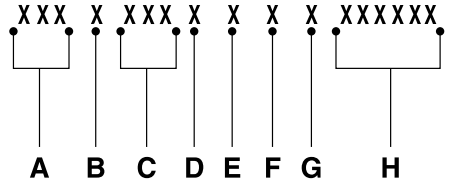

- A World manufacturer identifier.
- B Brake system, gross vehicle weight rating, restraint devices and their locations.
- C Make, vehicle line, series, body type.
- D Engine or motor type.
- E Check digit.
- F Model year.
- G Assembly plant.
- H Production sequence number.

Connected Vehicle

CONNECTED VEHICLE REQUIREMENTS

Connected service and related feature functionality requires a compatible vehicle network.

Some remote features require additional service activation. Log in to your Ford account for details. Some restrictions, third party terms and message or data rates may apply.

CONNECTED VEHICLE LIMITATIONS

Evolving technology, cellular networks, or regulations could affect functionality and availability, or continued provision of some features. These changes could even stop some features from functioning.

CONNECTING THE VEHICLE TO A MOBILE NETWORK

WHAT IS THE MODEM



The modem allows access to a range of features built into your vehicle.

ENABLING AND DISABLING THE MODEM

1. Press **Settings**.
2. Press **FordPass Connect**.
3. Press **Connectivity Settings**.
4. Switch connectivity features on or off.

DISABLING THE CONNECTIVITY DEVICE

To disable the connectivity device, contact the Ford Customer Relationship Center.

CONNECTING FORDPASS TO THE MODEM

1. Make sure that the modem is enabled using the vehicle settings menu.
2. Open the FordPass app on your device and log in.
3. Add your vehicle or select your vehicle if already added.
4. Select the option to activate your vehicle.
5. Make sure that the name on the screen matches the name shown in your FordPass account.
6. Confirm that FordPass account is connected to the modem.

CONNECTED VEHICLE – TROUBLESHOOTING

CONNECTED VEHICLE – FREQUENTLY ASKED QUESTIONS

Why can I not confirm the connection of my FordPass account to the modem?

- The modem is not enabled. Switch vehicle connectivity on.
- The network signal is weak. Move your vehicle closer to a place where the network signal is not obstructed.

Audio System (If Equipped)

GENERAL INFORMATION



WARNING: Driving while distracted can result in loss of vehicle control, crash and injury. We strongly recommend that you use extreme caution when using any device that may take your focus off the road. Your primary responsibility is the safe operation of your vehicle. We recommend against the use of any

hand-held device while driving and encourage the use of voice-operated systems when possible. Make sure you are aware of all applicable local laws that may affect the use of electronic devices while driving.

Radio Frequencies and Reception Factors

Note: *Listening to loud audio for long periods of time could damage your hearing.*

Radio Reception Factors	
Distance and strength	The further you travel from a FM station, the weaker the signal and the weaker the reception.
Terrain	Hills, mountains, tall buildings, bridges, tunnels, freeway overpasses, parking garages, dense tree foliage and thunderstorms can interfere with the reception.
Station overload	When you pass a ground-based broadcast repeating tower, a stronger signal may overtake a weaker one and result in the audio system muting.

AUDIO UNIT



WARNING: Driving while distracted can result in loss of vehicle control, crash and injury. We strongly recommend that you use extreme caution when using any device that may take your focus off the road. Your primary responsibility is the safe operation of your vehicle. We recommend against the use of any hand-held device while driving and encourage the use of voice-operated systems when possible. Make sure you are aware of all applicable local laws that may affect the use of electronic devices while driving.



Note: *Depending on your vehicle option package, the controls may look different from what you see here.*

Note: *Some features, such as satellite radio, may not be available in your location. Check with an authorized dealer.*

Audio System (If Equipped)

Accessing the Sound Settings



Press the button to adjust the sound settings. You can also activate and set the sensitivity of the adaptive or speed compensated volume.

Accessing the System Settings



Press the button.

Adjusting the Volume

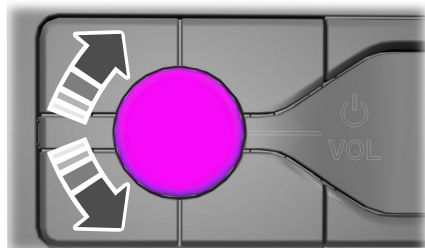

E260697

Turn to adjust the volume.

Changing Radio Stations

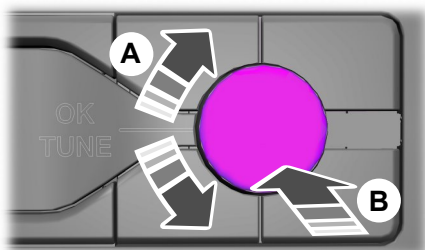

E260687

- A Auto or Manual tuning.
- B Station name tuning.

Note: You can change between auto or manual tuning with the rotary control using the system settings.

Note: You can change radio stations using the seek buttons.

Note: You can recall radio stations using the numeric preset buttons.

Pausing or Playing Media



In media mode, press and release the button to pause playback. Press the button again to resume playback.

In radio mode, press the button to mute the signal. Press the button again to restore the signal.

Returning to the Previous Screen



Press and release the button.

Scrolling Through the Menu Options

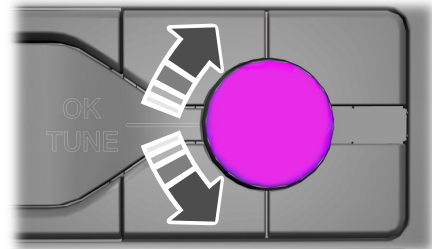

E260782

Selecting Media



Press the button to select media mode.

Repeatedly press the button, or rotate the right-hand rotary control to scroll through the available media sources.

Audio System (If Equipped)

Selecting a Menu Option

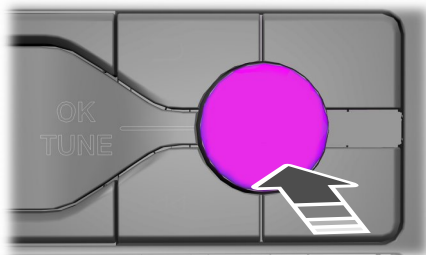

E260781

Switching the Audio Unit On and Off

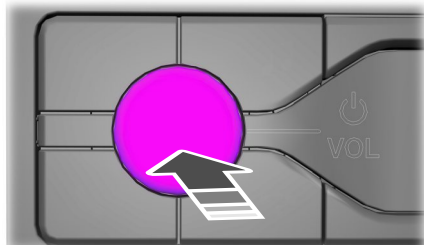

E260686

Selecting the Radio



Press the button to select radio mode.

Press the button again to display the available radio sources. Repeatedly press the button, or rotate the right-hand rotary control to scroll through the available radio sources.

Setting a Memory Preset

Tune to a station then press and hold one of the numbered memory preset buttons. The audio mutes briefly while the system saves the station and returns once the station is stored.

Press and release the button.

Using a Cell Phone



Press the button to either answer an incoming phone call or to make a phone call.



Press and hold the button to end a phone call.

Using Seek, Fast Forward and Reverse



Press and release the button to skip to the next track.

Press and hold the button to fast forward through the track.



Press and release the button to return to the beginning of a track.

Repeatedly press the button to return to previous tracks.

Press and hold the button to rewind.

In radio mode, select a frequency band and press and release either button. The system stops at the first station it finds in that direction.

Audio System (If Equipped)

In satellite radio mode, press and release to select the next or previous satellite radio station. If you select a specific category, such as jazz, rock or news, press to find the next or previous station in the category you select.

CONNECTING A BLUETOOTH® DEVICE

Pairing a Device



Press the button.

Select **Bluetooth®** and follow the instructions on the screen.

Note: When pairing a new device, you can choose to download contacts, set this as the primary device and enable Emergency Assistance.

STREAMING BLUETOOTH AUDIO

Selecting a Bluetooth® Source



1. Press the button to display the menu.
2. Repeatedly press the button to scroll to the **Bluetooth®** device.
3. Press the **OK** button.



Press the button to play the track. Press the button again to pause the track.



Press the button to skip to the next track.

Press and hold the button to fast forward through the track.



Press the button once to return to the beginning of the track. Repeatedly press the button to return to previous tracks.

Press and hold the button to fast rewind.

Note: Not all functions are supported by all phones.

PLAYING MEDIA FROM A USB DEVICE

Supported Audio File Formats

You can play audio file formats including MP3, WMA, WAV, M4A, M4B, AAC, and FLAC.

Note: The NTFS file system is not supported.

Selecting the USB Device



Press the button to display the menu.

Repeatedly press the button to scroll to your USB device.

Press the **OK** button.

Playing from the USB Device



Press the button to play a track. Press the button again to pause the track.



Press the button to skip to the next track.

Press and hold the button to fast forward through the track.



Press the button once to return to the beginning of a track. Repeatedly press the button to return to previous tracks.

Press and hold the button to fast rewind.

Audio System (If Equipped)

Sorting by Categories

You can also sort and play music by specific categories, for example artist or album.

Press the **OK** button to view the available categories.

USB PORT



WARNING: Driving while distracted can result in loss of vehicle control, crash and injury. We strongly recommend that you use extreme caution when using any device that may take your focus off the road. Your primary responsibility is the safe operation of your vehicle. We recommend against the use of any hand-held device while driving and encourage the use of voice-operated systems when possible. Make sure you are aware of all applicable local laws that may affect the use of electronic devices while driving.

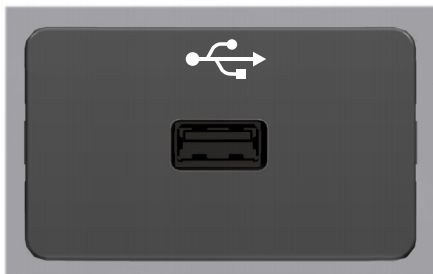

The USB port allows you to plug in media playing devices, memory sticks and charge devices.

Note: Not all USB ports in your vehicle have data transfer capabilities. See **Auxiliary Power Points** (page 79).

USING VOICE RECOGNITION

Phone Voice Service

This system allows you to use the voice recognition features of your phone and focus on your driving.



Press and hold the voice control button on the audio unit.

Note: This only works when connected via Bluetooth. See **Connecting a Bluetooth® Device** (page 242).

Note: When using voice recognition use the language set on the device.

Note: We recommend that you check your data plan before using your phone voice service through the system. Using them could result in additional charges.

Accessories

For a complete listing of the accessories that are available for your vehicle, please contact your authorized dealer or visit the online store web site:

Web Address (United States)

www.Accessories.Ford.com
--

Web Address (Canada)

www.Accessories.Ford.ca
--

We will repair or replace any properly authorized dealer-installed Ford Original Accessory found to be defective in factory-supplied materials or workmanship during the warranty period, as well as any component damaged by the defective accessories.

We will warrant your Ford Original Accessory through the warranty that provides the greatest benefit:

- 24 months, unlimited mileage.
- The remainder of your new vehicle limited warranty.

Contact an authorized dealer for details and a copy of the warranty.

Ford Licensed Accessories are the accessory manufacturer's designs. The manufacturer develops and therefore warrants Ford Licensed Accessories, and does not design or test these accessories to Ford Motor Company engineering requirements. Contact an authorized Ford dealer for the manufacturer's limited warranty details, and request a copy of the Ford Licensed Accessories product limited warranty from the accessory manufacturer.

For maximum vehicle performance, keep the following information in mind when adding accessories or equipment to your vehicle:

- When adding accessories, equipment, passengers and luggage to your vehicle, do not exceed the total weight capacity of the vehicle or of the front or rear axle (GVWR or GAWR as indicated on the Safety Compliance Certification label). Ask an authorized dealer for specific weight information.
- The Federal Communications Commission (FCC) and Canadian Radio Telecommunications Commission (CRTC) regulate the use of mobile communications systems that are equipped with radio transmitters, for example two-way radios, telephones and theft alarms. Any such equipment installed in your vehicle should comply with Federal Communications Commission (FCC) and Canadian Radio Telecommunications Commission (CRTC) regulations and should be installed only by an authorized dealer.
- An authorized dealer needs to install mobile communications systems. Improper installation may harm the operation of your vehicle, particularly if the manufacturer did not design the mobile communication system specifically for automotive use.
- If you or an authorized Ford dealer add any non-Ford electrical or electronic accessories or components to your vehicle, you may adversely affect battery performance and durability. In addition, you may also adversely affect the performance of other electrical systems in the vehicle.

Accessories

AUXILIARY SWITCHES (IF EQUIPPED)

For maximum vehicle performance, keep the following information in mind when adding accessories or equipment to your vehicle:

- When adding accessories, equipment, passengers and luggage to your vehicle, do not exceed the total weight capacity of the vehicle or of the front or rear axle (GVWR or GAWR as indicated on the Safety Compliance Certification label). Ask an authorized dealer for specific weight information.
- The Federal Communications Commission (FCC) and Canadian Radio Telecommunications Commission (CRTC) regulate the use of mobile communications systems equipped with radio transmitters, for example, two-way radios, telephones and theft alarms. Any such equipment installed in your vehicle should comply with Federal Communications Commission (FCC) and Canadian Radio Telecommunications Commission (CRTC) regulations, and should be installed by an authorized dealer.
- An authorized dealer needs to install mobile communications systems. Improper installation may harm the operation of your vehicle, particularly if the manufacturer did not design the mobile communication system specifically for automotive use.
- If you or an authorized Ford dealer add any non-Ford electrical or electronic accessories or components to your vehicle, you may adversely affect battery performance and durability. In addition, you may also adversely affect the performance of other electrical systems in the vehicle.



E163431

The auxiliary switch option package provides four switches, mounted in the center of the instrument panel. These switches operate when the vehicle is running or from battery power, depending on the switchable PDB fuse locations #82 and #83. Ford recommends, however, that the engine remain running to maintain battery charge when using the auxiliary switches for extended periods of time or higher current draws.

When switched on, the auxiliary switches provide 20 amps or 40 amps of electrical battery power for a variety of personal or commercial uses.

The switches include the fuse and relay kit. This kit contains the required fuses and relays that an authorized technician needs to install into the power distribution box, located under the hood. Refer to the instruction sketch included in the kit. Contact an authorized dealer for service.

Each switch includes a power lead (a blunt-cut and sealed wire) located in the underhood cowl shield above the engine block powertrain control module.

The power leads are coded as follows:

Accessories

Switch	Circuit Number	Wire Color	Fuse Amp Rating
AUX 1	CAC05	Yellow	40A
AUX 2	CAC06	Green with Brown Trace	40A
AUX 3	CAC07	Violet with Green Trace	20A
AUX 4	CAC08	Brown	20A

Learn more about auxiliary switches by visiting <https://www.fleet.ford.com/truckbbas/>.

Upfitter Interface Module (If Equipped)

The Upfitter Interface Module (UIM) is an electronic control module that operates equipment (such as lift buckets, cranes, motors, salt spreaders and snow plows) with external relays.

If you replace the module, it will require additional programming by the upfitter. Obtain this data directly from the upfitter company. The upfitter contact information is in the vehicle door opening.

For more information on the Upfitter Interface Module and the auxiliary switches, contact your upfitter.

Ford Protect

PROTECT YOURSELF FROM THE RISING COST OF VEHICLE REPAIRS WITH A FORD PROTECT EXTENDED SERVICE PLAN.

Ford Protect Extended Service Plans (U.S. Only)

Ford Protect extended service plan means peace of mind. It is the extended service plan backed by Ford Motor Company, and provides more protection beyond the New Vehicle Limited Warranty coverage. When you visit your Ford Dealer, Insist on Ford Protect extended service plans!

Ford Protect Can Quickly Pay for Itself

One trip to the Service Center could easily exceed the price of your Ford Protect extended service plan. With Ford Protect extended service plan you minimize your risk for unexpected repair bills and rising repair costs.

Up to 1,000+ Covered Vehicle Components

There are four mechanical Ford Protect extended service plans with different levels of coverage. Ask your authorized dealer for details.

1. PremiumCARE - Our most comprehensive coverage. With over 1,000 covered components, this plan is so complete it is probably easier to list what is not covered.
2. ExtraCARE - Covers 113 components, and includes many high-tech items.
3. BaseCARE - Covers 84 components.
4. PowertrainCARE - Covers 29 critical components.

Ford Protect extended service plans are honored by all authorized Ford dealers in the U.S., Canada and Mexico.

That means you get:

- Reliable, quality service at any Ford or Lincoln dealership.
- Repairs performed by factory trained technicians, using genuine parts.

Rental Car Reimbursement

1st day Rental Benefit

If you bring your car into your dealer for service, we'll give you a loaner to use for the day.

Extended Rental Benefits

If your vehicle is kept overnight for covered repairs, you are eligible for rental car coverage, including warranty repairs, and Field Service Actions.

Roadside Assistance

Exclusive 24/7 roadside assistance, including:

- Towing, flat-tire change and battery jump starts.
- Out of fuel and lock-out assistance.
- Travel expense reimbursement for lodging, meals and rental car.
- Assistance for taxi, shuttle, rental car coverage or other transportation.

Transferable Coverage

If you sell your vehicle before your Ford Protect extended service plan coverage expires, you can transfer any remaining coverage to the new owner. Which should give you and your potential buyer a little more peace of mind.

Ford Protect

Less Cost to Properly Maintain Your Vehicle

Ford Protect extended service plan also offers a Premium Maintenance Plan that covers all scheduled maintenance, and selected wear items. The coverage is prepaid, so you never have to worry about the cost of your vehicle's maintenance.

Covered maintenance includes:

- Windshield wiper blades.
- Spark plugs.
- The clutch disc (if equipped).
- Brake pads and linings.
- Shock absorbers.
- Struts.
- Engine belts.
- Engine coolant hoses, clamps and O-rings.
- Diesel exhaust fluid replenishment (if equipped).
- Cabin air filter replacement every 20,000 mi (32,000 km) (electric vehicles only).

Interest Free Finance Options

Just a 5% down payment will provide you with an affordable, no interest, no fee payment program allowing you all the security and benefits Ford Protect extended service plan has to offer while paying over time. You are pre-approved with no credit check or hassles. To learn more, call our Ford Protect extended service plan specialists at 800-367-3377.

Ford Protect Extended Service Plan
P.O. Box 321067
Detroit, MI 48232

Ford Protect Extended Service Plan (CANADA ONLY)

You can get more protection for your vehicle by purchasing a Ford Protect extended service plan. Ford Protect extended service plan is the only service contract backed by Ford Motor Company of Canada, Limited. Depending on the plan you purchase, Ford Protect extended service plan provides benefits such as:

- Rental reimbursement.
- Coverage for certain maintenance and wear items.
- Protection against repair costs after your New Vehicle Limited Warranty Coverage expires.
- Roadside Assistance benefits.

There are several Ford Protect extended service plans available in various time, distance and deductible combinations. Each plan is tailored to fit your own driving needs, including reimbursement for towing and rental. When you purchase Ford Protect extended service plan, you receive added peace-of-mind protection throughout Canada, the United States and Mexico, provided by a network of participating authorized Ford Motor Company dealers.

Note: *Repairs performed outside of Canada and the United States are not eligible for Ford Protect extended service plan coverage.*

This information is subject to change. For more information; visit your local Ford of Canada dealer or www.ford.ca to find the Ford Protect extended service plan that is right for you.

Scheduled Maintenance

GENERAL MAINTENANCE INFORMATION

Why Maintain Your Vehicle?

Carefully following the maintenance schedule helps protect against major repair expenses resulting from neglect or inadequate maintenance and may help to increase the value of your vehicle when you sell or trade it. Keep all receipts for completed maintenance with your vehicle.

We have established regular maintenance intervals for your vehicle based upon rigorous testing. It is important that you have your vehicle serviced at the proper times. These intervals serve two purposes; one is to maintain the reliability of your vehicle and the second is to keep your cost of owning your vehicle down.

It is your responsibility to have all scheduled maintenance performed and to make sure that the materials used meet the specifications identified in this owner's manual. See **Capacities and Specifications** (page 226).

Failure to perform scheduled maintenance invalidates warranty coverage on parts affected by the lack of maintenance.

Why Maintain Your Vehicle at Your Dealership?

Factory-trained Technicians

Service technicians participate in extensive factory-sponsored certification training to help them become experts on the operation of your vehicle. Ask your dealership about the training and certification their technicians have received.

Genuine Ford and Motorcraft Replacement Parts

Dealerships stock Ford, Motorcraft and Ford-authorized branded re-manufactured replacement parts. These parts meet or exceed our specifications. Parts installed at your dealership carry a nationwide 24-month or unlimited mile (kilometer) parts and labor limited warranty.

If you do not use Ford authorized parts they may not meet our specifications and depending on the part, it could affect emissions compliance.

Convenience

Many dealerships have extended evening and Saturday hours to make your service visit more convenient and they offer one stop shopping. They can perform any services that are required on your vehicle, from general maintenance to collision repairs.

Note: *Not all dealers have extended hours or body shops. Please contact your dealer for details.*

Protecting Your Investment

Maintenance is an investment that pays dividends in the form of improved reliability, durability and resale value. To maintain the proper performance of your vehicle and its emission control systems, make sure you have scheduled maintenance performed at the designated intervals.

Your vehicle is very sophisticated and built with multiple, complex, performance systems. Every manufacturer develops these systems using different specifications and performance features. That is why it is important to rely upon your dealership to properly diagnose and repair your vehicle.

Scheduled Maintenance

Ford Motor Company has recommended maintenance intervals for various parts and component systems based upon engineering testing. Ford Motor Company relies upon this testing to determine the most appropriate mileage for replacement of oils and fluids to protect your vehicle at the lowest overall cost to you and recommends against maintenance schedules that deviate from the scheduled maintenance information.

Your vehicle can be driven in such a way that dilutes and increases the level of oil by short trips that do not allow the engine to get to operating temperature, extended idling, and low speed driving for long periods of time.

We strongly recommend the use of only genuine Ford, Motorcraft or Ford-authorized re-manufactured replacement parts engineered for your vehicle.

Additives and Chemicals

This owner's manual and the Ford Workshop Manual list the recommended additives and chemicals for your vehicle. We do not recommend using chemicals or additives not approved by us as part of your vehicle's normal maintenance. Please consult your warranty information.

Oils, Fluids and Flushing

In many cases, fluid discoloration is a normal operating characteristic and, by itself, does not necessarily indicate a concern or that the fluid needs to be changed. However, a qualified expert, such as the factory-trained technicians at your dealership, should inspect discolored fluids that also show signs of overheating or foreign material contamination immediately.

Make sure to change your vehicle's oils and fluids at the specified intervals or in conjunction with a repair. Flushing is a viable way to change fluid for many vehicle sub-systems during scheduled maintenance. It is critical that systems are flushed only with new fluid that is the same as that required to fill and operate the system or using a Ford-approved flushing chemical.

Owner Checks and Services

Make sure you perform the following basic maintenance checks and inspections every month or at six-month intervals.

Check every month
Engine oil level.
Function of all interior and exterior lights.
Tires (including spare) for wear and proper pressure.
Windshield washer fluid level.

Scheduled Maintenance

Check every six months
Battery connections. Clean if necessary.
Body and door drain holes for obstructions. Clean if necessary.
Cooling system fluid level and coolant strength.
Door weatherstrips for wear. Lubricate if necessary.
Hinges, latches and outside locks for proper operation. Lubricate if necessary.
Parking brake for proper operation.
Seatbelts and seat latches for wear and function.
Safety warning lamps (brake, ABS, airbag and seatbelt) for operation.
Washer spray and wiper operation. Clean or replace blades as necessary.

Multi-point Inspection

In order to keep your vehicle running right, it is important to have the systems on your vehicle checked regularly. This can help identify potential issues and prevent major problems. We recommend having the following multi-point inspection performed at every scheduled maintenance interval to help make sure your vehicle keeps running great.

Multi-point inspection	
Accessory drive belt(s)	Horn operation
Battery performance	Radiator, cooler, heater and A/C hoses
Engine air filter	Suspension component for leaks or damage
Exhaust system	Steering and linkage
Exterior lamps and hazard warning system operation	Tires (including spare) for wear and proper pressure**

Scheduled Maintenance

Multi-point inspection	
Fluid levels*; fill if necessary	Windshield for cracks, chips or pits
For oil and fluid leaks	Washer spray and wiper operation

* Brake, coolant recovery reservoir, automatic transmission, power steering and window washer.

**If your vehicle is equipped with a temporary mobility kit, check the tire sealant expiration Use By date on the canister. Replace as needed.

Be sure to ask your dealership service advisor or technician about the multi-point vehicle inspection. It is a comprehensive way to perform a thorough inspection of your vehicle. Your checklist gives you immediate feedback on the overall condition of your vehicle.

NORMAL SCHEDULED MAINTENANCE

Note: Do not exceed the mileage or time intervals.

Maintenance	
Every 7,500 mi (12,000 km)	Rotate the tires, inspect tire wear and measure tread depth. ¹
	Inspect the wheels and related components for abnormal noise, wear, looseness or drag.
	Perform a multi-point inspection.
Every 10,000 mi (16,000 km) /12 months or 700 engine hours, whichever comes first	Change the engine oil and filter.

¹ Rotate the front wheels on vehicles with dual rear wheels when specified. Only rotate the rear wheels if you notice unusual wear.

Scheduled Maintenance

Maintenance	
Every 15,000 mi (24,000 km)	Inspect the automatic transmission fluid level. Consult dealer for requirements.
	Inspect the brake pads, rotors, hoses and parking brake.
	Inspect the engine cooling system strength and hoses.
	Inspect the exhaust system and heat shields.
	Inspect the steering linkage, ball joints, suspension, tie-rod ends, driveshaft and the U-joints.

Brake Fluid Maintenance ¹	
Every 3 Years	Change the brake fluid. ²

¹ Perform this maintenance item every 3 years. Do not exceed the designated time for the interval.

² Brake fluid servicing requires special equipment available at your authorized dealer.

Other Maintenance Items	
Every 30,000 mi (48,000 km)	Replace the engine air filter. Torque the rear axle U-bolts to specification.
Every 60,000 mi (96,000 km)	Replace the front wheel bearing grease and grease seal, if you use non-sealed bearings.
Every 97,500 mi (157,000 km)	Replace the spark plugs.
	Replace the rear axle fluid. See Special Operating Conditions Scheduled Maintenance (page 255).
Every 105,000 mi (168,000 km)	Inspect the accessory drive belts. ¹
Every 150,000 mi (240,000 km)	Change the automatic transmission fluid.
	Change the automatic transmission filter.
	Replace the accessory drive belts if not replaced within the last 100,000 mi (160,000 km).

Scheduled Maintenance

Other Maintenance Items	
	Replace the front wheel bearings and seals, if you use non-sealed bearings.
Every 200,000 mi (320,000 km)	Change the engine coolant. ²

¹ If not replaced, inspect every 15,000 mi (24,000 km).

² Initial replacement at ten years or 200,000 mi (320,000 km), then every five years or 100,000 mi (160,000 km).

Scheduled Maintenance

SPECIAL OPERATING CONDITIONS SCHEDULED MAINTENANCE

If you operate your vehicle **primarily** in any of the following conditions, you need to

perform extra maintenance as indicated. If you operate your vehicle **occasionally** under any of these conditions, it is not necessary to perform the extra maintenance. For specific recommendations, see your dealership service advisor or technician.

Towing a Trailer or Using a Car-top Carrier	
As required	Change the engine oil and filter as indicated by the instrument cluster display and perform services listed in the Normal Scheduled Maintenance chart.
Inspect frequently, service as required	Inspect the U-joints.
Every 22,500 mi (36,000 km)	Replace the rear axle fluid. See axle maintenance items under Exceptions .
Every 60,000 mi (96,000 km)	Replace the spark plugs.

Extensive Idling or Low-speed Driving for Long Distances, as in Heavy Commercial Use (Such as Delivery, Taxi, Patrol Car or Livery) Short Trips that do not allow the engine to get to operating temperature causing fuel dilution and an increase of the engine oil level	
As required	Change the engine oil and filter as indicated by the instrument cluster display and perform services listed in the Normal Scheduled Maintenance chart.
Inspect frequently, service as required	Replace the engine air filter.
Every 22,500 mi (36,000 km)	Replace the rear axle fluid. See axle maintenance items under Exceptions .
Every 60,000 mi (96,000 km)	Replace the spark plugs.

Scheduled Maintenance

Operating in Dusty or Sandy Conditions (Such as Unpaved or Dusty Roads)	
Inspect frequently, service as required	Replace engine air filter.
Every 5,000 mi (8,000 km)	Inspect the wheels and related components for abnormal noise, wear, looseness or drag.
	Rotate the tires ¹ , inspect tires for wear and measure the tread depth.
Every 5,000 mi (8,000 km) or six months	Change the engine oil and filter. ²
	Perform a multi-point inspection.

¹Vehicles with dual rear wheels should rotate the front wheels when specified; rear wheels only if unusual wear is noted.

²Reset your Intelligent Oil-Life Monitor after each engine oil and filter change. See **Oil Change Indicator Reset** (page 164).

Exclusive Use of E85 - Flex Fuel Vehicles Only	
Every oil change	If ran exclusively on E85, fill the fuel tank with regular unleaded fuel.

Exceptions

There are several exceptions to the Normal Schedule:

Axle(s) and transfer case, four-wheel drive vehicles, fluid changes or level checks are not required unless a leak is suspected or the assembly has been submerged in water. Contact an authorized dealer for service.

California fuel filter replacement: If you register your vehicle in California, the California Air Resources Board has determined that the failure to perform this maintenance item does not nullify the emission warranty or limit recall liability before the completion of your vehicle's useful life. We however, urge you to have all recommended maintenance services performed at the specified intervals and to record all vehicle service.

Hot climate oil change intervals: Vehicles operating in the Middle East, North Africa, Sub-Saharan Africa or locations with similar climates using an American Petroleum Institute (API) Certified for Gasoline Engines (Certification mark) oil of SM or SN quality, the normal oil change interval is 5,000 mi (8,000 km).

Scheduled Maintenance

If the available API SM or SN oils are not available, then the oil change interval is 3,000 mi (4,800 km).

Engine air filter replacement: The life of the engine air filter is dependent on exposure to dusty and dirty conditions. Vehicles operated in these conditions require frequent inspection and replacement of the engine air filter.

Customer Information

RADIO FREQUENCY CERTIFICATION LABELS

CRUISE CONTROL MODULE

Argentina



Brazil



Djibouti

AGREE PAR LE MCPT (REPUBLIQUE DE DJIBOUTI)
Numéro d'agrément : 594/dpt/2017
Date d'agrément : 09/04/2017

Ghana

NCA PRODUCT IDENTIFIER: OR2-9H-7E1-x4D

Indonesia

SERTIFIKAT NOMOR : 53104/SDPPI/2017
PLG ID: 4927



Jamaica

This product has been Type Approved
by Jamaica: SMA - L2C0065TR.

Customer Information

Malaysia



RALM/61A/0318/S(18-0852)

Mauritania

AGREE PAR L'ANE MAURITANIE
Numéro d'agrément: 0409/ARE/2017
Date d'agrément: 12/04/2017

Moldova



Morocco

AGREE PAR L'ANRT MAROC
Numéro d'agrément: MR 13639 ARNT 2017
Date d'agrément: 28/03/2017

Pakistan



Paraguay



Customer Information

Serbia



South Korea



Singapore

R-CMM-DLH-L2C0065TR

Syria

Complies with IMDA Standards

DA105753

SyTRA
REGISTERED No:
FR00085-17

South Africa

Taiwan, China

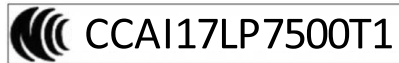

Customer Information

Ukraine



This device complies with Part 15 of the FCC Rules and with Innovation, Science and Economic Development Canada's licence-exempt RSS(s). Operation is subject to the following two conditions:

1. This device may not cause harmful interference, and
2. This device must accept any interference received, including interference that may cause undesired operation.

Zambia

United Arab Emirates



United States and Canada

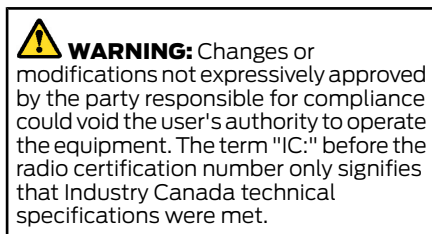

TIRE PRESSURE MONITORING SYSTEM SENSORS

Argentina



FCC ID: L2C0065TR

IC: 3432A-0065TR

Customer Information

China

CMIIT ID: 2016DJ6033

Djibouti

AGREE PAR LE MCPT
(REPUBLIQUE DE DJIBOUTI)
Numéro d'agrément : 547/MCPT/DPT/16
Date d'agrément : 27/09/16

Democratic Republic of Congo

Agréé par l'ARPTC

N° d'homologation: HIR-0099/09/2016

Date d'homologation: 15/09/2016

European Union (EU)



The RED 2014/53/EU (replacing R&TTE Directive 1999/5/EC on 13 June 2016) explicitly states that instructions for intentional radiators include reference to "(a) frequency band(s) in which the radio equipment operates; and (b) maximum radio-frequency power transmitted in the frequency band(s) in which the radio equipment operates," in addition to carrying over the general operational instruction and Declaration of Conformity inclusion requirements from the R&TTE Directive.

Hereby, Schrader Electronics Ltd. declares that the radio equipment type FP4 is in compliance with Directive 2014/53/EU. The full text of the EU declaration of conformity is available at the following internet address:

http://www.tpmseuroshop.com/documents/declaration_conformities

Customer Information

f=433.92MHz

P<10mW (e.i.r.p)

Schrader Electronics Ltd. 11 Technology Park, Belfast Road, Antrim BT41 1QS, Northern Ireland United Kingdom.

Ghana

NCA APPROVED: 2R9-8M-7E0-0BE

Independent State of Samoa



Israel

1. מספר אישור התאמה מטעם משרד התקשורת: 51-83847
2. תל אישור לבצע פנויות במכשיר שיש בהן כירי לפנות את תכונותיו האלוסיות של המכשיר, ובכלל זה שינוי תוכנת, החלפת אינטנר מקורית או הוספת אפשרות לחיבור לאינטנר חיצונית, בלא קבלת אישור משרד התקשורת, כשל החשש להפרעת אלוסיות.

Mauritania

AGREE PAR L'ANE MAURITANIE
Numéro d'agrément : 0358/ARE/2016
Date d'agrément : 04/10/2016

Moldova



Customer Information

Nigeria

Connection and use of this communications equipment is permitted by the Nigerian Communications Commission

Paraguay



Oman

OMAN TRA
TA-R/3591/16
D080134

Serbia

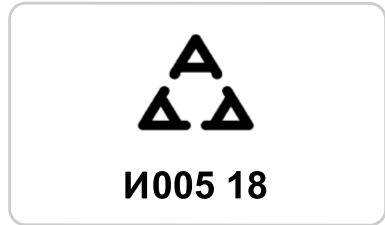

Pakistan

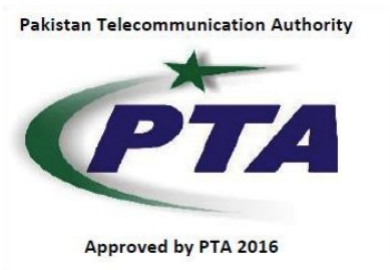

Sierra Leone



TAN: 2016-002-0035

Customer Information

South Korea



MSIP-CRM-SRD-FP4

Ukraine



Unites Arab Emirates (U.A.E.)

TRA REGISTERED No:

ER12204/22

DEALER No:

DA37380/15

United Kingdom



United States and Canada



WARNING: Changes or modifications not expressly approved by the party responsible for compliance could void the user's authority to operate the equipment. The term "IC:" before the radio certification number only signifies that Industry Canada technical specifications were met.

FCC ID: MRXFP4

IC: 2546A-FP4

This device complies with Part 15 of the FCC Rules and with Innovation, Science and Economic Development Canada's licence-exempt RSS(s). Operation is subject to the following two conditions:

1. This device may not cause harmful interference, and
2. This device must accept any interference received, including interference that may cause undesired operation.

TIRE PRESSURE MONITORING SYSTEM SENSORS

Argentina



Customer Information

CNC ID: H-28035

Europe Union EU

Brazil



13309-22-08001

EAC Marking - Russia, Belarus, Kazakhstan



The RED 2014/53/EU (replacing R&TTE Directive 1999/5/EC on 13 June 2016) explicitly states that instructions for intentional radiators include reference to "(a) frequency band(s) in which the radio equipment operates; and (b) maximum radio-frequency power transmitted in the frequency band(s) in which the radio equipment operates," in addition to carrying over the general operational instruction and Declaration of Conformity inclusion requirements from the R&TTE Directive.

Hereby, Schrader Electronics Ltd. declares that the radio equipment type BG2BP4 is in compliance with Directive 2014/53/EU. The full text of the EU declaration of conformity is available at the following internet address:

http://www.tpmseuroshop.com/documents/declaration_conformities

f=433.92MHz

P<10mW (e.i.r.p)

Schrader Electronics Ltd. 11 Technology Park, Belfast Road, Antrim BT41 1QS, Northern Ireland United Kingdom.

Customer Information

Israel

1. מספר אישור התאמה מסעם משרד התקשורת: 51-86230
2. תל אישור לכצע פעולות במכשיר שיש בהן כדי לענות את תכונותיו האלחוטיות של המכשיר, ובכלל זה שיווי תובנה, החלפת אנטנה פקורית או הוספת אישורות לחיבור לאנטנה חיצונית, בלא קבלת אישור משרד התקשורת, בשל החשש להפרעת אלחוטיות.

Singapore

Complies with IMDA Standards

DA 00461

South Africa



Jamaica

This product has been Type Approved by Jamaica: SMA - BG2BP4.

Moldova



South Korea



MSIP-R-C-SRD-BG2BP4

Serbia

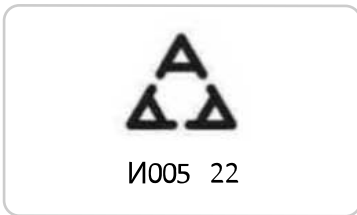

Taiwan



CCAB22LP0730T0

Customer Information

Thailand

1. ***This telecommunication equipment conforms to NTC technical requirement.***
2. ***This radiocommunication equipment has the electromagnetic field strength in compliance with the Safety Standard for the Use of Radiocommunication Equipment on Human Health announced by the National Telecommunications Commission.***

Unites Arab Emirates (U.A.E.)

TRA REGISTERED No:

ER10488/22

DEALER No:

DA37380/15

United Kingdom

**UK
CA**

United States and Canada



WARNING: Changes or modifications not expressly approved by the party responsible for compliance could void the user's authority to operate the equipment. The term "IC:" before the radio certification number only signifies that Industry Canada technical specifications were met.

FCC ID: MRXBG2BP4

IC: 2546A-BG2BP4

This device complies with Part 15 of the FCC Rules and with Innovation, Science and Economic Development Canada's licence-exempt RSS(s). Operation is subject to the following two conditions:

1. This device may not cause harmful interference, and
2. This device must accept any interference received, including interference that may cause undesired operation.

WARRANTY INFORMATION

The following warranties may apply to your vehicle:

- New vehicle limited warranties.
- Emissions warranties, if applicable. (Note: Fully-electric vehicles are not eligible for emissions warranties.)
- Other warranties, if applicable.

Detailed warranty information specific to your vehicle can be found in the Warranty Guide at www.owner.ford.com.

The following California Warranty Statement, required by California regulations, applies to vehicles certified to California emissions standards and registered in a state that requires California emissions warranty. If applicable, additional California Emissions Warranties can be found in the Warranty Guide at www.owner.ford.com.

Customer Information

CALIFORNIA EMISSION CONTROL WARRANTY STATEMENT

YOUR WARRANTY RIGHTS AND OBLIGATIONS

The California Air Resources Board and Ford Motor Company are pleased to explain the emission control system warranty on your (year) vehicle. In California, new motor vehicles must be designated, built and equipped to meet the State's stringent anti-smog standards. Ford Motor Company must warrant the emission control system on your vehicle for the periods of time listed below provided there has been no abuse, neglect or improper maintenance of your vehicle.

Your emission control system may include parts such as the carburetor or fuel-injection system, the ignition system, catalytic converter and engine computer. Also included may be hoses, belts, connectors and other emission-related assemblies. Where a warrantable condition exists, Ford Motor Company will repair your vehicle at no cost to you including diagnosis, parts and labor.

MANUFACTURER'S WARRANTY COVERAGE:

(For 1990 and subsequent model passenger cars, light-duty trucks, and medium-duty vehicles.)

- For 3 years or 50,000 miles (whichever occurs first);

1) If your vehicle fails a Smog Check inspection, all necessary repairs and adjustments will be made by Ford Motor Company to ensure that your emission control system **PERFORMANCE WARRANTY**.

2) If any emission-related part on your vehicle is defective, the part will be repaired or replaced by Ford Motor Company. This is your short-term emission control system **DEFECTS WARRANTY**.

- For 7 years or 70,000 miles (whichever occurs first);

1) If an emission-related part listed in this warranty booklet specially noted with coverage for 7 years or 70,000 miles is defective, the part will be repaired or replaced by Ford Motor Company. This is your long-term emission control system **DEFECTS WARRANTY**.

OWNER'S WARRANTY RESPONSIBILITIES:

- As the vehicle owner, you are responsible for the performance of the required maintenance listed in your owner's manual. Ford Motor Company recommends that you retain all receipts covering maintenance on your vehicle, but Ford Motor Company cannot deny warranty solely for the lack of receipts or for your failure to ensure the performance of all scheduled maintenance.

- You are responsible for presenting your vehicle to a Ford or Lincoln dealer as soon as a problem exists. The warranty repairs should be completed in a reasonable amount of time, not to exceed 30 days.

- As the vehicle owner, you should also be aware that Ford Motor Company may deny you warranty coverage if your vehicle or a part has failed due to abuse, neglect, improper maintenance or unapproved modifications.

If you have any questions regarding your warranty rights and responsibilities, you should contact Ford Customer Service at 1-800-392-3673 or the California Air Resource Board at 9528 Telstar Avenue, El Monte, CA 91731.

Appendices

ELECTROMAGNETIC COMPATIBILITY



WARNING: Do not place objects or mount equipment on or near the airbag cover, on the side of the front or rear seatbacks, or in areas that may come into contact with a deploying airbag. Failure to follow these instructions may increase the risk of personal injury in the event of a crash.



WARNING: Do not fasten antenna cables to vehicle wiring, fuel pipes and brake pipes.



WARNING: Keep antenna and power cables at least 4 in (10 cm) from any electronic modules and airbags.

Note: We test and certify your vehicle to meet electromagnetic compatibility legislation. It is your responsibility to make sure that any equipment an authorized dealer installs on your vehicle complies with applicable local legislation and other requirements. Installation of some aftermarket electronic devices could degrade the performance of vehicle functions, which use radio frequency signals such as broadcast radio receiver, tire pressure monitoring system, push button start, **Bluetooth®** connectivity or satellite navigation.

Note: Any radio frequency transmitter equipment in your vehicle (such as cellular telephones and amateur radio transmitters) must keep to the parameters in the following illustrations and table. We do not provide any other special provisions or conditions for installations or use.

Car/SUV

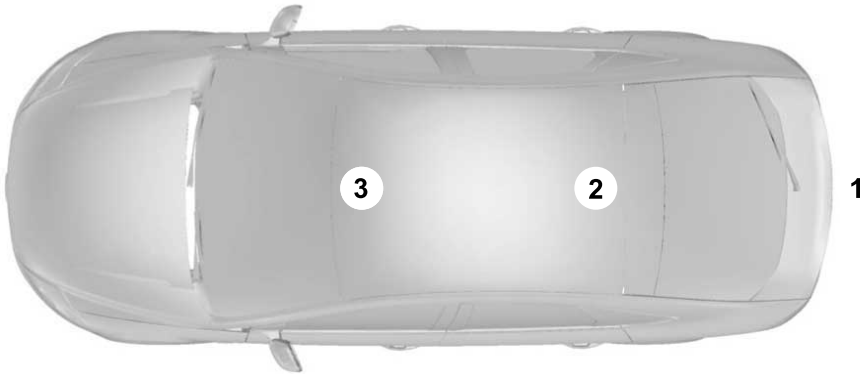

Appendices

Van

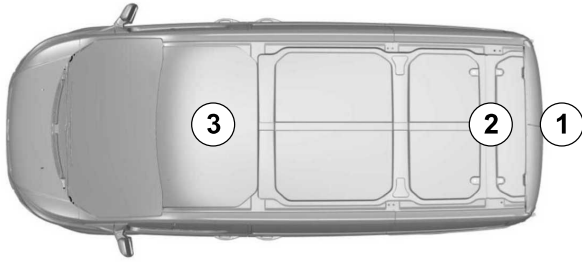

Truck

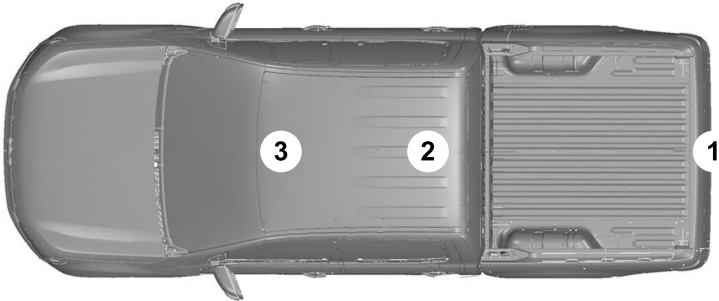

Appendices

Frequency Band MHz	Maximum Output Power Watt (Peak RMS)	Antenna Positions
1-30	50	1
50-54	50	2, 3
68-87	50	2, 3
142-176	50	2, 3
380-512	50	2, 3
806-870	10	2, 3

Appendices

END USER LICENSE AGREEMENT

SYNC End User License Agreement (EULA)

- You have acquired a device ("DEVICE") that includes software licensed by Ford Motor Company and its affiliates ("FORD MOTOR COMPANY") from an affiliate of Microsoft Corporation ("MS"). Those installed software products of MS origin, as well as associated media, printed materials, and "online" or electronic documentation ("MS SOFTWARE") are protected by international intellectual property laws and treaties. The MS SOFTWARE is licensed, not sold. All rights reserved.
- The MS SOFTWARE may interface with and/or communicate with, or may be later upgraded to interface with and/or communicate with additional software and/or systems provided by FORD MOTOR COMPANY. The additional software and systems of FORD MOTOR COMPANY origin, as well as associated media, printed materials, and "online" or electronic documentation ("FORD SOFTWARE") are protected by international intellectual property laws and treaties. The FORD SOFTWARE is licensed, not sold. All rights reserved.

- The MS SOFTWARE and/or FORD SOFTWARE may interface with and/or communicate with, or may be later upgraded to interface with and/or communicate with additional software and/or systems provided by third party software and service suppliers. The additional software and services of third party origin, as well as associated media, printed materials, and "online" or electronic documentation ("THIRD PARTY SOFTWARE") are protected by international intellectual property laws and treaties. The THIRD PARTY SOFTWARE is licensed, not sold. All rights reserved.
- The MS SOFTWARE, FORD SOFTWARE and THIRD PARTY SOFTWARE hereinafter collectively and individually will be referred to as "SOFTWARE".

IF YOU DO NOT AGREE TO THIS END USER LICENSE AGREEMENT ("EULA") DO NOT USE THE DEVICE OR COPY THE SOFTWARE. ANY USE OF THE SOFTWARE, INCLUDING BUT NOT LIMITED TO USE ON THE DEVICE, WILL CONSTITUTE YOUR AGREEMENT TO THIS EULA (OR RATIFICATION OF ANY PREVIOUS CONSENT).

GRANT OF SOFTWARE LICENSE: This EULA grants you the following license:

- You may use the SOFTWARE as installed on the DEVICE and as otherwise interfacing with systems and/or services provide by or through FORD MOTOR COMPANY or its third party software and service providers.

Appendices

Description of Other Rights and Limitations

- **Speech Recognition:** If the SOFTWARE includes speech recognition component(s), you should understand that speech recognition is an inherently statistical process and that recognition errors are inherent in the process. Neither FORD MOTOR COMPANY nor its suppliers shall be liable for any damages arising out of errors in the speech recognition process.
- **Limitations on Reverse Engineering, Decompilation and Disassembly:** You may not reverse engineer, decompile, or disassemble nor permit others to reverse engineer, decompile or disassemble the SOFTWARE, except and only to the extent that such activity is expressly permitted by applicable law notwithstanding this limitation.
- **Limitations on Distributing, Copying, Modifying and Creating Derivative Works:** You may not distribute, copy, make modifications to or create derivative works based on the SOFTWARE, except and only to the extent that such activity is expressly permitted by applicable law notwithstanding this limitation.
- **Single EULA:** The end user documentation for the DEVICE and related systems and services may contain multiple EULAs, such as multiple translations and/or multiple media versions (e.g., in the user documentation and in the software). Even if you receive multiple EULAs, you are licensed to use only one (1) copy of the SOFTWARE.
- **SOFTWARE Transfer:** You may permanently transfer your rights under this EULA only as part of a sale or transfer of the DEVICE, provided you retain no copies, you transfer all of the SOFTWARE (including all component parts, the media and printed materials, any upgrades, and, if applicable, the Certificate(s) of Authenticity), and the recipient agrees to the terms of this EULA. If the SOFTWARE is an upgrade, any transfer must include all prior versions of the SOFTWARE.
- **Termination:** Without prejudice to any other rights, FORD MOTOR COMPANY or MS may terminate this EULA if you fail to comply with the terms and conditions of this EULA.
- **Security Updates/Digital Rights Management:** Content owners use the WMDRM technology included in your DEVICE to protect their intellectual property, included copyrighted content. Portions of the SOFTWARE on your DEVICE use WMDRM software to access WMDRM-protected content. If the WMDRM software fails to protect the content, content owners may ask Microsoft to revoke the SOFTWARE's ability to use WMDRM to play or copy protected content. This action does not affect unprotected content. When your DEVICE downloads licenses for protected content, you agree that Microsoft may include a revocation list with the licenses. Content owners may require you to upgrade the SOFTWARE on your DEVICE to access their content. If you decline an upgrade, you will not be able to access content that requires the upgrade.

Appendices

- **Consent to Use of Data:** You agree that MS, Microsoft Corporation, FORD MOTOR COMPANY, third party software and systems suppliers, their affiliates and/or their designated agent may collect and use technical information gathered in any manner as part of product support services related to the SOFTWARE or related services. MS, Microsoft Corporation, FORD MOTOR COMPANY, third party software and services suppliers, their affiliates and/or their designated agent may use this information solely to improve their products or to provide customized services or technologies to you. MS, Microsoft Corporation, FORD MOTOR COMPANY, third party software and systems suppliers, their affiliates and/or their designated agent may disclose this information to others, but not in a form that personally identifies you.
- **Internet-Based Services Components:** The SOFTWARE may contain components that enable and facilitate the use of certain Internet-based services. You acknowledge and agree that MS, Microsoft Corporation, FORD MOTOR COMPANY, third party software and service suppliers, their affiliates and/or their designated agent may automatically check the version of the SOFTWARE and/or its components that you are utilizing and may provide upgrades or supplements to the SOFTWARE that may be automatically downloaded to your DEVICE.
- **Additional Software/Services:** The SOFTWARE may permit FORD MOTOR COMPANY, third party software and service suppliers, MS, Microsoft Corporation, their affiliates and/or their designated agent to provide or make available to you SOFTWARE updates,

supplements, add-on components, or Internet-based services components of the SOFTWARE after the date you obtain your initial copy of the SOFTWARE ("Supplemental Components").

If FORD MOTOR COMPANY or third party software and services suppliers provide or make available to you Supplemental Components and no other EULA terms are provided along with the Supplemental Components, then the terms of this EULA shall apply.

If MS, Microsoft Corporation, their affiliates and/or their designated agent make available Supplemental Components, and no other EULA terms are provided, then the terms of this EULA shall apply, except that the MS, Microsoft Corporation or affiliate entity providing the Supplemental Component(s) shall be the licensor of the Supplemental Component(s).

FORD MOTOR COMPANY, MS, Microsoft Corporation, their affiliates and/or their designated agent reserve the right to discontinue without liability any Internet-based services provided to you or made available to you through the use of the SOFTWARE.

Appendices

- **Links to Third Party Sites:** The MS SOFTWARE may provide you with the ability to link to third party sites through the use of the SOFTWARE. The third party sites are not under the control of MS, Microsoft Corporation, their affiliates and/or their designated agent. Neither MS nor Microsoft Corporation nor their affiliates nor their designated agent are responsible for (i) the contents of any third party sites, any links contained in third party sites, or any changes or updates to third party sites, or (ii) webcasting or any other form of transmission received from any third party sites. If the SOFTWARE provides links to third party sites, those links are provided to you only as a convenience, and the inclusion of any link does not imply an endorsement of the third party site by MS, Microsoft Corporation, their affiliates and/or their designated agent.
- **Obligation to Drive Responsibly:** You recognize your obligation to drive responsibly and keep attention on the road. You will read and abide with the DEVICE operating instructions particularly as they pertain to safety and assumes any risk associated with the use of the DEVICE.

UPGRADES AND RECOVERY MEDIA:

If the SOFTWARE is provided by FORD MOTOR COMPANY separate from the DEVICE on media such as a ROM chip, CD ROM disk(s) or via web download or other means, and is labeled "For Upgrade Purposes Only" or "For Recovery Purposes Only" you may install one (1) copy of such SOFTWARE onto the DEVICE as a replacement copy for the existing SOFTWARE, and use it in accordance with this EULA, including any additional EULA terms accompanying the upgrade SOFTWARE.

INTELLECTUAL PROPERTY RIGHTS:

All title and intellectual property rights in and to the SOFTWARE (including but not limited to any images, photographs, animations, video, audio, music, text and "applets" incorporated into the SOFTWARE), the accompanying printed materials, and any copies of the SOFTWARE, are owned by MS, Microsoft Corporation, FORD MOTOR COMPANY, or their affiliates or suppliers. The SOFTWARE is licensed, not sold. You may not copy the printed materials accompanying the SOFTWARE. All title and intellectual property rights in and to the content which may be accessed through use of the SOFTWARE is the property of the respective content owner and may be protected by applicable copyright or other intellectual property laws and treaties. This EULA grants you no rights to use such content. All rights not specifically granted under this EULA are reserved by MS, Microsoft Corporation, FORD MOTOR COMPANY, third party software and service providers, their affiliates and suppliers. Use of any on-line services which may be accessed through the SOFTWARE may be governed by the respective terms of use relating to such services. If this SOFTWARE contains documentation that is provided only in electronic form, you may print one copy of such electronic documentation.

EXPORT RESTRICTIONS: You acknowledge that the SOFTWARE is subject to U.S. and European Union export jurisdiction. You agree to comply with all applicable international and national laws that apply to the SOFTWARE, including the U.S. Export Administration Regulations, as well as end-user, end-use and destination restrictions issued by U.S. and other governments. For additional information, see:

Appendices

Website
http://www.microsoft.com/exporting/

TRADEMARKS: This EULA does not grant you any rights in connection with any trademarks or service marks of FORD MOTOR COMPANY, MS, Microsoft Corporation, third party software or service providers, their affiliates or suppliers.

PRODUCT SUPPORT: Product support for the SOFTWARE is not provided by MS, its parent corporation Microsoft Corporation, or their affiliates or subsidiaries. For product support, please refer to FORD MOTOR COMPANY instructions provided in the documentation for the DEVICE. Should you have any questions concerning this EULA, or if you desire to contact FORD MOTOR COMPANY for any other reason, please refer to the address provided in the documentation for the DEVICE.

No Liability for Certain Damages: EXCEPT AS PROHIBITED BY LAW, FORD MOTOR COMPANY, ANY THIRD PARTY SOFTWARE OR SERVICES SUPPLIERS, MS, MICROSOFT CORPORATION AND THEIR AFFILIATES SHALL HAVE NO LIABILITY FOR ANY INDIRECT, SPECIAL, CONSEQUENTIAL OR INCIDENTAL DAMAGES ARISING FROM OR IN CONNECTION WITH THE USE OR PERFORMANCE OF THE SOFTWARE. THIS LIMITATION SHALL APPLY EVEN IF ANY REMEDY FAILS OF ITS ESSENTIAL PURPOSE. IN NO EVENT SHALL MS, MICROSOFT CORPORATION AND/OR THEIR AFFILIATES BE LIABLE FOR ANY AMOUNT IN EXCESS OF U.S. TWO HUNDRED FIFTY DOLLARS (U.S. \$250.00).

- THERE ARE NO WARRANTIES OTHER THAN THOSE THAT MAY EXPRESSLY BE PROVIDED FOR YOUR NEW VEHICLE.

Adobe

Contains Adobe® [Flash® Player] or [AIR®] technology by Adobe Systems Incorporated. This [Licensee Product] contains [Adobe® Flash® Player] [Adobe® AIR®] software under license from Adobe Systems Incorporated, Copyright ©1995-2009 Adobe Macromedia Software LLC. All rights reserved. Adobe, Flash and AIR are trademarks of Adobe Systems Incorporated.

End User Notice

Microsoft® Windows® Mobile for Automotive Important Safety Information

This system Ford SYNC contains software that is licensed to Manufacturer FORD MOTOR COMPANY by an affiliate of Microsoft Corporation pursuant to a license agreement. Any removal, reproduction, reverse engineering or other unauthorized use of the software from this system in violation of the license agreement is strictly prohibited and may subject you to legal action.

Read and follow instructions: Before using your Windows Automotive- based system, read and follow all instructions and safety information provided in this end user manual ("User's Guide"). Not following precautions found in this User's Guide can lead to an accident or other serious consequences.

Appendices

Keep User's Guide in vehicle: When kept in the vehicle, the User's Guide will be a ready reference for you and other users unfamiliar with the Windows Automotive-based system. Please make certain that before using the system for the first time, all persons have access to the User's Guide and read its instructions and safety information carefully.



WARNING: Driving while distracted can result in loss of vehicle control, crash and injury. We strongly recommend that you use extreme caution when using any device that may take your focus off the road. Your primary responsibility is the safe operation of your vehicle. We recommend against the use of any hand-held device while driving and encourage the use of voice-operated systems when possible. Make sure you are aware of all applicable local laws that may affect the use of electronic devices while driving.

General Operation

Voice Command Control: Functions within the Windows Automotive-based system may be accomplished using only voice commands. Using voice commands while driving allows you to operate the system without removing your hands from the wheel.

Prolonged Views of Screen: Do not access any function requiring a prolonged view of the screen while you are driving. Pull over in a safe and legal manner before attempting to access a function of the system requiring prolonged attention. Even occasional short scans to the screen may be hazardous if your attention has been diverted away from your driving task at a critical time.

Volume Setting: Do not raise the volume excessively. Keep the volume at a level where you can still hear outside traffic and emergency signals while driving. Driving while unable to hear these sounds could cause an accident.

Use of Speech Recognition Functions: Speech recognition software is inherently a statistical process which is subject to errors. It is your responsibility to monitor any speech recognition functions included in the system and address any errors.

Navigation Features: Any navigation features included in the system are intended to provide turn by turn instructions to get you to a desired destination. Please make certain all persons using this system carefully read and follow instructions and safety information fully.

Distraction Hazard: Any navigation features may require manual (non-verbal) setup. Attempting to perform such set-up or insert data while driving can seriously distract your attention and could cause an accident or other serious consequences. Stop the vehicle in a safe and legal manner before attempting these operations.

Let Your Judgment Prevail: Any navigation features are provided only as an aid. Make your driving decisions based on your observations of local conditions and existing traffic regulations. Any such feature is not a substitute for your personal judgment. Any route suggestions made by this system should never replace any local traffic regulations or your personal judgment or knowledge of safe driving practices.

Appendices

Route Safety: Do not follow the route suggestions if doing so would result in an unsafe or illegal maneuver, if you would be placed in an unsafe situation, or if you would be directed into an area that you consider unsafe. The driver is ultimately responsible for the safe operation of the vehicle and therefore, must evaluate whether it is safe to follow the suggested directions.

Potential Map Inaccuracy: Maps used by this system may be inaccurate because of changes in roads, traffic controls or driving conditions. Always use good judgment and common sense when following the suggested routes.

Emergency Services: Do not rely on any navigation features included in the system to route you to emergency services. Ask local authorities or an emergency services operator for these locations. Not all emergency services such as police, fire stations, hospitals and clinics are likely to be contained in the map database for such navigation features.

Telenav Software End User License Agreement

Please read these terms and conditions carefully before you use the Telenav Software. Your use of the Telenav Software indicates that you accept these terms and conditions. If you do not accept these terms and conditions, do not break the seal of the package, launch, or otherwise use the Telenav Software.

These terms and conditions represent the agreement ("Agreement") between you and Telenav, Inc. ("Telenav") with respect to the Telenav Software (including upgrades, modifications, or additions thereto) (collectively "Telenav Software"). All references herein to "you" and "your" means you, your employees, agents, and contractors, and any other entity on whose behalf you accept these terms and

conditions, all of whom shall also be bound by this Agreement. Additionally, all of your account information, as well as other payment and personal information provided by you to Telenav (directly or through the use of the Telenav Software, is subject to Telenav's privacy policy located at <http://www.telenav.com>.

Telenav may revise this Agreement and the privacy policy at any time, with or without notice to you. You agree to visit <http://www.telenav.com> from time to time to review the then current version of this Agreement and of the privacy policy.

1. Safe and Lawful Use

You acknowledge that devoting attention to the Telenav Software may pose a risk of injury or death to you and others in situations that otherwise require your undivided attention, and you therefore agree to comply with the following when using the Telenav Software: (a) observe all traffic laws and otherwise drive safely; (b) use your own personal judgment while driving. If you feel that a route suggested by the Telenav Software instructs you to perform an unsafe or illegal maneuver, places you in an unsafe situation, or directs you into an area that you consider to be unsafe, do not follow such instructions; (c) do not input destinations, or otherwise manipulate the Telenav Software, unless your vehicle is stationary and parked; (d) do not use the Telenav Software for any illegal, unauthorized, unintended, unsafe, hazardous, or unlawful purposes, or in any manner inconsistent with this Agreement; (e) arrange all GPS and wireless devices and cables necessary for use of the Telenav Software in a secure manner in your vehicle so that they will not interfere with your driving and will not prevent the operation of any safety device (such as an airbag).

Appendices

You agree to indemnify and hold Telenav harmless against all claims resulting from any dangerous or otherwise inappropriate use of the Telenav Software in any moving vehicle, including as a result of your failure to comply with the directions above.

2. Account Information

You agree: (a) when registering the Telenav Software, to provide Telenav with true, accurate, current, and complete information about yourself, and (b) to inform Telenav promptly of any changes to such information, and to keep it true, accurate, current and complete.

3. Software License

Subject to your compliance with the terms of this Agreement, Telenav hereby grants to you a personal, non-exclusive, non-transferable license (except as expressly permitted below in connection with your permanent transfer of the Telenav Software license), without the right to sublicense, to use the Telenav Software (in object code form only) in order to access and use the Telenav Software. This license shall terminate upon any termination or expiration of this Agreement. You agree that you will use the Telenav Software only for your personal business or leisure purposes, and not to provide commercial navigation services to other parties.

3.1 License Limitations

You agree not to do any of the following: (a) reverse engineer, decompile, disassemble, translate, modify, alter or otherwise change the Telenav Software or any part thereof; (b) attempt to derive the source code, audio library or structure of the Telenav Software without the prior express written consent of Telenav; (c) remove from the Telenav Software, or alter, any of Telenav's or its suppliers' trademarks, trade names, logos, patent or

copyright notices, or other notices or markings; (d) distribute, sublicense or otherwise transfer the Telenav Software to others, except as part of your permanent transfer of the Telenav Software; or (e) use the Telenav Software in any manner that (i) infringes the intellectual property or proprietary rights, rights of publicity or privacy or other rights of any party, (ii) violates any law, statute, ordinance or regulation, including but not limited to laws and regulations related to spamming, privacy, consumer and child protection, obscenity or defamation, or (iii) is harmful, threatening, abusive, harassing, tortuous, defamatory, vulgar, obscene, libelous, or otherwise objectionable; and (f) lease, rent out, or otherwise permit unauthorized access by third parties to the Telenav Software without advanced written permission of Telenav.

4. Disclaimers

To the fullest extent permissible pursuant to applicable law, in no event will Telenav, its licensors and suppliers, or agents or employees of any of the foregoing, be liable for any decision made or action taken by you or anyone else in reliance on the information provided by the Telenav Software. Telenav also does not warrant the accuracy of the map or other data used for the Telenav Software. Such data may not always reflect reality due to, among other things, road closures, construction, weather, new roads and other changing conditions. You are responsible for the entire risk arising out of your use of the Telenav Software. For example but without limitation, you agree not to rely on the Telenav Software for critical navigation in areas where the well-being or survival of you or others is dependent on the accuracy of navigation, as the maps or functionality of the Telenav Software are not intended to support such high risk applications, especially in more remote geographical areas.

Appendices

TELENAV EXPRESSLY DISCLAIMS AND EXCLUDES ALL WARRANTIES IN CONNECTION WITH THE TELENAV SOFTWARE, WHETHER STATUTORY, EXPRESS OR IMPLIED, INCLUDING ALL WARRANTIES WHICH MAY ARISE FROM COURSE OF DEALING, CUSTOM OR TRADE AND INCLUDING, BUT NOT LIMITED TO, THE IMPLIED WARRANTIES OF MERCHANTABILITY, FITNESS FOR A PARTICULAR PURPOSE AND NON-INFRINGEMENT OF THIRD PARTY RIGHTS WITH RESPECT TO THE TELENAV SOFTWARE. Certain jurisdictions do not permit the disclaimer of certain warranties, so this limitation may not apply to you.

5. Limitation of Liability

TO THE EXTENT PERMITTED UNDER APPLICABLE LAW, UNDER NO CIRCUMSTANCES SHALL TELENAV OR ITS LICENSORS AND SUPPLIERS BE LIABLE TO YOU OR TO ANY THIRD PARTY FOR ANY INDIRECT, INCIDENTAL, CONSEQUENTIAL, SPECIAL OR EXEMPLARY DAMAGES (INCLUDING IN EACH CASE, BUT NOT LIMITED TO, DAMAGES FOR THE INABILITY TO USE THE EQUIPMENT OR ACCESS DATA, LOSS OF DATA, LOSS OF BUSINESS, LOSS OF PROFITS, BUSINESS INTERRUPTION OR THE LIKE) ARISING OUT OF THE USE OF OR INABILITY TO USE THE TELENAV SOFTWARE, EVEN IF TELENAV HAS BEEN ADVISED OF THE POSSIBILITY OF SUCH DAMAGES.

NOTWITHSTANDING ANY DAMAGES THAT YOU MIGHT INCUR FOR ANY REASON WHATSOEVER (INCLUDING, WITHOUT LIMITATION, ALL DAMAGES REFERENCED HEREIN AND ALL DIRECT OR GENERAL DAMAGES IN CONTRACT, TORT (INCLUDING NEGLIGENCE) OR OTHERWISE), THE ENTIRE LIABILITY OF TELENAV AND OF ALL OF TELENAV'S SUPPLIERS SHALL BE LIMITED TO THE AMOUNT ACTUALLY PAID BY YOU FOR

THE TELENAV SOFTWARE. SOME STATES AND/OR JURISDICTIONS DO NOT ALLOW THE EXCLUSION OR LIMITATION OF INCIDENTAL OR CONSEQUENTIAL DAMAGES, SO THE ABOVE LIMITATIONS OR EXCLUSIONS MAY NOT APPLY TO YOU.

6. Arbitration and Governing Law

You agree that any dispute, claim or controversy arising out of or relating to this Agreement or the Telenav Software shall be settled by independent arbitration involving a neutral arbitrator and administered by the American Arbitration Association in the County of Santa Clara, California. The arbitrator shall apply the Commercial Arbitration Rules of the American Arbitration Association, and the judgment upon the award rendered by the arbitrator may be entered by any court having jurisdiction. Note that there is no judge or jury in an arbitration proceeding and the decision of the arbitrator shall be binding upon both parties. You expressly agree to waive your right to a jury trial.

This Agreement and performance hereunder will be governed by and construed in accordance with the laws of the State of California, without giving effect to its conflict of laws provisions. To the extent judicial action is necessary in connection with the binding arbitration, both Telenav and you agree to submit to the exclusive jurisdiction of the courts of the County of Santa Clara, California. The United Nations Convention on Contracts for the International Sale of Goods shall not apply.

7. Assignment

You may not resell, assign, or transfer this Agreement or any of your rights or obligations, except in totality, in connection with your permanent transfer of the Telenav Software, and expressly conditioned upon the new user of the

Appendices

Telenav Software agreeing to be bound by the terms and conditions of this Agreement. Any such sale, assignment or transfer that is not expressly permitted under this paragraph will result in immediate termination of this Agreement, without liability to Telenav, in which case you and all other parties shall immediately cease all use of the Telenav Software. Notwithstanding the foregoing, Telenav may assign this Agreement to any other party at any time without notice, provided the assignee remains bound by this Agreement.

8. Miscellaneous

8.1

This Agreement constitutes the entire agreement between Telenav and you with respect to the subject matter hereof.

8.2

Except for the limited licenses expressly granted in this Agreement, Telenav retains all right, title and interest in and to the Telenav Software, including without limitation all related intellectual property rights. No licenses or other rights which are not expressly granted in this Agreement are intended to, or shall be, granted or conferred by implication, statute, inducement, estoppel or otherwise, and Telenav and its suppliers and licensors hereby reserve all of their respective rights other than the licenses explicitly granted in this Agreement.

8.3

By using the Telenav Software, you consent to receive from Telenav all communications, including notices, agreements, legally required disclosures or other information in connection with the Telenav Software (collectively, "Notices") electronically. Telenav may provide such

Notices by posting them on Telenav's Website or by downloading such Notices to your wireless device. If you desire to withdraw your consent to receive Notices electronically, you must discontinue your use of the Telenav Software.

8.4

Telenav's or your failure to require performance of any provision shall not affect that party's right to require performance at any time thereafter, nor shall a waiver of any breach or default of this Agreement constitute a waiver of any subsequent breach or default or a waiver of the provision itself.

8.5

If any provision herein is held unenforceable, then such provision will be modified to reflect the intention of the parties, and the remaining provisions of this Agreement will remain in full force and effect.

8.6

The headings in this Agreement are for convenience of reference only, will not be deemed to be a part of this Agreement, and will not be referred to in connection with the construction or interpretation of this Agreement. As used in this Agreement, the words "include" and "including," and variations thereof, will not be deemed to be terms of limitation, but rather will be deemed to be followed by the words "without limitation."

9. Other Vendors Terms and Conditions

The Telenav Software utilizes map and other data licensed to Telenav by third party vendors for the benefit of you and other end users. This Agreement includes end-user terms applicable to these companies (included at the end of this

Appendices

Agreement), and thus your use of the Telenav Software is also subject to such terms. You agree to comply with the following additional terms and conditions, which are applicable to Telenav's third party vendor licensors:

9.1 End User Terms Required by HERE North America, LLC

The data ("Data") is provided for your personal, internal use only and not for resale. It is protected by copyright, and is subject to the following terms and conditions which are agreed to by you, on the one hand, and Telenav ("Telenav") and its licensors (including their licensors and suppliers) on the other hand.

© 2013 HERE. All rights reserved.

The Data for areas of Canada includes information taken with permission from Canadian authorities, including: © Her Majesty the Queen in Right of Canada, © Queen's Printer for Ontario, © Canada Post Corporation, GeoBase®, © Department of Natural Resources Canada.

HERE holds a non-exclusive license from the United States Postal Service® to publish and sell ZIP+4® information.

©United States Postal Service® 2014. Prices are not established, controlled or approved by the United States Postal Service®. The following trademarks and registrations are owned by the USPS: United States Postal Service, USPS, and ZIP+4.

The Data for Mexico includes certain data from Instituto Nacional de Estadística y Geografía.

TERMS AND CONDITIONS

9.2 End User Terms Required by NAV2 (Shanghai) Co., Ltd

The data ("Data") is provided for your personal, internal use only and not for resale. It is protected by copyright, and is subject to the following terms and conditions which are agreed to by you, on the one hand, and NAV2 (Shanghai) Co., Ltd ("NAV2") and its licensors (including their licensors and suppliers) on the other hand.

© 20xx. All rights reserved.

Permitted Use.

You agree to use this Data together with the Telenav Software solely for the internal business and personal purposes for which you were licensed, and not for service bureau, time-sharing or other similar purposes. Accordingly, but subject to the restrictions set forth in the following paragraphs, you agree not to otherwise reproduce, copy, modify, decompile, disassemble, create any derivative works of, or reverse engineer any portion of this Data, and may not transfer or distribute it in any form, for any purpose, except to the extent permitted by mandatory laws.

Restrictions.

Except where you have been specifically licensed to do so by Telenav, and without limiting the preceding paragraph, you may not use this Data (a) with any products, systems, or applications installed or otherwise connected to or in communication with vehicles, capable of vehicle navigation, positioning, dispatch, real time route guidance, fleet management or similar applications; or (b) with or in communication with any

Appendices

positioning devices or any mobile or wireless-connected electronic or computer devices, including without limitation cellular phones, palmtop and handheld computers, pagers, and personal digital assistants or PDAs.

Warning.

The Data may contain inaccurate or incomplete information due to the passage of time, changing circumstances, sources used and the nature of collecting comprehensive geographic data, any of which may lead to incorrect results.

No Warranty.

This Data is provided to you “as is,” and you agree to use it at your own risk. Telenav and its licensors (and their licensors and suppliers) make no guarantees, representations or warranties of any kind, express or implied, arising by law or otherwise, including but not limited to, content, quality, accuracy, completeness, effectiveness, reliability, fitness for a particular purpose, usefulness, use or results to be obtained from this Data, or that the Data or server will be uninterrupted or error-free.

Disclaimer of Warranty:

TELENAV AND ITS LICENSORS (INCLUDING THEIR LICENSORS AND SUPPLIERS) DISCLAIM ANY WARRANTIES, EXPRESS OR IMPLIED, OF QUALITY, PERFORMANCE, MERCHANTABILITY, FITNESS FOR A PARTICULAR PURPOSE OR NON-INFRINGEMENT. Some States, Territories and Countries do not allow certain warranty exclusions, so to that extent the above exclusion may not apply to you.

Disclaimer of Liability:

TELENAV AND ITS LICENSORS (INCLUDING THEIR LICENSORS AND SUPPLIERS) SHALL NOT BE LIABLE TO YOU: IN RESPECT OF ANY CLAIM, DEMAND OR ACTION, IRRESPECTIVE OF THE NATURE OF THE CAUSE OF THE CLAIM, DEMAND OR ACTION ALLEGING ANY LOSS, INJURY OR DAMAGES, DIRECT OR INDIRECT, WHICH MAY RESULT FROM THE USE OR POSSESSION OF THE INFORMATION; OR FOR ANY LOSS OF PROFIT, REVENUE, CONTRACTS OR SAVINGS, OR ANY OTHER DIRECT, INDIRECT, INCIDENTAL, SPECIAL OR CONSEQUENTIAL DAMAGES ARISING OUT OF YOUR USE OF OR INABILITY TO USE THIS INFORMATION, ANY DEFECT IN THE INFORMATION, OR THE BREACH OF THESE TERMS OR CONDITIONS, WHETHER IN AN ACTION IN CONTRACT OR TORT OR BASED ON A WARRANTY, EVEN IF TELENAV OR ITS LICENSORS HAVE BEEN ADVISED OF THE POSSIBILITY OF SUCH DAMAGES. Some States, Territories and Countries do not allow certain liability exclusions or damages limitations, so to that extent the above may not apply to you.

Export Control.

You shall not export from anywhere any part of the Data or any direct product thereof except in compliance with, and with all licenses and approvals required under, applicable export laws, rules and regulations, including but not limited to the laws, rules and regulations administered by the Office of Foreign Assets Control of the U.S. Department of Commerce and the Bureau of Industry and Security of the U.S. Department of Commerce. To the extent

Appendices

that any such export laws, rules or regulations prohibit HERE from complying with any of its obligations hereunder to deliver or distribute Data, such failure shall be excused and shall not constitute a breach of this Agreement.

Entire Agreement.

These terms and conditions constitute the entire agreement between Telenav (and its licensors, including their licensors and suppliers) and you pertaining to the subject matter hereof, and supersedes in their entirety any and all written or oral agreements previously existing between us with respect to such subject matter.

Governing Law.

The above terms and conditions shall be governed by the laws of the State of Illinois [insert "Netherlands" where European HERE Data is used], without giving effect to (i) its conflict of laws provisions, or (ii) the United Nations Convention for Contracts for the International Sale of Goods, which is explicitly excluded. You agree to submit to the jurisdiction of the State of Illinois [insert "The Netherlands" where European HERE Data is used] for any and all disputes, claims and actions arising from or in connection with the Data provided to you hereunder.

Government End Users.

If the Data is being acquired by or on behalf of the United States government or any other entity seeking or applying rights similar to those customarily claimed by the United States government, this Data is a "commercial item" as that term is defined at 48 C.F.R. ("FAR") 2.101, is licensed in accordance with these End-User Terms, and each copy of Data delivered or otherwise furnished shall be marked and embedded as appropriate with the following "Notice of Use," and shall be treated in accordance with such Notice:

NOTICE OF USE

CONTRACTOR (MANUFACTURER/
SUPPLIER) NAME: HERE

CONTRACTOR (MANUFACTURER/
SUPPLIER) ADDRESS: c/o Nokia, 425
West Randolph Street, Chicago, Illinois
60606

This Data is a commercial item as defined in FAR 2.101 and is subject to these End-User Terms under which this Data was provided.

© 1987 – 2014 HERE – All rights reserved.

If the Contracting Officer, federal government agency, or any federal official refuses to use the legend provided herein, the Contracting Officer, federal government agency, or any federal official must notify HERE prior to seeking additional or alternative rights in the Data.

I. US/Canada Territory

A. United States Data. The End-User Terms for any Application containing Data for the United States shall contain the following notices:

"HERE holds a non-exclusive license from the United States Postal Service® to publish and sell ZIP+4® information."

"©United States Postal Service® 20XX. Prices are not established, controlled or approved by the United States Postal Service®. The following trademarks and registrations are owned by the USPS: United States Postal Service, USPS, and ZIP+4."

Appendices

B. Canada Data. The following provisions apply to the Data for Canada, which may include or reflect data from third party licensors (“Third Party Data”), including Her Majesty the Queen in Right of Canada (“Her Majesty”), Canada Post Corporation (“Canada Post”) and the Department of Natural Resources of Canada (“NRCan”):

1. Disclaimer and Limitation: Client agrees that its use of the Third Party Data is subject to the following provisions:

a. Disclaimer: The Third Party Data is licensed on an “as is” basis. The licensors of such data, including Her Majesty, Canada Post and NRCan, make no guarantees, representations or warranties respecting such data, either express or implied, arising by law or otherwise, including but not limited to, effectiveness, completeness, accuracy or fitness for a particular purpose.

b. Limitation on Liability: The Third Party Data licensors, including Her Majesty, Canada Post and NRCan, shall not be liable: (i) in respect of any claim, demand or action, irrespective of the nature of the cause of the claim, demand or action alleging any loss, injury or damages, direct or indirect, which may result from the use or possession of such Data; or (ii) in any way for loss of revenues or contracts, or any other consequential loss of any kind resulting from any defect in the Data.

2. Copyright Notice: In connection with each copy of all or any portion of the Data for the Territory of Canada, Client shall affix in a conspicuous manner the following copyright notice on at least one of: (i) the label for the storage media of the copy; (ii) the packaging for the copy; or (iii) other materials packaged with the copy, such as user manuals or end user license agreements: “This data includes information taken with permission from Canadian authorities, including © Her Majesty the Queen in Right of Canada, © Queen’s Printer for Ontario, © Canada Post Corporation, GeoBase®, © The Department of Natural Resources Canada. All rights reserved.”

3. End-User Terms: Except as otherwise agreed by the parties, in connection with the provision of any portion of the Data for the Territory of Canada to End-Users as may be authorized under the Agreement, Client shall provide such End-Users, in a reasonably conspicuous manner, with terms (set forth with other end user terms required to be provided under the Agreement, or as otherwise may be provided, by Client) which shall include the following provisions on behalf of the Third Party Data licensors, including Her Majesty, Canada Post and NRCan:

The Data may include or reflect data of licensors, including Her Majesty the Queen in the Right of Canada (“Her Majesty”), Canada Post Corporation (“Canada Post”) and the Department of Natural Resources Canada (“NRCan”). Such data is licensed on an “as is” basis. The licensors, including Her Majesty, Canada Post and NRCan, make no guarantees, representations or warranties respecting such data,

Appendices

either express or implied, arising by law or otherwise, including but not limited to, effectiveness, completeness, accuracy or fitness for a particular purpose. The licensors, including Her Majesty, Canada Post and NRCan, shall not be liable in respect of any claim, demand or action, irrespective of the nature of the cause of the claim, demand or action alleging any loss, injury or damages, direct or indirect, which may result from the use or possession of the data or the Data. The licensors, including Her Majesty, Canada Post and NRCan, shall not be liable in any way for loss of revenues or contracts, or any other consequential loss of any kind resulting from any defect in the data or the Data.

End User shall indemnify and save harmless the licensors, including Her Majesty, Canada Post and NRCan, and their officers, employees and agents from and against any claim, demand or action, irrespective of the nature of the cause of the claim, demand or action, alleging loss, costs, expenses, damages or injuries (including injuries resulting in death) arising out of the use or possession of the data or the Data.

4. Additional Provisions: The terms contained in this Section are in addition to all of the rights and obligations of the parties under the Agreement. To the extent that any of the provisions of this Section are inconsistent with, or conflict with, any other provisions of the Agreement, the provisions of this Section shall prevail.

II. Mexico. The following provision applies to the Data for Mexico, which includes certain data from the Instituto Nacional de Estadística y Geografía (“INEGI”):

A. Any and all copies of the Data and/or packaging containing Data for Mexico shall contain the following notice: “Fuente: INEGI (Instituto Nacional de Estadística y Geografía)”

III. Latin America Territory

A. Third Party Notices. Any and all copies of the Data and/or packaging relating thereto shall include the respective Third Party Notices set forth below and used as described below corresponding to the Territory (or portion thereof) included in such copy:

Territory	Notice
Ecuador	“INSTITUTO GEOGRAFICO MILITAR DEL ECUADOR AUTORIZACION N° IGM-2011-01- PCO-01 DEL 25 DE ENERO DE 2011” “source: © IGN 2009 - BD TOPO ®”
Guadeloupe, French Guiana and Martinique Mexico	“Fuente: INEGI (Instituto Nacional de Estadística y Geografía)”

IV. Middle East Territory

Appendices

A. Third Party Notices. Any and all copies of the Data and/or packaging relating thereto shall include the respective Third Party Notices set forth below and used as described below corresponding to the Territory (or portion thereof) included in such copy:

Country	Notice
Jordan	“© Royal Jordanian Geographic Centre”. The foregoing notice requirement for Jordan Data is a material term of the Agreement. If Client or any of its permitted sublicensees (if any) fail to meet such requirement, HERE shall have the right to terminate Client’s license with respect to the Jordan Data.

B. Jordan Data. Client and its permitted sublicensees (if any) are restricted from licensing and/or otherwise distributing HERE’s database for the country of Jordan (“Jordan Data”) for use in Enterprise Applications to (i) non-Jordanian entities for use of the Jordan Data solely in Jordan or (ii) Jordan-based customers. In addition, Client, its permitted sublicensees (if any) and End-Users are restricted from using the Jordan Data in Enterprise Applications if such party is (i) a non-Jordanian entity using the Jordan Data solely in Jordan or (ii) a Jordan-based customer. For purposes of the foregoing, “Enterprise Applications” shall mean Geomarketing applications, GIS applications, mobile business asset management applications, call center applications, telematics applications, public organization Internet applications or for providing geocoding services.

V. Europe Territory

A. Use of Certain Traffic Codes in Europe

1. General Restrictions Applicable to Traffic Codes. Client acknowledges and agrees that in certain countries of the Europe Territory, Client will need to obtain rights directly from third party RDS-TMC code providers to receive and use the Traffic Codes in the Data and to deliver to End-Users Transactions in any way derived from or based on such Traffic Codes. For such countries, HERE shall deliver the Data incorporating Traffic Codes to Client only after receiving certification from Client of its having obtained such rights.

2. Display of Third Party Rights Legends for Belgium. Client shall, for each Transaction that uses Traffic Codes for Belgium, provide the following notice to the End-User: “Traffic Codes for Belgium are provided by the Ministerie van de Vlaamse Gemeenschap and the Ministère de l’Équipement et des Transports.”

B. Paper Maps. With respect to any license granted to Client relating to making, selling or distributing paper maps (i.e., a map fixed on a paper or paper-like medium): (a) such license with respect to Data for the Territory of Great Britain is conditioned on Client’s entering into and complying with a separate written agreement with the Ordnance Survey (“OS”) to create and sell paper maps, Client’s paying to the OS any and all applicable paper map royalties, and Client’s complying with the OS copyright notice requirements; (b) such license for selling or otherwise distributing for charge with respect to Data for the Territory of Czech Republic

Appendices

is conditioned on Client's obtaining prior written consent from Kartografie a.s.; (c) such license for selling or distributing with respect to Data for the Territory of Switzerland is conditioned on Client's obtaining a permit from Bundesamt für Landestopografie of Switzerland; (d) Client is restricted from using Data for the Territory of France to create paper maps with a scale between 1:5,000 and 1:250,000; and (e) Client is restricted from using any Data to create, sell or distribute paper maps that are the same or substantially similar, in terms of data content and specific use of color, symbols and scale, to paper maps published by the European national mapping agencies, including without limitation, Landervermessungämter of Germany, Topografische Dienst of the Netherlands, Nationaal Geografisch Instituut of Belgium, Bundesamt für Landestopografie of Switzerland, Bundesamt für Eich-und Vermessungswesen of Austria, and the National Land Survey of Sweden.

C. OS Enforcement. Without limiting Section IV(B) above, with respect to Data for the Territory of Great Britain, Client acknowledges and agrees that the Ordnance Survey ("OS") may bring a direct action against Client to enforce compliance with the OS copyright notice (see Section IV(D) below) and paper map requirements (see Section IV(B) above) contained in this Agreement.

D. Third Party Notices. Any and all copies of the Data and/or packaging relating thereto shall include the respective Third Party Notices set forth below and used as described below corresponding to the Territory (or portion thereof) included in such copy:

Country(ies) Notice

Austria	"© Bundesamt für Eich-und Vermessungswesen"
Croatia Cyprus, Estonia, Latvia, Lithuania, Moldova, Poland, Slovenia and/or Ukraine	"© EuroGeographics"
France	"source: © IGN 2009 – BD TOPO ®"
Germany	"Die Grundlegendaten wurden mit Genehmigung der zuständigen Behörden entnommen"
Great Britain	"Contains Ordnance Survey data © Crown copyright and database right 2010 Contains Royal Mail data © Royal Mail copyright and database right 2010"
Greece	"Copyright Geomatics Ltd."
Hungary	"Copyright © 2003; Top-Map Ltd."
Italy	"La Banca Dati Italiana è stata prodotta usando quale riferimento anche cartografia numerica ed al tratto prodotta e fornita dalla Regione Toscana."
Norway	"Copyright © 2000; Norwegian Mapping Authority"
Portugal	"Source: IgeoE – Portugal"

Appendices

Spain	“Información geográfica propiedad del CNIG”
Sweden	“Based upon electronic data © National Land Survey Sweden.”
Switzerland	“Topografische Grundlage: © Bundesamt für Landestopographie.

E. Respective Country Distribution. Client acknowledges that HERE has not received approvals to distribute map data for the following countries in such respective countries: Albania, Belarus, Kyrgyzstan, Moldova and Uzbekistan. HERE may update such list from time to time. The license rights granted to Client under this TL with respect to the Data for such countries are contingent upon Client's compliance with all applicable laws and regulations, including, without limitation, any required licenses or approvals to distribute the Application incorporating such Data in such respective countries.

VI. Australia Territory

A. Third Party Notices. Any and all copies of the Data and/or packaging relating thereto shall include the respective Third Party Notices set forth below and used as described below corresponding to the Territory (or portion thereof) included in such copy:

Copyright. Based on data provided under license from PSMA Australia Limited (www.pasma.com.au).

Product incorporates data which is © 20XX Telstra Corporation Limited, GM Holden Limited, Intelomatics Australia Pty Ltd and Continental Pty Ltd.

B. Third Party Notices for Australia. In addition to the foregoing, the End-User Terms for any Application containing RDS-TMC Traffic Codes for Australia shall contain the following notice: “Product incorporates traffic location codes which is © 20XX Telstra Corporation Limited and its licensors.”

VII. China Territory

Personal Use Only

You agree to use this Data together with [insert name of Client Application] for the solely personal, non-commercial purposes for which you were licensed, and not for service bureau, time-sharing or other similar purposes. Accordingly, but subject to the restrictions set forth in the following paragraphs, you may copy this Data only as necessary for your personal use to (i) view it, and (ii) save it, provided that you do not remove any copyright notices that appear and do not modify the Data in any way. You agree not to otherwise reproduce, copy, modify, decompile, disassemble or reverse engineer any portion of this Data, and may not transfer or distribute it in any form, for any purpose, except to the extent permitted by mandatory laws.

Restrictions

Except where you have been specifically licensed to do so by NAV2 , and without limiting the preceding paragraph, you may not (a) use this Data with any products, systems, or applications installed or otherwise connected to or in communication with vehicles, capable of vehicle navigation, positioning, dispatch, real time route guidance, fleet management or similar applications; or (b)

Appendices

with or in communication with any positioning devices or any mobile or wireless-connected electronic or computer devices, including without limitation cellular phones, palmtop and handheld computers, pagers, and personal digital assistants or PDAs. You agree to cease using this Data if you fail to comply with these terms and conditions.

Limited Warranty

NAV2 warrants that (a) the Data will perform substantially in accordance with the accompanying written materials for a period of ninety (90) days from the date of receipt, and (b) any support services provided by NAV2 shall be substantially as described in applicable written materials provided to you by NAV2, and NAV2's support engineers will make commercially reasonable efforts to solve any problem issues.

rigCustomer Remedies

NAV2 and its suppliers' entire liability and your exclusive remedy shall be, at NAV2's sole discretion, either (a) return of the price paid, if any, or (b) repair or replacement of the Data that do not meet NAV2's Limited Warranty and that are returned to NAV2 with a copy of your receipt. This Limited Warranty is void if failure of the Data has resulted from accident, abuse, or misapplication. Any replacement Data will be warranted for the remainder of the original warranty period or thirty (30) days, whichever is longer. Neither these remedies nor any product support services offered by NAV2 are available without proof of purchase from an authorized international source.

No Other Warranty:

EXCEPT FOR THE LIMITED WARRANTY SET FORTH ABOVE AND TO THE EXTENT PERMITTED BY APPLICABLE LAW, NAV2 AND ITS LICENSORS (INCLUDING THEIR LICENSORS AND SUPPLIERS) DISCLAIM ANY WARRANTIES, EXPRESS OR IMPLIED, OF QUALITY, PERFORMANCE, MERCHANTABILITY, FITNESS FOR A PARTICULAR PURPOSE, OWNERSHIP OR NON-INFRINGEMENT. Certain warranty exclusions may not be permitted under applicable law, so to that extent the above exclusion may not apply to you.

Limited Liability:

TO THE EXTENT PERMITTED BY APPLICABLE LAW, NAV2 AND ITS LICENSORS (INCLUDING THEIR LICENSORS AND SUPPLIERS) SHALL NOT BE LIABLE TO YOU: IN RESPECT OF ANY CLAIM, DEMAND OR ACTION, IRRESPECTIVE OF THE NATURE OF THE CAUSE OF THE CLAIM, DEMAND OR ACTION ALLEGING ANY LOSS, INJURY OR DAMAGES, DIRECT OR INDIRECT, WHICH MAY RESULT FROM THE USE OR POSSESSION OF THE INFORMATION; OR FOR ANY LOSS OF PROFIT, REVENUE, CONTRACTS OR SAVINGS, OR ANY OTHER DIRECT, INDIRECT, INCIDENTAL, SPECIAL OR CONSEQUENTIAL DAMAGES ARISING OUT OF YOUR USE OF OR INABILITY TO USE THIS INFORMATION, ANY DEFECT IN THE INFORMATION, OR THE BREACH OF THESE TERMS OR CONDITIONS, WHETHER IN AN ACTION IN CONTRACT OR TORT OR BASED ON A WARRANTY, EVEN IF NAV2 OR ITS LICENSORS HAVE BEEN ADVISED OF THE POSSIBILITY OF SUCH DAMAGES. UNDER NO CIRCUMSTANCES SHALL NAV2'S OR ITS SUPPLIERS' LIABILITY HEREUNDER EXCEED THE PRICE PAID. Certain liability exclusions may not be permitted under applicable law, so to that extent the above exclusion may not apply to you.

Appendices

Export Control

You agree not to export to anywhere any part of the Data provided to you or any direct product thereof except in compliance with, and with all licenses and approvals required under, applicable export laws, rules and regulations.

IP Protection

The Data are owned by NAV2 or its suppliers and are protected by applicable copyright and other intellectual property law and treaties. The Data are provided solely on the basis of a license to use, not sale.

Entire Agreement

These terms and conditions constitute the entire agreement between NAV2 (and its licensors, including their licensors and suppliers) and you pertaining to the subject matter hereof, and supersedes in their entirety any and all written or oral agreements previously existing between us with respect to such subject matter.

Governing Law.

The above terms and conditions shall be governed by the laws of the People's Republic of China, without giving effect to (i) its conflict of laws provisions, or (ii) the United Nations Convention for Contracts for the International Sale of Goods, which is explicitly excluded. Any dispute arising from or in connection with the Data provided to you hereunder shall be submitted to the Shanghai International Economic and Trade Arbitration Commission for arbitration.

Gracenote® Copyright

CD and music-related data from Gracenote, Inc., copyright© 2000-2007 Gracenote. Gracenote Software, copyright © 2000-2007 Gracenote. This product and service may practice one or more of the following U.S. Patents #5,987,525, #6,061,680, #6,154,773, #6,161,132, #6,230,192, #6,230,207, #6,240,459, #6,330,593 and other patents issued or pending. Some services supplied under license from Open Globe, Inc. for U.S. Patent: #6,304,523.

Gracenote and CDDB are registered trademarks of Gracenote. The Gracenote logo and logotype, and the "Powered by Gracenote™" logo are trademarks of Gracenote.

Gracenote® End User License Agreement (EULA)

This device contains software from Gracenote, Inc. of 2000 Powell Street Emeryville, California 94608 ("Gracenote").

The software from Gracenote (the "Gracenote Software") enables this device to do disc and music file identification and obtain music-related information, including name, artist, track, and title information ("Gracenote Data") from online servers ("Gracenote Servers"), and to perform other functions. You may use Gracenote Data only by means of the intended End User functions of this device.

This device may contain content belonging to Gracenote's providers. If so, all of the restrictions set forth herein with respect to Gracenote Data shall also apply to such content and such content providers shall be entitled to all of the benefits and protections set forth herein that are available to Gracenote.

Appendices

You agree that you will use the content from Gracenote ("Gracenote Content"), Gracenote Data, the Gracenote Software, and Gracenote Servers for your own personal, non-commercial use only. You agree not to assign, copy, transfer or transmit the Gracenote Content, Gracenote Software or any Gracenote Data (except in a Tag associated with a music file) to any third party. YOU AGREE NOT TO USE OR EXPLOIT GRACENOTE CONTENT, GRACENOTE DATA, THE GRACENOTE SOFTWARE, OR GRACENOTE SERVERS, EXCEPT AS EXPRESSLY PERMITTED HEREIN.

You agree that your non-exclusive licenses to use the Gracenote Content, Gracenote Data, the Gracenote Software, and Gracenote Servers will terminate if you violate these restrictions. If your licenses terminate, you agree to cease any and all use of the Gracenote Content, Gracenote Data, the Gracenote Software, and Gracenote Servers. Gracenote, respectively, reserve all rights in Gracenote Data, the Gracenote Software, and the Gracenote Servers and Gracenote Content, including all ownership rights. Under no circumstances will either Gracenote become liable for any payment to you for any information that you provide, including any copyrighted material or music file information. You agree that Gracenote may enforce its respective rights, collectively or separately, under this agreement against you, directly in each company's own name.

Gracenote uses a unique identifier to track queries for statistical purposes. The purpose of a randomly assigned numeric identifier is to allow Gracenote to count queries without knowing anything about who you are. For more information, see the web page at www.gracenote.com for the Gracenote Privacy Policy.

THE GRACENOTE SOFTWARE, EACH ITEM OF GRACENOTE DATA AND THE GRACENOTE CONTENT ARE LICENSED TO YOU "AS IS". NEITHER GRACENOTE MAKES ANY REPRESENTATIONS OR WARRANTIES, EXPRESS OR IMPLIED, REGARDING THE ACCURACY OF ANY GRACENOTE DATA FROM THE GRACENOTE SERVERS OR GRACENOTE CONTENT. GRACENOTE COLLECTIVELY AND SEPARATELY RESERVE THE RIGHT TO DELETE DATA AND/OR CONTENT FROM THE COMPANIES' RESPECTIVE SERVERS OR, IN THE CASE OF GRACENOTE, CHANGE DATA CATEGORIES FOR ANY CAUSE THAT GRACENOTE DEEMS SUFFICIENT. NO WARRANTY IS MADE THAT EITHER GRACENOTE CONTENT OR THE GRACENOTE SOFTWARE OR GRACENOTE SERVERS ARE ERROR-FREE OR THAT THE FUNCTIONING OF THE GRACENOTE SOFTWARE OR GRACENOTE SERVERS WILL BE UNINTERRUPTED. GRACENOTE IS NOT OBLIGATED TO PROVIDE YOU WITH ANY ENHANCED OR ADDITIONAL DATA TYPES THAT GRACENOTE MAY CHOOSE TO PROVIDE IN THE FUTURE AND IS FREE TO DISCONTINUE ITS ONLINE SERVICES AT ANY TIME. GRACENOTE DISCLAIMS ALL WARRANTIES EXPRESS OR IMPLIED, INCLUDING, BUT NOT LIMITED TO, IMPLIED WARRANTIES OF MERCHANTABILITY, FITNESS FOR A PARTICULAR PURPOSE, TITLE, AND NON-INFRINGEMENT. NEITHER GRACENOTE WARRANTS THE RESULTS THAT WILL BE OBTAINED BY YOUR USE OF THE GRACENOTE SOFTWARE OR ANY GRACENOTE SERVER. IN NO CASE WILL GRACENOTE BE LIABLE FOR ANY CONSEQUENTIAL OR INCIDENTAL DAMAGES OR FOR ANY LOST PROFITS OR LOST REVENUES FOR ANY REASON WHATSOEVER.

© Gracenote 2007.

Appendices

Vehicle with SYNC only

United States and Mexico

FCC ID: KMHSG1G1

IC: 1422A-SG1G1

Mexico

Model: KMHSG1P1

NOM-121-SCT1-2009

The operation of this equipment is subject to the following two conditions: (1) This equipment or device may not cause harmful interference, and (2) this equipment or device must accept any interference, including interference that may cause undesired operation.

Vehicle with SYNC with Touchscreen/My Touch

FCC ID: KMHSYNGG2

IC: 1422A-SYNGG2

This device complies with Part 15 of the FCC Rules and with RSS-210 of Industry Canada. Operation is subject to the following two conditions: (1) This device may not cause harmful interference, and (2) this device must accept any interference received, including interference that may cause undesired operation.



WARNING: Changes or modifications not expressly approved by the party responsible for compliance could void the user's authority to operate the equipment. The term "IC:" before the radio certification number only signifies that Industry Canada technical specifications were met.

The antenna used for this transmitter must not be co-located or operating in conjunction with any other antenna or transmitter.

Index

A

A/C	
See: Climate Control.....	73
About This Manual.....	7
ABS	
See: Brakes.....	99
ABS driving hints	
See: Hints on Driving With Anti-Lock Brakes.....	100
Accessories.....	244
Accessories	
See: Replacement Parts Recommendation.....	8
ACC	
See: Using Adaptive Cruise Control.....	107
Adjusting the Headlamps.....	176
Adjusting the Steering Wheel.....	48
Airbag Disposal.....	41
Air Conditioning	
See: Climate Control.....	73
Air Conditioning System Capacity and Specification.....	232
Air Filter	
See: Changing the Engine Air Filter.....	165
Appendices.....	270
At a Glance.....	18
Audible Warnings and Indicators.....	63
Audio System.....	239
General Information.....	239
Audio Unit.....	239
Autolamps.....	52
Automatic Crash Shutoff.....	143
Automatic Crash Shutoff Precautions.....	143
Re-Enabling Your Vehicle.....	143
What Is Automatic Crash Shutoff.....	143
Automatic High Beam Control.....	54
Automatic High Beam Control Indicators.....	54
Automatic Transmission.....	95
Automatic Transmission Fluid Capacity and Specification.....	233
Automatic Transmission Fluid Check.....	170
Auxiliary Power Points.....	79
Auxiliary Switches.....	245

B

Battery	
See: Changing the 12V Battery.....	173
Bonnet Lock	
See: Opening and Closing the Hood.....	161
Booster Seats.....	26
Brake Fluid Check.....	172
Brake Fluid Specification.....	234
Brakes.....	99
General Information.....	99
Breaking-In.....	137
Bulb Specification Chart.....	228

C

Canceling the Set Speed.....	107
Capacities and Specifications.....	226
Car Wash	
See: Cleaning the Exterior.....	183
Catalytic Converter.....	92
Changing a Bulb.....	179
Changing a Fuse.....	159
Changing a Road Wheel.....	218
Changing the 12V Battery.....	173
Changing the Engine Air Filter.....	165
Changing the Wiper Blades.....	178
Checking the Wiper Blades.....	178
Child Restraint and Seatbelt Maintenance.....	34
Child Restraint Positioning.....	28
Child Safety.....	20
General Information.....	20
Cleaning Leather Seats.....	186
Cleaning Products.....	182
Cleaning the Engine.....	184
Cleaning the Exterior.....	183
Cleaning the Instrument Panel and Instrument Cluster Lens.....	186
Cleaning the Interior.....	185
Cleaning the Wheels.....	187
Cleaning the Windows and Wiper Blades.....	185
Climate Control.....	73
Connected Vehicle.....	238
Connected Vehicle – Troubleshooting.....	238

Index

Connecting the Vehicle to a Mobile Network.....	238
Connected Vehicle Data.....	16
Connected Vehicle Limitations.....	238
Connected Vehicle Requirements.....	238
Connected Vehicle – Troubleshooting.....	238
Connected Vehicle – Frequently Asked Questions.....	238
Connecting a Bluetooth® Device.....	242
Connecting the Vehicle to a Mobile Network.....	238
Connecting FordPass to the Modem.....	238
Disabling the Connectivity Device.....	238
Enabling and Disabling the Modem.....	238
What Is the Modem.....	238
Coolant Check	
See: Engine Coolant Check.....	165
Cooling System Capacity and Specification.....	230
Crash and Breakdown Information.....	142
Automatic Crash Shutoff.....	143
Crash Sensors and Airbag Indicator.....	40
Cruise Control.....	106
Cruise Control Indicators.....	107
Cruise Control - Vehicles With: Adaptive Cruise Control.....	48
Cruise Control - Vehicles With: Cruise Control.....	48
Customer Assistance.....	144
Customer Information.....	258
Radio Frequency Certification Labels.....	258
D	
Data Privacy.....	14
Daytime Running Lamps - Vehicles With: Configurable Daytime Running Lamps.....	52
Daytime Running Lamps - Vehicles With: Daytime Running Lamps (DRL).....	53
Direction Indicators.....	53
Doors and Locks.....	45
Driver Alert.....	114
Driver and Passenger Airbags.....	36
Driving Aids.....	114
Driving Hints.....	136
Driving Through Water.....	137
DRL	
See: Daytime Running Lamps - Vehicles With: Configurable Daytime Running Lamps.....	52
See: Daytime Running Lamps - Vehicles With: Daytime Running Lamps (DRL).....	53
E	
Economical Driving.....	136
Electromagnetic Compatibility.....	270
Emergency Call System Data.....	16
Emission Law.....	91
End User License Agreement.....	273
Engine Block Heater.....	83
Engine Coolant Check.....	165
Engine Emission Control.....	91
Engine Immobilizer	
See: Passive Anti-Theft System.....	47
Engine Oil Capacity and Specification.....	229
Engine Oil Check.....	163
Engine Oil Dipstick.....	163
Engine Specifications.....	226
Environment.....	17
Essential Towing Checks.....	129
Event Data.....	15
Exterior Mirrors.....	56
F	
Fastening the Seatbelts.....	31
Flat Tire	
See: Changing a Road Wheel.....	218
Floor Mats.....	137
Ford Credit.....	7
Ford Protect.....	247
Fuel and Refueling.....	85
Fuel Consumption.....	89
Fuel Filter.....	178
Fuel Quality - E85.....	85
Fuel Quality - Gasoline.....	87
Fuel Tank Capacity.....	231
Fuses.....	150
Fuse Specification Chart.....	150

Index

G

Gauges.....	58
Gearbox	
See: Transmission.....	95
General Information on Radio	
Frequencies.....	42
General Maintenance Information.....	249
Getting Assistance Outside the U.S. and	
Canada.....	147
Getting the Services You Need.....	144

H

Handbrake	
See: Parking Brake.....	100
Hazard Flashers.....	139
Headlamp Adjusting	
See: Adjusting the Headlamps.....	176
Headlamp Removal	
See: Removing a Headlamp.....	179
Headrest	
See: Head Restraints.....	76
Head Restraints.....	76
Heating	
See: Climate Control.....	73
Hill Start Assist.....	101
Hints on Controlling the Interior	
Climate.....	74
Hints on Driving With Anti-Lock	
Brakes.....	100
Hood Lock	
See: Opening and Closing the Hood.....	161
Horn.....	49
Hydraulic Power Steering Fluid Capacity	
and Specification.....	236

I

Ignition Switch.....	81
In California (U.S. Only).....	145
Information Display Control.....	49
Information Displays.....	64
General Information.....	64
Information Messages.....	68
Installing Child Restraints.....	22
Instrument Cluster.....	58
Instrument Lighting Dimmer.....	52

Instrument Panel.....	18
Interior Mirror.....	57
Introduction.....	7

J

Jump Starting the Vehicle.....	139
--------------------------------	-----

K

Keys and Remote Controls.....	42
-------------------------------	----

L

Lane Keeping System.....	115
Lighting Control.....	51
Lighting.....	51
General Information.....	51
Load Carrying.....	122
Load Limit.....	122
Locking and Unlocking.....	45
Lug Nuts	
See: Changing a Road Wheel.....	218

M

Maintenance.....	161
General Information.....	161
Manual Climate Control.....	73
Manual Seats.....	77
Message Center	
See: Information Displays.....	64
Mirrors	
See: Windows and Mirrors.....	56
Mobile Communications	
Equipment.....	10
Motorcraft Parts - 7.3L.....	227

N

Normal Scheduled Maintenance.....	252
-----------------------------------	-----

O

Oil Change Indicator Reset.....	164
Oil Check	
See: Engine Oil Check.....	163
Opening and Closing the Hood.....	161

Index

Ordering Additional Owner's Literature.....	148
Overriding Automatic High Beam Control.....	55

P

Parking Aids.....	105
Parking Brake.....	100
Passive Anti-Theft System.....	47
PATS	
See: Passive Anti-Theft System.....	47
Perchlorate.....	7
Playing Media From a USB Device.....	242
Post-Collision Braking.....	143
Power Door Locks	
See: Locking and Unlocking.....	45
Power Seats.....	78
Power Steering Fluid Check.....	173
Power Windows.....	56
Pre-Collision Assist.....	118
Protecting the Environment.....	17
Puncture	
See: Changing a Road Wheel.....	218

R

Radio Frequency Certification	
Labels.....	258
Cruise Control Module.....	258
Tire Pressure Monitoring System	
Sensors.....	261
Rear Axle Fluid Capacity and Specification.....	234
Rear Passenger Climate Controls.....	75
Rear View Camera.....	105
Rear View Camera	
See: Rear View Camera.....	105
Recommended Towing Weights.....	128
Reduced Engine Performance.....	136
Refueling.....	88
Remote Control.....	42
Removing a Headlamp.....	179
Repairing Minor Paint Damage.....	187
Replacement Parts	
Recommendation.....	8
Replacing a Lost Key or Remote Control.....	44

Reporting Safety Defects (Canada Only).....	149
Reporting Safety Defects (U.S. Only).....	148
Resuming the Set Speed.....	107
Roadside Assistance.....	142
Roadside Emergencies.....	139
Running-In	
See: Breaking-In.....	137
Running Out of Fuel.....	87

S

Safety Precautions.....	85
Scheduled Maintenance.....	249
Seatbelt Extensions.....	34
Seatbelt Height Adjustment.....	33
Seatbelts.....	30
Principle of Operation.....	30
Seatbelt Warning Lamp and Indicator Chime.....	33
Seats.....	76
Security.....	47
Service Data.....	15
Setting the Cruise Control Speed.....	106
Sitting in the Correct Position.....	76
Snow Chains	
See: Using Snow Chains.....	212
Spare Wheel	
See: Changing a Road Wheel.....	218
Special Notices.....	8
Special Operating Conditions Scheduled Maintenance.....	255
Speed Control	
See: Cruise Control.....	106
Stability Control.....	103
Principle of Operation.....	103
Starter Switch	
See: Ignition Switch.....	81
Starting a Gasoline Engine.....	82
Starting and Stopping the Engine.....	81
General Information.....	81
Steering.....	118
Steering Wheel.....	48
Streaming Bluetooth Audio.....	242
Sun Visors.....	57
Supplementary Restraints System.....	35
Principle of Operation.....	35

Index

Switching Automatic High Beam Control On and Off.....	54
Switching Cruise Control On and Off.....	106
Symbols Glossary.....	11
Symbols Used on Your Vehicle.....	11
T	
Technical Specifications See: Capacities and Specifications.....	226
The Better Business Bureau (BBB) Auto Line Program (U.S. Only).....	146
Tire Care.....	191
Tire Pressure Monitoring System.....	213
Tires See: Wheels and Tires.....	190
Towing a Trailer.....	127
Towing the Vehicle on Four Wheels.....	135
Towing.....	127
Traction Control.....	102
Principle of Operation.....	102
Transmission.....	95
Transporting the Vehicle.....	140
U	
Under Hood Overview.....	162
USB Port.....	243
Using Adaptive Cruise Control.....	107
Using Snow Chains.....	212
Using Stability Control.....	104
Using Traction Control.....	102
Using Voice Recognition.....	243
V	
Vehicle Care.....	182
General Information.....	182
Vehicle Identification Number.....	237
Locating the Vehicle Identification Number.....	237
Vehicle Identification Number Overview.....	237
Vehicle Identification.....	237
Vehicle Identification Number.....	237
Vehicle Storage.....	187
Ventilation See: Climate Control.....	73
W	
Warning Lamps and Indicators.....	61
Warranty Information.....	268
Washer Fluid Check.....	177
Washer Fluid Specification.....	232
Washers See: Cleaning the Exterior.....	183
See: Wipers and Washers.....	50
Waxing.....	184
What Is Automatic High Beam Control.....	54
What Is Cruise Control.....	106
Wheel Nuts See: Changing a Road Wheel.....	218
Wheels and Tires.....	190
General Information.....	190
Technical Specifications.....	225
Windows and Mirrors.....	56
Windshield Washers.....	50
Windshield Wipers.....	50
Wiper Blades See: Checking the Wiper Blades.....	178
Wipers and Washers.....	50