

<b>Pictorial index</b>	Search by illustration	
<b>For safety and security</b>	Make sure to read through them (Main topics: Child seat, theft deterrent system)	1
<b>Vehicle status information and indicators</b>	Reading driving-related information (Main topics: Meters, multi-information display)	2
<b>Before driving</b>	Opening and closing the doors and windows, adjustment before driving (Main topics: Keys, doors, seats, power windows)	3
<b>Driving</b>	Operations and advice which are necessary for driving (Main topics: Starting hybrid system, refueling)	4
<b>Interior features</b>	Usage of the interior features (Main topics: Air conditioner, storage features)	5
<b>Maintenance and care</b>	Caring for your vehicle and maintenance procedures (Main topics: Interior and exterior, lights)	6
<b>When trouble arises</b>	What to do in case of malfunction and emergency (Main topics: 12-volt battery discharge, flat tire)	7
<b>Vehicle specifications</b>	Vehicle specifications, customizable features (Main topics: Fuel, oil, tire inflation pressure)	8
<b>For owners</b>	Reporting safety defects for U.S. owners, and seat belt, SRS airbag and headlight aim instructions for Canadian owners	9
<b>Index</b>	Search by symptom	
	Search alphabetically	

For your information.....	6
Reading this manual .....	13
How to search.....	14
Pictorial index .....	16

## 1 For safety and security

### 1-1. For safe use

Before driving.....	28
For safe driving .....	29
Seat belts .....	31
SRS airbags.....	36
Front passenger occupant classification system .....	44
Exhaust gas precautions..	49

### 1-2. Child safety

Riding with children.....	50
Child restraint systems.....	51

### 1-3. Emergency assistance

Safety Connect .....	64
----------------------	----

### 1-4. Hybrid system

Hybrid system features ....	69
Hybrid system precautions .....	72

### 1-5. Theft deterrent system

Immobilizer system .....	77
Alarm.....	78

## 2 Vehicle status information and indicators

### 2-1. Instrument cluster

Warning lights and indicators .....	82
Gauges and meters (with 7- inch display) .....	89

Gauges and meters (12.3- inch display) .....	92
Multi-information display (7- inch display) .....	96
Multi-information display (12.3-inch display) .....	106
Head-up display .....	117
Fuel consumption informa- tion.....	121

## 3 Before driving

### 3-1. Key information

Keys .....	124
Digital Key .....	127

### 3-2. Opening, closing and locking the doors

Side doors .....	129
Back door .....	134
Glass hatch .....	147
Smart key system.....	150

### 3-3. Adjusting the seats

Front seats .....	155
Rear seats.....	156
Head restraints.....	162

### 3-4. Adjusting the steering wheel and mirrors

Steering wheel.....	165
Inside rear view mirror...	166
Digital Rear-view Mirror.	167
Outside rear view mirrors .....	177

### 3-5. Opening, closing the windows and moon roof

Power windows .....	181
Moon roof .....	184

**3-6. Favorite settings**

- Driving position memory 187
- My Settings ..... 192

**4 Driving**

**4-1. Before driving**

- Driving the vehicle..... 197
- Cargo and luggage ..... 204
- Vehicle load limits ..... 208
- Trailer towing (with towing hitch) ..... 209
- Dinghy towing ..... 221

**4-2. Driving procedures**

- Power (ignition) switch.. 222
- Automatic transmission. 227
- Turn signal lever ..... 233
- Parking brake ..... 233
- Brake Hold ..... 237

**4-3. Operating the lights and wipers**

- Headlight switch ..... 240
- AHB (Automatic High Beam) ..... 242
- Fog light switch ..... 245
- Windshield wipers and washer..... 246
- Rear window wiper and washer..... 248

**4-4. Refueling**

- Opening the fuel tank cap ..... 251

**4-5. Using the driving support systems**

- Toyota Safety Sense 3.0 software update..... 254

- Toyota Safety Sense 3.0 256
- Driver monitor..... 266
- PCS (Pre-Collision System) ..... 268
- LTA (Lane Tracing Assist) ..... 280
- LCA (Lane Change Assist) ..... 285
- LDA (Lane Departure Alert) ..... 288
- PDA (Proactive driving assist) ..... 294
- FCTA (Front Cross Traffic Alert)..... 300
- RSA (Road Sign Assist) 302
- Dynamic radar cruise control ..... 305
- Cruise control ..... 316
- Emergency Driving Stop System ..... 319
- Traffic Jam Assist..... 322
- BSM (Blind Spot Monitor) ..... 328
- Safe Exit Assist ..... 333
- Intuitive parking assist... 337
- RCTA (Rear Cross Traffic Alert) function ..... 343
- RCD (Rear Camera Detection) function..... 349
- PKSB (Parking Support Brake)..... 353
- Parking Support Brake function (static objects front and rear of the vehicle)..... 358
- Parking Support Brake function (moving vehicles rear of the vehicle)..... 360

1

2

3

4

5

6

7

8

9

Parking Support Brake function (pedestrians rear of the vehicle).....	362
Multi-terrain Monitor .....	364
Driving mode select switch .....	433
Four-wheel drive system	435
Rear differential lock system .....	437
Crawl Control .....	439
Multi-terrain Select .....	442
Downhill assist control system .....	445
Driving assist systems ..	448
Trailer brake controller ..	453
SDM (Stabilizer with Disconnection Mechanism)....	456

#### 4-6. Driving tips

Off-road precautions .....	458
Hybrid Electric Vehicle driving tips.....	461
Winter driving tips .....	463

## 5 Interior features

### 5-1. Using the air conditioning system and defogger

Front automatic air conditioning system .....	468
Rear automatic air conditioning system .....	478
Heated steering wheel/seat heaters/seat ventilators	480

### 5-2. Using the interior lights

Interior lights list .....	483
----------------------------	-----

### 5-3. Using the storage features

List of storage features .	486
----------------------------	-----

Luggage compartment features .....	490
------------------------------------	-----

### 5-4. Using the other interior features

Other interior features ...	494
Power outlet (2400 W)...	509
When the power outlet (2400 W) cannot be used properly .....	515
Garage door opener .....	517

## 6 Maintenance and care

### 6-1. Maintenance and care

Cleaning and protecting the vehicle exterior .....	526
Cleaning and protecting the vehicle interior .....	529

### 6-2. Maintenance

Maintenance requirements .....	533
General maintenance ....	534
Emission inspection and maintenance (I/M) programs .....	537

### 6-3. Do-it-yourself maintenance

Do-it-yourself service precautions .....	538
Hood.....	540
Engine compartment .....	542
12-volt battery.....	548
Tires .....	551
Tire inflation pressure....	563
Wheels .....	565
Air conditioning filter .....	566

Cleaning the hybrid battery (traction battery) air intake vents..... 568

Electronic key battery.... 571

Checking and replacing fuses..... 573

Headlight aim ..... 576

Light bulbs..... 577

**7 When trouble arises**

**7-1. Essential information**

Emergency flashers ..... 580

If your vehicle has to be stopped in an emergency ..... 581

If the vehicle is submerged or water on the road is rising ..... 582

**7-2. Steps to take in an emergency**

If your vehicle needs to be towed..... 583

If you think something is wrong ..... 586

If a warning light turns on or a warning buzzer sounds ..... 587

If a warning message is displayed..... 598

If you have a flat tire..... 606

If the hybrid system will not start ..... 616

If you lose your keys ..... 617

If the electronic key does not operate properly ..... 618

If the 12-volt battery is discharged ..... 620

If your vehicle overheats 625

If the vehicle becomes stuck ..... 627

**8 Vehicle specifications**

**8-1. Specifications**

Maintenance data (fuel, oil level, etc.)..... 630

Fuel information..... 638

Tire information ..... 640

**8-2. Customization**

Customizable features... 649

**8-3. Initialization**

Items to initialize..... 666

**9 For owners**

**9-1. For owners**

Reporting safety defects for U.S. owners..... 668

Reporting safety defects for Canadian owners ..... 669

Seat belt instructions for Canadian owners (in French) ..... 669

SRS airbag instructions for Canadian owners (in French) ..... 671

Headlight aim instructions for Canadian owners (in French) ..... 677

**Index**

What to do if... (Trouble-shooting) ..... 680

Alphabetical Index ..... 683

1

2

3

4

5

6

7

8

9

## For your information



### WARNING

#### ■ General precautions while driving

**Driving under the influence:** Never drive your vehicle when under the influence of alcohol or drugs that have impaired your ability to operate your vehicle. Alcohol and certain drugs delay reaction time, impair judgment and reduce coordination, which could lead to an accident that could result in death or serious injury.

**Defensive driving:** Always drive defensively. Anticipate mistakes that other drivers or pedestrians might make and be ready to avoid accidents.

**Driver distraction:** Always give your full attention to driving. Anything that distracts the driver, such as adjusting controls, talking on a cellular phone or reading can result in a collision with resulting death or serious injury to you, your occupants or others.

#### ■ General precaution regarding children's safety

Never leave children unattended in the vehicle, and never allow children to have or use the key.

Children may be able to start the vehicle or shift the vehicle into neutral. There is also a danger that children may injure themselves by playing with the windows, the moon roof (if equipped), or other features of the vehicle. In addition, heat build-up or extremely cold temperatures inside the vehicle can be fatal to children.

## Main Owner's Manual

Please note that this manual

applies to all models and explains all equipment, including options. Therefore, you may find explanations for equipment not installed on your vehicle and the illustrations used may differ from your vehicle.

All specifications provided in this manual are current at the time of printing. Over time, your vehicle may receive updates that modify the vehicle and make material in this manual incomplete and/or inaccurate. Because of Toyota's interest in continual product improvement, Toyota reserves the right to make changes to this manual at any time without notice.

If Toyota chooses to update the manual, updated versions can be viewed by selecting your vehicle by model and year at the following URL or on your mobile device if you have access to the Toyota app.

[www.toyota.com/owners](http://www.toyota.com/owners)

### Noise from under vehicle after turning off the hybrid system

Approximately five hours after the hybrid system is turned off, you may hear sound coming from under the vehicle for several minutes. This is the sound of a fuel evaporation leakage check and, it does not indicate a

malfunction.

### **Accessories, spare parts and modification of your Toyota**

A wide variety of non-genuine spare parts and accessories for Toyota vehicles are currently available in the market. You should know that Toyota does not warrant these products and is not responsible for their performance, repair, or replacement, or for any damage they may cause to, or adverse effect they may have on, your Toyota vehicle.

This vehicle should not be modified with non-genuine Toyota products. Modification with non-genuine Toyota products could affect its performance, safety or durability, and may even violate governmental regulations. In addition, damage or performance problems resulting from the modification may not be covered under warranty.

Also, remodeling like this will have an effect on advanced safety equipment such as Toyota Safety Sense 3.0 and there is a danger that it will not work properly or the danger that it may work in situations where it should not be working.

### **Cyber Attack Risk**

Installing electronic devices and radios increases the risk of cyber attacks through the installed parts, which may lead to unexpected accidents and leakage of personal information. Toyota does not make any guarantees for problems caused by installing non-genuine Toyota products.

### **Installation of a mobile two-way radio system**

The installation of a mobile two-way radio system in your vehicle could affect electronic systems such as:

- Hybrid system
- Multiport fuel injection system/sequential multiport fuel injection system
- Toyota Safety Sense 3.0
- Anti-lock brake system
- SRS airbag system
- Seat belt pretensioner system

Be sure to check with your Toyota dealer for precautionary measures or special instructions regarding installation of a mobile two-way radio system.

High voltage parts and cables on the hybrid vehicles emit approximately the same amount of electromagnetic waves as the conventional gasoline powered

vehicles or home electronic appliances despite of their electromagnetic shielding.

Unwanted noise may occur in the reception of the mobile two-way radio.

## Vehicle data recording

This vehicle is equipped with sophisticated computers that record certain data regarding vehicle controls and operations.

### ■ Data recorded by the computers<sup>\*1</sup>

<sup>\*1</sup>: The recorded data varies according to the vehicle grade level and options with which it is equipped.

Certain data, such as the following, is recorded depending on the operation timing and status of each function.

- Basic vehicle behavior related data (engine speed/electric motor speed, accelerator/brake pedal operation, vehicle speed, etc.)
- Operating state of the driving support systems (recorded during system operation, includes basic vehicle behavior related data)
- Driving support system sensor data
- Image data (images from the front, rear, vehicle periphery, and driver monitor cameras)<sup>\*2</sup>

<sup>\*2</sup>: The vehicle has multiple cameras. For details on from which cameras images are recorded, contact your Toyota dealer.

### ● Location information

These computers do not record conversations, sounds, or images of the inside of the vehicle.

Also, personal information which may be used to identify the owner of the vehicle (name, gender, age, etc.) is not recorded.

### ■ Usage of recorded data and personal information by the Toyota Safety Sense 3.0

The operating state of each system, data from each sensor, image data (images from the front/rear cameras), and position information is recorded by the Toyota Safety Sense 3.0 in the following situations. Toyota obtains this information when the vehicle is brought to the dealership or when sent to the Toyota servers.

- In certain collisions or collision-like situations
- When driving on roads with certain traffic situations, such as congestion, poor road surfaces, poor weather, etc.
- When driving on certain roads, such as roads which were recently opened or extended



- After the hybrid system is started, for a certain amount of time

To learn more about the vehicle data collected, used and shared by Toyota, please visit [www.toyota.com/privacyvts/](http://www.toyota.com/privacyvts/).

### ■ Data provision and use purpose by third parties

Data recorded by the computers may be used for collision analysis, malfunction diagnosis, automated driving, advanced safety and map related technologies (technology, product development, product improvement, etc.) and products and services which use data (maps used for automated driving and advanced safety technologies, driving condition analysis, analysis of the driving environment, such as road infrastructure, traffic condition communication, etc. Herein referred to as “individual services”).

Also, this data may be used for customer support related to a collision, collision analysis or resolution.

In situations such as the following, Toyota may disclose the recorded data to a third party:

- When the consent of the vehicle owner (or the lessee if the vehicle is leased) has been given
- When officially requested by the police, a court of law or a government agency
- When it is to be used by Toyota in a lawsuit
- When data is to be used for research purposes after processing so that the data is not tied to a specific vehicle or vehicle owner

In addition to the above, Toyota may disclose the data recorded by the Toyota Safety Sense 3.0 to a third party in the following situations:

- When separate consent of the vehicle owner (or the lessee if the vehicle is leased) has been given. This includes situations when the user subscribes to an individual service which is provided by a second party and uses vehicle recorded data, where the provider has obtained the user’s consent for providing data to a third-party
- When providing data to a company involved in autonomous driving software, etc. for the purpose of research and development (technology, product development, product improvement, etc.) of automated driving, advanced safety and map related technologies
- When providing image data and position information to a

company involved in map creation, etc. for the purpose of research and development map related technologies

- When providing image data and position information to a local government for the purpose of road maintenance, etc.
- When providing processed image data and position information to traffic condition communication individual services
- When providing image data from near a fire, or other area that emergency services are dispatched, to the fire department of a local government which has entered a separate contract with Toyota

---

Image information recorded by the vehicle can be erased by your Toyota dealer.

The image recording function can be disabled. However, if the function is disabled, data from when systems operate will not be available.

If you wish to stop the collection of Toyota Safety Sense 3.0 data by the Toyota servers for the purpose of research and development and provision to individual services, contact your Toyota dealer.

## **Statement on Warranty Coverage for Aftermarket and Recycled Parts (For U.S. Owners)**

The Magnuson-Moss Warranty

Act, 15 U.S.C. s.2301 et seq., makes it illegal for motor vehicle manufacturers to void a motor vehicle warranty or deny warranty coverage solely because an aftermarket or recycled part has been used to repair the vehicle or someone other than the authorized service provider performed service on the vehicle. This provision does not apply to a new motor vehicle purchased solely for commercial or industrial use.

Under federal law, a manufacturer may deny warranty coverage and charge for repairs to a vehicle if it is discovered that an aftermarket or recycled part installed on the vehicle is defective or was installed incorrectly and caused damage to another part of the vehicle otherwise covered under warranty. The Federal Trade Commission requires that a manufacturer demonstrate that an aftermarket or recycled part or service performed by a person other than an authorized service provider caused damage to another part of the vehicle otherwise covered under warranty before denying warranty coverage. Additionally, federal law allows a manufacturer to void a motor vehicle warranty or deny warranty coverage if the manufacturer provides the article or service to consumers free of

charge under the warranty or the manufacturer has secured a waiver from the Federal Trade Commission.

### Event data recorder

This vehicle is equipped with an event data recorder (EDR). The main purpose of an EDR is to record, in certain crash or near crash-like situations, such as an airbag deployment or hitting a road obstacle, data that will assist in understanding how a vehicle's systems performed. The EDR is designed to record data related to vehicle dynamics and safety systems for a short period of time, typically 30 seconds or less.

The EDR in this vehicle is designed to record such data as:

- How various systems in your vehicle were operating;
- Whether or not the driver and passenger safety belts were buckled/fastened;
- How far (if at all) the driver was depressing the accelerator and/or brake pedal; and,
- How fast the vehicle was traveling.

These data can help provide a better understanding of the circumstances in which crashes and injuries occur.

**NOTE:** EDR data are recorded

by your vehicle only if a non-trivial crash situation occurs; no data are recorded by the EDR under normal driving conditions and no personal data (e.g., name, gender, age, and crash location) are recorded. However, other parties, such as law enforcement, could combine the EDR data with the type of personally identifying data routinely acquired during a crash investigation.

To read data recorded by an EDR, special equipment is required, and access to the vehicle or the EDR is needed. In addition to the vehicle manufacturer, other parties, such as law enforcement, that have the special equipment, can read the information if they have access to the vehicle or the EDR.

#### ● Disclosure of the EDR data

Toyota will not disclose the data recorded in an EDR to a third party except when:

- An agreement from the vehicle's owner (or the lessee for a leased vehicle) is obtained
- In response to an official request by the police, a court of law or a government agency
- For use by Toyota in a lawsuit

However, if necessary, Toyota may:

- Use the data for research on vehicle safety performance
- Disclose the data to a third party

for research purposes without disclosing information about the specific vehicle or vehicle owner

## Scrapping of your Toyota

The SRS airbag and seat belt pretensioner devices in your Toyota contain explosive chemicals. If the vehicle is scrapped with the airbags and seat belt pretensioners left as they are, this may cause an accident such as fire. Be sure to have the systems of the SRS airbag and seat belt pretensioner removed and disposed of by a qualified service shop or by your Toyota dealer before you scrap your vehicle.

## Perchlorate Material

Special handling may apply, See [www.dtsc.ca.gov/hazardouswaste/perchlorate](http://www.dtsc.ca.gov/hazardouswaste/perchlorate).

Your vehicle has components that may contain perchlorate. These components may include the airbags, seat belt pretensioners, wireless remote control batteries, and the batteries in the tire pressure warning valve and transmitters.

## “QR Code”





The word “QR Code” is registered trademark of DENSO WAVE INCORPORATED in

Japan and other countries.

## Caution symbols attached to the high voltage components

High voltage components, such as the power control unit, may have labels attached indicating care required.



Each caution symbol indicates the following:

Symbols	Meanings
	Indicates danger
	Indicates high voltage part
	Indicates not to touch
	Indicates high temperature part

## Reading this manual



### Explains symbols used in this manual

### Symbols in this manual

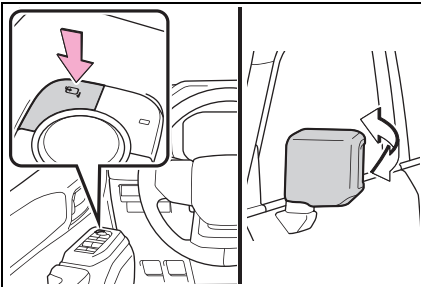

Symbols	Meanings
	<b>WARNING:</b> Explains something that, if not obeyed, could cause death or serious injury to people.
	<b>NOTICE:</b> Explains something that, if not obeyed, could cause damage to or a malfunction in the vehicle or its equipment.
1 2 3...	Indicates operating or working procedures. Follow the steps in numerical order.

### Symbols in illustrations

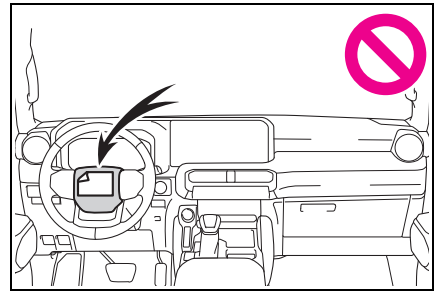

Symbols	Meanings
	Indicates the action (pushing, turning, etc.) used to operate switches and other devices.
	Indicates the outcome of an operation (e.g. a lid opens).



Symbols	Meanings
	Indicates the component or position being explained.
	Means <b>Do not, Do not do this, or Do not let this happen.</b>

## How to search

### ■ Searching by name

- Alphabetical index: →P.683

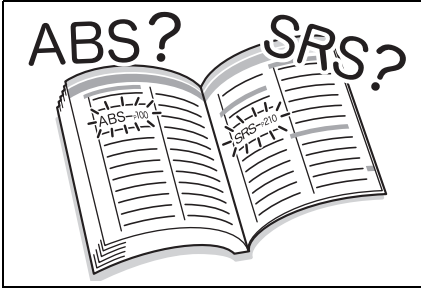

### ■ Searching by installation position

- Pictorial index: →P.16

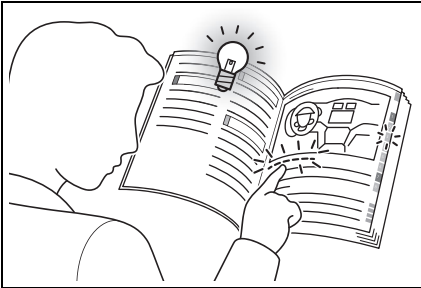

### ■ Searching by symptom or sound

- What to do if... (Troubleshooting): →P.680



### ■ Searching by title

- Table of contents: →P.2

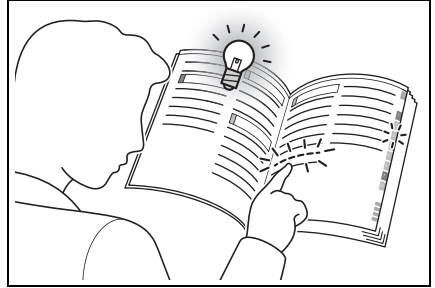



# Pictorial index

## ■ Exterior

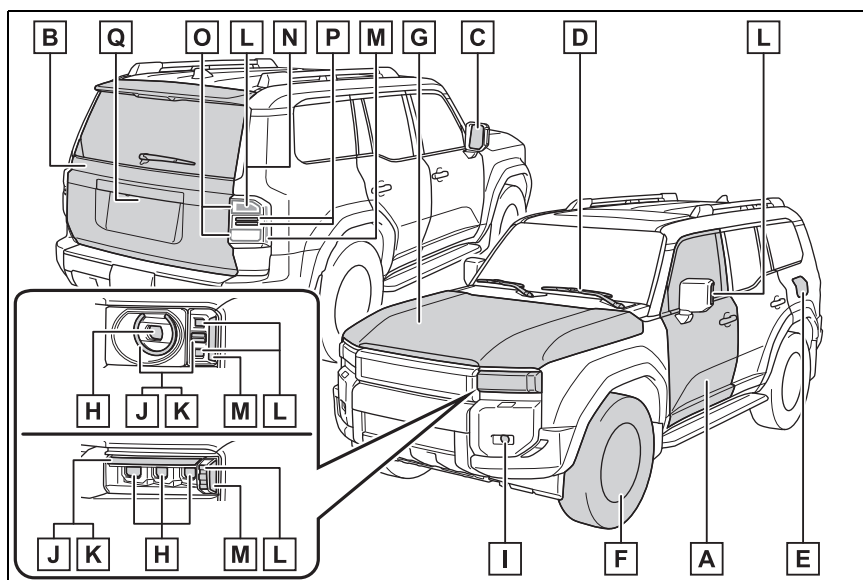

- A Side doors .....P.129**  
 Locking/unlocking .....P.129, 132  
 Opening/closing the side windows .....P.181  
 Locking/unlocking by using the mechanical key .....P.618  
 Warning messages .....P.598
- B Back door .....P.134**  
 Locking/unlocking .....P.136  
 Opening/closing the back door .....P.136, 138  
 Power back door\* .....P.138  
 Glass hatch .....P.147  
 Warning messages .....P.598
- C Outside rear view mirrors .....P.177**  
 Adjusting the mirror angle .....P.177  
 Folding the mirrors .....P.178  
 Driving position memory\* .....P.188  
 Defogging the mirrors\* .....P.470



<b>D</b>	<b>Windshield wipers</b> .....	<b>P.246</b>
	Precautions against winter season .....	P.463
	To prevent freezing (windshield de-icer*) .....	P.474
	Precautions against car wash .....	P.527
<b>E</b>	<b>Fuel filler door</b> .....	<b>P.251</b>
	Refueling method .....	P.252
	Fuel type/fuel tank capacity .....	P.632
<b>F</b>	<b>Tires</b> .....	<b>P.551</b>
	Tire size/inflation pressure .....	P.637
	Winter tires/tire chain .....	P.463
	Checking/rotation/tire pressure warning system .....	P.551
	Coping with flat tires .....	P.606
<b>G</b>	<b>Hood</b> .....	<b>P.540</b>
	Opening .....	P.540
	Engine oil .....	P.633
	Coping with overheat .....	P.625
	Warning messages .....	P.598

### Exterior lights for driving

(Replacing: P.577)

<b>H</b>	<b>Headlights</b> .....	<b>P.240</b>
<b>I</b>	<b>Fog lights*</b> .....	<b>P.245</b>
<b>J</b>	<b>Parking lights</b> .....	<b>P.240</b>
<b>K</b>	<b>Daytime running lights</b> .....	<b>P.240</b>
<b>L</b>	<b>Turn signal lights</b> .....	<b>P.233</b>
<b>M</b>	<b>Side marker lights</b> .....	<b>P.240</b>
<b>N</b>	<b>Stop lights</b>	
	Indicator .....	P.86
	Dynamic radar cruise control .....	P.307
	Secondary Collision Brake .....	P.449

Downhill assist control system \* .....P.445

**O** Tail lights .....P.240

**P** Back-up lights

Shifting the shift lever to R .....P.229

**Q** License plate lights.....P.240

\*: If equipped

**Instrument panel**

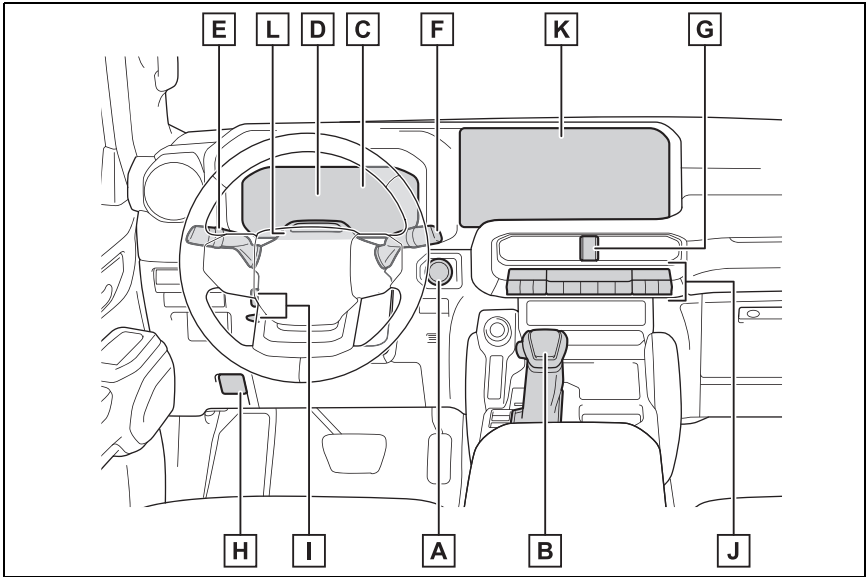

- A Power switch .....P.222**
  - Starting the hybrid system/changing the modes .....P.222
  - Emergency stop of the hybrid system .....P.581
  - When the hybrid system will not start .....P.616
  - Warning messages .....P.598
- B Shift lever .....P.227**
  - Changing the shift position .....P.229
  - Precautions against towing .....P.583
  - When the shift lever does not move .....P.229
- C Meters .....P.89, 92**
  - Reading the meters/adjusting the instrument cluster light  
.....P.89, 92
  - Warning lights/indicator lights .....P.82
  - When the warning lights come on .....P.587
- D Multi-information display .....P.96, 106**
  - Display .....P.96, 106

	When the warning messages are displayed .....	P.598
<b>E</b>	<b>Turn signal lever .....</b>	<b>P.233</b>
	<b>Headlight switch .....</b>	<b>P.240</b>
	Headlights/parking lights/tail lights/daytime running lights ...	P.240
	Fog lights <sup>*1</sup> .....	P.245
<b>F</b>	<b>Windshield wiper and washer switch .....</b>	<b>P.246</b>
	<b>Rear window wiper and washer switch .....</b>	<b>P.248</b>
	Usage.....	P.246, 248
	Adding washer fluid.....	P.547
	Warning messages .....	P.547
<b>G</b>	<b>Emergency flasher switch.....</b>	<b>P.580</b>
<b>H</b>	<b>Hood lock release lever .....</b>	<b>P.540</b>
<b>I</b>	<b>Tilt and telescopic steering lock release lever <sup>*1</sup>/tilt and tele-</b>	
	<b>scopic steering control switch <sup>*1</sup> .....</b>	<b>P.165</b>
	Adjustment .....	P.165
	Driving position memory <sup>*1</sup> .....	P.188
<b>J</b>	<b>Air conditioning system .....</b>	<b>P.468</b>
	Usage.....	P.468
	Rear window defogger .....	P.470
<b>K</b>	<b>Audio system <sup>*2</sup></b>	
<b>L</b>	<b>Driver monitor camera <sup>*1</sup> .....</b>	<b>P.266</b>

<sup>\*1</sup>: If equipped

<sup>\*2</sup>: Refer to "MULTIMEDIA OWNER'S MANUAL".

■ Switches

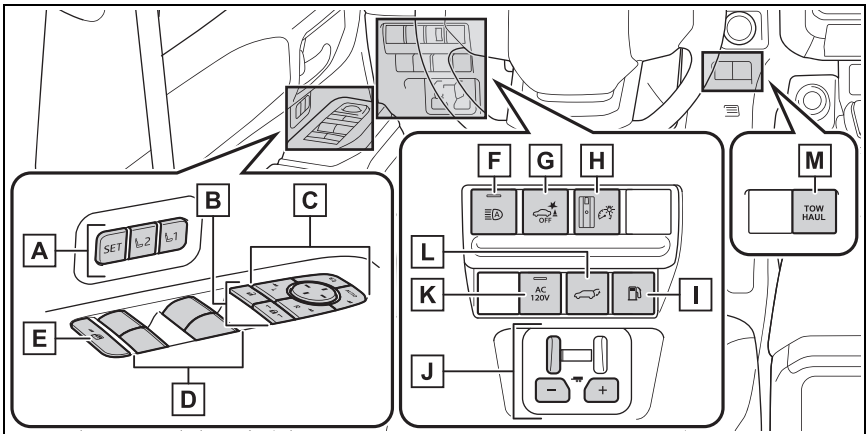

- A** Driving position memory buttons \* .....P.188
- B** Door lock switches .....P.132
- C** Outside rear view mirror switches .....P.177
- D** Power window switches .....P.181
- E** Window lock switch .....P.183
- F** Automatic High Beam switch .....P.242
- G** PKSB switch .....P.354
- H** Instrument panel light control dial .....P.91 95
- I** Fuel filler door opener switch .....P.252
- J** Trailer brake control switch .....P.453
- K** AC 120 V switch \* .....P.509
- L** Power back door switch \* .....P.138
- M** “TOW HAUL” switch .....P.232

\*: If equipped

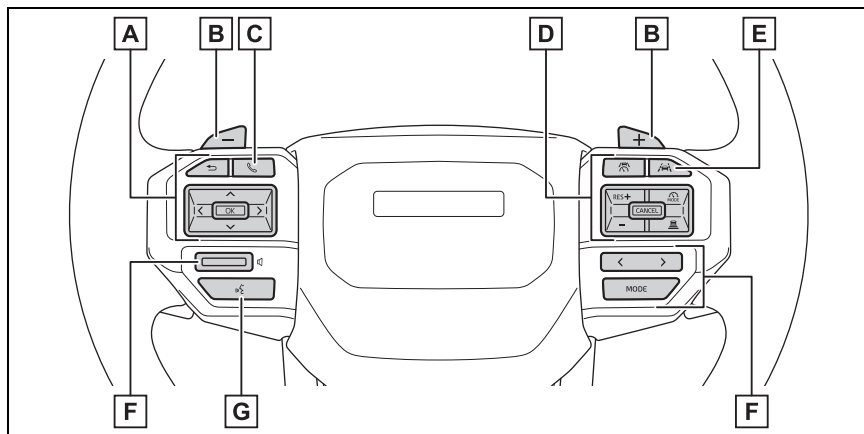

- A** Meter control switches .....P.97, 108
- B** Paddle shift switches <sup>\*1</sup>.....P.230, 231
- C** Telephone switch <sup>\*2</sup>
- D** Cruise control switches
  - Dynamic radar cruise control .....P.305
  - Cruise control.....P.316
- E** LTA (Lane Tracing Assist) switch .....P.282
- F** Audio remote control switches <sup>\*2</sup>
- G** Talk switch <sup>\*2</sup>

<sup>\*1</sup>: If equipped

<sup>\*2</sup>: Refer to "MULTIMEDIA OWNER'S MANUAL".

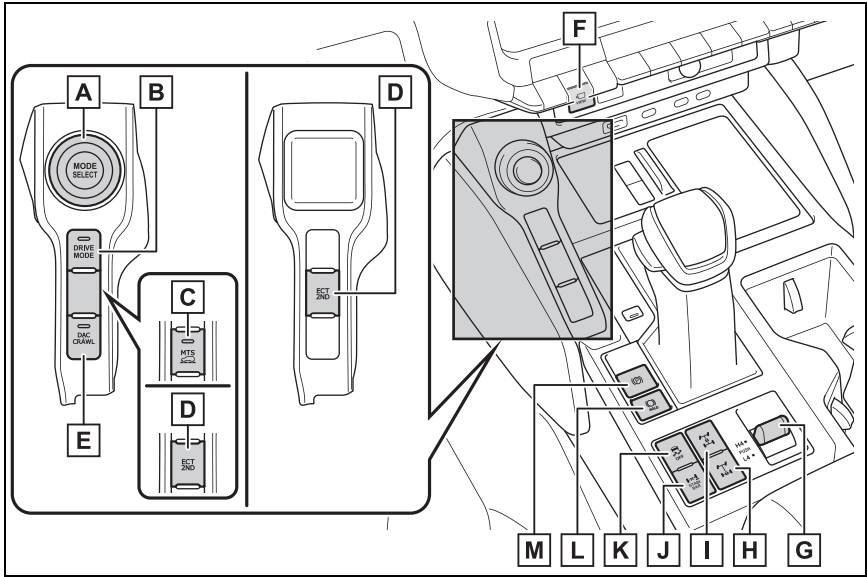

- A** MODE SELECT switch\*<sup>1</sup> .....P.433, 439, 443, 446
- B** DRIVE MODE switch\*<sup>1</sup> .....P.433
- C** MTS switch\*<sup>1</sup> .....P.443
- D** Second start mode switch\*<sup>1</sup> .....P.230
- E** DAC/CRAWL switch\*<sup>1</sup> .....P.439, 445
- F** Camera switch\*<sup>1, 2</sup> .....P.368
- G** Four-wheel drive control switch .....P.435
- H** Rear differential lock switch\*<sup>1</sup> .....P.437
- I** Center differential lock switch .....P.435
- J** SDM switch\*<sup>1</sup> .....P.456
- K** VSC OFF switch .....P.449
- L** Brake hold switch .....P.237
- M** Parking brake switch .....P.233
  - Applying/releasing.....P.233
  - Precautions against winter season .....P.464

Warning buzzer/message .....P.235, 587

\*1: If equipped

\*2: Vehicles with panoramic view monitor, refer to "MULTIMEDIA OWNER'S MANUAL".



■ Interior

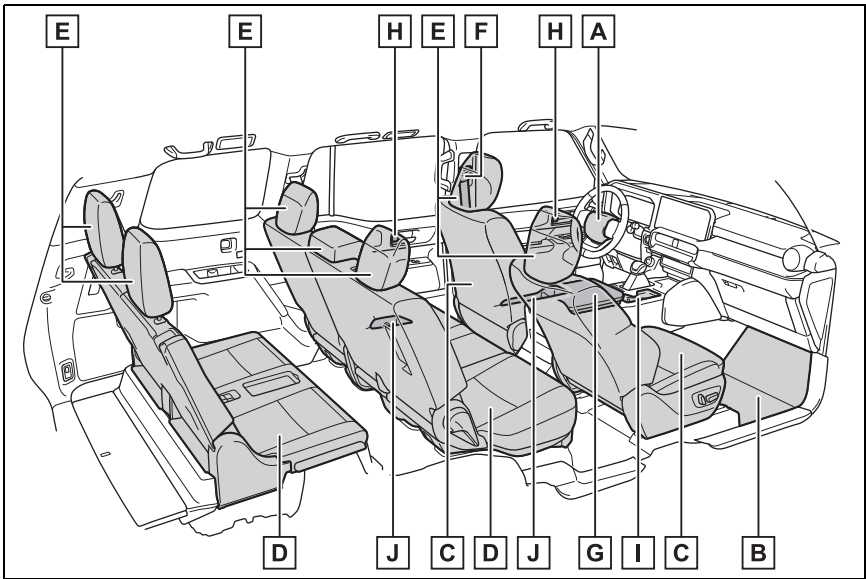

<b>A</b>	<b>SRS airbags</b> .....	<b>P.36</b>
<b>B</b>	<b>Floor mats</b> .....	<b>P.28</b>
<b>C</b>	<b>Front seats</b> .....	<b>P.155</b>
<b>D</b>	<b>Rear seats</b> .....	<b>P.156</b>
	Second seats .....	P.156
	Third seats * .....	P.156
<b>E</b>	<b>Head restraints</b> .....	<b>P.162</b>
<b>F</b>	<b>Seat belts</b> .....	<b>P.31</b>
<b>G</b>	<b>Console box</b> * .....	<b>P.487</b>
	<b>Cool box</b> * .....	<b>P.494</b>
<b>H</b>	<b>Inside lock buttons</b> .....	<b>P.132</b>
<b>I</b>	<b>Cup holders</b> .....	<b>P.487</b>
<b>J</b>	<b>Bottle holders</b> .....	<b>P.488</b>

\* : If equipped

## ■ Ceiling

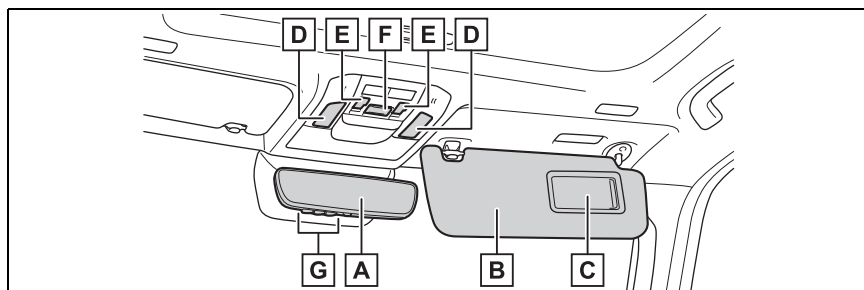

<b>A</b>	Inside rear view mirror <sup>*1</sup> .....	P.166
	Digital Rear-view Mirror <sup>*1</sup> .....	P.167
<b>B</b>	Sun visors .....	P.495
<b>C</b>	Vanity mirrors .....	P.495
<b>D</b>	Interior lights <sup>*2</sup> .....	P.484
	Personal lights .....	P.485
<b>E</b>	Moon roof switches <sup>*1</sup> .....	P.184
<b>F</b>	“SOS” button .....	P.66
<b>G</b>	Garage door opener buttons .....	P.517

<sup>\*1</sup>: If equipped

<sup>\*2</sup>: The illustration shows the front, but they are also equipped in the rear.

# For safety and security

## 1

### 1-1. For safe use

Before driving .....	28
For safe driving .....	29
Seat belts .....	31
SRS airbags .....	36
Front passenger occupant classification system ....	44
Exhaust gas precautions	49

### 1-2. Child safety

Riding with children .....	50
Child restraint systems...	51

### 1-3. Emergency assistance

Safety Connect .....	64
----------------------	----

### 1-4. Hybrid system

Hybrid system features ..	69
Hybrid system precautions .....	72

### 1-5. Theft deterrent system

Immobilizer system .....	77
Alarm.....	78

## Before driving

Observe the following before starting off in the vehicle to ensure safety of driving.

### Installing floor mats

Use only floor mats designed specifically for vehicles of the same model and model year as your vehicle. Fix them securely in place onto the carpet.

- 1 Insert the retaining hooks (clips) into the floor mat eye-lets.

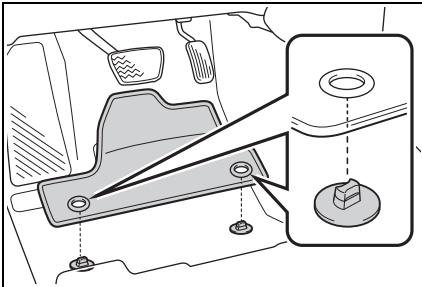

- 2 Turn the upper knob of each retaining hook (clip) to secure the floor mats in place.

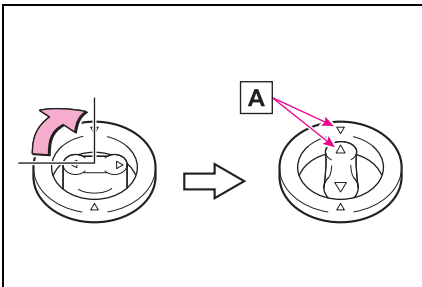

Always align the  $\triangle$  marks **A**.

The shape of the retaining hooks (clips) may differ from that shown in the illustration.

### WARNING

Observe the following precautions.

Failure to do so may cause the driver's floor mat to slip, possibly interfering with the pedals while driving. An unexpectedly high speed may result or it may become difficult to stop the vehicle. This could lead to an accident, resulting in death or serious injury.

#### ■ When installing the driver's floor mat

- Do not use floor mats designed for other models or different model year vehicles, even if they are Toyota Genuine floor mats.
- Only use floor mats designed for the driver's seat.
- Always install the floor mat securely using the retaining hooks (clips) provided.
- Do not use two or more floor mats on top of each other.
- Do not place the floor mat bottom-side up or upside-down.

## ⚠ WARNING

### ■ Before driving

- Check that the floor mat is securely fixed in the correct place with all the provided retaining hooks (clips). Be especially careful to perform this check after cleaning the floor.

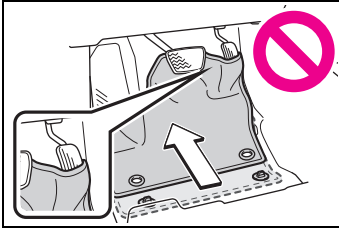

- With the hybrid system stopped and the shift lever in P, fully depress each pedal to the floor to make sure it does not interfere with the floor mat.

## For safe driving

**For safe driving, adjust the seat and mirror to an appropriate position before driving.**

## Correct driving posture

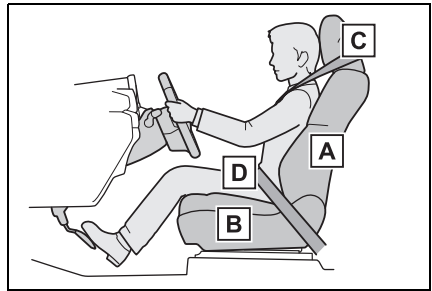

- A** Adjust the angle of the seat-back so that you are sitting straight up and so that you do not have to lean forward to steer. (→P.155)
- B** Adjust the seat so that you can depress the pedals fully and so that your arms bend slightly at the elbow when gripping the steering wheel. (→P.155)
- C** Lock the head restraint in place with the center of the head restraint closest to the top of your ears. (→P.162)
- D** Wear the seat belt correctly. (→P.32)

**WARNING**

Observe the following precautions.

Failure to do so may result in death or serious injury.

- Do not adjust the position of the driver's seat while driving. Doing so could cause the driver to lose control of the vehicle.
- Do not place a cushion between the driver or passenger and the seatback. A cushion may prevent correct posture from being achieved, and reduce the effectiveness of the seat belt and head restraint.
- Do not place anything under the front seats. Objects placed under the front seats may become jammed in the seat tracks and stop the seat from locking in place. This may lead to an accident and the adjustment mechanism may also be damaged.
- Always observe the legal speed limit when driving on public roads.
- When driving over long distances, take regular breaks before you start to feel tired. Also, if you feel tired or sleepy while driving, do not force yourself to continue driving and take a break immediately.

properly wear the vehicle's seat belt. (→P.51)

**Adjusting the mirrors**

Make sure that you can see backward clearly by adjusting the inside rear view mirror (if equipped), Digital Rear-view Mirror (if equipped) and outside rear view mirrors properly. (→P.166, 167, 177)

**Correct use of the seat belts**

Make sure that all occupants are wearing their seat belts before driving the vehicle. (→P.32)

Use a child restraint system appropriate for the child until the child becomes large enough to

## Seat belts

**Make sure that all occupants are wearing their seat belts before driving the vehicle.**

### WARNING

Observe the following precautions to reduce the risk of injury in the event of sudden braking, sudden swerving or an accident. Failure to do so may cause death or serious injury.

#### ■ Wearing a seat belt

- Ensure that all passengers wear a seat belt.
- Always wear a seat belt properly.
- Each seat belt should be used by one person only. Do not use a seat belt for more than one person at once, including children.
- Toyota recommends that children be seated in the rear seat and always use a seat belt and/or an appropriate child restraint system.
- To achieve a proper seating position, do not recline the seat more than necessary. The seat belt is most effective when the occupants are sitting up straight and well back in the seats.
- Do not wear the shoulder belt under your arm.
- Always wear your seat belt low and snug across your hips.

- Vehicles with third seats: Make sure that the seat belts are removed from the hangers when using the seat belts for the third seats. (→P.161)

#### ■ Pregnant women

Obtain medical advice and wear the seat belt in the proper way. (→P.32)

Women who are pregnant should position the lap belt as low as possible over the hips in the same manner as other occupants, extending the shoulder belt completely over the shoulder and avoiding belt contact with the rounding of the abdominal area.

If the seat belt is not worn properly, not only the pregnant woman, but also the fetus could suffer death or serious injury as a result of sudden braking or a collision.

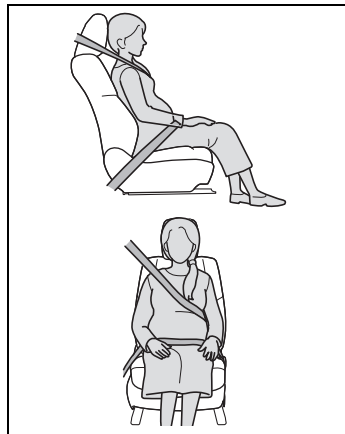

#### ■ People suffering illness

Obtain medical advice and wear the seat belt in the proper way. (→P.32)

#### ■ When children are in the vehicle

→P.59

## WARNING

### ■ Seat belt damage and wear

- Do not damage the seat belts by allowing the belt, plate, or buckle to be jammed in the door.
- Inspect the seat belt system periodically. Check for cuts, fraying, and loose parts. Do not use a damaged seat belt until it is replaced. Damaged seat belt cannot protect an occupant from death or serious injury.
- Ensure that the belt and plate are locked and the belt is not twisted.  
If the seat belt does not function correctly, immediately contact your Toyota dealer.
- Replace the seat assembly, including the belts, if your vehicle has been involved in a serious accident, even if there is no obvious damage.
- Do not attempt to install, remove, modify, disassemble or dispose of the seat belts. Have any necessary repairs carried out by your Toyota dealer. Inappropriate handling may lead to incorrect operation.

## Correct use of the seat belts

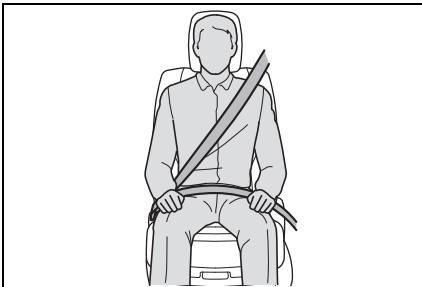

- Extend the shoulder belt so

that it comes fully over the shoulder, but does not come into contact with the neck or slide off the shoulder.

- Position the lap belt as low as possible over the hips.
- Adjust the position of the seatback.  
Sit up straight and well back in the seat.
- Do not twist the seat belt.

### ■ Child seat belt usage

The seat belts of your vehicle were principally designed for persons of adult size.

- Use a child restraint system appropriate for the child, until the child becomes large enough to properly wear the vehicle's seat belt. (→P.51)
- When the child becomes large enough to properly wear the vehicle's seat belt, follow the instructions regarding seat belt usage. (→P.31)

### ■ Seat belt extender

If your seat belts cannot be fastened securely because they are not long enough, a personalized seat belt extender is available from your Toyota dealer free of charge.

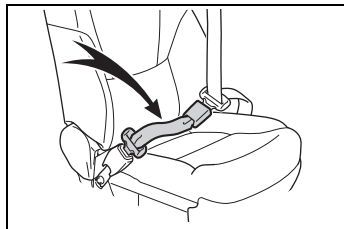



## ⚠ WARNING

### ■ Using a seat belt extender

Observe the following precautions to reduce the risk of injury in the event of sudden braking, sudden swerving or an accident. Failure to do so may cause death or serious injury.

- Do not wear the seat belt extender if you can fasten the seat belt without the extender.
- Do not use the seat belt extender when installing a child restraint system because the belt will not securely hold the child restraint system, increasing the risk of death or serious injury in the event of an accident.
- The personalized extender may not be safe on another vehicle, when used by another person, or at a different seating position other than the one originally intended.

## ⚠ NOTICE

### ■ When using a seat belt extender

When releasing the seat belt, press on the buckle release button on the extender, not on the seat belt.

This helps prevent damage to the vehicle interior and the extender itself.

## Fastening and releasing the seat belt

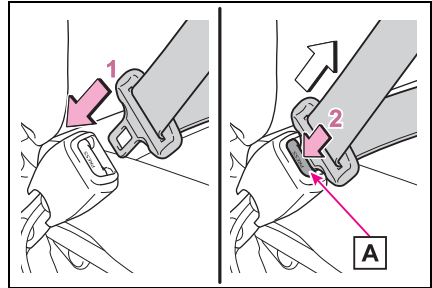

- 1 To fasten the seat belt, push the plate into the buckle until a click sound is heard.
- 2 To release the seat belt, press the release button **A**.

### ■ Emergency locking retractor (ELR)

The retractor will lock the belt during a sudden stop or on impact. It may also lock if you lean forward too quickly. A slow, easy motion will allow the belt to extend so that you can move around fully.

### ■ Automatic locking retractor (ALR)

When a passenger's shoulder belt is completely extended and then retracted even slightly, the belt is locked in that position and cannot be extended. This feature is used to hold a child restraint system (CRS) firmly. To free the belt again, fully retract the belt and then pull the belt out once more.

## Adjusting the seat belt shoulder anchor height (front seats)

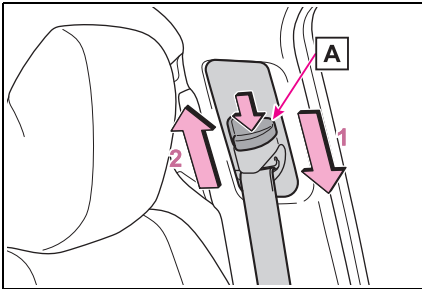

- 1 Push the seat belt shoulder anchor down while pressing the release button **A**.
- 2 Push the seat belt shoulder anchor up while pressing the release button **A**.

Move the height adjuster up and down as needed until you hear a click.

### **! WARNING**

#### ■ Adjustable shoulder anchor

Always make sure the shoulder belt is positioned across the center of your shoulder. The belt should be kept away from your neck, but not falling off your shoulder. Failure to do so could reduce the amount of protection in an accident and cause death or serious injuries in the event of a sudden stop, sudden swerve or accident.

## Seat belt pretensioners

When the vehicle is subjected to a severe frontal or side impact or rollover, the pretensioners retract the seat belts of the front

seats and second outer seats to securely restrain the occupants.

The pretensioners will not operate in minor frontal or side impacts, or rear impacts.

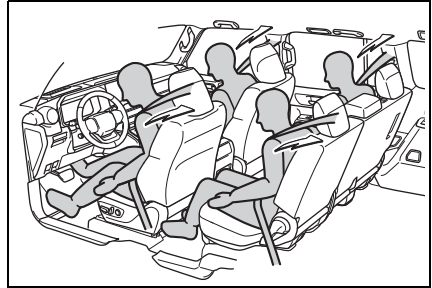

### ■ Replacing the belt after the pretensioner has been activated

If the vehicle is involved in multiple collisions, the pretensioner will activate for the first collision, but will not activate for the second or subsequent collisions.

### ■ PCS-linked seat belt pretensioner control

If the PCS (Pre-Collision System) determines that the possibility of a collision with a vehicle is high, the seat belt pretensioners will be prepared to operate.

### **! WARNING**

#### ■ Seat belt pretensioners

Observe the following precautions to reduce the risk of injury in the event of sudden braking or an accident.

Failure to do so may result in death or serious injury.

**WARNING**

- Do not place anything, such as a cushion, on the front passenger's seat. Doing so will disperse the passenger's weight, which prevents the sensor from detecting the passenger's weight properly. As a result, the seat belt pretensioner for the front passenger's seat may not operate in the event of a collision.
- If a pretensioner has operated, the SRS warning light will illuminate. In this situation, the seat belt cannot be used and must be replaced by your Toyota dealer.

## SRS airbags

The SRS airbags deploy when the vehicle is subjected to certain types of severe impact that may cause significant injury to the occupants. The airbags work together with the seat belts to help reduce the risk of death or serious injury.

### SRS airbag system

#### ■ Location of the SRS airbags

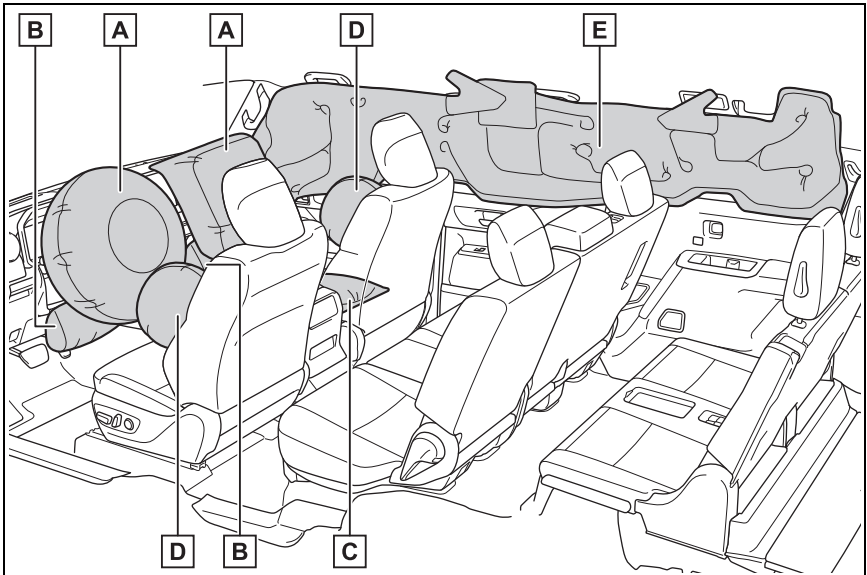

**A** SRS driver airbag/front passenger airbag

Help reduce impact to the head and chest of the driver and front passenger

**B** SRS knee airbags

Help reduce impact to the driver and front passenger

**C** SRS seat cushion airbag

Helps reduce impact to the front passenger

**D** SRS side airbags

Help reduce impact to the chest of the occupants of the front seats

**E** SRS curtain shield airbags

- Help reduce impact to the heads of the occupants of the front and rear outer seats

- Can help prevent the occupants from being thrown from the vehicle in the event of a vehicle rollover

Your vehicle is equipped with ADVANCED AIRBAGS designed based on US motor vehicle safety standards (FMVSS208). The airbag sensor assembly (ECU) controls airbag deployment based on information obtained from the sensors, etc., shown in the system components diagram above. This information includes crash severity and occupant information. As the airbags deploy, a chemical reaction in the inflators quickly fills the airbags with non-toxic gas to help restrain the motion of the occupants.

### ■ If the SRS airbags deploy (inflate)

- Slight abrasions, burns, bruising, etc., may be sustained from SRS airbags, due to the extremely high speed of deployment (inflation) by hot gases.
- A loud noise and white powder will be emitted.
- Parts of the airbag module (steering wheel hub, airbag cover and inflator) as well as the parts around the airbags may be hot for several minutes. The airbag itself may also be hot.
- The windshield may crack.
- The hybrid system will be stopped and fuel supply to the engine will be stopped. (→P.75)
- All of the doors will be unlocked. (→P.130)
- The brakes and stop lights will be controlled automatically. (→P.449)
- The interior lights will turn on automatically. (→P.484)
- The emergency flashers will turn on automatically. (→P.580)
- For Safety Connect subscribers, if any of the following situations occur, the system is designed to send an emergency call to the response center, notifying them of the vehicle's location (without needing to push the "SOS" button) and an agent will attempt to speak with the occupants to ascertain the level of emergency and assistance required. If the occupants are unable to communicate, the agent automatically treats the call as an emergency and helps to dispatch the necessary emergency services. (→P.64)
- When an SRS airbag has been deployed
- When a seat belt pretensioner has operated
- When the vehicle has been involved in a severe rear-end collision

### ■ The SRS airbags deploy in a frontal impact when

- The following SRS airbags will deploy in the event of an impact that exceeds a threshold level (level of force corresponding to an approximately 12 - 18 mph [20 - 30 km/h] frontal collision with a fixed wall that does not move or deform):
  - SRS front airbags
  - SRS seat cushion airbag
  - SRS knee airbags
- The threshold level at which the SRS airbags will deploy will be higher than normal in the in the following situations:
  - When the vehicle collides with an object, such as a parked vehicle or sign pole, which moves or deforms on impact
  - If the vehicle is involved in an underride collision, such as a colli-

sion in which the front of the vehicle underrides, or goes under, the bed of a truck

- Depending on the type of collision, only the following may deploy:
- Seat belt pretensioners
- The SRS airbags for the front passenger's seat will not deploy if there is no passenger in the front passenger seat. However, the SRS airbags for the front passenger's seat may deploy, even if the seat is unoccupied, if luggage is put on the seat.
- The SRS seat cushion airbag for the front passenger's seat will not deploy if the seat belt of the front passenger's seat is unfastened.
- In the event of an especially severe frontal collision, the left and right SRS curtain shield airbags may also deploy.

#### ■ The SRS airbags deploy in a side impact when

- The following SRS airbags will deploy in the event of an impact that exceeds the set threshold level (level of force corresponding to the impact force produced by an approximately 3300 lb. [1500 kg] vehicle colliding with the passenger compartment at a perpendicular angle at an approximate speed of 12 - 18 mph [20 - 30 km/h]):
- SRS side airbags
- SRS curtain shield airbags
- If the vehicle is involved in a rollover, the following SRS airbags will deploy:
- Both left and right SRS curtain shield airbags

#### ■ The SRS airbags deploy in an underside impact when

- The following airbags may deploy if the underside of the vehicle collides with a hard object:
- SRS front airbags
- SRS knee airbags
- SRS seat cushion airbag

- SRS side airbags
- SRS curtain shield airbags

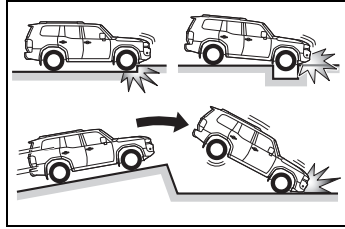

- The following airbags may deploy if the vehicle becomes significantly tilted or is strongly impacted by skidding into a curb, etc.:
- SRS curtain shield airbags

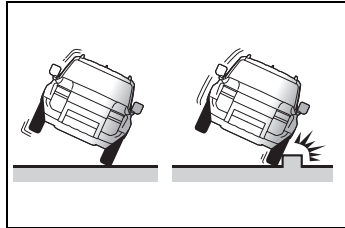

#### ■ The SRS airbags will not deploy when

- The following SRS airbags will not normally deploy in side or rear collisions, vehicle rollovers, or low speed frontal collisions. However, if such a collision causes sufficient sudden deceleration, the SRS airbags may deploy.
- SRS front airbags
- SRS knee airbags
- SRS seat cushion airbag

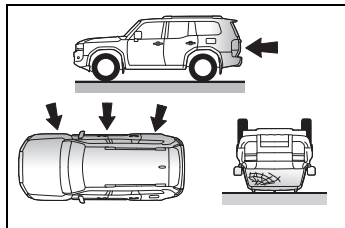

- The following SRS airbags may not deploy if the vehicle is collided with at a certain angle or in a side collision where an area of the vehicle other than the passenger compartment is collided with:

- SRS side airbags
- SRS curtain shield airbags

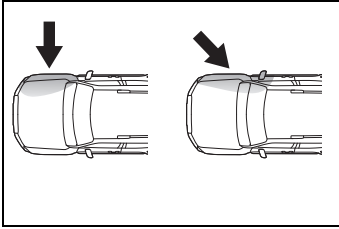

- The following SRS airbags will not normally deploy in front or rear collisions, vehicle rollovers, or low speed side collisions:
- SRS side airbags

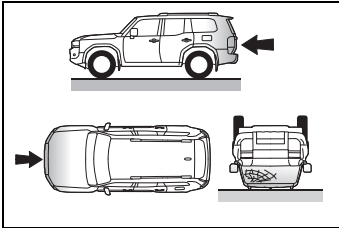

- The following SRS airbags will not normally deploy in rear collisions, end over end vehicle rollovers, or low speed front or side collisions:
- SRS curtain shield airbags

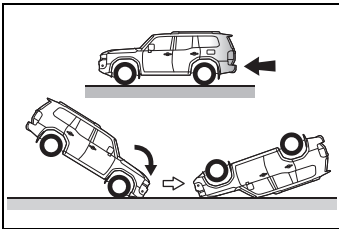

### ■ When to contact your Toyota dealer

In the following situations, the vehicle will require inspection and/or repair. Contact your Toyota dealer as soon as possible.

- When any of the SRS airbags have been deployed
- When the front of the vehicle is damaged or deformed, or was involved in a collision that was not severe enough to cause any of

the following SRS airbags to deploy:

- SRS front airbags
- SRS knee airbags
- SRS seat cushion airbag

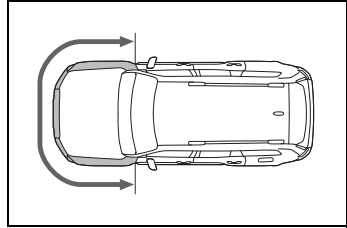

- When a door or its surrounding area is damaged, deformed or has had a hole made in it, or was involved in a collision that was not severe enough to cause any of the following SRS airbags to deploy:
- SRS side airbags
- SRS curtain shield airbags

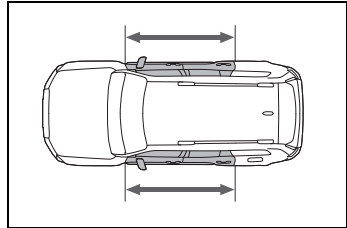

- When the pad section of the steering wheel, the dashboard near the front passenger SRS airbag or the lower side of the instrument panel is scratched, cracked, or otherwise damaged.

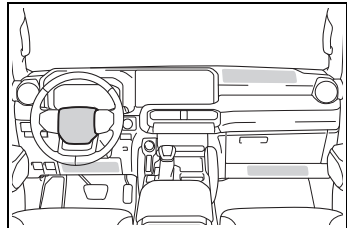

- When the seat cushion surface is scratched, cracked, or otherwise damaged.

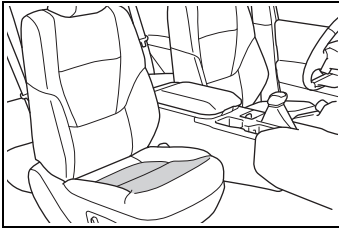

- When the surface of a seat with an SRS side airbag is scratched, cracked, or otherwise damaged.

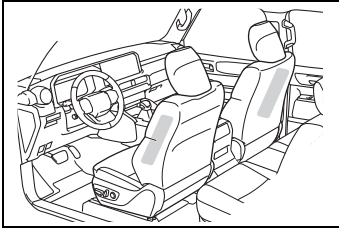

- When the part of a front pillar, rear pillar or roof side rail garnish (padding) which covers a SRS curtain shield airbag is scratched, cracked, or otherwise damaged.

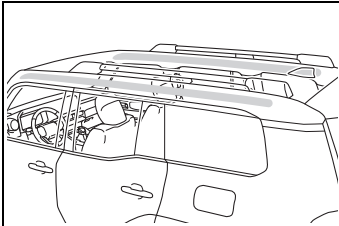

## WARNING

### ■ SRS airbag precautions

Observe the following precautions. Failure to do so may result in death or serious injury.

- The driver and all passengers must wear their seat belts correctly. The SRS airbags are supplemental devices to be used with the seat belts.

- The SRS driver airbag deploys with considerable force, and can cause death or serious injury, especially if the driver is very close to the airbag. The National Highway Traffic Safety Administration (NHTSA) advises:

Since the risk zone for the driver's airbag is the first 2 - 3 in. (50 - 75 mm) of inflation, placing yourself 10 in. (250 mm) from your driver airbag provides you with a clear margin of safety. This distance is measured from the center of the steering wheel to your breastbone. If your current driving position places you less than 10 in. (250 mm) away from the driver airbag, you can change your driving position in several ways:

- Move your seat to the rear as far as possible while still being able to reach the pedals comfortably.
- Slightly recline the seatback. Although vehicle designs vary, many drivers can achieve the 10 in. (250 mm) distance, even with the driver seat all the way forward, simply by reclining the seatback somewhat. If reclining the seatback makes it hard to see the road, raise yourself by using a firm, non-slippery cushion, or raise the seat if your vehicle has that feature.
- If your steering wheel is adjustable, tilt it downward. This points the airbag toward your chest instead of your head and neck. The seat should be adjusted as recommended by the NHTSA, while still being able to control the vehicle with the pedals and steering wheel, and maintaining your view of the instrument panel controls.



## ⚠ WARNING

- If a seat belt extender has been connected to a front seat belt buckle but the latch plate of the seat belt has not been fastened to the seat belt extender, the SRS airbag system will judge that the occupant is wearing the seat belt even though the seat belt has not been fastened. In this case, the SRS front airbags may not deploy correctly in a collision, resulting in death or serious injury. Be sure to wear the seat belt correctly when using a seat belt extender.

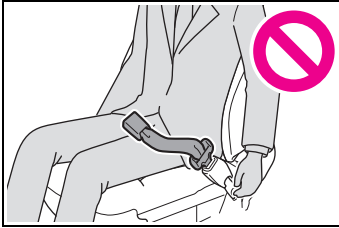

- The SRS front passenger airbag deploys with considerable force, and can cause death or serious injury, especially if the front passenger is very close to the airbag. The front passenger seat should be positioned as far possible from the airbag with the seatback adjusted so that the passenger is sat upright.
- Improperly seated and/or restrained infants and children can be killed or seriously injured by a deploying airbag. An infant or child who is too small to use a seat belt should be properly secured using a child restraint system. Toyota strongly recommends that all infants and children be placed in the rear seats of the vehicle and properly restrained. The rear seats are safer for infants and children than the front passenger seat. (→P.51)

- Do not sit on the edge of the seat or lean against the dashboard.

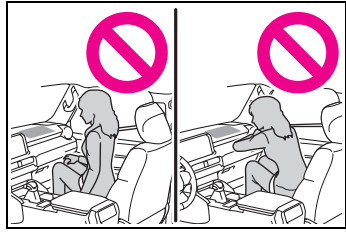

- Do not allow a child to stand in front of the SRS front passenger airbag or sit on the lap of a front passenger.
- Front seat occupants should never hold items on their lap.

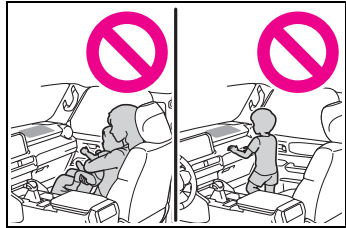

- Do not lean against the door, roof side rail, or front, side, or rear pillar.

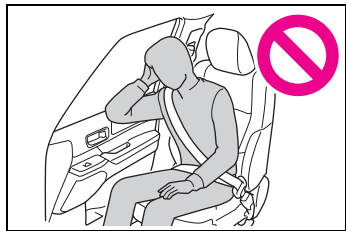

**⚠ WARNING**

- Do not allow anyone to kneel on a seat toward the door or put their head or hands outside the vehicle.

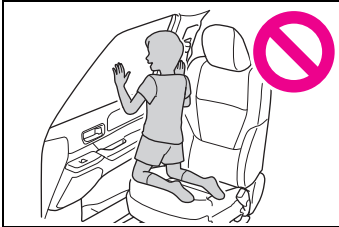

- Do not attach anything to or lean anything against areas such as the dashboard, steering wheel pad and lower portion of the instrument panel.

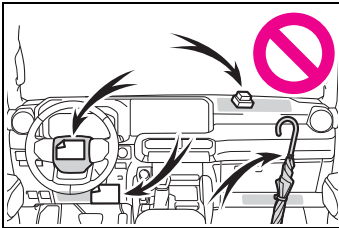

- Do not attach anything to areas such as the doors, windshield, side windows, front or rear pillars, roof side rails and assist grips.

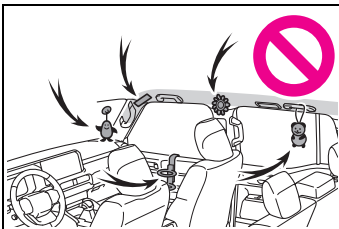

- Do not hang coat hangers or other hard objects on the coat hooks. These items could become projectiles if the SRS curtain shield airbags deploy, possibly leading to death or serious injury.

- If a vinyl cover is attached to the area where the SRS knee airbag deploys, be sure to remove it.
- Do not use seat accessories which cover the parts from which the SRS airbags deploy, as they may interfere with inflation of the SRS airbags. Such accessories may prevent the SRS airbags from deploying correctly, may disable the system or cause the SRS airbags to inflate unintentionally, possibly resulting in death or serious injury.
- Do not strike or apply significant force to the SRS airbag system components, front doors or their surrounding area. Doing so may cause the SRS airbags to malfunction.
- Do not touch any components of the SRS airbags immediately after the SRS airbags have deployed (inflated) as they may be hot.
- If breathing becomes difficult after the SRS airbags have deployed, open a door or window to allow fresh air in, or leave the vehicle if it is safe to do so. Wash off any residue as soon as possible to prevent skin irritation.
- If a part where an SRS airbag is stored is damaged or cracked, have it replaced by your Toyota dealer.

**WARNING**

● Do not place anything, such as a cushion, on the front passenger's seat. Doing so will disperse the passenger's weight, which prevents the sensor from detecting the passenger's weight properly. As a result, the SRS front airbags for the front passenger's seat may not deploy in the event of a collision.

■ **Modification and disposal of SRS airbag system components**

Do not dispose of your vehicle or perform any of the following modifications without consulting your Toyota dealer. The SRS airbags may malfunction or deploy unintentionally, possibly leading to death or serious injury.

- Removal, installation, disassembly or repair of the SRS airbags
- Repair, removal or modification of the following parts or their surrounding
  - Steering wheel
  - Instrument panel
  - Dashboard
  - Seats
  - Seat upholstery
  - Front pillars
  - Side pillars
  - Rear pillars
  - Roof side rails
  - Front door panels
  - Front door trim
  - Front door speakers

- Modifications to the front door panels (such as making holes in them)
- Repair or modification of the following parts or their surrounding
  - Front fender
  - Front bumper
  - Sides of the vehicle interior
- Installation of the following parts or accessories
  - Bull bars or kangaroo bars
  - Snow plows
  - Winches
  - Roof luggage carriers
- Modifications to the vehicle's suspension
- Installation of electronic devices such as mobile two-way radios (RF-transmitter) and CD players
- Modifications to your vehicle for a person with a physical disability

## Front passenger occupant classification system

Your vehicle is equipped with a front passenger occupant classification system. This system detects the conditions of the front passenger seat and activates or deactivates the following SRS airbags.

- SRS front passenger airbag
- SRS front passenger knee airbag
- Front passenger's seat SRS seat cushion airbag

### System components

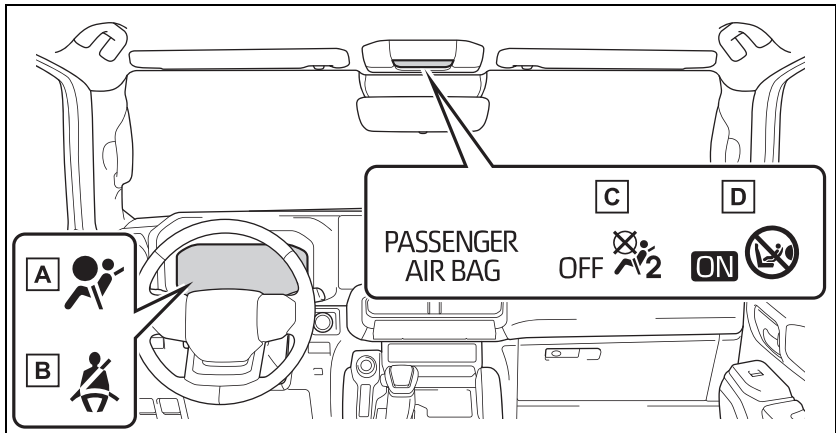

- A** SRS warning light
- B** Driver's and front passenger's seat belt reminder light
- C** "PASSENGER AIR BAG OFF" indicator light
- D** "PASSENGER AIR BAG ON" indicator light

#### **⚠ WARNING**

#### **■ Front passenger occupant classification system precautions**

Observe the following precautions regarding the front passenger occupant classification system. Failure to do so may cause death or serious injury.

- Wear the seat belt properly.
- Make sure the front passenger's seat belt plate has not been left inserted into the buckle before someone sits in the front passenger seat.

**WARNING**

- Make sure the “PASSENGER AIR BAG OFF” indicator light is not illuminated when using the seat belt extender for the front passenger seat. If the “PASSENGER AIR BAG OFF” indicator light is illuminated, disconnect the extender tongue from the seat belt buckle, and reconnect the seat belt. Reconnect the seat belt extender after making sure the “PASSENGER AIR BAG ON” indicator light is illuminated. If you use the seat belt extender while the “PASSENGER AIR BAG OFF” indicator light is illuminated, the SRS airbags for the front passenger will not activate, which could cause death or serious injury in the event of a collision.
  - Do not apply a heavy load to the front passenger seat or equipment (e.g. seatback pocket).
  - Do not put weight on the front passenger seat by putting your hands or feet on the front passenger seat seatback from the rear passenger seat.
  - Do not let a rear passenger lift the front passenger seat with their feet or press on the seatback with their legs.
  - Do not put objects under the front passenger seat.
- Do not recline the front passenger seatback so far that it touches a rear seat. This may cause the “PASSENGER AIR BAG OFF” indicator light to be illuminated, which indicates that the SRS airbags for the front passenger will not activate in the event of a severe accident. If the seatback touches the rear seat, return the seatback to a position where it does not touch the rear seat. Keep the front passenger seatback as upright as possible when the vehicle is moving. Reclining the seatback excessively may lessen the effectiveness of the seat belt system.
  - If an adult sits in the front passenger seat, the “PASSENGER AIR BAG ON” indicator light is illuminated. If the “PASSENGER AIR BAG OFF” indicator is illuminated, ask the passenger to sit up straight, well back in the seat, feet on the floor, and with the seat belt worn correctly. If the “PASSENGER AIR BAG OFF” indicator still remains illuminated, either ask the passenger to move to the rear seat, or if that is not possible, move the front passenger seat fully rearward.
  - When it is unavoidable to install a forward-facing child restraint system on the front passenger seat, install the child restraint system on the front passenger seat in the proper order. (→P.53)
  - Do not modify or remove the front seats.

**WARNING**

- Do not kick the front passenger seat or subject it to severe impact. Otherwise, the SRS warning light may come on to indicate a malfunction of the front passenger occupant classification system. In this case, contact your Toyota dealer immediately.
- Child restraint systems installed on the rear seat should not contact the front seatbacks.
- Do not use a seat accessory, such as a cushion and seat cover, that covers the seat cushion surface.
- Do not modify or replace the upholstery of the front seat.

## Front passenger occupant classification system conditions and operation

### ■ Adult\*<sup>1</sup>

Indicators/warning lights	“PASSENGER AIR BAG ON” and “PASSENGER AIR BAG OFF” indicator lights	“PASSENGER AIR BAG ON”
	SRS warning light	Off
	Driver’s and front passenger’s seat belt reminder light	Off* <sup>2</sup> or flashing* <sup>3</sup>
Devices	Front passenger airbag	Activated
	Front passenger knee airbag	
	Seat cushion airbag in the front passenger side	Activated* <sup>2</sup> or deactivated* <sup>3</sup>

### ■ Child\*<sup>4</sup>

Indicators/warning lights	“PASSENGER AIR BAG ON” and “PASSENGER AIR BAG OFF” indicator lights	“PASSENGER AIR BAG OFF” or “PASSENGER AIR BAG ON” <sup>*4</sup>
	SRS warning light	Off
	Driver's and front passenger's seat belt reminder light	Off <sup>*2</sup> or flashing <sup>*3</sup>
Devices	Front passenger airbag	Deactivated or activated <sup>*4</sup>
	Front passenger knee airbag	
	Seat cushion airbag in the front passenger side	Deactivated or activated <sup>*2, 4</sup>

### ■ Child restraint system with infant<sup>\*5</sup>

Indicators/warning lights	“PASSENGER AIR BAG ON” and “PASSENGER AIR BAG OFF” indicator lights	“PASSENGER AIR BAG OFF” <sup>*6</sup>
	SRS warning light	Off
	Driver's and front passenger's seat belt reminder light	Off <sup>*2</sup> or flashing <sup>*3</sup>
Devices	Front passenger airbag	Deactivated
	Front passenger knee airbag	
	Seat cushion airbag in the front passenger side	

### ■ Unoccupied

Indicators/warning lights	“PASSENGER AIR BAG ON” and “PASSENGER AIR BAG OFF” indicator lights	“PASSENGER AIR BAG OFF”
	SRS warning light	Off
	Driver's and front passenger's seat belt reminder light	

Devices	Front passenger airbag	Deactivated
	Front passenger knee airbag	
	Seat cushion airbag in the front passenger side	

### ■ System malfunction

Indicators/warning lights	“PASSENGER AIR BAG ON” and “PASSENGER AIR BAG OFF” indicator lights	“PASSENGER AIR BAG OFF”
	SRS warning light	On
	Driver's and front passenger's seat belt reminder light	
Devices	Front passenger airbag	Deactivated
	Front passenger knee airbag	
	Seat cushion airbag in the front passenger side	

\*1: The system judges a person of adult size as an adult. When a smaller adult sits in the front passenger seat, the system may not recognize them as an adult depending on their physique and posture.

\*2: In the event the front passenger is wearing a seat belt.

\*3: In the event the front passenger does not wear a seat belt.

\*4: For some children, child in seat, child in booster seat or child in convertible seat, the system may not recognize them as a child. Factors which may affect this can be the physique or posture.

\*5: Never install a rear-facing child restraint system on the front passenger seat. A forward-facing child restraint system should only be installed on the front passenger seat when it is unavoidable. (→P.54)

\*6: In case the indicator light is not illuminated, consult this manual on how to install the child restraint system properly. (→P.51)



## Exhaust gas precautions

**Harmful substance to the human body is included in exhaust gases if inhaled.**

### **WARNING**

Exhaust gases include harmful carbon monoxide (CO), which is colorless and odorless. Observe the following precautions. Failure to do so may cause exhaust gases enter the vehicle and may lead to an accident caused by light-headedness, or may lead to death or a serious health hazard.

#### ■ Important points while driving

- Keep the back door closed.
- If you smell exhaust gases in the vehicle even when the back door is closed, open the windows and have the vehicle inspected at your Toyota dealer as soon as possible.

#### ■ When parking

- If the vehicle is in a poorly ventilated area or a closed area, such as a garage, stop the hybrid system.
- Do not leave the vehicle with the hybrid system operating for a long time.  
If such a situation cannot be avoided, park the vehicle in an open space and ensure that exhaust fumes do not enter the vehicle interior.

- Do not leave the hybrid system operating in an area with snow build-up, or where it is snowing. If snowbanks build up around the vehicle while the hybrid system is operating, exhaust gases may collect and enter the vehicle.

#### ■ Exhaust pipe

The exhaust system needs to be checked periodically. If there is a hole or crack caused by corrosion, damage to a joint or abnormal exhaust noise, be sure to have the vehicle inspected and repaired by your Toyota dealer.

## Riding with children

**Observe the following precautions when children are in the vehicle.**

**Use a child restraint system appropriate for the child, until the child becomes large enough to properly wear the vehicle's seat belt.**

- It is recommended that children sit in the rear seats to avoid accidental contact with the shift lever, wiper switch etc.
- Use the rear door child-protector lock or the window lock switch to avoid children opening the door while driving or operating the power window accidentally.  
(→P.133, 183)
- Do not let small children operate equipment which may catch or pinch body parts, such as the power window, hood, back door, seats etc.



## WARNING

### ■ When children are in the vehicle

Never leave children unattended in the vehicle, and never allow children to have or use the key.

Children may be able to start the vehicle or shift the vehicle into neutral. There is also a danger that children may injure themselves by playing with the side windows, the moon roof (if equipped) or other features of the vehicle. In addition, heat build-up or extremely cold temperatures inside the vehicle can be fatal to children.

## Child restraint systems

**Before installing a child restraint system in the vehicle, there are precautions that need to be observed, different types of child restraint systems, as well as installation methods, etc., written in this manual.**

Use a child restraint system when riding with a small child that cannot properly use a seat belt. For the child's safety, install the child restraint system to a rear seat. Be sure to follow the installation method that is in the operation manual enclosed with the restraint system.

## Table of contents

- Points to remember: P.51
- Child restraint system: P.53
- When using a child restraint system: P.54
- Child restraint system installation method
  - Fixed with a seat belt: P.56
  - Fixed with a child restraint LATCH anchor: P.60
  - Using an anchor bracket (for top tether strap): P.62

## Points to remember

The laws of all 50 states of the U.S.A. as well as Canada now require the use of child restraint systems.

- Prioritize and observe the warnings, as well as the laws and regulations for child restraint systems.
- Use a child restraint system until the child becomes large enough to properly wear the vehicle's seat belt.
- Choose a child restraint system that suits your vehicle and is appropriate to the age and size of the child.



### WARNING

#### ■ When a child is riding

Observe the following precautions.

Failure to do so may result in death or serious injury.

- For effective protection in automobile accidents and sudden stops, a child must be properly restrained, using a seat belt or child restraint system which is correctly installed. For installation details, refer to the operation manual enclosed with the child restraint system. General installation instruction is provided in this manual.

**WARNING**

- Toyota strongly urges the use of a proper child restraint system that conforms to the weight and size of the child, installed on the rear seat. According to accident statistics, the child is safer when properly restrained in the rear seat than in the front seat.
- Holding a child in your or someone else's arms is not a substitute for a child restraint system. In an accident, the child can be crushed against the windshield or between the holder and the interior of the vehicle.

**■ Handling the child restraint system**



If the child restraint system is not properly fixed in place, the child or other passengers may be seriously injured or even killed in the event of sudden braking, sudden swerving, or an accident.

- If the vehicle were to receive a strong impact from an accident, etc., it is possible that the child restraint system has damage that is not readily visible. In such cases, do not reuse the restraint system.
- Make sure you have complied with all installation instructions provided with the child restraint system manufacturer and that the system is properly secured.
- Keep the child restraint system properly secured on the seat even if it is not in use. Do not store the child restraint system unsecured in the passenger compartment.
- If it is necessary to detach the child restraint system, remove it from the vehicle or store it securely in the luggage compartment.

## Child restraint system

### ■ Types of child restraint system installation methods

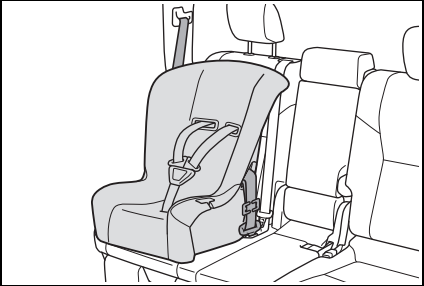
Confirm with the operation manual enclosed with the child restraint system about the installation of the child restraint system.

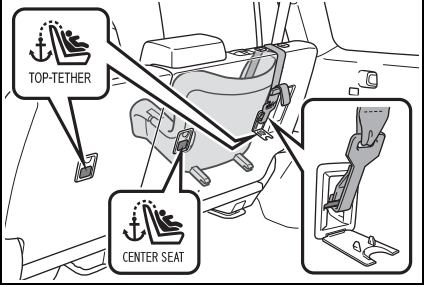
Installation method		Page
Seat belt attachment		P.56
Child restraint LATCH anchors attachment		P.60
Anchor brackets (for top tether strap) attachment		P.62

## When using a child restraint system

### ■ When installing a child restraint system to a front passenger seat

For the safety of a child, install child restraint systems to a rear seats. When installing child restraint system to a front passenger seat is unavoidable, adjust the seat as follows and install the child restraint system.

- Adjust the seatback angle to the most upright position.

If there is a gap between the child seat and the seatback, adjust the seatback angle until good contact is achieved.

- Move the front seat fully rearward. If the passenger seat height can be adjusted, move it to the upper most position.
- If the head restraint interferes with the child restraint system, and the head restraint can be removed, remove the head restraint. Otherwise, put the head restraint in the upper most position.

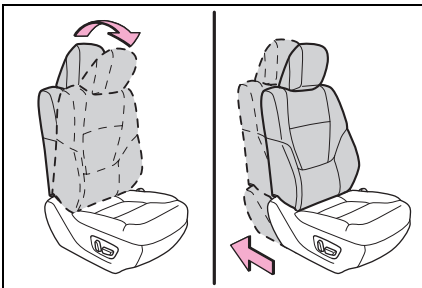

## ⚠ WARNING

### ■ When using a child restraint system

Observe the following precautions. Failure to do so may result in death or serious injury.

- Never install a rear-facing child restraint system on the front passenger seat even if the "AIR BAG OFF" indicator light is illuminated. In the event of an accident, the force of the rapid inflation of the front passenger airbag can cause death or serious injury to the child if the rear-facing child restraint system is installed on the front passenger seat.
- A forward-facing child restraint system may be installed on the front passenger seat only when it is unavoidable. A child restraint system that requires a top tether strap should not be used in the front passenger seat since there is no top tether strap anchor for the front passenger seat.

## ⚠ WARNING

- A forward-facing child restraint system may be installed on the front passenger seat only when it is unavoidable. When installing a forward-facing child restraint system on the front passenger seat, adjust the seat-back angle to the most upright position, move the seat to the rearmost position, even if the “AIR BAG OFF” indicator light is illuminated.

If the head restraint interferes with the child restraint system, and the head restraint can be removed, remove the head restraint.

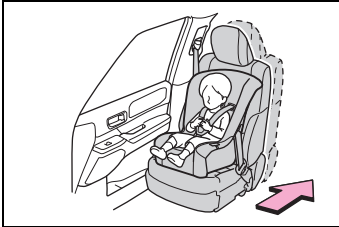

- Do not allow the child to lean his/her head or any part of his/her body against the door or the area of the seat, front or rear pillars, or roof side rails from which the SRS side airbags or SRS curtain shield airbags deploy even if the child is seated in the child restraint system. It is dangerous if the SRS side airbags and curtain shield airbags inflate, and the impact could cause death or serious injury to the child.



- When a booster seat is installed, always ensure that the shoulder belt is positioned across the center of the child's shoulder. The belt should be kept away from the child's neck, but not so that it could fall off the child's shoulder.
- Use a child restraint system suitable to the age and size of the child and install it to the rear seat.
- If the driver's seat interferes with the child restraint system and prevents it from being attached correctly, attach the child restraint system to the right-hand second seat.

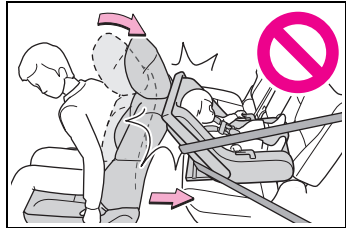

- Adjust the front passenger seat so that it does not interfere with the child restraint system.
- When installing a child restraint system on the second center seat, align both seatbacks at the same angle. The seatbacks must be adjusted to the same angle. Otherwise, the child restraint system cannot be securely restrained and this may cause death or serious injuries in the event of sudden braking, sudden swerving or an accident.
- Child restraint system installed on the third seat (if equipped) should not contact the second seatbacks.

## Child restraint system fixed with a seat belt

A child restraint system for a small child or baby must itself be properly restrained on the seat with the lap portion of the lap/shoulder belt.

### ■ Installing child restraint system using a seat belt (child restraint lock function belt)

Install the child restraint system in accordance to the operation manual enclosed with the child restraint system.

#### ■ Rear-facing — Infant seat/convertible seat

##### 1 Adjust the rear seat

If there is a gap between the child restraint system and the seatback, adjust the seatback angle until good contact is achieved.

##### 2 Place the child restraint system on the rear seat facing the rear of the vehicle.

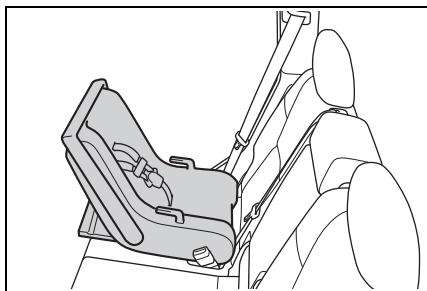

##### 3 Run the seat belt through the child restraint system and insert the plate into the

buckle. Make sure that the belt is not twisted.

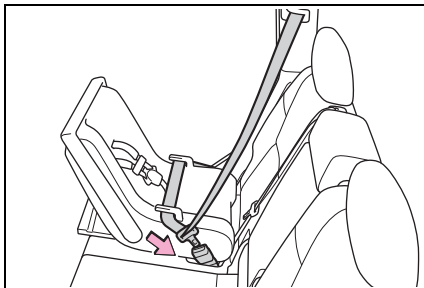

##### 4 Fully extend the shoulder belt and allow it to retract to put it in lock mode. In lock mode, the belt cannot be extended.

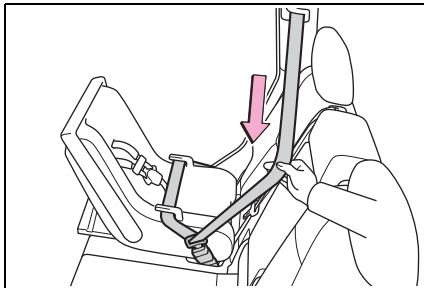

##### 5 While pushing the child restraint system down into the rear seat, allow the shoulder belt to retract until the child restraint system is securely in place.

After the shoulder belt has retracted to a point where there is no slack in the belt, pull the belt to



check that it cannot be extended.

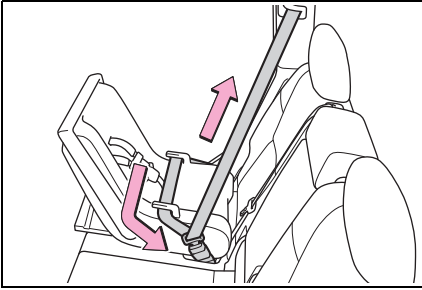

- 6 After installing the child restraint system, rock it back and forth to ensure that it is installed securely. (→P.59)

### ■ Forward-facing — Convertible seat

- 1 Adjust the seat.

When using the front passenger seat: If installing the child restraint system to the front passenger seat is unavoidable, refer to P.54 for front passenger seat adjustment.

When using the rear seat: If there is a gap between the child restraint system and the seatback, adjust the seatback angle until good contact is achieved.

- 2 If the head restraint interferes with the child restraint system, and the head restraint can be removed, remove the head restraint. (→P.162)

- 3 Place the child restraint system on the seat facing the front of the vehicle.

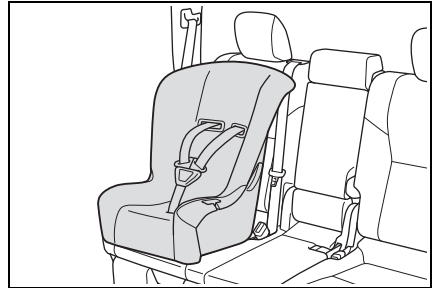

- 4 Run the seat belt through the child restraint system and insert the plate into the buckle. Make sure that the belt is not twisted.

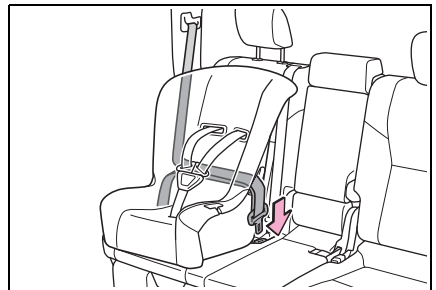

- 5 Fully extend the shoulder belt and allow it to retract to put it in lock mode. In lock mode, the belt cannot be extended.

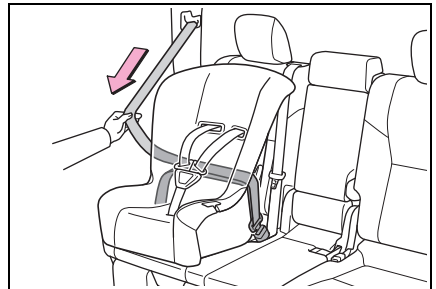

- 6 While pushing the child restraint system into the rear

seat, allow the shoulder belt to retract until the child restraint system is securely in place.

After the shoulder belt has retracted to a point where there is no slack in the belt, pull the belt to check that it cannot be extended.

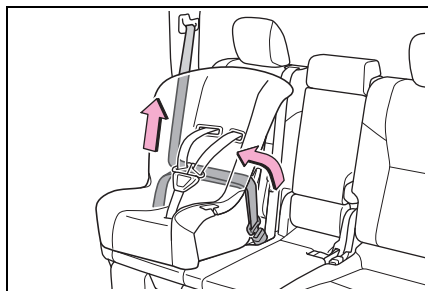

7 If the child restraint has a top tether strap, follow the child restraint manufacturer's operation manual regarding the installation, using the top tether strap to latch onto the top tether strap anchor. (→P.62)

8 After installing the child restraint system, rock it back and forth to ensure that it is installed securely. (→P.59)

### ■ Booster seat

1 If installing the child restraint system to the front passenger seat is unavoidable, refer to P.54 for front passenger seat adjustment.

2 High back type: If the head restraint interferes with your child restraint system, and the head restraint can be removed, remove the head

restraint. Otherwise, put the head restraint in the upper most position. (→P.162)

3 Place the child restraint system on the seat facing the front of the vehicle.

#### ► Booster type

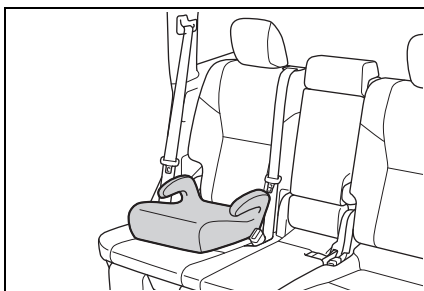

#### ► High back type

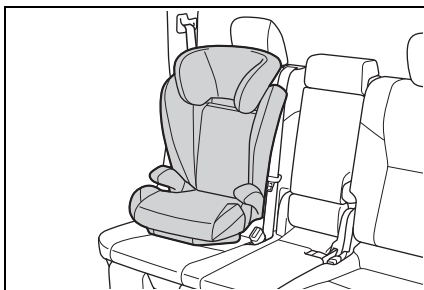

4 Sit the child in the child restraint system. Fit the seat belt to the child restraint system according to the manufacturer's instructions and insert the plate into the buckle. Make sure that the belt is not twisted.

Check that the shoulder belt is correctly positioned over the child's shoulder and that the lap belt is as

low as possible. (→P.32)



### ■ Removing a child restraint system installed with a seat belt

Press the buckle release button and fully retract the seat belt.

When releasing the buckle, the child restraint system may spring up due to the rebound of the seat cushion. Release the buckle while holding down the child restraint system.

Since the seat belt automatically reels itself, slowly return it to the stowing position.

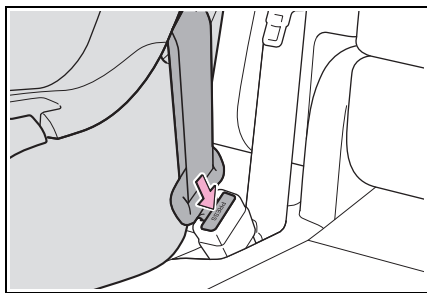

### ⚠ WARNING

#### ■ When installing a child restraint system

Observe the following precautions.

Failure to do so may result in death or serious injury.

- Do not allow children to play with the seat belt. If the seat belt becomes twisted around a child's neck, it may lead to choking or other serious injuries that could result in death. If this occurs and the buckle cannot be unfastened, scissors should be used to cut the belt.
- Ensure that the belt and plate are securely locked and the seat belt is not twisted.
- Shake the child restraint system left and right, and forward and backward to ensure that it has been securely installed.
- After securing a child restraint system, never adjust the seat.
- When a booster seat is installed, always ensure that the shoulder belt is positioned across the center of the child's shoulder. The belt should be kept away from the child's neck, but not so that it could fall off the child's shoulder.
- Follow all installation instructions provided by the child restraint system manufacturer.
- When securing some types of child restraint systems in rear seat, it may not be possible to properly use the seat belts in positions next to the child restraint without interfering with it or affecting seat belt effectiveness. Be sure your seat belt fits snugly across your shoulder and low on your hips. If it does not, or if it interferes with the child restraint, move to a different position. Failure to do so may result in death or serious injury.

### **WARNING**

● When installing a child restraint system in the second center seat, adjust both seatbacks at the same angle. Otherwise, the child restraint system cannot be securely restrained and this may cause death or serious injuries in the event of sudden braking, sudden swerving or an accident.

#### ■ **When installing a booster seat**

To prevent the belt from going into ALR lock mode, do not fully extend the shoulder belt. ALR mode causes the belt to tighten only. This could cause injury or discomfort to the child. (→P.33)

#### ■ **Do not use a seat belt extender**

If a seat belt extender is used when installing a child restraint system, the seat belt will not securely hold the child restraint system, which could cause death or serious injury to the child or other passengers in the event of sudden braking, sudden swerving or an accident.

### **Child restraint system fixed with a child restraint LATCH anchor**

#### ■ **Child restraint LATCH anchors**

LATCH anchors are provided for the second outboard seats. (Marks displaying the location of the anchorages are attached to the seats.)

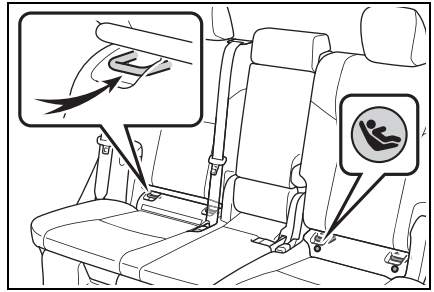

#### ■ **When installing in the second outboard seats**

Install the child restraint system in accordance to the operation manual enclosed with the child restraint system.

- 1 Adjust the seatback angle to the most upright position. When installing a forward-facing child seat, if there is a gap between the child seat and the seatback, adjust the seatback angle until good contact is achieved.
- 2 If the head restraint interferes with the child restraint system, and the head restraint can be removed, remove the head restraint. Otherwise, put the head restraint in the upper most position. (→P.162)
- 3 Open the cover.

Put the cover between the seat

cushion and seatback.

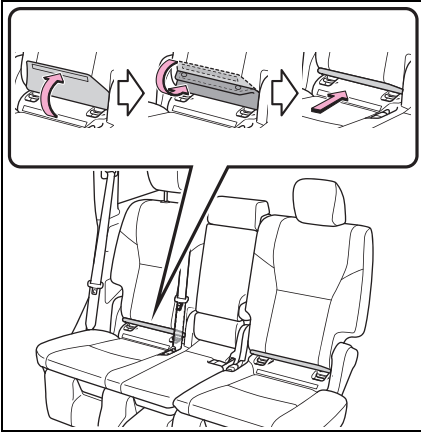

► With flexible lower attachments

- 4 Latch the hooks of the lower attachments onto the LATCH anchors.

For owners in Canada:  
The symbol on a child restraint system indicates **A** the presence of a lower connector system.

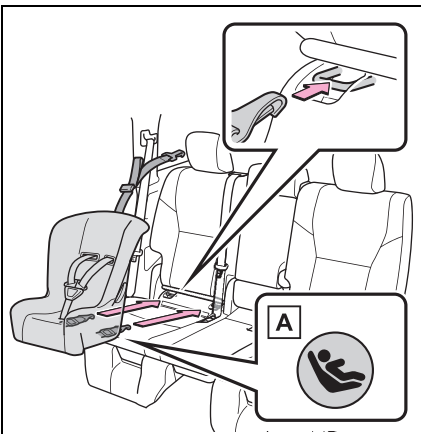

► With rigid lower attachments

- 4 Latch the buckles onto the LATCH anchors.

For owners in Canada:

The symbol on a child restraint system indicates **A** the presence of a lower connector system.

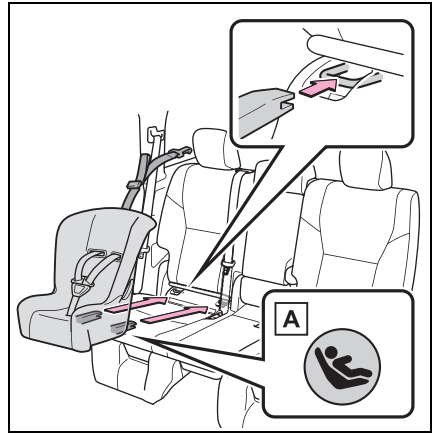

- 5 If the child restraint has a top tether strap, follow the child restraint manufacturer's operation manual regarding the installation, using the top tether strap to latch onto the top tether strap anchor. (→P.62)

- 6 After installing the child restraint system, rock it back and forth to ensure that it is installed securely. (→P.59)

#### ■ When installing in the second center seat

There are no LATCH anchors behind the second center seat. However, the inboard LATCH anchors of the second outboard seats, which are 18.2 in. (463 mm) apart, can be used if the child restraint system manufacturer's instructions permit use of those anchors with the anchor spacing stated.

Child restraint systems with rigid lower attachments cannot be installed in the second center seat. This type of child restraint system can only be installed in the second outboard seat.

### ■ Laws and regulations pertaining to anchors

The LATCH system conforms to FMVSS225 or CMVSS210.2. Child restraint systems conforming to FMVSS213 or CMVSS213 specifications can be used. This vehicle is designed to conform to SAE J1819.

### ⚠ WARNING

#### ■ When installing a child restraint system

Observe the following precautions.

Failure to do so may result in death or serious injury.

- When using the LATCH anchors, be sure that there are no foreign objects around the anchors and that the seat belt is not caught behind the child restraint system.
- Follow all installation instructions provided by the child restraint system manufacturer.
- Never attach two child restraint system attachments to the same anchor. In a collision, one anchor may not be strong enough to hold two child restraint system attachments and may break. If the LATCH anchors are already in use, use the seat belt to install a child restraint system.

- When securing some types of child restraint systems in rear seats, it may not be possible to properly use the seat belts in positions next to the child restraint without interfering with it or affecting seat belt effectiveness. Be sure your seat belt fits snugly across your shoulder and low on your hips. If it does not, or if it interferes with the child restraint, move to a different position. Failure to do so may result in death or serious injury.
- If the seat is adjusted, reconfirm the security of the child restraint system.

### Using an anchor bracket (for top tether strap)

#### ■ Anchor brackets (for top tether strap)

Anchor brackets are provided for each second seat.

Use anchor brackets when fixing the top tether strap.

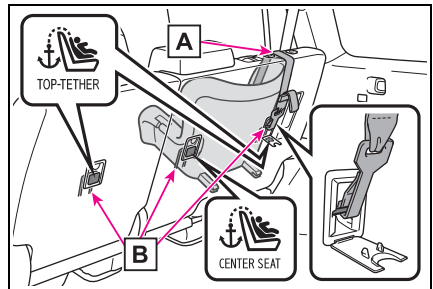

**A** Top tether strap

**B** Anchor brackets

#### ■ Fixing the top tether strap to the anchor bracket

Install the child restraint system

in accordance to the operation manual enclosed with the child restraint system.

- 1 Adjust the head restraint to the upmost position.

If the head restraint interferes with the child restraint system or top tether strap installation and the head restraint can be removed, remove the head restraint.

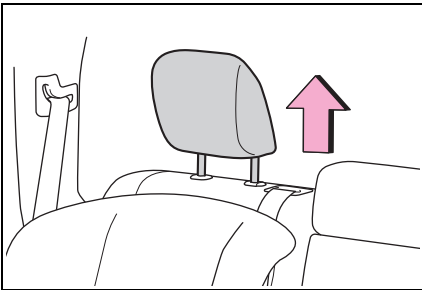

- 2 Open the anchor bracket cover, latch the hook onto the anchor bracket and tighten the top tether strap.

Make sure the top tether strap is securely latched. (→P.59)

When installing the child restraint system with the head restraint being raised, be sure to have the top tether strap pass underneath the head restraint.

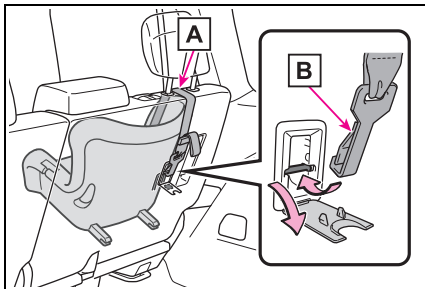

**A** Top tether strap

**B** Hook

### ■ Laws and regulations pertaining to anchors

The LATCH system conforms to FMVSS225 or CMVSS210.2.

Child restraint systems conforming to FMVSS213 or CMVSS213 specifications can be used.

This vehicle is designed to conform to SAE J1819.

### ⚠ WARNING

#### ■ When installing a child restraint system

Observe the following precautions.

Failure to do so may result in death or serious injury.

- Firmly attach the top tether strap and make sure that the belt is not twisted.
- Do not attach the top tether strap to anything other than the anchor bracket.
- After securing a child restraint system, never adjust the seat.
- Follow all installation instructions provided by the child restraint system manufacturer.
- When installing the child restraint system with the head restraint being raised, after the head restraint has been raised and then the anchor bracket has been fixed, do not lower the head restraint.

### ⚠ NOTICE

#### ■ Anchor brackets (for top tether strap)

When not in use, make certain to close the cover. If it remains open, the lid may be damaged.

## Safety Connect

**Safety Connect** is a subscription-based telematics service that uses Global Positioning System (GPS) data and embedded cellular technology to provide safety and security features to subscribers. Safety Connect is supported by Toyota's designated response center, which operates 24 hours per day, 7 days per week.

Safety Connect service is available by subscription on select, telematics hardware-equipped vehicles.

By using the Safety Connect service, you are agreeing to be bound by the Telematics Subscription Service Agreement and its Terms and Conditions, as in effect and amended from time to time, a current copy of which is available at [Toyota.com](http://Toyota.com) in the United States, [Toyotapr.com](http://Toyotapr.com) in Puerto Rico and [Toyota.ca](http://Toyota.ca) in Canada. All use of the Safety Connect service is subject to such then-applicable Terms and Conditions.

## System components

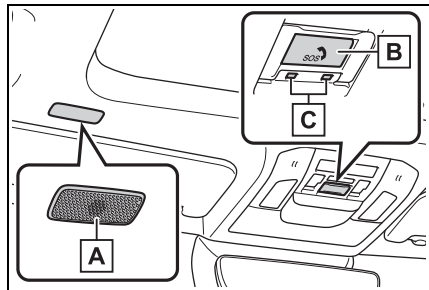

- A** Microphone
- B** "SOS" button
- C** LED light indicators

## Services

Subscribers have the following Safety Connect services available:

- Automatic Collision Notification\*

Helps drivers receive necessary response from emergency service providers. (→P.66)

\*: U.S. Patent No. 7,508,298 B2

- Stolen Vehicle Location

Helps drivers in the event of vehicle theft. (→P.66)

- Emergency Assistance Button ("SOS")

Connects drivers to response-center support. (→P.66)

- Enhanced Roadside Assistance

Provides drivers various on-road assistance. (→P.67)



## Subscription

After you have signed the Telematics Subscription Service Agreement and are enrolled, you can begin receiving services.

A variety of subscription terms are available for purchase. Contact your Toyota dealer, call the following appropriate Customer Experience Center or push the “SOS” button in your vehicle for further subscription details.

- The United States

1-800-331-4331

- Canada

1-888-869-6828

- Puerto Rico

1-877-855-8377

### ■ Safety Connect Services Information

- Phone calls using the vehicle’s Bluetooth® technology will not be possible when Safety Connect is active and in use.

Bluetooth® is a registered trademark of Bluetooth SIG, Inc.

- Safety Connect is available beginning Fall 2009 on select Toyota models (in the contiguous United States only). Contact with the Safety Connect response center is dependent upon the telematics device being in operative condition, cellular connection availability, and GPS satellite signal reception, which can limit the ability to reach the response center or receive emergency service support. Enrollment and Telematics

Subscription Service Agreement are required. A variety of subscription terms are available; charges vary by subscription term selected and location.

- Automatic Collision Notification, Emergency Assistance and Stolen Vehicle Location are available in the United States, including Hawaii and Alaska, Puerto Rico and Canada, and Enhanced Roadside Assistance are available in the United States, Puerto Rico and Canada.
- Automatic Collision Notification, Emergency Assistance, Stolen Vehicle and Enhanced Road Assistance are not available in the U.S. Virgin Islands. For vehicles first sold in the U.S. Virgin Islands, no Safety Connect services will function in or outside the U.S. Virgin Islands.
- Safety Connect services are not subject to section 255 of the Telecommunications Act and the device is not TTY compatible.

### ■ Languages

The Safety Connect response center will offer support in multiple languages. The Safety Connect system will offer voice prompts in English, Spanish, and French. Please indicate your language of choice when enrolling.

### ■ When contacting the response center

You may be unable to contact the response center if the network is busy.

## Safety Connect LED light Indicators

When the power switch is turned to ON, the red indicator light comes on for 2 seconds then turns off. Afterward, the green

indicator light comes on, indicating that the service is active.

The following indicator light patterns indicate specific system usage conditions:

- Green indicator light on = Active service
- Green indicator light flashing = Safety Connect call in process
- Red indicator light (except at vehicle start-up) = System malfunction (contact your Toyota dealer)
- No indicator light (off) = Safety Connect service not active

## Safety Connect services

### ■ Automatic Collision Notification

In case of either airbag deployment or severe rear-end collision, the system is designed to automatically call the response center. The responding agent receives the vehicle's location and attempts to speak with the vehicle occupants to assess the level of emergency. If the occupants are unable to communicate, the agent automatically treats the call as an emergency, contacts the nearest emergency services provider to describe the situation, and requests that assistance be sent

to the location.

### ■ Stolen Vehicle Location

If your vehicle is stolen, Safety Connect can work with local authorities to assist them in locating and recovering the vehicle. After filing a police report, call the Customer Experience Center at 1-800-331-4331 in the United States, 1-877-855-8377 in Puerto Rico or 1-888-869-6828 in Canada, and follow the prompts for Safety Connect to initiate this service.

In addition to assisting law enforcement with recovery of a stolen vehicle, Safety-Connect-equipped vehicle location data may, under certain circumstances, be shared with third parties to locate your vehicle. Further information is available at [Toyota.com](http://Toyota.com) in the United States, [Toyotapr.com](http://Toyotapr.com) in Puerto Rico and [Toyota.ca](http://Toyota.ca) in Canada.

### ■ Emergency Assistance Button (“SOS”)

In the event of an emergency on the road, push the “SOS” button to reach the Safety Connect response center. The answering agent will determine your vehicle's location, assess the emergency, and dispatch the necessary assistance required.

If you accidentally press the “SOS” button, tell the response-center agent that you are not experiencing an emergency.

### ■ Enhanced Roadside Assistance

Enhanced Roadside Assistance adds GPS data to the already included warranty-based Toyota roadside service.

Subscribers can press the “SOS” button to reach a Safety Connect response-center agent, who can help with a wide range of needs, such as: towing, flat tire, fuel delivery, etc. For a description of the Enhanced Roadside Assistance services and their limitations, please see the Safety Connect Terms and Conditions, which are available at [Toyota.com](http://Toyota.com) in the United States, [Toyotapr.com](http://Toyotapr.com) in Puerto Rico and [Toyota.ca](http://Toyota.ca) in Canada.

### Safety information for Safety Connect

Important! Read this information before using Safety Connect.

#### ■ Exposure to radio frequency signals

The Safety Connect system installed in your vehicle is a low-power radio transmitter and receiver. It receives and also sends out radio frequency (RF) signals.

In August 1996, the Federal Communications Commission (FCC) adopted RF exposure guidelines with safety levels for

mobile wireless phones. Those guidelines are consistent with the safety standards previously set by the following U.S. and international standards bodies.

- ANSI (American National Standards Institute) C95.1 [1992]
- NCRP (National Council on Radiation Protection and Measurement) Report 86 [1986]
- ICNIRP (International Commission on Non-Ionizing Radiation Protection) [1996]

Those standards were based on comprehensive and periodic evaluations of the relevant scientific literature. Over 120 scientists, engineers, and physicians from universities, and government health agencies and industries reviewed the available body of research to develop the ANSI Standard (C95.1).

The design of Safety Connect complies with the FCC guidelines in addition to those standards.

#### ■ Free/Open Source Software Information

This product contains Free/Open Source Software (FOSS). The license information and/or the source code of such FOSS can be found at the following URL.

[https://opensource.lge.com/  
product/  
list?page=&keyword=TL21BNU](https://opensource.lge.com/product/list?page=&keyword=TL21BNU)

## Hybrid system features

Your vehicle is a Hybrid Electric Vehicle. It has characteristics different from conventional vehicles. Be sure you are closely familiar with the characteristics of your vehicle, and operate it with care.

The hybrid system combines the use of a gasoline engine and an electric motor (traction motor) according to driving conditions, improving fuel efficiency and reducing exhaust emissions.

## System components

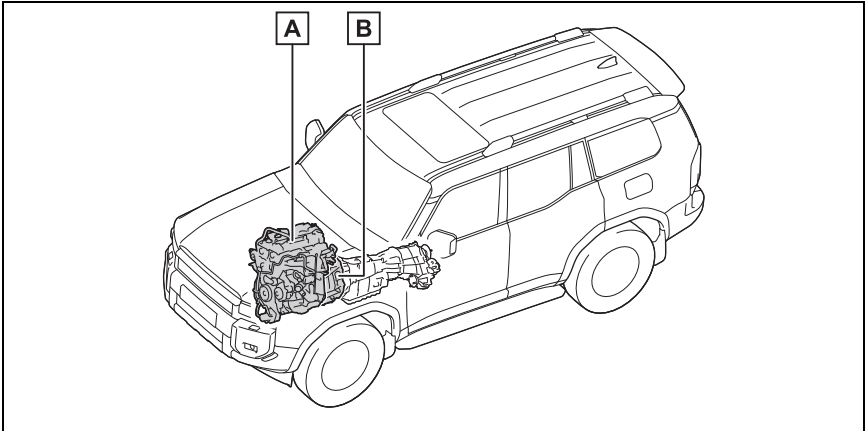

The illustration is an example for explanation and may differ from the actual item.

- A** Gasoline engine
- B** Electric motor (traction motor)

### ■ When stopped/during start off

The gasoline engine stops\* when the vehicle is stopped. During start off, the electric motor (traction motor) drives the vehicle. At slow speeds or when traveling down a gentle slope,

the engine is stopped\* and the electric motor (traction motor) is used.

\*: When the hybrid battery (traction battery) requires charging or the engine is warming up, etc., the gasoline engine will not automatically stop. (→P.70)

### ■ During normal driving

The gasoline engine is predominantly used. The electric motor (traction motor) charges the hybrid battery (traction battery) as necessary.

### ■ When accelerating sharply

When the accelerator pedal is depressed heavily, the power of the hybrid battery (traction battery) is added to that of the gasoline engine via the electric motor (traction motor).

### ■ When braking (regenerative braking)

The wheels operate the electric motor (traction motor) as a power generator, and the hybrid battery (traction battery) is charged.

---

### ■ Regenerative braking

In the following situations, kinetic energy is converted to electric energy and deceleration force can be obtained in conjunction with the recharging of the hybrid battery (traction battery).

- The accelerator pedal is released while driving with the shift position in D or M.
- The brake pedal is depressed while driving with the shift position in D or M.

### ■ Conditions in which the gasoline engine may not stop

The gasoline engine starts and stops automatically. However, it may not stop automatically, possibly reducing fuel economy\*:

- During gasoline engine warm-up

- During hybrid battery (traction battery) charging
- When the temperature of the hybrid battery (traction battery) is high or low
- When the heater is switched on
- When repeatedly accelerating/decelerating rapidly
- When repeatedly operating the hybrid system for a long time
- When driving down a long slope
- When the hood is opened during "READY" indicator is illuminated

\*: Depending on the circumstances, the gasoline engine may also not stop automatically in other situations.

### ■ Charging the hybrid battery (traction battery)

As the gasoline engine charges the hybrid battery (traction battery), the battery does not need to be charged from an outside source. However, if the vehicle is left parked for a long time the hybrid battery (traction battery) will slowly discharge. For this reason, be sure to drive the vehicle at least once every few months for at least 30 minutes or 10 miles (16 km). If the hybrid battery (traction battery) becomes fully discharged and you are unable to start the hybrid system, contact your Toyota dealer.

### ■ Charging the 12-volt battery

→P.622

### ■ After the 12-volt battery has discharged or when the terminal has been removed and installed during exchange, etc.

The gasoline engine may not stop even if the vehicle is being driven by the hybrid battery (traction battery). If this continues for a few days, contact your Toyota dealer.

### ■ Sounds and vibrations specific to a Hybrid Electric Vehicle

There may be no engine sound or vibration even though the vehicle is able to move with the “READY” indicator is illuminated. For safety, make sure to shift the shift lever to P and apply the parking brake when parked.

The following sounds or vibrations may occur when the hybrid system is operating and are not a malfunction:

- Motor sounds may be heard from the engine compartment.
- Sounds may be heard from the hybrid battery (traction battery) under the rear seats when the hybrid system starts or stops.
- Relay operating sounds such as a snap or soft clank will be emitted from the hybrid battery (traction battery), under the luggage compartment (vehicles without third seats) or third seats (vehicles with third seats), when the hybrid system is started or stopped.
- Sounds from the hybrid system may be heard when the back door is open.
- Sounds may be heard from the transmission when the gasoline engine starts or stops, when driving at low speeds, or during idling.
- Engine sounds may be heard when accelerating sharply.
- Sounds may be heard due to regenerative braking when the brake pedal is depressed or as the accelerator pedal is released.
- Vibration may be felt when the gasoline engine starts or stops.
- Cooling fan sounds may be heard from the air intake vents on the rear side trims.

### ■ Maintenance, repair, recycling, and disposal

Contact your Toyota dealer regarding maintenance, repair, recycling

and disposal. Do not dispose of the vehicle yourself.

### Acoustic Vehicle Alerting System

When driving with the gasoline engine stopped, a sound, which changes in accordance with the driving speed, will be played in order to warn people nearby of the vehicle's approach. This sound may be heard inside the vehicle. The sound will stop when the vehicle speed exceeds approximately 22 mph (35 km/h).

### ■ Acoustic Vehicle Alerting System

In the following cases, the Acoustic Vehicle Alerting System may be difficult for surrounding people to hear.

- In very noisy areas
- In the wind or the rain

### ■ If “Acoustic Vehicle Alerting System Malfunction Visit your Dealer” is displayed on the multi-information display

The system may be malfunctioning. Have the vehicle inspected by your Toyota dealer.

## Hybrid system precautions

Take care when handling the hybrid system, as it is a high voltage system (about 288 V at maximum) as well as contains parts that become extremely hot when the hybrid system is operating. Read the following descriptions carefully before using the hybrid system, and handle the hybrid system correctly. Note that warning labels with a ⚡ mark are attached to the high voltage components, to remind you of careful handling required.

## System components

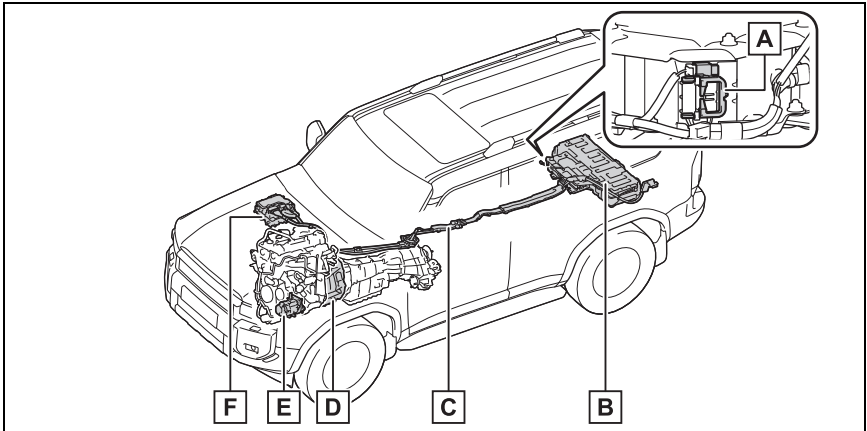

The illustration is an example for explanation and may differ from the actual item.

- A** Service plug
- B** Hybrid battery (traction battery)
- C** High voltage cables (orange)
- D** Electric motor (traction motor)
- E** Air conditioning compressor
- F** Power control unit

### ■ Running out of fuel

When the vehicle has run out of fuel and the hybrid system cannot be

started, refuel the vehicle with at least enough gasoline to make the low fuel level warning light (→P.594) go off. If there is only a small



amount of fuel, the hybrid system may not be able to start. (The standard amount of fuel is about 3.1 gal. [11.9 L, 2.6 Imp.gal.], when the vehicle is on a level surface. This value may vary when the vehicle is on a slope. Add extra fuel when the vehicle is inclined.)

### ■ Electromagnetic waves

- High voltage parts and cables on Hybrid Electric Vehicles incorporate electromagnetic shielding, and therefore emit approximately the same amount of electromagnetic waves as conventional gasoline powered vehicles or home electronic appliances.
- Your vehicle may cause sound interference in some third party-produced radio parts.

### ■ Hybrid battery (traction battery)

The hybrid battery (traction battery) has a limited service life. The lifespan of the hybrid battery (traction battery) can change in accordance with driving style and driving conditions.

## ⚠ WARNING

### ■ High voltage precautions

This vehicle has high voltage DC and AC systems as well as a 12-volt system. DC and AC high voltage is very dangerous and can cause severe burns and electric shock that may result in death or serious injury.

- Never touch, disassemble, remove or replace the high voltage parts, cables or their connectors.
- Do not touch the high voltage components. They are extremely hot, especially after driving.

- Vehicles without third seats: Never try to open the service plug access hole located in the deck under tray behind the second seat. The service plug is used only when the vehicle is serviced and is subject to high voltage.

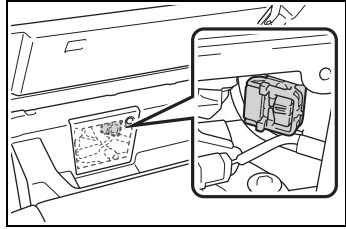

- Vehicles with third seats: Never try to open the service plug access hole located underneath the right side third seat. The service plug is used only when the vehicle is serviced and is subject to high voltage.

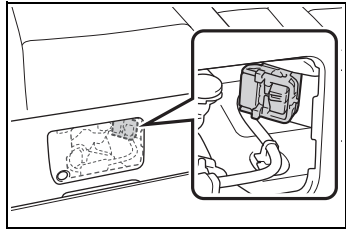

### ■ Road accident cautions

Observe the following precautions to reduce the risk of death or serious injury:

- Pull your vehicle off the road, apply the parking brake, shift the shift lever to P, and turn the hybrid system off.
- Do not touch the high voltage parts, cables and connectors.
- If electric wires are exposed inside or outside your vehicle, an electric shock may occur. Never touch exposed electric wires.

**WARNING**

- If a fluid leak occurs, do not touch the fluid as it may be strong alkaline electrolyte from the hybrid battery (traction battery). If it comes into contact with your skin or eyes, wash it off immediately with a large amount of water or, if possible, boric acid solution. Seek immediate medical attention.
- If a fire occurs in the Hybrid Electric Vehicle, leave the vehicle as soon as possible. Never use a fire extinguisher that is not meant for electric fires. Using even a small amount of water may be dangerous.
- If your vehicle needs to be towed, do so with four wheels raised. If the wheels connected to the electric motor (traction motor) are on the ground when towing, the motor may continue to generate electricity. This may cause a fire. (→P.583)
- Carefully inspect the ground under the vehicle. If you find that liquid has leaked onto the ground, the fuel system may have been damaged. Leave the vehicle as soon as possible.
- **Hybrid battery (traction battery)**
- Never resell, hand over or modify the hybrid battery. To prevent accidents, hybrid batteries that have been removed from a disposed vehicle are collected through Toyota dealer. Do not dispose of the battery yourself.

Unless the battery is properly collected, the following may occur, resulting in death or serious injury:

- The hybrid battery may be illegally disposed of or dumped, and it is hazardous to the environment or someone may touch a high voltage part, resulting in an electric shock.
- The hybrid battery is intended to be used exclusively with your Hybrid Electric Vehicle. If the hybrid battery is used outside of your vehicle or modified in any way, accidents such as electric shock, heat generation, smoke generation, an explosion and electrolyte leakage may occur.

When reselling or handing over your vehicle, the possibility of an accident is extremely high because the person receiving the vehicle may not be aware of these dangers.

- If your vehicle is disposed of without the hybrid battery having been removed, there is a danger of serious electric shock if high voltage parts, cables and their connectors are touched. In the event that your vehicle must be disposed of, the hybrid battery must be disposed of by your Toyota dealer or a qualified service shop. If the hybrid battery is not disposed of properly, it may cause electric shock that can result in death or serious injury.

**NOTICE**

■ **Hybrid battery (traction battery)**

Do not carry large amounts of water such as water cooler bottles in the vehicle. If water spills onto the hybrid battery (traction battery), the battery may be damaged. Have the vehicle inspected by your Toyota dealer.

## Hybrid battery (traction battery) air intake vents

There are air intake vents on the rear side trims for the purpose of cooling the hybrid battery (traction battery).

If the vents become blocked, it may interfere with the cooling of the hybrid battery (traction battery).

If input/output of the hybrid battery (traction battery) becomes limited and the distance that the vehicle can be driven using the electric motor (traction motor) is reduced, the fuel economy may be reduced.

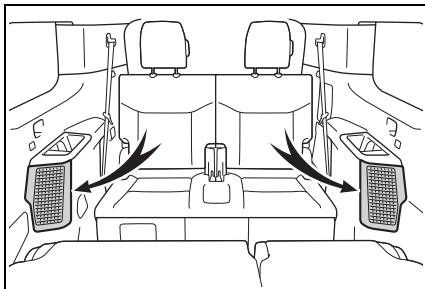

### NOTICE

#### Hybrid battery (traction battery) air intake vents

- Make sure not to block the air intake vents with anything, such as a seat cover, plastic cover, or luggage.

The input/output of the hybrid battery (traction battery) may be restricted, leading to a reduction in hybrid battery (traction battery) output and a malfunction.

- Periodically clean the air intake vents to prevent it from clogging. (→P.568)

- Do not get water or foreign materials in the air intake vents as this may cause a short circuit and damage the hybrid battery (traction battery).

## Emergency shut off system

When a certain level of impact is detected by the impact sensor, the emergency shut off system blocks the high voltage current and stops the fuel pump to minimize the risk of electrocution and fuel leakage. If the emergency shut off system activates, your vehicle will not restart. To restart the hybrid system, contact your Toyota dealer.

## Hybrid warning message

A message is automatically displayed when a malfunction occurs in the hybrid system or an improper operation is attempted.

If a warning message is shown on the multi-information display, read the message and follow the instructions.

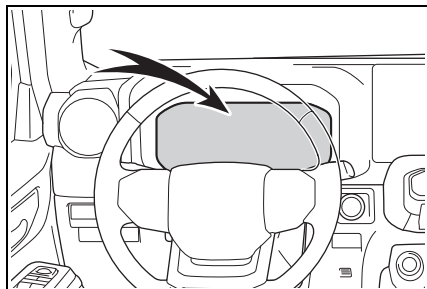

- **If a warning light comes on, a warning message is displayed, or the 12-volt battery is disconnected**

The hybrid system may not start. In this case, try to start the system again. If the “READY” indicator does not come on, contact your Toyota dealer.

## Immobilizer system

The vehicle's keys have built-in transponder chips that prevent the hybrid system from starting if a key has not been previously registered in the vehicle's on-board computer.

**Never leave the keys inside the vehicle when you leave the vehicle.**

This system is designed to help prevent vehicle theft but does not guarantee absolute security against all vehicle thefts.

## Operating the system

The indicator light flashes after the power switch has been turned off to indicate that the system is operating.

The indicator light stops flashing after the power switch has been turned to ACC or ON to indicate that the system has been canceled.

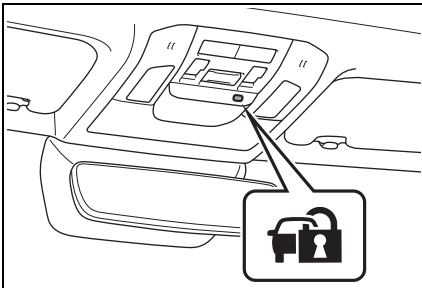

### ■ System maintenance

The vehicle has a maintenance-free type immobilizer system.

### ■ Conditions that may cause the system to malfunction

- If the key is in contact with a metallic object
- If the key is in close proximity to or touching a key to the security system (key with a built-in transponder chip) of another vehicle

### ⚠ NOTICE

#### ■ To ensure the system operates correctly

Do not modify or remove the system. If modified or removed, the proper operation of the system cannot be guaranteed.

## Alarm

**The alarm uses light and sound to give an alert when an intrusion is detected. The alarm is triggered in the following situations when the alarm is set:**

- A locked door, back door or glass hatch is unlocked or opened in any way other than using the entry function, wireless remote control or mechanical key. (The doors will lock again automatically.)
- The hood is opened.

### Setting/deactivating/stopping the alarm system

#### ■ Items to check before locking the vehicle

To prevent unexpected triggering of the alarm and vehicle theft, make sure of the following:

- Nobody is in the vehicle.
- The windows and moon roof (if equipped) are closed before the alarm is set.
- No valuables or other personal items are left in the vehicle.

#### ■ Setting

Close the doors, back door, glass hatch and hood, and lock all the doors.

The system will be set automatically after 30 seconds.

The indicator light changes from being on to flashing when the system is set.

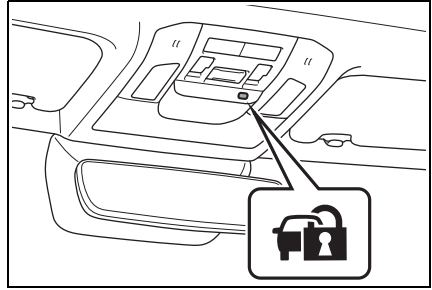

#### ■ Deactivating or stopping

Do one of the following to deactivate or stop the alarm.

- Unlock the doors.
- Turn the power switch to ACC or ON, or start the hybrid system. (The alarm will be deactivated or stopped after a few seconds.)

#### ■ Setting the alarm

The alarm can be set if all the doors are closed even with the hood open.

#### ■ System maintenance

The vehicle has a maintenance-free type alarm system.

#### ■ Triggering of the alarm

The alarm may be triggered in the following situations: (Stopping the alarm deactivates the alarm system.)

- The doors are unlocked using the mechanical key.

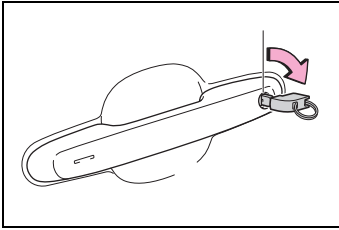

- A person inside the vehicle opens a door, the back door or hood, or unlocks the vehicle.

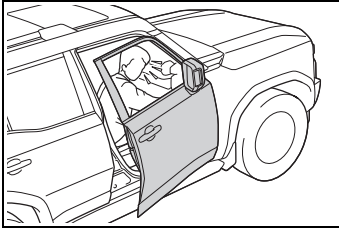

- The 12-volt battery is recharged or replaced when the vehicle is locked. (→P.620)

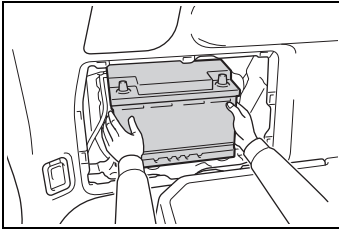

### ■ Alarm-operated door lock

In the following cases, depending on the situation, the door may automatically lock to prevent improper entry into the vehicle:

- When a person remaining in the vehicle unlocks the door and the alarm is activated.
- While the alarm is activated, a person remaining in the vehicle unlocks the door.
- When recharging or replacing the 12-volt battery.

### ⚠ NOTICE

#### ■ To ensure the system operates correctly

Do not modify or remove the system. If modified or removed, the proper operation of the system cannot be guaranteed.

### Pre-alarm

If a door is unlocked with the mechanical key while the alarm is being set, the pre-alarm will sound for 10 seconds.

If either the door is locked again or the pre-alarm is stopped within those 10 seconds, an alarm will sound.

Do any of the following in order to deactivate or stop the pre-alarm:

- Close the doors, and lock all doors by smart key system or wireless remote control.
- Turn the power switch to ACC or ON, or start the hybrid system. (The alarm will be deactivated or stopped after a few seconds.)





## Vehicle status information and indicators

### 2

#### 2-1. Instrument cluster

Warning lights and indicators .....	82
Gauges and meters (with 7-inch display) .....	89
Gauges and meters (12.3-inch display) .....	92
Multi-information display (7-inch display) .....	96
Multi-information display (12.3-inch display).....	106
Head-up display .....	117
Fuel consumption information .....	121

## Warning lights and indicators

The warning lights and indicators on the instrument cluster, overhead console panel and outside rear view mirrors inform the driver of the status of the vehicle's various systems.

### Warning lights and indicators displayed on the instrument cluster

#### ■ With 7-inch display

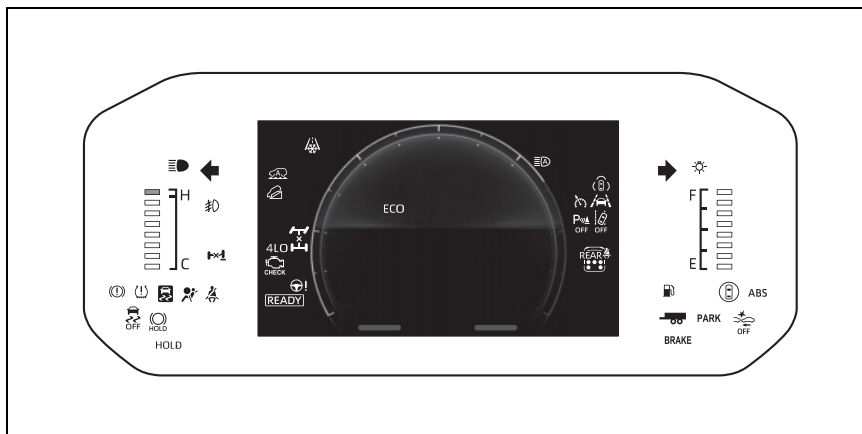

The units used on the meters and some indicators may differ depending on the target region.

The image may differ from the actual condition.

## ■ With 12.3-inch display

### ▶ Type 1

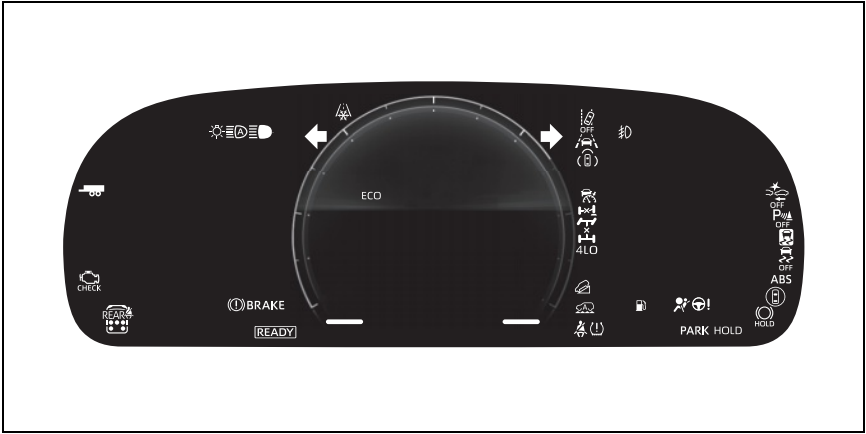

The location of warning lights and indicators may differ depending on the intended destination of the vehicle.

The image may differ from the actual condition.

### ▶ Type 2

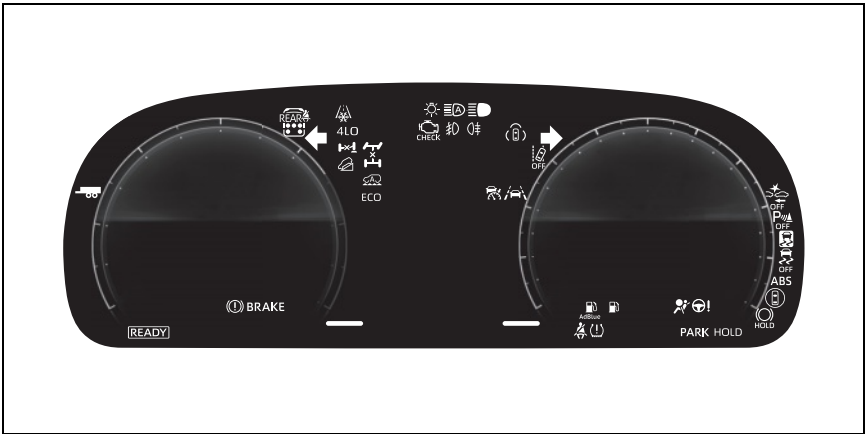

The location of warning lights and indicators may differ depending on the intended destination of the vehicle.

The image may differ from the actual condition.

## ► Type 3

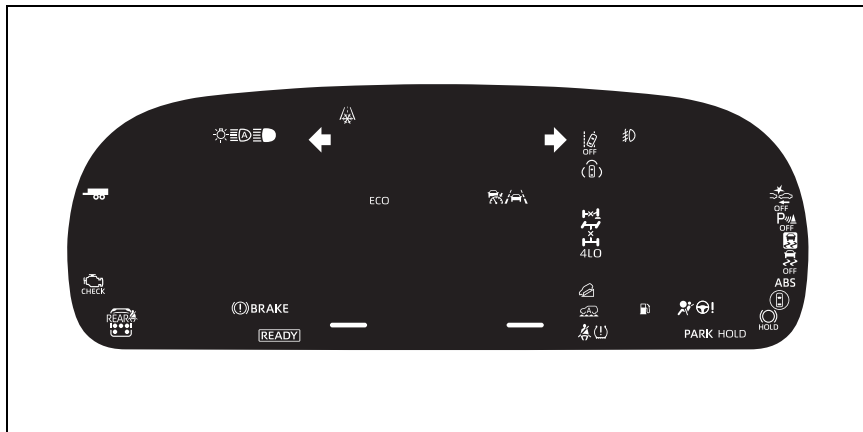



The location of warning lights and indicators may differ depending on the intended destination of the vehicle.

The image may differ from the actual condition.

## Warning lights

Warning lights inform the driver of malfunctions in the indicated vehicle's systems.

 Brake system warning light<sup>\*1</sup> (→P.587)  
(U.S.A.)

 Brake system warning light<sup>\*1</sup> (→P.587)  
(Canada)  
(Red)

 Brake system warning light<sup>\*1</sup> (→P.587)  
(Yellow)

 Charging system warning light<sup>\*2</sup> (→P.587)

 Low engine oil pressure warning light<sup>\*2</sup> (→P.588)

 High coolant temperature warning light<sup>\*2</sup> (→P.588)

 Malfunction indicator lamp<sup>\*1</sup> (→P.588)  
(U.S.A.)

 Malfunction indicator lamp<sup>\*1</sup> (→P.588)  
(Canada)

 SRS warning light<sup>\*1</sup> (→P.588)

 ABS warning light<sup>\*1</sup> (→P.589)  
(U.S.A.)

 ABS warning light<sup>\*1</sup> (→P.589)  
(Canada)

 Power steering system warning light<sup>\*1</sup> (→P.589)  
(Red)

 Power steering system warning light<sup>\*1</sup> (→P.589)  
(Yellow)

 PCS warning light<sup>\*1</sup> (→P.590)



LTA indicator (→P.590)

(Yellow)



(Yellow)

LDA indicator (→P.590)



(Yellow)

PDA indicator (→P.590)



(Yellow)

Cruise control indicator  
(→P.590)

(Yellow)

Dynamic radar cruise control indicator (→P.591)

Driving assist information indicator\*<sup>1</sup> (→P.591)Intuitive parking assist OFF indicator\*<sup>1</sup> (→P.591)Inappropriate pedal operation warning light\*<sup>2</sup>  
(→P.592)Slip indicator light\*<sup>1</sup>  
(→P.592)Trailer brake warning light  
(→P.592)

(Flashes)

Low speed four-wheel drive indicator light  
(→P.593)

(Flashes)

Center differential lock indicator (→P.593)



(Flashes)

Rear differential lock indicator (if equipped)  
(→P.593)

(U.S.A.)

Parking brake indicator  
(→P.593)(Canada)  
(Flashes)Parking brake indicator  
(→P.593)

(Flashes)

Brake hold operated indicator\*<sup>1</sup> (→P.593)

Low fuel level warning light (→P.594)

Tire pressure warning light\*<sup>1</sup> (→P.594)

Driver's and front passenger's seat belt reminder light (→P.594)

Rear passengers' seat belt reminder light  
(→P.595)

\*<sup>1</sup>: These lights turn on when the power switch is turned to ON to indicate that a system check is being performed. They will turn off after the hybrid system is on, or after a few seconds. There may be a malfunction in a system if the light does not come on, or turn off. Have the vehicle inspected by your Toyota dealer.

\*<sup>2</sup>: This light illuminates on the multi-information display with a message.

### ! WARNING

#### ■ If a safety system warning light does not come on

Should a safety system warning light such as the ABS and SRS warning light not come on when you start the hybrid system, this could mean that these systems are not available to help protect you in an accident, which could result in death or serious injury. Have the vehicle inspected by your Toyota dealer immediately if this occurs.

## Indicators

The indicators inform the driver of the operating state of the vehicle's various systems.



Turn signal indicator  
(→P.233)



(U.S.A.)

Headlight indicator  
(→P.240)



(Canada)

Tail light indicator  
(→P.240)



Headlight high beam indicator  
(→P.244)



AHB indicator (→P.242)



Fog light indicator (if equipped)  
(→P.245)



PCS warning light<sup>\*1, 2</sup>  
(→P.269)



(White)

LTA indicator (→P.283)



(Green)

LTA indicator (→P.283)



(Yellow)  
(Flashes)

LTA indicator (→P.283)



(Green)

LDA indicator (→P.292)



(Yellow)  
(Flashes)

LDA indicator (→P.292)



LDA OFF indicator<sup>\*2, 9</sup>  
(→P.292)



(White)

PDA indicator (→P.298)



(Green)

PDA indicator (→P.298)



(Green)

Cruise control indicator  
(→P.318)



(White)

Cruise control indicator  
(→P.318)



(Green)

Dynamic radar cruise control indicator  
(→P.314)



(White)

Dynamic radar cruise control indicator  
(→P.314)



Driving assist information indicator<sup>\*1, 2, 7</sup>  
(→P.591)



Outside rear view mirror indicators<sup>\*3</sup>  
(→P.328)



OFF indicator<sup>\*1, 2, 7</sup>  
(→P.338)



Intuitive parking assist detection indicator<sup>\*8</sup>  
(→P.338)



(Flashes)

Slip indicator light<sup>\*1</sup>  
(→P.449)



VSC OFF indicator<sup>\*1, 2</sup>  
(→P.449)



Downhill assist control system indicator<sup>\*1</sup> (if equipped)  
(→P.445)



Crawl Control indicator<sup>\*1</sup> (if equipped) (→P.439)



Second start mode indicator (if equipped) (→P.230)



“TOW HAUL” indicator (→P.232)



SDM indicator (if equipped) (→P.456)



Low speed four-wheel drive indicator light (→P.435)



Center differential lock indicator (→P.435)



Rear differential lock indicator (if equipped) (→P.437)



Parking brake indicator (U.S.A.) (→P.233)



Parking brake indicator (Canada) (→P.233)



Brake hold standby indicator<sup>\*1</sup> (→P.237)



Brake hold operated indicator<sup>\*1</sup> (→P.237)



Security indicator<sup>\*4</sup> (→P.77, 78)



Smart key system indicator<sup>\*5</sup> (→P.222)



“READY” indicator (→P.222)



Low outside temperature indicator<sup>\*6</sup> (→P.94, 436)



Stop light indicator (→P.88)



“PASSENGER AIR BAG” indicator lights<sup>\*4</sup> (→P.44)



Eco drive mode indicator (if equipped) (→P.433)



Sport mode indicator (if equipped) (→P.433)



AUTO mode indicator (if equipped) (→P.442)



DIRT mode indicator (if equipped) (→P.442)



SAND mode indicator (if equipped) (→P.442)



MUD mode indicator (if equipped) (→P.442)



DEEP SNOW mode indicator (if equipped) (→P.442)



ROCK mode indicator (if equipped) (→P.442)

<sup>\*1</sup>: These lights turn on when the power switch is turned to ON to indicate that a system check is being performed. They will turn off after the hybrid system is on, or after a few seconds. There may be a malfunction in a system if the lights do not turn on, or turn off. Have the vehicle inspected by your Toyota dealer.

<sup>\*2</sup>: The light comes on when the system is turned off.

<sup>\*3</sup>: This light illuminates on the outside rear view mirrors.

<sup>\*4</sup>: This light illuminates on the overhead console panel.

<sup>\*5</sup>: This light illuminates on the multi-information display with a message.

<sup>\*6</sup>: When the outside temperature is approximately 37°F (3°C) or

lower, the indicator will flash for approximately 10 seconds, then stay on.

\*7: When the trailer with 7-pin connector is connected, the light comes on and rear sensor of the Toyota parking assist-sensor, RCD (Rear Camera Detection) function and Parking Support Brake function automatically turn off.

\*8: Vehicles without multimedia display or rear camera

\*9: For Puerto Rico

---

### ■ Intuitive parking assist OFF indicator

Vehicles without Multimedia display: The indicators turn off when the shift position is changed to R regardless of whether the intuitive parking assist function is turned on or off.

### ■ Stop light indicator

This light comes on when the stop lights are illuminated by the operation of the brake pedal or the driving assist system.



## Gauges and meters (with 7-inch display)

## Meter display

## ■ Locations of gauges and meters

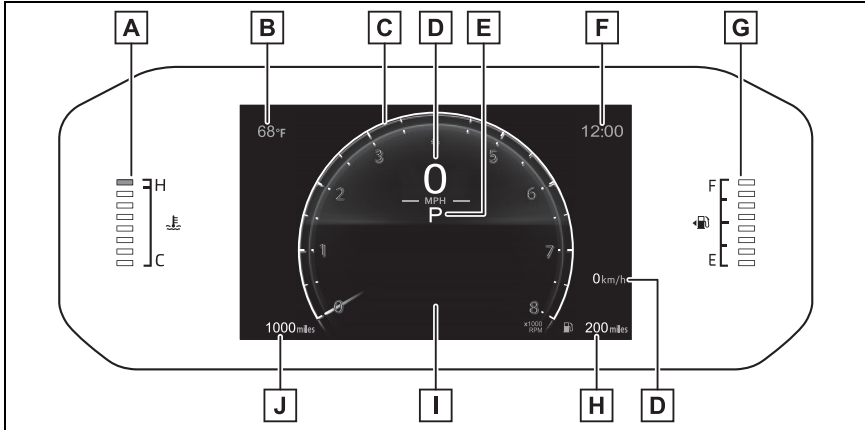

The units used on the meter and display may differ depending on the target region.

**A** Engine coolant temperature gauge

Displays the engine coolant temperature

**B** Outside temperature (→P.90)

**C** Tachometer/Analog speedometer (→P.101)

Tachometer:

Displays the engine speed in revolutions per minute

Analog speedometer:

Displays the vehicle speed

**D** Digital speedometer

Displays the vehicle speed

**E** Shift position and gear position

Displays the selected shift position or selected gear position (→P.227)

**F** Clock

The GPS clock's time is automatically adjusted by utilizing GPS time information. For details, refer to the "MULTIMEDIA OWNER'S MANUAL".

**G** Fuel gauge

Displays the quantity of fuel remaining in the tank

**H** Distance to empty

Displays the driving range with remaining fuel

**I** Multi-information display

Presents the driver with a variety of driving-related data (→P.96)

Displays warning messages if a malfunction occurs (→P.598)

**J** Odometer

Displays the total distance that the vehicle has been driven

**■ The meters and display illuminate when**

The power switch is in ON.

**■ Engine speed**

On hybrid electric vehicles, engine speed is precisely controlled in order to help improve fuel efficiency and reduce exhaust emissions etc. There are times when the engine speed that is displayed may differ even when vehicle operation and driving conditions are the same.

**■ Distance to empty**

- This distance is computed based on your average fuel consumption. As a result, the actual distance that can be driven may differ from that displayed.
- When only a small amount of fuel is added to the tank, the display may not be updated. When refueling, turn the power switch off. If the vehicle is refueled without turning the power switch off, the display may not be updated.
- When "Refuel" is displayed, the remaining fuel amount is low and the distance that can be driven with the remaining fuel cannot be calculated. Refuel immediately.

**■ Outside temperature display**

- In the following situations, the correct outside temperature may not be displayed, or the display may take longer than normal to change.
  - When stopped, or driving at low speeds (less than 12 mph [20

km/h])

- When the outside temperature has changed suddenly (at the entrance/exit of a garage, tunnel, etc.)
- When "--" or "E" is displayed, the system may be malfunctioning. Take your vehicle to your Toyota dealer.
- Displays the outside temperature within the range of -40°F (-40°C) to 140°F (60°C).
- When the outside temperature is approximately 37°F (3°C) or lower, the indicator  will flash for approximately 10 seconds, then stay on.

**■ Liquid crystal display**

→P.97

**■ Free/Open Source Software Information**

This product contains Free/Open Source Software (FOSS). The license information and/or the source code of such FOSS can be found at the following URL.

<https://www.yazaki-group.com/rd-tech/oss/860>

**⚠ WARNING****■ The information display at low temperatures**

Allow the interior of the vehicle to warm up before using the liquid crystal information display. At extremely low temperatures, the display monitor may respond slowly, and display changes may be delayed.

For example, there is a lag between the driver's shifting and the new gear number appearing on the display. This lag could cause the driver to downshift again, causing rapid and excessive engine braking and possibly an accident resulting in death or injury.

**⚠ NOTICE****■ To prevent damage to the engine and its components**

- Do not let the indicator needle of the tachometer enter the red zone, which indicates the maximum engine speed.
- The engine may be overheating if the engine coolant temperature gauge is in the red zone ("H"). In this case, immediately stop the vehicle in a safe place, and check the engine after it has cooled completely. (→P.625)

**Changing the instrument panel light brightness**

The brightness of the instrument panel lights can be adjusted.

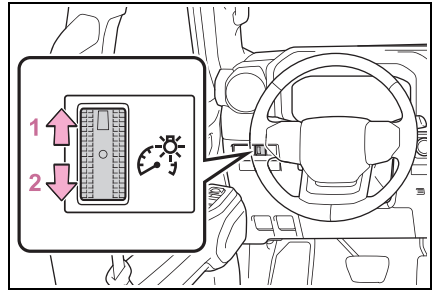

- 1 Brighter
- 2 Darker

**■ Brightness of the meter lights (day mode and night mode)**

The brightness of the meter lights can be adjusted individually.

In the following situations, the meters changes between day mode and night mode.

- Day mode: When the tail lights are off or when the tail lights are on but the surrounding area is bright
- Night mode: When the tail lights are on and the surrounding area is dark

**■ Instrument panel light dimming control**

When the tail lights are turned on while the power switch is in ACC, or while the power switch is in ON and the surrounding area is dark, the meter will be dimmed.

However, if the instrument panel light control dial is set to the brightest position while the power switch is in ON, the meter will not be dimmed.

## Gauges and meters (12.3-inch display)

The meters display various drive information.

### Meter display

#### ■ Locations of gauges and meters

The meter display type setting can be changed. (→P.112)

#### ▶ Type 1/Type 3

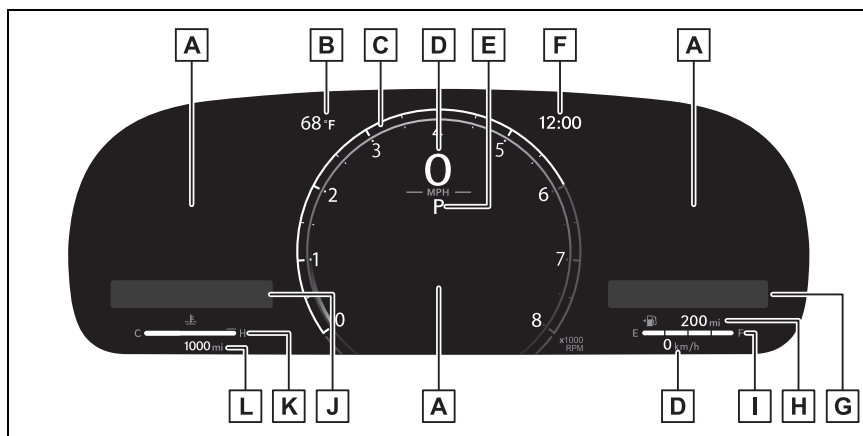

The units of measure may differ depending on the intended destination of the vehicle.

#### **A** Multi-information display

Presents the driver with a variety of vehicle data (→P.106)

Displays warning messages if a malfunction occurs (→P.598)

#### **B** Outside temperature (→P.94)

#### **C** Analog meter (Type 1 only)

Analog meter can be changed on the settings. (→P.112)

Tachometer:

Displays the engine speed in revolutions per minute

Analog speedometer:

Displays the vehicle speed

#### **D** Digital speedometer

Displays the vehicle speed.

#### **E** Shift position and gear position

Displays the selected shift position or selected gear position (→P.227)

### **F** Clock

The GPS clock's time is automatically adjusted by utilizing GPS time information. For details, refer to the "MULTIMEDIA OWNER'S MANUAL".

### **G** Widget (Audio system-linked display)

Displays the selected audio source or track on the meter. (→P.110)

While list of items for content display area (→P.108) is displayed, widget will not be displayed.

### **H** Distance to empty

Displays the driving range with remaining fuel (→P.94)

### **I** Fuel gauge

Displays the quantity of fuel remaining in the tank.

### **J** Widget (Fuel economy)

Displays fuel economy information. (→P.109)

While list of items for content display area (→P.108) is displayed, widget will not be displayed.

### **K** Engine coolant temperature gauge

Displays the engine coolant temperature

### **L** Odometer display

Displays the total distance that the vehicle has been driven

### ► Type 2

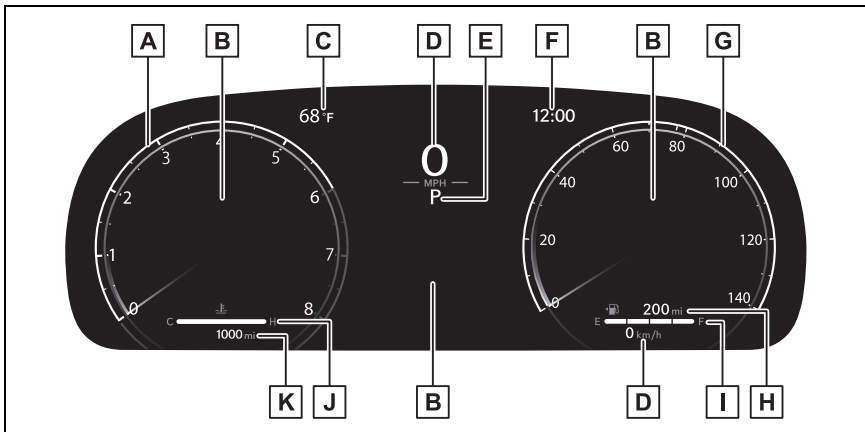

The location of some displayed items and the units of measure may differ depending on the intended destination of the vehicle.

### **A** Tachometer

Displays the engine speed in revolutions per minute

**B** Multi-information display

Presents the driver with a variety of vehicle data (→P.106)

Displays warning messages if a malfunction occurs (→P.598)

**C** Outside temperature (→P.94)

**D** Digital speedometer

Displays the vehicle speed

**E** Shift position and gear position (→P.227)

**F** Clock

The GPS clock's time is automatically adjusted by utilizing GPS time information. For details, refer to the "MULTIMEDIA OWNER'S MANUAL".

**G** Analog speedometer

Displays the vehicle speed

**H** Distance to empty

Displays the driving range with remaining fuel (→P.94)

**I** Fuel gauge

Displays the quantity of fuel remaining in the tank.

**J** Engine coolant temperature gauge

Displays the engine coolant temperature

**K** Odometer display

Displays the total distance that the vehicle has been driven

---

**■ The meters and display illuminate when**

The power switch is in ON.

**■ Engine speed**

On hybrid electric vehicles, engine speed is precisely controlled in order to help improve fuel efficiency and reduce exhaust emissions etc. There are times when the engine speed that is displayed may differ even when vehicle operation and driving conditions are the same.

**■ Distance to empty**

- This distance is computed based on your average fuel consumption. As a result, the actual distance that can be driven may

differ from that displayed.

- When only a small amount of fuel is added to the tank, the display may not be updated. When refueling, turn the power switch off. If the vehicle is refueled without turning the power switch off, the display may not be updated.
- When "Refuel" is displayed, the remaining fuel amount is low and the distance that can be driven with the remaining fuel cannot be calculated. Refuel immediately.
- **Outside temperature display**
- Displays the outside temperature within the range of -40°F (-40°C) to 140°F (60°C).

- When the outside temperature is approximately 37°F (3°C) or lower, the indicator  will flash for approximately 10 seconds, then stay on.
- In the following situations, the correct outside temperature may not be displayed, or the display may take longer than normal to change:
  - When stopped, or driving at low speeds (less than 12 mph [20 km/h])
  - When the outside temperature has changed suddenly (at the entrance/exit of a garage, tunnel, etc.)
- When “--” or “E” is displayed, the system may be malfunctioning. Take your vehicle to your Toyota dealer.

#### ■ Liquid crystal display

→P.107

#### ■ Free/Open Source Software Information

This product contains Free/Open Source Software (FOSS). The license information and/or the source code of such FOSS can be found at the following URL.

<https://www.yazaki-group.com/rd-tech/oss/880>

#### ■ Customization

The gauges and meters can be customized on  of the multi-information display. (→P.112)

### WARNING

#### ■ The information display at low temperatures

Allow the interior of the vehicle to warm up before using the liquid crystal information display. At extremely low temperatures, the information display monitor may respond slowly, and display changes may be delayed.

For example, there is a lag between the driver's shifting and the new gear number appearing on the display. This lag could cause the driver to downshift again, causing rapid and excessive engine braking and possibly an accident resulting in death or injury.

### NOTICE

#### ■ To prevent damage to the engine and its components

- Do not let the indicator needle of the tachometer enter the red zone, which indicates the maximum engine speed.
- The engine may be overheating if the engine coolant temperature gauge is in the red zone (H). In this case, immediately stop the vehicle in a safe place, and check the engine after it has cooled completely. (→P.625)

### Changing the instrument panel light brightness

The brightness of the instrument panel lights can be adjusted.

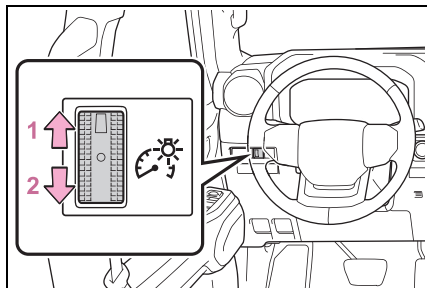

- 1 Brighter
- 2 Darker

### ■ Brightness of the meter lights (day mode and night mode)

The brightness of the meter lights can be adjusted individually.

In the following situations, the meters changes between day mode and night mode.

- Day mode: When the tail lights are off or when the tail lights are on but the surrounding area is bright
- Night mode: When the tail lights are on and the surrounding area is dark

### ■ Instrument panel light dimming control

When the tail lights are turned on while the power switch is in ACC, or while the power switch is in ON and the surrounding area is dark, the meter will be dimmed.

However, if the instrument panel light control dial is set to the brightest position while the power switch is in ON, the meter will not be dimmed.

## Multi-information display (7-inch display)

### Display contents

Following information is displayed on the multi-information display.

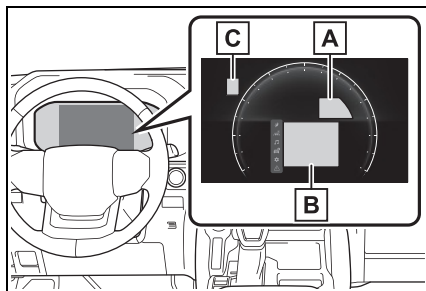

**A** Driving support system information

**B** Information display area

A variety of information can be displayed by selecting a menu icon.

Additionally, warning or suggestion/advice pop-up displays will be displayed in some situations.

**C** RSA (Road Sign Assist) display area (if equipped)

Displays recognized signs while the RSA (Road Sign Assist) is operating. (→P.302)

### ■ The multi-information display is displayed when

The power switch is in ON.

### ■ When changing driving mode

Background color of the multi-information display is changed following the selected driving mode or Multi-terrain Select mode. (→P.433, 442)



### ■ Liquid crystal display

Small spots or light spots may appear on the display. This phenomenon is characteristic of liquid crystal displays, and there is no problem continuing to use the display.

### Changing the display

The multi-information display is operated using the meter control switches.

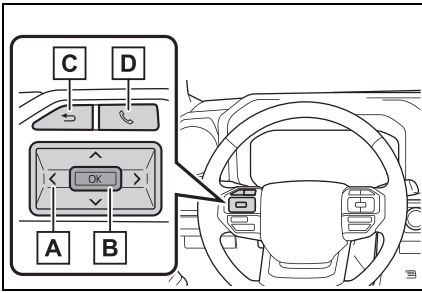

- A** < / > : Change the screen and move the cursor up/down  
 ^ / v : Change displayed content and scroll up/down the screen
- B** Press: Enter/Set  
 Press and hold: Reset
- C** Return to the previous screen
- D** Call sending/receiving and history display

Linked with the hands-free system, sending or receiving call is displayed. For details regarding the hands-free system, refer to the "MULTIMEDIA OWNER'S MANUAL".

### ⚠ WARNING

#### ■ Caution for use while driving

For safety, avoid operating the meter control switch while driving as much as possible, and do not look continuously at the multi-information display while driving. Stop the vehicle and operate the meter control switch. Failure to do so may cause a steering wheel operation error, resulting in an unexpected accident.

### Menu icons

Information related to each icon can be displayed by selecting the icon with the meter control switches.

Some of the information may be displayed automatically depending on the situation.

Icon	Display
	Driving information display (→P.98)
	Driving support system information display (→P.98)
	Audio system-linked display (→P.98)
	Vehicle information display (→P.99)
	Settings display (→P.101)
	Warning message display (→P.105)

## Driving information display

Select to display fuel consumption data in various forms.

### ■ Fuel Economy

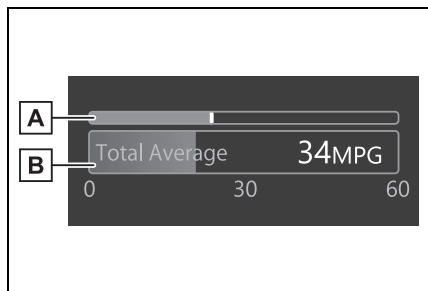

#### **A** Current fuel consumption

Displays the instantaneous current fuel consumption.

#### **B** Average fuel economy (after start)

Displays the average fuel economy since the function was reset or the average fuel economy after starting. \*1, 2, 3

The average fuel economy selected by “Fuel Economy” on the  screen is displayed.

\*1: Use the displayed fuel consumption as a reference only.

\*2: Average fuel economy after starting is reset each time the hybrid system stops.

\*3: Average fuel economy since the function was reset can be reset by pressing and holding OK .

## Driving support system information display

### ■ Driving support system information display

Select to display the operational status of the following systems:

- LTA (Lane Tracing Assist) (→P.280)
- LCA (Lane Change Assist) (if equipped) (→P.285)
- LDA (Lane Departure Alert) (→P.288)
- PDA (Proactive driving assist) (→P.294)
- Dynamic radar cruise control (→P.305)
- Cruise control (→P.316)

### ■ Navigation system-linked display (if equipped)

Select to display the following navigation system-linked information.

- Route guidance
- Compass display

## Audio system-linked display

The operating conditions of the audio system can be displayed on the multi-information display.

## Vehicle information display

### ■ Drive information

2 items that are selected using the “Drive Info Item” setting (average speed and distance) can be displayed vertically.

Use the displayed information as a reference only.

- Average vehicle speed: Displays the average vehicle speed since hybrid system start\*
- Distance: Displays the distance driven since hybrid system start\*
- Elapsed time: Displays elapsed time since hybrid system start\*

\*: These items are reset each time the hybrid system stops.

### ■ Trip information

2 items that are selected using the “TRIP A” or “TRIP B” setting (average speed and distance) can be displayed vertically.

Use the displayed information as a reference only.

- Average vehicle speed: Displays the average vehicle speed since the display was reset\*
- Distance: Displays the distance driven since the display was reset\*

- Elapsed time: Displays elapsed time since the display was reset\*

\*: To reset, display the desired item and press and hold OK.

### ■ Tire inflation pressure

Displays inflation pressure of each tire. (→P.554)

### ■ Traction monitor display

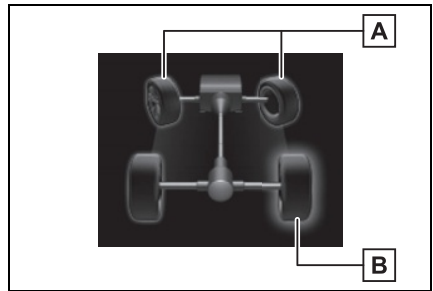

#### ■ A Front tire direction display

Displays the operation amount and direction of the steering wheel via changes to the front tires on the display.

#### ■ B Wheel spin display\*

When a tire is spinning, its icon on the display changes its color and blinks.

\*: This item is displayed only when driving mode is set to sport mode.

### ■ Pitch & Roll (Inclinometer display)

Displays the vertical and horizontal tilt angles of the vehicle.

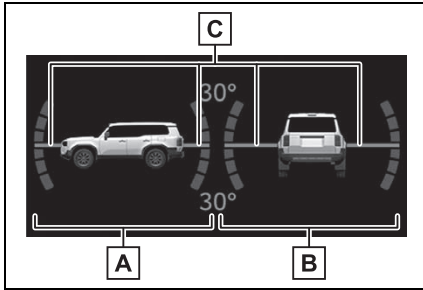

**A** Degree markers of incline to the front and rear

Indicates the vehicle inclination in degrees in the front and rear directions.

**B** Degree markers of incline to the left and right

Indicates the vehicle inclination in degrees in the left and right directions.

**C** Pointer

Indicates the degree of the vehicle inclination in comparison to a parallel line.

■ **Trailer brake controller**

Displays “Gain” values, manual brake outputs, trailer brake types, and the trailer connection status. (→P.453)

■ **Auxiliary Gauges**



**A** Voltmeter

Displays the charge state.

**B** Engine oil pressure gauge

Displays the engine oil pressure. A buzzer will sound and warning message will be displayed if the engine oil pressure becomes low. (→P.588)

This display is intended for use as a guideline. Depending on factors such as the road surface condition, temperature and vehicle speed, the display may not show the actual condition of the vehicle.

■ **Engine oil temperature gauge/transmission oil temperature gauge**

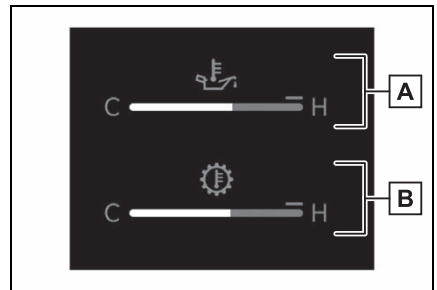

**A** Engine oil temperature gauge

Displays the engine oil temperature. The display will flash if the engine oil temperature exceeds 284°F (140°C).

**B** Transmission oil temperature gauge

Displays transmission oil fluid temperature.

■ **Boost gauge**

Displays the boost pressure.

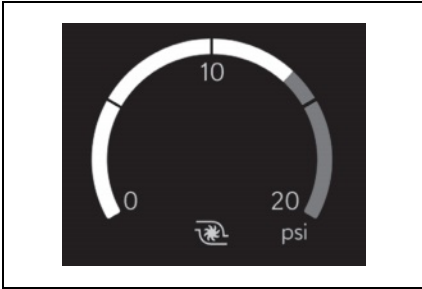

This display is intended for use as a guideline. Depending on factors such as the road surface condition, temperature and vehicle speed, the display may not show the actual condition of the vehicle.

### ■ Electric Boost Gauge/SOC (State of Charge) gauge

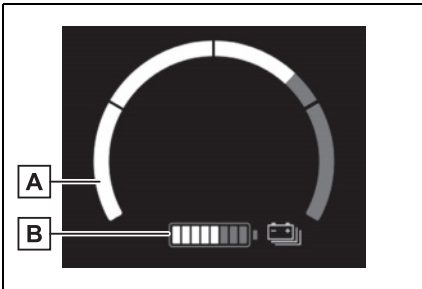

#### **A** Electric Boost Gauge

Shows that the power of the motor assists the engine.

#### **B** SOC (State of Charge) gauge

Displays the current amount of charge remaining in the 12-volt battery.

### NOTICE





#### Voltmeter

When the voltmeter indicates 19 V or higher or 9 V or lower while the engine is running, there may be a battery or charging system malfunction. Have the vehicle inspected at your Toyota dealer.

## Settings display

Vehicle settings and the content displayed on the screen can be changed by using the meter control switches

### ■ Setting procedure

- 1 Operate  or  of the meter control switches and select .
- 2 Operate  or  of the meter control switches and select the desired item.
  - If the function is turned on and off or the volume, etc. is changed on the setting screen, the setting is changed each time OK is pressed.
  - For functions that allow operation contents, display contents, etc., of function to be selected, the setting screen is displayed by pressing and holding OK. When the setting screen is displayed, select the setting or desired value (time, etc.) with OK.

- 3 After changing the settings, press  of the meter control switches.

■  **LDA (Lane Departure Alert) (→P.288)**

Select to set up the following items.

- Lane Departure Alert on/off

Select to enable/disable Lane Departure Alert system.

- “Alert Options”

Select to set the alert type.

- “Alert Timing”

Select to set the alert timing.

■  **BSM (Blind Spot Monitor) (→P.328)**

Select to set up the following items.

- BSM (Blind Spot Monitor) on/off

Select to enable/disable the BSM system.

- “Sensitivity”

Select to change the alert timing for an approaching vehicle.

- “Brightness”

Select to switch the brightness of the outside rear view mirror indicators. (→P.328)

- Buzzer warning

Select to enable/disable the buzzer alert which sounds when BSM system is operated.

■  **PCS (Pre-Collision System) (→P.268)**

Select to set up the following items.

- PCS on/off

Select to enable/disable the pre-collision system.

- “Warning timing”

Select to change the pre-collision warning timing.

■  **PDA (Proactive driving assist) (→P.294)**

Select to set up the following items.

- PDA on/off

Select to enable/disable the Proactive driving assist.

- “Sensitivity”

Select to change the alert timing for a detected object.

- “SA” (Steering Assist)

Select to enable/disable the Steering Assist function.

- “DA” (Deceleration Assist)

Select to enable/disable the Deceleration Assist function.

- “OAA” (Obstacle Anticipation Assist)

Select to enable/disable the Obstacle Anticipation Assist function.

■  **Intuitive parking assist (→P.337)**

Select to set up the following items.

- Intuitive parking assist on/off

Select to enable/disable the intuitive parking assist.

- “Volume”

Select to set the volume of the buzzer which sounds when the RCTA, the RCD (if equipped) or the intuitive parking assist function is operated.

### ■ **RCTA (Rear Cross Traffic Alert) (→P.343)**

- RCTA (Rear Cross Traffic Alert) on/off

Select to enable/disable the RCTA system.

- “Volume”

Select to set the volume of the buzzer which sounds when the RCTA, the RCD (if equipped) or the intuitive parking assist function is operated.

### ■ **RCD (Rear Camera Detection) (if equipped) (→P.349)**

Select to enable/disable the Rear Camera Detection function.

### ■ **SEA (Safe Exit Assist) (→P.333)**

- Safe Exit Assist on/off

Select to enable/disable the Safe Exit Assist system.

- “Sensitivity”

Select to change the alert timing for a vehicle or bicycle.

- Mirror indicate on/off

Select to enable/disable the outside rear view mirrors display.

### ■ **RSA (Road Sign Assist) (if equipped) (→P.302)**

Select to set up the following items.

- Road Sign Assist on/off

Select to enable/disable the RSA system.

- “Notification Method”

Select to change each notification method used to notify the driver when the system recognizes excess speed, no overtaking and no-entry sign.

- “Notification Level”

Select to change each notification level used to notify the driver when the system recognizes a speed limit sign.

### ■ **Vehicle Settings**

- Driver Break Suggestion

Select to enable/disable the drive break suggestion. (→P.291)

-  DRCC (→P.305)

Select to set up the following items.

- “Acceleration Setting”

Select to change the setting for when vehicle accelerates until the set vehicle speed is reached.

- “Guide message”

Select to enable/disable the guide message display.

- “Curve Speed Reduction”

Select to change the curve speed reduction function setting. (→P.322)

-  PBD (Power Back Door) (if equipped) (→P.134)

Select to set up the following items.

- System settings

Select to enable/disable the power back door system.

- “Opening Adjustment”

Select the open position when power back door is fully open.

- “Volume”

Select to set the volume of the buzzer which sounds when the power back door system operates.

- “Select Brake Type”

Select to change the settings of the trailer brake type. (→P.454)

- “TPWS” (Tire Pressure Warning System) (→P.554)

- “Tire Set Switching”

Select to change the tire pressure warning system sensor ID code set. To enable this function, a second set of tire pressure warning system sensor ID codes must be registered by a Toyota dealer. For information regarding changing the registered ID code set, contact your Toyota dealer.

- “Tire Rotation”

Registration of the position of each wheel. (→P.556)

- “Tire Pressure Setting”

Select to set a specified tire inflation pressure. (→P.557)

- “Pressure unit setting”

Select to change the units of measure displayed.

- “Scheduled Maintenance”

(→P.533)

Select to reset the scheduled maintenance information (message indicating maintenance is required and distance until the next maintenance) after all maintenance is performed.

- Oil Maintenance (→P.544)

Select to reset the Oil maintenance.

- Rear Seat Reminder (→P.131)

Select to enable/disable the rear seat reminder function.

- Stop light indicator

Select to enable/disable stop light indicator. (→P.88)

## ■ Settings

- “Language”

Select to change the language on the multi-information display.

- “Units”

Select to change the unit of measure for fuel consumption.

- Meter Style

Select to change the meter style.

- Dial Type

Select to change dial type. (→P.89)

-  (Driving information display settings)

Select to set up the following items.

- “Fuel Economy”

Select to change the display on Fuel Economy. (→P.98)

-  (Audio settings)

Select to enable/disable 



screen.

-  (Vehicle information display settings)

- “Display Contents”

Select to display the following items.

- “Drive Info Items”

Select to set the items on the upper and lower side of the drive information screen from three items, average speed, distance and total time.

- Pop-Up Display

Select to enable/disable the pop-up displays, which may appear in some situations.

- “MID OFF”

A blank screen is displayed

- “Default Settings”

Select to reset the meter display settings.

### ■ Suspension of the settings display

- Some settings cannot be changed while driving. When changing settings, park the vehicle in a safe place.
- If a warning message is displayed, operation of the settings display will be suspended.
- Settings for functions not equipped to the vehicle are not displayed.
- When a function is turned off, the related settings for that function are not selectable.

### WARNING

#### ■ Cautions during setting up the display

As the engine needs to be running during setting up the display, ensure that the vehicle is parked in a place with adequate ventilation. In a closed area such as a garage, exhaust gases including harmful carbon monoxide (CO) may collect and enter the vehicle. This may lead to death or a serious health hazard.

### NOTICE

#### ■ During setting up the display

To prevent battery discharge, ensure that the engine is running while setting up the display features.

### Warning message display

Select to display warning messages and measures to be taken if a malfunction is detected. (→P.598)

### Suggestion function

Displays suggestions to the driver in the following situations. To select a response to a displayed suggestion, use the meter control switches.

#### ■ Suggestion to turn on the headlights

If the headlight switch is in other than  or AUTO, and the vehicle speed is 3 mph (5 km/h) or higher for a certain amount of time when the surroundings are

dark, a suggestion message will be displayed.

### ■ Suggestion to turn off the headlights

If the headlights are left on for a certain amount of time after the power switch has been turned off, a suggestion message will be displayed.

### ■ Suggestion to enable the power back door (if equipped)

If the power back door system is disabled (setting on  set to off) and the power back door switch on the instrument panel is operated, a suggestion message will be displayed asking if you wish to enable the power back door system.

### ■ Customization

The suggestion function can be turned on/off. (Customizable features: →P.649)

Multi-information display (12.3-inch display)

**The multi-information display is used to display fuel efficiency related information and various types of driving-related information. The multi-information display can also be used to change the display settings and other settings.**

### Display contents

Following information is displayed in each area on the multi-information display.

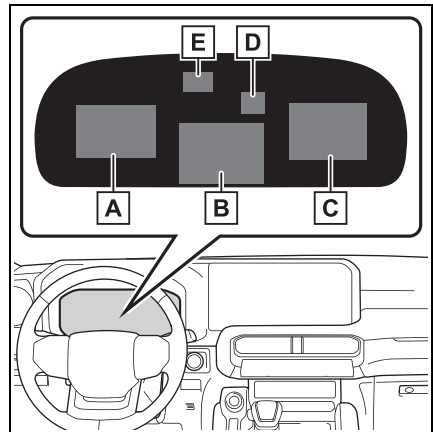

- A** Content display area (left)
- B** Content display area (center)
- C** Content display area (right)
- D** Driving support system information display area

When driving information support

system is displayed on the content display area, the system operating state will not be displayed in this area.

**E** RSA (Road Sign Assist) display area (if equipped)  
(→P.302)

### ■ Content display area (center)

- Blank (→P.112)
- Driving support system information display (→P.109)
- Map display (if equipped) (→P.109)
- Settings display (→P.112)
- Warning message display

### ■ Content display area (left/right)

- Blank (→P.112)
- Fuel Economy (→P.109)
- Driving support system information display (→P.109)
- Navigation system-linked information display (if equipped) (→P.109)
- Audio system-linked display (→P.110)
- Drive information display (→P.110)
- Tire inflation pressure (→P.557)
- Traction monitor (→P.112)
- Pitch & Roll (Inclinometer display) (→P.110)
- Trailer brake controller

(→P.111)

- Auxiliary Gauges (→P.111)
- Engine oil temperature/transmission oil temperature (→P.111)
- Boost gauge (→P.112)
- Electric Boost Gauge/SOC (State of Charge) gauge (→P.112)

### ■ Liquid crystal display

Small spots or light spots may appear on the display. This phenomenon is characteristic of liquid crystal displays, and there is no problem continuing to use the display.

### ■ When changing driving mode

Background color of the multi-information display is changed following the selected driving mode.  
(→P.433)

### WARNING

#### ■ Caution for use while driving

- When operating the multi-information display while driving, pay extra attention to the safety of the area around the vehicle.
- Do not look continuously at the multi-information display while driving as you may fail to see pedestrians, objects on the road, etc. ahead of the vehicle.

#### ■ The information display at low temperatures

→P.95

## Meter control switches

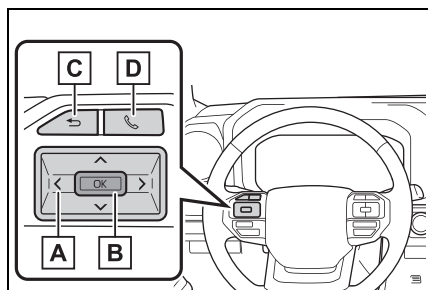

- A** < / > : Change the screen and move the cursor up/down  
 ^ / v : Change displayed content and scroll up/down the screen
- B** Press: Enter/Set  
 Press and hold: Reset
- C** Return to the previous screen
- D** Call sending/receiving and history display

Linked with the hands-free system, sending or receiving call is displayed. For details regarding the hands-free system, refer to the "MULTIMEDIA OWNER'S MANUAL".

## Changing the display

The multi-information display is operated using the meter control switches.

### ■ Changing the meter display type setting

The meter display type setting can be changed on .  
 (→P.112)

### ■ Changing the screen

Select items from the combination of 3 screens to display on each 3 content display areas.

Press < or > of the meter control switch to scroll the screen.

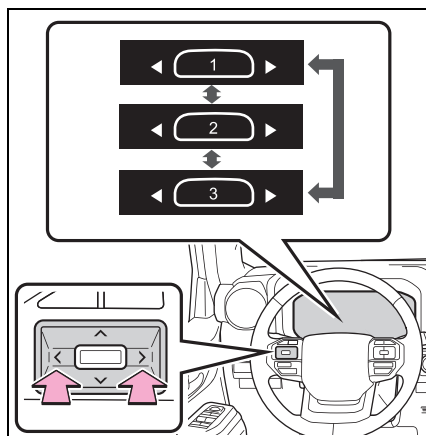

### ■ Changing the display contents

Switches items displayed on each contents display area (left/center/right).

- 1 Press and hold OK to display the cursor on the content display area (center).
- 2 Press < or > to move the cursor and select the content display area.
- 3 Press ^ or v to select the items.

### ■ Items displayed in the content display area

Select to enable/disable items on the content display area

(left/right).

- 1 Press and hold OK to display the cursor on the content display area (center).
- 2 Press < or > to move the cursor and select the content display area.
- 3 Contents display area (left):  
Press < to display contents list.  
Contents display area (right):  
Press > to display contents list.
- 4 Press ^ or v to select the items.
- 5 Press OK to select enable/disable items.

## Fuel Economy

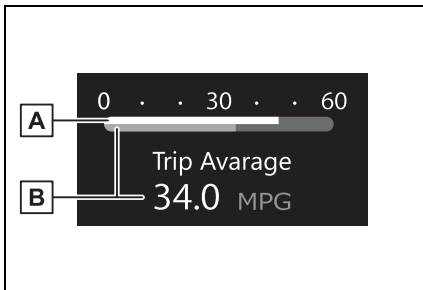

- A** Current fuel economy  
Displays the driving range with remaining fuel.
- B** Average fuel economy  
Displays the average fuel economy since the function was reset or the average fuel economy after starting or refueling. <sup>\*1, 2, 3</sup>

The average fuel economy selected by “Fuel Economy” on the  screen is displayed.

<sup>\*1</sup>: Use the displayed fuel consumption as a reference only.

<sup>\*2</sup>: Average fuel economy after starting is reset each time the hybrid system stops.

<sup>\*3</sup>: Average fuel economy since the function was reset can be reset by pressing and holding OK .

## Driving support system information display

Select to display the operational status of the following systems:

- LTA (Lane Tracing Assist) (→P.280)
- LDA (Lane Departure Alert) (→P.288)
- PDA (Proactive driving assist) (→P.294)
- Cruise control (→P.316)
- Dynamic radar cruise control (→P.305)

## Map display (if equipped)

Displays the map data according to the navigation system. Switches the displayed map size by pressing OK .

## Navigation system-linked display (if equipped)

Select to display the following

navigation system-linked information.

- Route guidance to destination
- Street name
- Compass display

### Audio system-linked display

The operating conditions of the audio system can be displayed on the multi-information display.

### Driving information display

#### ■ Drive information

2 items that are selected using the “Drive Info Items” setting (average speed and distance) can be displayed vertically.

Use the displayed information as a reference only.

- “Average Speed”: Displays the average vehicle speed since hybrid system start<sup>\*</sup>
- “Distance”: Displays the distance driven since hybrid system start<sup>\*</sup>
- “Total Time”: Displays elapsed time since hybrid system start<sup>\*</sup>

<sup>\*</sup>: These items are reset each time the hybrid system stops.

#### ■ Trip information

2 items that are selected using the “TRIP A Items” or “TRIP B

Items” setting (average speed and distance) can be displayed vertically.

Use the displayed information as a reference only.

- “Average Speed”: Displays the average vehicle speed since the display was reset<sup>\*</sup>
- “Distance”: Displays the distance driven since the display was reset<sup>\*</sup>
- “Total Time”: Displays elapsed time since the display was reset<sup>\*</sup>

<sup>\*</sup>: To reset, display the desired item and press and hold OK.

### Pitch & Roll (Inclinometer display)

Displays the vertical and horizontal tilt angles of the vehicle.

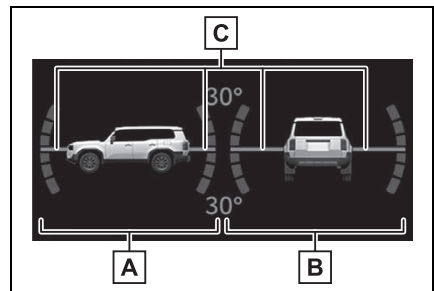

**A** Degree markers of incline to the front and rear

Indicates the vehicle inclination in degrees in the front and rear directions.

**B** Degree markers of incline to the left and right

Indicates the vehicle inclination in degrees in the left and right directions.

### C Pointer

Indicates the degree of the vehicle inclination in comparison to a parallel line.

## Auxiliary Gauges

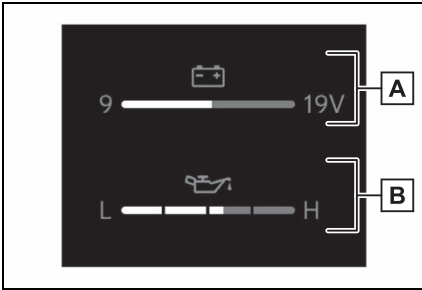

### A Voltmeter

Displays the charge state.

### B Engine oil pressure gauge

Displays the engine oil pressure. A buzzer will sound and warning message will be displayed if the engine oil pressure becomes low. (→P.588)

This display is intended for use as a guideline. Depending on factors such as the road surface condition, temperature and vehicle speed, the display may not show the actual condition of the vehicle.

## ⚠ NOTICE

### ■ Voltmeter

When the voltmeter indicates 19 V or higher or 9 V or lower while the engine is running, there may be a battery or charging system malfunction. Have the vehicle inspected at your Toyota dealer.

## Trailer brake controller

Displays “Gain” values, manual brake outputs, trailer brake types, and the trailer connection status. (→P.453)

## Engine oil temperature gauge/transmission oil temperature gauge

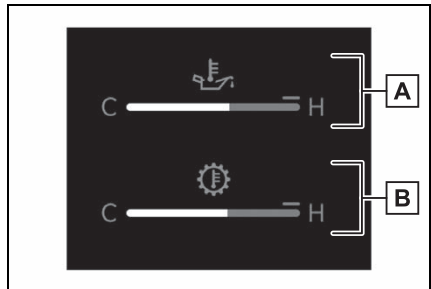

### A Engine oil temperature gauge

Displays the engine oil temperature. The display will flash if the engine oil temperature exceeds 284°F (140°C).

### B Transmission oil temperature gauge

Displays transmission oil fluid temperature.

### Boost gauge

Displays the boost pressure.

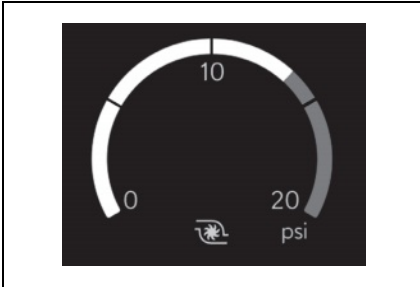

This display is intended for use as a guideline. Depending on factors such as the road surface condition, temperature and vehicle speed, the display may not show the actual condition of the vehicle.

### Electric Boost Gauge/SOC (State of Charge) gauge

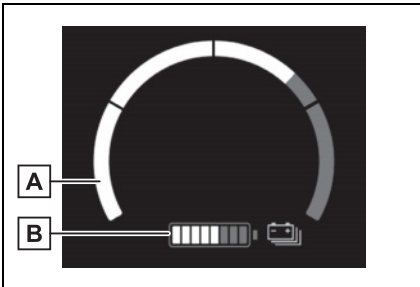

#### A Electric Boost Gauge

Shows that the power of the motor assists the engine.

#### B SOC (State of Charge) gauge

Displays the current amount of charge remaining in the 12-volt battery.

### Tire inflation pressure

→P.557

### Traction monitor

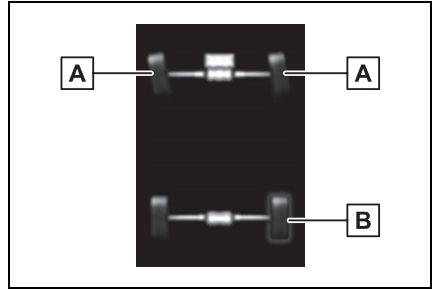

#### A Front tire direction display

Displays the operation amount and direction of the steering wheel via changes to the front tires on the display.

#### B Wheel spin display \*

When a tire is spinning, its icon on the display changes its color and blinks.

\*: This item is displayed only when driving mode is set to sport mode.

### Blank (No items)

Displays no drive information contents on the multi-information display.

### Settings display

Vehicle settings and the content displayed on the screen can be changed by using the meter control switches.



## ■ Setting procedure

- 1 Press **OK** to display the cursor on the content display area (center).
- 2 Press **▲** or **▼** with the cursor on the content display area (center), then select .
- 3 Press **▲** or **▼** of the meter control switch and move the cursor to select the item for changing settings.

If the function is turned on and off or the volume, etc. is changed on the setting screen, the setting is changed each time is pressed **OK**. For functions that allow operation contents, display contents, etc., of function to be selected, the setting screen is displayed by pressing and holding **OK**. When the setting screen is displayed, select the setting or desired value (time, etc.) with **OK**.

- 4 After changing the settings, press **↩** of the meter control switches.

### ■ **LDA (Lane Departure Alert)** (→P.288)

Select to set up the following items.

- Lane Departure Alert on/off

Select to enable/disable Lane Departure Alert system.

- “Alert Options”

Select to set the alert type.

- “Sensitivity”

Select to set the warning sensitivity.

### ■ **BSM (Blind Spot Monitor)** (→P.328)

Select to set up the following items.

- BSM (Blind Spot Monitor) on/off

Select to enable/disable the BSM system.

- “Sensitivity”

Select to change the alert timing for an approaching vehicle.

- “Brightness”

Select to switch the brightness of the outside rear view mirror indicators. (→P.328)

- Buzzer warning

Select to enable/disable the buzzer warning when BSM system is operated.

### ■ **PCS (Pre-Collision System)** (→P.268)

Select to set up the following items.

- PCS on/off

Select to enable/disable the pre-collision system.

- “Warning timing”

Select to change the pre-collision warning timing.

### ■ **PDA (Proactive driving assist)** (→P.294)

Select to set up the following items.

- PDA on/off

Select to enable/disable the Proactive driving assist.

- “Sensitivity”

Select to change the alert timing for a detected object.

- “SA” (Steering Assist)

Select to enable/disable the Steering Assist function.

- “DA” (Deceleration Assist)

Select to enable/disable the Deceleration Assist function.

- “OAA” (Obstacle Anticipation Assist)

Select to enable/disable the Obstacle Anticipation Assist function.

### ■ Intuitive parking assist (→P.337)

Select to set up the following items.

- Intuitive parking assist on/off

Select to enable/disable the intuitive parking assist.

- “Volume”

Select to set the volume of the buzzer which sounds when the RCTA, the RCD (if equipped) or intuitive parking assist function is operated.

### ■ RCTA (Rear Cross Traffic Alert) (→P.343)

Select to set up the following items.

- RCTA (Rear Cross Traffic Alert) on/off

Select to enable/disable the RCTA system.

- “Volume”

Select to set the volume of the buzzer which sounds when the RCTA, the RCD (if equipped) and the intuitive parking assist is operated.

### ■ RCD (Rear Camera Detection) function (if equipped) (→P.349)

Select to enable/disable the Rear Camera Detection function.

### ■ SEA (Safe Exit Assist) (→P.333)

Select to set up the following items.

- Safe Exit Assist on/off

Select to enable/disable the Safe Exit Assist system.

- “Sensitivity”

Select to change the alert timing for a vehicle or bicycle.

- Mirror indicate on/off

Select to enable/disable the outside rear view mirrors display.

### ■ RSA (Road Sign Assist) (if equipped) (→P.302)

- Road Sign Assist on/off

Select to enable/disable the RSA (Road Sign Assist).

- “Notification Method”

Select to change each notification method used to notify the driver when the system recognizes excess speed and Do Not Enter

sign.

- “Notification Level”

Select to change each notification level used to notify the driver when the system recognizes a speed limit sign.

## ■ Vehicle Settings

- Driver Break Suggestion

(→P.291)

Select to enable/disable the drive break suggestion.

-  DRCC (→P.305)

Select to set up the following items.

- “Acceleration Setting”

Select to change the setting for when vehicle accelerates until the set vehicle speed is reached.

- “Guide message”

Select to enable/disable the guide message display.

- “Curve Speed Reduction”

Select to change the curve speed reduction function setting.  
(→P.322)

-  PBD (Power Back Door)  
(if equipped) (→P.134)

Select to set up the following items.

- System settings

Select to enable/disable the power back door system.

- “Opening Adjustment”

Select the open position when power back door is fully open.

- “Volume”

Select to set the volume of the buzzer which sounds when the

power back door system operates.

- “Select Brake Type”

Select to change the settings of the trailer brake type. (→P.454)

- “TPWS setting” (Tire Pressure Warning System)  
(→P.554)

- “Tire Set Switching”

Select to change the tire pressure warning system sensor ID code set. To enable this function, a second set of tire pressure warning system sensor ID codes must be registered by a Toyota dealer. For information regarding changing the registered ID code set, contact your Toyota dealer.

- “Tire Rotation”

Registration of the position of each wheel. (→P.556)

- “Tire Pressure Setting”

Select to set a specified tire inflation pressure. (→P.557)

- “Pressure unit setting”

Select to change the units of measure displayed.

- “Scheduled Maintenance”  
(→P.533)

Select to reset the scheduled maintenance information (message indicating maintenance is required and distance until the next maintenance) after all maintenance is performed.

- Oil Maintenance

Select to reset the Oil maintenance.  
(→P.544)

- Rear Seat Reminder  
(→P.131)

Select to enable/disable the rear seat reminder function.

- Stop light indicator

Select to enable/disable stop light indicator. (→P.88)

■  **Settings**

- Language

Select to change the language on the multi-information display.

- Units

Select to change the unit of measure for fuel consumption.

- Meter Type

Select to change the meter type setting.

- Meter Style

Select to change the meter style.

- Dial Type

Select to change dial type. (→P.92)

- Fuel Economy

Select to change the display on Fuel Economy. (→P.109)

- Drive Info

Select to change displayed items on drive information display. (→P.110)

- Pop-Up Display

Select to enable/disable the pop-up displays, which may appear in some situations.

- Default Settings

Select to reset the meter display settings.

■ **Suspension of the settings display**

- Some settings cannot be changed while driving. When changing settings, park the vehicle in a safe place.
- If a warning message is displayed, operation of the settings display will be suspended.
- Settings for functions not equipped to the vehicle are not displayed.
- When a function is turned off, the related settings for that function are not selectable.

 **WARNING**

■ **Cautions during setting up the display**

As the hybrid system needs to be operating during setting up the display, ensure that the vehicle is parked in a place with adequate ventilation. In a closed area such as a garage, exhaust gases including harmful carbon monoxide (CO) may collect and enter the vehicle. This may lead to death or a serious health hazard.

 **NOTICE**

■ **During setting up the display**

To prevent 12-volt battery discharge, ensure that the hybrid system is operating while setting up the display features.

**Warning message display**

Select to display warning messages and measures to be taken if a malfunction is detected. (→P.598)

## Suggestion function

Displays suggestions to the driver in the following situations. To select a response to a displayed suggestion, use the meter control switches.

### ■ Suggestion to turn off the headlights

If the headlights are left on for a certain amount of time after the power switch has been turned off, a suggestion message will be displayed.

### ■ Suggestion to enable the power back door (if equipped)

If the power back door system is disabled (setting on  set to off) and the power back door switch on the instrument panel is operated, a suggestion message will be displayed asking if you wish to enable the power back door system.

### ■ Customization

Some functions can be customized. (→P.649)

## Head-up display\*

\*: If equipped

**The head-up display projects a variety of driving-related information and the operating state of the driving support systems on the windshield.**

## System components

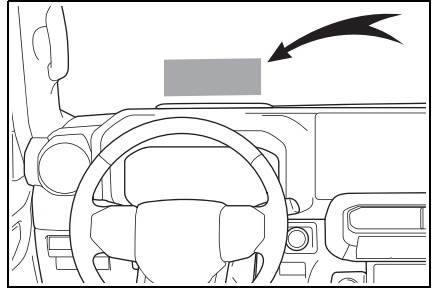

The meter display type setting of head-up display can be changed. (→P.112)

The content displayed will differ according to the driving conditions and display mode of the head-up display. Depending on the situation, pop-up displays will also be displayed.

### ■ Full

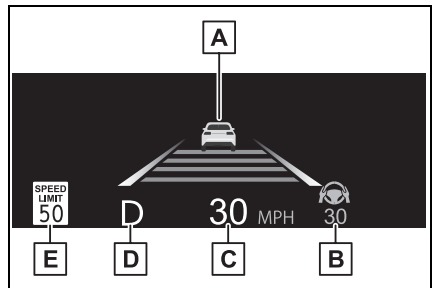

Illustrations used in this text are intended as examples, and may differ from the image that is actually displayed by the head-up display.

- A** Driving support system display area (→P.120)/Navigation system-linked display area (if equipped)/Tachometer display area (→P.121)
- B** Driving support system display area (→P.120)
- C** Speedometer
- D** Shift position/gear position (→P.227)
- E** RSA (Road Sign Assist) display (if equipped) (→P.96)

■ **Standard**

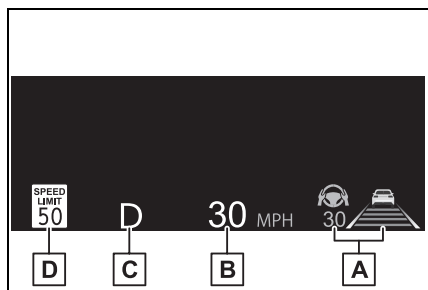

Illustrations used in this text are intended as examples, and may differ from the image that is actually displayed by the head-up display.

- A** Driving support system display area (if equipped) (→P.120)
- B** Speedometer
- C** Shift position/gear position (→P.227)
- D** RSA (Road Sign Assist) dis-

play (if equipped) (→P.96)

■ **Minimum**

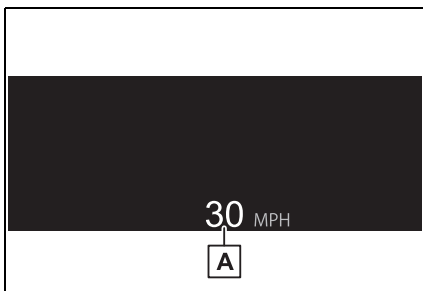

- A** Speedometer

■ **Head-up display will operate when**

The power switch is in ON.

■ **When using the head-up display**

The head-up display may seem dark or hard to see when viewed through sunglasses, especially polarized sunglasses. Adjust the brightness of the head-up display or remove your sunglasses.

■ **Street name display**

Only street names which are included in the map data will be displayed.

**! WARNING**

■ **When using the head-up display**

- Check that the position and brightness of the head-up display image does not interfere with safe driving. Incorrect adjustment of the image's position or brightness may obstruct the driver's view and lead to an accident, resulting in death or serious injury.

### WARNING

- Do not continuously look at the head-up display while driving as you may fail to see pedestrians, objects on the road, etc. ahead of the vehicle.

### NOTICE

#### ■ Head-up display projector

- Do not place any drinks near the head-up display projector. If the projector gets wet, electrical malfunctions may result.

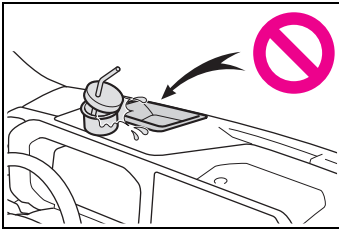

- Do not place anything on or put stickers onto the head-up display projector. Doing so could interrupt head-up display indications.
- Do not touch the inside of the head-up display projector or thrust sharp edges or the like into the projector. Doing so could cause mechanical malfunctions.

## Using the head-up display

### ■ Changing settings of the head-up display

The following settings can be changed on  of the multi-information display. (→P.106)

- Enabling/disabling the head-up display

Select to enabling/disabling the

head-up display.

- Head-up display type

Select to change head-up display type. (→P.117)

- Brightness and vertical position of the head-up display

Select to adjust the brightness or vertical position of the head-up display.

- Display angle

Select to adjust the angle of the head-up display.

### ■ Enabling/disabling of the head-up display

If the head-up display is disabled, it will remain disabled when the power switch is turned off then back to ON.

### ■ Display brightness

The brightness of the head-up display can be adjusted on  of the multi-information display. Also, it is automatically adjusted according to the ambient brightness.

### ■ Head-up display automatic position adjustment

If the display position is recorded into memory, the head-up display will be automatically adjusted to the desired position. (→P.187)

### ■ When the 12-volt battery is disconnected

The customize settings of the head-up display will be reset.

**WARNING****Caution for changing settings of the head-up display**

As the hybrid system needs to be operating while changing the settings of the head-up display, ensure that the vehicle is parked in a place with adequate ventilation. In a closed area such as a garage, exhaust gases including harmful carbon monoxide (CO) may collect and enter the vehicle. This may lead to death or a serious health hazard.

**NOTICE****When changing the settings of the head-up display**

To prevent 12-volt battery discharge, ensure that the hybrid system is operating while changing the settings of the head-up display.

**Driving support system display area**

Displays the operational status of the following systems:

- LTA (Lane Tracing Assist) (→P.280)
- LDA (Lane Departure Alert) (→P.288)
- Dynamic radar cruise control (→P.305)

Details of content displayed on the head-up display may differ from that displayed on the multi-information display. For details, refer to the explanation of each system.

**Navigation system-linked display area (if equipped)**

Displays the following items which are linked to the navigation system:

- Street name
- Route guidance to destination
- Compass

**Pop-up display**

Pop-up displays for the following systems will be displayed when necessary.

**Driving support systems**

Displays a warning/suggestion/advice message or the operating state of a relevant system.

- PCS (Pre-Collision System) (→P.268)
- LTA (Lane Tracing Alert) (→P.280)
- LDA (Lane Departure Alert) (→P.288)
- Dynamic radar cruise control (→P.305)
- PKSB (Parking Support Brake) (→P.353)
- Brake Override System (→P.198)
- Drive-Start Control (DSC) (→P.203)

Details of content displayed on the head-up display may differ from



that displayed on the multi-information display. For details, refer to the explanation of each system.

### ■ Warning message

Some warning messages are displayed when necessary, according to certain conditions.

Details of content displayed on the head-up display may differ from that displayed on the multi-information display.

### ■ Hands-free system status

Displayed when the hands-free system is operated.

### ■ When a pop-up display is displayed

When a pop-up display is displayed, a current display may no longer be displayed. In this case, the display will return after the pop-up display disappears.

## Tachometer display area

Displays the engine speed in revolutions per minute.

### ■ Head-up display is displayed when

The power switch is in ON.

### ■ Tachometer is displayed when

All of the following conditions are met:

- When LTA (Lane Tracing Assist), LDA (Lane Departure Alert) and dynamic radar cruise control is turned off.
- Full mode (→P.121) is selected as head-up display type.
- When other than Eco drive mode is selected.

## Fuel consumption information

The fuel consumption information can be displayed on the Multimedia Display.

### Display procedure

Press  on the main menu, then press “Trip information” on the sub menu.

For detail regarding the Multimedia Display, refer to “MULTIMEDIA OWNER’S MANUAL”.

### ■ Current fuel consumption screen

If a screen other than current fuel consumption screen is displayed, press “Current”.

Use the displayed average fuel consumption as a reference.

Some screens may vary depending on the type of multi-media display.

The image is an example only, and may vary slightly from actual conditions.

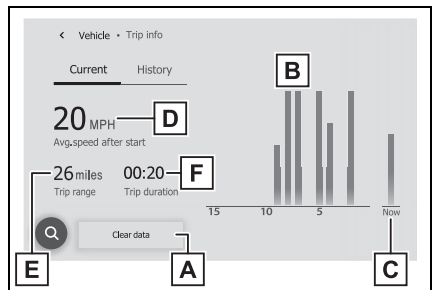

**A** Resetting the consumption data

- B** Fuel consumption in the past 15 minutes
- C** Current fuel consumption
- D** Average vehicle speed since the hybrid system was started.
- E** Trip range
- F** Elapsed time since the hybrid system was started.

### ■ History screen

If a screen other than history screen is displayed, press “History”.

Use the displayed average fuel consumption as a reference.

Some screens may vary depending on the type of multi-media display.

The image is an example only, and may vary slightly from actual conditions.

sumption data

### ■ Updating the history data

Update the latest fuel consumption by pressing “Update” to measure the current fuel consumption again.

### ■ Resetting the data

The fuel consumption data can be deleted by pressing “Clear data”.

### ■ Trip range

Displays the estimated maximum distance that can be driven with the quantity of fuel remaining.

This distance is computed based on your average fuel consumption. As a result, the actual distance that can be driven may differ from that displayed.

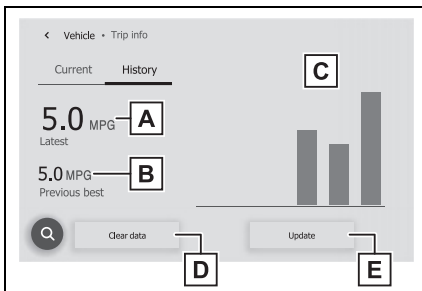

- A** Latest fuel consumption
- B** Best recorded fuel consumption
- C** Previous fuel consumption record
- D** Resetting the history data
- E** Updating the latest fuel con-

**3-1. Key information**

Keys ..... 124

Digital Key ..... 127

**3-2. Opening, closing and locking the doors**

Side doors ..... 129

Back door ..... 134

Glass hatch ..... 147

Smart key system ..... 150

**3-3. Adjusting the seats**

Front seats ..... 155

Rear seats ..... 156

Head restraints ..... 162

**3-4. Adjusting the steering wheel and mirrors**

Steering wheel ..... 165

Inside rear view mirror 166

Digital Rear-view Mirror  
..... 167Outside rear view mirrors  
..... 177**3-5. Opening, closing the windows and moon roof**

Power windows ..... 181

Moon roof ..... 184

**3-6. Favorite settings**Driving position memory  
..... 187

My Settings ..... 192

## Keys

### Key types

The following keys are provided with the vehicle.

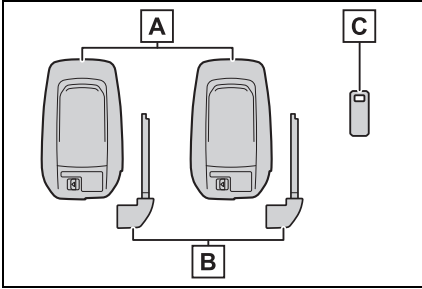

#### A Electronic keys

- Operating the smart key system (→P.150)
- Operating the wireless remote control function (→P.126)

#### B Mechanical keys

#### C Key number plate

### ■ When riding in an aircraft

When bringing a key with wireless remote control function onto an aircraft, make sure you do not press any buttons on the key while inside the aircraft cabin. If you are carrying the key in your bag etc., ensure that the buttons are not likely to be pressed accidentally. Pressing a button may cause the key to emit radio waves that could interfere with the operation of the aircraft.

### ■ Electronic key battery depletion

- The standard battery life is 1 to 2 years.
- If the battery becomes low, an alarm will sound in the cabin when the hybrid system stops.
- To reduce key battery depletion when the electronic key is to not

be used for long periods of time, set the electronic key to the battery-saving mode. (→P.151)

- As the electronic key always receives radio waves, the battery will become depleted even if the electronic key is not used. The following symptoms indicate that the electronic key battery may be depleted. Replace the battery when necessary.
- The smart key system or the wireless remote control does not operate.
- The detection area becomes smaller.
- The LED indicator on the key surface does not turn on.
- You can replace the battery by yourself (→P.571). However, as there is a danger that the electronic key may be damaged, it is recommended that replacement is carried out by your Toyota dealer.
- To avoid serious deterioration, do not leave the electronic key within 3 ft. (1 m) of the following electrical appliances that produce a magnetic field:
  - TVs
  - Personal computers
  - Recharging cellular phones or cordless phones
  - Table lamps
  - Induction cookers
- If the electronic key is near the vehicle for longer than necessary, even if the smart key system is not used, the key battery may become depleted faster than normal. When not using the smart key system, it is recommended not to stay with the electronic key near the vehicle longer than necessary.

### ■ If a message regarding the state of the electronic key or power switch mode, etc. is shown

To prevent trapping the electronic key inside the vehicle, leaving the vehicle carrying the electronic key on your person without turning the

power switch to OFF or other passengers from unintentionally taking the key out of the vehicle, etc., a message that prompts the user to confirm the state of the electronic key or power switch mode may be shown on the multi-information display. In those cases, follow the instructions on the display immediately.

■ **If “Key Battery Low Replace Key Battery” is displayed on the multi-information display**

The electronic key has a low battery. Replace the electronic key battery. (→P.571)

■ **Replacing the key battery**

→P.571

■ **Confirmation of the registered key number**

The number of keys already registered to the vehicle can be confirmed. Ask your Toyota dealer.

■ **If “A New Key has been Registered Contact Your Dealer for Details” is shown on the multi-information display**

This message will be displayed each time the driver's door is opened when the doors are unlocked from the outside for approximately 10 days after a new electronic key has been registered.

If this message is displayed but you have not had a new electronic key registered, ask your Toyota dealer to check if an unknown electronic key (other than those in your possession) has been registered.



**NOTICE**

■ **To prevent key damage**

- Do not drop the keys, subject them to strong shocks or bend them.

- Do not expose the keys to high temperatures for long periods of time.

- Do not get the keys wet or wash them in an ultrasonic washer, etc.

- Do not attach metallic or magnetic materials to the keys or place the keys close to such materials.

- Do not disassemble the keys.

- Do not attach a sticker or anything else to the surface of the electronic key.

- Do not place the keys near objects that produce magnetic fields, such as TVs, audio systems and induction cookers.

- Do not place the keys near medical electrical equipment such as low-frequency therapy equipment or microwave therapy equipment, and do not receive medical attention with the keys on your person.

■ **Carrying the electronic key on your person**

Carry the electronic key 3.9 in. (10 cm) or more away from electric appliances that are turned on. Radio waves emitted from electric appliances within 3.9 in. (10 cm) of the electronic key may interfere with the key, causing the key to not function properly.

■ **In case of a smart key system malfunction or other key-related problems**

→P.618

■ **When an electronic key is lost**

→P.617

## Wireless remote control

The keys are equipped with the following wireless remote control:

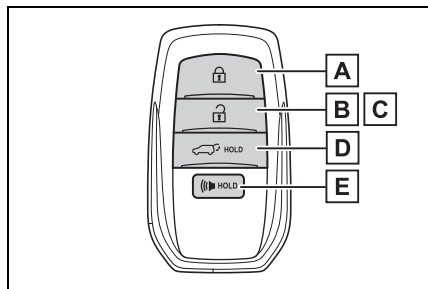

- A** Locks the doors (→P.129)
- B** Unlocks the doors (→P.129)
- C** Opens the windows and the moon roof\*<sup>1, 2</sup> (→P.129)
- D** Opens and closes the power back door\*<sup>2</sup> (→P.138)
- E** Sounds the alarm (→P.126)

\*<sup>1</sup>: These settings must be customized at your Toyota dealer.

\*<sup>2</sup>: If equipped

## ■ Panic mode

When  is pressed for longer than about 1 second, an alarm will sound intermittently and the vehicle lights will flash to deter any person from trying to break into or damage your vehicle.

To stop the alarm, press any button on the wireless remote control.

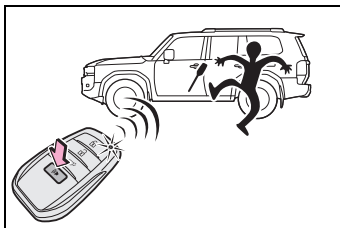

## Using the mechanical key

To take out the mechanical key, slide the release lever **A** and take the key out.

The mechanical key can only be inserted in one direction, as the key only has grooves on one side. If the key cannot be inserted in a lock cylinder, turn it over and re-attempt to insert it.

After using the mechanical key, store it in the electronic key. Carry the mechanical key together with the electronic key. If the electronic key battery is depleted or the entry function does not operate properly, you will need the mechanical key. (→P.618)

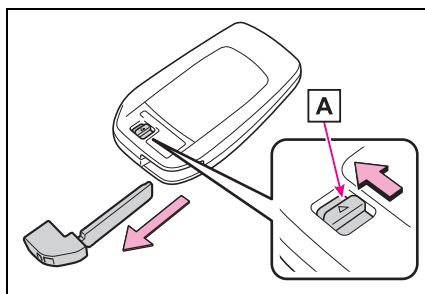

## ■ When required to leave the vehicle's key with a parking attendant

Lock the glove box as circumstances demand. (→P.487)  
Remove the mechanical key for

your own use and provide the attendant with the electronic key only.

■ **If you lose your keys**

→P.617

## Digital Key\*

\*: If equipped

**A smartphone can be used instead of the electronic key of the vehicle by installing the dedicated Digital Key App on a smartphone. Also, Digital Key can be shared with your family or friends using the Digital Key App.**

■ **Free/open source software information**

This product contains Free/open source software (FOSS). License information and/or the source code of this FOSS can be obtained at the following URL:

<https://www.denso.com/global/en/opensource/dkey/toyota/>

## Digital key usage conditions

In order to use the Digital Key, you need to install the Toyota App, Register the Vehicle to the customer's Toyota App profile, and subscribe to Remote Services, and enroll in Digital Key.

## Digital key precautions

- A Digital Key can be used when the smartphone and server can communicate. The Digital Key may become unusable if the smartphone is not connected to the Internet.

Be sure to carry the electronic key of the vehicle if traveling to a location with unreliable communications.

- If the smartphone battery is depleted, the smartphone cannot be used as Digital Key. If the battery level is low, be sure to charge the smartphone prior to going out.
- The Digital Key system is related to the smart key system. If the smart key system has been deactivated in the vehicle customization setting, the Digital Key will also be disabled.
- Depending on the radio wave environment, the Digital Key may not be able to be used. (→P.151)
- When transferring vehicle ownership, make sure to delete the Digital Keys.
- If the vehicle is not operated for 14 days or more, the Digital Key will not connect automatically. Therefore, it may take some time before the system operates after a door handle is touched.
- A part of the services may be stopped for a certain period of time due to server maintenance. However, registered Digital Keys can be used during the maintenance.
- A smartphone with the Digital

Key App enabled will be able to lock and unlock the doors, start the hybrid system and perform any other operations as same as the electronic key of the vehicle. Be especially careful not to lose the smartphone or allow it to be stolen. If the smartphone is lost or stolen, contact your Toyota dealer immediately.

- When taking your vehicle to a Toyota dealer for an inspection or repairs, make sure to bring an electronic key.
- With the Digital Key alone, no vehicle lights will illuminate when approached to the vehicle. Also, with the Digital Key alone, some functions, such as the power back door's close & lock (walk-away) function, etc., cannot be used.



## Side doors

The vehicle can be locked and unlocked using the entry function, wireless remote control, door lock switches or inside lock buttons.

### Unlocking and locking the doors from the outside

#### ■ Using the entry function

Carry the electronic key to enable this function.

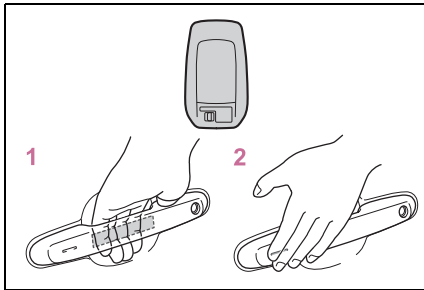

- 1 Grip the driver's door handle to unlock the door. Holding the driver's door handle for approximately 2 seconds unlocks all the doors. Grip the front passenger's door handle to unlock all the doors.\*

Make sure to touch the sensor on the back of the handle. The doors cannot be unlocked for 3 seconds after the doors are locked.

\*: The door unlock settings can be changed.

- 2 Touch the lock sensor (the

indentation on the surface of the door handle) to lock the doors.

Check that the door is securely locked.

#### ■ Using the wireless remote control

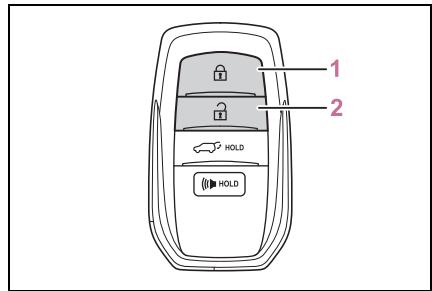

- 1 Locks all the doors

Check that the door is securely locked.

- 2 Unlocks all the doors



Pressing the button unlocks the driver's door. Pressing the button again within 5 seconds unlocks the other doors.



Press and hold to open the side windows and moon roof (if equipped).\*

\*: This setting must be customized at your Toyota dealer.



#### ■ Switching the door unlock function

It is possible to set which doors the entry function unlocks using the wireless remote control. Perform the switching operation in the vehicle or within approximately 3.2 ft. (1 m) of the vehicle.

- 1 Turn the power switch off.
- 2 When the indicator light on the key surface is not on, press and hold  ,  (if equipped)

or  for approximately 5 seconds while pressing and holding .

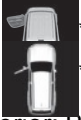
The setting changes each time an operation is performed, as shown below. (When changing the setting continuously, release the buttons, wait for at least 5 seconds, and repeat step 2.)

Multi-information display/Beep	Unlocking function
 <p>*1 *2</p> <p>Exterior: Beeps 3 times</p>	<p>Holding the driver's door handle unlocks only the driver's door.</p>
 <p>*1 *2</p> <p>Exterior: Beeps twice</p>	<p>Holding a passenger's door handle unlocks all the doors.</p>
 <p>*1 *2</p> <p>Exterior: Beeps twice</p>	<p>Holding a door handle unlocks all the doors.</p>

\*1: Vehicles with 7-inch display

\*2: Vehicles with 12.3-inch display

To prevent unintended triggering of the alarm, unlock the doors using the wireless remote control and open and close a door once after the settings have been changed. (If a door or the glass hatch is not opened within 60 seconds after

 is pressed, the doors will be locked again and the alarm will automatically be set.)

In case that the alarm is triggered, immediately stop the alarm.

(→P.78)

### ■ Impact detection door lock release system

In the event that the vehicle is subject to a strong impact, all the doors are unlocked. Depending on the force of the impact or the type of accident, however, the system may not operate.

### ■ Operation signals

Doors: A buzzer sounds and the emergency flashers flash to indicate that the doors have been locked/unlocked. (Locked: Once; Unlocked: Twice)

Side windows and moon roof (if equipped): A buzzer sounds to indicate that the side windows and moon roof are operating.

### ■ Security feature

If a door or the glass hatch is not opened within approximately 60 seconds after the vehicle is unlocked, the security feature automatically locks the vehicle again. (However, depending on the location of the electronic key, the key may be detected as being in the vehicle. In this case, vehicle may be unlocked.)

### ■ When the door cannot be locked by the lock sensor on the surface of the door handle

When the door cannot be locked even if the lock sensor on the surface of the door handle is touched by a finger, touch the lock sensor with the palm.

When gloves are being worn, remove the gloves.

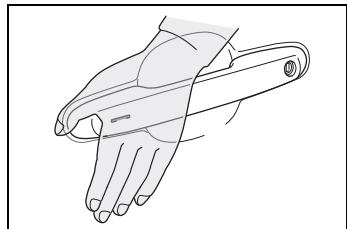

### ■ Door lock buzzer

If an attempt to lock the doors using the entry function is made when a door other than the door you are locking or the glass hatch is open, a buzzer sounds continuously for 5 seconds. Fully close all the doors and glass hatch, and lock the vehicle once more.

### ■ Setting the alarm

Locking the doors will set the alarm system. (→P.78)

### ■ Conditions affecting the operation of the smart key system or wireless remote control

→P.151

#### ■ If the smart key system or the wireless remote control does not operate properly

- Use the mechanical key to lock and unlock the doors. (→P.618)
- Replace the key battery with a new one if it is depleted. (→P.571)

#### ■ If the 12-volt battery is discharged

The doors cannot be locked and unlocked using the smart key system or wireless remote control. Lock or unlock the doors using the mechanical key. (→P.618)

### ■ Rear seat reminder function

As the first reminder so as not to forget luggage, etc. in the rear seat, when the power switch is turned off after any of the following conditions are met, a buzzer will sound and a message will be displayed on the multi-information display for approximately 6 seconds.

Also, as the second reminder, when the doors are locked, a buzzer will sound and the emergency flashers will flash for a few seconds, and a message will be displayed on the multi-information display.

- The hybrid system is started within approximately 10 minutes after opening and closing a rear

door.

- A rear door has been opened and closed after the hybrid system was started.

The second reminder will not be activated if a rear door was opened before the doors are locked.

However, if a rear door is opened and then closed within approximately 2 seconds, the rear seat reminder function may not operate.

The rear seat reminder function determines that luggage, etc. has been placed in a rear seat based on opening and closing of a rear door. Therefore, depending on the situation, the rear seat reminder function may not operate and you may still forget luggage, etc. in the rear seat, or it may operate unnecessarily.

### ■ Customization

Settings (e.g. unlocking function using a key) can be changed. (Customizable features: →P.649)



#### WARNING

#### ■ To prevent an accident

Observe the following precautions while driving the vehicle. Failure to do so may result in a door opening and an occupant could be thrown out of the vehicle, resulting in death or serious injury.

- Ensure that all doors are properly closed and locked.



#### WARNING

- Do not pull the inside handle of the doors while driving. Be especially careful for the front doors, as the doors may be opened even if the inside lock buttons are in locked position.

- Set the rear door child-protector locks when children are seated in the second seat.

### ■ When opening or closing a door

Check the surroundings of the vehicle such as whether the vehicle is on an incline, whether there is enough space for a door to open and whether a strong wind is blowing. When opening or closing the door, hold the door handle tightly to prepare for any unpredictable movement.

### ■ When using the wireless remote control and operating the power windows or moon roof (if equipped)

Operate the power window or moon roof after checking to make sure that there is no possibility of any passenger having any of their body parts caught in the window or moon roof. Also, do not allow children to operate the wireless remote control. It is possible for children and other passengers to get caught in the power window or moon roof.

## Unlocking and locking the doors from the inside

### ■ Using the door lock switches

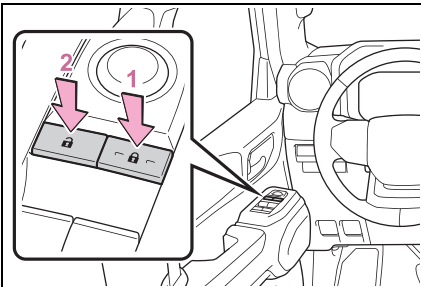

- 1 Locks all the doors

- 2 Unlocks all the doors

### ■ Using the inside lock buttons

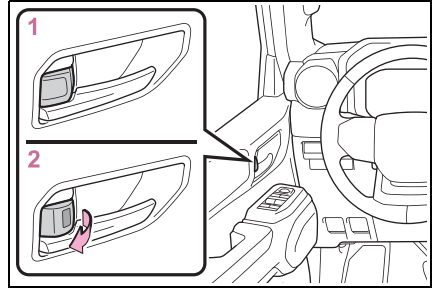

- 1 Locks the door
- 2 Unlocks the door

The front doors can be opened by pulling the inside door handle even if the lock buttons are in the lock position.

### ■ Locking the front doors from the outside without a key

- 1 Move the inside lock button to the lock position.
- 2 Close the door.

The door cannot be locked if the power switch is in ACC or ON, or the electronic key is left inside the vehicle.

However, the key may not be detected correctly and the door may be locked.

### ■ If a symbol indicating one or more doors are open is shown on the multi-information display

The hood or one or more of the doors are not fully closed. The system also indicates which doors are not fully closed. If the vehicle reaches a speed of 3 mph (5 km/h), a buzzer sounds to indicate that the door(s) are not yet fully closed. Make sure that the hood and all the doors are closed.

**■ When all the doors are locked with the entry function or wireless remote control**

- The doors cannot be unlocked with the door lock switch.
- The door lock switch can be reset by unlocking all the doors with the entry function or wireless remote control.

**Rear door child-protector lock**

The door cannot be opened from inside the vehicle when the lock is set.

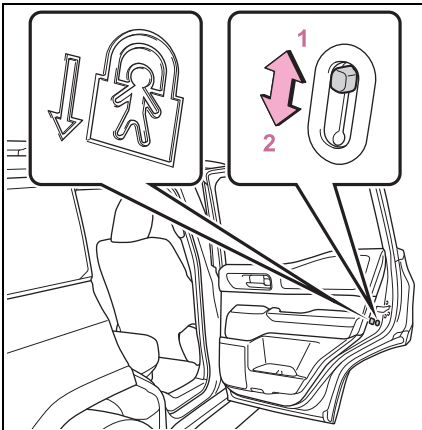

1 Unlock

2 Lock

These locks can be set to prevent children from opening the rear doors. Push down on each rear door switch to lock both rear doors.

**Automatic door locking and unlocking systems**

The following functions can be set or canceled:

For instructions on customizing,

refer to P.649.

Function	Operation
Speed linked door locking function	All doors are locked when the vehicle speed is approximately 12 mph (20 km/h) or higher.
Shift position linked door locking function	Shifting the shift lever out of P locks all the doors.
Shift position linked door unlocking function	Shifting the shift lever to P unlocks all the doors.
Driver's door linked door unlocking function	All the doors are unlocked when the driver's door is opened within approximately 45 seconds after turning the power switch off.

## Back door

The back door can be locked/unlocked and opened/closed by the following procedures.

### WARNING

Observe the following precautions.

Failure to do so may result in death or serious injury.

#### ■ Before driving

- Make sure that the back door is fully closed.  
If the back door is not fully closed, it may open unexpectedly while driving and hit nearby objects or luggage in the luggage compartment may be thrown out, causing an accident.
- Do not allow children to play in the luggage compartment.  
If a child is accidentally locked in the luggage compartment, they could get heat exhaustion or other injuries.
- Do not allow a child to open or close the back door.  
Doing so may cause the back door to move unexpectedly, or cause the child's hands, head, or neck to be caught by the closing back door.

#### ■ Important points while driving

- Keep the back door closed while driving.  
If the back door is left open, it may hit near-by objects or luggage in the luggage compartment may be thrown out, causing an accident.

### WARNING

- Never let anyone sit in the luggage compartment.  
In the event of sudden braking, sudden swerving or a collision, they are susceptible to death or serious injury.

#### ■ Operating the back door

Observe the following precautions.

Failure to do so may cause parts of the body to be caught, resulting in death or serious injury.

- Remove any heavy loads, such as snow and ice, from the back door before opening it. Failure to do so may cause the back door to suddenly shut again after it is opened.
- When opening or closing the back door, thoroughly check to make sure the surrounding area is safe.
- If anyone is in the vicinity, make sure they are safe and let them know that the back door is about to open or close.
- Use caution when opening or closing the back door in windy weather as it may move abruptly in strong wind.

- Vehicles without power back door: The back door may suddenly shut if it is not opened fully. It is more difficult to open or close the back door on an incline than on a level surface, so beware of the back door unexpectedly opening or closing by itself. Make sure that the back door is fully open and secure before using the luggage compartment.

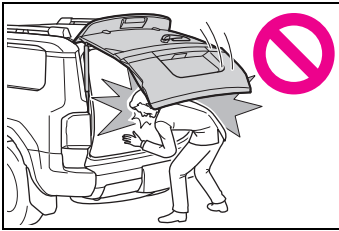

- Vehicles with power back door: The back door may suddenly shut if it is not opened fully, while on a steep incline. Make sure that the back door is secured before using the luggage compartment.
- When closing the back door, take extra care to prevent your fingers etc. from being caught.

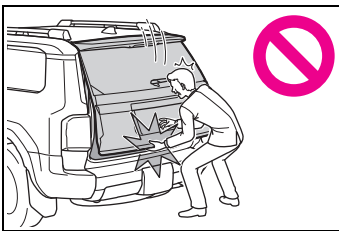

- Vehicles without power back door: When closing the back door, make sure to press it lightly on its outer surface. If the back door handles are used to fully close the back door, it may result in hands or arms being caught.

### ⚠ WARNING

- Do not pull on the back door damper stay (vehicles without power back door) (→P.138) or back door spindle (vehicles with power back door) (→P.145) to close the back door, and do not hang on the back door damper stay (vehicles without power back door) or back door spindle (vehicles with power back door). Doing so may cause hands to be caught or the back door damper stay (vehicles without power back door) or back door spindle (vehicles with power back door) to break, causing an accident.
- If a bicycle carrier or similar heavy object is attached to the back door, it may suddenly shut again after being opened, causing someone's hands, head or neck to be caught and injured. When installing an accessory part to the back door, using a genuine Toyota part is recommended.

### Unlocking and locking the back door from the outside

#### ■ Using the entry function

Carry the electronic key to enable this function.

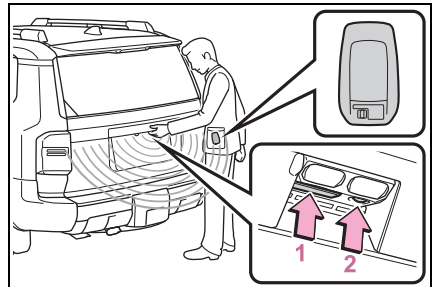

### 1 Unlocks all the doors

The doors cannot be unlocked for 3 seconds after the doors are locked.

### 2 Locks all the doors

Check that the door is securely locked.

#### ■ Using the wireless remote control

→P.126

#### ■ Operation signals

→P.130

#### ■ Security feature

→P.130

## Unlocking and locking the back door from the inside

#### ■ Using the door lock switches

→P.132

## Opening/closing the back door (vehicles without power back door)

#### ■ Open

Raise the back door while pressing up the back door opener to release the lock to open the back door.

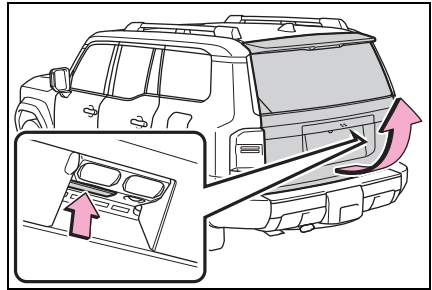

#### ■ Close

Lower the back door using the back door handles **A**, and make sure to push the back door down from the outside to close it.

Be careful not to pull the back door sideways when closing the back door with the handles.

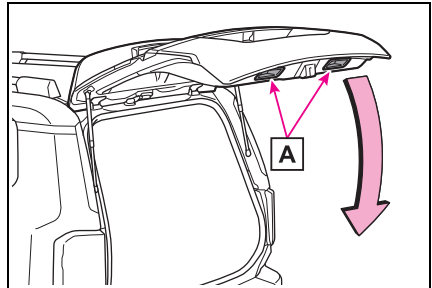

#### ■ Luggage compartment lights

- The luggage compartment lights turn on when the back door is opened.
- When the power switch is turned to OFF, the lights will go off automatically after 20 minutes.

#### ■ If the back door opener is inoperative

The back door can be unlocked from the inside.

- 1 Remove the cover.

To prevent damage, cover the tip of the screwdriver with a rag.



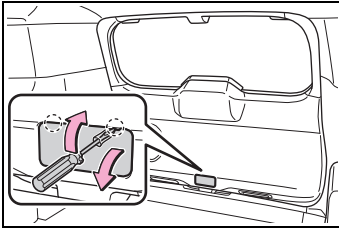

2 Loosen the screw.

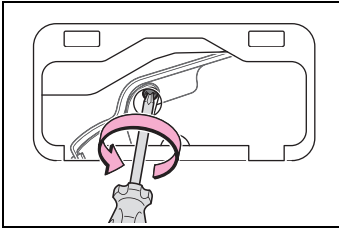

3 Turn the cover.

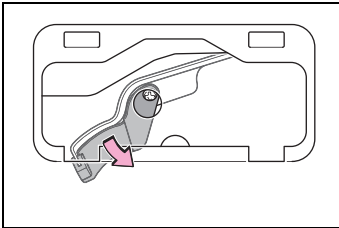

4 Move the lever.

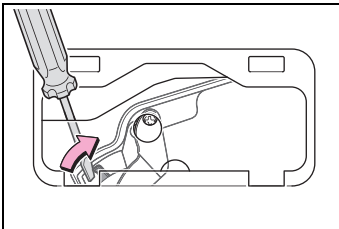

5 When installing, reverse the steps listed.

■ **Open door warning buzzer**

→P.133

 **NOTICE**

■ **Back door damper stays**

The back door is equipped with damper stays that hold the back door in place.

Observe the following precautions.

Failure to do so may cause damage to the back door damper stay, resulting in malfunction.

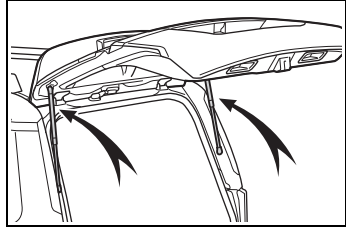

● Do not attach any foreign objects, such as stickers, plastic sheets, or adhesives to the damper stay rod.

● Do not touch the damper stay rod with gloves or other fabric items.

● Do not attach any accessories other than genuine Toyota parts to the back door.

● Do not place your hand on the damper stay or apply lateral forces to it.

**Opening/closing the back door (vehicles with power back door)**

■ **Using the wireless remote control**

Press and hold the switch.

The power back door automatically opens/closes.

Pressing the switch while the power back door is opening/closing stops

the operation. When the switch is pressed and held again during the halted operation, the back door will perform the reverse operation.

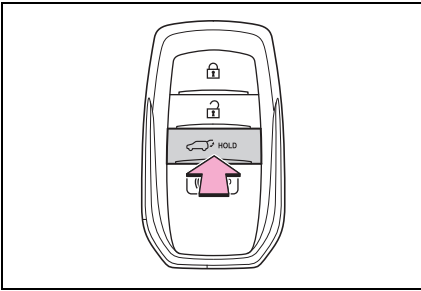

### ■ Using the power back door switch on the instrument panel

Press and hold the switch.

The power back door automatically opens/closes.

Unlock the back door before operating.

Pressing the switch while the power back door is opening/closing stops the operation. When the switch is pressed and held again during the halted operation, the back door will perform the reverse operation.

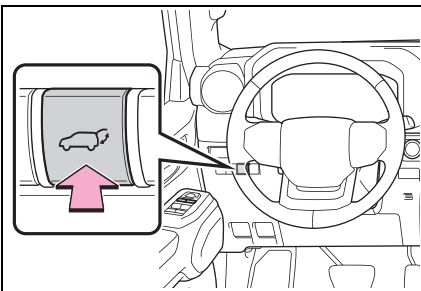

### ■ Using the switches on the back door

#### ● Open

When the back door is unlocked:

Press the back door opener switch.

When the back door is locked:

While carrying the electronic key on your person, press and hold the back door opener switch.

The power back door automatically opens.

Pressing the switch while the power back door is opening/closing stops the operation.

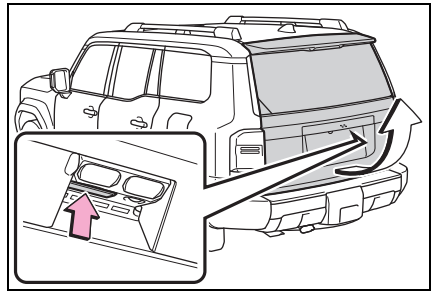

#### ● Close

Press the  switch on the lower part of the back door.

The power back door automatically closes.

Pressing the  switch while the power back door is operating will

stop the operation. When the  switch is pressed again during the halted operation, the back door will perform the reverse operation.

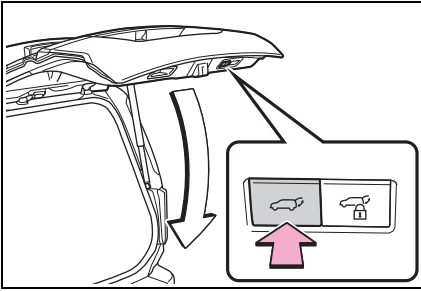

- Close the back door and lock all doors (close & lock function)

Close all of the doors except the back door, carrying an electronic key and press the  switch on the lower part of the back door.

A different buzzer than the normal one will sound and the back door will begin closing automatically. All the doors except the back door are locked and then back door will also be locked at the same time it is closed. Operation signals will indicate that all the doors have been closed and locked. (→P.130)

Pressing the  switch while the back door is operating will stop the operation. When the switch is pressed again during the halted operation, the back door will be closed.

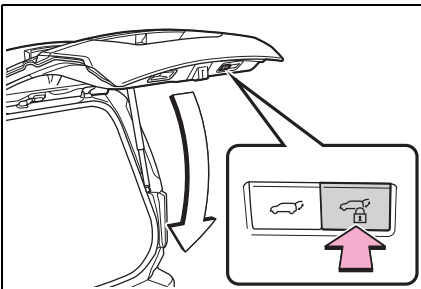

- Close the back door and lock all doors after moving away from the back door (close & lock [Walk-Away] function)\*

\*: This setting must be customized at your Toyota dealer.

- 1 Close all of the doors except the back door, carrying an electronic key and press the  switch on the lower part of the back door.

A different buzzer than the normal one will sound and the close & lock (Walk-Away) function will go into standby.

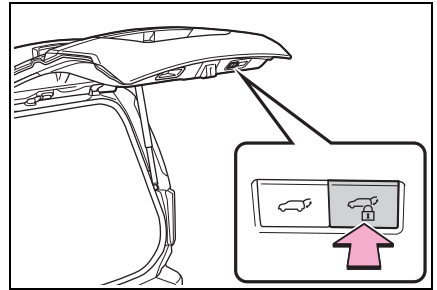

- 2 While the buzzer is sounding, move away from the back door.

When the sensor detects that you are away from the back door, the buzzer will sound and the emergency flashers will flash. Depending on the direction of moving away from the back door, the location and how to hold the electronic key or circumstances, it may not be detected properly.

All the doors other than the back door will be locked, and after the back door is closed, the back door will also be locked. When all the doors have been closed and locked, the buzzer will sound and the emergency flashers will flash.

The standby state is canceled if you do not move away from the back door for 30 seconds. To operate the function again, perform the procedure again from the beginning.

If you approach the back door carrying the electronic key, the back door operation will stop, all the doors will be unlocked, and the buzzer will sound and the emergency flashers will flash.

If the  switch is pressed after the back door operation has stopped, the close & lock (Walk-Away) function will go into standby again.

### ■ Using the back door handle

Lower the back door using the back door handle .

The back door closing assist (→P.141) will be activated, and the power back door will fully close automatically.

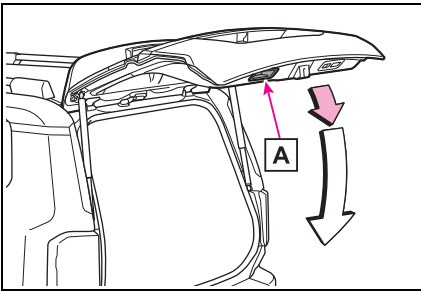

### ■ Luggage compartment lights

- The luggage compartment lights turn on when the back door is opened.
- When the power switch is turned to OFF, the lights will go off automatically after 20 minutes.

### ■ Back door closer

In the event that the back door is left slightly open, the back door closer will automatically close it to the fully

closed position.

Whatever the state of the power switch, the back door closer operates.

### ■ Power back door operating conditions

The power back door can automatically open and close under the following conditions:

- When the glass hatch is closed.
- When the power back door system is enabled. (→P.101, 112)
- When the back door is unlocked.

However, if the back door opener switch is pressed and held while carrying the electronic key on your person, the power back door will be operated even if the back door is locked. (→P.138)

- When the power switch is in ON, in addition to the above for the opening operations, the back door operates for any of the following conditions:
  - Parking brake is engaged
  - The brake pedal is depressed
  - The shift lever is in P.

### ■ Operation of the power back door

- A buzzer sounds to indicate that the back door is opening/closing.
- When the power back door system is disabled, the power back door does not operate but it can be opened and closed by hand.
- When the power back door automatically opens, if an abnormality due to people or objects is detected, operation will stop.

### ■ Jam protection function

Sensors are equipped on both sides of the power back door. If anything obstructs the power back door while it is closing, the back door will automatically operate in the opposite direction or stop.

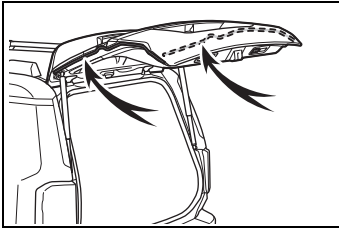

### ■ Fall-down protection function

While the power back door is opening automatically, applying excessive force to it will stop the opening operation to prevent the power back door from suddenly shutting.

### ■ Back door closing assist

If the back door is lowered manually when the back door is stopped at an open position, the back door will fully close automatically.

### ■ Back door reserve lock function

This function is a function which reserves locking of all doors, beforehand, when the power back door is open.

When the following procedure is performed, all the doors except the power back door are locked and then power back door will also be locked at the same time it is closed.

- 1 Close all doors, except the back door.
- 2 During the power back door closing operation, lock the doors using the smart key system (→P.129) or the wireless remote control. (→P.129)

Operation signals will indicate that all the doors have been closed and locked. (→P.130)

- If the electronic key is placed inside the vehicle after starting a close operation via the door reserve lock function, the electronic key may become locked inside the vehicle.
- If the power back door does not fully close due to the operation of the jam protection function, etc., while the back door is automati-

cally closing after a door reserve lock operation is performed, the door reserve lock function is canceled and all the doors will unlock.



- Before leaving the vehicle, make sure that all the doors are closed and locked.
- ### ■ Close & lock function operating conditions

This function can be operated when all of the following conditions are met:

- An electronic key is not detected within the vehicle.
- All of the doors other than the power back door are closed.
- The power switch is in OFF.

### ■ Situations in which the close & lock function may not operate properly

In the following situations, the close & lock function may not operate properly:

- If the  switch on the lower part of the power back door is pressed by a hand which is holding an electronic key
  - If the  switch on the lower part of the power back door is pressed when the electronic key is in a bag, etc. that is placed on the ground
  - If the  switch on the lower part of the power back door is pressed with the electronic key not near the vehicle
- ### ■ Close & lock (Walk-Away) function\* operating conditions

\*: This setting must be customized at your Toyota dealer.

This function can be operated when all of the following conditions are met:

- Close & lock (Walk-Away) function is enabled.
- An electronic key is not detected within the vehicle.
- All of the doors other than the back door are closed.
- The brake pedal is not depressed.
- The power switch is in OFF.
- The electronic key is within the effective range (detection areas).

■ **Situations in which the close & lock (Walk-Away) function\* may not operate properly**

\*: This setting must be customized at your Toyota dealer.

In the following situations, the function may not operate properly:

- When the smart key system does not operate properly.
- When the close & lock function does not operate properly.
- When moving away from the back door while the close & lock (Walk-Away) function is in the standby state.
- When the number of electronic keys registered in the vehicle increases.

■ **When reconnecting the 12-volt battery**

To enable the power back door to operate properly, close the back door manually.

■ **If the back door opener is inoperative**

The back door can be unlocked from the inside.

1 Remove the cover.

To prevent damage, cover the tip of the screwdriver with a rag.

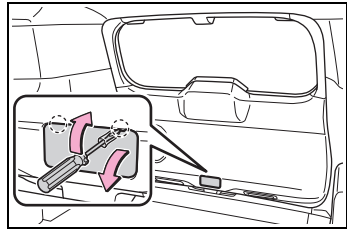

2 Loosen the screw.

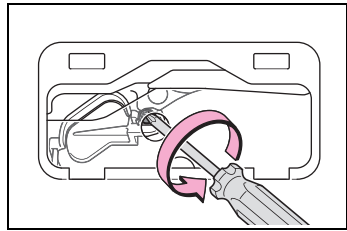

3 Turn the cover.

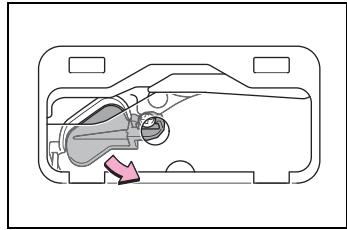

4 Move the lever.

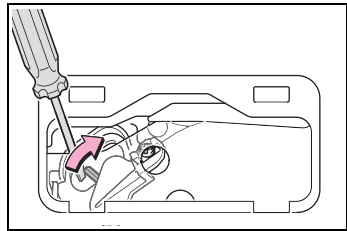

5 When installing, reverse the steps listed.

■ **Customization**

Settings (e.g. power back door opening angle) can be changed. (Customizable features: →P.649)

**⚠ WARNING****■ Back door closer**

- In the event that the back door is left slightly open, the back door closer will automatically close it to the fully closed position. It takes several seconds before the back door closer begins to operate. Be careful not to catch fingers or anything else in the back door, as this may cause bone fractures or other serious injuries.

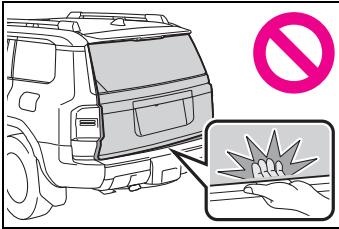

- Use caution when using the back door closer as it still operates when the power back door system is canceled.

**■ Power back door**

Observe the following precautions when operating the power back door. Failure to do so may cause death or serious injury.

- Check the safety of the surrounding area to make sure there are no obstacles or anything that could cause any of your belongings to get caught.
- If anyone is in the vicinity, make sure they are safe and let them know that the back door is about to open or close.

**⚠ WARNING**

- If the power back door system is turned off while the back door is operating automatically, the automatic operation is stopped. The back door then has to be operated manually. Take extra care when on an incline, as the back door may open or close unexpectedly.
- If the operating conditions of the power back door are no longer met, a buzzer may sound and the back door may stop opening or closing. The back door then has to be operated manually. Take extra care when on an incline, as the back door may open or close abruptly.
- On an incline, the back door may suddenly shut after it opens. Make sure the back door is fully open and secure.
- In the following situations, the power back door may detect an abnormality and automatic operation may be stopped. In this case, the back door has to be operated manually. Take extra care when on an incline, as the back door may open or close abruptly.
  - When the back door contacts an obstacle
  - When the 12-volt battery voltage suddenly drops, such as when the power switch is turned to ON or the hybrid system is started during automatic operation

- If a bicycle carrier or similar heavy object is attached to the back door, the power back door may not operate, causing itself to malfunction, or the back door may suddenly shut again after being opened, causing someone's hands, head or neck to be caught and injured. When installing an accessory part to the back door, using a genuine Toyota part is recommended.

### ■ Jam protection function

Observe the following precautions.

Failure to do so may cause death or serious injury.

- Never use any part of your body to intentionally activate the jam protection function.
- The jam protection function may not work if something gets caught just before the back door fully closes. Be careful not to catch fingers or anything else.
- The jam protection function may not work depending on the shape of the object that is caught. Be careful not to catch fingers or anything else.

### ■ Close & Lock (Walk-Away) function

\*: This setting must be customized at your Toyota dealer.

The back door starts to close automatically when leaving the back door. Check the safety of the surrounding area to make sure there are no obstacles or anything that could cause any of your belongings to get caught.

### ⚠ NOTICE

#### ■ Back door spindles

The back door is equipped with spindles that hold the back door in place.

Observe the following precautions.

Failure to do so may cause damage to the back door spindle, resulting in malfunction.

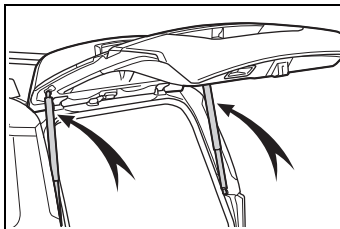

- Do not attach any foreign objects, such as stickers, plastic sheets, or adhesives to the spindle rod.
- Do not attach any accessories other than genuine Toyota parts to the back door.
- Do not place your hand on the spindle or apply lateral forces to it.

#### ■ To prevent back door closer malfunction

Do not apply excessive force to the back door while the back door closer is operating. Applying excessive force may cause the back door closer to malfunction.

#### ■ To prevent damage to the power back door

- Make sure that there is no ice between the back door and frame that would prevent movement of the back door. Operating the power back door when excessive load is present on the back door may cause a malfunction.



- Do not apply excessive force to the back door while the power back door is operating.
- Take care not to damage the sensors (installed on the right and left edges of the power back door) with a knife or other sharp object. If the sensor is disconnected, the power back door will not close automatically.

### ■ Close & lock function



When closing the power back door using the close & lock function, a different buzzer than the normal one will sound before the operation begins.

To check that the operation has started correctly, check that a different buzzer than the normal one has sounded.

Additionally, when the power back door is fully closed and locked, operation signals will indicate that all of the doors have been locked. (→P.130)

Before leaving the vehicle, make sure that the operational signals have operated and that all of the doors are locked.

### Changing settings of the power back door system (vehicles with power back door)

The settings of the power back door system can be changed by displaying  "PBD" from  "Vehicle Settings" on  of the multi-information display. (→P.101, 112)

The changed power back door settings are not reset by turning the

power switch to OFF. In order to restore the original settings, they need to be changed back on  of the multi-information display.

### Adjusting the open position of the back door (vehicles with power back door)

The open position of the power back door can be adjusted.

- 1 Stop the back door in the desirable position. (→P.138)
- 2 Press and hold the  switch on the lower part of the back door for approximately 2 seconds.

When the settings are completed, the buzzer sounds 4 times.

When opening the back door the next time, the back door will stop at that position.

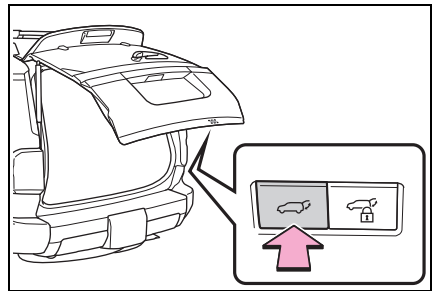

### ■ Canceling the adjusted open position of the back door

Press and hold the  switch on the lower part of the back door for approximately 7 seconds.

After the buzzer sounds 4 times, it sounds twice more. When the

power back door does the opening operation the next time, the door will open to the initial settings position.

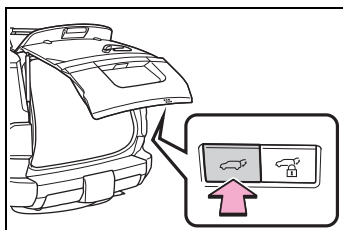

### ■ Customization

The opening position can be set with the multi-information display. (→P.101, 112)

Priority for the stop position is given to the last position set by either the

 switch on the lower part of the back door or multi-information display.

### Rear step bumper

The rear step bumper is for rear end protection and easier step-up loading.

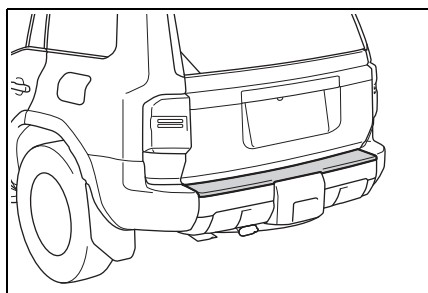

### Glass hatch

The glass hatch can be opened using the glass hatch opener.

### Opening the glass hatch

#### ■ Glass hatch opener

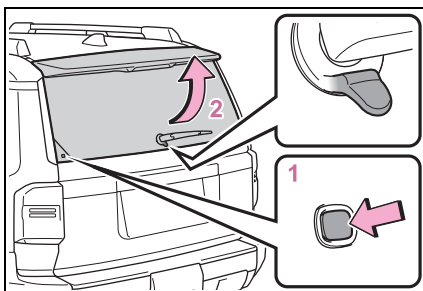

1 Press the button to pop up the glass hatch.

2 Raise

The glass hatch cannot be opened when the back door is locked. Unlock the back door to open the glass hatch. (→P.136)

#### ■ Smart key system

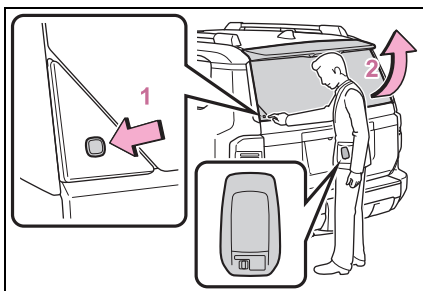

1 While carrying the electronic key, press the button to pop up the glass hatch.

2 Raise

The glass hatch can be opened even when the back door is locked.

#### ■ When opening the glass hatch

- Open the glass hatch slowly and carefully.
- Use the glass hatch opener when the back door is closed.

#### ■ Opening the glass hatch while the rear window wiper is in operation

Rear window wiper operation will stop moving. Operation will recommence after the glass hatch has been closed.

#### ■ Door lock buzzer

→P.131

#### ■ Function to prevent the glass hatch being locked with the electronic key inside

- When all doors are being locked, closing the glass hatch with the electronic key left inside the luggage compartment will sound an alarm. In this case, the glass hatch can be opened using the entry function.
- Even when the spare electronic key is put in the luggage compartment with all the doors locked, the key confinement prevention function can be activated so the glass hatch can be opened. In order to prevent theft, take all electronic keys with you when leaving the vehicle.
- Even when the electronic key is put in the luggage compartment with all the doors are locked, the key may not be detected depending on the places and the surrounding radio wave conditions. In this case, the key confinement prevention function cannot be activated, causing the doors to lock when the glass hatch is closed. Make sure to check where the key is before closing the glass hatch.

- If you want to lock the spare electronic key in the vehicle, do not open or close the glass hatch after locking all doors. Otherwise, the glass hatch can be opened due to the key confinement prevention function and the risk of vehicle theft increases significantly.

#### ■ After closing the glass hatch

Check that the glass hatch is firmly closed. If it is not firmly closed, the power back door (if equipped), the rear window wiper and washer will not operate correctly.

### WARNING

#### ■ While driving

- Keep the glass hatch closed while driving.

If the glass hatch is left open, it may hit near-by objects while driving or luggage may be unexpectedly thrown out, causing an accident.

In addition, exhaust gases may enter the vehicle, causing death or a serious health hazard. Make sure to close the glass hatch before driving.

- Before driving the vehicle, make sure that the glass hatch is fully closed. If the glass hatch is not fully closed, it may open unexpectedly while driving, causing an accident.

#### ■ When children are in the vehicle

Do not allow a child to open or close the glass hatch.

Doing so may cause the glass hatch to move unexpectedly, or cause the child's hands, head, or neck to be caught by the closing glass hatch.

### ■ Operating the glass hatch

Observe the following precautions.

Failure to do so may cause parts of the body to be caught, resulting in death or serious injury.

- Remove any heavy loads, such as snow and ice, from the glass hatch before opening it. Failure to do so may cause the glass hatch suddenly shut again after it is opened.
- When opening or closing the glass hatch, thoroughly check to make sure the surrounding area is safe.
- If anyone is in the vicinity, make sure they are safe and let them know that the glass hatch is about to open or close.
- Use caution when opening or closing the glass hatch in windy weather as it may move abruptly in strong wind.
- The glass hatch may close if it is not opened fully. It is more difficult to open or close the glass hatch on an incline than on a level surface, so beware of the glass hatch unexpectedly opening or closing by itself. Make sure that the glass hatch is fully open and secure before using the luggage compartment.

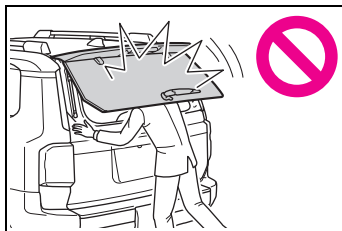

### ⚠ WARNING

- When closing the glass hatch, take extra care to prevent your fingers, etc. from being caught.

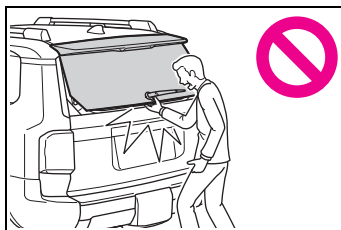

- When closing the glass hatch, make sure to press it lightly on its outer surface.
- Do not pull on the glass hatch damper stay to close the glass hatch, and do not hang on the glass hatch damper stay.  
Doing so may cause hands to be caught or the glass hatch damper stay to break, causing an accident.
- Do not attach any accessories other than genuine Toyota parts to the glass hatch. Such additional weight on the glass hatch may cause the glass hatch to suddenly shut again after it is opened.

 NOTICE

### ■ Glass hatch damper stays

The glass hatch is equipped with damper stays that hold the glass hatch in place.

Observe the following precautions.

Failure to do so may cause damage to the glass hatch damper stay, resulting in malfunction.

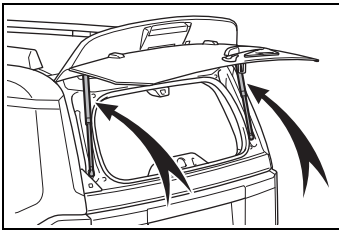

- Do not attach any foreign objects, such as stickers, plastic sheets, or adhesives to the damper stay rod.
- Do not touch the damper stay rod with gloves or other fabric items.
- Do not attach any accessories other than genuine Toyota parts to the glass hatch.
- Do not place your hand or foot on the damper stay or apply lateral forces to it.

## Smart key system

The following operations can be performed simply by carrying the electronic key on your person, for example in your pocket. The driver should always carry the electronic key.

- Locks and unlocks the doors (→P.129)
- Locks and unlocks the back door (→P.136)
- Starts the hybrid system (→P.222)

### ■ Antenna location

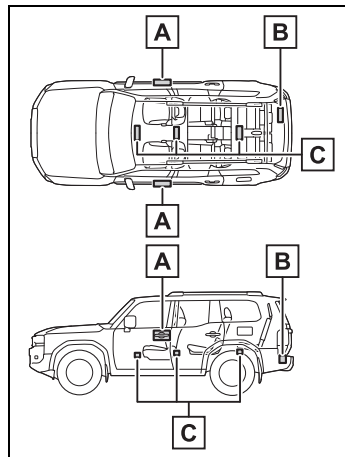

- A** Antennas outside the cabin
- B** Antenna outside the luggage compartment
- C** Antennas inside the cabin

■ **Effective range (areas within which the electronic key is detected)**

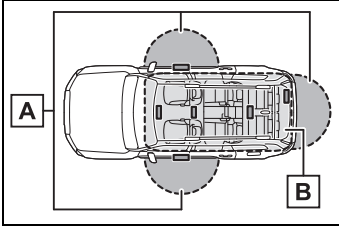

**A** When locking or unlocking the doors

The system can be operated when the electronic key is within about 2.3 ft. (0.7 m) of the front door handles and back door opener switch. (Only the doors detecting the key can be operated.)

**B** When starting the hybrid system or changing power switch modes

The system can be operated when the electronic key is inside the vehicle.

■ **If an alarm sounds or a warning message is displayed**

An alarm sounds and warning message displays shown on the multi-information display are used to protect against unexpected accidents or theft of the vehicle resulting from erroneous operation. When a warning message is displayed, take appropriate measures based on the displayed message.

When only an alarm sounds, circumstances and correction procedures are as follows.

- When an exterior alarm sounds once for 5 seconds

Situation	Correction procedure
An attempt was made to lock the vehicle while a door was open.	Close all of the doors and lock the doors again.

- When an interior alarm pings continuously

Situation	Correction procedure
The power switch was turned to ACC while the driver's door was open (or the driver's door was opened while the power switch was in ACC).	Turn the power switch to OFF and close the driver's door.

■ **Battery-saving function**



The battery-saving function will be activated in order to prevent the electronic key battery and the 12-volt battery from being discharged while the vehicle is not in operation for a long time.

- In the following situations, the smart key system may take some time to unlock the doors. Also the illuminated entry system may not operate properly.
- The electronic key has been left in an area of approximately 11.5 ft. (3.5 m) of the outside of the vehicle for 40 seconds or longer.
- The smart key system has not been used for 5 days or longer.
- If the smart key system has not been used for 14 days or longer, the doors cannot be unlocked at any doors except the driver's door. In this case, take hold of the

driver's door handle, or use the wireless remote control or the mechanical key, to unlock the doors.

### ■ Turning an electronic key to battery-saving mode

- When battery-saving mode is set, battery depletion is minimized by stopping the electronic key from receiving radio waves.

Press  twice while pressing and holding .

Confirm that the electronic key indicator flashes 4 times.

While the battery-saving mode is set, the smart key system cannot be used. To cancel the function, press any of the electronic key buttons.

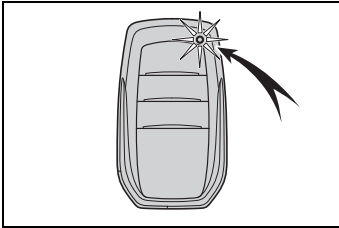

- Electronic keys that will not be used for long periods of time can be set to the battery-saving mode in advance.

### ■ When electronic key function stops

If the position of the electronic key has not changed for a certain amount of time such as when the electronic key is left somewhere, the function of the electronic key stops to reduce depletion of the battery. In this case, function can automatically be restored by moving the position of the key such as by lifting it up.

### ■ Conditions affecting operation

The smart key system uses weak radio waves. In the following situations, the communication between the electronic key and the vehicle

may be affected, preventing the smart key system, wireless remote control and immobilizer system from operating properly.

- When the electronic key battery is depleted
- Near a TV tower, electric power plant, gas station, radio station, large display, airport or other facility that generates strong radio waves or electrical noise
- When the electronic key is in contact with, or is covered by the following metallic objects
  - Cards to which aluminum foil is attached
  - Cigarette boxes that have aluminum foil inside
  - Metallic wallets or bags
  - Coins
  - Hand warmers made of metal
  - Media such as CDs and DVDs
- When other wireless key (that emits radio waves) is being used nearby
- When carrying the electronic key together with the following devices that emit radio waves
  - Portable radio, cellular phone, cordless phone or other wireless communication devices
  - Another electronic key or a wireless key that emits radio waves
  - Personal computers or personal digital assistants (PDAs)
  - Digital audio players
  - Portable game systems
- If window tint with a metallic content or metallic objects are attached to the rear window
- When the electronic key is placed near a battery charger or electronic devices
- When the vehicle is parked in a pay parking spot where radio waves are emitted.

If the doors cannot be locked/unlocked using the smart key system, lock/unlock the doors by performing any of the following:

- Bring the electronic key close to either front door handle and operate the entry function.
- Operate the wireless remote control.

If the doors cannot be locked/unlocked using the above methods, use the mechanical key. (→P.126)

If the hybrid system cannot be started using the smart key system, refer to P.619.

### ■ Note for the entry function

- Even when the electronic key is within the effective range (detection areas), the system may not operate properly in the following cases:
  - The electronic key is too close to the window or outside door handle, near the ground, or in a high place when the doors are locked or unlocked.
  - The electronic key is on the instrument panel, luggage cover (if equipped) or floor, or in the door pockets or glove box when the hybrid system is started or power switch modes are changed.
- Do not leave the electronic key on top of the instrument panel or near the door pockets when exiting the vehicle. Depending on the radio wave reception conditions, it may be detected by the antenna outside the cabin and the door will become lockable from the outside, possibly trapping the electronic key inside the vehicle.
- As long as the electronic key is within the effective range, the doors may be locked or unlocked by anyone. However, only the doors detecting the electronic key can be used to unlock the vehicle.
- Even if the electronic key is not inside the vehicle, it may be possible to start the hybrid system if the electronic key is near the window.
- The doors may unlock if a large amount of water splashes on the door handle, such as in the rain or in a car wash when the electronic key is within the effective range. (The doors will automatically be locked after approximately 60 seconds if the doors are not opened and closed.)
- If the wireless remote control is used to lock the doors when the electronic key is near the vehicle, there is a possibility that the door may not be unlocked by the entry function. (Use the wireless remote control to unlock the doors.)
- Touching the door lock sensor while wearing gloves may delay or prevent lock operation. Remove the gloves and touch the lock sensor again.
- When the lock operation is performed using the lock sensor, recognition signals will be shown up to two consecutive times. After this, no recognition signals will be given. (if equipped)
- If the door handle becomes wet while the electronic key is within the effective range, the door may lock and unlock repeatedly. In that case, follow the following correction procedures to wash the vehicle:
  - Place the electronic key in a location 6 ft. (2 m) or more away from the vehicle. (Take care to ensure that the key is not stolen.)
  - Set the electronic key to battery-saving mode to disable the smart key system. (→P.151)
- If the electronic key is inside the vehicle and a door handle becomes wet during a car wash, a message may be shown on the multi-information display and a buzzer will sound outside the vehicle. To turn off the alarm, lock all the doors.
- The lock sensor may not work properly if it comes into contact with ice, snow, mud, etc. Clean



the lock sensor and attempt to operate it again, or use the lock sensor on the lower part of the door handle.

- A sudden approach to the effective range or door handle may prevent the doors from being unlocked. In this case, return the door handle to the original position and check that the doors unlock before pulling the door handle again.
- If there is another electronic key in the detection area, it may take slightly longer to unlock the doors after the door handle is gripped.

#### ■ When the vehicle is not driven for extended periods

- To prevent theft of the vehicle, do not leave the electronic key within 6 ft. (2 m) of the vehicle.
- The smart key system can be deactivated in advance. (→P.655)
- Battery-saving mode can reduce the power consumption of electronic keys. (→P.151)

#### ■ To operate the system properly

Make sure to carry the electronic key when operating the system. Do not get the electronic key too close to the vehicle when operating the system from the outside of the vehicle.

Depending on the position and holding condition of the electronic key, the key may not be detected correctly and the system may not operate properly. (The alarm may go off accidentally, or the door lock prevention may not operate.)

#### ■ If the smart key system does not operate properly

- Locking and unlocking the doors: Use the mechanical key. (→P.618)
- Starting the hybrid system: →P.619

#### ■ Customization

Settings (e.g. smart key system) can be changed.

(Customizable features: →P.655)

If the smart key system has been deactivated in a customized setting, refer to the explanations for the following operations.

- Locking and unlocking the doors: Use the wireless remote control or mechanical key. (→P.129, 618)
- Starting the hybrid system and changing power switch modes: →P.619
- Stopping the hybrid system: →P.224



#### WARNING

##### ■ Caution regarding interference with electronic devices

- People with implantable cardiac pacemakers, cardiac resynchronization therapy-pacemakers or implantable cardioverter defibrillators should maintain a reasonable distance between themselves and the smart key system antennas. (→P.150)

The radio waves may affect the operation of such devices. If necessary, the entry function can be disabled. Ask your Toyota dealer for details, such as the frequency of radio waves and timing of the emitted radio waves. Then, consult your doctor to see if you should disable the entry function.

- User of any electrical medical device other than implantable cardiac pacemakers, cardiac resynchronization therapy-pacemakers or implantable cardioverter defibrillators should consult the manufacturer of the device for information about its operation under the influence of radio waves.  
Radio waves could have unexpected effects on the operation of such medical devices.

Ask your Toyota dealer for details for disabling the entry function.

## Front seats

The seats can be adjusted (longitudinally, vertically, etc.). Adjust the seat to ensure the correct driving posture.

### Adjustment procedure

#### ▶ Manual seat

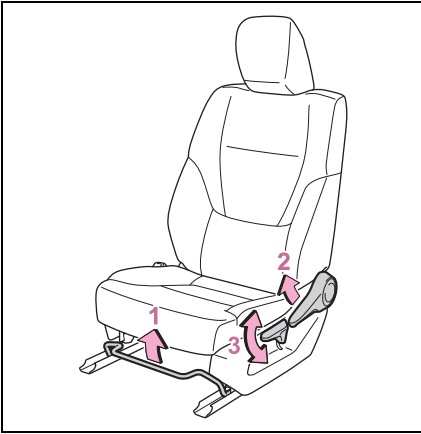

- 1 Seat position adjustment lever
- 2 Seatback angle adjustment lever
- 3 Vertical height adjustment lever (driver's side only)

#### ▶ Power seat

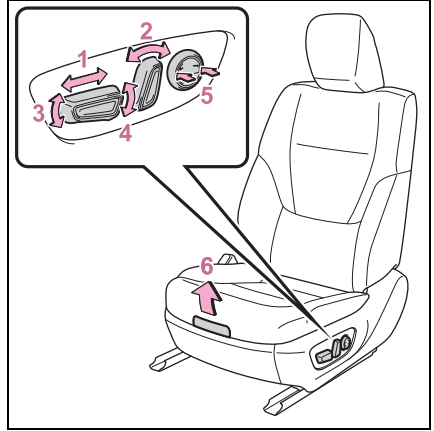

- 1 Seat position control switch
- 2 Seatback angle control switch
- 3 Seat cushion (front) angle control switch
- 4 Vertical height control switch
- 5 Lumbar support control switch (driver's side only)
- 6 Seat cushion length adjustment lever (driver's side only) (if equipped)

Slide the seat cushion while pulling up the lever.

#### ■ When adjusting the seat

- Make sure that any surrounding passengers or objects are not contact the seat.
- Take care when adjusting the seat so that the head restraint does not touch the ceiling.

#### ■ Power easy access system (if equipped)

The driver's seat and steering wheel move in accordance with power switch mode and the driver's seat belt condition. (→P.187)

### WARNING

#### ■ When adjusting the seat position

- Take care when adjusting the seat position to ensure that other passengers are not injured by the moving seat.
- Do not put your hands under the seat or near the moving parts to avoid injury. Fingers or hands may become jammed in the seat mechanism.
- Make sure to leave enough space around the feet so they do not get stuck.
- Manual seat only: After adjusting the seat, make sure that the seat is locked in position.

#### ■ Seat adjustment

To reduce the risk of sliding under the lap belt during a collision, do not recline the seat more than necessary.

If the seat is too reclined, the lap belt may slide past the hips and apply restraint forces directly to the abdomen, or your neck may contact the shoulder belt, increasing the risk of death or serious injury in the event of an accident. Adjustments should not be made while driving as the seat may unexpectedly move and cause the driver to lose control of the vehicle.

## Rear seats

### Adjustment procedure

#### ■ Second seat

Pull the lever and adjust the seatback angle.

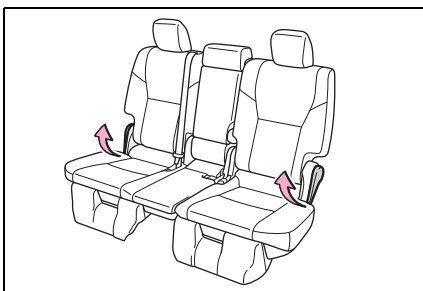

#### ■ Third seat (if equipped)

Pull the lever and adjust the seatback angle.

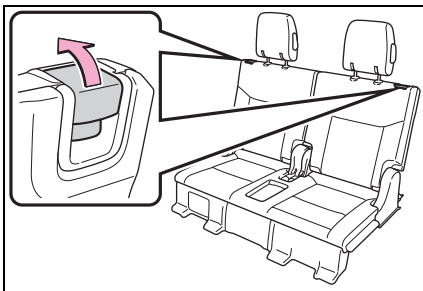

### WARNING

#### ■ When operating the seatback

Observe the following precautions.

Failure to do so may cause death or serious injury.

- Keep other passengers from being hit with the seatback.

### WARNING

- Do not bring your hands close to the moving parts or between the seats, as well as do not let any part of your body get caught.
- After adjusting the seat, make sure that the seat is locked in position.

### ■ Adjusting the reclining angle

Do not fold the seatback more than required. During a collision, your body could slip beneath the seat belt resulting in extreme pressure being applied to your abdomen, or the shoulder belt could wrap around your neck, which may result in death or serious injury.

### When entering and exiting the third seat (if equipped)

For easy access to the third seat, perform step 1 in “Tumbling the second seats”.  
(→P.157)

### When tumbling the second seats

#### ■ Before tumbling the second seats

- 1 Lower the head restraints to the lowest position.

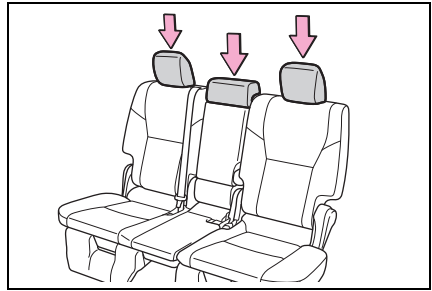

- 2 Stow the second seat belt buckles.

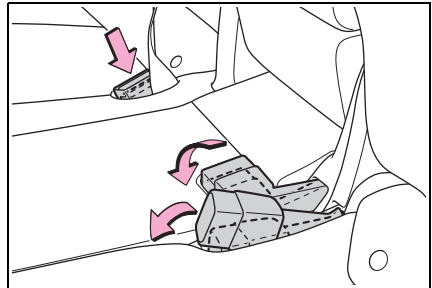

- 3 Stow the armrest. (→P.505)
- 4 Adjust the front seat so that it does not interfere with the second seat. (→P.155)

#### ■ Tumbling the second seats

- 1 Pull the seatback adjustment lever or tumble lever on the seatback of the second seat.

The seatback is folded forward and

the seat springs up.

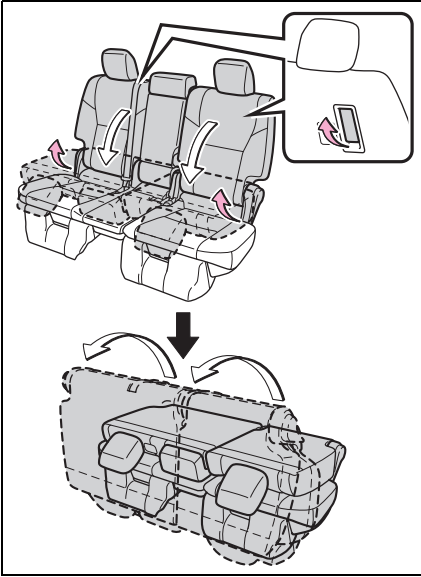

- 2 Vehicles without third seats: Open the cover on the back of the seat cushion, take out the tumble band and attach the band to the assist grip.

Pass the hook through the assist grip, attach the hook to the band and tighten the tumble band.

After securing the seat, close the tumble band cover.

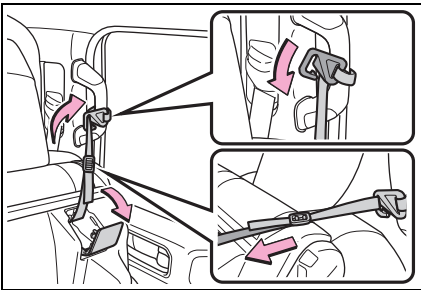

- 3 Remove the seat hook covers from the back of the seat

cushion, and install them on the seat hooks.

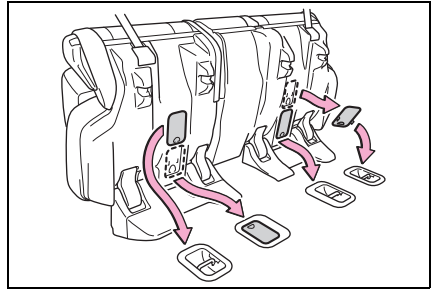

### ■ Returning the second seat to its original position

- 1 Remove the seat hook covers from the seat hooks, and return them to their original positions.

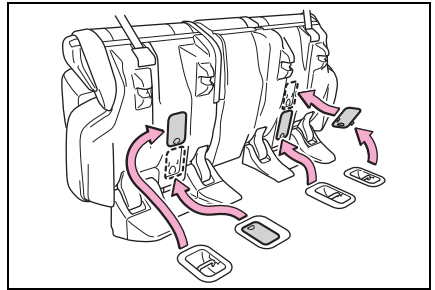

- 2 Vehicles without third seats: Remove the tumble band from the assist grip.

If removing from the assist grip is difficult, loosen the band.

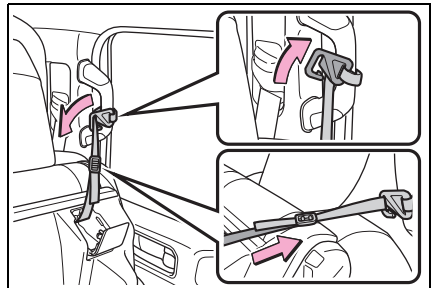

- 3** Vehicles without third seats: Stow the tumble band to its original position, and then close the cover.

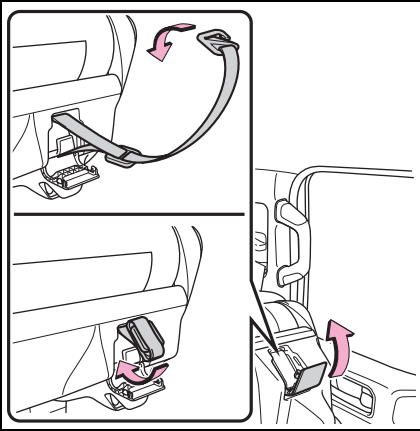

- 4** Return the seat to its original position.

Push the seat until it is locked.

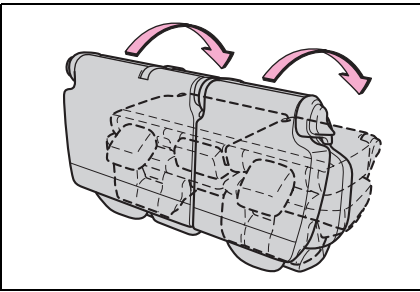

- 5** Return the seatback securely to the locked position.

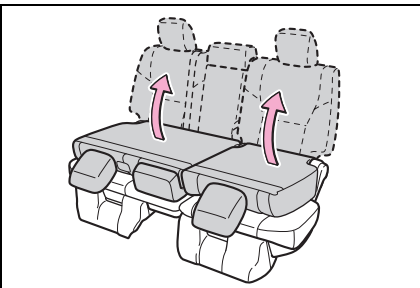

### **⚠ WARNING**

#### ■ **When tumbling the second seat**

Observe the following precautions.

Failure to do so may result in death or serious injury.

- Do not tumble the seat while driving.
- Stop the vehicle on level ground, set the parking brake and shift the shift lever to P.
- Check that there is no luggage and that there are no other people around the seat before tumbling operation.
- Do not insert hands or feet into the moving parts of the seat.
- Do not allow children to operate the seat.
- Do not tumble the second seat with any electrical devices left connected to the power outlet or USB Type-C charging ports (if equipped) on the rear of the console. The second seat could strike the electrical device and damage it.

#### ■ **After tumbling the second seat**

- Do not allow anyone to sit on a folded seatback or in the luggage compartment while driving.
- Do not allow children to enter the luggage compartment.
- Vehicles without third seats: Be sure to secure the seat using the tumble band after tumbling the second seat. If the seat is not secured, the seat may return while driving, resulting in serious injury.

### WARNING

- **Vehicles without third seats:**  
After securing the seat using the tumble band, make sure that the front seatback does not touch the tumbled seat. If the front passenger seatback touches the tumbled seat, the "PASSENGER AIR BAG OFF" indicator light to be illuminated, which indicates that the SRS airbags for the front passenger will not activate in the event of a severe accident.
- **Vehicles with third seats:** Do not drive with the second seat tumbled. This may cause the seat may return while driving, resulting in serious injury
- Be sure to install the seat hook covers on the seat hooks, or you may get burned when they become hot.
- **When returning the second seat to its original position**
- Make sure the seat legs are securely latched to the floor when putting back the seats.

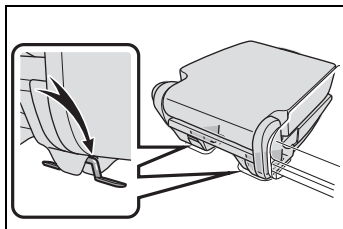

- When returning the second seat to the original position, be careful not to get hand, foot or any luggage caught between the second seat and the floor.

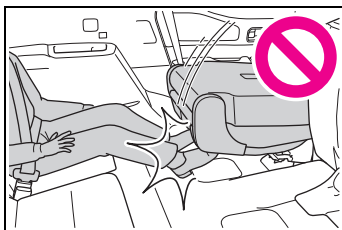

- **After returning the second seat to its original position**
- Gently shake the second seat to the front and rear and check that it is secure.
- Do not pinch the seat belt.

### When folding down the third seatbacks

#### ■ Before folding down the third seatbacks

- 1 Pass the seat belts through the seat belt hangers and secure the seat belt plates.

This prevents the shoulder belt from being damage.

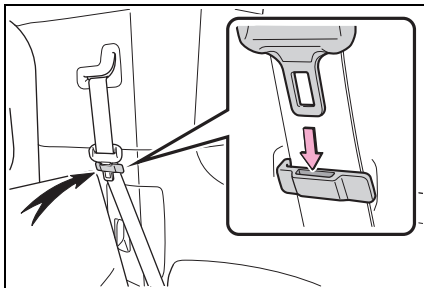



- 2 Operate the lever and fold the head restraint.

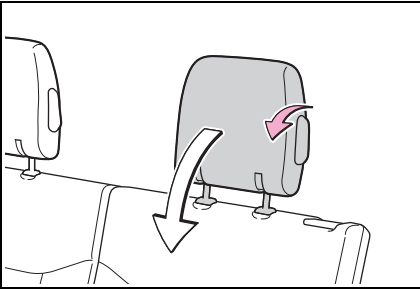

- 3 Adjust the seatback of the second seat so that it does not interfere with the third seat. (→P.156)

#### ■ Folding down the third seat-backs

While pulling the seatback angle adjustment lever, fold the seat-back down.

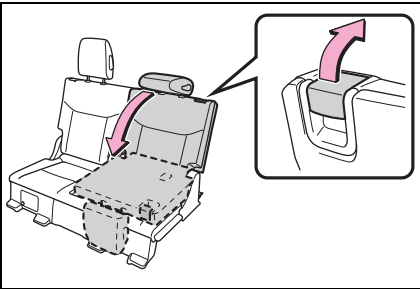

#### ■ Returning the third seat-backs

- 1 While pulling the seatback angle adjustment lever, lift up the seat back and return it

securely to the locked position.

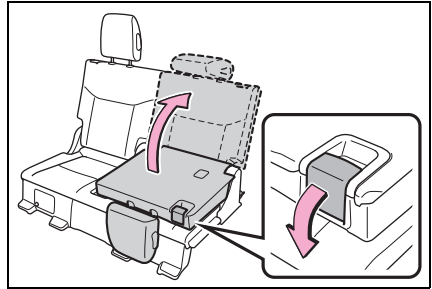

- 2 Lift the head restraint.

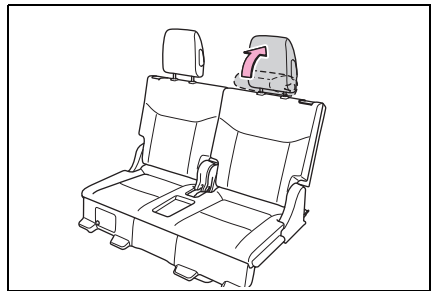

- 3 Remove the seat belt from the seat belt hanger before using the third seat.

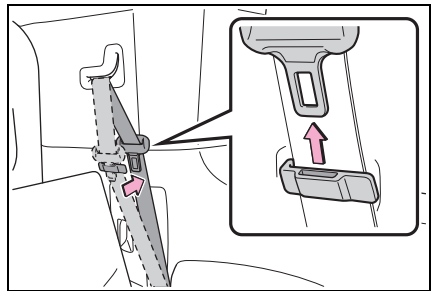

#### ⚠ WARNING

#### ■ When folding down the third seatback

Observe the following precautions.

Failure to do so may result in death or serious injury.

**⚠ WARNING**

- Check that there is no luggage and that there are no other people around the seat before folding operation.
  - Conduct the procedure slowly and carefully.
  - Do not insert hands or feet into the moving parts of the seat.
  - Do not allow children to operate the seat.
- **After returning the third seat-back to its original position**
- Gently shake the third seatback and head restraint to the front and rear and check that they are secure.
  - Do not pinch the seat belt.
  - Make sure that the seat belt is removed from the hanger as before.

**⚠ NOTICE**

■ **When folding down the third seatback (vehicles with luggage cover)**

If there is a luggage cover attached to the vehicle, remove the luggage cover. (→P.492)

The third seat could strike the luggage cover and damage it.

**Head restraints**

**Head restraints are provided for all seats.**

**⚠ WARNING**

■ **Head restraint precautions**

Observe the following precautions regarding the head restraints. Failure to do so may result in death or serious injury.

- Use the head restraints designed for each respective seat.
- Adjust the head restraints to the correct position at all times.
- After adjusting the head restraints, push down on them and make sure they are locked in position.
- Do not drive with the head restraints removed.
- Vehicles with third seat: When sitting on the third seat, make sure that the head restraint is not folded.

**Vertical adjustment**

■ **Front seats and outboard second seats**

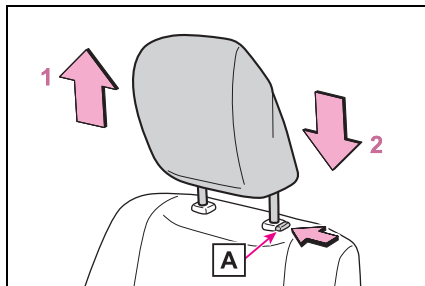

1 Up

**2 Down**

Push the head restraint down while pressing the lock release button

**A** .

■ **Second center seat**

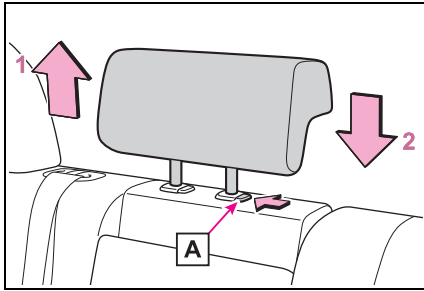
**1 Up****2 Down**

Push the head restraint down while pressing the lock release button

**A** .

■ **Adjusting the height of the head restraints (front seats and outboard second seats)**

Make sure that the head restraints are adjusted so that the center of the head restraint is closest to the top of your ears.

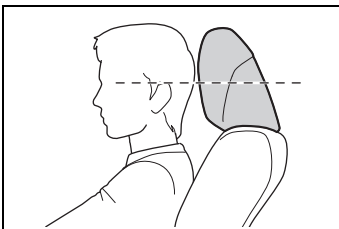

■ **Using the second center seat head restraint**

Always raise the head restraint one level from the stowed position when using.

**Folding the head restraint (third seats) (if equipped)**

Operate the head restraint angle lever to fold the head restraint.

To return the head restraint, pull it up.

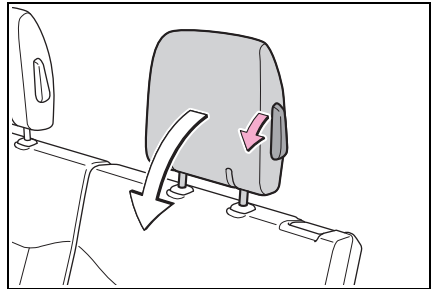

**Removing the head restraints**

■ **Front seats and outboard second seats**

Pull the head restraint up while pressing the lock release button

**A** .

If the head restraint touches the ceiling, making the removal difficult, change the seat height or angle. (→P.155, 156)

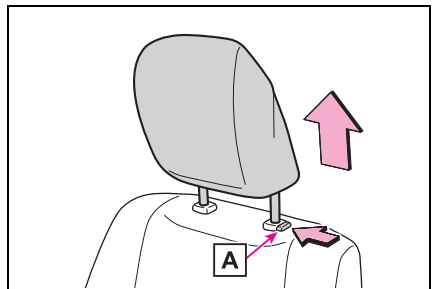

■ **Second center seat**

Pull the head restraint up while

pressing the lock release buttons **A**.

If the head restraint touches the ceiling, making the removal difficult, change the seat angle. (→P.156)

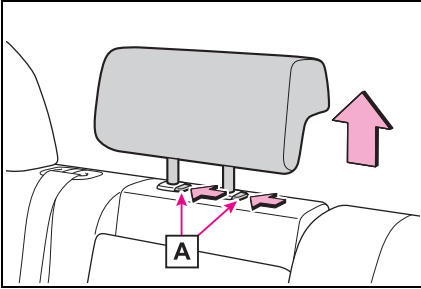

#### ■ Third seats (if equipped)

The head restraint cannot be removed.

### Installing the head restraints

#### ■ Front seats and outboard second seats

Align the head restraint with the installation holes and push it down to the lock position.

Press and hold the lock release button **A** when lowering the head restraint.

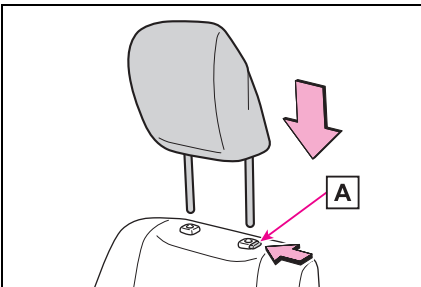

#### ■ Second center seat

Align the head restraint with the installation holes and push it down to the lock position.

Press and hold the lock release button **A** when lowering the head restraint.

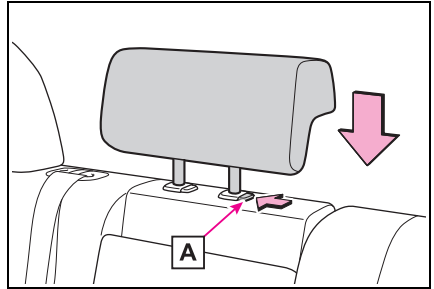

## Steering wheel

### Adjustment procedure

#### ► Manual adjustment type

- 1 Hold the steering wheel and pull the lever down.

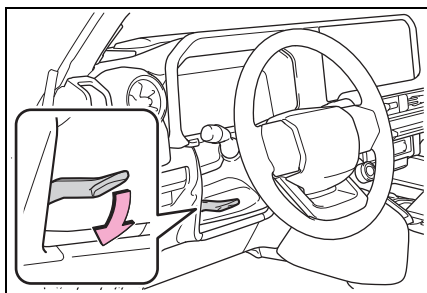

- 2 Adjust to the ideal position by moving the steering wheel horizontally and vertically.

After adjustment, pull the lever up to secure the steering wheel.

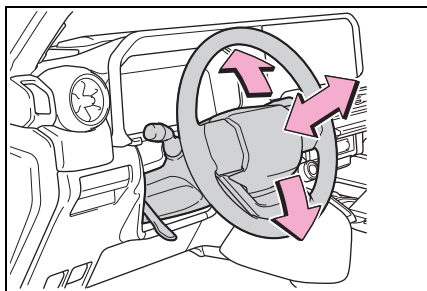

#### ► Power adjustment type

Operating the switch moves the steering wheel in the following directions:

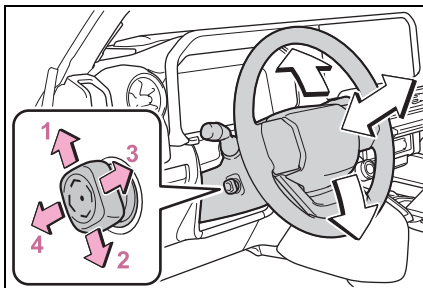

- 1 Up
- 2 Down
- 3 Toward the driver
- 4 Away from the driver

#### ■ The power adjustment type steering wheel can be adjusted when

The power switch is in ACC or ON.

#### ■ Power easy access system (if equipped)

The steering wheel and driver's seat move in accordance with power switch mode and the driver's seat belt condition. (→P.187)

#### ■ Automatic adjustment of the steering position (if equipped)

A desired steering position can be entered to memory and recalled automatically by the driving position memory system. (→P.188)

#### ■ Auto tilt away (if equipped)

When the power switch is turned off, the steering wheel returns to its stowed position by moving up and away to enable easier driver entry and exit.

Turning the power switch to ACC or ON will return the steering wheel to the original position.

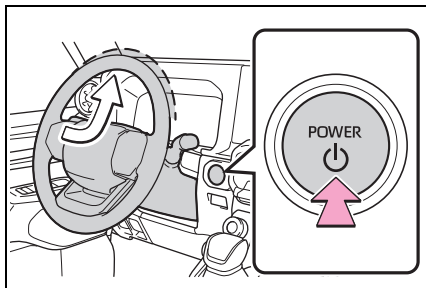

### ⚠ WARNING

#### ■ Caution while driving

Do not adjust the steering wheel while driving.

Doing so may cause the driver to mishandle the vehicle and cause an accident, resulting in death or serious injury.

#### ■ After adjusting the steering wheel (manual adjustment type)

Make sure that the steering wheel is securely locked.

Otherwise, the steering wheel may move suddenly, possibly causing an accident, and resulting in death or serious injury. Also, the horn may not sound if the steering wheel is not securely locked.

### Sounding the horn

To sound the horn, press on or close to the  mark.

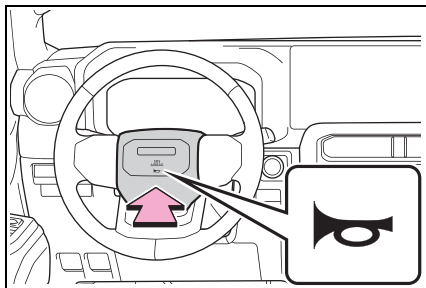

### Inside rear view mirror\*

\*: If equipped

The rear view mirror's position can be adjusted to enable sufficient confirmation of the rear view.

### Adjusting the height of rear view mirror

The height of the rear view mirror can be adjusted to suit your driving posture.

Adjust the height of the rear view mirror by moving it up and down.

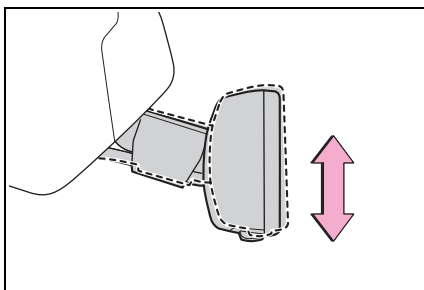

### ⚠ WARNING

#### ■ Caution while driving

Do not adjust the position of the mirror while driving.

Doing so may lead to mishandling of the vehicle and cause an accident, resulting in death or serious injury.

### Anti-glare function

Responding to the level of brightness of the headlights of

vehicles behind, the reflected light is automatically reduced.

Changing automatic anti-glare function mode ON/OFF

When the automatic anti-glare function is in ON mode, the indicator **A** illuminates.

The function will be set to ON mode each time the power switch is turned to ON.

Pressing the button turns the function to OFF mode. (The indicator **A** also turns off.)

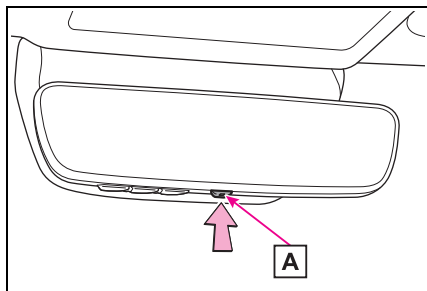

#### ■ To prevent sensor error

To ensure that the sensors operate properly, do not touch or cover them.

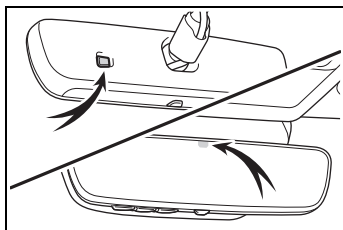

## Digital Rear-view Mirror\*

\*: If equipped

**The Digital Rear-view Mirror is a system that uses the camera on the rear of the vehicle and displays its image on the display of the Digital Rear-view Mirror.**

**The Digital Rear-view Mirror can be changed between optical mirror mode and digital mirror mode by operating the lever.**

**The Digital Rear-view Mirror allows the driver to see the rear view despite obstructions, such as the head restraints or luggage, ensuring rear visibility.**

**Also, the rear seats are not displayed and privacy of the passengers is enhanced.**

### ⚠ WARNING

Observe the following precautions.

Failure to do so may result in death or serious injury.

#### ■ Before using the Digital Rear-view Mirror

- Make sure to adjust the mirror before driving. (→P.169)
- Change to optical mirror mode and adjust the position of the Digital Rear-view Mirror so that the area behind your vehicle can be viewed properly.

**⚠ WARNING**

- Change to digital mirror mode and adjust the display settings.
- As the range of the image displayed by the Digital Rear-view Mirror is different from that of the optical mirror, make sure to check this difference before driving.

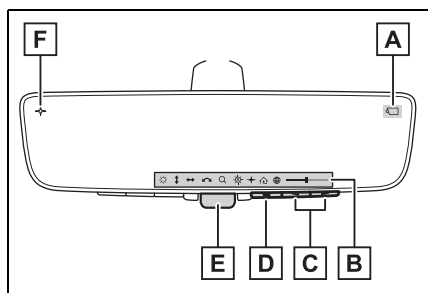
**System components****A** Camera indicator

Indicates that the camera is operating normally.

**B** Icon display area

Displays icons, adjusting gauge, etc. (→P.169)

**C** Select/adjust button

Press to change the setting of the item you want to adjust.

**D** Menu button

Press to display the icon display area and select the item you want to adjust.

**E** Lever

Operate to change between digital mirror mode and optical mirror mode.

**F** Digital anti-glare mode indicator

In digital mirror mode, this indicates that the anti-glare function is on. (→P.169)

**Changing modes**

Operate the lever to change between digital mirror mode and optical mirror mode.

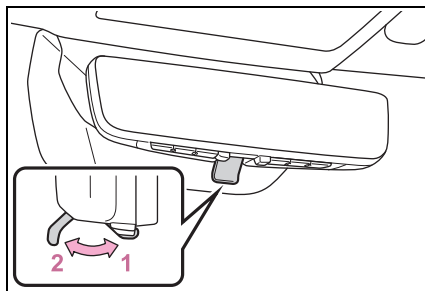
**1** Digital mirror mode

Displays an image of the area behind the vehicle.

 will illuminate in this mode.

**2** Optical mirror mode

Turns off the display of the Digital Rear-view Mirror allows it to be used as an optical mirror.

**■ Digital mirror mode operating condition**

The power switch is turned to ON.

When the power switch is changed from ON to OFF or ACC, the image will disappear after several seconds.

**■ When using the Digital Rear-view Mirror in digital mirror mode**

- If it is difficult to see the displayed image due to light reflected off the Digital Rear-view Mirror, the camera being dirty or covered with water droplets, dust, etc., or if lights of a vehicle behind your vehicle or the displayed image are



bothering you, change to optical mirror mode.

- When it is raining, if the image is unclear due to water on the rear window, operate the rear wiper.
- When the back door is open, the Digital Rear-view Mirror image may not display properly. Before driving, make sure the back door is closed.
- If the display is difficult to see due to reflected light, close the sunshade for the moon roof (if equipped).
- Any of the following conditions may occur when driving in the dark, such as at night. None of them indicates that a malfunction has occurred.
  - Colors of objects in the displayed image may differ from their actual color.
  - Depending on the height of the lights of the vehicle behind, the area around the vehicle may appear white and blurry.
  - Automatic image adjustment for brighter surrounding image may cause flickering.

If it is difficult to see the displayed image or flickering bothers you, change to optical mirror mode.

- The Digital Rear-view Mirror may become hot while it is in digital mirror mode. This is not a malfunction.
- Depending on your physical condition or age, it may take longer than usual to focus on the displayed image. In this case, change to optical mirror mode.
- Do not let passengers stare at the displayed image when the vehicle is being driven, as doing so may cause motion sickness.

#### ■ When the system malfunctions

If the symbol shown in the illustration is displayed when using the Digital Rear-view Mirror in digital

mirror mode, the system may be malfunctioning. The symbol will disappear in a few seconds. Operate the lever, change to optical mirror mode and have the vehicle inspected by your Toyota dealer.

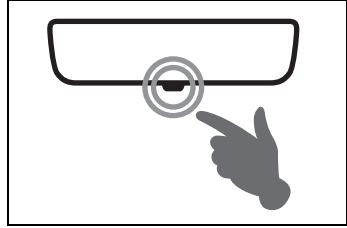

### Adjusting the mirror

#### ■ Adjusting the mirror height

The height of the rear view mirror can be adjusted to suit your driving posture.

Change to optical mirror mode, adjusting the height of the rear view mirror by moving it up and down.

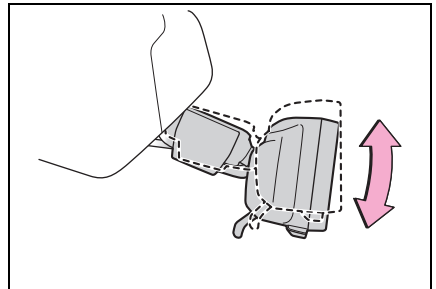



#### ■ Display settings (digital mirror mode)

Settings of the display in the digital mirror mode, on/off operation of the automatic anti-glare function, etc. can be changed.



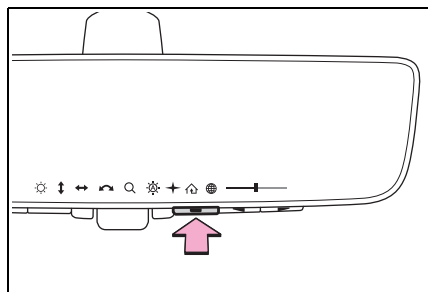

- 1 Press the menu button.





The icons will be displayed.



- 2 Press the menu button repeatedly and select the item you want to adjust.
- 3 Press  or  to change the setting.

The icons will disappear if a button is not operated for approximately 5 seconds or more.

Icons	Settings
	Select to adjust the brightness of the display.
	Select to adjust the area displayed up/down.
	Select to adjust the area displayed to the left/right.
	Select to adjust the angle of the displayed image.
	Select to zoom in/out the displayed image.

Icons	Settings
	<p>Select to enable/disable the automatic anti-glare function.*</p> <p>Responding to the brightness of the headlights of vehicles behind, the reflected light is automatically adjusted.</p> <p>The automatic anti-glare function is enabled each time the power switch is changed to ON.</p>
	Select to display HomeLink® Training Tutorial to assist customers to train their garage door opener system. (→P.517)
	Select to change the language of the Homelink® Training Tutorial.
	<p>The digital anti-glare mode can be turned on and off.</p> <p>When enabled, the brightness of the display is reduced at night to reduce headlight glare from vehicles to the rear.</p>

\*: This is a function for the optical mirror mode, however, the setting can also be changed while using the digital mirror mode.

#### ■ Enabling/disabling the automatic anti-glare function (optical mirror mode)

The automatic anti-glare function in the optical mirror mode can be enabled/disabled. The setting can be changed in both

the digital mirror mode and the optical mirror mode.

▶ When using the digital mirror mode



→P.169

▶ When using the optical mirror mode

1 Press the menu button.

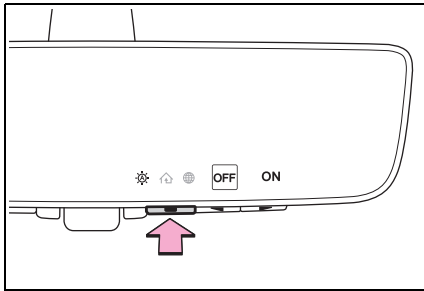
The icons will be displayed.



2 Press  or  to enable (ON)/disable (OFF) the automatic anti-glare function.

The icons will disappear if a button is not operated for approximately 5 seconds or more.

#### ■ Adjusting the display (digital mirror mode)

- The icons will disappear if a button is not operated for approximately 5 seconds or more.
- If the displayed image is adjusted, it may appear distorted. This is not a malfunction.
- If the brightness of the Digital Rear-view Mirror is set too high, it may cause eye strain. Adjust the Digital Rear-view Mirror to an appropriate brightness. If your eyes become tired, change to optical mirror mode.

- The brightness of the Digital Rear-view Mirror will change automatically according to the brightness of the area in front of your vehicle.
- The digital anti-glare mode operates only in locations where the surroundings are dark. Depending on the surrounding illumination environment, the image may not darken and it may not be possible to reduce headlight glare from vehicles to the rear.

#### ■ To prevent the light sensors from malfunctioning

To prevent the light sensors from malfunctioning, do not touch or cover them.

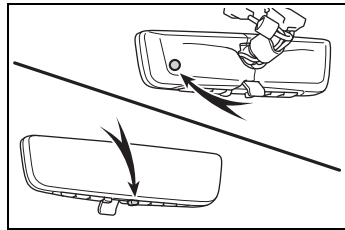

#### ⚠ WARNING

Observe the following precautions.

Failure to do so may result in death or serious injury.

#### ■ While driving

- Do not adjust the position of the Digital Rear-view Mirror or adjust the display settings while driving. Stop the vehicle and operate the Digital Rear-view Mirror control switches. Failure to do so may cause a steering wheel operation error, resulting in an unexpected accident.

### WARNING

- Always pay attention to the vehicle's surroundings.

The size of the vehicles and other objects may look different when in digital mirror mode and optical mirror mode.

When backing up, make sure to directly check the safety of the area around your vehicle, especially behind the vehicle.

Additionally, if a vehicle approaches from the rear in the dark, such as at night, the surrounding area may appear dim.

#### ■ To prevent causes of fire

If the driver continues using the Digital Rear-view Mirror while smoke or odor comes from the mirror, it may result in fire. Stop using the system immediately and contact your Toyota dealer.

## Cleaning the Digital Rear-view Mirror

### ■ Cleaning the mirror surface

If the mirror surface is dirty, the image on the display may be difficult to see.

Clean the mirror surface gently using a soft dry cloth.

### ■ The camera

The camera for the Digital Rear-view Mirror is located as shown.

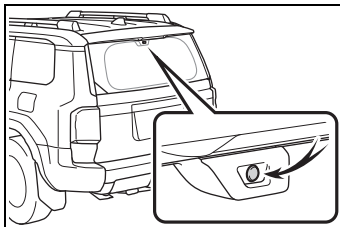

### NOTICE

#### ■ To prevent the Digital Rear-view Mirror from malfunctioning

Do not block the vent holes of the mirror. Otherwise, the mirror may be hot, leading to a malfunction or a fire.

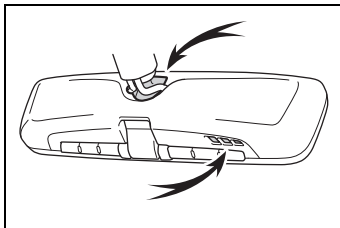

#### ■ To prevent the camera from malfunctioning

- Observe the following precautions, otherwise the Digital Rear-view Mirror may not operate properly.
  - Do not strike or hit the camera or subject it to a strong impact, as the camera installation position and angle may be changed.
  - Do not remove, disassemble or modify the camera.
  - Do not allow an organic solvent, car wax, window cleaner or glass coating to adhere to the camera. If this happens, wipe it off as soon as possible.



**NOTICE**



- When applying colored film (including transparent film) to the rear window glass, do not apply it to the area in front of the camera. If film is applied to the area in front of the camera, the image from the camera may not display properly.
- Do not subject the camera to a strong impact as this could cause a malfunction. If this happens, have the vehicle inspected by your Toyota dealer as soon as possible.

**If you notice any symptoms**

If you notice any of the following symptoms, refer to the following table for the likely cause and the solution. If the symptom is not resolved by the solution, have the vehicle inspected by your Toyota dealer.

Symptom	Likely cause	Solution
The image is difficult to see.	The mirror surface is dirty.	Clean the mirror surface gently, using a soft dry cloth.
	Sunlight or headlights are shining directly into the Digital Rear-view Mirror.	Change to optical mirror mode. (If the light is coming through the moon roof [if equipped], close the sunshade.)
	<ul style="list-style-type: none"> <li>• The vehicle is in a dark area.</li> <li>• The vehicle is near a TV tower, broadcasting station, electric power plant, or other location where strong radio waves or electrical noise may be present.</li> <li>• The temperature around the camera is extremely high/low.</li> <li>• The ambient temperature is extremely low.</li> <li>• It is raining or humid.</li> <li>• Sunlight or headlights are shining directly into the camera lens.</li> <li>• The vehicle is under fluorescent lights, sodium lights, mercury lights, etc.</li> <li>• Exhaust gas is obstructing the camera.</li> </ul>	Change to optical mirror mode. (Change back to digital mirror mode when the conditions have improved.)

Symptom	Likely cause	Solution
The image is difficult to see.	Foreign matters such as water droplets or dust is on the camera lens.	Have the vehicle inspected by your Toyota dealer.
	The luggage in the luggage compartment is reflected off the rear window glass and obstructing the camera.	<ul style="list-style-type: none"> <li>• Change to optical mirror mode.</li> <li>• Move the luggage to a position where it does not obstruct the camera or cover it with a black cloth to reduce the amount it is reflected off the rear window glass.</li> </ul>
	The rear window glass is fogged up.	Change to optical mirror mode. After defogging the rear window using the rear window defogger (→P.470), use the digital mirror mode again.
	The outside of the rear window glass is dirty.	Use the rear window wiper to remove dirt.
	The inside of the rear window glass is dirty.	Have the vehicle inspected by your Toyota dealer.
The image is out of alignment.	The back door is not fully closed.	Fully close the back door.
	The camera or its surrounding area has received a strong impact.	Change to optical mirror mode and have the vehicle inspected by your Toyota dealer.
The display is dim and  is displayed.	The system may be malfunctioning.	Change to optical mirror mode and have the vehicle inspected by your Toyota dealer.
 goes off.		

Symptom	Likely cause	Solution
 is displayed.	The Digital Rear-view Mirror is extremely hot. (The display will gradually become more dim. If the temperature continues to increase, the Digital Rear-view Mirror will turn off.)	Reducing the cabin temperature is recommended to reduce the temperature of the mirror. (  will disappear when the mirror becomes cool.) If  does not disappear even though the mirror is cool, have the vehicle inspected by your Toyota dealer.
The lever cannot be operated properly.	The lever may be malfunctioning.	Change to optical mirror mode and have the vehicle inspected by your Toyota dealer. (To change to optical mirror mode, press and hold the menu button for approximately 10 seconds.)



## Outside rear view mirrors

The rear view mirror's position can be adjusted to enable sufficient confirmation of the rear view.

### Defogging the mirrors (if equipped)

The outside rear view mirrors can be cleared using the mirror defoggers. Turn on the rear window defogger to turn on the outside rear view mirror defoggers. (→P.470)

### When using the outside rear view mirrors in a cold weather

When it is cold and the outside rear view mirrors are frozen, it may not be possible to fold/extend them or adjust the mirror surface. Remove the ice, snow, etc. covering the outside rear view mirrors.

### WARNING

#### Important points while driving

Observe the following precautions while driving.

Failing to do so may result in loss of control of the vehicle and cause an accident, resulting in death or serious injury.

- Do not adjust the mirrors while driving.
- Do not drive with the mirrors folded.
- Both the driver and passenger side mirrors must be extended and properly adjusted before driving.

#### When the mirror defoggers are operating (if equipped)

Do not touch the rear view mirror surfaces, as they can become very hot and burn you.

#### NOTICE

#### If ice should jam the mirror

Do not operate the control or scrape the mirror face. Use a spray de-icer to free the mirror.

### Adjustment procedure

- 1 To select a mirror to adjust, press the switch.

▶ Type A

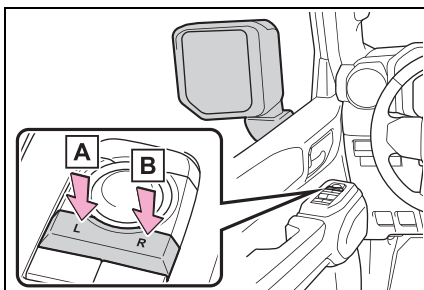

A Left

B Right

▶ Type B

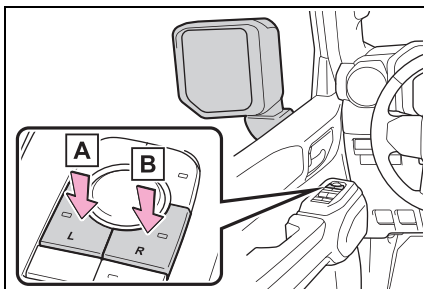

A Left

**B** Right

When selecting the mirror to adjust, the indicator on the switch illuminates.

Pressing the same switch again will put the switch in neutral.

- To adjust the mirror, press the switch.

## ▶ Type A

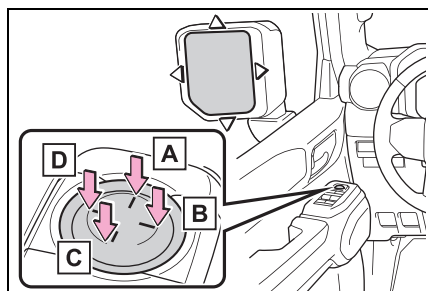
**A** Up**B** Right**C** Down**D** Left

## ▶ Type B

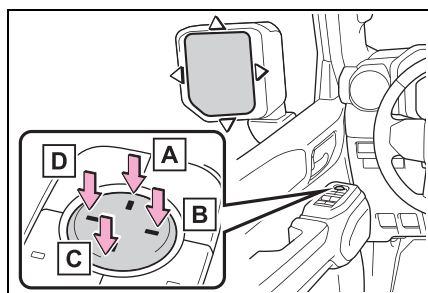
**A** Up**B** Right**C** Down**D** Left■ **Mirror angle can be adjusted when**

The power switch is in ACC or ON.

■ **Automatic adjustment of the mirror angle (if equipped)**

A desired mirror face angle can be entered to memory and recalled automatically by the driving position memory. (→P.188)

**Folding and extending the mirrors**■ **Using the switch**

## ▶ Type A

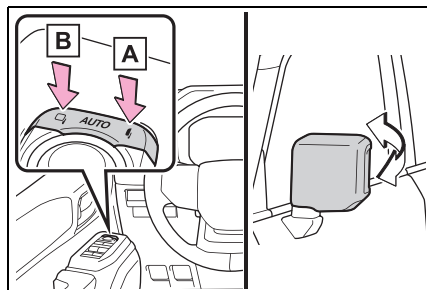
**A** Folds the mirrors**B** Extends the mirrors

## ▶ Type B

Press the switch to fold the mirrors.

Press it again to extend them to the original position.

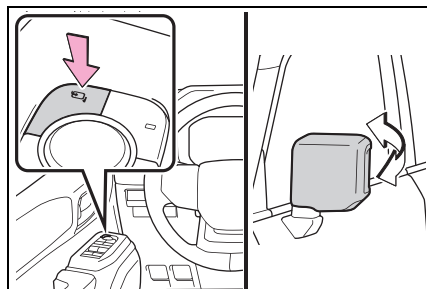

### ■ Setting automatic mode

#### ▶ Type A

Putting the outside rear view mirror folding switch in the neutral position sets the mirrors to automatic mode.

Automatic mode allows the folding or extending of the mirrors to be linked to locking/unlocking of the doors.

#### ▶ Type B

Press the “AUTO” switch to set automatic mode.

When in automatic mode, the indicator **A** will come on.

Automatic mode allows the folding or extending of the mirrors to be linked to locking/unlocking of the doors.

Pressing the switch again will return to manual mode.

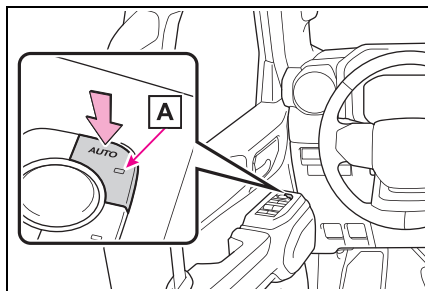

### ■ When disconnecting and reconnecting 12-volt battery terminals (type B)

The automatic folding/extending mirror function will return to off as default. To turn the function on, press the switch again to select on.

### ■ Customization (vehicles with automatic mode)

The automatic mirror folding and

extending operation can be changed. (Customizable features: →P.649)

### ⚠ WARNING

#### ■ When a mirror is moving

To avoid personal injury and mirror malfunction, be careful not to get your hand caught by the moving mirror.

### Linked mirror function when reversing (if equipped)

When either “L” or “R” of the mirror select switch is selected, the outside rear view mirrors will automatically angle downwards when the vehicle is reversing in order to give a better view of the ground.

To disable this function, select neither “L” nor “R”.

### ■ Adjusting the mirror angle when the vehicle is reversing

With the shift lever in R, adjust the mirror angle at a desired position. The adjusted angle will be memorized and the mirror will automatically tilt to the memorized angle whenever the shift lever is shifted to R from next time.

The memorized downward tilt position of the mirror is linked to the normal position (angle adjusted with the shift lever in other than R). Therefore, if the normal position is changed after adjustment, the tilt

position will also change.

When the normal position is changed, readjust the angle in reversing.

## Power windows

### Opening and closing the power windows

The power windows can be opened and closed using the switches.

Operating the switch moves the windows as follows:

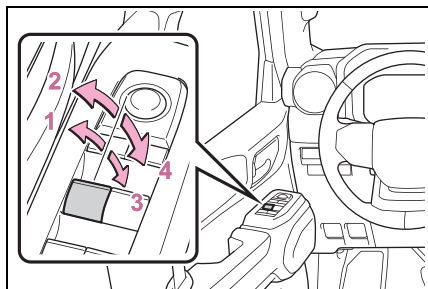

- 1 Closing
- 2 One-touch closing \*
- 3 Opening
- 4 One-touch opening \*

\*: To stop the window partway, operate the switch in the opposite direction.

#### ■ The power windows can be operated when

The power switch is in ON.

#### ■ Operating the power windows after turning the hybrid system off

The power windows can be operated for approximately 45 seconds even after the power switch is turned to ACC or turned off. They cannot, however, be operated once either front door is opened.

#### ■ Jam protection function

If an object becomes jammed

between the window and the window frame while the window is closing, window movement is stopped and the window is opened slightly.

#### ■ Catch protection function

If an object becomes caught between the door and window while the window is opening, window movement is stopped.

#### ■ When the window cannot be opened or closed

When the jam protection function or catch protection function operates unusually and the side window cannot be opened and closed, perform the following operations with the power window switch of that door.

- Stop the vehicle. With the power switch in ON, within 4 seconds of the jam protection function or catch protection function activating, continuously operate the power window switch in the one-touch closing direction or one-touch opening direction so that the side window can be opened and closed.
- If the side window cannot be opened and closed even when performing the above operations, perform the following procedure for function initialization.
  - 1 Turn the power switch to ON.
  - 2 Pull and hold the power window switch in the one-touch closing direction and completely close the side window.
  - 3 Release the power window switch for a moment, resume pulling the switch in the one-touch closing direction, and hold it there for approximately 6 seconds or more.
  - 4 Press and hold the power window switch in the one-touch opening direction. After the side window is completely opened, continue holding the switch for an additional 1 second or more.

- 5 Release the power window switch for a moment, resume pushing the switch in the one-touch opening direction, and hold it there for approximately 4 seconds or more.
- 6 Pull and hold the power window switch in the one-touch closing direction again. After the side window is completely closed, continue holding the switch for a further 1 second or more.

If you release the switch while the window is moving, start again from the beginning.

If the window reverses and cannot be fully closed or opened, have the vehicle inspected by your Toyota dealer.

#### ■ Door lock linked window operation (if equipped)

- The power windows can be opened and closed using the mechanical key.\* (→P.618)
- The power windows can be opened using the wireless remote control.\* (→P.129)
- Vehicles with intrusion sensor: if the power windows are closed using the door lock linked window operation when the alarm system is set, the alarm may be triggered.

\*: These settings must be customized at your Toyota dealer.

#### ■ Power window open reminder function

A message is shown on the multi-information display when the power switch is turned to OFF and the driver's door is opened with the power windows open.

#### ■ Customization

Settings (e.g. linked door lock operation) can be changed. (Customizable features: →P.649)

### ⚠ WARNING

Observe the following precautions.

Failing to do so may result in death or serious injury.

#### ■ Closing the windows

- The driver is responsible for all the power window operations, including the operation for the passengers. In order to prevent accidental operation, especially by a child, do not let a child operate the power windows. It is possible for children and other passengers to have body parts caught in the power window. Also, when riding with a child, it is recommended to use the window lock switch. (→P.183)
- Check to make sure that all passengers do not have any part of their body in a position where it could be caught when a window is being operated.

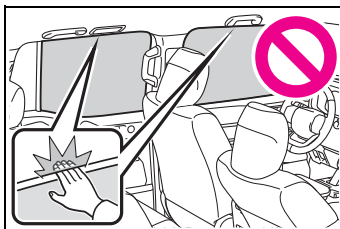

- When using the wireless remote control or mechanical key and operating the power windows, operate the power window after checking to make sure that there is no possibility of any passenger having any of their body parts caught in the window. Also, do not let a child operate window by the wireless remote control or mechanical key. It is possible for children and other passengers to get caught in the power window.

### **WARNING**

- When exiting the vehicle, turn the power switch off, carry the key and exit the vehicle along with the child. There may be accidental operation, due to mischief, etc., that may possibly lead to an accident.
- **Jam protection function**
- Never use any part of your body to intentionally activate the jam protection function.
- The jam protection function may not work if something gets jammed just before the window is fully closed. Be careful not to get any part of your body jammed in the window.
- **Catch protection function**
- Never use any part of your body or clothing to intentionally activate the catch protection function.
- The catch protection function may not work if something gets caught just before the window is fully opened. Be careful not to get any part of your body or clothing caught in the window.

### **Preventing accidental operation (window lock switch)**

This function can be used to prevent children from accidentally opening or closing a passenger window.

Press the switch.

The indicator **A** will come on and the passenger windows will be locked.

The passenger windows can still be

opened and closed using the driver's switch even if the lock switch is on.

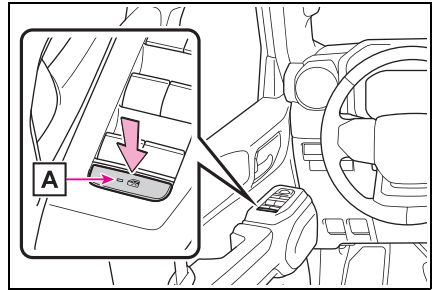

#### ■ **The window lock switch can be operated when**

The power switch is in ON.

#### ■ **When the 12-volt battery is disconnected**

The window lock switch is disabled. If necessary, press the window lock switch after reconnecting the 12-volt battery.

## Moon roof\*

\*: If equipped

**Use the overhead switches to open and close the moon roof and tilt it up and down.**

### Operating the moon roof

#### ■ Opening and closing

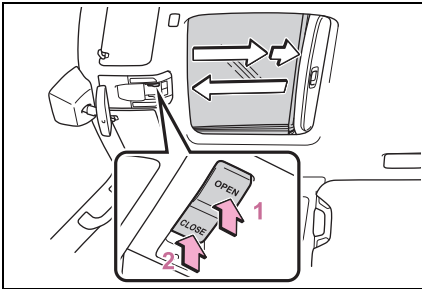

#### 1 Opens the moon roof\*

The moon roof stops slightly before the fully open position to reduce wind noise.

Press the switch again to fully open the moon roof.

#### 2 Closes the moon roof\*

\*: Lightly press either end of the moon roof switch to stop the moon roof partway.

#### ■ Tilting up and down

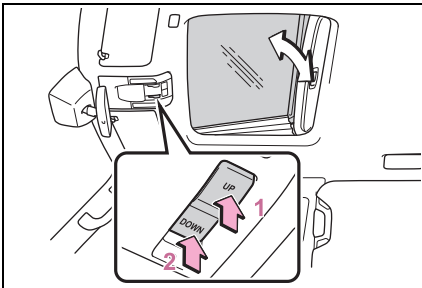

#### 1 Tilts the moon roof up\*

#### 2 Tilts the moon roof down\*

\*: Lightly press either end of the moon roof switch to stop the moon roof partway.

#### ■ The moon roof can be operated when

The power switch is in ON.

#### ■ Operating the moon roof after turning the hybrid system off

The moon roof can be operated for approximately 45 seconds after the power switch is turned to ACC or turned off. It cannot, however, be operated once either front door is opened.

#### ■ Jam protection function

If an object is detected between the moon roof and the frame while the moon roof is closing or tilting down, travel is stopped and the moon roof opens slightly.

#### ■ Sunshade

The sunshade can be opened and closed manually. However, the sunshade will open automatically when the moon roof is opened.

#### ■ Door lock linked moon roof operation (if equipped)

- The moon roof can be opened and closed using the mechanical key.\* (→P.618)
- The moon roof can be opened using the wireless remote control.\* (→P.129)
- Vehicles with intrusion sensor: if the moon roof is closed using the door lock linked window operation when the alarm system is set, the alarm may be triggered.

\*: These settings must be customized at your Toyota dealer.



### ■ When the moon roof does not close normally

Perform the following procedure:

- If the moon roof closes but then re-opens slightly

- 1 Stop the vehicle.
- 2 Press and hold the “CLOSE” switch.<sup>\*1</sup>  
The moon roof will close, re-open and pause for approximately 10 seconds.<sup>\*2</sup> Then it will close again, tilt up and pause for approximately 1 second. Finally, it will tilt down, open and close.

- 3 Check to make sure that the moon roof is completely closed and then release the switch.

- If the moon roof tilts down but then tilts back up

- 1 Stop the vehicle.
- 2 Press and hold the “UP” switch<sup>\*1</sup> until the moon roof moves into the tilt up position and stops.
- 3 Release the “UP” switch once and then press and hold the “UP” switch again.<sup>\*1</sup>

The moon roof will pause for approximately 10 seconds in the tilt up position.<sup>\*2</sup> Then it will adjust slightly and pause for approximately 1 second.

Finally, it will tilt down, open and close.

- 4 Check to make sure that the moon roof is completely closed and then release the switch.

<sup>\*1</sup>: If the switch is released at the incorrect time, the procedure will have to be performed again from the beginning.

<sup>\*2</sup>: If the switch is released after the above mentioned 10 second pause, automatic operation will be disabled. In that case, press and hold the “CLOSE” or “UP” switch, and the moon roof will tilt up and pause for approximately 1

second. Then it will tilt down, open and close. Check to make sure that the moon roof is completely closed and then release the switch.

If the moon roof does not fully close even after performing the above procedure correctly, have the vehicle inspected by your Toyota dealer.

### ■ Moon roof open reminder function

A message is shown on the multi-information display when the power switch is turned to OFF and the driver's door is opened with the moon roof open.

### ■ Customization

Settings (e.g. linked door lock operation) can be changed. (Customizable features: →P.649)

### WARNING

Observe the following precautions.

Failure to do so may cause death or serious injury.

#### ■ Opening the moon roof

- Do not allow any passengers to put their hands or head outside the vehicle while it is moving.
- Do not sit on top of the moon roof.

#### ■ Opening and closing the moon roof

- The driver is responsible for moon roof opening and closing operations.  
In order to prevent accidental operation, especially by a child, do not let a child operate the moon roof. It is possible for children and other passengers to have body parts caught in the moon roof.

**⚠ WARNING**

- Check to make sure that all passengers do not have any part of their body in a position where it could be caught when the moon roof is being operated.

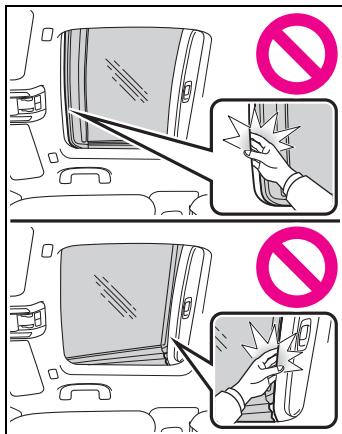

- When using the wireless remote control or mechanical key and operating the moon roof, operate the moon roof after checking to make sure that there is no possibility of any passenger having any of their body parts caught in the moon roof. Also, do not let a child operate moon roof by the wireless remote control or mechanical key. It is possible for children and other passengers to get caught in the moon roof.
  - When exiting the vehicle, turn the power switch off, carry the key and exit the vehicle along with the child. There may be accidental operation, due to mischief, etc., that may possibly lead to an accident.
- **Jam protection function**
- Never use any part of your body to intentionally activate the jam protection function.

- The jam protection function may not work if something gets caught just before the moon roof is fully closed.

## Driving position memory\*

\*: If equipped

**This feature automatically adjusts the positions of the driver's seat, steering wheel, outside rear view mirrors and head-up display (if equipped) to make entering and exiting the vehicle easier or to suit your preferences.**

**When My Settings is turned on:**

**Driving positions for the registered drivers (3 patterns) and guest (1 pattern) can be registered in My Settings.**

**When electronic key assignment is registered for My Settings, the driving position for each driver can be recalled (memory recall function).**

**When My Settings is turned off:**

**Up to 2 different driving positions can be recorded.**

**Each electronic key can be registered to recall your preferred driving position (memory recall function).**

**For details about My Settings, refer to P.192.**

## Enabling easier driver entry and exit (power easy access system)

When all of the following have been performed, the driver's seat and steering wheel are automatically adjusted to a position that allows driver to enter and exit the vehicle easily.

- The shift lever has been shifted to P.
- The power switch has been turned to OFF.
- The driver's seat belt has been unfastened.

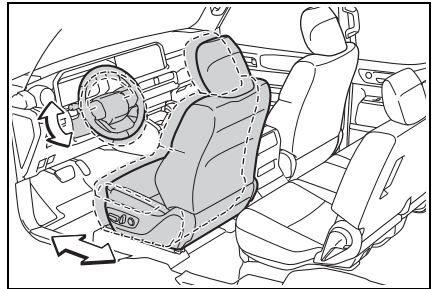

When any of the following has been performed, the driver's seat and steering wheel automatically return to their original positions.

- The power switch has been turned to ACC or ON.
- The driver's seat belt has been fastened.

### ■ Operation of the power easy access system

- When exiting the vehicle, the power easy access system may

not operate if the seat is already close to the rearmost position, etc.

- If the seat position is adjusted during power easy access system operation, the automatic operation will stop. (The seat will change to manual operation.)
- If the seat position is adjusted during or after the power easy access system operation when the driver is exiting the vehicle, the power easy access system will not operate when entering the vehicle.

■ **Jam protection function**

If a person or object interferes while the seat is moving automatically, the operation will stop.

■ **Customization**

Settings (e.g. the seat movement amount settings of the power easy access system) can be customized. (Customizable features: →P.649)

**! WARNING**

■ **While the power easy access system is operating and the steering wheel and seat is moving**

Be careful not to get body parts or luggage caught. Failure to do so may cause an injury or damage to the luggage.

**Recording/recalling a driving position**

■ **Recording procedure**

- 1 Check that the shift lever is in P.
- 2 Turn the power switch to ON.
- 3 Adjust the driver's seat, steering wheel, outside rear view mirrors and head-up

display (if equipped) to the desired positions.

- 4 While pressing the "SET" button, or within 3 seconds after the "SET" button is pressed, press button "1" or "2" until the buzzer sounds.

If the selected button has already been preset, the previously recorded position will be overwritten.

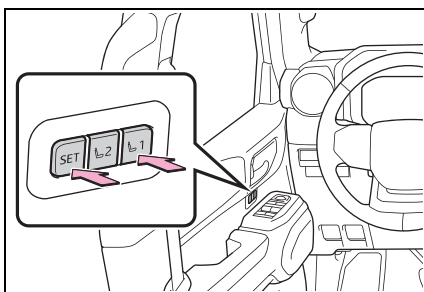

■ **Recall procedure**

- 1 Check that the shift lever is in P.
- 2 Turn the power switch to ON.
- 3 Press one of the buttons for the driving position you want to recall until the buzzer sounds.

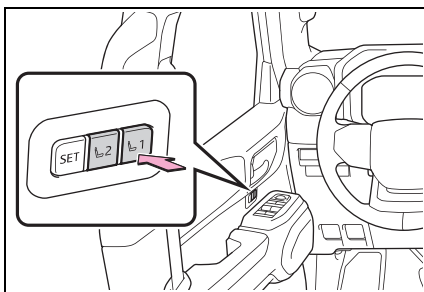

■ **To stop the position recall operation part-way through**

Perform any of the following:

- Press the “SET” button.
- Press button “1” or “2”.
- Operate any of the seat adjustment switches (only cancels seat position recall).
- Operate the tilt and telescopic steering control switch (only cancels steering wheel position recall).

#### ■ Jam protection function

If a person or object interferes while the seat is moving automatically, the operation will stop.

#### ■ Seat position that can be memorized (→P.155)

The adjusted positions other than the position adjusted by lumbar support switch and seat cushion length adjustment lever (if equipped) can be recorded.

#### ■ Operating the driving position memory after turning the power switch off

Recorded seat positions can be activated up to 180 seconds after the driver’s door is opened and another 60 seconds after it is closed again.

#### ■ In order to correctly use the driving position memory function

If a seat position is already in the furthest possible position and the seat is operated in the same direction, the recorded position may be slightly different when it is recalled.

#### ■ When recalling the driving position

Take care when recalling the driving position so that the head restraint does not touch the ceiling.

#### ■ When the recorded seat position cannot be recalled

The seat position may not be recalled in some situations when the seat position is recorded in a certain range. For details, contact your

Toyota dealer.

### WARNING

#### ■ Seat adjustment caution

Take care during seat adjustment so that the seat does not strike the rear passenger or squeeze your body against the steering wheel.

### Registering/recalling/canceling a driving position to an electronic key (memory recall function)

#### ■ When My Settings is turned on (an individual is identified with an electronic key):

The driving positions can be automatically recalled for each registered driver by registering electronic key assignments in My Settings.

#### ● Registering procedure

When the shift lever is shifted to P after driving the vehicle, the current driving position will be recorded.

#### ● Recall procedure

- 1 Carry only the electronic key that has been assigned and registered in My Settings, and then unlock and open the driver’s door using the smart key system or wireless remote control.

The driving position other than the steering wheel and head-up display (if equipped) will move to the recorded position. However, the seat will move to a position slightly behind the recorded position in

order to make entering the vehicle easier.

If the driving position is in a position that has already been recorded, the driving position will not move.

- 2 Turn the power switch to ACC or ON.

The seat, steering wheel and head-up display (if equipped) (only when the power switch is in ON) will move to the recorded position.

- **Cancellation procedure**

Initialize the driver registered settings in My Settings.

For information on initializing driver registered settings, refer to the "MULTIMEDIA OWNER'S MANUAL".

- **When My Settings is turned on (an individual is identified with face information) (vehicles with face authentication system):**

The driving position can automatically be recalled for each registered driver by registering face information in the face authentication system and registering the face information assignment in My Settings.

- **Registering procedure**

When the shift lever is shifted to P after driving the vehicle, the current driving position will be recorded.

- **Recall procedure**

Turn the power switch to ACC or ON.

After face authentication is performed successfully, the seat, steering wheel and head-up display

(if equipped) (only when the power switch is turned to ON) move to the registered driving position.

If the driving position is in a position that has already been recorded, the driving position will not move.

- **Cancellation procedure**

Delete face information from the face authentication system.

For information on deleting face information, refer to "MULTIMEDIA OWNER'S MANUAL".

- **When My Settings is turned off:**

Each electronic key can be registered to automatically recall your preferred driving position.

- **Registering procedure**

Record your driving position to button "1" or "2" before performing the following:

Carry only the electronic key you want to register, and then close the driver's door.

If 2 or more electronic keys are in the vehicle, the driving position cannot be recorded properly.

- 1 Check that the shift lever is in P.
- 2 Turn the power switch to ON.
- 3 Recall the driving position that you want to record.
- 4 While pressing the recalled button, press and hold the door lock switch (either lock or unlock) until the buzzer sounds.

If the button could not be registered, the buzzer sounds continu-

ously for approximately 3 seconds.

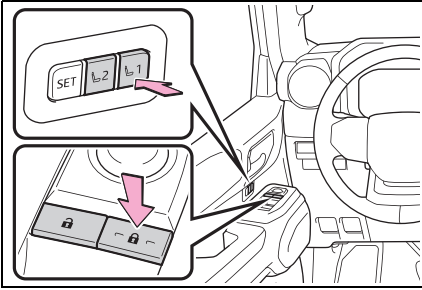

### ● Recall procedure

- 1 Make sure that the doors are locked before recalling the driving position. Carry the electronic key that has been registered to the driving position, and then unlock and open the driver's door using the smart key system or wireless remote control.

The driving position other than the steering wheel and head-up display (if equipped) will move to the recorded position. However, the seat will move to a position slightly behind the recorded position in order to make entering the vehicle easier.

If the driving position is in a position that has already been recorded, the driving position will not move.

- 2 Turn the power switch to ACC or ON, or fasten a seat belt.

The seat, steering wheel and head-up display (if equipped) (only when the power switch is in ON) will move to the recorded position.

### ● Cancellation procedure

- 1 Carry only the electronic key you want to cancel and then close the driver's door.

If 2 or more keys are in the vehicle, the driving position cannot be canceled properly.

- 2 Check that the shift lever is in P.
- 3 Turn the power switch to ON.
- 4 While pressing the "SET" button, press and hold the door lock switch (either lock or unlock) until the buzzer sounds twice.

If the button could not be canceled, the buzzer sounds continuously for approximately 3 seconds.

### ■ Recalling the driving position using the memory recall function (when My Settings is turned off)

If a door other than the driver's door is unlocked with the smart key system, the driving position cannot be recalled. In this case, press the driving position button which has been set.

### ■ Jam protection function

If a person or object interferes while the seat is moving automatically, the operation will stop.

### ■ Customization

Some functions can be customized. (Customizable features: →P.649)

## My Settings

**By identifying an individual through a device, such as an electronic key, the driving position and vehicle settings recorded for that driver can be recalled when the vehicle is entered.**

**By assigning an authentication device to a driver in advance, the driver can enter the vehicle with their preferred settings.**

**Settings for up to 3 drivers can be recorded by My Settings.**

**For details on how to assign/delete electronic keys, set driver names, perform initialization, change drivers manually, or delete a driver, refer to “MULTIMEDIA OWNER’S MANUAL”.**

## Types of assigned authentication devices

An individual can be identified using the following authentication devices.

- **Electronic key/Digital key\***

An individual is identified when the smart key system detects their electronic key/digital key. (→P.127, 150)

- **Face authentication system\***

An individual is identified at the opening/closing of the door when face information registered using the driver monitor camera is identified. (→P.266)

Individual identification by face authentication is prioritized than by electronic key/digital key\*, if the latter has identified with another registered driver.

- **Bluetooth® devices**

An individual can be identified if the same Bluetooth® device that was used as a hands-free phone the last time the vehicle was entered is connected to the audio system.

If an individual is identified by detecting an electronic key, digital key\* or face information\*, identification by Bluetooth® device will not be performed.

Bluetooth® is a registered trademark of Bluetooth SIG, Inc.

\*: If equipped

## Recalled functions

When an individual is identified from an authentication device, settings for the following functions are recalled.

- **Driving position (memory recall function)\*<sup>1</sup>**

After an individual is identified, the driving position that was set when driving was last completed (with shift lever set to P) is recalled when either of the following operations is performed.

- When an individual is identified



from an electronic key: Unlocking the doors using the smart key system or wireless remote control

- When an individual is identified from a digital key<sup>\*1</sup>: Unlocking the doors using the smart key system
- When an individual is identified from the face authentication system<sup>\*1</sup>: After the driver monitor identifies face information, turning the power switch to ACC or ON
- Meter displays<sup>\*2</sup> and head-up display information<sup>\*1, 2</sup>

When an individual is identified, the display settings used when the power switch was last turned off are recalled.

- Multimedia settings<sup>\*2</sup>

When an individual is identified, the multimedia system settings used when the power switch was last turned off are recalled.

- Safe driving support function<sup>\*2</sup>

When an individual is identified, the vehicle settings used when the power switch was last turned off are recalled.

- Vehicle settings available on the multimedia system<sup>\*2</sup>

When an individual is identified, the vehicle settings used when the power switch was last turned off are recalled.

<sup>\*1</sup>: If equipped

<sup>\*2</sup>: Some settings are excluded



**4-1. Before driving**

Driving the vehicle.....	197
Cargo and luggage .....	204
Vehicle load limits .....	208
Trailer towing (with towing hitch) .....	209
Dinghy towing .....	221

**4-2. Driving procedures**

Power (ignition) switch	222
Automatic transmission	227
Turn signal lever .....	233
Parking brake .....	233
Brake Hold .....	237

**4-3. Operating the lights and wipers**

Headlight switch.....	240
AHB (Automatic High Beam).....	242
Fog light switch .....	245
Windshield wipers and washer.....	246
Rear window wiper and washer.....	248

**4-4. Refueling**

Opening the fuel tank cap .....	251
---------------------------------	-----

**4-5. Using the driving support systems**

Toyota Safety Sense 3.0 software update.....	254
--	-----

Toyota Safety Sense 3.0 .....	256
Driver monitor.....	266
PCS (Pre-Collision System) .....	268
LTA (Lane Tracing Assist) .....	280
LCA (Lane Change Assist) .....	285
LDA (Lane Departure Alert) .....	288
PDA (Proactive driving assist).....	294
FCTA (Front Cross Traffic Alert).....	300
RSA (Road Sign Assist) .....	302
Dynamic radar cruise control .....	305
Cruise control .....	316
Emergency Driving Stop System .....	319
Traffic Jam Assist.....	322
BSM (Blind Spot Monitor) .....	328
Safe Exit Assist .....	333
Intuitive parking assist.	337
RCTA (Rear Cross Traffic Alert) function .....	343
RCD (Rear Camera Detection) function.....	349

PKSB (Parking Support Brake).....	353
Parking Support Brake function (static objects front and rear of the vehicle) .....	358
Parking Support Brake function (moving vehicles rear of the vehicle) ....	360
Parking Support Brake function (pedestrians rear of the vehicle).....	362
Multi-terrain Monitor ....	364
Driving mode select switch .....	433
Four-wheel drive system .....	435
Rear differential lock system .....	437
Crawl Control .....	439
Multi-terrain Select .....	442
Downhill assist control system .....	445
Driving assist systems	448
Trailer brake controller	453
SDM (Stabilizer with Disconnection Mechanism) .....	456

#### 4-6. Driving tips

Off-road precautions ...	458
Hybrid Electric Vehicle driving tips.....	461
Winter driving tips .....	463

## Driving the vehicle

The following procedures should be observed to ensure safe driving:

### Driving procedure

#### ■ Starting the hybrid system

→P.222

#### ■ Driving

- 1 With the brake pedal depressed, shift the shift lever to D. (→P.229)
- 2 Release the parking brake. (→P.233)

If the parking brake is in automatic mode, the parking brake will be released automatically. (→P.234)

- 3 Gradually release the brake pedal and gently depress the accelerator pedal to accelerate the vehicle.

#### ■ Stopping

- 1 With the shift lever in D, depress the brake pedal.
- 2 If necessary, set the parking brake. (→P.233)

If the vehicle is to be stopped for an extended period of time, shift the shift lever to P or N. (→P.229)

#### ■ Parking the vehicle

- 1 With the shift lever in D, depress the brake pedal.
- 2 Set the parking brake (→P.233), and shift the shift lever to P (→P.229).

Make sure the parking brake indicator light is on.

- 3 Press the power switch to stop the hybrid system.
- 4 Lock the door, making sure that you have the electronic key on your person.

If parking on a hill, block the wheels as needed.

#### ■ Starting off on a steep uphill

- 1 With the brake pedal depressed, shift the shift lever to D. (→P.229)
- 2 Pull the parking brake switch to set the parking brake manually. (→P.233)
- 3 Release the brake pedal and gently depress the accelerator pedal to accelerate the vehicle.
- 4 Press the parking brake switch and parking brake is released manually.

#### ■ When starting off on a uphill

The hill-start assist control will activate. (→P.448)

#### ■ For fuel-efficient driving

Keep in mind that Hybrid Electric Vehicles are similar to conventional vehicles, and it is necessary to refrain from activities such as sudden acceleration. (→P.461)

#### ■ Driving in the rain

- Drive carefully when it is raining, because visibility will be reduced, the windows may become fogged-up, and the road will be slippery.
- Drive carefully when it starts to rain, because the road surface will

be especially slippery.

- Refrain from high speeds when driving on an expressway in the rain, because there may be a layer of water between the tires and the road surface, preventing the steering and brakes from operating properly.

### ■ Engine speed while driving

In the following conditions, the engine speed may become high while driving. This is due to automatic up-shifting control or down-shifting implementation to meet driving conditions. It does not indicate sudden acceleration.

- The vehicle is judged to be driving uphill or downhill
- When the accelerator pedal is released
- When the brake pedal is depressed while sport mode\* is selected (→P.433)
- When the brake pedal is depressed while "TOW HAUL" mode is selected

\*: If equipped

### ■ Restraining the hybrid system output (Brake Override System)

- When the accelerator and brake pedals are depressed at the same time, the hybrid system output may be restrained.
- A warning message is displayed on the multi-information display while the system is operating.

### ■ Breaking in your new Toyota

To extend the life of the vehicle, observing the following precautions is recommended:

- For the first 200 miles (300 km): Avoid sudden stops.
- For the first 500 miles (800 km): Do not tow a trailer.
- For the first 1000 miles (1600 km):
- Do not drive at extremely high speeds.

- Avoid sudden acceleration.
- Do not drive continuously in low gears.
- Do not drive at a constant speed for extended periods.

### ■ Idling time before stopping the hybrid system

To prevent damage to the turbo-charger, allow the engine to idle immediately after high-speed driving or driving up a hill.

Driving condition	Idling time
Normal city driving or high-speed driving (at the highway speed limit or recommended speed)	Not necessary
Steep hill driving or continuous driving (race-track driving etc.)	Approximately 1 minute

### ■ Operating your vehicle in a foreign country

Comply with the relevant vehicle registration laws and confirm the availability of the correct fuel. (→P.632)

### WARNING

Observe the following precautions.

Failure to do so may result in death or serious injury.

#### ■ When starting the vehicle

Always keep your foot on the brake pedal while stopped with the "READY" indicator is illuminated. This prevents the vehicle from creeping.

#### ■ When driving the vehicle

- Do not drive if you are unfamiliar with the location of the brake and accelerator pedals to avoid depressing the wrong pedal.

**WARNING**

- Accidentally depressing the accelerator pedal instead of the brake pedal will result in sudden acceleration that may lead to an accident.
- When backing up, you may twist your body around, leading to a difficulty in operating the pedals. Make sure to operate the pedals properly.
- Make sure to keep a correct driving posture even when moving the vehicle only slightly. This allows you to depress the brake and accelerator pedals properly.
- Depress the brake pedal using your right foot. Depressing the brake pedal using your left foot may delay response in an emergency, resulting in an accident.
- The driver should pay extra attention to pedestrians when the vehicle is powered only by the electric motor (traction motor). As there is no engine noise, the pedestrians may misjudge the vehicle's movement. Even though the vehicle is equipped with the acoustic vehicle alerting system, drive with care as pedestrians in the vicinity may still not notice the vehicle if the surrounding area is noisy
- Do not drive the vehicle over or stop the vehicle near flammable materials.  
The exhaust system and exhaust gases can be extremely hot. These hot parts may cause a fire if there is any flammable material nearby.

- During normal driving, do not turn off the hybrid system. Turning the hybrid system off while driving will not cause loss of steering or braking control, however, power assist to the steering will be lost. This will make it more difficult to steer smoothly, so you should pull over and stop the vehicle as soon as it is safe to do so.  
In the event of an emergency, such as if it becomes impossible to stop the vehicle in the normal way: →P.581
- Use engine braking (downshift) to maintain a safe speed when driving down a steep hill.  
Using the brakes continuously may cause the brakes to overheat and lose effectiveness.  
(→P.227)
- Do not adjust the positions of the steering wheel, the seat, inside rear view mirror (if equipped), Digital Rear-view Mirror (if equipped) or outside rear view mirrors while driving.  
Doing so may result in a loss of vehicle control.
- Always check that all passengers' arms, heads or other parts of their body are not outside the vehicle.
- Do not drive in excess of the speed limit. Even if the legal speed limit permits it, do not drive over 85 mph (140 km/h) unless your vehicle has high-speed capability tires. Driving over 85 mph (140 km/h) may result in tire failure, loss of control and possible injury. Be sure to consult a tire dealer to determine whether the tires on your vehicle are high-speed capability tires or not before driving at such speeds.

**WARNING**

■ **When driving on slippery road surfaces**

- Sudden braking, acceleration and steering may cause tire slippage and reduce your ability to control the vehicle.
- Sudden acceleration, engine braking due to shifting, or changes in engine speed could cause the vehicle to skid.
- After driving through a puddle, lightly depress the brake pedal to make sure that the brakes are functioning properly. Wet brake pads may prevent the brakes from functioning properly. If the brakes on only one side are wet and not functioning properly, steering control may be affected.

■ **When shifting the shift lever**

- Do not let the vehicle roll backward while the shift lever is in a driving position, or roll forward while the shift lever is in R. Doing so may result in an accident or damage to the vehicle.
- Do not shift the shift lever to P while the vehicle is moving. Doing so can damage the transmission and may result in a loss of vehicle control.
- Do not shift the shift lever to R while the vehicle is moving forward. Doing so can damage the transmission and may result in a loss of vehicle control.
- Do not shift the shift lever to a driving position while the vehicle is moving backward. Doing so can damage the transmission and may result in a loss of vehicle control.

- Moving the shift lever to N while the vehicle is moving will disengage the hybrid system. Engine braking is not available with the hybrid system disengaged.

- Be careful not to shift the shift lever with the accelerator pedal depressed. Shifting the shift lever to a gear other than P or N may lead to unexpected rapid acceleration of the vehicle that may cause an accident and result in death or serious injury.

■ **If you hear a squealing or scraping noise (brake pad wear indicators)**

Have the brake pads checked and replaced by your Toyota dealer as soon as possible.

Rotor damage may result if the pads are not replaced when needed.

It is dangerous to drive the vehicle when the wear limits of the brake pads and/or those of the brake discs are exceeded.

■ **When the vehicle is stopped**

- Do not depress the accelerator pedal unnecessarily.

If the shift lever is in any position other than P or N, the vehicle may accelerate suddenly and unexpectedly, causing an accident.

- In order to prevent accidents due to the vehicle rolling away, always keep depressing the brake pedal while stopped with the "READY" indicator is illuminated, and apply the parking brake as necessary.



**WARNING**

- If the vehicle is stopped on an incline, in order to prevent accidents caused by the vehicle rolling forward or backward, always depress the brake pedal and securely apply the parking brake as needed.
- Avoid revving or racing the engine.  
Running the engine at high speed while the vehicle is stopped may cause the exhaust system to overheat, which could result in a fire if combustible material is nearby.
- **When the vehicle is parked**
- Do not leave glasses, cigarette lighters, spray cans, or soft drink cans in the vehicle when it is in the sun.  
Doing so may result in the following:
  - Gas may leak from a cigarette lighter or spray can, and may lead to a fire.
  - The temperature inside the vehicle may cause the plastic lenses and plastic material of glasses to deform or crack.
  - Soft drink cans may fracture, causing the contents to spray over the interior of the vehicle, and may also cause a short circuit in the vehicle's electrical components.
- Do not leave cigarette lighters in the vehicle. If a cigarette lighter is in a place such as the glove box or on the floor, it may be lit accidentally when luggage is loaded or the seat is adjusted, causing a fire.

- Do not attach adhesive discs to the windshield or windows. Do not place containers such as air fresheners on the instrument panel or dashboard. Adhesive discs or containers may act as lenses, causing a fire in the vehicle.
- Do not leave a door or window open if the curved glass is coated with a metallized film such as a silver-colored one. Reflected sunlight may cause the glass to act as a lens, causing a fire.
- Always apply the parking brake, shift the shift position to P, stop the hybrid system and lock the vehicle.  
Do not leave the vehicle unattended while the "READY" indicator is illuminated. If the vehicle is parked with the shift position in P but the parking brake is not set, the vehicle may start to move, possibly leading to an accident.
- If the shift lever is moved before the low speed four-wheel drive indicator turns on/off, the transfer mode may not be shifted completely.

The transfer mode disengages both the front and rear driveshafts from the powertrain and allows the vehicle to move regardless of the shift position. (At this time, the indicator blinks and the buzzer sounds.)

Therefore, the vehicle is free to roll even if the shift lever is in P. You or someone else could be seriously injured. You must complete the shifting of the transfer mode. (→P.435)

**WARNING**

- Do not touch the exhaust pipes while the “READY” indicator is illuminated or immediately after turning the hybrid system off. Doing so may cause burns.

#### ■ When taking a nap in the vehicle

Always turn the hybrid system off. Otherwise, if you accidentally move the shift lever or depress the accelerator pedal, this could cause an accident or fire due to hybrid system overheating. Additionally, if the vehicle is parked in a poorly ventilated area, exhaust gases may collect and enter the vehicle, leading to death or a serious health hazard.

#### ■ When braking

- When the brakes are wet, drive more cautiously. Braking distance increases when the brakes are wet, and this may cause one side of the vehicle to brake differently than the other side. Also, the parking brake may not securely hold the vehicle.
- If the electronically controlled brake system does not operate, do not follow other vehicles closely and avoid hills or sharp turns that require braking. In this case, braking is still possible, but the brake pedal should be depressed more firmly than usual. Also, the braking distance will increase. Have your brakes fixed immediately.

- The brake system consists of 2 individual hydraulic systems; if one of the systems fails, the other will still operate. In this case, the brake pedal should be depressed more firmly than usual and the braking distance will increase. Have your brakes fixed immediately.

#### ■ If the vehicle becomes stuck

Do not spin the wheels excessively when any of the tires is up in the air, or the vehicle is stuck in sand, mud, etc. This may damage the driveline components or propel the vehicle forward or backward, causing an accident.

**NOTICE**

#### ■ When driving the vehicle

- Do not depress the accelerator and brake pedals at the same time during driving, as this may restrain the hybrid system output.
  - Do not use the accelerator pedal or depress the accelerator and brake pedals at the same time to hold the vehicle on a hill.
- #### ■ Avoiding damage to vehicle parts
- Do not turn the steering wheel fully in either direction and hold it there for an extended period of time. Doing so may damage the power steering.
  - When driving over bumps in the road, drive as slowly as possible to avoid damaging the wheels, underside of the vehicle, etc.

**NOTICE**

- Make sure to idle the engine immediately after high-load driving. Stop the hybrid system only after the turbocharger has cooled down. Failure to do so may cause damage to the turbocharger.

**■ If you get a flat tire while driving**

A flat or damaged tire may cause the following situations. Hold the steering wheel firmly and gradually depress the brake pedal to slow down the vehicle.

- It may be difficult to control your vehicle.
- The vehicle will make abnormal sounds or vibrations.
- The vehicle will lean abnormally.

Information on what to do in case of a flat tire (→P.606)

**■ When encountering flooded roads**

Do not drive on a road that has flooded after heavy rain, etc. Doing so may cause the following serious damage to the vehicle:

- Engine stalling
- Short in electrical components
- Engine damage caused by water immersion

In the event that you drive on a flooded road and the vehicle is flooded, be sure to have your Toyota dealer check the following:

- Brake function
- Changes in quantity and quality of oil and fluid used for the engine, transmission, transfer, differentials, etc.

- Lubricant condition for the propeller shaft, bearings and suspension joints (where possible), and the function of all joints, bearings, etc.

- Cooling failure due to clogging of the radiator or operation failure of the cooling fan, etc.

**■ When parking the vehicle**

Always set the parking brake, and shift the shift lever to P. Failure to do so may cause the vehicle to move or the vehicle may accelerate suddenly if the accelerator pedal is accidentally depressed.

**Sudden start restraint control (Drive-Start Control [DSC])**

When the following unusual operation is performed with the accelerator pedal depressed, the hybrid system output may be restrained.

- When the shift lever is shifted to R\*.
- When the shift lever is shifted from P or R to forward drive shift position such as D\*.

When the system operates, a message appears on the multi-information display. Read the message and follow the instruction.

\*: Depending on the situation, the shift position may not be changed.

**■ Drive-Start Control (DSC)**

- When the Active TRAC is turned off (→P.449), sudden start

restraint control also does not operate. If your vehicle have trouble escaping from the mud or fresh snow due to sudden start restraint control operation, deactivate Active TRAC (→P.449) so that the vehicle may become able to escape from the mud or fresh snow.

Also, sudden start restraint control will not operate in the following conditions:

- When the four-wheel drive control switch is in “L4” position.
- When the center differential is locked
- When Multi-terrain Select\* is selected

\*: If equipped

## Cargo and luggage

### Take notice of the following information about storage precautions, cargo capacity and load:

#### WARNING

#### ■ Things that must not be carried in the luggage compartment

The following things may cause a fire if loaded in the luggage compartment:

- Receptacles containing gasoline
- Aerosol cans

#### ■ Storage precautions

Observe the following precautions.

Failure to do so may prevent the pedals from being depressed properly, may block the driver's vision, or may result in items hitting the driver or passengers, possibly causing an accident.

- Stow cargo and luggage in the luggage compartment whenever possible.
- Do not stack anything in the luggage compartment higher than the seatbacks.
- When you fold down the rear seats, long items should not be placed directly behind the front seats.

**WARNING**

- Never allow anyone to ride in the luggage compartment. It is not designed for passengers. They should ride in their seats with their seat belts properly fastened. Otherwise, they are much more likely to suffer death or serious bodily injury, in the event of sudden braking, sudden swerving or an accident.
- Do not place cargo or luggage in or on the following locations.
  - At the feet of the driver
  - On the front passenger or rear seats (when stacking items)
  - On the luggage cover (if equipped)
  - On the instrument panel
  - On the dashboard
  - On the auxiliary box or tray that has no lid
- Secure all items in the occupant compartment.

**Capacity and distribution**

Cargo capacity depends on the total weight of the occupants.

(Cargo capacity) = (Total load capacity) — (Total weight of occupants)

Steps for Determining Correct Load Limit —

(1) Locate the statement “The combined weight of occupants and cargo should never exceed XXX kg or XXX lbs.” on your vehicle’s placard.

(2) Determine the combined

weight of the driver and passengers that will be riding in your vehicle.

(3) Subtract the combined weight of the driver and passengers from XXX kg or XXX lbs.

(4) The resulting figure equals the available amount of cargo and luggage load capacity. For example, if the “XXX” amount equals 1400 lbs. and there will be five 150 lb passengers in your vehicle, the amount of available cargo and luggage load capacity is 650 lbs. ( $1400 - 750 (5 \times 150) = 650$  lbs.)

(5) Determine the combined weight of luggage and cargo being loaded on the vehicle. That weight may not safely exceed the available cargo and luggage load capacity calculated in Step 4.

(6) If your vehicle will be towing a trailer, load from your trailer will be transferred to your vehicle. Consult this manual to determine how this reduces the available cargo and luggage load capacity of your vehicle. (→P.208)

**WARNING****Capacity and distribution**

- Do not exceed the maximum axle weight rating or the total vehicle weight rating.

**WARNING**

- Even if the total load of occupant's weight and the cargo load is less than the total load capacity, do not apply the load unevenly. Improper loading may cause deterioration of steering or braking control which may cause death or serious injury.

### Calculation formula for your vehicle

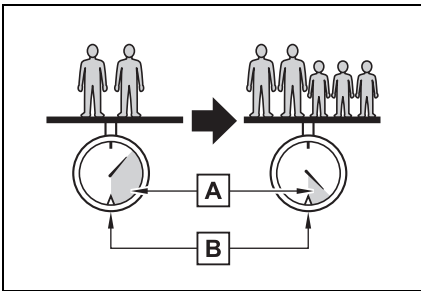

- A** Cargo capacity
- B** Total load capacity (vehicle capacity weight) (→P.630)

When 2 people with the combined weight of A lb. (kg) are riding in your vehicle, which has a total load capacity (vehicle capacity weight) of B lb. (kg), the available amount of cargo and luggage load capacity will be C lb. (kg) as follows:

$$B^{*2} \text{ lb. (kg)} - A^{*1} \text{ lb. (kg)} = C^{*3} \text{ lb. (kg)}$$

\*1: A = Weight of people

\*2: B = Total load capacity

\*3: C = Available cargo and luggage load

In this condition, if 3 more passen-

gers with the combined weight of D lb. (kg) get on, the available cargo and luggage load will be reduced E lb. (kg) as follows:

$$C \text{ lb. (kg)} - D^{*4} \text{ lb. (kg)} = E^{*5} \text{ lb. (kg)}$$

\*4: D = Additional weight of people

\*5: E = Available cargo and luggage load

As shown in the example above, if the number of occupants increases, the cargo and luggage load will be reduced by an amount that equals the increased weight due to the additional occupants. In other words, if an increase in the number of occupants causes an excess of the total load capacity (combined weight of occupants plus cargo and luggage load), you must reduce the cargo and luggage on your vehicle.

### Roof luggage carrier (if equipped)\*

\*: The roof luggage carrier differs depending on the models.

## ■ Roof luggage carrier components

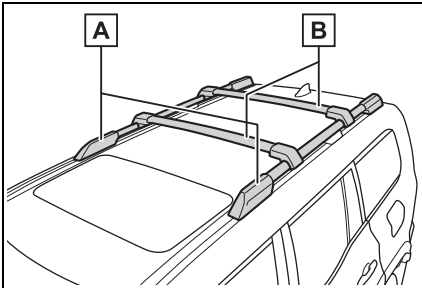

**A** Roof rails

**B** Cross rails

### WARNING

#### ■ When loading cargo on the roof luggage carrier

To use the roof rails as a roof luggage carrier, you must fit the roof rails with two or more genuine Toyota cross rails or their equivalent. When you load cargo on the roof luggage carrier, observe the following:

- Place the cargo so that its weight is distributed evenly between the front and rear axles.
- If loading long or wide cargo, never exceed the vehicle overall length or width. (→P.630)
- Before driving, make sure the cargo is securely fastened on the roof luggage carrier.
- Loading cargo on the roof luggage carrier will make the center of gravity of the vehicle higher. Avoid high speeds, sudden starts, sharp turns, sudden braking or abrupt maneuvers, otherwise it may result in loss of control or vehicle rollover due to failure to operate this vehicle correctly and result in death or serious injury.

● If driving for a long distance, on rough roads, or at high speeds, stop the vehicle now and then during the trip to make sure the cargo remains in its place.

● Do not exceed 165 lb. (75 kg) cargo weight on the roof luggage carrier. Place the cargo so that its weight is distributed evenly between both cross rails.

### NOTICE

#### ■ When loading cargo (vehicles with moon roof)

Be careful not to scratch the surface of the moon roof.

## Vehicle load limits

**Vehicle load limits include total load capacity, seating capacity, TWR (Trailer Weight Rating) and cargo capacity.**

- Total load capacity (vehicle capacity weight):  
→P.630

Total load capacity means the combined weight of occupants, cargo and luggage.

- Seating capacity:  
→P.631

Seating capacity means the maximum number of occupants whose estimated average weight is 150 lb. (68 kg) per person.

- TWR (Trailer Weight Rating):  
→P.213, 630

TWR means the maximum gross trailer weight (trailer weight plus its cargo weight) that your vehicle is able to tow.

- Cargo capacity

Cargo capacity may increase or decrease depending on the weight and the number of occupants.

the tire and loading information label. (→P.563)

### WARNING

#### ■ Overloading the vehicle

Do not overload the vehicle. It may not only cause damage to the tires, but also degrade steering and braking ability, resulting in an accident.

### ■ Total load capacity and seating capacity

These details are also described on



## Trailer towing (with towing hitch)

Your vehicle is designed primarily as a passenger-and-load-carrying vehicle. Towing a trailer can have an adverse impact on handling, performance, braking, durability, and fuel consumption. For your safety and the safety of others, you must not overload your vehicle or trailer. You must also ensure that you are using appropriate towing equipment, that the towing equipment has been installed correctly and used properly, and that you employ the requisite driving habits.

Vehicle-trailer stability and braking performance are affected by trailer stability, brake performance and setting, trailer brakes, the hitch and hitch systems (if equipped).

To tow a trailer safely, use extreme care and drive the vehicle in accordance with your trailer's characteristics and operating conditions.

**Toyota warranties do not apply to damage or malfunction caused by towing a trailer for commercial purposes.**

Contact your Toyota dealer for further information about additional requirements such as towing kits, etc.

### ■ Trailer brake controller

→P.453

### ■ Before towing

Check that the following conditions are met:

- Ensure that your vehicle's tires are properly inflated. (→P.637)
- Trailer tires are inflated according to the trailer manufacturer's recommendation.
- All trailer lights work as required by law.
- All lights work each time you connect them.
- The trailer ball is set at the proper height for the coupler on the trailer.
- The trailer is level when it is hitched.  
Do not drive if the trailer is not level, and check for improper tongue weight, overloading, worn suspension, or other possible causes.
- The trailer cargo is securely loaded.
- The rear view mirrors conform to all applicable federal, state/provincial or local regulations. If they do not, install rear view mirrors appropriate for towing purposes.

### ■ When towing a trailer

- Disable the following systems, as the systems may not operate

- properly.
- LTA (Lane Tracing Assist) (→P.280)
- LDA (Lane Departure Alert) (→P.288)
- Dynamic radar cruise control (→P.305)
- BSM (Blind Spot Monitor) (→P.328)
- Intuitive parking assist\*<sup>1</sup> (→P.337)
- RCTA (Rear Cross Traffic Alert) function (→P.343)
- RCD (Rear Camera Detection) function\*<sup>2, 3</sup> (→P.349)
- PKSB (Parking Support Brake)\*<sup>4</sup> (→P.353)

\*<sup>1</sup>: When the 7-pin connector is connected, the rear sensor automatically turns off.

\*<sup>2</sup>: If equipped

\*<sup>3</sup>: When the 7-pin connector is connected, the Rear Camera Detection function automatically turns off.

\*<sup>4</sup>: When the 7-pin connector is connected, the Parking Support Brake function automatically turns off.

- The cover that can be attached when towing is included. Attach the cover and then install the clips.

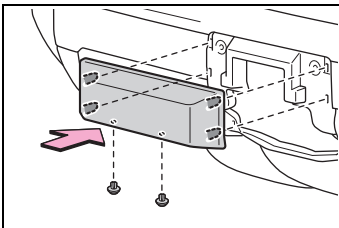

**⚠ WARNING**

**■ Trailer towing precautions**

To tow a trailer safely, use extreme care and drive the vehicle in accordance with the trailer's characteristics and operating conditions. Failure to do so could cause an accident resulting in death or serious injury. Vehicle stability and braking performance are affected by trailer stability, brake setting and performance, and the hitch. Your vehicle will handle differently when towing a trailer.

**■ To avoid accident or injury**

- Do not exceed the TWR, unbraked TWR, GCWR, GVWR or GAWR.
- If the gross trailer weight is over 2000 lb. (907 kg), a sway control device with sufficient capacity is required.
- If the gross trailer weight is over 5000 lb. (2268 kg), a weight distributing hitch with sufficient capacity is required.
- Adjust the tongue weight within the appropriate range. Place heavier loads as close to the trailer axle as possible.
- Do not exceed 65 mph (104 km/h), the posted towing speed limit or the speed limit for your trailer as set forth in your trailer owner's manual, whichever is lowest. Slow down sufficiently before making a turn, in cross winds, on wet or slippery surface, etc. to help avoid an accident. If you experience a vehicle-trailer instability from reducing a certain speed, slow down and make sure you keep your vehicle speed under the speed of which you experience the instability.

**WARNING**

- Do not make jerky, abrupt or sharp turns.
- Do not apply the brakes suddenly as you may skid, resulting in jackknifing and loss of vehicle control. This is especially true on wet or slippery surfaces.
- Do not exceed the trailer hitch assembly weight, gross vehicle weight, gross axle weight and trailer tongue weight capacities.
- Do not use dynamic radar cruise control with full-speed range when towing.
- Slow down and downshift before descending steep or long downhill grades. Do not make sudden downshifts while descending steep or long downhill grades.
- Vehicle-trailer instability is more likely on steep long downhills. Before descending steep or long downhill grades, slow down and downshift. Do not make sudden downshifts when descending steep or long downhill grades. Avoid holding the brake pedal down too long or applying the brakes too frequently. This could cause the brakes to overheat and result in reduced braking efficiency.

#### ■ When towing a trailer

Toyota recommends trailers with brakes that conform to any applicable federal and state/provincial regulations.

- If the gross trailer weight exceeds unbraked TWR, trailer brakes are required. Toyota recommends trailers with brakes that conform to all applicable federal and state/provincial regulations.

- Never tap into your vehicle's hydraulic system, as this will lower the vehicle's braking effectiveness.
- Never tow a trailer without using a safety chain securely attached to both the trailer and the vehicle. If damage occurs to the coupling unit or hitch ball, there is danger of the trailer wandering into another lane.

### Towing related terms

#### ■ GCWR (Gross Combination Weight Rating)

The maximum allowable gross combination weight. The gross combination weight is the sum of the total vehicle weight (including the occupants, cargo and any optional equipment installed on the vehicle) and the weight of the trailer being towed (including the cargo in the trailer).

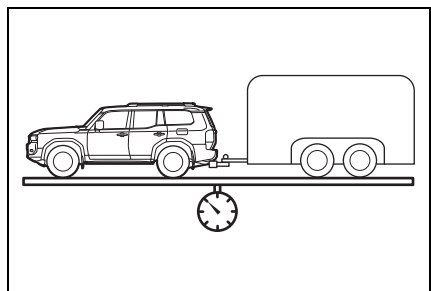

#### ■ GVWR (Gross Vehicle Weight Rating)

The maximum allowable gross vehicle weight. The gross vehicle weight is the total weight of the vehicle. When towing a

trailer, it is the sum of the vehicle weight (including the occupants, cargo and any optional equipment installed on the vehicle) and the tongue weight.

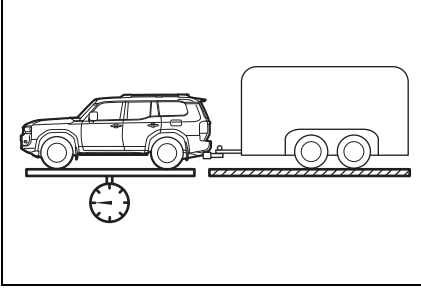

### ■ GAWR (Gross Axle Weight Rating)

The maximum allowable gross axle weight. The gross axle weight is the load placed on each axle (front and rear).

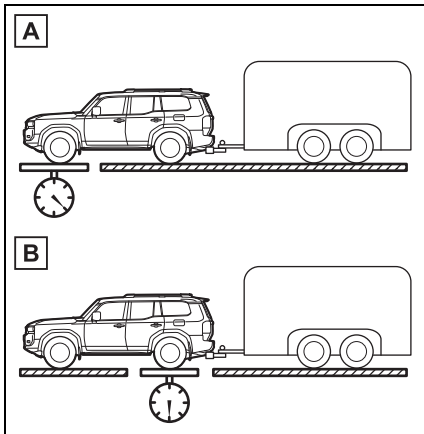

**A** Front GAWR

**B** Rear GAWR

### ■ TWR (Trailer Weight Rating)

The maximum allowable gross trailer weight. The gross trailer weight is the sum of the trailer

weight and the weight of the cargo in the trailer.

TWR is calculated assuming base vehicle with one driver, one front passenger towing package (if available), hitch and hitch systems (if required).

Additional optional equipment, passengers and cargo in the vehicle will reduce the trailer weight rating so as not to exceed GCWR, GVWR and GAWR.

If the gross trailer weight exceeds 3000 lb. (1360 kg), it is recommended to use a trailer with 2 or more axles.

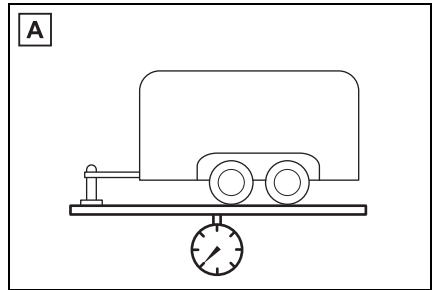

**A** (With brakes)

### ■ Unbraked TWR (Unbraked Trailer Weight Rating)

The trailer weight rating for towing a trailer without a trailer service brake system.

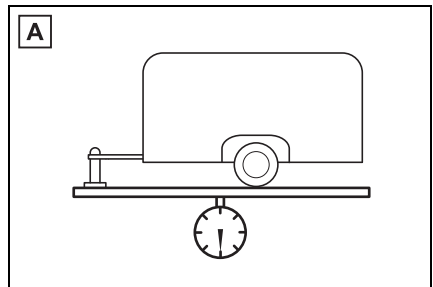

**A** (Without brakes)

### ■ Tongue Weight

The load placed on the trailer hitch ball. (→P.214)

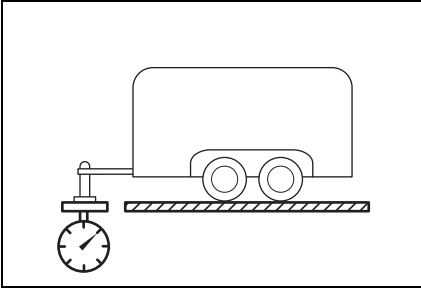

### Weight limits

- The gross trailer weight must never exceed 6000 lb. (2720 kg).
- The gross combination weight must never exceed the following:

▶ TJH250L-GNZUZA model\*<sup>1</sup>  
12725 lb. (5770 kg)

▶ TJH250L-GNZAZA model\*<sup>1</sup>

- 12835 lb. (5820 kg)\*<sup>2</sup>
- 12900 lb. (5850 kg)\*<sup>3, 4, 5</sup>
- 12920 lb. (5860 kg)\*<sup>3, 4, 6</sup>
- 12945 lb. (5870 kg)\*<sup>3, 7</sup>

\*<sup>1</sup>: The model code is indicated on the Certification Regulation label. (→P.631)

\*<sup>2</sup>: 5-passenger models

\*<sup>3</sup>: 7-passenger models

\*<sup>4</sup>: Vehicles without SDM (Stabilizer with Disconnection Mechanism)

\*<sup>5</sup>: Vehicles without moon roof

\*<sup>6</sup>: Vehicles with moon roof

\*<sup>7</sup>: Vehicles with SDM (Stabilizer with Disconnection Mechanism)

- The gross vehicle weight must never exceed the GVWR indicated on the Certification Label.
- The gross axle weight on each axle must never exceed the GAWR indicated on the Certification Label.

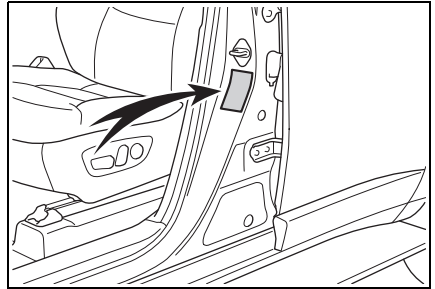

- If the gross trailer weight is over the unbraked TWR, trailer service brakes are required.
- If the gross trailer weight is over 2000 lbs. (907 kg), a sway control device with sufficient capacity is required.
- If the gross trailer weight is over 5000 lb. (2268 kg), a weight distributing hitch with sufficient capacity is required.

### GCWR, TWR and Unbraked TWR

Confirm that the gross trailer weight, gross combination

weight, gross vehicle weight, gross axle weight and tongue weight are all within the limits.

### ■ GCWR\*<sup>1</sup>

The gross combination weight must never exceed the following:

- ▶ TJH250L-GNZUZA model\*<sup>2</sup>  
12725 lb. (5770 kg)
- ▶ TJH250L-GNZAZA model\*<sup>2</sup>
  - 12835 lb. (5820 kg)\*<sup>3</sup>
  - 12900 lb. (5850 kg)\*<sup>4, 5, 6</sup>
  - 12920 lb. (5860 kg)\*<sup>4, 5, 7</sup>
  - 12945 lb. (5870 kg)\*<sup>4, 8</sup>

\*<sup>1</sup>: This model meets the tow-vehicle trawling requirement of SAE International per SAE J2807.

\*<sup>2</sup>: The model code is indicated on the Certification Regulation label. (→P.631)

\*<sup>3</sup>: 5-passenger models

\*<sup>4</sup>: 7-passenger models

\*<sup>5</sup>: Vehicles without SDM (Stabilizer with Disconnection Mechanism)

\*<sup>6</sup>: Vehicles without moon roof

\*<sup>7</sup>: Vehicles with moon roof

\*<sup>8</sup>: Vehicles with SDM (Stabilizer with Disconnection Mechanism)

### ■ TWR\*

6000 lb. (2720 kg)

\*: This model meets the tow-vehicle trawling requirement of SAE International per SAE J2807.

### ■ Unbraked TWR\*

1650 lb. (750 kg)

\*: This model meets the tow-vehicle trawling requirement of SAE International per SAE J2807.

## Trailer Tongue Weight

- A recommended tongue weight varies in accordance with the types of trailers or towing as described below.
- To ensure the recommended values shown below, the trailer must be loaded by referring to the following instructions.
- Tongue Weight

The gross trailer weight should be distributed so that the tongue weight is 9% to 11%.

(Tongue weight /Gross trailer weight x 100 = 9% to 11%)

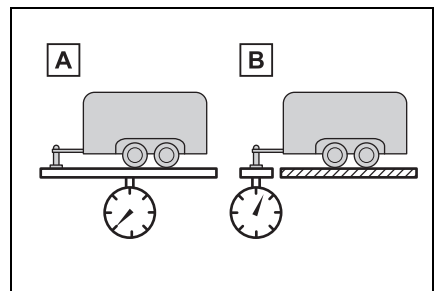

**A** Gross trailer weight

**B** Tongue weight

If using a weight distributing hitch when towing, return the front axle to the same weight as before the trailer connection.

If front axle weight cannot be measured directly, measure the front fender height above the front axle before connection. Adjust weight distributing hitch torque until front fender is returned to the same height as before connection.

The gross trailer weight, gross axle weight and tongue weight can be measured with platform scales found at a highway weighing station, building supply company, trucking company, junk yard, etc.

## Hitch

Trailer hitch assemblies have different weight capacities. Toyota recommends the use of Toyota hitch/bracket for your vehicle. For details, contact your Toyota dealer.

- If you wish to install a trailer hitch, contact your Toyota dealer.
- Use only a hitch that conforms to the gross trailer weight requirement of your vehicle.
- Follow the directions supplied by the hitch manufacturer.
- Lubricate the hitch ball with a light coating of grease.
- Remove the hitch ball whenever you are not towing a trailer. Remove the trailer

hitch if you do not need it. After removing the hitch, seal any mounting holes in the vehicle body to prevent entry of any substances into the vehicle.

### WARNING

#### ■ Hitch

Trailer hitch assemblies have different weight capacities established by the hitch manufacturer. Even though the vehicle may be physically capable of towing a higher weight, the operator must determine the maximum weight rating of the particular hitch assembly and never exceed the maximum weight rating specified for the trailer hitch. Exceeding the maximum weight rating set by the trailer hitch manufacturer can cause an accident resulting in death or serious personal injuries.

### NOTICE

#### ■ When installing a trailer hitch

Use only the position recommended by your Toyota dealer. Do not install the trailer hitch on the bumper; this may cause body damage.

## Removing hitch cover

- 1 Remove the clips.

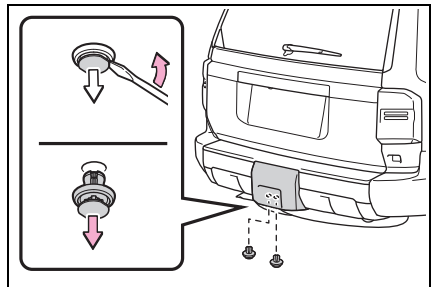

- 2 Pull the lower edge of the hitch cover toward you and remove the 6 claws.

When reattaching the cover, reverse the steps listed.

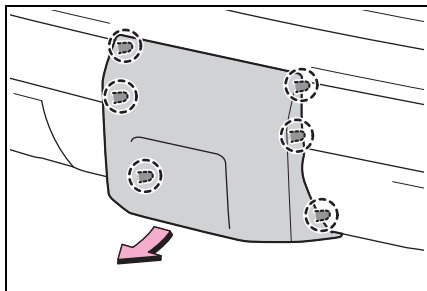

### Selecting trailer ball

Use the correct trailer ball for your application.

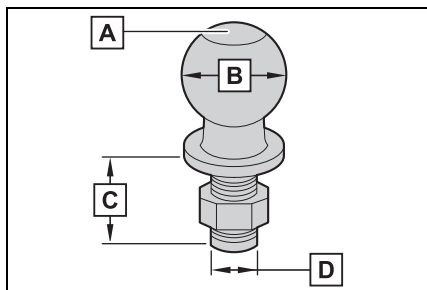

- A** Trailer ball load rating  
Matches or exceeds the gross trailer weight rating of the trailer.

- B** Ball diameter  
Matches the size of the trailer coupler. Most couplers are stamped with the required trailer ball size.

Trailer class	Typical trailer ball size
IV	2 5/16 in.

Trailer class	Typical trailer ball size
II and III	2 in.
I	1 7/8 in.

- C** Shank length

Protrudes beyond the bottom of the lock washer and nut by at least 2 threads.

- D** Shank diameter

Matches the ball mount hole diameter size.

### Matching trailer ball height to trailer coupler height

No matter which class of tow hitch applies, for a safe trailer hookup, the trailer ball setup on must be proper height for the coupler on the trailer.

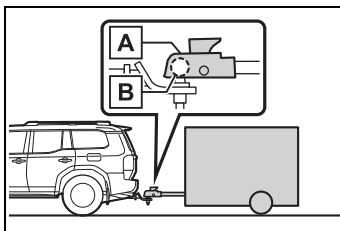
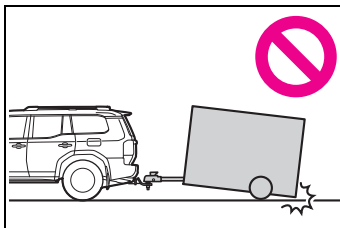

- A** Coupler
- B** Trailer ball



## Positions for towing hitch receiver and hitch ball

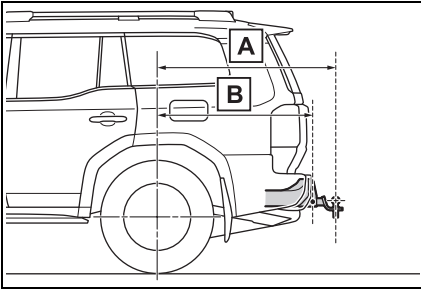

- A** Weight carrying ball position: 51.7 in. (1312.2 mm)
- B** Hitch receiver pin hole position: 44.9 in. (1140.2 mm)

## Connecting trailer lights

Use the wire harness stored in the rear end under the vehicle body.

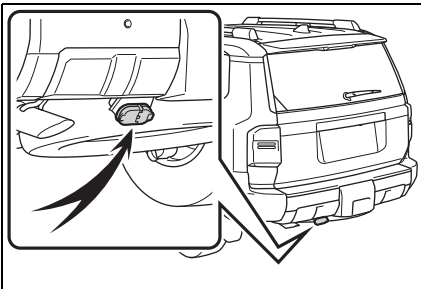

Please consult your dealer when installing trailer lights, as incorrect installation may cause damage to the vehicle's lights. Please take care to comply with your state's laws when installing trailer lights.

## ■ Auto current cut-off function

In case of over current, the auto cut-off function stops the power flowing to the trailer lights to prevent damage to the vehicle's electrical system.

This function is activated when the rated current of any of the following trailer light circuit components is exceeded:

- Stop/turn signal light (right): maximum 10 A
- Stop/turn signal light (left): maximum 10 A

## ■ When the auto current cut function is activated

If a trailer light does not come on due to the activation of the auto current cut function, the light system will need to be reset.

Follow the reset procedure shown below.

- If a tail light does not come on, turn off the headlight switch.
- If the right-side stop/turn signal light does not come on, put the turn signal in the off position or remove foot from the brake pedal.
- If the left-side stop/turn signal light does not come on, put the turn signal in the off position or remove foot from the brake pedal.

If the emergency flashers do not operate, press the emergency flasher switch to turn them off.

After the light system is reset, operate the light switches again to see if the lights operate normally.

If the lights do not operate normally, have the vehicle inspected by your Toyota dealer.



## NOTICE

**Do not directly splice trailer lights**

Do not directly splice trailer lights. Directly splicing trailer lights may damage your vehicle's electrical system and cause a malfunction.

**Trailer towing tips**

Your vehicle will handle differently when towing a trailer. Help to avoid an accident, death or serious injury, keep the following in mind when towing:

- Speed limits for towing a trailer vary by state or province. Do not exceed the posted towing speed limit.
- Toyota recommends that the vehicle-trailer speed limit is 65 mph (104 km/h) on a flat, straight, dry road. Do not exceed this limit, the posted towing speed limit or the speed limit for your trailer as set forth in your trailer owner's manual, whichever is lowest. Instability of the towing vehicle-trailer combination (trailer sway) increases as speed increases. Exceeding speed limits may cause loss of control.
- Before starting out, check the trailer lights, tires and the vehicle-trailer connections. Recheck after driving a short distance.
- Practice turning, stopping and reversing with the trailer attached in an area away from traffic until you become accustomed to the feel of the vehicle-trailer combination.
- Reversing with a trailer attached is difficult and requires practice. Grip the bottom of the steering wheel and move your hand to the left to move the trailer to the left. Move your hand to the right to move the trailer to the right. (This is generally opposite to reversing without a trailer attached.) Avoid sharp or prolonged turning. Have someone guide you when reversing to reduce the risk of an accident.
- As stopping distance is increased when towing a trailer, vehicle-to vehicle distance should be increased. For each 10 mph (16 km/h) of speed, allow at least one vehicle and trailer length.
- Avoid sudden braking as you may skid, resulting in the trailer jackknifing and a loss of vehicle control. This is especially true on wet or slippery surfaces.
- Avoid jerky starts or sudden acceleration.
- Avoid jerky steering and sharp turns, and slow down before making turn.

- Note that when making a turn, the trailer wheels will be closer than the vehicle wheels to the inside of the turn. Compensate by making a wider than normal turning radius.
- Slow down before making a turn, in cross winds, on wet or slippery surfaces, etc.

Increasing vehicle speed can destabilize the trailer.

- Take care when passing other vehicles. Passing requires considerable distance. After passing a vehicle, do not forget the length of your trailer, and be sure you have plenty of room before changing lanes.
  - To maintain engine braking efficiency and charging system performance, when using engine braking, do not put the transmission in D. If in the M mode, the transmission shift range position must be in 6 or lower. (→P.231)
  - Instability happens more frequently when descending steep or long downhill grades. Before descending, slow down and downshift. Do not make sudden downshifts while descending steep or long downhill grades.
  - Avoid holding the brake pedal down too long or applying the brakes too frequently. This could cause the brakes to overheat and result in reduced braking efficiency.
- Due to the added load of the trailer, your vehicle's engine may overheat on hot days (at temperatures over 85°F [30°C]) when driving up a long or steep grade. If the engine coolant temperature gauge indicates overheating, immediately turn off the air conditioning (if in use), pull your vehicle off the road and stop in a safe spot. (→P.625)
  - Always place wheel blocks under both the vehicle's and the trailer's wheels when parking. Apply the parking brake firmly, and put the transmission in P. Avoid parking on a slope, but if unavoidable, do so only after performing the following:
    - 1 Apply the brakes and keep them applied.
    - 2 Have someone place wheel blocks under both the vehicle's and trailer's wheels.
    - 3 When the wheel blocks are in place, release the brakes slowly until the blocks absorb the load.
    - 4 Apply the parking brake firmly.
    - 5 Shift into P and turn off the hybrid system.
  - When restarting after parking

on a slope:

- 1 With the transmission in P, start the hybrid system. Be sure to keep the brake pedal depressed.
- 2 Shift into a forward gear. If reversing, shift into R.
- 3 If the parking brake is in manual mode, release the parking brake. (→P.233)
- 4 Release the brake pedal, and slowly pull or back away from the wheel blocks. Stop and apply the brakes.
- 5 Have someone retrieve the blocks.

---

#### ■ Driving mode select switch \*

\*: If equipped

The suspension can be switched for improvement in driveability. (→P.433)

#### ■ Break-in schedule

If your vehicle is new or equipped with any new power train components (such as an engine, transmission, differential or wheel bearing), Toyota recommends that you do not tow a trailer until the vehicle has been driven for over 500 miles (800 km).

After the vehicle has been driven for over 500 miles (800 km), you can start towing. However, for the next 500 miles (800 km), drive the vehicle at a speed of less than 45 mph (72 km/h) when towing a trailer, and avoid full throttle acceleration.

#### ■ Maintenance

- If you tow a trailer, your vehicle will require more frequent maintenance due to the additional load. (See “Owner’s Guide”, “Warranty

and Services Guide”, “Owner’s Manual Supplement” or “Warranty Booklet”).

- Retighten the fixing bolts of the towing ball and bracket after approximately 600 miles (1000 km) of trailer towing.

#### ■ If trailer sway occurs

One or more factors (crosswinds, passing vehicles, rough roads, etc.) can adversely affect handling of your vehicle and trailer, causing instability.

- If trailer swaying occurs:
  - Firmly grip the steering wheel. Steer straight ahead. Do not try to control trailer swaying by turning the steering wheel.
  - Begin releasing the accelerator pedal immediately but very gradually to reduce speed. Do not increase speed. Do not apply vehicle brakes.

If you make no extreme correction with the steering or brakes, your vehicle and trailer should stabilize (if enabled, Trailer Sway Control can also help to stabilize the vehicle and trailer.).

- After the trailer swaying has stopped:
  - Stop in a safe place. Get all occupants out of the vehicle.
  - Check the tires of the vehicle and the trailer.
  - Check the load in the trailer. Make sure the load has not shifted. Make sure the tongue weight is appropriate, if possible.
  - Check the load in the vehicle. Make sure the vehicle is not overloaded after occupants get in.

If you cannot find any problems, the speed at which trailer swaying occurred is beyond the limit of your particular vehicle-trailer combination. Drive at a lower speed to prevent instability. Remember that

swaying of the towing vehicle-trailer increases as speed increases.

## Dinghy towing

**Your vehicle is not designed to be dinghy towed (with 4 wheels on the ground) behind a motor home.**

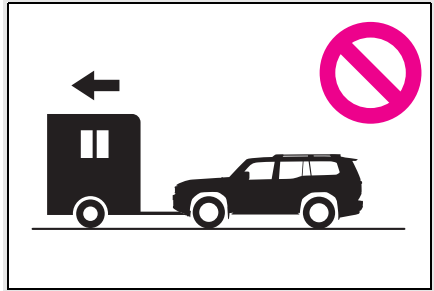

### NOTICE

**■ To avoid serious damage to your vehicle**

Do not tow your vehicle with the four wheels on the ground.

## Power (ignition) switch

Performing the following operations when carrying the electronic key on your person starts the hybrid system or changes power switch modes.

### Starting the hybrid system

- 1 Pull the parking brake switch to check that the parking brake is set. (→P.233)

The parking brake indicator will come on.

- 2 Check that the shift lever is in P.
- 3 Firmly depress the brake pedal.

 and a message will be displayed on the multi-information display.

If it is not displayed, the hybrid system cannot be started.

- 4 Press the power switch shortly and firmly.

When operating the power switch, one short, firm press is enough. It is not necessary to press and hold the switch.

If the “READY” indicator turns on, the hybrid system will operate normally.

Continue depressing the brake pedal until the “READY” indicator is illuminated.

The hybrid system can be started

from any power switch mode.

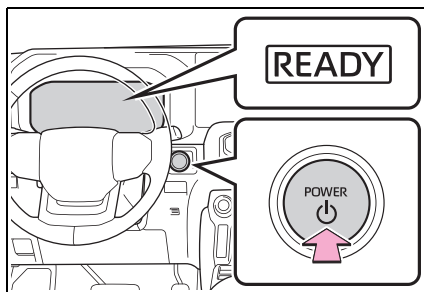

- 5 Check that the “READY” indicator is illuminated.

The vehicle will not move when the “READY” indicator is off.

### ■ Power switch illumination

According to the situation, the power switch illumination operates as follows.

- When driver's door or front passenger's door is opened, the power switch illumination illuminates.
- When the power switch is in OFF and depressing the brake pedal with carrying the electronic key on your person, the power switch illumination blinks.
- When the power switch is in ACC or ON, the power switch illumination illuminates.
- When the power switch mode is changed from ACC or ON to OFF, the power switch illumination illuminates for a certain amount of time. Afterwards, the power switch illumination turns off.

### ■ If the hybrid system does not start

- The immobilizer system may not have been deactivated. (→P.77) Contact your Toyota dealer.
- If a message related to start-up is shown on the multi-information display, read the message and follow the instructions.

- If the door is unlocked with the mechanical key, the hybrid system cannot be started using the smart key system. Refer to P.619 to start the hybrid system. However, if the electronic key is carried inside the vehicle and the doors are locked (→P.132), the hybrid system can be started.

#### ■ When the ambient temperature is low, such as during winter driving conditions

- When starting the hybrid system, the flashing time of the “READY” indicator may be long. Leave the vehicle as it is until the “READY” indicator is steady on, as steady means the vehicle is able to move.
- When the hybrid battery (traction battery) is extremely cold (below approximately -31°F [-35°C]) under the influence of the outside temperature, it may not be possible to start the hybrid system. In this case, try to start the hybrid system again after the temperature of the hybrid battery increases due to the outside temperature increase, etc.
- When the outside temperature is extremely cold, the hybrid system may be started by the starter motor.

#### ■ Starting the hybrid system by the starter motor

- When starting the hybrid system for the first time after more than approximately 10 months since the last time the hybrid system was started by the starter motor
- When the outside temperature is extremely cold (the hybrid system may be started by the starter motor)

#### ■ Sounds and vibrations specific to a Hybrid Electric Vehicle

→P.71

#### ■ If the 12-volt battery is discharged

The hybrid system cannot be started using the smart key system. Refer to P.619 to restart the hybrid system.

#### ■ Electronic key battery depletion

→P.124

#### ■ Conditions affecting operation

→P.151

#### ■ Note for the entry function

→P.152

#### ■ When “Smart Key System Malfunction See Owner’s Manual” is displayed on the multi-information display

The system may be malfunctioning. Have the vehicle inspected by your Toyota dealer immediately.

#### ■ If the “READY” indicator does not come on

In the event that the “READY” indicator does not come on even after performing the proper procedures for starting the vehicle, contact your Toyota dealer immediately.

#### ■ When “Check Fuel Cap” is displayed on the multi-information display

→P.253

#### ■ If the hybrid system is malfunctioning

→P.75

#### ■ Electronic key battery

→P.571

#### ■ Operation of the power switch

- If the switch is not pressed shortly and firmly, the power switch mode may not change or the hybrid system may not start.
- If attempting to restart the hybrid system immediately after turning the power switch to OFF, the hybrid system may not start in some cases. After turning the

power switch to OFF, please wait a few seconds before restarting the hybrid system.

**■ Customization**

If the smart key system has been deactivated in a customized setting, refer to P.619.

 **WARNING**

**■ When starting the hybrid system**

Always start the hybrid system while sitting in the driver's seat. Do not depress the accelerator pedal while starting the hybrid system under any circumstances. Doing so may cause an accident resulting in death or serious injury.

 **NOTICE**

**■ When starting the hybrid system**

If the hybrid system becomes difficult to start, have your vehicle checked by your Toyota dealer immediately.

**■ Symptoms indicating a malfunction with the power switch**

If the power switch seems to be operating somewhat differently than usual, such as the switch sticking slightly, there may be a malfunction. Contact your Toyota dealer immediately.

**Stopping the hybrid system**

- 1 Stop the vehicle completely.
- 2 If the parking brake is in manual mode, set the parking brake. (→P.233)

Check the parking brake indicator is illuminated.

- 3 Shift the shift lever to P. (→P.229)

Do not press the shift lever button after shifting the shift lever to P.

- 4 Press the power switch shortly and firmly.

The hybrid system will stop, and the meter display will be extinguished.

- 5 Release the brake pedal and check that "ACCESSORY" or "POWER ON" is not shown on the multi-information display.

**■ Automatic hybrid system shut off feature**

- The vehicle is equipped with a feature that automatically shuts off the hybrid system when the shift lever is in P with the hybrid system operating for an extended period.
- The hybrid system will automatically shut off after approximately 1 hour if it has been left running while the shift lever is in P.
- The timer for the automatic hybrid system shut off feature will reset if the brake pedal is depressed or if the shift lever is in a position other than P.
- After the vehicle is parked, if the door is locked with the door lock switch (→P.132) from the inside or the mechanical key from the outside, the automatic hybrid system shut off feature will be disabled. The timer for the automatic hybrid system shut off feature will be re-enabled if the driver's door is opened.

**■ When the hybrid system is stopped**

Even if the power switch is turned off, the cooling fan may continue to



operate for a short time.



### WARNING

#### ■ Stopping the hybrid system in an emergency

- If you want to stop the hybrid system in an emergency while driving the vehicle, press and hold the power switch for more than 2 seconds, or press it briefly 3 times or more in succession. (→P.581)  
However, do not touch the power switch while driving except in an emergency. Turning the hybrid system off while driving will not cause loss of steering or braking control. However, power assist for the steering wheel may be lost making it difficult to steer smoothly before stopping the vehicle depending on the remaining charge in the 12-volt battery or usage conditions. In this situation, you should pull over and stop the vehicle as soon as it is safe to do so.
- If the power switch is operated while the vehicle is running, a warning message will be shown on the multi-information display and a buzzer sounds.
- To restart the hybrid system after performing an emergency shutdown, shift the shift lever to N and then press the power switch.

#### ■ When parking

Exhaust gases include harmful carbon monoxide (CO), which is colorless and odorless. Observe the following precautions.

Failure to do so may cause exhaust gases to enter the vehicle and may lead to an accident caused by light-headedness, or may lead to death or a serious health hazard.

- If the vehicle is in a poorly ventilated area or a closed area, such as a garage, stop the hybrid system.
- Do not leave the vehicle with the hybrid system operating for a long time. If such a situation cannot be avoided, park the vehicle in an open space and ensure that exhaust fumes do not enter the vehicle interior.
- Do not leave the hybrid system operating in an area with snow build-up, or where it is snowing. If snowbanks build up around the vehicle while the hybrid system is operating, exhaust gases may collect and enter the vehicle.

#### Changing power switch modes

Modes can be changed by pressing the power switch with the brake pedal released. (The mode changes each time the switch is pressed.)

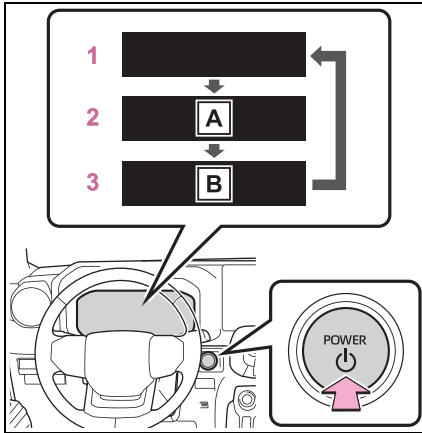

**A** “ACCESSORY”

**B** “POWER ON”

### 1 OFF\*<sup>1</sup>

The emergency flashers can be used.

### 2 ACC\*<sup>2</sup>

Some electrical components such as the audio system can be used. “ACCESSORY” will be displayed on the multi-information display.

### 3 ON

All electrical components can be used.

“POWER ON” will be displayed on the multi-information display.

\*<sup>1</sup>: If the shift lever is in a position other than P or the shift lever button is pressed when turning off the hybrid system, the power switch will remain ON, will not turn to OFF.

\*<sup>2</sup>: ACC mode can be enabled/disabled on the customize menu. (→P.658)

#### ■ When ACC customization is in off

- With the power switch is turned off, the multimedia system can still be used for a certain time until the battery saving function starts operating.
- When the safe exit assist is operating, a buzzer will sound and a voice guidance will be given.

#### ■ Auto power off function

- If the vehicle is left in ACC or ON (the hybrid system is not operating) for more than 20 minutes with the shift lever is in P or the shift lever button is not pressed, the power switch will automatically turn to OFF.
- If the 12-volt battery is low with the shift lever is in P or the shift lever button is not pressed, and the power switch is in ACC or ON (the hybrid system is not operating), a buzzer sounds and a message will be displayed on the multi-information display. If this continues, the power switch is automatically turn to OFF.

However, this function cannot entirely prevent the 12-volt battery discharge. Do not leave the vehicle with the power switch in ACC or ON for long periods of time when the hybrid system is not operating.

#### ⚠ NOTICE

##### ■ To prevent 12-volt battery discharge

- Do not leave the power switch in ACC or ON for long periods of time without the hybrid system on.
- If “ACCESSORY” or “POWER ON” is displayed on the multi-information display, the power switch is not in OFF. Exit the vehicle after turning the power switch to OFF.

## When stopping the hybrid system with the shift lever in a position other than P

If the hybrid system is stopped with the shift lever in a position other than P, the power switch will not be turned to OFF. Perform the following procedure to turn the switch to OFF:

- 1 Check that the parking brake is set.
- 2 Shift the shift lever to P.
- 3 Check that "POWER ON" is displayed on the multi-information display and press the power switch shortly and firmly.
- 4 Check that "ACCESSORY" or "POWER ON" on the multi-information display is off.



### NOTICE

#### ■ To prevent 12-volt battery discharge

Do not stop the hybrid system with the shift lever in a position other than P or the shift lever button pressed. If the hybrid system is stopped with the shift lever in a position other than P or the shift lever button pressed, the power switch will not be turned to OFF but instead remain ON. If the vehicle is left in ON, 12-volt battery discharge may occur.

## Automatic transmission

Select the shift position depending on your purpose and situation.

### Shift position purpose and functions

Shift position	Objective or function
P	Parking the vehicle/starting the hybrid system
R	Reversing
N	Neutral (Condition in which the power is not transmitted)
D	Normal driving <sup>*1</sup>
M	M mode driving <sup>*2</sup> (→P.231)

<sup>\*1</sup>: Shifting to the D position allows the system to select a gear suitable for the driving conditions. Setting the shift lever to the D position is recommended for normal driving.

<sup>\*2</sup>: Selecting gear steps using the M position achieves suitable engine braking forces by operating the shift lever or paddle shift switches (if equipped).

#### ■ Automatic transmission fail-safe control

The fail-safe mechanism activates restricting the transmission function,

when the hybrid system malfunctions. In this event, the following messages are displayed in the multi-information display and/or the malfunction indicator lamp comes on.

- “Hybrid System Malfunction”
- “Check Engine”
- “Hybrid Battery System Malfunction”

#### ■ Driving on a downhill

On declines, there may be case where the vehicle shifts down automatically to obtain engine braking. As a result of the downshifting, the engine speed may increase.

#### ■ To protect the automatic transmission

- If the tires spin continually when the vehicle becomes stuck in mud, dirt or snow, or if the accelerator pedal is depressed and released repeatedly while driving, the automatic transmission temperature may become too high and the automatic transmission may be damaged.

To avoid damaging the automatic transmission, the system may temporarily lock the gear.

If the automatic transmission temperature falls, the gear locking is canceled and the automatic transmission is returned to the normal operation.

- If the automatic transmission fluid temperature is high, “Transmission Oil Temp. High Stop in a Safe Place and See Owner’s Manual” will be displayed on the multi-information display. Immediately stop the vehicle in a safe place, shift the shift lever to P and wait until the warning message go off. If the warning message goes off, you may start the vehicle again. If the warning message does not go off, contact your Toyota dealer.

#### ■ When driving with dynamic radar cruise control or cruise control activated

Even when switching the driving mode to sport mode\* while driving in D position (→P.433) with the intent of enabling engine braking, engine braking will not activate because dynamic radar cruise control or cruise control will not be canceled.

\*: If equipped

#### ■ Restraining sudden start (Drive-Start Control)

→P.203

#### ■ AI-SHIFT

The AI-SHIFT automatically selects the suitable gear according to driver performance and driving conditions.

The AI-SHIFT automatically operates when the shift lever is in D position. (Shifting the shift lever to the M position cancels the function.)



#### WARNING

##### ■ When driving on slippery road surfaces

Do not accelerate or shift gears suddenly.

Sudden changes in engine braking may cause the vehicle to spin or skid, resulting in an accident.

## Shifting the shift lever

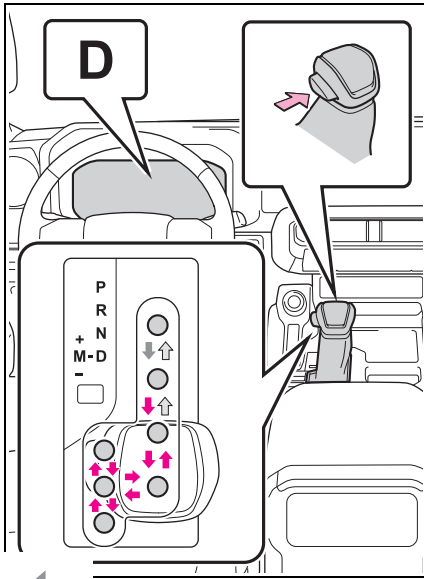

While the power switch is in ON and the brake pedal depressed\*, shift the shift lever while pushing the shift release button on the shift knob.

Shift the shift lever while pushing the shift release button on the shift knob.

Shift the shift lever normally.

When shifting the shift lever between P and D, make sure that the vehicle is completely stopped.

\*: For the vehicle to be able to be shifted from P, the brake pedal must be depressed before the shift release button is pushed. If the shift release button is pushed

first, the shift lock will not be released.

### ■ Shift lock system

The shift lock system is a system to prevent accidental operation of the shift lever in starting.

- When shifting from P, the shift lever can be shifted from P only when the power switch is in ON and the brake pedal is being depressed.
- When shifting from N, the shift lever cannot be shifted from N if the brake pedal is not depressed at a stop or at very low speeds with the hybrid system operating ("READY" Indicator ON).

### ■ If the shift lever cannot be shifted from P

First, check whether the brake pedal is being depressed.

If the shift lever cannot be shifted even though the brake pedal is depressed and the shift release button is pushed, there may be a problem with the shift lock system. Have the vehicle inspected by your Toyota dealer immediately.

The following steps may be used as an emergency measure to ensure that the shift lever can be shifted.

Releasing the shift lock:

- 1 Set the parking brake.
- 2 Turn the power switch off.
- 3 Depress the brake pedal.
- 4 Pry the cover up with a flathead screwdriver or equivalent tool. To prevent damage to the cover, cover the tip of the screwdriver with a rag.

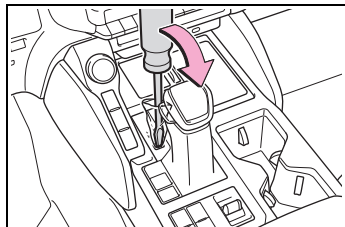

- 5 Press and hold the shift lock override button and then push the button on the shift knob. The shift lever can be shifted while both buttons are pressed.

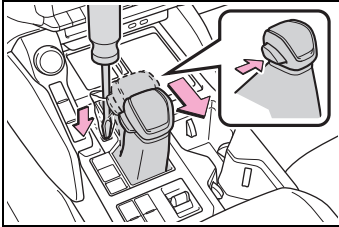

### ⚠ WARNING

#### ■ To prevent an accident when releasing the shift lock

Before pressing the shift lock override button, make sure to set the parking brake and depress the brake pedal.

If the accelerator pedal is accidentally depressed instead of the brake pedal when the shift lock override button is pressed and the shift lever is shifted out of P, the vehicle may suddenly start, possibly leading to an accident resulting in death or serious injury.

### Selecting the driving mode

#### ■ Drive mode (if equipped)

→P.433

#### ■ Second start mode (if equipped)

Use second start mode for accelerating and driving on slippery road surfaces such as snow.

Press the button to use second start mode.

Press the button again to cancel

second start mode.

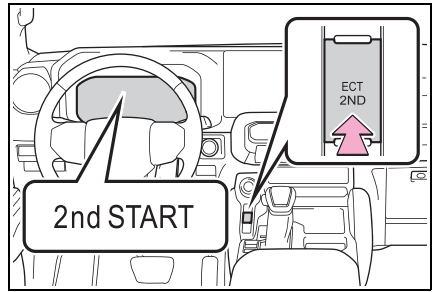

#### ■ Second start mode automatic deactivation

Second start mode is automatically deactivated if the hybrid system is turned off after driving in second start mode.

### Selecting gear steps in the D position (vehicles with paddle shift switches)

To drive using temporary gear step selection, operate the “-” or “+” paddle shift switch when driving with the shift lever in D.

Changing the gear step allows restriction of the highest gear, preventing unnecessary upshifting and enabling the level of engine braking force to be selected.

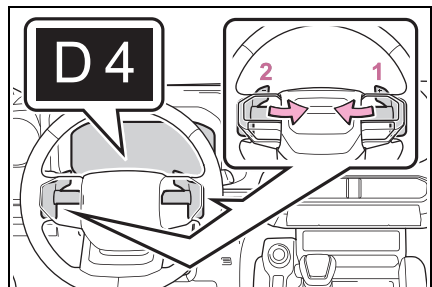

- 1 Upshifting
- 2 Downshifting

The selected gear step, from D1 to D8, will be displayed in the meter.

To return to normal D position driving, the “+” paddle shift switch must be held down for a period of time.

### ■ Gear step functions

- 8 levels of accelerating force and engine braking can be selected.
- A lower gear step will provide greater accelerating force and engine braking force than a higher gear step, and the engine revolutions will also increase.

### ■ Automatic deactivation of gear step selection in the D position

Gear step selection in the D position will be deactivated in the following situations:

- When the vehicle comes to a stop
- If the accelerator pedal is depressed for more than a certain period of time
- When the shift lever is shifted to a position other than D
- When the “+” paddle shift switch is pressed and held

### ■ Downshifting restriction warning buzzer

To help ensure safety and driving performance, downshifting operation may sometimes be restricted. In some circumstances, downshifting may not be possible even when the paddle shift switch is operated. (A buzzer will sound twice.)

## Selecting gears in M mode

To enter M mode, shift the shift lever to M. Gears can be selected by operating the shift

lever or paddle shift switches (if equipped), allowing you to drive in the gear of your choosing.

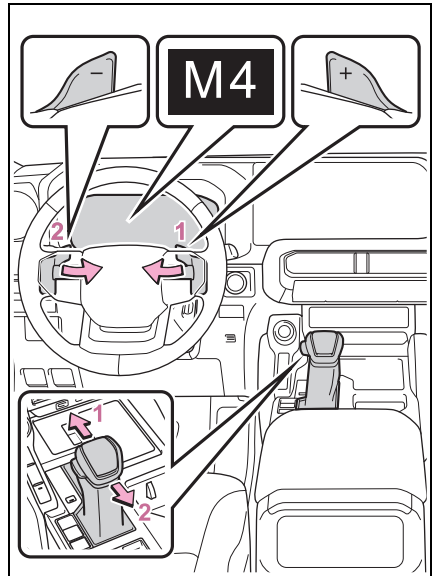

- 1 Upshifting
- 2 Downshifting

The gear changes once every time the shift lever or paddle shift switch is operated.

The selected gear, from M1 to M8, will be fixed and displayed on the meter.

When in the M position, the gear will not change unless the shift lever or paddle shift switch (if equipped) is operated.

However, even when in the M position, the gears will be automatically changed in the following situations:

- When vehicle speed drops (downshift only).
- When the accelerator pedal is firmly depressed.
- When it is necessary to pro-

tect the engine or automatic transmission when the engine coolant temperature is low, the automatic transmission fluid temperature is high or low, or other reasons.

Also, the gear will not shift when the vehicle speed is low, even if an upshift operation is performed.

### ■ Downshifting restriction warning buzzer

To help ensure safety and driving performance, downshifting operation may sometimes be restricted. In some circumstances, downshifting may not be possible even when the shift lever or paddle shift switch (if equipped) is operated. (A buzzer will sound twice.)

### ■ If the “M” indicator does not come on even after shifting the shift lever to M

This may indicate a malfunction in the automatic transmission system. Have the vehicle inspected by your Toyota dealer immediately.

## “TOW HAUL” switch

Use “TOW HAUL” mode when pulling a trailer or hauling a heavy load. Activating “TOW HAUL” mode changes engine, transmission, and steering to be more suitable when pulling a trailer.

Press the “TOW HAUL” switch to use “TOW HAUL” mode.

The “TOW HAUL” indicator will come on.

Press the switch once more to cancel the mode.

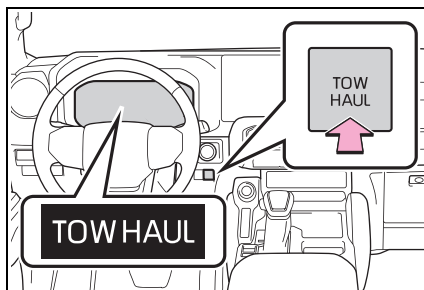

### ■ Automatic deactivation of “TOW HAUL” mode

“TOW HAUL” mode is deactivated the following conditions:

- When the front-wheel drive control switch is in “L4”
- When driving mode select or Multi-terrain Select (if equipped) is selected



## Turn signal lever

### Operating instructions

The turn signal lever can be used to show the following intentions of the driver:

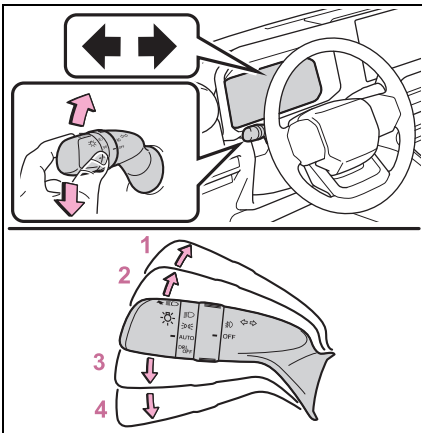

- 1 Right turn
- 2 Lane change to the right (move the lever partway and release it)

The right hand signals will flash 3 times.

- 3 Lane change to the left (move the lever partway and release it)

The left hand signals will flash 3 times.

- 4 Left turn

#### ■ Turn signals can be operated when

The power switch is in ON.

#### ■ If the indicator flashes faster than usual

Have the vehicle inspected by your Toyota dealer.

## Parking brake

The parking brake can be set or released automatically or manually. In automatic mode, the parking brake can be set or released automatically according to shift lever operation. Also, even in automatic mode, the parking brake can be set or released manually.

### Operating instructions

#### ■ Using the manual mode

The parking brake can be set and released manually.

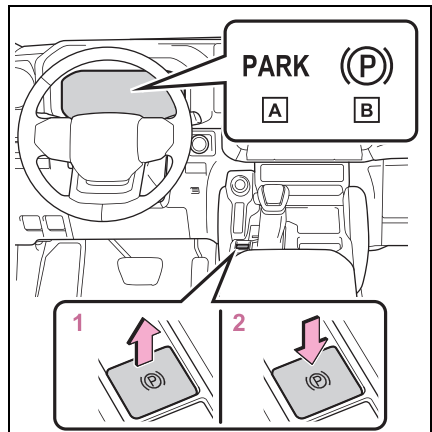

**A** Parking brake indicator light (U.S.A.)

**B** Parking brake indicator light (Canada)

- 1 Pull the switch to set the parking brake.

The parking brake indicator light will turn on.

Pull and hold the parking brake switch if an emergency occurs and it is necessary to operate the parking brake while driving.

- 2 Press the switch to release the parking brake.
- Operate the parking brake switch while depressing the brake pedal.
- Using the parking brake automatic release function, the parking brake can be released by depressing the accelerator pedal. When using this function, slowly depress the accelerator pedal. (→P.234)

Make sure that the parking brake indicator light turn off.

If the parking brake indicator light flash, operate the switch again. (→P.593)

### ■ Turning the automatic mode on

While the vehicle is stopped, pull and hold the parking brake switch until a buzzer sounds and a message is shown on the multi-information display.

When the automatic mode is turned on, the parking brake operates as follows.

- When the shift lever is shifted from P, the parking brake will be released, and the parking brake indicator light will turn off.
- When the shift lever is shifted to P, the parking brake will be set, and the parking brake indicator light will turn on.

Operate the shift lever with the vehicle stopped and the brake pedal depressed.

The auto function may not operate if the shift lever is moved extremely quickly or the brake pedal is not firmly depressed. In this situation, apply the parking brake manually. (→P.237)

### ■ Turning the automatic mode off

While the vehicle is stopped and depressing the brake pedal, press and hold the parking brake switch until a buzzer sounds and a message is shown on the multi-information display.

---

### ■ Parking brake operation

- When the power switch is not in ON, the parking brake cannot be released using the parking brake switch.
- When the power switch is not in ON, automatic mode (automatic brake setting and releasing) is not available.

### ■ Parking brake automatic release function

When all of the following conditions are met, the parking brake can be released by depressing the accelerator pedal.

- The driver's door is closed
- The driver is wearing the seat belt
- The shift lever is in a forward driving position or reverse driving position
- The malfunction indicator lamp or brake system warning light is not illuminated

When depressing the accelerator pedal, depress it slowly.

If the parking brake is not released when the accelerator pedal is depressed, release the parking brake manually.

When the shift lever is shifted from P, the parking brake will be released automatically.

#### ■ Parking brake automatic lock function

The parking brake will be set automatically under the following conditions:

- The brake pedal is not depressed
- The driver's door is open
- The driver's seat belt is not fastened
- The shift lever is in a position other than N
- The malfunction indicator lamp and brake system warning light are not illuminated

#### ■ If "Parking Brake Temporarily Unavailable" is displayed on the multi-information display

If the parking brake is operated repeatedly over a short period of time, the system may restrict operation to prevent overheating. If this happens, refrain from operating the parking brake. Normal operation will return after about 1 minute.

#### ■ If "Parking Brake Unavailable" is displayed on the multi-information display

Operate the parking brake switch. If the message does not disappear after operating the switch several times, the system may be malfunctioning. Have the vehicle inspected by your Toyota dealer.

#### ■ Parking brake operation sound

When the parking brake operates, a motor sound (whirring sound) may be heard. This does not indicate a malfunction.

#### ■ Parking brake indicator light

- Depending on the power switch mode, the parking brake indicator light will turn on and stay on as described below:  
ON: Comes on until the parking brake is released.  
Not in ON: Stays on for approximately 15 seconds.
- When the power switch is turned to OFF with the parking brake set, the parking brake indicator light will stay on for about 15 seconds. This does not indicate a malfunction.

#### ■ When the parking brake switch malfunctions

Automatic mode (automatic brake setting and releasing) will be turned on automatically.

#### ■ Parking the vehicle

→P.197

#### ■ Parking brake engaged warning buzzer

A buzzer will sound if the vehicle is driven with the parking brake engaged. "Parking Brake ON" is displayed on the multi-information display (with the vehicle reaching a speed of 3 mph [5 km/h]).

#### ■ If the brake system warning light comes on

→P.587

#### ■ Usage in winter time

→P.464

### WARNING

#### ■ When parking the vehicle

Do not leave a child in the vehicle alone. The parking brake may be released unintentionally by a child and there is the danger of the vehicle moving that may lead to an accident resulting in death or serious injury.

**WARNING****■ Parking brake switch**

Do not set any objects near the parking brake switch. Objects may interfere with the switch and may lead the parking brake to unexpectedly operate.

**■ Parking brake automatic lock function**

Never use the automatic parking brake engagement function in place of normal parking brake operation. This function is designed to reduce the risk of a collision due to the driver forgetting to engage the parking brake. Over-reliance on this function to park the vehicle safely may lead to an accident resulting in death or serious injury.

**■ When the parking brake cannot be released due to a malfunction**

Driving the vehicle with the parking brake set will lead to brake components overheating, which may affect braking performance and increase brake wear. Have the vehicle inspected by your Toyota dealer immediately if this occurs.

**NOTICE****■ When parking the vehicle**

Before you leave the vehicle, shift the shift lever to P, set the parking brake and make sure that the vehicle does not move.

**■ When the system malfunctions**

Stop the vehicle in a safe place and check the warning messages.

**■ When the vehicle 12-volt battery is discharged**

The parking brake system cannot be activated. (→P.620)

## Brake Hold

The brake hold system keeps the brake applied when the shift lever is in D, M, N or P with the system on and the brake pedal has been depressed to stop the vehicle. The system releases the brake when the accelerator pedal is depressed with the shift lever in D or M to allow smooth start off.

### Enabling the system

Turns the brake hold system on

The brake hold standby indicator

**A** (green) comes on. While the system is holding the brake, the brake hold operated indicator **B** (yellow) comes on.

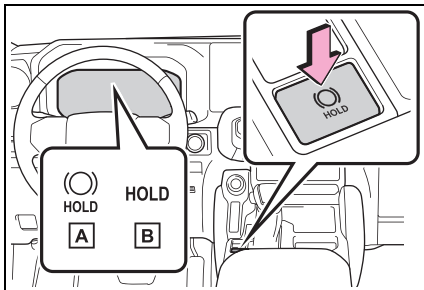

### ■ Brake hold system operating conditions

The brake hold system cannot be turned on in the following conditions:

- The driver's door is not closed.
- The driver is not wearing the seat belt.

- "Parking Brake Unavailable" or "Parking Brake Malfunction Visit Your Dealer" is displayed on the multi-information display.

If any of the conditions above are detected when the brake hold system is enabled, the system will turn off and the brake hold standby indicator light will go off. In addition, if any of the conditions are detected while the system is holding the brake, a warning buzzer will sound and a message will be shown on the multi-information display. The parking brake will then be set automatically.

### ■ Brake hold function

- If the brake pedal is left released for a period of about 3 minutes after the system has started holding the brake, the parking brake will be set automatically. In this case, a warning buzzer sounds and a message is shown on the multi-information display.
- To turn the system off while the system is holding the brake, firmly depress the brake pedal and press the button again.
- The brake hold function may not hold the vehicle when the vehicle is on a steep incline. In this situation, it may be necessary for the driver to apply the brakes. A warning buzzer will sound and the multi-information display will inform the driver of this situation. If a warning message is shown on the multi-information display, read the message and follow the instructions.
- When do not wish for the parking brake to operate automatically, press and hold the brake hold switch until the standby indicator (green) turns off, and then turn the power switch off.

### ■ When the parking brake is set automatically while the system is holding the brakes

Perform any of the following opera-

tions to release the parking brake:

- Depress the accelerator pedal. (The parking brake will not be released automatically if the seat belt is not fastened.)
- Operate the parking brake switch with the brake pedal depressed.

Make sure that the parking brake indicator light goes off. (→P.233)

#### ■ When an inspection at your Toyota dealer is necessary

When the brake hold standby indicator (green) does not illuminate even when the brake hold switch is pressed with the brake hold system operating conditions met, the system may be malfunctioning. Have the vehicle inspected at your Toyota dealer.

#### ■ If “Brake Hold Malfunction Press Brake to Deactivate Visit Your Dealer” or “Brake Hold Malfunction Visit Your Dealer” is displayed on the multi-information display

The system may be malfunctioning. Have the vehicle inspected by your Toyota dealer.

#### ■ Warning messages and buzzers

Warning messages and buzzers are used to indicate a system malfunction or to inform the driver of the need for caution. If a warning message is shown on the multi-information display, read the message and follow the instructions.

#### ■ When another control activates with the brake hold system (vehicles with downhill assist control system)

A message is displayed on the multi-information display in any of the following cases.

- “Brake Hold Unavailable See the Owner’s Manual”
- When the brake hold switch is pressed while the downhill assist control system is activated.
- When the brake hold switch is

pressed while the four-wheel drive control switch is turned to L4 mode.

- “Brake Hold Unavailable Press Brake to Deactivate”
- When the DAC/CRAWL switch is operated while the brake hold system is activated.
- When the four-wheel drive control switch is turned to L4 mode while the brake hold system is activated.

The brake hold system and downhill assist control system or transfer L4 mode cannot be activated at the same time.

Please press the brake hold switch with the brake pedal depressed to turn off the brake hold system.

#### ■ If the brake hold operated indicator flashes

→P.593

#### WARNING

##### ■ When the vehicle is on a steep incline

Take care when using the brake hold system on a steep incline, exercise caution. The brake hold function may not hold brakes in such situations.

Also, the system may not activate depending on the angle of the slope.

##### ■ When stopped on a slippery road

The system cannot stop the vehicle when the gripping ability of the tires has been exceeded. Do not use the system when stopped on a slippery road.



## NOTICE

**■ When parking the vehicle**

The brake hold system is not designed for use when parking the vehicle for a long period of time. Turning the power switch off while the system is holding the brake may release the brake, which would cause the vehicle to move. When operating the power switch, depress the brake pedal, shift the shift lever to P and set the parking brake.

## Headlight switch

The headlights can be operated manually or automatically.

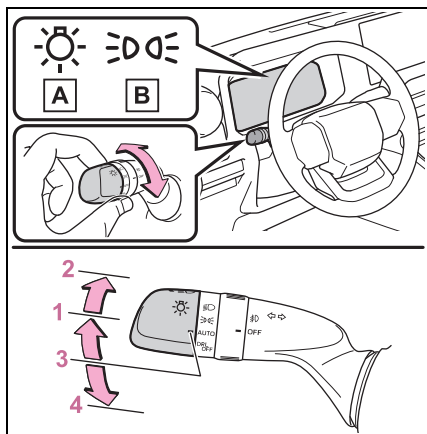

### Turning on the headlights

Operating the  switch turns on the lights as follows:



**A** For the U.S.A.

**B** For Canada

- 1  The side marker, parking, tail, license plate, instrument panel lights, and daytime running lights (→P.240) turn on.
- 2  The headlights and all lights listed above (except daytime running lights) turn on.
- 3  The headlights, daytime running lights (→P.240) and all lights listed above turn on and off automatically.

### 4 (U.S.A.) Off

■ **AUTO mode can be used when**  
The power switch is in ON.

#### ■ Daytime running light system

- The daytime running lights illuminate the parking lights and illuminate brighter than the parking lights.
- To make your vehicle more visible to other drivers during daytime driving, the daytime running lights turn on automatically when all of the following conditions are met. (The daytime running lights are not designed for use at night.)
  - The hybrid system is operating
  - The parking brake is released
  - The headlight switch is in the  or AUTO (when the surroundings are bright) position

The daytime running lights remain on after they illuminate due to the conditions above, even if the parking brake is set again.

- For the U.S.A.: Daytime running lights can be turned off by operating the headlight switch to  position.
- Compared to turning on the headlights, the daytime running light system offers greater durability and consumes less electricity, so it can help improve fuel economy.

#### ■ Headlight control sensor



The sensor may not function properly if an object is placed on the sensor, or anything that blocks the sensor is affixed to the windshield. Doing so interferes with the sensor detecting the level of ambient light and may cause the automatic headlight system to malfunction.

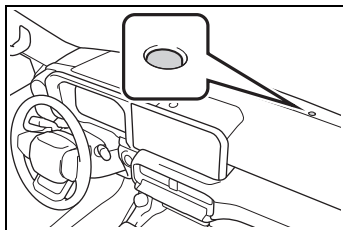



### ■ Automatic light off system

- When the headlights come on:  
The headlights and tail lights turn off 30 seconds after a driver's door is opened and closed if the power switch is turned to OFF. (The lights turn off immediately if  on the key is pressed after all the doors are locked.)
- When only the tail lights come on:  
The tail lights turn off automatically if the power switch is turned to OFF and the driver's door is opened.

To turn the lights on again, turn the power switch to ON, or turn the light switch to **AUTO** or **DRL OFF** once and then back to  or .

### ■ Light reminder buzzer

A buzzer sounds when the power switch is turned to ACC or OFF and the driver's door is opened while the lights are turned on.

### ■ Automatic headlight leveling system

The level of the headlights is automatically adjusted according to the number of passengers and the loading condition of the vehicle to ensure that the headlights do not interfere with other road users.

### ■ 12-volt battery-saving function

In order to prevent the 12-volt battery of the vehicle from discharging, if the headlights and/or tail lights are on when the power switch is turned

off the 12-volt battery saving function will operate and automatically turn off all the lights after approximately 20 minutes. When the power switch is turned to ON, the 12-volt battery-saving function will be disabled.

When any of the following are performed, the 12-volt battery-saving function is canceled once and then reactivated. All the lights will turn off automatically 20 minutes after the 12-volt battery-saving function has been reactivated:

- When the headlight switch is operated
- When a door is opened or closed
- **When unlocking the doors (welcome lamp)**

The parking lights automatically turn on when the surroundings are dark and the doors are unlocked using the entry function or wireless remote control if the light switch is in the **AUTO** position.

### ■ Windshield wiper linked headlight illumination

When driving during daytime with the headlight switch turned to **AUTO** position, if the windshield wipers are used, the headlights will turn on automatically after several seconds to help enhance the visibility of your vehicle.

### ■ Customization

Settings (e.g. light sensor sensitivity) can be changed. (Customizable features: →P.649)



## NOTICE

■ **To prevent 12-volt battery discharge**

Do not leave the lights on longer than necessary when the hybrid system is not operating.

### Turning on the high beam headlights

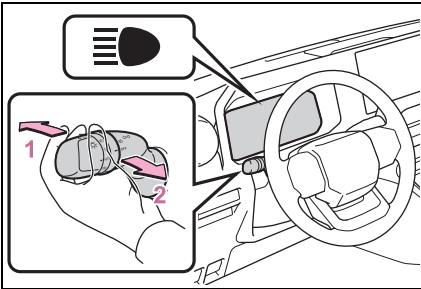

- 1** With the headlights on, push the lever forward to turn on the high beams.

Pull the lever back to the center position to turn the high beams off.

- 2** Pull the lever toward you and release it to flash the high beams once.

You can flash the high beams with the headlights on or off.

## AHB (Automatic High Beam)

The Automatic High Beam uses a front camera located on the upper portion of the windshield to detect the brightness of the lights of vehicles ahead, streetlights, etc., and automatically changes the head lights between the high beams and low beams.



## WARNING

■ **For safe use**

Do not overly rely on the Automatic High Beam. Always drive safely, taking care to observe your surroundings and turning the high beams on or off manually if necessary.

■ **To prevent unintentional operation of the Automatic High Beam System**

- When it is necessary to disable the system: →P.256

### Using the Automatic High Beam system

- 1** Press the Automatic High Beam switch.

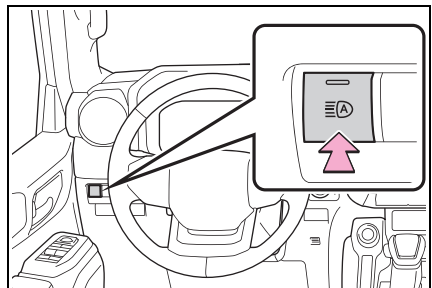

- 2 Turn the headlight switch to the **AUTO** or  position.

When the headlight switch lever is in the low beam position, the AHB system will be enabled and the AHB indicator will illuminate.

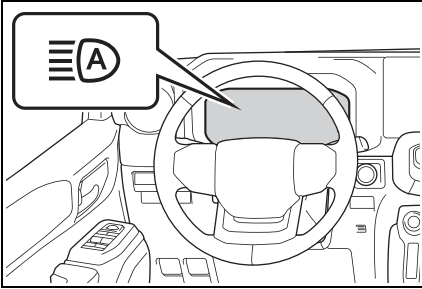

#### ■ Automatic operating conditions of the high beams

- When all of the following conditions are met, the high beams will illuminate automatically:
  - The vehicle speed is approximately 21 mph (34 km/h) or more.
  - The area ahead of the vehicle is dark.
  - There are no vehicles ahead with lights on.
  - There are few streetlights or other lights on the road ahead.
- If any of the following conditions are met, the headlights will change to the low beams:
  - Vehicle speed drops below approximately 17 mph (27 km/h).
  - The area ahead of the vehicle is not dark.
  - There is a vehicle ahead with lights on.
  - There are many streetlights or other lights on the road ahead.

#### ■ Front camera detection

- In the following situations, the high beams may not be automatically changed to the low beams:
  - When a vehicle cuts in front of your vehicle
  - When another vehicle crosses in front of the vehicle

- When vehicles ahead are repeatedly detected and then hidden due to repeated curves, road dividers or roadside trees
- When a vehicle ahead approaches from a far lane
- When a vehicle ahead is far away
- When a vehicle ahead has no lights
- When the lights of a vehicle ahead are dim
- When a vehicle ahead is reflecting strong light, such as own headlights
- Situations in which the sensors may not operate properly: →P.261
- The headlights may change to the low beams if a vehicle ahead that is using fog lights without its headlights turned on is detected.
- House lights, street lights, traffic signals, and illuminated billboards or signs may cause the high beams to change to the low beams, or the low beams to remain on.
- The following may change the timing at which the headlights change to the low beams:
  - The brightness of lights of vehicles ahead
  - The movement and direction of vehicles ahead
  - The distance between the vehicle and a vehicle ahead
  - When a vehicle ahead only has lights illuminated on one side
  - When a vehicle ahead is a two-wheeled vehicle
  - The condition of the road (gradient, curve, condition of the road surface, etc.)
  - The number of passengers and amount of luggage
- The headlights may change between the high beams and low beams unexpectedly.
- Bicycles and other small vehicles may not be detected.
- In the following situations, the system may not be able to correctly detect the brightness of the sur-

roundings. This may cause the low beams to remain on or the high beams to flash or dazzle pedestrians or vehicles ahead. In such a case, it is necessary to manually change between the high beams and low beams.

- When there are lights similar to headlights or tail lights in the surrounding area
- When headlights or tail lights of vehicles ahead are turned off, dirty, changing color, or not aimed properly
- When the headlights are repeatedly changing between the high beams and low beams.
- When use of the high beams is inappropriate or when the high beams may be flashing or dazzling pedestrians or other drivers.
- When the vehicle is used in an area in which vehicles travel on the opposite side of the road of the country for which the vehicle was designed, for example using a vehicle designed for right-hand traffic in a left-hand traffic area, or vice versa
- When it is necessary to disable the system: →P.256
- Situations in which the sensors may not operate properly: →P.261

#### ■ Temporarily reducing front camera sensitivity

The sensitivity of the front camera can be temporarily reduced.

- 1 Turn the power switch off with the following conditions met.
  - The headlight switch is in the  or AUTO position.
  - The headlight switch lever is in the low beam position.
  - The automatic High Beam switch is on.
- 2 Turn the power switch to ON.
- 3 Within 60 seconds after performing step 2, push the headlight switch lever to the high beam position then pull it to the original

position quickly 10 times, then leave the lever in its original position.

- 4 If the sensitivity is changed, the Automatic High Beam indicator will blink 3 times.

### Turning the high beams on/off manually

#### ■ Changing to the high beams

Push the lever forward.

The AHB indicator will turn off and the headlight high beam indicator will turn on.

Pull the lever to its original position to enable the Automatic High Beam system again.

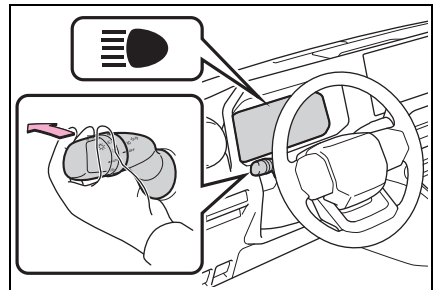

#### ■ Changing to the low beams

Press the Automatic High Beam switch.

The AHB indicator will turn off.

Press the switch to enable the Automatic High Beam system again.

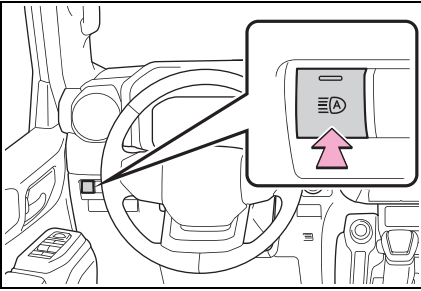

### Temporarily changing to the low beams

It is recommended to switch to the low beams when use of the high beams is inappropriate or when the high beams may cause problems or distress to other drivers or pedestrians nearby.

Pull the lever rearward and then return it to its original position.

The high beams will illuminate while the lever is pulled, however, after the lever is returned to its original position, the low beams will remain on for a certain amount of time. After this, the Automatic High Beam system will operate.

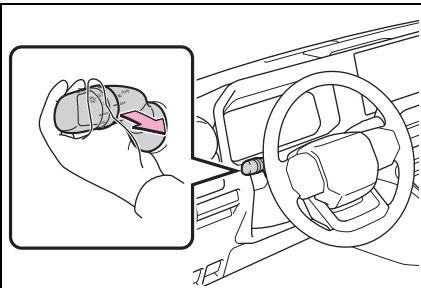

### Fog light switch\*

\*: If equipped

The fog lights offer improved visibility in difficult driving conditions, such as in rain and fog.

### Operating procedure

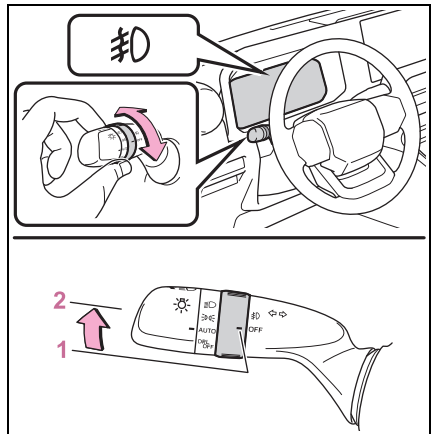

- 1 OFF \*1 or ○ \*2 Off
- 2 ☞ Front fog lights on

\*1: For the U.S.A.

\*2: For Canada

### ■ Fog lights can be used when

The headlights are on in low beam.

## Windshield wipers and washer

Operating the lever can switch between automatic operation and manual operation, or can use the washer.



### NOTICE

#### ■ When the windshield is dry

Do not use the wipers, as they may damage the windshield.

## Operating the wiper lever

Operating the  lever operates the wipers or washer as follows. When "AUTO" is selected, the wipers will operate automatically when the sensor detects falling rain. The system automatically adjusts wiper timing in accordance with rain volume and vehicle speed.

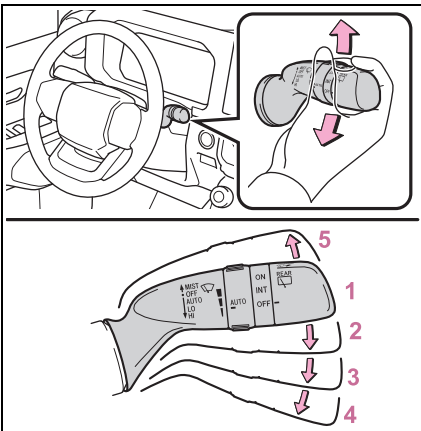

**1 OFF** \*1 or ○ \*2 Off

**2 AUTO** Rain-sensing operation

**3 LO** \*1 or ▼ \*2 Low speed operation

**4 HI** \*1 or ▼ \*2 High speed operation

**5 MIST** \*1 or ▲ \*2 Temporary operation

\*1: For the U.S.A.

\*2: For Canada

When "AUTO" is selected, the sensor sensitivity can be adjusted by turning the switch ring.

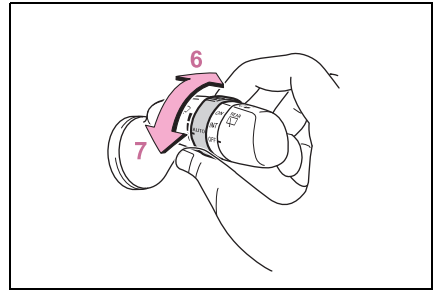

**6** Increases the sensitivity

**7** Decreases the sensitivity

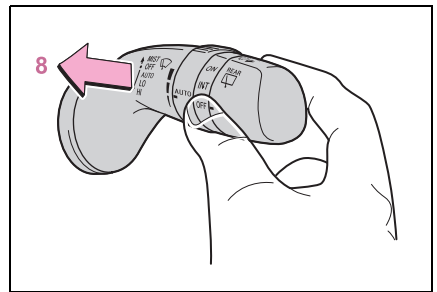

**8**  Washer/wiper dual operation

Pulling the lever operates the wipers and washer.

After operating several times, the

wipers operate one more time after a short delay to prevent dripping.

### ■ The windshield wiper and washer can be operated when

The power switch is in ON.

### ■ Operating the windshield wipers and washer using the Intelligent Assistant system \*

\* : If equipped

The following operation can be performed using the Intelligent Assistant system.

- Operating the windshield wipers only once
- Operating the windshield washer (it can be performed only when the vehicle is stopped)

For details regarding the Intelligent Assistant system, refer to the "MULTIMEDIA OWNER'S MANUAL".

### ■ Effects of vehicle speed on wiper operation

With low speed windshield wiper operation selected, wiper operation will be switched from low speed to intermittent wiper operation when the vehicle is stationary. (However, when the sensor sensitivity is adjusted to the highest level, the mode will not switch.)

### ■ Raindrop sensor

- The raindrop sensor judges the amount of raindrops.

An optical sensor is adopted. It may not operate properly when sunlight from the rising or setting of the sun intermittently strikes the windshield, or if bugs etc. are present on the windshield.

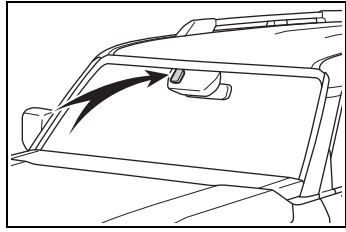

- If the wiper switch is turned to the "AUTO" position while the power switch is in ON, the wipers will operate once to show that "AUTO" mode is activated.
  - If the temperature of the raindrop sensor is 185°F (85°C) or higher, or 22°F (-30°C) or lower, automatic operation may not occur. In this case, operate the wipers in any mode other than "AUTO".
- If no windshield washer fluid sprays

Check that the washer nozzles are not blocked if there is washer fluid in the windshield washer fluid reservoir.

### ⚠ WARNING

#### ■ Caution regarding the use of windshield wipers in **AUTO** mode

The windshield wipers may operate unexpectedly if the sensor is touched or the windshield is subject to vibration in **AUTO** mode.

Take care that your fingers or anything else does not become caught in the windshield wipers.

#### ■ Caution regarding the use of washer fluid

When it is cold, do not use the washer fluid until the windshield becomes warm. The fluid may freeze on the windshield and cause low visibility. This may lead to an accident, resulting in death or serious injury.



## NOTICE

**When there is no washer fluid spray from the nozzle**

Damage to the washer fluid pump may be caused if the lever is pulled toward you and held continually.

**When a nozzle becomes blocked**

In this case, contact your Toyota dealer.

Do not try to clear it with a pin or other object. The nozzle will be damaged.

**To prevent 12-volt battery discharge**

Do not leave the wiper on longer than necessary when the hybrid system is off.

**Rear window wiper and washer**

The rear window wiper and washer can be used by operating the lever.



## NOTICE

**When the rear window is dry**

Do not use the wiper, as it may damage the rear window.

**Operating the wiper lever**

Operating the  switch operates the rear window wiper as follows:

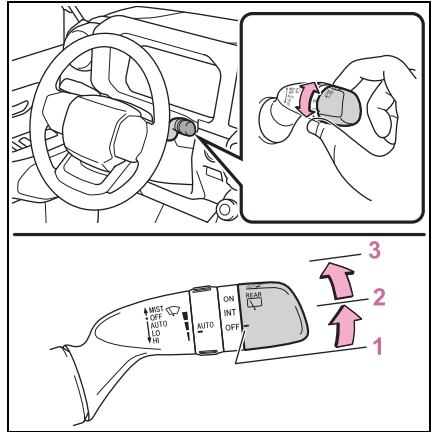

- 1 OFF** <sup>\*1</sup> or **○** <sup>\*2</sup> Off
- 2 INT** <sup>\*1</sup> or **---** <sup>\*2</sup> Intermittent operation
- 3 ON** <sup>\*1</sup> or **—** <sup>\*2</sup> Normal operation

<sup>\*1</sup>: For the U.S.A.

<sup>\*2</sup>: For Canada



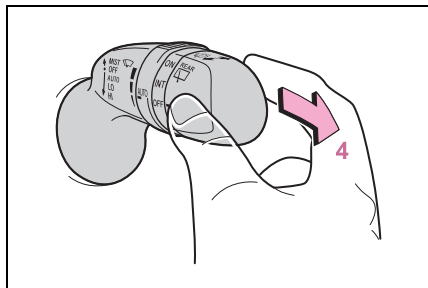

#### 4 Washer/wiper dual operation

Pushing the lever operates the wiper and washer.

Vehicles with camera cleaning washer: The washer will automatically operate and clean the following cameras.

- The camera for Rear view monitor\* (if equipped)
- The camera for Multi-terrain Monitor (if equipped) (→P.421)

\*: Refer to “MULTIMEDIA OWNER’S MANUAL”.

#### ■ The rear window wiper and washer can be operated when

The rear window wiper and washer are operate when all of the following conditions are met:

- The power switch is in ON.
- The glass hatch is closed.

#### ■ Operating the rear window wiper and washer using the Intelligent Assistant system\*

\*: If equipped

The following operation can be performed using the Intelligent Assistant system.

- Operating the rear window wiper only once
- Operating the rear window washer (it can be performed only when the vehicle is stopped)

For details regarding the Intelligent Assistant system, refer to the “MULTIMEDIA OWNER’S MANUAL”.

#### ■ If no washer fluid sprays

Check that the washer nozzle is not blocked if there is washer fluid in the washer fluid reservoir.

#### ■ Dripping prevention wiper sweep

When the washer is operated, the wipers will operate once more time after a short delay to prevent dripping.

#### ■ Back door opening linked rear window wiper stop function

When the rear window wiper is operating, if the back door is opened while the vehicle is stopped, operation of the rear window wiper will be stopped to prevent anyone near the vehicle from being sprayed by water from the wiper. When the back door is closed, wiper operation will resume.

#### ■ Reverse-linked rear window wiper function

When the shift lever is shifted to R when the front wipers are operating, the rear window wiper will operate once.

#### NOTICE

#### ■ When the washer fluid tank is empty

Do not operate the switch continually as the washer fluid pump may overheat.

#### ■ When a nozzle becomes blocked

In this case, contact your Toyota dealer. Do not try to clear it with a pin or other object. The nozzle will be damaged.



## NOTICE

**■ To prevent 12-volt battery discharge**

Do not leave the wiper on longer than necessary when the hybrid system is off.

## Opening the fuel tank cap

The fuel tank of your vehicle has a special structure, which requires a reduction in fuel tank pressure before refueling. After the opener switch has been pressed, it will take several seconds until the vehicle is ready for refueling.

## Before refueling the vehicle

- Turn the power switch off and ensure that all the doors and windows are closed.
- Confirm the type of fuel.

### ■ Fuel types

→P.638

### ■ Fuel tank opening for unleaded gasoline

To help prevent incorrect fueling, your vehicle has a fuel tank opening that only accommodates the special nozzle on unleaded fuel pumps.

## WARNING

### ■ When refueling the vehicle

Observe the following precautions while refueling the vehicle. Failure to do so may result in death or serious injury.

- After exiting the vehicle and before opening the fuel door, touch an unpainted metal surface to discharge any static electricity. It is important to discharge static electricity before refueling because sparks resulting from static electricity can cause fuel vapors to ignite while refueling.
- Always hold the grips on the fuel tank cap and turn it slowly to remove it. A whooshing sound may be heard when the fuel tank cap is loosened. Wait until the sound cannot be heard before fully removing the cap. In hot weather, pressurized fuel may spray out of the filler neck and cause injury.
- Do not allow anyone that has not discharged static electricity from their body to come close to an open fuel tank.
- Do not inhale vaporized fuel. Fuel contains substances that are harmful if inhaled.
- Do not smoke while refueling the vehicle. Doing so may cause the fuel to ignite and cause a fire.
- Do not return to the vehicle or touch any person or object that is statically charged. This may cause static electricity to build up, resulting in a possible ignition hazard.

### ⚠ WARNING

#### ■ When refueling

Observe the following precautions to prevent fuel overflowing from the fuel tank:

- Securely insert the fuel nozzle into the fuel filler neck.
- Stop filling the tank after the fuel nozzle automatically clicks off.
- Do not top off the fuel tank.

### ⚠ NOTICE

#### ■ Refueling

- Finish refueling within 30 minutes. If more than 30 minutes passes, the internal valve closes. In this condition, fuel may overflow during the refueling process. Press the fuel filler door opener switch again.
- Make sure that the fuel filler door lock is not pushed by the fuel nozzle boot, etc. If the lock is held, the internal valve closes and fuel may overflow. To prevent it, press the fuel filler door opener switch again.

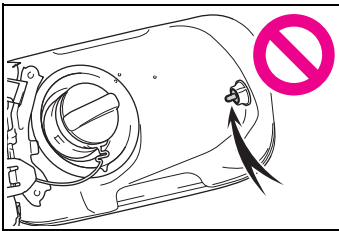

- Do not spill fuel during refueling. Doing so may damage the vehicle, such as causing the emission control system to operate abnormally or damaging fuel system components or the vehicle's painted surface.

### Opening the fuel tank cap

- 1 Press the opener switch to open the fuel filler door.

The fuel filler door will open within about 10 seconds of the switch being pressed. Before refueling is possible, a message will be shown on the multi-information display in the instrument cluster to indicate the progress of the fuel filler door opener.

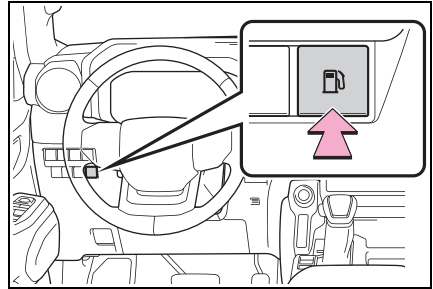

- 2 Turn the fuel tank cap slowly to open it and put it into the holder on the fuel filler door.

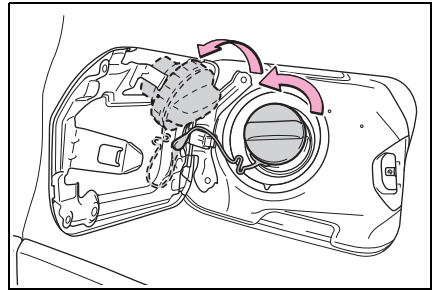

#### ■ If the fuel filler door cannot be opened

Consult your Toyota dealer.

### Closing the fuel tank cap

After refueling, turn the fuel tank cap until you hear a click. Once the cap is released, it will turn

slightly in the opposite direction.

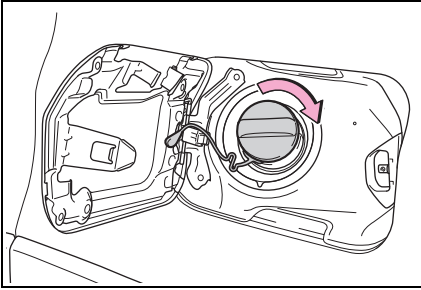

■ **When “Check Fuel Cap” is displayed on the multi-information display**

The fuel tank cap may be unfastened or loose. Turn the power switch off, check the cap and tighten it securely. If the message remains, wait a few seconds and then turn the power switch off once again.



**WARNING**

■ **When replacing the fuel tank cap**

Do not use anything but a genuine Toyota fuel tank cap designed for your vehicle. Doing so may cause a fire or other incident which may result in death or serious injury.

## Toyota Safety Sense 3.0 software update

It is necessary to enter a connected services contract, provided by Toyota, to use these functions. For details, contact your Toyota dealer.

### WARNING

#### ■ For safe use

When the Toyota Safety Sense 3.0 software is updated, the operating methods of functions may change. Using this system without knowing the correct operating methods may lead to an accident resulting in death or serious injury.

- Make sure to read the Digital Owner's Manual which corresponds to the software version of the system, available at the Owner's Manual website, before using this system.

## Content of the Toyota Safety Sense 3.0 Owner's Manual

This Owner's Manual contains information for Ver. 2. For the latest information about the controls, use, warnings/precautions, etc. of each function of Toyota Safety Sense 3.0 refer to the Digital Owner's Manual at the Owner's Manual website.

If the software of this system has been updated after initial purchase of the vehicle, before using this system, be sure to read the Owner's Manual which corresponds to the software version of the system.

### ■ Precautions for use

- Be aware that some functions may temporarily be disabled if a legal or safety related issue occurs.
- If a connected services contract has not been entered or has expired, software updates will not be able to be performed wirelessly.

## Checking your vehicle's Toyota Safety Sense 3.0 version

If the software of this system has been updated after initial purchase of the vehicle, to access the appropriate Owner's Manual, it is necessary to check the software version of the system and then visit the Owner's Manual website.

### ■ Checking the version using Toyota App

The software version of the system can be checked using Toyota

App.

### ■ Selecting your vehicle's Toyota Safety Sense 3.0 version

1 Access the following URL using a computer or smartphone:

Country	Language	URL	QR Code
U.S.A.	English	<a href="https://www.toyota.com/owners/resources/warranty-owners-manuals/manual?om=om60x34u.landcruiserprado.2025.2410.hev.vh">https://www.toyota.com/owners/resources/warranty-owners-manuals/manual?om=om60x34u.landcruiserprado.2025.2410.hev.vh</a>	
Canada	English	<a href="https://www.toyota.ca/toyota/owners/manual?om=om60x34u.landcruiserprado.2025.2410.hev.vh">https://www.toyota.ca/toyota/owners/manual?om=om60x34u.landcruiserprado.2025.2410.hev.vh</a>	
	French	<a href="https://www.toyota.ca/toyota/owners/manual?om=om60x34d.landcruiserprado.2025.2410.hev.vh">https://www.toyota.ca/toyota/owners/manual?om=om60x34d.landcruiserprado.2025.2410.hev.vh</a>	

2 Select the file which includes the previously checked system version.

## Updating the software

If a software update is available, a notification will be displayed by Toyota App. Follow the instructions displayed on the screen.

### ■ Software update precautions

- After a software update has been performed, it will not be possible to revert to a previous version.
- Depending on the communication environment and the content of an update, a software update may take several hours. Although an update will be suspended when the power switch is turned off, it will resume when the power switch is changed back to ON.
- Toyota Safety Sense 3.0 can still be used while a software update is being performed.

### ■ What can be checked using the Toyota App

The following items can be checked or performed.

- Software version, update details, precautions, use methods, etc.
- Software update

## Toyota Safety Sense 3.0

**The Toyota Safety Sense 3.0 consists of the driving assist systems and contributes to a safe and comfortable driving experience:**



### WARNING

#### ■ Toyota Safety Sense 3.0

The Toyota Safety Sense 3.0 operates under the assumption that the driver will drive safely, and is designed to help reduce the impact to the occupants in a collision and assist the driver under normal driving conditions.

As there is a limit to the degree of recognition accuracy and control performance that this system can provide, do not overly rely on this system. The driver is solely responsible for paying attention to the vehicle's surroundings and driving safely.

#### ■ For safe use

- Do not overly rely on this system. The driver is solely responsible for paying attention to the vehicle's surroundings and driving safely. This system may not operate in all situations and provided assistance is limited. Over-reliance on this system to drive the vehicle safely may lead to an accident resulting in death or serious injury.
- Do not attempt to test the operation of the system, as it may not operate properly, possibly leading to an accident.

- If attention is necessary while performing driving operations or a system malfunction occurs, a warning message or warning buzzer will be operated. If a warning message is displayed on the display, follow the instructions displayed.
- Depending on external noise, the volume of the audio system, etc. it may be difficult to hear the warning buzzer. Also, depending on the road conditions, it may be difficult to recognize the operation of the system.

#### ■ When it is necessary to disable the system

In the following situations, make sure to disable the system.

Failure to do so may lead to the system not operating properly, possibly leading to an accident resulting in death or serious injury.

- When the vehicle is tilted due to being overloaded or having a flat tire
- When driving at extremely high speeds
- When towing another vehicle with the TDA (Trailer Driving Assist) (→P.264) deactivated
- When the vehicle is being transported by a truck, ship, train, etc.
- When the vehicle is raised on a lift and the tires are allowed to rotate freely
- When inspecting the vehicle using a drum tester such as a chassis dynamometer or speedometer tester, or when using an on vehicle wheel balancer
- When the vehicle is driven in a sporty manner or off-road



**WARNING**

- When using an automatic car wash
- When a sensor is misaligned or deformed due to a strong impact being applied to the sensor or the area around the sensor
- When accessories which obstruct a sensor or light are temporarily installed to the vehicle
- When a compact spare tire or tire chains are installed to the vehicle or an emergency tire puncture repair kit has been used
- When the tires are excessively worn or the inflation pressure of the tires is low
- When tires other than the manufacturer specified size are installed
- When the vehicle cannot be driven stably, due to a collision, malfunction, etc.

**Driving assist systems**

- **AHB (Automatic High Beam)**  
→P.242
- **PCS (Pre-Collision System)**  
→P.268
- **LTA (Lane Tracing Assist)**  
→P.280
- **LDA (Lane Departure Alert)**  
→P.288

■ **LCA (Lane Change Assist)\***

→P.285

■ **FCTA (Front Cross Traffic Alert)\***

→P.300

■ **PDA (Proactive Driving Assist)**

→P.294

■ **RSA (Road Sign Assist)\***

→P.302

■ **Dynamic radar cruise control**

→P.305

■ **Cruise control**

→P.316

■ **Emergency Driving Stop System**

→P.319

■ **Traffic Jam Assist\***

→P.322

■ **Driver monitor\***

→P.266

\*: If equipped

**Sensors used by Toyota Safety Sense 3.0**

Various sensors are used to obtain the necessary information for system operation.

### ■ Sensors which detect the surrounding conditions

#### ► Front

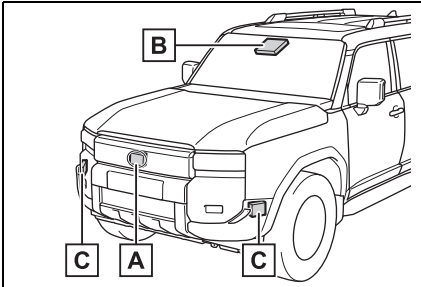

**A** Front radar sensor

**B** Front camera

**C** Front side radar sensors\*

\*: If equipped

#### ► Rear

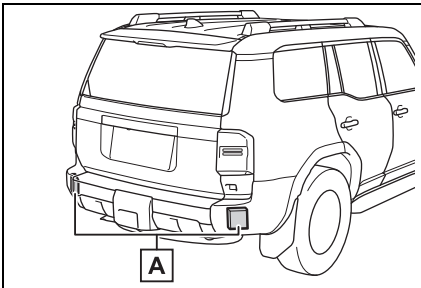

**A** Rear side radar sensors

### ■ Sensors which detect the driver condition

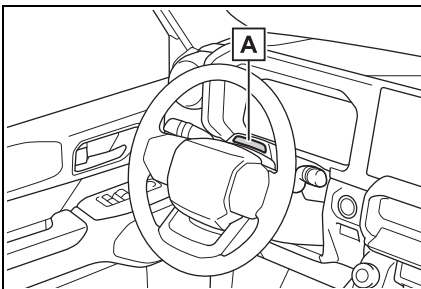

**A** Driver monitor camera\*

\*: If equipped

### ⚠ WARNING

#### ■ To prevent malfunction of the radar sensors

Observe the following precautions.

Failure to do so may lead to a radar sensor not operating properly, possibly leading to an accident resulting in death or serious injury.

● Keep the radar sensors and radar sensor covers clean at all times.

Clean the front of a radar sensor or the front or back of a radar sensor cover if it is dirty or covered with water droplets, snow, etc.

When cleaning the radar sensor and radar sensor cover, use a soft cloth to remove dirt so as to not damage them.

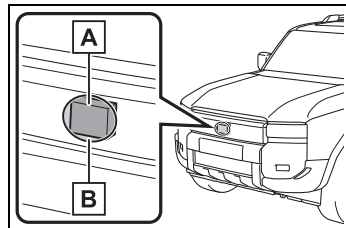

**A** Radar sensor

**B** Radar sensor cover

**WARNING**

- Vehicles with front side radar sensors: Keep the surrounding area of the front side radar sensors on the front bumper clean at all times.

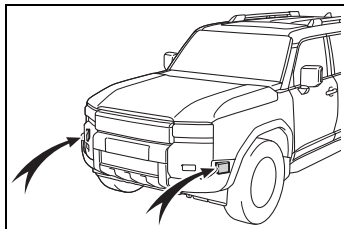

- Do not attach accessories, stickers (including transparent stickers), aluminum tape, etc. to a radar sensor or radar sensor cover and their surrounding area.
- Do not subject a radar sensor or its surrounding area to impact.

If a radar sensor, the front grille, or front bumper has been subjected to an impact, have the vehicle inspected by your Toyota dealer.

- Do not disassemble the radar sensors.
- Do not modify or paint the radar sensors or radar sensor cover, or replace them with anything other than Toyota genuine parts.
- In the following situations, recalibration of the radar sensors will be necessary. For details, contact your Toyota dealer.
  - When a radar sensor is removed and installed, or replaced
  - When the front bumper or the front grille has been replaced

**■ To prevent malfunction of the front camera**

Observe the following precautions.

Failure to do so may lead to the front camera not operating properly, possibly leading to an accident resulting in death or serious injury.

- Always keep the windshield clean.
  - If the windshield is dirty or covered with an oily film, water droplets, snow, etc., clean the windshield.
  - Even if a glass coating agent is applied to the windshield, it will still be necessary to use the windshield wipers to remove water droplets, etc. from the area of the windshield in front of the front camera.
  - If the inner side of the windshield where the front camera is installed is dirty, contact your Toyota dealer.
- Do not attach stickers (including transparent stickers) or other items to the area of the windshield in front of the front camera (shaded area in the illustration).

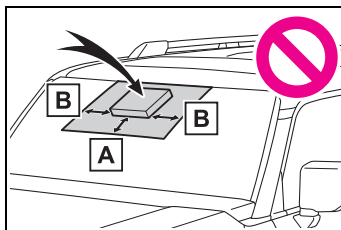

**A** Approximately 1.6 in. (4 cm)

**B** Approximately 1.6 in. (4 cm)

**WARNING**

- If the part of the windshield in front of the front camera is fogged up or covered with condensation or ice, use the windshield defogger to remove the fog, condensation, or ice.
- If water droplets cannot be properly removed from the area of the windshield in front of the front camera by the windshield wipers, replace the wiper insert or wiper blade.
- Do not attach window tint to the windshield.
- Replace the windshield if it is damaged or cracked.

If the windshield has been replaced, recalibration of the front camera will be necessary. For details, contact your Toyota dealer.

- Do not allow liquids to contact the front camera.
- Do not allow bright lights to shine into the front camera.
- Do not damage the lens of the front camera or allow it to become dirty.

When cleaning the inside of the windshield, do not allow glass cleaner to contact the lens of the front camera. Do not touch the lens of the front camera.

If the lens of the front camera is dirty or damaged, contact your Toyota dealer.

- Do not subject the front camera to a strong impact.
- Do not change the position or orientation of the front camera or remove it.

- Do not disassemble the front camera.
- Do not modify any parts around the front camera, such as the inside rear view mirror or ceiling.
- Do not attach accessories which may obstruct the front camera to the hood, front grille, or front bumper. For details, contact your Toyota dealer.
- If a surfboard or other long object is to be mounted on the roof, make sure that it will not obstruct the front camera.
- Do not modify or change the headlights and other lights.

#### ■ Front camera installation area on the windshield

If the system determines that the windshield may be fogged up, it will automatically operate the heater to defog the part of the windshield around the front camera. When cleaning, etc., be careful not to touch the area around the front camera until the windshield has cooled sufficiently, as touching it may cause burns.

#### ■ Precautions for the driver monitor camera

Observe the following precautions.

Failure to do so may lead to malfunction of the driver monitor camera and the systems not operating properly, possibly leading to an accident resulting in death or serious injury.

**WARNING**

- Do not subject the driver monitor camera or its surrounding area to strong impact.

If subjected to a strong impact, the driver monitor camera may move out of alignment and the driver may no longer be detected correctly. In this case, have the vehicle inspected by your Toyota dealer.

- Do not disassemble or modify the driver monitor camera.
- Do not attach accessories, stickers (including transparent stickers), etc. to the driver monitor camera or its surrounding area.
- Do not allow the driver monitor camera or its surrounding area to get wet.
- Do not cover the driver monitor camera or place anything in front of it.
- Keep the lens of the driver monitor camera free from damage.
- Do not touch the lens of the driver monitor camera or allow it to become dirty.

When there is dirt or fingerprints on the camera lens, clean it with a dry, soft cloth so as to not mark or damage it.

- When cleaning the lens, do not use detergents or organic solvents that may damage plastic.

**■ Precautions for use**

It is necessary to enter a connected services contract, provided by Toyota, to use these functions. For details, contact your Toyota dealer.

- LCA (Lane Change Assist) (if equipped)

→P.285

- Radar Cruise Control: Extended resume time (if equipped)

→P.305

- Traffic Jam Assist (if equipped)

→P.322

**■ Situations in which the sensors may not operate properly**

- When the height or inclination of the vehicle has been changed due to modifications
- When the windshield is dirty, fogged up, cracked or damaged
- When the ambient temperature is high or low
- When mud, water, snow, dead insects, foreign matter, etc., is attached to the front of the sensor
- When in inclement weather such as heavy rain, fog, snow, or a sandstorm
- When water, snow, dust, etc. is thrown up in front of the vehicle, or when driving through mist or smoke
- When the headlights are not illuminated while driving in the dark, such as at night or when in a tunnel
- When the lens of a headlight is dirty and illumination is weak
- When the headlights are misaligned
- When a headlight is malfunctioning
- When the headlights of another vehicle, sunlight, or reflected light shines directly into the front camera
- When the brightness of the surrounding area changes suddenly
- When driving near a TV tower, broadcasting station, electric power plant, radar equipped vehi-

cles, etc., or other location where strong radio waves or electrical noise may be present

- When a wiper blade is blocking the front camera
- When in a location or near objects which strongly reflect radio waves, such as the following:
  - Tunnels
  - Truss bridges
  - Gravel roads
  - Rutted, snow-covered roads
  - Walls
  - Large trucks
  - Manhole covers
  - Guardrail
  - Metal plates
- When near a step or protrusion
- When a detectable vehicle is narrow, such as a small mobility vehicle
- When a detectable vehicle has a small front or rear end, such as an unloaded truck
- When a detectable vehicle has a low front or rear end, such as a low bed trailer

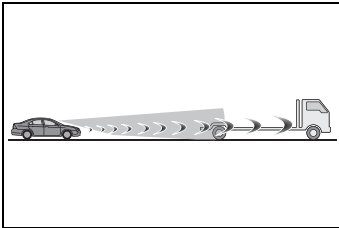

- When a detectable vehicle has extremely high ground clearance

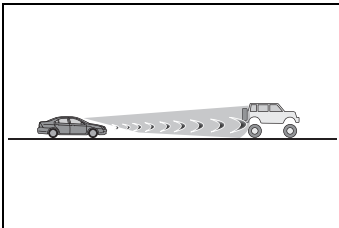

- When a detectable vehicle is carrying a load which protrudes from its cargo area

- When a detectable vehicle has little exposed metal, such as a vehicle which is partially covered with cloth, etc.
- When a detectable vehicle is irregularly shaped, such as a tractor, sidecar, etc.
- When the distance between the vehicle and a detectable vehicle has become extremely short
- When a detectable vehicle is at an angle
- When snow, mud, etc. is attached to a detectable vehicle
- When driving on the following kinds of roads:
  - Roads with sharp curves or winding roads
  - Roads with changes in grade, such as sudden inclines or declines
  - Roads which is sloped to the left or right
  - Roads with deep ruts
  - Roads which are rough and unmaintained
  - Roads which frequently undulate or are bumpy
- When the steering wheel is being operated frequently or suddenly
- When the vehicle is not in a constant position within a lane
- When parts related to this system, the brakes, etc. are cold or extremely hot, wet, etc.
- When the wheels are misaligned
- When driving on slick road surfaces, such as when it is covered with ice, snow, gravel, etc.
- When the course of the vehicle differs from the shape of a curve
- When the vehicle speed is excessively high when entering a curve
- When entering/exiting a parking lot, garage, car elevator, etc.
- When driving in a parking lot
- When driving through an area where there are obstructions

which may contact your vehicle, such as tall grass, tree branches, a curtain, etc.

- When driving in strong wind

#### ■ Situations in which the lane monitor may not be detected

- When the lane is extremely wide or narrow
- Immediately after changing lanes or passing through an intersection
- When driving in a temporary lane or lane regulated by construction
- When there are structures, patterns, shadows which are similar to lane lines in the surrounding
- When there are multiple white lines for a lane line
- When the lane lines are not clear or driving on a wet road surface
- When a lane line is on a curb
- When driving on a bright, reflective road surface, such as concrete

#### ■ Situations in which some or all of the functions of the system cannot operate

- When a malfunction is detected in this system or a related system, such as the brakes, steering, etc.
- When the VSC, Active TRAC, or other safety related system is operating
- When the VSC, Active TRAC, or other safety related system is off

#### ■ Changes in brake operation sound and pedal response

- When the brakes have been operated, brake operation sounds may be heard and the brake pedal response may change, but this does not indicate a malfunction.
- When the system is operating, the brake pedal may feel stiffer than expected or sink. In either situation the brake pedal can be depressed further. Further depress the brake pedal as nec-

essary.

#### ■ Situations in which the driver monitor may not operate properly

In situations such as the following, the driver monitor camera may not be able to detect the driver's face, and the function may not operate properly.

- When the inside of the vehicle is hot, such as after the vehicle has been parked in the sun
- When a very bright light, such as the sun or the headlights of following vehicle, shines onto the driver monitor camera
- When the brightness inside the vehicle changes frequently due to the shadows of surrounding structures, etc.
- When a very bright light, such as the sun or the headlights of an oncoming vehicle, is shining onto the driver's face
- When light, either inside or outside of the vehicle, is being reflected from the lenses of eyeglasses or sunglasses
- When there are multiple faces in the detection range of the driver monitor camera, such as when a front or rear passenger is leaning toward the driver's seat
- When the driver's face is outside of the detection range of the driver monitor camera, such as when leaned forward or when their head is outside of the window
- When the driver monitor camera is being blocked by the steering wheel, a hand holding the steering wheel, an arm, etc.
- When the driver is wearing a hat
- When the driver is wearing an eyepatch
- When the driver is wearing eyeglasses or sunglasses that do not easily transmit infrared rays

- When the driver is wearing contact lenses
- When the driver is wearing a face mask
- When the driver is laughing or their eyes are only slightly open
- When the driver's eyes, nose, mouth, or shape of their face is blocked
- When the driver is wearing makeup which makes it difficult to detect their eyes, nose, mouth, or shape of their face
- When the driver's eyes are blocked by the frame of eye-glasses, sunglasses, hair, etc.
- When there is a device inside the vehicle that radiates near infrared rays, such as a non-genuine driver monitoring system.

■ **When the SDM (Stabilizer with Disconnection Mechanism) is operating, (→P.456)**

each function is limited as follows:

Function	Status
PCS (Pre-Collision System) (→P.268)	O
LTA (Lane Tracing Assist) (→P.280)	—
LCA (Lane Change Assist) <sup>*3</sup> (→P.285)	—
LDA (Lane Departure Alert) (→P.288)	*1
PDA (Proactive driving assist) (→P.294)	*2
Dynamic radar cruise control (→P.305)	O
Emergency Driving Stop System (→P.319)	—

Definition of symbols:

O = Available,

— = Not available

\*1: Alert is available only

\*2: Partially unavailable

\*3: If equipped

● PDA some functions

The following functions are disabled when the SDM is operating.

- PDA-OAA (Obstacle Anticipation Assist) functions

The brake assist function operates, but the steering wheel assist function does not.

- PDA-SA (Steering Assist) function

The steering wheel assist function does not operate.

■ **TDA (Trailer Driving Assist)**

TDA (Trailer Drive Assist) is a system that adjusts certain driver assist settings to support towing functionality. It is recommended to use a genuine trailer brake controller (→P.453) when towing. Towing without a genuine trailer brake controller increases the risk of vehicle/trailer instability.

● System functions

When the TDA is operating, each function is limited as follows:

Function	Status
PCS (Pre-Collision System) (→P.268)	*1
LTA (Lane Tracing Assist) (→P.280)	—
LCA (Lane Change Assist) <sup>*3</sup> (→P.285)	—
LDA (Lane Departure Alert) (→P.288)	*2
PDA (Proactive driving assist) (→P.294)	—



Function	Status
Dynamic radar cruise control (→P.305)	O
Emergency Driving Stop System (→P.319)	—

Definition of symbols:

O = Available,

— = Not available

\*1: Partially unavailable

\*2: Not available for Puerto Rico, and only alert is available except for Puerto Rico.

\*3: If equipped

#### ● Operating conditions

When towing a trailer connected to a genuine trailer brake controller (→P.453), a message is displayed on the multi-information display when a trailer is detected. Enable the function according to the instructions on the multi-information display.

#### ● PCS (Pre-Collision System) some functions

The following functions are disabled when a trailer is detected.

- Moderate braking for pre-collision warning
  - Acceleration suppression at low speed (vehicles with automatic transmission)
  - Emergency steering assist
  - Intersection collision avoidance support (left/right turn)
- When towing a trailer
- This system has limitations. Do not overly rely on the system. It is the driver's responsibility to always be aware of the surroundings and drive safely.
  - Please check P.209 on how to tow a trailer properly.



### WARNING

#### ■ For safe use

If the vehicle is being driven on a slippery surface such as an icy road or a very wet road, disable the system, as it may not operate properly, possibly leading to an accident resulting in death or serious injury.

## Driver monitor\*

\*: If equipped

### Basic functions

During controlled driving, the driver monitor camera detects the position and direction the driver is facing, and whether their eyes are opened or closed. Through this, the system determines if the driver is checking their surroundings and if the driver can perform driving operations.

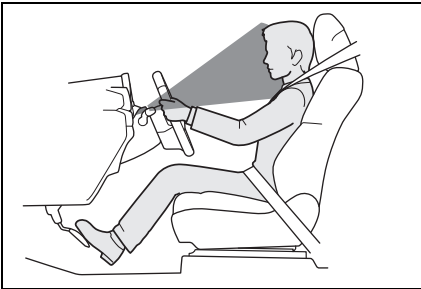

### Warning function

In situations such as the following, a buzzer will sound and a message will be displayed to warn the driver.

- When the system determines that the driver is not paying attention to the road or their eyes are closed
- When the driver's face cannot be detected or the system determines that the driver has poor driving posture

### Face identification

The driver monitor is used as a device to identify faces in order to identify an individual.

For information about how to use the face identification function, priorities among other devices of individual identification, and linked vehicle settings, see "My Settings". (→P.192)

### ⚠ WARNING

#### ■ For safe use

- The driver monitor is not designed to prevent the driver from driving carelessly or having a poor driving posture. Pay careful attention to the surrounding conditions in order to ensure safe driving.
- The driver monitor cannot reduce drowsiness. If you feel unable to concentrate or drowsy, take a break and sleep as necessary in order to ensure safe driving.

### ■ Warning function

These functions may not operate when the vehicle speed is low.

#### ■ Face identification

Face identification starts when the door is opened then closed.

In face identification, facial traits are digitized and stored in a built-in computer, to be used for identification in My Settings.

- Face image or video are not stored. Voice is not stored either.
- Digitized face information is not used for any purpose other than identification in My Settings. Additionally, face information cannot be decoded and will not be dis-

closed or provided to a third party.

- Face information can be deleted by yourself.
- For the handling of face information, please consent to the following before using it:
- Face identification does not guarantee a complete identity authentication, collation, or identification.
- When face information registration fails frequently or face identification fails frequently, the driver cameras should be cleaned or face information should be registered again.
- Face information stored in the vehicle computer cannot be decoded or moved to another media. Therefore, it is necessary to register face information again once it is deleted or relevant parts are replaced.
- Once deleted, face information cannot be restored. It is necessary to register face information again.

#### ■ Situations where face identification may not be performed correctly

This system is designed for use to identify facial traits. In the following situations, face information may not be able to be registered or identified correctly:

- When a part of the driver's face (eyebrows, eyes, nose, or mouth) is not visible
- When the driver is wearing glasses/sun glasses, a face mask, muffler, etc.
- When the driver is not facing front
- When part of driver's face is covered with hair, beard, a hand, clothes, jewelry, etc.
- When the driver is closing eyes
- When a non-registered driver is a twin, etc. with a registered driver, whose face looks quite alike with each other

#### ■ Situations in which the driver monitor may not operate properly

→P.263

### Changing Driver monitor settings

The settings of Driver monitor can be changed through customize settings. (→P.661)

## PCS (Pre-Collision System)

The pre-collision system uses sensors to detect objects (→P.268) in the path of the vehicle. When the system determines that the possibility of a frontal collision with a detectable object is high, a warning operates to urge the driver to take evasive action and the potential brake pressure is increased to help the driver avoid the collision. If the system determines that the possibility of a collision is extremely high, the brakes are automatically applied to help avoid the collision or help reduce the impact of the collision.

The pre-collision system can be disabled/enabled and the warning timing can be changed. (→P.279)

### WARNING

#### ■ For safe use

- Driving safely is solely the responsibility of the driver. Pay careful attention to the surrounding conditions in order to ensure safe driving.

Never use the pre-collision system in place of normal braking operations. This system cannot help avoid or reduce the impact of a collision in every situation. Over-reliance on this system to drive the vehicle safely may lead to an accident resulting in death or serious injury.

- Although the pre-collision system is designed to help avoid or help reduce the impact of a collision, its effectiveness may change according to various conditions. Therefore, it may not always be able to achieve the same level of performance.

Read the following items carefully. Do not overly rely on this system and always drive carefully.

- For safe use: →P.256

#### ■ When to disable the pre-collision system

- When it is necessary to disable the system: →P.256

### Detectable objects

The system can detect the following as detectable objects. (Detectable objects differ depending on the function.)

- Vehicles
- Bicycles\*

- Pedestrians
- Motorcycles\*
- Walls

\*: Detected as a detectable object only when being ridden.

## System functions

### ■ Pre-collision warning

When the system determines that the possibility of a collision is high, a buzzer will sound and an icon and warning message will be displayed on the multi-information display to urge the driver to take evasive action.

If the detectable object is a vehicle, moderate braking will be performed with the warning.

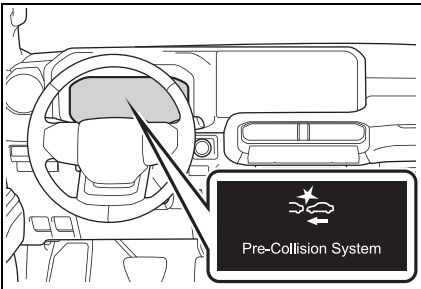

If the system determines that the accelerator pedal is strongly depressed, the following icon and message will be displayed on the multi-information display.

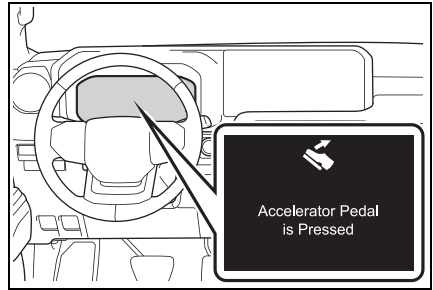

### ■ Pre-collision brake assist

If the system determines that the possibility of a collision is high and the brake operation by the driver is insufficient, the braking power will be increased.

### ■ Pre-collision brake control

If the system determines that the possibility of a collision is extremely high, the brakes are automatically applied to help avoid the collision or reduce the impact of the collision.

### ■ Emergency steering assist

If the system determines that the following conditions are met, assistance will be provided to help enhance vehicle stability and prevent lane departure. During assistance, in addition to the pre-collision warning, the following icon will be displayed on the multi-information display.

- The possibility of a collision is high
- There is sufficient space within the lane to perform evasive steering maneuvers
- The driver is operating the

steering wheel

Vehicles with active steering function: The brakes and steering are controlled to help avoid a collision or reduce the impact of a collision, regardless of the evasive steering maneuvers performed by the driver.

During assistance, the pre-collision warning will operate and a message will be displayed to warn the driver.

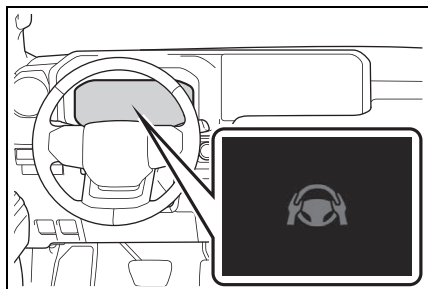

#### ■ Intersection collision avoidance support (left/right turn)

In situations such as the following, if the system determines that the possibility of a collision is high, the pre-collision warning and pre-collision braking will operate.

Depending on the intersection, assistance may not operate correctly.

- When turning left/right at an intersection and crossing the path of an oncoming vehicle

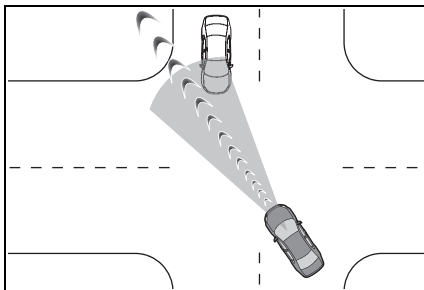

- When turning left/right and a pedestrian or bicycle is detected

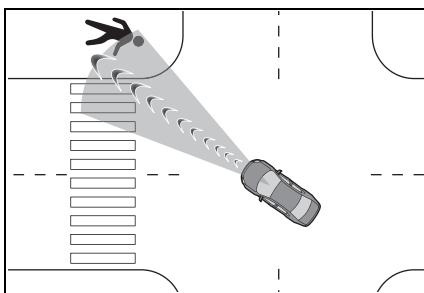

#### ■ Intersection collision avoidance support (crossing vehicles)

At an intersection, etc., if the system determines that the possibility of a collision with an approaching vehicle or motorcycle is high, the pre-collision warning and pre-collision braking will operate.

Depending on the intersection, assistance may not operate correctly.

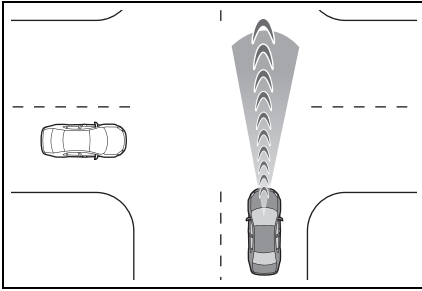

### ■ Acceleration Suppression at Low Speed

When driving at a low speed, if the accelerator pedal is strongly depressed and the system determines that there is a possibility of a collision, hybrid system output will be restrained or the brakes will be applied weakly to restrict acceleration. During operation, a buzzer will sound and the following icon and message will be displayed on the multi-information display.

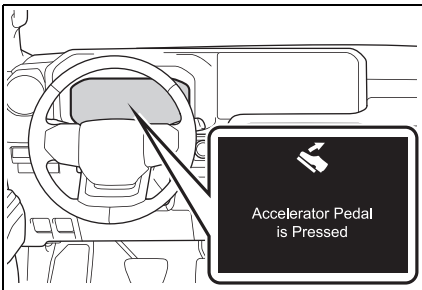

### ⚠ WARNING

#### ■ Pre-collision braking

- When the pre-collision braking function is operating, a large amount of braking force will be applied.

- The pre-collision braking function is not designed to hold the vehicle stopped. If the vehicle is stopped by pre-collision brake control, the driver should operate the brakes immediately as necessary.

- The pre-collision braking function may not operate if certain operations are performed by the driver. If the accelerator pedal is being depressed strongly or the steering wheel is being turned, the system may determine that the driver is taking evasive action and possibly prevent the pre-collision braking function from operating.

- If the brake pedal is being depressed, the system may determine that the driver is taking evasive action and possibly delay the operation timing of the pre-collision brake control.

#### ■ Acceleration Suppression at Low Speed

If the steering wheel is being turned, the system may determine that the driver is taking evasive action and possibly prevent the Acceleration Suppression at Low Speed function from operating or possibly causing its operation to be canceled.

#### ■ Emergency steering assist

- The emergency steering assist will be canceled when the system determines that lane departure prevention control has completed.
- Depending on operations performed by the driver, emergency steering assist may not operate or operation may be canceled.

**WARNING**

- If the accelerator pedal is depressed strongly, the steering wheel is turned heavily, the brake pedal is depressed, or the turn signal lever is operated, the system may determine that the driver is taking evasive action and the emergency steering assist may not operate.
- While the emergency steering assist is operating, if the accelerator pedal is depressed strongly, the steering wheel is turned heavily, or the brake pedal is depressed, the system may determine that the driver is taking evasive action and emergency steering assist operation may be canceled.
- While the emergency steering assist is operating, if the steering wheel is held or turned in the opposite direction of system operation, emergency steering assist operation will be canceled.

---

**■ Operating conditions of each function of the pre-collision system**

The pre-collision system is enabled and the system determines that the possibility of a frontal collision with a detected object is high.

However, the system will not operate in the following situations:

- When the vehicle has not been driven a certain amount after a terminal of the 12-volt battery has been disconnected and reconnected
- When the shift lever is in R
- When the VSC OFF indicator is illuminated (only the pre-collision warning function will be operational)

The following are the operational speeds and cancelation conditions of each function:



## ● Pre-collision warning

Detectable objects	Vehicle speed	Relative speed between your vehicle and object
Preceding vehicles, stopped vehicles	Approximately 3 to 110 mph (5 to 180 km/h)	Approximately 3 to 110 mph (5 to 180 km/h)
Oncoming vehicles	Approximately 20 to 110 mph (30 to 180 km/h)	Approximately 50 to 130 mph (80 to 220 km/h)
Bicycles	Approximately 3 to 50 mph (5 to 80 km/h)	Approximately 3 to 50 mph (5 to 80 km/h)
Pedestrians	Approximately 3 to 50 mph (5 to 80 km/h)	Approximately 3 to 50 mph (5 to 80 km/h)
Preceding motorcycles, stopped motorcycles	Approximately 3 to 110 mph (5 to 180 km/h)	Approximately 3 to 50 mph (5 to 80 km/h)
Oncoming motorcycles	Approximately 20 to 110 mph (30 to 180 km/h)	Approximately 20 to 110 mph (30 to 180 km/h)

While the pre-collision warning is operating, if the steering wheel is operated heavily or suddenly, the pre-collision warning may be cancelled.

## ● Pre-collision brake assist

Detectable objects	Vehicle speed	Relative speed between your vehicle and object
Preceding vehicles, stopped vehicles	Approximately 20 to 110 mph (30 to 180 km/h)	Approximately 7 to 110 mph (10 to 180 km/h)
Bicycles	Approximately 20 to 50 mph (30 to 80 km/h)	Approximately 20 to 50 mph (30 to 80 km/h)
Pedestrians	Approximately 20 to 50 mph (30 to 80 km/h)	Approximately 20 to 50 mph (30 to 80 km/h)
Preceding motorcycles, stopped motorcycles	Approximately 20 to 110 mph (30 to 180 km/h)	Approximately 7 to 50 mph (10 to 80 km/h)

## ● Pre-collision braking

Detectable objects	Vehicle speed	Relative speed between your vehicle and object
Preceding vehicles, stopped vehicles	Approximately 3 to 110 mph (5 to 180 km/h)	Approximately 3 to 110 mph (5 to 180 km/h)
Oncoming vehicles	Approximately 20 to 110 mph (30 to 180 km/h)	Approximately 50 to 130 mph (80 to 220 km/h)

Detectable objects	Vehicle speed	Relative speed between your vehicle and object
Bicycles	Approximately 3 to 50 mph (5 to 80 km/h)	Approximately 3 to 50 mph (5 to 80 km/h)
Pedestrians	Approximately 3 to 50 mph (5 to 80 km/h)	Approximately 3 to 50 mph (5 to 80 km/h)
Preceding motorcycles, stopped motorcycles	Approximately 3 to 110 mph (5 to 180 km/h)	Approximately 3 to 50 mph (5 to 80 km/h)
Oncoming motorcycles	Approximately 20 to 110 mph (30 to 180 km/h)	Approximately 20 to 110 mph (30 to 180 km/h)

If either of the following occur while the pre-collision braking function is operating, it will be canceled:

- The accelerator pedal is strongly depressed
- The steering wheel is operated heavily or suddenly
- Emergency steering assist

The emergency steering assist will not operate when the turn signal lights are flashing.

Detectable objects	Vehicle speed	Relative speed between your vehicle and object
Preceding vehicles, stopped vehicles, bicycles, pedestrians, motorcycles	Approximately 25 to 50 mph (40 to 80 km/h)	Approximately 25 to 50 mph (40 to 80 km/h)
Preceding vehicles, stopped vehicles, bicycles, pedestrians, motorcycles	Active steering function (if equipped): * to 50 mph (* to 80 km/h)	Active steering function (if equipped): * to 50 mph (* to 80 km/h)

\*: Minimum vehicle speed: Vehicle speed at which evasion using pre-collision brake control is difficult

While the emergency steering assist is operating, if any of the following are performed, emergency steering assist operation may be cancelled:

- The accelerator pedal is strongly depressed
- The steering wheel is operated heavily or suddenly
- The brake pedal is depressed
- Intersection collision avoidance support (left/right turn)

The intersection collision avoidance support (for left/right turning vehicles) will not operate when the turn signal lights are not flashing.

Detectable objects	Vehicle speed	Oncoming vehicle speed	Relative speed between your vehicle and object
Oncoming vehicles	Approximately 3 to 25 mph (5 to 40 km/h)	Approximately 3 to 45 mph (5 to 75 km/h)	Approximately 7 to 70 mph (10 to 115 km/h)
Pedestrians	Approximately 3 to 20 mph (5 to 30 km/h)	-	Approximately 3 to 25 mph (5 to 40 km/h)
Bicycles	Approximately 3 to 20 mph (5 to 30 km/h)	-	Approximately 3 to 30 mph (5 to 50 km/h)
Oncoming motorcycles	Approximately 3 to 25 mph (5 to 40 km/h)	Approximately 3 to 45 mph (5 to 75 km/h)	Approximately 7 to 70 mph (10 to 115 km/h)

● Intersection collision avoidance support (crossing vehicles)

► Vehicles without front side radars

Detectable objects	Vehicle speed	Crossing vehicle speed	Relative speed between your vehicle and object
Vehicles, Motorcycles (side)	Approximately 3 to 38 mph (5 to 60 km/h)	<ul style="list-style-type: none"> <li>Your vehicle speed or less</li> <li>Approximately 25 mph or less (40 km/h or less)</li> </ul>	Approximately 3 to 38 mph (5 to 60 km/h)

► Vehicles with front side radars

Detectable objects	Vehicle speed	Crossing vehicle speed	Relative speed between your vehicle and object
Vehicles, Motorcycles (side)	Approximately 3 to 38 mph (5 to 60 km/h)	Approximately 31 mph or less (50 km/h or less)	Approximately 3 to 38 mph (5 to 60 km/h)

When driving at approximately 29 mph (40 km/h) or more, this system will only operate when the speed of the other vehicle is approximately 29 mph (40 km/h) or less.

The system operates only when the crossing vehicle speed is same as or less than the vehicle speed.

### ● Acceleration Suppression at Low Speed

The Acceleration Suppression at Low Speed function will not operate when the turn signal lights are flashing.

Detectable objects	Vehicle speed	Relative speed between your vehicle and object
Preceding vehicles, stopped vehicles, Pedestrians, Bicycles, Wall	Approximately 0 to 9 mph (0 to 15 km/h)	Approximately 0 to 9 mph (0 to 15 km/h)

While the Acceleration Suppression at Low Speed function is operating, if any of the following are performed, the low speed sudden acceleration suppression function operation will be cancelled:

- The accelerator pedal is released.
- The steering wheel is operated heavily or suddenly

### ■ Detection of detectable objects

Objects are detected based on their size, shape, and movement.

Depending on the ambient brightness, movement, posture and direction of a detectable object, it may not be detected and the system may not operate properly.

The system detects shapes, such as the following, as detectable objects.

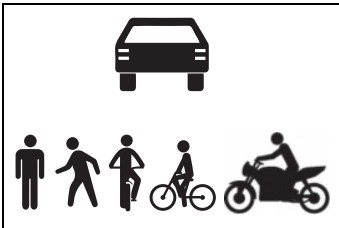

### ■ Situations in which the system may operate even though the possibility of a collision is not high

- In certain situations, such as the following, the system may determine that the possibility of a collision is high and operate:
  - When passing a detectable object
  - When changing lanes while overtaking a detectable object
  - When suddenly approaching a

detectable object

- When approaching a detectable object or other object on the roadside, such as guardrails, utility poles, trees, walls, etc.
- When there is a detectable object or other object by the roadside at the entrance of a curve

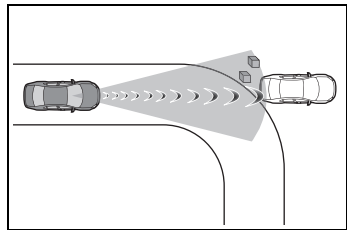

- When there are patterns or a painting ahead of the vehicle that may be mistaken for a detectable object
- When passing a detectable object that is changing lanes or turning left/right

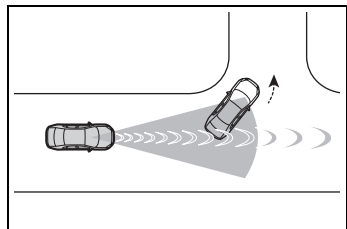

- When passing a detectable object which is stopped to make a left/right turn

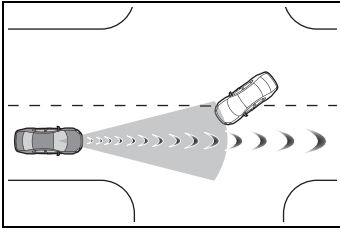

- When a detectable object stops immediately before entering the path of the vehicle
- When passing through a location with a structure above the road (traffic sign, billboard, etc.)

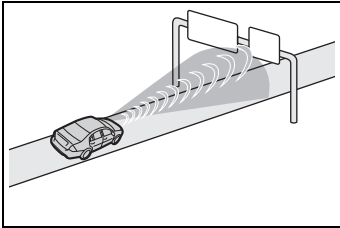

- When approaching an electric toll gate barrier, parking lot barrier, or other barrier that opens and closes
- When turning left/right and an oncoming vehicle, oncoming motorcycle, pedestrian or bicycle crosses in front of the vehicle
- When attempting to turn left/right in front of an oncoming vehicle, oncoming motorcycle, pedestrian or bicycle
- When turning left/right and an oncoming vehicle, oncoming motorcycle, pedestrian or bicycle stops or changes course immediately before entering the path of the vehicle
- When turning left/right and an oncoming vehicle turns left/right in front of the vehicle

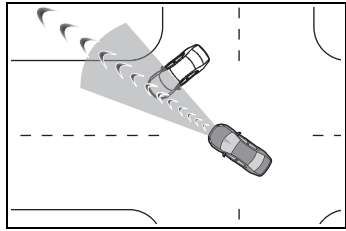

- When the steering wheel is operated toward the path of an oncoming vehicle
- When there is an object moving above or under the road

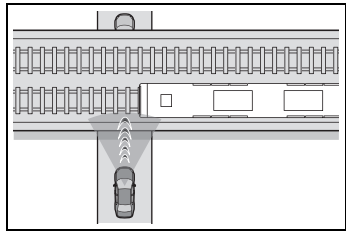

#### ■ Situations in which the system may not operate properly

- In certain situations, such as the following, a detectable object may not be detected by the front sensors, and the system may not operate properly:
  - When a detectable object is approaching your vehicle
  - When your vehicle or a detectable object is wandering
  - When a detectable object makes an abrupt maneuver (such as sudden swerving, acceleration or deceleration)
  - When suddenly approaching a detectable object
  - When the detectable object is near a wall, fence, guardrail, manhole cover, steel plate on the road surface, or another vehicle
  - When there is a structure above a detectable object
  - When part of a detectable object is hidden by another object (large luggage, umbrella, guardrail, etc.)
  - When multiple detectable objects are overlapping
  - When a bright light, such as the sun, is reflecting off of a detect-

able object

- When a detectable object is white and looks extremely bright
- When the color or brightness of a detectable object causes it to blend in with its surroundings
- When a detectable object cuts in front of or suddenly emerges in front of your vehicle
- When approaching a vehicle which is diagonal
- If a bicycle is a child sized bicycle, is carrying a large load, is carrying an extra passenger, is carrying a forward leaning rider, or has an unusual shape (bicycles equipped with a child seat, tandem bicycles, etc.)
- If a pedestrian or bicycle is shorter than approximately 3.2 ft. (1 m) or taller than approximately 6.5 ft. (2 m).
- When the silhouette of a pedestrian or bicycle is unclear (such as when they are wearing a raincoat, long skirt, etc.)
- When a pedestrian is bending forward or squatting
- When a pedestrian or bicycle is moving at high speed
- When a pedestrian is pushing a stroller, wheelchair, bicycle or other vehicle
- When a detectable object blends in with the surrounding area, such as when it is dim (at dawn or dusk) or dark (at night or in a tunnel)
- When the vehicle has not been driven for a certain amount of time after the hybrid system was started
- While turning left/right or a few seconds after turning left/right
- While driving around a curve and a few seconds after driving around a curve
- When turning left/right and an oncoming vehicle is driving in a lane 3 or more lanes from the vehicle
- When turning left/right and the direction of the vehicle differs greatly from the direction traffic flows in the oncoming lane

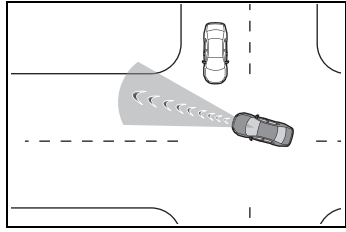

- When turning left/right, a pedestrian or bicycle behind the vehicle comes in front of it as if it overtakes the vehicle

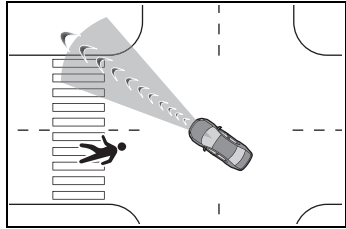

- When at an intersection, the approaching crossing vehicle is long in overall length, such as a large truck, towing trailer, etc.
- In addition to the preceding, in certain situations, such as the following, the emergency steering assist may not operate properly:
  - When a detectable object is too close to the vehicle
  - When there is insufficient space to perform evasive steering maneuvers or an obstruction exists in the evasion direction
  - When there is an oncoming vehicle
  - In addition to the preceding, in certain situations, such as the following, walls may not be detected as a target object and the Acceleration Suppression at Low Speed function may not operate properly:
    - When scenery behind the wall is visible, such as a glass door, grid fence, etc.
    - When the wall is slanted or low
    - When the wall is narrow, such as a pole, etc.
    - When the wall is made of plants, such as a hedge, etc.

- When the road, etc. is reflected on the wall
- When the vehicle is approaching the wall at an angle

### Changing the pre-collision setting

- The pre-collision system can be enabled/disabled through a customize setting. (→P.659)

The system is enabled each time the power switch is turned to ON.

- When the system is disabled, the PCS warning light will illuminate and a message will be displayed on the multi-information display.
- The pre-collision setting can be changed on the customize settings. (→P.659)
- Vehicles without active steering function: When the pre-collision warning timing is changed, the emergency steering assist timing will also be changed.

When later is selected, the emergency steering assist will not operate in most cases.

- Vehicles with active steering function: When the pre-collision warning timing is changed, the emergency steering assist (excluding the active steering function) timing will also be changed.

When later is selected, the

emergency steering assist (excluding the active steering function) will not operate in most cases.

- Vehicles with a driver monitor camera: When the system determines that the driver is not facing forward, the pre-collision warning and emergency steering assist will operate at the earlier timing, regardless of the user setting.
- When the dynamic radar cruise control is operating, the pre-collision warning will operate at the earlier timing, regardless of the user setting.
- Vehicles with Traffic Jam Assist: When the Traffic Jam Assist is operating, the pre-collision warning will operate at the earlier timing, regardless of the user setting.

## LTA (Lane Tracing Assist)

### LTA functions

- When driving on a road with clear lane lines with the dynamic radar cruise control operating, lane lines and preceding and surrounding vehicles are detected using the front camera and radar sensor, and the steering wheel is operated to maintain the vehicle's lane position.

Use this function only on highways and expressways.

If the dynamic radar cruise control is not operating, the function will not operate.

In situations where the lane lines are difficult to see or are not visible, such as when in a traffic jam, support will be provided using the path of preceding and surrounding vehicles.

If the system determines that the steering wheel has not been operated for a certain amount of time or the steering wheel is not being firmly gripped, the driver will be alerted and this function will be temporarily canceled.

If the steering wheel is firmly gripped, the function will begin operating again.

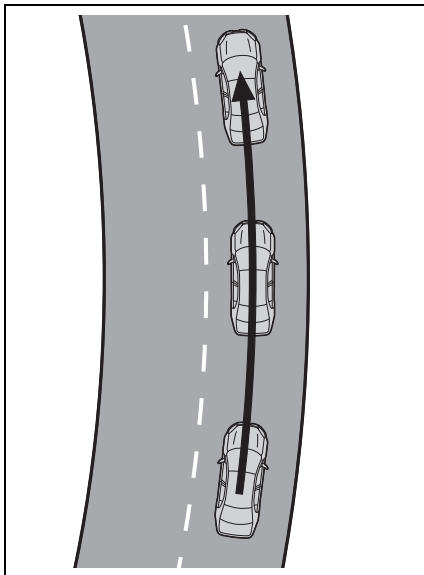

- When the function is operating, if the vehicle is likely to depart from its lane, the driver will be alerted via a display and buzzer.

When the buzzer sounds, check the area around the vehicle and carefully operate the steering wheel to move the vehicle back to the center of the lane.



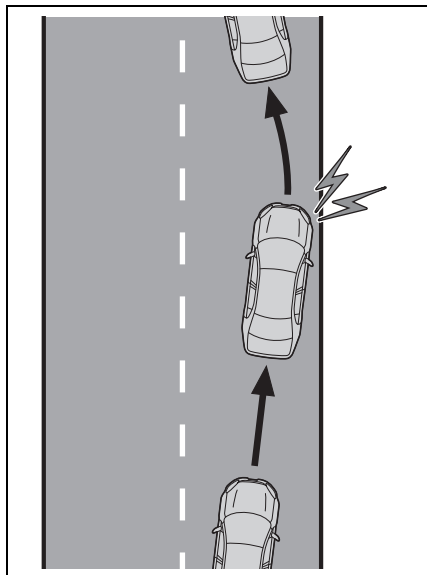

### **⚠ WARNING**

#### **■ Before using the LTA system**

- Do not overly rely on the LTA system. The LTA system is not a system which provides automated assistance in driving and it is not a system which reduces the amount of attention necessary for safe driving. The driver is solely responsible for paying attention to their surroundings and operating the steering wheel as necessary to ensure safety. Also, the driver is responsible for taking adequate breaks when fatigued, such as when driving for a long time.
- Failure to perform appropriate driving operations and pay careful attention may lead to an accident.
- When not using the LTA system, turn it off using the LTA switch.

#### **■ Operating conditions of function**

This function is operable when all of the following conditions are met:

- The LTA system detects lane lines or the path of preceding or surrounding vehicles.
- The dynamic radar cruise control is operating.
- The lane width is approximately 10 to 13 ft. (3 to 4 m).
- The turn signal lever is not being operated.
- The vehicle is not being driven around a sharp curve.
- The vehicle is not accelerating or decelerating more than a certain amount.
- The steering wheel is not being turned with a large force.
- The hands off steering wheel warning (→P.282) is not operating.
- The vehicle is being driven in the center of a lane.
- The stabilizer is not unlocked. (→P.264)

#### **■ Temporary cancelation of functions**

- When the operating conditions are no longer met, a function may be temporarily canceled. However, when the operation conditions are met again, operation of the function will automatically be restored. (→P.281)
- If the operating conditions of a function are no longer met while the function is operating, a buzzer may sound to indicate that the function has been temporarily canceled.
- The steering assist operation of the function can be overridden by the steering wheel operation of the driver.

### ■ Lane departure warning function when the LTA is operating

- Even if the LDA warning method is changed to vibration of the steering wheel, if the vehicle deviates from the lane while the LTA is operating, the warning buzzer will sound to alert the driver.
- If steering wheel operation equivalent to that necessary for a lane change is detected, the system will determine the vehicle is not deviating from the lane and the warning will not operate.

### ■ Hands off steering wheel warning operation

- When the system determines the driver is not holding the steering wheel, a message urging the driver to grip the steering wheel and the icon shown in the illustration will be displayed on the multi-information display to warn the driver. If the system detects that the steering wheel is held, the warning will be canceled. When using the system, make sure to grip the steering wheel firmly, regardless of whether the warning is operating or not.

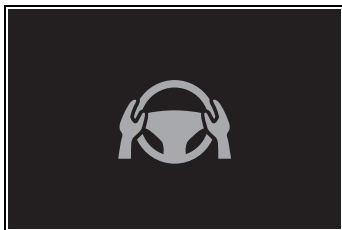

- If no operations are detected for a certain amount of time, the warning will operate and the function will be temporarily canceled. This warning may also operate if the driver only operates steering wheel a small amount continuously.
- Situations in which the hands off steering wheel warning may not operate properly
- Depending on the condition of the

vehicle, handle control condition and road surface, the warning function may not operate.

- Vehicles with LCA: In the following situations, the system may not be able to detect when the driver's hands are off the steering wheel.
  - When a steering wheel cover is installed
  - When the driver is wearing gloves
  - When foreign matter is attached to the steering wheel
  - When the driver is gripping the wood trim, seam of the leather, spokes, or other part of the steering wheel that does not have sensors
- Vehicles with LCA: In the following situations, the hands off steering wheel warning may not operate and the LTA function may continue operating even though the driver's hands are off the steering wheel:
  - When something other than a hand is contacting the steering wheel
  - When a wide object or arms are held across the steering wheel

### Enabling/disabling the system

The LTA will change between ON/OFF each time the LTA switch is pressed.

When the LTA is ON, the LTA indicator will illuminate.

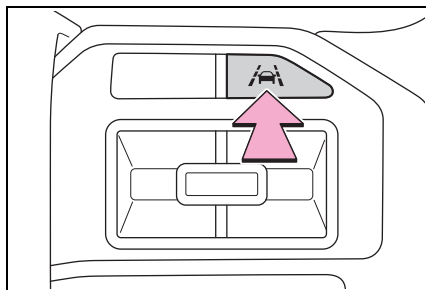

**WARNING**

**Situations in which the functions may not operate properly**

In the following situations, the functions may not operate properly and the vehicle may depart from its lane. Do not overly rely on these functions. The driver is solely responsible for paying attention to their surroundings and operating the steering wheel as necessary to ensure safety.

- When a preceding or surrounding vehicle changes lanes (Your vehicle may follow the preceding or surrounding vehicle and also change lanes)

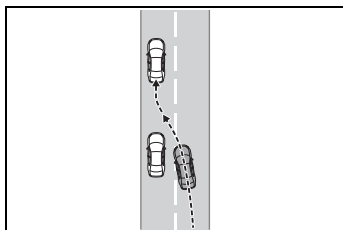









- When a preceding or surrounding vehicle is swaying (Your vehicle may sway accordingly and depart from the lane)

- When a preceding or surrounding vehicle departs from a lane (Your vehicle may follow the preceding or surrounding vehicle and also depart from the lane)
- When a preceding or surrounding vehicle is being driven extremely close to the left/right lane line (Your vehicle may follow the preceding or surrounding vehicle accordingly and depart from the lane)
- When there are moving objects or structures in the surrounding area (Depending on the position of the moving object or structure relative to your vehicle, your vehicle may sway)
- When the vehicle is struck by a crosswind or the turbulence of other nearby vehicles
- Situations in which the sensors may not operate properly: →P.261
- Situations in which the lane may not be detected: →P.263
- When it is necessary to disable the system: →P.256

## Operation display of steering wheel operation support

The operating state of the LTA system is indicated.

Indicator	Lane display	Steering icon	Situation
 White	 Gray/White	 Gray	LTA is on standby
 Green	 Green	 Green	LTA is operating
 Yellow Flashing	 Yellow Flashing	 Green	The vehicle is departing the lane toward the side which the lane display is flashing

## LCA (Lane Change Assist)\*

\*: If equipped

### LCA functions

This function is linked to the LTA and provides assistance in performing lane changes through steering wheel operations.

Use this function only on highways and expressways.

The steering assist operation can be overridden by the steering wheel operation of the driver.

The lane change assist function is not designed to operate when changing lanes at a junction.

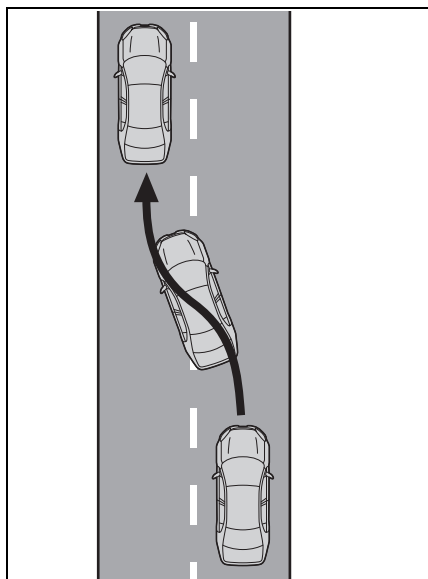

## ⚠ WARNING

### ■ Before using the LCA system

● Do not overly rely on the LCA system.

The LCA system is not a system which provides automated assistance in driving and it is not a system which reduces the need for checking an adjacent lane for other vehicles, approaching vehicles, etc. when changing lanes. The driver is solely responsible for paying attention to their surroundings and operating the steering wheel as necessary to ensure safety.

Also, do not use the LCA to change lanes into which a lane change should not be performed (oncoming lanes, road shoulders, etc.).

● Failure to perform appropriate driving operations and pay careful attention may lead to an accident.

### ■ Operating conditions of function

This function is operable when all of the following conditions are met:

- The LTA is operating.
- The lane change assist function is enabled by a customize setting.
- The vehicle speed is between approximately 55 and 85 mph (90 and 140 km/h).
- The system detects a broken white line on the side which the lane change is to be performed.
- A vehicle is not detected in the lane toward which the turn signal is operated.
- The steering wheel is not being turned with a large force.

- The hands off steering wheel warning (→P.282) is not operating.

### ■ Cancellation of functions

In the following situations, LCA operation may be canceled during operation, while notifying the driver with the display and a buzzer:

- When the operating conditions (→P.281) are no longer met
- When the system can no longer detect lane lines
- When the turn signal lever is operated to the second position (→P.286)
- When the turn signal lever is operated in the opposite direction of the lane change
- When the system detects operation of the steering wheel, brake pedal or accelerator pedal by the driver

If the system detects that a vehicle is quickly approaching in the lane toward which the turn signal is operated a buzzer will sound and a message will be displayed to alert the driver. At the same time the steering wheel may be slightly operated to help keep the vehicle away from the approaching vehicle.

### ■ Hands off steering wheel warning operation

When the system determines the driver is not holding the steering wheel, a message urging the driver to grip the steering wheel and the icon shown in the illustration will be displayed on the multi-information display to warn the driver. If the system detects that the steering wheel is held, the warning will be canceled. When using the system, make sure to grip the steering wheel firmly, regardless of whether the warning is operating or not.

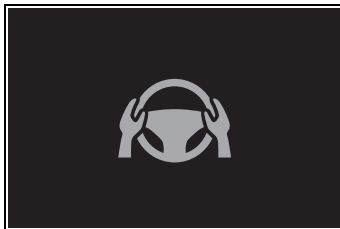

### ■ Situations in which the hands off steering wheel warning may not operate properly

- Depending on the condition of the vehicle, handle control condition and road surface, the warning function may not operate.
- In the following situations, the system may not be able to detect when the driver's hands are off the steering wheel.
  - When a steering wheel cover is installed
  - When the driver is wearing gloves
  - When foreign matter is attached to the steering wheel
  - When the driver is gripping the wood trim, seam of the leather, spokes, or other part of the steering wheel that does not have sensors
- In the following situations, the hands off steering wheel warning may not operate and the LCA function may continue operating even though the driver's hands are off the steering wheel:
  - When something other than a hand is contacting the steering wheel
  - When a wide object or arms are held across the steering wheel

## Operating the LCA

If the turn signal lever is held in the first position, the lane change direction will be displayed and the function will operate.

To change lanes by holding the turn signal lever in the first position without using the LCA, turn the customize setting of the LCA off.

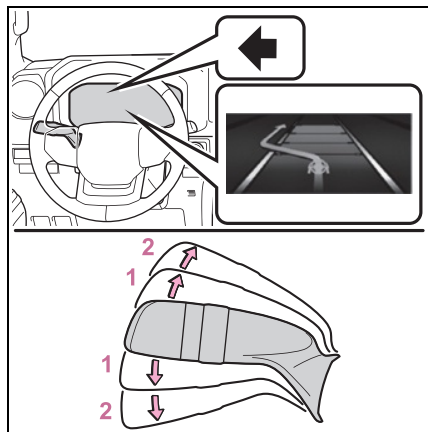

1 First position: LCA is opera-

tional

2 Second position: LCA is not operational

### ⚠ WARNING

#### ■ Situations in which the LCA should not be used





- When driving on a one lane road
- When there is no broken white line between the current lane and the lane to be changed to

### Enabling/disabling the system

LCA can be enabled/disabled through a customize setting. (→P.659)

## Displays and system operation

The operating state of the LCA system is indicated.

LCA display	Steering icon	Condition
 Blue arrow and white line	 Green	LCA is operating
	 Gray	Approaching vehicle detected while LCA is operating
Not displayed	 Gray	Lane line no longer detected while LCA is operating

## LDA (Lane Departure Alert)

### Basic functions

The LDA system warns the driver if the vehicle may deviate from the current lane or course<sup>\*</sup>, and also can slightly operate the steering wheel to help avoid deviation from the lane or course<sup>\*</sup>.

The front camera is used to detect lane lines or a course<sup>\*</sup>.

\*: Boundary between the asphalt and grass, soil, etc., or structures, such as a curb, guardrail, etc.

### ■ Lane departure alert function

When the system determines that the vehicle might depart from its lane or course<sup>\*</sup>, a warning is displayed on a display, and either a warning buzzer will sound or the steering wheel will vibrate to alert the driver.

Check the area around your vehicle and carefully operate the steering wheel to move the vehicle back to the center of the lane or course<sup>\*</sup>.

If the system determines that the vehicle may collide with a vehicle in an adjacent lane, the lane departure alert will operate even if the turn signals are operating.

\*: Boundary between the asphalt and grass, soil, etc., or structures, such as a curb, guardrail, etc.

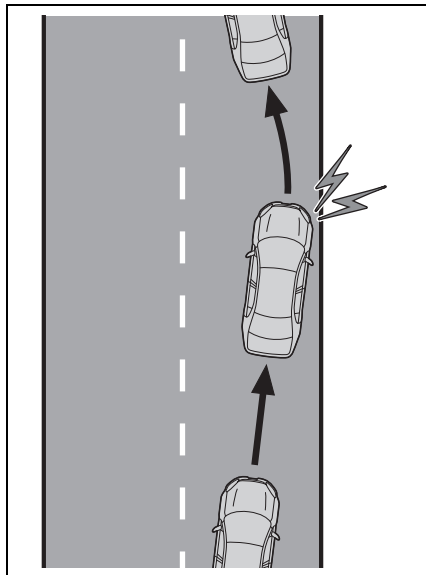

### ■ Lane departure prevention function

If the system determines that the vehicle is likely to depart from its lane or course<sup>\*</sup>, it provides assistance through steering wheel operations to help avoid deviation from the lane or course.

If the system determines that the steering wheel has not been operated for a certain amount of time or the steering wheel is not being firmly gripped, a warning message may be displayed and a warning buzzer may sound to alert the driver.

If the system determines that the vehicle may collide with a vehicle in an adjacent lane, the lane departure prevention function will operate even if the turn signals are operating.

\*: Boundary between the asphalt



and grass, soil, etc., or structures, such as a curb, guardrail, etc.

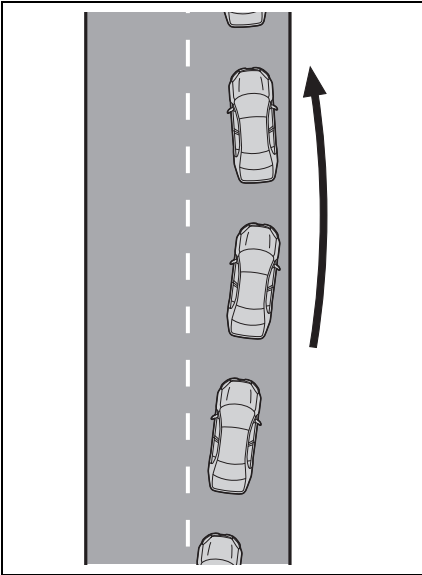

#### ■ Break suggestion function

If the vehicle is swaying, a message will be displayed and a buzzer will sound to urge the driver to take a break.

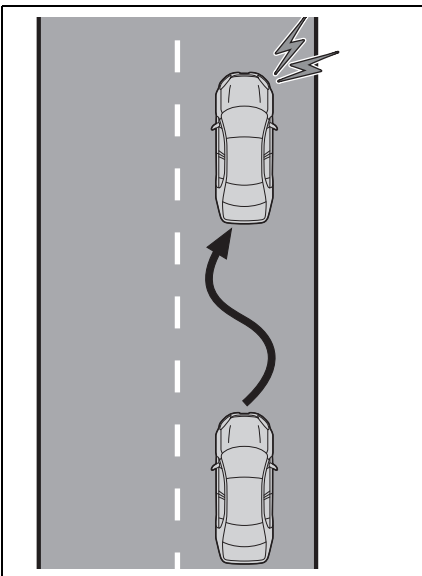

#### ⚠ WARNING

##### ■ Before using the LDA system

- Do not overly rely on the LDA system. The LDA system is not a system which provides automated assistance in driving and it is not a system which reduces the amount of attention necessary for safe driving. The driver is solely responsible for paying attention to their surroundings and operating the steering wheel as necessary to ensure safety. Also, the driver is responsible for taking adequate breaks when fatigued, such as when driving for a long time.
- Failure to perform appropriate driving operations and pay careful attention may lead to an accident.

#### ■ Operating conditions of each function

- Lane departure alert/prevention function

This function is operable when all of the following conditions are met:

- The vehicle speed is approximately 30 mph (50 km/h) or more.

Operation may be possible when the vehicle speed is approximately 25 mph (40 km/h) or more if vehicles, motorcycles, bicycles, or pedestrians are detected near the lane.

- The system recognizes a lane or course\*.  
(When recognized on only one side, the system will operate only for the recognized side.)
- The lane width is approximately 9.8 ft. (3 m) or more.
- The turn signal lever is not being operated.  
(Except when a vehicle is detected in the direction that the

turn signal lever is operated.)

- The vehicle is not being driven around a sharp curve.
- The vehicle is not accelerating or decelerating more than a certain amount.
- The steering wheel is not being turned sufficiently to perform a lane change.
- When the VSC or Active TRAC system is not turned off
- When the stabilizer is not unlocked.

(Operating condition of Lane departure prevention function) (→P.264)

\*: Boundary between the asphalt and grass, soil, etc., or structures, such as a curb, guardrail, etc.

#### ■ Temporary cancellation of functions

When the operating conditions are no longer met, a function may be temporarily canceled. However, when the operation conditions are met again, operation of the function will automatically be restored. (→P.285)

#### ■ Operation of the lane departure alert function/lane departure prevention function

- Depending on the vehicle speed, road conditions, lane departure angle, etc., operation of the lane departure prevention function may not be felt or the function may not operate.
- Depending on the conditions, the warning buzzer may operate even if vibration is selected through a customize setting.
- If a course\* is not clear or straight, the lane departure alert function or lane departure prevention function may not operate.
- The lane departure alert function or lane departure prevention function may not operate if the system judges that the vehicle is intentionally being steered to avoid a

pedestrian or parked vehicle.

- It may not be possible for the system to judge if there is danger of a collision with a vehicle in an adjacent lane.
- Vehicles with a driver monitor camera: Depending on the driver condition, the lane departure alert function or lane departure prevention function changes the timing of operation.
- The steering assist operation of the lane departure prevention function can be overridden by the steering wheel operation of the driver.

\*: Boundary between the asphalt and grass, soil, etc., or structures, such as a curb, guardrail, etc.

#### ■ Hands off steering wheel warning operation

In the following situations, a message urging the driver to operate the steering wheel and an icon will be displayed and a buzzer will sound to warn the driver. When using the system, make sure to grip the steering wheel firmly, regardless of whether the warning is operating or not.

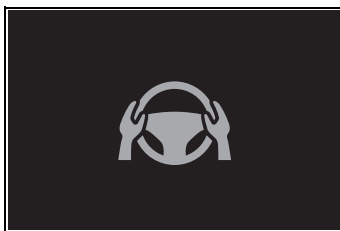

- When the system determines that the driver is not securely holding the steering wheel, or the steering wheel is not being operated when the steering assist operation of the lane departure prevention function is operating

Except for Puerto Rico: The length of time that the warning buzzer operates will become longer as the

frequency of the steering assist operating increases. If the system judges that the steering wheel has been operated, the warning buzzer will stop.

For Puerto Rico: The length of time that the warning buzzer operates will become longer as the frequency of the steering assist operating increases. Even if the system judges that the steering wheel has been operated, the warning buzzer will sound for a certain amount of time.

### ■ Break suggestion function

This function is operable when all of the following conditions are met:

- The vehicle speed is approximately 40 mph (65 km/h) or more.\*<sup>1</sup>
- The vehicle speed is approximately 32 mph (50 km/h) or more.\*<sup>2</sup>
- The lane width is approximately 9.8 ft. (3 m) or more.

Depending on the condition of the vehicle and road surface, the break suggestion function may not operate.



Press the  meter control switch to turn off the message.\*<sup>1</sup>

Unless  is pressed, the message of the break suggestion function will remain displayed.\*<sup>1</sup>

\*<sup>1</sup>: For Puerto Rico

\*<sup>2</sup>: Except for Puerto Rico

## Changing LDA settings

- The LDA system can be enabled/disabled through a customize setting. (→P.659)
- The settings of the LDA can be changed on the customize settings. (→P.659)

### ⚠ WARNING

#### ■ Situations in which the system may not operate properly













In the following situations, the system may not operate properly and the vehicle may depart from its lane. Do not overly rely on these functions. The driver is solely responsible for paying attention to their surroundings and operating the steering wheel as necessary to ensure safety.

- When the boundary between the asphalt and grass, soil, etc., or structures, such as a curb, guardrail, etc. is not clear or straight
- When the vehicle is struck by a crosswind or the turbulence of other nearby vehicles
- Situations in which the lane may not be detected: →P.263
- Situations in which the sensors may not operate properly: →P.261
- Situations in which some or all of the functions of the system cannot operate: →P.263
- When it is necessary to disable the system: →P.256











## Displays and system operation

The operating state of the lane departure alert function and steering assist operation of the lane departure prevention function are indicated.

► Except for Puerto Rico

Indicator	Lane display	Steering icon	Condition
Not illuminated	Not illuminated	Not illuminated	System disabled
 White	 Gray	Not illuminated	Lane lines are not detected by the system
 White	 White	Not illuminated	Lane lines are detected by the system
 Yellow Flashing	 Yellow Flashing	Not illuminated	Lane departure alert function is operating for the side which the lane display is flashing
 Green	 Green	 Green	Lane departure prevention function is operating for the side which the lane display is illuminated
 Yellow Flashing	 Yellow Flashing	 Green	Lane departure alert function/lane departure prevention function is operating for the side which the lane display is flashing

## ► For Puerto Rico

Indicator	Lane display	Steering icon	Situation
 Yellow Illuminated	Not illuminated	Not illuminated	System disabled
Not illuminated	 Gray	Not illuminated	Lane lines are not detected by the system
Not illuminated	 White	Not illuminated	Lane lines are detected by the system
 Yellow Flashing	 Yellow Flashing	Not illuminated	Lane departure alert function is operating for the side which the lane display is flashing
 Green	 Green	 Green	Lane departure prevention function is operating for the side which the lane display is illuminated
 Yellow Flashing	 Yellow Flashing	 Green	Lane departure alert function/lane departure prevention function is operating for the side which the lane display is flashing

## PDA (Proactive driving assist)

**When a detectable object (→P.295) is detected, the proactive driving assist operates the brakes and steering wheel to help prevent the vehicle from approaching too close to the object.**



### WARNING

#### ■ For safe use

Driving safely is solely the responsibility of the driver.

- The proactive driving assist is designed to provide some assistance for regular braking and steering operations, as well as helping to prevent the vehicle from approaching too close to a detectable object. However, the scope of this assistance is limited.

The driver should perform brake and steering operations as necessary. Read the following items carefully. Do not overly rely on the proactive driving assist and always drive carefully. (→P.296)

- The proactive driving assist is not a system which reduces the amount of attention necessary for safe driving. Even if the system is operating correctly, the surrounding conditions as recognized by the driver and detected by the system may differ. It is necessary for the driver to pay attention, assess risks, and ensure safety. Over-reliance on this system to drive the vehicle safely may lead to an accident resulting in death or serious injury.

- Proactive driving assist is not a system which allows for inattentive driving and is not a system which assists in poor visibility conditions. The driver is solely responsible for paying attention to their surroundings and driving safely.

#### ■ When turning proactive driving assist off

- Situations in which the sensors may not operate properly:  
→P.261
- When it is necessary to disable the system: →P.256

## System operating conditions and detectable objects

According to the driving conditions, the operation and detectable objects of the proactive driving assist will change as follows.

Function	Conditions	Operation	Detectable objects
Obstacle Anticipation Assist (OAA)	A detectable object is detected crossing the road	Assistance with some brake operations is provided in order to reduce the possibility of a collision.	<ul style="list-style-type: none"> <li>• Pedestrians</li> <li>• Bicyclists</li> </ul>
	A detectable object is detected on the side of the road	Assistance with some brake and steering wheel operations are provided according to the surrounding conditions to help prevent the vehicle from approaching too close to a detected object.	<ul style="list-style-type: none"> <li>• Pedestrians</li> <li>• Bicyclists</li> <li>• Parked vehicles</li> </ul>
		Assistance with steering wheel operations is provided within a range that the vehicle will not deviate from its current lane.	
Deceleration Assist (DA)	A preceding vehicle or an adjacent vehicle cutting in front of the vehicle is detected	The vehicle is gently decelerated so that the vehicle-to-vehicle distance will not be excessively short.	<ul style="list-style-type: none"> <li>• Preceding vehicles</li> <li>• Motorcycles</li> </ul>
	A curve is detected ahead of the vehicle	The vehicle is gently decelerated if the vehicle speed is determined to be too high for the curve ahead.	None
Steering Assist (SA)	Lane is detected	The system anticipates the driver's operation and supports the operation of the steering wheel.	None

### ■ Vehicle speeds at which the system can operate

- Detectable object crossing the road assistance

Approximately 20 to 35 mph (30 to 60 km/h)

- Detectable object on the side of the road assistance

Approximately 20 to 35 mph (30 to 60 km/h)

- Preceding vehicle deceleration assistance

Approximately 15 mph (20 km/h) or more

- Curve deceleration assistance

Approximately 15 mph (20 km/h) or more

- Steering assist within a lane

Approximately 5 to 80 mph (10 to 140 km/h)

### ■ System operation will be canceled when

- In the following situations, system operation will be canceled:

- When the dynamic radar cruise control or cruise control is operating
- When the PCS is off
- Situations in which some or all of the functions of the system cannot operate: →P.263
- When the P, R or N shift position is selected

- In the following situations, the brake operation assist will be canceled:

- The vehicle speed is approximately 9 mph (15 km/h) or less
- When a certain vehicle speed has been reached, as judged by the system, according to the surrounding conditions

- In the following situations, system operation may be canceled:

- When the brake control or output

restriction control of a driving support system operates (For example: PCS, drive-start control)

- When the system determines that a detected object has moved away from the vehicle
- When the stabilizer is unlocked. (→P.264)
- When lane lines can no longer be detected
- When the brake pedal has been depressed
- When the accelerator pedal has been depressed
- When the steering wheel has been operated with more than a certain amount of force
- When the turn signal lever is operated to the left/right turn position

### WARNING

#### ■ Situations in which the system may not operate properly

- Situations in which the lane may not be detected: →P.263
- When a detectable object stops immediately before entering the path of the vehicle
- When passing extremely close to a detectable object behind a guardrail, fence, etc.
- When changing lanes while overtaking a detectable object
- When passing a detectable object that is changing lanes or turning left/right
- When there are objects (guardrails, power poles, trees, walls, fences, poles, traffic cones, mailboxes, etc.) in the surrounding area
- When there are patterns or a painting ahead of the vehicle that may be mistaken for a detectable object



**WARNING**

- When passing through a place with a low structure above the road (tunnel with a low ceiling, traffic sign, signboard, etc.)
- When driving on snowy, icy, or rutted roads
- When a detectable object is approaching your vehicle
- When your vehicle or a detectable object is wandering
- When the movement of a detectable object changes (change in direction, sudden acceleration or deceleration, etc.)
- When suddenly approaching a detectable object
- When a preceding vehicle or motorcycle is not directly in front of your vehicle
- When there is a structure above a detectable object
- When part of a detectable object is hidden by another object (large luggage, umbrella, guardrail, etc.)
- When multiple detectable objects are overlapping
- When a bright light, such as the sun or headlights of another vehicle, is reflecting off of the detectable object
- When the detectable object is white and looks extremely bright
- When the color or brightness of the detectable object causes it to blend in with its surroundings
- When a detectable object cuts in front of or emerges from beside a vehicle
- When approaching a vehicle ahead which is perpendicular or at an angle to the vehicle, or is facing the vehicle
- If a parked vehicle is perpendicular or at an angle to the vehicle
- When a bicycle is a child sized bicycle, is carrying a large load, is carrying an extra passenger, or has an unusual shape (bicycles equipped with a child seat, tandem bicycles, etc.)
- When a pedestrian or bicyclist is shorter than approximately 3.2 ft. (1 m) or taller than approximately 6.5 ft. (2 m)
- When the silhouette of a pedestrian or bicyclist is unclear (such as when they are wearing a raincoat, long skirt, etc.)
- When a pedestrian or bicyclist is bending forward or squatting
- When a pedestrian or bicyclist is moving at high speed
- When a pedestrian is pushing a stroller, wheelchair, bicycle or other vehicle
- When a detectable object blends in with the surrounding area, such as when it is dim (at dawn or dusk) or dark (at night, in a tunnel, etc.)
- When the lane width is 13.1 ft. (4 m) or more
- When the lane width is 8.2 ft. (2.5 m) or less
- When the vehicle has not been driven for a certain amount of time after the hybrid system was started
- While turning left or right or a few seconds after turning left or right

**WARNING**

- While changing lanes or a few seconds after changing lanes
- When entering a curve, driving around a curve and a few seconds after driving around a curve



### Changing proactive driving assist settings





- The proactive driving assist can be enabled/disabled through a customize setting. (→P.660)
- The following settings of the proactive driving assist can be changed through customize settings. (→P.660)

### System operation display

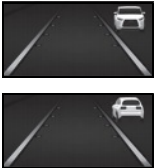
Depending on the situation, the following indicators or icons will be displayed.

Some icons cannot be displayed unless the display is changed to the driving safety support function information screen.

Icon	Meaning
	<ul style="list-style-type: none"> <li>● White: Monitoring for detectable objects</li> <li>● Green: Detectable object crossing the road or detectable object on the side of the road assistance operating</li> </ul>
	<p>A pedestrian has been detected as crossing the road or on the side of the road and brake or steering assistance is operating</p>
	<p>A vehicle has been detected on the side of the road and brake or steering operation assistance is being performed</p>

Icon	Meaning
	<ul style="list-style-type: none"> <li>Steering operation assistance is being performed to prevent the vehicle from approaching too close to a detectable object on the side of the road</li> <li>When the steering assist is operating</li> </ul>
	Preceding vehicle deceleration assistance is being performed
	Warning to maintain appropriate vehicle-to-vehicle distance
	Curve deceleration assistance is being performed

#### ■ Hands off steering wheel warning operation

In the following situations, a message urging the driver to grip the steering wheel and the icon shown in the illustration will be displayed on the display to warn the driver. If the system detects that the steering wheel is held, the warning will be canceled. When using the system, make sure to grip the steering wheel firmly, regardless of whether the warning is operating or not.

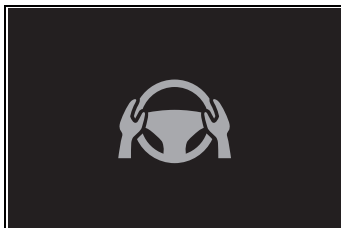

- When assistance to a detectable object crossing the road or assistance to a detectable object on the side of the road is performed and the system determines the driver is not holding the steering wheel

If no operations are detected for a

certain amount of time, a buzzer will sound, the warning will operate.

This warning may also operate if the driver only operates steering wheel a small amount continuously.

#### ■ Warning operation after preceding vehicle deceleration assistance has ended

After preceding vehicle deceleration assistance has ended, if the driver does not operate the brake pedal or accelerator pedal and the vehicle approaches the preceding vehicle, the display will flash and a buzzer will sound to urge the driver to decelerate. If the system determines that the driver is operating the brake pedal or accelerator pedal, the warning will be canceled.

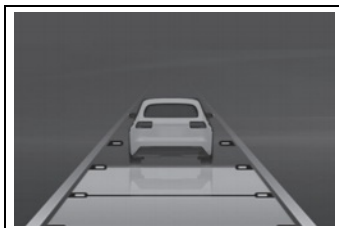

## FCTA (Front Cross Traffic Alert)\*

\*: If equipped

When approaching an intersection, etc., at a low speed, vehicles approaching from the left and right of the front of the vehicle can be detected and the driver informed of these vehicles.

### FCTA system control

- When the system detects a vehicle approaching from the left or right in front of your vehicle when approaching an intersection, a notification will be displayed.
- Head-up display

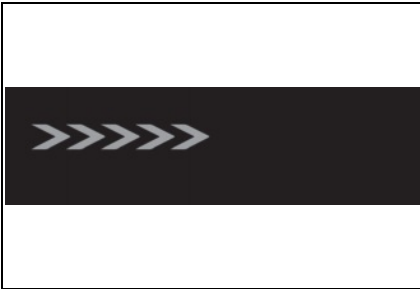

- When the system determines that your vehicle may be about to enter an intersection even though a vehicle is approaching from the left or right in front of your vehicle, a buzzer will sound and a message will be displayed to urge you to depress the brake pedal.

- Multi-information display

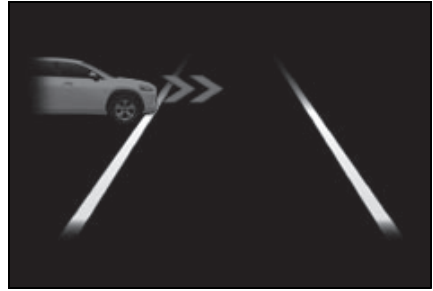

### ⚠ WARNING

#### ■ For safe use

Driving safely is solely the responsibility of the driver. Pay careful attention to the surrounding conditions in order to ensure safe driving. The FCTA system is a supplementary system that informs the driver of vehicles approaching from the left and right of the front of the vehicle.

Over-reliance on this system may lead to an accident resulting in death or serious injury. The details of the warning display may differ from the actual traffic conditions. Although the warning display will stop being displayed after a certain amount of time, this does not necessarily indicate that there are no longer any vehicles or pedestrians around your vehicle.

#### ■ FCTA system operating conditions

The system will operate when all of the following conditions are met:

- A shift position other than P or R is selected
- The vehicle speed is approximately 10 mph (15 km/h) or less
- A vehicle is approaching from the left or right in front of your vehicle at a speed between approximately 7 to 37 mph (10 to 60 km/h)

- There are no vehicles in front of your vehicle
- The accelerator pedal is not being strongly depressed
- The brake pedal is not being strongly depressed

■ **Situations in which the system may operate even though no vehicles are approaching**

In certain situations, such as the following, the system may operate even though no vehicles are approaching:

- When approaching objects on the roadside, such as guardrails, traffic signs, utility poles, street lights, trees, tall grass, walls, etc.
- When passing an object on the side of the road, such as a parked vehicle
- When a vehicle or pedestrian is approaching from the left or right in front of your vehicle in the distance
- When a vehicle or pedestrian is moving within a parking spot, etc., next to the lane your vehicle is in
- When a pedestrian or bicyclist is approaching on a sidewalk
- When a vehicle or pedestrian is moving away from your vehicle
- When an approaching vehicle is decelerating or stops
- When an approaching vehicle makes a left/right turn immediately in front of your vehicle
- When a pedestrian is approaching your vehicle
- When an oncoming vehicle makes a right/left turn
- When your vehicle enters an intersection before a vehicle approaching from the left or right in front of your vehicle
- When stopped at traffic light and a vehicle approaches from the left or right in front of your vehicle

- When making a left/right turn in front of an approaching vehicle

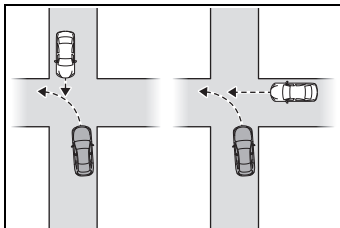

- When an oncoming vehicle approaches and passes
- When being overtaken by another vehicle
- When driving next to another vehicle or a pedestrian
- When a vehicle or pedestrian approaches the side of your vehicle

■ **Situations in which the system may not operate properly**

In situations such as the following, a vehicle may not be detected by a front side radar sensor and the system may not operate properly:

- If an approaching vehicle moves suddenly (sudden steering, acceleration, deceleration, etc.)

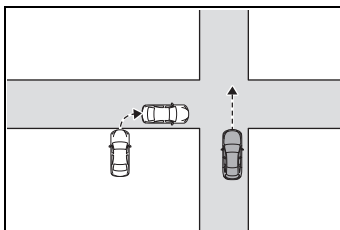

- If a vehicle is approaching from the left or right of the front of your vehicle diagonally
- When a vehicle is approaching from the left or right in front of your vehicle in the distance
- When there is an object between your vehicle and an approaching vehicle
- When several vehicles are approaching with little space

between them

- Situations in which the sensors may not operate properly: →P.261
- Situations in which some or all of the functions of the system cannot operate: →P.263

### Changing FCTA settings

- The FCTA can be enabled/disabled through a customize setting. (→P.659)
- The settings of the FCTA can be changed through customize settings. (→P.659)

### RSA (Road Sign Assist)\*

\*: If equipped

**The RSA system detects specific road signs using the front camera and/or navigation system (when speed limit information is available) and warns the driver via displays and buzzers.**

#### WARNING

##### ■ For safe use

- Driving safely is solely the responsibility of the driver. Pay careful attention to the surrounding conditions in order to ensure safe driving.
- Do not rely solely upon the RSA. The RSA assists the driver by providing road sign information, but it is not a replacement for the driver's own vision and awareness. Driving safely is solely the responsibility of the driver. Pay careful attention to the surrounding conditions in order to ensure safe driving.

##### ■ Situations in which the RSA should not be used

When it is necessary to disable the system: →P.256

##### ■ Situations in which the system may not operate properly

- Situations in which the sensors may not operate properly: →P.261

### Display Function

- When the front camera

detects a sign or information of a sign is available from the navigation system, the sign will be displayed on the display.

- Multiple signs can be displayed.

Depending on the specifications of the vehicle, the number of displayed signs may be limited.

#### ■ Operating conditions of sign display

Signs will be displayed when the following conditions are met:

- The system has detected a sign

In the following situations, a displayed sign may stop being displayed:

- When a new sign has not been detected for a certain distance
- When the system determines that the road being driven on has changed, such as after a left or right turn

#### ■ Situations in which the display function may not operate properly

In the following situations, the RSA system may not operate properly and may not detect signs or may display the incorrect sign. However, this does not indicate a malfunction.

- When a sign is dirty, faded, tilted or bent
- When the contrast of an electronic sign is low
- When all or part of a sign is hidden by a tree, utility pole, etc.
- When a sign is detected by the front camera for a short amount of time
- When the driving state (turning, changing lanes, etc.) is judged incorrectly

- When a sign is immediately after a freeway junction or in an adjacent lane just before merging
- When stickers are attached to the rear of a preceding vehicle
- When a sign similar to a system compatible sign is detected as a system compatible sign
- When a speed limit sign for a frontage road is within detection range of the front camera
- When driving around a roundabout
- When a sign intended for trucks, etc. is detected
- When the navigation system map data is out of date
- When the navigation system cannot be used

In this case, the speed limit signs displayed on the multi-information display and navigation system display may differ.

### Notification function

In the following situations, the RSA system will output a warning to notify the driver.

- If the vehicle speed exceeds the speed warning threshold of the speed limit sign displayed on the display, the sign display will be emphasized and a buzzer will sound.
- When the RSA system detects a do not enter sign and determines that the vehicle has entered a no-entry area, the do not enter sign displayed on the display will flash and a buzzer will sound.

### ■ Operating conditions of the notification functions

#### ● Excess speed notification function

This function will operate when the following condition is met:

- A speed limit road sign is recognized by the system.

#### ● No entry notification function

This function will operate when all of the following conditions are met:

- More than one no entry road signs are recognized by the system simultaneously.
- The vehicle is passing between no entry road signs recognized by the system.

### Types of road signs supported

- The following types of road signs can be displayed.

However, non-standard or recently introduced traffic signs may not be displayed.



Speed limit



Do Not Enter



No U-turn



No Turn On Red



Stop



Yield



Warning

- Depending on the specifications of the vehicle, signs may be displayed overlapping.

### Changing RSA settings

- The following settings of the RSA can be changed through customize settings. (→P.660)



## Dynamic radar cruise control

**This dynamic radar cruise control detects the presence of vehicles ahead, determines the current vehicle-to-vehicle distance, and operates to maintain a suitable distance from the vehicle ahead. The desired vehicle-to-vehicle distance can be set by operating the vehicle-to-vehicle distance switch.**

**Use the dynamic radar cruise control only on highways and expressways.**



### WARNING

#### ■ For safe use

- Driving safely is solely the responsibility of the driver. Do not overly rely on this system, and pay careful attention to the surrounding conditions in order to ensure safe driving.
- The dynamic radar cruise control provides driving assistance to reduce the driver's burden. However, there are limitations to the assistance provided.

Read the following items carefully. Do not overly rely on this system and always drive carefully.

Conditions under which the system may not operate correctly:  
→P.311

- Set the speed appropriately according to the speed limit, traffic flow, road conditions, weather conditions, etc. The driver is responsible for confirming the set speed.

- Even if the system is operating correctly, the condition of a preceding vehicle as recognized by the driver and detected by the system may differ. Therefore, it is necessary for the driver to pay attention, assess risks, and ensure safety. Over-reliance on this system to drive the vehicle safely may lead to an accident resulting in death or serious injury.

#### ■ Precautions for the driving assist systems

Observe the following precautions, as there are limitations to the assistance provided by the system. Over-reliance on this system may lead to an accident resulting in death or serious injury.

- Details of support provided for the driver's vision

The dynamic radar cruise control is only intended to help the driver in determining the distance between the driver's own vehicle and a designated preceding vehicle. It is not a system which allows for careless or inattentive driving, and is not a system which assists in poor visibility conditions.

The driver must pay attention to their surroundings, even when the vehicle stops.

- Details of support provided for the driver's judgement

**WARNING**

The dynamic radar cruise control determines whether the distance between the driver's own vehicle and a designated preceding vehicle is within a set range. It is not capable of making any other type of judgement. Therefore, it is absolutely necessary for the driver to remain vigilant and to determine whether or not there is a possibility of danger.

- Details of support provided for the driver's operation

The dynamic radar cruise control does not include functions which will prevent or avoid collisions with vehicles ahead of your vehicle. Therefore, if there is ever any possibility of danger, the driver must take immediate and direct control of the vehicle and act appropriately in order to ensure safety.

■ **Situations in which the dynamic radar cruise control should not be used**

Do not use the dynamic radar cruise control in the following situations. As the system will not be able to provide appropriate control, using it may lead to an accident resulting in death or serious injury.

- Roads where there are pedestrians, cyclists, etc.
- When driving on a highway or expressway entrance or exit
- When the approach warning sounds frequently
- Situations in which the sensors may not operate properly:  
→P.261
- Situations in which the lane may not be detected: →P.263

## Basic functions

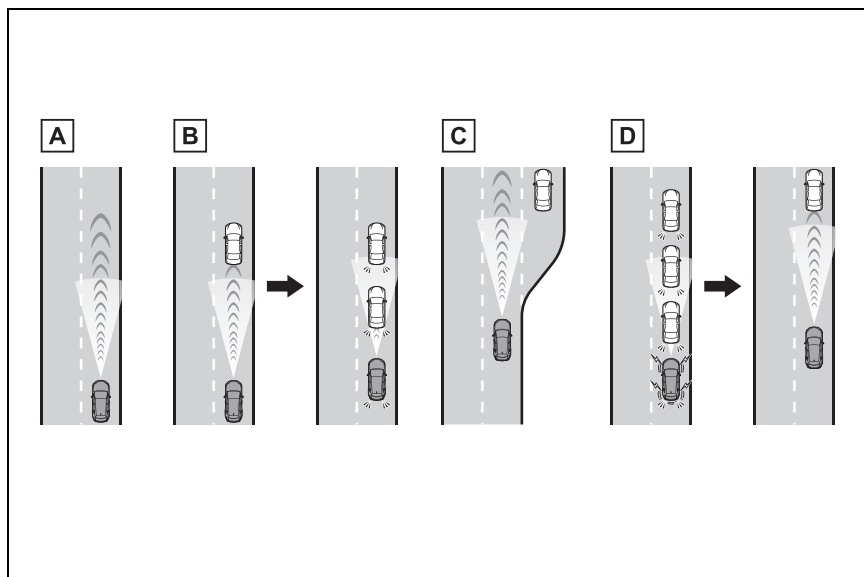

### A Constant speed cruising

When there are no vehicles ahead

The vehicle drives at the speed set by the driver.

If the set vehicle speed is exceeded while driving down a hill, the set vehicle speed display will blink and a buzzer will sound.

### B Deceleration and follow-up cruising

When a preceding vehicle driving slower than the set vehicle speed is detected

When a vehicle is detected driving ahead of your vehicle, the vehicle automatically decelerates and if a greater reduction in vehicle speed is necessary, the brakes are applied (the stop lights will come on at this time). The vehicle is controlled to maintain the vehicle-to-vehicle distance set by the driver, in accordance with changes in the speed of the preceding vehicle. If vehicle deceleration is not sufficient and the vehicle approaches the vehicle ahead, the approach warning will sound.

### C Acceleration

When there are no longer any preceding vehicles driving slower than the set vehicle speed

The vehicle accelerates until the set vehicle speed is reached and then resumes constant speed cruising.

### D Starting off

If a preceding vehicle stops, the vehicle will also stop (controlled stop). After the preceding vehicle starts off, pressing the “RES” switch or depressing the accelerator pedal will resume follow-up cruising (start off operation). If a start off operation is not performed, the controlled stop will continue.

Vehicles with Traffic Jam Assist: While driving on a highway or expressway, if a preceding vehicle stops, your vehicle will stop accordingly. On some highways and expressways, if the system determines that the preceding vehicle starts off within approximately 3 minutes of stopping, a buzzer will sound and a message will be displayed on the multi-information display to notify the driver, and your vehicle will start off accordingly following the preceding vehicle. (Extended resume time)

## System components

### ■ Meter display

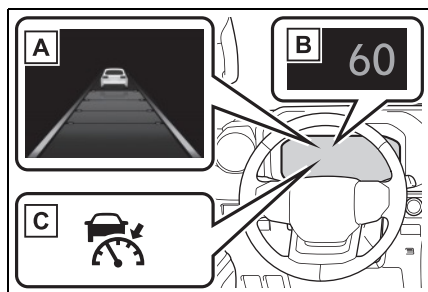

A Multi-information display

B Set vehicle speed

C Indicators

### ■ Switches

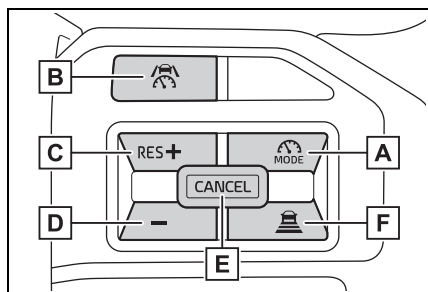

A Driving assist mode select switch

B Driving assist switch

C “+” switch / “RES” switch

D “-” switch

E Cancel switch

F Vehicle-to-vehicle distance switch

## Using the dynamic radar cruise control

### ■ Setting the vehicle speed

- 1 Press the driving assist mode select switch to select dynamic radar cruise control.

The dynamic radar cruise control

indicator will illuminate.

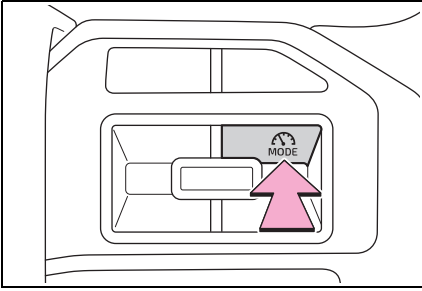

- 2 Using the accelerator pedal, accelerate or decelerate to the desired vehicle speed (approximately 20 mph [30 km/h] or more), and press the driving assist switch to set the set vehicle speed.

The set vehicle speed will be displayed on the multi-information display.

The vehicle speed at the moment the switch is released will be the set vehicle speed.

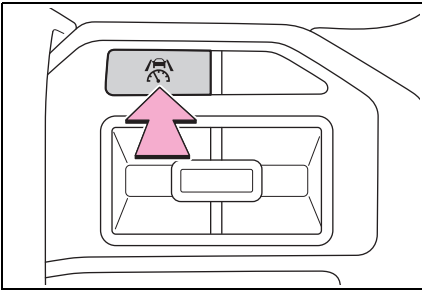

#### ■ Adjusting the set vehicle speed

- Adjusting the set vehicle speed using the switches

To change the set vehicle speed, press the “+” switch or “-” switch until the desired speed is displayed.

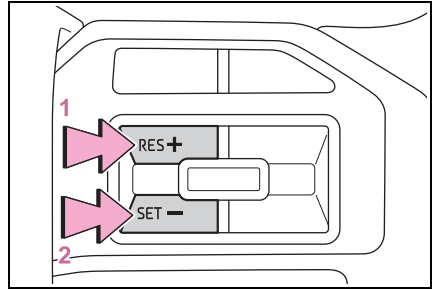

- 1 Increase set vehicle speed

- 2 Decrease set vehicle speed

Short press adjustment: Press the switch

Long press adjustment: Press and hold the switch until the desired set vehicle speed is reached.

The set vehicle speed will increase or decrease as follows:

- ▶ For the U.S. mainland, Hawaii and Puerto Rico

Short press adjustment:  
Increases or decreases by 1 mph (1.6 km/h) each time the switch is pressed

Long press adjustment:  
Increases or decreases in 1 mph (1.6 km/h) increments continuously while the switch is pressed and held

- ▶ Except for the U.S. mainland, Hawaii and Puerto Rico

Short press adjustment: By 0.6 mph (1 km/h) or 1.6 km/h (1 mph) each time the switch is pressed

Long press adjustment:  
Increases or decreases in 3.1 mph (5 km/h) or 8 km/h (5 mph) increments continuously while

the switch is pressed and held

- Increasing the set vehicle speed using the accelerator pedal
- 1 Depress the accelerator pedal to accelerate the vehicle to the desired vehicle speed.
  - 2 Press the “+” switch.

#### ■ Canceling/resuming control

- 1 Press the cancel switch or driving assist switch to cancel control.

Control will also be canceled if the brake pedal is depressed. (If the vehicle has been stopped by system control, depressing the brake pedal will not cancel control.)

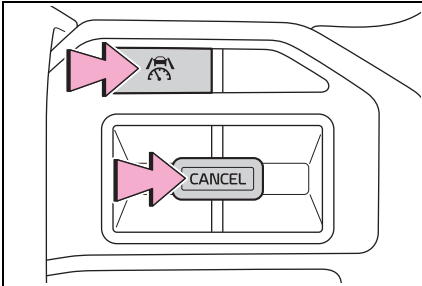

- 2 Press the “RES” switch to resume control.

#### ■ Changing the vehicle-to-vehicle distance

Each time the switch is pressed, the vehicle-to-vehicle distance setting will change as follows:

If a preceding vehicle is detected, the preceding vehicle mark **A** will be displayed.

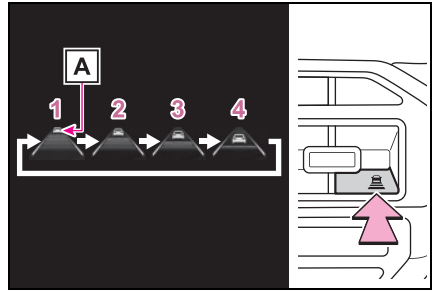

Illustration Number	Vehicle-to-vehicle distance	Approximate Distance (Vehicle Speed: 60 mph [100 km/h])
1	Extra long	Approximately 200 ft. (60 m)
2	Long	Approximately 145 ft. (45 m)
3	Medium	Approximately 100 ft. (30 m)
4	Short	Approximately 85 ft. (25 m)

The actual vehicle-to-vehicle distance varies in accordance with the vehicle speed. Also, when the vehicle is stopped by system control, it will be stopped at a certain distance from the preceding vehicle, depending on the situation, regardless of the setting.

#### ■ Operating conditions

- The shift lever is in D.
- The desired set speed can be set when the vehicle speed is approximately 20 mph (30 km/h) or more.
- If the vehicle speed is set while driving at below approximately 20 mph (30 km/h), the set vehicle speed will be approximately 20 mph (30 km/h).

- If the vehicle speed is set while driving at a speed that exceeds the system's upper limit, the set vehicle speed will be the system's upper limit.

#### ■ Accelerating after setting the vehicle speed

As with normal driving, acceleration can be performed by depressing the accelerator pedal. After accelerating, the vehicle will return to the set vehicle speed. However, while in vehicle-to-vehicle distance control mode, the vehicle speed may decrease to below the set vehicle speed in order to maintain the distance from the preceding vehicle.

#### ■ When the vehicle is stopped by system control during follow-up cruising

- When the "RES" switch is pressed while the vehicle is stopped by system control, if the preceding vehicle starts off within approximately 3 seconds, follow-up cruising will resume.
- If the preceding vehicle starts off within approximately 3 seconds of the vehicle being stopped by system control, follow-up cruising will resume.

#### ■ Automatic cancellation of vehicle-to-vehicle distance control mode

In the following situations, vehicle-to-vehicle distance control mode will be canceled automatically:

- When the brake control or output restriction control of a driving support system operates (For example: Pre-Collision System, drive-start control)
- When the parking brake has been operated
- When the driver's seat belt is unfastened while driving
- When the Pre-Collision System is disabled
- When the vehicle is stopped by

system control on a steep incline

- When any of the following are detected while the vehicle is stopped by system control:
  - The driver's seat belt is unfastened
  - The driver's door is opened
  - Approximately 3 minutes have elapsed since the vehicle was stopped

The parking brake may be actived automatically.

- Situations in which some or all of the functions of the system cannot operate: →P.263

#### ■ Dynamic radar cruise control system warning messages and buzzers

For safe use: →P.256

#### ■ Preceding vehicles that the sensor may not detect correctly

In the following situations, depending on the conditions, if the system cannot provide sufficient deceleration or acceleration is necessary, operate the brake pedal or accelerator pedal.

As the sensor may not be able to correctly detect these types of vehicles, the approach warning (→P.312) may not operate.

- When a vehicle cuts in front of your vehicle or changes lanes away from your vehicle extremely slowly or quickly
- When changing lanes
- When a preceding vehicle is driving at a low speed
- When a vehicle is stopped in the same lane as the vehicle
- When a motorcycle is traveling in the same lane as the vehicle

#### ■ Conditions under which the system may not operate correctly

In the following situations, operate the brake pedal (or accelerator pedal, depending on the situation)

as necessary.

As the sensor may not be able to correctly detect a vehicle, the system may not operate properly.

- When a preceding vehicle brakes suddenly
- When changing lanes at low speeds, such as in a traffic jam

#### ■ **Conditions for extended resume time (Vehicles with Traffic Jam Assist)**

Extended resume time is activated when all of the following conditions are satisfied:

- Vehicles with a display audio: The connected service that Toyota provides is subscribed to. Contact your Toyota dealer for details.
- The vehicle is driving on a vehicle-only road, such as an expressway.
- There is a preceding vehicle and the system is able to detect it.
- No vehicle interruptions occur.
- The preceding vehicle has not been replaced.
- Clearance sonar and FCTA are not detecting the object in front of you.
- The driver monitor judges that the driver is looking forward.
- The steering wheel has not been operated.
- The brake pedal has not been operated.

### **Approach warning**

In situations where the vehicle approaches a preceding vehicle and the system cannot provide sufficient deceleration, such as if a vehicle cuts in front of the vehicle, a warning display will flash and a buzzer will sound to

alert the driver. Depress the brake pedal to ensure appropriate vehicle-to-vehicle distance.

#### ■ **Warnings may not occur when**

In the following situations, the warning may not operate even though the vehicle-to-vehicle distance is short.

- When the preceding vehicle is traveling at the same speed or faster than your vehicle
- When the preceding vehicle is traveling at an extremely low speed
- Immediately after the vehicle speed has been set
- When the accelerator pedal is depressed

### **Curve speed reduction function**

When a curve is detected, the vehicle speed will begin being reduced. When the curve ends, the vehicle speed reduction will end.

Depending on the situation, the vehicle speed will then return to the set vehicle speed.

In situations where vehicle-to-vehicle distance control needs to operate, such as when a preceding vehicle cuts in front of your vehicle, the curve speed reduction function will be canceled.



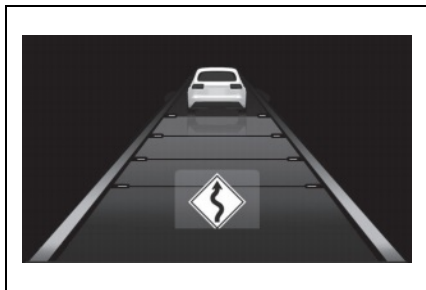

### ■ Situations in which the curve speed reduction function may not operate

In situations such as the following, the curve speed reduction function may not operate:

- When the vehicle is being driven around a gentle curve
- When the accelerator pedal is being depressed
- When the vehicle is being driven around an extremely short curve

### Driver Monitor support function (if equipped)

While a warning of the driver monitor is being displayed, the vehicle acceleration will be restrained.

When the warning of the driver monitor disappears, the restrained acceleration control will end.

### Support for lane change

If your vehicle is being driven at approximately 50 mph (80 km/h) or more and a lane change to the passing lane is performed, when the turn signal lever is operated and the lane is

changed, the vehicle will accelerate up to the set speed to assist in overtaking.

The system's recognition of which lane is the passing lane may be based solely on the location of the steering wheel in the vehicle (left-hand drive/right-hand drive). If the vehicle is driven in a location where the passing lane is on the opposite side of that where the vehicle was originally sold, the vehicle may accelerate when the turn signal lever is operated away from the passing lane. (e.g. The vehicle was manufactured to be driven on roads for right-hand drive vehicles [that overtake on the right], but is being used on roads for left-hand drive vehicles [that overtake on the left]. In this case, the vehicle may accelerate when the turn signal lever is operated to the right.)







If your vehicle is being driven at approximately 50 mph (80 km/h) or more and the lane is changed to that with a vehicle traveling slower than your vehicle, when the turn signal lever is operated the vehicle will gradually decelerate to assist in changing lanes.



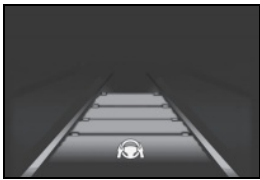

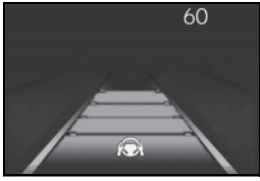
### Changing Dynamic radar cruise control settings

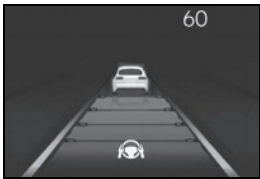
The settings of Dynamic radar cruise control can be changed through customize settings. (→P.660)

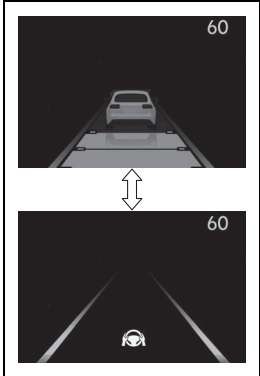
## Display and system operation state

The operating state of Dynamic radar cruise control is indicated.

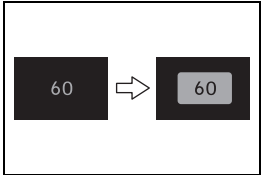
Indicator	Multi-information display		Situation
 White		Vehicle-to-vehicle distance setting: Gray	Dynamic radar cruise control being OFF
 Green		Vehicle-to-vehicle distance setting: Blue  Set vehicle speed: Green	Constant speed cruising
 Green		Vehicle-to-vehicle distance setting: Blue  Set vehicle speed: Green  Preceding vehicle: White	Follow-up cruising
 Green		Vehicle-to-vehicle distance setting: Orange flashing  Set vehicle speed: Green  Preceding vehicle: Orange flashing	Approach warning

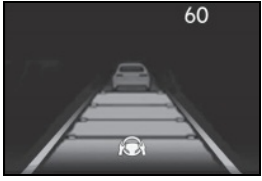
Indicator	Multi-information display		Situation
 <p>Green</p>		<p>Vehicle-to-vehicle distance setting: Gray</p> <p>Set vehicle speed: White</p> <p>Preceding vehicle: Gray</p>	<p>Accelerating with the accelerator pedal</p>
 <p>Green</p>		<p>Set vehicle speed: White in reverse display</p>	<p>Set vehicle speed being exceeded</p>
 <p>Green</p>		<p>Vehicle-to-vehicle distance setting: Gray</p> <p>Set vehicle speed: White</p> <p>Preceding vehicle: Gray</p>	<p>Vehicle in controlled stop</p>

## Cruise control

The vehicle can be driven at a set speed even if the accelerator pedal is not depressed.

Use the cruise control only on highways and expressways.

### ⚠ WARNING

#### ■ For safe use

- Driving safely is solely the responsibility of the driver. Therefore, do not overly rely on this system. The driver is solely responsible for paying attention to the vehicle's surroundings and driving safely.
- Set the speed appropriately according to the speed limit, traffic flow, road conditions, weather conditions, etc. The driver is responsible for confirming the set speed.

#### ■ Situations in which cruise control should not be used

Do not use the cruise control in the following situations. As the system will not be able to provide appropriate control, using it may lead to an accident resulting in death or serious injury.

- On roads with sharp bends
- On winding roads
- On slippery roads, such as those covered with rain, ice or snow
- On steep downhill, or where there are sudden changes between sharp up and down gradients

Vehicle speed may exceed the set speed when driving down a steep hill.

- When it is necessary to disable the system: →P.256

## System Components

### ■ Meter display

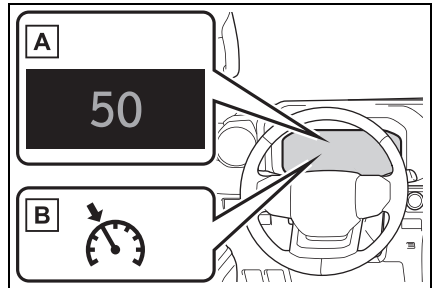

A Set vehicle speed

B Cruise control indicator

### ■ Switches

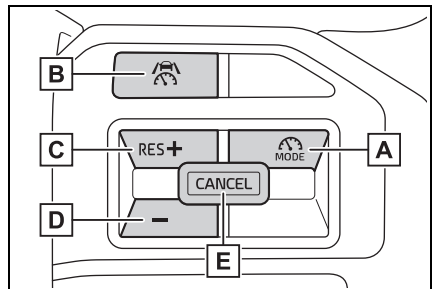

A Driving assist mode select switch

B Driving assist switch

C "+" switch / "RES" switch

D "-" switch

E Cancel switch

## Using the cruise control

### ■ Setting the vehicle speed

- 1 Press the driving assist mode select switch to select cruise control.

The cruise control indicator will illuminate.

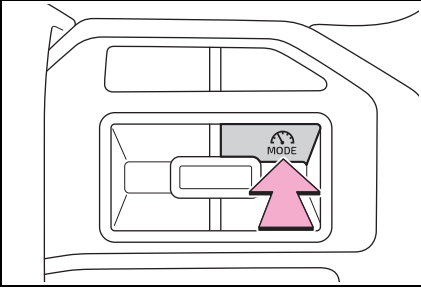

- 2 Using the accelerator pedal, accelerate to the desired vehicle speed (approximately 20 mph [30 km/h] or more), and press the driving assist switch to set the set vehicle speed.

The vehicle speed at the moment the switch is released will be the set vehicle speed.

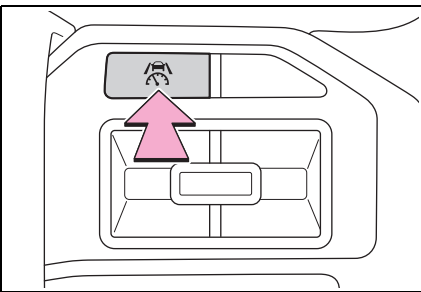

### ■ Adjusting the set vehicle speed

- Adjusting the set vehicle speed using the switches

To change the set vehicle speed, press the “+” or “-” switch until the desired speed is displayed.

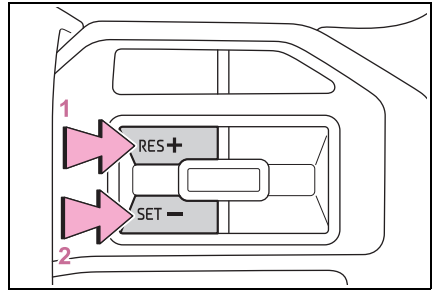

- 1 Increase set vehicle speed
- 2 Decrease set vehicle speed

The set vehicle speed will increase or decrease as follows:

Fine adjustment: By 1 mph (1.6 km/h) or 1 km/h (0.6 mph) each time the switch is pressed

Large adjustment: Increases continuously while the switch is pressed and held

- Increasing the set vehicle speed using the accelerator pedal

- 1 Depress the accelerator pedal to accelerate the vehicle to the desired vehicle speed.
- 2 Press the “+” switch.

### ■ Canceling/resuming control

- 1 Press the cancel switch or driving assist switch to cancel control.

Control will also be canceled if the

brake pedal is depressed.

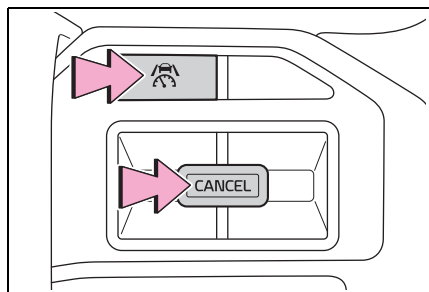

2 Press the “RES” switch to resume control.





### ■ Automatic cancellation of the cruise control

In the following situations, the cruise control will be canceled automatically:

- When the vehicle speed drops approximately 10 mph (16 km/h) or more below the set vehicle speed
- When the vehicle speed drops below approximately 20 mph (30 km/h)
- When the brake control or output restriction control of a driving support system operates (For example: PCS, drive-start control)
- When the parking brake has been operated
- When the driver’s seat belt is unfastened
- Situations in which some or all of the functions of the system cannot operate: →P.263

## Display and system operation state

The operating state of cruise control is indicated.

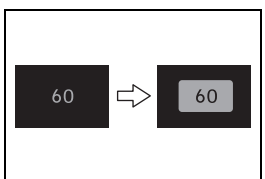
Indicator	Multi-information display	Situation
 White		Blank Cruise control being OFF
 Green		Set vehicle speed: Green Constant speed cruising
 Green		Set vehicle speed: White in reverse display Set vehicle speed being exceeded

## Emergency Driving Stop System

The emergency driving stop system is a system which automatically decelerates and stops the vehicle within its lane if the driver becomes unable to continue driving the vehicle, such as if they have suffered a medical emergency, etc.

During LTA (Lane Tracing Assist) control, if the system does not detect driving operations, such as if the driver is not holding the steering wheel, and determines the driver is not responsive, the vehicle will be decelerated and stopped within its current lane to help avoid a collision or reduce the impact of a collision.

The vehicle will also decelerate/stop during the Traffic Jam Assist controls, when no driver's response to the vehicle's warning to hold the steering wheel is detected.

### WARNING

#### ■ For safe use

- Driving safely is solely the responsibility of the driver. Pay careful attention to the surrounding conditions in order to ensure safe driving. The emergency driving stop system is designed to provide support in an emergency where it is difficult for the driver to continue driving, such as if they have had a medical emergency. It is not designed to support driving while drowsy or in poor physical health, or inattentive driving.
- Although the emergency driving stop system is designed to decelerate the vehicle within its lane to help avoid or help reduce the impact of a collision if the system determines that it is difficult for the driver to continue driving, its effectiveness may change according to various conditions. Therefore, it may not always be able to achieve the same level of performance. Also, if the operating conditions are not met, this function will not operate.
- After the emergency driving stop system operates, if driving becomes possible again, immediately begin driving again or, if necessary, park the vehicle on the shoulder of the road and set a warning reflector and flare to warn other drivers of your stopped vehicle.
- After this system operates, passengers should attend to the driver as necessary and take appropriate hazard prevention measures, such as moving to a place where safety can be ensured, such as the shoulder of the road or behind a guard-rail.

**WARNING**

- This system detects the condition of the driver through the operation of the steering wheel. This system may operate if the driver is aware but intentionally and continuously does not operate the vehicle. Also, the system may not operate if it cannot determine that the driver is not responsive, such as if they are leaning on the steering wheel.
- Situations in which the driver monitor may not operate properly: →P.263

**Summary of the system**

Operation of this system is separated into 4 control states. Through control state “warning phase 1” and “warning phase 2”, the system determines if the driver is aware and responsive while outputting a warning and controlling the vehicle speed. If the system determines the driver is not responsive, it will operate in control state “deceleration stop phase” and “stop hold phase” and decelerate and stop the vehicle. It will then operate continuously in “stop hold phase”.

**■ Operating conditions**

This system operates when all of the following conditions are met:

- When the LTA is on
- Or during the Traffic Jam Assist controls
- When the vehicle speed is approximately 30 mph (50 km/h)

or more

During the Traffic Jam Assist controls, the system may operate at below 30 mph (50 km/h).

**■ Operation cancelation conditions**

In the following situations, system operation will be canceled:

- When LTA control has been canceled (the LTA switch has been pressed, etc.)
- When the dynamic radar cruise control has been canceled
- When driver operations are detected (the steering wheel is held, the brake pedal, accelerator pedal, parking brake, emergency flasher switch, or turn signal lever is operated)
- When the driving assist switch is pressed while in the stop and hold phase
- When the power switch has been turned from ON to off
- Situations in which some or all of the functions of the system cannot operate: →P.263

**■ LTA control when operation is canceled**

When emergency driving stop system operation is canceled, LTA control may also be canceled.

**Warning phase 1**

If driving operations are not detected after the hands off steering wheel warning operates, a buzzer will sound intermittently and a message will be displayed to warn the driver, and the system will judge if the driver is responsive or not. If driving operations, such as holding the steering wheel, are not per-



formed within a certain amount of time, the system will enter warning phase 2.

Vehicles with a driver monitor camera: Depending on the type of detection of the driver's unresponsiveness, the system may skip warning phase 1 and start the control of warning phase 2.

### Warning phase 2

After entering warning phase 2, a buzzer will sound in short intervals and a message will be displayed to warn the driver, and the vehicle will slowly decelerate. If driving operations, such as holding the steering wheel, are not performed within a certain amount of time, the system will determine that the driver is not responsive and enter the deceleration stop phase.

The audio system will be muted until the driver becomes responsive.

When the vehicle is decelerating, the brake lights may illuminate, depending on the road conditions, etc.

### Deceleration stop phase

After entering the deceleration stop phase, a buzzer will sound continuously and a message will be displayed to warn the driver, and the vehicle will slowly decelerate and stop. After the vehicle

stops, the system will enter the stop and hold phase.

### Stop hold phase

After the vehicle is stopped, the parking brake will be applied automatically. After entering the stop and hold phase, the buzzer will continue sounding continuously and the emergency flashers (hazard lights) will flash to warn other drivers of the emergency.

#### ■ Restricted functions after the operation is canceled

After shifting to the deceleration stop phase, the following functions will not be available until the hybrid system is re-started even though the emergency driving stop system is canceled:

- LTA
- LCA (if equipped)
- Traffic Jam Assist (if equipped)

## Traffic Jam Assist\*

\*: If equipped

**Traffic Jam Assist is a system which, through confirmation of the conditions by the driver, provides lane keeping, accelerating/decelerating, stopping, and starting off support on some highways and expressways. Also, in an emergency, the system can decelerate and stop, to help avoid a collision or help reduce the impact of a collision.**

### ■ Precautions for use

→P.261

## Sensors that support the Traffic Jam Assist

- Sensors which detect the surrounding conditions (→P.258)
- Sensors which detect the driver condition (→P.258)

### ■ Situations in which some or all of the functions of the system cannot operate

→P.263

### ■ Changes in brake operation sound and pedal response

→P.263

### ■ Situations in which the driver monitor may not operate properly

→P.263

## Emergency Driving Stop System

→P.319

## Extended resume time of dynamic radar cruise control

→P.307

## Traffic Jam Assist Function

The Traffic Jam Assist function, through confirmation of the conditions by the driver, provides lane keeping, accelerating/decelerating and stopping support on some highways and expressways.

This function is operable when all of the operation conditions are met. When this function is operating, it is possible to take your hands off of the steering wheel.

Before using the Traffic Jam Assist function, familiarize yourself with the content of the dynamic radar cruise control and the LTA (Lane Tracing Assist).

Make sure that the driver steers the vehicle when entering a service area/parking area or toll gate, or when changing lanes.

### ■ Driver monitor camera recording

When the operation of Traffic

Jam Assist is started, the following message will be displayed:

- “Allow Driver Monitor Camera Recording?”

When recording is approved, the system records images of the area around the driver in certain crash or near crash-like situations, such as an SRS airbag being deployed or the vehicle hitting an object on the road. (→P.8)



### WARNING

#### ■ For safe use

- Driving safely is solely the responsibility of the driver. Do not overly rely on this system, and pay careful attention to the surrounding conditions in order to ensure safe driving.
- The Traffic Jam Assist function is not an automated driving system. This function provides the driver with information and driving assistance according to the road shape and conditions, traffic conditions, and the condition of the driver themselves. Always pay careful attention to the surrounding conditions as use of the system is the responsibility of the driver.
- Depending on the condition of the surrounding area, the road, or the driver, the Traffic Jam Assist function may not operate or operation may be suspended. Also, it may not always be able to achieve the same level of performance. Read the operating conditions of the function carefully. Do not overly rely on this function and always drive carefully.

- As the recognition performance and control performance of the Traffic Jam Assist function are limited, driver operation is necessary to ensure safety while the system is operating. Also, the steering assist of this system is designed to operate only for slow steering operations during a traffic jam. While this function is operating, the lane deviation control function of the LDA will not operate. If, for some reason, the vehicle is about to deviate the lane, it is the driver's responsibility to drive properly.
- Even if Traffic Jam Assist is operating properly, the surrounding conditions as recognized by the driver and detected by the system may differ. Therefore, it is necessary for the driver to pay attention, assess risks, and ensure safety. Overreliance on this system to drive the vehicle safely may lead to an accident resulting in death or serious injury.
- While the Traffic Jam Assist function is operating, as driver operation may become necessary, the driver must ensure they have clear visibility of their surroundings.
- In certain situations, a message urging the driver to hold the steering wheel may be displayed by the Traffic Jam Assist function. In this case, hold the steering wheel and drive the vehicle manually to ensure safety.

**WARNING**

- The Traffic Jam Assist function cannot detect the following objects. Operate the steering wheel, accelerator pedal, or brake pedal as necessary to avoid a collision. As the function will not be able to provide appropriate control, using it may lead to an accident resulting in death or serious injury.
- Objects on the road surface
- Vehicles outside of a lane (such as on the shoulder of the road)
- Potholes, cracks, ruts, or other road damage
- Road construction zones
- Vehicles running in parallel with your vehicle or nearby walls
- Animals

■ **Situations in which Traffic Jam Assist Function should not be used**

Do not use Traffic Jam Assist Function in situations such as the following. As the system will not be able to provide appropriate control, using it may lead to an accident resulting in death or serious injury.

■ **When it is necessary to disable the system**

→P.256

■ **Situations in which the sensors may not operate properly**

→P.261

■ **Situations in which the lane may not be detected**

→P.263

■ **Situations in which the function may not operate properly**

In situations such as the following, the Traffic Jam Assist function may not operate properly. Manually operate the vehicle as necessary.

- When a sensor is splashed by water
  - When the ambient temperature is high or low
  - When a vehicle cuts in front of your vehicle
  - When another lane merges into the lane in the same traveling direction as your vehicle
  - When driving in low visibility conditions
  - When the vehicle posture is changing
  - When the traction on the road surface differs greatly between the left and right side tires
  - When driving on an expressway with no median strips or when driving on an expressway equipped with temporary median markers, such as poles.
  - When there is a significant difference in speed between your vehicle and the other vehicle
  - The map data has not been updated properly.
- **To prevent malfunction of the radar sensors**
- P.258
- **To prevent malfunction of the front camera**
- P.259

**WARNING****Front camera installation area on the windshield**

→P.260

**Operating conditions of the function**

This function is operable when all of the following conditions are met:

- The system detects lane lines and the path of preceding or surrounding vehicles.
- The dynamic radar cruise control and the lane tracing assist are operating.
- The turn signal lever is not being operated.
- The vehicle is not being driven around a sharp curve.
- The vehicle is being driven in the center of a lane.
- The driver monitor camera is detecting that the driver is facing front of the vehicle.
- The vehicle is driving in traffic jam on a highway or expressway at approximately 25 mph (40 km/h) or less. (In some situations, such as when a traffic jam starts, this function may be operational at approximately 20 mph (30 km/h) or less.)
- It is necessary to enter a connected services contract, provided by Toyota, to use these functions. For details, contact your Toyota dealer.
- The driver's door is closed.
- The driver's seat belt is fastened.
- Customized setting of the Traffic Jam Assist is not set to off.
- Functions and components composing the system are in proper condition.
- Customized setting of the PCS

(Pre-Collision System) is not set to off.

- Customized setting of the dynamic radar cruise control (re-start time extension) is not set to off.

**Temporary cancelation of the function**

- When the operating conditions are no longer met, a function may be temporarily canceled. However, when the operation conditions are met again, operation of the function will automatically be restored.
- If the operating conditions of a function are no longer met while the function is operating, a buzzer may sound with a display to indicate that the function has been temporarily canceled. If no driver's responses to the indication are detected, the driver emergency stop assist function may operate. For types of display and action to be taken, see the page mentioned below. (→P.326)

**Driving operations during controlled driving:**

- Accelerator pedal

As with normal driving, acceleration can be performed by depressing the accelerator pedal. When the accelerator pedal is depressed at approximately 6 mph (10 km/h) or more, this function will be canceled.

- Brake pedal

As with normal driving, deceleration can be performed by depressing the brake pedal. However, controlled driving will be cancelled.

- Steering wheel

As with normal driving, the steering wheel can be operated. If the steering wheel is operated more than a certain amount, controlled driving will be cancelled.

### ■ When a warning message is displayed

- “TrafficJamAsst System Malfunction Visit Your Dealer”

The Traffic Jam Assist function may not be operating properly.

- “TrafficJamAsst Unavailable Stop Assist Activated”





The system temporarily cannot be used as the driver emergency stop assist function has operated.



### Changing Traffic Jam Assist settings

- The setting of Traffic Jam Assist can be enabled/disabled through a customize setting. (→P.661)
- The setting of driver monitor camera recording can be enabled/disabled through a customize setting. (→P.661)

### Display and system operation

The following displays indicate the operating status of the Traffic Jam Assist function:

Display	Status	Action to be taken
	Traffic Jam Assist function is operating	—
 Gray	Traffic Jam Assist function is about to end	Hold the steering wheel.
 Orange	Traffic Jam Assist function has ended	Hold the steering wheel.
 Red	Operation of either or both of dynamic radar cruise control/LTA (Lane Tracing Assist) ended	Manually operate the steering wheel immediately.

Display	Status	Action to be taken
 Yellow	Indicates that driving actions are necessary to cope with cut-in or other behavior of surrounding vehicles	The driver must operate the steering wheel, accelerator pedal and brake pedal in accordance with the surrounding environment.
	Indicates that the recording function of the driver monitor camera is operational (Blinking of this icon indicates that recording is under-going, and constant illumination indicates ready for recording.)	—

## BSM (Blind Spot Monitor)

The Blind Spot Monitor is a system that uses rear side radar sensors installed on the inner side of the rear bumper on the left and right side to assist the driver in confirming safety when changing lanes.

### ⚠ WARNING

#### ■ Cautions regarding the use of the system

- The driver is solely responsible for safe driving. Always drive safely, taking care to observe your surroundings.
- The Blind Spot Monitor is a supplementary function which alerts the driver that a vehicle is in a blind spot of the outside rear view mirrors or is approaching rapidly from behind into a blind spot. Do not overly rely on the Blind Spot Monitor. As the function cannot judge if it is safe to change lanes, over reliance could lead to an accident resulting in death or serious injury. As the system may not function correctly under certain conditions, the driver's own visual confirmation of safety is necessary.

## System components

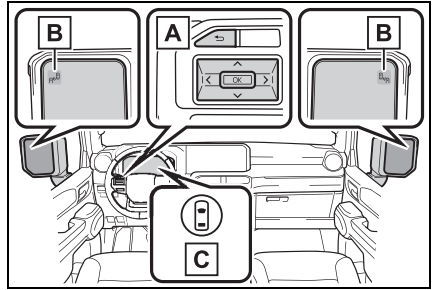

### A Meter control switches

Turning the Blind Spot Monitor on/off.

### B Outside rear view mirror indicators

When a vehicle is detected in a blind spot of the outside rear view mirrors or approaching rapidly from behind into a blind spot, the outside rear view mirror indicator (→P.86) on the detected side will illuminate. If the turn signal lever is operated toward the detected side, the outside rear view mirror indicator will flash and a buzzer will sound.

### C Driving assist information indicator

Illuminates when the Blind Spot Monitor is turned off. At this time, a message will be displayed on the multi-information display.

### ■ Outside rear view mirror indicator visibility

In strong sunlight, the outside rear view mirror indicator may be difficult to see.

### ■ Buzzer

If the volume setting of the audio system is high or the surrounding area is loud, it may be difficult to



hear the buzzer.

### ■ Customization

Some functions can be customized.  
(→P.649)

#### WARNING

#### ■ To ensure the system can operate properly

Blind Spot Monitor sensors installed on the inner side of the rear bumper on the left and right side respectively. Observe the following to ensure the Blind Spot Monitor can operate correctly.

- Keep the sensors and the surrounding areas on the rear bumper clean at all times. If a sensor or its surrounding area on the rear bumper is dirty or covered with snow, the Blind Spot Monitor may not operate and a warning message will be displayed. In this situation, clear off the dirt or snow and drive the vehicle with the operation conditions of the BSM function (→P.331) satisfied for approximately 10 minutes. If the warning message does not disappear, have the vehicle inspected by your Toyota dealer.

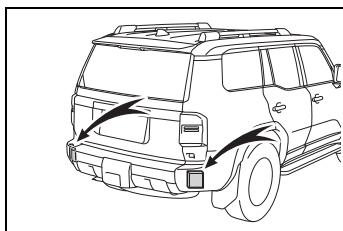

- Do not attach accessories, stickers (including transparent stickers), aluminum tape, etc. to a sensor or its surrounding area on the rear bumper.
- Do not paint the surrounding area of a sensor on the rear bumper.

- Do not subject a sensor or its surrounding area on the rear bumper to a strong impact. If a sensor is moved even slightly off position, the system may malfunction and vehicles may not be detected correctly. In the following situations, have your vehicle inspected by your Toyota dealer.

- A sensor or its surrounding area is subject to a strong impact.
- If the surrounding area of a sensor is scratched or dented, or part of them has become disconnected.

- Do not disassemble the sensor.
- Do not modify the sensor or surrounding area on the rear bumper.
- If a sensor or the rear bumper needs to be removed/installed or replaced, contact your Toyota dealer.
- The sensors are likely to be affected by paint on the rear bumper. If the rear bumper is not repaired correctly, the Blind Spot Monitor may not operate with a warning message displayed. If any paint repair is needed, contact your Toyota dealer.

### Turning the Blind Spot Monitor on/off

The Blind Spot Monitor can be enabled/disabled through a customize setting. (→P.649)

When the Blind Spot Monitor is off, the driving assist information indicator (→P.86) will illuminate and a message will be displayed on the multi-information display.

Each time the power switch is turned to ON, the Blind Spot Monitor is enabled. Monitor is enabled.

### Blind Spot Monitor operation

#### ■ Objects that can be detected while driving

The Blind Spot Monitor uses rear side radar sensors to detect the following vehicles traveling in adjacent lanes and advises the driver of the presence of such vehicles via the indicators on the outside rear view mirrors.

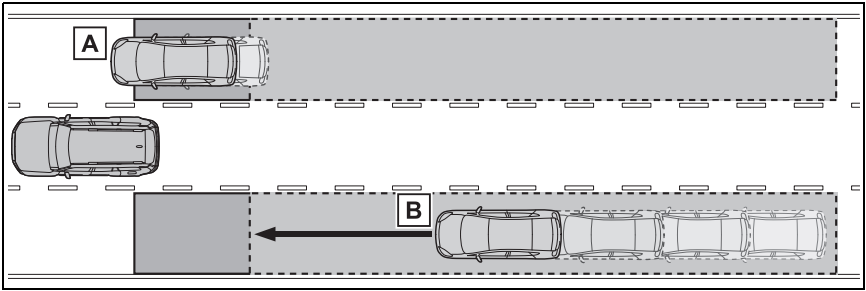

- A** Vehicles that are traveling in areas that are not visible using the outside rear view mirrors (the blind spots)
- B** Vehicles that are approaching rapidly from behind in areas that are not visible using the outside rear view mirrors (the blind spots)

#### ■ Detection range while driving

The areas that vehicles can be detected in are outlined below.

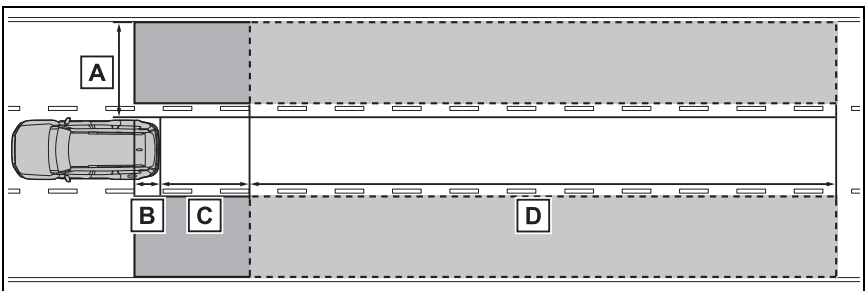

The range of each detection area is:

- A** Approximately 1.6 ft. (0.5 m) to 11.5 ft. (3.5 m) from either side of the vehicle<sup>\*1</sup>
- B** Approximately 3.3 ft. (1 m) forward of the rear bumper<sup>\*2</sup>

- C** Approximately 9.8 ft. (3 m) from the rear bumper
- D** Approximately 9.8 ft. (3 m) to 230 ft. (70 m) from the rear bumper<sup>\*3</sup>

<sup>\*1</sup>: The area between the side of the vehicle and 1.6 ft. (0.5 m) from the side of the vehicle cannot be detected.

<sup>\*2</sup>: While the vehicle is to being overtaken, up to approximately 9.8 ft. (3 m) forward of the rear bumper will be detected.

<sup>\*3</sup>: The greater the difference in speed between your vehicle and the detected vehicle is, the farther away the vehicle will be detected, causing the outside rear view mirror indicator to illuminate or flash.

### ■ The Blind Spot Monitor linked function

The LDA (Lane Departure Alert) has a function that uses information of detected vehicles driving in an adjacent lane. For details about the function and its operating conditions, P.288.

### ■ The Blind Spot Monitor is operational when

The Blind Spot Monitor is operational when all of the following conditions are met:

- The power switch is in ON.
- The Blind Spot Monitor is on.
- The shift position is in a position other than R.
- The vehicle speed is approximately 7 mph (10 km/h) or more.

### ■ The Blind Spot Monitor will detect a vehicle when

The Blind Spot Monitor will detect a vehicle present in the detection area in the following situations:

- A vehicle in an adjacent lane overtakes your vehicle.
- You overtake a vehicle in an adjacent lane slowly.
- Another vehicle enters the detection area when it changes lanes.

### ■ Situations in which the Blind Spot Monitor cannot detect vehicles

The Blind Spot Monitor cannot detect the following vehicles and other objects:

- Small motorcycles, bicycles, pedestrians, etc.\*
- Vehicles traveling in the opposite direction
- Guardrails, walls, signs, parked vehicles and similar stationary objects\*
- Following vehicles that are in the same lane\*
- Vehicles traveling 2 lanes away from your vehicle\*
- Vehicles which are being overtaken rapidly by your vehicle\*

\*: Depending on the conditions, detection of a vehicle and/or object may occur.

### ■ Conditions in which a buzzer may not sound

In situations such as the following, while the turn signal lever is being operated, the indicator will flash but a buzzer may not sound.

- When a second vehicle is detected while the turn signal lever is being held
- When overtaking a vehicle in the

adjacent lane at a much higher speed than it\*

\*: Depending on the situations, a buzzer may sound.

### ■ Conditions under which the system may not function correctly

● The Blind Spot Monitor may not detect vehicles correctly in the following situations:

- When the sensor is misaligned due to a strong impact to the sensor or its surrounding area
- When mud, snow, ice, a sticker, etc., is covering the sensor or surrounding area on the rear bumper
- When driving on a road surface that is wet with standing water during bad weather, such as heavy rain, snow, or fog
- When multiple vehicles are approaching with only a small gap between each vehicle
- When the distance between your vehicle and a following vehicle is short
- When there is a significant difference in speed between your vehicle and the vehicle that enters the detection area
- When the difference in speed between your vehicle and another vehicle is changing
- When a vehicle enters a detection area traveling at about the same speed as your vehicle
- As your vehicle starts from a stop, a vehicle remains in the detection area
- When driving up and down consecutive steep inclines, such as hills, dips in the road, etc.
- When driving on roads with sharp bends, consecutive curves, or uneven surfaces
- When vehicle lanes are wide, or when driving on the edge of a lane, and the vehicle in an adjacent lane is far away from your vehicle
- When an accessory (such as a bicycle carrier) is installed to the

rear of the vehicle

- When there is a significant difference in height between your vehicle and the vehicle that enters the detection area
- Immediately after the Blind Spot Monitor is turned on
- When towing with the vehicle
- Instances of the Blind Spot Monitor unnecessarily detecting a vehicle and/or object may increase in the following situations:
  - When the sensor is misaligned due to a strong impact to the sensor or its surrounding area
  - When the distance between your vehicle and a guardrail, wall, etc. that enters the detection area is short
  - When driving up and down consecutive steep inclines, such as hills, dips in the road, etc.
  - When vehicle lanes are narrow, or when driving on the edge of a lane, and a vehicle traveling in a lane other than the adjacent lanes enters the detection area
  - When driving on roads with sharp bends, consecutive curves, or uneven surfaces
  - When the tires are slipping or spinning
  - When the distance between your vehicle and a following vehicle is short
  - When an accessory (such as a bicycle carrier) is installed to the rear of the vehicle
  - When towing with the vehicle

## Safe Exit Assist

The safe exit assist is a system that uses rear side radar sensors installed on the inner side of the rear bumper to help occupants judge if an approaching vehicle or bicycle may collide with a door when exiting, to help reduce the possibility of a collision.

### WARNING

#### ■ Cautions regarding the use of the system

- The driver is solely responsible for safe driving. Always drive safely, taking care to observe your surroundings.
- The safe exit assist is a supplementary system that, when the vehicle is stopped, informs occupants of the existence of approaching vehicles and bicycles. As this system alone cannot be used to judge safety, over-reliance on this system may lead to an accident resulting in death or serious injury.

In certain situations, this system may not function to its fullest extent. Therefore it is necessary for the occupants to visually check for safety directly and using the mirrors.

## System components

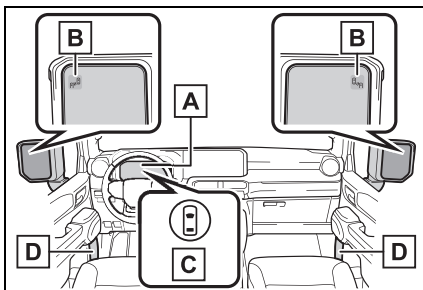

### **A** Multi-information display

Turning the safe exit assist on/off. If collision with a door is likely and the door is opened, the door will be displayed on the multi-information display. Also, if a door is opened when an outside rear view mirror indicator is illuminated, a buzzer will sound as a warning.

### **B** Outside rear view mirror indicators

When a vehicle or bicycle which may collide with a door (other than the back door) when opened is detected, the outside rear view mirror indicator (→P.86) on the detected side will illuminate. If the door on the detected side is opened, the outside rear view mirror indicator will blink.

### **C** Driving assist information indicator

Illuminates when the safe exit assist is turned off. At this time, a message will be displayed on the multi-information display.

### **D** Speakers

When the outside rear view mirror indicator blinks, the driver is informed through voice guidance

that the system has operated. After the notification through voice guidance is made, no more voice guidance notifications will be made again until the door is fully closed.

### ■ Outside rear view mirror indicator visibility

In strong sunlight, the outside rear view mirror indicator may be difficult to see.

### ■ Buzzer

If the volume setting of the audio system is high or the surrounding area is loud, it may be difficult to hear the buzzer.

### ■ Voice notifications

In the following situations, voice notifications will not be output:

- When it is estimated that no occupants are on board\*
- After opening a door and entering the vehicle, until the hybrid system is started
- When 3 minutes or more have elapsed since the hybrid system was stopped
- When the language setting of the multimedia display has been set to a language that does not support voice notifications
- When all of the doors have been locked from outside the vehicle
- When a door remains open for 1 minute or more after the hybrid system is stopped
- When the ACC mode (→P.649) has been enabled through a cus-

tomize setting on the multimedia display and the hybrid system has been stopped

- When the parking assist volume setting on the multimedia display has been set to off
- \*: For each seating position, judgment is made based on the opening and closing of a door, before driving for ingress and after driving for egress.

### ■ Customization

Some functions can be customized. (→P.649)

### WARNING

■ To ensure the system can operate properly

→P.329

## Turning the safe exit assist system ON/OFF

The safe exit assist system can be enabled/disabled through a customize setting. (→P.649)

When the safe exit assist is off, the driving assist information indicator will illuminate and a message will be displayed on the multi-information display.

Each time the power switch is turned to ON, the safe exit assist is enabled.

## Safe exit assist operation

### ■ Objects that can be detected by the safe exit assist

When the safe exit assist detects the following vehicles or bicycles behind your vehicle using a rear side radar sensor, the occupants of the vehicle are informed through an outside rear view mirror indica-

tor, buzzer, multi-information display, and voice notification.

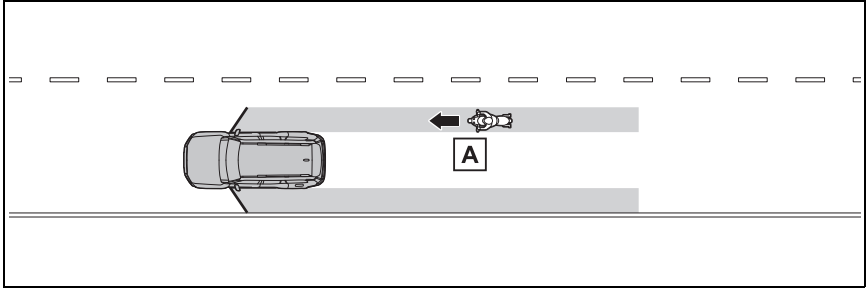

**A** Vehicle or bicycle which has a high possibility of colliding with a door (other than the back door) when opened

### ■ The safe exit assist detection areas

The areas that vehicles can be detected in are outlined below.

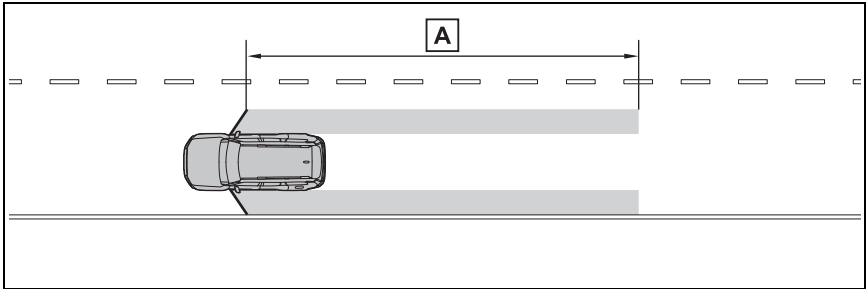

**A** Approximately 145 ft. (45 m) rearward from the front door\*

\*: The faster a vehicle or bicycle is approaching, the distance at which an outside rear view mirror indicator will illuminate or blink will become further.

### ■ The safe exit assist is operational when

The safe exit assist is operational when all of the following conditions are met:

- When the power switch is ON, less than 3 minutes have elapsed since the hybrid system was off, or less than 3 minutes have elapsed since a door was opened and someone has entered the vehicle (the time which operation is possible may be extended if a door is opened and closed)

- Safe exit assist is on
- The vehicle is stopped.
- The shift position is in a position other than R.

### ■ The safe exit assist will detect a vehicle when

The safe exit assist will detect a vehicle present in the detection area in the following situations:

- When the vehicle is stopped and a vehicle or bicycle, which is traveling parallel to the vehicle, is approaching within the area that a door opens (other than the back

door)

#### ■ Conditions under which the system will not detect a vehicle

- Safe exit assist does not detect the following objects, vehicles, and bicycles:
  - Vehicles or bicycles which are approaching slowly\*
  - Vehicles or bicycles which are determined to have a low possibility of colliding with a door (other than the back door) when opened\*
  - Vehicles or bicycles which are approaching from directly behind\*
  - Vehicles or bicycles which are approaching from the front\*
  - Guardrails, walls, signs, parked vehicles, and other stationary objects\*
  - Pedestrians, animals, etc.\*

\*: Depending on the conditions, detection of a vehicle and/or object may occur.

- In situations such as the following, safe exit assist will not operate:

- When 3 minutes or more have elapsed since the hybrid system off (the time which operation is possible may be extended if a door is opened and closed)
- When your vehicle is not completely stopped

#### ■ Conditions under which the system may not function correctly

- The safe exit assist may not detect vehicles correctly in the following situations:
  - When the sensor is misaligned due to a strong impact to the sensor or its surrounding area
  - When mud, snow, ice, a sticker, etc., is covering the sensor or surrounding area on the rear bumper
  - When driving on a road surface that is wet with standing water during bad weather, such as heavy rain, snow, or fog
  - When a vehicle or bicycle

approaches from behind a nearby parked vehicle

- When an approaching vehicle or bicycle suddenly changes direction
- Immediately after a vehicle or bicycle starts moving
- When the back door is open
- When a bicycle carrier, ramp, or other accessory is installed to the back of the vehicle
- When a parked vehicle, wall, sign, person or other stationary object is behind the vehicle
- When the vehicle is stopped at an angle to the road
- When a vehicle is traveling near an approaching vehicle or bicycle
- When an approaching vehicle or bicycle is traveling along a stationary object, such a wall or sign
- When a vehicle or bicycle is approaching at high speed
- When towing with the vehicle
- When stopped on a steep slope
- When stopped on a curve or at the exit of a curve
- Instances of the safe exit assist unnecessarily detecting a vehicle and/or object may increase in the following situations:
  - When the sensor is misaligned due to a strong impact to the sensor or its surrounding area
  - When a vehicle or bicycle approaches your vehicle from directly behind in an offset position
  - When the vehicle is stopped at an angle to the road
  - When a vehicle or bicycle approaches from behind a parked vehicle at an angle
  - When a parked vehicle, wall, sign, person or other stationary object is behind the vehicle
  - When an approaching vehicle or bicycle suddenly changes direction
  - When an approaching vehicle or bicycle is traveling along a stationary object, such a wall or sign
  - When the back door is open
  - When a bicycle carrier, ramp, or



other accessory is installed to the back of the vehicle

- When a vehicle or bicycle is approaching at high speed
- When towing with the vehicle
- When stopped on a steep slope
- When stopped on a curve or at the exit of a curve
- When a vehicle or bicycle approaches from behind a vehicle stopped in an adjacent lane

## Intuitive parking assist

**The intuitive parking assist function detects the approximate distance from the vehicle and an object such as a wall using ultrasonic sensors and informs the driver with the multimedia display distance display and buzzer.**

## System components

### ■ Type of sensors

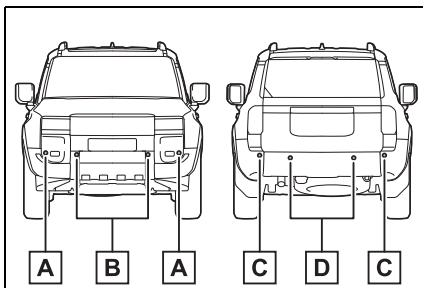

**A** Front corner sensors

**B** Front center sensors

**C** Rear corner sensors

**D** Rear center sensors

### ■ Display

When the sensors detect an object, such as a wall, a graphic is shown on the multimedia display depending on the position and distance to the object.

Vehicles without multimedia display or rear camera: When

detecting a stationary object, the intuitive parking assist detection indicator illuminates. (→P.86)

► Multimedia display

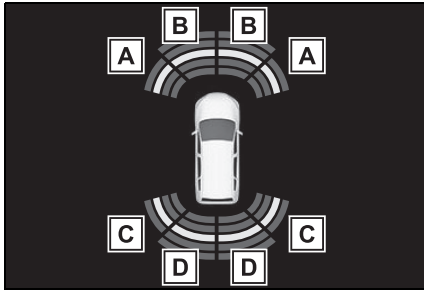

- A** Front corner sensor detection
- B** Front center sensor detection
- C** Rear corner sensor detection
- D** Rear center sensor detection

### Turning the intuitive parking assist function ON/OFF

The intuitive parking assist function can be enabled/disabled through a customize setting. (→P.649)

When the intuitive parking assist function is disabled, the intuitive parking assist OFF indicator (→P.86) illuminates on the multi-information display.

If the system switches to OFF (disabled) and the intuitive parking assist is stopped, the intuitive parking assist will not be re-enabled until ON (enabled) is selected again from the customize setting (→P.649). (It remains

off even if the power switch is turned to ON again after the power switch has been turned off.)

Vehicles without the multimedia display or rear camera: However, the system will automatically turn on (enabled) and the intuitive parking assist OFF indicator will turn off if the shift position is changed to R.

When the shift position is R, the intuitive parking assist cannot be turned on or off.

The setting of intuitive parking assist itself will not change.

#### ■ When towing a trailer

When the 7-pin connector is connected, the rear sensor automatically turns off.

When reversing, the rear sensors turn off, but the front corner sensors operate.

#### ⚠ WARNING

##### ■ Cautions regarding the use of the system

There is a limit to the degree of recognition accuracy and control performance that this system can provide, do not overly rely on this system. The driver is always responsible for paying attention to the vehicle's surroundings and driving safely.

##### ■ To ensure the system can operate properly

Make sure to observe the following precautions. The system may not operate properly and may lead to an unexpected accident. When these precautions cannot be observed, turn the system off.

**WARNING**

- Do not damage the sensors, and always keep them clean.
  - Do not attach a sticker or install an electronic component, such as a backlit license plate (especially fluorescent type), fog lights, fender pole or wireless antenna near a radar sensor.
  - Do not subject the surrounding area of the sensor to a strong impact. If subjected to an impact, have the vehicle inspected by your Toyota dealer. If the front or rear bumper needs to be removed/installed or replaced, contact your Toyota dealer.
  - Do not modify, disassemble or paint the sensors.
  - Do not attach a license plate cover.
  - Keep your tires properly inflated.
  - Do not install a suspension other than a genuine suspension.
- Notes when washing the vehicle**
- When using a high pressure washer to wash the vehicle, do not spray the sensors directly, as doing so may cause a sensor to malfunction.
  - When using steam to clean the vehicle, do not direct steam too close to the sensors, as doing so may cause a sensor to malfunction.

**■ The system can be operated when**

- The power switch is in ON.
- The intuitive parking assist is on.

- The vehicle speed is less than about 6 mph (10 km/h).
- A shift position other than P is selected.
- Vehicles without the multimedia display or rear camera: The system will automatically turn on (enabled) and the intuitive parking assist OFF indicator will turn off if the shift position is changed to R. The setting of intuitive parking assist itself will not change.

**■ Sensor detection information**

- The sensor's detection areas are limited to the areas around the vehicle's front and rear bumpers.
- Certain vehicle conditions and the surrounding environment may affect the ability of a sensor to correctly detect an object.
- Objects may not be detected if they are too close to the sensor.
- There will be a short delay between object detection and display. Even at low speeds, there is a possibility that the object will come within the sensor's detection areas before the display is shown and the warning beep sounds.
- It might be difficult to hear the buzzer due to the volume of the audio system or air flow noise of the air conditioning system.
- It may be difficult to hear the sound of this system due to the buzzers of other systems.
- If the meter malfunctions, the buzzer may not sound.

**■ Objects which the system may not be properly detected**

The shape of the object may prevent the sensor from detecting it. Pay particular attention to the following objects:

- Wires, fences, ropes, etc.
- Cotton, snow and other materials that absorb sound waves
- Sharply-angled objects

- Low objects
- Tall objects with upper sections projecting outwards in the direction of your vehicle

People may not be detected if they are wearing certain types of clothing.

#### ■ Situations in which the system may not operate properly

Certain vehicle conditions and the surrounding environment may affect the ability of a sensor to correctly detect objects. Particular instances where this may occur are listed below.

- There is dirt, snow, water drops or ice on a sensor. (Cleaning the sensors will resolve this problem.)
- A sensor is frozen. (Thawing the area will resolve this problem.) In especially cold weather, if a sensor is frozen the sensor display may be displayed abnormally, or objects, such as a wall, may not be detected.
- When a sensor or the area around a sensor is extremely hot or cold.

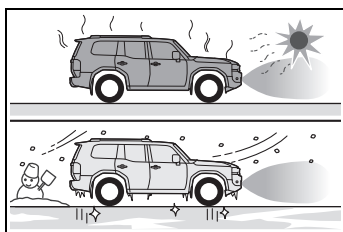

- On an extremely bumpy road, on an incline, on gravel, or on grass.
- When vehicle horns, vehicle detectors, motorcycle engines, air brakes of large vehicles, the clearance sonar of other vehicles or other devices which produce ultrasonic waves are near the vehicle.
- A sensor is coated with a sheet of spray or heavy rain.
- If objects draw too close to the sensor.

- When a pedestrian is wearing clothing that does not reflect ultrasonic waves (ex. skirts with gathers or frills).
  - When objects that are not perpendicular to the ground, not perpendicular to the vehicle traveling direction, uneven, or waving are in the detection range.
  - When strong winds are blowing.
  - When driving in inclement weather such as fog, snow or a sandstorm.
  - When an object that cannot be detected is between the vehicle and a detected object.
  - If an object such as a vehicle, motorcycle, bicycle or pedestrian cuts in front of the vehicle or runs out from the side of the vehicle.
  - If the orientation of a sensor has been changed due to a collision or other impact.
  - When equipment such as a towing eyelet, transport hook, bumper protector, bumper trim, bicycle carrier or snow-removal device (snow plow) is installed near the sensor.
  - If the front of the vehicle is raised or lowered due to the carried load.
  - If the vehicle cannot be driven in a stable manner, such as when the vehicle has been in an accident or is malfunctioning.
  - When tire chains, compact spare tire or an emergency tire puncture repair kit are used.
  - When towing with the vehicle.
- #### ■ Situations in which the system may operate even if there is no possibility of a collision
- In some situations, such as the following, the system may operate even though there is no possibility of a collision.
- When driving on a narrow road.

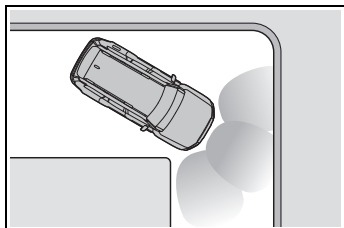

- When driving toward a banner, flag, low-hanging branch or boom barrier (such as those used at railroad crossings, toll gates and parking lots).
- When there is a rut or hole in the surface of the road.
- When driving on a metal cover (grating), such as those used for drainage ditches.
- When driving up or down a steep slope.
- If a sensor is hit by a large amount of water, such as when driving on a flooded road.
- There is dirt, snow, water drops or ice on a sensor. (Cleaning the sensors will resolve this problem.)
- A sensor is coated with a sheet of spray or heavy rain.
- When driving in inclement weather such as fog, snow or a sandstorm.
- When strong winds are blowing.

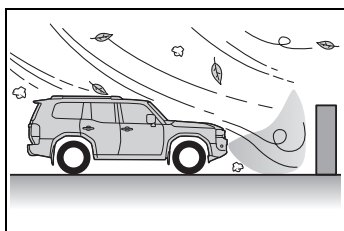

- When vehicle horns, vehicle detectors, motorcycle engines, air brakes of large vehicles, the clearance sonar of other vehicles or other devices which produce ultrasonic waves are near the vehicle.
- If the front of the vehicle is raised or lowered due to the carried load.

- If the orientation of a sensor has been changed due to a collision or other impact.
- The vehicle is approaching a tall or curved curb.
- Driving close to columns (H-shaped steel beams, etc.) in multi-story parking garages, construction sites, etc.
- If the vehicle cannot be driven in a stable manner, such as when the vehicle has been in an accident or is malfunctioning.
- On an extremely bumpy road, on an incline, on gravel, or on grass.

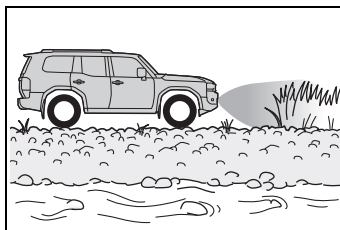

- When tire chains, compact spare tire or an emergency tire puncture repair kit are used.

### Sensor detection display, object distance

#### ■ Detection range of the sensors

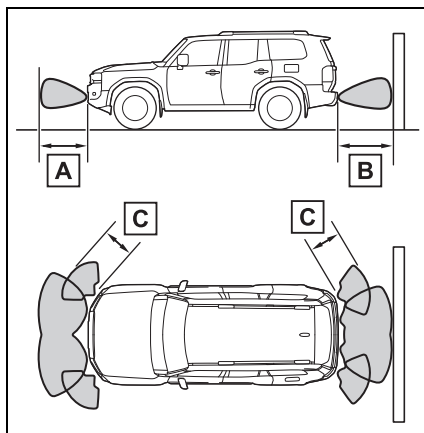

- A** Approximately 3.3 ft. (100 cm)
- B** Approximately 4.9 ft. (150 cm)
- C** Approximately 2.0 ft. (60 cm)

The diagram shows the detection range of the sensors. Note that the sensors cannot detect objects that are extremely close to the vehicle.

The range of the sensors may change depending on the shape of the object, etc.

### ■ The distance and buzzer

Approximate distance to obstacle	Buzzer
Front center sensor: Approximately 3.3 ft. (100 cm) to 2.0 ft. (60 cm)* Rear center sensor: Approximately 4.9 ft. (150 cm) to 2.0 ft. (60 cm)*	Slow
Approximately 2.0 ft. (60 cm) to 1.5 ft. (45 cm)*	Medium
Approximately 1.5 ft. (45 cm) to 1.0 ft. (30 cm)*	Fast
Approximately less than 1.0 ft. (30 cm)	Continuous

\*: Automatic buzzer mute function is enabled. (→P.342)

### Intuitive parking assist buzzer

A buzzer sounds when the sensors are operating.

- The buzzer beeps faster as the vehicle approaches a static object. When the vehicle comes within the approximately 1.0 ft. (30 cm) of the object, the buzzer will sound continuously.
- When 2 or more sensors simultaneously detect a static object, the buzzer sounds for the nearest object.

- After a buzzer begins sounding, if the distance between the vehicle and the detected a static object does not become shorter, the buzzer will be muted automatically. (automatic buzzer mute function)

### ■ Adjusting the buzzer volume

The buzzer volume of the intuitive parking assist, RCTA, and RCD can all be changed at once from the customize settings. (→P.649)

### ■ Muting a buzzer

When the temporary mute switch is displayed on the multimedia display, this switch can be pressed to temporarily mute the buzzer.

Select the switch to mute a buzzer of the intuitive parking assist, RCTA, and RCD all together.

- Mute will be automatically canceled in the following situations:
  - When the shift position is changed.
  - When the vehicle speed exceeds a certain speed.
  - When there is a malfunction in a sensor or the system is temporarily unavailable.
  - When the operating function is disabled manually.
  - When the power switch is turned off.

## RCTA (Rear Cross Traffic Alert) function

The RCTA function uses the BSM rear side radar sensors installed on the inner side of the rear bumper. This function is intended to assist the driver in checking areas that are not easily visible when backing up.

### WARNING

#### ■ Cautions regarding the use of the system

The driver is solely responsible for safe driving. Always drive safely, taking care to observe your surroundings.

The RCTA function is only a supplementary function which alerts the driver that a vehicle is approaching from the right or left at the rear of the vehicle.

As the RCTA function may not function correctly under certain conditions, the driver's own visual confirmation of safety is necessary.

Over reliance on this function may lead to an accident resulting death or serious injury.

#### ■ To ensure the system can operate properly

→P.329

## System components

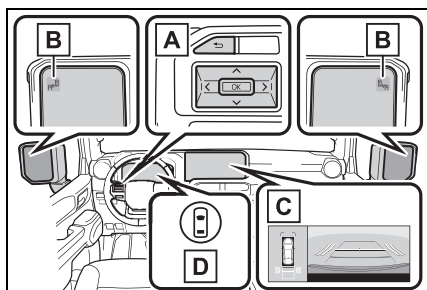

### A Meter control switches

Operate the meter control switches to enable/disable the RCTA function on the multi-information display.

### B Outside rear view mirror indicators

If a vehicle is detected as approaching from the left or right behind the vehicle, both outside rear view mirror indicators (→P.86) will blink and a buzzer will sound.

### C Multimedia display

If a vehicle approaching from the right or left at the rear of the vehicle is detected, the RCTA icon (→P.345) for the detected side will be displayed on the multimedia display. This illustration\* shows an example of a vehicle approaching from both sides of the vehicle.

\*: Depending on the vehicle grade and equipped options, the actual screen may be different from this illustration.

### D Driving assist information indicator

Illuminates when the RCTA is turned off. At this time, a message will be displayed on the multi-infor-

mation display.

## Turning the RCTA function on/off

The RCTA can be enabled/disabled through a customize setting. (→P.649)

When the RCTA function is off, the driving assist information indicator (→P.86) will illuminate and a message will be displayed on the multi-information display. Each time the power switch is turned to ON, the RCTA function is enabled.

### ■ Outside rear view mirror indicator visibility

In strong sunlight, the outside rear view mirror indicator may be difficult to see.

### ■ Hearing the RCTA buzzer

The RCTA buzzer may be difficult to hear over loud noises, such as if the audio system volume is high.

### ■ Rear side radar sensors

→P.329

## RCTA function

### ■ Operation of the RCTA function

The RCTA function uses rear side radar sensors to detect vehicles approaching from the right or left at the rear of the vehicle and alerts the driver of the presence of such vehicles by flashing the outside rear view mirror indicators and sounding a



buzzer.

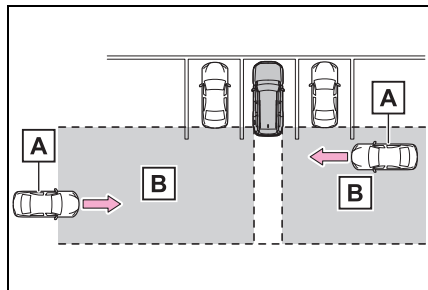

- A** Approaching vehicles
- B** Detection areas of approaching vehicles

### ■ RCTA icon display

When a vehicle approaching from the right or left at the rear of the vehicle is detected, the following will be displayed on the multimedia display.

- Example: Vehicles are approaching from both sides of the vehicle

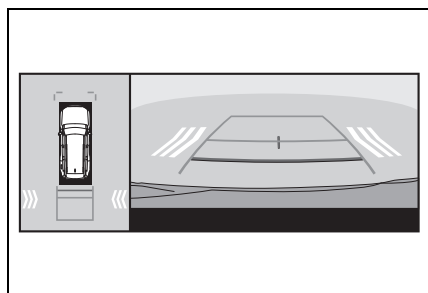

### ■ RCTA function detection areas

The areas that vehicles can be detected in are outlined below.

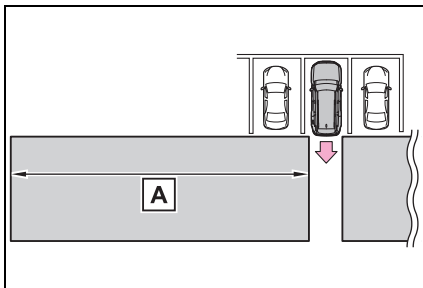

The buzzer can alert the driver of faster vehicles approaching from farther away.

Example:

Approaching vehicle speed	<b>A</b> Approximate alert distance
34 mph (56 km/h) (fast)	98 ft. (30 m)
5 mph (8 km/h) (slow)	13 ft. (4 m)

### ■ The RCTA function is operational when

The RCTA function operates when all of the following conditions are met:

- The power switch is in ON.
- The RCTA function is on.
- The shift position is in R.
- The vehicle speed is less than approximately 9 mph (15 km/h).
- The approaching vehicle speed is between approximately 5 mph (8 km/h) and 34 mph (56 km/h).

### ■ Setting the buzzer volume

The buzzer volume of the RCTA, intuitive parking assist, and RCD (if equipped) can be adjusted all together through a customize setting. (→P.649)

### ■ Muting a buzzer temporarily

When an object is detected, the

temporary mute switch is displayed on the multimedia display.

Select the switch to mute the buzzer of the intuitive parking assist, RCTA, and RCD (if equipped) all together.

Mute will be canceled automatically in the following situations:

- When the shift position is changed.
- When the vehicle speed exceeds a certain speed.
- When there is a malfunction in a sensor or the system is temporarily unavailable.
- When the operating function is disabled manually.
- When the power switch is turned off.

#### ■ Conditions under which the system will not detect a vehicle

The RCTA function is not designed to detect the following types of vehicles and/or objects:

- Vehicles approaching from directly behind
- Vehicles backing up in a parking space next to your vehicle
- Vehicles that the sensors cannot detect due to obstructions

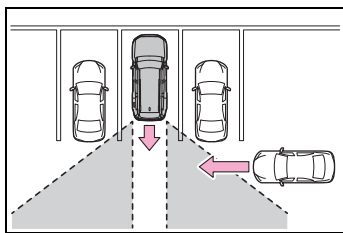

- Guardrails, walls, signs, parked vehicles and similar stationary objects\*
- Small motorcycles, bicycles, pedestrians, etc.\*
- Vehicles moving away from your vehicle
- Vehicles approaching from the parking spaces next to your vehi-

cle\*

- The distance between the sensor and approaching vehicle gets too close

\*: Depending on the conditions, detection of a vehicle and/or object may occur.

#### ■ Situations in which the system may not operate properly

The RCTA function may not detect vehicles correctly in the following situations:

- When the sensor is misaligned due to a strong impact to the sensor or its surrounding area
- When mud, snow, ice, a sticker, etc., is covering the sensor or surrounding area on the rear bumper
- When driving on a road surface that is wet with standing water during bad weather, such as heavy rain, snow, or fog
- When multiple vehicles are approaching with only a small gap between each vehicle
- When a vehicle is approaching at high speed
- When equipment that may obstruct a sensor is installed, such as a towing eyelet, bumper protector (an additional trim strip, etc.), bicycle carrier, or snow plow
- When backing up on a slope with a sharp change in grade

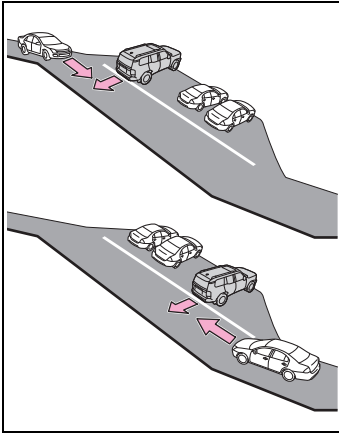

- When backing out of a sharp angle parking spot

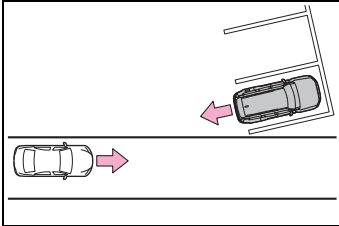

- Immediately after the RCTA function is turned on
- Immediately after the hybrid system is started with the RCTA function on
- When the sensors cannot detect a vehicle due to obstructions
- When towing with the vehicle
- When there is a significant difference in height between your vehicle and the vehicle that enters the detection area
- When a sensor or the area around a sensor is extremely hot or cold
- If the suspension has been modified or tires of a size other than specified are installed
- If the front of the vehicle is raised or lowered due to the carried load
- When turning while backing up

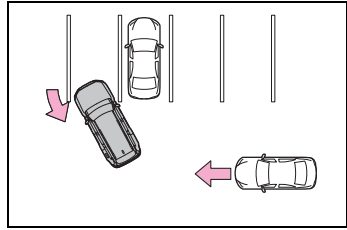

- When a vehicle turns into the detection area

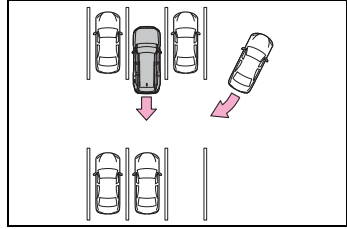

- Situations in which the system may operate even if there is no possibility of a collision

Instances of the RCTA function unnecessarily detecting a vehicle and/or object may increase in the following situations:

- When the parking space faces a street and vehicles are being driven on the street

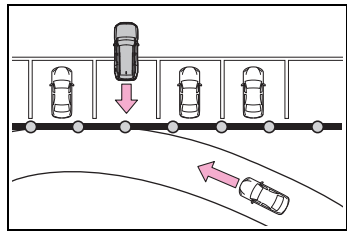

- When the distance between your vehicle and metal objects, such as a guardrail, wall, sign, or parked vehicle, which may reflect electrical waves toward the rear of the vehicle, is short

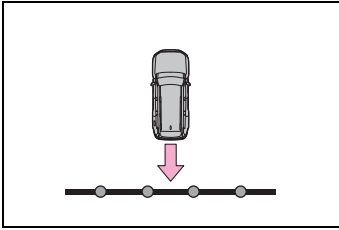

- When equipment that may obstruct a sensor is installed, such as a towing eyelet, bumper protector (an additional trim strip, etc.), bicycle carrier, or snow plow
- When a vehicle passes by the side of your vehicle

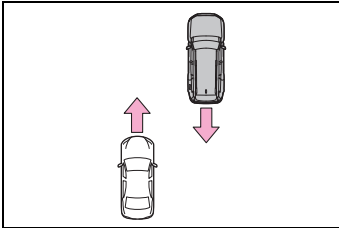

- When a detected vehicle turns while approaching the vehicle

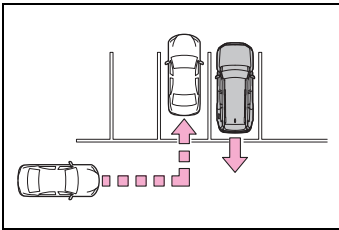

- When there are spinning objects near your vehicle such as the fan of an air conditioning unit
- When water is splashed or sprayed toward the rear bumper, such as from a sprinkler
- Moving objects (flags, exhaust fumes, large rain droplets or snowflakes, rain water on the road surface, etc.)
- When the distance between your vehicle and a guardrail, wall, etc., that enters the detection area is short
- Gratings and gutters

- When a sensor or the area around a sensor is extremely hot or cold
- If the suspension has been modified or tires of a size other than specified are installed
- If the front of the vehicle is raised or lowered due to the carried load
- When towing with the vehicle

## RCD (Rear Camera Detection) function \*

\*: If equipped

**When the vehicle is backing up, the rear camera detection function can detect pedestrians in the detection area behind the vehicle. If a pedestrian is detected, a buzzer will sound and an icon will be displayed on the multimedia display to inform the driver of the pedestrian.**



### WARNING

#### ■ Cautions regarding the use of the system

The recognition and control capabilities for this system are limited.

The driver should always drive safely by always being responsible without over relying on the system and have a understanding of the surrounding situations.

#### ■ To ensure the system can operate properly

Observe the following, otherwise there is the danger that could lead to an accident.

- Always clean the camera without damaging it.
- Do not install market electronic parts (such as illuminated license plate, fog lamps, etc.) in the camera vicinity.
- Do not subject the camera vicinity to strong impacts. If the vicinity is subjected to a strong impact, have the vehicle inspected by your Toyota dealer.

- Do not disassemble, remodel or paint the camera.
- Do not attach accessories or stickers to the camera.
- Do not install market protection parts (bumper trim, etc.) to the rear bumper.
- Maintain suitable tire air pressure.
- Make sure the back door is completely closed.

#### ■ RCD function is turned off

In the following situations the system turns off. The RCD function may not operate properly and thus there is the danger that an accident may occur.

- The contents mentioned above are not observed.
- Suspensions other than the genuine parts are installed.

## System component

### Location of the rear camera

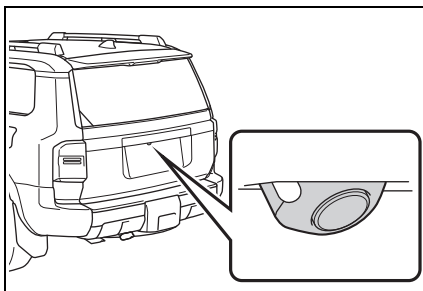

## RCD display

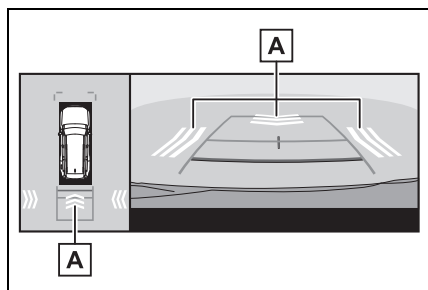

**A** Pedestrian detection icon  
Displayed automatically when a pedestrian is detected behind the vehicle.

## Turning the RCD function on/off

The RCD function can be enabled/disabled through a customize setting.

When the RCD function is disabled, the driving assist information indicator (→P.649) illuminates, and a message is displayed on the multi-information display.

Each time the power switch is turned off then changed to ON, the RCD function will be enabled automatically.

### ■ When towing a trailer

When the 7-pin connector is connected, the RCD function may stop a buzzer and displaying icon.

## When a pedestrian is detected

If a pedestrian is in the area behind the vehicle or if the rear camera detected that a pedestrian is approaching the vehicle from behind, the system urges caution from the driver by sounding the buzzer and displaying the detection of a pedestrian on the multimedia display as follows:

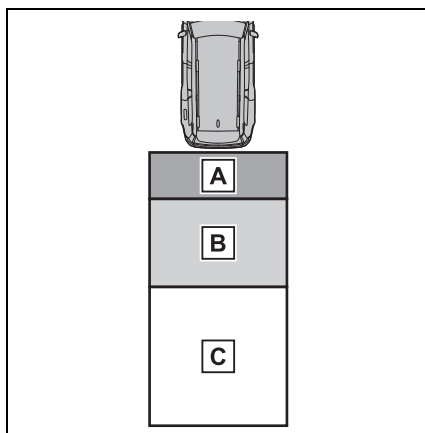

- A** If a pedestrian is detected in area **A**  
Buzzer: Sounds repeatedly  
Pedestrian detection icon: Blinks
- B** If a pedestrian is detected in area **B**  
Buzzer (When the vehicle is stationary): Sounds 3 times  
Buzzer (When the vehicle is backing up, when a pedestrian approaches the rear of the vehicle): Sounds repeat-

edly

Pedestrian detection icon:

Blinks

**C** If the system determines that your vehicle may collide with

a pedestrian in area **C**

Buzzer: Sounds repeatedly

Pedestrian detection icon:

Blinks

#### ■ **The rear camera detection function is operational when**

- The power switch is in ON.
- RCD function is on.
- The shift position is in R.

#### ■ **Setting the buzzer volume**

The buzzer volume of the intuitive parking assist, RCTA, and RCD can all be changed at once from the customize settings. (→P.649)

#### ■ **Muting a buzzer temporarily**

When an object is detected, the temporary mute switch is displayed on the multimedia display.

Select the switch to mute a buzzer of the intuitive parking assist, RCTA, and RCD all together.

Mute will be automatically canceled in the following situations:

- When the shift position is changed.
- When the vehicle speed exceeds a certain speed.
- When there is a malfunction in a sensor or the system is temporarily unavailable.
- When the operating function is disabled manually.
- When the power switch is turned off.

#### ■ **Situations in which the system may not operate properly**

- Some pedestrians, such as the

following, may not be detected by the rear camera detection function, preventing the function from operating properly:

- Pedestrians who are bending forward or squatting
- Pedestrians who are lying down
- Pedestrians who are running
- Pedestrians who suddenly appear from the shadow of the vehicle or a building
- Pedestrians who are riding moving objects such as a bicycle or skateboard
- Pedestrians wearing oversized clothing such as a rain coat, long skirt, etc., making their silhouette obscure
- Pedestrians whose body is partially hidden by an object, such as a cart or umbrella
- Pedestrians which are obscured by darkness, such as at night
- In some situations, such as the following, pedestrians may not be detected by the rear camera detection function, preventing the function from operating properly:
  - When backing up in inclement weather (rain, snow, fog, etc.)
  - The lens is dirty (by dirt or snow-melting agent, etc.) or scratched
  - When a very bright light, such as the sun, or the headlights of another vehicle, shines directly into the rear camera
  - When backing up in a place where the surrounding brightness changes suddenly, such as at the entrance or exit of a garage or underground parking lot
  - When backing up in a dim environment such as during dusk or in an underground parking lot
  - When the camera position and direction are deviated
  - When a towing hook is attached
  - When water droplets are flowing on the camera lens
  - When the vehicle height is extremely changed (nose up, nose down, etc.)
  - When tire chains or an emergency tire puncture repair kit are used

- When the suspension has been lowered or tires that have a different size than the genuine tires are installed
- When an aftermarket electronic part (backlit license plate, fog light, etc.) is installed near the rear camera
- If a bumper protector, such as an additional trim strip, is installed to the rear bumper
- When towing with the vehicle

#### ■ Situations in which the system may operate unexpectedly

- Even though there are no pedestrians in the detection area, some objects, such as the following, may be detected, possibly causing the rear camera detection function to operate.
  - Three dimensional objects, such as a pole, traffic cone, fence, or parked vehicle
  - Moving objects, such as a car or motorcycle
  - Objects moving toward your vehicle when backing up, such as flags or puddles (or airborne matter, such as smoke, steam, rain, or snow)
  - Cobblestone or gravel roads, tram rails, road repairs, white lines, pedestrian crossings or fallen leaves on the road
  - Metal covers (gratings), such as those used for drainage ditches
  - Objects reflected in a puddle or on a wet road surface
  - Shadows on the road
- In some situations, such as the following, the rear camera detection function may operate even though there are no pedestrians in the detection area.
  - When backing up toward the roadside or a bump on the road
  - When backing up toward an incline/decline
  - When the vehicle height is extremely changed (nose up, nose down, etc.)
  - When an aftermarket electronic part (backlit license plate, fog light, etc.) is installed near the rear camera
- Situations in which the rear camera detection function may be difficult to notice
  - The buzzer may be difficult to hear if the surrounding area is noisy or the audio system volume is high.
  - If the temperature in the cabin is extremely high or low, the multimedia display may not operate correctly.

- If a bumper protector, such as an additional trim strip, is installed to the rear bumper
- If the orientation of the rear camera has been changed due to a collision or other impact, or removal and installation
- If a towing eyelet is installed to the rear of the vehicle
- When water is flowing over the rear camera lens
- The lens is dirty (by dirt or snow-melting agent, etc.)
- If there is a flashing light in the detection area, such as the emergency flashers of another vehicle
- When tire chains or an emergency tire puncture repair kit are used
- When towing with the vehicle



## PKSB (Parking Support Brake)

The PKSB (Parking Support Brake) is a system that issues warnings and automatically performs braking to help reduce collision damage with operation targets that were detected when traveling at a low speed such as when parking.

## PKSB (Parking Support Brake) system

The system has detected the following as operation targets. (The operation targets vary depending on the function.)

- Parking Support Brake function (static objects front and rear of the vehicle):→P.358
- Parking Support Brake function (moving vehicles rear of the vehicle):→P.360
- Parking Support Brake function (pedestrians rear of the vehicle) (if equipped):→P.362

## WARNING

### ■ Cautions regarding the use of the system

Do not overly rely on the system, as doing so may lead to an accident.

Always drive while checking the safety of the surroundings of the vehicle.

Depending on the vehicle and road conditions, weather, etc., the system may not operate.

The detection capabilities of sensors and radars are limited. Always drive while checking the safety of the surroundings of the vehicle.

- The driver is solely responsible for safe driving. Always drive carefully, taking care to observe your surroundings. The Parking Support Brake system is designed to provide support to lessen the severity of collisions. However, it may not operate in some situations.
- The Parking Support Brake system is not designed to stop the vehicle completely. Additionally, even if the system has stopped the vehicle, it is necessary to depress the brake pedal immediately as brake control will be canceled after approximately 2 seconds.
- It is extremely dangerous to check the system operations by intentionally driving the vehicle into the direction of a wall, etc. Never attempt such actions.

### ■ When to disable the Parking Support Brake

In the following situations, disable the Parking Support Brake as the system may operate even though there is no possibility of a collision.

**WARNING**

- When inspecting the vehicle using a chassis roller, chassis dynamo or free roller
- When loading the vehicle onto a boat, truck or other transport vessel
- If the suspension has been modified or tires of a size other than specified are installed
- If the front of the vehicle is raised or lowered due to the carried load
- When equipment such as a towing hook, transport hook, bumper protector, bumper trim, bicycle carrier or snow-removal device (snow plow) is installed near the sensor
- When using automatic car washing devices
- If the vehicle cannot be driven in a stable manner, such as when the vehicle has been in an accident or is malfunctioning
- When the vehicle is driven in a sporty manner or off-road
- When the tires are not properly inflated
- When the tires are very worn
- When tire chains, a compact spare tire or an emergency tire puncture repair kit are used
- When towing with the vehicle

**■ Precautions for the suspension**

Do not modify the suspension of the vehicle. If the height or tilt of the vehicle is changed, the sensors may not be able to detect detectable objects and the system may not operate correctly, possibly leading to an accident.

**Enabling/Disabling the Parking Support Brake**

The Parking Support Brake function can be enabled/disabled by pressing the PKSB switch.

When the PKSB (Parking Support Brake) is disabled, the driving assist information indicator (→P.86) illuminates, and a message is displayed on the multi-information display.

If the system switches to OFF (disabled) and the PKSB (Parking Support Brake) is stopped, the PKSB (Parking Support Brake) will not be re-enabled until the PKSB switch is pressed again to turn the system ON (enabled).

(It remains off even if the power switch is turned to ON again after the power switch has been turned off.)

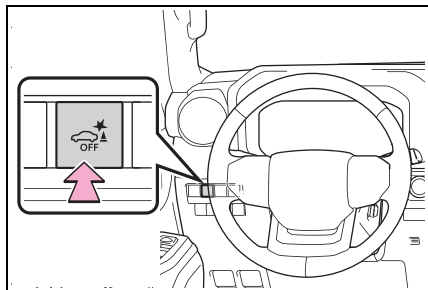

#### ■ If the four-wheel drive control switch is in L4

The Parking Support Brake function automatically turns off.

#### ■ When towing a trailer

When the 7-pin connector is connected, the Parking Support Brake function automatically turns off.

### Display and buzzer for hybrid system output restriction control and brake control

If the hybrid system output restriction control or brake control operates, a buzzer will sound and a message will be displayed on the multimedia display and multi-information display, to alert the driver.

Depending on the situation, output restriction control operates to either limit acceleration or restrict output as much as possible.

- Hybrid system output restriction control is operating (acceleration restriction)

Acceleration greater than a certain amount is restricted by the system.

Multimedia display: No warning displayed

Multi-information display: "Object

Detected Acceleration Reduced"

Driving assist information indicator: Not illuminated

Buzzer: Does not sound

- Hybrid system output restriction control is operating (output restricted as much as possible)

The system has determined that stronger-than-normal brake operation is necessary.

Multimedia display (vehicles with a Multi-terrain Monitor): "BRAKE!"

Multi-information display: "BRAKE!"

Driving assist information indicator: Not illuminated

Buzzer: Short beep

- Brake control is operating

The system determined that emergency braking is necessary.

Multimedia display (vehicles with a Multi-terrain Monitor): "BRAKE!"

Multi-information display: "BRAKE!"

Driving assist information indicator: Not illuminated

Buzzer: Short beep

- Vehicle stopped by system operation

The vehicle has been stopped by brake control operation.

Multimedia display (vehicles with a Multi-terrain Monitor): "Switch to Brake"

Multi-information display: "Accelerator Pedal is Pressed Press Brake Pedal" (If the accelerator pedal is not depressed, "Press Brake Pedal" will be displayed.)

Driving assist information indicator:  
Illuminated

Buzzer: Sounds repeatedly

### System overview

If the Parking Support Brake determines that a collision with a detected object or pedestrian is possible, the hybrid system output will be restricted to restrain any increase in the vehicle speed. (Hybrid system output restriction control: See figure 2 below.)

Additionally, if the accelerator pedal continues to be depressed, the brakes will be applied automatically to reduce the vehicle speed. (Brake control: See figure 3.)

- Figure 1: When the PKSB (Parking Support Brake) is not operating

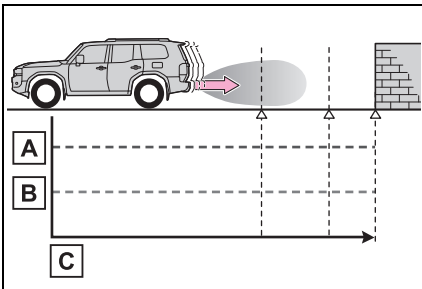

- A Hybrid system output
- B Braking force
- C Time

- Figure 2: When hybrid system output restriction control operates

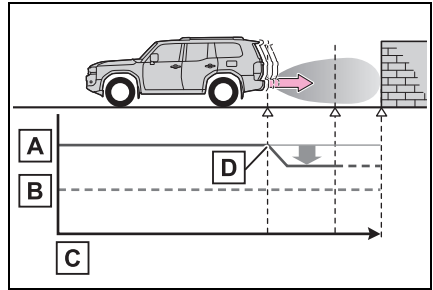

- A Hybrid system output
- B Braking force
- C Time
- D Hybrid system output restriction control begins operating (System determines that possibility of collision with detected object is high)

- Figure 3: When hybrid system output restriction control and brake control operates

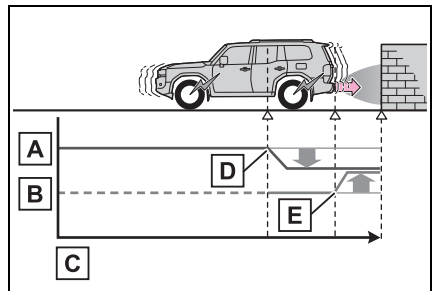

- A Hybrid system output
- B Braking force
- C Time
- D Hybrid system output restriction control begins operating (System determines that possibility of collision with detected object is high)

**E** Brake control begins operating (System determines that possibility of collision with detected object is extremely high)

distance to the object when the brake control and the hybrid system output restriction control are operated.

---

#### ■ If the Parking Support Brake has operated

If the vehicle is stopped due to operation of the Parking Support Brake, the Parking Support Brake will be disabled and the driving assist information indicator will illuminate. In addition, even when the PKSB (Parking Support Brake) operates, the brake control is canceled after approximately 2 seconds to start off. Furthermore, the brake control also can be canceled by depressing the brake pedal. Depressing the accelerator pedal again after that allows the vehicle to start off.

#### ■ Re-enabling the Parking Support Brake

To re-enable the Parking Support Brake when it is disabled due to operation of the PKSB (Parking Support Brake), either enable the system again, or turn the power switch off and then back to ON.

Additionally, if any of the following conditions are met, the system will be re-enabled automatically and the driving assist information indicator will turn off (→P.86):

- The P shift position is selected
- Drive with no operation targets in the traveling direction of the vehicle
- Change the traveling direction of the vehicle

#### ■ Buzzer

Regardless of whether the intuitive parking assist is enabled or not (→P.307), if the PKSB (Parking Support Brake) system is enabled (→P.354), the buzzer will sound to notify the driver of the approximate

### Parking Support Brake function (static objects front and rear of the vehicle)

If the sensors detect a static object, such as a wall, in the traveling direction of the vehicle and the system determines that a collision may occur due to the vehicle suddenly moving forward due to an accidental accelerator pedal operation, the vehicle moving the unintended direction due to the wrong shift position parking or traveling at low speeds, the system will operate to lessen the impact with the detected static object and reduce the resulting damage.

### Examples of function operation (static objects front and rear of the vehicle)

This function will operate in situations such as the following if an object is detected in the traveling direction of the vehicle.

- When traveling at a low speed and the brake pedal is not depressed, or is depressed late

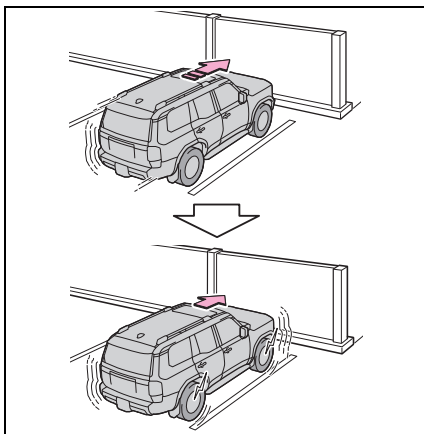

- When the accelerator pedal is depressed excessively

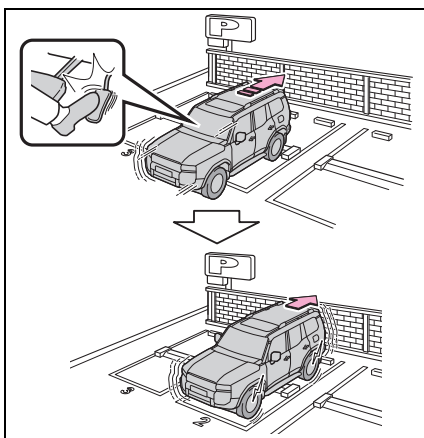

### ■ When the vehicle moves forward due to the incorrect shift position being selected

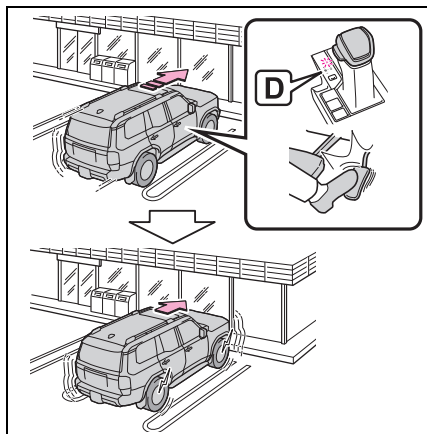

### Types of sensors

→P.337

#### ⚠ WARNING

■ To ensure the system can operate properly

→P.338

■ If the Parking Support Brake function operates unnecessarily, such as at a railroad crossing

→P.357

■ Notes when washing the vehicle

→P.339

### ■ The Parking Support Brake function (static objects front and rear of the vehicle) will operate when

The function will operate when the driving assist information indicator is not illuminated (→P.84, 86) and all of the following conditions are met:

- Hybrid system output restriction control
- The Parking Support Brake is enabled.
- The vehicle speed is approximately 9 mph (15 km/h) or less.
- There is a static object in the traveling direction of the vehicle and approximately 6 to 13 ft. (2 to 4 m) away.
- The Parking Support Brake determines that a stronger-than-normal brake operation is necessary to avoid a collision.
- Brake control
- Hybrid system output restriction control is operating.
- The Parking Support Brake determines that an immediate brake operation is necessary to avoid a collision.

### ■ The Parking Support Brake function (static objects front and rear of the vehicle) will stop operating when

The function will stop operating if any of the following conditions are met:

- Hybrid system output restriction control
- The Parking Support Brake is disabled.
- The system determines that the collision has become avoidable with normal brake operation.
- The static object is no longer approximately 6 to 13 ft. (2 to 4 m) away from the vehicle or in the traveling direction of the vehicle.
- Brake control
- The Parking Support Brake is disabled.
- Approximately 2 seconds have elapsed since the vehicle was stopped by brake control.
- The brake pedal is depressed after the vehicle is stopped by brake control.
- The static object is no longer approximately 6 to 13 ft. (2 to 4 m) away from the vehicle or in the traveling direction of the vehicle.

■ **Detection range of the Parking Support Brake function (static objects front and rear of the vehicle)**

The detection range of the Parking Support Brake function (static objects front and rear of the vehicle) differs from the detection range of the intuitive parking assist (→P.308). Therefore, even if the intuitive parking assist detects an object and provides a warning, the Parking Support Brake function (static objects front and rear of the vehicle) may not start operating.

■ **Situations in which the system may not operate properly**

→P.340

■ **Situations in which the system may operate even if there is no possibility of a collision**

→P.340

Parking Support Brake function (moving vehicles rear of the vehicle)

**If a rear radar sensor detects a vehicle approaching from the right or left at the rear of the vehicle and the system determines that the possibility of a collision is high, this function will perform brake control to reduce the likelihood of an impact with the approaching vehicle.**

**Examples of the function operation**

This function will operate in situations such as the following if a vehicle is detected in the traveling direction of the vehicle.

- **When reversing, a vehicle is approaching and the brake pedal is not depressed, or is depressed late**

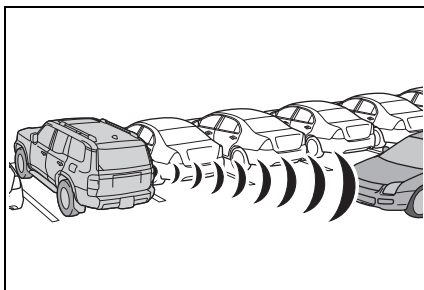



## Types of sensors

→P.329



### WARNING

■ To ensure the system can operate properly

→P.329

### ■ The Parking Support Brake function (moving vehicles rear of the vehicle) will operate when

The function will operate when the driving assist information indicator is not illuminated (→P.84, 86) and all of the following conditions are met:

- Hybrid system output restriction control
- The Parking Support Brake is enabled.
- The vehicle speed is approximately 9 mph (15 km/h) or less.
- Vehicles are approaching from the right or left at the rear of the vehicle at a traveling speed of approximately 5 mph (8 km/h) or more.
- The shift position is in R.
- The Parking Support Brake determines that a stronger than normal brake operation is necessary to avoid a collision with an approaching vehicle.
- Brake control
- Hybrid system output restriction control is operating.
- The Parking Support Brake determines that an emergency brake operation was necessary to avoid a collision with a vehicle approaching from the rear.

### ■ The Parking Support Brake function (moving vehicles rear of the vehicle) will stop operating when

The function will stop operating if any of the following conditions are met:

- Hybrid system output restriction control
- The Parking Support Brake is disabled.
- The collision becomes avoidable with normal brake operation.
- A vehicle is no longer approaching from the right or left at the rear of the vehicle.
- Brake control
- The Parking Support Brake is disabled.
- Approximately 2 seconds have elapsed since the vehicle was stopped by brake control.
- The brake pedal is depressed after the vehicle is stopped by brake control.

### ■ Situations in which the system may not operate properly

→P.346

### ■ Situations in which the system may operate even if there is no possibility of a collision

→P.347

## Parking Support Brake function (pedestrians rear of the vehicle)\*

\*: If equipped

If the rear camera sensor detects a pedestrian behind the vehicle while backing up and the system determines that the possibility of colliding with the detected pedestrian is high, a buzzer will sound. If the system determines that the possibility of colliding with the detected pedestrian is extremely high, the brakes will be applied automatically to help reduce the impact of the collision.

## Examples of system operation

The system operates when an approaching pedestrian is detected behind the vehicle while backing up, and when the brake pedal is not depressed or is depressed late.

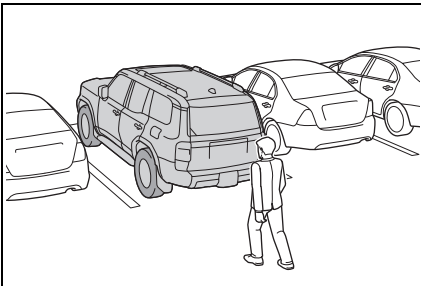

## Screen display of pedestrians rear of the vehicle

Displays a message to urge the driver to take evasive action when a pedestrian is detected in the detection area behind the vehicle.

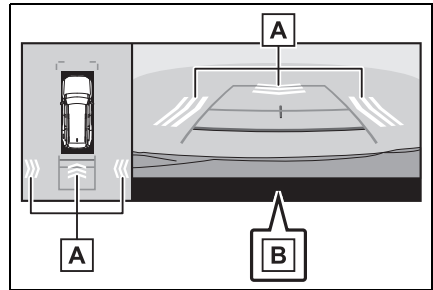

A Pedestrian detection icon

B "BRAKE!"

## ⚠ WARNING

■ If the Parking Support Brake function (pedestrians rear of the vehicle) operates unnecessarily

Depress the brake pedal immediately after the Parking Support Brake function (pedestrians rear of the vehicle) operates. (Operation of the function is canceled by depressing the brake pedal.)

■ Correct use of the Parking Support Brake function (pedestrians rear of the vehicle)

→P.319

■ The Parking Support Brake function (pedestrians rear of the vehicle) will operate when

The function will operate when the driving assist information indicator is not illuminated (→P.84, 86) and all

of the following conditions are met:

- Hybrid system output restriction control
- The Parking Support Brake is enabled.
- The vehicle speed is 9 mph (15 km/h) or less.
- The shift position is in R.
- When a pedestrian is to the rear of the vehicle
- The PKSB (Parking Support Brake) determines that a stronger-than-normal brake operation is necessary to avoid a collision.
- Brake control
- Hybrid system output restriction control is operating.
- The Parking Support Brake determines that an emergency brake operation is necessary to avoid a collision with a pedestrian.

■ **The Parking Support Brake function (pedestrians rear of the vehicle) will stop operating when**

The function will stop operating if any of the following conditions are met:

- Hybrid system output restriction control
- The Parking Support Brake is disabled.
- The collision becomes avoidable with normal brake operation.
- The pedestrian is no longer detected behind your vehicle.
- Brake control
- The Parking Support Brake is disabled.
- Approximately 2 seconds have elapsed since the vehicle was stopped by brake control.
- The brake pedal is depressed after the vehicle is stopped by brake control.

■ **Re-enabling the Parking Support Brake function (pedestrians rear of the vehicle)**

→P.357

■ **Detection area of the Parking Support Brake function (pedestrians rear of the vehicle)**

The detection area of the Parking Support Brake function (pedestrians rear of the vehicle) differs from the detection area of the RCD function (→P.321). Therefore, even if the RCD function detects a pedestrian and provides an alert, the Parking Support Brake function (pedestrians rear of the vehicle) may not start operating.

■ **Situations in which the system may not operate properly**

→P.351

■ **Situations in which the system may operate unexpectedly**

→P.352

## Multi-terrain Monitor\*

\*: If equipped

**The Multi-terrain Monitor helps the driver to check the vehicle surroundings. It assists in determining the conditions around the driver in a variety of situations, such as when judging conditions during off-road driving or checking for obstacles when parking.**

- The screen illustrations used in this text are intended as examples, and may differ from the image that is actually displayed on the screen.



### WARNING

#### ■ When using the Multi-terrain Monitor system

Observe the following precautions to avoid an accident that could result in death or serious injuries.

- Never rely solely on the Multi-terrain Monitor. As with unequipped vehicles, drive carefully while directly confirming the safety of your surroundings and the area to the rear of the vehicle. Take particular care to avoid parked cars and other obstacles.
- Due to the characteristics of the camera lens, the actual position and distance of people and other obstacles will differ from those shown on the Multi-terrain Monitor screen. Directly confirm the safety of your surroundings before driving.

- Always make sure to visually check behind you and your surroundings while you are driving.
- Never drive while looking only at the screen as the image on the screen is different from actual conditions. If you are driving while looking only at the screen, you may hit a person or an object, resulting in an accident. When driving, be sure to check the vehicle's surroundings with your own eyes and the vehicle's mirrors.
- The position of the guide lines displayed on the screen may change due to factors such as number of passengers, load capacity, and road gradient. Always make sure to visually check behind you and your surroundings while you are driving.
- In low temperatures, the screen may darken or the images may become faint. Images of moving objects in particular may distort or disappear from the screen. Therefore, make sure to drive carefully while directly visually confirming the safety of your surroundings.
- If you replace your tires, the position of the guide lines displayed on the screen may be incorrect.



### NOTICE

#### ■ Multi-terrain Monitor

When the camera malfunctions, the screen may be displayed as follows:

- When the shift position is in any position other than "R", the camera image continue to be displayed



## NOTICE

- When the shift position is in “R”, part or all of the screen may appear black
- When the shift position is in “R”, the screen may not change to the camera image
- The guide lines are not displayed on the camera image, and attention symbols and caution notices are displayed

### Multi-terrain Monitor screens

The following screens can be selected according to driving conditions.

- Screens that can be selected vary depending on conditions such as shift position and vehicle speed. (→P.368)
- Depending on the displayed screen, the display can be switched from normal to full screen display.

#### ■ Screens when the four-wheel drive control switch is in L4 or H4 and Multi-terrain Select is in on.

- When checking the area to the front and sides of the vehicle
- ▶ Front view & dual side views

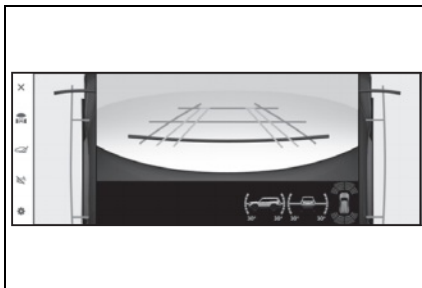

→P.373

- ▶ Front view (magnified)

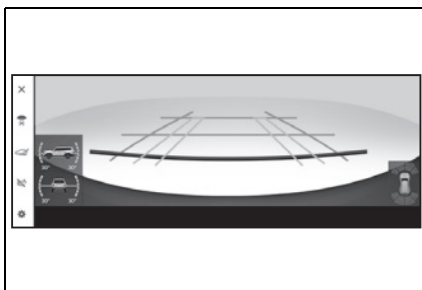

→P.373

- When checking the condition of the road surface under the vehicle
- ▶ Under vehicle terrain view & dual side views

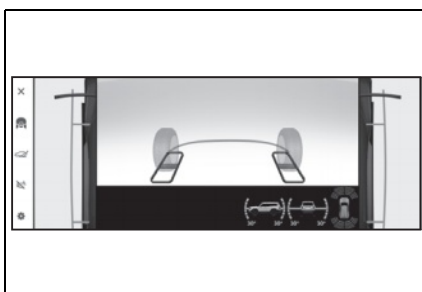

→P.377

- ▶ Under vehicle terrain view (magnified)

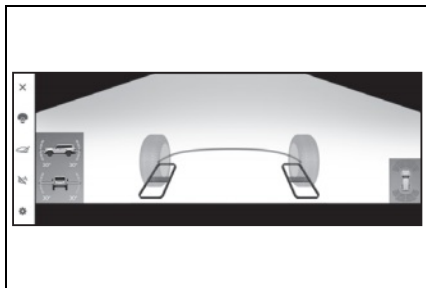

→P.377

- ▶ Under vehicle terrain view (rear wheel) & dual side views

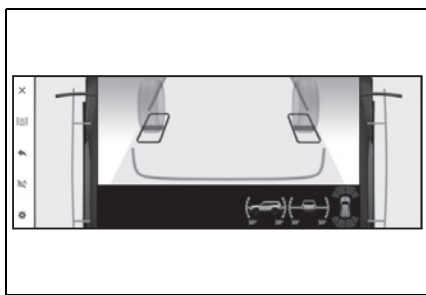

→P.380

- ▶ Under vehicle terrain view (rear wheel) (magnified)

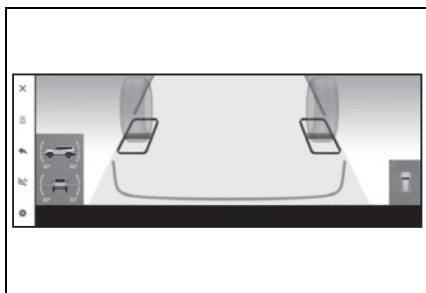

→P.380

- When checking the area to the rear of the vehicle
- ▶ Rear view & dual side views

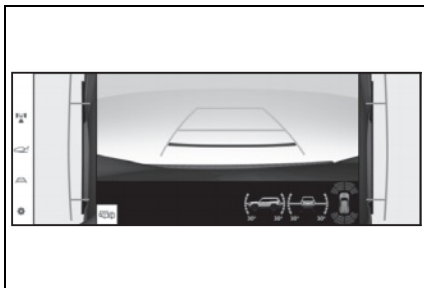

→P.383

- ▶ Wide rear view & dual side views

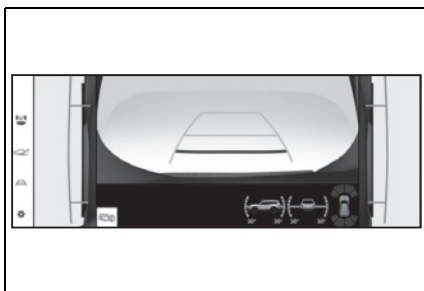

→P.383

- ▶ Under vehicle terrain view (rear side) & dual side views

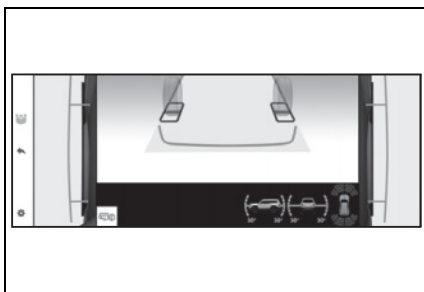

→P.387

- ▶ Under vehicle terrain view (rear side) (magnified)

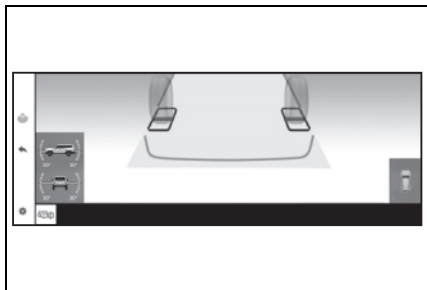

→P.387

■ **Screens when the four-wheel drive control switch is in H4 and Multi-terrain Select is in off.**

- When checking the area to the around of the vehicle

▶ Moving view

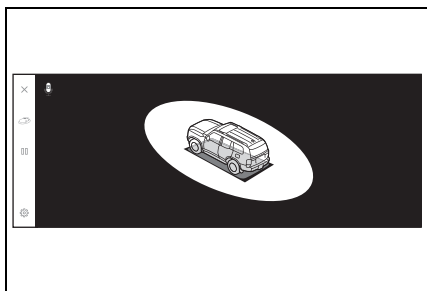

→P.390

▶ See-through view

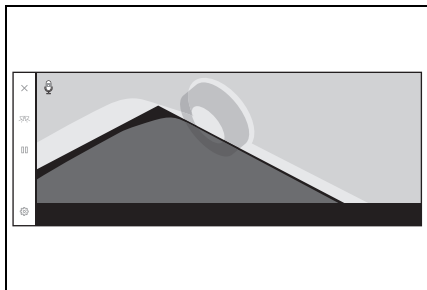

→P.390

- When checking the area to the front of the vehicle

▶ Wide front view & panoramic view

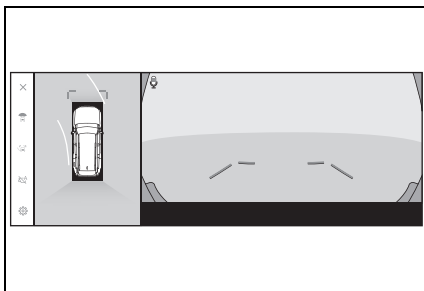

→P.392

▶ Side Clearance View & panoramic view

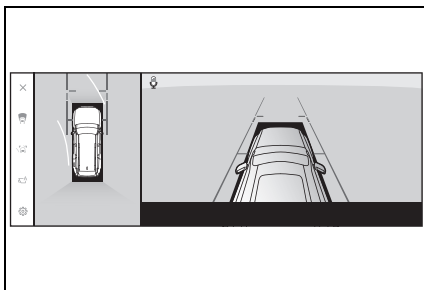

→P.392

▶ Cornering View & panoramic view

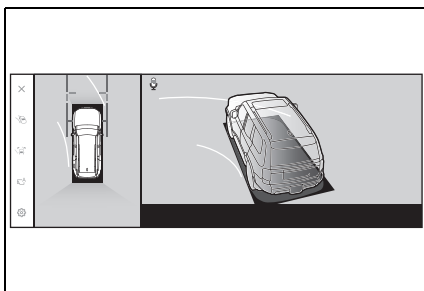

→P.392

- When checking the area to the rear of the vehicle

▶ Rear view & panoramic view

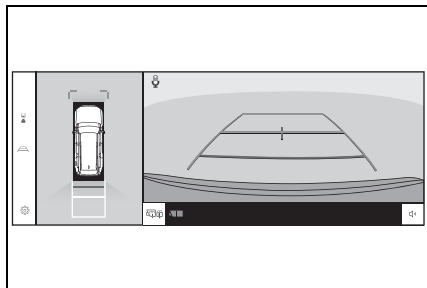

→P.401

▶ Wide rear view &amp; panoramic view

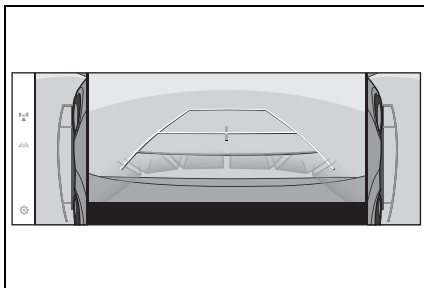

→P.410

▶ Side view &amp; Wide rear view

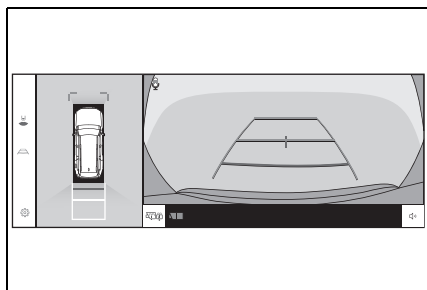

→P.401

● When folding the outside rear view mirrors

▶ Side view &amp; Wide front view

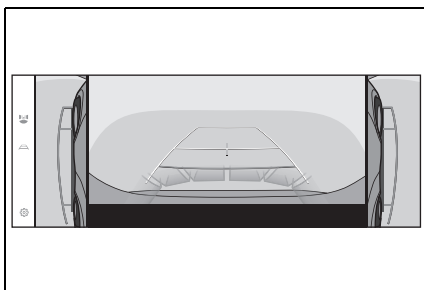

→P.410

### Camera switch

The camera switch is located as shown in the illustration.

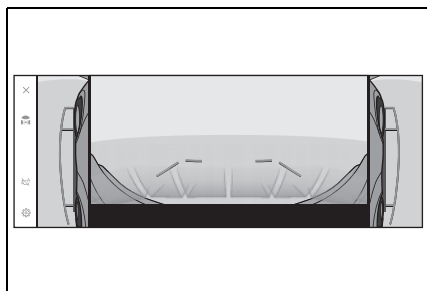

→P.410

▶ Side view &amp; Rear view

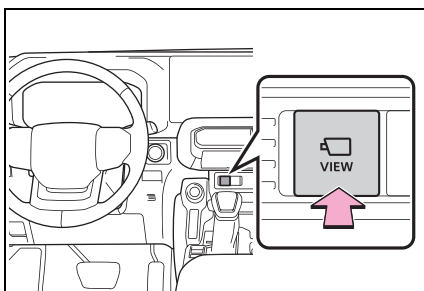

### How to switch the screen

When you press the camera switch while the power switch is in ON, the monitor display operates.

The monitor displays various views of the position of the vehicle.



(The following is an example)

**Four-wheel drive control switch is in L4 or H4 and Multi-terrain Select is in on**

■ **When the shift lever is in the P, D or N position**

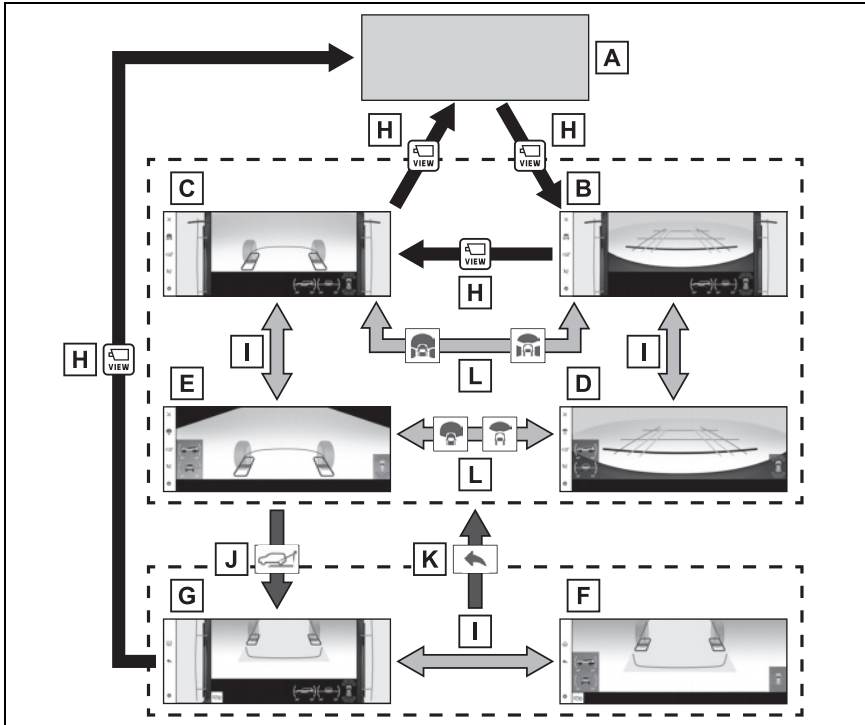

- A** Audio screen, etc.
- B** Front view & dual side views
- C** Under vehicle terrain view & dual side views
- D** Front view (magnified)
- E** Under vehicle terrain view (magnified)
- F** Under vehicle terrain view (rear wheel) (magnified)
- G** Under vehicle terrain view (rear wheel) & dual side views
- H** Press the camera switch
- I** Select the Multi-terrain Monitor screen

- J** Select the under vehicle terrain view (rear wheel) button
- K** Select the return button
- L** Select the display mode button

**■ When the shift lever is in the R position**

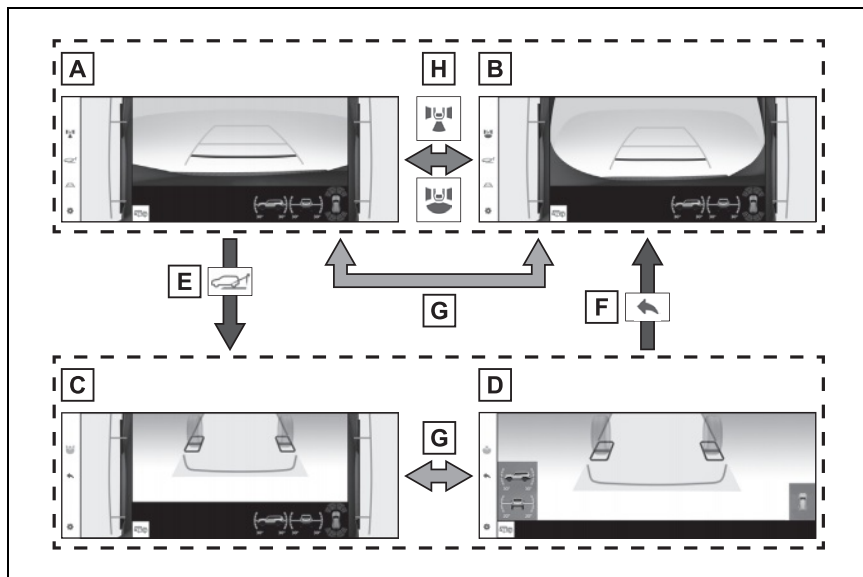

- A** Rear view & dual side views
- B** Wide rear view & dual side views
- C** Under vehicle terrain view (rear side) & dual side views
- D** Under vehicle terrain view (rear side) (magnified)
- E** Select the under vehicle terrain view (rear side) button
- F** Select the return button
- G** Select the Multi-terrain Monitor screen
- H** Select the display mode button

Four-wheel drive control switch is in H4 and Multi-terrain Select is in off

■ When the shift lever is in the P position

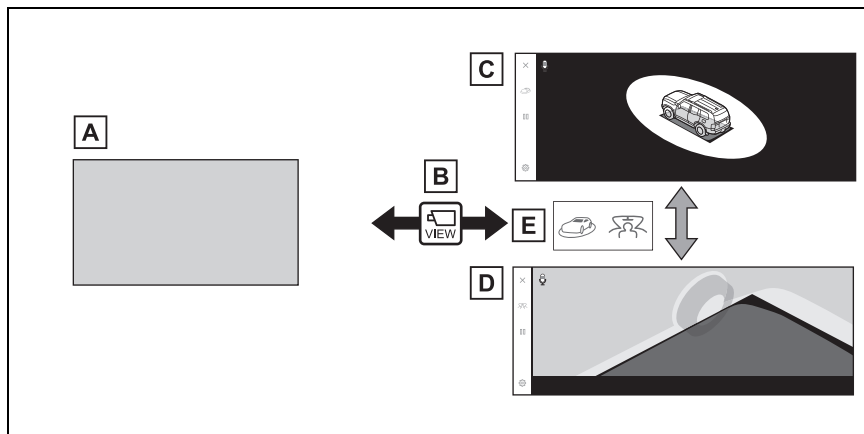

- A** Navigation screen, audio screen, etc.
- B** Pressing the camera switch
- C** Moving view
- D** See-through view
- E** Touch the display mode switching button

### ■ When the shift lever is in the D or N position

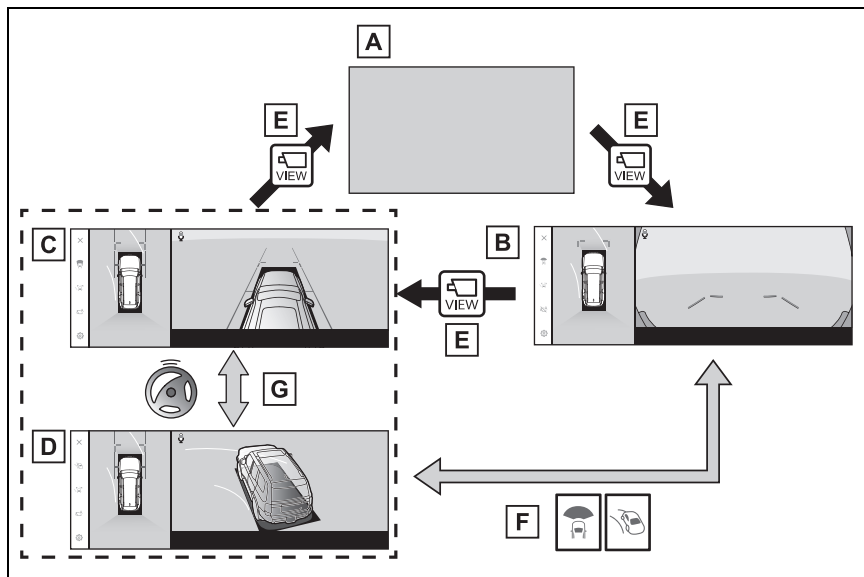

**A** Navigation screen, audio screen, etc.

**B** Wide front view & panoramic view

**C** Side clearance view & panoramic view

**D** Cornering view & panoramic view

**E** Pressing the camera switch

**F** Touch the display mode switching button

**G** When the steering wheel is turned by 180 degrees or more from the center (straight-line) position

### ■ When the shift lever is in the R position

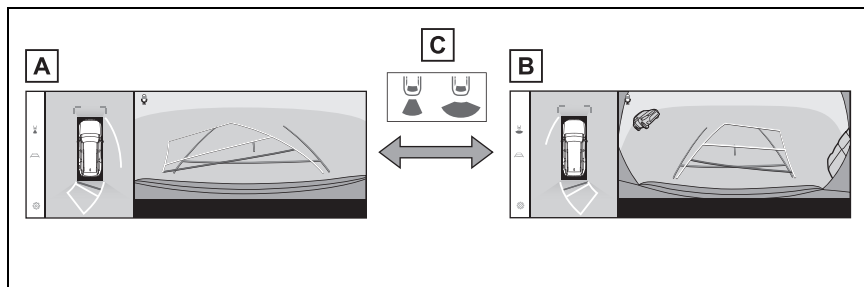

**A** Rear view & panoramic view

- B** Wide rear view & panoramic view
- C** Touch the display mode switching button

### ■ Multi-terrain Monitor screen display

- The amount of time that the Multi-terrain Monitor screen is displayed changes as follows according to the vehicle speed at the time the camera switch was pressed.
- The Multi-terrain Monitor screen is displayed if the vehicle speed is approximately 7 mph (12 km/h) or less when the camera switch is pressed.
- If the vehicle speed exceeds approximately 7 mph (12 km/h), the Multi-terrain Monitor display is canceled.
- Display settings such as guide lines mode can be saved as the my settings by registering a driver, and then applied when entering the vehicle.
- The Intelligent Assistant can be used to display the panoramic view monitor screen, change the screen mode and for other operations.

### Screen display and functions

When the four-wheel drive control switch is in L4 or H4 and Multi-terrain Select is on, the various screens display information to support several different driving situations, such as when checking for obstacles when moving forward or in reverse, or when judging road surface conditions during off-road driving.

### Front view & dual side views

Front view & dual side views can be used to check the area around the front of the vehicle.

To display the screen, press the camera switch when the shift lever is in the P, D or N position.

- In addition to an image of the front of the vehicle, guide lines are displayed in a composite view to provide reference for when deciding a direction to move forward in.
- If the front view display is selected while the screen is displayed, the screen switches from normal to magnified display. (Selecting the display again returns the screen to the normal display)
- If the steering wheel is turned 270° or more, guide lines and other features to support turning are automatically displayed.

## Screen display

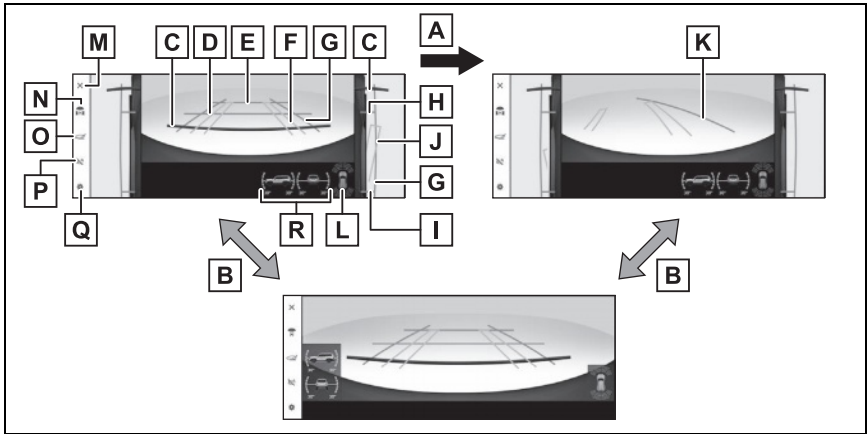

**A** If the steering wheel is turned 270° or more

**B** Selecting the display

**C** 1.5 ft. (0.5 m) distance guide line (red)

**D** 3 ft. (1 m) distance guide line (blue)

**E** 6 ft. (2 m) distance guide line (blue)

Items **C** to **E** indicate the estimated distance from the front end of the vehicle.

**F** Front tire course line (yellow)

Indicates the estimated course of the front tires according to steering wheel position.

**G** Vehicle width lines (blue)

Indicate the width of the vehicle including the outside rear view mirrors.

**H** Front tire contact line (blue)

**I** Rear tire contact line (blue)

Items **H** and **I** indicate estimated tire positions on the image.

**J** Rear tire course line (yellow)

Indicates the estimated course of the rear tires.

**K** Forward movement guide line (blue)

Indicates the estimated tire course of the tightest possible turn.

**L** Intuitive parking assist/slip display

Indicates tire spinning by changing color and flashing the tire displayed. If the intuitive parking assist detects a static object when the system is enabled, the indicator is displayed on the screen. (→P.375)

#### **M** Display off button

Changes the screen back to the previously displayed screen, such as the audio screen.

#### **N** Display mode switching button

Switches display mode every time touch the button.

#### **O** Under vehicle terrain view (rear wheel) selection button

Switch the under vehicle terrain view (rear wheel) & dual side views (→P.380)

#### **P** Automatic display mode selection button

→P.376

#### **Q** Setting button

Changes settings, such as the automatically display cornering view, the vehicle body color, the intuitive parking assist detection distance. (→P.413)

#### **R** Tilt meter

Displays the vehicle's estimated degree of incline. (→P.375)

#### ■ Tilt meter

Tilt meter displays the vehicle inclination to the front, rear, left and right within a range of 0° to approximately 30°.

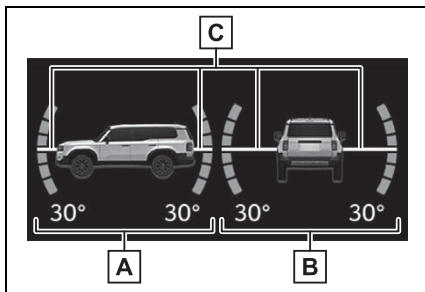

#### **A** Degree markers of incline to the front and rear

Indicates the vehicle inclination in degrees in the front and rear directions.

#### **B** Degree markers of incline to the left and right

Indicates the vehicle inclination in degrees in the left and right directions.

#### **C** Pointer

Indicates the degree of the vehicle inclination in comparison to a parallel line.

#### ■ Intuitive parking assist/slip display

Indicates the tire that is spinning when tire spinning is detected.

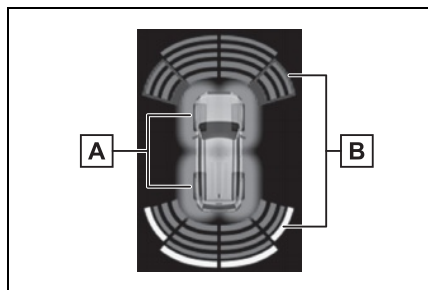

#### A Tire icon

The tire that is spinning flashes in orange.

#### B Intuitive parking assist pop-up display

Displayed if an obstacle is detected while the intuitive parking assist is enabled.

### Automatic display mode

In addition to screen switching by operating the camera switch, automatic display mode is available. In this mode, the screen is switched automatically in response to vehicle speed.

In automatic display mode, the monitor will automatically display images in the following situations:

- Touching the automatic display button  turns on auto display mode.
- Turning on auto display mode automatically displays the views in the following situations:
- When the shift lever is in “D” or “N”

- The vehicle decelerates to less than 6 mph (10 km/h) (the shift lever is in any position other than “R”)

#### ■ Front view & dual side views display

The screen can be displayed when the shift lever is in P, D or N.

#### ■ Tilt meter display

- The display indicates the incline of the vehicle in degrees shown by the movement of the pointer and the rotation of the vehicle image.
- The color of the degree markers of incline to the front, rear, left and right changes according to the current incline of the vehicle.
- After the power switch is turned to ON, the degree of incline is not displayed until such information is determined
- The degree of incline showed on the tilt meter is only an approximate indication, and may differ from the degree of incline measured using other equipment.
- When the degree of incline is larger than 30°, the pointer will be displayed beyond 30°.
- If the system malfunctions, the vehicle image and pointer are not displayed. In this case, have the vehicle inspected by your Toyota dealer.

#### ■ Slip display

If the system malfunctions, the tire icon is not displayed. In this case, have the vehicle inspected by your Toyota dealer.



## Under vehicle terrain view & dual side views

Lines indicating current vehicle and tire position are displayed in a composite view on an image taken behind the current vehicle position and assists the driver to check conditions underneath the vehicle or determine the position of the front tires.

To display the screen, press the camera switch when the shift lever is in the P, D or N position.

- It is necessary to drive a certain distance or more for the image to be displayed.
- If the under vehicle terrain view display is selected while the screen is displayed, the screen switches from normal to magnified display. (Selecting the display again returns the screen to the normal display)

### Screen display

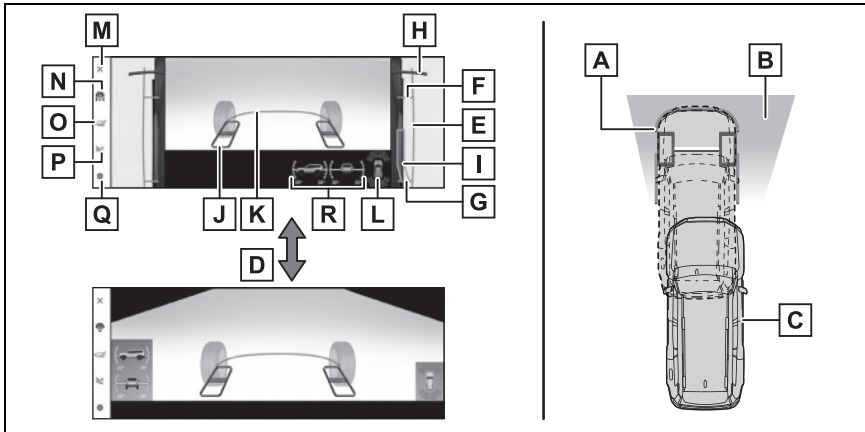

- A** Current vehicle position
- B** Image displayed in the under vehicle terrain view (image taken behind the current vehicle position)
- C** Vehicle position at the time the image was taken (behind the current vehicle position)
- D** Selecting the display
- E** Vehicle width lines (blue)

Indicate the width of the vehicle including the outside rear view mirrors.

**F** Front tire contact line (blue)

**G** Rear tire contact line (blue)

Items **F** and **G** indicate estimated tire positions on the image.

**H** 1.5 ft. (0.5 m) distance guide line (red, black)

Indicate the estimated distance from the front end of the vehicle.

**I** Rear tire course line (yellow)

Indicates the estimated course of the rear tires.

**J** Tire position indicator lines (black, white)

Indicates the estimated position of the front tires.

**K** Vehicle position indicator lines (blue)

Indicates the estimated position of the vehicle.

**L** Intuitive parking assist/slip display

Indicates tire spinning by changing color and flashing the tire displayed. If the intuitive parking assist detects a static object when the system is enabled, the indicator is displayed on the screen. (→P.375)

**M** Display off button

Changes the screen back to the previously displayed screen, such as the audio screen.

**N** Display mode switching button

Switches display mode every time touch the button.

**O** Under vehicle terrain view (rear wheel) selection button

Switch the under vehicle terrain view (rear wheel) & dual side views (→P.380)

**P** Automatic display mode selection button

→P.378

**Q** Setting button

Changes settings, such as the automatically display cornering view, the vehicle body color, the intuitive parking assist detection distance. (→P.413)

**R** Tilt meter

Displays the vehicle's estimated degree of incline. (→P.375)

### Automatic display mode

In addition to screen switching by operating the camera switch,

automatic display mode is available. In this mode, the screen is switched automatically in response to vehicle speed.

In automatic display mode, the monitor will automatically display images in the following situations:

- Touching the automatic display button  turns on auto display mode.
- Turning on auto display mode automatically displays the views in the following situations:
  - When the shift lever is in “D” or “N”
  - The vehicle decelerates to less than 6 mph (10 km/h) (the shift lever is in any position other than “R”)

#### ■ Under vehicle terrain view & dual side views

- The screen can be displayed when the shift lever is in P, D or N.
- In the following situations, under vehicle terrain view will disappear.
  - When the vehicle is driven with the steering wheel turned almost all the way to one side
  - After the hybrid system starts or the system returns to normal, a fixed distance or more has not yet been driven
  - When the tires are slipping or spinning
  - ABS is activated
  - When there is a malfunction in the system
- If the outside rear view mirrors are folded while the under vehicle terrain view is being displayed, a separate screen is displayed.
- If the vehicle is driven with the steering wheel turned to a certain steering angle or greater, a part of the screen may disappear. However, this is not a malfunction.

- In the following situations, the system may not operate normally.
  - The road is covered with snow
  - When there are shadows due to light sources such as sunlight or illumination
  - When driving on slippery roads or tires are spinning
  - Dirt or foreign matter is adhering to the camera lens
  - There is water in front of the vehicle (a river, puddle, sea water, etc.)
  - Optional equipment has been installed
  - When the camera is covered or there is an object in the image capture range
  - Tires have been replaced
  - When the back door is open
  - When the steering wheel is operated at or more than a specified steering angle
  - On roads that are not flat, such as slopes
- As vision that was captured in the past is being displayed, the screen and the actual situation may differ in the following cases:
  - An obstacle appears or moves after vision is captured.
  - Sand or snow crumbles and moves after vision is captured.
  - Mud or puddles are in the display range.
  - When the vehicle slips.



#### WARNING

##### ■ Guide lines

The tire position indicator lines and vehicle position indicator lines may differ from actual vehicle positions depending on the number of passengers, cargo weight, road grade, road surface conditions, brightness of the surrounding environment, whether tires or suspension parts other than those specified are equipped, etc. Always drive the vehicle while confirming the safety of your surroundings.

**WARNING****Under vehicle terrain view display**

The image displayed is one that was previously taken at a point behind the current vehicle position. In cases such as when objects move after the image is taken, the image displayed on the screen may differ from the actual state. In addition, when driving in the dark such as at night, there are cases when obstacles cannot be confirmed from the image.

**Under vehicle terrain view (rear wheel) & dual side views**

Lines indicating current vehicle and tire position are displayed in a composite view on an image taken behind the current vehicle position and assists the driver to check conditions underneath the vehicle or determine the position of the rear tires.

To display the screen, press the camera switch when the shift lever is in the P, D or N position, select the under vehicle terrain view (rear wheel) selection switch.

- It is necessary to drive a certain distance or more for the image to be displayed.
- If the under vehicle terrain view display is selected while the screen is displayed, the screen switches from normal to magnified display. (Selecting the display again returns the screen to the normal display)

## Screen display

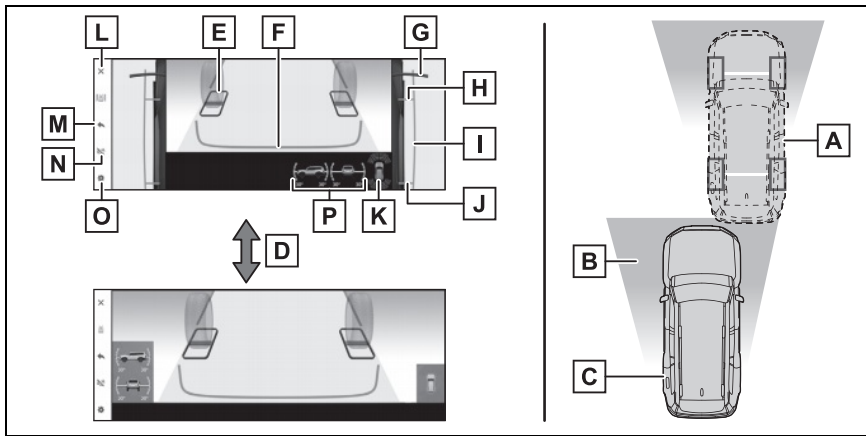

- A** Current vehicle position
- B** Image displayed in the under vehicle terrain view (rear wheel)  
(image taken behind the current vehicle position)
- C** Vehicle position at the time the image was taken (behind the current vehicle position)
- D** Selecting the display
- E** Tire position indicator lines (black, white)  
Indicates the estimated position of the rear tires.
- F** Vehicle position indicator lines (blue)  
Indicates the estimated position of the vehicle.
- G** 1.5 ft. (0.5 m) distance guide line (red, black)  
Indicate the estimated distance from the front end of the vehicle.
- H** Front tire contact line (blue)  
Indicate estimated tire positions on the image.
- I** Vehicle width lines (blue)  
Indicate the width of the vehicle including the outside rear view mirrors.
- J** Rear tire contact line (blue)  
Indicate estimated tire positions on the image.
- K** Intuitive parking assist/slip display  
Indicates tire spinning by changing color and flashing the tire displayed. If the intuitive parking assist detects a static object when the system is

enabled, the indicator is displayed on the screen. (→P.375)

#### **L** Display off button

Changes the screen back to the previously displayed screen, such as the audio screen.

#### **M** Return button

Return to the previous screen

#### **N** Automatic display mode selection button

→P.382

#### **O** Setting button

Changes settings, such as the automatically display cornering view, the vehicle body color, the intuitive parking assist detection distance. (→P.413)

#### **P** Tilt meter

Displays the vehicle's estimated degree of incline. (→P.375)

### Automatic display mode

In addition to screen switching by operating the camera switch, automatic display mode is available. In this mode, the screen is switched automatically in response to vehicle speed. In automatic display mode, the monitor will automatically display images in the following situations:

- Touching the automatic display button  turns on auto display mode.
- Turning on auto display mode automatically displays the views in the following situations:
  - When the shift lever is in "D" or "N"
  - The vehicle decelerates to less than 6 mph (10 km/h) (the shift

lever is in any position other than "R")

#### ■ Under vehicle terrain view (rear wheel)

- The screen can be displayed when the shift lever is in P, D or N.
- In the following situations, the display of the under vehicle terrain view (rear wheel) ends and the screen automatically returns to the most recently used camera screen. In addition, the under vehicle terrain view (rear wheel) selection switch cannot be operated until the next screen can be displayed.
  - When vehicle speed reaches or exceeds approximately 3 mph (5 km/h)
  - When the vehicle is driven with the steering wheel turned almost all the way to one side
  - When the tires are slipping or spinning
  - ABS is activated
  - When there is a malfunction in the system
  - When the steering wheel is operated at or more than a specified steering angle

- If the outside rear view mirrors are folded while the under vehicle terrain view (rear wheel) is being displayed, a separate screen is displayed.
- If the vehicle is driven with the steering wheel turned to a certain steering angle or greater, a part of the screen may disappear. However, this is not a malfunction.
- In the following situations, the system may not operate normally or may not be able to switch to the under vehicle terrain view (rear wheel). In addition, the under vehicle terrain view (rear wheel) selection switch cannot be operated until the next screen can be displayed.
  - The road is covered with snow
  - When there are shadows due to light sources such as sunlight or illumination
  - When driving on slippery roads or tires are spinning
  - Dirt or foreign matter is adhering to the camera lens
  - There is water in front of the vehicle (a river, puddle, sea water, etc.)
  - Optional equipment has been installed
  - When the camera is covered or there is an object in the image capture range
  - Tires have been replaced
  - When the back door is open
  - When the steering wheel is operated at or more than a specified steering angle
  - On roads that are not flat, such as slopes
- As vision that was captured in the

past is being displayed, the screen and the actual situation may differ in the following cases:

- An obstacle appears or moves after vision is captured.
- Sand or snow crumbles and moves after vision is captured.
- Mud or puddles are in the display range.
- When the vehicle slips.

### WARNING

#### ■ Guide lines

The tire position indicator lines and vehicle position indicator lines may differ from actual vehicle positions depending on the number of passengers, cargo weight, road grade, road surface conditions, brightness of the surrounding environment, whether tires or suspension parts other than those specified are equipped, etc.

Always drive the vehicle while confirming the safety of your surroundings.

#### ■ Under vehicle terrain view (rear wheel) display

The image displayed is one that was previously taken at a point behind the current vehicle position. In cases such as when objects move after the image is taken, the image displayed on the screen may differ from the actual state. In addition, when driving in the dark such as at night, there are cases when obstacles cannot be confirmed from the image.

## Rear view & dual side views/wide rear view & dual side views

The rear view & dual side views and the wide rear view & dual side views screen provide support when checking the areas of behind the vehicle and around the vehicle while backing up, for example while

parking.

The screens will be displayed when the shift lever is in the R position.

### Screen display

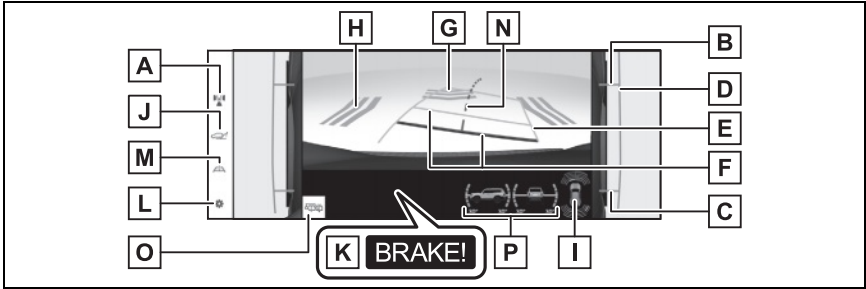

#### **A** Display mode switching button

Each time the display mode switching button is selected, the mode will change between the rear view & dual side views mode and the wide rear view & dual side views mode.

#### **B** Front tire contact line (blue)

#### **C** Rear tire contact line (blue)

Items **B** and **C** indicate estimated tire positions on the image.

#### **D** Vehicle width extension guide line (blue)

Indicates the estimated vehicle width including the outside rear view mirrors.

#### **E** Projected course lines (yellow)

Indicate the estimated course of the vehicle according to steering operations.

#### **F** Distance guide line

Shows the distance behind the vehicle when the steering wheel is turned.

- The guide lines move in conjunction with the estimated course lines.
- The guide lines display points approximately 1.5 ft. (0.5 m) (red) and approximately 3 ft. (1 m) (yellow) from the center of the edge of the bumper.

#### **G** Rear Camera Detection

Displayed automatically when a pedestrian is detected.

#### **H** Rear Cross Traffic Alert/Rear Camera Detection

The indicator is displayed on the screen in the following situations.



- When the rear radar detects an approaching vehicle or obstacle from the rear
- When the rear camera detects a pedestrian to the rear

#### **I** Intuitive parking assist/slip display

Indicates tire spinning by changing color and flashing the tire displayed. If the intuitive parking assist detects a static object when the system is enabled, the indicator is displayed on the screen. (→P.375)

#### **J** Under vehicle terrain view (rear side) selection button

Switch the under vehicle terrain view (rear side) & dual side views (→P.387)

#### **K** Parking Support Brake

When the system determines that the possibility of a collision with detected target objects is high, a warning message is displayed.

#### **L** Setting button

Changes settings, such as the automatically display cornering view, the vehicle body color, the intuitive parking assist detection distance. (→P.413)

#### **M** Guide line switching button

Each time the guide line switching button is selected, the mode will change between the estimated course line mode and the vehicle center estimated course line mode.

#### **N** Vehicle center estimated course line

Shows a vehicle center estimated course when the steering wheel is turned.

#### **O** Rear camera washer switch

Press shortly:

The rear camera washer operates for a certain period of time.

Press and hold:

The rear camera washer operates while the rear camera washer switch remains pressed.

#### **P** Tilt meter

Displays the vehicle's estimated degree of incline. (→P.375)

---

#### **■ Rear view & dual side views/wide rear view & dual side views**

- The monitor is canceled when the shift lever is shifted into any position other than the R position.
- For details about the intuitive parking assist (→P.337), Rear Cross Traffic Alert function (→P.343) and Parking Support Brake function. (→P.353)
- The display position of the intuitive parking assist and the position of obstacles displayed in the camera image do not match.

### ■ Guide lines

If the back door is not closed, guide lines will not be displayed. If the guide lines do not display even when the back door is closed, have the vehicle inspected at your Toyota dealer.



### WARNING

#### ■ Intuitive parking assist display

When a sensor indicator on the intuitive parking assist display illuminates in red or a buzzer sounds continuously, be sure to check the area around the vehicle immediately and do not proceed any further until safety has been ensured, otherwise an unexpected accident may occur.

#### ■ Rear view & dual side views/wide rear view & dual side views display

As the intuitive parking assist display and Rear Cross Traffic Alert display are displayed over the camera view, it may be difficult to see the intuitive parking assist display and Rear Cross Traffic Alert display depending on the color and brightness of the surrounding area.

## Parking

When parking in a space which is in the reverse direction to the space described in the procedure below, the steering directions will be reversed.

- 1 Shift the shift lever to the R position.
- 2 Turn the steering wheel so that the estimated course

lines are within the parking space, and back up slowly.

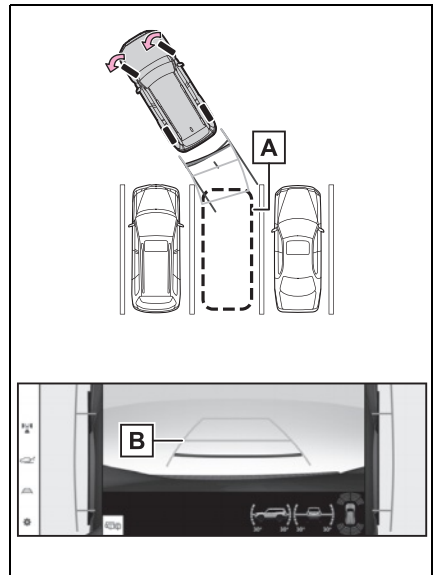

**A** Parking space

**B** Estimated course lines

- 3 When the rear position of the vehicle has entered the park-

ing space, turn the steering wheel so that the vehicle width guide lines are within the left and right dividing lines of the parking space.

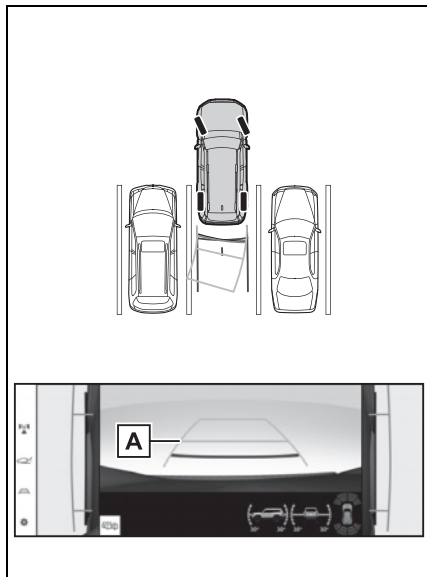

**A** Estimated course lines

- 4 Once the estimated course lines and the parking space lines are parallel, straighten the steering wheel and back up slowly until the vehicle has completely entered the parking space.
- 5 Stop the vehicle in an appropriate place, and finish parking.

### Under vehicle terrain view (rear side) & dual side views

Lines indicating current vehicle and tire position are displayed in a composite view on an image taken in front of the current vehicle position and assists the driver to check conditions underneath the vehicle or determine the position of the rear tires.

To display the screen, when the shift lever is in the R position, select the under vehicle terrain view (rear side) selection switch.

- It is necessary to drive a certain distance or more for the image to be displayed.
- If the under vehicle terrain view display is selected while the screen is displayed, the screen switches from normal to magnified display. (Selecting the display again returns the screen to the normal display)

## Screen display

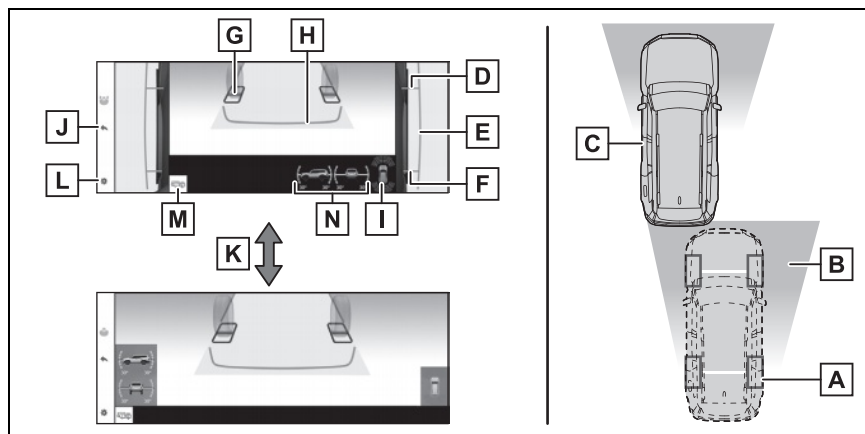

**A** Current vehicle position

**B** Image displayed in the under vehicle terrain view (rear side)  
(image taken in front of the current vehicle position)

**C** Vehicle position at the time the image was taken (in front of the  
current vehicle position)

**D** Front tire contact line (blue)

Indicate estimated tire positions on the image.

**E** Vehicle width lines (blue)

Indicate the width of the vehicle including the outside rear view mirrors.

**F** Rear tire contact line (blue)

Indicate estimated tire positions on the image.

**G** Tire position indicator lines (black, white)

Indicates the estimated position of the rear tires.

**H** Vehicle position indicator lines (blue)

Indicates the estimated position of the vehicle.

**I** Intuitive parking assist/slip display

Indicates tire spinning by changing color and flashing the tire displayed. If the intuitive parking assist detects a static object when the system is enabled, the indicator is displayed on the screen. (→P.375)

**J** Return switch

Return to the previous screen

**K** Selecting the display**L** Setting button

Changes settings, such as the automatically display cornering view, the vehicle body color, the intuitive parking assist detection distance. (→P.413)

**M** Rear camera washer switch

Press shortly:

The rear camera washer operates for a certain period of time.

Press and hold:

The rear camera washer operates while the rear camera washer switch remains pressed.

**N** Tilt meter

Displays the vehicle's estimated degree of incline. (→P.375)

**■ Under vehicle terrain view (rear side)**

- The screen can be displayed when the shift lever is in R.
- While the under vehicle terrain view (rear side) is displayed, if the vehicle speed reaches or exceeds approximately 3 mph (5 km/h), the screen automatically returns to the previous display.
- In the following situations, the display of the under vehicle terrain view (rear side) ends and the screen automatically returns to the most recently used camera screen. In addition, the under vehicle terrain view (rear side) selection switch cannot be operated until the next screen can be displayed.
  - When the tires are slipping or spinning
  - ABS is activated
  - When there is a malfunction in the system
  - Rear Cross Traffic Alert, Rear Camera Detection or Parking Support Brake is activated
  - When the back door is open
- If the outside rear view mirrors are folded while the under vehicle terrain view (rear side) is being displayed, a separate screen is displayed.
  - If the vehicle is driven with the steering wheel turned to a certain steering angle or greater, a part of the screen may disappear. However, this is not a malfunction.
  - In the following situations, the system may not operate normally or may not be able to switch to the under vehicle terrain view (rear side). In addition, the under vehicle terrain view (rear side) selection switch cannot be operated until the next screen can be displayed.
    - The road is covered with snow
    - When there are shadows due to light sources such as sunlight or illumination
    - When driving on slippery roads or tires are spinning
    - Dirt or foreign matter is adhering to the camera lens
    - There is water in front of the vehicle (a river, puddle, sea water, etc.)
    - Optional equipment has been installed
    - When the camera is covered or there is an object in the image capture range
    - Tires have been replaced
    - When the back door is open
    - When the steering wheel is operated at or more than a specified

- steering angle
- On roads that are not flat, such as slopes



### WARNING

#### ■ Guide lines

The tire position indicator lines and vehicle position indicator lines may differ from actual vehicle positions depending on the number of passengers, cargo weight, road grade, road surface conditions, brightness of the surrounding environment, whether tires or suspension parts other than those specified are equipped, etc.

Always drive the vehicle while confirming the safety of your surroundings.

#### ■ Under vehicle terrain view (rear side) display

- The image displayed is one that was previously taken at a point in front of the current vehicle position. In cases such as when objects move after the image is taken, the image displayed on the screen may differ from the actual state. In addition, when driving in the dark such as at night, there are cases when obstacles cannot be confirmed from the image.

- The area covered by the camera is limited. When driving, be sure to check the vehicle's surroundings with your own eyes and the vehicle's mirrors.

### Screen display and functions

When the four-wheel drive control switch is in H4 and Multi-terrain Select is off, the various screens display information to support several different driving situations, such as when checking for obstacles when moving forward

### Display mode when the shift lever is in "P"

This is a mode that displays images combined from the cameras to enable you to check obstacles around the vehicle. Images are displayed as if seen from the driver's seat and on an angle from above the vehicle.

## Screen display

- 1 Shift the shift lever to “P”.
  - 2 Press the camera switch.
    - The mode changes every time the display mode switching button is touched.
    - Pressing the camera switch again returns the display to the previous screen, such as the navigation screen.
- Moving view

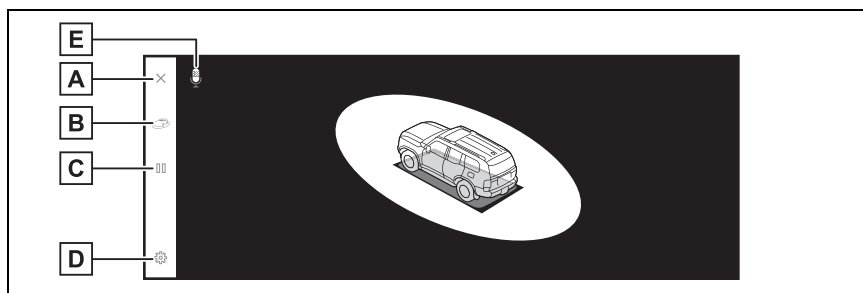

### **A** Screen off button

Turns off the camera screen and returns the previous screen, such as the audio screen.

### **B** Display mode switching button

Switches between see-through view and moving view.

### **C** Rotation pause/resume button

Pauses and resumes the rotation of the display.

### **D** Customize settings button

Changes settings, such as the automatically display cornering view, the vehicle body color, the intuitive parking assist detection distance. (→P.413)

### **E** Voice recognition icon

This icon is displayed when the Intelligent Assistant is in operation.

► See-through view

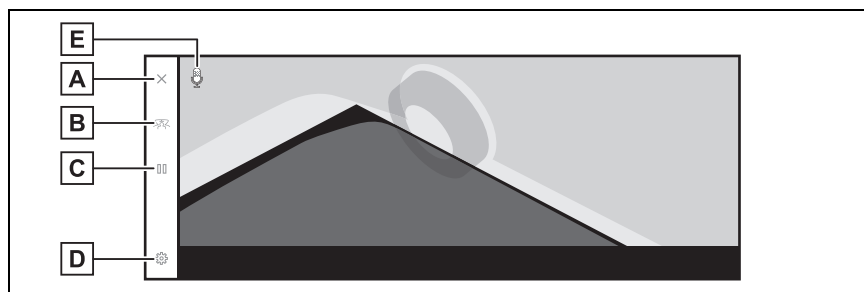

**A** Screen off button

Turns off the camera screen and returns the previous screen, such as the audio screen.

**B** Display mode switching button

Switches between see-through view and moving view.

**C** Rotation pause/resume button

Pauses and resumes the rotation of the display.

**D** Customize settings button

Changes settings, such as the automatically display cornering view, the vehicle body color, the intuitive parking assist detection distance. (→P.413)

**E** Voice recognition icon

This icon is displayed when the Intelligent Assistant is in operation.

- When the intuitive parking assist (→P.337) is turned on, you can display see-through view or moving view.
- You can also pause and resume the rotation of the see-through view and moving view screen by touching any point on the screen.

### Display mode when the shift lever is in “D” or “N”

You can check for nearby pedestrians, bicycles, and vehicles at intersections with poor visibility and T-junctions by displaying vision of your surroundings on the screen. This mode also provides support to check both sides of the vehicle for safety, avoid collisions on narrow roads, and pulling over to the side of the road.

### Screen display

- 1 Shift the shift lever to “D” or “N”.



2 Press the camera switch.

- The mode changes every time you press the camera switch.

- If the cornering view mode is on and you turn the steering wheel more than 180 degrees from the straight position, the display will change from side clearance view & panoramic view to cornering view & panoramic view.

► Wide front view & panoramic view

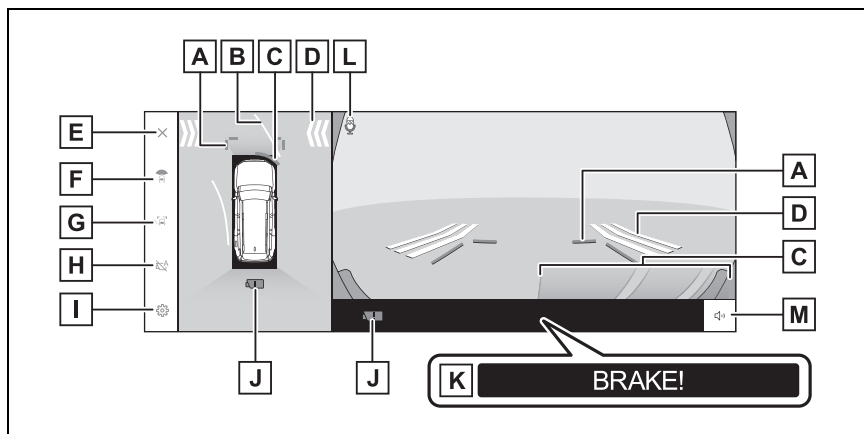

**A** Front distance guide lines

Displays about 3 ft. (1 m) in front of the vehicle.

**B** Forward estimated course lines

Displays course lines that are linked to operation of the steering wheel. (Yellow)

These lines are displayed when the steering wheel is turned more than 90 degrees from the straight position.

**C** Intuitive parking assist

Displays an indicator on the screen and sounds a buzzer when an object is detected by a sensor.

**D** FCTA (Front Cross Traffic Alert)\*

If FCTA detects nearby vehicles and/or obstacles from the front or rear of the vehicle, an indicator is displayed on the screen.

**E** Screen off button

Turns off the camera screen and returns the previous screen, such as the navigation.

**F** Display mode switching button

Switches display mode every time you touch the button.

**G** Guide line switching button

Switches guide line mode every time you touch the button. (→P.398)

**H** Automatic display button

Turns the auto display mode on or off. When the shift lever is in “D” or “N”, wide front view & panoramic view or side clearance view/cornering view & panoramic view will be automatically displayed in accordance with the vehicle speed. (→P.398)

**I** Customize settings button

Changes settings, such as the automatically display cornering view, the vehicle body color, the intuitive parking assist detection distance. (→P.413)

**J** Camera dirt detection icon

This icon is displayed when dirt is detected on the camera.

**K** PKSB (Parking Support Brake)

If an obstacle that you may collide with is detected, a message is displayed on the screen.

**L** Voice recognition icon

This icon is displayed when the Intelligent Assistant is in operation.

**M** Intuitive parking assist mute button

This button temporarily mutes the intuitive parking assist sound.

\*: If equipped

► Side clearance view & panoramic view

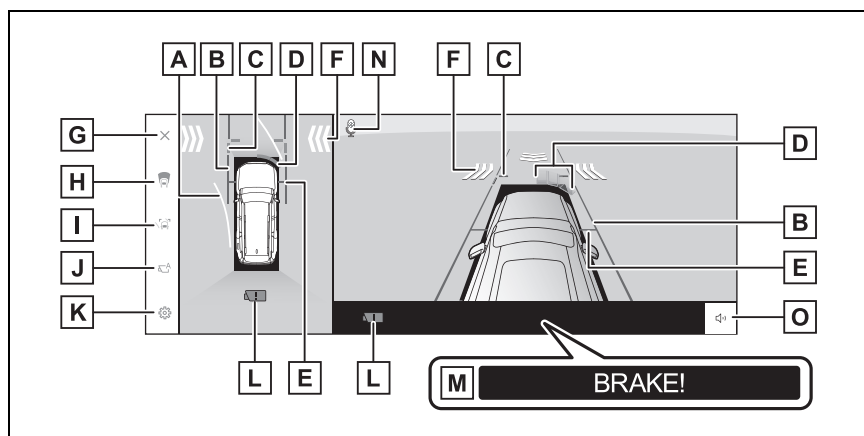

**A** Forward estimated course lines

Displays course lines that are linked to operation of the steering wheel.

(Yellow)

These lines are displayed when the steering wheel is turned more than 90 degrees from the straight position.

**B** Vehicle width guide lines

Shows guide lines of the vehicle's width including the outside rear view mirrors.

**C** Front distance guide lines

Displays about 3 ft. (1 m) in front of the vehicle.

**D** Intuitive parking assist

Displays an indicator on the screen and sounds a buzzer when an object is detected by a sensor.

**E** Front tire guide lines

Displays the position of the front tires.

**F** FCTA (Front Cross Traffic Alert)\*

If FCTA detects nearby vehicles and/or obstacles from the front or rear of the vehicle, an indicator is displayed on the screen.

**G** Screen off button

Turns off the camera screen and returns the previous screen, such as the navigation.

**H** Display mode switching button

Switches display mode every time you touch the button.

**I** Guide line switching button

Switches guide line mode every time you touch the button. (→P.398)

**J** Automatic display button

Turns the auto display mode on or off. When the shift lever is in "D" or "N", wide front view & panoramic view or side clearance view/cornering view & panoramic view will be automatically displayed in accordance with the vehicle speed.

**K** Customize settings button

Changes settings, such as the automatically display cornering view, the vehicle body color, the intuitive parking assist detection distance. (→P.413)

**L** Camera dirt detection icon

This icon is displayed when dirt is detected on the camera.

**M** PKSB (Parking Support Brake)

If an obstacle that you may collide with is detected, a message is displayed on the screen.

**N** Voice recognition icon

This icon is displayed when the Intelligent Assistant is in operation.

**O** Intuitive parking assist mute button

This button temporarily mutes the intuitive parking assist sound.

\*: If equipped

## ▶ Cornering view &amp; panoramic view

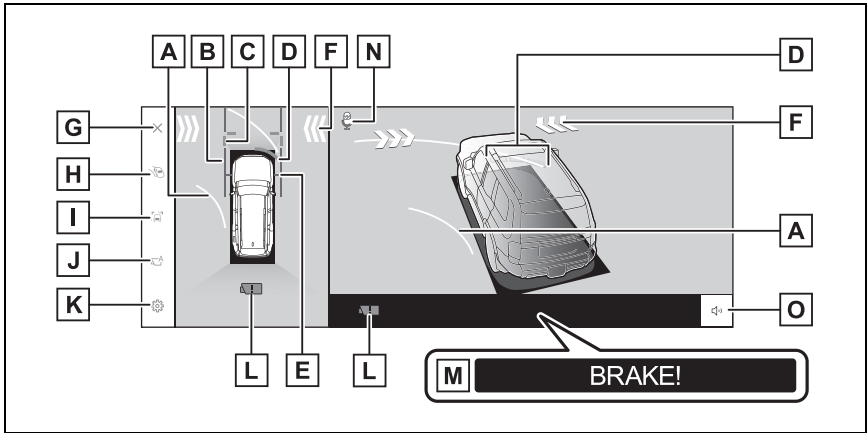
**A** Forward estimated course lines

Displays course lines that are linked to operation of the steering wheel. (Yellow)

These lines are displayed when the steering wheel is turned more than 90 degrees from the straight position.

**B** Vehicle width guide lines

Shows guide lines of the vehicle's width including the outside rear view mirrors.

**C** Front distance guide lines

Displays about 3 ft. (1 m) in front of the vehicle.

**D** Intuitive parking assist

Displays an indicator on the screen and sounds a buzzer when an object is detected by a sensor.

**E** Front tire guide lines

Displays the position of the front tires.

**F** FCTA (Front Cross Traffic Alert)\*

If FCTA detects nearby vehicles and/or obstacles from the front or rear of the vehicle, an indicator is displayed on the screen.

**G** Screen off button

Turns off the camera screen and returns the previous screen, such as the navigation.

**H** Display mode switching button

Switches display mode every time you touch the button.

**I** Guide line switching button

Switches guide line mode every time you touch the button. (→P.398)

**J** Automatic display button

Turns the auto display mode on or off. When the shift lever is in “D” or “N”, wide front view & panoramic view or side clearance view/cornering view & panoramic view will be automatically displayed in accordance with the vehicle speed.

**K** Customize settings button

Changes settings, such as the automatically display cornering view, the vehicle body color, the intuitive parking assist detection distance. (→P.413)

**L** Camera dirt detection icon

This icon is displayed when dirt is detected on the camera.

**M** PKSB (Parking Support Brake)

If an obstacle that you may collide with is detected, a message is displayed on the screen.

**N** Voice recognition icon

This icon is displayed when the Intelligent Assistant is in operation.

**O** Intuitive parking assist mute button

This button temporarily mutes the intuitive parking assist sound.

\*: If equipped

---

**■ Side Clearance View & panoramic view screen/Cornering View & panoramic view display**

- When the intuitive parking assist (→P.337) is turned on, you can display side clearance view & panoramic view/cornering view.
- The display position of the intuitive parking assist may not match the position of the obstacle displayed in the camera image.

**WARNING**

### ■ Guide line

The position of the guide lines displayed on the screen may change due to factors such as number of passengers, load weight, and road gradient. Always make sure to visually check behind you and your surroundings while you are driving.

### ■ Intuitive parking assist and FCTA (Front Cross Traffic Alert) display

The intuitive parking assist and Front Cross Traffic Alert (FCTA) displays are superimposed on the camera image, so it may be difficult to see depending on the brightness of the surroundings and colors.

## Changing the guide line display mode

The guide line display mode changes every time the guide line display mode button is touched.

### ▶ Distance guide lines mode

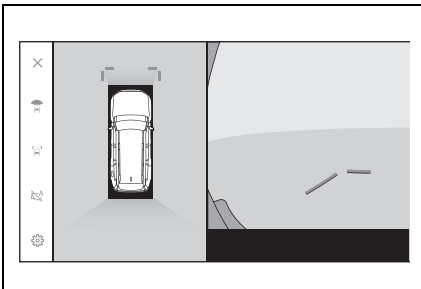

Displays about 3 ft. (1 m) in front of the vehicle. (blue)

### ▶ Estimated course lines mode

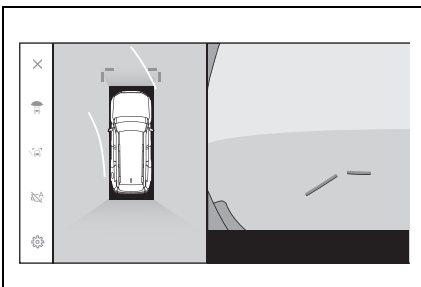

Displays course lines that are linked to operation of the steering wheel. (Yellow) These lines are displayed when the steering wheel is turned more than 90 degrees from the straight position.

## Auto display mode

Although you can display wide front view & panoramic view and side clearance view & panoramic view/cornering view by pressing the camera switch, you can also set auto display mode to display the views automatically in accordance with the vehicle speed.

- Touching the automatic display button  turns on auto display mode.
- Turning on auto display mode automatically displays the views in the following situations:
  - When the shift lever is in “D” or “N”
  - The vehicle decelerates to less

than 6 mph (10 km/h) (the shift lever is in any position other than “R”)

### Cornering view auto display

You can set the cornering view auto display mode to automatically display cornering view & panoramic view in accordance with the operation of the steering wheel.

- Turning on cornering view auto display mode automatically displays cornering view in the following situations:
  - When the shift position is in “D” or “N”
  - The vehicle decelerates to less than 7 mph (12 km/h)
  - When the steering wheel is turned by 180 degrees or more from the center (straight-line) position

### ■ Cornering view auto display

You can change cornering view auto mode in the custom settings.

### Intuitive parking assist linked display

Depending on the intuitive parking assist detection state, wide front view & panoramic view/Side clearance view/Cornering view & panoramic view will be displayed.

- The views are displayed automatically when the intuitive parking assist detects an

obstacle (when the shift position is in “D” or “N”).

- The display returns to the previous screen automatically when the intuitive parking assist stops detecting an obstacle.

### ■ Intuitive parking assist linked display

- You can also return to the previous screen by pressing the camera switch displayed on the screen.
- If the panoramic view monitor screen is canceled when an obstacle is detected, the panoramic view monitor screen can be displayed again by touching the intuitive parking assist mark shown on the multimedia system screen.

### Using the vehicle width guide lines

#### ■ Side Clearance View & panoramic view

- Check the positional relationship between the vehicle width guide lines and an obstacle.
- Turn the steering wheel and drive forward so that the vehicle width guide lines do not overlap the actual obstacle.

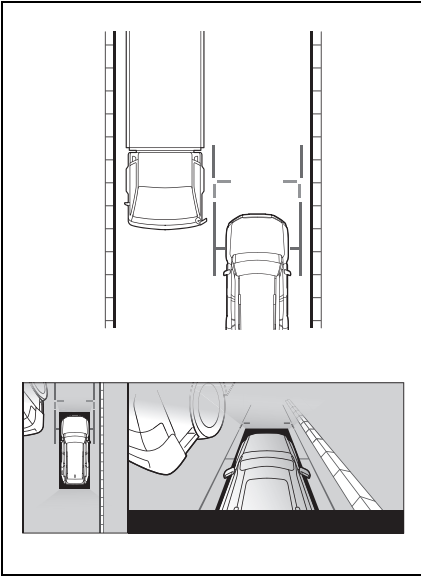

- Check the positional relationship between the vehicle width guide lines and an object such as curbs on the shoulder of a road.
- Pull the vehicle over so that the vehicle width guide lines do not overlap the obstacle as shown in the figure.
- By driving with the vehicle width guide lines parallel to the object, you can park alongside the object.

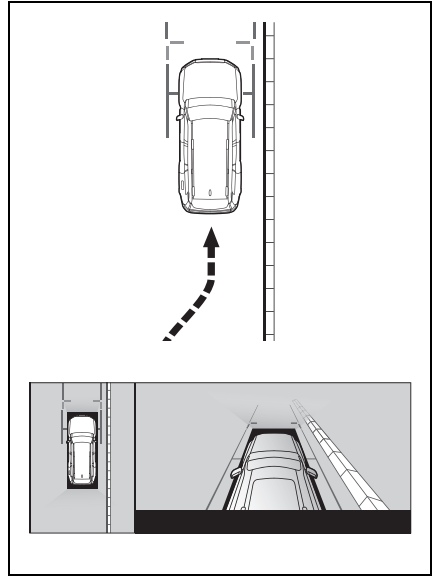

#### Using the forward estimated course lines

##### ■ Cornering View & panoramic view

- Check the positional relationship between the forward estimated course lines and an obstacle.
- Turn the steering wheel and drive forward so that the forward estimated course lines do not overlap the actual obstacle.



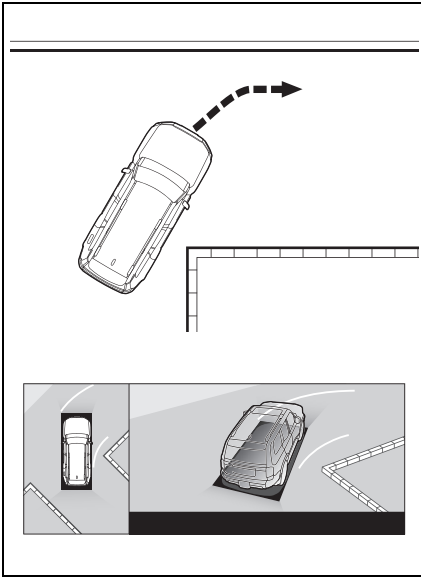

### Display mode when the shift lever is in “R”

To check for safety when parking the vehicle, an image is displayed from above the vehicle and from the rear camera.

#### Screen display

- 1 Shift the shift lever to “R”.

The mode changes every time you touch the display mode switching button.

## ▶ Rear view &amp; panoramic view

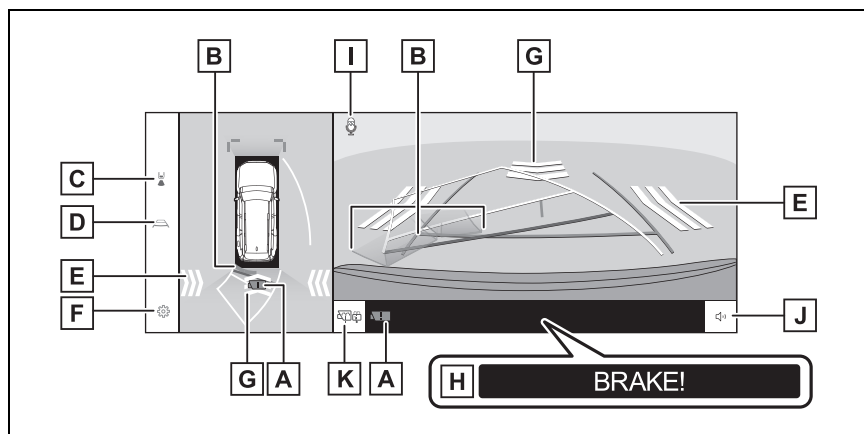
**A** Camera dirt detection icon

This icon is displayed when dirt is detected on the camera.

**B** Intuitive parking assist

Displays an indicator on the screen and sounds a buzzer when an object is detected by a sensor.

**C** Display mode switching button

Switches display mode every time you touch the button.

**D** Guide line switching button

Switches guide line mode every time you touch the button. (→P.405)

**E** RCTA (Rear Cross Traffic Alert)/RCD (Rear Camera Detection)

The indicator is displayed on the screen in the following situations.

- When the rear radar detects an approaching vehicle or obstacle from the rear
- When the rear camera detects a pedestrian to the rear

**F** Customize settings button

Changes settings, such as the automatically display cornering view, the vehicle body color, the intuitive parking assist detection distance. (→P.413)

**G** RCD (Rear Camera Detection)

If the rear camera detects a pedestrian behind the vehicle, an indicator is displayed on the screen.

**H** PKSB (Parking Support Brake)

If an obstacle that you may collide with is detected, a message is displayed on the screen.

**I** Voice recognition icon

This icon is displayed when the Intelligent Assistant is in operation.

**J** Intuitive parking assist/RCTA (Rear Cross Traffic Alert)/RCD (Rear Camera Detection) mute button

This button temporarily mutes the intuitive parking assist, RCTA (Rear Cross Traffic Alert) and RCD (Rear Camera Detection) buzzer sound. Operating the shift automatically cancels mute.

**K** Rear camera washer switch

Press shortly:

The rear camera washer operates for a certain period of time.

Press and hold:

The rear camera washer operates while the rear camera washer switch remains pressed.

## ► Wide rear view &amp; panoramic view

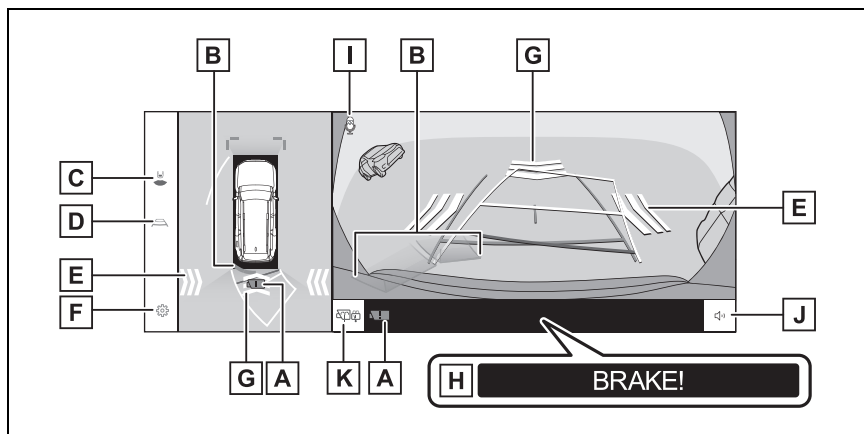
**A** Camera dirt detection icon

This icon is displayed when dirt is detected on the camera.

**B** Intuitive parking assist

Displays an indicator on the screen and sounds a buzzer when an object is detected by a sensor.

**C** Display mode switching button

Switches display mode every time you touch the button.

**D** Guide line switching button

Switches guide line mode every time you touch the button. (→P.405)

**E** RCTA (Rear Cross Traffic Alert)/RCD (Rear Camera Detection)

The indicator is displayed on the screen in the following situations.

- When the rear radar detects an approaching vehicle or obstacle from the rear
- When the rear camera detects a pedestrian to the rear

#### **F** Customize settings button

Changes settings, such as the automatically display cornering view, the vehicle body color, the intuitive parking assist detection distance. (→P.413)

#### **G** RCD (Rear Camera Detection)

If the rear camera detects a pedestrian behind the vehicle, an indicator is displayed on the screen.

#### **H** PKSB (Parking Support Brake)

If an obstacle that you may collide with is detected, a message is displayed on the screen.

#### **I** Voice recognition icon

This icon is displayed when the Intelligent Assistant is in operation.

#### **J** Intuitive parking assist/RCTA (Rear Cross Traffic Alert)/RCD (Rear Camera Detection) mute button

This button temporarily mutes the intuitive parking assist, RCTA (Rear Cross Traffic Alert) and RCD (Rear Camera Detection) buzzer sound. Operating the shift automatically cancels mute.

#### **K** Rear camera washer switch

Press shortly:

The rear camera washer operates for a certain period of time.

Press and hold:

The rear camera washer operates while the rear camera washer switch remains pressed.

#### **■ Rear view & panoramic view/wide rear view & panoramic view display**

- Pressing the camera switch when the shift lever is in “R” enables you to change to panoramic view & wide front view.
- The display position of the intuitive parking assist (→P.337) may not match the position of the obstacle displayed in the camera image.

#### **▲ WARNING**

##### **■ Guide line**

- The position of the guide lines displayed on the screen may change due to factors such as number of passengers, load weight, and road gradient. Always make sure to visually check behind you and your surroundings while you are driving.

**WARNING****Intuitive parking assist, RCTA (Rear Cross Traffic Alert) and RCD (Rear Camera Detection) display**

The intuitive parking assist, RCTA (Rear Cross Traffic Alert) and RCD (Rear Camera Detection) displays are overlapped and displayed on the camera image, so it may be difficult to see depending on the brightness of the surroundings and colors.

**Changing the guide line display mode**

The guide line display mode changes every time you touch the guide line switching button.

## ▶ Estimated course lines mode

This mode displays estimated course lines that move in accordance with the operation of the steering wheel.

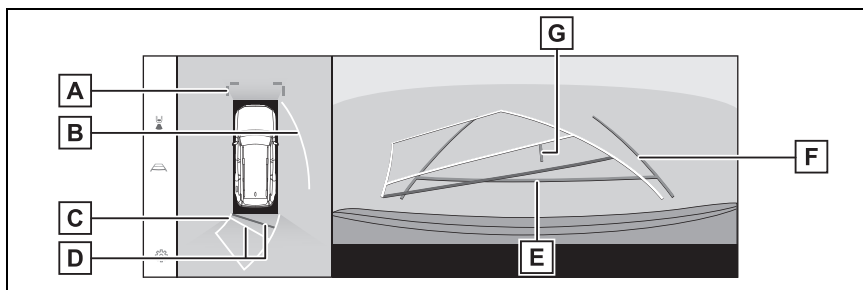
**A** Front distance guide lines

Displays about 3 ft. (1 m) (blue) in front of the vehicle.

**B** Side estimated course lines

Displays course lines (yellow) that are linked to operation of the steering wheel.

**C** Reverse estimated course lines

Displays course lines (yellow) that are linked to operation of the steering wheel.

**D** Rear distance guide lines

Displays the distance behind the vehicle.

- The distance guide line is linked to the estimated course lines.
- Displays about 1.5 ft. (0.5 m) (red) and 3 ft. (1 m) (yellow) from the center end of the rear bumper.

**E** Rear distance guide line

Displays about 1.5 ft. (0.5 m) (blue) from the end of the rear bumper.

**F** Vehicle width guide lines

Displays course lines when the vehicle is being reversed in a straight line.

- The lines are wider than the actual width of the vehicle.
- When the vehicle is straight, the guide lines will overlap with the estimated course lines.

**G** Vehicle center guide line

Displays the center of the vehicle width guide lines.

## ▶ Parking assist guide lines mode

This mode displays the steering wheel return points (parking assist guide lines). This mode is recommended for those who have a sense of the vehicle and can park the vehicle without the aid of the estimated course lines.

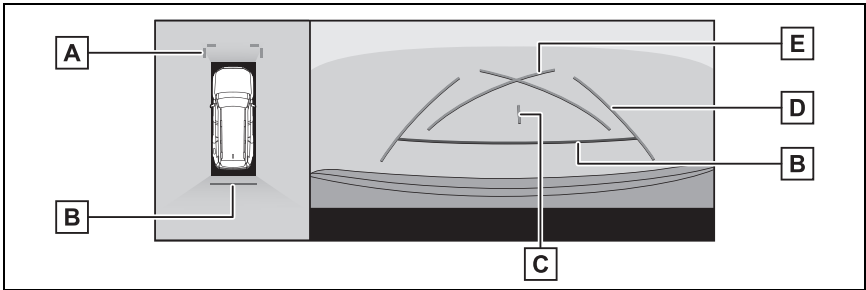
**A** Front distance guide lines

Displays about 3 ft. (1 m) (blue) in front of the vehicle.

**B** Rear distance guide lines

Displays the distance behind the vehicle.

- Displays about 1.5 ft. (0.5 m) (red) from the center end of the rear bumper.

**C** Vehicle center guide line

Displays the center of the vehicle width guide lines.

**D** Vehicle width guide lines

Displays course lines when the vehicle is being reversed in a straight line.

- The lines are wider than the actual width of the vehicle.

**E** Parking assist guide lines

Displays the course lines of the smallest turn possible behind the vehicle.

- Use the position of operating the steering wheel when parking as a guide.

## ▶ Distance guide lines mode

This mode only displays the distance guide lines. It is recommended

for those who do not need the guide lines.

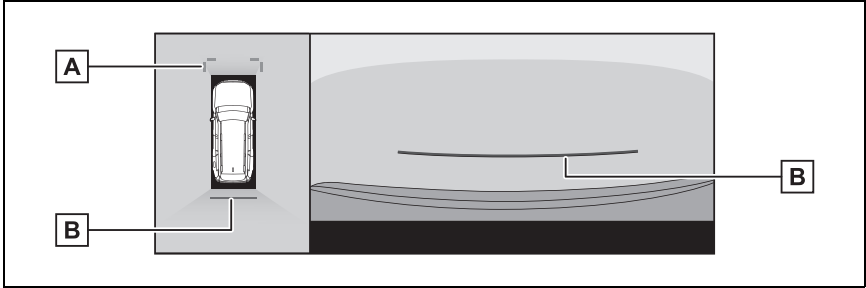

**A** Front distance guide lines

Displays about 3 ft. (1 m) (blue) in front of the vehicle.

**B** Rear distance guide lines

Displays the distance behind the vehicle.

- Displays about 1.5 ft. (0.5 m) (red) from the center end of the rear bumper.

► Estimated course center line mode

This mode displays estimated course lines and a vehicle center guide line that move in accordance with the operation of the steering wheel.

Use this mode when approaching a signpost or pole with the center of the rear bumper.

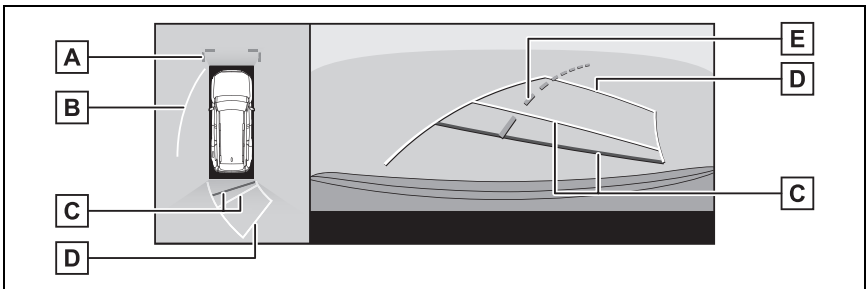

**A** Front distance guide lines

Displays about 3 ft. (1 m) (blue) in front of the vehicle.

**B** Side estimated course lines

Displays course lines (yellow) that are linked to operation of the steering wheel.

**C** Rear distance guide lines

Displays the distance behind the vehicle.

- The distance guide line is linked to the estimated course lines.
- Displays about 1.5 ft. (0.5 m) (red) and 3 ft. (1 m) (yellow) from the center end of the rear bumper.

#### **D** Reverse estimated course lines

Displays course lines (yellow) that are linked to operation of the steering wheel.

#### **E** Estimated course center line

Displays the vehicle center guide line (green) that is linked to operation of the steering wheel.

### ■ Guide line display mode

The guide lines will not be displayed if the back door is not closed. If the back door is closed but the guide lines are still not displayed, have the vehicle inspected by your Toyota dealer.

### **!** WARNING

#### ■ Guide line display mode

The rear vehicle width guide lines are wider than the actual width of the vehicle. Always make sure to visually check behind you and your surroundings when you are reversing.

### Parking using the estimated course lines mode

- 1 Shift the shift lever to "R".
- 2 Turn the steering wheel so that the estimated course lines are within the parking

space and then reverse slowly.

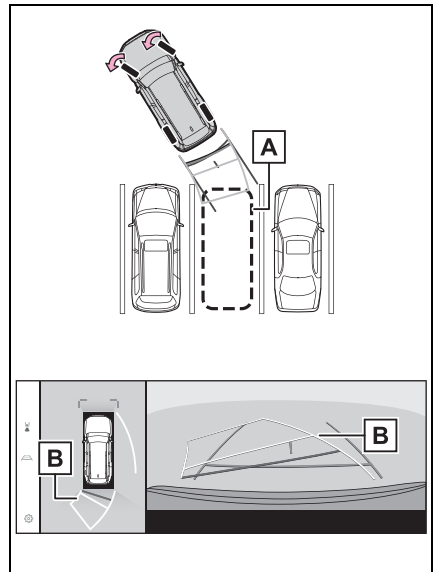

**A** Parking space



**B** Estimated course lines

- When the rear of the vehicle has entered the parking space, turn the steering wheel so that the vehicle width guide lines are within the left and right dividing lines of the parking space.

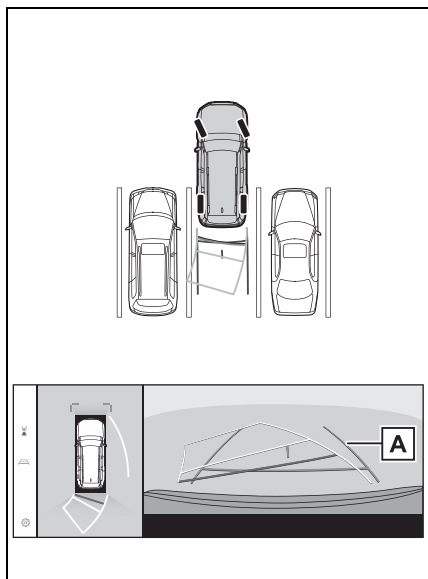
**A** Vehicle width guide lines

- Once the vehicle width guide lines and the parking space lines are parallel, straighten the steering wheel and reverse slowly until the vehicle has completely entered the parking space.
- Stop the vehicle in an appropriate place to finish parking.

**Parking using the parking assist guide lines mode**

- Shift the shift lever to "R".
- Reverse until the parking assist guide lines align with the right-hand dividing line of the parking space.

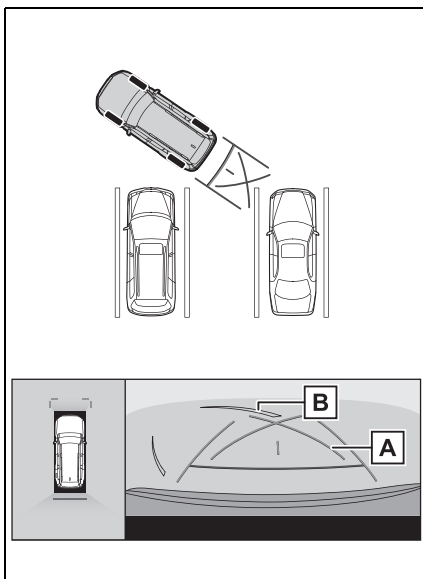
**A** Parking assist guide lines**B** Parking space dividing lines

- Turn the steering wheel all the way to the left, and reverse slowly.
- Once the vehicle is parallel with the parking space, straighten the steering wheel and reverse slowly until the vehicle has completely entered the parking space.
- Stop the vehicle in an appropriate place to finish parking.

## The screen when the outside rear view mirrors are folded

When the outside rear view mirrors are folded, an image from the side cameras rather than panoramic view will be displayed. This can assist you in confirming that the vicinity of the vehicle is safe when you are parking in a narrow place.

### Screen display

#### ► Side view & Wide front view

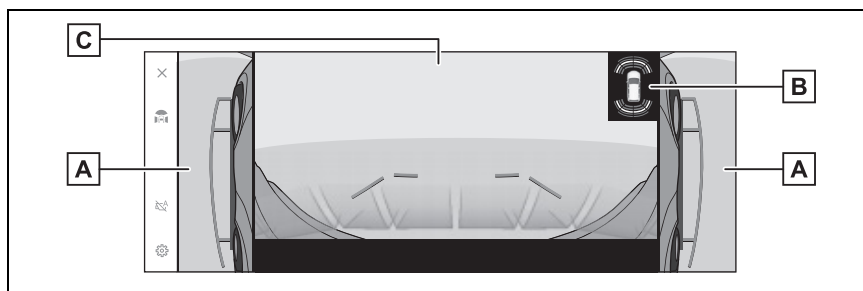

**A** Side views

**B** Intuitive parking assist

Displays an indicator on the screen and sounds a buzzer when an object is detected by a sensor.

**C** Wide front view

#### ► Side view & Rear view

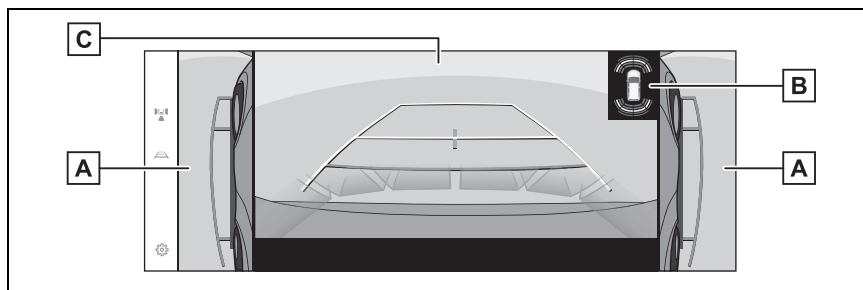

**A** Side views

**B** Intuitive parking assist

Displays an indicator on the screen and sounds a buzzer when an object is detected by a sensor.

**C** Rear view

## ▶ Side view &amp; Wide rear view

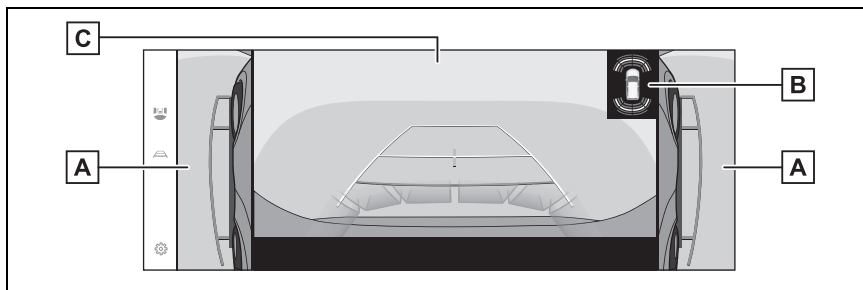
**A** Side views**B** Intuitive parking assist

Displays an indicator on the screen and sounds a buzzer when an object is detected by a sensor.

**C** Wide rear view

## ■ Intuitive parking assist display

The display position of the intuitive parking assist (→P.337) may not match the position of the obstacle displayed in the camera image.

**Zooming in on the screen**

Zooming in on the screen can be done if the image on the screen is too small and hard to see.

Touch the area that you want to zoom in on the panoramic view.

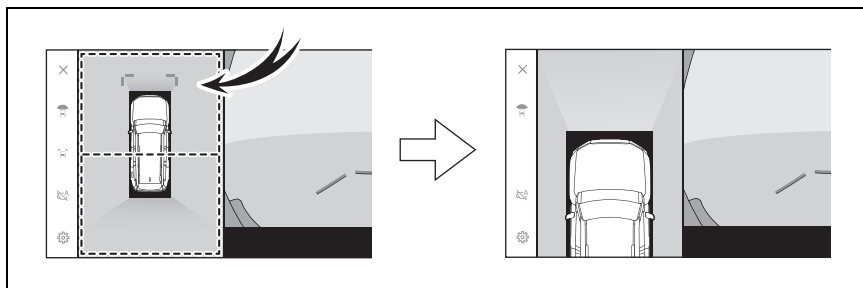
**Screen display**

- The selected area is zoomed in on.

- You can zoom in on either the area in front of the vehicle or the area behind it in panoramic view.
- To cancel the zoom, touch the screen again.

### ■ Zooming in on the screen

- The zoom feature is enabled when all of the following conditions are met:
  - The vehicle speed is below 7 mph (12 km/h)
  - The intuitive parking assist (→P.337) is turned on
- In any of the following situations, the zoom feature will be canceled automatically:
  - The vehicle speed is above 7 mph (12 km/h)
  - The intuitive parking assist is turned off
- The guide lines will not be displayed when the panoramic view is zoomed.

## Displaying transparent underfloor vision

A composite of camera vision captured in the past from the current vehicle position to assist understanding of the situation under the vehicle, tire positions, and so on can be displayed. The vision is displayed in panoramic view, side clearance view, or cornering view.

### Screen display

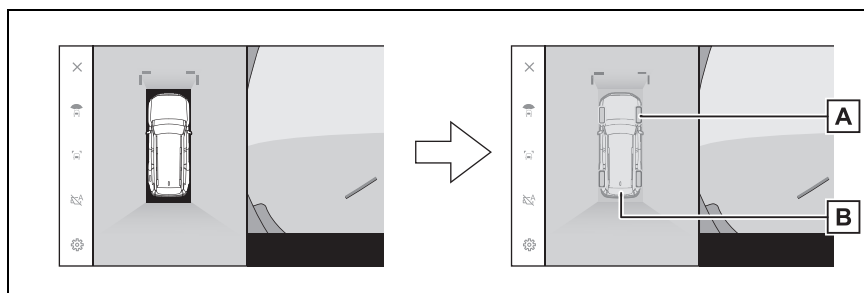

#### A Tire tracks

Displays the tire position guides linked to the steering wheel.

#### B Vehicle guide lines

Displays the exterior of the vehicle.

### ■ Transparent underfloor vision

- Transparent underfloor vision is displayed when the setting on the customized setting screen is turned on and the vehicle is moving forward or backward.
- Transparent underfloor vision is not displayed in the following cases:

- The vehicle speed is above 12 mph (20 km/h)
- The vehicle stops and a certain amount of time passes.
- If the vehicle does not move a certain distance after it is started.
- The side mirrors are folded.
- ABS is operating.
- The system is not functioning correctly.
- The system may not function correctly in the following situations:
  - Snow covered roads.
  - There are shadows from lights and so forth.
  - There is dirt or a foreign object on the camera lens.
  - Water (river, sea, etc.).
  - Optional equipment has been installed.
  - There is an obstacle in front of the camera.
  - The tires were replaced.
  - The back door is open and the camera is not in the correct position.
  - The road surface is slippery or the wheels slip.
  - The vehicle is on a hill or other steep roads.
- As vision that was captured in the past is being displayed, the screen and the actual situation may differ in the following cases:
  - An obstacle appears or moves after vision is captured.
  - Sand or snow crumbles and moves after vision is captured.
  - Mud or puddles are in the display range.
  - When the vehicle slips.
- Part or all of the transparent underfloor vision may appear black in the following cases:
  - The vehicle starts moving with no captured vision.
  - The steering wheel is turned more than a certain angle.
  - The vehicle stops and a certain amount of time passes.

**WARNING****■ Transparent underfloor vision**

- The tire and vehicle guide lines may not align correctly with the actual vehicle position due to the number of passengers, vehicle load, road gradient, road surface conditions, brightness of the surroundings, optional equipment, tire replacements, and other reasons. Always make sure to check your surroundings while you are driving.
- Displayed vision is vision that was captured in the past. Therefore, if obstacles and other objects move after being captured, the transparent underfloor vision and the actual situation may not always match.

**Changing the Multi-terrain Monitor settings**

Settings related to Multi-terrain Monitor such as the cornering view auto display and vehicle body color can be changed.

## 1 Touch the .

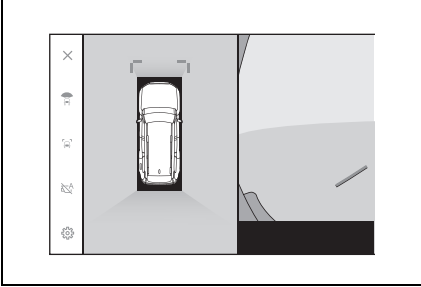

## 2 Select the desired item.

### ● Cornering view

Automatically display the cornering view.

### ● View Under Vehicle

Turn the transparent underfloor vision display setting on or off. Setting it to on and moving the vehicle forward or backwards displays a composite of camera vision captured in the past from the current vehicle position to assist understanding of the situation under the vehicle, front tire positions, and so on. The vision is displayed in panoramic view, side clearance view, or cornering view.

### ● Toyota Park Assist 3D Display

Show or hide the intuitive parking assist 3D display.

### ● Toyota Park Assist Distance

Change the distance that the intuitive parking assist starts detecting obstacles.

### ● Vehicle Body Color

Change the vehicle body color displayed on the screen.

## ■ Suspension of the settings display

For safety purposes, you cannot display the custom settings screen while the vehicle is moving.

## When using the Multi-terrain Monitor

Observe the following precautions. Failure to do so may result in an unexpected accident. Also, when driving, make sure to directly confirm the safety of your surroundings and the area to the rear of the vehicle.



### WARNING

#### ■ Conditions under which the Multi-terrain Monitor should not be used

Do not use the Multi-terrain Monitor in the following situations. The system may not operate properly, resulting in an unexpected accident.

- On icy or slick road surfaces, or in snow
- When using tire chains or emergency tires
- When the front door(s) or back door are not closed completely
- On roads that are not flat, such as hills
- If the tires of a size other than specified by Toyota are installed
- If the suspension has been modified
- If a non-Toyota product is installed on the area displayed on the screen

**WARNING****■ Guide lines**

The tire position indicator lines and vehicle position indicator lines may differ from actual vehicle positions depending on the number of passengers, cargo weight, road grade, road surface conditions, brightness of the surrounding environment, etc. Always drive the vehicle while confirming the safety of your surroundings.

**NOTICE****■ Panoramic view**

- See-through view, moving view, panoramic view, side clearance view, and cornering view produce an image that is a composite of images captured by the front camera, rear camera, and side cameras. As there is a limit to the displayable range and content, make sure you fully understand the features of the panoramic view monitor before you use it.
- The four corners of the see-through view, moving view, panoramic view, side clearance view, and cornering view have a video composition processing region centered on borders of the cameras, and image clarity may decline. However this is not a fault.
- Depending on lighting conditions near each camera, bright and dark patches may appear on the see-through view, moving view, panoramic view, side clearance view, and cornering view.

- See-through view, moving view, panoramic view, side clearance view, and cornering view does not extend higher than the installation position and image capture range of each camera.
- There are blind spots around the vehicle and as such there are regions not displayed on the panoramic view monitor.
- Three-dimensional objects displayed in wide front view, rear view, wide rear view or side view may not be displayed in see-through view, moving view, panoramic view, side clearance view, and cornering view.
- People and other three-dimensional obstacles may appear differently when displayed on the panoramic view monitor. (These differences include cases in which displayed objects appear to have fallen over, disappear near image processing regions, appear from video composition processing areas, or when the actual distance to an object differs from the displayed position.)
- When the back door, which is equipped with the rear camera, or front doors, which are equipped with side mirrors that have the built-in side cameras, are open, images will not be displayed properly on the panoramic view monitor.



## NOTICE

- The vehicle icon displayed in see-through view, moving view, panoramic view, side clearance view, and cornering view is a computer generated image, so the color, shape and size will differ from the actual vehicle. Therefore, nearby three-dimensional objects may appear to be touching the vehicle, and actual distances to three-dimensional objects may differ from those displayed.

### Area displayed on the screen

There are blind spots around the vehicle and as such there are regions not displayed on the screen. Even if nothing around the vehicle is displayed on the screen, there may actually be obstacles on the road, which you may collide with. Always make sure to visually check your surroundings.

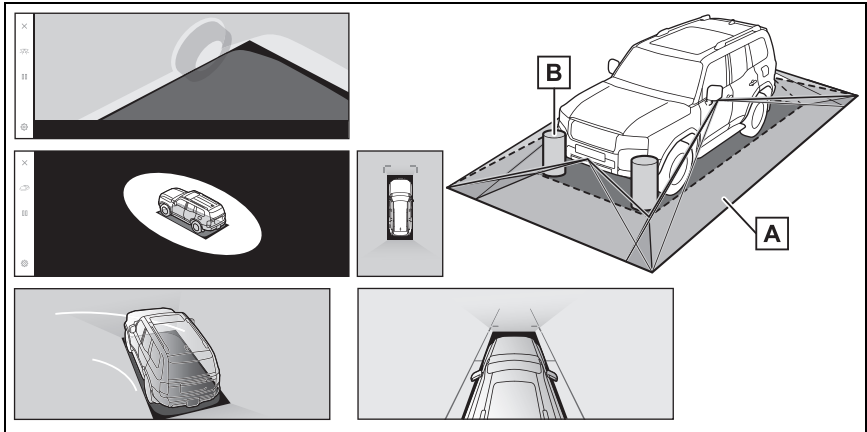

**A** Area displayed on the screen

**B** Objects not displayed on the screen

Objects in the black areas do not appear on the screen.



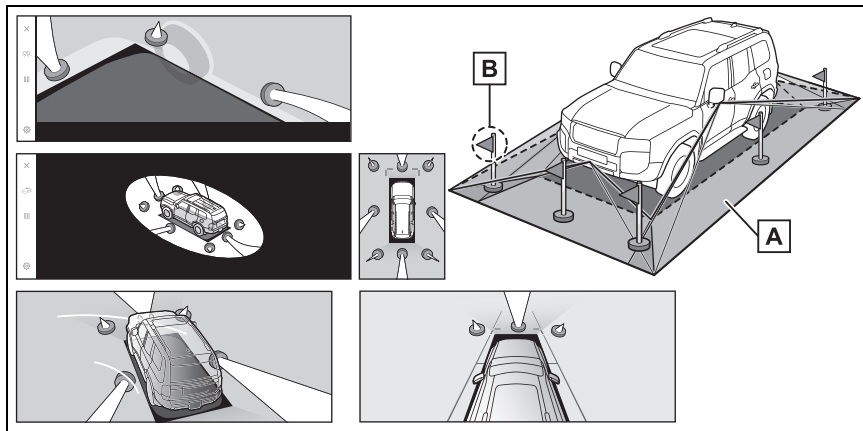

**A** Area displayed on the screen

**B** Parts of objects not displayed on the screen

Parts higher than the road do not appear on the screen.

#### ■ Area displayed on screen

- The black parts around the vehicle icon are not displayed by the camera. Visually check those areas.
- As the images are obtained from four cameras are processed and displayed on the standard of a flat road surface, see-through view, moving view, panoramic view (including zoomed display), side clearance view, and cornering view may be displayed as follows:
  - Objects may look collapsed; thinner or bigger than usual.
  - An object with a higher position than the road surface may look further away than it actually is or may not appear at all.
  - Tall objects may appear protruding from the non-displayed areas of the image.
- Variations in the brightness of the image may appear for every camera due to lighting conditions.
- The displayed image may be misaligned due to inclination of the vehicle body or change in vehicle height caused by the number of passengers, vehicle load, and quantity of fuel.
- If the doors are not completely closed, the image and the guide lines may not be displayed correctly.
- The positional relationship of the road surface and objects with the vehicle icon displayed on see-through view, moving view, panoramic view (including zoomed display), side clearance view, and cornering view may differ to the actual positions.
- Light from a back-lit license plate may appear on the screen.
- Images indicated by  in the figure are a composite, and hence some areas may be difficult to see.

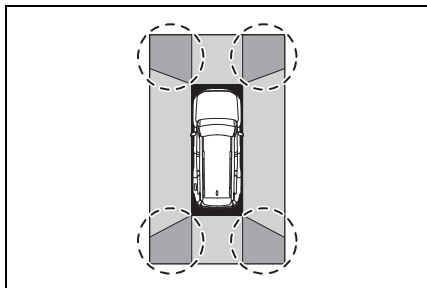

### ■ Wide front view

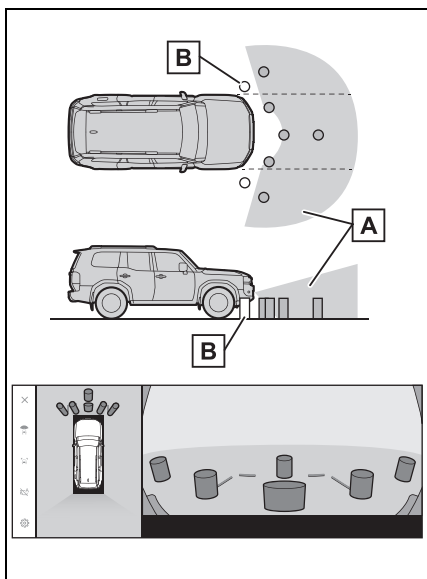

**A** Area displayed on the screen

**B** Objects not displayed on the screen

Areas close to both corners of the bumpers will not appear on the screen.

### ■ Display range

- The area covered by the camera is limited. Objects that are close to either corner of the bumper or under the bumper cannot be displayed on the screen.
- The depth perception of the image displayed on the screen differs to

the actual distance.

- The wide front view camera uses a special lens, so the depth perception of the image displayed on the screen differs to the actual distance.
- ▶ Side view & Rear view (when the side mirrors are folded)

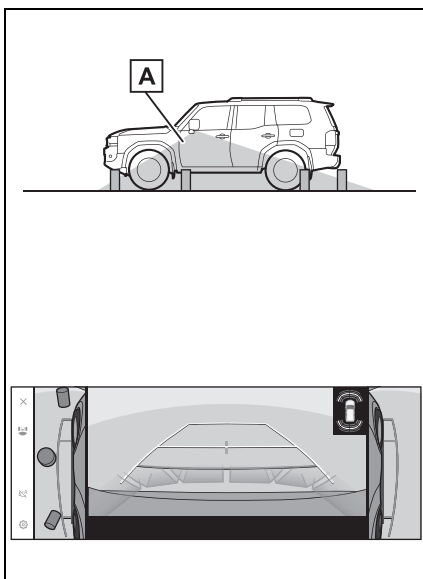

**A** Area displayed on the screen

### ■ Display range

- The range that is displayed on the screen may differ due to the state of the vehicle and road surface.
- The area covered by the camera is limited. Objects that are close to the bumper on the passenger's side or under the bumper cannot be displayed on the screen.
- The depth perception of the image displayed on the screen differs to the actual distance.
- The cameras on side view & rear view use a special lens, so the depth perception of the image displayed on the screen differs to the actual distance.

## ▶ Rear view

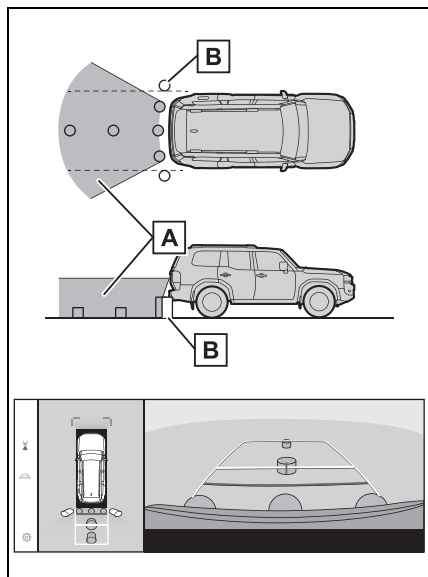

**A** Area displayed on the screen

**B** Objects not displayed on the screen

Areas close to both corners of the bumpers will not appear on the screen.

## ▶ Wide rear view

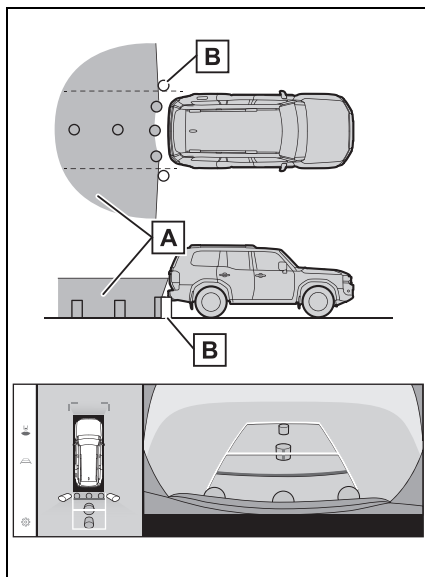

**A** Area displayed on the screen

**B** Objects not displayed on the screen

Areas close to both corners of the bumpers will not appear on the screen.

### ■ Display range

- The range that is displayed on the screen may differ due to the state of the vehicle and road surface.
- The area covered by the camera is limited. Objects that are close to either corner of the bumper or under the bumper cannot be displayed on the screen.
- The depth perception of the image displayed on the screen differs to the actual distance.
- The rear view and wide rear view cameras use a special lens, so the depth perception of the image displayed on the screen differs to the actual distance.
- Objects that are higher than the

rear camera may not appear in the monitor.

- Light from a back-lit license plate may appear on the screen.

### Camera position

The Multi-terrain Monitor cameras are in the locations shown in the figures.

#### ■ Front camera

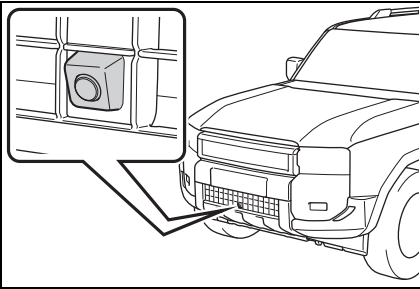

#### ■ Side cameras

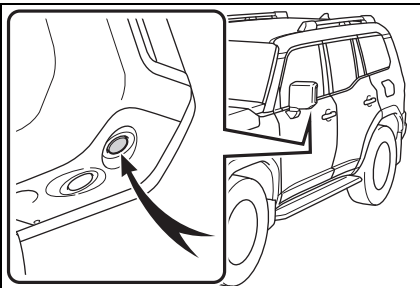

#### ■ Rear camera

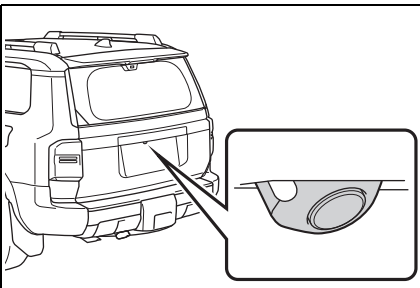

### Cleaning the camera

If dirt or foreign matter, such as water droplets, snow, or mud, has stuck to the camera, you will not be able to see the image clearly. If that happens, splash the camera with a large amount of water and then wipe the camera lens clean with a soft, damp cloth.

Rear camera: Dirt on the camera lens can be cleaned by operating the dedicated camera cleaning washer. (→P.248)

#### ⚠ NOTICE

##### ■ How to use the cameras

- The Multi-terrain Monitor may stop functioning correctly. Take note of the following items:
  - Do not hit or apply a forceful impact on the camera. Doing so may change the position and mounting angle of the camera.
  - The camera is designed to be waterproof. Do not detach, disassemble, or modify it.
  - When washing the camera lens, splash the camera with a large amount of water and then wipe the camera lens clean with a soft, damp cloth. Rubbing the camera lens forcibly may scratch the camera lens and you may no longer be able to see images clearly.
  - The camera cover is made of resin. Do not allow an organic solvent, car wax, window cleaner, or glass coating to adhere to the camera. If this happens, wipe it off immediately.

**NOTICE**

- Do not pour hot water on the vehicle in cold weather or apply other rapid changes of temperature.
- If you wash the vehicle with a high pressure car washer, do not point the hose directly at the camera or camera area. Applying strong water pressure may result in the camera malfunctioning.
- If the camera is hit, it may cause a camera malfunction. If this happens, have the vehicle inspected by your Toyota dealer as soon as possible.

**Cleaning the rear camera with washer fluid**

Dirt on the rear camera lens can be cleaned by operating the dedicated camera cleaning washer.

- When cleaning the camera, it may be difficult to see the image due to the washer fluid. When backing up, be sure to visually check all around the vehicle both directly and using the mirrors before proceeding.
- If washer fluid remains on the camera lens surface after cleaning, the image may be difficult to see at night due to the height or inclination of the headlights of the vehicle behind.
- Some dirt may not be

removed completely after cleaning. In this case, rinse the camera lens with a large quantity of water and then wipe it clean with a soft cloth dampened with water.

- Washer fluid is sprayed onto the camera lens surface. Therefore, the ice, snow, etc. adhering around the camera cannot be removed.

**NOTICE**

- If there is a sufficient amount of washer fluid but it does not spray out, check that the washer nozzle is not blocked.
- When the washer fluid reservoir is empty, do not operate the switch continually as the washer fluid pump may overheat.
- When a nozzle becomes blocked, contact your Toyota dealer. Do not try to clear it with a pin or other object. The nozzle would be damaged.
- Some foreign matters may not be removed completely after cleaning. In this case, rinse the rear camera lens with a large quantity of water and then wipe it clean with a soft cloth dampened with water. Do not strongly rub the rear camera lens, as it may be scratched and will not be able to transmit a clear image.
- Washer fluid is sprayed onto the rear camera lens surface. Therefore, the ice, snow, etc. adhering around the rear camera such as the garnish cannot be removed.

**NOTICE**

- Use fluids that are appropriate to the outside temperatures, in order to prevent the washer fluid from freezing.
- When washing the vehicle, do not let water from the high-pressure washer directly hit the nozzle. Due to the shock from the high pressure water, it is possible that the device may not operate normally. Also, the water may enter the nozzle injection opening and freeze. It causes the washer fluid not to spray properly.
- Do not subject the nozzle to sudden change of temperature such as by pouring hot water into the nozzle under the cold weather.
- The washer fluid will need to be replaced more often when the rear camera cleaner system is frequently used. Because the washer reservoir is shared with the windshield washer.
- Do not strike or hit the nozzle or subject it to a strong impact, as the nozzle installation position and angle may be changed.
- When the vehicle got strong vibration, it may be difficult to see the image due to the washer fluid drop from the nozzle.
- The display screen and placement position of the washer switch may differ depending on the type of screen and system.
- When the washer switch is pressed and held, washer fluid is sprayed while the switch is pressed.

- When activate rear camera washer, it also activate rear windows shield washer simultaneously.
- When cleaning the rear camera, it may be difficult to see the image due to the washer fluid. In this case, directly check the surroundings of the vehicle.
- If washer fluid remains on the rear camera lens surface after cleaning. Then the image may be difficult to see at night due to the height or inclination of the headlights of the vehicle behind.

### Parking assist lights

The parking assist lights of the Multi-terrain Monitor system are installed in the locations shown in the figure.

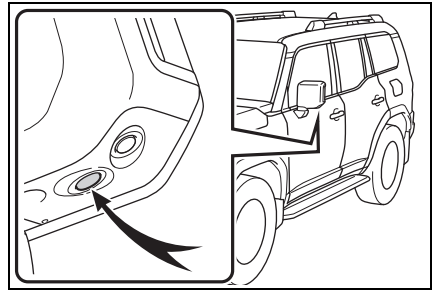
**NOTICE**

### ■ Parking assist lights

- Make sure to observe the following precautions, otherwise the Multi-terrain Monitor system may not operate correctly:
  - Do not apply excessive force to a light or subject it to a strong impact. Doing so may cause the position or installation angle of the light to deviate.



## NOTICE

- Do not remove, disassemble, or modify the lights as they have a waterproof construction.
  - When cleaning the lights, wash them with a large amount of water, and then wipe them with a soft wet cloth.
  - Do not apply organic solvents, waxes, oil removing solvents, glass coatings, etc. to the covers of the lights, as they are made of resin. If such is applied, remove it immediately.
  - Do not expose the lights to sudden temperature changes, such as applying hot water to them when it is cold.
  - When washing the vehicle with a high-pressure washer, do not spray water directly on the lights or their surrounding area. High-pressure water can damage the lights and cause them to not operate correctly.
- If a light has been subjected to a strong impact, it may be damaged. Have the vehicle inspected by your Toyota dealer as soon as possible.

### Difference between the screen and the actual road

The composite images on the Multi-terrain Monitor and guide lines give a distance guide for flat road surfaces. Therefore, there is a margin of error between the guide lines on the screen and the actual distance and course on the road.

### When the ground behind the vehicle slopes up sharply

The distance guide lines will appear to be closer to the vehicle than the actual distance. Thus, objects on up-slopes will appear to be farther away than they actually are. In the same way, there will be a margin of error between the guidelines and the actual distance and course on the road.

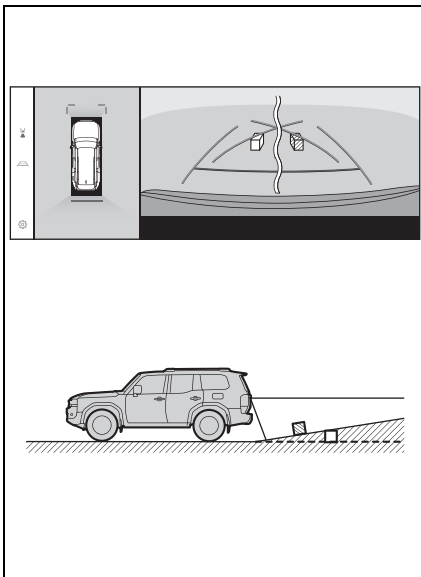

### When the ground behind the vehicle slopes down sharply

The distance guide lines will appear to be further from the vehicle than the actual distance. Thus, objects on down-slopes will appear to be closer than they actually are. In the same way, there will be a margin of error between the guidelines and the actual distance and course on the road.

error between the guidelines and the actual distance and course on the road.

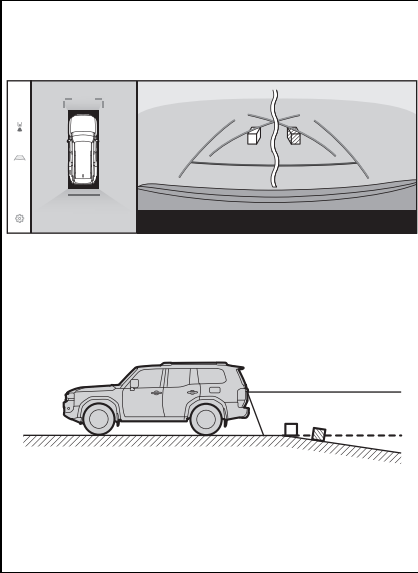

### When any part of the vehicle sags

When any part of the vehicle sags due to the number of passengers or the distribution of the load, there is a margin of error between the guide lines on the

screen and the actual distance and course on the road.

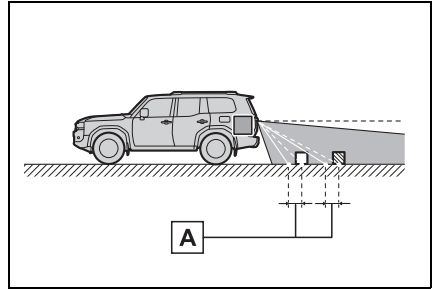

**A** Margin of error

### Estimated course center line

As the guide lines are shown midair near the rear bumper, there are times that they may look like they are off-center.

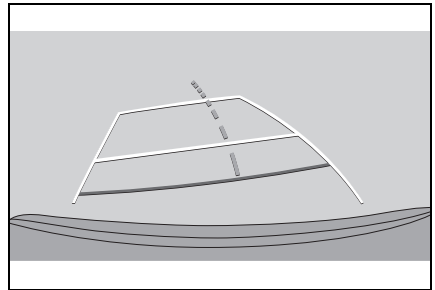

### Differences between the screen and actual 3D objects

Since the guide lines displayed on the screen are for a flat road surface, it is not possible to determine the position of three-dimensional objects. When approaching a three-dimensional object that extends outward (such as the flatbed of a truck), take note of the following cautions.



## ⚠ WARNING

### ■ Intuitive parking assist pop-up display

When the intuitive parking assist display is red, make sure to visually check before moving the vehicle any further. There is the danger that you may collide with another vehicle or have some other unforeseen accident.

### Displaying panoramic view (including zoom display)

On the screen, it appears that there is a gap between the vehicle's bumper and another object or vehicle, and it does not look as if the vehicle will collide with the object or vehicle. However, the vehicle is over the course lines, so the vehicle may collide with the object or vehicle. Make sure to visually check your surroundings.

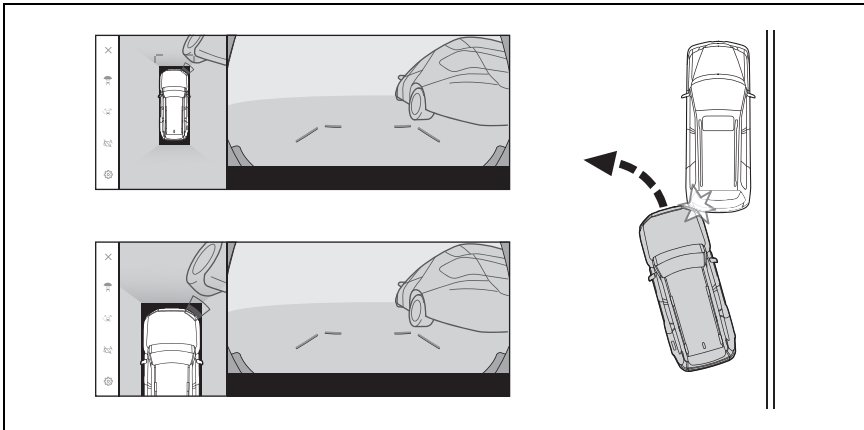

### Estimated course lines

- On the screen, it appears that the vehicle's bumper is outside of the estimated course lines, and it does not look as if the vehicle will collide with the object or vehicle. However, the vehicle is over the course lines, so the vehicle may collide with the object or vehicle. Make sure to visually check your surroundings.

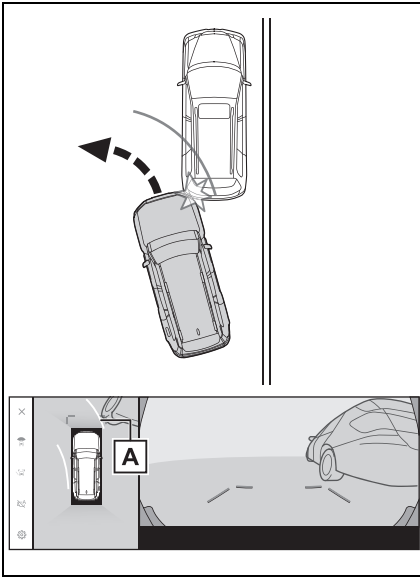

**A** Estimated course lines

- Three-dimensional objects in high positions (such as the overhang of a wall or loading platform of a truck) may not appear on the screen. Make sure to visually check your surroundings.

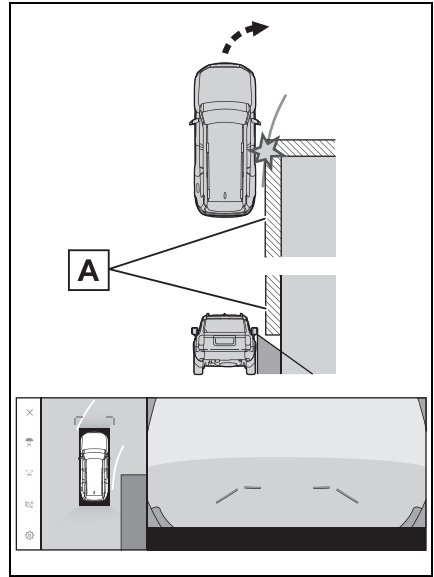

**A** Overhang of a wall

- On the screen, a truck flatbed may appear to be outside of the estimated course lines and the vehicle does not look as if it will collide with the truck. However, the flatbed may actually cross over the estimated course lines and if you reverse as guided by the estimated course lines, the vehicle may hit the truck. Make sure to visually check your surroundings.

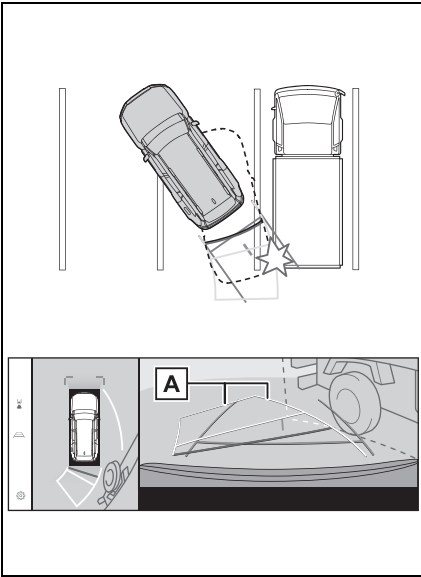

**A** Estimated course lines

### Distance guide lines

On the screen, the distance guide lines shows that a truck is parking at point **B**. However, in reality if you reverse to point **A**, you will collide with the truck. On the screen, it appears that point **A** is closest followed by points **B** and **C**. However, in reality, the distance to points **A** and **C** is the same, and point **B** is farther than **A** and **C**. Make sure to visually check behind you and your surroundings. The distance to point **D** is about 3 ft. (1 m).

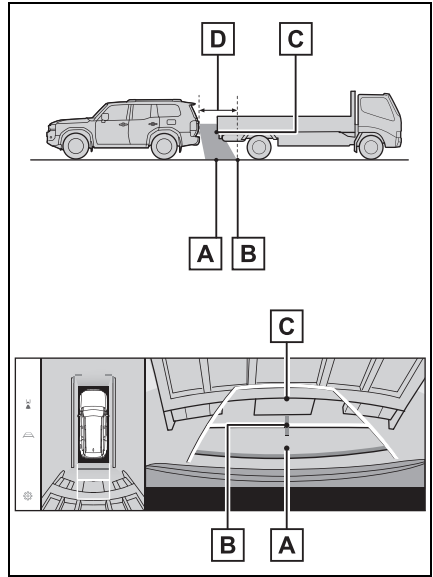

### Overhang of a diagonal beam

In panoramic view, a diagonal beam may appear straight and seems likely not to be struck, however, since the top part of the beam is actually overhanging, the vehicle may hit it. Make sure to visually check the rear and surroundings.

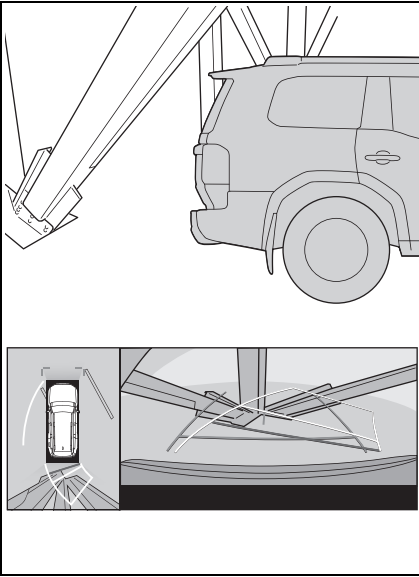

### Magnifying function

Unlike the normal panoramic view, the panoramic view magnifying function zooms in on the vehicle icon. Therefore, white lines on the road, walls, and other objects may look bent.

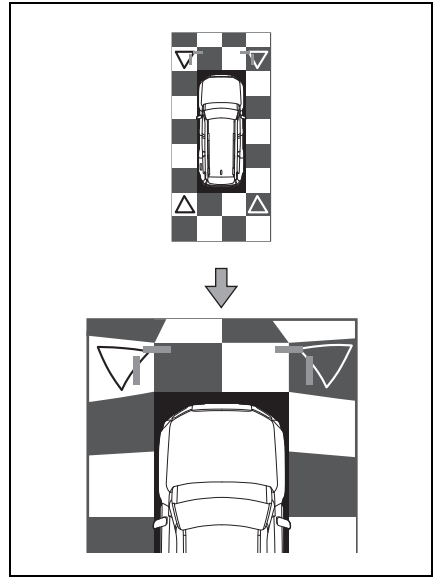

### Under vehicle terrain view

The tire position indicator lines and vehicle position indicator lines may differ from actual vehicle positions depending on the number of passengers, weight of the load, road grade, road surface conditions, brightness of the surrounding environment, etc. Always drive the vehicle while directly confirming the safety of your surroundings

#### ■ Using under vehicle terrain view

- The images displayed were previously taken behind the current vehicle position. Therefore, actual conditions may differ from those shown on the screen in the following situations.
- When conditions changed such as when an object moved or entered the frame after the image was taken.

- Loose material like sand or snow has crumbled or shifted
- An obstacle has moved
- There is a puddle, tract of mud, etc., within the display range
- The vehicle slips
- In the following situations, actual tire positions and vehicle position may differ from those indicated by the tire position indicator lines and vehicle position indicator lines.
- Tires have been replaced
- Optional equipment has been installed

 **WARNING****■ Guide lines**

The displayed guide lines are composed with the image that was previously taken and may differ from the actual state. Always drive the vehicle while confirming the safety of your surroundings.

**Things you should know****If you notice any symptoms**

If you notice or are troubled by any of the symptoms below, check the issue again referring to the likely cause and solution.

If the symptom is not resolved by the solution, have the vehicle inspected by your Toyota dealer.

Symptom	Likely cause	Solution
The screen is difficult to see	<ul style="list-style-type: none"> <li>• The vehicle is in a dark area or it is night.</li> <li>• The temperature around the lens is either high or low</li> <li>• The outside temperature is low</li> <li>• There are water droplets on the camera</li> <li>• It is raining or humid</li> <li>• Foreign matter (mud, etc.) is stuck to the camera</li> <li>• Sunlight or headlights are shining directly into the camera</li> <li>• The vehicle is under fluorescent lights, sodium lights, mercury lights, etc.</li> </ul>	<p>Visually check the vehicle's surroundings while you are driving.</p> <p>Use the Multi-terrain Monitor again once the camera and conditions have improved.</p> <p>The procedure for adjusting the picture quality of the Multi-terrain Monitor system is the same as the procedure for adjusting the screen display. Refer to the "MULTIMEDIA OWNER'S MANUAL".</p>
The image is blurry	Dirt or foreign matter, such as water droplets, snow, or mud, has stuck to the camera lens.	<p>Splash the camera with a large amount of water and then wipe the camera lens clean with a soft, damp cloth.</p> <p>Rear camera: Operate the dedicated camera cleaning washer and clean the camera lens. (→P.248)</p>
The screen is misaligned	The camera has received a strong impact.	Have the vehicle inspected by your Toyota dealer.

Symptom	Likely cause	Solution
The guide lines are significantly misaligned	The camera position is misaligned.	Have the vehicle inspected by your Toyota dealer.
	<ul style="list-style-type: none"> <li>• The vehicle is tilted. (There is a heavy load on the vehicle, tire pressure is low due to a tire puncture, etc.)</li> <li>• The vehicle is on an incline.</li> </ul>	Visually check the vehicle's surroundings while you are driving.
The estimated course lines move even though the steering wheel is straight (the vehicle width guide lines and estimated course lines are out of alignment).	There is a malfunction in the signals being output by the steering sensor.	Have the vehicle inspected by your Toyota dealer.
The guide lines are not displayed	The back door is open.	Close the back door. If this does not resolve the symptom, have the vehicle inspected by your Toyota dealer.
<p>The panoramic view display cannot be enlarged.</p> <p>The see-through view/moving view, side clearance view, and cornering view cannot be displayed.</p>	The intuitive parking assist may be malfunctioning or dirty.	Follow the correction procedures for malfunctions of the intuitive parking assist. (→P.337)

Symptom	Likely cause	Solution
Washer fluid dose not spray out.	When the washer fluid reservoir is empty.	Replenish washer fluid.
	When a nozzle becomes blocked.	Have the vehicle inspected by your Toyota dealer.
	When washer fluid is frozen.	Use washer fluids that are appropriate to the outside temperatures.
	The back door is open.	Close the back door.
	Washer fluid is not filled into the washer path hose due to no operation for an extended period of time.	Operate the rear camera washer several times.
Rear camera image is difficult to see.	Foreign matters (such as water droplets, mud, snow and snow melting agents.) is on the camera lens.	Rinse the camera with a large quantity of water, wipe it clean with a soft cloth dampened with water.
	Foreign matters (such as Ice, snow and mud) is attached to surrounding parts of the camera lens.	Remove foreign matters.
The washer switch does not respond.	The panoramic view monitor is malfunctioning.	Have the vehicle inspected by your Toyota dealer.

### Information about free/open source software

#### About Free / Open-Source Software Information

This product includes the free / open-source software.

You can obtain the licensing information of the free / open-source software from the following URL.

<https://www.denso.com/global/en/opensource/svss/toyota/>



## Driving mode select switch\*

\*: If equipped

The driving modes can be selected to suit driving condition.

## System components

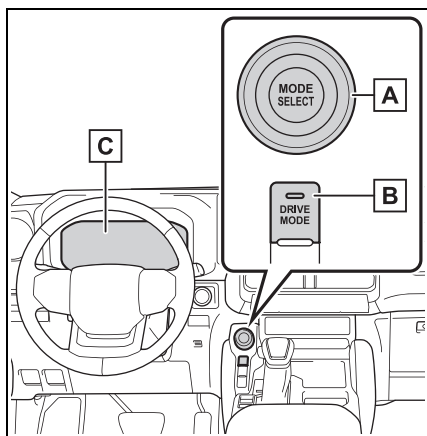

- A** MODE SELECT switch
- B** DRIVE MODE switch
- C** Multi-information display (→P.96, 106)

## Selecting the driving mode

- 1 Press the DRIVE MODE switch.

The indicator **A** on the switch will

turn on.

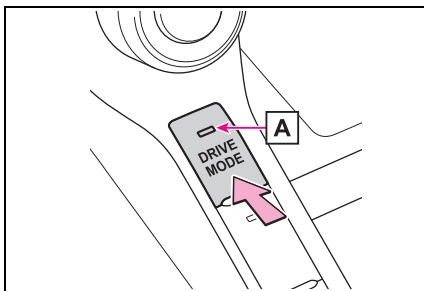

- 2 Select the driving modes on the multi-information display while turning the MODE SELECT switch left and right.

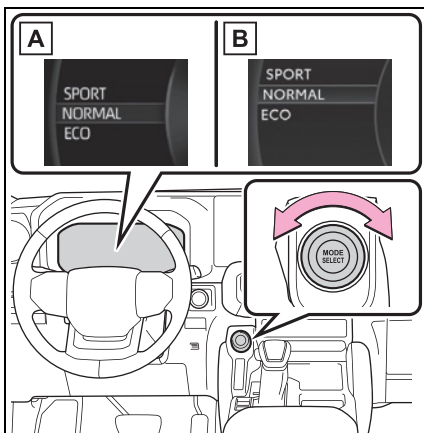

- A** Multi-information display (7-inch display model)
- B** Multi-information display (12.3-inch display model)

- Normal mode

Provides an optimal balance of fuel economy, quietness, and dynamic performance. Suitable for city driving.

- Eco drive mode

Helps the driver accelerate in an eco-friendly manner and improve fuel economy through moderate

throttle characteristics and by controlling the operation of the air conditioning system (heating/cooling). The “ECO” indicator comes on.

- Sport mode

Controls the hybrid system to provide quick, powerful acceleration. This mode is suitable for when agile driving response is desired, such as when driving on roads with many curves. The “SPORT” indicator comes on.

- ▶ When Eco drive mode is selected
- When the four-wheel drive control switch is in L4
- When the Multi-terrain Select (if equipped) is turned on
- When the “TOW HAUL” mode is turned on

---

#### ■ The driving mode select switch can be operated when

The four-wheel drive control switch is in H4.

#### ■ Operation of the air conditioning system in Eco drive mode

Eco drive mode controls the heating/cooling operations and fan speed of the air conditioning system to enhance fuel efficiency. To improve air conditioning performance, perform the following operations:

- Turn off eco air conditioning mode (→P.476)
- Adjust the fan speed (→P.469)
- Turn off Eco drive mode (→P.433)

#### ■ Automatic deactivation of driving mode

Driving mode is deactivated and the driving mode will be changed to normal mode in the following conditions:

- ▶ When Sport mode is selected
- After turning the power switch off and then turning it to ON.
- When the four-wheel drive control switch is in L4
- When the Multi-terrain Select (if equipped) is turned on
- When the “TOW HAUL” mode is turned on

## Four-wheel drive system

Use the four-wheel drive control switch and center differential lock switch to select the following transfer and center differential modes.

### Four-wheel drive control switch

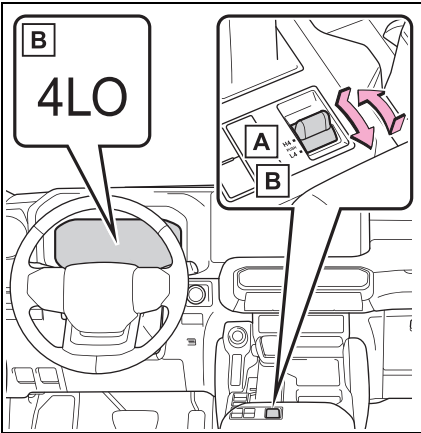

#### **A** H4 (high speed position)

Normal driving on all types of roads.

#### **B** L4 (low speed position)

Driving requiring maximum power and traction such as climbing or descending steep hills, off-road driving, and hard pulling in sand or mud, etc.

The low speed four-wheel drive indicator will come on.

## Shifting between H4 and L4

### ■ Shifting from H4 to L4

- 1 Stop the vehicle completely.
- 2 Shift the shift lever to N.
- 3 Push and shift the four-wheel drive control switch to L4.

Maintain this condition until the low speed four-wheel drive indicator turns on.

### ■ Shifting from L4 to H4

- 1 Stop the vehicle completely.
- 2 Shift the shift lever to N.
- 3 Push and shift the four-wheel drive control switch to H4.

Maintain this condition until the low speed four-wheel drive indicator turns off.

## Center differential lock switch

Lock the center differential when your vehicle's wheels get stuck in a ditch or when driving on a slippery or bumpy surface.

The center differential lock indicator will come on.

To unlock the center differential, push the switch again.

Unlock the center differential after the wheels have been freed, or after moving to a flat, non-slippery surface.

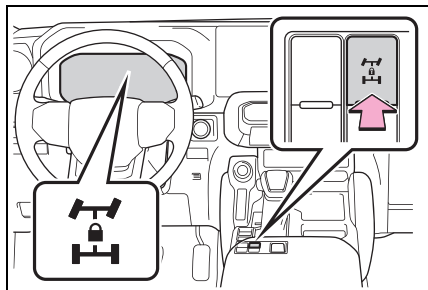

#### ■ The four-wheel drive control switch can be operated when

- The power switch is in ON.
- The shift lever is in N.
- The vehicle is stopped completely.

#### ■ The low speed four-wheel drive indicator light

The indicator light blinks while shifting between “H4” and “L4”.

#### ■ Advice for driving on slippery roads

- If you shift the four-wheel drive control switch to L4 and the shift lever to the 2 range of M mode while driving in steep off-road areas, the output of the brake can be controlled effectively by the Active TRAC, which assists the driver to control the driving power of 4 wheels.
- Use the 1 range of M mode of the shift lever for maximum power and traction when your wheels get stuck or when driving down a steep incline.

#### ■ The center differential lock indicator

The indicator blinks while locking/unlocking the center differential.

#### ■ The center differential lock switch can be operated when

- The power switch is in ON.
- The vehicle speed is less than 62 mph (100 km/h).

#### ■ Locking/unlocking the center differential

- When the four-wheel drive control switch is in L4 with the center differential locked, VSC is automatically turned off. (The center differential lock and VSC OFF indicator lights come on.)
- If the operation is not completed, the center differential lock indicator blinks. If the indicator light does not turn off when unlocking the center differential, drive straight ahead while accelerating or decelerating, or drive in reverse.
- If the center differential lock/unlock is not completed within 5 seconds while the cruise control system is on, cancel the cruise control system.

#### ■ If the low speed four-wheel drive indicator light or the center differential lock indicator blinks

- If the low speed four-wheel drive indicator light continues to blink when using the four-wheel drive control switch, stop the vehicle completely, move the shift lever to N and then operate the switch again.
- If the hybrid system is started when the outside temperature is low, the four-wheel drive control switch may not be shifted between “H4” and “L4”, as the automatic transmission fluid temperature is low. In this case, follow the instructions displayed on the multi-information display and operate the switch again after warming up the engine.

If the low speed four-wheel drive indicator light or the center differential lock indicator continues to blink even after attempting the above, there may be a malfunction in the engine, the brake system or the four-wheel drive system. In this

case, you may not be able to shift between H4 and L4, and the center differential lock may not be operable. Have the vehicle inspected by your Toyota dealer immediately.

### WARNING

#### ■ While driving

Never move the four-wheel drive control switch if the wheels have lost traction. Doing so may cause an accident resulting in death or serious injury.

#### ■ When the vehicle is parked

If the shift lever is moved before the low speed four-wheel drive indicator turns on/off, the transfer mode may not be shifted completely. The transfer mode disengages both the front and rear driveshafts from the powertrain and allows the vehicle to move regardless of the shift position. (At this time, the indicator blinks and the buzzer sounds.)

Therefore, the vehicle is free to roll even if the shift lever is in "P". You or someone else could be seriously injured. You must complete the shifting of the transfer mode.

### NOTICE

#### ■ To prevent damage to the center differential

- For normal driving on dry and hard surface roads, unlock the center differential.
- Unlock the center differential after the wheels are out of the ditch or off the slippery or bumpy surface.
- Do not push the center differential lock switch when the vehicle is turning or when its wheels are spinning freely off the ground.

## Rear differential lock system\*

\*: If equipped

**Use the rear differential lock system only when wheel spinning occurs in a ditch or on a slippery or ragged surface. This system is effective in case one of the rear wheels is spinning.**

## Rear differential lock switch

Press the switch to turn the system on/off.

At this time, the rear differential lock indicator and indicator in the differential lock/unlock display will blink. Wait a few seconds for the system to complete operation. After the rear differential is locked, the indicators will stop blinking and remain on.

To unlock the rear differential, push the switch again.

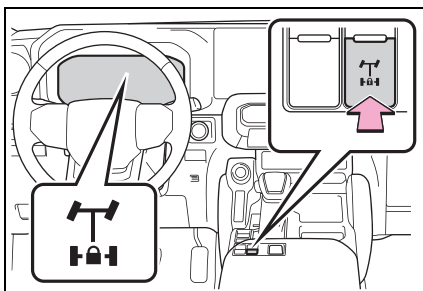

### ■ Operating tips

First turn the four-wheel drive control switch to "L4" to see if you can move forward. If this does not work, use the rear differential lock system

also.

- Be sure to stop the wheels before locking the differential.
- Unlock the differential as soon as the vehicle moves out.

#### ■ Unlocking the rear differential

If the rear differential lock indicator still flashes even after unlocking the rear differential, check the safety of the surrounding area and slightly turn the steering wheel in either direction while the vehicle is in motion.

#### ■ Automatic unlocking feature

The differential will unlock if any of the following conditions are met:

- Turn off the power switch.
- Shifting the four-wheel drive control switch to “H4”.
- Unlock the center differential.

#### ■ After unlocking the rear differential

Check that the indicators go off.

#### ■ The rear differential lock indicator and indicator in the differential lock/unlock display

- The indicators blink while locking/unlocking the rear differential.
- If the indicators continue to blink when you operate the rear differential lock switch, check the safety of the surrounding area and turn the steering wheel in either direction while the vehicle is in motion.

If the indicators continue to blink even if doing so, have the vehicle inspected by your Toyota dealer as soon as possible. There may be a trouble in the four-wheel drive system.

#### ■ Locking the rear differential

The following systems do not operate when the rear differential is locked.

- ABS

- Brake assist system
- VSC
- Downhill assist control system
- Active TRAC



#### WARNING

#### ■ When using the rear differential lock system

Failure to observe the following precautions may result in an accident.

- Do not lock the rear differential in the conditions other than above.
- Do not lock the rear differential until the wheels have stopped spinning.
- Do not drive over 5 mph (8 km/h) when the differential is locked.
- After unlocking the rear differential, turn the switch off immediately and do not keep driving with the switch on.

## Crawl Control\*

\*: If equipped

**Allows travel on extremely rough off-road surfaces at a fixed low speed without pressing the accelerator or brake pedal. Minimizes loss of traction or vehicle slip when driving on slippery road surfaces, allowing for stable driving.**



### WARNING

#### ■ When using Crawl Control

Do not rely solely on the Crawl Control. This function does not extend the vehicle's performance limitations. Always thoroughly check the road conditions, and drive safely.

#### ■ These conditions may cause the system not to operate properly

When driving on the following surfaces, the system may not be able to maintain a fixed low speed, which may result in an accident:

- Extremely steep inclines.
- Extremely uneven surfaces.
- Snow-covered roads, or other slippery surfaces.

## System components

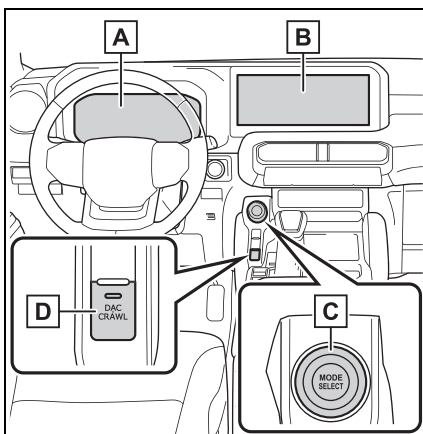

- A Meter (→P.82)
- B Multimedia display (→P.506)
- C MODE SELECT switch
- D DAC/CRAWL switch

## Turning Crawl Control on

- 1 Press the DAC/CRAWL switch.

The indicator light **A** and the Crawl Control indicator on the meter will come on, and the slip indicator light will flash.

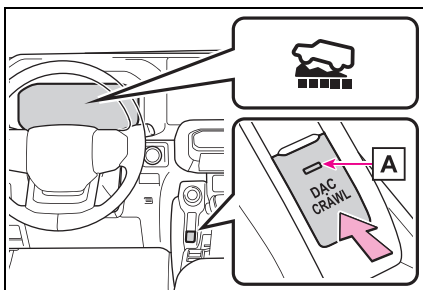

- 2 Turn the MODE SELECT switch left or right to select a mode on the meter.

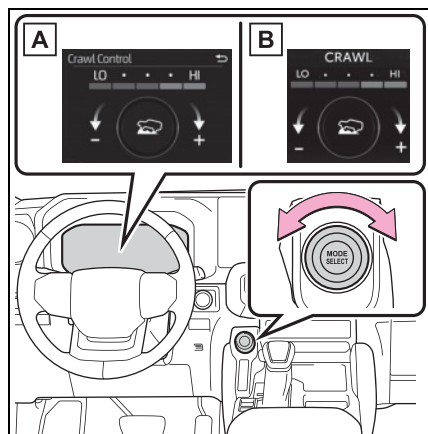

**A** Multi-information display (7-inch display model)

**B** Multi-information display (12.3-inch display model)

### Selectable modes

A mode which matches the road conditions can be selected from among the following 5 modes.

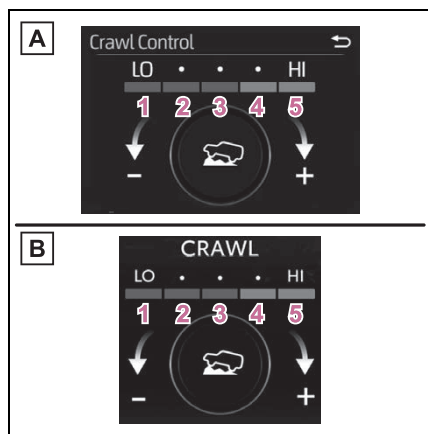

**A** Multi-information display (7-

inch display model)

**B** Multi-information display (12.3-inch display model)

1 Lo

Suitable for driving on rocky roads or decline

2 Lo-Mid

Suitable for driving on rocky roads, decline or bumpy incline

3 Mid

Suitable for driving on bumpy inclines

4 Mid-Hi

Suitable for driving on bumpy inclines, debris roads, snow-covered roads, muddy roads, gravel roads and grass roads

5 Hi

Suitable for driving on bumpy inclines, debris roads, snow-covered roads, muddy roads, gravel roads and grass roads

### Turning Crawl Control off

- ▶ When the DAC/CRAWL switch indicator illuminates

Press the DAC/CRAWL switch again.

- ▶ When the DAC/CRAWL switch indicator does not illuminate

Press the DAC/CRAWL switch to turn the indicator on. Press the DAC/CRAWL switch again with the indicator turned on.

If Crawl Control is turned off, the Crawl Control indicator and slip indicator will go off and a message



stating that Crawl Control has been turned off will be displayed on the multi-information display for several seconds.

When turning off Crawl Control while driving, drive extremely carefully.

#### ■ Operation conditions of the Crawl Control

- The hybrid system is operating.
- The shift lever is in any gear other than P or N.
- The four-wheel drive control switch is in L4.
- The driver's door is closed.

#### ■ Automatic system cancelation of Crawl Control

In the following situations, the buzzer will sound intermittently and Crawl Control will be canceled automatically. In this event, the Crawl Control indicator will flash and then go off, and a message stating that Crawl Control has been turned off will be displayed on the multi-information display for several seconds.

- When the shift lever is moved to P or N.
- When the four-wheel drive control switch is in H4.
- When the driver's door is opened.

#### ■ Function limitations of Crawl Control

- In the following situations, brake control can be used to drive downhill at a constant speed. However, hybrid system control is not available when driving uphill at a constant speed.
- When switched to second start mode.\*
- When the vehicle speed exceeds approximately 6 mph (10 km/h).

\*: If equipped

- In the following situation, hybrid system control and brake control will stop temporarily. In this event, the Crawl Control indicator will flash.
- With the rear differential\* is locked: when the vehicle speed exceeds approximately 6 mph (10 km/h).
- With the rear differential\* is unlocked: when the vehicle speed exceeds approximately 15 mph (25 km/h).

\*: If equipped

#### ■ When the Crawl Control system is operated continuously

- If Crawl Control is used continuously for a long time, the brake system may overheat. In this case, a buzzer will sound, a message stating a malfunction will be displayed on the multi-information display, and the Crawl Control indicator will flash and then go off. In this event, as Crawl Control will be temporarily inoperable, stop the vehicle immediately in a safe place, and allow the brake system to cool down sufficiently until the message goes off. (In the meantime, normal driving is possible.)
- If Crawl Control is used continuously for a long time, the automatic transmission may overheat. In this case, a buzzer will sound, the system will be temporarily canceled, and a message stating a malfunction may be displayed on the multi-information display. In this event, stop the vehicle in a safe place until the message goes off.
- **Sounds and vibrations caused by the Crawl Control system**
  - A sound may be heard from the engine compartment when the hybrid system is started or just after the vehicle begins to move. This sound does not indicate that a malfunction has occurred in Crawl Control system.

- Either of the following conditions may occur when the Crawl Control system is operating. None of these are indicators that a malfunction has occurred.
- Vibrations may be felt through the vehicle body and steering.
- A motor sound may be heard after the vehicle comes to a stop.

#### ■ When there is a malfunction in the system

Warning lights and/or warning messages will turn on. (→P.592, 598)

## Multi-terrain Select\*

\*: If equipped

### Multi-terrain Select is a system that improves drivability in off-road situations.

Select a mode that most closely matches the type of terrain on which you are driving from several modes. Brake control, drive force control and suspension control can be optimized in accordance with the selected mode.

When AUTO mode is selected, brake control, drive force control and suspension control are optimized automatically according to the road conditions.

### WARNING

#### ■ When using the Multi-terrain Select

Observe the following precautions to avoid an accident that could result in death or serious injuries:

- Check that the selected mode indicators are illuminated before driving. Multi-terrain Select will not operate when the indicators are off.
- The road conditions listed (→P.443) are for reference only. There is a chance that the function may not be the most appropriate in terms of road conditions such as pitch, slipperiness, undulation, etc. Thoroughly check the road conditions before driving.

**WARNING**

- Multi-terrain Select is not intended to expand the limits of the vehicle. Check the road conditions thoroughly beforehand, and drive safely and carefully.

**NOTICE****Precaution for use**

The Multi-terrain Select is intended for use during off-road driving. Do not use the system at any other time.

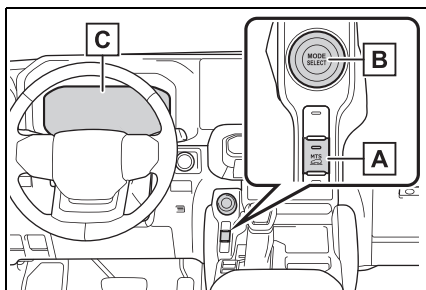
**System components**

**A** MTS switch

**B** MODE SELECT switch

**C** Multi-information display

Selected mode is displayed.

**Switching modes**

**1** Press the MTS switch.

The indicator **A** on the switch will

turn on.

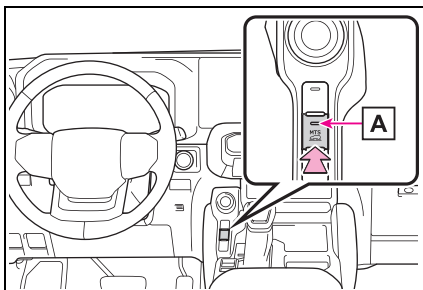

**2** Select the driving modes on the multi-information display while turning the MODE SELECT switch left and right.

Depending on the positions of the four-wheel drive control switch, a mode can be selected from among the following modes.

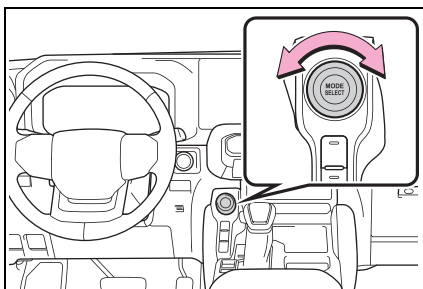





► Four-wheel drive control switch is in L4

Mode		Road Conditions
	AUTO	Suitable for the road conditions
	SAND	Suitable for sandy roads
	MUD	Suitable for muddy roads
	ROCK K	Suitable for rocky terrain

If the brake control has activated,

the slip indicator light will flash.

- ▶ Four-wheel drive control switch is in H4

Mode		Road Conditions
	AUTO	Suitable for the road conditions
	DIRT	Suitable for dirt roads
	SAND	Suitable for sandy roads
	MUD	Suitable for muddy roads
	DEEP SNO W	Suitable for deep snow roads

If the brake control has activated, the slip indicator light will flash. When the vehicle is in SAND, MUD or DEEP SNOW mode, VSC is automatically turned off. (VSC OFF indicator light come on.)

### ■ Multi-terrain Select

Multi-terrain Select controls the vehicle so that it can maximize the drive force and improve drivability on rough roads. As a result, fuel efficiency may diminish when compared to driving in normal mode.

### ■ Automatic system cancelation

In the following situations, Multi-terrain Select will be canceled automatically.

- When the DRIVE MODE switch is pressed while the four-wheel drive control switch is in H4.
- When the power switch is turned off

### ■ AUTO mode

Estimates the road conditions where

the vehicle is being driven and optimizes brake control, drive force control and suspension control.

The capability to estimate the road conditions is limited and there is a chance that the Multi-terrain Select may not be the most appropriate for road conditions such as pitch, slipperiness, undulation, etc. In these cases, select the mode that matches the road conditions before driving.

### ■ Turning off Multi-terrain Select

Performing the following turns Multi-terrain Select off, and then the display on the multi-information display will disappear.

- ▶ When the MTS switch indicator is illuminated

Press the MTS switch while the system is in operation.

- ▶ When the MTS switch indicator is not illuminated

Press the MTS switch to turn the indicator on.

Press the MTS switch again with the Multi-terrain Select indicator illuminated.

### ■ When the vehicle is stuck

Switching the transfer and differential

For the operation of the following functions, refer to the following pages.

- Four-wheel drive system (→P.435)
- Center differential lock (→P.435)
- Rear differential lock\* (→P.437)

\*: If equipped

### ■ Driving in Multi-terrain Select

The following types of situations may occur, but they are not malfunctions.

- Vibrations may be felt throughout the vehicle or steering wheel.

- Operating noise may be heard from the engine compartment.

#### ■ When an inspection at your Toyota dealer is necessary

In the following situations, the system may be malfunctioning. Have the vehicle inspected by your Toyota dealer immediately.

- When the slip indicator light illuminates.
- When the indicator for each mode does not illuminate on the multi-information display even though Multi-terrain Select is selected.

### Downhill assist control system\*

\*: If equipped

**The downhill assist control system helps to prevent excessive speed on steep downhill slopes. The system will operate when the vehicle is traveling under 18 mph (30 km/h) with the accelerator and brake pedals released and the transfer mode is in H4.**

#### WARNING

##### ■ When using downhill assist control system

Do not rely overmuch on the downhill assist control system. This function does not extend the vehicle's performance limitations. Always thoroughly check the road conditions, and drive safely.

### System operation

Press the DAC/CRAWL switch.

The downhill assist control system indicator will come on and the system will operate.

When the system is in operation, the slip indicator will flash, and the stop lights/high mounted stop lights will be lit. A sound may also occur during the operation. This does not indicate a malfunction.

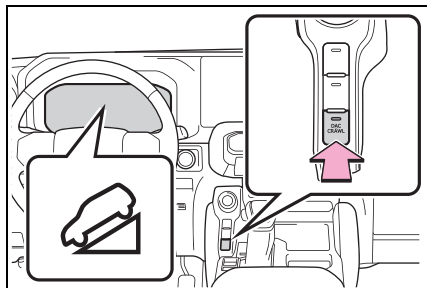

## Setting the speed of the downhill assist control system

Turn the MODE SELECT switch to set the desired speed (Approximately 3 to 18 mph (4 to 30 km/h)). The set speed is displayed on the multi-information display.

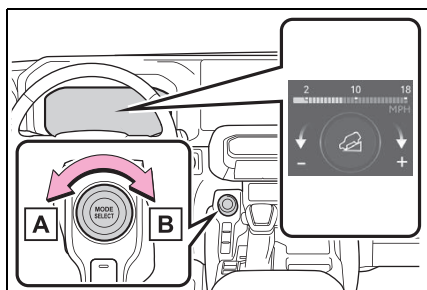

**A** Decreases the speed

**B** Increases the speed

## Turning off the system

▶ When the DAC/CRAWL switch indicator illuminates

Press the DAC/CRAWL switch again.

▶ When the DAC/CRAWL switch indicator does not illuminate

Press the DAC/CRAWL switch to turn the indicator on. Press the DAC/CRAWL switch again with the indicator turned on.

The downhill assist control system indicator will flash as the system gradually ceases operation, and will turn off when the system is fully off.

### ■ Operating tips

The system will operate when the shift lever is in a position other than P or N.

### ■ The system will not operate when

- The transfer mode is in L4.
- The rear differential is locked. (if equipped)

### ■ If the downhill assist control system indicator flashes

- In the following situations, the indicator flashes and the system will not operate:
  - The transfer mode is not in L4 or H4.
  - The rear differential is locked. (if equipped)
  - The shift lever is in P.
  - The vehicle speed exceeds approximately 18 mph (30 km/h).
  - The brake system overheats.
- In the following situations, the indicator flashes to alert the driver, but the system will operate:
  - The shift lever is in N.

The system will gradually cease operation. The indicator will flash during operation.

### ■ When the downhill assist control system is operated continuously

This may cause the brake actuator

to overheat. In this case, the downhill assist control system will stop operating, a buzzer will sound and the downhill assist control system indicator will start flashing, and the “Traction Control Turned OFF” will be shown on the multi-information display.

Refrain from using the system until the downhill assist control system indicator stays on and “Traction Control Turned OFF” turns off. (The vehicle can be driven normally during this time.)

#### ■ Sounds and vibrations caused by the downhill assist control system

- A sound may be heard from the engine compartment when the hybrid system is started or just after the vehicle begins to move. This sound does not indicate that a malfunction has occurred in downhill assist control system.
- Either of the following conditions may occur when the downhill assist control system is operating. None of these are indicators that a malfunction has occurred.
  - Vibrations may be felt through the vehicle body and steering.
  - A motor sound may be heard after the vehicle comes to a stop.

#### ■ System malfunction

In the following cases, have your vehicle checked by your Toyota dealer.

- The downhill assist control system indicator does not come on when power switch is turned to ON.
- The downhill assist control system indicator does not come on when the DAC/CRAWL switch is pressed.
- The slip indicator comes on.



#### WARNING

■ The system may not operate on the following surfaces, which may lead to an accident causing death or serious injury

- Slippery surfaces such as wet or muddy roads
- Icy surface
- Unpaved roads

## Driving assist systems

**To keep driving safety and performance, the following systems operate automatically in response to various driving situations. Be aware, however, that these systems are supplementary and should not be relied upon too heavily when operating the vehicle.**

### Summary of the driving assist systems

#### ■ ECB (Electronically Controlled Brake System)

The electronically controlled system generates braking force corresponding to the brake operation

#### ■ ABS (Anti-lock Brake System)

Helps to prevent wheel lock when the brakes are applied suddenly, or if the brakes are applied while driving on a slippery road surface

Vehicles with Multi-terrain Select system: The ABS operates in synchronization with the Multi-terrain Select

#### ■ Brake assist

Generates an increased level of braking force after the brake pedal is depressed when the system detects a panic stop sit-

uation

#### ■ VSC (Vehicle Stability Control)

Helps the driver to control skidding when swerving suddenly or turning on slippery road surfaces.

#### ■ Enhanced VSC (Enhanced Vehicle Stability Control)

Provides cooperative control of the ABS, Active TRAC, VSC and EPS.

Helps to maintain directional stability when swerving on slippery road surfaces by controlling steering performance.

#### ■ Trailer Sway Control (vehicles with towing hitch)

Helps the driver to control trailer sway by selectively applying brake pressure for individual wheels and reducing driving torque when trailer sway is detected.

#### ■ Active TRAC (Traction Control)

Helps to maintain drive power and prevent the drive wheels from spinning when starting the vehicle or accelerating on slippery roads

#### ■ Hill-start assist control

Helps to reduce the backward movement of the vehicle when starting on an uphill



### ■ EPS (Electric Power Steering)

Employs an electric motor to reduce the amount of effort needed to turn the steering wheel

### ■ The Secondary Collision Brake

When the SRS airbag sensor detects a collision and the system operates, the brakes and brake lights are automatically controlled to reduce the vehicle speed and help reduce the possibility of further damage due to a secondary collision.

### ■ When the Active TRAC/VSC/ABS/Trailer Sway Control (vehicles with towing hitch) systems are operating

The slip indicator light will flash while the Active TRAC/VSC/ABS/Trailer Sway Control systems are operating.

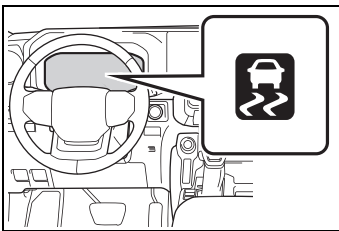

### ■ Disabling the Active TRAC system

If the vehicle gets stuck in mud, dirt or snow, the Active TRAC system may reduce power from the hybrid system to the wheels.

Pressing  to turn the system off may make it easier for you to rock the vehicle in order to free it.

To turn the Active TRAC system off, quickly press and release .

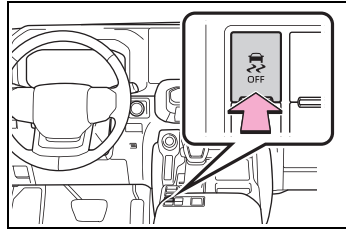

“Traction Control Turned OFF” will be shown on the multi-information display.

Press  again to turn the system back on.

### ■ Turning off the Active TRAC/VSC/Trailer Sway Control (vehicles with towing hitch) systems

To turn the Active TRAC/VSC/Trailer Sway Control systems off, press and hold  for more than 3 seconds while the vehicle is stopped.

The VSC OFF indicator light will come on and the “Traction Control Turned OFF” will be shown on the multi-information display.\*

Press  again to turn the systems back on.

\*: PCS will also be disabled (only Pre-Collision warning is available). The PCS warning light will come on and a message will be displayed on the multi-information display. (→P.272)

■ **When the message is displayed on the multi-information display showing that Active TRAC has been disabled even if**



**has not been pressed**

Active TRAC is temporarily deactivated. If the information continues to show, contact your Toyota dealer.

■ **Operating conditions of hill-start assist control**

When all of the following conditions are met, the hill-start assist control will operate:

- The shift lever is in a position other than P or N (when starting off forward/backward on an upward incline).
- The vehicle is stopped.
- The accelerator pedal is not depressed.
- The parking brake is not engaged.
- The power switch is in ON

■ **Automatic system cancelation of hill-start assist control**

The hill-start assist control will turn off in any of the following situations:

- The shift lever is shifted to P or N.
- The accelerator pedal is depressed.
- The brake pedal is depressed and the parking brake is engaged.
- A maximum of 2 seconds have elapsed after the brake pedal is released.
- The power switch is turned to OFF.

■ **Reduced effectiveness of the EPS system**

The effectiveness of the EPS system is reduced to prevent the system from overheating when there is frequent steering input over an extended period of time. The steering wheel may feel heavy as a result.

Should this occur, refrain from excessive steering input or stop the vehicle and turn the hybrid system off. The EPS system should return to normal within 10 minutes.

■ **Sounds and vibrations caused by the ABS, brake assist, VSC, Trailer Sway Control (vehicles with towing hitch), Active TRAC and hill-start assist control systems**

- A sound may be heard from the engine compartment when the brake pedal is depressed repeatedly, when the hybrid system is started or just after the vehicle begins to move. This sound does not indicate that a malfunction has occurred in any of these systems.
- Any of the following conditions may occur when the above systems are operating. None of these indicates that a malfunction has occurred.
  - Vibrations may be felt through the vehicle body and steering.
  - A motor sound may be heard also after the vehicle comes to a stop.

■ **ECB operating sound**

ECB operating sound may be heard in the following cases, but it does not indicate that a malfunction has occurred.

- Operating sound heard from the engine compartment when the brake pedal is operated.
- Motor sound of the brake system heard from the front part of the vehicle when the driver's door is opened.
- Operating sound heard from the engine compartment when one or two minutes passed after the stop of the hybrid system.

■ **Automatic reactivation of Active TRAC, Trailer Sway Control (vehicles with towing hitch) and VSC systems**

After turning the Active TRAC, Trailer Sway Control and VSC sys-

tems off, the systems will be automatically re-enabled in the following situations:

- When the power switch is turned off.
- If only the Active TRAC system is turned off, the Active TRAC will turn on when vehicle speed increases.  
If both the Active TRAC and VSC systems are turned off, automatic re-enabling will not occur when vehicle speed increases.

#### ■ Secondary Collision Brake operating conditions

The system operates when the SRS airbag sensor detects a collision while the vehicle is in motion. However, the system does not operate when the components are damaged.

#### ■ Secondary Collision Brake automatic cancellation

The system is automatically canceled in any of the following situations

- The vehicle speed drops to approximately 0 mph (0 km/h).
- A certain amount of time elapses during operation
- The accelerator pedal is depressed a large amount



#### WARNING

##### ■ The ABS does not operate effectively when

- The limits of tire gripping performance have been exceeded (such as excessively worn tires on a snow covered road).
- The vehicle hydroplanes while driving at high speed on wet or slick roads.

##### ■ Stopping distance when the ABS is operating may exceed that of normal conditions

The ABS is not designed to shorten the vehicle's stopping distance. Always maintain a safe distance from the vehicle in front of you, especially in the following situations:

- When driving on dirt, gravel or snow-covered roads
- When driving with tire chains
- When driving over bumps in the road
- When driving over roads with potholes or uneven surfaces

##### ■ Active TRAC/VSC may not operate effectively when

Directional control and power may not be achievable while driving on slippery road surfaces, even if the Active TRAC/VSC system is operating.

Drive the vehicle carefully in conditions where stability and power may be lost.

##### ■ Hill-start assist control does not operate effectively when

- Do not overly rely on hill-start assist control. Hill-start assist control may not operate effectively on steep inclines and roads covered with ice.
- Unlike the parking brake, hill-start assist control is not intended to hold the vehicle stationary for an extended period of time. Do not attempt to use hill-start assist control to hold the vehicle on an incline, as doing so may lead to an accident.

**WARNING**

■ **When the Active TRAC/ABS/VSC/Trailer Sway Control (vehicles with towing hitch) is activated**

The slip indicator light flashes. Always drive carefully. Reckless driving may cause an accident. Exercise particular care when the indicator light flashes.

■ **When the Active TRAC/VSC/Trailer Sway Control (vehicles with towing hitch) systems are turned off**

Be especially careful and drive at a speed appropriate to the road conditions. As these are the systems to help enhance vehicle stability and driving force, do not turn the Active TRAC/VSC/Trailer Sway Control systems off unless necessary.

Trailer Sway Control is part of the VSC system and will not operate if VSC is turned off or experiences a malfunction.

■ **Replacing tires**

Make sure that all tires are of the specified size, brand, tread pattern and total load capacity. In addition, make sure that the tires are inflated to the recommended tire inflation pressure level.

The ABS, Active TRAC, Trailer Sway Control (vehicles with towing hitch) and VSC systems will not function correctly if different tires are installed on the vehicle. Contact your Toyota dealer for further information when replacing tires or wheels.

■ **Handling of tires and the suspension**

Using tires with any kind of problem or modifying the suspension will affect the driving assist systems, and may cause a system to malfunction.

■ **Trailer Sway Control precaution (vehicles with towing hitch)**

The Trailer Sway Control system is not able to reduce trailer sway in all situations. Depending on many factors such as the conditions of the vehicle, trailer, road surface and driving environment, the Trailer Sway Control system may not be effective. Refer to your trailer owner's manual for information on how to tow your trailer properly.

■ **If trailer sway occurs (vehicles with towing hitch)**

Observe the following precautions.

Failing to do so may cause death or serious injury.

- Firmly grip the steering wheel. Steer straight ahead. Do not try to control trailer swaying by turning the steering wheel.
- Begin releasing the accelerator pedal immediately but very gradually to reduce speed. Do not increase speed. Do not apply vehicle brakes.

If you make no extreme correction with the steering or brakes, your vehicle and trailer should stabilize. (→P.209)

■ **Secondary Collision Brake**

Do not rely solely upon the Secondary Collision Brake. This system is designed to help reduce the possibility of further damage due to a secondary collision, however, that effect changes according to various conditions. Overly relying on the system may result in death or serious injury.

## Trailer brake controller

The trailer brakes can be controlled by the Trailer brake controller via the 7-pin connector. By selecting the type of brakes that are being used on the trailer (electric or electric-over-hydraulic) and setting the “Gain” for the controller, the manual brake slider is used to slow just the trailer. The vehicle brake pedal will also slow down as well as stop the trailer when applied, also via the same connector. “Gain” values, manual brake outputs, trailer brake types, and the trailer connection status are displayed in the multi-information display.



### WARNING

#### ■ When driving on slippery road surfaces

When stopping with ABS activated, output to the trailer might be reduced in order to reduce the likelihood of trailer wheels to lock. The trailer is not equipped with ABS. Drive safely on slippery road surfaces.

## System operation

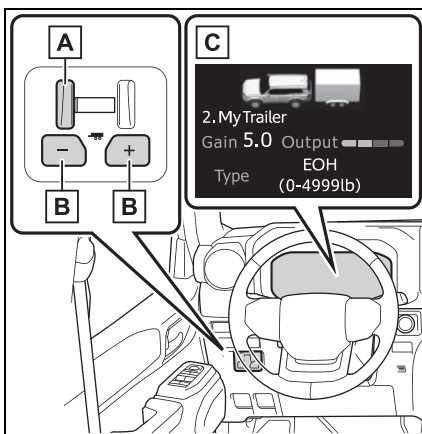

### A Manual brake slider

Adjusting this slider position will engage the trailer’s brakes only. If the manual brake slider is used while the vehicle brake is applied, the greater of the two outputs will be sent to the trailer brakes.

### B “GAIN” (+/-) selection button



Pressing the “GAIN” (+/-) buttons will adjust the amount of power that can be outputted to the trailer brakes. The “Gain” can be adjusted from 0 (no trailer braking) to 10 (maximum output) in 0.5 increments. Each press of the button will increase or decrease the “Gain” setting by one step. The “Gain” value will appear in the multi-information display.

### C Multi-information display

Trailer brake type can be selected by using the multi-information. “Gain” values, manual brake outputs, trailer brake types, and the trailer connection status are displayed.

## Changing settings of the trailer brake type

The trailer brake type can be changed as follows on the multi-information screen (→P.101, 112)

- 1 Use the meter control switches (→P.97, 108) to select  (→P.101, 112)
- 2 Use the meter control switches to select , then press OK.
- 3 Use the meter control switches to select “Select Brake Type”, then press OK.
- 4 According to the display, select the desired setting and then press OK.

Changing trailer brake type will cause the current “Gain” setting to reset to zero. Make sure to set the “Gain” as described in the following section.

## Setting the “Gain”

“Gain” setting on trailer brake controller should be set for a specific towing condition. “Gain” setting should be adjusted each time the vehicle load, trailer load, road conditions, or weather changes. Setting the “Gain” value to 0 will disable the trailer brake controller output.

- 1 Make sure the trailer brakes are in good working condition and functioning normally. See trailer dealer if necessary.
- 2 Hook up the trailer and make proper electrical connections.
- 3 Select the correct type of trailer brakes that are equipped on the trailer by using the multi-information display.
- 4 Drive vehicle with trailer attached on a level road surface similar to towing condition and in traffic-free environment. Driving speed should be approximately 20 - 25 mph [35 - 40 km/h].
- 5 Using the “GAIN” (+/-) selection buttons, set a starting “Gain” of 5.0.

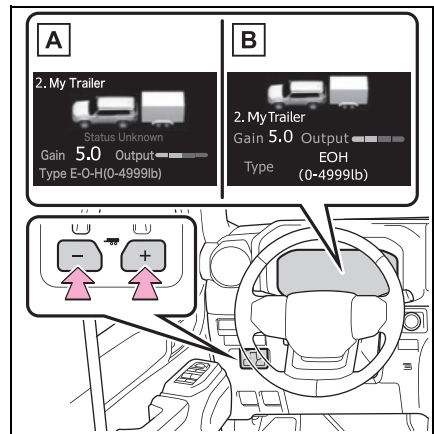

- A Multi-information display (7-inch display model)
- B Multi-information display

(12.3-inch display model)

- 6 While driving 20 - 25 mph [35 - 40 km/h], fully apply the manual brake slider.
- 7 Adjust the “Gain” setting, using the “GAIN” (+/-) selection buttons, to either increase or decrease to just below the point of trailer wheel lock-up.
- 8 For confirmation, repeat steps 6 and 7 until desired “Gain” setting is reached (just below point of trailer wheel lock-up).

#### ■ When setting the “Gain”

Wheel lock-up occurs when the trailer wheel squeals or tire smoke occurs. Trailer wheels may not lockup while driving heavily loaded trailer. During this case, adjust the Trailer “Gain” to the highest allowable setting for the towing condition.

#### ■ Trailer Sway Control Function

Helps suppress trailer sway at an early stage by using the trailer brake control system to operate the trailer brakes.

#### ■ If the Trailer brake warning light comes on

Indicates a malfunction in the Trailer brake control system or Trailer connector circuit.

Have the vehicle inspected by your Toyota dealer immediately.

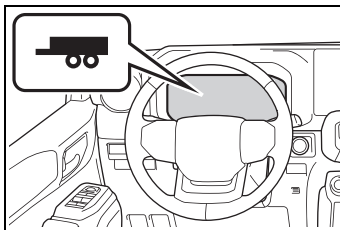

### ⚠ WARNING

#### ■ Trailer brake type setting

It is the responsibility of the driver to make sure the trailer brakes are functioning normally and adjusted appropriately. Failure to check and maintain trailer brakes may result in loss of vehicle control, crash, or serious injury. Trailer brake control system will work with most electric and electric-over-hydraulic trailer braking systems up to 3 axles (24A output to trailer brakes). Please be sure to test compatibility with the system at low speeds and in a safe area. If a warning message appears in the multi-information display (→P.598), have the vehicle inspected by your Toyota dealer immediately. Some electric-over-hydraulic trailer brakes will take some minimum output to activate. Trailer brake control system will not work with trailer hydraulic surge brakes.

## SDM (Stabilizer with Disconnection Mechanism)\*

\*: If equipped

**SDM (Stabilizer with Disconnection Mechanism) is a system that switches conditions of the front stabilizer to maintain vehicle stability and drivability in paved-road and off-road situations.**

## How SDM (Stabilizer with Disconnection Mechanism) works

Depending on the switch operation or vehicle speed, the stabilizer is locked/unlocked, which results in the following effects.

### ■ During driving on paved roads

The stabilizer is locked and the movement of the suspensions is restrained, resulting in stable driving.

### ■ During off-road driving

- The stabilizer is unlocked and it becomes easier that the suspensions extend and retract, leading to improvement of drivability on rough roads
- The vibration of the vehicle body is reduced, which helps enhance riding comfort.

## Turning the system on/off

Press the SDM switch

The stabilizer is unlocked and the SDM indicator will come on.

Press the switch again to lock the stabilizer (the SDM indicator will turn off).

While the stabilizer is being locked or unlocked, the SDM indicator flashes.

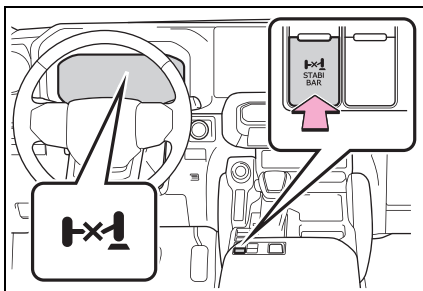

### ■ Operation conditions by the switch

The power switch is in ON and the vehicle speed is approximately 18 mph (30 km/h) or less.

### ■ Automatic control by vehicle speed

The stabilizer will be locked again when the vehicle speed exceeds approximately 18 mph (30 km/h).

### ■ Operation sounds

When the stabilizer is being locked or unlocked, an operating sound may be heard from the underside of the vehicle. However, it does not indicate a malfunction.

### ■ When the state of the SDM indicator differs from the stabilizer status

On an uneven surface, the stabilizer status may not be switched and may differ from the state of the SDM indicator. The stabilizer status will be



switched after the vehicle is driven and the suspensions are extend and retract.

■ **When the outside temperature is extremely low**

Do not use the system when the outside temperature is below -22°F (-30 °C), as the system may not operate properly.

■ **After the power switch is turned to OFF**

The stabilizer status is hold even when the power switch is turned to OFF. To switch the status, turn the power switch to ON again and press the SDM switch.

■ **When the stabilizer is unlocked**

When the stabilizer is unlocked, some of the Toyota Safety Sense 3.0 are not operate. (→P.264)

## Off-road precautions

**This vehicle belongs to the utility vehicle class, which has higher ground clearance and narrower tread in relation to the height of its center of gravity to make it capable of performing in a wide variety of off-road applications.**

## Off-road vehicle features

- Specific design characteristics give it a higher center of gravity than ordinary passenger cars. This vehicle design feature causes this type of vehicle to be more likely to rollover. And, utility vehicles have a significantly higher rollover rate than other types of vehicles.
- An advantage of the higher ground clearance is a better view of the road allowing you to anticipate problems.
- It is not designed for cornering at the same speeds as ordinary passenger cars any more than low-slung sports cars are designed to perform satisfactorily under off-road conditions. Therefore, sharp turns at excessive speeds may cause the vehicle to rollover.

## WARNING

### Off-road vehicle precautions

Always observe the following precautions to minimize the risk of death, serious injury or damage to your vehicle:

- In a rollover crash, an unbelted person is significantly more likely to die than a person wearing a seat belt. Therefore, the driver and all passengers should always fasten their seat belts.
- Avoid sharp turns or abrupt maneuvers, if at all possible. Failure to operate this vehicle correctly may result in loss of control or vehicle rollover causing death or serious injury.
- Loading cargo on the roof luggage carrier will make the center of the vehicle gravity higher. Avoid high speeds, sudden starts, sharp turns, sudden braking or abrupt maneuvers, otherwise it may result in loss of control or vehicle rollover due to failure to operate this vehicle correctly.
- Always slow down in gusty crosswinds. Because of its profile and higher center of gravity, your vehicle is more sensitive to side winds than an ordinary passenger car. Slowing down will allow you to have better control.
- Do not drive horizontally across steep slopes. Driving straight up or straight down is preferred. Your vehicle (or any similar off-road vehicle) can tip over sideways much more easily than forward or backward.

## Off-road driving

When driving your vehicle off-

road, please observe the following precautions to ensure your driving enjoyment and to help prevent the closure of areas to off-road vehicles:

- Drive your vehicle only in areas where off-road vehicles are permitted to travel.
- Respect private property. Get owner's permission before entering private property.
- Do not enter areas that are closed. Honor gates, barriers and signs that restrict travel.
- Stay on established roads. When conditions are wet, driving techniques should be changed or travel delayed to prevent damage to roads.

#### ■ Additional information for off-road driving

► For owners in U.S. mainland, Hawaii and Puerto Rico:

To obtain additional information pertaining to driving your vehicle off-road, consult the following organizations.

- State and Local Parks and Recreation Departments
- State Motor Vehicle Bureau
- Recreational Vehicle Clubs
- U.S. Forest Service and Bureau of Land Management



#### WARNING

##### ■ Off-road driving precautions

Always observe the following precautions to minimize the risk of death, serious injury or damage to your vehicle:

- Drive carefully when off the road. Do not take unnecessary risks by driving in dangerous places.
- Do not grip the steering wheel spokes when driving off-road. A bad bump could jerk the wheel and injure your hands. Keep both hands and especially your thumbs on the outside of the rim.
- Always check your brakes for effectiveness immediately after driving in sand, mud, water or snow.
- After driving through tall grass, mud, rock, sand, rivers, etc., check that there is no grass, bush, paper, rags, stone, sand, etc. adhering or trapped on the underbody. Clear off any such matter from the underbody. If the vehicle is used with these materials trapped or adhering to the underbody, a breakdown or fire could occur.
- When driving off-road or in rugged terrain, do not drive at excessive speeds, jump, make sharp turns, strike objects, etc. This may cause loss of control or vehicle rollover causing death or serious injury. You are also risking expensive damage to your vehicle's suspension and chassis.



## NOTICE

**■ To prevent the water damage**

Take all necessary safety measures to ensure that water damage to the engine or other components does not occur.

- Water entering the engine air intake will cause severe engine damage.
- Water entering the automatic transmission will cause deterioration in shift quality, locking up of your transmission accompanied by vibration, and ultimately damage.
- Water can wash the grease from wheel bearings, causing rusting and premature failure, and may also enter the differentials, transmission and transfer case, reducing the gear oil's lubricating qualities.

**■ When you drive through water**

- If driving through water, such as when crossing shallow streams, first check the depth of the water and the bottom of the riverbed for firmness. Drive slowly and avoid deep water.
- When crossing a river or a puddle, be sure to cross it without stopping midway. If you stop or drive at extremely low speeds in water, water may enter the vehicle and damage the hybrid battery making the vehicle unable to be driven.

**■ Inspection after off-road driving**

- Sand and mud that has accumulated in brake drums and around brake discs may affect braking efficiency and may damage brake system components.

- Always perform a maintenance inspection after each day of off-road driving that has taken you through rough terrain, sand, mud, or water. For scheduled maintenance information, refer to the "Warranty and Services Guide", "Owner's Manual Supplement" or "Scheduled Maintenance".

## Hybrid Electric Vehicle driving tips

**For economical and ecological driving, pay attention to the following points:**

### Using Eco drive mode (if equipped)

When using Eco drive mode, the torque corresponding to the accelerator pedal depression amount can be generated more smoothly than it is in normal conditions. In addition, the operation of the air conditioning system (heating/cooling) will be minimized, improving the fuel economy. (→P.433)

### Shift lever operation

Shift the shift lever to D when stopped at a traffic light, or driving in heavy traffic etc. Shift the shift lever to P when parking. When using the N position, there is no positive effect on fuel consumption.

### Accelerator pedal/brake pedal operation

- Drive your vehicle smoothly. Avoid abrupt acceleration and deceleration. Gradual acceleration and deceleration will make more effective use of

the electric motor (traction motor) without having to use gasoline engine power.

- Avoid repeated acceleration. Repeated acceleration consumes hybrid battery (traction battery) power, resulting in poor fuel consumption. Battery power can be restored by driving with the accelerator pedal slightly released.

### When braking

Make sure to operate the brakes gently and in a timely manner. A greater amount of electrical energy can be regenerated when slowing down.

### Delays

Repeated acceleration and deceleration, as well as long waits at traffic lights, will lead to bad fuel economy. Check traffic reports before leaving and avoid delays as much as possible. When driving in a traffic jam, gently release the brake pedal to allow the vehicle to move forward slightly while avoiding overuse of the accelerator pedal. Doing so can help control excessive gasoline consumption.

### Highway driving

Control and maintain the vehicle

at a constant speed. Before stopping at a toll booth or similar, allow plenty of time to release the accelerator and gently apply the brakes. A greater amount of electrical energy can be regenerated when slowing down.

### **Air conditioning**

Use the air conditioning only when necessary. Doing so can help reduce excessive gasoline consumption.

In summer: When the ambient temperature is high, use the recirculated air mode. Doing so will help to reduce the burden on the air conditioning system and reduce fuel consumption as well.

In winter: Because the gasoline engine will not automatically cut out until it and the interior of the vehicle are warm, it will consume fuel. Also, fuel consumption can be improved by avoiding overuse of the heater.

### **Checking tire inflation pressure**

Make sure to check the tire inflation pressure frequently.

Improper tire inflation pressure can cause poor fuel economy.

Also, as snow tires can cause large amounts of friction, their

use on dry roads can lead to poor fuel economy. Use tires that are appropriate for the season.

### **Luggage**

Carrying heavy luggage will lead to poor fuel economy. Avoid carrying unnecessary luggage. Installing a large roof rack will also cause poor fuel economy.

### **Warming up before driving**

Since the gasoline engine starts up and cuts out automatically when cold, warming up the engine is unnecessary.

Moreover, frequently driving short distances will cause the engine to repeatedly warm up, which can lead to excess fuel consumption.

## Winter driving tips

**Carry out the necessary preparations and inspections before driving the vehicle in winter. Always drive the vehicle in a manner appropriate to the prevailing weather conditions.**

## Pre-winter preparations

- Use fluids that are appropriate to the prevailing outside temperatures.
- Engine oil
- Engine coolant
- Washer fluid
- Have a service technician inspect the condition of the 12-volt battery.
- Have the vehicle fitted with four snow tires or purchase a set of tire chains for the rear tires.\*

Ensure that all tires are the same size and brand, and that chains match the size of the tires.

\*: Tire chains cannot be mounted on vehicles with 265/70R18 and 265/60R20 tires.



## WARNING

### ■ Driving with snow tires

Observe the following precautions to reduce the risk of accidents. Failure to do so may result in a loss of vehicle control and cause death or serious injury.

- Use tires of the specified size.
- Maintain the recommended level of air pressure.
- Do not drive in excess of 75 mph (120 km/h), regardless of the type of snow tires being used.
- Use snow tires on all, not just some wheels.

### ■ Driving with tire chains (vehicles without 265/70R18 and 265/60R20 tires)

Observe the following precautions to reduce the risk of accidents. Failure to do so may result in the vehicle being unable to be driven safely, and may cause death or serious injury.

- Do not drive in excess of the speed limit specified for the tire chains being used, or 30 mph (50 km/h), whichever is lower.
- Avoid driving on bumpy road surfaces or over potholes.
- Avoid sudden acceleration, abrupt steering, sudden braking and shifting operations that cause sudden engine braking.
- Slow down sufficiently before entering a curve to ensure that vehicle control is maintained.
- Do not use LTA (Lane Tracing Assist) system.
- Do not use LDA (Lane Departure Alert) system.



## NOTICE

### ■ Repairing or replacing snow tires

Request repairs or replacement of snow tires from your Toyota dealer or legitimate tire retailers. This is because the removal and attachment of snow tires affects the operation of the tire pressure warning valves and transmitters.

## Before driving the vehicle

Perform the following according to the driving conditions:

- Do not try to forcibly open a window or move a wiper that is frozen. Pour warm water over the frozen area to melt the ice. Wipe away the water immediately to prevent it from freezing.
- To ensure proper operation of the climate control system fan, remove any snow that has accumulated on the air inlet vents in front of the windshield.
- Check for and remove any excess ice or snow that may have accumulated on the exterior lights, outside rear view mirrors, side windows, vehicle's roof, chassis, around the tires or on the brakes.
- Remove any snow or mud from the bottom of your shoes before getting in the vehicle.

## When driving the vehicle

Accelerate the vehicle slowly, keep a safe distance between you and the vehicle ahead, and drive at a reduced speed suitable to road conditions.

## When parking the vehicle

- Turn automatic mode of the parking brake off. Otherwise, the parking brake may freeze and not be able to be released automatically.

Also, avoid using the following as the parking brake may operate automatically, even if automatic mode is off.

- Brake hold system
- Park the vehicle and shift the shift lever to P without setting the parking brake. The parking brake may freeze up, preventing it from being released. If the vehicle is parked without setting the parking brake, make sure to block the wheels. Failure to do so may be dangerous because it may cause the vehicle to move unexpectedly, possibly leading to an accident.
- When the parking brake is in automatic mode, release the parking brake after shifting the shift lever to P. (→P.229)
- If the vehicle is parked without setting the parking brake,



confirm that the shift lever cannot be moved out of P.

- If the vehicle is left parked with the brakes damp in cold temperatures, there is a possibility of the brakes freezing.

### Selecting tire chains

- ▶ Vehicles without 265/70R18 and 265/60R20 tires

Use the correct tire chain size when mounting the snow chains. Chain size is regulated for each tire size.

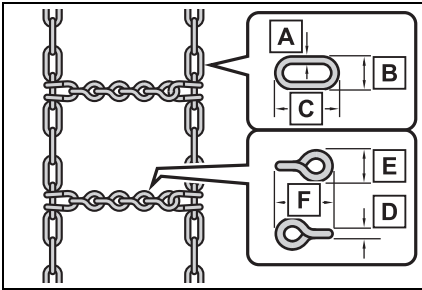

Side chain:

- A** 0.20 in. (5 mm) in diameter
- B** 0.71 in. (18 mm) in width
- C** 1.81 in. (46 mm) in length

Cross chain:

- D** 0.25 in. (6.3 mm) in diameter
- E** 0.89 in. (22.6 mm) in width
- F** 1.50 in. (38.1 mm) in length

- ▶ Vehicles with 265/70R18 and 265/60R20 tires

Tire chains cannot be mounted.

Snow tires should be used

instead.

### Regulations on the use of tire chains (vehicles without 265/70R18 and 265/60R20 tires)

Regulations regarding the use of tire chains vary depending on location and type of road.

Always check local regulations before installing chains.

#### ■ Tire chain installation

Observe the following precautions when installing and removing chains:

- Install and remove tire chains in a safe location.
- Install tire chains on the rear tires only. Do not install tire chains on the front tires.
- Install tire chains on rear tires as tightly as possible. Retighten chains after driving 1/4 - 1/2 mile (0.5 - 1.0 km).
- Install tire chains following the instructions provided with the tire chains.

#### ⚠ NOTICE

#### ■ Fitting tire chains

The tire pressure warning valves and transmitters may not function correctly when tire chains are fitted.



**5-1. Using the air conditioning system and defogger**

Front automatic air conditioning system ..... 468

Rear automatic air conditioning system ..... 478

Heated steering wheel/seat heaters/seat ventilators ..... 480

**5-2. Using the interior lights**

Interior lights list ..... 483

**5-3. Using the storage features**

List of storage features 486

Luggage compartment features ..... 490

**5-4. Using the other interior features**

Other interior features . 494

Power outlet (2400 W) 509

When the power outlet (2400 W) cannot be used properly ..... 515

Garage door opener.... 517

## Front automatic air conditioning system

Air outlets and fan speed are automatically adjusted according to the temperature setting.

### Air conditioning controls

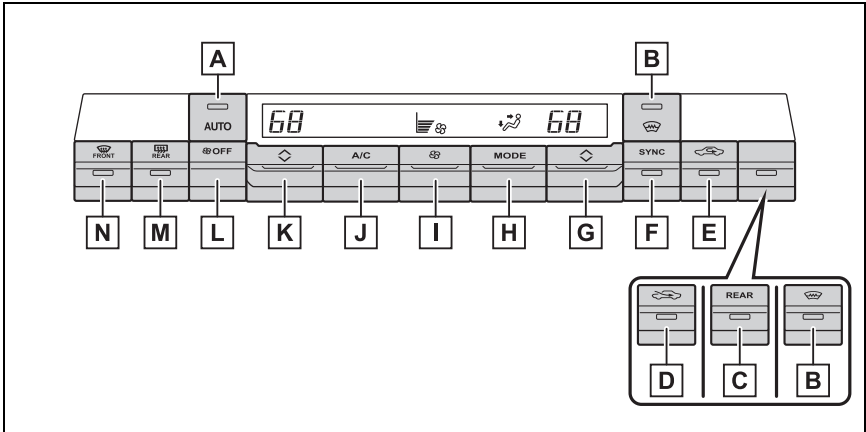

- A** Automatic mode switch
- B** Windshield de-icer switch (if equipped)
- C** “REAR” switch (if equipped)
- D** Outside air mode switch (if equipped)
- E** Recirculated air mode switch
- F** “SYNC” switch
- G** Right-hand side temperature control switch
- H** Airflow mode control switch
- I** Fan speed control switch
- J** “A/C” switch
- K** Left-hand side temperature control switch
- L** “OFF” switch
- M** Rear window and outside rear view mirror (if equipped) defoggers switch
- N** Windshield defogger switch

### ■ Adjusting the temperature setting

Operate the temperature control switch upwards to increase the temperature and downwards to decrease the temperature.

If the "A/C" switch is not pressed, the system will blow ambient temperature air or heated air.

### ■ Setting the fan speed

Operate the fan speed control switch upwards to increase the fan speed and downwards to decrease the fan speed.

The fan speed is shown on the display. (7 levels)

Press the "OFF" switch to turn the fan off.

### ■ Change the airflow mode

Operate the airflow mode control switch upwards or downwards to change the airflow mode.

The mode changes as follows each time the switch is operated.

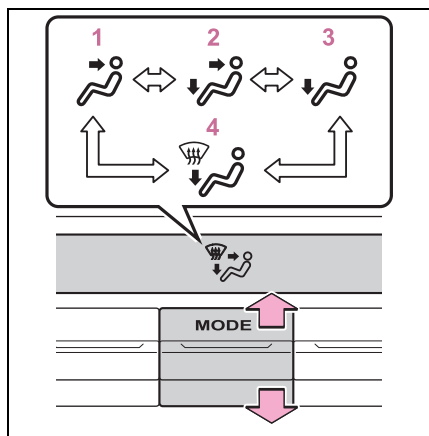

1 Air flows to the upper body

2 Air flows to the upper body and feet

3 Air flows to the feet

4 Air flows to the feet and the windshield defogger operates

### ■ Switching between outside air and recirculated air modes

▶ Vehicles without outside air mode switch

Press the recirculated air mode switch.

The mode switches between outside air mode and recirculated air mode each time the switch is pressed.

When recirculated air mode is selected, the indicator on the recirculated air mode switch illuminates.

▶ Vehicles with outside air mode switch

● To change to recirculated air mode, press the recirculated air mode switch.

The indicator on the recirculated air mode switch illuminates.

● To change to outside air mode, press the outside air mode switch.

The indicator on the outside air mode switch illuminates.

### ■ Set cooling and dehumidification function

Press the "A/C" switch.

When the function is on, "A/C ON" is shown on the display.

### ■ Defogging the windshield

Defoggers are used to defog the windshield and front side windows.

Press the windshield defogger switch.

Set the outside/recirculated air mode to outside air mode if the recirculated air mode is used. (It may switch automatically.)

To defog the windshield and the side windows quickly, turn the air flow and temperature up.

To return to the previous mode, press the windshield defogger switch again when the windshield is defogged.

When the function is on, the indicator on the windshield defogger switch illuminates.

### ■ Defogging the rear window and outside rear view mirrors (if equipped)

Defoggers are used to defog the rear window and to remove raindrops, dew and frost from the outside rear view mirrors.

Press the rear window and outside rear view mirror defoggers switch.

When the function is on, the indicator on the switch illuminates.

The rear window and rear view mirror defoggers automatically turn off after approximately 60 minutes.

However, the rear window and rear view mirror defoggers might automatically turn off after approximately 15 minutes depending on

conditions including the outside temperature and charging system conditions.

---

### ■ When the outside temperature exceeds 75°F (24°C) and the air conditioning system is on

- In order to reduce the air conditioning power consumption, the air conditioning system may switch to recirculated air mode automatically. This may also reduce fuel consumption.
- Recirculated air mode is selected as a default mode when the power switch is turned to ON.
- It is possible to switch to outside air mode at any time by pressing the recirculated air mode switch (vehicles without outside air mode switch) or the outside air mode switch (vehicles with outside air mode switch).

### ■ Fogging up of the windows

- The windows will easily fog up when the humidity in the vehicle is high. Turning the cooling and dehumidification function on will dehumidify the air from the outlets and defog the windshield effectively.
- If you turn the cooling and dehumidification function off, the windows may fog up more easily.
- The windows may fog up if the recirculated air mode is used.

### ■ When driving on dusty roads

Close all windows. If dust thrown up by the vehicle is still drawn into the vehicle after closing the windows, it is recommended that the air intake mode be set to outside air mode and the fan speed to any setting except off.

### ■ Outside/recirculated air mode

- Setting to the recirculated air mode temporarily is recommended in preventing dirty air

from entering the vehicle interior and helping to cool the vehicle when the outside air temperature is high.

- Outside/recirculated air mode may automatically switch depending on the temperature setting or the inside temperature.

#### ■ When the outside temperature falls to nearly 32°F (0°C)

The dehumidification function may not operate even when "A/C" switch is pressed.

#### ■ Operation of the air conditioning system in the eco air conditioning mode

- In the eco air conditioning mode, the air conditioning system is controlled as follows to prioritize fuel efficiency:
  - Engine speed and compressor operation controlled to restrict heating/cooling capacity
  - Fan speed restricted when automatic mode is selected
- The eco air conditioning mode can be turned on and off using the option screen of the air conditioning control screen. (→P.475)
- When the driving mode is changed to Eco drive mode, the eco air conditioning mode is turned on automatically. (→P.433)
- When in eco air conditioning mode, "ECO" is shown on the display of air conditioning control panel.
- To improve air conditioning performance, perform the following operations:
  - Adjust the fan speed
  - Deactivate Eco drive mode (→P.433)
  - Turn off eco air conditioning mode (→P.475)

#### ■ Ventilation and air conditioning odors

- To let fresh air in, set the air conditioning system to the outside air

mode.

- During use, various odors from inside and outside the vehicle may enter into and accumulate in the air conditioning system. This may then cause odor to be emitted from the vents.
- In order to suppress odors that occur when the air conditioning system starts, the air flow mode may change to blow air to the feet or air may stop blowing for a short period of time immediately after the air conditioning system is started in automatic mode.
- When parking, the system automatically switches to outside air mode to encourage better air circulation throughout the vehicle, helping to reduce odors that occur when starting the vehicle.

#### ■ Using the voice control system (if equipped)

Air conditioning system can be operated using voice control system.

For details regarding the voice control system, refer to "MULTIMEDIA OWNER'S MANUAL".

#### ■ While the cool box is on (vehicles with cool box)

The front air conditioning system cannot be turned off.

#### ■ Air conditioning filter

→P.566

#### ■ Air conditioning system refrigerant

- A label regarding the refrigerant of the air conditioning system is attached to the hood at the location shown in the following illustration.

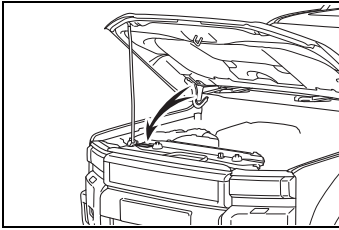

- The meaning of each symbol on the label are as follows:

	Caution
	Air conditioning system
	Air conditioning system lubricant type
	Requires registered technician to service air conditioning system
	Flammable refrigerant

### ■ Customization

Some functions can be customized.  
(Customizable features: →P.649)

### WARNING

#### ■ To prevent the windshield from fogging up

Do not use the windshield defogger switch during cool air operation in extremely humid weather. The difference between the temperature of the outside air and that of the windshield can cause the outer surface of the windshield to fog up, blocking your vision.

#### ■ When the outside rear view mirror defoggers (if equipped) are operating

Do not touch the rear view mirror surfaces when the outside rear view mirror defoggers are on.

### NOTICE

#### ■ To prevent 12-volt battery discharge

Do not leave the air conditioning system on longer than necessary when the hybrid system is off.

#### ■ When repairing/replacing parts of the air conditioning system

Have repair/replacement performed by your Toyota dealer. When a part of the air conditioning system, such as the evaporator, is to be replaced, it must be replaced with a new one.

## Using automatic mode

- 1 Press the "AUTO" switch.
- 2 Adjust the temperature setting.
- 3 To stop the operation, press the "OFF" switch.

If the fan speed setting or air flow modes are operated, the automatic mode indicator goes off. However, automatic mode for functions other than that operated is maintained.

### ■ Using automatic mode

Fan speed is adjusted automatically according to the temperature setting and the ambient conditions. Therefore, the fan may stop for a



while until warm or cool air is ready to flow immediately after the automatic mode switch is pressed.

Cool air may blow around the upper body even when the heater is on due to sunlight.

### Adjusting the temperature for driver and passenger seats simultaneously (“SYNC” mode)

Press the “SYNC” switch to turn on the “SYNC” mode.

The driver’s side temperature control switch can be used to adjust the temperature for the driver’s and passenger’s side. To enter individual mode, operate the passenger’s side temperature control switch or press the “SYNC” switch again.

When the “SYNC” mode is on, the indicator on the “SYNC” switch illuminates.

### Front seat concentrated airflow mode (S-FLOW)

This function automatically controls the air conditioning airflow so that priority is given to the front seats. Unnecessary air conditioning is suppressed, contributing to increased fuel efficiency.

Front seat concentrated airflow mode operates in the following situations.

- No passengers are detected in the rear seats
- The windshield defogger is

not operating

While operating,  illuminates.

### Manually turning front seat concentrated airflow mode on/off

In front seat concentrated airflow mode, directing airflow to the front seats only and to all seats can be switched via switch operation. When the mode has been switched manually, automatic airflow control stops operating.

Touch  on the air conditioning control screen of the multimedia display and switch the airflow.

- Indicator illuminated: Airflow to the front seats only
- Indicator off: Airflow to all the seats

### Operation of automatic airflow control

- In order to maintain a comfortable interior, airflow may be directed to seats without passengers immediately after the hybrid system is started and at other times depending on the outside temperature.
- After the hybrid system is started, if passengers move around inside or enter/exit the vehicle, the system cannot accurately detect the presence of passengers and automatic airflow control will not operate.

### Operation of manual airflow control

Even if the function is manually

switched to directing airflow to only the front seats, when a rear seat is occupied, it may automatically direct airflow to all seats.

#### ■ To return to automatic airflow control

- 1 With the indicator off, turn the power switch off.
- 2 After 60 minutes or more elapse, turn the power switch to ON.

### Changing the rear seat settings from the front seat (vehicles with rear air conditioning system)

Press the “REAR” switch to turn on the rear air conditioning system control mode.

When in rear air conditioning system control mode, “REAR” is shown on the display.

If the “REAR” switch is pressed again or operations are not performed for a few seconds, the control mode returns to the front air conditioning system control mode.

#### ■ Adjusting the temperature setting

Operate the temperature control switch on the driver’s side upwards to increase the temperature and downwards to decrease the temperature.

#### ■ Setting the fan speed

Operate the fan speed control switch upwards to increase the fan speed and downwards to decrease the fan speed.

Press the “OFF” switch to turn the fan off.

#### ■ Change the airflow mode

Operate the airflow mode control switch upwards or downwards to change the airflow mode.

The mode changes each time the switch is operated.

### Windshield de-icer (if equipped)

This feature is used to prevent ice from building up on the windshield and wiper blades.

Press the switch to turn the system on/off.

When the system is on, the indicator on the switch illuminates.

The windshield de-icer will automatically turn off after approximately 15 minutes.

- ▶ Vehicles without heated steering wheel

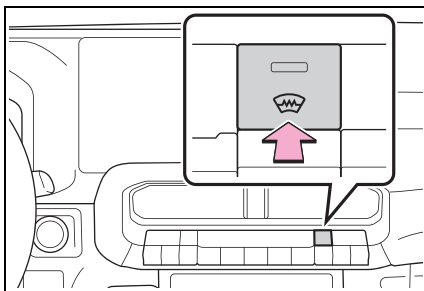

- ▶ Vehicles with heated steering wheel

For vehicles without rear automatic air conditioning system, the system can be operated using the front air conditioning control panel.

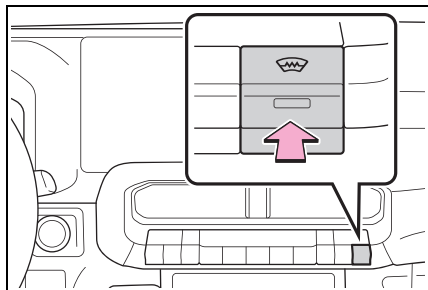

For vehicles with rear automatic air conditioning system, the system can be operated using the option control screen on the multimedia display. (→P.476)

### **WARNING**

#### **To prevent burns**

Do not touch the glass at lower part of the windshield or to the side of the front pillars when the windshield de-icer is on.

## **Air conditioning control screen**

For detail regarding the multimedia display, refer to “MULTIMEDIA OWNER’S MANUAL”.

### ■ **Display procedure**

- 1 Touch  on the main menu on the multimedia display.
- 2 Touch “Climate” on the sub menu.

### 3 Select any screen.

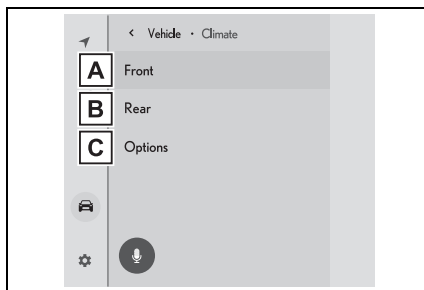

- A** Displays the front air conditioning control screen.
- B** Displays the rear air conditioning control screen. (if equipped)
- C** Displays the option control screen.

### ■ **Front air conditioning control screen**

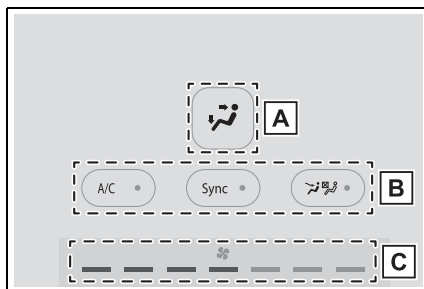

#### **A** Select the air flow mode

Each time the switch is touched, the air flow mode changes.

 : Air flows to the upper body

 : Air flows to the upper body and feet

 : Air flows to the feet

: Air flows to the feet and the windshield defogger operates

**B** Turns each function on/off

Each time the switch is touched, the function turns on/off.

When the function is on, the indicator on the switch illuminates.

“A/C”: Cooling and dehumidification function (→P.469)

“Sync”: “SYNC” mode (→P.473)

: Front seat concentrated air-flow mode (S-FLOW) (→P.473)

**C** Fan speed display

Setting of the fan speed is displayed.

### ■ Rear air conditioning control screen (if equipped)

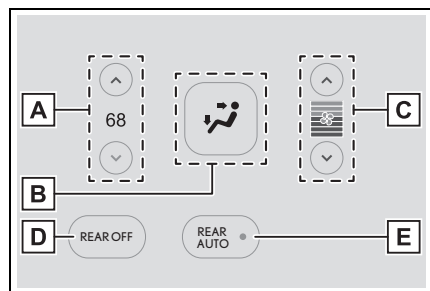

**A** Adjusts the rear seats temperature setting

**B** Select the air flow mode

Each time the switch is touched, the air flow mode changes.

: Air flows to the upper body

: Air flows to the upper body and feet

: Air flows to the feet

**C** Adjusts the rear seats fan speed setting

**D** Turns the fan off

**E** Turns the automatic mode on/off

### ■ Option control screen

The functions can be switched

(ON) and  (OFF).

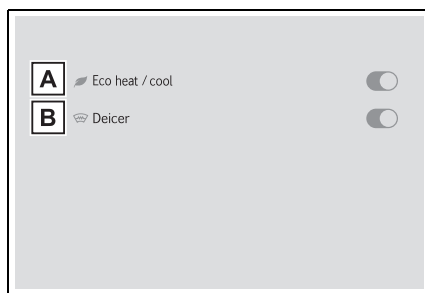

**A** Eco air conditioning mode (→P.471)

**B** Windshield de-icer (→P.474)

## Air outlet layout and operations

### ■ Location of air outlets

The air outlets and air volume change according to the selected air flow mode.

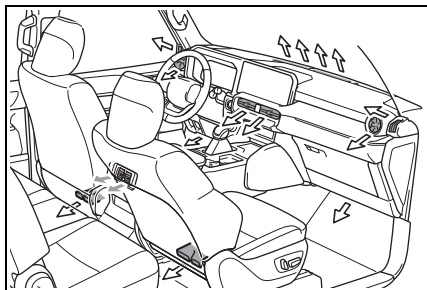

←: If equipped

### ■ Adjusting the air flow direction and opening/closing the air outlets

► Front side

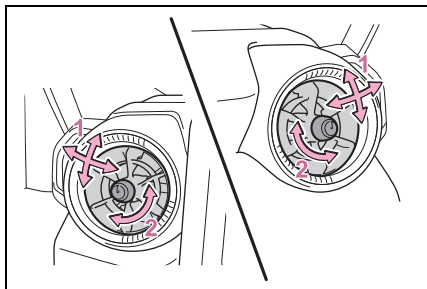

- 1 Direct air flow to the left or right, up or down
- 2 Turn the knob to open or close the vent

► Front center

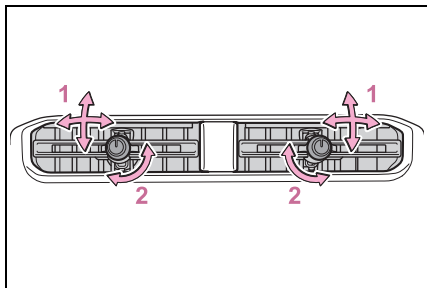

- 1 Direct air flow to the left or right, up or down
- 2 Turn the knob to open or

close the vent

► Rear (if equipped)

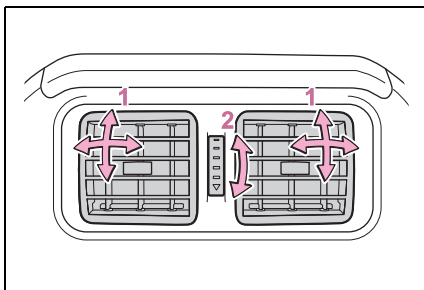

- 1 Direct air flow to the left or right, up or down
- 2 Turn the knob to open or close the vent

### ⚠ WARNING

#### ■ To not interrupt the windshield defogger from operating

Do not place anything on the instrument panel which may cover the air outlets. Otherwise, air flow may be obstructed, preventing the windshield defoggers from defogging.

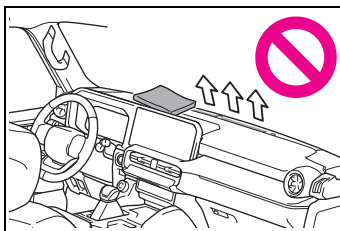

## Rear automatic air conditioning system\*

\*: If equipped

**Air outlets and fan speed are automatically adjusted according to the temperature setting.**

## Rear air conditioning controls

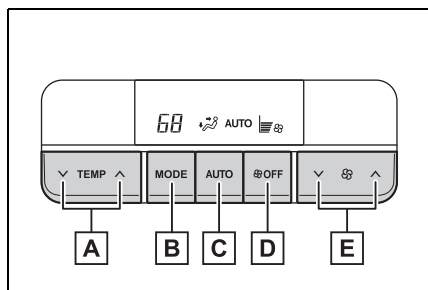

- A** Temperature control switch
- B** Airflow mode control switch
- C** Automatic mode switch
- D** "OFF" switch
- E** Fan speed control switch

### ■ Adjusting the temperature setting

Press **▲** of the temperature control switch to increase the temperature and **▼** to decrease the temperature.

### ■ Setting the fan speed

Press **▲** of the fan speed control switch to increase the fan speed and **▼** to decrease the

fan speed.

The fan speed is shown on the display. (7 levels)

Press the "OFF" switch to turn off the fan.

### ■ Change the airflow mode

Press the airflow mode control switch.

The airflow mode changes as follows each time the switch is pressed.

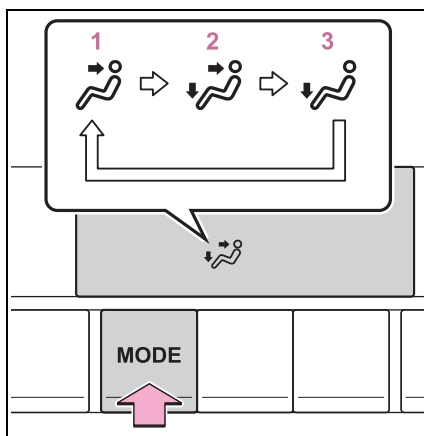

- 1 Air flows to the upper body
- 2 Air flows to the upper body and feet
- 3 Air flows to the feet

### ■ Rear automatic air conditioning system operation condition

When the front air conditioning system is off, only air blows without the cooling function activated.

### ■ Ventilation and air conditioning odors

During use, various odors from inside the vehicle may enter into and accumulate in the air conditioning system. This may then cause odor to be emitted from the vents.

### ■ Changing the rear seat settings from the front seat

The rear automatic air conditioning system settings can be changed from the front air conditioning system control panel by operating the "REAR" switch. (→P.474)

### ■ Air conditioning control screen

→P.475



#### NOTICE

#### ■ To prevent 12-volt battery discharge

Do not leave the rear air conditioning system on longer than necessary when the hybrid system is off.

### Using the automatic mode

- 1 Press the "AUTO" switch.
- 2 Adjust the temperature setting.
- 3 To stop the operation, press the "OFF" switch.

If the fan speed setting or air flow modes are operated, "AUTO" on the display goes off. However, automatic mode for functions other than that operated is maintained.

### ■ Using automatic mode

Fan speed is adjusted automatically according to the temperature setting and the ambient conditions.

Therefore, the fan may stop for a while until warm or cool air is ready to flow immediately after the automatic mode switch is pressed.

Cool air may blow around the upper body even when the heater is on due to sunlight.

### Air outlet layout and operations

#### ■ Location of air outlets

The air outlets and air volume changes according to the selected air flow mode.

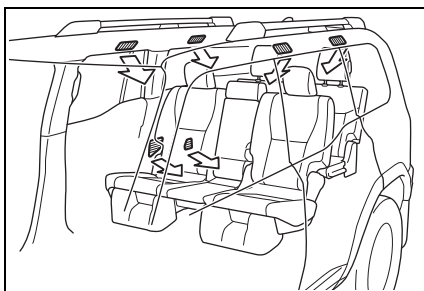

#### ■ Adjusting the air flow direction and opening/closing the air outlets (side ceiling)

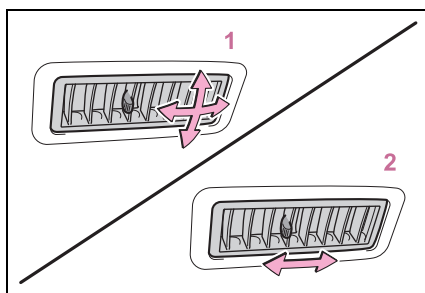

- 1 Direct air flow to the left or right, up or down.
- 2 Open or close the vent  
To close the vent, move the knob fully rearward.

## Heated steering wheel<sup>\*</sup> / seat heaters<sup>\*</sup> / seat ventilators<sup>\*</sup>

<sup>\*</sup>: If equipped

- Heated steering wheel

Warm up the grips of the steering wheel

- Seat heaters

Warm up the seat upholstery

- Seat ventilators

Maintain good ventilation by sucking air into the seats

### WARNING

#### ■ To prevent minor burn injuries

Care should be taken if anyone in the following categories comes in contact with the steering wheel or seats when the heater is on:

- Babies, small children, the elderly, the sick and the physically challenged
- Persons with sensitive skin
- Persons who are fatigued
- Persons who have taken alcohol or drugs that induce sleep (sleeping drugs, cold remedies, etc.)

### NOTICE

#### ■ To prevent damage to the seat heaters and seat ventilators

Do not put heavy objects that have an uneven surface on the seat and do not stick sharp objects (needles, nails, etc.) into the seat.

#### ■ To prevent 12-volt battery discharge

Do not use the functions when the hybrid system is off.

## Operating the heated steering wheel

Press the switch to turn the heated steering wheel on/off.

The indicator light  comes on during operation.

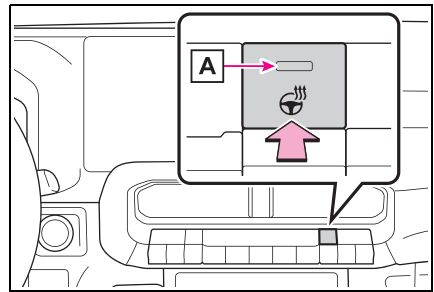

### ■ Operation condition

The power switch is in ON.

### ■ If the indicator light flashes

Press the switch to turn the heated steering wheel off and then press the switch again. If the indicator light still flashes, a malfunction may be occurring. Turn the heated steering wheel off and have the vehicle inspected by your Toyota dealer.



## Operating the seat heaters

### ■ Front seats

Press the switch to turn the seat heater on/off.

The level indicators **A** come on during operation.

Each time the switch is pressed, the operation condition changes as follows.

Hi (3 segments lit) → Mid (2 segments lit) → Lo (1 segment lit) → Off

### ▶ Vehicles without seat ventilators

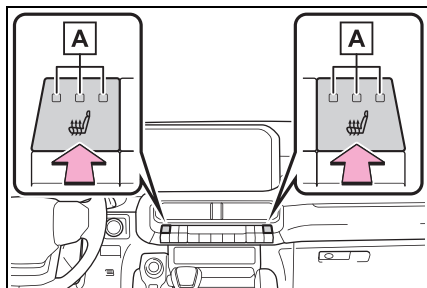

### ▶ Vehicles with seat ventilators

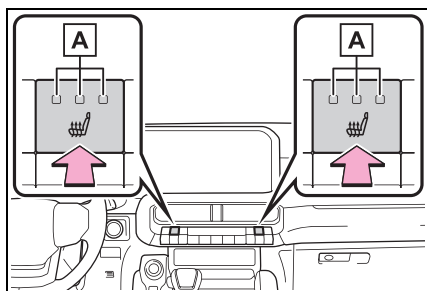

### ■ Outboard second seats (if equipped)

Press the switch to turn the seat heater on/off.

The level indicators **A** come on during operation.

Each time the switch is pressed, the operation condition changes as follows.

Hi (3 segments lit) → Mid (2 segments lit) → Lo (1 segment lit) → Off

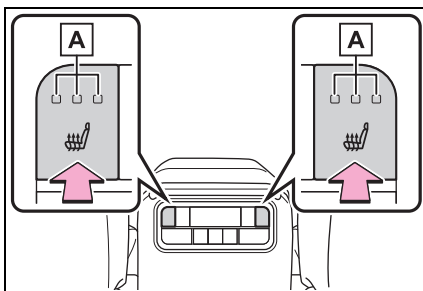

### ■ The seat heaters can be used when

The power switch is in ON.

### ⚠ WARNING

#### ■ To prevent causes of overheating and minor burn injuries

Observe the following precautions when using a seat heater

- Do not cover the seat with a blanket or cushion when using the seat heater.
- Do not use seat heater more than necessary.

## Operating the seat ventilators

### ■ Front seats

Press the switch to turn the seat ventilator on/off.

The level indicators **A** come on

during operation.

Each time the switch is pressed, the operation condition changes as follows.

Hi (3 segments lit) → Mid (2 segments lit) → Lo (1 segment lit) → Off

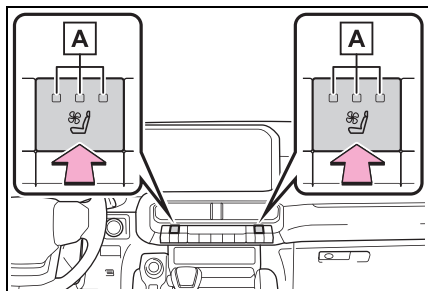

### ■ Outboard second seats (if equipped)

Press the switch to turn the seat ventilator on/off.

The level indicators **A** come on during operation.

Each time the switch is pressed, the operation condition changes as follows.

Hi (3 segments lit) → Mid (2 segments lit) → Lo (1 segment lit) → Off

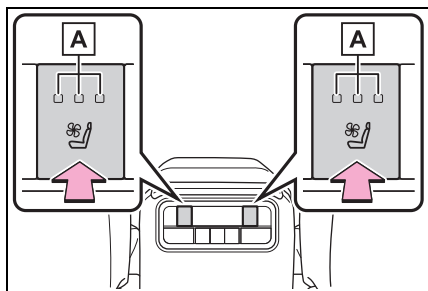

### ■ The seat ventilators can be used when

The power switch is in ON.

### ■ Air conditioning system-linked control mode

When a seat ventilator is set to Hi, the fan speed of the seat ventilator may increase according to the fan speed of the air conditioning system.

## Interior lights list

## Location of the interior lights

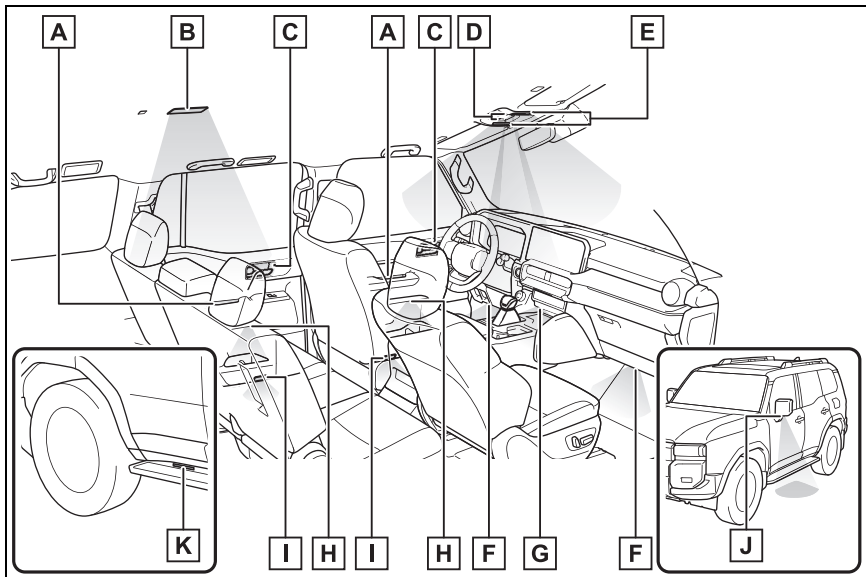

- A** Pull handle lights (if equipped)
- B** Rear interior light (→P.484)
- C** Inside door handle lights (if equipped)
- D** Shift lever lights \*
- E** Front interior light/personal lights (→P.484, 485)
- F** Footwell lights (if equipped)
- G** Open tray light (if equipped)
- H** Door pocket lights (if equipped)
- I** Door courtesy lights (if equipped)
- J** Outer foot lights (if equipped)
- K** Running board lights (if equipped)

\*: The shift lever lights turn on/off together with the tail lights.

#### ■ Illuminated entry system

The lights automatically turn on/off

according to the power switch mode, the presence of the electronic key, whether the doors are

locked/unlocked, and whether the doors are opened/closed.

■ **To prevent the 12-volt battery from being discharged**

If the interior lights remain on when the power switch is turned to OFF, the lights will go off automatically after 20 minutes.

■ **Automatic illumination of the interior lights**

If any of the SRS airbags deploy (inflate) or in the event of a strong rear impact, the interior lights will turn on automatically. The interior lights will turn off automatically after approximately 20 minutes.

The interior lights can be turned off manually. However, in order to help prevent further collisions, it is recommended that they be left on until safety can be ensured. (The interior lights may not turn on automatically depending on the force of the impact and conditions of the collision.)

■ **Customization**

Setting (e.g. the time elapsed before the lights turn off) can be changed. (Customizable features: →P.649)

together with the front interior light. When a door is opened while the door position is on, the light turns on.

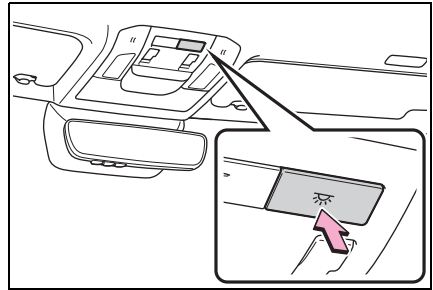

■ **Turning the rear interior light on/off**

Press the switch.

Each time the switch is pressed, the light turns on/off.

The rear interior light is also turned on/off by the front interior light operations. If the light is turned on by front interior light operation, the rear interior light cannot turn off by pressing the switch.

	<p><b>NOTICE</b></p>
<p>■ <b>To prevent 12-volt battery discharge</b></p>	
<p>Do not leave the lights on longer than necessary when the hybrid system is off.</p>	

**Operating interior lights**

■ **Turning the front interior light on/off**

Press the switch.

Each time the switch is pressed, the light turns on/off.

The rear interior light turns on/off

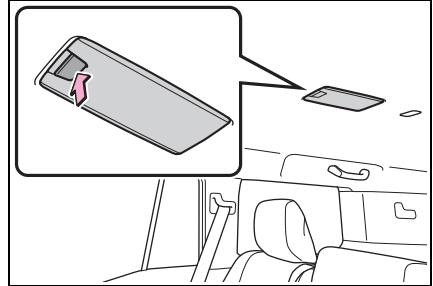

■ **Turning the door position on/off**

Press the door-linked interior light switch.

The lights are turned on and off according to whether the doors are opened/closed while the door posi-

tion is on.

Each time the switch is pressed, the door position turns on/off.

When the door position is on, the indicator **A** on the switch illuminates.

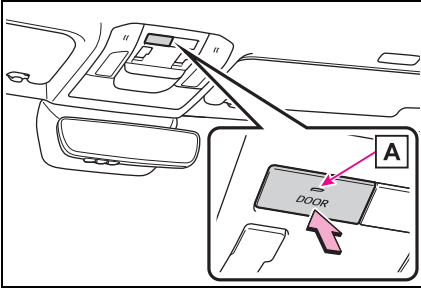

### Operating personal lights

Touch the light.

Each time the light is touched, the light turns on/off.

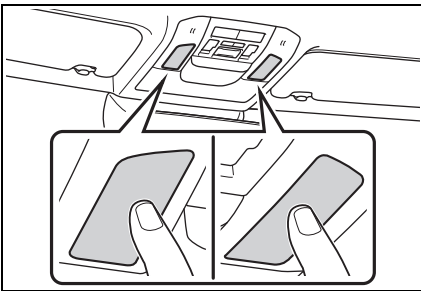

#### ■ When personal light does not respond as normal

- When water, dirt, etc., have adhered to the lens surface
- When operated with a wet hand
- When wearing gloves, etc.

#### ⚠ NOTICE

#### ■ Removing personal light lenses

Never remove the lens for the personal lights. Otherwise, the lights will be damaged. If the lens need to remove, contact your Toyota dealer.

## List of storage features

### Location of the storage features

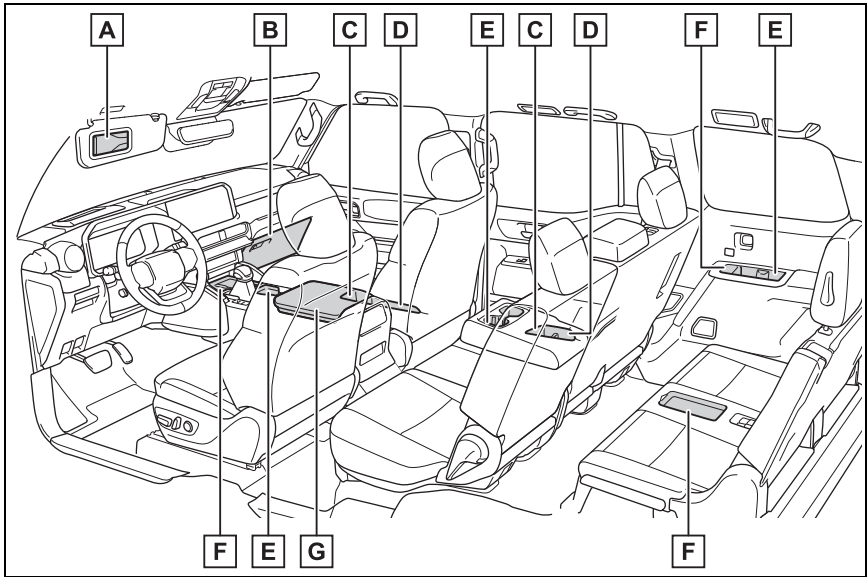

- A** Ticket holders (→P.488)
- B** Glove box (→P.487)
- C** Bottle holders (→P.488)
- D** Door pockets
- E** Cup holders (→P.487)
- F** Open trays (→P.489)
- G** Console box (if equipped) (→P.487)



#### WARNING

##### Items that should not be left in the storage spaces

Do not leave glasses, lighters or spray cans in the storage spaces, as this may cause the following when cabin temperature becomes high:

- Glasses may be deformed by heat or cracked if they come into contact with other stored items.
- Lighters or spray cans may explode. If they come into contact with other stored items, the lighter may catch fire or the spray can may release gas, causing a fire hazard.

## Glove box

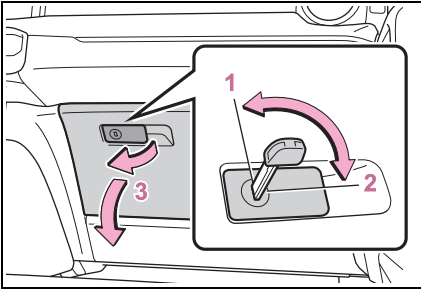

- 1 Unlock with the mechanical key
- 2 Lock with the mechanical key
- 3 Open (pull the lever)

### ■ Glove box light

The glove box light turns on when the tail lights are on.

### ■ Removing the partition

The partition inside the glove box can be removed by pulling it.

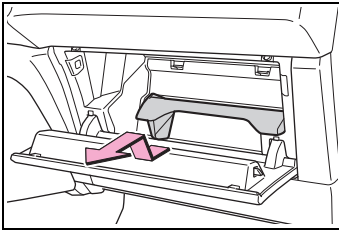

### ▲ WARNING

#### ■ Caution while driving

Keep the glove box closed. In the event of sudden braking or sudden swerving, an accident may occur due to an occupant being struck by the open glove box or the items stored inside.

## Console box (if equipped)

Your vehicle is equipped with either a console box or cool box.

For vehicles with the cool box, refer to P.494.

While pressing the button, lift up and open the lid.

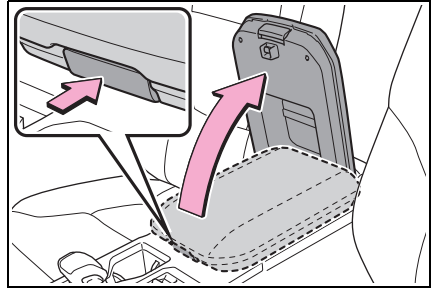

### ▲ WARNING

#### ■ Caution while driving

Keep the console box closed.

Injuries may result in the event of an accident or sudden braking.

## Cup holders

### ■ Front seats

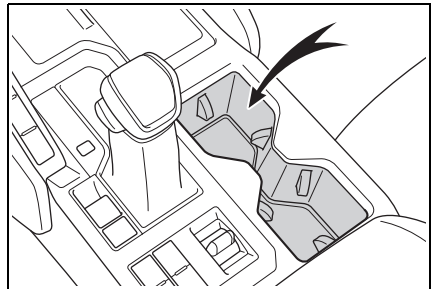

### ■ Second seats

Pull the armrest down.

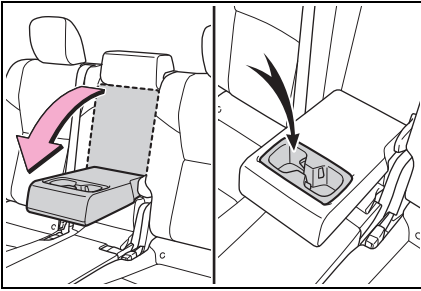

### ■ Rear side trims

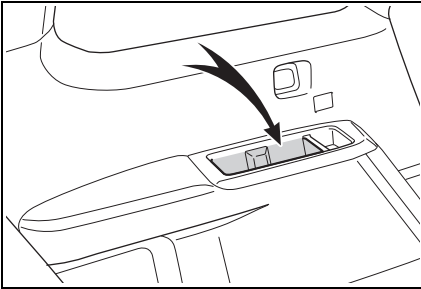

### ⚠ WARNING

#### ■ Items unsuitable for the cup holders

Do not place anything other than a cup, beverage can or bottle\* in the cup holders. Other items may be thrown out of the holders in the event of an accident or sudden braking and cause injury. If possible, cover hot drinks to prevent burns.

\*: Except for second seat cup holders

## Bottle holders

### ■ Front doors

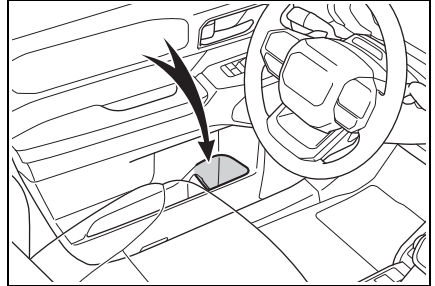

### ■ Rear doors

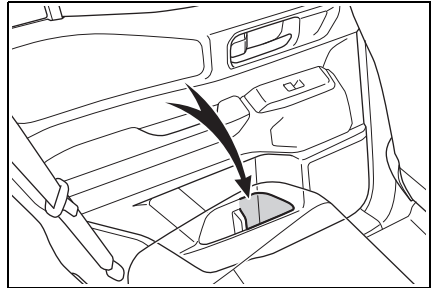

### ■ Bottle holders

- When storing a bottle, close the cap.
- The bottle may not be stored depending on its size or shape.

### ⚠ NOTICE

#### ■ Items that should be not stowed in the bottle holders

Do not place open bottles or glass and paper cups containing liquid in the bottle holders. The contents may spill and glasses may break.

## Ticket holders

Flip the sun visor down to use.



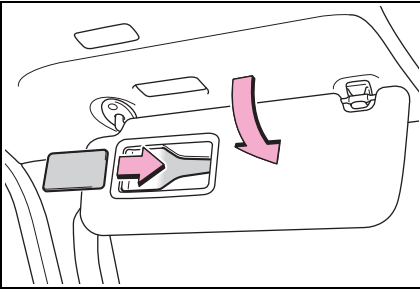

### Open trays

#### ■ Type A (if equipped)

Vehicles with wireless charger:  
→P.497

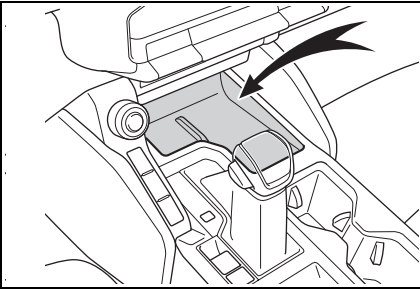

#### ■ Type B

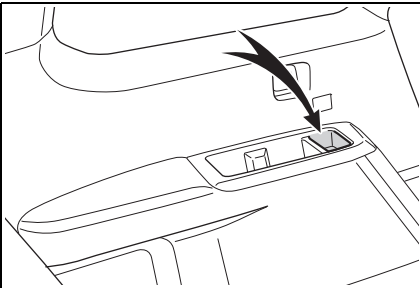

#### ■ Type C (if equipped)

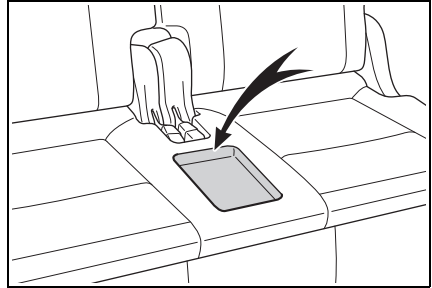

#### ⚠ WARNING

#### ■ Items unsuitable for the open tray

Observe the following precautions when putting items in the open tray. Failure to do so may cause items to be thrown out of the tray in the event of sudden braking or steering. In these cases, the items may interfere with pedal operation or cause driver distraction, resulting in an accident.

- Do not store items in the tray that can easily shift or roll out.
- Do not stack items in the tray higher than the tray's edge.
- Do not put items in the tray that may protrude over the tray's edge.

## Luggage compartment features

### Cargo hooks

Raise the hook to use.

The cargo hooks are provided for securing loose items.

#### ► Vehicles without third seats

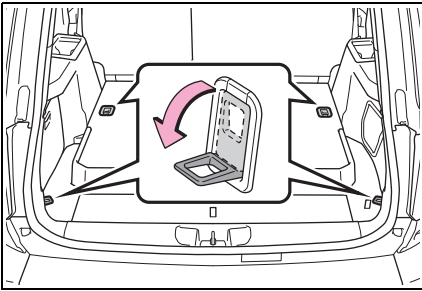

#### ► Vehicles with third seats

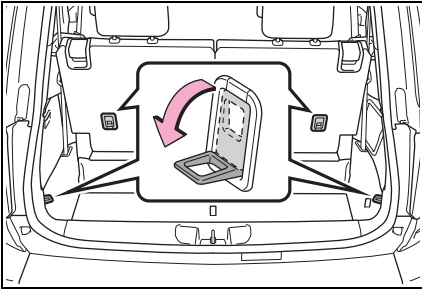

#### ■ Cargo hooks on the back of third seats (if equipped)

The cargo hooks can also be used with the third seats folded.

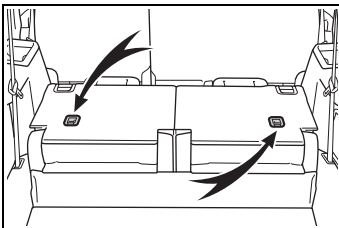

### ⚠ WARNING

#### ■ When cargo hooks are not in use

To avoid injury, always return the hooks to their stowed positions when not in use.

### Deck board

Pull the strap upwards and open the deck board.

#### ► Vehicles without third seats

Rear of the luggage compartment:

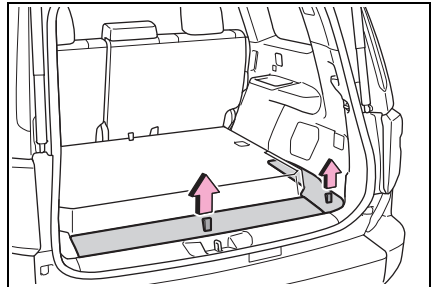

Behind the second seats:

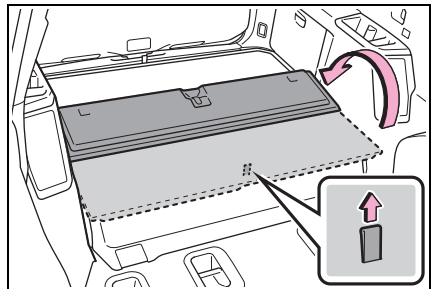

► Vehicles with third seats

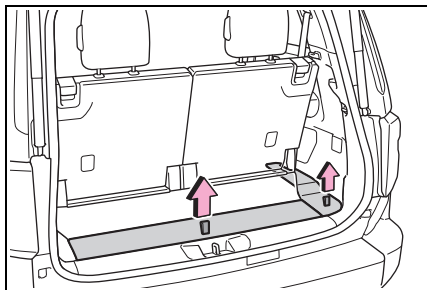

■ **When installing the deck board (vehicles without third seats [rear of the luggage compartment] and vehicles with third seats)**

Insert the claw in to the hole, and return the deck board.

► Vehicles without third seats (rear of the luggage compartment)

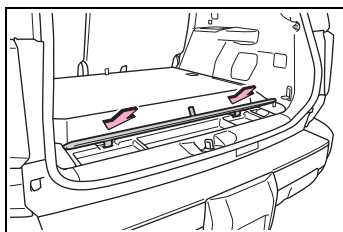

► Vehicles with third seats

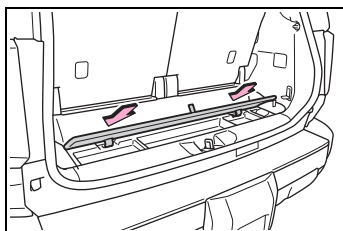

**⚠ WARNING**

■ **When operating the deck board**

Do not place anything on the deck board when operating the board. Otherwise, your fingers may be caught or an accident may result causing injuries.

■ **Caution while driving**

Keep the deck board closed.

In the event of sudden braking, an accident may occur due to an occupant being struck by the deck board or the items stored under the deck board.

**Deck under tray**

Open the deck board. (→P.490)

The following items can be stowed.

► Vehicles without third seats

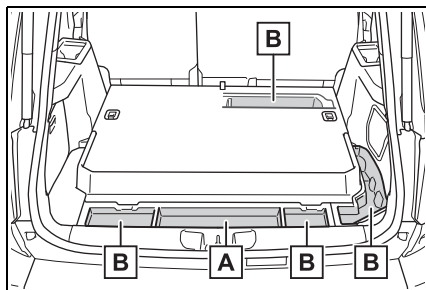

**A** Warning reflector\*

**B** Accessories

\*: The warning reflector itself is not included as an original equipment.

► Vehicles with third seats

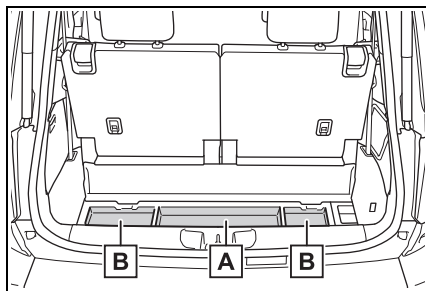

**A** Warning reflector\*

**B** Accessories

\*: The warning reflector itself is not included as an original equipment.

### ■ Warning reflector

Depending on the size and shape of the warning reflector case, you may not be able to store it.

## Luggage cover (if equipped)

### ■ Installing the luggage cover

- 1 Install one side of the luggage cover to the holder. While pushing that side in, install the other side to the opposite holder.

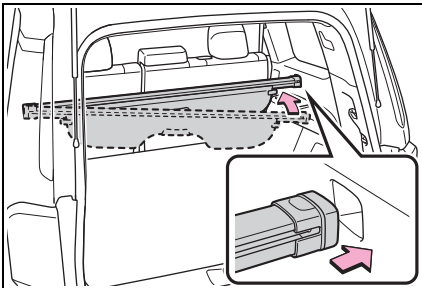

- 2 Pull out the luggage cover and secure it to the hook brackets.

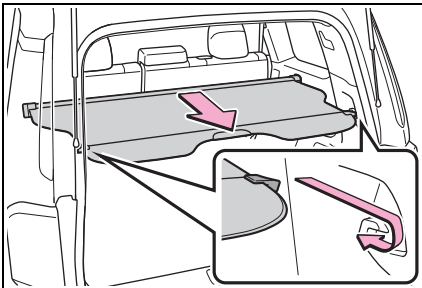

### ■ Removing the luggage cover

- 1 Detach the both ends of the luggage cover from the holder and retract it.

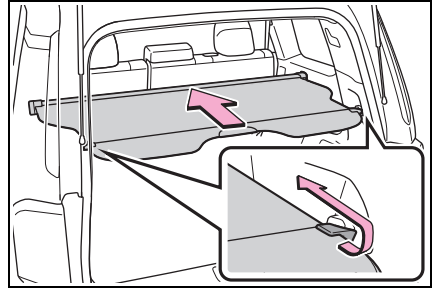

- 2 Push one end of the luggage cover inward and remove it from the holder.

After remove the luggage cover, remove it from the vehicle.

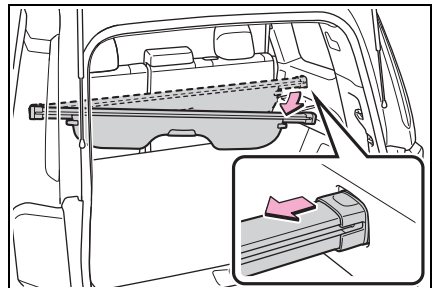

### ⚠ WARNING

#### ■ Luggage cover

- Do not place anything on the luggage cover. In the event of sudden braking or turning, the item may go flying and strike an occupant. This could lead to an unexpected accident, resulting in death or serious injury.

**WARNING**

- Do not allow children to climb on the luggage cover. Climbing on the luggage cover could result in damage to the luggage cover, possibly causing death or serious injury to the child.

## Other interior features

### Cool box (if equipped)

While the hybrid system is operating, the cool box, which is cooled by the air conditioning, can be used.

- 1 While pressing the button, lift up and open the lid.

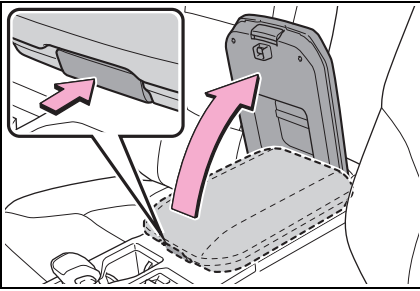

- 2 Turns the cool box on/off

When on, the indicator light **A** comes on.

If the front air conditioning system is not in use, the front air conditioning system is automatically turned on when the cool box is turned on.

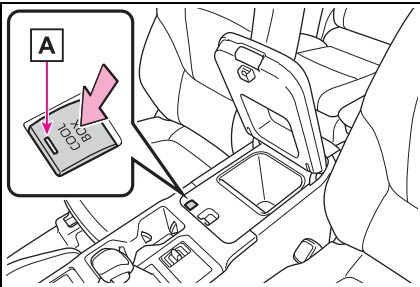

#### ■ If the front air conditioning system is not in use

When the cool box is turned on, the front air conditioning system is automatically turned on.

#### ■ While the cool box is on

- The front air conditioning system cannot be turned off.
- To adjust the temperature of the cool box, the cool box may stop operating temporarily.

#### ■ When the outside temperature is 32°F (0°C) or below

The cool box may not operate.

#### ■ Items unsuitable for the cool box

- Drinks in unsealed containers
- Fragile items, perishables or anything with strong odor
- Owner's manual, electronic devices, CDs, etc.

#### ■ When cleaning the inside of the cool box

Wipe dirt off with a cloth dampened with water. Directly applying water may cause a malfunction.

#### ⚠ WARNING

##### ■ Caution while driving

Keep the cool box closed while driving.

Injuries may result in the event of sudden braking, sudden swerving or an accident.

#### ⚠ NOTICE

##### ■ To prevent 12-volt battery discharge

Do not leave the cool box on longer than necessary when the hybrid system is off.

## Sun visors

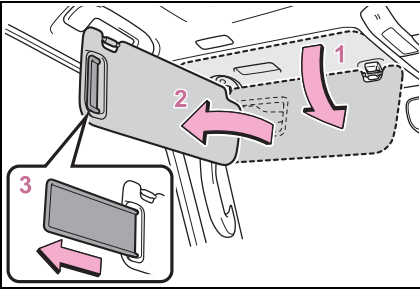

- 1** To set the visor in the forward position, flip it down.
- 2** To set the visor in the side position, flip down, unhook, and swing it to the side.
- 3** To use the side extender, place the visor in the side position, then slide it backward.

## Vanity mirrors

Slide the cover to open.

The light turns on when the cover is opened.

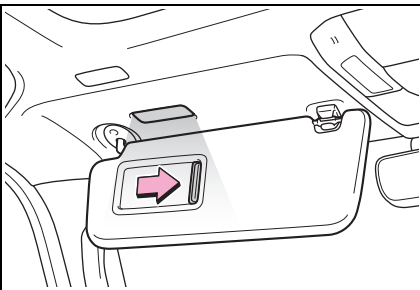

### ■ Automatic light off to prevent 12-volt battery discharge

If the vanity lights remain on when the power switch is turned to OFF, the lights will go off automatically after 20 minutes.

### ⚠ NOTICE

#### ■ To prevent 12-volt battery discharge

Do not leave the vanity lights on for extended periods while the hybrid system is off.

## Power outlet (12 VDC)

Please use a power supply for electronic goods that use less than 12 VDC/10 A (power consumption of 120 W).

When connecting multiple devices, make sure that the total power consumption of all the connected devices is less than 120 W.

### ■ Type A

Open the lid.

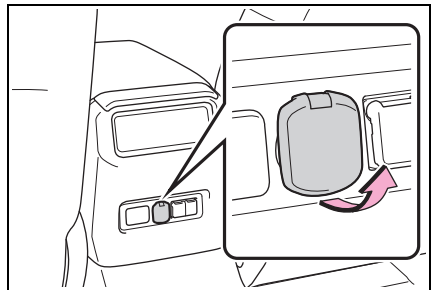

### ■ Type B (if equipped)

Open the lid.

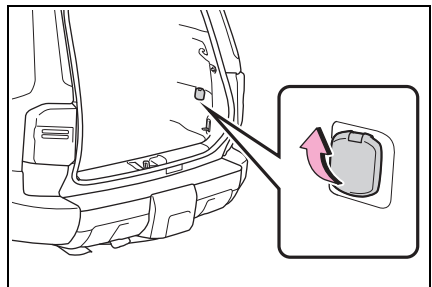

### ■ The power outlet can be used when

The power switch is in ACC or ON.

### ■ When turning the power switch off

Disconnect electrical devices with charging functions, such as mobile battery packs.

If such devices are left connected, the power switch may not be turned off normally.



### NOTICE

#### ■ To avoid damaging the power outlet

Close the lid when the power outlet is not in use.

Foreign objects or liquids that enter the power outlet may cause a short circuit.

#### ■ To prevent 12-volt battery discharge

Do not use the power outlet longer than necessary when the hybrid system is off.

## USB Type-C charging ports

The USB Type-C charging ports are used to supply 3 A of electricity at 5 V to external devices. The USB Type-C charging ports are for charging only. They are not designed for data transfer or other purposes.

Depending on the external device, it may not charge properly. Refer to the manual included with the device before using a USB Type-C charging port.

### ■ Type A

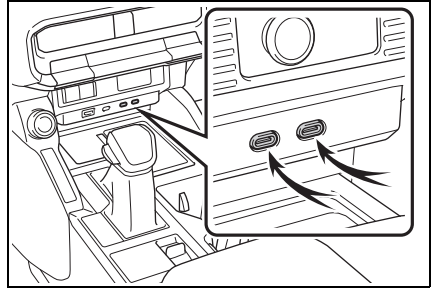

### ■ Type B

Open the lid.

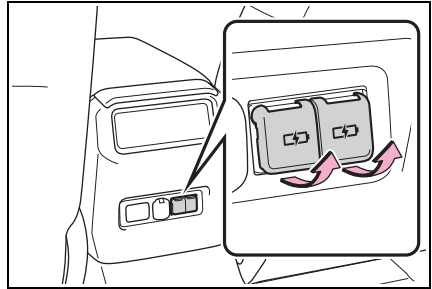

### ■ Type C (if equipped)

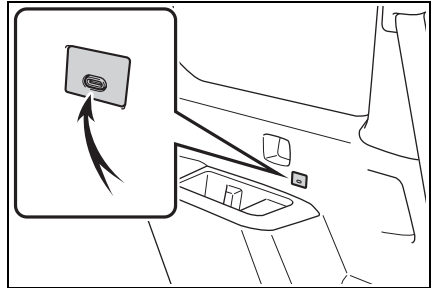

### ■ The USB Type-C charging ports can be used when

The power switch is in ACC or ON.

### ■ Situations in which the USB Type-C charging ports may not operate correctly

- If a device which consumes more than 3 A at 5 V is connected
- If a device designed to communicate with a personal computer,



such as a USB memory device, is connected

- If the connected external device is turned off (depending on device)
- If the temperature inside the vehicle is high, such as after the vehicle has been parked in the sun

#### ■ About connected external devices

Depending on the connected external device, charging may occasionally be suspended and then start again. This is not a malfunction.



#### NOTICE

##### ■ To prevent damage to the USB Type-C charging ports

- Do not insert foreign objects into the ports.
- Do not spill water or other liquids into the ports.
- Type B: When the USB Type-C charging ports are not in use, close the lids. If a foreign object or liquid enters a port may cause a short circuit.
- Do not apply excessive force to or impact the USB Type-C charging ports.
- Do not disassemble or modify the USB Type-C charging ports.

##### ■ To prevent damage to external devices

- Do not leave external devices in the vehicle. The temperature inside the vehicle may become high, resulting in damage to an external device.
- Do not push down on or apply unnecessary force to an external device or the cable of an external device while it is connected.

##### ■ To prevent 12-volt battery discharge

Do not use the USB Type-C charging ports for a long period of time with the hybrid system is off.

#### Wireless charger (if equipped)

A portable device can be charged by just placing Qi standard wireless charge compatible portable devices according to the Wireless Power Consortium, such as smartphones and mobile batteries, etc., on the charge area.

The compatible portable devices can be found on the following Wireless Power Consortium website.

<https://www.wirelesspowerconsortium.com/>

This function cannot be used with portable devices that cannot be placed on the wireless charger. Also, depending on the portable device, it may not operate as normal. Please read the operation manual for portable devices to be used.

##### ■ The “Qi” logo

The “Qi” logo is a trademark of the Wireless Power Consortium.



### ■ Name for all parts

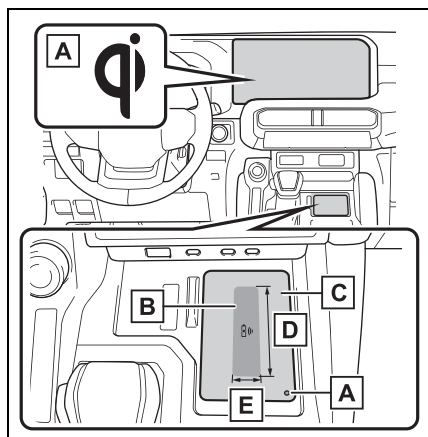

- A** Operation indicator light
- B** Charge area\*
- C** Charging tray
- D** Approximately 3.9 in. (10 cm)
- E** Approximately 1.0 in. (2.5 cm)

\*: The charging coil in the wireless charger can be moved within the charge area up to the position of the charging coil inside a portable device. Charging is possible if the center of the coil of the portable device is placed within the charge area.

If 2 or more portable devices are placed on the wireless charger, their charging coils may not be properly detected and they may not be charged.

### ■ Using the wireless charger

Place the portable device on the wireless charger.

Place the charging side of the portable device down with the center of the device in the center of the charge area.

When charging, the operation indicator light (orange) on the wireless charger comes on.

Refer to “Situations in which the function may not operate normally” (→P.503) when charging is not performed.

When charging is complete, the operation indicator light (green) on the wireless charger comes on.

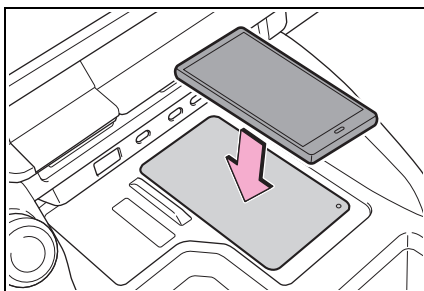

### ■ Recharging function

- When charging is complete and after a fixed time in the charge suspension state, charging restarts.
- When a portable device is moved significantly in the charge area, the charging coil is disconnected and charging is stopped momentarily. However, if there is the center of a charging coil in the charge area, the charging coil inside the wireless charger will move

toward it and then charging restarts. If the portable device is moved to somewhere outside of the charge area, charging will stop. Place the portable device near the center of the charge area.

### ■ Rapid charging function

- The following portable devices support rapid charging.
- Portable devices compliant with WPC Ver1.3.2 and compatible

with rapid charging

- iPhone's with an iOS version that supports 7.5 W charging (iPhone 8 and later models)
- Portable devices compatible with Galaxy original rapid charging standard.
- When a portable device that supports rapid charging is charged, charging automatically switches to the rapid charging function.

### ■ Lighting conditions of operation indicator light

Operation indicator light		Conditions
Charging tray side	Multimedia display side	
Turning off	Disappear	When power for Multimedia is off or the power switch is off
Green (comes on)	Gray	On Standby (charging possible state) <sup>*1</sup>
		When charging is complete <sup>*2</sup>
Orange (comes on)	Blue	Charging

<sup>\*1</sup>: Charging power will not be output during standby. A metallic object will not be heated, if it is placed on the wireless charger in this state.

<sup>\*2</sup>: Depending on the portable device, there are cases where the operation indicator light will continue being lit up orange even after the charging is complete.

### ■ When the wireless charger does not operate properly

When the wireless charger does not operate properly, handle the probable cause based on the following tables.

Operation indicator light		Suspected causes/Handling method
Charging tray side	Multimedia display side	
Orange (Flashing repeatedly once every second)	Gray	<p><b>Vehicle to wireless charger communication failure</b></p> <p>→ <b>If the hybrid system is operating, stop and then restart the hybrid system.</b></p> <p>If the power switch is in ACC, start the hybrid system. (→P.222)</p>
Green (Flashing repeatedly once every second)	Disappear	<p><b>Wireless charger and multimedia system communication failure</b></p> <p>→ <b>If the hybrid system is operating, stop and then restart the hybrid system.</b></p> <p>If the power switch is in ACC, start the hybrid system. (→P.222)</p>
Green (comes on)	Blue	<p><b>AM radio stations are being automatically selected</b></p> <p>→ <b>Wait until the system has completed the automatic selection of AM radio stations. In the case that automatic selection cannot be completed, stop automatic selection.</b></p>
		<p><b>The smart key system is detecting the electronic key.</b></p> <p>→ <b>Wait until electronic key detection has completed.</b></p>

Operation indicator light		Suspected causes/Handling method
Charging tray side	Multimedia display side	
Green (comes on)	Gray	<p><b>Foreign substance detection:</b> The abnormal heating prevention function for foreign substances operated due to the presence of a metallic foreign substance in the charge area</p> <p>→ Remove the foreign substance from the charge area.</p>
		<p><b>Portable device misaligned / distanced from charging surface:</b> The charging coil in the portable device moved outside of the charging area, or lens convex is large, or case is thick so the abnormal heating prevention function operated</p> <p>→ Remove the portable device from the wireless charger, after 5 seconds, then place the portable device so that it is near the center of the wireless charger. Also, if a case or cover is installed to the portable device, remove it.</p>

Operation indicator light		Suspected causes/Handling method
Charging tray side	Multimedia display side	
Green (comes on)	Gray	<p><b>Battery protection function of portable device:</b></p> <p><b>Before full charging, battery protection function of portable device operated</b></p> <p>→ <b>Confirm the setting of portable device.</b></p>
		<p><b>Continued detection of an electronic key:</b></p> <p><b>When a Multimedia function is used through vehicle customization, the electronic key is continually detected without being confirmed.</b></p> <p>→ <b>In this case, turn the power switch ACC or ON to confirm the key.</b></p>
Orange (Repeatedly flashes 4 times continuously)	Gray	<p><b>Safety shutdown resulting when the temperature within the wireless charger exceeded the set value</b></p> <p>→ <b>Stop charging, remove the portable device from the wireless charger, wait for the temperature to drop, and then start charging again.</b></p>

#### ■ The wireless charger can be operated when

The power switch is in ACC or ON.

#### ■ Usable portable devices

- Devices compatible with wireless charging Qi standards can be used. However, compatibility with portable devices that comply with Qi Ver. 1.0, 1.3.2 and later versions is not guaranteed.
- Starting with mobile phones and smartphones, it is aimed for low power electrically supplied portable devices of no more than 5W.
- However, charging exceeding 5 W is supported by the following portable devices.
  - Charging at 7.5 W or less is supported by iPhone's that support 7.5 W charging.
  - Charging at 10 W or less is supported by Galaxy device that support 10 W charging of original standard.
  - Charging at 15 W or less is supported by portable devices compliant with EPP output as defined by WPC standard Ver1.3.2.

### ■ Using the smart key system

If the smart key system detects the electronic key while a device is being charged, charging will be temporarily stopped. When the electronic key is detected, charging will automatically start again.

### ■ When covers and accessories are attached to portable devices

Do not charge in situations where cover and accessories not able to handle Qi are attached to the portable device. Depending on the type of cover (including for certain genuine manufacturer parts) and accessory, it may not be possible to charge. When charging is not performed even with the portable device placed on the charge area, remove the cover and accessories.

### ■ AM radio cooperation function during charging

- During charging, if noise occurs when listening to the AM radio, the charging frequency is automatically changed to reduce the noise.
- When automatically seeking AM radio stations, charging will be suspended to prevent charging noise from being detected as a radio station. Charging will resume automatically when seek tuning is stopped.

### ■ Important points of the wireless charger

- If the electronic key cannot be detected within the vehicle interior, charging cannot be done. When the door is opened and closed, charging may be temporarily suspended.
- When charging, the wireless charging device and portable device will get warmer, however this is not a malfunction. When a portable device gets warm while charging, charging may stop due to the protection function on the portable device

side. In this case, when the temperature of the portable device drops significantly, charge again.

The fan may start operating to lower the temperature inside the wireless charger, however this is not a malfunction.

### ■ Operation sounds

A buzzing noise may be heard when pressing the power switch to turn to ACC or ON or when detecting a portable device. However, this is not a malfunction.

### ■ Cleaning the wireless charger

→P.530

### ■ Situations in which the function may not operate normally

Devices may not be charged normally in the following situations.

- The portable device is fully charged
- The portable device is being charged with a cable connected
- There is foreign matter between the charge area and portable device
- Charging has caused the portable device to heat up
- The temperature around the wireless charger is 95°F (35°C) or higher, such as in extreme heat
- The portable device is placed with its charging surface facing up
- The small portable device such as foldable type is placed in an area misaligned from the charge area
- The portable device is larger than the charging tray
- The vehicle is in an area where strong electrical waves or noise are emitted, such as near a television tower, power plant, gasoline station, broadcasting station, large display, airport, etc.
- The electronic key is not inside the vehicle

- Any of the following objects is stuck or installed between the charging side of the portable device and the charge area.
  - Thick cases or covers
  - A case or cover attached with an uneven or tilted surface, so that the charging side is not flat
  - Thick decorations
  - Accessories, such as finger rings, straps, etc.
- When there is a gap between the charging side of the portable device and the charge area due to a protrusion such as a camera on the charging side of the portable device.
- When the portable device is in contact with, or is covered by any of the following metallic objects:
  - A card that has metal on it, such as aluminum foil, etc.
  - A pack of cigarettes that includes aluminum foil
  - A wallet or bag that is made of metal
  - Coins
  - A heating pad
  - CDs, DVDs or other media
  - A metal accessory
  - A case or cover made of metal
  - A flip type case with a magnet on the charging side of the portable device
- Electric wave type wireless remote controls are being used nearby
- 2 or more portable devices are placed on the wireless charger at the same time
- If you use a device with a built-in S-Pen (Galaxy Note series, etc.) and the device with the S-Pen inserted is on the tray.

If charging is abnormal or the operation indicator light continues to flash for any other reason, the wireless charger may be malfunctioning. Contact your Toyota dealer.

#### ■ If the smartphone OS has been updated

If the smartphone OS has been updated to a newer version, its charging specifications may have changed significantly. For details, check the information on the manufacturer's website.

#### ■ Trademark information

- iPhone is a trademark of Apple Inc., registered in the U.S. and other countries.
- Galaxy is a trademark or registered trademark of Samsung Electronics Co., Ltd.



#### WARNING

##### ■ Caution while driving

When charging a portable device, for safety reasons, the driver should not operate the main part of the portable device while driving.

##### ■ Caution regarding interference with electronic devices

People with implantable cardiac pacemakers, cardiac resynchronization therapy-pacemakers or implantable cardioverters, as well as any other electrical medical device, should consult their physician about the usage of the wireless charger.

##### ■ To prevent malfunctions or burns

Observe the following precautions. Failure to do so may result in a equipment failure and damage, catch fire, burns due to over-heat or electric shock.

- Do not insert any metallic objects between the charge area and the portable device while charging



**⚠ WARNING**

- Do not attach an aluminum sticker or other metallic object to the charge area
- Do not attach an aluminum sticker or other metallic object to the side of the portable device (or to its case or cover) that touches the charge area
- Do not store items on the wireless charger instead of in an auxiliary box
- Do not subject to a strong force or impact
- Do not disassemble, modify or remove
- Do not charge devices other than specified portable devices
- Keep away from magnetic items
- Do not perform charging if the charging area is dirty
- Do not cover with a cloth or similar material

**⚠ NOTICE****■ To prevent malfunctions and data corruptions**

- When charging, bringing a credit, or other magnetic card, or magnetic storage media close to the charge area may clear any stored data due to magnetic influence. Also, do not bring a wristwatch or other precision instrument close to the charge area since doing so may cause it to malfunction.

- Do not charge with a non-contact IC card such as a transportation system IC card inserted between the charging side of a portable device and the charge area. The IC chip may become extremely hot and damage the portable device or IC card. Be especially careful not to charge a portable device inside a case or cover with a non-contact IC card attached.

- Do not leave portable devices inside the vehicle. The inside of the vehicle can become hot in extreme heat, which could cause a malfunction.

**■ To prevent 12-volt battery discharge**

Do not use the wireless charger for a long period of time when the hybrid system is stopped.

**Armrest**

Fold down the armrest for use.

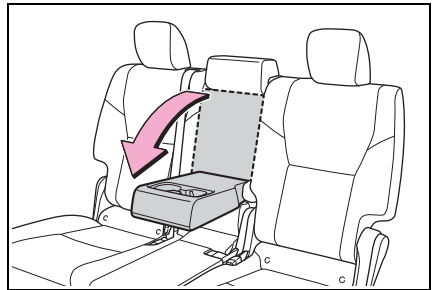
**⚠ NOTICE****■ To prevent damage to the armrest**

Do not apply too much load on the armrest.

**Coat hooks**

The coat hooks are provided

with the second seat assist grips.

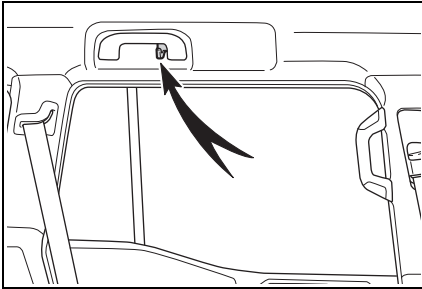

### **⚠ WARNING**

■ **Items that must not be hanged on the hook (vehicles with SRS curtain shield airbags)**

Do not hang coat hangers or other hard or sharp objects on the hook. If the SRS curtain shield airbags deploy, these items may become projectiles, causing death or serious injury.

### **Assist grips**

An assist grip (type A) installed on the ceiling can be used to support your body while sitting on the seat.

An assist grip (type B) installed on the pillar can be used when getting in or out of the vehicle and others.

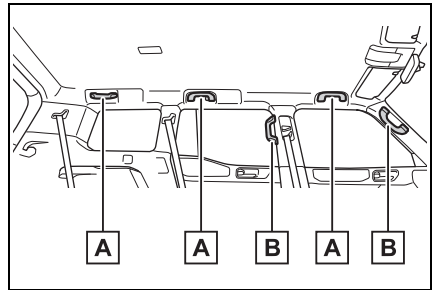

**A** Assist grip (type A)

**B** Assist grip (type B)

### **⚠ WARNING**

■ **Assist grip (type A)**

Do not use the assist grip (type A) when getting in or out of the vehicle or rising from your seat.

### **⚠ NOTICE**

■ **To prevent damage to the assist grip**

Do not hang any heavy object or put a heavy load on the assist grip.

### **Off-road driving information display screen (if equipped)**

Information related to off-road driving is shown on the multimedia display.

#### ■ **Display procedure**

Press  on the main menu, then press "Off-road information" on the sub menu.

For detail regarding the Multimedia Display, refer to "MULTIMEDIA OWNER'S MANUAL".

## ■ Off-road driving information display screen

► When the Multi-terrain Select is turned on

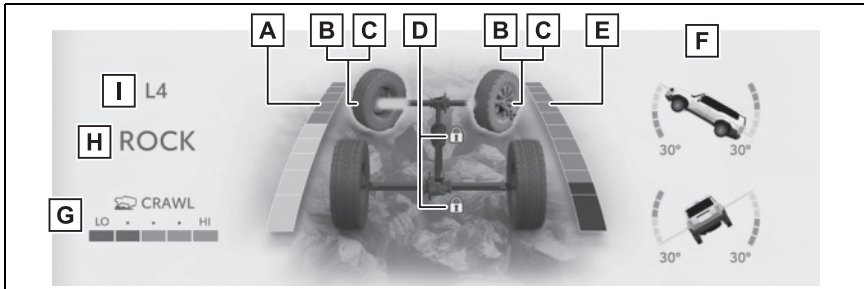

### A Brake pedal display

Displays the amount of depression of the brake pedal.

### B Front tire direction display

Displays the estimated direction of the front tires.

### C Active TRAC operation display

The tires with Active TRAC operating are shown in orange.

### D Differential lock operation display

### E Accelerator pedal display

Displays the amount of depression of the accelerator pedal.

### F Inclinometer display

Displays the vertical and horizontal tilt angles of the vehicle.

### G Crawl Control mode display

Downhill assist control system set speed display

### H Multi-terrain Select mode display

### I Transfer mode display

► When the Multi-terrain Select is turned off

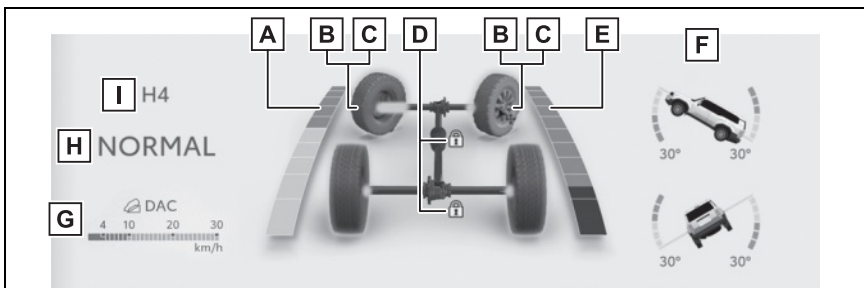

**A** Brake pedal display

Displays the amount of depression of the brake pedal.

**B** Front tire direction display

Displays the estimated direction of the front tires.

**C** Active TRAC operation display

The tires with Active TRAC operating are shown in orange.

**D** Differential lock operation display**E** Accelerator pedal display

Displays the amount of depression of the accelerator pedal.

**F** Inclinometer display

Displays the vertical and horizontal tilt angles of the vehicle.

**G** Crawl Control mode display

Downhill assist control system set speed display

**H** Driving mode select display**I** Transfer mode display

## Power outlet (2400 W)\*

\*: If equipped

**This system allows the use of electrical devices with a total power consumption of 2400 W at 120 VAC in the vehicle. Supplying power to electrical devices outside the vehicle is not recommended, as it may violate the laws and regulations of the country or region where it is used. When supplying power to electrical devices outside the vehicle, check the laws and regulations with the relevant local government of each country or region in advance. Also, be careful not to drag electrical devices and cords when moving the vehicle.**

## Precautions for using the power outlets while parked

Observe the following precautions before starting the power supply:

- Park the vehicle in a well-ventilated area, avoiding locations with poor ventilation such as garages, as the engine may start while the system is operating.
- Park the vehicle on a solid

and level place.

Block the wheels as needed.

- Check that the hood is closed.
- Check that the parking brake is engaged.
- Check that the P shift position is selected.
- Check that the power switch is off.
- Note that the alarm system cannot be enabled during the power supply. For theft prevention, do not leave valuable items, etc. in the cabin or luggage compartment.

## Name for all parts

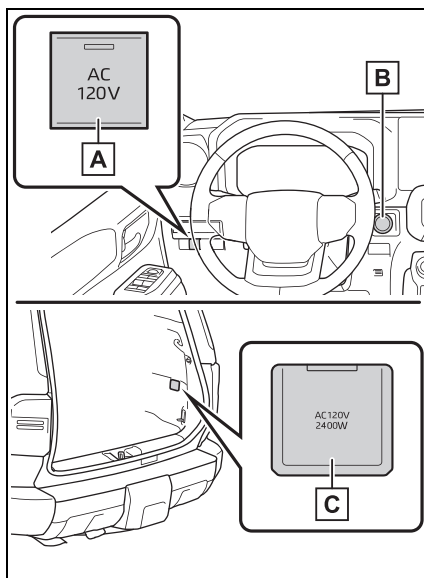

- A** “AC 120 V” switch
- B** Power switch (→P.222)
- C** Power outlet (luggage com-

partment)

### Using the power outlet (2400 W)

- 1 Check that the parking brake is engaged, securely depress the brake pedal and press the power switch. (→P.222)
- 2 Check that the READY indicator is illuminated, and press the “AC 120 V” switch.

The power outlet can be used when the indicator on the “AC 120 V” switch is illuminated.

The power outlet are turned off/on each time the “AC 120 V” switch is pressed.

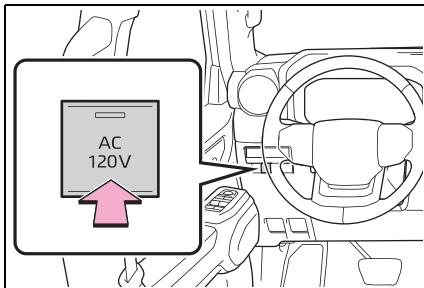

- 3 Open the lid, and fully and securely insert the plug of the device into the power outlet. (→P.510)

### Stopping the use of the power outlet (2400 W)

Follow the procedure described below:

- 1 Turn the connected devices off.
- 2 Press the “AC 120 V” switch to turn the power outlet off.

- 3 Disconnect each plug from the power outlet.
- 4 Close the lid of the power outlet.

### Connecting a device

#### ■ When connecting a device

Make sure to read the instruction manual which came with a device and observe warnings on the device.

Before connecting a device to the power outlet, make sure that the power of the electrical device is turned off.

- 1 Open the lid, and fully and securely insert the plug of the device into the power outlet.

Do not leave the plug halfway inserted.

In the following situations, use cable extension, etc. and connect the plug securely to the power outlet:

- When the plug of a device is too large to allow it to be inserted fully and securely into the power outlet.
- When the plug of a device is heavy, possibly causing it to come off the power outlet.

#### ■ Power outlet

- With this power outlet, use devices which operate on 120 VAC and have a combined maximum power consumption of 2400 W or less. If a device is connected and the power consumption is exceeded, a protection circuit may

be activated and the power supply function may be stopped.

- Some of the devices that consume a large amount of power, such as an electric grille, may require the exclusive use of the power outlets. When such a device is connected, do not connect other device(s) to the power outlets.
- When multiple devices are connected, depending on the device, a connected device may not operate properly. For such a device, use exclusively the power outlets.
- When a power outlet is being used, depending on the device to be used, the current flow may be high and the initial peak wattage may exceed 2400 W.
- When a power outlet is being used, depending on the device to be used, it may cause interference with TV and radio broadcasts.
- While a power outlet is being used, a cooling fan sound may be heard from near a luggage compartment. This does not indicate a malfunction.

#### ■ Devices which may not operate correctly

The following devices may not operate properly even if the combined power consumption is 2400 W or less:

- Devices with high initial peak wattage
- Devices requiring larger amount of power supply than the power consumption specified in its instruction manual
- Measuring devices that process precise data
- Devices that require an extremely stable power supply
- Devices that require a constant power supply from the power outlet, such as a device with a timer.

#### ■ Idling stop regulations

The engine starts automatically and charging is performed when the remaining charge of the hybrid battery (traction battery) decreases, etc. Some local governments have regulations against starting the engine while parked or stopped. Use the power outlets appropriately after checking the regulations of the applicable local government.

#### ■ When the power outlets are used while the vehicle is parked or stopped

- The doors cannot be locked/unlocked using the smart key system.
- The doors cannot be locked/unlocked using an electronic key. The doors can only be locked/unlocked using a mechanical key.
- When a door is opened/closed, a buzzer may sound or “Key Not Detected Check Key Location” may be displayed on the multi-information display. Check that an electronic key is carried with you.
- When the vehicle’s surroundings become dark while supplying power, the headlights etc. turn on automatically. Refer to P.240 for information about turning off the lights.



#### WARNING

##### ■ For safe use

Observe the following precautions. Failure to do so may lead to an accident, resulting in death or serious injury.

- Do not allow children or other people not used to the operation to perform the power supply by themselves.

**WARNING**

- Do not disconnect the plug of a device while your hands are wet or insert a pin or other object into the power outlet. Also, if a liquid or snow is on the power outlet, dry the outlet before using it.
- Do not attempt to modify, disassemble or repair a power outlet. For information on repairs, contact your Toyota dealer.
- Keep the power outlets free of dust and foreign matter. Also, make sure to clean the power outlets periodically.
- Hold the plug body to plug in/out of a power outlet. Do not touch the plug blades. Do not pull on a cord for unplugging, as otherwise the plug or cord may be damaged.
- Stop the use immediately if abnormal heat is observed on a cord or power outlet. To prevent the cord or power outlet from becoming hot, observe the following precautions:
- Do not connect 2 or more multi-point outlet adapters, such as dual adapters.

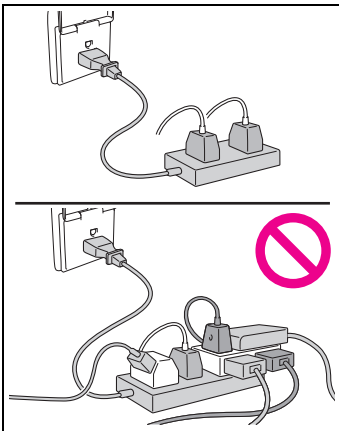

- When an extension cord reel is used, make sure to draw the whole cord out of the reel.
- If the device to be used has a ground wire, use a conversion adapter available on the market and connect the ground wire to the ground terminal of the conversion adapter.
- If the plug of a device fits loosely in a power outlet, even though it is fully inserted, replace the power outlet. For information on replacement, contact your Toyota dealer.
- **Devices to be connected**
- Make sure to read any instruction manual which came with a device and observe any warnings on the device.
- Do not connect a device to a power outlet if the device is malfunctioning or its plug is damaged.
- Otherwise, the device may be further malfunctioning, especially when the outside temperature is high or low.
- Devices requiring to be installed on a level place may not operate properly.
- Do not use devices, other than waterproof devices, in a place where water, such as rain, is splashed over or where it is humid.
- Do not use a device that has been or likely to have been merged in water or absorbed water within.
- Do not connect a medical device, as depending on the vehicle condition, the power supply function may be temporarily stopped.



**WARNING**

**When the power outlets are used while the vehicle is parked or stopped**

- The power outlets are designed to be connected to electric devices, such as lighting devices. Do not use them as a generator that supplies power to a house, etc. Also, when they are to be used on an emergency power supply device for homes, such as an exclusive device having connection to an external power source, or a device whose power supply circuit for external power source is separate from electric wiring of power companies, consult with the manufacturer or a retailer of the device.
- When using a power outlet, make sure to securely engage the parking brake and shift the shift position to P. Otherwise, the vehicle may move, possibly leading to an accident.
- When using a power outlet, do not move away from the vehicle.
- Do not perform power supply during weather when lightning may occur. Stop supplying power if lightning is observed during power supply.
- Do not use the power outlets if the vehicle has a vehicle cover installed.
- Do not use a power outlet when the vehicle is parked on a slanted place or a slope. When a power outlet is being used, do not move the vehicle or cause it to be inclined.
- Observe the following precautions when a connected cord is to be brought outside the vehicle:

- Take due care for not allowing rain to enter. If the power outlet is wet with raindrops, dry it before use.
- Prevent the cord from being caught in the window or door
- Allow slack in a connected cord. Do not cause it to be extraordinary tense.

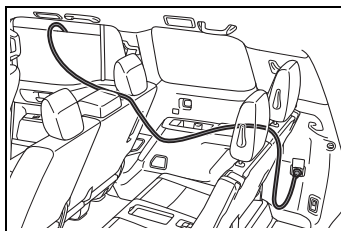

- Do not start off the vehicle by mistake.
- Do not refuel or wash the vehicle when using a power outlet.
- Make sure that the hood is closed.

As the engine will start automatically depending on the condition of the vehicle, make sure that nothing is left near or contacting the exhaust pipes.

Also, do not put your head or hands anywhere inside the engine compartment, as the cooling fan may operate suddenly. Keep hands and clothing (especially a tie, scarf, etc.) away from the fan as they may get caught in a fan.

- Do not stop the vehicle near objects which burn easily.
- If the exhaust system is extremely hot, it may cause a fire.
- Do not use in places where corrosive gases or fluids are generated.

**WARNING**

- The gasoline engine starts automatically when the remaining charge of the hybrid battery (traction battery) decreases. When using a power outlet in an area with poor ventilation or an enclosed area, such as a garage or a place where snow has piled up, properly use an air intake and exhaust device to prevent lack of oxygen and fullness of exhaust gas. If such device cannot be used, do not use the power outlet.
- Use of a power outlet while driving**
- In situations such as the following, do not use an electric device while driving. Also, do not use a device if it cannot be secured within the vehicle.
  - When a device is likely to distract the driver and be a hindrance to safe driving, such as a TV, video/DVD player, etc.
  - When an inadequately secured device is likely to fall over in case of sudden braking or an accident
  - When a device is likely to cause fire if it falls or generates heat
  - When a device is likely to cause burns, such as a toaster, microwave, electric heater, electric kettle, coffee maker, etc.
  - When a device is likely to fall under the pedals and prevent the brake pedal from being depressed, such as a hair dryer, AC adapter, mouse, etc.

- Do not use devices which produce steam while the windows are closed. Doing so may cause the windows to fog up, reducing visibility and making it difficult to drive safely. Also, the steam may damage or negatively affect other devices. If the device must be used, stop the vehicle and open the windows before use.

**NOTICE****■ To avoid short circuit or malfunction**

Observe the following precautions. Failure to do so may lead to the power outlets not operating correctly or damage to the vehicle or a connected device.

- Do not set a toaster or other device which generates heat near the interior components or on a seat. Heat may cause these parts to melt or burn.
  - Do not use devices which are sensitive to vibration or heat in the vehicle. These devices may malfunction due to vibration while driving or heat while the vehicle is parked in the sun.
  - When not using a power outlet, make sure to close the lid. If foreign matter or a liquid enters the power outlet, it may cause a malfunction or short circuit.
- Using the power outlet while parked or stopped**
- Water may leak from the exhaust pipe while the engine running if the power outlet is used for a long time. However, this is not a malfunction.



## NOTICE

- At extremely low temperatures, water may freeze in the exhaust pipe and make it difficult to start the engine, or an odor may come from the exhaust pipe. In this case, stop using the power outlet, and then drive the vehicle for 15 to 30 minutes.

**When the power outlet (2400 W) cannot be used properly\***

\*: If equipped

**When the power outlet cannot be used, even though the normal procedure is followed, check the following items.**

**When the power outlet cannot be used properly**

When power supply does not start, even though the normal procedure is followed, check each of the following items.

Likely cause	Correction procedure
Quantity of fuel remaining is low and the remaining charge of the hybrid battery (traction battery) is insufficient	After refueling, drive for a while to restore the remaining charge of the hybrid battery (traction battery). Then, press the "AC 120 V" switch again.
The hybrid battery (traction battery) becomes hot when the outside temperature is especially high	Move the vehicle to the shade or other cooler location, or use the air conditioning to lower the temperature inside the vehicle. Then, after waiting for a while, press the "AC 120 V" switch again.
The hybrid battery (traction battery) becomes cold when the outside temperature is especially low	Drive for a while or use the air conditioning to raise the temperature inside the vehicle. Then, after waiting for a while, press the "AC 120 V" switch again.

Likely cause	Correction procedure
Electrical device does not operate	Disconnect the power source plug of the electrical device and check that the device is not malfunctioning. Then, press the "AC 120 V" switch again. Check the instruction manual of the electrical device.

Likely cause	Correction procedure
Total power consumption exceeds 2400 W	Disconnect the power source plug of the electrical device and check that the total power consumption does not exceed 2400 W. Then, press the “AC 120 V” switch again.
Short circuit in the power outlet	Disconnect the power source plug of the electrical device and check the following items. Then, press the “AC 120 V” switch again. <ul style="list-style-type: none"> <li>• No foreign matter such as a pin has been inserted</li> <li>• No substances such as drinking water, rain, or snow are adhered</li> <li>• No dirt or dust is adhered</li> </ul>

If the power outlet cannot be used even after performing the procedures above, have the vehicle inspected by your Toyota dealer.

## Garage door opener

**The garage door opener can be programmed using the HomeLink® to operate garage doors, gates, entry doors, door locks, home lighting systems, security systems, and other devices.**

### ■ HomeLink® programming procedure

The programming procedures can also be found at the following URL.  
Website: [www.homelink.com/toyota](http://www.homelink.com/toyota)



For support, contact customer support at the following.

Help Line: 1-800-355-3515

## System components

The HomeLink® wireless control system in your vehicle has 3 buttons which can be programmed to operate 3 different devices. Refer to the programming methods on the following pages to determine the method which is appropriate for the device.

- ▶ Vehicles with auto anti-glare inside rear view mirror

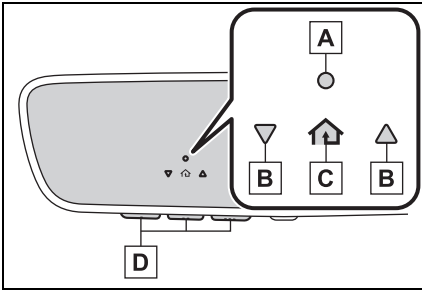

- A** HomeLink® indicator light
- B** Garage door operation indicators
- C** HomeLink® icon

Illuminates while HomeLink® is operating.

- D** Buttons

- ▶ Vehicles with Digital Rear-view Mirror

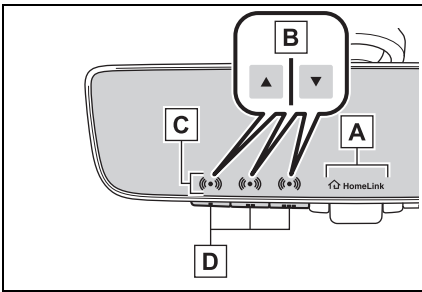

- A** HomeLink® logo

Appears while HomeLink® is operating.

When the HomeLink® button is pressed, the logo disappears even while the HomeLink® is operating.

- B** Garage door operation indicators
- C** HomeLink® indicator light

Illuminates above each button selected.

- D** Buttons

### ■ Codes stored in the HomeLink® memory

- The registered codes are not erased even if the 12-volt battery cable is disconnected.
- If learning failed when registering a different code to a HomeLink® button that already has a code registered to it, the already registered code will not be erased.

### ⚠ WARNING

#### ■ When programming a garage door or other remote control device

The garage door or other device may operate, so ensure people and objects are out of danger to prevent potential harm.

#### ■ Conforming to federal safety standards

Do not use the HomeLink® compatible transceiver with any garage door opener or device that lacks safety stop and reverse features as required by federal safety standards.

This includes any garage door that cannot detect an interfering object. A door or device without these features increases the risk of death or serious injury.

#### ■ When operating or programming HomeLink®

Never allow a child to operate or play with the HomeLink® buttons.

## Programming HomeLink®

### ■ Before programming

#### HomeLink®

- During programming, it is possible that garage doors, gates, or other devices may operate. For this reason, make sure that people and objects are clear of the garage door or other devices to prevent injury or other potential harm.
- It is recommended that a new battery be placed in the remote control transmitter for more accurate programming.
- Garage door opener motors manufactured after 1995 may be equipped with rolling code protection. If this is the case, you may need a stepladder or other sturdy, safe device to reach the “Learn” or “Smart” button on the garage door opener motor.

### ■ Programming HomeLink®

Steps 2 through 4 must be performed within 60 seconds, otherwise the HomeLink® indicator light will stop flashing and programming will not be successfully completed.

- 1 Vehicles with Digital Rear-view Mirror: Press the HomeLink® button or menu button

When the HomeLink® button is pressed: HomeLink® Training Tutorial will be displayed to assist you programming the HomeLink®.

When HomeLink® Training Tutorial is displayed, follow the instructions displayed.

When the menu button is pressed: Press the menu button  and select the “Set Up >”. HomeLink® Training Tutorial will be displayed to assist you programming the HomeLink®.

When HomeLink® Training Tutorial is displayed, follow the instructions displayed.

- 2 Press and release the HomeLink® button you want to program and check that the HomeLink® indicator light flashes (orange).
- 3 Point the remote control transmitter for the device at the rear view mirror, 1 to 3 in. (25 to 75 mm) from the HomeLink® buttons.

Keep the HomeLink® indicator light in view while programming.

- ▶ Vehicles with auto anti-glare inside rear view mirror

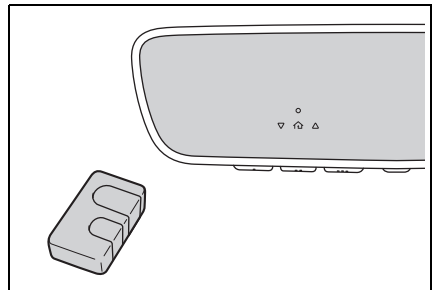

- ▶ Vehicles with Digital Rear-view Mirror

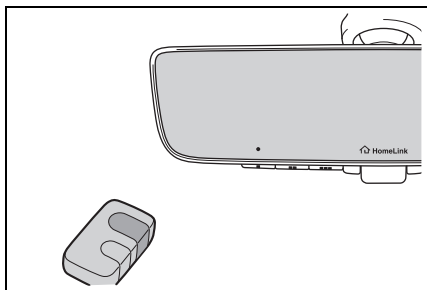

- 4 Program a device.

- ▶ Vehicles with auto anti-glare inside rear view mirror

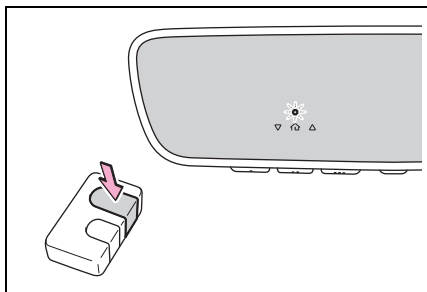

- ▶ Vehicles with Digital Rear-view Mirror

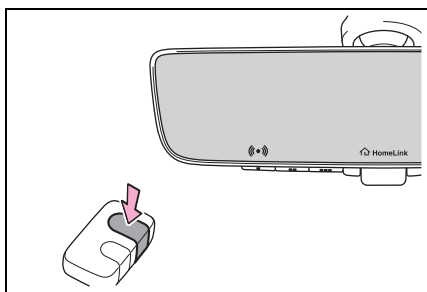

- ▶ Programming a device other than an entry gate (for U.S.A. owners)

Press and hold the remote control transmitter button until the HomeLink<sup>®</sup> indicator light

changes from slowly flashing orange to rapidly flashing green (rolling code) or continuously lit green (fixed code), then release the button.

- ▶ Programming an entry gate (for U.S.A. owners)/Programming a device in the Canadian market

Press and release the remote control transmitter button at 2 second intervals, repeatedly, until the HomeLink<sup>®</sup> indicator light changes from slowly flashing (orange) to rapidly flashing (green) (rolling code) or continuously lit (green) (fixed code).

- 5 Test the HomeLink<sup>®</sup> operation by pressing the newly programmed button and observing the HomeLink<sup>®</sup> indicator light:

- HomeLink<sup>®</sup> indicator light illuminates: Programming of a fixed code device has completed. The garage door or other device should operate when a HomeLink<sup>®</sup> button is pressed and released.
- HomeLink<sup>®</sup> indicator light flashes rapidly: The garage door opener motor or other device is equipped with a rolling code. To complete programming, firmly press and hold the HomeLink<sup>®</sup> button for 2 seconds then release it.
- If the garage door or other



device does not operate, proceed to “Programming a rolling code system”.

- 6 Repeat the steps above to program another device for any of the remaining HomeLink<sup>®</sup> buttons.

### ■ Programming a rolling code system

Two or more people may be needed to complete rolling code programming.

- 1 Locate the “Learn” or “Smart” button on the garage door opener motor in the garage.

This button can usually be found where the hanging antenna wire is attached to the unit. The name and color of the button may vary by manufacturer. Refer to the owner’s manual supplied with the garage door opener motor for details.

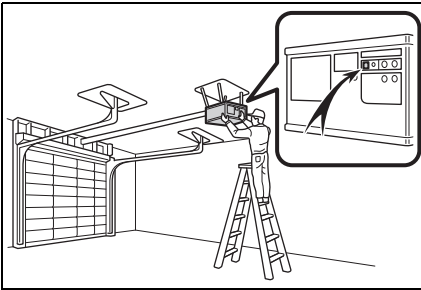

- 2 Press and release the “Learn” or “Smart” button.

Perform step 3 within 30 seconds

after performing step 2.

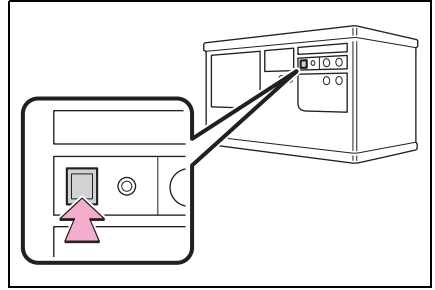

- 3 Press and hold the desired HomeLink<sup>®</sup> button (inside the vehicle) for 2 seconds and release it. Repeat this sequence (press/hold/release) up to 3 times to complete programming.

If the garage door opener motor operates when the HomeLink<sup>®</sup> button is pressed, the garage door opener motor recognizes the HomeLink<sup>®</sup> signal.

- ▶ Vehicles with auto anti-glare inside rear view mirror

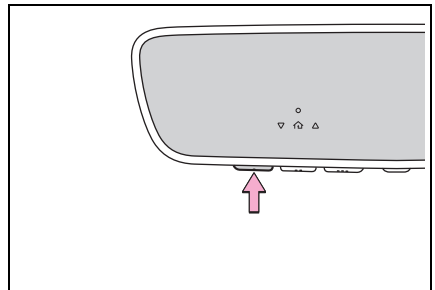

- ▶ Vehicles with Digital Rear-view Mirror

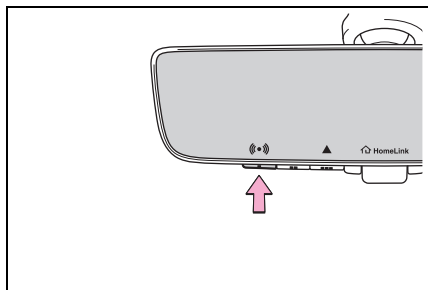

### ■ Enabling 2-way communication with a garage door (only available for compatible devices)

When enabled, 2-way communication allows you to check the status of the opening and closing of a garage door through indicators in your vehicle.

2-way communication is only available if the garage door opener motor used is a compatible device. (To check device compatibility, refer to [www.homelink.com](http://www.homelink.com).)

- 1 Within 5 seconds after programming the garage door opener has been completed, if the garage door opener motor is trained to HomeLink<sup>®</sup>, both garage door operation indicators will flash rapidly (green) and the light on the garage door opener motor will blink twice, indicating that 2-way communication is enabled.

If the indicators do not flash, per-

form steps 2 and 3 within the first 10 presses of the HomeLink<sup>®</sup> button after programming has been completed.

- 2 Press a programmed HomeLink<sup>®</sup> button to operate a garage door.
- 3 Within 1 minute of pressing the HomeLink<sup>®</sup> button, after the garage door operation has stopped, press the “Learn” or “Smart” button on the garage door opener motor. Within 5 seconds of the establishment of 2-way communication with the garage door opener, both garage door operation indicators in the vehicle will flash rapidly (green) and the light on the garage door opener motor will blink twice, indicating that 2-way communication is enabled.

### ■ Reprogramming a single HomeLink<sup>®</sup> button

When the following procedure is performed, buttons which already have devices registered to them can be overwritten:

- 1 Press and hold the desired HomeLink<sup>®</sup> button.
- 2 When the HomeLink<sup>®</sup> indicator starts flashing (orange), release the HomeLink<sup>®</sup> button and perform “Programming HomeLink<sup>®</sup>” step 1 (it takes 20 seconds for the

HomeLink® indicator to start flashing).

### ■ Before programming

- Install a new battery in the transmitter.
- The battery side of the transmitter must be pointed away from the HomeLink® buttons.

## Operating HomeLink®

Press the appropriate HomeLink® button. The HomeLink® indicator light will turn on.

The status of the opening and closing of a garage door is shown by the garage door operation indicators.

- ▶ Vehicles with auto anti-glare inside rear view mirror

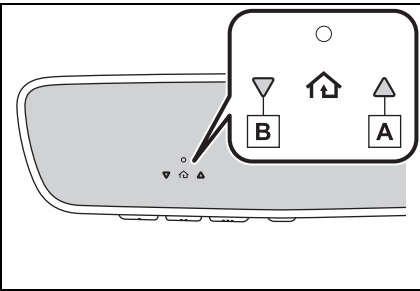

**A** Opening

**B** Closing

- ▶ Vehicles with Digital Rear-view Mirror

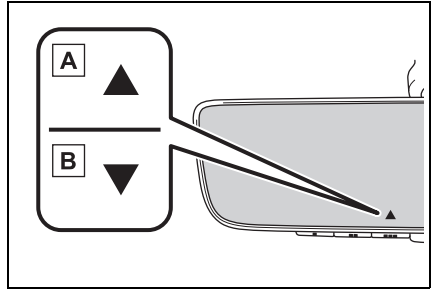

**A** Opening







**B** Closing

This function is only available if the garage door opener motor used is a compatible device. (To check device compatibility, refer to [www.homelink.com](http://www.homelink.com).)

Color	Status
Orange (flashing)	Currently opening/closing
Green	Opening/closing has completed
Red (flashing)	Feedback signals cannot be received

The indicators can operate within approximately 820 ft. (250 m) of the garage door. However, if there are obstructions between the garage door and the vehicle, such as houses and trees, feedback signals from the garage door may not be received.

To recall the previous door operation status, press and release either HomeLink® buttons 

and  or  and  (vehicles with auto anti-glare inside rear view mirror),  and  or  and  (vehicles with Digital Rear-view Mirror) simultaneously. The last recorded status will be displayed for 3 seconds.

### Erasing the entire HomeLink® memory (all three codes)

Press and hold the 2 outside buttons for 10 seconds until the HomeLink® indicator light changes from continuously lit (orange) to rapidly flashing (green).

If you sell your vehicle, be sure to erase the programs stored in the HomeLink® memory.

- ▶ Vehicles with auto anti-glare inside rear view mirror

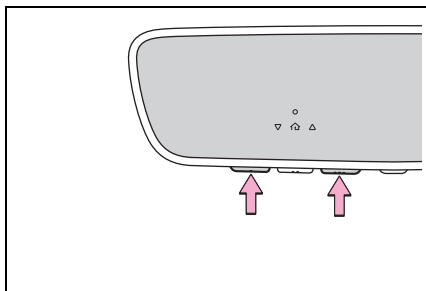

- ▶ Vehicles with Digital Rear-view Mirror

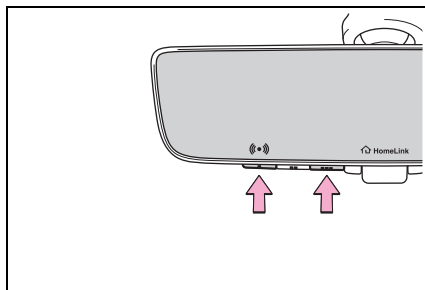

**6-1. Maintenance and care**

Cleaning and protecting the  
vehicle exterior ..... 526

Cleaning and protecting the  
vehicle interior ..... 529

**6-2. Maintenance**

Maintenance requirements  
..... 533

General maintenance.. 534

Emission inspection and  
maintenance (I/M) pro-  
grams ..... 537

**6-3. Do-it-yourself maintenance**

Do-it-yourself service pre-  
cautions..... 538

Hood ..... 540

Engine compartment... 542

12-volt battery ..... 548

Tires ..... 551

Tire inflation pressure . 563

Wheels ..... 565

Air conditioning filter.... 566

Cleaning the hybrid battery  
(traction battery) air intake  
vents..... 568

Electronic key battery.. 571

Checking and replacing  
fuses..... 573

Headlight aim ..... 576

Light bulbs..... 577

## Cleaning and protecting the vehicle exterior

**Perform the following to protect the vehicle and maintain it in prime condition:**

### Cleaning instructions

- Working from top to bottom, liberally apply water to the vehicle body, wheel wells and underside of the vehicle to remove any dirt and dust.
- Wash the vehicle body using a sponge or soft cloth, such as a chamois.
- For hard-to-remove marks, use car wash soap and rinse thoroughly with water.
- Wipe away any water.
- Wax the vehicle when the waterproof coating deteriorates.

If water does not bead on a clean surface, apply wax when the vehicle body is cool.

#### ■ Automatic car washes

- Before washing the vehicle:
  - Fold the mirrors
  - Turn off the power back door (if equipped)

Start washing from the front of the vehicle.

Extend the mirrors before driving.

- Brushes used in automatic car

washes may scratch the vehicle surface, parts (wheel, etc.) and harm your vehicle's paint.

- Rear spoiler may not be washable in some automatic car washes. There may also be an increased risk of damage to vehicle.

#### ■ High pressure car washes

- As water may enter the cabin, do not bring the nozzle tip near the gaps around the doors or perimeter of the windows, or spray these areas continuously.
- Do not use the high-pressure washer too close to the bearings and oil seals of drivetrain system parts (such as the differential gear).

If used too close to such parts, the high water pressure may cause water to enter the parts and grease to be washed out, causing the system performance to decrease.

#### ■ Wheels and wheel ornaments

- Remove any dirt immediately by using a neutral detergent.
- Wash detergent off with water immediately after use.
- To protect the paint from damage, make sure to observe the following precautions.
  - Do not use acidic, alkaline or abrasive detergent.
  - Do not use hard brushes.
  - Do not use detergent on the wheels when they are hot, such as after driving or parking in hot weather.

#### ■ Brake pads and calipers

Rust may form if the vehicle is parked with wet brake pads or disc rotors, causing them to stick. Before parking the vehicle after it is washed, drive slowly and apply the brakes several times to dry the parts.

### ■ Bumpers and side moldings

Do not scrub with abrasive cleaners.

### ■ Plated portions

If dirt cannot be removed, clean the parts as follows:

- Use a soft cloth dampened with an approximately 5% solution of neutral detergent and water to clean the dirt off.
- Wipe the surface with a dry, soft cloth to remove any remaining moisture.
- To remove oily deposits, use alcohol wet wipes or a similar product.

### ■ Note for a smart key system

If the door handle becomes wet while the electronic key is within the effective range, the door may lock and unlock repeatedly. In that case, follow the following correction procedures to wash the vehicle:

- Place the key in a position 2 m (6 ft.) or more separate from the vehicle while the vehicle is being washed. (Take care to ensure that the key is not stolen.)
- If the electronic key is inside the vehicle and a door handle becomes wet during a car wash, a message may be shown on the multi-information display and a buzzer will sound outside the vehicle. To turn off the alarm, lock all the doors.



### WARNING

#### ■ When washing the vehicle

Do not apply water to the inside of the engine compartment. Doing so may cause the electrical components, etc. to catch fire.

### ■ When cleaning the windshield (vehicles with rain-sensing windshield wipers)

Set the wiper switch to off.

If the wiper switch is in "AUTO", the wipers may operate unexpectedly in the following situations, and may result in hands being caught or other serious injuries and cause damage to the wiper blades.

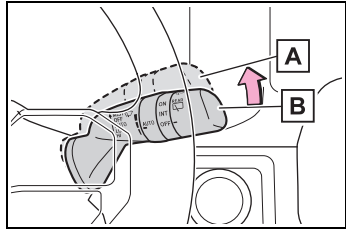

**A** Off

**B** AUTO

- When the upper part of the windshield where the raindrop sensor is located is touched by hand
- When a wet rag or similar is held close to the raindrop sensor
- If something bumps against the windshield
- If you directly touch the raindrop sensor body or if something bumps into the raindrop sensor

### ■ Precautions regarding the exhaust pipes

Exhaust gasses cause the exhaust pipes to become quite hot.

When washing the vehicle, be careful not to touch the pipes until they have cooled sufficiently, as touching hot exhaust pipes can cause burns.

**WARNING****■ Precaution regarding the front and rear bumpers**

If the paint of the front or rear bumper is chipped or scratched, the following systems may not function correctly. If this occurs, consult your Toyota dealer.

- Toyota Safety Sense 3.0
- FCTA (Front Crossing Traffic Alert) (if equipped)
- BSM
- SEA
- Intuitive parking assist
- RCTA
- PKSB

**NOTICE****■ To prevent paint deterioration and corrosion on the body and components (aluminum wheels, etc.)**

- Wash the vehicle immediately in the following cases:
  - After driving near the sea coast
  - After driving on salted roads
  - If coal tar or tree sap is present on the paint surface
  - If dead insects, insect droppings or bird droppings are present on the paint surface
  - After driving in an area contaminated with soot, oily smoke, mine dust, iron powder or chemical substances
  - If the vehicle becomes heavily soiled with dust or mud
  - If liquids such as benzene and gasoline are spilled on the paint surface

- If the paint is chipped or scratched, have it repaired immediately.
- To prevent the wheels from corroding, remove any dirt and store in a place with low humidity when storing the wheels.

**■ Cleaning the exterior lights**

- Wash carefully. Do not use organic substances or scrub with a hard brush. This may damage the surfaces of the lights.
- Do not apply wax to the surfaces of the lights. Wax may cause damage to the lenses.

**■ When using an automatic car wash (vehicles with rain-sensing windshield wipers)**

Set the wiper switch to off position.

If the wiper switch is in "AUTO", the wipers may operate and the wiper blades may be damaged.

**■ When using a high pressure car wash**

- When washing the vehicle, do not spray the camera or its surrounding area directly with a high pressure washer. Shock applied from high pressure water may cause the device to not operate normally.
- Vehicles with Toyota Safety Sense: Do not spray water directly on the radar which is equipped behind the emblem. Otherwise it may cause the device to be damaged.



**NOTICE**

- Do not bring the nozzle tip close to boots (rubber or resin manufactured cover), connectors or the following parts.  
The parts may be damaged if they come into contact with high-pressure water.
  - Traction related parts
  - Steering parts
  - Suspension parts
  - Brake parts
- Keep the cleaning nozzle at least 30 cm (11.9 in.) away from the vehicle body. Otherwise resin section, such as moldings and bumpers, may be deformed and damaged. Also, do not continuously hold the nozzle in the same place.
- Do not spray the lower part of the windshield continuously. If water enters the air conditioning system intake located near the lower part of the windshield, the air conditioning system may not operate correctly.
- Do not wash the underside of the vehicle using a high pressure car washer.

**Cleaning and protecting the vehicle interior**

**Perform cleaning in a manner appropriate to each component and its material.**

**Protecting the vehicle interior**

- Remove dirt and dust using a vacuum cleaner. Wipe dirty surfaces with a cloth dampened with lukewarm water.
- If dirt cannot be removed, wipe it off with a soft cloth dampened with neutral detergent diluted to approximately 1%.  
Wring out any excess water from the cloth and thoroughly wipe off remaining traces of detergent and water.

**■ Shampooing the carpets**

There are several commercial foaming-type cleaners available. Use a sponge or brush to apply the foam. Rub in overlapping circles. Do not use water. Wipe dirty surfaces and let them dry. Excellent results are obtained by keeping the carpet as dry as possible.

**■ Handling the seat belts**

Clean with mild soap and lukewarm water using a cloth or sponge. Also check the belts periodically for excessive wear, fraying or cuts.

**WARNING****Water in the vehicle**

- Do not splash or spill liquid in the vehicle, such as on the floor, in the hybrid battery (traction battery) air vents, and in the luggage compartment. (→P.75)  
Doing so may cause the hybrid battery, electrical components, etc. to malfunction or catch fire.
- Do not get any of the SRS components or wiring in the vehicle interior wet. (→P.36)  
An electrical malfunction may cause the airbags to deploy or not function properly, resulting in death or serious injury.
- Vehicles with wireless charger: Do not let the wireless charger (→P.497) get wet. Failure to do so may cause the charger to become hot and cause burns or could cause electric shock resulting in death or serious injury.

**Cleaning the interior (especially instrument panel)**

Do not use a polish wax or polish cleaner. The instrument panel may reflect off the windshield, obstructing the driver's view and leading to an accident, resulting in death or serious injury.

**NOTICE****Cleaning detergents**

- Do not use the following types of detergent, as they may discolor the vehicle interior or cause streaks or damage to painted surfaces:
  - Non-seat portions: Organic substances such as benzene or gasoline, alkaline or acidic solutions, dye, and bleach
  - Seats: Alkaline or acidic solutions, such as thinner, benzene, and alcohol
- Do not use a polish wax or polish cleaner. The instrument panel's or other interior part's painted surface may be damaged.

**Preventing damage to leather surfaces**

Observe the following precautions to avoid damage to and deterioration of leather surfaces:

- Remove any dust or dirt from leather surfaces immediately.
- Do not expose the vehicle to direct sunlight for extended periods of time. Park the vehicle in the shade, especially during summer.
- Do not place items made of vinyl, plastic, or containing wax on the upholstery, as they may stick to the leather surface if the vehicle interior heats up significantly.



## NOTICE

**Water on the floor**

Do not wash the vehicle floor with water.

Vehicle systems such as the audio system may be damaged if water comes into contact with electrical components such as the audio system above or under the floor of the vehicle. Water may also cause the body to rust.

**When cleaning the inside of the windshield (vehicles with Toyota Safety Sense)**

Do not allow glass cleaner to contact the lens. Also, do not touch the lens. (→P.256)

**Cleaning the inside of the rear quarter windows and rear window**

- Do not use glass cleaner to clean the rear quarter windows and rear window, as this may cause damage to the rear window defogger heater wires or antenna. Use a cloth dampened with lukewarm water to gently wipe the window clean. Wipe the window in strokes running parallel to the heater wires or antenna.
- Be careful not to scratch or damage the heater wires or antenna.

**Cleaning the areas with satin-finish metal accents**

- Remove dirt using a water-dampened soft cloth or synthetic chamois.
- Wipe the surface with a dry soft cloth to remove any remaining moisture.

**Cleaning the areas with satin-finish metal accents**

The metal areas use a layer of real metal to the surface. It is necessary to clean them regularly. If dirty areas are left uncleaned for long period of time, they may be difficult to clean.

**Cleaning the leather areas**

- Remove dirt and dust using a vacuum cleaner.
- Wipe off any excess dirt and dust with a soft cloth dampened with diluted detergent.

Use a diluted water solution of approximately 5% neutral wool detergent.

- Wring out any excess water from the cloth and thoroughly wipe off all remaining traces of detergent.
- Wipe the surface with a dry, soft cloth to remove any remaining moisture. Allow the leather to dry in a shaded and ventilated area.

**Caring for leather areas**

Toyota recommends cleaning the interior of the vehicle at least twice a year to maintain the quality of the vehicle's interior.

**Cleaning the synthetic leather areas**

- Remove dirt and dust using a vacuum cleaner.
- Wipe it off with a soft cloth dampened with neutral deter-

gent diluted to approximately 1%.

- Wring out any excess water from the cloth and thoroughly wipe off remaining traces of detergent and water.

## Maintenance requirements

**To ensure safe and economical driving, day-to-day care and regular maintenance are essential. It is the owner's responsibility to perform regular checks. Toyota recommends the following maintenance:**

### ■ Repair and replacement

It is recommended that genuine Toyota parts be used for repairs to ensure performance of each system. If non-Toyota parts are used in replacement or if a repair shop other than a Toyota dealer performs repairs, confirm the warranty coverage.

### ■ Allow inspection and repairs to be performed by a Toyota dealer

- Toyota technicians are well-trained specialists and are kept up to date with the latest service information. They are well informed about the operation of all systems on your vehicle.
- Keep a copy of the repair order. It proves that the maintenance that has been performed is under warranty coverage. If any problem should arise while your vehicle is under warranty, your Toyota dealer will promptly take care of it.



### WARNING

#### ■ If your vehicle is not properly maintained

Improper maintenance could result in serious damage to the vehicle and possible serious injury or death.

### ■ Handling of the battery

- Engine exhaust, some of its constituents, and a wide variety of automobile components contain or emit chemicals known to the State of California to cause cancer and birth defects and other reproductive harm. Work in a well ventilated area.
- Oils, fuels and fluids contained in vehicles as well as waste produced by component wear contain or emit chemicals known to the State of California to cause cancer and birth defects or other reproductive harm. Avoid exposure and wash any affected area immediately.
- 12-volt battery posts, terminals and related accessories contain lead and lead compounds which are known to cause brain damage. Wash your hands after handling. (→P.548)

## General maintenance

General maintenance should be performed on a daily basis. This can be done by yourself or by a Toyota dealer.

## Scheduled maintenance



Scheduled maintenance should be performed at specified intervals according to the maintenance schedule.

For details about maintenance items and schedules, refer to the "Scheduled Maintenance Guide" or "Owner's Manual Supplement".

### ■ Resetting the message indicating maintenance is required

After the required maintenance is performed according to the maintenance schedule, please reset the message.

To reset the message, follow the procedures described below:

- 1 Select  in  screen of the multi-information display, and then press and hold **OK**.
- 2 Select “Scheduled Maintenance” and then press and hold **OK**.
- 3 Select “Yes” and then press **OK**.

A message will be displayed on the multi-information display when the reset procedure has been completed.

### Do-it-yourself maintenance

You can perform some maintenance procedures by yourself. Please be aware that do-it-yourself maintenance may affect warranty coverage.

The use of Toyota repair manuals is recommended.

For details about warranty coverage, refer to the separate “Owner’s Warranty Information Booklet” or “Owner’s Manual Supplement”.

### General maintenance

Listed below are the general maintenance items that should be performed at the intervals specified in the “Owner’s Warranty Information Booklet” or “Owner’s Manual Supplement/Scheduled Maintenance Guide”. It is recommended that any problem you notice should be brought to the attention of your Toyota dealer or qualified service shop for advice.

#### WARNING

##### ■ If the engine is running

Turn the engine off and ensure that there is adequate ventilation before performing maintenance checks.

### Engine compartment

Items	Check points
Brake fluid	Is the brake fluid at the correct level? (→P.547)
Engine/power control unit coolant	Is the engine/power control unit coolant at the correct level? (→P.545)
Engine oil	Is the engine oil at the correct level? (→P.542)

Items	Check points
Exhaust system	There should not be any fumes or strange sounds.
Engine radiator/condenser/intercooler radiator	The engine radiator, condenser and intercooler radiator should be free from foreign objects. (→P.546)
Washer fluid	Is there sufficient washer fluid? (→P.547)

### Luggage compartment

Items	Check points
12-volt battery	Check the connections. (→P.548)

### Vehicle interior

Items	Check points
Accelerator pedal	<ul style="list-style-type: none"> <li>The accelerator pedal should move smoothly (without uneven pedal effort or catching).</li> </ul>
Automatic transmission "Park" mechanism	<ul style="list-style-type: none"> <li>When parked on a slope and the shift lever is in P, is the vehicle securely stopped?</li> </ul>

Items	Check points
Brake pedal	<ul style="list-style-type: none"> <li>Does the brake pedal move smoothly?</li> <li>Does the brake pedal have appropriate clearance from the floor?</li> <li>Does the brake pedal have the correct amount of free play?</li> </ul>
Brakes	<ul style="list-style-type: none"> <li>The vehicle should not pull to one side when the brakes are applied.</li> <li>The brakes should work effectively.</li> <li>The brake pedal should not feel spongy.</li> <li>The brake pedal should not get too close to the floor when the brakes are applied.</li> </ul>
Head restraints	<ul style="list-style-type: none"> <li>Do the head restraints move smoothly and lock securely?</li> </ul>
Indicators/buzzers	<ul style="list-style-type: none"> <li>Do the indicators and buzzers function properly?</li> </ul>
Lights	<ul style="list-style-type: none"> <li>Do all the lights come on?</li> <li>Are the headlights aimed correctly?</li> </ul>

Items	Check points
Parking brake	<ul style="list-style-type: none"> <li>• Does the parking brake switch operate normally?</li> <li>• When parked on a slope and the parking brake is on, is the vehicle securely stopped?</li> </ul>
Seat belts	<ul style="list-style-type: none"> <li>• Do the seat belts operate smoothly?</li> <li>• The seat belts should not be damaged.</li> </ul>
Seats	<ul style="list-style-type: none"> <li>• Do the seat controls operate properly?</li> </ul>
Steering wheel	<ul style="list-style-type: none"> <li>• Does the steering wheel rotate smoothly?</li> <li>• Does the steering wheel have the correct amount of free play?</li> <li>• There should not be any strange sounds coming from the steering wheel.</li> </ul>

### Vehicle exterior

Items	Check points
Doors	<ul style="list-style-type: none"> <li>• Do the doors operate smoothly?</li> </ul>
Engine hood	<ul style="list-style-type: none"> <li>• Does the engine hood lock system work properly?</li> </ul>

Items	Check points
Fluid leaks	<ul style="list-style-type: none"> <li>• There should not be any signs of fluid leakage after the vehicle has been parked.</li> </ul>
Tires	<ul style="list-style-type: none"> <li>• Is the tire inflation pressure correct?</li> <li>• The tires should not be damaged or excessively worn.</li> <li>• Have the tires been rotated according to the maintenance schedule?</li> <li>• The wheel nuts should not be loose.</li> </ul>
Windshield wipers/rear window wiper	<ul style="list-style-type: none"> <li>• The wiper blades should not show any signs of cracking, splitting, wear, contamination or deformation.</li> <li>• The wiper blades should clear the windshield/rear window without streaking or skipping.</li> </ul>



## Emission inspection and maintenance (I/M) programs

**Some states have vehicle emission inspection programs which include OBD (On Board Diagnostics) checks. The OBD system monitors the operation of the emission control system.**

### If the malfunction indicator lamp comes on

The OBD system determines that a problem exists somewhere in the emission control system. Your vehicle may not pass the I/M test and may need to be repaired. Contact your Toyota dealer to service the vehicle.

### Your vehicle may not pass the I/M test in the following situations:

- When the 12-volt battery is disconnected or discharged Readiness codes that are set during ordinary driving are erased. Also, depending on your driving habits, the readiness codes may not be completely set.
- When the fuel tank cap is

loose

The malfunction indicator lamp comes on indicating a temporary malfunction and your vehicle may not pass the I/M test.

### When the malfunction indicator lamp still remains on after several driving trips

The error code in the OBD system will not be cleared unless the vehicle is driven 40 or more times.

### If your vehicle does not pass the I/M test

Contact your Toyota dealer to prepare the vehicle for re-testing.

## Do-it-yourself service precautions

**If you perform maintenance by yourself, be sure to follow the correct procedure as given in these sections.**

## Maintenance

Items	Parts and tools
12-volt battery condition (→P.548)	<ul style="list-style-type: none"> <li>• Grease</li> <li>• Conventional wrench (for terminal clamp bolts)</li> </ul>
Brake fluid level (→P.547)	<ul style="list-style-type: none"> <li>• FMVSS No.116 DOT 3 or SAE J1703 brake fluid</li> <li>• FMVSS No.116 DOT 4 or SAE J1704 brake fluid</li> <li>• Rag or paper towel</li> <li>• Funnel (used only for adding brake fluid)</li> </ul>

Items	Parts and tools
Engine/power control unit coolant level (→P.545)	<ul style="list-style-type: none"> <li>• “Toyota Super Long Life Coolant” or a similar high quality ethylene glycol-based non-silicate, non-amine, non-nitrite and non-borate coolant with long-life hybrid organic acid technology</li> </ul> <p>For the U.S.A.: “Toyota Super Long Life Coolant” is premixed with 50% coolant and 50% deionized water.</p> <p>For Canada: “Toyota Super Long Life Coolant” is premixed with 55% coolant and 45% deionized water.</p> <ul style="list-style-type: none"> <li>• Funnel (used only for adding coolant)</li> </ul>
Engine oil level (→P.542)	<ul style="list-style-type: none"> <li>• “Toyota Genuine Motor Oil” or equivalent</li> <li>• Rag or paper towel</li> <li>• Funnel (used only for adding engine oil)</li> </ul>
Fuses (→P.573)	<ul style="list-style-type: none"> <li>• Fuse with same amperage rating as original</li> </ul>
Hybrid battery (traction battery) air intake vent (→P.568)	<ul style="list-style-type: none"> <li>• Vacuum cleaner, etc,</li> </ul>

Items	Parts and tools
Headlight aim (→P.576)	• Phillips-head screwdriver
Engine radiator, condenser and intercooler radiator (→P.546)	—
Tire inflation pressure (→P.548)	• Tire pressure gauge • Compressed air source
Washer fluid (→P.547)	• Water or washer fluid containing antifreeze (for winter use) • Funnel (used only for adding water or washer fluid)

**WARNING**

The engine compartment contains many mechanisms and fluids that may move suddenly, become hot, or become electrically energized. To avoid death or serious injury, observe the following precautions.

■ **When working on the engine compartment**

- Make sure that “POWER ON” on the multi-information display and the “READY” indicator are both off.
- Keep hands, clothing and tools away from the moving fan and engine drive belt.
- Be careful not to touch the engine, power control unit, radiator, exhaust manifold, etc. right after driving as they may be hot. Oil and other fluids may also be hot.

- Do not leave anything that may burn easily, such as paper and rags, in the engine compartment.
- Do not smoke, cause sparks or expose an open flame to fuel. Fuel fumes are flammable.
- Take care because brake fluid can harm your hands or eyes and damage painted surfaces. If fluid gets on your hands or in your eyes, flush the affected area with clean water immediately. If you still experience discomfort, consult a doctor.

■ **When working near the cooling fan or radiator grille**

Be sure the power switch is off. With the power switch in ON, the cooling fan may automatically start to run if the air conditioning is on and/or the coolant temperature is high. (→P.542)

■ **When working on or under the vehicle**

Do not get under the vehicle with just the jack supporting it. Always use automotive jack stands or other solid supports.

■ **Safety glasses**

Wear safety glasses to prevent flying or falling material, fluid spray, etc., from getting in your eyes.

**NOTICE**

■ **If you remove the air cleaner filter**

Driving with the air cleaner filter removed may cause excessive engine wear due to dirt in the air.



## NOTICE

**■ If the fluid level is low or high**

It is normal for the brake fluid level to go down slightly as the brake pads wear or when the fluid level in the accumulator is high.

If the reservoir needs frequent refilling, it may indicate a serious problem.

**Hood**

**Release the lock from the inside of the vehicle to open the hood.**

**Opening the hood**

- 1** Pull the hood lock release lever.

The hood will pop up slightly.

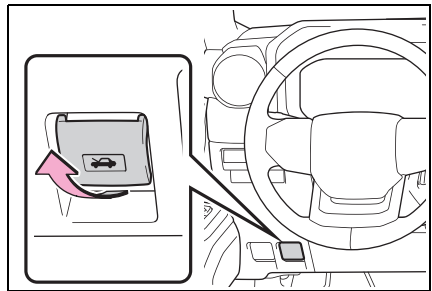

- 2** Pull up the auxiliary catch lever and lift the hood.

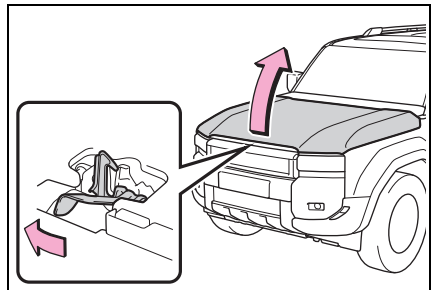

- 3 Hold the hood open by inserting the supporting rod into the slot.

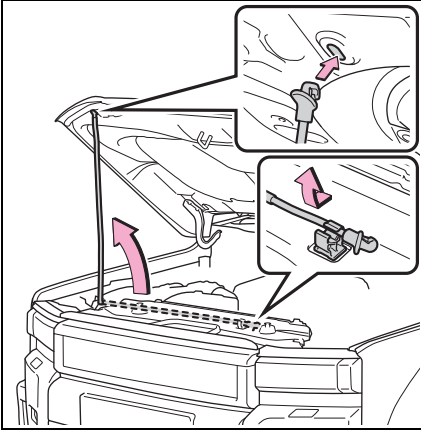

### **⚠ WARNING**

#### ■ When the hood is open

Even if the power switch is turned off, the cooling fan may continue to operate for a short time. When the cooling fan is rotating, do not touch or approach the inside of the engine compartment.

#### ■ Pre-driving check

Check that the hood is fully closed and locked.

If the hood is not locked properly, it may open while the vehicle is in motion and cause an accident, which may result in death or serious injury.

#### ■ To prevent injuries

The support rod may be hot after driving the vehicle. Touching the hot support rod may lead to burns or other serious injuries.

#### ■ After installing the support rod into the slot

Make sure the rod supports the hood securely from falling down on to your head or body.

#### ■ When closing the hood

When closing the hood, take extra care to prevent your fingers etc. from being caught.

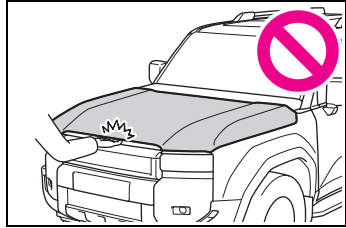

### **⚠ NOTICE**

#### ■ When closing the hood

Be sure to return the support rod to the clip before closing the hood. Closing the hood without returning the support rod properly could cause the hood to bend.

## Engine compartment

### Components

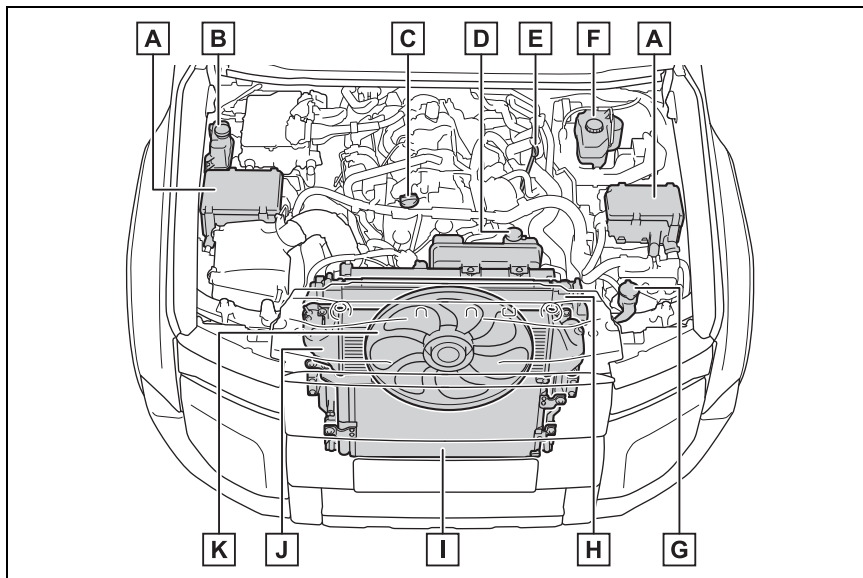

- A** Fuse boxes (→P.573)
- B** Power control unit coolant reservoir (→P.545)
- C** Engine oil filler cap (→P.544)
- D** Engine coolant reservoir (→P.545)
- E** Engine oil level dipstick (→P.542)
- F** Brake fluid reservoir (→P.547)
- G** Washer fluid tank (→P.547)
- H** Engine radiator (→P.546)
- I** Condenser (→P.546)
- J** Intercooler radiator (→P.546)
- K** Cooling fan (→P.546)

### Checking the engine oil

With the engine at operating

temperature and turned off, check the oil level on the dipstick.

- 1 Park the vehicle on level ground. After warming up the engine and turning off the engine, wait about 5 minutes for the oil to drain back into the bottom of the engine.
- 2 Holding a rag under the end, pull the dipstick out.

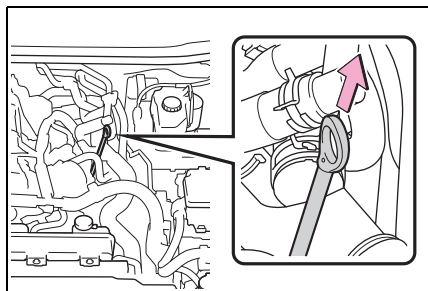

- 3 Wipe the dipstick clean.
- 4 Reinsert the dipstick fully.
- 5 Holding a rag under the end, pull the dipstick out and check whether the oil level is above low level mark.

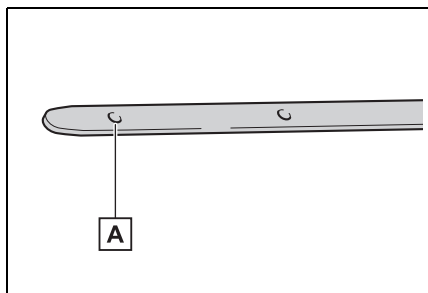

**A** Low level mark

The shape of the dipstick may differ depending on the type of vehicle or engine.

- 6 Wipe the dipstick and reinsert it fully.

 NOTICE

**■ To prevent serious engine damage**

Check the oil level on a regular basis.

**■ Engine oil consumption**

A certain amount of engine oil will be consumed while driving. In the following situations, oil consumption may increase, and engine oil may need to be refilled in between oil maintenance intervals.

- When the engine is new, for example directly after purchasing the vehicle or after replacing the engine
- If low quality oil or oil of an inappropriate viscosity is used
- When driving at high engine speeds or with a heavy load, or when driving while accelerating or decelerating frequently
- When leaving the engine idling for a long time, or when driving frequently through heavy traffic

**■ Engine oil level rise**

If the vehicle is repeatedly driven without the engine warmed up, moisture caused by dew condensation inside the engine or fuel which did not burn mixes into the engine oil, resulting in a rise in engine oil level. However, this is not a malfunction.

For example, the engine become difficult to be warmed up in the following situations.

- When driving a short distance
- When driving at a low speed
- When the outside temperature is low

When checking the engine oil, make sure that the engine is warmed up. If the engine oil level exceeds the refill upper limit mark, contact your Toyota dealer.

## Adding engine oil

### ■ Checking the oil type and preparing the items needed

Make sure to check the oil type and prepare the items needed before adding oil.

- Engine oil selection

→P.633

- Oil quantity (Low level mark  
→ Refill upper limit mark)

1.5 qt. (1.4 L, 1.2 Imp.qt.)

- Items

Clean funnel

### ■ Adding engine oil

If the oil level is below or near the low level mark, add engine oil of the same type as that already in the engine.

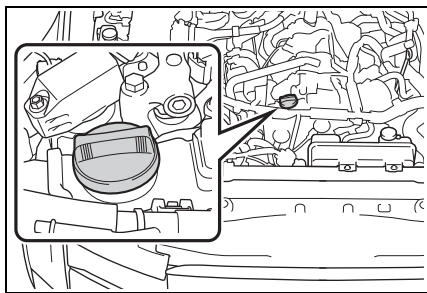

- 1 Remove the oil filler cap by turning it counterclockwise.
- 2 Add engine oil slowly, checking the dipstick.

Make sure that the oil level does not exceed the refill upper limit mark and is between the low level

mark and refill upper limit mark.

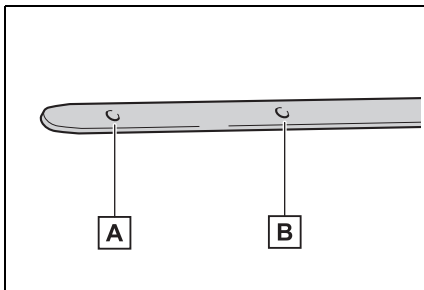

**A** Low level mark

**B** Refill upper limit mark

The shape of the dipstick may differ depending on the type of vehicle or engine.

- 3 Install the oil filler cap by turning it clockwise.

### ■ After changing the engine oil

The engine oil maintenance data should be reset. Perform the following procedures:

- 1 Select in screen of the multi-information display, and then press and hold OK .
- 2 Select “Oil Maintenance” and then press OK .
- 3 Select “Yes” and then press OK .

A message will be displayed when the reset procedure has been completed.



## ⚠ WARNING

### ■ Used engine oil

- Used engine oil contains potentially harmful contaminants which may cause skin disorders such as inflammation and skin cancer, so care should be taken to avoid prolonged and repeated contact. To remove used engine oil from your skin, wash thoroughly with soap and water.
- Dispose of used oil and filters only in a safe and acceptable manner. Do not dispose of used oil and filters in household trash, in sewers or onto the ground. Call your Toyota dealer, service station or auto parts store for information concerning recycling or disposal.
- Do not leave used engine oil within the reach of children.

## ⚠ NOTICE

### ■ To prevent serious engine damage

Check the oil level on a regular basis.

### ■ When replacing the engine oil

- Be careful not to spill engine oil on the vehicle components.
- Avoid overfilling, or the engine could be damaged.
- Check the oil level on the dipstick every time you refill the vehicle.
- Be sure the engine oil filler cap is properly tightened.

### ■ After changing the engine oil

Make sure to reset the engine oil maintenance data. If it is not reset, the next maintenance timing will not be displayed properly.

## Checking the coolant

The coolant level is satisfactory if it is between the “F”/“FULL” and “L”/“LOW” lines on the reservoir when the hybrid system is cold.

### ■ Engine coolant reservoir

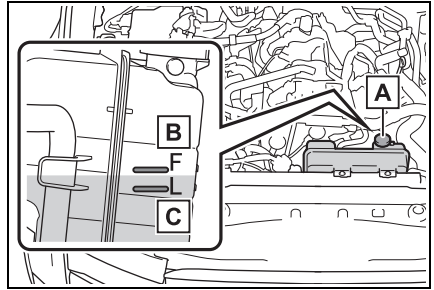

**A** Reservoir cap

**B** “F” line

**C** “L” line

If the level is on or below the “L” line, add coolant up to the “F” line. (→P.625)

### ■ Power control unit coolant reservoir

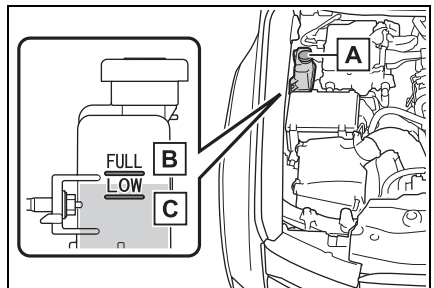

**A** Reservoir cap

**B** “FULL” line

**C** “LOW” line

If the level is on or below the “LOW” line, add coolant up to the “FULL” line. (→P.625)

### ■ Coolant selection

Only use “Toyota Super Long Life Coolant” or a similar high quality ethylene glycol based non-silicate, non-amine, non-nitrite, and non-borate coolant with long-life hybrid organic acid technology.

U.S.A.:

“Toyota Super Long Life Coolant” is a mixture of 50% coolant and 50% deionized water. (Minimum temperature: -31°F [-35°C])

Canada:

“Toyota Super Long Life Coolant” is a mixture of 55% coolant and 45% deionized water. (Minimum temperature: -44°F [-42°C])

For more details about coolant, contact your Toyota dealer.

### ■ If the coolant level drops within a short time of replenishing

Visually check the radiators, hoses, engine/power control unit coolant reservoir caps, drain cock and water pump.

If you cannot find a leak, have your Toyota dealer, test the cap and check for leaks in the cooling system.



### WARNING

#### ■ When the hybrid system is hot

Do not remove the engine/power control unit coolant reservoir caps.

The cooling system may be under pressure and may spray hot coolant if the cap is removed, causing serious injuries, such as burns.



### NOTICE

#### ■ When adding coolant

Coolant is neither plain water nor straight antifreeze. The correct mixture of water and antifreeze must be used to provide proper lubrication, corrosion protection and cooling. Be sure to read the antifreeze or coolant label.

#### ■ If you spill coolant

Be sure to wash it off with water to prevent it from damaging parts or paint.

### Checking the engine radiator, condenser and intercooler radiator

Check the engine radiator, condenser and intercooler radiator and clear any foreign objects. If any of the above parts are extremely dirty or you are not sure of their condition, have your vehicle inspected by your Toyota dealer.



### WARNING

#### ■ When the engine is hot

Do not touch the engine radiator, condenser or intercooler radiator as they may be hot and cause serious injuries, such as burns.

**⚠ WARNING**

**■ When the electric cooling fan is operating**

Do not touch the engine compartment.

With the power switch in ON, the electric cooling fan may automatically start to run if the air conditioning is on and/or the coolant temperature is high. Be sure the power switch is OFF when working near the electric cooling fan or radiator grille.

## Checking and adding the brake fluid

### ■ Checking fluid level

The brake fluid level should be between the “MAX” and “MIN” lines on the tank.

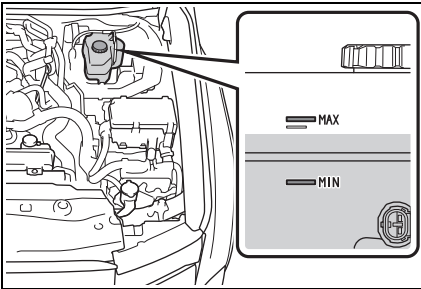

### ■ Adding fluid

Make sure to check the fluid type and prepare the necessary item.

#### ● Fluid type

FMVSS No.116 DOT 3 or SAE J1703 brake fluid  
FMVSS No.116 DOT 4 or SAE J1704 brake fluid

#### ● Items

Clean funnel

### ■ Refilling brake fluid

- 1 Turn the power switch off.
- 2 Depress the brake pedal more than 40 times.
- 3 Remove the reservoir cap by hand. Add brake fluid up to the “MAX” line. If you do not follow the procedure above, the reservoir may overflow

### ■ Brake fluid can absorb moisture from the air

Excess moisture in the brake fluid can cause a dangerous loss of braking efficiency. Use only newly opened brake fluid.

**⚠ WARNING**

**■ When filling the reservoir**

Take care as brake fluid can harm your hands and eyes and damage painted surfaces.

If fluid gets on your hands or in your eyes, flush the affected area with clean water immediately. If you still experience discomfort, see a doctor.

**⚠ NOTICE**

**■ If the fluid level is low or high**

It is normal for the brake fluid level to go down slightly as the brake pads wear out or when the fluid level in the accumulator is high. If the reservoir needs frequent refilling, there may be a serious problem.

## Adding the washer fluid

If none of the washer does not work or the “Windshield Washer Fluid Low” appears on the multi-

information display, the washer tank may be empty. Add washer fluid.

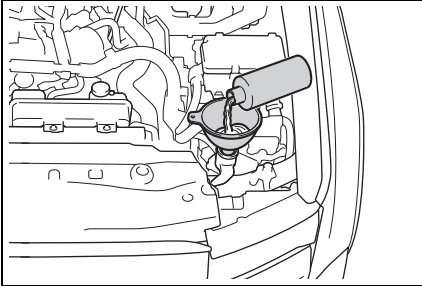

### WARNING

#### ■ When adding washer fluid

Do not add washer fluid when the hybrid system is hot or running as washer fluid contains alcohol and may catch fire if spilled on the engine, etc.



### NOTICE

#### ■ Do not use any fluid other than washer fluid

Do not use soapy water or engine antifreeze instead of washer fluid. Doing so may cause streaking on the vehicle's painted surfaces, as well as damaging the pump leading to problems of the washer fluid not spraying.

#### ■ Diluting washer fluid

Dilute washer fluid with water as necessary. Refer to the freezing temperatures listed on the label of the washer fluid bottle.

## 12-volt battery

### Location

The 12-volt battery is located in the left side of luggage compartment.

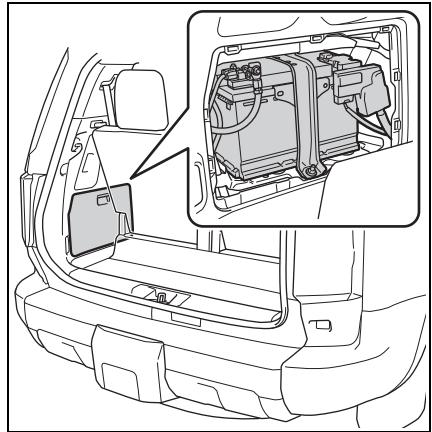

### ■ Before recharging

When recharging, the 12-volt battery produces hydrogen gas which is flammable and explosive. Therefore, observe the following precautions before recharging:

- If recharging with the 12-volt battery installed on the vehicle, be sure to disconnect the ground cable.
- Make sure the power switch on the charger is off when connecting and disconnecting the charger cables to the 12-volt battery.

### ■ After recharging/reconnecting the 12-volt battery

- Unlocking the doors using the smart access system with push-button start may not be possible immediately after reconnecting the 12-volt battery. If this happens, use the wireless remote control or the mechanical key to lock/unlock the doors.

- Start the hybrid system with the power switch in ACC. The hybrid system may not start with the power switch turned off. However, the hybrid system will operate normally from the second attempt.
- The power switch mode is recorded by the vehicle. If the 12-volt battery is disconnected and reconnected, the vehicle will return the power switch mode to the status it was in before the 12-volt battery was disconnected. Make sure to turn off the power switch before disconnecting the 12-volt battery. Take extra care when connecting the 12-volt battery if the power switch mode prior to the 12-volt battery being disconnected is unknown.

If the system will not start even after multiple attempts at all the methods above, contact your Toyota dealer.



## WARNING

### ■ Chemicals in the 12-volt battery

The 12-volt battery contains poisonous and corrosive sulfuric acid and may produce hydrogen gas which is flammable and explosive. To reduce the risk of death or serious injury, take the following precautions while working on or near the 12-volt battery:

- Do not cause sparks by touching the 12-volt battery terminals with tools.
- Do not smoke or light a match near the 12-volt battery.
- Avoid contact with eyes, skin and clothes.
- Never inhale or swallow electrolyte.

- Wear protective safety glasses when working near the 12-volt battery.

- Keep children away from the 12-volt battery.

### ■ Where to safely charge the 12-volt battery

Always charge the 12-volt battery in an open area. Do not charge the 12-volt battery in a garage or closed room where there is insufficient ventilation.

### ■ How to recharge the 12-volt battery

Only perform a slow charge (5 A or less). The 12-volt battery may explode if charged at a quicker rate.

### ■ Emergency measures regarding electrolyte

- If electrolyte gets in your eyes  
Flush your eyes with clean water for at least 15 minutes and get immediate medical attention. If possible, continue to apply water with a sponge or cloth while traveling to the nearest medical facility.
- If electrolyte gets on your skin  
Wash the affected area thoroughly. If you feel pain or burning, get medical attention immediately.
- If electrolyte gets on your clothes  
It can soak through clothing on to your skin. Immediately take off the clothing and follow the procedure above if necessary.
- If you accidentally swallow electrolyte  
Drink a large quantity of water or milk. Get emergency medical attention immediately.

### WARNING

#### ■ When replacing the 12-volt battery

Use a 12-volt battery designed for this vehicle. Failure to do so may cause gas (hydrogen) to enter the passenger compartment, causing a fire or explosion.

For replacement of the 12-volt battery, contact your Toyota dealer.

#### ■ When there is insufficient 12-volt battery fluid

Do not use if there is insufficient fluid in the 12-volt battery. There is a possible danger that the 12-volt battery may explode.

#### ■ When handling the 12-volt battery

→P.623

### NOTICE

#### ■ When recharging the 12-volt battery

Never recharge the 12-volt battery while the hybrid system is operating. Also, be sure all accessories are turned off.

## Removing the 12-volt battery cover

Remove the cover.

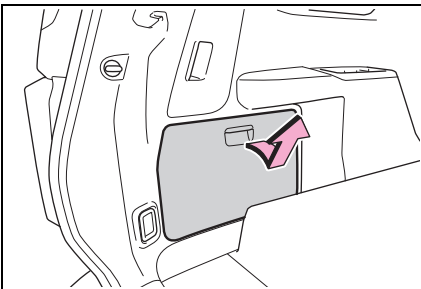

## Exterior

Make sure that the 12-volt battery terminals are not corroded and that there are no loose connections, cracks, or loose clamps.

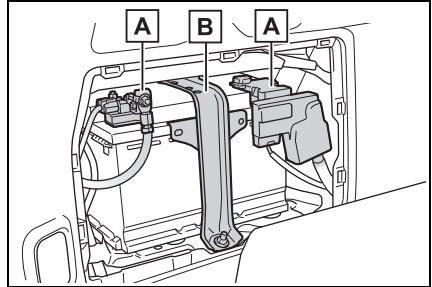

**A** Terminals

**B** Hold-down clamp

## Checking the 12-volt battery condition

Check the 12-volt battery condition by indicator color.

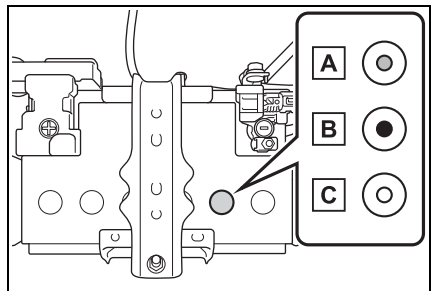

**A** Blue: Good condition

**B** Red: Charging is necessary. Have the vehicle inspected by your Toyota dealer.

**C** Clear: Replacement is necessary.

Have the 12-volt battery checked by your Toyota dealer.

## Tires

**Replace or rotate tires in accordance with maintenance schedules and treadwear.**

### Checking tires

Check if the treadwear indicators are showing on the tires. Also check the tires for uneven wear, such as excessive wear on one side of the tread. Check the spare tire condition and pressure if not rotated.

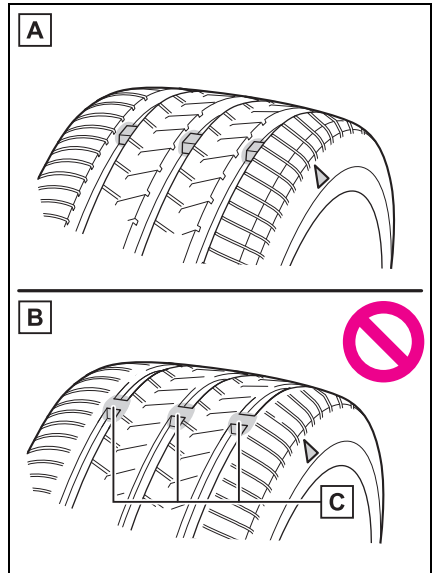

**A** New tread

**B** Worn tread

**C** Treadwear indicator

The location of treadwear indicators is shown by a “TWI” or “ $\triangle$ ” mark,

etc., molded into the sidewall of each tire.

Replace the tires if the treadwear indicators are showing on a tire.

### ■ When to replace your vehicle's tires

Tires should be replaced if:

- The treadwear indicators are showing on a tire.
- You have tire damage such as cuts, splits, cracks deep enough to expose the fabric, and bulges indicating internal damage.
- A tire goes flat repeatedly or cannot be properly repaired due to the size or location of a cut or other damage.

If you are not sure, consult with your Toyota dealer.

### ■ Tire life

Any tire over 6 years old must be checked by a qualified technician even if it has seldom or never been used or damage is not obvious.

### ■ Maximum load of tire

Check that the number given by dividing the maximum load by 1.10 of the replacement tire is greater than 1/2 of the Gross Axle Weight Ratings (GAWR) of either the front axle or the rear axle, whichever is greater.

For the GAWR, see the Certification Label. For the maximum load of the tire, see the load limit at maximum cold tire inflation pressure mentioned on the sidewall of the tire. (→P.563)

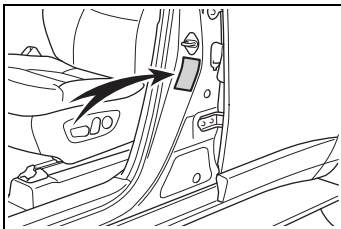

### ■ Tire types

#### ● Summer tires

Summer tires are high-speed performance tires best suited to highway driving under dry conditions. Since summer tires do not have the same traction performance as snow tires, summer tires are inadequate for driving on snow-covered or icy roads. For driving on snow-covered roads or icy roads, the use of snow tires is recommended. When installing snow tires, be sure to replace all four tires.

#### ● All season tires

All season tires are designed to provide better traction in snow and to be adequate for driving in most winter conditions as well as for use year-round. All season tires, however, do not have adequate traction performance compared with snow tires in heavy or loose snow. Also, all season tires fall short in acceleration and handling performance compared with summer tires in highway driving.

#### ● Snow tires

For driving on snow-covered roads or icy roads, we recommend using snow tires. If you need snow tires, select tires of the same size, construction and load capacity as the originally installed tires. Since your vehicle has radial tires as original equipment, make sure your snow tires also have radial construction. Do not install studded tires without first checking local regulations for possible restrictions. Snow tires should be installed on all wheels. (→P.463)

### ■ If the tread on snow tires wears down below 4 mm (0.16 in.)

The effectiveness of the tires as snow tires is lost.



### WARNING

#### ■ When inspecting or replacing tires

Observe the following precautions to prevent accidents. Failure to do so may cause damage to parts of the drive train as well as dangerous handling characteristics, which may lead to an accident resulting in death or serious injury.

- Do not mix tires of different makes, models or tread patterns. Also, do not mix tires of remarkably different treadwear.
- Do not use tire sizes other than those recommended by Toyota.
- Do not mix differently constructed tires (radial, bias-belted or bias-ply tires).
- Do not mix summer, all season and snow tires.
- Do not use tires that have been used on another vehicle. Do not use tires if you do not know how they were used previously.

### NOTICE

#### ■ Driving on rough roads

Take particular care when driving on roads with loose surfaces or potholes.

These conditions may cause losses in tire inflation pressure, reducing the cushioning ability of the tires. In addition, driving on rough roads may cause damage to the tires themselves, as well as the vehicle's wheels and body.

#### ■ If tire inflation pressure of each tire becomes low while driving

Do not continue driving, or your tires and/or wheels may be ruined.

### Tire rotation

Rotate the tires in the order shown.

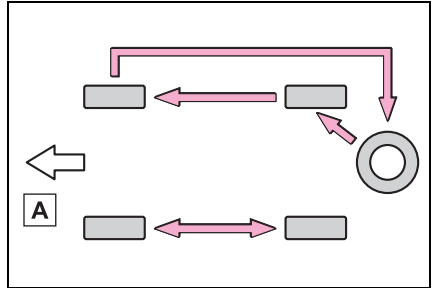

#### **A** Front

To equalize tire wear and extend tire life, Toyota recommends that tire rotation is carried out at the same interval as tire inspection.

Do not fail to initialize the tire pressure warning system after tire rotation.

#### ■ When rotating the tires (vehicles with the tire pressure warning system)

Make sure that the power switch is OFF. If the tires are rotated while the power switch is in ON, the tire position information will not be updated.

If this accidentally occurs, either turn the power switch to OFF and then to ON, or initialize the system after checking that the tire pressure is properly adjusted.

## Tire pressure warning system

Your vehicle is equipped with a tire pressure warning system that uses tire pressure warning valves and transmitters to detect low tire inflation pressure before serious problems arise.

The tire pressure warning system of this vehicle adopts a 2-type warning system. (→P.594)

- ▶ 7-inch multi-information display

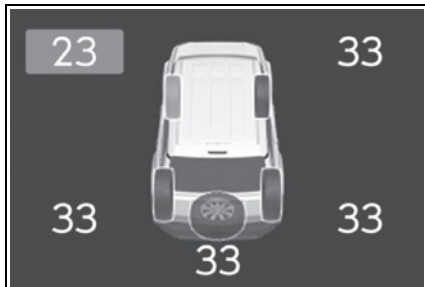

- ▶ 12.3-inch multi-information display

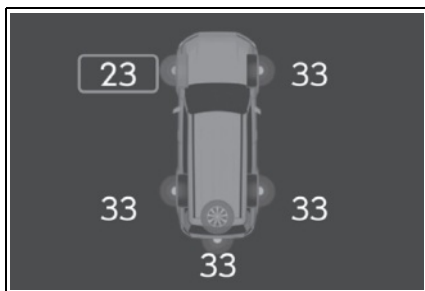

- When “Adjust Pressure” is displayed on the multi-information display (Normal Warning)

A warning with the tire pressure warning light and warning buzzer

when there is an unknown level of low tire pressure with the appearance of the tire due to natural air leakage as well as the pressure lowering due to changes in the pressure according to the outside temperature.

- When “Immediately Check tire when Safe” is displayed on the multi-information display (Emergency Warning)

A warning with the tire pressure warning light and warning buzzer when there is a known level of low tire pressure with the appearance of the tire due to pressure suddenly lowering.

However, the system may not be able to detect sudden tire ruptures (bursting, etc.).

- The tire pressure detected by the tire pressure warning system can be displayed on the multi-information display. (→P.99)

### ■ Routine tire inflation pressure checks

The tire pressure warning system does not replace routine tire inflation pressure checks. Make sure to check tire inflation pressure as part of your routine of daily vehicle checks.

### ■ Tire inflation pressure

- It may take a few minutes to display the tire inflation pressure after the power switch is turned to ON. It may also take a few minutes to display the tire inflation pressure after inflation pressure has been adjusted.
- Tire inflation pressure changes with temperature. The displayed

values may also be different from the values measured using a tire pressure gauge.

#### ■ Situations in which the tire pressure warning system may not operate properly

- In the following cases, the tire pressure warning system may not operate properly.
  - If non-genuine Toyota wheels are used.
  - A tire has been replaced with a tire that is not an OE (Original Equipment) tire.
  - A tire has been replaced with a tire that is not of the specified size.
  - Tire chains, etc. are equipped.
  - If a window tint that affects the radio wave signals is installed.
  - If there is a lot of snow or ice on the vehicle, particularly around the wheels or wheel housings.
  - If the tire inflation pressure is extremely higher than the specified level.
  - If tires not equipped with tire pressure warning valves and transmitters are used.
  - If the ID code on the tire pressure warning valves and transmitters is not registered in the tire pressure warning computer.
- Performance may be affected in the following situations.
  - Near a TV tower, electric power plant, gas station, radio station, large display, airport or other facility that generates strong radio waves or electrical noise
  - When carrying a portable radio, cellular phone, cordless phone or other wireless communication device
- If tire position information is not correctly displayed due to the radio wave conditions, the display may be corrected by changing the location of the vehicle as the radio wave conditions may change.
- When the vehicle is parked, the time taken for the warning to start or go off could be extended.

- When tire inflation pressure declines rapidly for example when a tire has burst, the warning may not operate.

### Installing tire pressure warning valves and transmitters

When replacing tires or wheels, tire pressure warning valves and transmitters must also be installed.

When new tire pressure warning valves and transmitters are installed, new ID codes must be registered in the tire pressure warning computer. (→P.559)

#### ■ Replacing tires and wheels

If the ID code of the tire pressure warning valve and transmitter is not registered, the tire pressure warning system will not work properly. In this case, after driving for about 20 minutes, the tire pressure warning light blinks for 1 minute and stays on to indicate a system malfunction.

#### NOTICE

#### ■ Repairing or replacing tires, wheels, tire pressure warning valves, transmitters and tire valve caps

- When removing or fitting the wheels, tires or the tire pressure warning valves and transmitters, contact your Toyota dealer as the tire pressure warning valves and transmitters may be damaged if not handled correctly.

**NOTICE**

- Make sure to install the tire valve caps. If the tire valve caps are not installed, water could enter the tire pressure warning valves, corrode the valve, and cause sticking and air leaks.
- When replacing tire valve caps, do not use tire valve caps other than those specified. The cap may become stuck.

## Registering the position of each wheel

### ■ When to register the position of each wheel

It is necessary to register the position of each wheel after performing a tire rotation.

Wheel position registration can be performed by oneself. Wheel position registration is performed by driving forward with moderate left and right turns. However, depending on the driving conditions and driving environment, registration may take some time to complete.

### ■ Registering the position of each wheel

- 1 Park the vehicle in a safe place, turn the power switch off and wait 15 minutes or more.
- 2 Start the hybrid system.

The wheel position registration procedure cannot be performed while the vehicle is moving.

- 3 Select  on the multi-information display.
- 4 Select “Vehicle Settings”.
- 5 Select “TPWS setting”.
- 6 Select “Tire Rotation”.
- 7 Select “Yes”.

A message indicating that wheel position registration is being performed will be displayed on the multi-information display. “---” will be displayed for the tire inflation pressure of each tire and wheel position registration will begin.

- 8 Drive straight (with occasional left and right turns) at approximately 25 mph (40 km/h) or more for approximately 10 to 30 minutes.

When wheel position registration is complete, a message indicating that registration has been completed and the inflation pressure of each tire will be displayed on the multi-information display.

Even if it is not possible to drive continuously at approximately 25 mph (40 km/h) or more, registration can be completed by driving for a long time. However, if registration does not complete after driving for 1 hour or more, park the vehicle in a safe place and leave it with the power switch in ON for approximately 15 minutes or more, and then perform the driving procedure again.

### ■ When performing wheel position registration

- Normally, wheel position registration can be completed within approximately 30 minutes.
- Wheel position registration is performed while driving at a vehicle speed of approximately 25 mph

(40 km/h) or more.

### ■ Wheel position registration procedure

- If the power switch is turned off while registering the wheel position, the next time the power switch is turned to ON, the wheel position registration will resume and it will not be necessary to restart the procedure.
- While the position of each wheel is being determined and the inflation pressures are not being displayed, if the inflation pressure of a tire drops, the tire pressure warning light will come on.

### ■ If the wheel position cannot be registered easily

- In the following situations, wheel position registration may take longer than usual to be completed or may not be possible.
  - Vehicle is not driven at approximately 25 mph (40 km/h) or more
  - Vehicle is driven on unpaved roads
- If wheel position registration does not complete after driving for 1 hour or more, park the vehicle in a safe place for approximately 15 minutes and then drive the vehicle again.
- If the vehicle is reversed during wheel position registration, all data collected until then will be cleared. Perform driving again.

## Setting the tire pressure

### ■ When you need to setting the tire pressure

In the following situations, it will be necessary to perform the tire inflation pressure setting procedure of the tire pressure warning system.

- When the specified tire infla-

tion pressure has changed, such as due to carried load, etc.

- When the tire inflation pressure is changed such as when the tire size is changed.

If the tire inflation pressure has been adjusted to the specified level, perform the tire inflation setting procedure by selecting specified inflation pressure on the multi-information display. (→P.557)

When the tire inflation pressure is to be other than specified, such as when tires other than the specified size are used, etc., set the tire inflation pressure using the current pressure. Make sure to adjust the tire inflation pressure of each tire to the appropriate level before performing tire pressure setting. The tire pressure warning system operates based on this tire inflation pressure. (→P.558)

### ■ Setting by selecting a specified tire inflation pressure

- 1 Start the hybrid system.

The tire inflation pressure cannot be set while the vehicle is moving.

- 2 Select  on the multi-information display.
- 3 Select "Vehicle Settings".
- 4 Select "TPWS setting".
- 5 Select "Tire Pressure Setting".

- 6 Select “Setting by Specified Pressure” and then select the desired front and rear tire pressures.

- 7 Select “Yes”.

The tire pressure warning light will slowly blink 3 times.

After setting the tire inflation pressure, a message indicating that setting has been completed will be displayed on the multi-information display.

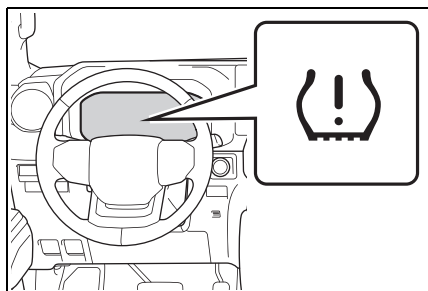

#### ■ Setting using the current tire inflation pressure

- 1 Adjust the tire inflation pressure of each tire to the appropriate level.

Make sure to adjust the tire inflation pressure with the tires cold.

- 2 Start the hybrid system.

The tire inflation pressure cannot be set while the vehicle is moving.

- 3 Select  on the multi-information display.
- 4 Select “Vehicle Settings”.
- 5 Select “TPWS setting”.
- 6 Select “Tire Pressure Setting”.
- 7 Select “Setting by Current Pressure”.

- 8 Select “Yes”.

The tire pressure warning light will slowly blink 3 times and a message indicating that tire inflation pressure is being set will be displayed on the multi-information display.

After setting the tire inflation pressure, a message indicating that setting has been completed will be displayed on the multi-information display.

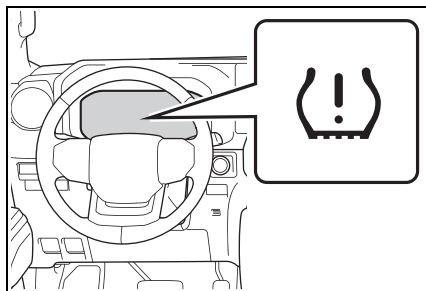

#### ■ Warning performance of the tire pressure warning system (Setting using the current tire inflation pressure)

- When performing the tire pressure setting using the current tire inflation pressure, the warning timing of the tire pressure warning system will vary according to the conditions under which tire pressure setting was performed. Therefore, a warning may be output even if the tire inflation pressure drops slightly or if the tire inflation pressure increases above that when the tire inflation pressure was set.
- Make sure to perform the tire pressure setting procedure after adjusting the tire inflation pressure. Also, make sure the tires are cold before performing the tire pressure setting procedure or adjusting the tire inflation pressure.

- **Tire inflation pressure setting procedure (Setting using the current tire inflation pressure)**
- If the power switch is turned off while setting the tire inflation pressure, the next time the power switch is turned on, the setting procedure will resume and it will not be necessary to restart the procedure.
- If the tire inflation pressure setting procedure is started unnecessarily, adjust the tire inflation pressure to the specified level with the tires cold and then perform setting by selecting a specified tire inflation pressure, or perform the tire inflation pressure setting procedure with the current tire inflation pressure.
- **If the tire inflation pressure cannot be set easily**
- Normally, it takes approximately 3 minutes to complete the setting procedure to the current tire inflation pressure.
- If the tire pressure warning light does not blink 3 times when starting the tire inflation pressure setting procedure, the procedure may not have started. Perform the procedure again from the beginning.
- If tire inflation pressure setting procedure cannot be completed after performing the above procedure, contact your Toyota dealer.

### **WARNING**

#### ■ **When setting using the current tire inflation pressure**

Make sure to adjust the tire inflation pressure of each tire to the appropriate level before performing tire pressure setting. Otherwise, the tire pressure warning light may not illuminate even if the tire inflation pressure drops or may illuminate even though the tire inflation pressure is normal.

### **Registering ID codes**

#### ■ **When to register ID codes**

The tire pressure warning valve and transmitter is equipped with a unique ID code. When new tire pressure warning valves and transmitters are installed, new ID codes must be registered in the tire pressure warning computer.

#### ■ **How to registration ID code**

Before performing ID code registration, make sure that no wheels with tire pressure warning valve and transmitters installed are near the vehicle.

- 1 Park the vehicle in a safe place, turn the power switch off and wait 15 minutes or more.
- 2 Start the hybrid system.

The ID code registration procedure cannot be performed while the vehicle is moving.

- 3 Select  on the multi-information display.

- 4 Select "Vehicle Settings".
- 5 Select "TPWS setting".
- 6 Select "Tire Set Switching".
- 7 Select "Register New Valve / ID".
- 8 Select the wheel set ("Tire Set 1" or "Tire Set 2") you wish to register.
- 9 Select "Yes".

The tire pressure warning light will slowly blink 3 times and a message indicating that ID code registration is being performed will be displayed on the multi-information display. Wheel set changing will be canceled and registration will begin.

When registration is being performed, the tire pressure warning light will blink for approximately 1 minute then illuminate and "---" will be displayed for the inflation pressure of each tire on the multi-information display.

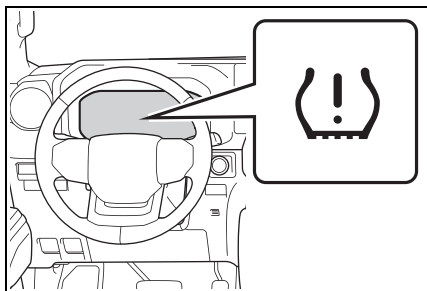

- 10 Drive straight (with occasional left and right turns) at approximately 25 mph (40 km/h) or more for approximately 10 to 30 minutes.

When registration is complete, the tire pressure warning light will turn off and a message indicating that registration has been completed will be displayed on the multi-information display.

Registration may take longer than normal to complete if the vehicle speed cannot be maintained at approximately 25 mph (40 km/h) or more. If registration cannot be completed after driving for 1 hour or more, perform the registration procedure again from the beginning.

- 11 If the tire inflation pressure of the wheel set installed differs from that of the previous set, it will be necessary to perform the tire inflation pressure setting procedure of the tire pressure warning system. (→P.557)

If the specified tire inflation pressure is the same, it will not be necessary to perform the tire inflation pressure setting procedure.

#### ■ When registering ID codes

- Normally, wheel position registration can be completed within approximately 30 minutes.
- ID code registration is performed while driving at a vehicle speed of approximately 25 mph (40 km/h) or more.
- ID codes can be registered by yourself, but depending on the driving conditions and driving environment, registration may take some time to complete.
- When using a wheel set which all of the ID codes have already been registered, the wheel set can be changed in a short amount of time. (→P.561)

#### ■ If ID codes are not registered easily

- In the following situations, ID code registration may take longer than usual to be completed or may not be possible.
- When the vehicle has not been parked for approximately 15 min-



- utes or more before being driven
- Vehicle is not driven at approximately 25 mph (40 km/h) or more
- Vehicle is driven on unpaved roads
- Vehicle is driven near other vehicles and system cannot recognize tire pressure warning valve and transmitters of your vehicle over those of other vehicles
- Wheel with tire pressure warning valve and transmitter installed is inside or near the vehicle
- If the vehicle is reversed during registration, all data collected until then will be cleared. Perform driving again.
- If registration does not complete after driving for 1 hour or more, perform the ID code registration procedure again from the beginning.
- If the tire pressure warning light does not blink 3 times when starting ID code registration procedure, the procedure may not have started. Perform the procedure again from the beginning.
- If the ID codes cannot be registered even when performing the above procedure, contact your Toyota dealer.

### Canceling ID code registration

To cancel ID code registration after it has been started, select “Register New Valve / ID” again on the multi-information display.

If ID code registration has been canceled, the tire pressure warning light will turn off.

If the warning light does not turn off, ID code registration may not have been cancelled correctly. To cancel registration, select “Register New

Valve / ID” again on the multi-information display.

### Selecting wheel set

Your vehicle is equipped with a tire pressure warning system with a function to register two sets of ID codes. This allows for registration of a second wheel set, for example a winter set.

- The wheel set can be changed only if a second wheel set has been registered to the system.

ID codes can be registered by yourself. (→P.559)

- Only a change between both registered wheel set is possible, mixing between these wheel sets is not supported.
- While registering ID codes, it may not be possible to change between wheel sets normally. Cancel registration before changing between wheel sets.

### Changing ID codes between different wheel sets

- 1 Install the desired wheel set.
- 2 Select  on the multi-information display.
- 3 Select “Vehicle Settings”.
- 4 Select “TPWS setting”.
- 5 Select “Tire Set Switching”.
- 6 Select “Register Valve / ID”.

7 Select the wheel set ("Tire Set 1" or "Tire Set 2") you wish to register

8 Select "Yes".

The tire pressure warning light will slowly blink 3 times, a message indicating that change is occurring will be displayed, and the wheel set change will begin.

Wheel set change will begin and the tire pressure warning light will blink for 1 minute and then illuminate. Also, while the change is being performed, "---" will be displayed for the tire inflation pressure of each tire on the multi-information display.

After approximately 2 minutes, the wheel set change will complete, the tire pressure warning light will turn off, and a completion message will be displayed on the multi-information display.

If changing does not complete after approximately 4 minutes, a message indicating that the change could not be completed will be displayed.

Check which wheel set is installed and perform the change procedure again from the beginning.

cedure of the tire pressure warning system. (→P.559)

If the specified tire inflation pressure is the same, it will not be necessary to perform the tire inflation pressure setting procedure.

10 Register the position of each wheel. (→P.556)

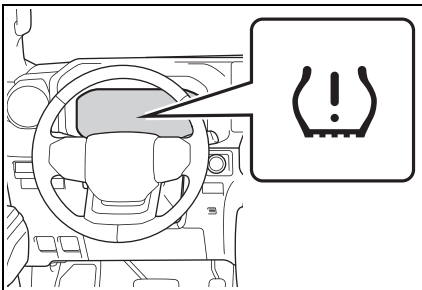

9 If the specified tire inflation pressure of the wheel set installed differs from that of the previous set, it will be necessary to perform the tire inflation pressure setting pro-

## Tire inflation pressure

Make sure to maintain the proper tire inflation pressure. Tire inflation pressure should be checked at least once per month. However, Toyota recommends that tire inflation pressure be checked once every two weeks.

### Checking the specified tire inflation pressure

The recommended cold tire inflation pressure and tire size are displayed on the tire and loading information label.  
(→P.637)

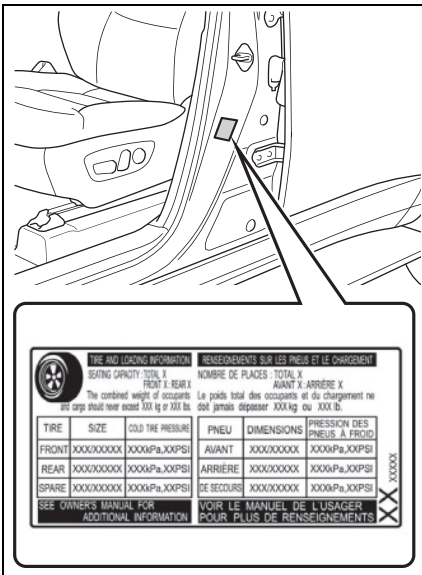

### Inspection and adjustment procedure

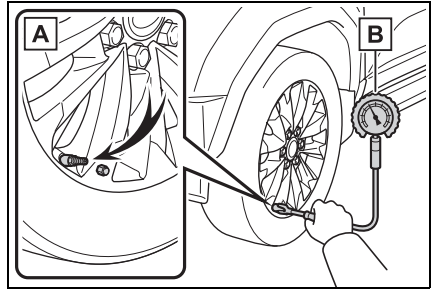

**A** Tire valve

**B** Tire pressure gauge

- 1 Remove the tire valve cap.
- 2 Press the tip of the tire pressure gauge onto the tire valve.
- 3 Read the pressure using the gauge gradations.
- 4 If the tire inflation pressure is not at the recommended level, adjust the pressure. If you add too much air, press the center of the valve to deflate.
- 5 After completing the tire inflation pressure measurement and adjustment, apply soapy water to the valve and check for leakage.
- 6 Put the tire valve cap back on.

### ■ Tire inflation pressure check interval

You should check tire inflation pressure every two weeks, or at least once a month.

Do not forget to check the spare.

### ■ Effects of incorrect tire inflation pressure

Driving with incorrect tire inflation pressure may result in the following:

- Reduced fuel economy
- Reduced driving comfort and poor handling
- Reduced tire life due to wear
- Reduced safety
- Damage to the drive train

If a tire needs frequent refilling, have it checked by your Toyota dealer.

### ■ Instructions for checking tire inflation pressure

When checking tire inflation pressure, observe the following:

- Check only when the tires are cold.  
If your vehicle has been parked for at least 3 hours or has not been driven for more than 1.5 km or 1 mile, you will get an accurate cold tire inflation pressure reading.
- Always use a tire pressure gauge. It is difficult to judge if a tire is properly inflated based only on its appearance.
- It is normal for the tire inflation pressure to be higher after driving as heat is generated in the tire. Do not reduce tire inflation pressure after driving.
- Never exceed the vehicle capacity weight. Passengers and luggage weight should be placed so that the vehicle is balanced.



### WARNING

#### ■ Proper inflation is critical to save tire performance

Keep your tires properly inflated. If the tires are not properly inflated, the following conditions may occur which could lead to an accident resulting in death or serious injury:

- Excessive wear
- Uneven wear
- Poor handling
- Possibility of blowouts resulting from overheated tires
- Air leaking from between tire and wheel
- Wheel deformation and/or tire damage
- Greater possibility of tire damage while driving (due to road hazards, expansion joints, sharp edges in the road, etc.)



### NOTICE

#### ■ When inspecting and adjusting tire inflation pressure

Be sure to put the tire valve caps back on.

If a valve cap is not installed, dirt or moisture may get into the valve and cause an air leak, resulting in decreased tire inflation pressure.

## Wheels

**If a wheel is bent, cracked or heavily corroded, it should be replaced. Otherwise, the tire may separate from the wheel or cause a loss of handling control.**

### Wheel selection

When replacing wheels, care should be taken to ensure that they are equivalent to those removed in load capacity, diameter, rim width and inset\*.

Replacement wheels are available at your Toyota dealer.

\*: Conventionally referred to as offset.

Toyota does not recommend using the following:

- Wheels of different sizes or types
- Used wheels
- Bent wheels that have been straightened

### ■ When replacing wheels

The wheels of your vehicle are equipped with tire pressure warning valves and transmitters that allow the tire pressure warning system to provide advance warning in the event of a loss in tire inflation pressure. Whenever wheels are replaced, tire pressure warning valves and transmitters must be installed. (→P.564)

### WARNING

#### ■ When replacing wheels

- Do not use wheels that are a different size from those recommended in the Owner's Manual, as this may result in a loss of handling control.
- Never use an inner tube in a leaking wheel which is designed for a tubeless tire. Doing so may result in an accident, causing death or serious injury.

#### ■ When installing the wheel nuts

- Be sure to install the wheel nuts with the tapered ends facing inward. (→P.613) Installing the nuts with the tapered ends facing outward can cause the wheel to break and eventually cause the wheel to come off while driving, which could lead to an accident resulting in death or serious injury.
- Never use oil or grease on the wheel bolts or wheel nuts. Oil and grease may cause the wheel nuts to be excessively tightened, leading to bolt or disc wheel damage. In addition, the oil or grease can cause the wheel nuts to loosen and the wheel may fall off, causing an accident and resulting in death or serious injury. Remove any oil or grease from the wheel bolts or wheel nuts.

#### ■ Use of defective wheels prohibited

Do not use cracked or deformed wheels.

Doing so could cause the tire to leak air during driving, possibly causing an accident.



## NOTICE

### Replacing tire pressure warning valves and transmitters

- Because tire repair or replacement may affect the tire pressure warning valves and transmitters, make sure to have tires serviced by your Toyota dealer or other qualified service shop. In addition, make sure to purchase your tire pressure warning valves and transmitters at your Toyota dealer.
- Ensure that only genuine Toyota wheels are used on your vehicle. Tire pressure warning valves and transmitters may not work properly with non-genuine wheels.

### Aluminum wheel precautions (if equipped)

- Use only Toyota wheel nuts and wrenches designed for use with your aluminum wheels.
- When rotating, repairing or changing your tires, check that the wheel nuts are still tight after driving 1000 miles (1600 km).
- Be careful not to damage the aluminum wheels when using tire chains.
- Use only Toyota genuine balance weights or equivalent and a plastic or rubber hammer when balancing your wheels.

### Air conditioning filter

The air conditioning filter must be changed regularly to maintain air conditioning efficiency.

### Removal method

- 1 Turn the power switch off.
- 2 Open the glove box and remove the separate tray. (→P.487)
- 3 Remove the panel.

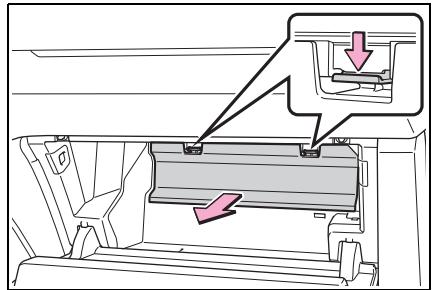

- 4 Unlock the filter cover (A), pull the filter cover out of the claws (B), and remove the filter cover.

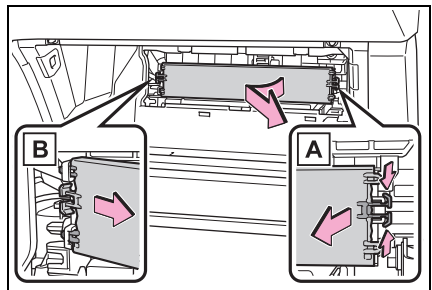

### 5 Remove the filter case.

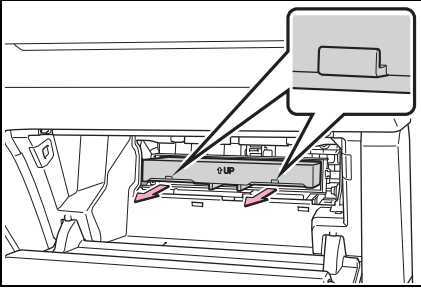

### 6 Remove the air conditioning filter from the filter case and replace it with a new one.

The “↑ UP” marks shown on the filter and the filter case should be pointing up.

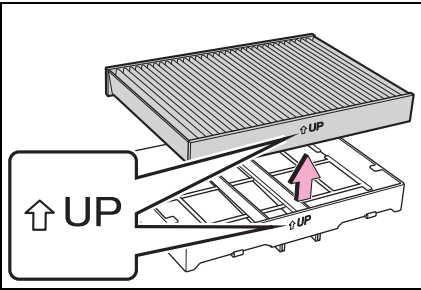

#### ■ Checking interval

Inspect and replace the air conditioning filter according to the maintenance schedule. In dusty areas or areas with heavy traffic flow, early replacement may be required. (For scheduled maintenance information, please refer to the “Owner’s Manual Supplement” or “Scheduled Maintenance”.)

#### ■ If air flow from the vents decreases dramatically

The filter may be clogged. Check the filter and replace if necessary.

#### ⚠ NOTICE

##### ■ When using the air conditioning system

Make sure that a filter is always installed. Using the air conditioning system without a filter may cause damage to the system.

##### ■ To prevent damage to the filter cover

When moving the filter cover in the direction of arrow to release the fitting, pay attention not to apply excessive force to the claws. Otherwise, the claws may be damaged.

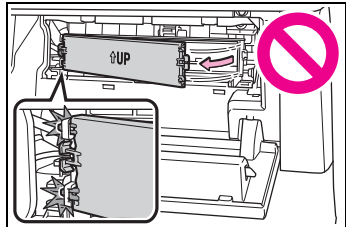

## Cleaning the hybrid battery (traction battery) air intake vents

To prevent the fuel economy from being affected, visually inspect the hybrid battery (traction battery) air intake vents periodically for dust and clogs.

If it is dusty or clogged or if “Maintenance Required for Traction Battery Cooling Parts See Owner’s Manual” is displayed on the multi-information display, clean the air intake vent using the following procedures:

### ■ Scheduled maintenance of the air intake vent is necessary when

In some situations such as when the vehicle is used frequently or in heavy traffic or dusty areas, the air intake vent may need to be cleaned more regularly. For details, refer to the “Warranty and Service Guide”, “Owner’s Manual Supplement” or “Scheduled Maintenance”.

### ■ Cleaning the air intake vent

Improper handling of the air intake vent cover and filter may result in damage to them. If you have any concerns about cleaning the filter, contact your Toyota dealer.

### ⚠ NOTICE

- If “Maintenance Required for Traction Battery Cooling Parts See Owner’s Manual” is displayed on the multi-information display

Clean the air intake vent immediately. If the vehicle is continuously driven with the warning message displayed, it may cause a malfunction or output restriction of the hybrid battery (traction battery).

## Cleaning procedure

- 1 Turn the power switch off.
- 2 Remove the rear side trim part.

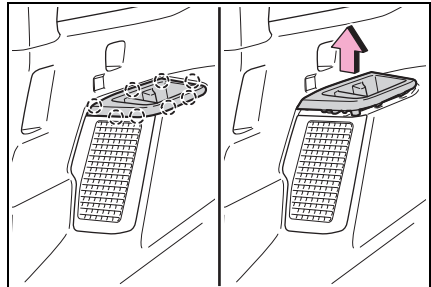

Disengage the 8 claws of the trim part and remove the trim part.

- 3 Remove the air intake vent cover.

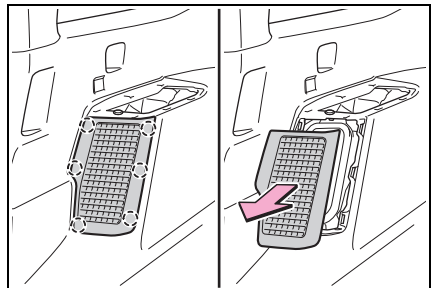

Disengage the 6 claws of the cover and remove the cover.



- 4 Remove the filter from the air intake vent cover.

If dust has accumulated on the air intake vent cover, remove the dust with a vacuum cleaner, etc.

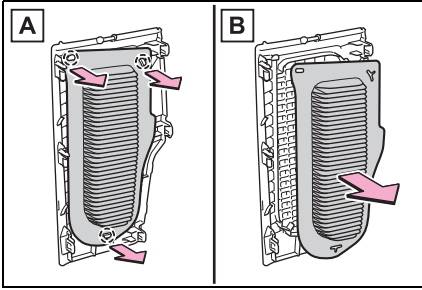

- A** Disengage the 3 claws as shown in the illustration.  
**B** Remove the filter from the cover.

- 5 Remove the dust and sand from the filter.

Using a vacuum cleaner, etc., absorb dust and sand from the filter by profiling the nozzle lightly along the fold.

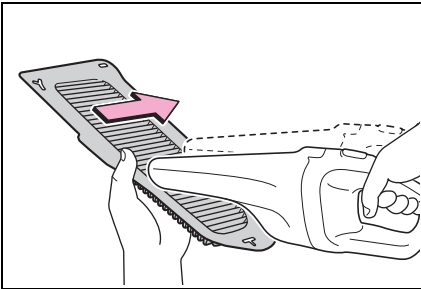

- 6 Hold the filter to the light and check if it is not clogged.

If the dust or sand cannot be removed completely, contact your

Toyota dealer.

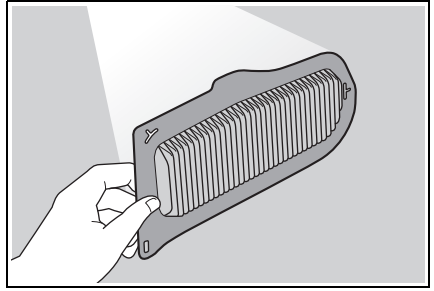

- 7 Reinstall the filter to the cover.

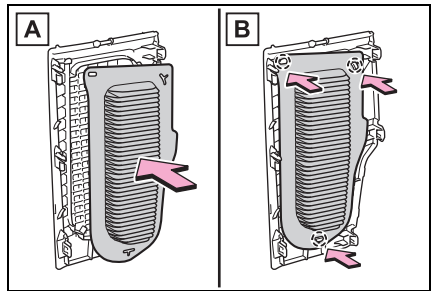

- A** Install the filter to the cover.  
**B** Engage the filter to the 3 claws as shown in the illustration.

Make sure that the filter is not crooked or deformed when installing it.

- 8 Install the air intake vent cover and then install the rear side trim part.

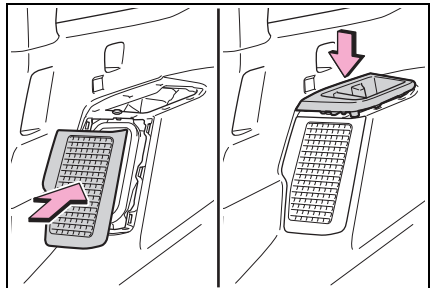

- ▶ If “Maintenance Required for Traction Battery Cooling Parts See Owner’s Manual” was displayed on the multi-information display
- 9 Start the hybrid system and check that the warning message is no longer displayed.

It may be necessary to drive the vehicle for approximately 20 minutes before the warning message is displayed again then disappears.

If the warning message does not disappear after some time, have the vehicle inspected by your Toyota dealer.

#### ■ If the dust or sand on the filter cannot be removed

It is recommended to use a vacuum cleaner with plastic brushes.



#### WARNING

##### ■ When cleaning the air intake vent

- Do not use water or other liquids to clean the air intake vent. If water is applied to the hybrid battery (traction battery) or other components, a malfunction or fire may occur.
- Before cleaning the air intake vents, make sure to turn the power switch off to stop the hybrid system.
- Do not put a hand or leg in the air intake vent. If it is caught in a cooling fan, or if it touches a high voltage part that results in an electric shock, death or serious injuries may result.



#### NOTICE

##### ■ When cleaning the air intake vent

Do not use an air blow gun, etc. Dust may be blown out, possibly causing a malfunction or output restriction of the hybrid battery (traction battery).

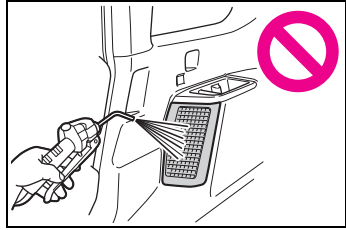

##### ■ To prevent damage to the vehicle

Observe the following precautions:

- Do not allow liquid or foreign matter to enter the air intake vent.
- Make sure to reinstall the filter and cover to their original positions after cleaning.
- Do not install anything to the air intake vent other than the exclusive filter for this vehicle or use the vehicle without the filter installed.

##### ■ To prevent damage to the filter

Observe the following precautions.

If the filter is damaged, have it replaced with a new filter by your Toyota dealer.

- Do not use an air blow gun, etc.
- Do not press hard a vacuum cleaner, etc. against the filter.
- Do not use a hard brush, such as a metal brush.

**NOTICE**

- Do not break the fold of the filter.

**Electronic key battery**

**Replace the battery with a new one if it is depleted. As the key may be damaged if the following procedure is not performed properly, it is recommended that key battery replacement be performed by your Toyota dealer.**

**■ If the electronic key battery is depleted**

The following symptoms may occur:

- The smart key system and wireless remote control will not function properly.
- The operational range will be reduced.

**Items to prepare**

Prepare the following before replacing the battery:

- Flathead screwdriver
- Small flathead screwdriver
- Lithium battery CR2450

**■ Use a CR2450 lithium battery**

- Batteries can be purchased at your Toyota dealer, local electrical appliance shops or camera stores.
- Replace only with the same or equivalent type recommended by the manufacturer.
- Dispose of used batteries according to the local laws.

## Replacing the battery

- 1 Release the lock and remove the mechanical key.

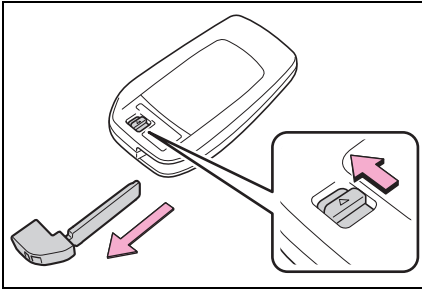

- 2 Remove the cover.

To prevent damage to the key, cover the tip of the flathead screwdriver with a rag.

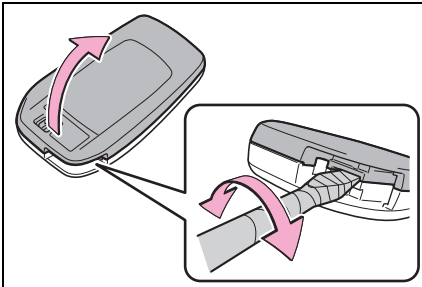

- 3 Remove the depleted battery using a small flathead screwdriver.

When removing the cover, the electronic key module may stick to the cover and the battery may not be visible. In this case, remove the electronic key module in order to remove the battery.

Insert a new battery with the "+" ter-

minal facing up.

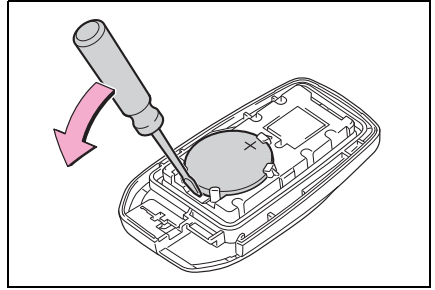

- 4 When installing, reverse the steps listed.

### ⚠ WARNING

#### ■ Battery precautions

Observe the following precautions. Failure to do so may result in death or serious injury.

- Do not swallow the battery. Doing so may cause chemical burns.
- A coin battery or button battery is used in the electronic key. If a battery is swallowed, it may cause severe chemical burns in as little as 2 hours and may result in death or serious injury.
- Keep away new and removed batteries from children.
- If the cover cannot be firmly closed, stop using the electronic key and stow the key in the place where children cannot reach, and then contact your Toyota dealer.
- If you accidentally swallow a battery or put a battery into a part of your body, get emergency medical attention immediately.

### WARNING

#### ■ To prevent battery explosion or leakage of flammable liquid or gas

- Replace the battery with a new battery of the same type. If a wrong type of battery is used, it may explode.
- Do not expose batteries to extremely low pressure due to high altitude or extremely high temperatures.
- Do not burn, break or cut a battery.

### NOTICE

#### ■ When replacing the battery

Use a flathead screwdriver of appropriate size. Applying excessive force may deform or damage the cover.

#### ■ For normal operation after replacing the battery

Observe the following precautions to prevent accidents:

- Always work with dry hands. Moisture may cause the battery to rust.
- Do not touch or move any other component inside the remote control.
- Do not bend either of the battery terminals.

## Checking and replacing fuses

If any of the electrical components do not operate, a fuse may have blown. If this happens, check and replace the fuses as necessary.

## Checking and replacing fuses

- 1 Turn the power switch off.
- 2 Open the fuse box cover.
  - ▶ Engine compartment

Type A:

Push the tab in and lift the lid off.

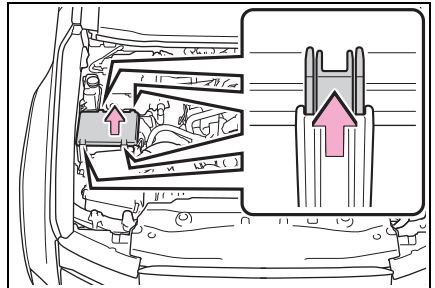

Type B:

Push the tab in and lift the lid off.

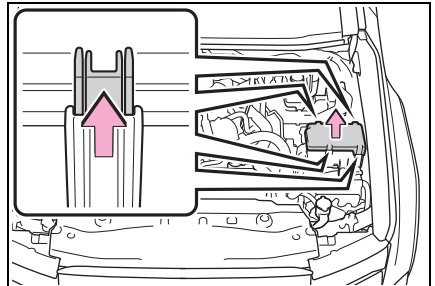

► Instrument panel

Remove the cover **A** and then remove the footwell light connector **B** (if equipped).

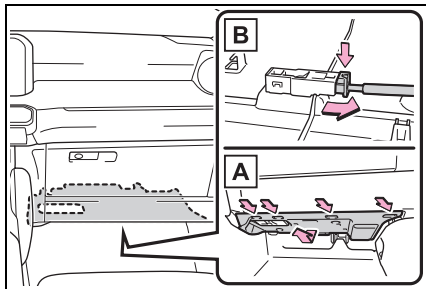

Remove the lid.

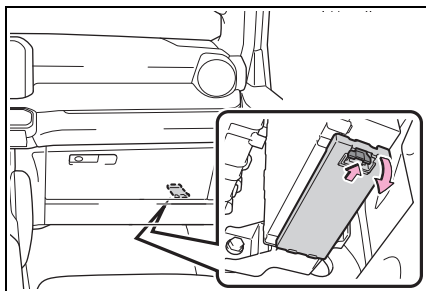

3 Remove the fuse with the pullout tool.

Only type A fuse can be removed using the pullout tool.

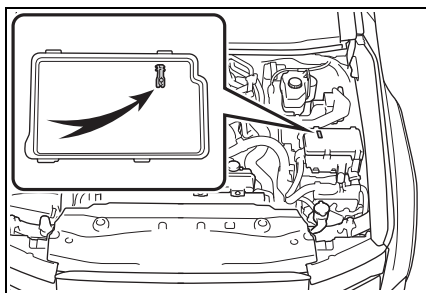

4 Check if the fuse is blown.

Type A and B:  
Replace the blown fuse with a new fuse of an appropriate amperage rating. The amperage rating can be

found on the fuse box lid.

Type C and D:  
Contact your Toyota dealer.

► Type A

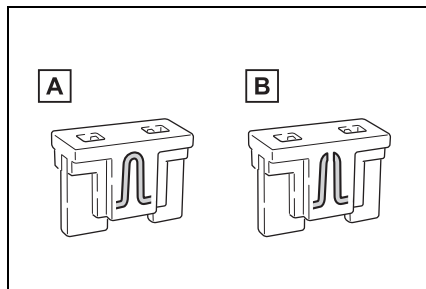

**A** Normal fuse

**B** Blown fuse

► Type B

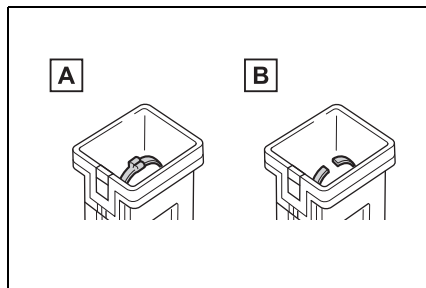

**A** Normal fuse

**B** Blown fuse

► Type C

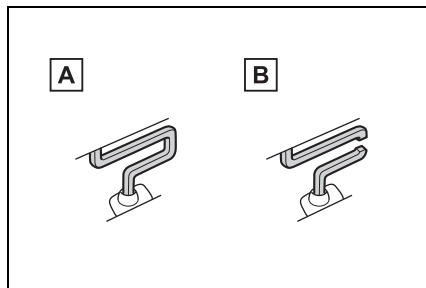

**A** Normal fuse

**B** Blown fuse

## ► Type D

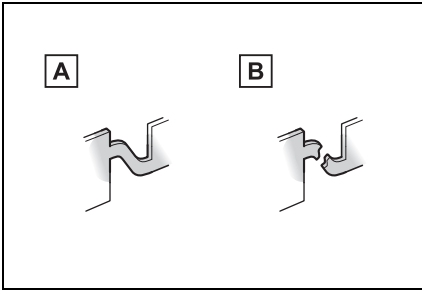
**A** Normal fuse**B** Blown fuse**■ After a fuse is replaced**

- When installing the lid, make sure that the tab is installed securely.
- If the lights do not turn on even after the fuse has been replaced, a bulb may need replacement. (→P.577)
- If the replaced fuse blows again, have the vehicle inspected by your Toyota dealer.

**■ If there is an overload in a circuit**

The fuses are designed to blow, protecting the wiring harness from damage.

**■ When replacing an electronic component, such as a lights, etc.**

Toyota recommends that you use genuine Toyota products designed for this vehicle. Because certain bulbs are connected to circuits designed to prevent overload, non-genuine parts or parts not designed for this vehicle may be unusable.

**⚠ WARNING****■ To prevent system breakdowns and vehicle fire**

Observe the following precautions.

Failure to do so may cause damage to the vehicle, and possibly a fire or injury.

- Never use a fuse of a higher amperage rating than that indicated, or use any other object in place of a fuse.
- Always use a genuine Toyota fuse or equivalent. Never replace a fuse with a wire, even as a temporary fix.
- Do not modify the fuses or fuse boxes.

**■ Fuse box near the power control unit**

Never check or replace the fuses as there are high voltage parts and wiring near the fuse box.

Doing so may cause electric shock, resulting in death or serious injury.

**⚠ NOTICE****■ Before replacing fuses**

Have the cause of electrical overload determined and repaired by your Toyota dealer as soon as possible.

## Headlight aim

### Vertical movement adjusting bolts

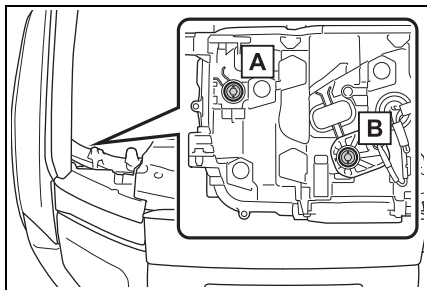

**A** Adjustment bolt A

**B** Adjustment bolt B

### Before checking the headlight aim

- Make sure the vehicle has a full tank of gasoline and the area around the headlight is not deformed.
- Park the vehicle on level ground.
- Make sure the tire inflation pressure is at the specified level.
- Have someone sit in the driver's seat.
- Bounce the vehicle several times.

### Adjusting the headlight aim

- 1 Using a Phillips-head screwdriver, turn bolt A in either direction.  
Remember the turning direction and the number of turns.

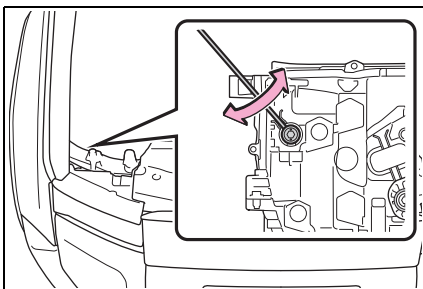

- 2 Turn bolt B the same number of turns and in the same direction as step 1.

If the headlight cannot be adjusted using this procedure, take the vehicle to your Toyota dealer to adjust the headlight aim.

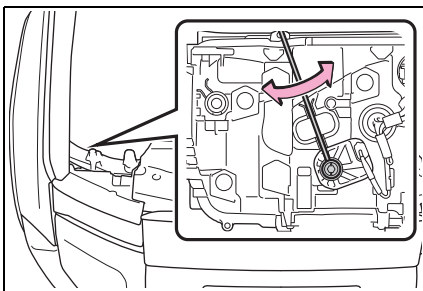



## Light bulbs

**If any lights burn out, have it replaced by your Toyota dealer.**

### ■ LED lights

The lights consist of a number of LEDs. If any of the LEDs burn out, take your vehicle to your Toyota dealer to have the light replaced.

### ■ Condensation build-up on the inside of the lens

Temporary condensation build-up on the inside of the light lens does not indicate a malfunction. Contact your Toyota dealer for more information in the following situations:

- Large drops of water have built up on the inside of the lens.
- Water has built up inside the light.



## When trouble arises

# 7

### 7-1. Essential information

Emergency flashers .... 580

If your vehicle has to be stopped in an emergency  
..... 581

If the vehicle is submerged or water on the road is rising ..... 582

### 7-2. Steps to take in an emergency

If your vehicle needs to be towed..... 583

If you think something is wrong ..... 586

If a warning light turns on or a warning buzzer sounds  
..... 587

If a warning message is displayed..... 598

If you have a flat tire.... 606

If the hybrid system will not start ..... 616

If you lose your keys ... 617

If the electronic key does not operate properly.. 618

If the 12-volt battery is discharged ..... 620

If your vehicle overheats  
..... 625

If the vehicle becomes stuck..... 627

## Emergency flashers

The emergency flashers are used to warn other drivers when the vehicle has to be stopped in the road due to a breakdown, etc.

### Operating instructions

Press the switch.

All the turn signal lights will flash.

To turn them off, press the switch once again.

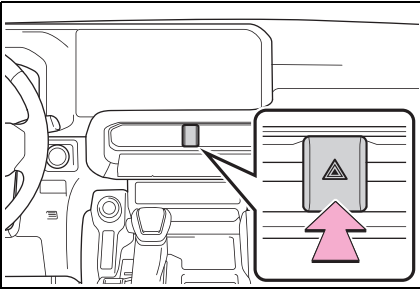

### Emergency flashers

- If the emergency flashers are used for a long time while the hybrid system is not operating (while the "READY" indicator is not illuminated), the 12-volt battery may discharge.
- If any of the SRS airbags deploy (inflate) or in the event of a strong rear impact, the emergency flashers will turn on automatically. The emergency flashers will turn off automatically after operating for approximately 20 minutes. To manually turn the emergency flashers off, press the switch twice. (The emergency flashers may not turn on automatically depending on the force of the impact and conditions of the colli-

sion.)

## If your vehicle has to be stopped in an emergency

Only in an emergency, such as if it becomes impossible to stop the vehicle in the normal way, stop the vehicle using the following procedure:

### Stopping the vehicle

- 1 Steadily step on the brake pedal with both feet and firmly depress it.  
Do not pump the brake pedal repeatedly as this will increase the effort required to slow the vehicle.
- 2 Shift the shift lever to N.
  - ▶ If the shift lever is shifted to N
- 3 After slowing down, stop the vehicle in a safe place by the road.
- 4 Stop the hybrid system.
  - ▶ If the shift lever cannot be shifted to N
- 3 Keep depressing the brake pedal with both feet to reduce vehicle speed as much as possible.
- 4 To stop the hybrid system, press and hold the power switch for 2 consecutive seconds or more, or press it

briefly 3 times or more in succession.

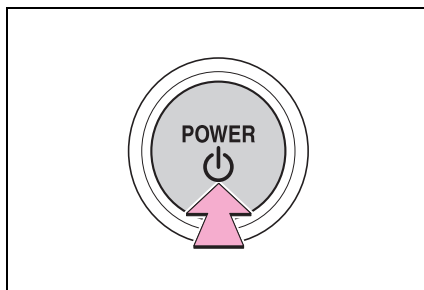

- 5 Stop the vehicle in a safe place by the road.

#### ■ If emergency stopped

The functions of the air conditioning, etc. may be partially limited in order to reduce the power consumption of the 12-volt battery.

#### ▲ WARNING

##### ■ If the hybrid system has to be turned off while driving

Turning the hybrid system off while driving will not cause loss of steering or braking control. However, power assist for the steering wheel may be lost making it difficult to steer smoothly before stopping the vehicle depending on the remaining charge in the 12-volt battery or usage conditions. Decelerate as much as possible before turning off the hybrid system.

## If the vehicle is submerged or water on the road is rising

**This vehicle is not designed to be able to drive on roads that are deeply flooded with water. Do not drive on roads where the roads may be submerged or the water may be rising. It is dangerous to remain in the vehicle, if it is anticipated that the vehicle will be flooded or set adrift. Remain calm and follow the following.**

- If the door can be opened, open the door and exit the vehicle.
- If the door cannot be opened, open the window using the power window switch and ensure an escape route.
- If the window can be opened, exit the vehicle through the window.
- If the door and window cannot be opened due to the rising water, remain calm, wait until the water level inside the vehicle rises to the point that the water pressure inside of the vehicle equals the water pressure outside of the vehicle and then open the door after waiting for the rising water to enter the vehicle, and exit the vehicle.

When the outside water level exceeds half the height of the door, the door cannot be opened from the inside due to water pressure.

### ■ Water level exceeds the floor

When the water level exceeds the floor and time has passed, the electrical equipment will get damaged, the power windows will not operate, the engine and motor will stop, and the vehicle may not be able to get moving.

### ■ Using an emergency escape hammer\*

Laminated glass is used in the windshield on this vehicle. Laminated glass cannot be shattered with an emergency hammer\*. Tempered glass is used in the windows on this vehicle.

\*: Contact your Toyota dealer or aftermarket accessory manufacturer for further information about an emergency hammer.



## WARNING

### ■ Caution while driving

Do not drive on roads where the roads may be submerged or the water may be rising. Otherwise the vehicle may be damaged and cannot move, as well as become flooded and set adrift, which may lead to death.

## If your vehicle needs to be towed

If towing is necessary, we recommend having your vehicle towed by your Toyota dealer or commercial towing service, using a wheel-lift type truck or flat-bed truck.

Use a safety chain system for all towing, and abide by all state/provincial and local laws.

## Situations when it is necessary to contact dealers before towing

The following may indicate a problem with your transmission. Contact your Toyota dealer or commercial towing service before towing.

- The hybrid system warning message is shown on the multi-information display and the vehicle does not move.
- The vehicle makes an abnormal sound.

## Towing with a wheel-lift type truck

- ▶ From the front

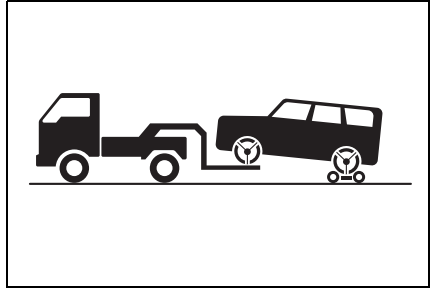

Use a towing dolly under the rear wheels.

- ▶ From the rear

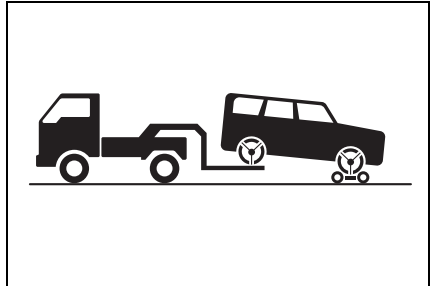

Use a towing dolly under the front wheels.

### **!** WARNING

Observe the following precautions.

Failure to do so may result in death or serious injury.

**WARNING****When towing the vehicle**

Be sure to transport the vehicle with all four wheels raised off the ground. If the vehicle is towed with the tires contacting the ground, the drivetrain or related parts may be damaged, the vehicle may fly off the truck, or electricity generated by the operation of the motor may cause a fire to occur depending on the nature of the damage or malfunction.

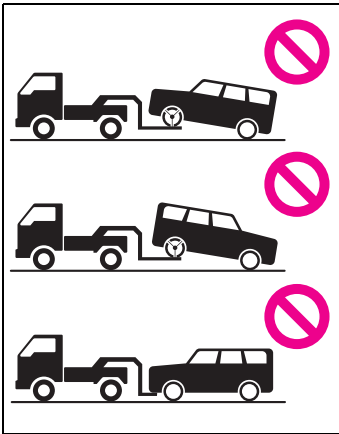
**NOTICE****To prevent damage to the vehicle when towing using a wheel-lift type truck**

When raising the vehicle, ensure adequate ground clearance for towing at the opposite end of the raised vehicle. Without adequate clearance, the vehicle could be damaged while being towed.

**Towing with a sling-type truck**

Do not tow with a sling-type truck to prevent body damage.

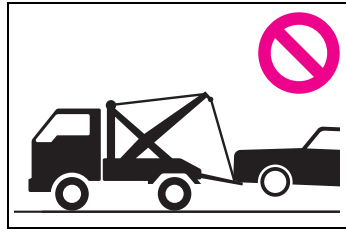
**Using a flatbed truck**

When using a flat-bed truck to transport the vehicle, use tire strapping belts. Refer to the owner's manual of the flat-bed truck for the tire strapping method.

In order to suppress vehicle movement during transportation, set the parking brake and turn the power switch off.

**Emergency towing**

If a tow truck is not available in an emergency, your vehicle may be temporarily towed using cables or chains secured to the emergency towing hooks. This should only be attempted on hard surfaced roads for short distances at under 18 mph (30 km/h).

A driver must be in the vehicle to steer and operate the brakes. The vehicle's wheels, drive train, axles, steering and brakes



must be in good condition.

## Emergency towing procedure

- 1 Securely attach cables or chains to the towing hooks.

Take care not to damage the vehicle body.

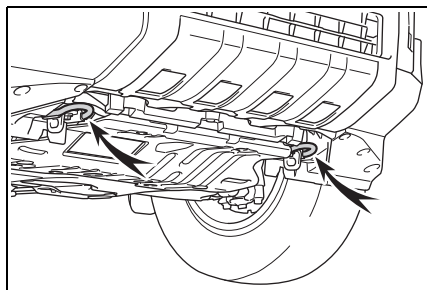

- 2 Enter the vehicle being towed and start the hybrid system.

If the hybrid system does not start, turn the power switch to ON.

- 3 Put the four-wheel drive control switch in "H4" and unlock the center and rear\* differential.

\*: If equipped

- 4 Shift the shift lever to N and release the parking brake.

Turn automatic mode off. (→P.234)

When the shift lever cannot be shifted: →P.229

### While towing

If the hybrid system is off, the power assist for the brakes and steering will not function, making steering and braking more difficult.

### WARNING

Observe the following precautions. Failure to do so may result in death or serious injury.

#### ■ While towing

When towing using cables or chains, avoid sudden starts, etc. which place excessive stress on the towing hooks, cables or chains. The towing hooks, cables or chains may become damaged, broken debris may hit people, and cause serious damage.

### NOTICE

#### ■ To prevent damage to the vehicle during emergency towing

Do not secure cables or chains to the suspension components.

## If you think something is wrong

**If you notice any of the following symptoms, your vehicle probably needs adjustment or repair. Contact your Toyota dealer as soon as possible.**

### Visible symptoms

- Fluid leaks under the vehicle (Water dripping from the air conditioning after use is normal.)
- Flat-looking tires or uneven tire wear
- Engine coolant temperature gauge needle continually points higher than normal.
- Engine oil pressure gauge continually points lower than normal.
- Voltmeter continually points higher or lower than normal.

### Audible symptoms

- Changes in exhaust sound
- Excessive tire squeal when cornering
- Strange noises related to the suspension system
- Pinging or other noises related to the engine

### Operational symptoms



- Engine missing, stumbling or running roughly
- Appreciable loss of power
- Vehicle pulls heavily to one side when braking
- Vehicle pulls heavily to one side when driving on a level road
- Loss of brake effectiveness, spongy feeling, pedal almost touches the floor

If a warning light turns on or a warning buzzer sounds

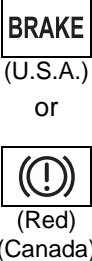

Calmly perform the following actions if any of the warning lights comes on or flashes. If a light comes on or flashes, but then goes off, this does not necessarily indicate a malfunction in the system. However, if this continues to occur, have the vehicle inspected by your Toyota dealer.

## Actions to the warning lights or warning buzzers



### ■ Brake system warning light (warning buzzer)

Warning light	Details/Actions
 <p><b>BRAKE</b> (U.S.A.) or  (Red) (Canada)</p>	<p>Indicates that:</p> <ul style="list-style-type: none"> <li>● The brake fluid level is low; or</li> <li>● The brake system is malfunctioning</li> </ul> <p>→ <b>Immediately stop the vehicle in a safe place and contact your Toyota dealer. Continuing to drive the vehicle may be dangerous.</b></p>

### ■ Brake system warning light (warning buzzer)

Warning light	Details/Actions
 <p> (Yellow)</p>	<p>Indicates a malfunction in:</p> <ul style="list-style-type: none"> <li>● The parking brake system; or</li> <li>● The electronically controlled brake system</li> </ul> <p>→ <b>Have the vehicle inspected by your Toyota dealer immediately.</b></p>

### ■ Charging system warning light\* (warning buzzer)

Warning light	Details/Actions
 <p></p>	<p>Indicates a malfunction in the vehicle's charging system</p> <p>→ <b>Immediately stop the vehicle in a safe place and contact your Toyota dealer.</b></p>

\*: This light illuminates on the multi-information display with a message.

### ■ Low engine oil pressure warning light\* (warning buzzer)

Warning light	Details/Actions
	Indicates that the engine oil pressure is too low → <b>Immediately stop the vehicle in a safe place and contact your Toyota dealer.</b>



\*: This light illuminates on the multi-information display with a message.

### ■ High coolant temperature warning light\* (warning buzzer)

Warning light	Details/Actions
	Indicates that the engine is overheating → <b>Immediately stop the vehicle in a safe place.</b> <b>Handling method (→P.625)</b>

\*: This light illuminates on the multi-information display with a message.

### ■ Malfunction indicator lamp

Warning light	Details/Actions
 (U.S.A.) or  (Canada)	Indicates a malfunction in: <ul style="list-style-type: none"> <li>● The hybrid system;</li> <li>● The electronic engine control system;</li> <li>● The electronic throttle control system;</li> </ul> → <b>Have the vehicle inspected by your Toyota dealer immediately.</b>

### ■ SRS warning light



Warning light	Details/Actions
	Indicates a malfunction in: <ul style="list-style-type: none"> <li>● The SRS airbag system; or</li> <li>● The seat belt pretensioner system</li> </ul> → <b>Have the vehicle inspected by your Toyota dealer immediately.</b>

This warning light indicates problems with the following:



- Airbag sensor assembly
- Front impact sensors
- Side impact sensors (front door)

- Side impact sensors (rear)
- Safing sensor (rear)
- Front passenger occupant classification sensors
- Driver's seat position sensor
- Driver's seat belt buckle switch
- Front passenger's seat belt buckle switch
- SRS warning light
- "AIR BAG ON" indicator light
- "AIR BAG OFF" indicator light
- Driver's seat belt pretensioner, front passenger's seat belt pretensioner and force limiter
- SRS airbags
- SRS system related wiring harnesses and power sources

### ■ ABS warning light

Warning light	Details/Actions
<div style="text-align: center;">             (U.S.A.)            or              (Canada)         </div>	<p>Indicates a malfunction in:</p> <ul style="list-style-type: none"> <li>● The ABS; or</li> <li>● The brake assist system</li> </ul> <p>→ <b>Have the vehicle inspected by your Toyota dealer immediately.</b></p>

### ■ Power steering system warning light

Warning light	Details/Actions
<div style="text-align: center;">             (Red)              (Yellow)         </div>	<p>Indicates a malfunction in the power steering system</p> <p>→ <b>Have the vehicle inspected by your Toyota dealer immediately.</b></p>

### ■ PCS warning light (warning buzzer)

Warning light	Details/Actions
	<p>Indicates a malfunction in the PCS (Pre-Collision System).</p> <p>→ <b>Follow the instructions displayed on the multi-information display.</b></p> <p>If the PCS (Pre-Collision System) or VSC (Vehicle Stability Control) system is disabled, the PCS warning light will illuminate.</p>

### ■ LTA indicator (warning buzzer)

Warning light	Details/Actions
	<p>Indicates a malfunction in the LTA (Lane Tracing Assist)</p> <p>→ <b>Follow the instructions displayed on the multi-information display.</b></p>

### ■ LDA indicator (warning buzzer)

Warning light	Details/Actions
	<p>Indicates a malfunction in the LDA (Lane Departure Alert)</p> <p>→ <b>Follow the instructions displayed on the multi-information display.</b></p>

### ■ PDA indicator (warning buzzer)

Warning light	Details/Actions
	<p>Indicates a malfunction in the PDA (Proactive Driving Assist).</p> <p>→ <b>Follow the instructions displayed on the multi-information display.</b></p>

### ■ Cruise control indicator (warning buzzer)

Warning light	Details/Actions
	<p>Indicates a malfunction in the cruise control system.</p> <p>→ <b>Follow the instructions displayed on the multi-information display.</b></p>

### ■ Dynamic radar cruise control indicator (warning buzzer)

Warning light	Details/Actions
 <p>(Yellow)</p>	<p>Indicates a malfunction in the dynamic radar cruise control system.</p> <p>→ <b>Follow the instructions displayed on the multi-information display.</b></p>

### ■ Driving assist information indicator

Warning light	Details/Actions
	<p>Indicates one of the following systems is malfunctioning.</p> <ul style="list-style-type: none"> <li>● PCS (Pre-Collision System)</li> <li>● LDA (Lane Departure Alert)</li> </ul> <p>→ <b>Follow the instructions displayed on the multi-information display.</b></p> <p>Indicates one of the following systems is malfunctioning or disabled.</p> <ul style="list-style-type: none"> <li>● PKSB (Parking Support Brake)</li> <li>● RCD (Rear Camera Detection) (if equipped)</li> <li>● BSM (Blind Spot Monitor)</li> <li>● RCTA (Rear cross traffic alert)</li> <li>● Safe Exit Assist</li> </ul> <p>→ <b>Follow the instructions displayed on the multi-information display.</b></p>

### ■ Intuitive parking assist OFF indicator (warning buzzer)

Warning light	Details/Actions
	<p>Indicates a malfunction in the intuitive parking assist function</p> <p>→ <b>Have the vehicle inspected by your Toyota dealer immediately.</b></p> <p>Indicates that the system is temporarily unavailable, possibly due to a sensor being dirty or covered with ice, etc.</p> <p>→ <b>Follow the instructions displayed on the multi-information display. (→P.598)</b></p>

### ■ Inappropriate pedal operation warning light\* (warning buzzer)

Warning light	Details/Actions
	<p><b>When a buzzer sounds:</b></p> <ul style="list-style-type: none"> <li>● Brake Override System is malfunctioning</li> <li>● Drive-Start Control is malfunctioning</li> <li>● Drive-Start Control is operating</li> </ul> <p>→ <b>Follow the instructions displayed on the multi-information display.</b></p> <p>When a buzzer does not sound: Brake Override System is operating.</p> <p>→ <b>Release the accelerator pedal and depress the brake pedal.</b></p>

\*: This light illuminates on the multi-information display with a message.

### ■ Slip indicator light

Warning light	Details/Actions
	<p>Indicates a malfunction in:</p> <ul style="list-style-type: none"> <li>● The VSC system;</li> <li>● The Trailer Sway Control system (If equipped);</li> <li>● The Active TRAC system;</li> <li>● The hill-start assist control system;</li> <li>● The downhill assist control system (if equipped)</li> <li>● The Multi-terrain Select (If equipped); or</li> <li>● The Crawl Control (If equipped)</li> </ul> <p>→ <b>Have the vehicle inspected by your Toyota dealer immediately.</b></p>

### ■ Trailer brake warning light

Warning light	Details/Actions
	<p>Indicates a malfunction in:</p> <ul style="list-style-type: none"> <li>● The Trailer brake control system; or</li> <li>● The Trailer connector circuit</li> </ul> <p>→ <b>Have the vehicle inspected by your Toyota dealer immediately.</b></p>



### ■ Low speed four-wheel drive indicator light

Warning light	Details/Actions
 (Flashes)	Indicates a malfunction in the four-wheel drive system when the light flashes rapidly. → <b>Have the vehicle inspected by your Toyota dealer immediately.</b>



### ■ Center differential lock indicator

Warning light	Details/Actions
 (Flashes)	Indicates a malfunction in the center differential lock system when the light flashes rapidly. → <b>Have the vehicle inspected by your Toyota dealer immediately.</b>

### ■ Rear differential lock indicator

Warning light	Details/Actions
 (Flashes) (If equipped)	Indicates a malfunction in the rear differential lock system when the light flashes rapidly. → <b>Have the vehicle inspected by your Toyota dealer immediately.</b>

### ■ Parking brake indicator

Warning light	Details/Actions
 (Flashes) (U.S.A.) or  (Flashes) (Canada)	It is possible that the parking brake is not fully engaged or released → <b>Operate the parking brake switch once again.</b>  This light comes on when the parking brake is not released. If the light turns off after the parking brake is fully released, the system is operating normally.

### ■ Brake hold operated indicator (warning buzzer)

Warning light	Details/Actions
 (Flashes)	Indicates a malfunction in the brake hold system → <b>Have the vehicle inspected by your Toyota dealer immediately.</b>

### ■ Low fuel level warning light

Warning light	Details/Actions
	Indicates that remaining fuel is approximately 2.7 gal. (10.2 L, 2.2 Imp.gal.) or less → <b>Refuel the vehicle.</b>

### ■ Tire pressure warning light (warning buzzer)

Warning light	Details/Actions
	When the light comes on after blinking for approximately 1 minute (a buzzer does not sound): Malfunction in the tire pressure warning system → <b>Have the system checked by your Toyota dealer.</b> When the light comes on (a buzzer sounds): ● Low tire inflation pressure from natural causes → <b>After the temperature of the tires has lowered sufficiently, check the inflation pressure of each tire and adjust them to the specified level.</b> ● Low tire inflation pressure from flat tire → <b>Immediately stop the vehicle in a safe place and perform the necessary actions.</b>

### ■ Driver's and front passenger's seat belt reminder light (warning buzzer)\*

Warning light	Details/Actions
	Warns the driver and/or front passenger to fasten their seat belts → <b>Fasten the seat belt.</b> <b>If the front passenger's seat is occupied, the front passenger's seat belt also needs to be fastened to make the warning light (warning buzzer) turn off.</b>

\*: Driver's seat belt warning buzzer:

The driver's seat belt warning buzzer sounds to alert the driver that his or her seat belt is not fastened. Once the power switch is turned to ON, the buzzer sounds. If the seat belt is still unfastened, the buzzer sounds intermittently for a certain period of time after the vehicle reaches a certain

speed.

Front passenger's seat belt warning buzzer:

The front passenger's seat belt warning buzzer sounds to alert the front passenger that his or her seat belt is not fastened. If the seat belt is unfastened, the buzzer sounds intermittently for a certain period of time after the vehicle reaches a certain speed.

### ■ Rear passengers' seat belt reminder light (warning buzzer)\*

Warning light	Details/Actions
 <p>(If equipped)</p>	<p>Warns the rear passengers to fasten their seat belts</p> <p>→ <b>Fasten the seat belt.</b></p>

\*: Rear passengers' seat belt warning buzzer:

The rear passengers' seat belt warning buzzer sounds to alert the rear passenger that his or her seat belt is not fastened. If the seat belt is unfastened, the buzzer sounds intermittently for a certain period of time, after the seat belt is fastened and unfastened and the vehicle reaches a certain speed.

### ■ Warning buzzer

In some cases, the buzzer may not be heard because of noisy place or an audio sound.

### ■ Front passenger detection sensor, seat belt reminder and warning buzzer

- If luggage is placed on the front passenger seat, the front passenger detection sensor may cause the warning light to flash and the warning buzzer to sound even if a passenger is not sitting in the seat.
- If a cushion is placed on the seat, the sensor may not detect a passenger, and the warning light may not operate properly.

### ■ If the malfunction indicator lamp comes on while driving

First check the following:

- Is the fuel tank empty?

If it is, fill the fuel tank immediately.

- Is the fuel tank cap loose?

If it is, tighten it securely.

The light will go off after several driving trips.

If the light does not go off even after several trips, contact your Toyota dealer as soon as possible.

### ■ Electric power steering system warning light (warning buzzer)

When the 12-volt battery charge becomes insufficient or the voltage temporarily drops, the electric power steering system warning light may come on and the warning buzzer may sound.

### ■ When the tire pressure warning light comes on

Inspect the tires to check if a tire is punctured.

If a tire is punctured: →P.606

If none of the tires are punctured:

Turn the power switch to OFF then turn it to ON. Check if the tire pressure warning light comes on or blinks.

- ▶ If the tire pressure warning light blinks for approximately 1 minute then stays on

There may be a malfunction in the tire pressure warning system. Have the vehicle inspected by your Toyota dealer immediately.

- ▶ If the tire pressure warning light comes on
  - 1 After the temperature of the tires has lowered sufficiently, check the inflation pressure of each tire and adjust them to the specified level.
  - 2 If the warning light does not turn off even after several minutes have elapsed, check that the inflation pressure of each tire is at the specified level and perform initialization. (→P.557)

#### ■ The tire pressure warning light may come on due to natural causes

The tire pressure warning light may come on due to natural causes such as natural air leaks and tire inflation pressure changes caused by temperature. In this case, adjusting the tire inflation pressure will turn off the warning light (after a few minutes).

#### ■ When a tire is replaced with a spare tire

The spare tire is also equipped with the tire pressure warning valve and transmitter. The tire pressure warning light will turn on if the tire inflation pressure of the spare tire is low. If a tire goes flat, even though the flat tire is replaced with the spare tire, the tire pressure warning light does not turn off. Replace the spare tire with the repaired tire and adjust the proper tire inflation pressure. The tire pressure warning light will turn off after a few minutes.

#### ■ Conditions that the tire pressure warning system may not function properly

→P.557

### WARNING

#### ■ If a warning light comes on or a warning buzzer sounds when a warning message is shown on the multi-information display

Check and follow the message shown on the multi-information display.

Failure to do so may result in death or serious injury.

#### ■ If both the ABS and the brake system warning lights remain on

Stop your vehicle in a safe place immediately and contact your Toyota dealer. The vehicle will become extremely unstable during braking, and the ABS system may fail, which could cause an accident resulting in death or serious injury.

#### ■ When the electric power steering system warning light comes on

When the light comes on yellow, the assist to the power steering is restricted. When the light comes on red, the assist to the power steering is lost and handling operations of the steering wheel become extremely heavy.

If the steering wheel becomes heavier than usual when operating, hold firmly and operate using more force than usual.

#### ■ If the tire pressure warning light comes on

Be sure to observe the following precautions. Failure to do so could cause a loss of vehicle control and result in death or serious injury.

- Stop your vehicle in a safe place as soon as possible. Adjust the tire inflation pressure immediately.

**WARNING**

- If the tire pressure warning light comes on even after tire inflation pressure adjustment, it is probable that you have a flat tire. Check the tires. If a tire is flat, change it with the spare tire and have the flat tire repaired by the nearest Toyota dealer.
- Avoid abrupt maneuvering and braking. If the vehicle tires deteriorate, you could lose control of the steering wheel or the brakes.
- **If a blowout or sudden air leakage should occur (vehicles with tire pressure warning system)**

The tire pressure warning system may not activate immediately.

**■ Maintenance of the tires**

Each tire, including the spare (if provided), should be checked monthly when cold and inflated to the inflation pressure recommended by the vehicle manufacturer on the vehicle placard or tire inflation pressure label (tire and load information label). (If your vehicle has tires of a different size than the size indicated on the vehicle placard or tire inflation pressure label [tire and load information label], you should determine the proper tire inflation pressure for those tires.)

As an added safety feature, your vehicle has been equipped with a tire pressure monitoring system (TPMS-tire pressure warning system) that illuminates a low tire pressure telltale (tire pressure warning light) when one or more of your tires is significantly under-inflated. Accordingly, when the low tire pressure telltale (tire pressure warning light) illuminates, you should stop and check your tires as soon as possible, and inflate them to the proper pressure. Driving on a significantly under-inflated tire causes the tire to overheat and can lead to tire failure. Under-inflation also reduces fuel efficiency and tire tread life, and may affect the vehicle's handling and stopping ability.

Please note that the TPMS (tire pressure warning system) is not a substitute for proper tire maintenance, and it is the driver's responsibility to maintain correct tire pressure, even if under-inflation has not reached the level to trigger illumination of the TPMS low tire pressure telltale (tire pressure warning light).

**WARNING**

Your vehicle has also been equipped with a TPMS (tire pressure warning system) malfunction indicator to indicate when the system is not operating properly. The TPMS (tire pressure warning system) malfunction indicator is combined with the low tire pressure telltale (tire pressure warning light). When the system detects a malfunction, the telltale will flash for approximately one minute and then remain continuously illuminated. This sequence will continue upon subsequent vehicle start-ups as long as the malfunction exists. When the malfunction indicator is illuminated, the system may not be able to detect or signal low tire pressure as intended.

TPMS (tire pressure warning system) malfunctions may occur for a variety of reasons, including the installation of replacement or alternate tires or wheels on the vehicle that prevent the TPMS (tire pressure warning system) from functioning properly. Always check the TPMS (tire pressure warning system) malfunction telltale after replacing one or more tires or wheels on your vehicle to ensure that the replacement or alternate tires and wheels allow the TPMS (tire pressure warning system) to continue to function properly.

**NOTICE**

■ **To ensure the tire pressure warning system operates properly**

Do not install tires with different specifications or manufacturers, as the tire pressure warning system may not operate properly.

## If a warning message is displayed

The multi-information display shows warnings of system malfunctions, incorrectly performed operations, and messages that indicate a need for maintenance. When a message is shown, perform the correction procedure appropriate to the message.

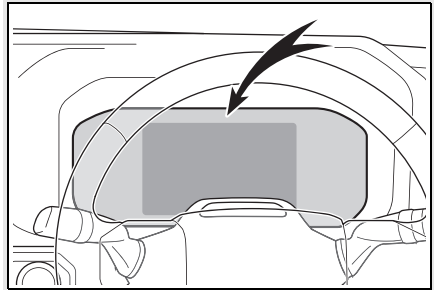

If a warning message is displayed again after the appropriate actions have been performed, contact your Toyota dealer.

## Messages and warnings

The warning lights and warning buzzers operate as follows depending on the content of the message. If a message indicates the need for inspection by a dealer, have the vehicle inspected by your Toyota dealer immediately.

Warning light	Warning buzzer*	Warning
—	Sounds	<ul style="list-style-type: none"> <li>• Indicates an important situation, such as when a system related to driving is malfunctioning or that danger may result if the correction procedure is not performed</li> <li>• Indicates a situation, such as when damage to the vehicle or danger may result</li> </ul>
Comes on or flashes	Sounds	Indicates an important situation, such as when the systems shown on the multi-information display may be malfunctioning
—	Does not sound	<ul style="list-style-type: none"> <li>• Indicates a condition, such as malfunction of electrical components, their condition, or indicates the need for maintenance</li> <li>• Indicates a situation, such as when an operation has been performed incorrectly, or indicates how to perform an operation correctly</li> </ul>

\*: A buzzer sounds the first time a message is shown on the multi-information display.

### ■ Warning messages

The warning messages explained below may differ from the actual messages according to operation conditions and vehicle specifications.

### ■ Warning buzzer

In some cases, the buzzer may not be heard because of noisy place or an audio sound.

### ■ If a message that indicates the need for visiting your Toyota dealer is displayed

The system or part shown on the multi-information display is malfunctioning. Have the vehicle inspected by your Toyota dealer immediately.

### ■ If a message about an operation is shown

- If a message about an operation of the accelerator pedal or brake pedal is shown

A warning message about an operation of the brake pedal may be

shown while the driving assist systems such as PCS (Pre-Collision system) or the dynamic radar cruise control is operating. If a warning message is shown, be sure to decelerate the vehicle or follow an instruction shown on the multi-information display.

A warning message is shown when Drive-Start Control or Parking Support Brake (if equipped) (→P.203, 353) operates. Follow the instructions on the multi-information display.

● If a message about an operation of the power switch is shown

An instruction for operation of the power switch is shown when the incorrect procedure for starting the hybrid system is performed or the power switch is operated incorrectly. Follow the instructions shown on the multi-information display to operate the power switch again.

● If a message about a shift lever operation is shown

To prevent the shift lever from being operated incorrectly or the vehicle from moving unexpectedly, a message that requires shifting the shift lever may be shown on the multi-information display. In that case, follow the instruction of the message and shift the shift lever.

● If a message or image about an open/close state of a part or replenishment of a consumable is shown

Confirm the part indicated by the multi-information display or a warning light, and then perform the coping method such as closing the open door or replenishing a consumable.

■ **If a message that indicates the need for referring to Owner's Manual is displayed**

- If the following messages are shown, follow the instructions, accordingly.
  - "Engine Coolant Temp High Stop in a Safe Place" (→P.625)
- If the following messages are shown, there may be a malfunction. Immediately stop the vehicle in a safe place and contact your Toyota dealer. Continuing to drive the vehicle may be dangerous.
  - "Access System with Elec. Key Malfunction"
  - "Hybrid system malfunction"
  - "Check Engine"
  - "Traction battery system malfunction"
  - "Accelerator system malfunction"
  - "Trailer Malfunction"
- If the following messages are shown, there may be a malfunction. Immediately have the vehicle inspected by your Toyota dealer.
  - "Oil Pressure Low"
  - "Braking Power Low"
- If "12-Volt Battery Charging System Malfunction Stop in a Safe Place" is shown

Indicates a malfunction in the vehicle's charging system. Pull over and stop the vehicle as soon as it is safe to do so. While the message is displayed, the functions of the air conditioning, etc. may be partially limited in order to reduce the power consumption of the battery.

● If "Hybrid Battery Low Some Functions Limited See Owner's Manual" is displayed

In order to charge the hybrid battery (traction battery), the idling speed may be temporarily increased, the functions of the air conditioning may be limited, and the functions of the



power supply (accessory sockets, etc.) may be limited. The message will disappear when the hybrid battery (traction battery) is sufficiently charged.

■ **If “Power reduced to lower engine temp” is displayed**

This message may be displayed when the engine coolant temperature is high.

At that time, the engine power output is reduced until the temperature decreases to the specified level. It is still possible to continue driving normally, meanwhile the acceleration performance or vehicle speed may be lowered. After driving for a while and the engine coolant temperature is dropped, this message will disappear and engine power output will resume once the engine coolant temperature has decreased to normal.

If after driving for a while the message does not disappear or it comes on and off frequently, contact your Toyota dealer.

■ **If “Shift into P before exiting vehicle” is shown**

Message is displayed when the driver’s door is opened without turning the power switch to OFF with the shift lever in any position other than P.

Shift the shift lever to P.

■ **If “Auto Power OFF to Conserve Battery” is shown**

Power was turned off due to the automatic power off function.

Next time when starting the engine, increase the engine speed slightly and maintain that level for approximately 5 minutes to recharge the battery.

■ **If “Engine Oil Level Low Add or Replace” is displayed**

The engine oil level may be low. Check the level of the engine oil,

and add engine oil if necessary. This message may be displayed if the vehicle is stopped on a slope. Move the vehicle to a level surface and check if the message disappears.

■ **If “Maintenance Required Soon” is displayed**

Indicates that all maintenance according to the driven distance on the maintenance schedule\* should be performed soon.

Comes on approximately 4500 miles (7200 km) after the message has been reset. If necessary, perform maintenance. Please reset the message after the maintenance is performed. (→P.544)

\*: Refer to the separate “Scheduled Maintenance” or “Owner’s Manual Supplement” for the maintenance interval applicable to your vehicle.

■ **If “Maintenance Required Visit Your Dealer” is displayed**

Indicates that all maintenance is required to correspond to the driven distance on the maintenance schedule\*.

Comes on approximately 5000 miles (8000 km) after the message has been reset. (The indicator will not work properly unless the message has been reset.) Perform the necessary maintenance. Please reset the message after the maintenance is performed. (→P.544)

\*: Refer to the separate “Scheduled Maintenance” or “Owner’s Manual Supplement” for the maintenance interval applicable to your vehicle.

■ **If “Engine Maintenance Required Visit Your Dealer” is shown**

The engine or an engine component is malfunctioning. Have the vehicle

inspected by your Toyota dealer immediately.

■ **If “Oil Maintenance Required Soon” is displayed**

Indicates that the engine oil should be scheduled to be changed.

Check the engine oil and change it if necessary. After changing the engine oil, make sure to reset the message. (→P.544)

■ **If “Oil Maintenance Required Visit Your Dealer” is displayed**

Indicates that the engine oil should be changed.

Check and change the engine oil, and oil filter by your Toyota dealer. After changing the engine oil, make sure to reset the message. (→P.544)

■ **If “Parking Assist Unavailable Sensor Blocked” is displayed**

A sensor may be covered with water drops, ice, snow, dirt, etc. Remove the water drops, ice, snow, dirt, etc., from the sensor to return the system to normal.

Also, due to ice forming on a sensor at low temperatures, a warning message may be displayed or the sensor may not be able to detect an object. Once the ice melts, the system will return to normal.

If a sensor is dirty, the position of the dirty sensor will be shown on the display.

If an abnormality is displayed even though there are no water drops, ice, snow or dirt, the sensor may be operating abnormally. Have the vehicle inspected by your Toyota dealer.

■ **If “Parking Assist Unavailable Low Visibility See Owner’s Manual” is displayed**

Indicates one of the following systems is disabled.

-  RCD (Rear Camera Detection) (if equipped)







tion) (if equipped)

-  PKSB (Parking Support Brake) (if equipped)

Remove any dirt or foreign matter from the rear cameras.

■ **If “System Malfunction Visit Your Dealer” is displayed**

Indicates one of the following systems is disabled.







- PCS (Pre-Collision System)
- LDA (Lane Departure Alert)
- LTA (Lane Tracing Assist)
-  LCA (Lane Change Assist) (if equipped)
- AHB (Automatic High Beam)
- Dynamic radar cruise control
-  RSA (Road Sign Assist) (if equipped)
- PDA (Proactive Driving Assist)
-  BSM (Blind Spot Monitor) (if equipped)
-  RCTA (Rear Cross Traffic Alert) (if equipped)
-  Safe Exit Assist (if equipped)
- Intuitive Parking Assist
-  PKSB (Parking Support Brake) (if equipped)
-  RCD (Rear Camera Detection) (if equipped)

Have the vehicle inspected by your Toyota dealer immediately.

■ **If “System Stopped See Owner’s Manual” is displayed**

Indicates one of the following systems is disabled.

- PCS (Pre-Collision System)

- LDA (Lane Departure Alert)
- LTA (Lane Tracing Assist)
-  LCA (Lane Change Assist) (if equipped)
- AHB (Automatic High Beam)
- Dynamic radar cruise control
-  RSA (Road Sign Assist) (if equipped)
- PDA (Proactive Driving Assist)
-  BSM (Blind Spot Monitor) (if equipped)
-  RCTA (Rear Cross Traffic Alert) (if equipped)
-  Safe Exit Assist (if equipped)
- Intuitive Parking Assist
-  PKSB (Parking Support Brake) (if equipped)
-  RCD (Rear Camera Detection) (if equipped)

Follow the following correction methods.

- Check the voltage of the 12-volt battery
- Check the sensors that the Toyota Safety Sense 3.0 uses for foreign matter covering them. Remove them if any. (→P.257)
- Vehicles with RCD (Rear Camera Detection): Check if the back door is open.

Indicates the sensors may not be operating properly. (→P.261, 332, 336, 340, 346, 351)



- Check the rear bumper around the sensors used by the BSM (if equipped), RCTA (if equipped) or Safe Exit Assist (if equipped) for foreign matter covering them. Remove them if any. (→P.329)
- Check the sensors including camera sensors used by the intuitive

parking assist, PKSB (if equipped), or RCD (if equipped) for foreign matter covering them. Remove them if any. (→P.337)

- When problems are solved and the sensors are operational, this indication may disappear by itself.

■ If **“System Stopped Front Camera Low Visibility See Owner’s Manual”** is displayed

Indicates one of the following systems is disabled.

- PCS (Pre-Collision System)
- LDA (Lane Departure Alert)
- LTA (Lane Tracing Assist)
-  LCA (Lane Change Assist) (if equipped)
- AHB (Automatic High Beam)
- Dynamic radar cruise control
-  RSA (Road Sign Assist) (if equipped)

- PDA (Proactive Driving Assist)

Follow the following correction methods.

- Using the windshield wipers, remove the dirt or foreign matter from the windshield.
- Using the air conditioning system, defog the windshield.
- Close the hood, remove any stickers, etc. to clear the obstruction in front of the front camera.

■ If **“System Stopped Front Camera Out of Temperature Range Wait until Normal Temperature”** is displayed

Indicates one of the following systems is disabled.

- PCS (Pre-Collision System)
- LDA (Lane Departure Alert)
- LTA (Lane Tracing Assist)
-  LCA (Lane Change Assist) (if equipped)

- AHB (Automatic High Beam)
- Dynamic radar cruise control
-  RSA (Road Sign Assist) (if equipped)
- PDA (Proactive Driving Assist)

Follow the following correction methods.

- If the front camera is hot, such as after the vehicle is parked in the sun, use the air conditioning system to decrease the temperature around the front camera
- If a sunshade was used when the vehicle was parked, depending on its type, the sunlight reflected from the surface of the sunshade may cause the temperature of the front camera to become excessively high
- If the front camera is cold, such as after the vehicle is parked in an extremely cold environment, use the air conditioning system to increase the temperature around the front camera

■ **If “System Stopped Front Radar Sensor Blocked Clean Radar Sensor” is displayed**

Indicates one of the following systems is disabled.

- PCS (Pre-Collision System)
- LDA (Lane Departure Alert)
- LTA (Lane Tracing Assist)
-  LCA (Lane Change Assist) (if equipped)
- AHB (Automatic High Beam)
- Dynamic radar cruise control
- PDA (Proactive Driving Assist)

Follow the following correction methods.

- Check if there is any foreign matter attached to the radar sensor or radar sensor cover and clean them if necessary (→P.329)
- This message may be displayed when driving in an open area with

few nearby vehicles or structures, such as a desert, grasslands, suburbs, etc.

The message may be cleared by driving the vehicle in an area with structures, vehicles, etc. nearby.

■ **If “System Stopped Front Radar Sensor Out of Temperature Range Wait until Normal Temperature” is displayed**

Indicates one of the following systems is disabled.

- PCS (Pre-Collision System)
- LDA (Lane Departure Alert)
- LTA (Lane Tracing Assist)
-  LCA (Lane Change Assist) (if equipped)
- AHB (Automatic High Beam)
- Dynamic radar cruise control
- PDA (Proactive Driving Assist)

The temperature of the radar sensor is outside of the operating range.

Wait for the temperature to become appropriate.

■ **If “System Stopped Front Radar In Self Calibration See Owner’s Manual” is displayed**

Indicates one of the following systems is disabled.

- PCS (Pre-Collision System)
- LDA (Lane Departure Alert)
- LTA (Lane Tracing Assist)
-  LCA (Lane Change Assist) (if equipped)
- AHB (Automatic High Beam)
- Dynamic radar cruise control
- PDA (Proactive Driving Assist)

Follow the following correction methods.

- Check if there is any foreign matter attached to the radar sensor or radar sensor cover and clean them if necessary (→P.329)

- The radar sensor may be misaligned and will be adjusted automatically while driving. Continue driving for a while.
- **If “Unavailable Activation Condition not Satisfied See Owner’s Manual” is displayed**

The  LCA function cannot be used as the operating conditions have not been met.

Operate the turn signal lever again after all of the operating conditions are met.

- **If “Cruise Control Unavailable See Owner’s Manual” is displayed**

Indicates one of the following systems is disabled.

- Dynamic radar cruise control
- Cruise control

A message is displayed when the driving assist switch is pushed repeatedly.

Press the driving assist switch quickly and firmly.



### WARNING

- **If a warning light comes on or a warning buzzer sounds when a warning message is shown on the multi-information display**

Check and follow the message displayed on the multi-information display. Failure to do so may result in death or serious injury.



### NOTICE

- **While the engine oil level warning is displayed**

Continued engine operation with low engine oil will damage the engine.

## If you have a flat tire

Your vehicle is equipped with a spare tire. The flat tire can be replaced with the spare tire.

For details about tires: →P.551

### WARNING

#### ■ If you have a flat tire

Do not continue driving with a flat tire.

Driving even a short distance with a flat tire can damage the tire and the wheel beyond repair, which could result in an accident.

## Before jacking up the vehicle

- Stop the vehicle in a safe place on a hard, flat surface.
- Set the parking brake.
- Shift the shift lever to P.
- Stop the hybrid system.
- Turn on the emergency flashers. (→P.580)

## Location of the spare tire, jack and tools

### ▶ 5-passenger models

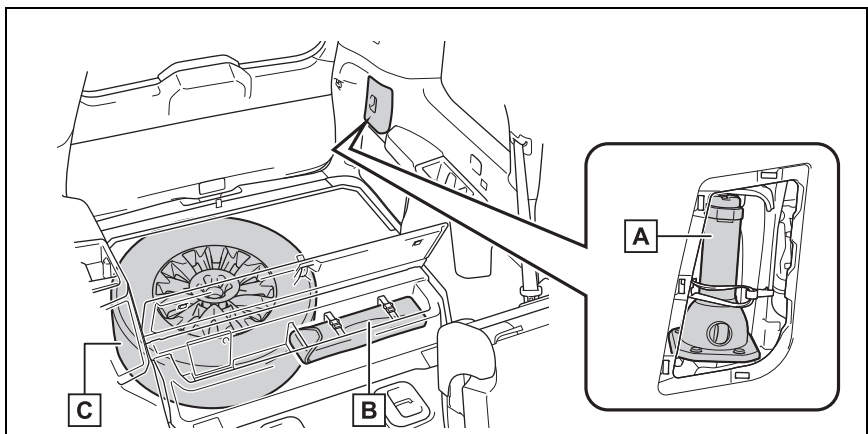

**A** Jack

**B** Tool bag

**C** Spare tire

► 7-passenger models

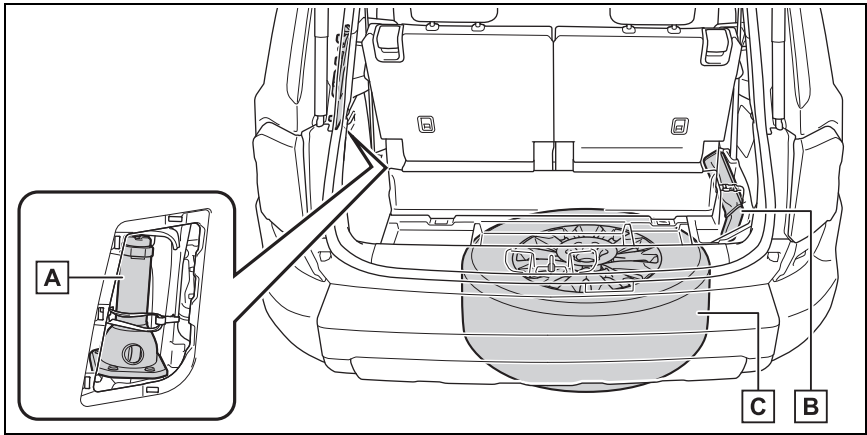

**A** Jack

**B** Tool bag

**C** Spare tire

**Tools**

► 5-passenger models

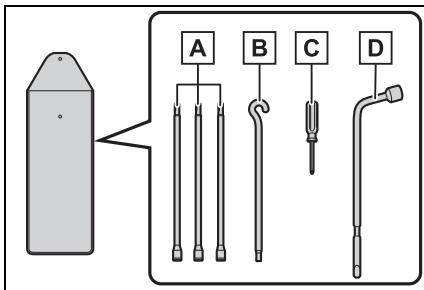

**A** Jack handle extension bar

**B** Jack handle bar

**C** Screwdriver

**D** Wheel nut wrench

► 7-passenger models

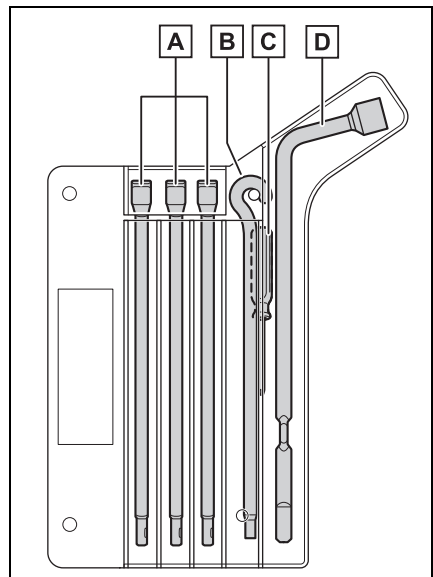

**A** Jack handle extension bar

- B** Jack handle bar
- C** Screwdriver
- D** Wheel nut wrench

### WARNING

#### ■ Using the tire jack

Observe the following precautions.

Improper use of the tire jack may cause the vehicle to suddenly fall off the jack, leading to death or serious injury.

- Do not use the tire jack for any purpose other than replacing tires or installing and removing tire chains.
- Only use the tire jack that comes with this vehicle for replacing a flat tire. Do not use it on other vehicles, and do not use other tire jacks for replacing tires on this vehicle.
- Put the jack properly in its jack point.
- Do not put any part of your body under the vehicle while it is supported by the jack.
- Do not start the hybrid system or drive the vehicle while the vehicle is supported by the jack.
- Do not raise the vehicle while someone is inside.
- When raising the vehicle, do not put an object on or under the jack.
- Do not raise the vehicle to a height greater than that required to replace the tire.

- Do not continue jacking up once the yellow caution line **A** has appeared.

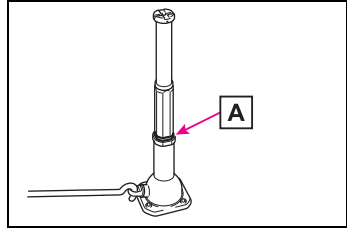

- Use a jack stand if it is necessary to get under the vehicle.

Take particular care when lowering the vehicle to ensure that no one working on or near the vehicle will be injured.

#### ■ Using the jack handle

Tighten all the jack handle bolts securely using the wheel nut wrench, to prevent the extension parts from coming apart unexpectedly.

### Taking out the jack

- 1 Remove the cover.

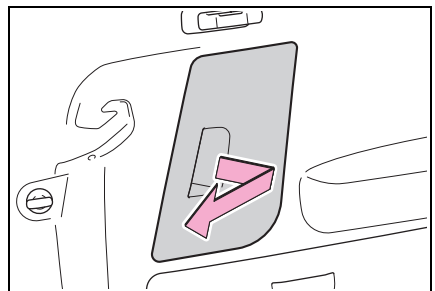



## 2 Unhook the rubber strap.

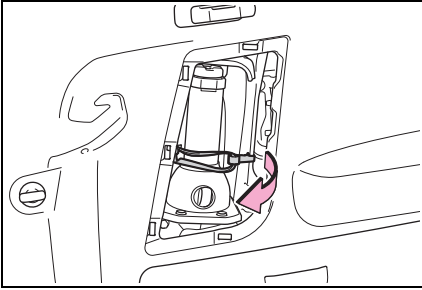

## ▶ 5-passenger models

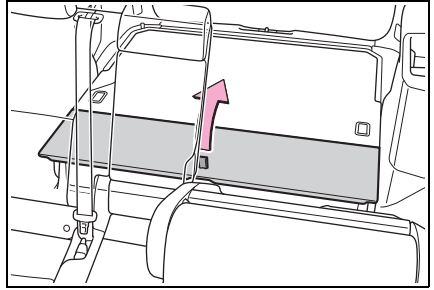

## 3 Take out the jack.

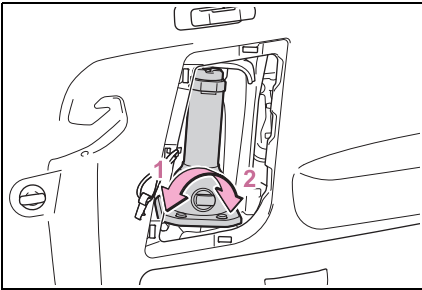

1 Loosen

2 Tighten

After using the jack, install the jack in the exact reverse order from which it was removed. Also, the jack should be properly secured using a rubber strap.

### Taking out the tool bag

1 5-passenger models: Tumbling the left-hand side second seats. (→P.157)

2 Lift the deck board.

## ▶ 7-passenger models

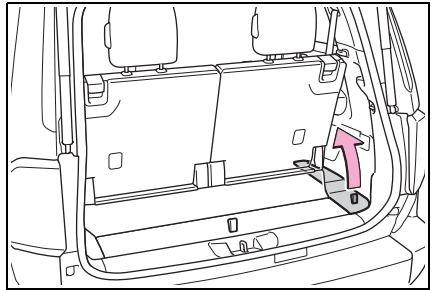

## 3 Take out the tool bag.

## ▶ 5-passenger models

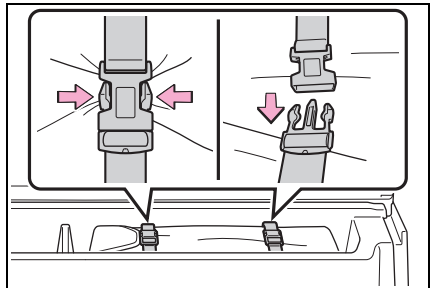

## ▶ 7-passenger models

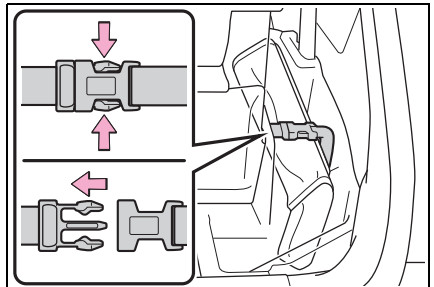

## Taking out the spare tire

- 1 Assemble the jack handle end, jack handle extensions and wheel nut wrench.

Remove the jack handle bar, jack handle extension bar and wheel nut wrench from the tool bag and assemble by following these steps.

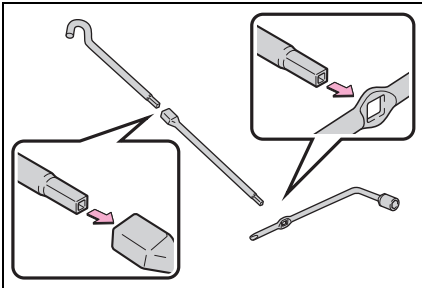

- 2 Remove the cover.

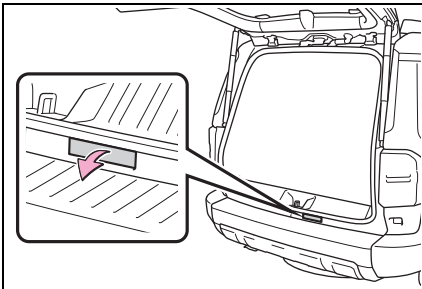

- 3 Insert the jack handle into the lowering screw.

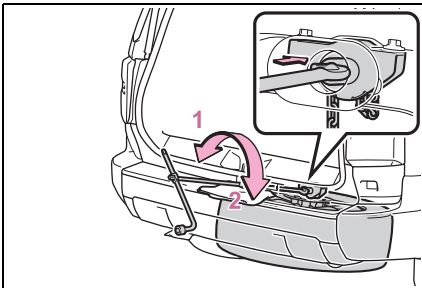

- 1 Lower
- 2 Raise

Place a rag under the jack handle to protect the rear bumper.

- 4 Lower the spare tire completely to the ground.

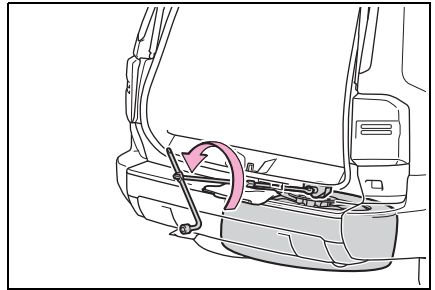

- 5 Pull out the spare tire and remove the holding bracket.

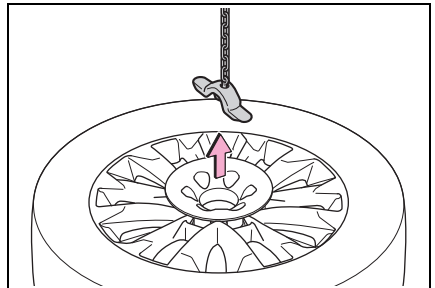

- 6 Remove the spare wheel cover.

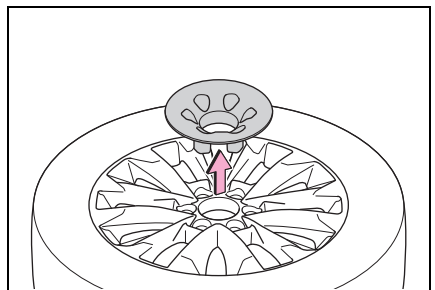

## Replacing a flat tire

- 1 Check the tires.

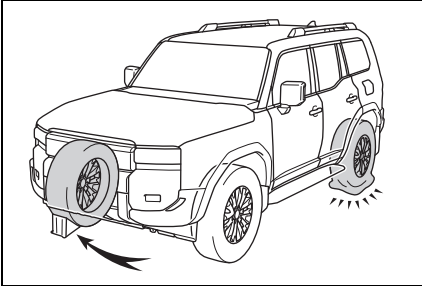

Flat tire	Wheel chock positions
Front left-hand side	Behind the rear right-hand side tire
Front right-hand side	Behind the rear left-hand side tire
Rear left-hand side	In front of the front right-hand side tire
Rear right-hand side	In front of the front left-hand side tire

- 2 Pry off the wheel ornament, using the beveled end of the wheel ornament remover as shown.

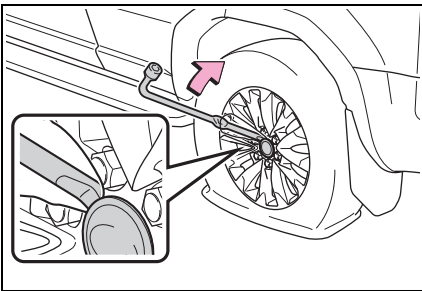

- 3 Slightly loosen the wheel nuts (one turn).

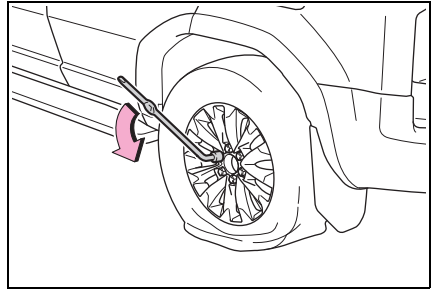

- 4 Assemble the jack handle end, jack handle extensions and wheel nut wrench.

Remove the jack handle bar, jack handle extension bar and wheel nut wrench from the tool bag and assemble by following these step.

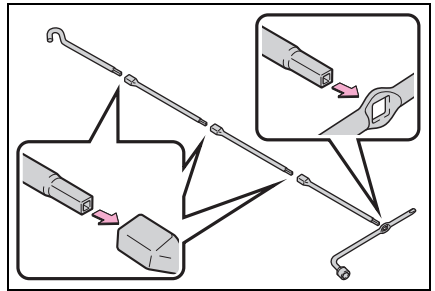

- 5 Position the jack at the jack points as shown.

► Front

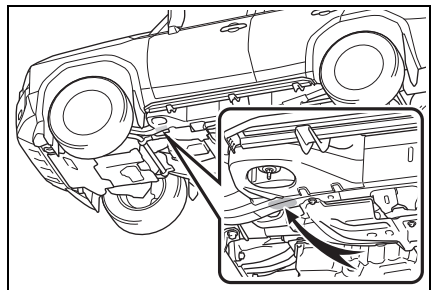

► Rear

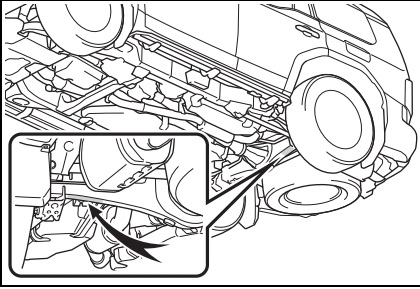

**6** Raise the vehicle until the tire is slightly raised off the ground.

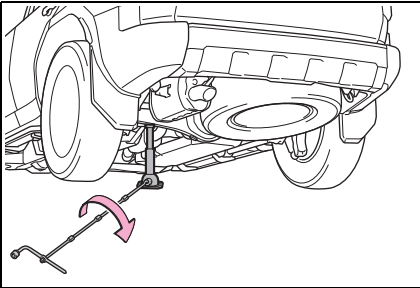

**7** Remove all the wheel nuts and the tire.

When resting the tire on the ground, place the tire so that the wheel design faces up to avoid scratching the wheel surface.

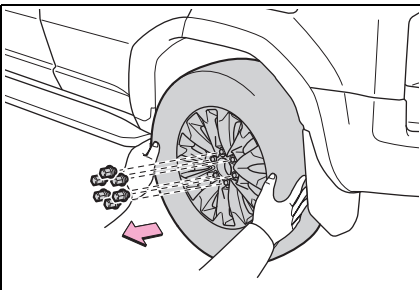

**⚠ WARNING**

**■ Replacing a flat tire**

● Do not touch the disc wheels or the area around the brakes immediately after the vehicle has been driven.

After the vehicle has been driven the disc wheels and the area around the brakes will be extremely hot. Touching these areas with hands, feet or other body parts while changing a tire, etc. may result in burns.

● Observe the following precautions. Failure to do so may result in serious injury:

- Lower the spare tire completely to the ground before removing it from under the vehicle.

- Do not try to remove the wheel ornament by hand. Take due care in handling the ornament to avoid unexpected personal injury.

- Failure to follow these precautions could cause the wheel nuts to loosen and the tire to fall off, resulting in death or serious injury.

- After replacing a tire, check the tightening torque as soon as possible.

Wheel nut torque: 97 ft•lbf (131 N•m, 13.4 kgf•m)

- When installing a tire, only use wheel nuts that have been specifically designed for that wheel.

- If there are any cracks or deformations in the bolt screws, nut threads or bolt holes of the wheel, have the vehicle inspected by your Toyota dealer.

### ⚠ WARNING

- Do not attach a heavily damaged wheel ornament, as it may fly off the wheel while the vehicle is moving.
- When installing the wheel nuts, be sure to install them with the tapered ends facing inward.

### ■ Replacing a flat tire for vehicles with power back door

In cases such as when replacing tires, make sure to cancel the power back door system. (→P.145) Failure to do so may cause the back door to operate unintentionally if the power back door switch is accidentally touched, resulting in hands and fingers being caught and injured.

### Installing the spare tire

- 1 Remove any dirt or foreign matter from the wheel contact surface.

If foreign matter is on the wheel contact surface, the wheel nuts may loosen while the vehicle is in motion, causing the tire to come off.

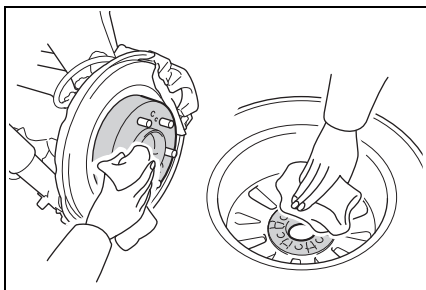

- 2 Install the spare tire and loosely tighten each wheel nut by hand by approximately the same amount.

When replacing an aluminum wheel

with an aluminum wheel, turn the wheel nuts until the washers **A** come into contact with the disc wheel **B**.

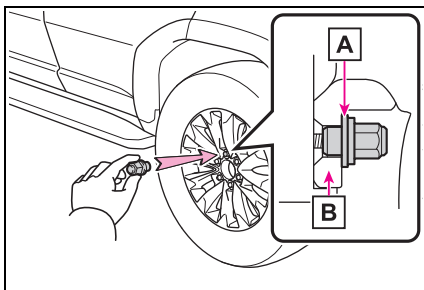

- 3 Lower the vehicle.

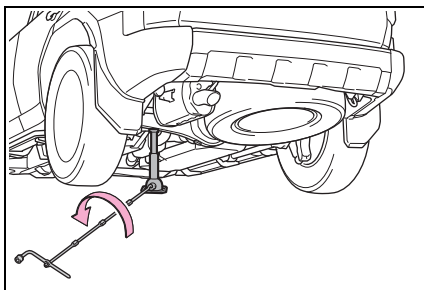

- 4 Securely tighten the wheel nuts two or three times in the order shown in the illustration using a wheel nut wrench.

Tightening torque:  
97 ft•lbf (131 N•m, 13.4 kgf•m)

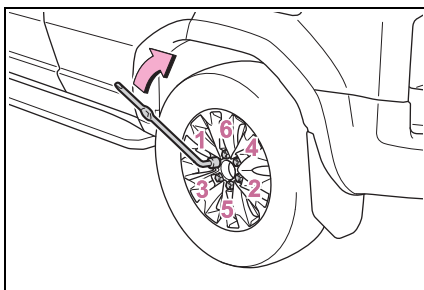

- 5 Reinstall the wheel ornament.

Remove the center wheel ornament

from the flat tire by pushing from the reverse side, and reinstall it.

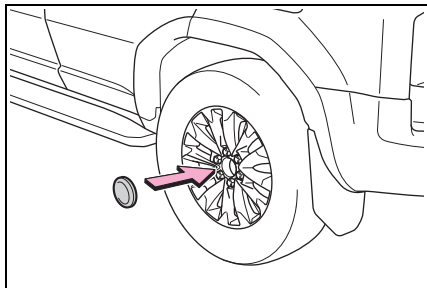

### Stowing the flat/spare tire, jack and tools

- 1 Lay down the tire with the valve stem facing up
- 2 Install the spare wheel cover.

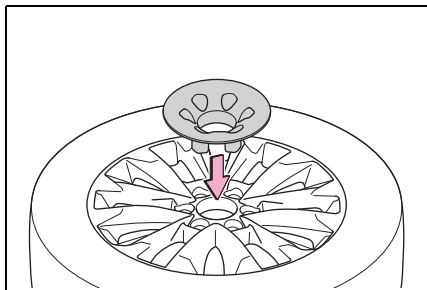

- 3 Install the holding bracket **A**. Turn the jack handle extension clockwise to take up slack in the chain.

Then, check to ensure the holding bracket is centered in the wheel

hub.

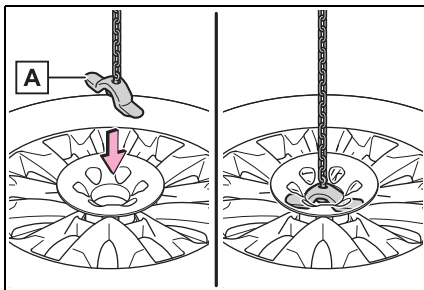

- 4 Raise the tire.

Place a rag under the jack handle to protect the rear bumper.

While raising, secure the tire, taking care that the tire goes straight up without catching on any surrounding part, to prevent it from flying forward during a collision or sudden braking.

After the tire goes half way up, check that the suspended chain is able to enter the tire hole, for proper storage.

#### Tightening torque:

34.7 ft•lbf (47 N•m, 4.8 kgf•m)

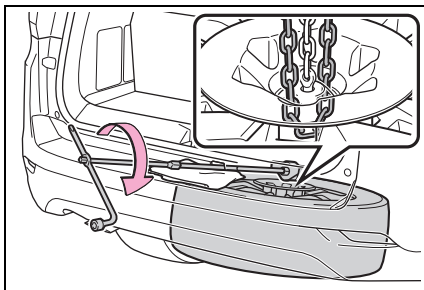

- 5** Confirm that the tire is not loose after tightening:

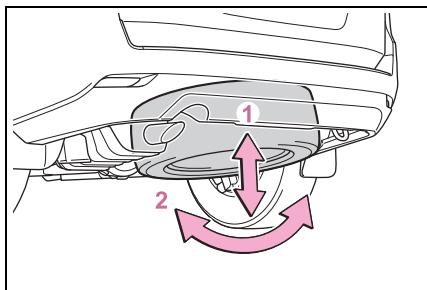

- 1** Push and pull the tire  
**2** Try rotating

Visually check to ensure the tire is not hung on surrounding parts.

If looseness or misassembly exists, repeat step 4 and step 5.

- 6** Repeat step 5, any time the tire is lowered or disturbed.  
**7** Install the cover as shown in the illustration.

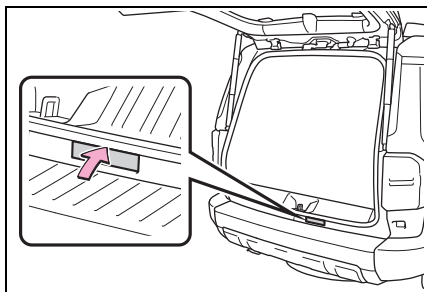

- 8** Stow the tools and jack securely.

**■ After completing the tire change**

The tire pressure warning system must be reset. (→P.557)

**⚠ WARNING**

**■ Stowing the flat tire**

Failure to follow the proper steps listed under stowing the tire may result in damage to the spare tire carrier and loss of the tire, which could result in death or serious injury.

**■ After using the tools and jack**

Before driving, make sure all the tools and jack are securely in place in their storage location to reduce the possibility of personal injury during a collision or sudden braking.

**⚠ NOTICE**

**■ When stowing the flat tire**

Ensure that there is no object caught between the tire and the vehicle underbody.

**■ When replacing the tires**

When removing or fitting the wheels, tires or the tire pressure warning valve and transmitter, contact your Toyota dealer as the tire pressure warning valve and transmitter may be damaged if not handled correctly.

**■ To avoid damage to the tire pressure warning valves and transmitters**

When a tire is repaired with liquid sealants, the tire pressure warning valve and transmitter may not operate properly. If a liquid sealant is used, contact your Toyota dealer or other qualified service shop as soon as possible. Make sure to replace the tire pressure warning valve and transmitter when replacing the tire. (→P.555)

### If the hybrid system will not start

**Reasons for the hybrid system not starting vary depending on the situation. Check the following and perform the appropriate procedure:**

#### **The hybrid system will not start even though the correct starting procedure is being followed (→P.222)**

One of the following may be the cause of the problem:

- The electronic key may not be functioning properly. (→P.618)
- There may not be sufficient fuel in the vehicle's tank. Refuel the vehicle. (→P.251)
- There may be a malfunction in the immobilizer system. (→P.77)
- The hybrid system may be malfunctioning due to an electrical problem such as electronic key battery depletion or a blown fuse. However, depending on the type of malfunction, an interim measure is available to start the hybrid system. (→P.616)

#### **The interior lights and headlights are dim, or the horn does not sound or sounds at a low volume**

One of the following may be the cause of the problem:

- The 12-volt battery may be discharged. (→P.620)
- The 12-volt battery terminal connections may be loose or corroded. (→P.550)

#### **The interior lights and headlights do not turn on, or the horn does not sound**

One of the following may be the cause of the problem:

- The 12-volt battery may be discharged. (→P.620)
- One or both of the 12-volt battery terminals may be disconnected. (→P.550)

Contact your Toyota dealer if the problem cannot be repaired, or if repair procedures are unknown.

#### **Starting the hybrid system in an emergency**

When the hybrid system does not start, the following steps can be used as an interim measure to start the hybrid system if the power switch is functioning nor-



mally.

Do not use this starting procedure except in cases of emergency.

- 1 Pull the parking brake switch to check that the parking brake is set. (→P.233)

Parking brake indicator will come on.

- 2 Shift the shift lever to P.

- 3 Turn the power switch to ACC.\*1, 2

- 4 Press and hold the power switch for about 15 seconds while depressing the brake pedal firmly.

Even if the hybrid system can be started using the above steps, the system may be malfunctioning. Have the vehicle inspected by your Toyota dealer.

\*1: ACC mode can be enabled/disabled on the customize menu. (→P.658)

\*2: When ACC is disabled, turn the power switch to ON then OFF, and perform the following step within 5 seconds.

### If you lose your keys

**New genuine keys can be made by your Toyota dealer using the other key and the key number stamped on your key number plate. Keep the plate in a safe place such as your wallet, not in the vehicle.**



#### NOTICE

#### ■ When an electronic key is lost

If the electronic key remains lost, the risk of vehicle theft increases significantly. Visit your Toyota dealer immediately with all remaining electronic keys that were provided with your vehicle.

## If the electronic key does not operate properly

If communication between the electronic key and vehicle is interrupted (→P.151) or the electronic key cannot be used because the battery is depleted, the smart key system and wireless remote control cannot be used. In such cases, the doors can be opened and the hybrid system can be started by following the procedure below.

### ■ When the electronic key does not work properly

- Make sure that the smart key system has not been deactivated in the customization setting. If it is off, turn the function on. (Customizable features: →P.655)
- Check if battery-saving mode is set. If it is set, cancel the function. (→P.151)
- The electronic key function may be suspended. (→P.151)



### NOTICE

### ■ In case of a smart key system malfunction, or other key related problems

Take your vehicle with all the electronic keys provided with your vehicle to your Toyota dealer.

## Locking and unlocking the doors

Use the mechanical key (→P.126) in order to perform the following operations.

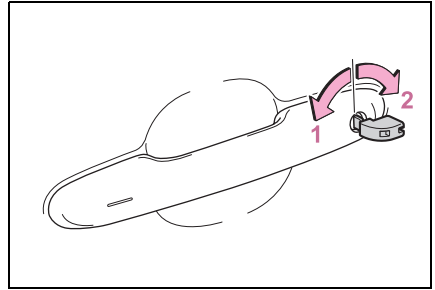

- 1 Locks all the doors
- 2 Unlocks the door

Turning the key rearward unlocks the driver's door. Turning the key once again within 5 seconds unlocks the other doors.

### ■ Key linked functions (if equipped)

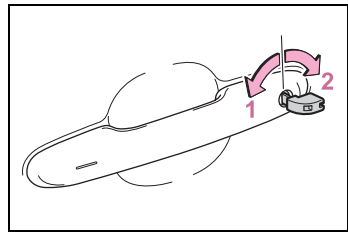

- 1 Closes the windows and the moon roof\*<sup>1</sup> (turn and hold)\*<sup>2</sup>
- 2 Opens the windows and the moon roof\*<sup>1</sup> (turn and hold)\*<sup>2</sup>

\*<sup>1</sup>: If equipped

\*<sup>2</sup>: These settings must be customized at your Toyota dealer.

**WARNING****■ When using the mechanical key and operating the power windows or the moon roof (if equipped)**

Operate the power window or moon roof after checking to make sure that there is no possibility of any passenger having any of their body parts caught in the window or moon roof. Also, do not allow children to operate the mechanical key. It is possible for children and other passengers to get caught in the power window or moon roof.

**Starting the hybrid system**

- 1 Ensure that the shift lever is in P and depress the brake pedal.
- 2 Touch the area behind the buttons on the electronic key to power switch.

When the electronic key is detected, a buzzer sounds and the power switch will turn to ON.

When the smart key system is deactivated in customization setting and ACC customization is in on, the power switch will turn to ACC.

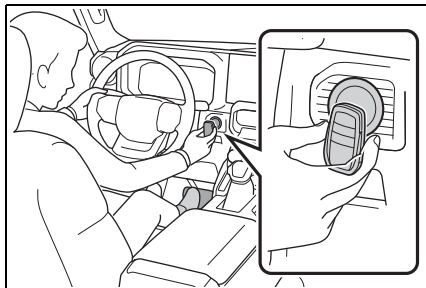

- 3 Firmly depress the brake pedal and check that 

and a message are displayed on the multi-information display.

- 4 Press the power switch shortly and firmly.

In the event that the hybrid system still cannot be started, contact your Toyota dealer.

**■ Stopping the hybrid system**

Shift the shift lever to P, set the parking brake and press the power switch as you normally do when stopping the hybrid system.

**■ Replacing the key battery**

As the above procedure is a temporary measure, it is recommended that the electronic key battery be replaced immediately when the battery is depleted. (→P.571)

**■ Alarm**

If a door is unlocked using the mechanical key when the alarm system is set, the alarm may be triggered. (→P.78)

**■ Changing power switch modes**

Release the brake pedal and press the power switch in step 3 above. The hybrid system does not start and modes will be changed each time the switch is pressed. (→P.225)

## If the 12-volt battery is discharged

The following procedures may be used to start the hybrid system if the vehicle's 12-volt battery is discharged.

You can also call your Toyota dealer or a qualified repair shop.

## Restarting the hybrid system

If you have a set of jumper (or booster) cables and a second vehicle with a 12-volt battery, you can jump start your vehicle by following the steps below.

- 1 Confirm that the electronic key is being carried.

When connecting the jumper (or booster) cables, depending on the situation, the alarm may activate

and the doors locked. (→P.79)

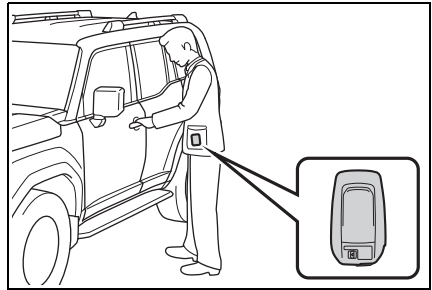

- 2 Open the hood (→P.540) and open the right-hand side fuse box cover.

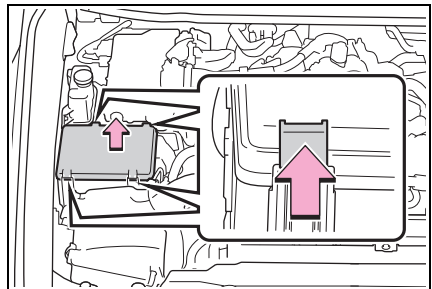

Push the tab in and lift the lid off.

- 3 Open the exclusive jump starting terminal cover.

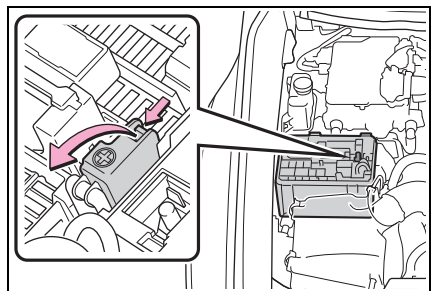

- 4 Connect a positive jumper cable clamp to **A** on your vehicle and connect the clamp on the other end of the positive cable to **B** on the second vehicle. Then, connect a negative cable clamp to **C** on the second vehicle and connect the clamp at the other end of the negative cable to **D**.

Use jumper cables that can reach the specified terminals and connecting

point.

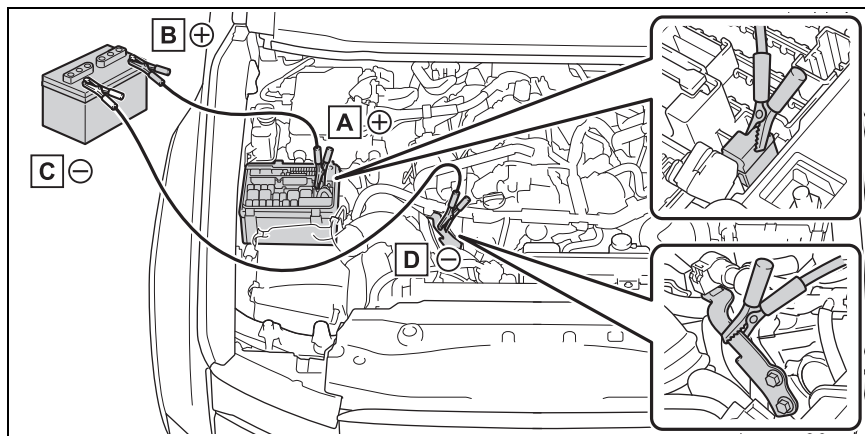

- A** Exclusive jump starting terminal (your vehicle)
- B** Positive (+) battery terminal (second vehicle)
- C** Negative (-) battery terminal (second vehicle)
- D** Metallic point shown in the illustration

- 5 Start the engine of the second vehicle. Increase the engine speed slightly and maintain at that level for approximately 5 minutes to recharge the 12-volt battery of your vehicle.
- 6 Maintain the engine speed of the second vehicle and start the hybrid system of your vehicle by turning the power switch to ON.
- 7 Make sure the “READY” indicator comes on. If the indicator does not come on, contact your Toyota dealer.
- 8 Once the vehicle’s hybrid system has started, remove the jumper cables in the

exact reverse order from which they were connected.

- 9 Close the exclusive jump starting terminal cover, and reinstall the fuse box cover to its original position.

Once the hybrid system starts, have the vehicle inspected at your Toyota dealer as soon as possible.

#### ■ Starting the hybrid system when the 12-volt battery is discharged

The hybrid system cannot be started by push-starting.

#### ■ To prevent 12-volt battery discharge

- Turn off the headlights and the audio system while the hybrid system is stopped.
- Turn off any unnecessary electrical components when the vehicle is running at a low speed for an

extended period, such as in heavy traffic.

- When ACC customization is in off, power is still provided to the multimedia system even though the power switch is off.

To turn off the multimedia system, use the multimedia system power switch. For details, refer to the "MULTIMEDIA OWNER'S MANUAL".

### ■ When the 12-volt battery is removed or discharged

- Information stored in the ECU is cleared. When the 12-volt battery is depleted, have the vehicle inspected at your Toyota dealer.
- Some systems may require initialization. (→P.666)

### ■ When removing the 12-volt battery terminals

When the 12-volt battery terminals are removed, the information stored in the ECU is cleared. Before removing the 12-volt battery terminals, contact your Toyota dealer.

### ■ Charging the 12-volt battery

The electricity stored in the 12-volt battery will discharge gradually even when the vehicle is not in use, due to natural discharge and the draining effects of certain electrical appliances. If the vehicle is left for a long time, the 12-volt battery may discharge, and the hybrid system may be unable to start. (The 12-volt battery recharges automatically while the hybrid system is operating.)

### ■ When recharging or replacing the 12-volt battery

- In some cases, it may not be possible to unlock the doors using the smart key system when the 12-volt battery is discharged. Use the wireless remote control or the mechanical key to lock or unlock the doors.
- The hybrid system may not start on the first attempt after the 12-volt battery has recharged but will start normally after the second attempt. This is not a malfunction.
- The power switch mode is memorized by the vehicle. When the 12-volt battery is reconnected, the system will return to the mode it was in before the 12-volt battery was discharged. Before disconnecting the 12-volt battery, turn the power switch off. If you are unsure what mode the power switch was in before the 12-volt battery discharged, be especially careful when reconnecting the 12-volt battery.

### ■ When replacing the 12-volt battery

- Use a 12-volt battery that conforms to European regulations.
- Use a 12-volt battery that the case size is same as the previous one (LN3), 20 hour rate capacity (20HR) is equivalent (70Ah) or greater, and performance rating (CCA) is equivalent (600A) or greater.
- If the sizes differ, the 12-volt battery cannot be properly secured.
- If an improper 12-volt battery is used, 12-volt battery performance may decrease and the hybrid system may not be able to restart.
- If the 20 hour rate capacity is low, even if the time period where the vehicle is not used is a short time, the 12-volt battery may discharge and hybrid system may not be able to start.
- Use a ventilation type calcium battery
- Use a 12-volt battery with a handle. If a 12-volt battery without a handle is used, removal is more difficult.
- After exchanging, firmly attach the following items to the exhaust hole of the 12-volt battery.
- Use the exhaust hose that was attached to the 12-volt battery before replacing and confirm that

it is firmly connected to the hole section of the vehicle.

- Use the exhaust hole plug included with the new 12-volt battery or the one installed on the 12-volt battery prior to the replacement. (Depending on the new 12-volt battery installed, the exhaust hole may be plugged.)

For details, consult your Toyota dealer.

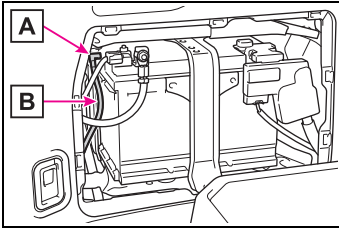

**A** Exhaust hole

**B** Exhaust hose



## WARNING

### ■ When removing the 12-volt battery terminals

Always remove the negative (-) terminal first. If the positive (+) terminal contacts any metal in the surrounding area when the positive (+) terminal is removed, a spark may occur, leading to a fire in addition to electrical shocks and death or serious injury.

### ■ Avoiding 12-volt battery fires or explosions

Observe the following precautions to prevent accidentally igniting the flammable gas that may be emitted from the 12-volt battery:

- Make sure each jumper cable is connected to the correct terminal and that it is not unintentionally in contact with any other than the intended terminal.

- Do not allow the other end of the jumper cable connected to the "+" terminal to come into contact with any other parts or metal surfaces in the area, such as brackets or unpainted metal.
- Do not allow the + and - clamps of the jumper cables to come into contact with each other.
- Do not smoke, use matches, cigarette lighters or allow open flame near the 12-volt battery.

### ■ 12-volt battery precautions

The 12-volt battery contains poisonous and corrosive acidic electrolyte, while related parts contain lead and lead compounds.

Observe the following precautions when handling the 12-volt battery:

- When working with the 12-volt battery, always wear safety glasses and take care not to allow any 12-volt battery fluids (acid) to come into contact with skin, clothing or the vehicle body.
- Do not lean over the 12-volt battery.
- In the event that 12-volt battery fluid comes into contact with the skin or eyes, immediately wash the affected area with water and seek medical attention. Place a wet sponge or cloth over the affected area until medical attention can be received.
- Always wash your hands after handling the 12-volt battery support, terminals, and other 12-volt battery-related parts.
- Do not allow children near the 12-volt battery.

**WARNING****■ After recharging the 12-volt battery**

Have the 12-volt battery inspected at your Toyota dealer as soon as possible. If the 12-volt battery is deteriorating, continued use may cause the 12-volt battery to emit a malodorous gas, which may be detrimental to the health of passengers.

**■ When exchanging the 12-volt battery**

- When the vent plug and indicator are close to the hold down clamp, the 12-volt battery fluid (sulfuric acid) may leak.
- After replacing, securely attach the exhaust hose and exhaust hole plug to the exhaust hole of the replaced 12-volt battery. If not properly installed, gases (hydrogen) may leak into the vehicle interior, and there is the possible danger of the gas igniting and exploding.
- For information regarding 12-volt battery replacement, contact your Toyota dealer.

**■ When disconnecting the 12-volt battery**

Do not disconnect the negative (-) terminal on the body side. The disconnected negative (-) terminal may touch the positive (+) terminal, which may cause a short and result in death or serious injury.

**NOTICE****■ When handling jumper cables**

When connecting the jumper cables, ensure that they do not become entangled in the cooling fan or engine drive belt.

**■ When connecting jumper cables**

Make sure to connect jumper cables to the specified terminals and connecting point. Failure to do so may adversely affect the electronic devices or damage to them.

**■ To prevent damaging the vehicle**

The exclusive jump starting terminal is to be used when charging the 12-volt battery from another vehicle in an emergency. It cannot be used to jump start another vehicle.



## If your vehicle overheats

The following may indicate that your vehicle is overheating.

- The engine coolant temperature gauge (→P.89, 92) is in the red zone or a loss of hybrid system power is experienced. (For example, the vehicle speed does not increase.)
- “Engine Coolant Temp High Stop in a Safe Place See Owner’s Manual” is shown on the multi-information display.
- Steam comes out from under the hood.

## Correction procedures

- **If the engine coolant temperature gauge enters the red zone or “Engine Coolant Temp High Stop in a Safe Place See Owner’s Manual” is shown on the multi-information display**

- 1 Stop the vehicle in a safe place and turn off the air conditioning system, and then stop the hybrid system.
- 2 If you see steam: Carefully lift the hood after the steam subsides.

If you do not see steam: Carefully lift the hood.

- 3 After the hybrid system has cooled down sufficiently, inspect the hoses and radiator core (radiator) for any leaks.

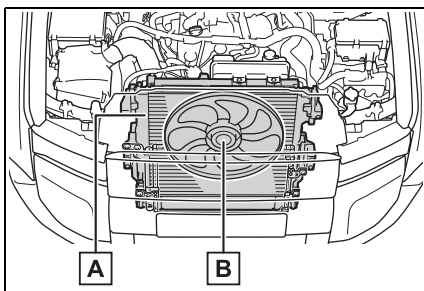

- A** Radiator
- B** Cooling fan

If a large amount of coolant leaks, immediately contact your Toyota dealer.

- 4 The coolant level is satisfactory if it is between the “F”/“FULL” and “L”/“LOW” lines on the reservoir.

### ► Engine

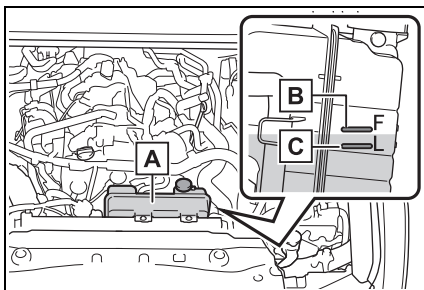

- A** Reservoir
- B** “F” line
- C** “L” line

## ▶ Power control unit

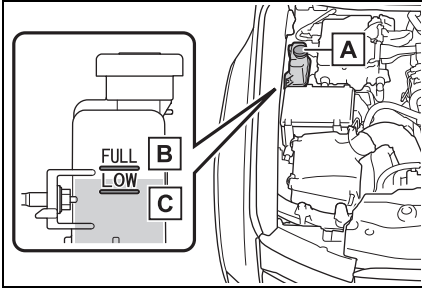

**A** Reservoir

**B** “FULL” line

**C** “LOW” line

**5** Add coolant if necessary.

Water can be used in an emergency if coolant is unavailable.

## ▶ Engine

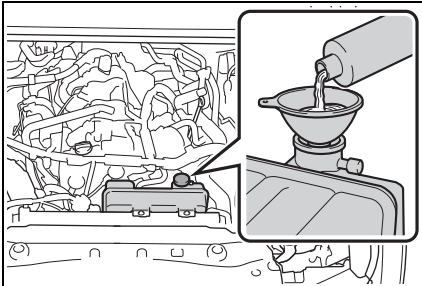

## ▶ Power control unit

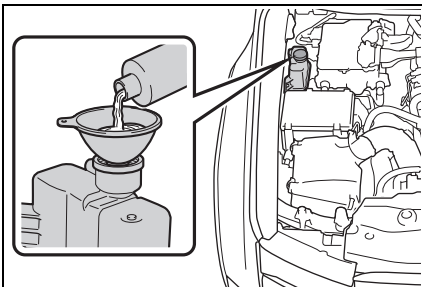

**6** Start the hybrid system and turn the air conditioning system on to check that the radiator

cooling fan operate and to check for coolant leaks from the radiator or hoses.

The fan operate when the air conditioning system is turned on immediately after a cold start. Confirm that the fan is operating by checking the fan sound and air flow. If it is difficult to check these, turn the air conditioning system on and off repeatedly.

(The fan may not operate in freezing temperatures.)

**7** If the fan is not operating:

Stop the hybrid system immediately and contact your Toyota dealer.

If the fan is operating:

Have the vehicle inspected at the nearest Toyota dealer.

**8** Check if “Engine Coolant Temp High Stop in a Safe Place See Owner’s Manual” is shown on the multi-information display.

If the message does not disappear: Stop the hybrid system and contact your Toyota dealer.

If the message is not displayed:

Have the vehicle inspected at the nearest Toyota dealer.

**⚠ WARNING**

■ **When inspecting under the hood of your vehicle**

Observe the following precautions.

Failure to do so may result in serious injury such as burns.

● If steam is seen coming from under the hood, do not open the hood until the steam has subsided. The engine compartment may be very hot.

**WARNING**

- After the hybrid system has been turned off, check that the “READY” indicator is off. When the hybrid system is operating, the gasoline engine may automatically start, or the cooling fan may suddenly operate even if the gasoline engine stops. Also, the cooling fan may operate for a while after turning off the hybrid system. Do not touch or approach rotating parts such as the fan, which may lead to fingers or clothing (especially a tie, a scarf or a muffler) getting caught, resulting in serious injury.
- Do not loosen the radiator cap and the coolant reservoir caps while the hybrid system and radiator are hot. High temperature steam or coolant could spray out.

**NOTICE****■ When adding engine/power control unit coolant**

Add coolant slowly after the hybrid system has cooled down sufficiently. Adding cool coolant to a hot hybrid system too quickly can cause damage to the hybrid system.

**■ To prevent damage to the cooling system**

Observe the following precautions:

- Avoid contaminating the coolant with foreign matter (such as sand or dust, etc.).
- Do not use any coolant additive.

**If the vehicle becomes stuck**

**Carry out the following procedures if the tires spin or the vehicle becomes stuck in mud, dirt or snow:**

**Recovering procedure**

- 1 Stop the hybrid system. Set the parking brake and shift the shift lever to P.

Do not press the shift release button after shifting the shift lever to P.

- 2 Remove the mud, snow or sand from around the rear wheels.
- 3 Place wood, stones or some other material under the rear wheels to help provide traction.
- 4 Restart the hybrid system.
- 5 Shift the shift lever to D or R and release the parking brake. Then, while exercising caution, depress the accelerator pedal.

**■ When it is difficult to free the vehicle**

Try the followings.

- Turn off the Active TRAC (→P.449)
- Switching the four-wheel drive control switch (→P.435)
- Using the center differential lock (→P.435)
- Using the rear differential lock\*

(→P.437)

● Using Crawl Control\* (→P.439)

● Using Multi-terrain Select\*  
(→P.442)

\* : If equipped



### WARNING

#### ■ When attempting to free a stuck vehicle

If you choose to push the vehicle back and forth to free it, make sure the surrounding area is clear to avoid striking other vehicles, objects or people. The vehicle may also lunge forward or lunge back suddenly as it becomes free. Use extreme caution.

#### ■ When shifting the shift lever

Be careful not to shift the shift lever with the accelerator pedal depressed.

This may lead to unexpected rapid acceleration of the vehicle that may cause an accident resulting in death or serious injury.

● When a warning message for the automatic transmission fluid temperature is displayed while attempting to free a stuck vehicle, immediately remove your foot from the accelerator pedal and wait until the warning message disappears. Otherwise, the transmission may become damaged. (→P.598)



### NOTICE

#### ■ To avoid damaging the transmission and other components

● Avoid spinning the wheels and depressing the accelerator pedal more than necessary.

● If the vehicle remains stuck even after these procedures are performed, the vehicle may require towing to be freed.

# Vehicle specifications

## 8

### 8-1. Specifications

Maintenance data (fuel, oil level, etc.)..... 630

Fuel information ..... 638

Tire information ..... 640

### 8-2. Customization

Customizable features 649

### 8-3. Initialization

Items to initialize ..... 666

## Maintenance data (fuel, oil level, etc.)

## Dimensions and weights

Overall length		196.5 in. (4990 mm)
Overall width		78.0 in. (1980 mm) <sup>*2</sup>
		76.4 in. (1940 mm) <sup>*3</sup>
Overall height <sup>*1</sup>		76.2 in. (1935 mm) <sup>*2</sup>
		75.8 in. (1925 mm) <sup>*3</sup>
Wheelbase		112.2 in. (2850 mm)
Tread	Front	65.5 in. (1664 mm) <sup>*2</sup>
		64.7 in. (1644 mm) <sup>*3</sup>
	Rear	65.7 in. (1668 mm) <sup>*2</sup>
		64.9 in. (1648 mm) <sup>*3</sup>
Vehicle capacity weight (Occupants + luggage)	5-passenger models	1100 lb. (500 kg)
	7-passenger models	1235 lb. (560 kg) <sup>*4, 5</sup>
		1280 lb. (580 kg) <sup>*4, 6</sup>
		1300 lb. (590 kg) <sup>*5, 7</sup>
		1245 lb. (565 kg) <sup>*6, 7</sup>
TWR (trailer weight + cargo weight)	With brake	6000 lb. (2720 kg)
	Without brake	1650 lb. (750 kg)

<sup>\*1</sup>: Unladen vehicle

<sup>\*2</sup>: Vehicles without 245/70R18 tires

<sup>\*3</sup>: Vehicles with 245/70R18 tires

<sup>\*4</sup>: Vehicles without SDM (Stabilizer with Disconnection Mechanism)

<sup>\*5</sup>: Vehicles without moon roof

<sup>\*6</sup>: Vehicles with moon roof

<sup>\*7</sup>: Vehicles with SDM (Stabilizer with Disconnection Mechanism)

## Seating capacity

Seating capacity	5-passenger models	5 (Front 2, Rear 3)
	7-passenger models	7 (Front 2, Rear 5)

## Vehicle identification

### ■ Vehicle identification number

The vehicle identification number (VIN) is the legal identifier for your vehicle. This is the primary identification number for your Toyota. It is used in registering the ownership of your vehicle.

On some models, this number is stamped on the front right frame.

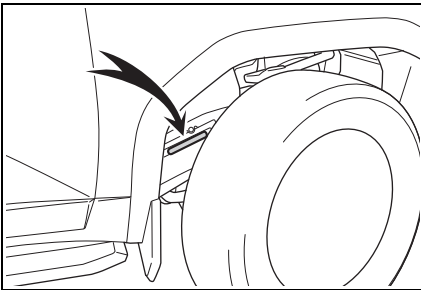

This number is also on the top left of the instrument panel.

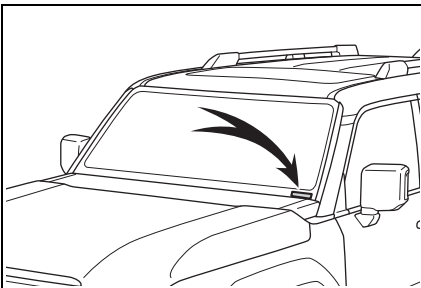

This number is also on the Certification Label.

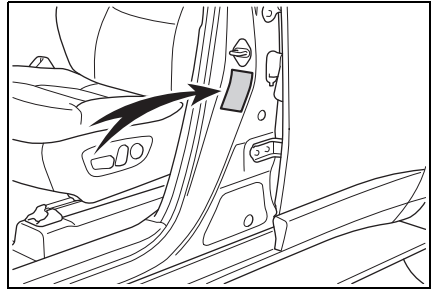

### ■ Engine number

The engine number is stamped on the engine block as shown.

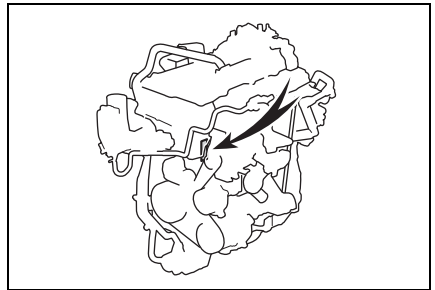

**Engine**

Model	2.4 L 4-cylinder (T24A-FTS)
Type	4-cylinder in line, 4-cycle, gasoline (with turbocharger)
Bore and stroke	3.44 × 3.91 in. (87.5 × 99.5 mm)
Displacement	146.0 cu. in. (2393 cm <sup>3</sup> )
Valve clearance	Automatic adjustment
Drive belt tension	Automatic adjustment

**Fuel**

Fuel type	Unleaded gasoline only
Octane rating	91 (Research Octane Number 96) or higher
Fuel tank capacity (Reference)	17.9 gal. (68 L, 14.9 Imp.gal.)

**Electric motor (traction motor)**

Type	Permanent magnet synchronous motor
Maximum output	36 kW
Maximum torque	184 ft•lbf (250 N•m, 25.5 kgf•m)

**Hybrid battery (traction battery)**

Type	Nickel-metal hydride battery
Voltage	7.2 V/module
Capacity	6.5 Ah
Quantity	40 modules
Nominal voltage	288 V



## Lubrication system

### Oil capacity (Drain and refill [Reference\*])

With filter	5.9 qt. (5.6 L, 4.9 Imp.qt.)
Without filter	5.6 qt. (5.3 L, 4.7 Imp.qt.)

\*: The engine oil capacity is a reference quantity to be used when changing the engine oil. When actually adding the engine oil, make sure that the oil level is between the low level mark and refill upper limit mark (→P.544). Warm up the engine and turn off the hybrid system, wait about 5 minutes, and check the oil level on the dipstick.

### Engine oil selection

“Toyota Genuine Motor Oil” is used in your Toyota vehicle. Use Toyota approved “Toyota Genuine Motor Oil” or equivalent to satisfy the following grade and viscosity.

Oil grade:

ILSAC GF-6A multigrade engine oil

Recommended viscosity:

SAE 0W-20

SAE 0W-20 is the best choice for good fuel economy and good starting in cold weather.

If SAE 0W-20 is not available, SAE 5W-20 oil may be used. However, it must be replaced

with SAE 0W-20 at the next oil change.

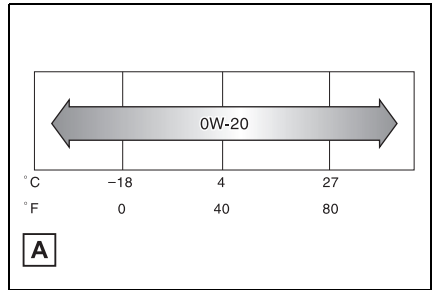

### A Outside temperature

Oil viscosity (0W-20 is explained here as an example):

- The 0W in 0W-20 indicates the characteristic of the oil which allows cold startability. Oils with a lower value before the W allow for easier starting of the engine in cold weather.
- The 20 in 0W-20 indicates the viscosity characteristic of the oil when the oil is at high temperature. An oil with a higher viscosity (one with a higher value) may be better suited if the vehicle is operated at high speeds, or under extreme load conditions.

How to read oil container label:

The International Lubricant Specification Advisory Committee (ILSAC) Certification Mark is added to some oil containers to help you select the oil you should use.



## Cooling system

Capacity* <sup>1</sup>	Gasoline engine	12.2 qt. (11.5 L, 10.1 Imp.qt.)* <sup>2</sup> 14.3 qt. (13.5 L, 11.9 Imp.qt.)* <sup>3</sup>
	Power control unit	2.5 qt. (2.4 L, 2.1 Imp.qt.)
Coolant type	Use either of the following: <ul style="list-style-type: none"> <li>• “Toyota Super Long Life Coolant”</li> <li>• Similar high-quality ethylene glycol-based non-silicate, non-amine, non-nitrite, and non-borate coolant with long-life hybrid organic acid technology</li> </ul> Do not use plain water alone.	

\*<sup>1</sup>: The coolant capacity is the quantity of reference. If replacement is necessary, contact your Toyota dealer.

\*<sup>2</sup>: Vehicles without rear air conditioning system

\*<sup>3</sup>: Vehicles with rear air conditioning system

## Ignition system

### ■ Spark plug

Make	NGK DILZKAR8E7H
Gap	0.028 in. (0.7 mm)



### NOTICE

#### ■ Iridium-tipped spark plugs

Use only iridium-tipped spark plugs. Do not adjust gap when tuning engine.

## Electrical system (12-volt battery)

Open voltage at 68°F (20°C):	12.0 V or higher (Turn the power switch to OFF and turn on the high beam headlights for 30 seconds.)
Charging rates:	5 A max.

## Differential

Oil capacity	Front	1.29 qt. (1.22 L, 1.07 Imp.qt.)
	Rear	5.94 qt. (5.62 L, 4.94 Imp.qt.)
Oil type and viscosity		Toyota Genuine Differential Gear Oil LT 75W-85 GL-5 or equivalent

Your Toyota vehicle is filled with “Toyota Genuine Differential Gear Oil” at the factory.

Use Toyota approved “Toyota Genuine Differential Gear Oil” or an equivalent of matching quality to satisfy the above specification. Please contact your Toyota dealer for further details.

## Automatic transmission

Fluid capacity (Reference)	13.2 qt. (12.5 L, 11.0 Imp.qt.)
Fluid type	Toyota Genuine ATF WS

The fluid capacity is the quantity of reference. If replacement is necessary, contact your Toyota dealer.



### NOTICE

#### Automatic transmission fluid type

Using transmission fluid other than the above type may cause abnormal noise or vibration, or damage the transmission of your vehicle.

## Transfer

Oil capacity	1.48 qt. (1.40 L, 1.23 Imp.qt.)
--------------	---------------------------------

Oil type *	Toyota Genuine Transfer Gear oil LF or equivalent
Recommended oil viscosity	SAE 75W

\*: Your Toyota vehicle is filled with “Toyota Genuine Transfer Gear oil LF” at the factory. Use Toyota approved “Toyota Genuine Transfer Gear oil LF” or an equivalent of matching quality to satisfy the above specification. Please contact your Toyota dealer for further details.

## Brakes

Pedal clearance *	5.03 in. (128 mm)
Pedal free play	0.04 — 0.24 in. (1 — 6 mm)
Brake pad wear limit	0.04 in. (1 mm)
Fluid type	SAE J1703 or FMVSS No. 116 DOT 3 SAE J1704 or FMVSS No. 116 DOT 4

\*: Minimum pedal clearance when depressed with a force of 67 lbf (300 N, 31 kgf) while the hybrid system is operating.

## Chassis lubrication (propeller shafts)

### ► Front

Spider	Lithium base chassis grease, NLGI No.2
Slide yoke	Molybdenum-disulfide lithium base chassis grease, NLGI No.2 or lithium base chassis grease, NLGI No.2

### ► Rear

Spider	Lithium base chassis grease, NLGI No.2
--------	--

## Steering

Free play	Less than 1.18 in. (30 mm)
-----------	----------------------------

## Tires and wheels

### ► 20-inch tires

Tire size	265/60R20 112H
Tire inflation pressure (Recommended cold tire inflation pressure)	Front: 33 psi (230 kPa, 2.3 kgf/cm <sup>2</sup> or bar) Rear: 33 psi (230 kPa, 2.3 kgf/cm <sup>2</sup> or bar) Spare: 33 psi (230 kPa, 2.3 kgf/cm <sup>2</sup> or bar)
Wheel size	20 × 7 1/2J
Wheel nut torque	97 ft•lbf (131 N•m, 13.4 kgf•m)

### ► 18-inch tires (type A)

Tire size	245/70R18 110H
Tire inflation pressure (Recommended cold tire inflation pressure)	Front: 33 psi (230 kPa, 2.3 kgf/cm <sup>2</sup> or bar) Rear: 33 psi (230 kPa, 2.3 kgf/cm <sup>2</sup> or bar) Spare: 33 psi (230 kPa, 2.3 kgf/cm <sup>2</sup> or bar)
Wheel size	18 × 7 J
Wheel nut torque	97 ft•lbf (131 N•m, 13.4 kgf•m)

### ► 18-inch tires (type B)

Tire size	265/70R18 116S
Tire inflation pressure (Recommended cold tire inflation pressure)	Front: 33 psi (230 kPa, 2.3 kgf/cm <sup>2</sup> or bar) Rear: 33 psi (230 kPa, 2.3 kgf/cm <sup>2</sup> or bar) Spare: 33 psi (230 kPa, 2.3 kgf/cm <sup>2</sup> or bar)
Wheel size	18 × 7 1/2J
Wheel nut torque	97 ft•lbf (131 N•m, 13.4 kgf•m)

## Fuel information

You must only use unleaded gasoline.

Select premium unleaded gasoline with an octane rating of 91 (Research Octane Number 96) or higher required for optimum engine performance and fuel economy.

At minimum, the gasoline you use should meet the specifications of ASTM D4814 in the U.S.A..

### Gasoline quality

In very few cases, driveability problems may be caused by the brand of gasoline you are using. If driveability problems persist, try changing the brand of gasoline. If this does not correct the problem, consult your Toyota dealer.

### Recommendation of the use of gasoline containing detergent additives

- Toyota recommends the use of gasoline that contains detergent additives to avoid the build-up of engine deposits.
- All gasoline sold in the U.S.A. contains minimum detergent additives to clean and/or keep clean intake systems, per EPA's lowest additives concentration program.
- Toyota strongly recommends the use of Top Tier Detergent Gasoline. For more information on Top Tier Detergent Gasoline and a list of marketers, please go to the official website [www.toptiergas.com](http://www.toptiergas.com).

### Recommendation of the use of low emissions gasoline

Gasolines containing oxygenates

such as ethers and ethanol, as well as reformulated gasolines, are available in some cities. These fuels are typically acceptable for use, providing they meet other fuel requirements.

Toyota recommends these fuels, since the formulations allow for reduced vehicle emissions.

### Non-recommendation of the use of blended gasoline

- Use only gasoline containing up to 15% ethanol.

DO NOT use any flex-fuel or gasoline that could contain more than 15% ethanol, including from any pump labeled E30 (30% ethanol **A**), E50 (50% ethanol **B**), E85 (85% ethanol **C**) (which are only some examples of fuel containing more than 15% ethanol).

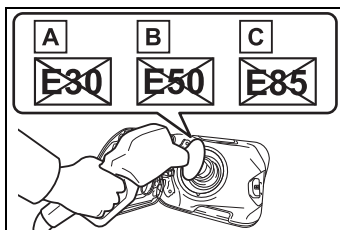

- If you use gasoline in your vehicle, be sure that it has an octane rating no lower than 91.
- Toyota does not recommend the use of gasoline containing methanol.

### Non-recommendation of the use of gasoline containing MMT

Some gasoline contains an octane enhancing additive called MMT (Methylcyclopentadienyl Manganese Tricarbonyl).

Toyota does not recommend the use of gasoline that contains MMT. If fuel containing MMT is used, your emission control system may be adversely affected.

The malfunction indicator lamp on the instrument cluster may come on. If this happens, contact your Toyota dealer for service.

### ■ If your engine knocks

- Consult your Toyota dealer.
- You may occasionally notice light knocking for a short time while accelerating or driving uphill. This is normal and there is no need for concern.



### NOTICE

#### ■ Notice on fuel quality

- Do not use improper fuels. If improper fuels are used, the engine will be damaged.
- Do not use leaded gasoline. Leaded gasoline can cause damage to your vehicle's three-way catalytic converters causing the emission control system to malfunction.
- Do not use gasohol other than the type previously stated. Other gasohol may cause fuel system damage or vehicle performance problems.
- Using unleaded gasoline with an octane number or rating lower than the level previously stated may cause persistent heavy knocking. At worst, this may lead to engine damage and will void the vehicle warranty.

#### ■ Fuel-related poor driveability

If poor driveability (poor hot starting, vaporization, engine knocking, etc.) is encountered after using a different type of fuel, discontinue the use of that type of fuel.

#### ■ When refueling with gasohol

Take care not to spill gasohol. It can damage your vehicle's paint.

## Tire information

## Typical tire symbols

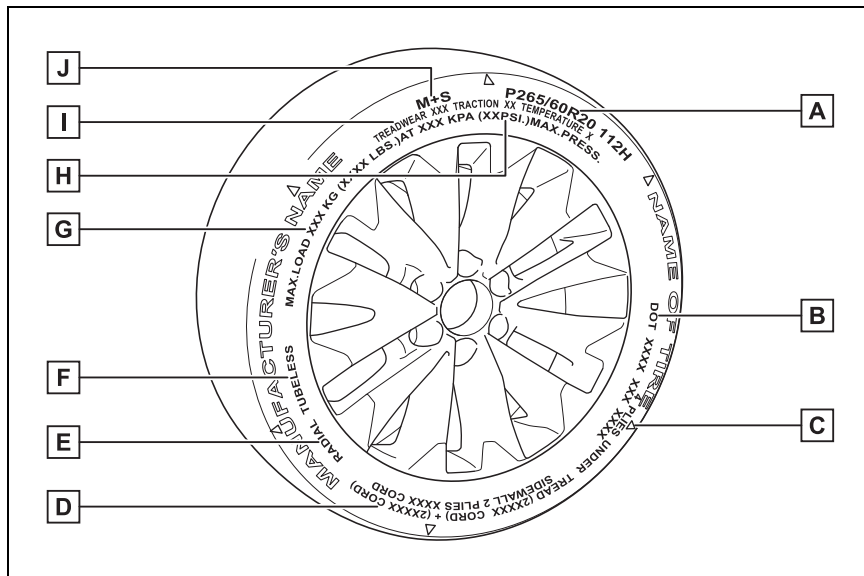

**A** Tire size (→P.641)

**B** DOT and Tire Identification Number (TIN) (→P.641)

**C** Location of treadwear indicators (→P.551)

**D** Tire ply composition and materials

Plies are layers of rubber-coated parallel cords. Cords are the strands which form the plies in a tire.

**E** Radial tires or bias-ply tires

A radial tire has “RADIAL” on the sidewall. A tire not marked “RADIAL” is a bias-ply tire.

**F** TUBELESS or TUBE TYPE

A tubeless tire does not have a tube and air is directly put into the tire. A tube type tire has a tube inside the tire and the tube maintains the air pressure.

**G** Load limit at maximum cold tire inflation pressure (→P.644)

**H** Maximum cold tire inflation pressure (→P.644)

This means the pressure to which a tire may be inflated.



**I** Uniform tire quality grading

For details, see “Uniform Tire Quality Grading” that follows.

**J** Summer tires or all season tires (→P.552)

An all season tire has “M+S” on the sidewall. A tire not marked “M+S” is a summer tire.

### Typical DOT and Tire Identification Number (TIN)

## ▶ Type A

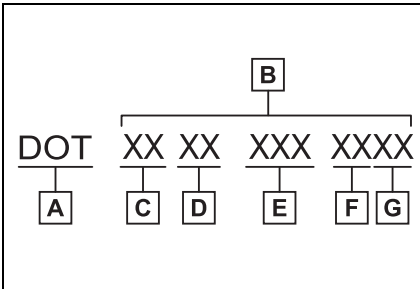
**A** DOT symbol\***B** Tire Identification Number (TIN)**C** Tire manufacturer's identification mark**D** Tire size code**E** Manufacturer's optional tire type code (3 or 4 letters)**F** Manufacturing week**G** Manufacturing year

\*: The DOT symbol certifies that the tire conforms to applicable Federal Motor Vehicle Safety Standards.

## ▶ Type B

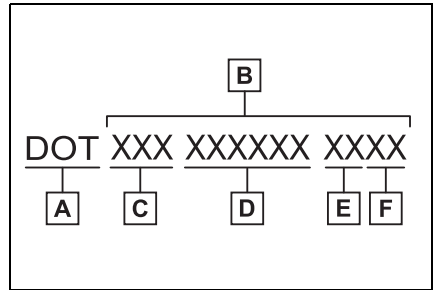
**A** DOT symbol\***B** Tire Identification Number (TIN)**C** Tire manufacturer's identification mark**D** Manufacturer's code**E** Manufacturing week**F** Manufacturing year

\*: The DOT symbol certifies that the tire conforms to applicable Federal Motor Vehicle Safety Standards.

### Tire size

#### ■ Typical tire size information

The illustration indicates typical tire size.

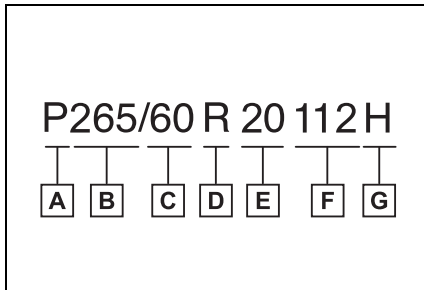

- A** Tire use  
(P = Passenger car,  
T = Temporary use)
- B** Section width (millimeters)
- C** Aspect ratio  
(tire height to section width)
- D** Tire construction code  
(R = Radial, D = Diagonal)
- E** Wheel diameter (inches)
- F** Load index (2 digits or 3 digits)
- G** Speed symbol (alphabet with one letter)

#### ■ Tire dimensions

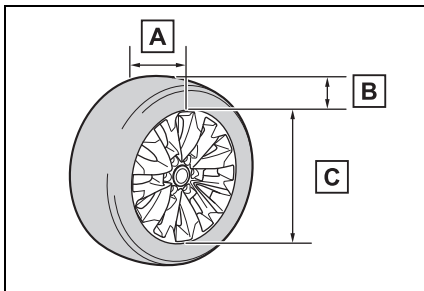

- A** Section width
- B** Tire height
- C** Wheel diameter

#### Tire section names

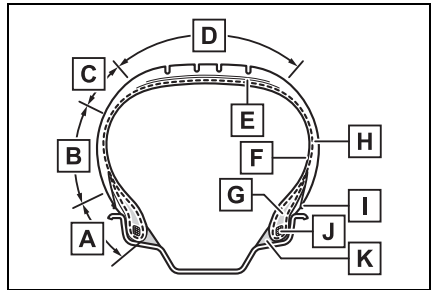

- A** Bead
- B** Sidewall
- C** Shoulder
- D** Tread
- E** Belt
- F** Inner liner
- G** Reinforcing rubber
- H** Carcass
- I** Rim lines
- J** Bead wires
- K** Chafer

#### Uniform Tire Quality Grading

This information has been prepared in accordance with regulations issued by the National Highway Traffic Safety Administration of the U.S. Department of Transportation.

It provides the purchasers and/or prospective purchasers of Toyota vehicles with information on uniform tire quality grad-

ing.

Your Toyota dealer will help answer any questions you may have as you read this information.

### ■ DOT quality grades

All passenger vehicle tires must conform to Federal Safety Requirements in addition to these grades. Quality grades can be found where applicable on the tire sidewall between tread shoulder and maximum section width.

For example: Treadwear 200 Traction AA Temperature A

### ■ Treadwear

The treadwear grade is a comparative rating based on the wear rate of the tire when tested under controlled conditions on a specified government test course.

For example, a tire graded 150 would wear one and a half (1 - 1/2) times as well on the government course as a tire graded 100.

The relative performance of tires depends upon the actual conditions of their use. Performance may differ significantly from the norm due to variations in driving habits, service practices and differences in road characteristics and climate.

### ■ Traction AA, A, B, C

The traction grades, from highest to lowest, are AA, A, B and C, and they represent the tire's ability to stop on wet pavement as measured under controlled

conditions on specified government test surfaces of asphalt and concrete.

A tire marked C may have poor traction performance.

Warning: The traction grade assigned to this tire is based on braking (straight ahead) traction tests and does not include cornering (turning) traction.

### ■ Temperature A, B, C

The temperature grades are A (the highest), B, and C, representing the tire's resistance to the generation of heat and its ability to dissipate heat when tested under controlled conditions on a specified indoor laboratory test wheel.

Sustained high temperature can cause the material of the tire to degenerate and reduce tire life, and excessive temperature can lead to sudden tire failure.

Grade C corresponds to a level of performance which all passenger car tires must meet under the Federal Motor Vehicle Safety Standard No. 109.

Grades B and A represent higher levels of performance on the laboratory test wheel than the minimum required by law.

Warning: The temperature grades of a tire assume that it is properly inflated and not overloaded.

Excessive speed, underinflation, or excessive loading, either separately or in combination, can cause heat buildup and possible tire failure.

## Glossary of tire terminology

Tire related term	Meaning
Cold tire inflation pressure	Tire pressure when the vehicle has been parked for three hours or more, or has not been driven more than 1 mile or 1.5 km under that condition
Maximum inflation pressure	The maximum cold inflated pressure to which a tire may be inflated, shown on the sidewall of the tire
Recommended inflation pressure	Cold tire inflation pressure recommended by a manufacturer
Accessory weight	The combined weight (in excess of those standard items which may be replaced) of hybrid transmission, power steering, power brakes, power windows, power seats, radio and heater, to the extent that these items are available as factory-installed equipment (whether installed or not)
Curb weight	The weight of a motor vehicle with standard equipment, including the maximum capacity of fuel, oil and coolant, and if so equipped, air conditioning and additional weight optional engine
Maximum loaded vehicle weight	The sum of: (a) Curb weight (b) Accessory weight (c) Vehicle capacity weight (d) Production options weight
Normal occupant weight	150 lb. (68 kg) times the number of occupants specified in the second column of Table 1* that follows
Occupant distribution	Distribution of occupants in a vehicle as specified in the third column of Table 1* below
Production options weight	The combined weight of installed regular production options weighing over 5 lb. (2.3 kg) in excess of the standard items which they replace, not previously considered in curb weight or accessory weight, including heavy duty brakes, ride levelers, roof rack, heavy duty 12-volt battery, and special trim

Tire related term	Meaning
Rim	A metal support for a tire or a tire and tube assembly upon which the tire beads are seated
Rim diameter (Wheel diameter)	Nominal diameter of the bead seat
Rim size designation	Rim diameter and width
Rim type designation	The industry manufacturer's designation for a rim by style or code
Rim width	Nominal distance between rim flanges
Vehicle capacity weight (Total load capacity)	The rated cargo and luggage load plus 150 lb. (68 kg) times the vehicle's designated seating capacity
Vehicle maximum load on the tire	The load on an individual tire that is determined by distributing to each axle its share of the maximum loaded vehicle weight, and dividing by two
Vehicle normal load on the tire	The load on an individual tire that is determined by distributing to each axle its share of curb weight, accessory weight, and normal occupant weight (distributed in accordance with Table 1* below), and dividing by two
Weather side	The surface area of the rim not covered by the inflated tire
Bead	The part of the tire that is made of steel wires, wrapped or reinforced by ply cords and that is shaped to fit the rim
Bead separation	A breakdown of the bond between components in the bead
Bias ply tire	A pneumatic tire in which the ply cords that extend to the beads are laid at alternate angles substantially less than 90 degrees to the center-line of the tread
Carcass	The tire structure, except tread and sidewall rubber which, when inflated, bears the load
Chunking	The breaking away of pieces of the tread or sidewall
Cord	The strands forming the plies in the tire

Tire related term	Meaning
Cord separation	The parting of cords from adjacent rubber compounds
Cracking	Any parting within the tread, sidewall, or innerliner of the tire extending to cord material
CT	A pneumatic tire with an inverted flange tire and rim system in which the rim is designed with rim flanges pointed radially inward and the tire is designed to fit on the underside of the rim in a manner that encloses the rim flanges inside the air cavity of the tire
Extra load tire	A tire designed to operate at higher loads and at higher inflation pressures than the corresponding standard tire
Groove	The space between two adjacent tread ribs
Innerliner	The layer(s) forming the inside surface of a tubeless tire that contains the inflating medium within the tire
Innerliner separation	The parting of the innerliner from cord material in the carcass
Intended outboard sidewall	(a)The sidewall that contains a whitewall, bears white lettering, or bears manufacturer, brand, and/or model name molding that is higher or deeper than the same molding on the other sidewall of the tire, or (b)The outward facing sidewall of an asymmetrical tire that has a particular side that must always face outward when mounted on a vehicle
Light truck (LT) tire	A tire designated by its manufacturer as primarily intended for use on lightweight trucks or multipurpose passenger vehicles
Load rating	The maximum load that a tire is rated to carry for a given inflation pressure
Maximum load rating	The load rating for a tire at the maximum permissible inflation pressure for that tire
Maximum permissible inflation pressure	The maximum cold inflation pressure to which a tire may be inflated

Tire related term	Meaning
Measuring rim	The rim on which a tire is fitted for physical dimension requirements
Open splice	Any parting at any junction of tread, sidewall, or innerliner that extends to cord material
Outer diameter	The overall diameter of an inflated new tire
Overall width	The linear distance between the exteriors of the sidewalls of an inflated tire, including elevations due to labeling, decorations, or protective bands or ribs
Passenger car tire	A tire intended for use on passenger cars, multi-purpose passenger vehicles, and trucks, that have a gross vehicle weight rating (GVWR) of 10,000 lb. or less.
Ply	A layer of rubber-coated parallel cords
Ply separation	A parting of rubber compound between adjacent plies
Pneumatic tire	A mechanical device made of rubber, chemicals, fabric and steel or other materials, that, when mounted on an automotive wheel, provides the traction and contains the gas or fluid that sustains the load
Radial ply tire	A pneumatic tire in which the ply cords that extend to the beads are laid at substantially 90 degrees to the centerline of the tread
Reinforced tire	A tire designed to operate at higher loads and at higher inflation pressures than the corresponding standard tire
Section width	The linear distance between the exteriors of the sidewalls of an inflated tire, excluding elevations due to labeling, decoration, or protective bands
Sidewall	That portion of a tire between the tread and bead
Sidewall separation	The parting of the rubber compound from the cord material in the sidewall

Tire related term	Meaning
Snow tire	A tire that attains a traction index equal to or greater than 110, compared to the ASTM E-1136 Standard Reference Test Tire, when using the snow traction test as described in ASTM F-1805-00, Standard Test Method for Single Wheel Driving Traction in a Straight Line on Snow-and Ice-Covered Surfaces, and which is marked with an Alpine Symbol (  ) on at least one sidewall
Test rim	The rim on which a tire is fitted for testing, and may be any rim listed as appropriate for use with that tire
Tread	That portion of a tire that comes into contact with the road
Tread rib	A tread section running circumferentially around a tire
Tread separation	Pulling away of the tread from the tire carcass
Treadwear indicators (TWI)	The projections within the principal grooves designed to give a visual indication of the degrees of wear of the tread
Wheel-holding fixture	The fixture used to hold the wheel and tire assembly securely during testing

\*: Table 1 — Occupant loading and distribution for vehicle normal load for various designated seating capacities

Designated seating capacity, Number of occupants	Vehicle normal load, Number of occupants	Occupant distribution in a normally loaded vehicle
2 through 4	2	2 in front
5 through 10	3	2 in front, 1 in second seat
11 through 15	5	2 in front, 1 in second seat, 1 in third seat, 1 in fourth seat
16 through 20	7	2 in front, 2 in second seat, 2 in third seat, 1 in fourth seat



## Customizable features

Your vehicle includes a variety of electronic features that can be personalized to your preferences. The settings of these features can be changed by using the multi-information display, the multimedia display or at your Toyota dealer.

Some of the customizable features are changed in conjunction with the settings of My Settings. (→P.192)

## Customizing vehicle features

### ■ Changing by using the multimedia display

- 1 Select  on the main menu.
- 2 Select “Vehicle customize” on the sub menu.
- 3 Select the item to change the settings of from the list.

### ■ Changing by using the multi-information display

Use the meter control switches to change settings. (→P.97, 108)

- 1 Operate the meter control switch to select . (→P.101, 112)
- 2 Operate the meter control switches to select the desired item to be customized.
- 3 According to the display, select the desired setting.

To go back to the previous screen or exit the customize mode, press



### ■ During customization

Stop the vehicle in a safe place, apply the parking brake, and shift the shift position to P. Also, to prevent 12-volt battery discharge, leave the hybrid system operating while customizing the features.

### WARNING

#### ■ During customization

As the hybrid system needs to be operating during customization, ensure that the vehicle is parked in a place with adequate ventilation. In a closed area such as a garage, exhaust gases including harmful carbon monoxide (CO) may collect and enter the vehicle. This may lead to death or a serious health hazard.

### NOTICE

#### ■ During customization

To prevent 12-volt battery discharge, ensure that the hybrid system is operating while customizing features.

## Customizable features

Some function settings are changed simultaneously with other func-

tions being customized. Contact your Toyota dealer for further details.

- A** Settings that can be changed using the multimedia display
- B** Settings that can be changed using the multi-information display
- C** Settings that can be changed by your Toyota dealer

Definition of symbols: O = Available, — = Not available

■ **Gauges, meters and multi-information display (with 7-inch display) (→P.89, 96)**

Function <sup>*1</sup>	Default setting	Customized setting	<b>A</b>	<b>B</b>	<b>C</b>
Language <sup>*2</sup>	English	French	O	O	—
		Spanish			
Units <sup>*3</sup>	km (km/L)	km (L/100 km)	—	O	—
		miles (MPG Imperial)			
		miles (MPG)			
Meter Style <sup>*2</sup>	“Smart”	“Tough”	—	O	—
		“Sporty”			
Dial Type <sup>*2</sup>	Tachometer	Speedometer	—	O	—
		Simple (non-dial)			
Fuel Economy	The average fuel economy after starting	The average fuel economy since the function was reset	—	O	—
		The average fuel economy after refuel			
Audio system linked display <sup>*2</sup>	On	Off	—	O	—
Traction monitor display <sup>*2</sup>	On	Off	—	O	—
Drive information items (first item) <sup>*2</sup>	Distance	Average Speed	—	O	—
		Total Time			

Function <sup>*1</sup>	Default setting	Customized setting	A	B	C
Drive information items (second item) <sup>*2</sup>	Total Time	Average Speed	—	O	—
		Distance	—	O	—
TRIP A Items (first item) <sup>*2</sup>	Distance	Average Speed	—	O	—
		Total Time	—	O	—
TRIP A Items (second item) <sup>*2</sup>	Total Time	Average Speed	—	O	—
		Distance	—	O	—
TRIP B Items (first item) <sup>*2</sup>	Distance	Average Speed	—	O	—
		Total Time	—	O	—
TRIP B Items (second item) <sup>*2</sup>	Total Time	Average Speed	—	O	—
		Distance	—	O	—
Pop-up display <sup>*2</sup>	On	Off	—	O	—
Suggestion function <sup>*2</sup>	On	On (when the vehicle is stopped)	O	—	O
		Off	—	—	—
Stop light indicator	On	Off	—	O	—



<sup>\*1</sup>: For details about each function: →P.101

<sup>\*2</sup>: The default setting is changed in conjunction with the settings of My Settings.

<sup>\*3</sup>: The default setting varies according to country.

### ■ Gauges, meters and multi-information display (with 12.3-inch display) (→P.92, 106)

Function <sup>*1</sup>	Default setting	Customized setting	A	B	C
Language <sup>*2</sup>	English	French	O	O	—
		Spanish	—	—	—
Units <sup>*3</sup>	km (km/L)	km (L/100 km)	—	O	—
		miles (MPG Imperial)	—	O	—
		miles (MPG)	—	O	—

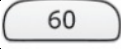
Function <sup>*1</sup>	Default setting	Customized setting	A	B	C
Meter Type <sup>*2</sup>		 <sup>*4</sup>  <sup>*4</sup>	—	O	—
Meter Style <sup>*2</sup>	“Smart”	“Casual” “Tough” “Sporty”	—	O	—
Dial Type <sup>*2</sup>	Tachometer	Speedometer <sup>*5</sup>	—	O	—
Fuel Economy	The average fuel economy after starting	The average fuel economy since the function was reset	—	O	—
Drive information items (first item) <sup>*2</sup>	Distance	Average Speed Total Time	—	O	—
Drive information items (second item) <sup>*2</sup>	Total Time	Average Speed Distance	—	O	—
TRIP A Items (first item) <sup>*2</sup>	Distance	Average Speed Total Time	—	O	—
TRIP A Items (second item) <sup>*2</sup>	Total Time	Average Speed Distance	—	O	—
TRIP B Items (first item) <sup>*2</sup>	Distance	Average Speed Total Time	—	O	—
TRIP B Items (second item) <sup>*2</sup>	Total Time	Average Speed Distance	—	O	—
Pop-up display <sup>*2</sup>	On	Off	—	O	—
Suggestion function <sup>*2</sup>	On	On (when the vehicle is stopped) Off	O	—	O
Stop light indicator	On	Off	—	O	—

<sup>\*1</sup>: For details about each function: →P.112

<sup>\*2</sup>: The default setting is changed in conjunction with the settings of My Set-

tings.

\*3: The default setting varies according to country.

\*4: The on/off operation of the widget can be changed.

\*5: The setting items may not be displayed depending on the meter type

### ■ Head-up Display\*1 (→P.117)

Function	Default setting	Customized setting	A	B	C
Head-up display*2	On	Off	—	O	—
Head-up display type*2	Standard	Full	—	O	—
		Minimum	—	O	—
Head-up display brightness*2	Standard	Desired brightness	—	O	—
Head-up display location*2	Standard	Desired location	—	O	—
Head-up display angle adjustment*2	Standard	Desired angle	—	O	—

\*1: If equipped

\*2: The default setting is changed in conjunction with the settings of My Settings.

### ■ Door lock (→P.129, 618)

Function	Default setting	Customized setting	A	B	C
Unlocking using a mechanical key	Driver's door unlocked in one step, all doors unlocked in two step	All doors unlocked in one step	—	—	O
Automatic door locking function*	Shift position linked door locking operation	Off	—	—	O
		Speed linked door locking operation	O	—	O

Function	Default setting	Customized setting	A	B	C
Automatic door unlocking function*	Shift position linked door unlocking operation	Off	O	—	O
		Driver's door linked door unlocking operation			

\*: The default setting is changed in conjunction with the settings of My Settings.

### ■ Rear seat reminder (→P.131)

Function	Default setting	Customized setting	A	B	C
Rear seat reminder function*	On	Off	—	O	—

\*: The default setting is changed in conjunction with the settings of My Settings.

### ■ Smart key system and wireless remote control (→P.126, 150)

Function	Default setting	Customized setting	A	B	C
Operating signal (Buzzers)*	Standard	Desired volume	O	—	O
Operation signal (Emergency flashers)*	On	Off	O	—	O
Time elapsed before automatic door lock function is activated if door is not opened after being unlocked*	60 seconds	Off	O	—	O
		30 seconds			
		120 seconds			
Open door warning buzzer (When locking the vehicle)	On	Off	—	—	O

\*: The default setting is changed in conjunction with the settings of My Settings.

### ■ Smart key system (→P.150)

Function	Default setting	Customized setting	A	B	C
Smart key system	On	Off	—	—	O
Smart door unlocking	Driver's door	All the doors	O	—	O
Time elapsed before unlocking all the door when gripping and holding the driver's door handle	2 seconds	Off	—	—	O
		1.5 seconds			
		2.5 seconds			
Number of consecutive door lock operations	2 times	As many as desired	—	—	O
Power switch illumination	On	Off	—	—	O

### ■ Wireless remote control (→P.126)

Function	Default setting	Customized setting	A	B	C
Unlocking operation* <sup>1</sup>	Driver's door unlocked in one step, all doors unlocked in two step	All doors unlocked in one step	O	—	O
Locking operation when door opened* <sup>1</sup>	On	Off	O	—	O
The function that activates the  switch of the wireless remote control when locking the door (→P.138)* <sup>2</sup>	On (Unlocking all the door)	On (Unlocking back door only)	—	—	O
		Off			
Theft deterrent panic mode	On	Off	—	—	O

\*<sup>1</sup>: The default setting is changed in conjunction with the settings of My Settings.

\*<sup>2</sup>: If equipped

### ■ Power back door\*<sup>1</sup> (→P.138)

Function	Default setting	Customized setting	A	B	C
Power back door operations	On	Off	—	O	—
Power back door switch operations	Press and hold	One short press	—	—	O
 switch of the wireless remote control operation	Press and hold	One short press	—	—	O
		Push twice			
		Off			
Operation buzzer volume	Level 3	Level 1	—	O	—
		Level 2			
Operation buzzer while the back door is operating* <sup>2</sup>	Off	On	—	—	O
Opening angle	5	1 to 4	—	O	—
		User setting* <sup>3</sup>			
Automatic closing of the back door when lowered	On	Off	—	—	O
Close & lock (Walk-Away) function	Off	On	—	—	O

\*1: If equipped

\*2: The operation buzzer that sounds when the back door begins to operate cannot be turned off.

\*3: The open position is set by the power back door switch. (→P.146)

### ■ Driving position memory\* (→P.187)

Function	Default setting	Customized setting	A	B	C
Function to prevent contact between the head restraint and ceiling (while moving to memory location)	On	Off	—	—	O

\*: If equipped



### ■ Enabling easier driver entry and exit (power easy access system) \*1 (→P.187)

Function	Default setting	Customized setting	A	B	C
Driver's seat slide movement when exiting the vehicle *2	Full	Off	O	—	O
		Partial			
Steering wheel movement *2	Tilt only	Off	O	—	—
		Telescopic only			
		Tilt and telescopic			

\*1: If equipped

\*2: The default setting is changed in conjunction with the settings of My Settings.

### ■ Outside rear view mirrors (→P.177)

Function	Default setting	Customized setting	A	B	C
Automatic mirror folding and extending operation	Linked to the locking/ unlocking of the doors	Off	—	—	O
		Linked to operation of the power switch			

### ■ Power windows and moon roof\* (→P.181, 184)

Function	Default setting	Customized setting	A	B	C
Mechanical key linked operation	Off	On	—	—	O
Wireless remote control linked operation (open)	Off	On	—	—	O
Wireless remote control linked operation signal (buzzer)	On	Off	—	—	O

\*: If equipped

### ■ Moon roof\* (→P.184)

Function	Default setting	Customized setting	A	B	C
Linked operation of components when mechanical key is used	Slide only	Tilt only	—	—	O
Linked operation of components when wireless remote control is used	Slide only	Tilt only	—	—	O

\*: If equipped

### ■ Power switch (→P.225)

Function	Customized setting	A	B	C
ACC customization Enabling/Disabling ACC mode	On/Off	O	—	O

### ■ Automatic light control system (→P.240)

Function	Default setting	Customized setting	A	B	C
Daytime Running Lights* <sup>1, 2</sup>	On	Off	O	—	O
Light sensor sensitivity* <sup>1</sup>	Normal	Brighter	O	—	O
		Bright			
		Dark			
		Darker			
Time elapsed before headlights automatically turn off after doors are closed* <sup>1</sup>	30 seconds	Off	O	—	O
		60 seconds			
		90 seconds			
Windshield wiper linked headlight illumination	On	Off	—	—	O

\*<sup>1</sup>: The default setting is changed in conjunction with the settings of My Settings.

\*<sup>2</sup>: Except for Canada

### ■ Lights (→P.240)

Function	Default setting	Customized setting	A	B	C
Welcome lamp	On	Off	—	—	O

### ■ Pre-Collision System (→P.268)

Function	Customized setting	A	B	C
Pre-Collision System	On/Off	—	O	—
Warning timing *	Later/Default/Earlier	—	O	—

\*: The default setting is changed in conjunction with the settings of My Settings.

### ■ Front Cross Traffic Alert<sup>\*1</sup> (→P.300)

Function	Customized setting	A	B	C
Front Cross Traffic Alert	On/Off	—	O	—
Alert timing <sup>*2</sup>	Later/Default/Earlier	—	O	—

\*1: If equipped

\*2: The default setting is changed in conjunction with the settings of My Settings.

### ■ Lane Departure Alert system (→P.288)

Function	Customized setting	A	B	C
Lane Departure Alert system *	On/Off	—	O	—
Alert timing *	Default/Earlier	—	O	—
Alert options *	Vibration/Audible	—	O	—

\*: The default setting is changed in conjunction with the settings of My Settings.

### ■ Lane Change Assist<sup>\*1</sup> (→P.285)

Function	Customized setting	A	B	C
Lane Change Assist <sup>*2</sup>	On/Off	—	O	—

\*1: If equipped

\*2: The default setting is changed in conjunction with the settings of My Settings.

### ■ Dynamic Radar Cruise Control (→P.305)

Function	Customized setting	A	B	C
Acceleration setting*	High/Mid/Low	—	<input type="radio"/>	—
Guide message*	On/Off	—	<input type="radio"/>	—
Curve speed reduction*	High/Mid/Low/Off	—	<input type="radio"/>	—

\*: The default setting is changed in conjunction with the settings of My Settings.

### ■ Proactive Driving Assist (→P.294)

Function	Customized setting	A	B	C
Proactive Driving Assist (PDA)*	On/Off	—	<input type="radio"/>	—
Support sensitivity*	Low/Mid/High	—	<input type="radio"/>	—
Steering Assist (SA)*	On/Off	—	<input type="radio"/>	—
Deceleration Assist (DA)*	On/Off	—	<input type="radio"/>	—
Obstacle Anticipation Assist (OAA)*	On/Off	—	<input type="radio"/>	—

\*: The default setting is changed in conjunction with the settings of My Settings.

### ■ Road Sign Assist\*1 (→P.302)

Function	Customized setting	A	B	C
Road Sign Assist*2	On/Off	—	<input type="radio"/>	—
Excess speed notification method*2	None/Visual/Visual & Audible	—	<input type="radio"/>	—
Other notifications method*2	None/Visual/Visual & Audible	—	<input type="radio"/>	—
Excess speed notification level*2	5 mph (10 km/h) / 3 mph (5 km/h) / 1 mph (2 km/h)	—	<input type="radio"/>	—

\*1: If equipped

\*2: The default setting is changed in conjunction with the settings of My Settings.

### ■ Driver break suggestion (→P.291)

Function	Customized setting	A	B	C
Driver break suggestion	On/Off	—	O	—

### ■ Traffic Jam Assist\*<sup>1</sup> (→P.322)

Function	Customized setting	A	B	C
Traffic Jam Assist* <sup>2</sup>	On/Off	—	O	—
Driver Monitor Camera Recording* <sup>2</sup>	On/Off	—	O	—

\*1: If equipped

\*2: This setting changes in accordance with My Settings.

### ■ Driver monitor\*<sup>1</sup> (→P.266)

Function	Customized setting	A	B	C
Warning function* <sup>2</sup>	On/Off	—	O	—

\*1: If equipped

\*2: The default setting is changed in conjunction with the settings of My Settings.

### ■ BSM (Blind Spot Monitor) (→P.328)

Function	Customized setting	A	B	C
BSM (Blind Spot Monitor)	On/Off	—	O	—
Outside rear view mirror indicator brightness*	Dim/Bright	—	O	—
Alert timing for presence of approaching vehicle (sensitivity)*	Late/Intermediate/Early	—	O	—
Buzzer warning*	On/Off	—	O	—

\*: The default setting is changed in conjunction with the settings of My Settings.

### ■ Safe Exit Assist (→P.333)

Function	Customized setting	A	B	C
Safe Exit Assist	On/Off	—	O	—
Outside rear view mirrors display*	On/Off	—	O	—
Detection sensitivity*	Low/Mid/High	—	O	—

\*: The default setting is changed in conjunction with the settings of My Settings.

### ■ Intuitive parking assist (→P.337)

Function	Customized setting	A	B	C
Intuitive parking assist	On/Off	—	O	—
Buzzer volume of intuitive parking assist when operating* <sup>1, 2</sup>	Level1 / Level2 / Level3	—	O	—

\*<sup>1</sup>: The default setting is changed in conjunction with the settings of My Settings.

\*<sup>2</sup>: The sound volume is linked among the buzzer volume of the intuitive parking assist, RCTA, and RCD\*<sup>3</sup>.

\*<sup>3</sup>: If equipped

### ■ RCTA (Rear Cross Traffic Alert) function (→P.343)

Function	Customized setting	A	B	C
RCTA (Rear Cross Traffic Alert) function	On/Off	—	O	—
Buzzer volume of RCTA when operating* <sup>1, 2</sup>	Level1/Level2/Level3	—	O	—

\*<sup>1</sup>: The default setting is changed in conjunction with the settings of My Settings.

\*<sup>2</sup>: This setting is linked with the buzzer volume of the intuitive parking assist, RCTA, and RCD\*<sup>3</sup>.

\*<sup>3</sup>: If equipped

### ■ RCD (Rear Camera Detection) function\* (→P.349)

Function	Customized setting	A	B	C
RCD (Rear Camera Detection) function	On/Off	—	O	—

\*: If equipped

### ■ Multi-terrain Monitor\*<sup>1</sup> (→P.413)

Function	Default setting	Customized setting	A	B	C
Cornering View* <sup>2</sup>	On	Off	O	—	—
View Under Vehicle* <sup>2</sup>	On	Off	O	—	—
TOYOTA Park Assist 3D Display* <sup>2</sup>	On	Off	O	—	—
Front side of TOYOTA Park Assist Distance* <sup>2</sup>	Near	Off	O	—	—
Rear side of TOYOTA Park Assist Distance* <sup>2</sup>	Near	Off	O	—	—
Vehicle Body Color* <sup>2</sup>	Color 1	Color 2 to 5	O	—	—

\*<sup>1</sup>: If equipped

\*<sup>2</sup>: The default setting is changed in conjunction with the settings of My Settings.

### ■ Automatic air conditioning system (→P.468)

Function	Default setting	Customized setting	A	B	C
Switching between outside air and recirculated air mode linked to "AUTO" switch operation*	On	Off	O	—	O
A/C auto switch operation*	On	Off	O	—	O

\*: The default setting is changed in conjunction with the settings of My Settings.

### ■ Illumination (→P.483)

Function	Default setting	Customized setting	A	B	C
Time elapsed before the interior lights turn off* <sup>1</sup>	15 seconds	Off	O	—	O
		7.5 seconds			
		30 seconds			
Operation after the power switch is turned off	On	Off	—	—	O
Operation when you approach the vehicle with the electronic key on your person	On	Off	—	—	O
Operation when the doors are unlocked	On	Off	—	—	O
All zones: brightness of the inside door handle lights* <sup>2</sup> , pull handle lights* <sup>2</sup> and footwell lights* <sup>2</sup> , etc* <sup>1, 2</sup>	Standard	Desired brightness	O	—	O
Lighting of footwell lights* <sup>2</sup>	On	Off	—	—	O
Lighting of front inside door handle lights* <sup>2</sup> and front pull handle lights* <sup>2</sup>	On	Off	—	—	O
Lighting of rear inside door handle lights* <sup>2</sup> and rear pull handle lights* <sup>2</sup>	On	Off	—	—	O
Time elapsed before the outer foot lights* <sup>2</sup> and running board lights* <sup>2</sup> turn off* <sup>1</sup>	15 seconds	Off	O	—	O
		7.5 seconds			
		30 seconds			



Function	Default setting	Customized setting	A	B	C
Operation of the outer foot lights <sup>*2</sup> and running board lights <sup>*2</sup> when you approach the vehicle with the electronic key on your person	On	Off	—	—	O
Operation of the outer foot lights <sup>*2</sup> and running board lights <sup>*2</sup> when the doors are unlocked	On	Off	—	—	O
Operation of the outer foot lights <sup>*2</sup> and running board lights <sup>*2</sup> when a door is opened	On	Off	—	—	O

\*1: The default setting is changed in conjunction with the settings of My Settings.

\*2: If equipped

### ■ Vehicle customization

- When the smart key system is off, the entry unlock function cannot be customized.
- When the doors remain closed after unlocking the doors and the timer activated automatic door lock function activates, signals will be generated in accordance with the operation buzzer volume and operational signal (Emergency flashers) function settings.
- Some settings can be changed using a switch or the multimedia display. If a setting is changed using a switch, the changed setting will not be reflected on the multimedia display. Until the power switch is turned off and then turned back to ON.

## Items to initialize

The following items must be initialized for normal system operation after such cases as the 12-volt battery being reconnected, or maintenance being performed on the vehicle:

### List of the items to initialize

Item	When to initialize	Reference
Tire pressure warning system	<ul style="list-style-type: none"> <li>• When rotating the tires</li> <li>• When the tire inflation pressure is changed by changing tire size. (When there are multiple specified pressures)</li> <li>• After registering the ID codes</li> </ul>	P.554
Message indicating maintenance is required	<ul style="list-style-type: none"> <li>• After the maintenance is performed</li> </ul>	P.534
Oil maintenance	<ul style="list-style-type: none"> <li>• After the maintenance is performed</li> </ul>	P.544
Power back door*	<ul style="list-style-type: none"> <li>• After reconnecting or changing the 12-volt battery</li> </ul>	P.142
Power window	<ul style="list-style-type: none"> <li>• When functioning abnormally</li> </ul>	P.181
Moon roof*		P.185

\*: If equipped

**9-1. For owners**

Reporting safety defects for  
U.S. owners..... 668

Reporting safety defects for  
Canadian owners ..... 669

Seat belt instructions for  
Canadian owners (in  
French)..... 669

SRS airbag instructions for  
Canadian owners (in  
French)..... 671

Headlight aim instructions  
for Canadian owners (in  
French)..... 677

## Reporting safety defects for U.S. owners

If you believe that your vehicle has a defect which could cause a crash or could cause injury or death, you should immediately inform the National Highway Traffic Safety Administration (NHTSA) in addition to notifying Toyota Motor Sales, U.S.A., Inc. (Toll-free: 1-800-331-4331).

If NHTSA receives similar complaints, it may open an investigation, and if it finds that a safety defect exists in a group of vehicles, it may order a recall and remedy campaign. However, NHTSA cannot become involved in individual problems between you, your dealer, or Toyota Motor Sales, U.S.A., Inc.

To contact NHTSA, you may call the Vehicle Safety Hotline toll-free at 1-888-327-4236 (TTY: 1-800-424-9153); go to <http://www.safercar.gov>; or write to: Administrator, NHTSA, 1200 New Jersey Ave. SE., Washington, DC 20590. You can also obtain other information about motor vehicle safety from <http://www.safercar.gov>.

## Reporting safety defects for Canadian owners

Canadian customers who wish to report a safety-related defect to Transport Canada, Defects Investigations and Recalls, may telephone the toll-free hotline 1-800-333-0510, mail Transport Canada - ASFAD, 330 Sparks Street, Ottawa, ON, K1A 0N5, or complete the online form at <https://www.tc.gc.ca/recalls>.

## Seat belt instructions for Canadian owners (in French)

The following is a French explanation of seat belt instructions extracted from the seat belt section in this manual.

See the seat belt section for more detailed seat belt instructions in English.

## Utilisation adéquate des ceintures de sécurité

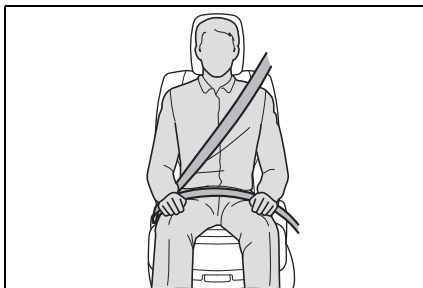

- Tirez sur la ceinture épaulière jusqu'à ce qu'elle recouvre entièrement l'épaule; elle ne doit cependant pas toucher le cou ni glisser de l'épaule.
- Placez la ceinture abdominale le plus bas possible sur les hanches.
- Réglez la position du dossier. Tenez-vous assis bien au fond du siège, le dos droit.
- Ne vrillez pas la ceinture de sécurité.

## Entretien et nettoyage

### ■ Manipulation des ceintures de sécurité

Avec un chiffon ou une éponge, nettoyez à l'aide d'un savon doux et de l'eau tiède. Vérifiez aussi les ceintures régulièrement pour vous assurer qu'elles ne présentent pas d'usure excessive, d'effilochage ou de coupures.



### AVERTISSEMENT

#### ■ Dommages et usure de la ceinture de sécurité

Vérifiez périodiquement le système de ceintures de sécurité. Vérifiez qu'il n'y a pas de coupures, d'effilochures ni de pièces desserrées. N'utilisez pas une ceinture de sécurité endommagée avant qu'elle ne soit remplacée. Une ceinture de sécurité endommagée ne peut pas protéger les occupants contre des blessures graves, voire mortelles.

## SRS airbag instructions for Canadian owners (in French)

The following is a French explanation of SRS airbag instructions extracted from the SRS airbag section in this manual.

See the SRS airbag section for more detailed SRS airbag instructions in English.

### Système de coussins gonflables SRS

#### ■ Emplacement des coussins gonflables SRS

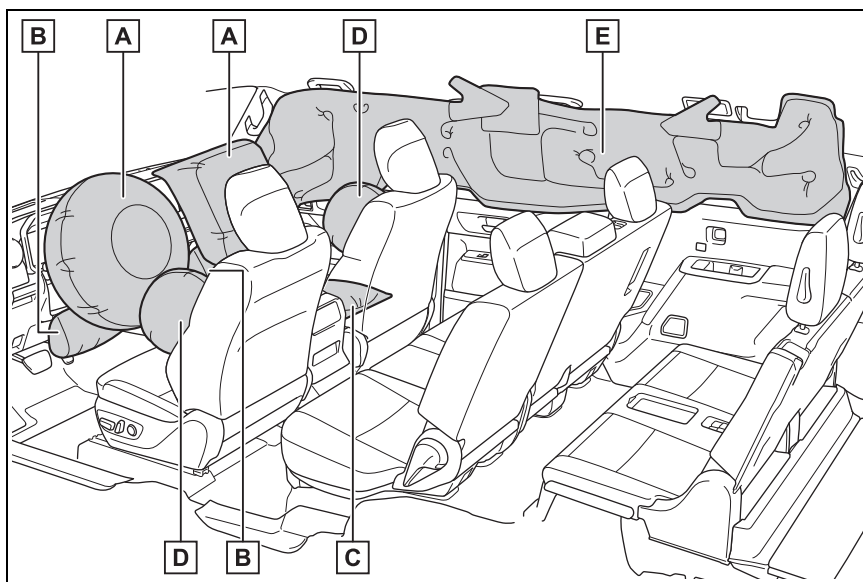

**A** Coussin gonflable SRS du conducteur/coussin gonflable SRS du passager avant

Permettent de réduire les blessures par choc à la tête et à la poitrine du conducteur et du passager avant

**B** Coussins gonflables SRS de protection des genoux

Permettent de réduire les blessures par choc du conducteur et du passager avant

**C** Coussin gonflable SRS d'assise de siège

Permet de réduire les blessures par choc du passager avant

**D** Coussins gonflables SRS latéraux

Permettent de réduire les blessures par choc à la poitrine des occupants des sièges avant

**E** Coussins gonflables SRS en rideau

- Permettent de réduire les blessures par choc à la tête des occupants des sièges avant et latéraux arrière
- Peuvent permettre d'éviter que les occupants soient éjectés du véhicule en cas de tonneaux

Votre véhicule est doté de COUSSINS GONFLABLES ÉVOLUÉS dont la conception s'appuie sur les normes de sécurité des véhicules à moteur américains (FMVSS208). Le module de capteur de coussin gonflable (ECU) contrôle le déploiement des coussins gonflables en fonction des informations obtenues des capteurs et d'autres éléments affichés dans le diagramme des composants du système ci-dessus. Ces informations comprennent des données relatives à la gravité de l'accident et aux occupants. Au moment du déploiement des coussins gonflables, une réaction chimique se produit dans les gonfleurs de coussin gonflable et les coussins gonflables se remplissent rapidement d'un gaz non toxique pour aider à limiter le mouvement des occupants.



**AVERTISSEMENT**

■ **Précautions relatives aux coussins gonflables SRS**

Observez les précautions suivantes. Négliger de le faire pourrait occasionner des blessures graves, voire mortelles.

- Le conducteur et tous les passagers doivent porter leur ceinture de sécurité de la manière appropriée. Les coussins gonflables SRS sont des dispositifs supplémentaires qui doivent être utilisés avec les ceintures de sécurité.



## AVERTISSEMENT

- Le coussin gonflable SRS du conducteur se déploie avec une force considérable et peut occasionner des blessures graves, voire mortelles, notamment lorsque le conducteur se trouve très près du coussin gonflable. La National Highway Traffic Safety Administration (NHTSA), aux États-Unis, fait les recommandations suivantes :

La zone à risque du coussin gonflable du conducteur couvre 2 à 3 in. (50 à 75 mm) de la zone de déploiement du coussin gonflable. Pour assurer une marge de sécurité suffisante, restez à 10 in. (250 mm) du coussin gonflable. Cette distance est mesurée du centre du volant à votre sternum. Si votre position de conduite actuelle vous place à moins de 10 in. (250 mm) du coussin gonflable du conducteur, vous pouvez changer votre position de plusieurs manières :

- Reculez votre siège à la position maximale vous permettant d'atteindre encore aisément les pédales.
- Inclinez légèrement le dossier du siège vers l'arrière. Bien que les véhicules soient conçus différemment, la plupart des conducteurs peuvent maintenir une distance de 10 in. (250 mm), même si leur siège est avancé au maximum, simplement en inclinant légèrement le dossier du siège vers l'arrière. Si la visibilité avant est compromise après avoir incliné le dossier du siège, utilisez un coussin ferme et non glissant pour être assis plus haut ou relevez le siège si cette option est disponible sur votre véhicule.

- Si votre volant est réglable en hauteur, inclinez-le vers le bas. Cela vous permet d'orienter le coussin gonflable vers votre buste plutôt que vers votre tête et vers votre cou. Le siège doit être réglé de la manière recommandée par la NHTSA, tout en vous permettant de conserver le contrôle des pédales et du volant du véhicule, ainsi que la vue sur les commandes du tableau de bord.
- Si la rallonge de ceinture de sécurité a été reliée à la boucle de la ceinture de sécurité du siège avant, mais que la plaque de blocage de la ceinture de sécurité du siège n'a pas été bloquée sur la rallonge de ceinture de sécurité, le système de coussins gonflables SRS considérera que l'occupant porte tout de même sa ceinture de sécurité même si la ceinture de sécurité n'est pas bouclée. Les coussins gonflables SRS avant peuvent alors ne pas se déployer correctement lors d'une collision, ce qui pourrait occasionner des blessures graves, voire mortelles. Assurez-vous de toujours porter la ceinture de sécurité correctement lors de l'usage d'une rallonge de ceinture de sécurité.

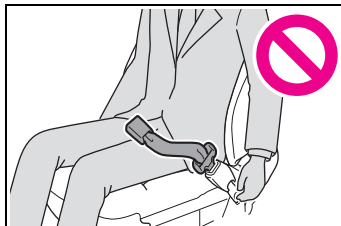



## AVERTISSEMENT

- Le coussin gonflable SRS du passager avant se déploie avec une force considérable et peut occasionner des blessures graves, voire mortelles, notamment lorsque le passager avant se trouve très près du coussin gonflable. Le siège du passager avant doit être positionné le plus loin possible du coussin gonflable avec le dossier de siège réglé de façon à ce que le passager soit assis bien droit sur son siège.
- Le déploiement d'un coussin gonflable risque d'infliger des blessures graves, voire mortelles, aux bébés et aux enfants mal assis et/ou mal attachés. Un bébé ou un enfant trop petit pour utiliser une ceinture de sécurité doit être correctement retenu à l'aide d'un dispositif de retenue pour enfants. Toyota recommande vivement de placer et d'attacher correctement tous les bébés et tous les enfants sur les sièges arrière du véhicule à l'aide de dispositifs de retenue adaptés. Les sièges arrière sont plus sécuritaires pour les bébés et les enfants que le siège du passager avant.
- N'installez jamais un dispositif de retenue pour enfants de type dos à la route sur le siège du passager avant, même si le voyant "AIR BAG OFF" est allumé. En cas d'accident, la force et la vitesse de déploiement du coussin gonflable du passager avant pourraient infliger à l'enfant des blessures graves, voire mortelles, si le dispositif de retenue pour enfants de type dos à la route était installé sur le siège du passager avant.

- Ne vous asseyez pas sur le bord du siège et ne vous appuyez pas sur la planche de bord.

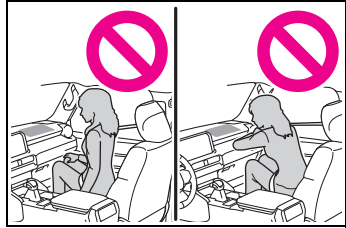

- Ne laissez pas un enfant se tenir face au coussin gonflable SRS du passager avant ni s'asseoir sur les genoux d'un passager avant.
- Les occupants des sièges avant ne doivent jamais placer d'objets sur leurs genoux.

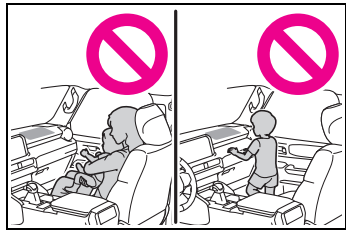

- Ne vous appuyez pas sur la portière ou sur un brancard de pavillon, ni sur un montant avant, latéral ou arrière.



## ⚠ AVERTISSEMENT

- Ne laissez personne s'agenouiller face à la portière, ni sortir la tête ou les mains à l'extérieur du véhicule.

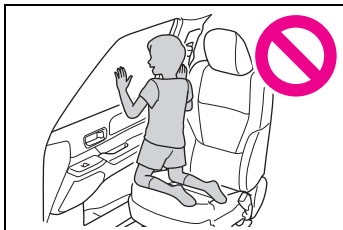

- Ne fixez et n'appuyez rien sur des zones telles que la planche de bord, le tampon de volant ou encore la partie inférieure du tableau de bord.

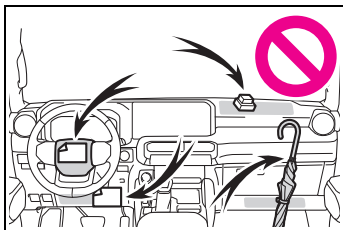

- Ne fixez rien sur des zones telles que les portières, le pare-brise, les glaces latérales, les montants avant ou arrière, les brancards de pavillon et les poignées de maintien.

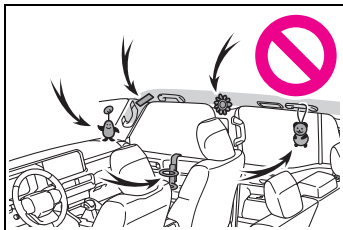

- N'accrochez pas de cintres ni d'autres objets rigides sur les crochets porte-vêtements. Ces objets pourraient se transformer en projectiles en cas de déploiement de coussins gonflables SRS en rideau, susceptibles d'occasionner des blessures graves, voire mortelles.

- Si un recouvrement de vinyle est fixé sur la zone de déploiement du coussin gonflable SRS de protection des genoux, veillez à le retirer.

- N'utilisez pas d'accessoires de sièges recouvrant les parties d'où les coussins gonflables SRS se déploient, car ils pourraient entraver le gonflage des coussins gonflables SRS. De tels accessoires peuvent empêcher les coussins gonflables SRS de se déployer correctement, rendre le système inopérant ou provoquer accidentellement le déploiement des coussins gonflables SRS, ce qui serait susceptible d'occasionner des blessures graves, voire mortelles.

- Ne frappez jamais et n'exercez aucune pression excessive sur les composants du système de coussins gonflables SRS, les portières avant, ni au niveau des zones environnantes. Cela peut provoquer un mauvais fonctionnement des coussins gonflables SRS.

- Ne touchez à aucun composant des coussins gonflables SRS immédiatement après leur déploiement (gonflage) car ils pourraient être chauds.



## AVERTISSEMENT

- Si vous avez de la difficulté à respirer après le déploiement des coussins gonflables SRS, ouvrez une portière ou une glace pour laisser entrer l'air frais, ou quittez le véhicule si vous pouvez le faire en toute sécurité. Dès que possible, nettoyez tous les résidus afin d'éviter les irritations cutanées.
  - Si une pièce abritant un coussin gonflable SRS est endommagée ou fissurée, faites-la remplacer par votre concessionnaire Toyota.
  - Ne placez aucun objet, par exemple un coussin, sur le siège du passager avant. Cela disperserait le poids du passager, ce qui empêcherait le capteur de le détecter correctement. Ceci pourrait empêcher le déploiement des coussins gonflables SRS du siège du passager avant en cas de collision.
  - **Modification et mise au rebut des composants du système de coussins gonflables SRS**
- Ne mettez pas votre véhicule au rebut et n'effectuez aucune des modifications suivantes sans d'abord consulter votre concessionnaire Toyota. Les coussins gonflables SRS pourraient fonctionner de manière incorrecte ou se déployer accidentellement, ce qui serait susceptible d'occasionner des blessures graves, voire mortelles.
- Retrait, installation, démontage ou réparation des coussins gonflables SRS
  - Réparation, retrait ou modification des pièces suivantes ou de leurs parties environnantes
  - Volant

- Tableau de bord
- Planche de bord
- Sièges
- Capitonnage des sièges
- Montants avant
- Montants latéraux
- Montants arrière
- Brancards de pavillon
- Panneaux des portières avant
- Garnitures des portières avant
- Haut-parleurs des portières avant
- Modifications des panneaux des portières avant (comme les perforer)
- Réparation ou modification des pièces suivantes ou de leurs parties environnantes
- Aile avant
- Pare-chocs avant
- Parties latérales de l'intérieur du véhicule
- Installation des parties ou accessoires suivants
- Barres safari ou barres kangourou
- Lames de déneigement
- Treuils
- Porte-bagages de toit
- Modifications de la suspension du véhicule
- Installation d'appareils électroniques tels qu'un émetteur-récepteur radio (émetteur RF) ou un lecteur de CD

**AVERTISSEMENT**

- Modifications à votre véhicule pour une personne aux capacités physiques réduites

## Headlight aim instructions for Canadian owners (in French)

The following is a French explanation of headlight aim instructions from the headlight aim section in this manual.

### Boulons de réglage vertical

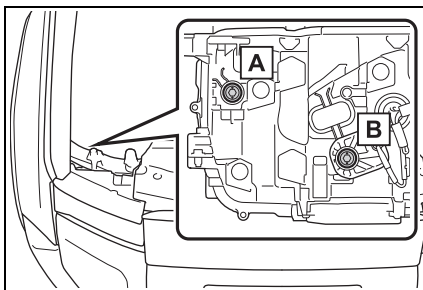

- A** Boulon de réglage A
- B** Boulon de réglage B

### Avant de vérifier la portée des phares

- Assurez-vous que le réservoir de carburant du véhicule est plein et que la partie de carrosserie située autour des phares n'est pas déformée.
- Garez le véhicule sur un sol parfaitement horizontal.
- Assurez-vous que la pression de gonflage des pneus est au niveau prescrit.

- Demandez à quelqu'un de s'asseoir sur le siège du conducteur.
- Faites rebondir le véhicule à plusieurs reprises.

### Réglage de la portée des phares

- 1 Tournez le boulon A vers la droite ou vers la gauche à l'aide d'un tournevis cruciforme.  
Retenez le sens de rotation et le nombre de tours.

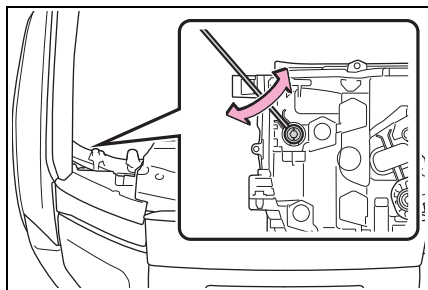

- 2 Tournez le boulon B du même nombre de tours et dans le même sens qu'à l'étape 1.

Si vous n'arrivez pas à régler vos phares en suivant cette procédure, amenez le véhicule chez votre concessionnaire Toyota afin qu'il règle

la portée des phares.

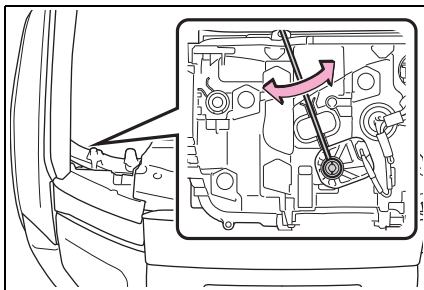

# Index

What to do if... (Troubleshooting) .....	680
Alphabetical Index .....	683

## What to do if... (Troubleshooting)

**If you have a problem, check the following before contacting your Toyota dealer.**

**The doors cannot be locked, unlocked, opened or closed**



**You lose your keys**

- If you lose your keys or mechanical keys, new genuine keys or mechanical keys can be made by your Toyota dealer. (→P.617)
- If you lose your electronic keys, the risk of vehicle theft increases significantly. Contact your Toyota dealer immediately. (→P.617)



**The doors cannot be locked or unlocked**

- Is the key battery weak or depleted? (→P.571)
- Is the power switch in ON? When locking the doors, turn the power switch off. (→P.225)
- Is the electronic key left inside the vehicle? When locking the doors, make sure that you have the

electronic key on your person.

- The function may not operate properly due to the condition of the radio wave. (→P.151)



**The rear door cannot be opened**

- Is the child-protector lock set? The rear door cannot be opened from inside the vehicle when the lock is set. Open the rear door from outside and then unlock the child-protector lock. (→P.133)

**If you think something is wrong**



**The engine does not start**

- Did you press the power switch while firmly depressing the brake pedal? (→P.222)
- Is the shift lever in P? (→P.222)
- Is the electronic key anywhere detectable inside the vehicle? (→P.150)
- Is the electronic key battery weak or depleted? In this case, the engine can be started in a temporary way. (→P.619)



- Is the battery discharged?  
(→P.620)



**The shift lever cannot be shifted from P even if you depress the brake pedal**

- Is the power switch in ON? If you cannot release the shift lever by depressing the brake pedal with the power switch in ON. (→P.229)



**The windows do not open or close by operating the power window switches**

- Is the window lock switch pressed?  
The power window except for the one at the driver's seat cannot be operated if the window lock switch is pressed.  
(→P.183)



**The power switch is turned off automatically**

- The auto power off function will be operated if the vehicle is left in ACC or ON (the engine is not running) for a period of time. (→P.226)



**A warning buzzer sounds during driving**

- The seat belt reminder light is flashing

Are the driver and the passengers wearing the seat belts? (→P.594, 595)

- The parking brake indicator is on

Is the parking brake released?  
(→P.233)

Depending on the situation, other types of warning buzzer may also sound. (→P.587, 598)



**An alarm is activated and the horn sounds (if equipped)**

- Did anyone inside the vehicle open a door during setting the alarm?

The sensor detects it and the alarm sounds. (→P.78)

To stop the alarm, turn the power switch to ON or start the engine.



**A warning buzzer sounds when leaving the vehicle**

- Is the message displayed on the multi-information display? Check the message on the multi-information display.  
(→P.598)



**A warning light turns on or a warning message is displayed**

- When a warning light turns on or a warning message is displayed, refer to P.587, 598.

## When a problem has occurred



### If you have a flat tire

- Stop the vehicle in a safe place and replace the flat tire with the spare tire. (→P.606)



### The vehicle becomes stuck

- Try the procedure for when the vehicle becomes stuck in mud, dirt, or snow. (→P.627)

# Alphabetical Index

## A

- A/C** ..... 468, 478  
 Air conditioning filter ..... 566  
 Eco air conditioning mode .... 471  
 Front automatic air conditioning system ..... 468  
 Front seat concentrated airflow mode (S-FLOW) ..... 473  
 Rear automatic air conditioning system ..... 478
- ABS (Anti-lock Brake System)** ..... 448  
 Warning light ..... 589
- Acoustic Vehicle Alerting System** ..... 71
- AHB (Automatic High Beam)** .242
- Airbags** ..... 36  
 Airbag operating conditions.... 37  
 Airbag precautions for your child ..... 40  
 Airbag warning light..... 588  
 Correct driving posture ..... 29  
 Curtain shield airbag operating conditions ..... 38  
 Curtain shield airbag precautions ..... 40  
 Front passenger occupant classification system ..... 44  
 General airbag precautions .... 40  
 Locations of airbags ..... 36  
 Modification and disposal of airbags ..... 43  
 Side airbag operating conditions ..... 38  
 Side airbag precautions ..... 40  
 Side and curtain shield airbags operating conditions ..... 38  
 Side and curtain shield airbags precautions..... 40  
 SRS airbags ..... 36  
 SRS warning light..... 588
- Air conditioning filter** .....566
- Air conditioning system**.468, 478  
 Air conditioning filter .....566  
 Eco air conditioning mode ....471  
 Front automatic air conditioning system .....468  
 Front seat concentrated airflow mode (S-FLOW) .....473  
 Rear automatic air conditioning system .....478
- Alarm**  
 Alarm .....78  
 Warning buzzer .....587, 599
- Anchor brackets** .....62
- Antenna**  
 Smart key system .....150
- Anti-lock Brake System (ABS)** .....448  
 Warning light .....589
- Armrest**.....505
- Assist grips** .....506
- Audio system-linked display** .98, 110
- Automatic air conditioning system** .....468, 478  
 Air conditioning filter .....566  
 Eco air conditioning mode ....471  
 Front automatic air conditioning system .....468  
 Front seat concentrated airflow mode (S-FLOW) .....473  
 Rear automatic air conditioning system .....478
- Automatic headlight leveling system** .....241
- Automatic High Beam (AHB)** .242
- Automatic light control system** .....240
- Automatic transmission**.....227  
 M mode .....231  
 Paddle shift switches ....230, 231
- Average fuel economy** .....98, 109

**Average vehicle speed ....98, 109****B****Back door..... 134**

- Back door closer ..... 140
- Back door opener switch ..... 138
- Luggage compartment lights 140
- Power back door switch ..... 138
- Power back door ..... 138
- Wireless remote control ..... 138

**Back-up lights**

- Replacing light bulbs ..... 577

**Battery (12-volt battery)..... 548**

- Battery checking..... 548
- If the vehicle battery is discharged ..... 620
- Preparing and checking before winter..... 463
- Warning light ..... 587

**Battery (traction battery) ..... 72**

- Air intake vent ..... 75
- Location..... 72
- Specification..... 632

**Blind Spot Monitor (BSM)..... 328**

- Blind Spot Monitor function .. 330

**Bottle holders ..... 488****Brake**

- Brake Hold ..... 237
- Fluid ..... 636
- Parking brake ..... 233
- Regenerative braking ..... 70
- Warning light ..... 587

**Brake assist ..... 448****Brake Hold ..... 237****Break-in tips ..... 198****Brightness control**

- Instrument panel light control 91, 95

**BSM (Blind Spot Monitor)..... 328**

- Blind Spot Monitor function .. 330

**Buzzer**

- Driver monitor..... 266

**C****Camera**

- Driver monitor ..... 266

**Care**

- Aluminum wheels ..... 526
- Exterior ..... 526
- Interior ..... 529
- Seat belts ..... 529

**Cargo hooks..... 490****Catch protection function**

- Power windows ..... 181

**Chains..... 465****Child-protector lock ..... 133****Child restraint system..... 51**

- Child seats definition ..... 51
- Child seats installation..... 53
- Fixed with a LATCH system ... 60
- Fixed with a seat belt..... 56
- Front passenger occupant classification system ..... 44
- Points to remember ..... 51
- Riding with children ..... 50
- Types of child restraint system installation method ..... 53
- Using an anchor bracket ..... 62

**Child safety ..... 50**

- 12-volt battery precautions .549, 623
- Airbag precautions ..... 40
- Back door precautions..... 134
- Child restraint system ..... 51, 53
- Glass hatch precautions..... 148
- Heated steering wheel precautions..... 480
- How your child should wear the seat belt..... 32
- Installing child restraints ..... 51
- Moon roof precautions..... 185
- Power window lock switch .... 183
- Power window precautions... 182
- Rear door child-protector lock

..... 133  
 Seat belt precautions ..... 31  
 Seat heater precautions ..... 480  
**Cleaning** ..... **526, 529**  
 Aluminum wheels ..... 526  
 Exterior ..... 526  
 Interior ..... 529  
 Radar sensor ..... 329  
 Seat belts ..... 529  
**Coat hooks** ..... **505**  
**Condenser** ..... **546**  
**Console box** ..... **487**  
**Consumption screen** ..... **121**  
**Coolant**  
 Capacity ..... 634  
 Checking ..... 545  
 Preparing and checking before  
 winter ..... 463  
 Warning light ..... 588  
**Cool box** ..... **494**  
**Cooling system** ..... **634**  
 Engine overheating ..... 625  
**Crawl Control** ..... **439**  
**Cruise control**  
 Cruise control ..... 316  
 Dynamic radar cruise control ..... 305  
**Cup holders** ..... **487**  
**Current fuel economy** ..... **98, 109**  
**Curtain shield airbags** ..... **36**  
**Customizable features** ..... **649**

**D**

**DAC**  
 Downhill assist control system  
 ..... 445  
**Daytime running light system** **240**  
 Replacing light bulbs ..... 577  
**Deck board** ..... **490**  
**Deck under tray** ..... **491**  
**Defogger**  
 Outside rear view mirrors ..... 470  
 Rear window ..... 470

Windshield ..... 470  
**Differential** ..... **635**  
**Digital Rear-view Mirror** ..... **167**  
**Dimensions** ..... **630**  
**Dinghy towing** ..... **221**  
**Display**  
 BSM (Blind Spot Monitor) ..... 328  
 Consumption screen ..... 121  
 Driving information ..... 98, 110  
 Head-up display ..... 117  
 Intuitive parking assist ..... 337  
 Multi-information display ..... 96, 106  
 Parking Support Brake function  
 (pedestrians rear of the vehicle)  
 ..... 362  
 RCD (Rear Camera Detection)  
 ..... 350  
 RCTA (Rear Cross Traffic Alert)  
 function ..... 344  
 Warning messages ..... 598  
**Do-it-yourself maintenance** ... **538**  
**Door courtesy lights** ..... **483**  
**Door lock**  
 Back door ..... 134  
 Side doors ..... 129  
 Smart key system ..... 129, 136  
 Wireless remote control ..... 126  
**Door pocket lights** ..... **483**  
**Door pockets** ..... **486**  
**Doors**  
 Automatic door locking and  
 unlocking system ..... 133  
 Back door ..... 134  
 Door glasses ..... 181  
 Door lock buzzer ..... 131  
 Door lock ..... 129  
 Glass hatch ..... 147  
 Outside rear view mirrors ..... 177  
 Rear door child-protector lock  
 ..... 133  
 Side doors ..... 129  
**Downhill assist control system**

.....	445
<b>Driver's seat belt reminder light</b>	
.....	594
<b>Driver's seat position memory</b>	
.....	188
Driving position memory.....	187
Memory recall function.....	189
<b>Driver monitor</b> .....	266
<b>Drive-Start Control (DSC)</b>	
Sudden start restraint control	203
<b>Driving</b>	
Break-in tips .....	198
Correct driving posture.....	29
Driving mode select switch...	433
Hybrid vehicle driving tips ....	461
Procedures.....	197
Winter drive tips .....	463
<b>Driving information display</b> ...	98, 110
<b>Driving mode select switch</b> ...	433
<b>Driving position memory</b> .....	187
Memory recall function.....	189
Position memory .....	188
Power easy access system..	187
<b>Driving support system information display</b> .....	98, 109
<b>DSC (Drive-Start Control)</b>	
Sudden start restraint control	203
<b>Dynamic radar cruise control</b>	
Function .....	305
Warning message .....	598

## E

### ECB

Electronically Controlled Brake System .....	448
--	-----

### EDR (Event data recorder).....

<b>Elapsed time</b> .....	99, 110
---------------------------	---------

### Electric motor (traction motor)

Location.....	69
Specification.....	632

### Electronic key.....

Battery-saving function.....	151
If the electronic key does not operate properly .....	618
Replacing the battery .....	571

### Emergency, in case of

If a warning buzzer sounds ..	587
If a warning light turns on ....	587
If a warning message is displayed.....	598
If the electronic key does not operate properly .....	618
If the engine will not start.....	616
If the vehicle battery is discharged .....	620
If the vehicle is submerged or water on the road is rising ..	582
If you have a flat tire .....	606
If you lose your keys.....	617
If you think something is wrong .....	586
If your vehicle becomes stuck .....	627
If your vehicle has to be stopped in an emergency.....	581
If your vehicle needs to be towed .....	583
If your vehicle overheats .....	625

### Emergency Driving Stop System

.....	319
-------	-----

### Emergency flashers .....

.....	580
-------	-----

### Engine

Compartment.....	542
Hood.....	540
Identification number .....	631
If the engine will not start.....	616
If your vehicle has to be stopped in an emergency.....	581
Ignition switch (power switch) .....	222
Overheating.....	625
Power switch (ignition switch) .....	222

Tachometer ..... 89, 92

**Engine coolant**

Capacity ..... 634

Checking ..... 545

Preparing and checking before winter..... 463

Warning light ..... 588

**Engine coolant temperature gauge..... 89, 92**

**Engine oil**

Capacity ..... 633

Checking ..... 542

Preparing and checking before winter..... 463

Warning light ..... 588

**Engine oil pressure gauge ..100, 111**

**Enhanced VSC (Enhanced Vehicle Stability Control) ..... 448**

**EPS (Electric Power Steering) ..... 449**

**Event data recorder (EDR)..... 11**

**F**

**FCTA (Front Cross Traffic Alert) ..... 300**

**Flat tire ..... 606**

Tire pressure warning system ..... 554

**Floor mats ..... 28**

**Fluid**

Automatic transmission ..... 635

Brake..... 636

Washer..... 547

**Fog lights**

Replacing light bulbs ..... 577

Switch..... 245

**Footwell lights ..... 483**

**Four-wheel drive system**

Center differential lock/unlock ..... 435

Four-wheel drive control switch

.....435

Rear differential lock/unlock .437

Warning light .....593

**Front fog lights**

Replacing light bulbs .....577

Switch.....245

**Front passenger’s seat belt reminder light.....594**

**Front passenger occupant classification system .....44**

**Front seats .....155**

Adjustment .....155

Cleaning .....529

Correct driving posture .....29

Driving position memory .....187

Head restraints .....162

Memory recall function .....189

Position memory.....188

Power easy access system ..187

Seat heaters .....481

Seat ventilators.....481

**Front side marker lights**

Replacing light bulbs .....577

Switch .....240

**Front turn signal lights**

Replacing light bulbs .....577

Turn signal lever.....233

**Fuel**

Capacity .....632

Fuel gauge .....89, 92

Information .....638

Refueling .....251

Warning light .....594

**Fuel filler door.....252**

Refueling .....251

**Fuel gauge.....89, 92**

**Fuses .....573**

**G**

**Garage door opener .....517**

**Gauges .....89, 92**

**Glass hatch .....147**

**Glove box** .....487

## H

**Headlights** .....240

AHB (Automatic High Beam) 242

Automatic headlight leveling system .....241

Replacing light bulbs .....577

Switch.....240

**Headlights aim**.....576

**Head restraints** .....162

**Head-up display** .....117

Driving support system display area .....120

Pop-up display .....120

Position memory .....188

Settings .....119

**Heated steering wheel** .....480

**Heaters**

Automatic air conditioning system .....468, 478

Heated steering wheel .....480

Outside rear view mirrors .....470

Seat heaters.....481

**High mounted spotlight**

Replacing light bulbs .....577

**Hill-start assist control** .....448

**Hood**

Hood.....540

Open .....540

**Hooks**

Cargo hooks.....490

Coat hooks .....505

Retaining hooks (floor mat) ....28

**Horn** .....166

**Hybrid battery (traction battery)**

.....72

Air intake vent .....75

Location.....72

Specification.....632

**Hybrid system** .....69

Acoustic Vehicle Alerting System

.....71

Consumption screen .....121

Emergency shut off system ....75

High voltage components.....72

Hybrid system precautions .....72

Hybrid vehicle driving tips.....461

If the hybrid system will not start .....616

Overheating .....625

Regenerative braking .....70

Starting the hybrid system ....222

## I

**I/M test** .....537

**Identification**

Engine .....631

Vehicle.....631

**Ignition switch (power switch)**

.....222

Auto power off function.....226

Changing the power switch modes.....225

If your vehicle has to be stopped in an emergency .....581

Starting the hybrid system ....222

**Illuminated entry system** .....483

**Immobilizer system** .....77

**Indicators** .....82

**Initialization**

Items to initialize .....666

Maintenance .....534

Moon roof .....185

Power back door .....142

Power windows .....181

**Inside door handle lights** .....483

**Inside rear view mirror** .....166

**Instrument panel light control** 91, 95

**Interior lights**.....484

**Interior lights list** .....483

**Intuitive parking assist**.....337



**J**

- Jack**
  - Vehicle-equipped jack ..... 606
- Jack handle**..... **606**
- Jam protection function**
  - Memory recall function ..... 191
  - Moon roof ..... 184
  - Position memory ..... 189
  - Power back door ..... 141
  - Power easy access system.. 188
  - Power windows ..... 181

**K**

- Keyless entry**
  - Smart key system..... 150
  - Wireless remote control ..... 126
- Keys**..... **124**
  - Battery-saving function..... 151
  - Electronic key ..... 124
  - If the electronic key does not operate properly ..... 618
  - If you lose your keys ..... 617
  - Key number plate ..... 124
  - Keyless entry..... 126, 150
  - Mechanical key ..... 126
  - Power switch (ignition switch) ..... 222
  - Replacing the battery ..... 571
  - Warning buzzer ..... 150
  - Wireless remote control key. 126
- Knee airbags**..... **36**

**L**

- Lane Tracing Assist (LTA)**..... **280**
  - Operation ..... 280
- Language (multi-information display)**..... **104, 116**
- LATCH anchors** ..... **60**
- LCA (Lane Change Assist)** .... **285**
- LDA (Lane Departure Alert)**... **288**

Operation.....288

**Lever**

- Auxiliary catch lever .....540
- Hood lock release lever.....540
- Shift lever .....227
- Tilt and telescopic steering lock release lever..... 165
- Turn signal lever.....233
- Wiper lever .....246, 248

**License plate lights**

- Replacing light bulbs .....577
- Switch.....240

**Light bulbs**

- Replacing .....577
- Welcome lighting .....241

**Lights**

- AHB (Automatic High Beam) 242
- Door courtesies lights.....483
- Door pocket lights.....483
- Fog light switch.....245
- Footwell lights.....483
- Front interior light .....484
- Headlight switch .....240
- Illuminated entry system.....483
- Inside door handle lights .....483
- Interior lights list .....483
- Open tray light .....483
- Outer foot lights .....483
- Personal lights.....485
- Pull handle lights .....483
- Rear interior light .....484
- Running board lights .....483
- Shift lever lights .....483
- Turn signal lever.....233
- Vanity lights .....495
- Welcome lighting .....241

**LTA (Lane Tracing Assist)**.....**280**

- Operation.....280

**Luggage compartment lights**137, 140

**Luggage cover** .....492

## M

**Maintenance**

- Do-it-yourself maintenance .. 538
- General maintenance ..... 534
- Maintenance data..... 630
- Maintenance requirements... 533

**Malfunction indicator lamp.... 588****Menu icons ..... 97, 108****Meter**

- Indicators..... 82
- Instrument panel light control 91, 95
- Meter control switches ... 97, 108
- Meters ..... 89, 92
- Multi-information display 96, 106
- Settings ..... 101, 112
- Units ..... 104, 116
- Warning lights ..... 587
- Warning messages ..... 105, 116, 598

**Meter control switches .... 97, 108****Mirrors**

- Digital Rear-view Mirror..... 167
- Inside rear view mirror..... 166
- Outside rear view mirror defoggers ..... 470
- Outside rear view mirrors ..... 177
- Vanity mirrors ..... 495

**Moon roof..... 184**

- Door lock linked moon roof operation ..... 184
- Jam protection function ..... 184
- Operation ..... 184

**Multi-information display**

- Audio system-linked display . 98, 110
- Changing the display..... 97, 108
- Display contents ..... 96, 106
- Driving information display ... 98, 110
- Driving support system informa-

- tion display ..... 98, 109
- Intuitive parking assist ..... 337
- Language ..... 104, 116
- LDA (Lane Departure Alert) .. 288
- Menu icons ..... 97, 108
- Meter control switches.... 97, 108
- Navigation system-linked display ..... 98, 109
- PCS (Pre-Collision System) . 268
- RSA (Road Sign Assist) ..... 302
- Settings ..... 101, 112
- Suggestion function ..... 105, 117
- Tire pressure ..... 554
- Units ..... 104, 116
- Vehicle information display..... 99
- Warning message display .. 105, 116

**Warning messages..... 598****Multi-terrain Monitor..... 364**

- How to switch the display ..... 368
- If you notice any symptoms .. 429
- Screen display ..... 365

**Multi-terrain Select ..... 442****My Settings ..... 192**

## N

**Navigation system-linked display ..... 98, 109**

## O

**Odometer..... 89, 92****Off-road precautions ..... 458****Oil**

- Engine oil..... 633
- Front differential oil ..... 635
- Rear differential oil ..... 635
- Transfer oil ..... 635

**Opener**

- Back door ..... 136, 138
- Fuel filler door..... 252
- Garage door ..... 517

Glass hatch ..... 147  
 Hood.....540  
**Open tray .....489**  
**Open tray light.....483**  
**Outer foot lights .....483**  
**Outside rear view mirrors..... 177**  
 Adjustment ..... 177  
 BSM (Blind Spot Monitor).....330  
 Folding and extending..... 178  
 Heaters.....470  
 Linked mirror function when  
 reversing ..... 179  
 Outside rear view mirror defog-  
 gers .....470  
 Position memory ..... 188  
 RCTA (Rear Cross Traffic Alert)  
 ..... 344  
 Safe Exit Assist ..... 334  
**Outside temperature ..... 89, 92**  
**Overheating ..... 625**

**P**

**Paddle shift switches.....230, 231**  
**Parking assist sensors (intuitive  
 parking assist)..... 337**  
**Parking brake**  
 Operation ..... 233  
 Parking brake engaged warning  
 buzzer ..... 235  
 Warning light ..... 593  
 Warning message ..... 235  
**Parking lights**  
 Replacing light bulbs ..... 577  
 Switch.....240  
**Parking Support Brake function  
 (moving vehicles rear of the  
 vehicle).....353, 360**  
 Function ..... 360  
**Parking Support Brake function  
 (pedestrians rear of the vehicle)  
 ..... 362**  
 Function ..... 362

**Parking Support Brake function  
 (static objects front and rear of  
 the vehicle).....353, 358**  
 Function.....358  
**PCS (Pre-Collision System)**  
 Function.....268  
 Warning light .....590  
**PDA (Proactive driving assist)  
 .....294**  
**Personal lights.....485**  
**PKSB (Parking Support Brake)  
 .....353**  
**Power back door.....138**  
 Close & lock function.....138  
 Jam protection function .....141  
 Power back door switch .....138  
**Power control unit.....72**  
**Power easy access system ...187**  
**Power outlet (12 VDC) .....495**  
**Power outlet (2400 W) .....509**  
**Power steering**  
 Warning light .....589  
**Power switch (ignition switch)  
 .....222**  
 Auto power off function.....226  
 Changing the power switch  
 modes.....225  
 If your vehicle has to be stopped  
 in an emergency.....581  
 Starting the hybrid system....222  
**Power windows.....181**  
 Catch protection function.....181  
 Jam protection function .....181  
 Operation.....181  
 Window lock switch .....183  
**Pre-Collision System (PCS)**  
 Function.....268  
 Warning light .....590  
**Pull handle lights.....483**

**R**

**Radar cruise control**

Dynamic radar cruise control 305  
**Radiator** ..... 546  
**RCD (Rear Camera Detection)**  
 ..... 349  
 Function ..... 349  
**RCTA (Rear Cross Traffic Alert)**  
 ..... 343  
 RCTA (Rear Cross Traffic Alert)  
 function..... 344  
**Rear automatic air conditioning  
 system**..... 478  
**Rear Camera Detection (RCD)**  
 ..... 349  
**Rear Cross Traffic Alert (RCTA)**  
 ..... 343  
**Rear differential lock system** 437  
**Rear passengers' seat belt  
 reminder light** ..... 595  
**Rear seats** ..... 156  
 Adjustment ..... 156  
 Folding down the third seatbacks  
 ..... 160  
 Head restraints..... 162  
 Rear seat reminder function. 131  
 Seat heaters..... 481  
 Seat ventilators ..... 481  
 Second seats ..... 156  
 Third seats ..... 156  
 Tumbling the second seats .. 157  
**Rear side marker lights**  
 Replacing light bulbs ..... 577  
 Switch..... 240  
**Rear turn signal lights**  
 Replacing light bulbs ..... 577  
 Turn signal lever..... 233  
**Rear view mirror**  
 Digital Rear-view Mirror..... 167  
 Inside rear view mirror..... 166  
 Outside rear view mirrors ..... 177  
**Rear window defogger**..... 470  
**Rear window wiper**..... 248  
**Refueling**..... 251

Capacity ..... 632  
 Fuel types..... 632  
 Opening the fuel tank cap .... 252  
**Regenerative braking** ..... 70  
**Replacing**  
 Electronic key battery ..... 571  
 Fuses..... 573  
 Light bulbs ..... 577  
 Tires ..... 606  
 Wireless remote control battery  
 ..... 571  
**Reporting safety defects for  
 Canadian owners**..... 669  
**Reporting safety defects for U.S.  
 owners**..... 668  
**Resetting the message indicat-  
 ing maintenance is required** 534  
**Road Sign Assist (RSA)**..... 302  
**RSA (Road Sign Assist)**..... 302  
**Running board lights** ..... 483

## S

**Safe Exit Assist**..... 333  
**Safety Connect** ..... 64  
**SDM (Stabilizer with Disconnec-  
 tion Mechanism)** ..... 456  
**Seat belt reminder light**.. 594, 595  
**Seat belts**..... 31  
 Adjusting the seat belt shoulder  
 anchor height..... 34  
 Automatic Locking Retractor .. 33  
 Child restraint system installation  
 ..... 56  
 Cleaning and maintaining the  
 seat belt..... 529  
 Emergency Locking Retractor 33  
 How to wear your seat belt..... 32  
 How your child should wear the  
 seat belt..... 32  
 Pregnant women, proper seat  
 belt use ..... 31  
 Reminder light and buzzer .594,

- 595
- Seat belt extender ..... 32
- Seat belt pretensioners ..... 34
- SRS warning light..... 588
- Seat cushion airbag ..... 36**
- Seat heaters ..... 481**
- Seating capacity ..... 208**
- Seat position memory ..... 188**
- Seats ..... 155, 156**
  - Adjustment precautions..... 156
  - Adjustment ..... 155, 156
  - Child restraint system installation  
..... 51
  - Cleaning ..... 529
  - Driving position memory..... 187
  - Head restraints..... 162
  - Memory recall function ..... 189
  - Position memory ..... 188
  - Power easy access system.. 187
  - Properly sitting in the seat..... 29
  - Seat heaters..... 481
  - Seat ventilators ..... 481
- Seat ventilators ..... 481**
- Second start mode ..... 230**
- Sensor**
  - Automatic headlight system . 240
  - BSM (Blind Spot Monitor)..... 329
  - Digital Rear-view Mirror..... 171
  - Door handle..... 129
  - Inside rear view mirror..... 167
  - Intuitive parking assist..... 337
  - LDA (Lane Departure Alert) . 288
  - LTA (Lane Tracing Assist).... 280
  - Parking Support Brake function  
(moving vehicles rear of the  
vehicle)..... 329
  - Parking Support Brake function  
(static objects front and rear of  
the vehicle)..... 337
  - Power back door ..... 141
  - Rain-sensing windshield wipers  
..... 247
  - RCTA (Rear Cross Traffic Alert)  
..... 329
  - Safe Exit Assist ..... 329
- Service plug ..... 72**
- Service reminder message .... 534**
- Shift lever ..... 227**
  - Automatic transmission ..... 227
  - If the shift lever cannot be shifted  
from P ..... 229
- Shift lever lights..... 483**
- Shift lock system ..... 229**
- Side airbags ..... 36**
- Side doors ..... 129**
- Side marker lights**
  - Replacing light bulbs ..... 577
  - Switch ..... 240
- Side mirrors ..... 177**
  - Adjustment ..... 177
  - BSM (Blind Spot Monitor) .... 330
  - Folding and extending ..... 178
  - Heaters ..... 470
  - Linked mirror function when  
reversing..... 179
  - Position memory..... 188
  - RCTA (Rear Cross Traffic Alert)  
..... 344
  - Safe Exit Assist ..... 334
- Side turn signal lights**
  - Replacing light bulbs ..... 577
  - Turn signal lever ..... 233
- Side windows ..... 181**
- Smart key system ..... 150**
  - Antenna location..... 150
  - Entry functions..... 129, 136
  - Starting the hybrid system .... 222
  - Warning message ..... 598
- Snow tires ..... 463**
- SOS button ..... 64**
- Spare tire**
  - Inflation pressure ..... 637
  - Storage location ..... 606
- Spark plug ..... 634**

- Specifications** ..... 630
- Speedometer** ..... 89, 92
- Sport mode** ..... 433
- Steering wheel**..... 165
- Adjustment ..... 165
  - Driving position memory..... 187
  - Heated steering wheel ..... 480
  - Meter control switches ... 97, 108
  - Position memory ..... 188
  - Power easy access system.. 187
- Stop lights**
- Replacing light bulbs ..... 577
- Storage feature**..... 486
- Storage precautions** ..... 486
- Stuck**
- If the vehicle becomes stuck 627
- Suggestion function**..... 105, 117
- Sunshade**
- Moon roof ..... 184
- Sun visors** ..... 495
- Switches**
- “GAIN” (+/-) selection button 453
  - “SOS” button ..... 64
  - “TOW HAUL” switch ..... 232
  - Automatic High Beam switch 242
  - Brake hold switch ..... 237
  - Camera switch ..... 368
  - Center differential lock switch  
..... 435
  - DAC/CRAWL..... 439, 445
  - Door lock switches ..... 132
  - DRIVE MODE switch ..... 433
  - Driving mode select switch... 433
  - Driving position memory buttons  
..... 188
  - Emergency flashers switch .. 580
  - Fog light switch ..... 245
  - Four-wheel drive control switch  
..... 435
  - Garage door opener buttons 517
  - Headlight switch ..... 240
  - Heated steering wheel switch  
..... 480
  - Ignition switch ..... 222
  - Instrument panel light control  
switches ..... 91, 95
  - Light switch ..... 240
  - Manual brake slider ..... 453
  - Meter control switches... 97, 108
  - MODE SELECT switch 433, 439,  
443, 445
  - Moon roof switches ..... 184
  - MTS ..... 443
  - Outside rear view mirror  
switches ..... 177
  - Paddle shift switches .... 230, 231
  - Parking brake switch ..... 233
  - PKSB (Parking Support Brake)  
switch ..... 354
  - Power back door switch ..... 138
  - Power door lock switch ..... 132
  - Power window switch ..... 181
  - Rear differential lock switch.. 437
  - Rear window and outside rear  
view mirror defoggers switch  
..... 470
  - Rear window wiper and washer  
switch ..... 248
  - SDM switch ..... 456
  - Seat adjustment switches ..... 156
  - Seat heater switches ..... 481
  - Seat ventilator switches ..... 481
  - Second start mode switch ... 230
  - Tilt and telescopic steering con-  
trol switch ..... 165
  - Trailer brake control switch .. 453
  - VIEW switch ..... 368
  - VSC OFF switch ..... 449
  - Window lock switch ..... 183
  - Windshield defogger switch.. 470
  - Windshield de-icer switch .... 474
  - Windshield wipers and washer  
switch ..... 246

**T**

**Tachometer** ..... **89, 92**

**Tail lights**

- Replacing light bulbs ..... 577
- Switch..... 240

**Theft deterrent system**

- Alarm..... 78
- Immobilizer system ..... 77

**Things you should know**

- If you notice any symptoms.. 429

**Ticket holders**..... **488**

**Tire inflation pressure**

- Tire inflation pressure display function..... 554
- Warning light ..... 594

**Tire information**..... **640**

- Glossary ..... 644
- Size ..... 641
- Tire identification number ..... 641
- Uniform Tire Quality Grading 642

**Tire pressure display** ..... **554**

**Tire pressure warning system**

- ..... **554**
- Function ..... 554
- Installing tire pressure warning valves and transmitters ..... 555
- Registering ID codes..... 559
- Registering the position of each wheel..... 556
- Selecting wheel set ..... 561
- Setting the tire pressure ..... 557
- Warning light ..... 594

**Tires**..... **551**

- Chains ..... 465
- Checking ..... 551
- If you have a flat tire ..... 606
- Inflation pressure..... 563
- Replacing ..... 606
- Rotating tires ..... 553
- Size ..... 637
- Snow tires ..... 463

- Spare tire ..... 606
- Tire inflation pressure display function..... 554
- Tire pressure warning system ..... 554
- Warning light ..... 594

**Tools**..... **606**

**Top tether strap** ..... **62**

**Total load capacity** ..... **630**

**Towing**

- Dinghy towing..... 221
- Emergency towing ..... 583
- Towing hook ..... 585
- Trailer sway control ..... 448
- Trailer towing..... 209

**Toyota Safety Sense 3.0** ..... **256**

- AHB (Automatic High Beam) 242
- Cruise control ..... 316
- Driver monitor ..... 266
- Dynamic radar cruise control 305
- Emergency Driving Stop System ..... 319
- FCTA (Front Cross Traffic Alert) ..... 300
- LCA (Lane Change Assist) ... 285
- LDA (Lane Departure Alert) .. 288
- LTA (Lane Tracing Assist) ... 280
- PCS (Pre-Collision System) . 268
- PDA (Proactive driving assist) ..... 294
- RSA (Road Sign Assist) ..... 302
- Traffic Jam Assist ..... 322

**Toyota Safety Sense 3.0 software update**..... **254**

**TRAC (Traction Control)** ..... **448**

**Traction battery (hybrid battery)**

- ..... **72**
- Air intake vent..... 75
- Location ..... 72
- Specification ..... 632

**Traction control (TRAC)**..... **448**

**Traction motor (electric motor)** **69**

<b>Trailer brake controller</b> .....	<b>453</b>
<b>Trailer sway control</b> .....	<b>448</b>
<b>Trailer towing</b> .....	<b>209</b>
<b>Transmission</b>	
Automatic transmission .....	227
M mode .....	231
Paddle shift switches.....	230, 231
<b>Turn signal lights</b>	
Replacing light bulbs .....	577
Turn signal lever.....	233

## U

<b>USB Type-C charging ports</b> ..	<b>496</b>
-------------------------------------	------------

## V

<b>Vanity lights</b> .....	<b>495</b>
<b>Vanity mirrors</b> .....	<b>495</b>
<b>Vehicle data recordings</b> .....	<b>8</b>
<b>Vehicle identification number</b>	<b>631</b>
<b>Vehicle Stability Control (VSC)</b>	
.....	<b>448</b>
<b>Ventilators</b>	
Seat ventilators .....	481
<b>Voltmeter</b> .....	<b>100, 111</b>
<b>VSC (Vehicle Stability Control)</b>	
.....	<b>448</b>

## W

<b>Warning buzzers</b>	
Brake hold .....	593
Brake Override System .....	592
Brake system .....	587
Downshifting.....	231, 232
Drive-Start Control .....	592
High coolant temperature .....	588
Low engine oil pressure .....	588
LTA (Lane Tracing Assist) ..	280, 590
Open door .....	133
Open hood .....	133

PKSB.....	592
RSA (Road Sign Assist) .....	302
Seat belt reminder .....	594, 595

## Warning lights

ABS .....	589
Brake hold operated indicator	
.....	593
Brake system.....	587
Center differential lock indicator	
.....	593
Charging system .....	587
Cruise control indicator.....	590
Driving assist information indicator	
.....	591
Dynamic radar cruise control indicator	
.....	591
High coolant temperature .....	588
Inappropriate pedal operation	
.....	592
Intuitive parking assist OFF indicator	
.....	591
LDA indicator .....	590
Low engine oil pressure .....	588
Low fuel level.....	594
Low speed four-wheel drive indicator light	
.....	593
LTA indicator .....	590
Malfunction indicator lamp.....	588
Parking brake indicator.....	593
PCS .....	590
PDA indicator .....	590
Power steering .....	589
Rear differential lock indicator	
.....	593
Seat belt reminder light	
594, 595	
Slip indicator .....	592
SRS .....	588
Tire pressure .....	594
Trailer brake .....	592

## Warning messages.....598

## Washer

Checking .....	547
----------------	-----



Low washer fluid warning message .....	547, 598
Preparing and checking before winter.....	463
Switch.....	246, 248
<b>Washing and waxing.....</b>	<b>526</b>
<b>Weights</b>	
Load limits .....	208
<b>Wheels.....</b>	<b>565</b>
Replacing wheels .....	606
<b>Window glasses</b>	
Power windows .....	181
<b>Window lock switch .....</b>	<b>183</b>
<b>Windows</b>	
Glass hatch .....	147
Power windows .....	181
Rear window defogger .....	470
Washer .....	246, 248
<b>Windshield defogger.....</b>	<b>470</b>
<b>Windshield de-icer .....</b>	<b>474</b>
<b>Windshield wipers</b>	
Rain-sensing windshield wipers .....	246
<b>Winter driving tips.....</b>	<b>463</b>
<b>Wireless charger .....</b>	<b>497</b>
<b>Wireless remote control .....</b>	<b>126</b>
Battery-saving function.....	151
Locking/Unlocking .....	126
Replacing the battery .....	571

---

---

For information regarding the equipment listed below, refer to "MULTIMEDIA OWNER'S MANUAL".

- Voice control
- Navigation system
- Audio system
- Hands-free calls
- Rear view monitor system

## Certifications

### Safety Connect

FCC ID : BEJTL21BNN

This device complies with part 15 of the FCC Rules and RSS-Gen of IC Rules.

Operation is subject to the following two conditions:

- (1) This device may not cause harmful interference, and
- (2) this device must accept any interference received, including interference that may cause undesired operation.

Changes or modifications not expressly approved by the manufacturer (or party responsible) for compliance could void the user's authority to operate the equipment.

This equipment complies with FCC RF Radiation exposure limits set forth for an uncontrolled environment. This device and its antenna must not be co-located or operating in conjunction with any other antenna or transmitter. This equipment should be installed and operated with a minimum distance of 20 cm between the radiator and your body

IC : 2703H-TL21BNN

IC Radiation Exposure Statement:

This equipment complies with IC radiation exposure limits set forth for an uncontrolled environment.

This equipment should be installed and operated with minimum distance 20 cm between the radiator & your body.

Operation is subject to the following two conditions:

- (1) This device may not cause interference.
- (2) This device must accept any interference, including interference that may cause undesired operation of the device.

**NOTE: THE MANUFACTURER IS NOT RESPONSIBLE FOR ANY RADIO OR TV INTERFERENCE CAUSED BY UNAUTHORIZED MODIFICATIONS TO THIS EQUIPMENT. SUCH MODIFICATIONS COULD VOID THE USER'S AUTHORITY TO OPERATE THE EQUIPMENT.**

IC : 2703H-TL21BNN

Avis d'Industrie Canada sur l'exposition aux rayonnements

Cet appareil est conforme aux limites d'exposition aux rayonnements d'Industrie Canada pour un environnement non contrôlé.

Il doit être installé de façon à garder une distance minimale de 20 centimètres entre la source de rayonnements et votre corps.

L'exploitation est autorisée aux deux conditions suivantes :

- 1.L'appareil ne doit pas produire de brouillage;
- 2.L'appareil doit accepter tout brouillage radioélectrique subi, même si le brouillage est susceptible d'en compromettre le fonctionnement.

REMARQUE: LE FABRICANT N'EST PAS RESPONSABLE DES INTERFÉRENCES RADIOÉLECTRIQUES CAUSÉES PAR DES MODIFICATIONS NON AUTORISÉES APPORTÉES À CET APPAREIL. DE TELLES MODIFICATIONS POURRAIT ANNULER L'AUTORISATION ACCORDÉE À L'UTILISATEUR DE FAIRE FONCTIONNER L'APPAREIL.

## Digital Key system

US

FCC ID:HYQ17EAD

### NOTE

This device complies with part 15 of the FCC Rules. Operation is subject to the following two conditions: (1) This device may not cause harmful interference, and (2) this device must accept any interference received, including interference that may cause undesired operation.

### FCC WARNING

Changes or modifications not expressly approved by the party responsible for compliance could void the user's authority to operate the equipment.

### CAUTION : Radio Frequency Radiation Exposure

This equipment complies with FCC radiation exposure limits set forth for an uncontrolled environment and meets the FCC radio frequency (RF) Exposure Guidelines. This equipment should be installed and operated keeping the radiator at least 20cm or more away from person's body.

Co-location: This transmitter must not be co-located or operated in conjunction with any other antenna or transmitter.

00

This device contains licence-exempt transmitter(s)/receiver(s) that comply with Innovation, Science and Economic Development Canada's licence-exempt RSS(s). Operation is subject to the following two conditions:

- (1) This device may not cause interference.
- (2) This device must accept any interference, including interference that may cause undesired operation of the device.

The antenna cannot be removed (and changed) by user.

**Co-location:** This transmitter must not be co-located or operated in conjunction with any other antenna or transmitter.

**CAUTION: Radio Frequency Radiation Exposure**

This equipment complies with ISED radiation exposure limits set forth for an uncontrolled environment and meets RSS-102 of the ISED radio frequency (RF) Exposure rules. This equipment should be installed and operated keeping the radiator at least 20 cm or more away from person's body.

L'émetteur/récepteur exempt de licence contenu dans le présent appareil est conforme aux CNR d'Innovation, Sciences et Développement économique Canada applicables aux appareils radio exempts de licence. L'exploitation est autorisée aux deux conditions suivantes :

- (1) L'appareil ne doit pas produire de brouillage;
- (2) L'appareil doit accepter tout brouillage radioélectrique subi, même si le brouillage est susceptible d'en compromettre le fonctionnement.

L'utilisateur n'est pas autorisé à retirer (ou modifier) l'antenne.

**Emplacement :** Cet émetteur ne doit pas être installé ou utilisé conjointement avec d'autres antennes ou émetteurs.

**ATTENTION : exposition aux radiofréquences**

Cet équipement est conforme aux limites d'exposition aux rayonnements d'ISDE établies pour un environnement non contrôlé ainsi que la norme CNR-102 de la réglementation d'ISDE relative à l'exposition aux radiofréquences (RF). Cet équipement doit être installé et utilisé avec un minimum de 20 cm de distance entre la source de rayonnement et le corps.

## Smart key system and immobilizer system

FCC ID: NI4TMLF19D-3

US

NOTE

This device complies with part 15 of the FCC Rules. Operation is subject to the following two conditions: (1) This device may not cause harmful interference, and (2) this device must accept any interference received, including interference that may cause undesired operation.

FCC WARNING

Changes or modifications not expressly approved by the party responsible for compliance could void the user's authority to operate the equipment.

NOTE

CA

This device contains licence-exempt transmitter(s)/receiver(s) that comply with Innovation, Science and Economic Development Canada's licence-exempt RSS(s). Operation is subject to the following two conditions:

- (1) This device may not cause interference.
- (2) This device must accept any interference, including interference that may cause undesired operation of the device.

811

NOTE

CA

L'émetteur/récepteur exempt de licence contenu dans le présent appareil est conforme aux CNR d'Innovation, Sciences et Développement économique Canada applicables aux appareils radio exempts de licence. L'exploitation est autorisée aux deux conditions suivantes:

- (1) L'appareil ne doit pas produire de brouillage;
- (2) L'appareil doit accepter tout brouillage radioélectrique subi, même si le brouillage est susceptible d'en compromettre le fonctionnement.

811

## Smart key system

US

FCC ID:HYQ23ABN

FCC ID:HYQ14FBX

**NOTE:**

This device complies with part 15 of the FCC Rules. Operation is subject to the following two conditions: (1) This device may not cause harmful interference, and (2) this device must accept any interference received, including interference that may cause undesired operation.

**FCC WARNING:**

Changes or modifications not expressly approved by the party responsible for compliance could void the user's authority to operate the equipment.

&lt;For 14FBX&gt;

The FCC ID is affixed inside the equipment. You can find the ID when replacing the battery.

00

CA

**NOTE:**

This device contains licence-exempt transmitter(s)/receiver(s) that comply with Innovation, Science and Economic Development Canada's licence-exempt RSS(s).

Operation is subject to the following two conditions:

- (1) This device may not cause interference.
- (2) This device must accept any interference, including interference that may cause undesired operation of the device.

&lt;For 14FBX&gt;

The IC Certification number is affixed inside the equipment. You can find the number when replacing the battery.

02

**NOTE:**

L'émetteur/récepteur exempt de licence contenu dans le présent appareil est conforme aux CNR d'Innovation, Sciences et Développement économique Canada applicables aux appareils radio exempts de licence.

L'exploitation est autorisée aux deux conditions suivantes :

- (1) L'appareil ne doit pas produire de brouillage;
- (2) L'appareil doit accepter tout brouillage radioélectrique subi, même si le brouillage est susceptible d'en compromettre le fonctionnement.

<Pour 14FBX>

Le numéro d'accréditation IC est apposé à l'intérieur de l'appareil. Ce numéro est visible au remplacement de la pile.

03

## Millimeter wave radar sensor

FCC ID: HYQDNMWR011

D11 US 01

**NOTE:**

This device complies with part 15 of the FCC Rules. Operation is subject to the following two conditions: (1) This device may not cause harmful interference, and (2) this device must accept any interference received, including interference that may cause undesired operation.

**FCC WARNING:**

Changes or modifications not expressly approved by the party responsible for compliance could void the user's authority to operate the equipment.

US 01

**Radiofrequency radiation exposure Information:**

This equipment complies with FCC radiation exposure limits set forth for an uncontrolled environment. This equipment should be installed and operated with minimum distance of 20 cm between the radiator (antenna) and your body. This transmitter must not be co-located or operating in conjunction with any other antenna or transmitter.

US 02



**NOTE:**

This device contains licence-exempt transmitter(s)/receiver(s) that comply with Innovation, Science and Economic Development Canada's licence-exempt RSS(s). Operation is subject to the following two conditions:

- (1) This device may not cause interference.
- (2) This device must accept any interference, including interference that may cause undesired operation of the device.

This equipment complies with ISED radiation exposure limits set forth for an uncontrolled environment and meets RSS-102 of the ISED radio frequency (RF) Exposure rules. This equipment should be installed and operated keeping the radiator at least 20 cm or more away from person's body.

CA 01

**NOTE:**

L'émetteur/récepteur exempt de licence contenu dans le présent appareil est conforme aux CNR d'Innovation, Sciences et Développement économique Canada applicables aux appareils radio exempts de licence. L'exploitation est autorisée aux deux conditions suivantes :

- (1) L'appareil ne doit pas produire de brouillage;
- (2) L'appareil doit accepter tout brouillage radioélectrique subi, même si le brouillage est susceptible d'en compromettre le fonctionnement.

Cet équipement est conforme aux limites d'exposition aux rayonnements énoncées pour un environnement non contrôlé et respecte les règles d'exposition aux fréquences radioélectriques (RF) CNR-102 de l'ISDE. Cet équipement doit être installé et utilisé en gardant une distance de 20 cm ou plus entre le dispositif rayonnant et le corps.

CA 02

## **BSM (Blind Spot Monitor)**

### Radiofrequency radiation exposure Information:

This equipment complies with FCC and IC radiation exposure limits set forth for an uncontrolled environment. This equipment should be installed and operated with minimum distance of 20 cm between the radiator and your body.

This transmitter must not be co-located or operating in conjunction with any other antenna or transmitter.

### FCC Notice:

Changes or modifications not expressly approved by the party responsible for compliance could void the user's authority to operate the equipment.

C5-002

This device contains licence-exempt transmitter(s)/receiver(s) that comply with Innovation, Science and Economic Development Canada's licence-exempt RSS(s). Operation is subject to the following two conditions:

- (1) This device may not cause interference.
- (2) This device must accept any interference, including interference that may cause undesired operation of the device.

### Radiofrequency radiation exposure information:

This equipment complies with radiation exposure limits set forth for an uncontrolled environment. This equipment should be installed and operated with minimum distance of 20 cm between the radiator and your body.

C5-003

L'émetteur/récepteur exempt de licence contenu dans le présent appareil est conforme aux CNR d'Innovation, Sciences et Développement économique Canada applicables aux appareils radio exempts de licence. L'exploitation est autorisée aux deux conditions suivantes :

- (1) L'appareil ne doit pas produire de brouillage;
- (2) L'appareil doit accepter tout brouillage radioélectrique subi, même si le brouillage est susceptible d'en compromettre le fonctionnement.

Informations sur l'exposition aux rayonnements radiofréquences:  
Cet équipement est conforme aux limites d'exposition aux rayonnements définies pour un environnement non contrôlé. Cet équipement doit être installé et utilisé avec un minimum de 20 cm de distance entre la source de rayonnement et votre corps.

C5-004

## Intuitive parking assist

Product name : Intuitive parking assist

Compliance statement : This device complies with part 18 of the FCC Rules.

Responsible Party : DENSO International America, Inc.

24777 Denso Drive, Southfield Michigan 48033 U.S.A.

<https://www.denso.com/us-ca/en/about-us/company-information/us/diam/>

This ISM device complies with Canadian ICES-001.

Cet appareil ISM est conforme à la norme NMB-001 du Canada.

## Wireless charger

FCC ID : ACJ932AT2301

### NOTE:

This device complies with part 15 and part 18 of the FCC Rules. Operation is subject to the following two conditions: (1) This device may not cause harmful interference, and (2) this device must accept any interference received, including interference that may cause undesired operation.

### FCC CAUTION

Changes or modifications not expressly approved by the party responsible for compliance could void the user's authority to operate the equipment. This equipment has been tested and found to comply with the limits for a wireless power charger, pursuant to part 18 of the FCC Rules. This equipment generates, uses and can radiate radio frequency energy and,

if not installed and used in accordance with the instructions, may cause harmful interference to radio communications. However, there is no guarantee that interference will not occur in a particular installation. If this equipment does cause harmful interference to radio communications, which can be determined by turning the equipment off and on, the user is encouraged to try to correct the interference by one or more of the following measures:

- Reorient or relocate the receiving antenna.
- Increase the separation between the equipment and receiver.
- Connect the equipment into an outlet on a circuit different from that to which the receiver is connected.

This equipment complies with FCC radiation exposure limits set forth for an uncontrolled environment and meets the FCC radio frequency (RF) Exposure Guidelines. This equipment should be installed and operated keeping the radiator at least 20cm or more away from person's body.

### NOTE:

This device contains licence-exempt transmitter(s)/receiver(s) that comply with Innovation, Science and Economic Development Canada's licence-exempt RSS(s). Operation is subject to the following two conditions: (1) This device may not cause interference. (2) This device must accept any interference, including interference that may cause undesired operation of the device.

L'émetteur/récepteur exempt de licence contenu dans le présent appareil est conforme aux CNR d'Innovation, Sciences et Développement économique Canada applicables aux appareils radio exempts de licence. L'exploitation est autorisée aux deux conditions suivantes :

- 1) L'appareil ne doit pas produire de brouillage;
- 2) L'appareil doit accepter tout brouillage radioélectrique subi, même si le brouillage est susceptible d'en compromettre le fonctionnement.

**CAUTION:**

This equipment complies with ISED radiation exposure limits set forth for an uncontrolled environment and meets RSS-102 of the ISED radio frequency (RF) Exposure rules. This equipment should be installed and operated keeping the radiator at least 20cm or more away from person's body.

Cet équipement est conforme aux limites d'exposition aux rayonnements énoncées pour un environnement non contrôlé et respecte les règles d'exposition aux fréquences radioélectriques (RF) CNR-102 de l'ISDE.

Cet équipement doit être installé et utilisé en gardant une distance de 20 cm ou plus entre le radiateur et le corps humain.

## Garage door opener

This device complies with FCC rules part 15 and Innovation, Science, and Economic Development Canada RSS-210. Operation is subject to the following two conditions: (1) This device may not cause harmful interference, and (2) This device must accept any interference that may be received including interference that may cause undesired operation. **WARNING:** The transmitter has been tested and complies with FCC and ISED rules. Changes or modifications not expressly approved by the party responsible for compliance could void the user's authority to operate the device.

This equipment complies with FCC and ISED radiation exposure limits set forth for an uncontrolled environment. End Users must follow the specific operating instructions for satisfying RF exposure compliance. This transmitter must be at least 20 cm from the user and must not be co-located or operating in conjunction with any other antenna or transmitter.

This device complies with FCC rules part 15 and Innovation, Science, and Economic Development Canada RSS-210. Operation is subject to the following two conditions: (1) This device may not cause harmful interference, and (2) This device must accept any interference that may be received including interference that may cause undesired operation. **WARNING:** The transmitter has been tested and complies with FCC and ISED rules. Changes or modifications not expressly approved by the party responsible for compliance could void the user's authority to operate the device.

This equipment complies with FCC and ISED radiation exposure limits set forth for an uncontrolled environment. End Users must follow the specific operating instructions for satisfying RF exposure compliance. This transmitter must be at least 20 cm from the user and must not be co-located or operating in conjunction with any other antenna or transmitter.

Cet appareil est conforme aux règlements de la FCC, section 15, et au CNR-210 d'Innovation, Sciences et Développement économique Canada. Le fonctionnement est assujéti aux deux conditions suivantes : (1) cet appareil ne doit pas causer d'interférences nuisibles et (2) cet appareil doit accepter toute interférence reçue, y compris celle qui pourrait entraîner un dysfonctionnement. **MISE EN GARDE :** L'émetteur a subi des tests et est conforme aux règlements de la FCC et d'ISDE. Les changements ou modifications non approuvés explicitement par la partie responsable de la conformité pourraient rendre caduque l'autorisation de l'utilisateur de se servir du dispositif.

Cet appareil est conforme aux limites d'exposition aux radiations de la FCC et d'ISDE établies pour un environnement non contrôlé. Les utilisateurs finaux doivent respecter les instructions d'utilisation spécifiques pour satisfaire aux exigences de conformité aux expositions de RF. L'émetteur doit se trouver à 20 cm au minimum de l'utilisateur et ne doit pas être situé au même endroit que tout autre émetteur ou antenne ni fonctionner avec un autre émetteur ou antenne.

## Tire pressure warning system

FCC ID: PAXPMVG001

### NOTE

This device complies with part 15 of the FCC Rules.

Operation is subject to the following two conditions:

- (1) This device may not cause harmful interference, and
- (2) this device must accept any interference received, including interference that may cause undesired operation.

### FCC WARNING

Changes or modifications not expressly approved by the party responsible for compliance could void the user's authority to operate the equipment.

FCC ID: PAXPMVG101

### NOTE

This device complies with part 15 of the FCC Rules.

Operation is subject to the following two conditions:

- (1) This device may not cause harmful interference, and
- (2) this device must accept any interference received, including interference that may cause undesired operation.

### FCC WARNING

Changes or modifications not expressly approved by the party responsible for compliance could void the user's authority to operate the equipment.

NOTE

This device contains licence-exempt transmitter(s)/ receiver(s) that comply with Innovation, Science and Economic Development Canada's licence-exempt RSS(s).

Operation is subject to the following two conditions:

- (1) This device may not cause interference.
- (2) This device must accept any interference, including interference that may cause undesired operation of the device.

NOTE

L'émetteur/récepteur exempt de licence contenu dans le présent appareil est conforme aux CNR d'Innovation, Sciences et Développement économique Canada applicables aux appareils radio exempts de licence.

L'exploitation est autorisée aux deux conditions suivantes :

- (1) L'appareil ne doit pas produire de brouillage;
- (2) L'appareil doit accepter tout brouillage radioélectrique subi, même si le brouillage est susceptible d'en compromettre le fonctionnement.

“Perchlorate Material – special handling may apply, See [www.dtsc.ca.gov/hazardouswaste/perchlorate](http://www.dtsc.ca.gov/hazardouswaste/perchlorate).”

## GAS STATION INFORMATION

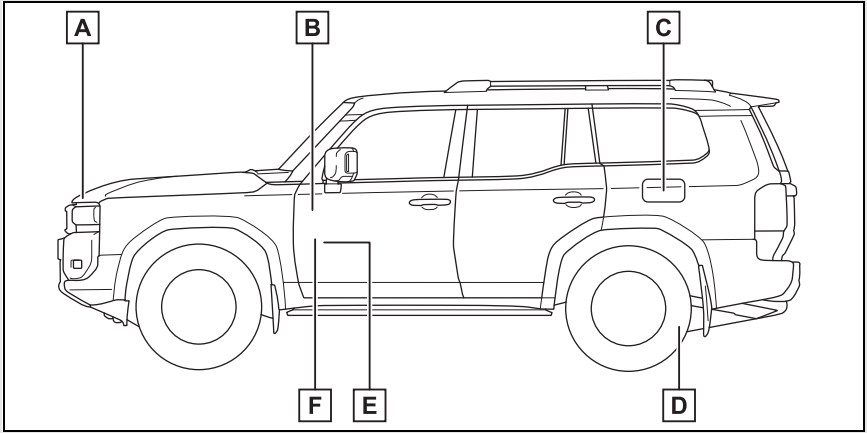

- A** Auxiliary catch lever (→P.540)
- B** Power back door switch\* (→P.138)
- C** Fuel filler door (→P.252)
- D** Tire inflation pressure (→P.637)
- E** Fuel filler door opener (→P.252)
- F** Hood lock release lever (→P.540)

\*: If equipped

Fuel tank capacity (Reference)	17.9 gal. (68 L, 14.9 Imp.gal.)
Fuel type	P.632
Cold tire inflation pressure	P.637
Engine oil capacity (Drain and refill — reference)	P.633
Engine oil type	P.633