



Digital – in the vehicle

Familiarize yourself with the contents of the Operator's Manual directly via the vehicle's multimedia system (menu item "Vehicle information"). Start with the quick guide or broaden your knowledge with practical tips.



Vehicle document wallet

Here you can find comprehensive information about operating your vehicle and about services and guarantees in printed form.



Digital – on the Internet

You can find the Operator's Manual on the Mercedes-Benz homepage.



Digital – as an app

The Mercedes-Benz Guides app is available free-of-charge in familiar app stores.

GLE



GLE

Operator's Manual

Mercedes-Benz



1675849206

Order no. P167 0139 13 Part no. 167 584 92 06
Edition B 2020



Apple® iOS



Android™

Mercedes-Benz

Front passenger airbag warning

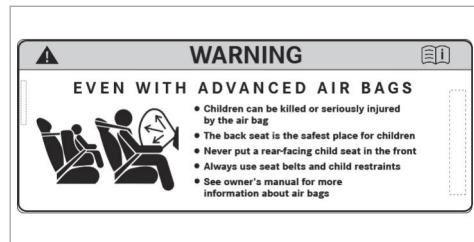

Example

⚠ WARNING Risk of injury or fatal injuries if the front-passenger airbag is enabled

If the front-passenger front airbag is enabled, a child on the front-passenger seat may be struck by the front-passenger airbag during an accident.

NEVER use a rearward-facing child restraint system on a seat with an ENABLED FRONT AIRBAG, DEATH or SERIOUS INJURY to the CHILD can occur.

Observe the chapter "Children in the vehicle".

Publication details

Internet

Further information about Mercedes-Benz vehicles and about Daimler AG can be found on the following websites:

<https://www.mbusa.com> (USA only)

<https://www.mercedes-benz.ca> (Canada only)

Documentation team

©Daimler AG: not to be reprinted, translated or otherwise reproduced, in whole or in part, without written permission from Daimler AG.

Vehicle manufacturer

Daimler AG

Mercedesstrasse 137

70327 Stuttgart

Germany

As at 03.08.19

Thank you for purchasing a Mercedes-Benz

Before you first drive off, read this Operator's Manual carefully and familiarize yourself with your vehicle. For your own safety and a longer operating lifespan of the vehicle, follow the instructions and warning notices in this Operator's Manual. Disregarding them may lead to damage to the vehicle or injury to people.

Damage to the vehicle resulting from the disregard of the instructions is not covered by the Mercedes-Benz Limited Warranty.

The standard equipment and product description of your vehicle may vary and depends on the following factors:

- Model
- Order
- National version
- Availability

Mercedes-Benz reserves the right to introduce changes in the following areas:

- Design
- Equipment

- Technical features

The equipment in your vehicle may therefore differ from that shown in the descriptions and illustrations.

The following documents are integral parts of the vehicle:

- Digital Operator's Manual
- Printed Operator's Manual
- Maintenance Booklet
- Equipment-dependent Supplements

Keep these documents in the vehicle at all times. If you sell the vehicle, always pass all of the documents on to the new owner.

Mercedes-Benz USA, LLC
Mercedes-Benz Canada, Inc.
A Daimler Company

1675849206



Symbols	5	Qualified specialist workshop	28	Roller sun blinds	90
		Correct use of the vehicle	28	Anti-theft protection	93
		Problems with your vehicle	29		
At a glance	6	Reporting safety defects	29	Seats and stowing	97
Cockpit	6	Limited Warranty	29	Notes on the correct driver's seat posi-	
Indicator and warning lamps	10	QR code for rescue card	30	tion	97
Overhead control panel	12	Data storage	30	Seats	97
Door control panel and seat adjustment	14	Copyright	33	Steering wheel	110
Control settings in the rear passenger				Easy entry and exit feature	111
compartment	16	Occupant safety	35	Operating the memory function	113
Emergencies and breakdowns	18	Restraint system	35	Stowage areas	114
		Seat belts	37	Cup holder	128
Digital Operator's Manual	20	Airbags	42	Ashtray and cigarette lighter	130
Calling up the Digital Operator's Manual	20	PRE-SAFE® system	49	Sockets	131
		Safely transporting children in the vehi-		Wireless charging of the mobile phone	
General notes	22	cle	51	and connection with the exterior antenna ..	134
Protecting the environment	22	Notes on pets in the vehicle	66	Installing/removing the floor mats	135
Mercedes-Benz Genuine Parts	23				
Operator's Manual	23	Opening and closing	67	Light and visibility	137
Service and vehicle operation	24	SmartKey	67	Exterior lighting	137
Operating safety	25	Doors	72	Interior lighting	142
Declaration of conformity for wireless		Cargo compartment	76	Windshield wiper and windshield washer	
vehicle components	27	Side windows	81	system	144
Diagnostics connection	27	Sliding sunroof	85	Mirrors	148

Operating the sun visors	151	Overview of the buttons on the steering wheel	280	Telephone	399
Area permeable to radio waves on the windshield	152	Operating the on-board computer	281	Online and Internet functions	427
Infrared-reflective windshield function	152	Adjusting the style of the Instrument Display	282	Media	434
Climate control	153	Showing display content on the instrument cluster	283	Radio	441
Overview of climate control systems	153	Overview of displays on the multifunction display	284	Sound	449
Operating the climate control system	154	Adjusting the instrument lighting	285	MBUX rear tablet	451
Driving and parking	161	Menus and submenus	285	Maintenance and care	454
Driving	161	Head-up Display	292	ASSYST PLUS service interval display	454
DYNAMIC SELECT switch	176	Voice Control System	294	Engine compartment	455
Automatic transmission	179	Notes on operating safety	294	Cleaning and care	461
Function of 4MATIC	183	Operation	295	Breakdown assistance	471
Refueling	184	Using the Voice Control System effectively	297	Flat tire	471
Parking	186	Essential voice commands	298	Battery (vehicle)	477
Driving and driving safety systems	196	MBUX multimedia system	313	Tow starting or towing away	482
Trailer hitch	274	Overview and operation	313	Electrical fuses	487
Vehicle towing instructions	278	System settings	348	Wheels and tires	490
Instrument Display and on-board computer	279	Navigation	358	Notes on noise or unusual handling characteristics	490
Instrument Display overview	279			Notes on regularly inspecting wheels and tires	490

4 Contents

Notes on snow chains	491
Tire pressure	492
Loading the vehicle	499
Tire labeling	503
Definition of terms for tires and loading	508
Changing a wheel	511
Emergency spare wheel	520
Collapsible spare wheel	522

Technical data

Technical data	525
Notes on technical data	525
Vehicle electronics	525
Vehicle identification plate, VIN and engine number overview	527
Operating fluids	529
Vehicle data	536
Trailer hitch	539

Display messages and warning/indicator lamps

Display messages and warning/indicator lamps	541
Display messages	541
Warning and indicator lamps	592

Index	607
--------------------	------------

In this Operator's Manual, you will find the following symbols:

⚠ DANGER Danger due to not observing the warning notices

Warning notices draw your attention to hazards that may endanger your health or life, or the health or life of others.

▶ Observe the warning notices.

🌿 ENVIRONMENTAL NOTE Environmental damage due to failure to observe environmental notes

Environmental notes include information on environmentally responsible behavior or environmentally responsible disposal.

▶ Observe environmental notes.

! NOTE Damage to property due to failure to observe notes on material damage

Notes on material damage inform you of risks which may lead to your vehicle being damaged.

▶ Observe notes on material damage.

ⓘ Useful instructions or further information that could be helpful to you.

▶ Instruction

(→ page) Further information on a topic

Display Information on the multifunction display/media display



Highest menu level, which is to be selected in the multimedia system



Corresponding submenus, which are to be selected in the multimedia system

* Marks a cause

6 At a glance – Cockpit

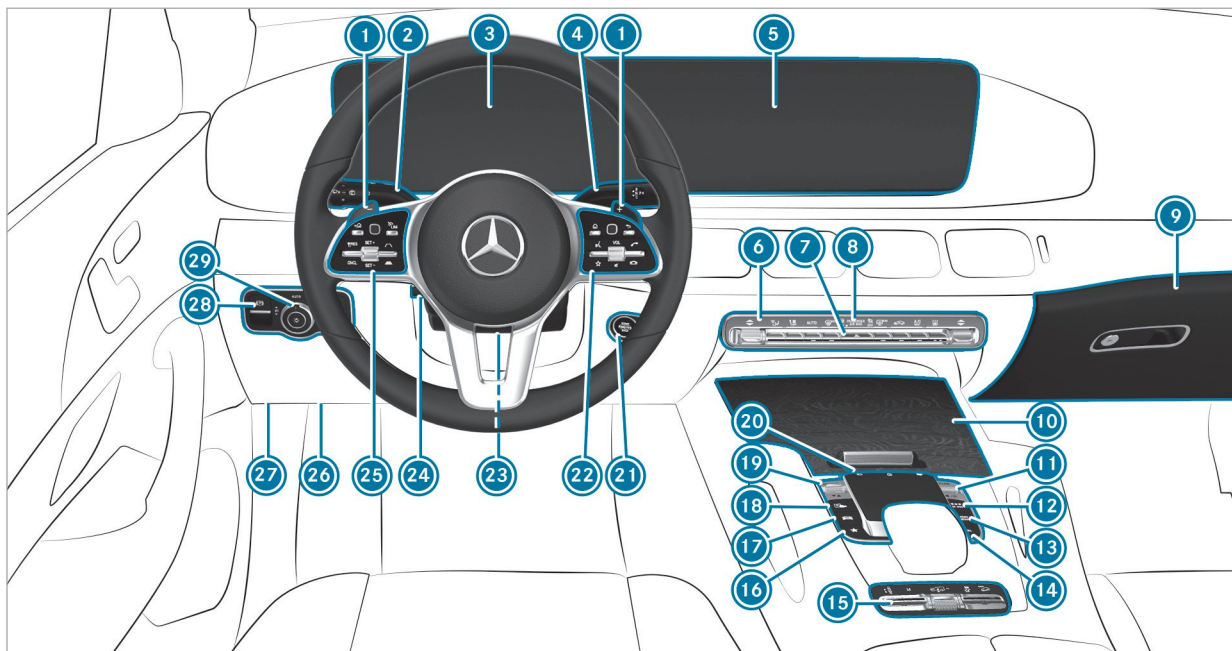

Left-hand drive vehicles

①	Steering wheel gearshift paddles	→	181	Individual wheel control (vehicles without off-road package) or	→	242	
②	Combination switch	→	138	Manual gearshifting	→	181	
③	Instrument Display	→	279	AIRMATIC or	→	228	
④	DIRECT SELECT lever	→	176	E-ACTIVE BODY CONTROL	→	236	
⑤	Media display	→	316	Activates/deactivates ESP®	→	198	
⑥	Climate control systems	→	154	Downhill Speed Regulation	→	211	
⑦	Hazard warning lights	→	139	⑩	Calls up favorites	→	334
⑧	PASSENGER AIR BAG indicator lamp	→	47	⑪	Calls up vehicle functions	→	326
⑨	Glove box	→	115	⑫	Active Parking Assist	→	261
⑩	Stowage compartment	→	115	⑬	DYNAMIC SELECT switch	→	177
⑪	Control knob for volume and switching sound on/off	→	313	⑭	Touchpad	→	316
⑫	Calls up navigation	→	358	⑮	Start/stop button	→	162
⑬	Calls up the radio	→	442	ECO start/stop function	→	174	
	Calls up media	→	437	⑯	MBUX multimedia system control panel	→	316
⑭	Calls up the telephone	→	400	⑰	Adjusts the steering wheel mechanically	→	110
⑮	Control panel for:			⑱	Adjusts the steering wheel electrically	→	111

8 At a glance – Cockpit



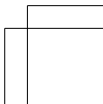
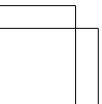
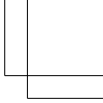
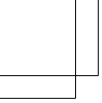



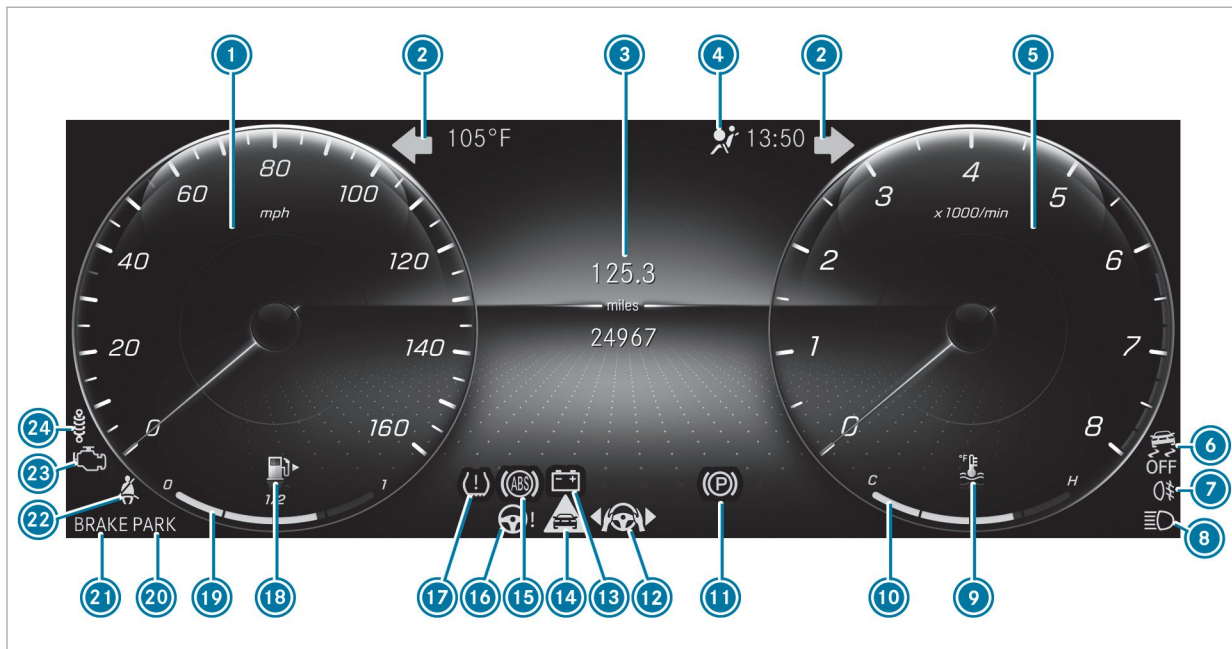



















Switches the steering wheel heater on/off	→	111	26	Diagnostics connection	→	27
25 Control panel for:			27	Opens the hood	→	455
On-board computer	→	280	28	Electric parking brake	→	192
Cruise control	→	210	29	Light switch	→	137
Active Distance Assist DISTRONIC	→	215				



10 At a glance – Indicator and warning lamps









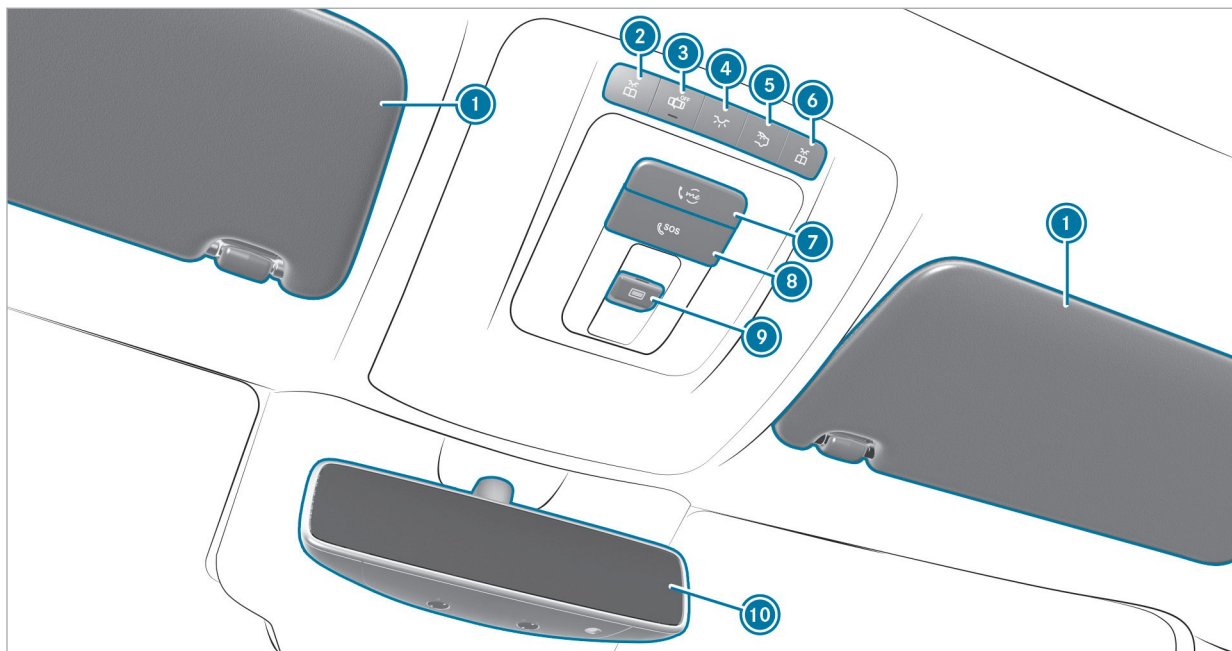

Instrument Display

①	Speedometer	→	279	⑭	 Distance warning	→	601
②	  Turn signal lights	→	138	⑮	 ABS malfunction	→	602
③	Multifunction display	→	284	⑯	 Electric power steering malfunction	→	595
④	 Restraint system	→	594	⑰	 Tire pressure monitor	→	605
⑤	Tachometer	→	279	⑱	 Fuel reserve with fuel filler cap location indicator	→	596
⑥	 ESP® OFF	→	602	⑲	Fuel level indicator		
	 ESP®	→	602	⑳	Electric parking brake applied (red)	→	599
⑦	 Rear fog light	→	138		 USA only		
⑧	 High beam	→	138		 Canada only		
	 Low beam	→	137	㉑	Brakes (red)	→	599
	 Parking lamps	→	137		 USA only		
⑨	 Coolant too hot/cold	→	596		 Canada only		
⑩	Coolant temperature display	→	279	㉒	 Seat belt not fastened	→	594
⑪	 Electric parking brake (yellow)	→	599	㉓	 Check Engine	→	596
⑫	 Active Lane Change Assist	→	222	㉔	 Suspension malfunction (red)	→	601
⑬	 Electrical malfunction	→	596		 Suspension malfunction (yellow)	→	601

12 At a glance – Overhead control panel



① Sun visors	→	151	⑥  Switches the right-hand reading lamp on/off	→	142
②  Switches the left-hand reading lamp on/off	→	142	⑦  me button	→	420
③  Switches automatic interior lighting control on/off	→	142	⑧  SOS button	→	420
④  Switches the front interior lighting on/off	→	142	⑨  Opens/closes the panorama roof with power tilt/sliding panel	→	85
⑤  Switches the rear interior lighting on/off	→	142	 Opens/closes the roller sunblind	→	85
			⑩ Inside rearview mirror	→	150

14 At a glance – Door control panel and seat adjustment

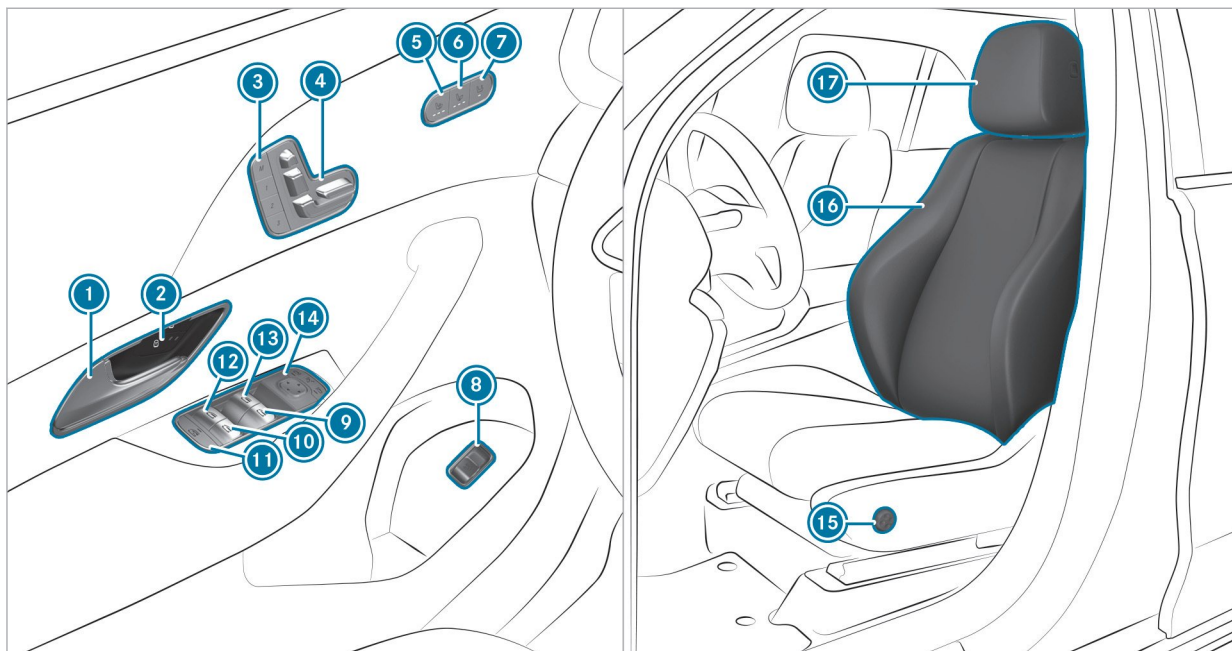

①	Opens the door	→	72	⑩	Opens/closes the rear right side window	→	81
②	Locks/unlocks the vehicle	→	72	⑪	Child safety lock for the rear side windows	→	66
③	Sets the memory function	→	113	⑫	Opens/closes the rear left side window	→	81
④	Adjusts the seats electrically	→	97	⑬	Opens/closes the left side window	→	81
⑤	Switches the seat heating on/off	→	108	⑭	Operates the outside mirrors	→	148
⑥	Switches the seat ventilation on/off	→	109	⑮	Adjusts the 4-way lumbar support	→	100
⑦	Adjusts the front passenger seat from the driver's seat	→	99	⑯	Seat adjustment using the multimedia system	→	106
⑧	Opens/closes the tailgate	→	76	⑰	Adjusts the head restraints	→	103
⑨	Opens/closes the right side window	→	81				

16 At a glance – Control settings in the rear passenger compartment

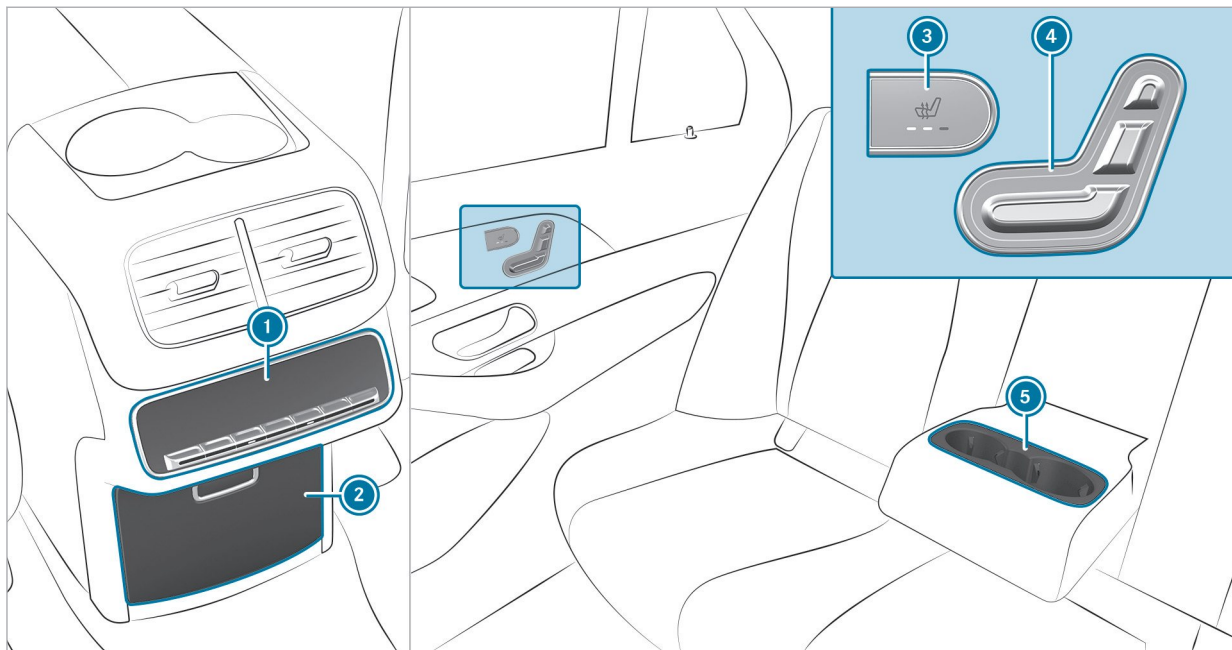

① Control panel for rear climate control	→	154
② Stowage compartment in the center console	→	116
115 V socket	→	132

③ Switches the rear seat heating on/off	→	108
④ Adjusts the rear seats electrically	→	100
⑤ Cup holder	→	116

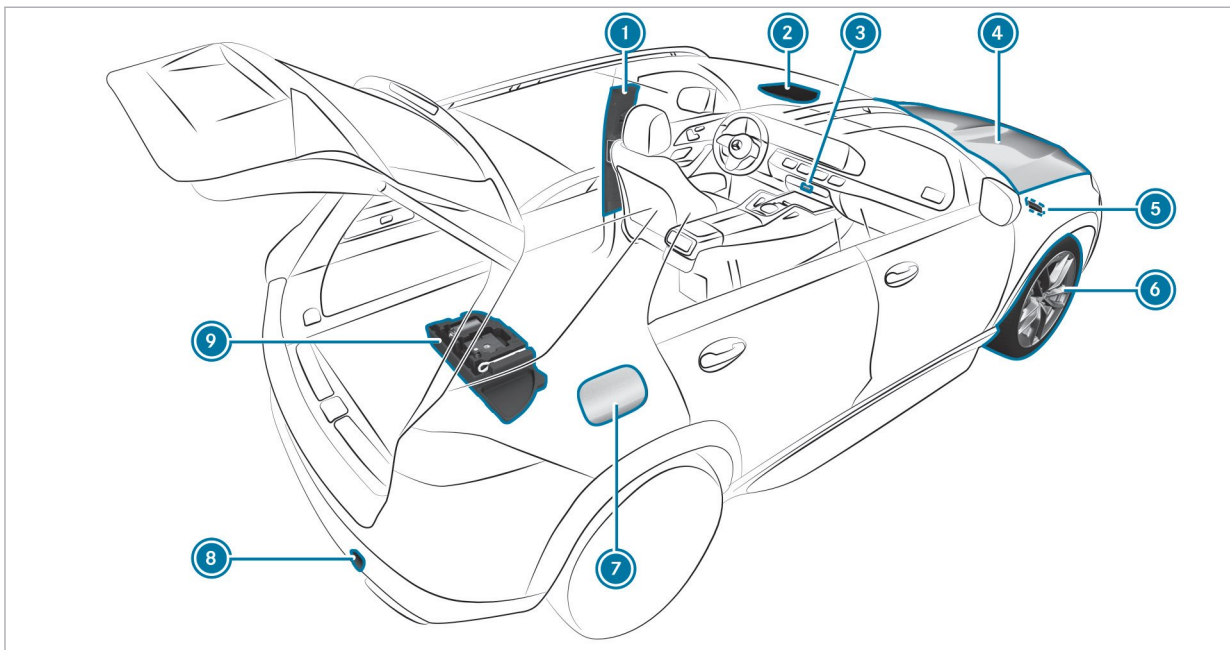

① QR code for accessing the rescue card	→	30	⑥ Flat tire	→	471
② me button and SOS button	→	420	⑦ Fuel filler flap with instruction labels for tire pressure, fuel type and QR code for accessing the rescue card	→	184
③ Hazard warning lights	→	139	⑧ Tow-starting and towing away	→	483
④ Checking and refilling operating fluids	→	529	⑨ TIREFIT kit	→	473
Starting assistance	→	481			
⑤ Tow-starting and towing away	→	483			

Calling up the Digital Operator's Manual

Multimedia system:

➔  ➔ Info ➔ Operator's Manual
 ➔ 



The Digital Operator's Manual describes the function and operation of:

- The vehicle
- The multimedia system

▶ Select one of the following menu items in the Digital Operator's Manual:

- **Search:** search for keywords in order to find quick answers to questions about the operation of the vehicle.
- **Quick start:** find the first steps towards setting up your vehicle.
- **Tips:** find information that prepares you for certain everyday situations with your vehicle.
- **Messages:** receive additional information about the messages in the instrument display.
- **Bookmarks:** gain access to your personally saved bookmarks.
- **Language:** select the language for the Digital Operator's Manual.

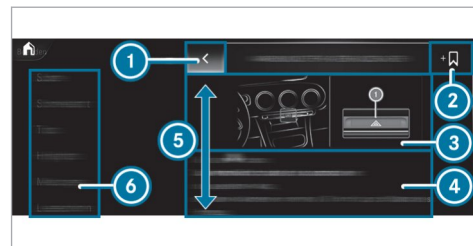

- ① Back
- ② Adds bookmarks
- ③ Picture
- ④ Contents section
- ⑤ Directions of movement of contents section
- ⑥ Menu

Some sections in the Digital Operator's Manual, e.g. warning notes, can be opened and closed.

Additional methods of calling up the Digital Operator's Manual:

Direct access: open the required content in the Digital Operator's Manual by pressing and hold-

ing an entry on the tab bar in the multimedia system:

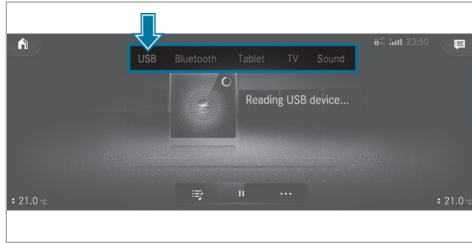

Instrument Display: call up brief information as display messages in the instrument cluster.

Voice Control System: call up via the voice control system

Global search: call up search results for contents of the Digital Operator's Manual in the home screen

For safety reasons, the Digital Operator's Manual is deactivated while driving.

i The Operator's Manual can also be found in the Mercedes-Benz Guides app in all common app stores.

Protecting the environment

 **ENVIRONMENTAL NOTE** Environmental damage due to operating conditions and personal driving style

The pollutant emission of the vehicle is directly related to the way you operate the vehicle.

Operate your vehicle in an environmentally responsible manner to help protect the environment. Please observe the following recommendations on operating conditions and personal driving style.

Operating conditions:

- ▶ Make sure that the tire pressure is correct.
- ▶ Do not carry any unnecessary weight (e.g. roof luggage racks once you no longer need them).
- ▶ Adhere to the service intervals. A regularly serviced vehicle will contribute to environmental protection.

- ▶ Always have maintenance work carried out at a qualified specialist workshop.

Personal driving style:

- ▶ Do not depress the accelerator pedal when starting the engine.
- ▶ Do not warm up the engine while the vehicle is stationary.
- ▶ Drive carefully and maintain a suitable distance from the vehicle in front.
- ▶ Avoid frequent, sudden acceleration and braking.
- ▶ Change gear in good time and use each gear only up to $\frac{2}{3}$ of its maximum engine speed.
- ▶ Switch off the engine in stationary traffic, e.g. by using the ECO start/stop function.
- ▶ Drive fuel-efficiently. Observe the ECO display for a fuel-efficient driving style.

 **ENVIRONMENTAL NOTE** Environmental pollution caused by irresponsible disposal of the high-voltage battery

A high-voltage battery contains materials which are harmful to the environment.

- ▶ Dispose of defective high-voltage batteries at a qualified specialist workshop.

Environmental issues and recommendations:

It is recommended that you re-use or recycle materials instead of just disposing of them.

The relevant environmental guidelines and regulations serve to protect the environment and must be strictly observed.

Mercedes-Benz Genuine Parts



ENVIRONMENTAL NOTE Environmental damage caused by not using recycled reconditioned components

Daimler AG offers recycled reconditioned components and parts with the same quality as new parts. The same entitlement from the Limited Warranty is valid as for new parts.

- ▶ Use recycled reconditioned components and parts from Daimler AG.



NOTE Impairment of the operating efficiency of the restraint systems from installing accessory parts or from repairs or welding

Airbags and Emergency Tensioning Devices, as well as control units and sensors for the restraint systems, may be installed in the following areas of your vehicle:

- Doors
- Door pillars

- Door sills
- Seats
- Cockpit
- Instrument cluster
- Center console
- Lateral roof frame

- ▶ Do not install accessory parts such as audio systems in these areas.
- ▶ Do not carry out repairs or welding.
- ▶ Have aftermarket installation of accessories carried out at a qualified specialist workshop.

You could jeopardize the operating safety of your vehicle if you use parts, tires and wheels as well as accessories relevant to safety which have not been approved by Mercedes-Benz. Safety-relevant systems, e.g. the brake system, may malfunction. Only use Mercedes-Benz Genuine Parts or parts of equal quality. Only use tires, wheels and accessories that have been specifically approved for your vehicle model.

Mercedes-Benz Genuine Parts are subject to strict quality control. Each part has been specially developed, manufactured or selected for Mercedes-Benz vehicles and fine-tuned for them. Therefore, only Mercedes-Benz Genuine Parts should be used.

More than 300,000 different Mercedes-Benz Genuine Parts are available for Mercedes-Benz models.

All authorized Mercedes-Benz Centers maintain a supply of Mercedes-Benz Genuine Parts for necessary service and repair work. In addition, strategically located parts delivery centers provide for quick and reliable parts service.

Always specify the vehicle identification number (VIN) (→ page 527) when ordering Mercedes-Benz Genuine Parts.

Operator's Manual

This Operator's Manual describes all models and all standard and optional equipment available for your vehicle at the time of this Operator's Manual going to press. Country-specific differences are possible. Note that your vehicle may not be

24 General notes

equipped with all features described. This is also the case for systems and functions relevant to safety. Therefore, the equipment on your vehicle may differ from that in the descriptions and illustrations.

The original purchase agreement for your vehicle contains a list of all of the systems in your vehicle.

Should you have any questions concerning equipment and operation, please consult an authorized Mercedes-Benz Center.

The Operator's Manual and Maintenance Booklet are important documents and should be kept in the vehicle.

Service and vehicle operation

Vehicle operation outside the USA or Canada

When you are abroad with your vehicle, observe the following points:

- service points or replacement parts may not be available immediately.

- unleaded fuel may not be available for vehicles with a catalytic converter. Leaded fuel may cause damage to the catalytic converter.
- the fuel may have an extremely low octane number. Unsuitable fuel can cause engine damage.

Some Mercedes-Benz models are available in Europe through our European Delivery Program. For more information, please consult an authorized Mercedes-Benz service center, or write to one of the following address:

in the USA:

Mercedes-Benz USA, LLC
European Delivery Department
One Mercedes-Benz Drive
Sandy Springs, GA 30328

in Canada:

Mercedes-Benz Canada, Inc.
European Delivery Department
98 Vanderhoof Avenue
Toronto, Ontario M4G 4C9

Maintenance

Your customer advisor confirms the service in the service report.

Roadside Assistance

The Mercedes-Benz Roadside Assistance Program offers technical help in the case of a breakdown. Your calls to the toll-free Roadside Assistance Hotline are answered by our agents 24 hours a day, 365 days a year.

1-800-FOR-MERCEdes (1-800-367-6372) (USA)
1-800-387-0100 (Canada)

You can find further information in the Mercedes-Benz Roadside Assistance Program brochure (USA) or the "Roadside Assistance" section in the Service and Warranty booklet (Canada). You will find both in the vehicle document wallet.

Change of address or change of ownership

In the event of a change of address, please send us the "Notification of address change" in the

Service and Guarantee booklet or simply call the Mercedes-Benz Customer Assistance Center (USA) on the hotline number 1-800-FOR-MERCEdes (1-800-367-6372) or Customer Service (Canada) on 1-800-387-0100. We can then reach you in a timely fashion, if necessary.

If you sell your Mercedes, please leave all literature in the vehicle so that it is available to the next owner. If you have purchased a used vehicle, please send us the "Notice of Purchase of Used Car" in the Service and Guarantee booklet or simply call the Mercedes-Benz Customer Assistance Center (USA) at the hotline number 1-800-FOR-MERCEdes (1-800-367-6372) or Customer Service (Canada) at 1-800-387-0100.

Possible danger due to substances hazardous to health

In compliance with Proposition 65 ("Prop65"), the following detachable label has been added to each vehicle sold in California:



WARNING



Operating, servicing and maintaining a passenger vehicle, pickup truck, van or off-road motor vehicle can expose you to chemicals including engine exhaust, carbon monoxide, phthalates, and lead, which are known to the State of California to cause cancer and birth defects or other reproductive harm. To minimize exposure, avoid breathing exhaust, do not idle the engine except as necessary, service your vehicle in a well-ventilated area and wear gloves or wash your hands frequently when servicing your vehicle. For more information go to www.P65Warnings.ca.gov/passenger-vehicle

A 000 817 82 02

Operating safety



WARNING Risk of accident due to malfunctions or system failures

If you do not have the prescribed service/maintenance work or any required repairs carried out, this could result in malfunctions or system failures.

- ▶ Always have the prescribed service/maintenance work as well any required repairs carried out at a qualified specialist workshop.



WARNING Risk of accident and injury as a result of incorrect modifications to electronic component parts

Modification to electronic components, their software or wiring could impair their function and/or the function of other networked component parts. In particular, systems relevant to safety could also be affected.

As a result, they may no longer function as intended and/or endanger the operating safety of the vehicle.

- ▶ Never tamper with the wiring and electronic component parts or their software.
- ▶ You should have all work on electrical and electronic components carried out at a qualified specialist workshop.

Observe the "On-board electronics" section in "Technical data".

⚠ WARNING Risk of fire due to flammable materials on hot parts of the exhaust system

Flammable material such as leaves, grass or twigs may ignite if they come into contact with hot parts of the exhaust system.

- ▶ When driving on unpaved roads or off-road, regularly check the vehicle underside.
- ▶ Remove trapped plants or other flammable material.
- ▶ If there is damage, consult a qualified specialist workshop immediately.

! NOTE Damage to the vehicle

In the following situations, in particular, there is a risk of damage to the vehicle:

- The vehicle becomes grounded, e.g. on a high curb or an unpaved road

- The vehicle is driven too fast over an obstacle, e.g. a curb, speed bump or pothole
- A heavy object strikes the underbody or chassis components

In situations such as this, the body, the underbody, chassis components, wheels or tires could be damaged without the damage being visible. Components damaged in this way can unexpectedly fail or, in the case of an accident, may not absorb the loads that arise as intended.

If the underbody paneling is damaged, flammable materials such as leaves, grass or twigs can collect between the underbody and the underbody paneling. These materials may ignite if they come into contact with hot parts on the exhaust system.

- ▶ Have the vehicle checked and repaired immediately at a qualified specialist workshop.

or

- ▶ If driving safety is impaired while continuing your journey, pull over and stop the vehicle immediately in accordance with the traffic conditions, and contact a qualified specialist workshop.

Vehicles with a 48 V on-board electrical system (EQ Boost technology)

⚠ DANGER Risk of fatal injury by touching damaged high-voltage components

Vehicles with a 48 V on-board electrical system contain individual high-voltage components. These high-voltage components are under high voltage.

If you modify component parts of these high-voltage components or touch damaged component parts, you may be electrocuted.

High voltage components may be damaged in an accident, although the damage may not be visible.

- ▶ Never perform modifications to component parts of high-voltage components.

- ▶ Never touch damaged component parts of high-voltage components.
- ▶ Never touch component parts of high-voltage components after an accident.

Vehicles with a 48 V on-board electrical system contain high voltage components. These components are marked with a high voltage label:



All work on high voltage components must be carried out at a qualified specialist workshop.

Declaration of conformity for wireless vehicle components

USA: "The wireless devices of this vehicle comply with Part 15 of the FCC Rules. Operation is subject to the following two conditions: 1) These devices may not cause harmful interference, and 2) These devices must accept any interference received, including interference that may cause undesired operation. Changes or modifications not expressly approved by the party responsible for compliance could void the user's authority to operate the equipment."

Canada: "The wireless devices of this vehicle comply with Industry Canada license-exempt RSS standard(s). Operation is subject to the following two conditions: (1) These devices may not cause interference, and (2) These devices must accept any interference, including interference that may cause undesired operation of the device."

USA: "Wireless charging system for mobile devices (model: WMI2 Wireless Mobile Interface): this device complies with Part 18 of the FCC Rules."

The name and address of the responsible party is:

peiker acustic GmbH
Max-Planck-Str. 28-32
61381 Friedrichsdorf
Germany

Diagnostics connection

The diagnostics connection is only intended for the connection of diagnostic devices at a qualified specialist workshop.

⚠ WARNING Risk of accident due to connecting devices to the diagnostics connection

If you connect equipment to a diagnostics connection in the vehicle, it may affect the operation of vehicle systems.

As a result, the operating safety of the vehicle could be affected.

- ▶ Only connect the vehicle diagnostics connection to devices which have been

tested with regard to their use and are considered safe.

⚠ WARNING Risk of accident due to objects in the driver's footwell

Objects in the driver's footwell may impede pedal travel or block a depressed pedal.

This jeopardizes the operating and road safety of the vehicle.

- ▶ Stow all objects in the vehicle securely so that they cannot get into the driver's footwell.
- ▶ Always install the floor mats securely and as prescribed in order to ensure that there is always sufficient room for the pedals.
- ▶ Do not use loose floor mats and do not place floor mats on top of one another.

! **NOTE** Battery discharging from using devices connected to the diagnostics connection

Using devices at the diagnostics connection drains the battery.

- ▶ Check the charge level of the battery.
- ▶ If the charge level is low, charge the battery, e.g. by driving a considerable distance.

Connecting equipment to the diagnostics connection can lead to emissions monitoring information being reset, for example. This may lead to the vehicle failing to meet the requirements of the next emissions inspection during the main inspection.

Qualified specialist workshop

An authorized Mercedes-Benz Center is a qualified specialist workshop. It has the necessary special skills, tools and qualifications to correctly carry out the work required on your vehi-

cle. This particularly applies to safety-relevant works.

For the following, always have your vehicle checked at an authorized Mercedes-Benz Center:

- safety-relevant works
- service and maintenance work
- repair work
- modifications as well as installations and conversions
- work on electronic components

Mercedes-Benz recommends a Mercedes-Benz service center.

Correct use of the vehicle

If you remove any warning stickers, you or others could fail to recognize certain dangers. Leave warning stickers in position.

Observe the following information in particular when driving your vehicle:

- the safety notes in this manual

- technical data for the vehicle
- traffic rules and regulations
- laws and safety standards pertaining to motor vehicles

Problems with your vehicle

If you should experience a problem with your vehicle, particularly one that you believe may affect its safe operation, we urge you to contact an authorized Mercedes-Benz Center immediately to have the problem diagnosed and rectified. If the problem is not resolved to your satisfaction, please discuss the problem again with an authorized Mercedes-Benz Center or, if necessary, contact us at one of the following addresses:

In the USA:

Mercedes-Benz USA, LLC
Customer Assistance Center
One Mercedes-Benz Drive
Sandy Springs, GA 30328

In Canada:

Mercedes-Benz Canada, Inc.
Customer Relations Department
98 Vanderhoof Avenue
Toronto, Ontario M4G 4C9

Reporting safety defects

USA only:

The following text is published as required of manufacturers under Title 49, Code of U.S. Federal Regulations, Part 575 pursuant to the "National Traffic and Motor Vehicle Safety Act of 1966".

If you believe that your vehicle has a defect which could cause a crash or could cause injury or death, you should immediately inform the National Highway Traffic Safety Administration (NHTSA) in addition to notifying Mercedes-Benz USA, LLC.

If NHTSA receives similar complaints, it may open an investigation, and if it finds that a safety defect exists in a group of vehicles, it may order a recall and remedy campaign. However, NHTSA cannot become involved in individual problems

between you, your dealer, or Mercedes-Benz USA, LLC.

To contact NHTSA, you may call the Vehicle Safety Hotline toll-free at 1-888-327-4236 (TTY: 1-800-424-9153) (inside the USA), go to <https://www.safercar.gov> or write to Administrator, NHTSA, 400 Seventh Street, SW, Washington, DC 20590, USA.

You can also obtain other information about motor vehicle safety from: <https://www.safercar.gov>

Limited Warranty

! **NOTE** Damage to the vehicle arising from violation of these operating instructions.

Damage to the vehicle can arise from violation of these operating instructions.

This damage is not covered either by the Mercedes-Benz implied warranty or by the New- or Used-Vehicle Warranty.

- ▶ Follow the instructions in these operating instructions on proper operation of your vehicle as well as on possible vehicle damage.

QR code for rescue card

The QR code is secured in the fuel filler flap and on the opposite side on the B-pillar. In the event of an accident, rescue services can use the QR code to quickly find the appropriate rescue card for your vehicle. The current rescue card contains the most important information about your vehicle in a compact form, e.g. the routing of the electric lines.

Further information can be obtained at <https://www.mercedes-benz.de/qrcode>.

Data storage

Electronic control units

Electronic control units are installed in your vehicle. Some of these are necessary for the safe operation of your vehicle, while some assist you

when driving (driver assistance systems). In addition, your vehicle provides comfort and entertainment functions, which are also made possible by electronic control units.

Electronic control units contain data memories which can temporarily or permanently store technical information about the vehicle's operating state, component loads, maintenance requirements and technical events or malfunctions.

In general, this information documents the state of a component part, a module, a system or the surroundings such as:

- Operating status of system components (e.g. fill levels, battery status, tire pressure)
- Status messages concerning the vehicle or its individual components (e.g. number of wheel revolutions/speed, longitudinal acceleration, lateral acceleration, display of fastened seat belts)
- Malfunctions or faults in important system components (e.g. lights, brakes)
- Information on events leading to vehicle damage
- System reactions in special driving situations (e.g. airbag deployment, intervention of stability control systems)
- Ambient conditions (e.g. temperature, rain sensor)

In addition to providing the actual control unit function, this data assists the manufacturer in detecting and rectifying malfunctions and optimizing vehicle functions. The majority of this data is temporary and is only processed in the vehicle itself. Only a small portion of the data is stored in the event or fault memory.

When your vehicle is serviced, technical data from the vehicle can be read out by service network employees (e.g. workshops, manufacturers) or third parties (e.g. breakdown services). Services include repair services, maintenance processes, warranty claims and quality assurance measures, for example. The read out is performed via the legally prescribed port for the diagnostics connection in the vehicle. The respective service network locations or third parties collect, process and use the data. They document technical statuses of the vehicle,

assist in finding malfunctions and improving quality and are transmitted to the manufacturer, if necessary. Furthermore, the manufacturer is subject to product liability. For this, the manufacturer requires technical data from vehicles.

Fault memories in the vehicle can be reset by a service outlet as part of repair or maintenance work.

Depending on the selected equipment, you can import data into vehicle convenience and infotainment functions yourself.

This includes, for example:

- Multimedia data such as music, films or photos for playback in an integrated multimedia system
- Address book data for use in connection with an integrated hands-free system or an integrated navigation system
- Entered navigation destinations
- Data about the use of Internet services

This data can be saved locally in the vehicle or it is located on a device which you have connected to the vehicle (e.g. a smartphone, USB flash

drive or MP3 player). If this data is stored in the vehicle, you can delete it at any time. This data is sent to third parties only at your request, particularly when you use online services in accordance with the settings that you have selected.

You can store or change convenience settings/individualization in the vehicle at any time.

Depending on the equipment, this includes, for example:

- Settings for the seat and steering wheel positions
- Suspension and climate control settings
- Customizations such as interior lighting

If your vehicle is accordingly equipped, you can connect your smartphone or another mobile end device to the vehicle. You can control this by means of the control elements integrated in the vehicle. Images and audio from the smartphone can be output via the multimedia system. Certain information is simultaneously transferred to your smartphone.

Depending on the type of integration, this can include:

- General vehicle data
- Position data

This allows you to use selected apps on your smartphone, such as navigation or music playback. There is no further interaction between the smartphone and the vehicle; in particular, vehicle data is not directly accessible. Which type of further data processing occurs is determined by the provider of the specific app used. Which settings you can make, if any, depends on the specific app and the operating system of your smartphone.

Online services

Wireless network connection

If your vehicle has a wireless network connection, it enables data to be exchanged between your vehicle and additional systems. The wireless network connection is enabled via the vehicle's transmission and reception unit or via connected mobile end devices (e.g. smartphones).

Online functions can be used via the wireless network connection. This includes online services and applications/apps provided by the manufacturer or other providers.

Manufacturer's services

Regarding online services of the manufacturer, the individual functions are described by the manufacturer in a suitable place (e.g. Operator's Manual, website of the manufacturer) along with the relevant data protection information. Personal data may be used for the provision of online services. Data is exchanged via a secure connection, e.g. the manufacturer's designated IT systems. Personal data is collected, processed and used via the provision of services exclusively on the basis of legal permissions or with prior consent.

The services and functions (sometimes subject to a fee) can usually be activated or deactivated. In some cases, this also applies to the entire vehicle's data connection. This excludes, in particular, legally prescribed functions and services.

Third party services

If it is possible to use online services from other providers, these services are the responsibility of the provider in question and subject to that provider's data protection conditions and terms of use. The manufacturer has no influence on the content exchanged.

For this reason, please ask the service provider for information about the type, extent and purpose of the collection and use of personal data when services are provided by third parties.

MBUX multimedia system/Mercedes me connect

If the vehicle is equipped with the MBUX multimedia system or Mercedes me connect, additional data about the vehicle's operation, the use of the vehicle in certain situations, and the location of the vehicle may be compiled by the MBUX multimedia system or Mercedes me connect.

For additional information, please refer to the "MBUX multimedia system" section and/or the Mercedes me connect Terms and Conditions.

Event data recorders

USA only:

This vehicle is equipped with an event data recorder (EDR). The main purpose of an EDR is to record, in certain crash or near crash-like situations, such as an airbag deployment or hitting a road obstacle, data that will assist in understanding how a vehicle's systems performed. The EDR is designed to record data related to vehicle dynamics and safety systems for a short period of time, typically 30 seconds or less.

The EDR in this vehicle is designed to record such data as:

- How various systems in your vehicle were operating
- Whether or not the driver and front passenger seat belts were buckled/fastened
- How far (if at all) the driver was depressing the accelerator and/or brake pedal and
- How fast the vehicle was traveling

This data can help provide a better understanding of the circumstances in which accidents and injuries occur. NOTE: EDR data is recorded by

your vehicle only if a non-trivial crash situation occurs; no data is recorded by the EDR under normal driving conditions and no personal data (e.g. name, gender, age and accident location) is recorded. However, other parties, such as law enforcement, could combine EDR data with the type of personally identifying data routinely acquired during a crash investigation.

To read data recorded by an EDR, special equipment is required, and access to the vehicle or the EDR is needed. In addition to the vehicle manufacturer, other parties that have the special equipment, such as law enforcement, can read the information by accessing the vehicle or the EDR.

EDR data may be used in civil and criminal matters as a tool in accident reconstruction, accident claims and vehicle safety. Since the Crash Data Retrieval (CDR) tool that is used to extract data from the EDR is commercially available, Mercedes-Benz USA, LLC ("MBUSA") expressly disclaims any and all liability arising from the extraction of this information by unauthorized Mercedes-Benz personnel.

MBUSA will not share EDR data with others without the consent of the vehicle owner or, if the vehicle is leased, without the consent of the lessee. Exceptions to this representation include responses to subpoenas by law enforcement; by federal, state or local government; in connection with or arising out of litigation involving MBUSA or its subsidiaries and affiliates; or, as required by law.

Warning: The EDR is a component of the Restraint System Module. Tampering with, altering, modifying or removing the EDR component may result in a malfunction of the Restraint System Module and other systems.

State laws or regulations regarding EDRs that conflict with federal regulation are pre-empted. This means that in the event of such conflict, the federal regulation governs. As of December 2016, 17 states have enacted laws relating to EDRs.

Copyright

Free and open-source software

Information on license for free and open-source software used in your vehicle can be found on the data carrier in your vehicle document wallet and with updates on the following website:

<http://www.mercedes-benz.com/opensource>

Registered trademarks

- Bluetooth® is a registered trademark of Bluetooth SIG Inc.
- DTS™ is a registered trademark of DTS, Inc.
- Dolby® and MLP™ are registered trademarks of DOLBY Laboratories.
- BabySmart™, ESP® and PRE-SAFE® are registered trademarks of Daimler AG.
- HomeLink® is a registered trademark of Johnson Controls.
- iPod® and iTunes® are registered trademarks of Apple Inc.

34 General notes

- Burmester® is a registered trademark of Burmester Audiosysteme GmbH.
- Microsoft® and Windows Media® are registered trademarks of Microsoft Corporation.
- SIRIUS® is a registered trademark of Sirius XM Radio Inc.
- HD Radio™ is a registered trademark of iBiquity Digital Corporation.
- Gracenote® is a registered trademark of Gracenote, Inc.
- ZAGATSurvey® and related brands are registered trademarks of ZagatSurvey, LLC.

Restraint system

Protection provided by the restraint system

The restraint system includes the following components:

- Seat belt system
- Airbags
- Child restraint system
- Child seat securing systems

The restraint system can help prevent the vehicle occupants from coming into contact with parts of the vehicle interior in the event of an accident. In the event of an accident, the restraint system can also reduce the forces to which the vehicle occupants are subjected.

A seat belt can only provide the best level of protection if it is worn correctly. Depending on the detected accident situation, Emergency Tensioning Devices and/or airbags supplement the protection offered by a correctly worn seat belt. Emergency Tensioning Devices and/or airbags are not deployed in every accident.

In order for the restraint system to provide the intended level of protection, each vehicle occupant must observe the following information:

- Fasten seat belts correctly.
- Sit in an almost upright seat position with their back against the seat backrest.
- Sit with their feet resting on the floor, if possible.
- Always secure persons under 5 ft (1.50 m) tall in an additional restraint system suitable for Mercedes-Benz vehicles.

However, no system available today can completely eliminate injuries and fatalities in every accident situation. In particular, the seat belt and airbag generally do not protect against objects penetrating the vehicle from the outside. It is also not possible to completely rule out the risk of injury caused by the airbag deploying.

Reduced restraint system protection

▲ WARNING Risk of injury or death from modifications to the restraint system

The restraint system can no longer function correctly after alterations have been made.

The restraint system may then not protect the vehicle occupants as intended by failing in an accident or triggering unexpectedly, for example

- ▶ Never alter the parts of the restraint system.
- ▶ Never tamper with the wiring or any electronic component parts or their software.

If it is necessary to modify the vehicle to accommodate a person with disabilities, contact an authorized Mercedes-Benz Center for details.



USA only: for details, contact our Customer Assistance Center on 1-800-FOR-MERCEDES (1-800-367-6372).

Restraint system functionality

When the ignition is switched on, a self-test is performed, during which the  restraint system warning lamp lights up. It goes out no later than a few seconds after the vehicle is started. The components of the restraint system are then functional.

Malfunctioning restraint system

A malfunction has occurred in the restraint system if:

- The  restraint system warning lamp does not light up when the ignition is switched on
- The  restraint system warning lamp lights up continuously or repeatedly during a journey

⚠ WARNING Risk of injury due to malfunctions in the restraint system

If the restraint system is malfunctioning, restraint system components may be trig-

gered unintentionally or may not deploy as intended during an accident. This may affect the Emergency Tensioning Devices or airbags, for example.

- ▶ Have the restraint system checked and repaired immediately at a qualified specialist workshop.

Function of the restraint system in an accident

How the restraint system works is determined by the severity of the impact detected and the type of accident anticipated:

- Frontal impact
- Rear impact
- Side impact
- Rollover

The activation thresholds for the components of the restraint system are determined based on the evaluation of the sensor values measured at various points in the vehicle. This process is pre-emptive in nature. The triggering/deployment of

the components of the restraint system must take place in good time at the start of the collision.

Factors which can only be seen and measured after a collision has occurred do not play a decisive role in the deployment of an airbag. Nor do they provide an indication of airbag deployment.

The vehicle may be deformed significantly without an airbag being deployed. This is the case if only parts which are relatively easily deformed are affected and the rate of vehicle deceleration is not high. Conversely, an airbag may be deployed even though the vehicle suffers only minor deformation. If very rigid vehicle parts such as longitudinal members are hit, for example, this may result in sufficiently high levels of vehicle deceleration.

The components of the restraint system can be activated or deployed independently of each other:

Component	Detected deployment situation
Emergency Tensioning Devices	Frontal impact, rear impact, side impact, rollover
Driver's airbag, front passenger airbag	Frontal impact
Knee airbag	Frontal impact
Side airbag	Side impact
Window curtain airbag	Side impact, rollover, frontal impact
PRE-SAFE® Impulse Side	Side impact

The front passenger airbag can only be deployed in an accident if the PASSENGER AIR BAG OFF indicator lamp is off. If the front passenger seat is occupied, make sure, both before and during

the journey, that the status of the front passenger airbag is correct (→ page 47).

⚠ WARNING Risk of burns from hot air bag components

The air bag parts are hot after an air bag has been deployed.

- ▶ Do not touch the air bag parts.
- ▶ Have a deployed air bag replaced at a qualified specialist workshop as soon as possible.

Mercedes-Benz recommends that you have the vehicle towed to a qualified specialist workshop after an accident. Take this into account, particularly if an Emergency Tensioning Device is triggered or an airbag deployed.

If the Emergency Tensioning Devices are triggered or an airbag is deployed, you will hear a bang, and a small amount of powder may also be released:

- The bang will not generally affect your hearing.

- In general, the powder released is not hazardous to health but may cause short-term breathing difficulties to persons suffering from asthma or other pulmonary conditions. Provided it is safe to do so, leave the vehicle immediately or open the window in order to prevent breathing difficulties.

Airbags and pyrotechnic Emergency Tensioning Devices contain perchlorate material, which may require special handling or environmental protection measures. National guidelines regarding waste disposal must be observed. In California, see <https://www.dtsc.ca.gov/HazardousWaste/Perchlorate/index.cfm>.

Seat belts

Protection provided by the seat belt

Always fasten your seat belt correctly before starting a journey. A seat belt can only provide the best level of protection if it is worn correctly.

▲ WARNING Risk of injury or death due to incorrectly fastened seat belt

If the seat belt is not worn correctly, it cannot perform its intended protective function. In addition, an incorrectly fastened seat belt can also cause injuries, for example, in the event of an accident or when braking or changing direction suddenly.

- ▶ Always ensure that all vehicle occupants have their seat belts fastened correctly and are sitting properly.

Always observe the instructions about the correct driver's seat position and adjusting the seat (→ page 97).

In order for the correctly worn seat belt to provide the intended level of protection, each vehicle occupant must observe the following information:

- The seat belt must not be twisted and must fit tightly and snugly across the body.

- The seat belt must be routed across the center of the shoulder and as low down across the hips as possible.
- The shoulder section of the seat belt should not touch your neck nor be routed under your arm or behind your back.
- Avoid wearing bulky clothing, e.g. a winter coat.
- Push the lap belt down as far as possible across your hips and pull tight with the shoulder section of the belt. Never route the lap belt across your abdomen.

Pregnant women must also take particular care with this.

- Never route the seat belt across sharp, pointed, abrasive or fragile objects.
- Only one person should use each seat belt at any one time. Never allow babies and children to travel sitting on the lap of another vehicle occupant.
- Never secure objects with a seat belt if the seat belt is also being used by one of the vehicle's occupants. Always observe the instructions for loading the vehicle when

securing objects, luggage or loads (→ page 114).

Also ensure that no objects, e.g. a cushion, are ever placed between a person and the seat.

The seat belts on the following seats are equipped with a special seatbelt retractor:

- Front passenger seat
- Rear seats

Activate or deactivate the special seatbelt retractor (→ page 57).

If children are traveling in the vehicle, be sure to observe the instructions and safety notes on "Children in the vehicle" (→ page 52).

Limitations of the protection provided by the seat belt

⚠ WARNING Risk of injury or death due to incorrect seat position

The seat belt does not offer the intended level of protection if you have not moved the seat backrest to an almost vertical position.

When braking or in the event of an accident, you could slide underneath the seat belt and sustain abdominal or neck injuries, for example.

- ▶ Adjust the seat properly before beginning your journey.
- ▶ Always ensure that the seat backrest is in an almost vertical position and that the shoulder section of your seat belt is routed across the center of your shoulder.

⚠ WARNING Risk of injury or death when additional restraint systems are not used for persons with a smaller build

Persons under 5 ft (1.50 m) tall cannot wear the seat belt correctly without a suitable additional restraint system.

If the seat belt is not worn correctly, it cannot perform its intended protective function. In addition, an incorrectly fastened seat belt can also cause injuries, for example, in the event of an accident or when braking or changing direction suddenly.

- ▶ Always secure persons under 5 ft (1.50 m) tall in a suitable restraint system.

⚠ WARNING Danger of injury or death due to blocked seat belt anchorages

The restraint effect of the seat belt is impaired if objects between the front seat and the door are blocking the movable seat belt anchorage on the front seat.

The seat belt may not then provide the proper protection.

- ▶ Before starting a journey, make sure that there are no objects between the front seat and the door.

⚠ WARNING Risk of injury or death due to damaged or modified seat belts

Seat belts cannot provide protection in the following situations:

- The seat belt is damaged, has been modified, is extremely dirty, bleached or dyed
- The seat belt buckle is damaged or extremely dirty
- Modifications have been made to the Emergency Tensioning Device, seat belt anchorage or seat belt retractor

Seat belts may sustain non-visible damage in an accident, e.g. due to glass splinters.

Modified or damaged seat belts could tear or fail in the event of an accident, for example.

Modified Emergency Tensioning Devices may be deployed unintentionally or not function as intended.

- ▶ Never modify the seat belts, Emergency Tensioning Devices, seat belt anchorages or seat belt retractors.
- ▶ Make sure that the seat belts are not damaged, are not worn and are clean.
- ▶ Always have the seat belts checked immediately after an accident at a qualified specialist workshop.

Only use seat belts that are approved for your vehicle by Mercedes-Benz.

▲ WARNING Risk of injury or death from deployed pyrotechnic Emergency Tensioning Devices

Pyrotechnic Emergency Tensioning Devices that have been deployed are no longer operational and are unable to perform their intended protective function.

- ▶ Therefore, have deployed pyrotechnic Emergency Tensioning Devices immedi-

ately replaced at a qualified specialist workshop.

Mercedes-Benz recommends that you have the vehicle towed to a qualified specialist workshop after an accident.

! **NOTE** Damage caused by trapping the seat belt

If an unused seat belt is not fully retracted, it may become trapped in the door or in the seat mechanism.

- ▶ Always ensure that an unused seat belt is fully retracted.

Fastening and adjusting seat belts

If the seat belt is pulled quickly or sharply, the seat belt retractor locks. The seat belt strap cannot be pulled out any further.



- ▶ Always engage seat belt tongue (2) of the seat belt into seat belt buckle (1) of the corresponding seat.
- ▶ Press and hold the seat belt outlet release and slide seat belt outlet (3) into the desired position.
- ▶ Let go of the seat belt outlet release and ensure that seat belt outlet (3) locks into position.

! **NOTE** Deployment of the Emergency Tensioning Device and side air bag when the front passenger seat is unoccupied

If the seat belt tongue is engaged in the seat belt buckle of the unoccupied front passenger seat, the Emergency Tensioning Device and the side air bag may also deploy in the event of an accident along with other systems.

- ▶ Only one person should use each seat belt at any one time.

Seat belt adjustment function

Vehicles with PRE-SAFE®: If the front seat belt is not pulled tightly across your body, the seat belt adjustment may automatically apply a certain tightening force. Do not hold the seat belt tightly while it is adjusting.

You can activate and deactivate the seat belt adjustment function using the multimedia system (→ page 41).

Releasing seat belts

- ▶ Press the release button in the seat belt buckle and guide the seat belt back with the seat belt tongue.

Activating/deactivating seat belt adjustment via the multimedia system

Multimedia system:

→  ▶ Settings ▶ Vehicle

- ▶ Activate or deactivate **Belt Adjustment**.

Seat belt warning function for the driver and front passenger

The  seat belt warning lamp in the Instrument Display is a reminder that all vehicle occupants must wear their seat belts correctly.

The  seat belt warning lamp lights up for six seconds every time the vehicle is started.

In addition, a warning tone may sound.

When the driver's and front passenger's doors are closed and the driver and front passenger

have fastened their seat belts, the seat belt warning goes out.

In the following cases, the seat belt warning lights up during a journey if:

- The vehicle speed exceeds 15 mph (25 km/h) and the driver's or front passenger seat belt is not fastened.
- The driver or front passenger unfastens their seat belt while the vehicle is in motion.

Airbags

Overview of airbags

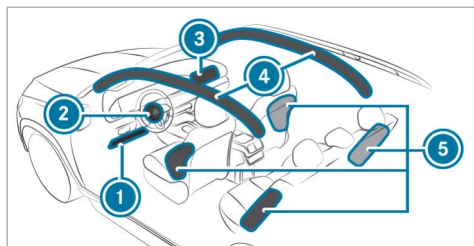

- ① Driver's knee bag
- ② Driver's airbag
- ③ Front passenger airbag
- ④ Window curtain airbag
- ⑤ Side airbag

The installation location of an airbag can be recognized by the AIRBAG symbol.

When enabled, an airbag can provide additional protection for the respective vehicle occupant.

Potential protection from each airbag:

AIRBAG	Potential protection for:
Knee airbag	Thigh, knee and lower leg
Driver's airbag, front passenger airbag	Head and ribcage
Window curtain airbag	Head
Side airbag	Ribcage and pelvis

⚠ WARNING Risk of injury or fatal injuries if the front-passenger airbag is enabled

If the front-passenger front airbag is enabled, a child on the front-passenger seat may be struck by the front-passenger airbag during an accident.

NEVER use a rearward-facing child restraint system on a seat with an ENABLED FRONT AIRBAG, DEATH or SERIOUS INJURY to the CHILD can occur.

When installing a child restraint system to the front passenger seat, observe the vehicle-specific information (→ page 63). Also, always observe the notes on rearward-facing or forward-facing child restraint systems on the front passenger seat.

Vehicles with automatic front passenger airbag shutoff:

The front passenger airbag can only be deployed in an accident if the PASSENGER AIR BAG OFF indicator lamp is off. If the front passenger seat is occupied, make sure, both before and during the journey, that the status of the front passenger airbag is correct (→ page 47).

! NOTE Important points to remember if the front passenger seat is unoccupied

In an accident, the components of the restraint system may deploy unnecessarily on the front passenger side if:

- There are heavy objects on the front passenger seat.

- The seat belt tongue is engaged in the seat belt buckle of the front passenger seat and the front passenger seat is unoccupied.

- ▶ Stow objects in a suitable place.
- ▶ Only one person should use each seat belt at any one time.

Depending on the detected accident situation, the window curtain airbag on the front passenger side may deploy. The airbag is deployed regardless of whether the front passenger seat is occupied.

Protection by the airbags

Depending on the accident situation, an airbag may supplement the protection offered by a correctly fastened seat belt.

⚠ WARNING Risk of injury or death due to incorrect seat position

If you deviate from the correct seat position, the airbag cannot perform its intended protective function and deployment may even cause further injuries.

In order to avoid risks, each vehicle occupant must always make sure of the following:

- Fasten seat belts correctly. Pregnant women must take particular care to ensure that the lap belt never lies across the abdomen.
- Adopt the correct seat position and keep as far away as possible from the airbags.
- Observe the following information.
- ▶ Always make sure that there are no objects between the airbag and vehicle occupant.

To avoid the risks resulting from the deployment of an airbag, each vehicle occupant must observe the following information in particular:

- Before starting your journey, adjust your seat correctly; the driver's seat and front passenger seat should be moved as far back as possible.

When doing so, always observe the information on the correct driver's seat position (→ page 97).

- Only hold the steering wheel by the steering wheel rim. This allows the airbag to be fully deployed.
- Always lean against the seat backrest when the vehicle is in motion. Do not lean forwards or against the door or side window. You may otherwise be in the deployment area of the airbags.
- Always keep your feet on the floor. Do not put your feet on the cockpit, for example. Your feet may otherwise be in the deployment area of the airbag.
- If children are traveling in the vehicle, observe the additional notes (→ page 52).

44 Occupant safety

- Always stow and secure objects correctly.

Objects in the vehicle interior may prevent an airbag from functioning correctly. Each vehicle occupant must always make sure of the following in particular:

- There are no people, animals or objects between the vehicle occupants and an airbag.
- There are no objects between the seat, door and door pillar (B-pillar).
- There are no hard objects, e.g. coat hangers, hanging on the grab handles or coat hooks.
- There are no accessory parts, such as mobile navigation devices, mobile phones or cup holders, attached to the vehicle within the deployment area of an airbag, e.g. on the cockpit, on the door, on the side window or on the side wall trim.

In addition, no connecting cables, tensioning straps or retaining straps must be routed or attached to the vehicle within the deployment area of an airbag. Always comply with the accessory manufacturer's installation

instructions and, in particular, the notes on suitable places for installation.

- There are no heavy, sharp-edged or fragile objects in the pockets of your clothing. Store such objects in a suitable place.

Limited protection provided by airbags

⚠ WARNING Risk of injury due to modifications to the airbag cover

If you modify the cover of an airbag or affix objects such as stickers to it, the airbag may no longer function correctly.

- ▶ Never modify the cover of an airbag and do not affix objects to it.

The installation location of an airbag is identified by the AIRBAG symbol (→ page 42).

⚠ WARNING Risk of injury or death due to the use of unsuitable seat covers

Unsuitable seat covers can obstruct or prevent the deployment of air bags integrated into the seats.

Consequently, the air bags cannot protect vehicle occupants as they are designed to do. In addition, operation of the automatic front passenger air bag shutoff may be restricted.

- ▶ You should only use seat covers that have been approved for the corresponding seats by Mercedes-Benz.

⚠ WARNING Risk of injury due to malfunctions of the sensors in the door paneling

Sensors to control the airbags are located in the doors. Modifications or work not performed correctly to the doors or door paneling, as well as damaged doors, can lead to the function of the sensors being impaired. The airbags might therefore not function properly any more.

Consequently, the airbags cannot protect vehicle occupants as they are designed to do.

- ▶ Never modify the doors or parts of the doors.
- ▶ Always have work on the doors or door paneling carried out at a qualified specialist workshop.

⚠ WARNING Risk of injury due to deployed airbag

A deployed airbag no longer has a protective function and cannot protect as intended in the event of an accident.

- ▶ Have the vehicle towed to a qualified specialist workshop in order to have the deployed airbag replaced.

Have deployed airbags replaced immediately.

Status of the front passenger front airbag

Function of the automatic front passenger airbag shutoff

The automatic front passenger airbag shutoff is able to detect whether the front passenger seat is occupied by a person or a child restraint system. The front passenger airbag is enabled or disabled accordingly.

When installing a child restraint system on the front passenger seat, always make sure of the following:

- Ensure that the child restraint system is positioned correctly (→ page 51).
- Always observe the child restraint system manufacturer's installation instructions.
- Never place objects, e.g. cushions, under or behind the child restraint system.
- Fully retract the seat cushion length adjustment.
- The entire base of the child restraint system must always rest on the sitting surface of the front passenger seat.

- The backrest of the forward-facing child restraint system must, as far as possible, be resting on the seat backrest of the front passenger seat.
- The child restraint system must not touch the roof or be put under strain by the head restraints. Adjust the seat backrest inclination and the head restraint setting accordingly.

⚠ WARNING Risk of injury or death due to objects between the sitting surface and the child restraint system

Objects between the sitting surface and the child restraint system could affect the function of the automatic front passenger airbag shutoff.

This could result in the front passenger airbag not functioning as intended during an accident.

- ▶ Do not place any objects between the sitting surface and the child restraint system.

- ▶ The entire base of the child restraint system must always rest on the sitting surface of the front passenger seat.
- ▶ The backrest of the forward-facing child restraint system must, as far as possible, be resting on the seat backrest of the front passenger seat.
- ▶ Always comply with the child restraint system manufacturer's installation instructions.

A person on the front passenger seat must observe the following information:

- Fasten seat belts correctly (→ page 37).
- Sit in an almost upright seat position with their back against the seat backrest.
- Sit with their feet resting on the floor, if possible.

The front passenger airbag may otherwise be disabled by mistake, for example in the following situations:

- The front passenger transfers their weight by supporting themselves on a vehicle armrest.

- The front passenger sits in such a way that their weight is raised from the sitting surface.

▲ WARNING Risk of injury or death due to deactivated front passenger airbag

If the PASSENGER AIR BAG OFF indicator lamp is lit, the front passenger airbag is disabled. It will not be deployed in the event of an accident and cannot perform its intended protective function.

A person in the front passenger seat could then, for example, come into contact with the vehicle interior, especially if the person is sitting too close to the cockpit.

If the front passenger seat is occupied, always ensure that:

- The classification of the person in the front passenger seat is correct and the front passenger airbag is enabled or disabled in accordance with the person in the front passenger seat.

- The front passenger seat has been moved as far back as possible.
- The person is seated correctly.
- ▶ Ensure, both before and during the journey, that the status of the front passenger airbag is correct.

If the front passenger seat is occupied, the classification of the person or child restraint system on the front passenger seat takes place after the front passenger airbag shutoff self-test. The PASSENGER AIR BAG indicator lamps display the status of the front passenger airbag.

Always observe the notes on the function of the PASSENGER AIR BAG indicator lamps (→ page 47).

Function of the PASSENGER AIR BAG indicator lamps

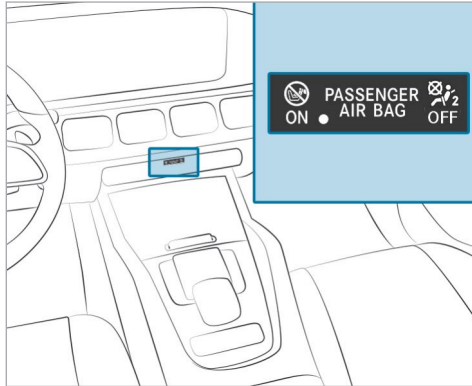

Self-test of automatic front passenger airbag shutoff

When the ignition is switched on, a self-test is performed during which the two PASSENGER AIR BAG ON and OFF indicator lamps light up simultaneously.

The status of the front passenger airbag is displayed after the self-test:

- PASSENGER AIR BAG ON lights up for 60 seconds, subsequently both indicator lamps are off (PASSENGER AIR BAG ON and OFF): the front passenger airbag is able to deploy in the event of an accident.
- PASSENGER AIR BAG OFF lights up continuously: the front passenger airbag is disabled. It will then not be deployed in the event of an accident.

If the PASSENGER AIR BAG ON indicator lamp is off, only the PASSENGER AIR BAG OFF indicator lamp shows the status of the front passenger airbag. The PASSENGER AIR BAG OFF indicator lamp may be lit continuously or be off.

If the PASSENGER AIR BAG OFF indicator lamp and the  restraint system warning lamp light up simultaneously, the front passenger seat may not be used. Also in this case, do not install a child restraint system on the front passenger seat. Have automatic front passenger airbag shutoff checked and repaired immediately at a qualified specialist workshop.

Status display

If the front passenger seat is occupied, ensure, both before and during the journey, that the status of the front passenger airbag is correct for the current situation.

After installing a rearward-facing child restraint system on the front passenger seat: PASSENGER AIR BAG OFF must be lit continuously.

⚠ WARNING Risk of injury or death from using a rearward-facing child restraint system when the front passenger front airbag is enabled

If you secure a child in a rearward-facing child restraint system on the front passenger seat and the PASSENGER AIR BAG OFF indicator lamp is off, the front passenger airbag can deploy in the event of an accident.

The child could be struck by the airbag.

Always ensure that the front passenger airbag is deactivated. The PASSENGER AIR BAG OFF indicator lamp must be lit.

NEVER use a rearward-facing child restraint system on a seat protected by an ENABLED FRONT AIRBAG in front of it, DEATH or SERIOUS INJURY to the CHILD can occur.

When installing a child restraint system on the front passenger seat, observe the vehicle-specific information (→ page 63).

Depending on the child restraint system and the stature of the child, the PASSENGER AIR BAG OFF indicator lamp may be off. In this case, do not install the rearward-facing child restraint system on the front passenger seat.

Instead, install the rearward-facing child restraint system on a suitable rear seat.

After installing a forward-facing child restraint system on the front passenger seat: depending on the child restraint system and the stature of the child, PASSENGER AIR BAG OFF may be lit continuously or be off. Always observe the following information.

⚠ WARNING Risk of injury or death due to incorrect positioning of the forward-facing child restraint system

If you secure a child in a forward-facing child restraint system on the front passenger seat and you position the front passenger seat too close to the cockpit, in the event of an accident, the child could:

- Come into contact with the vehicle interior if the PASSENGER AIR BAG OFF indicator lamp is lit, for example.
- Be struck by the air bag if the PASSENGER AIR BAG OFF indicator lamp is off.

▶ Always move the front passenger seat as far back as possible and fully retract the seat cushion length adjustment. Always make sure that the shoulder belt strap is correctly routed from the seat belt outlet on the vehicle to the shoulder belt guide on the child restraint system. The shoulder belt strap must be routed forwards and downwards from the vehicle belt outlet. If necessary,

adjust the seat belt outlet and the front passenger seat accordingly.

▶ Always observe the child restraint system manufacturer's installation instructions.

When installing a child restraint system on the front passenger seat, observe the vehicle-specific information (→ page 63).

If a person is sitting on the front passenger seat: PASSENGER AIR BAG OFF may be lit continuously or be off, depending on the person's stature.

A person on the front passenger seat must always observe the following information:

- If the front passenger seat is occupied by an adult or a person with a stature corresponding to that of an adult, the PASSENGER AIR BAG OFF indicator lamp must be off. This indicates that the front passenger airbag is enabled.

If the PASSENGER AIR BAG OFF indicator lamp is lit continuously, an adult or person

with a build corresponding to that of an adult should not use the front passenger seat.

Instead, they should use a rear seat.

- If the front passenger seat is occupied by a person of smaller stature (e.g. a teenager or small adult), the PASSENGER AIR BAG OFF indicator lamp either lights up continuously or remains off, depending on the result of the classification.
 - If the PASSENGER AIR BAG OFF indicator lamp is off: move the front passenger seat as far back as possible, or the person of smaller stature should use a rear seat.
 - If the PASSENGER AIR BAG OFF indicator lamp is lit continuously: the person of smaller stature should not use the front passenger seat.

⚠ WARNING Risk of injury or death when the PASSENGER AIR BAG OFF indicator lamp is lit

If the PASSENGER AIR BAG OFF indicator lamp remains lit after the system self-test, the front passenger air bag is deactivated. It will not be deployed in the event of an accident. In this case, the front passenger air bag cannot perform its intended protective function, e.g. when a person is seated in the front passenger seat.

That person could, for example, come into contact with the vehicle interior, especially if the person is sitting too close to the cockpit.

If the front passenger seat is occupied, always ensure that:

- The classification of the person in the front passenger seat is correct and the front passenger air bag is enabled or deactivated in accordance with the person in the front passenger seat.

- The person is seated properly with a correctly fastened seat belt.
- The front passenger seat has been moved as far back as possible.

Be sure to also observe the following further related subjects:

- Child restraint system on the front passenger seat (→ page 63).

PRE-SAFE® system

PRE-SAFE® (anticipatory occupant protection)

PRE-SAFE® is able to detect certain critical driving situations and implement pre-emptive measures to protect the vehicle occupants.

PRE-SAFE® can implement the following measures independently of each other:

- Tightening the seat belts on the driver's seat and front passenger seat.
- Closing the side windows.

- **Vehicles with sliding sunroof:** Close the sliding sunroof.
- **Vehicles with memory function:** Move the front passenger seat to a more favorable seat position.
- **Vehicles with multicontour seat:** Increase the air pressure in the seat side bolsters of the seat backrest.
- **PRE-SAFE® Sound:** provided that the multimedia system is switched on, generates a brief noise signal to stimulate the innate protective mechanism of a person's hearing.

! **NOTE** Damage caused by objects in the footwell or behind the seat

The automatic adjustment of the seat position may result in damage to the seat and/or the object.

- ▶ Stow objects in a suitable place.

Reversing the PRE-SAFE® system measures

If an accident did not occur, the pre-emptive measures that were taken are reversed.

You will need to perform certain settings yourself.

- ▶ If the seat belt pre-tensioning is not reduced, move the seat backrest back slightly. The locking mechanism releases.

Function of PRE-SAFE® PLUS (anticipatory occupant protection plus)

PRE-SAFE® PLUS can detect certain impacts, particularly an imminent rear impact, and take pre-emptive measures to protect the vehicle occupants. These measures cannot necessarily prevent an imminent impact.

PRE-SAFE® PLUS can implement the following measures independently of each other:

- Tightening the seat belts on the driver's seat and front passenger seat.
- Increasing brake pressure when the vehicle is stationary. This brake application is can-

celed automatically when the vehicle pulls away.

If an accident did not occur, the pre-emptive measures that were taken are reversed.

System limits

The system will not initiate any action in the following situations:

- when backing up
or
- when the vehicle is towing a trailer and there is a risk of a rear impact

The system will not initiate any braking application in the following situations:

- whilst driving
or
- when entering or exiting a parking space while using Active Parking Assist

Function of PRE-SAFE® Impulse Side

If an imminent side impact is detected, PRE-SAFE® Impulse Side can pre-emptively move the

front seat vehicle occupant's upper body towards the center of the vehicle. It does this by rapidly inflating an air cushion in the outer seat side bolster of the seat backrest on the side on which the impact is anticipated. This increases the distance between the door and the vehicle occupant.

If PRE-SAFE® Impulse Side has been deployed or is faulty, the [PRE-SAFE Impulse Side Inoperative](#) See Operator's Manual display message appears (→ page 542).

Safely transporting children in the vehicle

Always observe when children are traveling in the vehicle

- ⓘ Also strictly observe the safety notes for the specific situation. In this way you can recognize potential risks and avoid dangers if children are traveling in the vehicle (→ page 52).

Be diligent

Bear in mind that neglecting to secure a child in the child restraint system may have serious con-

sequences. Always be diligent in securing a child carefully before every journey.

To improve protection for children younger than 12 years old or under 5 ft (1.50 m) in height, Mercedes-Benz recommends you observe the following information:

- Always secure the child in a child restraint system suitable for this Mercedes-Benz vehicle.
- The child restraint system must be appropriate to the age, weight and size of the child.
- The vehicle seat must be suitable for installing a child restraint system.

Accident statistics show that children secured on the rear seats are generally safer than children secured on the front seats. For this reason, Mercedes-Benz strongly advises that you install a child restraint system on a rear seat.

Generic term "child restraint system"

The generic term child restraint system is used in this Operator's Manual. A child restraint system is, for example:

- A baby car seat

- A rearward-facing child seat
- A forward-facing child seat
- A child booster seat with a backrest and seat belt guide

Mercedes-Benz recommends using a child booster seat with a backrest.

The child restraint system must be appropriate to the age, weight and size of the child.

Observing laws and legal requirements

Always observe the legal requirements when using a child restraint system in the vehicle.

Observing standards for child restraint systems

All child restraint systems must meet the following standards:

- U.S. Federal Motor Vehicle Safety Standards 213 and 225
- Canadian Motor Vehicle Safety Standards 213 and 210.2

Confirmation that the child restraint system complies with the standards can be found on an

instruction label on the child restraint system. This confirmation can also be found in the installation instructions that are included with the child restraint system.

Detecting risks, avoiding danger

Securing systems for child restraint systems in the vehicle

Only use the following securing systems for child restraint systems:

- The LATCH-type (ISOFIX) mounting brackets
- The vehicle's seat belt system
- The Top Tether anchorages

Installing a LATCH-type (ISOFIX) child restraint system is preferred.

Simply attaching to the securing rings on the vehicle can reduce the risk of installing the child restraint system incorrectly.

When securing a child with the integrated seat belt of the LATCH-type (ISOFIX) child restraint system, always comply with the permissible

gross weight for the child and child restraint system (→ page 57).

A booster seat may be necessary to achieve proper seat belt positioning for children over 40 lbs (18 kg) in weight or until they reach a height where a three-point seat belt can be fitted properly without a booster seat.

Mercedes-Benz recommends a suitable child booster seat with a backrest and seat belt guide.

Advantage of a rearward-facing child restraint system

It is preferable to transport a baby or a small child in a suitable rearward-facing child restraint system. In this case, the child sits in the opposite direction to the direction of travel and faces backwards.

Babies and small children have comparatively weak neck muscles in relation to the size and weight of their head. The risk of injury to the cervical spine during an accident can be reduced in a rearward-facing child restraint system.

Always secure a child restraint system correctly

▲ WARNING Risk of injury or death caused by incorrect installation of the child restraint system

If the child restraint system is incorrectly installed on a suitable seating position, it cannot perform its intended protective function.

The child cannot be restrained in the event of an accident, heavy braking or a sudden change of direction.

- ▶ Always comply with the manufacturer's installation instructions for the child restraint system and its correct use.
- ▶ Make sure that the entire base of the child restraint system always rests on the sitting surface of the seat.
- ▶ Never place objects under or behind the child restraint system, e.g. cushions.

- ▶ Always use child restraint systems with the original cover designed for them.
- ▶ Always replace damaged covers with genuine covers.

▲ WARNING Risk of injury or death from unsecured child restraint systems in the vehicle

If the child restraint system is not correctly installed or secured, it could release in the event of an accident, sudden braking or a sudden change in direction.

The child restraint system could be flung around and hit vehicle occupants.

- ▶ Always install child restraint systems correctly, even when not in use.
- ▶ Always comply with the child restraint system manufacturer's installation instructions.

- Always observe the child restraint system manufacturer's installation and operating

instructions as well as the vehicle-specific information:

- Install the LATCH-type (ISOFIX) child restraint system on the rear seat (→ page 57).
- Secure the child restraint system with the seat belt on the rear seat (→ page 61).
- Secure the child restraint system with the seat belt on the front passenger seat (→ page 63). Observe the specific instructions for the rearward-facing and forward-facing child restraint systems (→ page 63).

If the front passenger seat is occupied, ensure, both before and during the journey, that the status of the front passenger airbag is correct for the current situation (→ page 47).

- Observe the warning labels in the vehicle interior and on the child restraint system.
- Also secure Top Tether if present.

Do not modify the child restraint system

▲ WARNING Risk of injury due to modifications to the child restraint system

The child restraint system may no longer function as it is supposed to if you make modifications or attach objects to it, e.g. toys or unsuitable accessories. This poses an increased risk of injury!

Never modify the child restraint system. Only attach accessories which the manufacturer of the child restraint system has authorized especially for this child restraint system.

Only use child restraint systems which are in proper working condition

▲ WARNING Risk of injury or death caused by the use of damaged child restraint systems

Child restraint systems or their retaining systems that have been subjected to a load in an accident may then not be able to perform their intended protective function.

The child cannot be restrained in the event of an accident, heavy braking or a sudden change of direction.

- ▶ Always replace child restraint systems immediately that have been damaged or involved in an accident.
- ▶ Have the securing systems for the child restraint systems checked at a qualified specialist workshop before installing a child restraint system again.

Avoid direct sunlight

⚠ WARNING Risk of burns when the child seat is exposed to direct sunlight

If the child restraint system is exposed to direct sunlight or heat, parts could heat up.

Children could suffer burns from these parts, particularly on metallic parts of the child restraint system.

- ▶ Always make sure that the child restraint system is not exposed to direct sunlight.

- ▶ Protect it with a blanket, for example.
- ▶ If the child restraint system has been exposed to direct sunlight, allow it to cool before securing a child into it.
- ▶ Never leave children unattended in the vehicle.

Observe when stopping or parking

⚠ WARNING Risk of accident and injury due to children left unattended in the vehicle

If children are left unattended in the vehicle, they could:

- Open doors, thereby endangering other persons or road users.
- Get out and be struck by oncoming traffic.
- Operate vehicle equipment and become trapped, for example.

In addition, the children could also set the vehicle in motion, for example by:

- Releasing the parking brake.
 - Changing the transmission position.
 - Starting the vehicle.
- ▶ Never leave children unattended in the vehicle.
 - ▶ When leaving the vehicle, always take the key with you and lock the vehicle.
 - ▶ Keep the vehicle key out of reach of children.

⚠ WARNING Risk of fatal injury due to exposure to extreme heat or cold in the vehicle



If people – particularly children – are exposed to extreme temperatures over an extended period of time, there is a risk of serious or even fatal injury.

- ▶ Never leave anyone – particularly children – unattended in the vehicle.

- ▶ Never leave animals in the vehicle unattended.

Overview of suitable seats in the vehicle for installing a child restraint system

Securing systems for child restraint systems

Vehicle seat		
Left/right rear seat (second seat row)	Favored securing system:  LATCH-type (ISOFIX) child seat securing system  Also secure Top Tether if present (→ page 60)	Alternative securing system: <ul style="list-style-type: none"> • Vehicle seat belt .
Left/right rear seat (third seat row, if present)	Securing system: <ul style="list-style-type: none"> • Vehicle seat belt 	

Vehicle seat		
Front passenger seat	Securing system: <ul style="list-style-type: none">• Vehicle seat belt	Be sure to observe: <ul style="list-style-type: none">• If the front passenger seat is occupied, ensure, both before and during the journey, that the status of the front passenger airbag is correct for the current situation (→ page 47).• Notes on automatic front passenger airbag shut-off (→ page 45).
Center rear seat (second seat row)	Securing system: <ul style="list-style-type: none">• Vehicle seat belt  Also secure Top Tether if present (→ page 60)	

Activating/deactivating the seat belt's special seatbelt retractor

⚠ WARNING Risk of injury or death if a seat belt is unfastened while the vehicle is in motion

If the seat belt is released while the vehicle is in motion, the child restraint system is no longer correctly secured. The child seat safety feature is deactivated and the seat belt is drawn in a bit by the inertia reel.

It is therefore not possible to engage the seat belt again.

- ▶ Pull over and stop the vehicle safely as soon as possible, paying attention to road and traffic conditions.
- ▶ Activate the child seat safety feature again and correctly secure the child restraint system.

When enabled, the special seatbelt retractor ensures that the seat belts of the front passenger seat and rear seats do not slacken once the child restraint system is secured.

The seat belts on the following seats are equipped with a special seatbelt retractor:

- Front passenger seat
- Rear seats

- ▶ **To install a child restraint system:** when installing a child restraint system, always observe the manufacturer's installation and operating instructions as well as the information in this Operator's Manual.
- ▶ Pull the seat belt smoothly from the seat belt outlet.
- ▶ Engage the seat belt tongue in the seat belt buckle.
- ▶ **To activate the special seatbelt retractor:** pull the seat belt out fully and let the inertia reel retract it again. When the special seatbelt retractor is activated, you should hear a ratcheting sound.
- ▶ Push the child restraint system down until the seat belt sits tightly.
- ▶ **To deactivate the special seatbelt retractor:** press the release button of the seat belt buckle.

- ▶ Hold the seat belt tongue and guide back to the seat belt outlet.

Installing the LATCH-type (ISOFIX) child restraint system on the rear seat

Installing a LATCH-type (ISOFIX) child restraint system on the rear seat

⚠ WARNING Risk of injury if the rear bench seat/rear seat and seat backrest are not engaged

If the rear bench seat/rear seat and seat backrest are not engaged they could fold forwards, e.g. when braking suddenly or in the event of an accident.

- If this is the case, the vehicle occupant would be forced into the seat belt by the rear bench seat/rear seat or by the seat backrest. The seat belt cannot protect as intended and could result in additional injury.

- Objects or loads in the trunk/cargo compartment cannot be restrained by the seat backrest.
- ▶ Make sure that the seat backrest and the rear bench seat/rear seat are engaged before every trip.

If the seat backrest is not engaged and locked in place, this will be shown on the multifunction display on the instrument cluster (fold rear seat back electrically) or the red lock verification indicator will be visible (fold rear seat back mechanically).

⚠ WARNING Risk of injury or death if the permissible gross mass of the child and child restraint system is exceeded

For LATCH-type (ISOFIX) child restraint systems in which the child is secured using the integrated seat belt in the child restraint system, the permissible gross mass of the child and child restraint system is 73 lb (33 kg).

If the child and the child restraint system together weigh more than 73 lb (33 kg), the LATCH-type (ISOFIX) child restraint system with integrated seat belt does not offer sufficient protection. An excessive load may be placed on the LATCH-type (ISOFIX) child seat attachments and the child may not be restrained in the event of an accident, for example.

- ▶ If the child and the child restraint system together weigh more than 73 lb (33 kg), use only a LATCH-type (ISOFIX) child restraint system that secures the child with the vehicle seat belt.
- ▶ Also secure the child restraint system with the Top Tether belt, if available.

Always comply with the information about the mass of the child restraint system:

- in the manufacturer's installation and operating instructions for the child restraint system used
- on a label on the child restraint system, if present

Regularly check that the permissible gross mass of the child and child restraint system is still complied with.

When installing a child restraint system, observe the following:

- ☑ Always observe the correct use of the seats and consider their suitability for attaching a child restraint system.
- ☑ Always comply with the manufacturer's installation and operating instructions for the child restraint system used.
- ☑ Make sure that the child's feet do not come into contact with the front seat. If necessary, move the front seat forward slightly.
- 🔄 When installing a LATCH-type (ISOFIX) child restraint system, also observe the following:
 - ☑ **When using a Group 0/0+ baby car seat and a Group I rearward-facing child restraint system on a rear seat:** adjust the front seat so that the seat does not touch the child restraint system.

- ✓ **When using a Group I forward-facing child restraint system:** remove the head restraint from the respective seat, if possible. In addition, the backrest of the child restraint system must, as far as possible, lie flat against the backrest of the vehicle seat. Once the child restraint system has been removed, replace the head restraints immediately and adjust them correctly.
- ✓ For certain child restraint systems in weight group II or III, there may be restrictions on the maximum size setting, e.g. due to possible contact with the roof.
- ✓ The child restraint system must not be tensioned between the roof and the seat cushion and/or be installed facing the wrong direction. Where possible, adjust the seat cushion inclination accordingly.
- ✓ The child restraint system must not be put under strain by the head restraints. Adjust the head restraints accordingly.
- ▶ Before every journey, make sure that the LATCH-type (ISOFIX) child restraint system is

engaged in both mounting brackets in the vehicle.

! **NOTE** Be careful not to damage the seat belt for the center seat when installing the child restraint system

▶ Make sure that the seat belt is not trapped.

Vehicles with rigid rear seats:

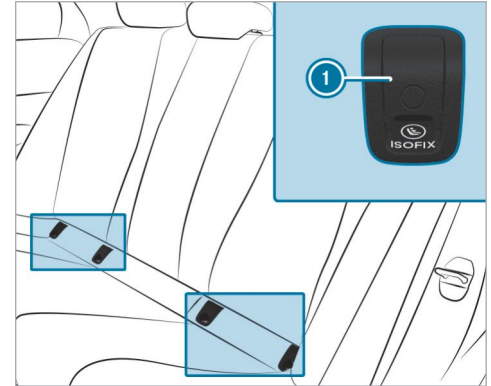

- ① LATCH-type (ISOFIX) mounting bracket
- ▶ Remove and stow away covers ① of the mounting brackets in the vehicle.
- ▶ Attach the LATCH-type (ISOFIX) child restraint system to both mounting brackets in the vehicle.

- ▶ After removing the child restraint system, re-attach covers ❶.

Vehicles with adjustable rear seats:

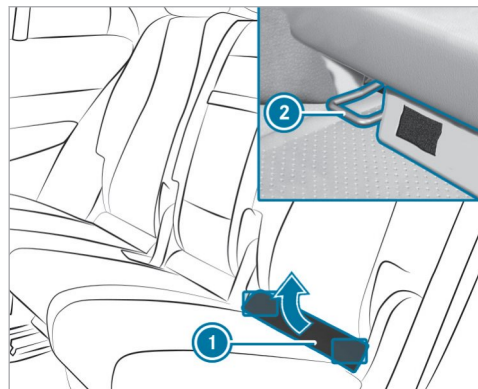

- ▶ Fold upholstered lining ❶ upwards.
 - ▶ Turn the support on the rear side of upholstered lining ❶ by 90°.
- Upholstered lining ❶ remains folded upwards.

- ▶ Attach the LATCH-type (ISOFIX) child restraint system to both mounting brackets ❷ in the vehicle.

Securing a Top Tether

⚠ WARNING Risk of injury or death if the rear seat backrests are not locked after installing Top Tether belts

If the rear seat backrests are not locked, they could fold forwards in the event of an accident or during braking or sudden changes of direction.

As a result, child restraint systems cannot perform their intended protective function. Rear seat backrests that are not locked can also cause additional injuries, e.g. in the event of an accident.

- ▶ Always lock rear seat backrests after installing Top Tether belts.
- ▶ Observe the lock verification indicator.

If the seat backrest is not engaged and locked in place, this will be shown on the multifunction

display on the instrument cluster (fold rear seat back electrically) or the red lock verification indicator will be visible (fold rear seat back mechanically).



If the child restraint system is equipped with a Top Tether belt:

The risk of injury can be reduced by a Top Tether. The Top Tether belt facilitates an additional connection between the child restraint system attached with LATCH-type (ISOFIX) and the vehicle.

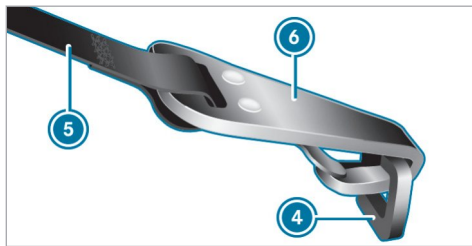
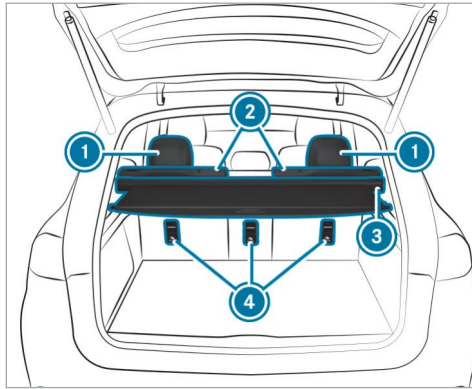

- ▶ If necessary, slide head restraint ① upwards (→ page 105).
- ▶ Install the LATCH-type (ISOFIX) child restraint system with Top Tether. Comply with the child restraint system manufacturer's installation instructions when doing so.
- ▶ Guide Top Tether belt ⑤ under head restraint ① between the two head restraint bars.
- ▶ If cargo compartment cover ③ is installed, guide Top Tether belt ⑤ downwards between cargo compartment cover ③ and seat backrest ②.
- ▶ Hook Top Tether hook ⑥ of Top Tether belt ⑤ into Top Tether anchorage ④ without twisting.
- ▶ Tension Top Tether belt ⑤. Comply with the child restraint system manufacturer's installation instructions when doing so.
- ▶ If necessary, slide head restraint ① downwards (→ page 105). Make sure that you do not interfere with the correct routing of Top Tether belt ⑤.

Securing the child restraint system with the seat belt

Securing the child restraint system with the seat belt on the rear seat

⚠ WARNING Risk of injury if the rear bench seat/rear seat and seat backrest are not engaged

If the rear bench seat/rear seat and seat backrest are not engaged they could fold forwards, e.g. when braking suddenly or in the event of an accident.

- If this is the case, the vehicle occupant would be forced into the seat belt by the rear bench seat/rear seat or by the seat backrest. The seat belt cannot protect as intended and could result in additional injury.
- Objects or loads in the trunk/cargo compartment cannot be restrained by the seat backrest.

- ▶ Make sure that the seat backrest and the rear bench seat/rear seat are engaged before every trip.

If the seat backrest is not engaged and locked in place, this will be shown on the multifunction display on the instrument cluster (fold rear seat back electrically) or the red lock verification indicator will be visible (fold rear seat back mechanically).

When installing a belt-secured child restraint system, observe the following:

- ✔ Always comply with the manufacturer's installation and operating instructions for the child restraint system used.
- ✔ **When using a category 0/0+ baby car seat and a category I rearward-facing child restraint system on a rear seat:** adjust the front seat so that the seat does not touch the child restraint system.
- ✔ **When using a category I forward-facing child restraint system:** remove the head restraint from the respective seat, if possible.

After the child restraint system has been removed, replace the head restraints immediately and adjust them correctly.

- ✔ The backrest of the forward-facing child restraint system must, as far as possible, be resting on the seat backrest of the rear seat.
- ✔ For certain child restraint systems in weight category II or III, there may be restrictions on the maximum size setting, e.g. due to possible contact with the roof.
- ✔ The child restraint system must not be put under strain between the roof and the seat cushion and/or be installed facing the wrong direction. Where possible, adjust the seat cushion inclination accordingly.
- ✔ The child restraint system must not be put under strain by the head restraint. Adjust the head restraints accordingly.
- ✔ Make sure that the child's feet do not touch the front seat. If necessary, move the front seat slightly forwards.

The seat belts on the following seats are equipped with a child seat safety feature:

- Front passenger seat
- Rear seats

When enabled, the child seat safety feature ensures that the seat belts of the front passenger seat and rear seats do not slacken once the child restraint system is secured (→ page 57).

- ▶ Install the child restraint system. The entire base of the child restraint system must always rest on the sitting surface of the rear seat.
- ▶ Always make sure that the shoulder belt strap is correctly routed from the seat belt outlet of the vehicle to the shoulder belt guide on the child restraint system. The shoulder belt strap must be routed forwards and downwards from the seat belt outlet.

Notes on rearward-facing and forward-facing child restraint systems on the front passenger seat

⚠ WARNING Risk of injury or death from using a rearward-facing child restraint system when the front passenger front airbag is enabled

If you secure a child in a rearward-facing child restraint system on the front passenger seat and the PASSENGER AIR BAG OFF indicator lamp is off, the front passenger airbag can deploy in the event of an accident.

The child could be struck by the airbag.

Always ensure that the front passenger airbag is deactivated. The PASSENGER AIR BAG OFF indicator lamp must be lit.

NEVER use a rearward-facing child restraint system on a seat protected by an ENABLED FRONT AIRBAG in front of it, DEATH or SERIOUS INJURY to the CHILD can occur.

Observe the specific instructions for the rearward-facing and forward-facing child restraint systems (→ page 63).

Always observe the status of the front passenger airbag on the PASSENGER AIR BAG OFF indicator lamp:

- When using a rearward-facing child restraint system on the front passenger seat, the front passenger airbag must always be disabled. This is only the case if the PASSENGER AIR BAG OFF indicator lamp is lit continuously (→ page 47).
- If the PASSENGER AIR BAG OFF indicator lamp is off, the front passenger airbag is enabled. The front passenger airbag may deploy during an accident.

Securing the child restraint system with the seat belt on the front passenger seat

When installing a belt-secured child restraint system on the front passenger seat, always observe the following:

- ☑ Observe the child restraint system manufacturer's installation and operating instructions.
 - ☑ When using a forward-facing child restraint system in category I: remove the head restraint from the respective seat, if possible.
- After the child restraint system has been removed, replace the head restraints immediately and adjust them correctly.
- ☑ The backrest of the forward-facing child restraint system must, as far as possible, be resting on the seat backrest of the front passenger seat.
 - ☑ For certain child restraint systems in weight category II or III, there may be restrictions on the maximum size setting, e.g. due to possible contact with the roof.

- ✓ The child restraint system must not be tensioned between the roof and the seat cushion and/or be installed facing the wrong direction.
- ✓ The child restraint system must not be put under strain by the head restraints. Adjust the head restraints accordingly.
- ✓ Never place objects under or behind the child restraint system, e.g. cushions.

The seat belt on the front passenger side is equipped with a special seat belt retractor.

When enabled, the special seat belt retractor function ensures that the seat belt does not slacken once the child restraint system is secured (→ page 57).

- ▶ Set the front passenger seat as far back as possible and move the seat into the highest position if possible.
- ▶ Fully retract the seat cushion length adjustment.
- ▶ Adjust the seat cushion inclination so that the front edge of the seat cushion is in the

highest position and the rear edge of the seat cushion is in the lowest position.

- ▶ Set the seat backrest to the most vertical position possible.
- ▶ Install the child restraint system. The entire base of the child restraint system must always rest on the sitting surface of the front passenger seat.
- ▶ Always make sure that the shoulder belt strap is correctly routed from the seat belt outlet of the vehicle to the shoulder belt guide on the child restraint system. The shoulder belt strap must be routed forwards and downwards from the seat belt outlet.
- ▶ If necessary, adjust the seat belt outlet and the front passenger seat accordingly.

Child safety locks

Activating/deactivating the child safety lock for the rear doors

⚠ WARNING Risk of accident and injury due to children left unattended in the vehicle

If children are left unattended in the vehicle, they could:

- Open doors, thereby endangering other persons or road users.
- Get out and be struck by oncoming traffic.
- Operate vehicle equipment and become trapped, for example.

In addition, the children could also set the vehicle in motion, for example by:

- Releasing the parking brake.
- Changing the transmission position.
- Starting the vehicle.

- ▶ Never leave children unattended in the vehicle.
- ▶ When leaving the vehicle, always take the key with you and lock the vehicle.
- ▶ Keep the vehicle key out of reach of children.

▲ WARNING Risk of fatal injury due to exposure to extreme heat or cold in the vehicle

If people – particularly children – are exposed to extreme temperatures over an extended period of time, there is a risk of serious or even fatal injury.

- ▶ Never leave anyone – particularly children – unattended in the vehicle.
- ▶ Never leave animals in the vehicle unattended.

▲ WARNING Risk of accident and injury due to children left unattended in the vehicle

If children are traveling in the vehicle, they could, in particular:

- Open doors, thereby endangering other persons or road users
 - Get out and be struck by oncoming traffic
 - Operate vehicle equipment and become trapped, for example
- ▶ Always activate the child safety locks installed if children are traveling in the vehicle.
 - ▶ Never leave children unattended in the vehicle.
 - ▶ When leaving the vehicle, always take the SmartKey with you and lock the vehicle.

There are child safety locks for the rear doors and the rear passenger compartment side windows.

The child safety lock on the rear doors secures each door separately. The doors can no longer be opened from the inside.

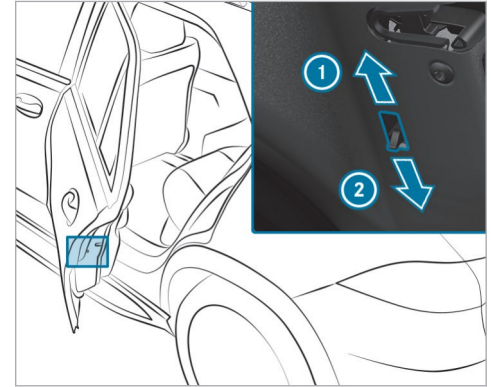

- ▶ Press the lever in direction ① (activate) or ② (deactivate).
- ▶ Make sure that the child safety locks are working properly.

Activating/deactivating the child safety lock for the rear passenger compartment side windows

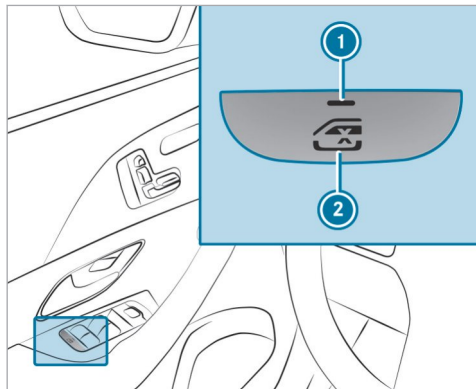

▶ **To activate/deactivate:** press button ②.

The rear passenger compartment side window can be opened or closed in the following cases:

- With indicator lamp ① lit: via the switch on the driver's door.
- With indicator lamp ① off: via the switch on the corresponding rear door or driver's door.

Notes on pets in the vehicle

⚠ WARNING Risk of accident and injury due to animals left unsecured or unattended in the vehicle

If you leave animals in the vehicle unattended or unsecured, they could possibly press down buttons or switches.

Thereby an animal may:

- activate vehicle equipment and become trapped, for example

- switch systems on or off and endanger other road users

Unsecured animals may be thrown around in the vehicle in the event of an accident or sudden steering and braking maneuver and injure vehicle occupants in the process.

- ▶ Never leave animals in the vehicle unattended.
- ▶ Always correctly secure animals while driving, for example using a suitable animal carrier.

SmartKey

Overview of SmartKey functions

⚠ WARNING Risk of accident and injury due to children left unattended in the vehicle

If children are left unattended in the vehicle, they could:

- Open doors, thereby endangering other persons or road users.
- Get out and be struck by oncoming traffic.
- Operate vehicle equipment and become trapped, for example.

In addition, the children could also set the vehicle in motion, for example by:

- Releasing the parking brake.
- Changing the transmission position.
- Starting the vehicle.

▶ Never leave children unattended in the vehicle.

- ▶ When leaving the vehicle, always take the key with you and lock the vehicle.
- ▶ Keep the vehicle key out of reach of children.



⚠ NOTE Damage to the key caused by magnetic fields

- ▶ Keep the key away from strong magnetic fields.

i The SmartKey may vary from the one shown in the diagram, depending on the vehicle equipment.



- ① Locks
- ② Battery check lamp
- ③ Unlocks
- ④ Opens/closes the tailgate
- ⑤ Panic alarm

i If battery check lamp ② does not light up after pressing the  or  button, the battery is discharged.

Replacing the SmartKey battery (→ page 69).

The SmartKey locks and unlocks the following components:

- The doors
- The fuel filler flap

- The tailgate

If the vehicle is not opened within approximately 40 seconds after unlocking, it locks again. Anti-theft protection is armed again.

Do not keep the SmartKey together with electronic devices or metal objects. This can affect the SmartKey's functionality.

Do not keep the SmartKey in the temperature-controlled cup holder. Otherwise, the SmartKey will not be reliably detected.

Activating/deactivating the acoustic locking verification signal

Multimedia system:

→  → Settings → Vehicle

▶ Activate or deactivate **Acoustic Lock**.

Activating/deactivating the panic alarm

Requirements:

- The ignition is switched off.

- ❗ The panic alarm function is only available in certain countries.





- ▶ **To activate:** press button ❶ for approximately one second. A visual and audible alarm is triggered.
 - ▶ **To deactivate:** briefly press button ❶ again.
- or
- ▶ Press the start/stop button on the cockpit (the SmartKey is inside the vehicle).

Changing the unlocking settings

Possible unlocking functions of the SmartKey:

- Central unlocking

- Unlocking the driver's door and fuel filler flap

▶ **To switch between settings:** press the  and  buttons simultaneously for approximately six seconds until the battery check lamp flashes twice.

Options if the unlocking function for the driver's door and fuel filler flap has been selected:

- **To unlock the vehicle centrally:** press the  button twice.
- **Vehicles with KEYLESS-GO:** if you touch the inner surface of the door handle on the driver's door, only the driver's door and fuel filler flap are unlocked.

Deactivating the SmartKey functions

If you do not use the vehicle or a SmartKey for an extended period of time, you can reduce the energy consumption of the respective SmartKey. To do so, deactivate the SmartKey functions.

▶ **To deactivate:** press the  button on the SmartKey twice in quick succession. The battery check lamp of the SmartKey flashes twice briefly and lights up once.

▶ **To activate:** press any button on the SmartKey.

i When the vehicle is started with the SmartKey in the marked space of the center console, the SmartKey functions are automatically activated (→ page 162).

Removing/inserting the emergency key

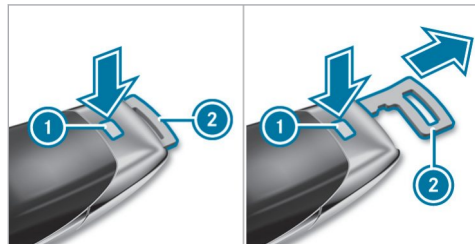

- ▶ **To remove:** press release knob **1**. Emergency key **2** is pushed out slightly.
- ▶ Pull out emergency key **2** until it engages in the intermediate position.
- ▶ Press release knob **1** again and fully remove emergency key **2**.
- ▶ **To insert:** press release knob **1**.
- ▶ Insert emergency key **2** to the intermediate position or fully until it engages.

i You can use the intermediate position of emergency key **2** to attach the SmartKey to a key ring.

Replacing the SmartKey battery

⚠ DANGER Serious damage to health caused by swallowing batteries

Batteries contain toxic and corrosive substances. Swallowing batteries may cause serious damage to health.

There is a risk of fatal injury.

- ▶ Keep batteries out of the reach of children.
- ▶ If batteries are swallowed, seek medical attention immediately.

🔥 ENVIRONMENTAL NOTE Environmental damage caused by improper disposal of batteries



Batteries contain pollutants. It is illegal to dispose of them with the household rubbish.



Dispose of batteries in an environmentally responsible manner. Take discharged batteries to a qualified specialist workshop or to a collection point for used batteries.

Requirements:

70 Opening and closing

- You require a CR 2032 3 V cell battery.

Mercedes-Benz recommends that you have the battery replaced at a qualified specialist workshop.

- ▶ Remove the emergency key (→ page 69).

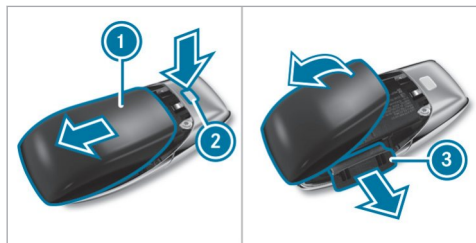

- ▶ Press release button (2) down fully and slide cover (1) in the direction of the arrow.
- ▶ Fold out cover (1) in the direction of the arrow and remove.
- ▶ Remove battery compartment (3) and take out the discharged battery.

- ▶ Insert the new battery into battery compartment (3). Observe the positive pole marking in the battery compartment and on the battery when doing this.
- ▶ Push in battery compartment (3).
- ▶ Re-attach cover (1) and push it until it engages.

Problems with the SmartKey

Problem	Possible causes/consequences and ► Solutions
You can no longer lock or unlock the vehicle.	<p>Possible causes:</p> <ul style="list-style-type: none">• The SmartKey battery is discharged or nearly discharged.• There is interference from a powerful radio signal source.• The SmartKey is faulty. <p>► Check the battery using the battery check lamp and replace if necessary (→ page 69).</p> <p>► Use the emergency key to lock or unlock (→ page 69).</p> <p>► Have the SmartKey checked at a qualified specialist workshop.</p>
You have lost a SmartKey.	<p>► Have the SmartKey deactivated at a qualified specialist workshop.</p> <p>► If necessary, have the mechanical lock changed as well.</p>

Doors

Unlocking and opening doors from the inside

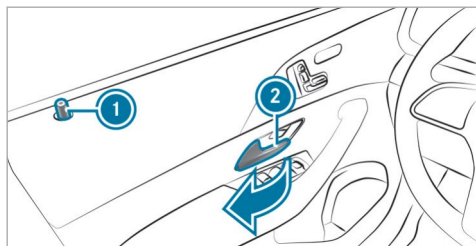

- ▶ **To unlock and open a front door:** pull door handle ②. Locking pin ① pops up when the door is unlocked.
- ▶ **To unlock a rear door:** pull the rear door handle. The locking pin pops up when the rear door is unlocked.
- ▶ **To open a rear door:** pull the rear door handle again.

Centrally locking and unlocking the vehicle from the inside

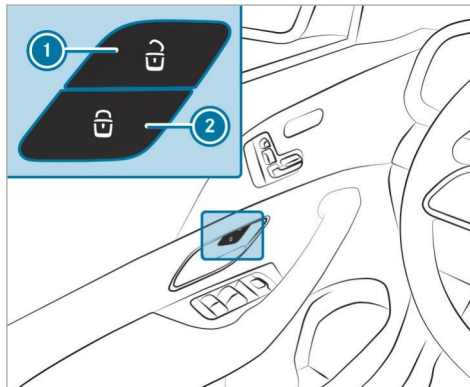

- ▶ **To unlock:** press button ①.
- ▶ **To lock:** press button ②.

This does not lock or unlock the fuel filler flap.

The vehicle is not unlocked:

- If you have locked the vehicle using the SmartKey.
- If you have locked the vehicle using KEY-LESS-GO.

Locking/unlocking the vehicle with KEY-LESS-GO

Requirements:

- The SmartKey is outside the vehicle.
- The distance between the SmartKey and the vehicle does not exceed 3 ft (1 m).
- The driver's door and the door at which the door handle is used are closed.

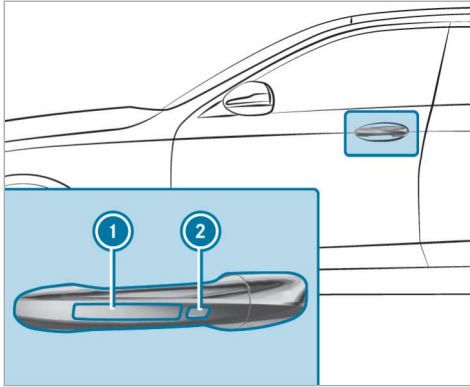

If you open the tailgate from outside it is automatically unlocked.

- ▶ **To unlock the vehicle:** touch the inner surface of the door handle.
 - ▶ **To lock the vehicle:** touch sensor surface ① or ②.
 - ▶ **Convenience closing:** touch recessed sensor surface ② until the closing process has been completed.
- ❶ Further information on convenience closing (→ page 83).

Problems with KEYLESS-GO

Problem	Possible causes/consequences and ► Solutions
You can no longer lock or unlock the vehicle using KEYLESS-GO.	<p>Possible causes are:</p> <ul style="list-style-type: none">• The key functions have been deactivated (→ page 68).• The SmartKey battery is discharged or nearly discharged.• There is interference from a powerful radio signal source.• The SmartKey is faulty. <p>► Activate the SmartKey functions (→ page 68).</p> <p>► Check the battery using the battery check lamp and replace if necessary (→ page 69).</p> <p>► Use the emergency key to unlock or lock the vehicle (→ page 69).</p> <p>► Have the vehicle and SmartKey checked at a qualified specialist workshop.</p>

Activating/deactivating the automatic locking feature

The vehicle is locked automatically when the ignition is switched on and the wheels are turning faster than walking pace.

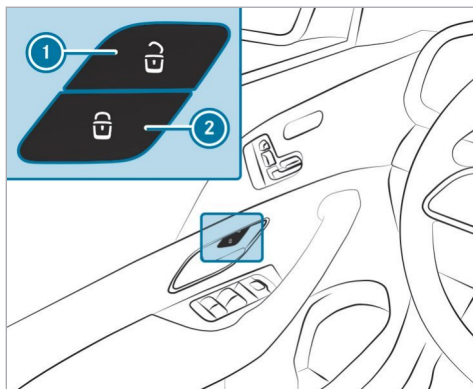

- ▶ **To activate:** press and hold button ② for approximately five seconds until an acoustic signal sounds.
- ▶ **To deactivate:** press and hold button ① for approximately five seconds until an acoustic signal sounds.

In the following situations, there is a danger of being locked out when the function is activated:

- While the vehicle is being tow started/ pushed.
- If the vehicle is being tested on a roller dynamometer.

Power closing function

If you push the door into the lock to the first detent position, the power closing function will automatically pull the door into the lock.

Locking/unlocking the driver's door with the emergency key

- ① If you wish to lock the vehicle entirely using the emergency key, first press the button for locking from the inside while the driver's door is open. Then proceed to lock the driver's door using the emergency key.

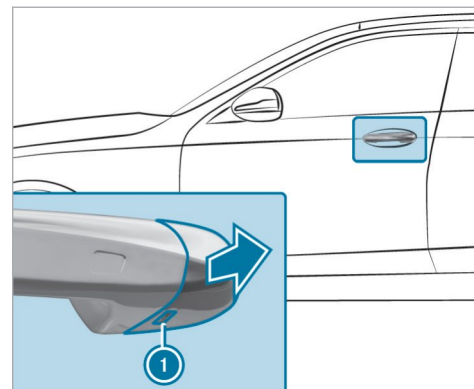

- ▶ Insert the emergency key as far as it will go into opening ① in the cover.
- ▶ Pull and hold the door handle.
- ▶ Pull the cover on the emergency key as straight as possible away from the vehicle until it releases.
- ▶ Release the door handle.

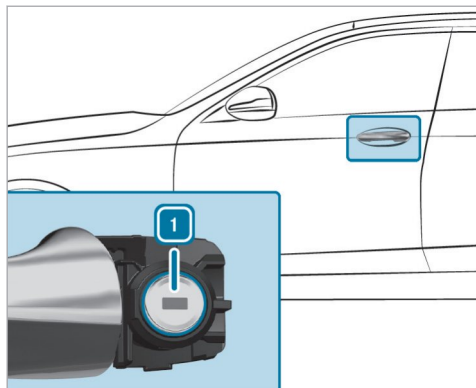

- ▶ **To unlock:** turn the emergency key counter-clockwise to position 1.
- ▶ **To lock:** turn the emergency key clockwise to position 1.
- ▶ Carefully press the cover onto the lock cylinder until it engages and is seated firmly.

Cargo compartment

Opening the tailgate

⚠ DANGER Risk of exhaust gas poisoning

Combustion engines emit poisonous exhaust gases such as carbon monoxide. Exhaust gases can enter the vehicle interior if the tailgate is open when the engine is running, especially if the vehicle is in motion.

- ▶ Always switch off the engine before opening the tailgate.
- ▶ Never drive with the tailgate open.

! **NOTE** Damage to the tailgate caused by obstacles above the vehicle

The tailgate swings rearwards and upwards when it is opened.

- ▶ Make sure that there is sufficient space behind and above the tailgate.

You have the following options for opening the tailgate:

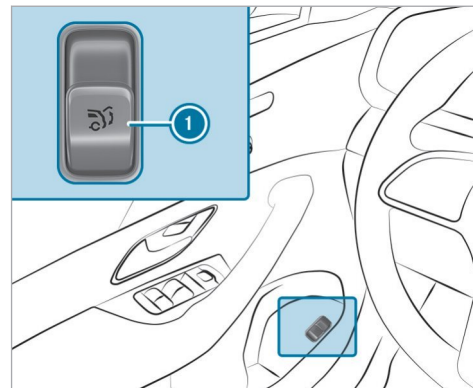

- ▶ Pull remote opening switch 1 for the tailgate.
- ▶ Press and hold the  button on the SmartKey.
- ▶ **Vehicles with HANDS-FREE ACCESS:** Make a kicking movement with your foot below the bumper (→ page 79).

- ▶ If the tailgate is unlocked, pull the tailgate handle and release it.
- ▶ For a tailgate stopped in an intermediate position, pull it upwards and release it as soon as it starts to open.

The tailgate is equipped with an automatic obstruction detection function. If a solid object blocks or restricts the tailgate during automatic opening, this process is stopped. The automatic obstruction detection function is only an aid. It is not a substitute for your attentiveness when you are opening the tailgate.

Closing the tailgate

⚠ WARNING Risk of injury from unsecured items in the vehicle

If objects, luggage or loads are not secured or not secured sufficiently, they could slip, tip over or be thrown around and thereby hit vehicle occupants.

There is a risk of injury, particularly in the event of sudden braking or a sudden change in direction.

- ▶ Always stow objects in such a way that they cannot be thrown around.
- ▶ Before the journey, secure objects, luggage or loads against slipping or tipping over.

Observe the notes on loading the vehicle.

To close the tailgate, the following options are available:

- ▶ Pull the tailgate downwards slightly. Release it as soon as it begins to close.

⚠ WARNING Risk of becoming trapped during automatic closing of the tailgate

Parts of the body could become trapped during automatic closing of the tailgate. Moreover, people, e.g. children, may be standing in the closing area or may enter the closing area during the closing process.

- ▶ Make sure that nobody is in the vicinity of the closing area during the closing process.

Use one of the following options to stop the closing process:

- Press the  button on the SmartKey.
- Press or pull the remote operating switch on the driver's door.
- Press the closing or locking button on the tailgate.
- Pull the tailgate handle.

- ▶ **Vehicles with HANDS-FREE ACCESS:** it is also possible to stop the closing process by making a kicking movement below the rear bumper.

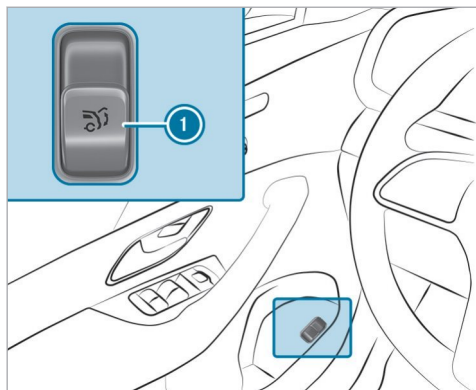

- ▶ Switch on the power supply or the ignition.
- ▶ Press remote operating switch ① for the tailgate.

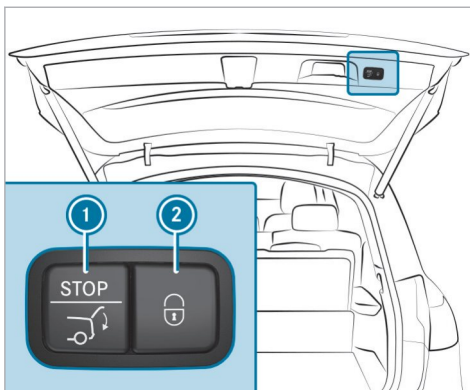

- ▶ Press closing button ① on the tailgate.

Vehicles with KEYLESS-GO

- ▶ Press locking button ② on the tailgate. If a SmartKey is detected outside the vehicle, the tailgate will close and the vehicle will be locked.

- ▶ Press and hold the  button on the SmartKey (with the SmartKey in the vicinity of the vehicle).

Vehicles with HANDS-FREE ACCESS

- ▶ Make a kicking movement with your foot below the bumper (→ page 79).

Automatic reversing function for the tailgate

The tailgate is equipped with automatic obstruction detection with reversing function. If a solid object blocks or restricts the tailgate during automatic closing, the tailgate will automatically open again slightly. Automatic obstruction detection with reversing function is only an aid. It is not a substitute for your attentiveness when you are closing the tailgate.

- ▶ During the closing process, make sure that no body parts are in the closing area.

⚠ WARNING Risk of becoming trapped despite the reversing function

The reversing function does not react:

- To soft, light and thin objects, e.g. fingers.
- Over the last $\frac{1}{3}$ in (8 mm) of the closing path.

In these situations in particular, the reversing function cannot prevent someone being trapped.

- ▶ When closing, make sure that no body parts are in the closing area.

If someone is trapped:

- Press the  button on the SmartKey, or
- Press or pull the remote operating switch on the driver's door, or
- Press the closing or locking button on the tailgate, or
- Pull the tailgate handle.

HANDS-FREE ACCESS function

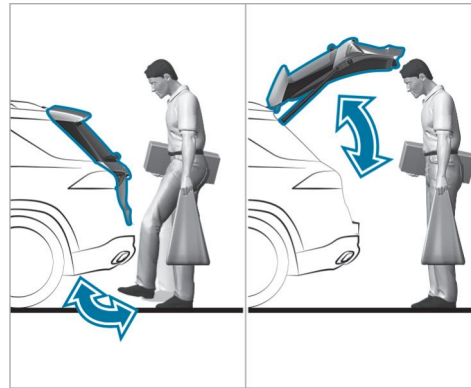

With HANDS-FREE ACCESS you can open, close or stop the closing process of the tailgate by performing a kicking movement under the rear bumper.

The kicking movement triggers the opening or closing process alternately.

Observe the notes when opening (→ page 76) and closing (→ page 77) the tailgate.

- ⓘ Two warning tones sound when the tailgate is opening or closing.

⚠ WARNING Risk of burns caused by a hot exhaust system

The vehicle exhaust system can become very hot. If you use HANDS-FREE ACCESS, you could burn yourself by touching the exhaust system.

- ▶ Always ensure that you only make a kicking movement within the detection range of the sensors.

! NOTE Vehicle damage due to unintentional opening of the tailgate

- when using an automatic car wash
- when using a high pressure cleaner
- ▶ Deactivate KEYLESS-GO or make sure that the key located is at least 10 ft

(3 m) away from the vehicle in such situations.

When making the kicking movement, make sure that your feet are firmly on the ground, otherwise you could lose your balance, e.g. on ice.

Observe the following notes:

- The SmartKey is behind the vehicle.
- Stand at least 12 in (30 cm) away from the vehicle while performing the kicking movement.
- Do not come into contact with the bumper while making the kicking movement.
- Do not carry out the kicking movement too slowly.
- The kicking movement must be towards the vehicle and back again.

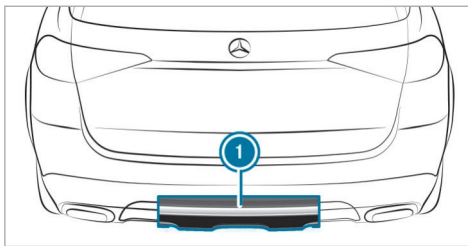

① Detection range of the sensors

If several consecutive kicking movements are not successful, wait ten seconds.

System limits

The system may be impaired or may not function in the following cases:

- The area around the sensor is dirty, e.g. due to road salt or snow.
- The kicking movement is made using a prosthetic leg.

The tailgate can open or close unintentionally in the following situations:

- If a person's arms or legs are moving in the sensor detection range, e.g. when polishing the vehicle or picking up objects.
- If objects are moved or placed behind the vehicle, e.g. tensioning straps or luggage.
- If clamping straps, tarps or other coverings are pulled over the bumper.
- If a protective mat with a length reaching over the trunk sill down into the detection range of the sensors is used.
- If the protective mat is not secured correctly.
- When working on the trailer hitch, trailers or rear bicycle racks.

Deactivate the SmartKey functions (→ page 68) or do not carry the SmartKey about your person in such situations.

Limiting the opening angle of the tailgate

Activating the opening angle limiter

You can limit the opening angle of the tailgate in the top half of its opening range to approximately 8 in (20 cm) before the end position.

- ▶ Stop the opening procedure of the tailgate at the desired position.
- ▶ Press and hold the closing button on the tailgate until you hear a short acoustic signal. The opening angle limiter will be activated. The tailgate will then stop in the stored position when opened.

To open the tailgate fully, pull the handle on the outside of the tailgate again after it has stopped automatically.

Deactivating the opening angle limiter

- ▶ Press and hold the closing button on the tailgate until two short acoustic signals sound.

Unlocking the tailgate with the emergency key

Requirements:

- The rear seat backrest has been folded forward.
- The cargo compartment cover has been removed (→ page 122).

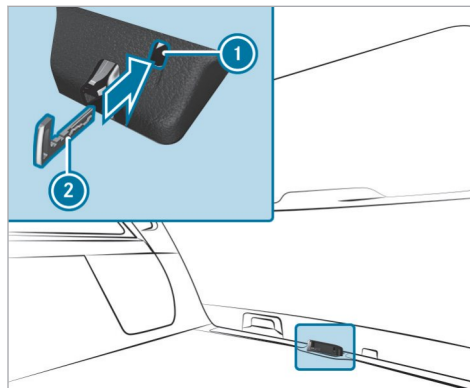

- ▶ Insert emergency key ② into opening ① in the trim and push it in. The tailgate will be unlocked.

Side windows

Opening and closing the side windows

⚠ WARNING Risk of entrapment when opening a side window

When opening a side window, parts of the body could be drawn in or become trapped between the side window and window frame.

- ▶ When opening, make sure that nobody is touching the side window.
- ▶ If someone is trapped, release the button immediately or pull it in order to close the side window again.

⚠ WARNING Risk of becoming trapped when closing a side window

When closing a side window, body parts could be trapped in the closing area in the process.

- ▶ When closing, make sure that no body parts are in the closing area.
- ▶ If someone is trapped, release the button immediately or press the button in order to reopen the side window.

⚠ WARNING Risk of becoming trapped when children operate the side windows

Children could become trapped if they operate the side windows, particularly when unattended.

- ▶ Activate the child safety lock for the rear side windows.
- ▶ When leaving the vehicle, always take the SmartKey with you and lock the vehicle.

- ▶ Never leave children unattended in the vehicle.

Requirements:

- The power supply or the ignition is switched on.

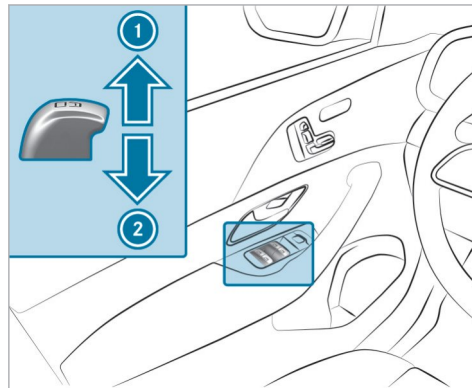

- ① Closes
- ② Opens

The buttons on the driver's door take precedence.

- ▶ **To start automatic operation:** press the  button beyond the point of resistance or pull and release it.

- ▶ **To interrupt automatic operation:** press or pull the  button again.

When the vehicle is switched off, the side windows can continue being operated.

This function is available for around four minutes or until a front door is opened.

- ⓘ **Vehicles with electric roller sunblinds on rear doors on the left and right:** The buttons for the rear side windows also open and close the roller sunblinds (→ page 90).

Automatic reversing function of the side windows

If an object blocks a side window during the closing process, the side window will open again automatically. The automatic reversing function is only an aid and is not a substitute for your attentiveness.

- ▶ During the closing process, make sure that no body parts are in the closing area.

⚠ WARNING Risk of becoming trapped despite there being reversing protection on the side window

The reversing function does not react:

- To soft, light and thin objects, e.g. fingers
- During resetting

This means that the reverse function cannot prevent someone from becoming trapped in these situations.

- ▶ When closing, make sure that no body parts are in the closing area.
- ▶ If someone becomes trapped, press the  button to open the side window again.

Convenience opening (ventilating the vehicle before starting a journey)

⚠ WARNING Risk of entrapment when opening a side window

When opening a side window, parts of the body could be drawn in or become trapped between the side window and window frame.

- ▶ When opening, make sure that nobody is touching the side window.
- ▶ Release the button immediately if somebody becomes trapped.

- ▶ Press and hold the  button on the SmartKey.

The following functions are performed:

- The vehicle is unlocked
- The side windows are opened.
- The sliding sunroof is opened.
- The panoramic sliding sunroof is opened.
- The seat ventilation of the driver's seat is switched on.

- ① If the roller sunblinds of the panoramic sliding sunroof are closed, the roller sunblinds are opened first.
- ① If the roller sunblinds of the rear doors are closed, the roller sunblinds are opened first.

▶ **To interrupt convenience opening:** release the  button.

▶ **To continue convenience opening:** press and hold the  button again.

Convenience closing (closing the vehicle from outside)

⚠ WARNING Risk of entrapment caused by inadvertent convenience closing

When the convenience closing feature is operating, parts of the body could become trapped in the closing area of the side window and the sliding sunroof.

- ▶ Observe the complete closing procedure when using convenience closing.
- ▶ When closing, make sure that no body parts are in the closing area.

▶ Press and hold the  button on the SmartKey.

The following functions are performed:

- The vehicle is locked.
- The side windows are closed.
- The sliding sunroof is closed.
- The panoramic sliding sunroof is closed.

▶ **To interrupt convenience closing:** release the  button.

▶ **To close the roller sunblinds:** press and hold the  button again.

 Convenience closing can also be operated with KEYLESS-GO (→ page 72).

Problems with the side windows

 **WARNING** Risk of becoming trapped or fatally injured if reversing protection is not activated

If you close a side window again immediately after it has been blocked, the side window will close with increased or maximum force. The reversing feature will then not be active.

Parts of the body could become trapped in the closing area in the process.

- ▶ Make sure that no parts of the body are in the closing area.
- ▶ To stop the closing process, release the button or press the button again to re-open the side window.

Problem

A side window cannot be closed and you cannot see the cause.

Possible causes/consequences and ▶ Solutions

- ▶ Check to see whether any objects are in the window guide.
- ▶ Adjust the side windows.

Adjusting the side windows

If a side window is obstructed during closing and reopens again immediately:

- ▶ Immediately after this, pull the corresponding button again until the side window has closed, and hold the button for at least one more second (re-adjustment).
The side window is closed without the automatic reversing function.

Problem	Possible causes/consequences and ► Solutions
	<p>If the side window is obstructed again and reopens again immediately:</p> <ul style="list-style-type: none"> ► Immediately after this, pull the corresponding button again until the side window has closed, and hold the button for at least one more second (follow-up adjustment). The side window is closed without the automatic reversing function.
The side windows cannot be opened or closed using the convenience opening feature.	<p>The SmartKey battery is discharged or nearly discharged.</p> <ul style="list-style-type: none"> ► Check the battery using the battery check lamp and replace if necessary (→ page 69).

Sliding sunroof

Opening and closing the sliding sunroof

i The term "sliding sunroof" also refers to the panorama roof with power tilt/sliding panel.

⚠ WARNING Risk of becoming trapped while opening and closing the sliding sunroof

During opening and closing, parts of the body could get caught in the sweep of the sliding sunroof.

- When opening or closing, make sure that no body parts are in the sweep.
 - Release the button immediately if somebody becomes trapped.
- or
- Press the button in any direction during the automatic opening/closing process. The opening/closing process is stopped.

⚠ WARNING Risk of becoming trapped if the sliding sunroof is operated by children

Children operating the sliding sunroof could get caught in the moving parts, particularly if unattended.

- Never leave children unattended in the vehicle.
- When leaving the vehicle, always take the key with you and lock the vehicle.

⚠ WARNING Risk of becoming trapped while opening and closing the roller sun blind

When opening or closing, make sure that no body parts become trapped between the roller sun blind and frame or the sliding sunroof.

- ▶ When opening or closing, make sure that no body parts are in the sweep of the roller sun blind.
- ▶ Release the button immediately if somebody becomes trapped.

or

- ▶ Press the button in any direction during the automatic opening/closing process. The opening/closing process is stopped.

! NOTE Malfunction caused by snow and ice

Snow and ice may lead to a malfunction of the sliding sunroof.

- ▶ Only open the sliding sunroof if it is free of snow and ice.

! NOTE Damage caused by protruding objects

Objects that protrude from the sliding sunroof may damage the sealing strips.

- ▶ Do not allow anything to protrude from the sliding sunroof.

! NOTE Important points to remember when a roof rack is installed

When a roof rack is installed, raising or opening the sliding sunroof may be limited.

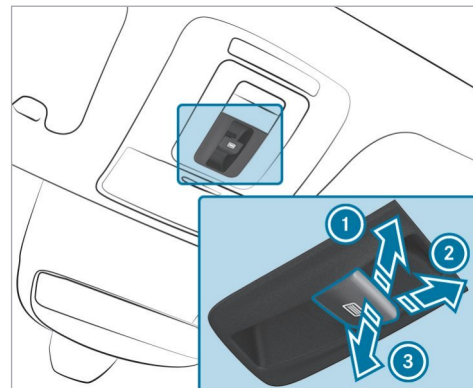

- ▶ Check whether the sliding sunroof can be raised or opened when a roof rack is installed.
- ▶ If in doubt, do not raise or open the sliding sunroof.



- ① Raises
- ② Opens
- ③ Closes/lowers

Use the  button to operate the panoramic sliding sunroof and the roller sunblind.

The panorama roof with power tilt/sliding panel can be operated only when the roller sunblind is open.

- ▶ Check whether the sliding sunroof can be raised or opened when a roof rack is installed.
- ▶ **To start automatic operation:** press the  button beyond the point of resistance or pull and release it.
- ▶ **To interrupt automatic operation:** briefly press the  button in any direction. The opening/closing process will be stopped.

Vehicles with a panorama roof with power tilt/sliding panel: The automatic raising feature is available only when the sliding sunroof is closed or raised.

Vehicles without a panorama roof with power tilt/sliding panel: The automatic opening and raising feature is available only when the sliding sunroof is closed.

Automatic reversing function of the sliding sunroof

If an object is obstructing the sliding sunroof during the closing process, the sliding sunroof will open again automatically. The automatic

reversing function is only an aid and is not a substitute for your attentiveness.

- ▶ During the closing process, make sure that no body parts are in the closing area.

WARNING Risk of entrapment even with the reversing function active

The reversing feature does not react in particular:

- To soft, light and thin objects, e.g. fingers
- Over the last 1/6 in (4 mm) of the closing path
- During resetting

This means that the reverse function cannot prevent someone from becoming trapped in these situations.

- ▶ When closing, make sure that no body parts are in the closing area.
- ▶ Release the button immediately if somebody becomes trapped.

or

- ▶ Briefly press the button in any direction during automatic operation. The closing process is stopped.

Automatic reversing function of the roller sunblind

If an object is obstructing the roller sunblind during the closing process, the roller sunblind will open again automatically. The automatic reversing function is only an aid and is not a substitute for your attentiveness.

- ▶ When closing the roller sunblind, make sure that no body parts are in the range of movement.

WARNING Risk of becoming trapped despite reversing feature

In particular, the reversing feature does not react to soft, light and thin objects, e.g. fingers.

This means that the reversing feature cannot prevent entrapment in these situations.

- ▶ When closing the roller sunblind, make sure that no body parts are in the range of movement.
- ▶ Release the button immediately if somebody becomes trapped.

or

- ▶ Press the button in any direction during the automatic closing process. The closing process is stopped.

Automatic functions of the sliding sunroof

- ① The term "sliding sunroof" also refers to the panoramic sliding sunroof.

By pushing or pulling the  button, you can interrupt the automatic functions: "Rain closing

function when driving" and "Automatic lowering".

Rain closing function when driving

Vehicles with a panoramic sliding sunroof: If it starts to rain, the raised sliding sunroof is automatically lowered while the vehicle is in motion.

Automatic lowering function

Vehicles with a panoramic sliding sunroof: If the sliding sunroof is raised at the rear, it is automatically lowered slightly at higher speeds. At low speeds, it is raised again automatically.

⚠ WARNING Risk of entrapment by automatic lowering of the sliding sunroof



At high speeds the raised sliding sunroof automatically lowers slightly at the rear.



This could trap you or other persons.

- ▶ Make sure that nobody reaches into the sweep of the sliding sunroof whilst the vehicle is in motion.
- ▶ If somebody becomes trapped, briefly push the sliding sunroof button forwards or backwards. The sliding sunroof lifts during opening.

Problems with the sliding sunroof

- ① The term "sliding sunroof" also refers to the panoramic sliding sunroof.

Problem	Possible causes/consequences and ► Solutions
<p>The sliding sunroof cannot be closed and you cannot see the cause.</p>	<p>▲ WARNING Risk of becoming trapped or fatal injury by closing the sliding sunroof again</p> <p>If you close the sliding sunroof again immediately after it has been blocked or reset, the sliding sunroof closes with increased force.</p> <p>Parts of the body could become trapped in the closing area in the process.</p> <ul style="list-style-type: none"> ▶ Make sure that no parts of the body are in the closing area. ▶ Release the button immediately if somebody becomes trapped. <p>or</p> <ul style="list-style-type: none"> ▶ Press the button in any direction during the automatic closing process. <p>The closing process is stopped.</p> <p>If the sliding sunroof is obstructed during closing and reopens again slightly:</p> <ul style="list-style-type: none"> ▶ Immediately after automatic reversing, pull and hold the  button down again to the point of resistance until the sliding sunroof is closed. <p>The sliding sunroof will be closed with increased force.</p> <p>If the sliding sunroof is obstructed again and reopens again slightly:</p> <ul style="list-style-type: none"> ▶ Repeat the previous step. <p>The sliding sunroof will be closed again with increased force.</p>
	<ul style="list-style-type: none"> ▶ Push the  button up to the point of resistance a number of times until the sliding sunroof is fully open.

Problem	Possible causes/consequences and ► Solutions
Vehicles without a panoramic sliding sunroof: The sliding sunroof does not operate smoothly.	<ul style="list-style-type: none"> ► Press the  button for another second. ► Close the sliding sunroof.
Vehicles with a panoramic sliding sunroof: The sliding sunroof or the roller sunblind does not operate smoothly.	<ul style="list-style-type: none"> ► Pull and hold the  button little by little until the sliding sunroof is fully closed. ► Pull and hold the  button little by little until the roller sunblind is fully closed. ► Use automatic operation to fully open and then close the sliding sunroof.

Roller sun blinds

Extending or retracting the roller sunblinds on the rear side windows

⚠ WARNING Risk of becoming trapped when extending or retracting the roller sunblind

Body parts could become trapped in the sweep of the roller sunblind when it is being extended or retracted.

- Make sure that no body parts are in the sweep of the roller sunblind when it is being extended or retracted.
- If someone becomes trapped, briefly press the button in the opposite direction. The opening or closing process will briefly be stopped. The roller sunblind will then return to its starting position.

! NOTE Damage caused by objects

- Make sure that the roller sun blind can move freely.

The roller sunblinds for the rear side windows can be operated with the buttons for the side windows in the driver's door and in the rear doors.

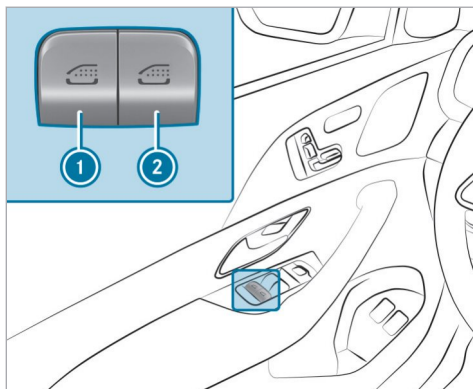

- ① Rear left side window/roller sunblind
- ② Rear right side window/roller sunblind

- ▶ **To close fully:** briefly pull the corresponding button when the side window is closed.
- ▶ **To open fully:** briefly press the corresponding button.

Operating the roller sunblind for the panoramic roof

⚠ WARNING Risk of becoming trapped when opening and closing the roller sunblinds

Body parts can become trapped between the roller sunblind and frame when opening or closing.

- ▶ When opening or closing, make sure that no body parts are in the range of movement of the roller sunblind.
- ▶ Release the button immediately if somebody becomes trapped.

or



- ▶ Briefly press the button in any direction during automatic operation. The opening/closing process is stopped.

Requirements:

- The power supply is switched on (→ page 161).

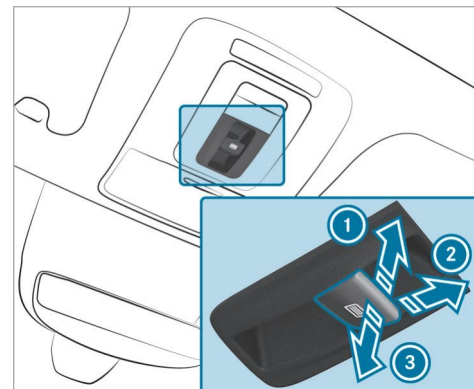
Opening and closing the roller sunblind



- ▶ **To open:** push the  button in direction ① or pull in direction ②.
- ▶ **To close:** pull the  button in direction ③.

If you push or pull the  button beyond the point of resistance, you will start automatic operation in the direction in question. You can

stop automatic operation by pushing or pulling the button again.

Operating the roller sunblind for the panoramic roof from the rear passenger compartment

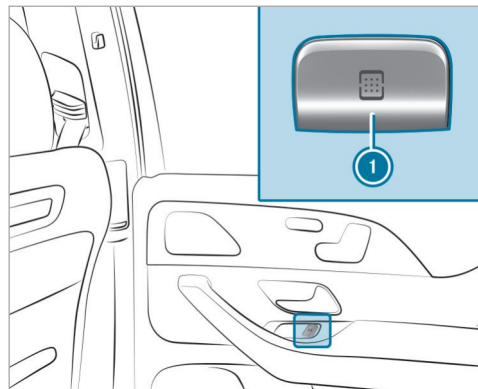

- ▶ **To open:** press button ①.
- ▶ **To close:** pull button ①.

① When the panoramic roof is open, it will close first. To close the roller sunblind, press button ① again.

If you push or pull button ① beyond the point of resistance, you will start automatic operation in the direction in question. You can stop automatic operation by pushing or pulling the button again.

Automatic reversing function of the roller sunblind

If an object is obstructing the roller sunblind during the closing process, the roller sunblind will open again automatically. The automatic reversing function is only an aid and is not a substitute for your attentiveness.

- ▶ When closing the roller sunblind, make sure that no body parts are in the range of movement.

⚠ WARNING Risk of becoming trapped despite reversing feature

In particular, the reversing feature does not react to soft, light and thin objects, e.g. fingers.

This means that the reversing feature cannot prevent entrapment in these situations.

- ▶ When closing the roller sunblind, make sure that no body parts are in the range of movement.
- ▶ Release the button immediately if somebody becomes trapped.

or

- ▶ Press the button in any direction during the automatic closing process. The closing process is stopped.



Adjusting the roller sunblind for the panoramic roof

Requirements:

- The power supply is switched on.

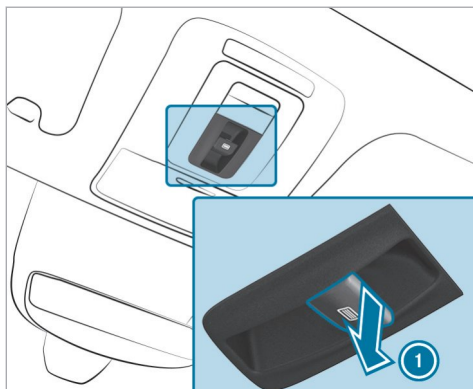
If the roller sunblind cannot be moved smoothly, re-adjust the roller sunblind.



- ▶ Pull the  button down repeatedly to the point of resistance in the direction of arrow ① until the roller sunblind is fully closed.
- ▶ Pull and hold the  button for another second.
- ▶ Check whether the roller sunblind can be completely opened again.

- ▶ If this is not the case, repeat the steps above.
- ▶ If the roller sunblind still cannot be moved smoothly, contact a qualified specialist workshop.

Anti-theft protection

Function of the immobilizer

The immobilizer prevents your vehicle from being started without the correct SmartKey.

The immobilizer is automatically activated when the ignition is switched off and deactivated when the ignition is switched on.

When leaving the vehicle, always take the SmartKey with you and lock the vehicle. Anyone can start the engine if a valid SmartKey has been left inside the vehicle.

- ① In the event the engine cannot be started (yet the vehicle's battery is charged), the system is not operational. Contact an authorized Mercedes-Benz Center or call 1-800-FOR-MERCEDES (in the USA) or 1-800-387-0100 (in Canada).

ATA (anti-theft alarm system)

Function of the ATA system

If the ATA system is armed, a visual and audible alarm is triggered in the following situations:

- When a door is opened
- When the tailgate is opened
- When the hood is opened
- When the interior motion sensor is triggered (→ page 95)
- When the tow-away alarm is triggered (→ page 94)

The ATA system is armed automatically after approximately ten seconds in the following situations:

- After locking the vehicle with the SmartKey
- After locking the vehicle using KEYLESS-GO

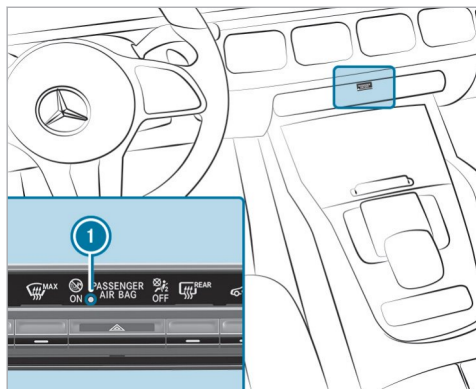

Indicator lamp ① flashes when the ATA system is armed.

The ATA system is deactivated automatically in the following situations:

- After unlocking the vehicle with the SmartKey

- After unlocking the vehicle using KEYLESS-GO
- After pressing the start/stop button with the SmartKey in the stowage compartment (→ page 162)

① When the Mercedes-Benz emergency call system is active and the alarm stays on for more than 30 seconds, a message is automatically sent to the Customer Assistance Center (→ page 425).

① In the case of severe battery discharging, the anti-theft alarm system is automatically deactivated to facilitate the next engine start.

Deactivating the ATA

▶ Press the ,  or  button on the SmartKey.

or

▶ Press the start/stop button with the SmartKey in the marked space (→ page 162)

Deactivating the alarm using KEYLESS-GO

▶ Grasp the outside door handle with the SmartKey outside the vehicle.

Function of the tow-away alarm

① This function may not be available in all countries.

An audible and visual alarm is triggered if an alteration to your vehicle's angle of inclination is detected while the tow-away alarm is armed.



The tow-away alarm is automatically armed after approximately 60 seconds:

- After locking the vehicle with the SmartKey
- After locking the vehicle using KEYLESS-GO

The tow-away alarm is only armed when the following components are closed:

- The doors
- The tailgate

The tow-away alarm is automatically deactivated:

- After pressing the  or  button on the SmartKey
- After pressing the start/stop button with the SmartKey in the marked space (→ page 162)
- After unlocking the vehicle using KEYLESS-GO
- When using HANDS-FREE ACCESS

Information on detecting damage on a parked vehicle (→ page 194).

Arming/disarming the tow-away alarm

Multimedia system:

 **Settings** **Quick Access**

 Activate or deactivate **Tow-away Protection**.

The tow-away alarm is armed again in the following cases:

- The vehicle is unlocked again.
- A door is opened.
- The vehicle is locked again.

- ⓘ If quick access is unavailable, select the **Vehicle** submenu in the **Settings** main menu to arm or disarm the tow-away alarm.

Function of the interior motion sensor

- ⓘ This function may not be available in all countries.

When the interior motion sensor is activated, a visual and audible alarm is triggered if movement is detected in the vehicle interior.



The interior motion sensor is activated automatically after approximately ten seconds:

- after locking the vehicle with the SmartKey
- after locking the vehicle using KEYLESS-GO

The interior motion sensor is only activated when the following components are closed:

- the doors
- the tailgate

The interior motion sensor is automatically deactivated:

- after pressing the  or  button on the SmartKey
- after pressing the start/stop button with the SmartKey in the stowage compartment (→ page 162)
- after unlocking the vehicle using KEYLESS-GO
- when using HANDS-FREE ACCESS

The following situations can lead to a false alarm:

- moving objects such as mascots in the vehicle interior
- when the side window is open
- when the sliding sunroof is open
- when the panoramic sliding sunroof is open

Activating/deactivating the interior motion sensor

Multimedia system:

→  ▶▶ Settings ▶▶ Quick Access

▶ Activate or deactivate Interior Motion Sensor.

The interior motion sensor is activated again in the following cases:

- The vehicle is unlocked again.
 - A door is opened.
 - The vehicle is locked again.
- ① If quick access is unavailable, select the **Vehicle** menu under **Settings** to activate or deactivate the interior motion sensor.

Notes on the correct driver's seat position

⚠ WARNING Risk of injury from adjusting the vehicle settings while the vehicle is in motion

You could lose control of the vehicle in the following situations:

- if you adjust the driver's seat, the head restraint, the steering wheel or the mirror while the vehicle is in motion
- if you fasten your seat belt while the vehicle is in motion

▶ Before starting the engine: adjust the driver's seat, the head restraint, the steering wheel or the mirror and fasten your seat belt.

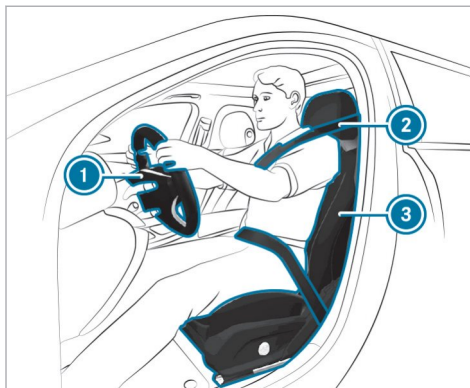

Ensure the following when adjusting steering wheel ①, seat belt ② and driver's seat ③:

- You are sitting as far away from the driver's airbag as possible, taking the following points into consideration.
- You are sitting in an upright position
- Your thighs are slightly supported by the seat cushion

- Your legs are not fully extended and you can depress the pedals properly
- The back of your head is supported at eye level by the center of the head restraint
- You can hold the steering wheel with your arms slightly bent
- You can move your legs freely
- You can see all the displays on the instrument cluster clearly
- You have a good overview of the traffic conditions
- Your seat belt sits snugly against your body and passes across the center of your shoulder and across your hips in the pelvic area

Seats

Adjusting the front seat

⚠ WARNING Risk of becoming trapped if the seats are adjusted by children

Children could become trapped if they adjust the seats, particularly when unattended.

- ▶ When leaving the vehicle, always take the SmartKey with you and lock the vehicle.
- ▶ Never leave children unattended in the vehicle.

The seats can be adjusted when the ignition is switched off.

⚠ WARNING Risk of becoming trapped when adjusting the seats

When you adjust a seat, you or other vehicle occupants could become trapped, e.g. on the seat guide rail.

- ▶ When adjusting a seat, make sure that no one has any body parts in the sweep of the seat.

Observe the safety notes on "Airbags" and "Children in the vehicle".

⚠ WARNING Risk of injury from adjusting the vehicle settings while the vehicle is in motion

You could lose control of the vehicle in the following situations:

- if you adjust the driver's seat, the head restraint, the steering wheel or the mirror while the vehicle is in motion
- if you fasten your seat belt while the vehicle is in motion

- ▶ Before starting the engine: adjust the driver's seat, the head restraint, the steering wheel or the mirror and fasten your seat belt.

⚠ WARNING Risk of becoming trapped if the seat height is adjusted carelessly

If you adjust the seat height carelessly, you or other vehicle occupants could be trapped and thereby injured.

Children in particular could accidentally press the electrical seat adjustment buttons and become trapped.

- ▶ While moving the seats, make sure that hands or other body parts do not get under the lever assembly of the seat adjustment system.

⚠ WARNING Risk of injury due to head restraints which are not installed or are adjusted incorrectly

If head restraints are not installed or are adjusted incorrectly, the head restraints cannot provide protection as intended.

There is an increased risk of injury in the head and neck area, e.g. in the event of an accident or when braking.

- ▶ Always drive with the head restraints installed.
- ▶ Before driving off, make sure for every vehicle occupant that the center of the head restraint supports the back of the head at about eye level.

Do not interchange the head restraints of the front and rear seats. Otherwise, you will not be able to adjust the height and angle of the head restraints correctly.

Adjust the head restraint fore-and-aft position so that it is as close as possible to the back of your head.

⚠ WARNING Risk of injury or death due to incorrect seat position

The seat belt does not offer the intended level of protection if you have not moved the seat backrest to an almost vertical position.

When braking or in the event of an accident, you could slide underneath the seat belt and sustain abdominal or neck injuries, for example.

- ▶ Adjust the seat properly before beginning your journey.
- ▶ Always ensure that the seat backrest is in an almost vertical position and that the shoulder section of your seat belt is routed across the center of your shoulder.

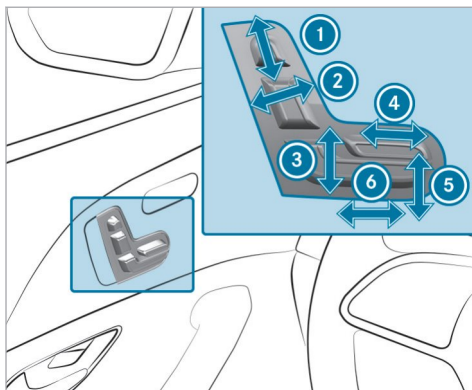

- ① Head restraint height
- ② Seat backrest inclination
- ③ Seat height
- ④ Seat cushion length
- ⑤ Seat cushion inclination
- ⑥ Seat fore-and-aft position

▶ Save the settings with the memory function (→ page 113).

Adjusting the front passenger seat electrically from the driver's seat

Requirements:

- The power supply is switched on.

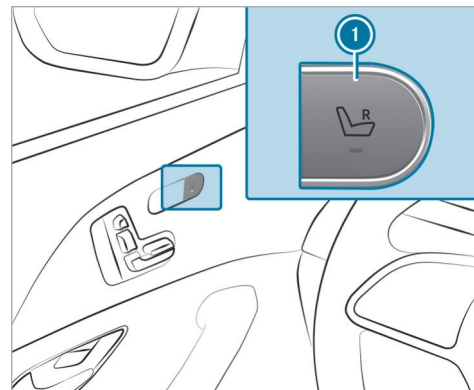

You can call up the following functions for the front passenger seat:

- Seat adjustment

- Seat heating
- Seat ventilation
- Memory function

▶ **To select the front passenger seat:** press button ❶.

When the indicator lamp lights up, the front passenger seat is selected.

▶ Adjust the front passenger seat using the buttons on the driver's side door control panel.

▶ **Select the driver's seat:** press button ❶ again.

When the indicator lamp goes out, the driver's seat has been selected.

Adjusting the 4-way lumbar support

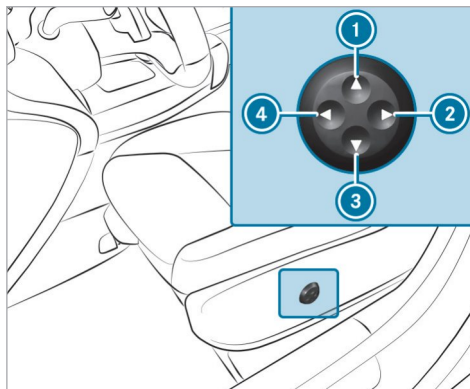

- ❶ Higher
- ❷ Softer
- ❸ Lower
- ❹ Firmer

▶ Using buttons ❶ to ❹, adjust the contour of the backrest individually to suit your back.

Adjusting the rear seats electrically

The middle seat backrest is adjusted together with the left seat.

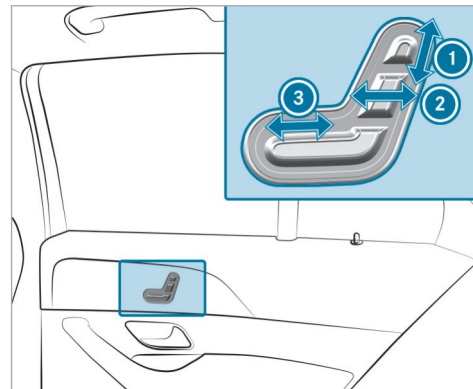

- ❶ Head restraint height
- ❷ Seat backrest inclination
- ❸ Seat fore-and-aft position

Folding the rear seats forwards electrically

⚠ WARNING Risk of becoming trapped when adjusting the seats

When you adjust a seat, you may trap yourself or a vehicle occupant.

- ▶ When adjusting a seat, make sure that no one has any body parts in the sweep of the seat.

⚠ WARNING Risk of accident if seat and seat backrest are not engaged

If the seat and seat backrest are not engaged they could fold forwards, e.g. when braking or in the event of an accident.

This poses the following risks in particular:

- A seat or seat backrest that is not engaged can push the vehicle occupant against the seat belt. The seat belt would then not be able to provide the intended protection and could cause additional injury.

- A child restraint system would no longer be supported correctly or positioned correctly and would no longer perform its intended function.
- The seat backrest cannot restrain objects or goods in the cargo compartment.

Always ensure that the seat and seat backrest are engaged, especially:

- before passengers travel on a seat with the easy entry and exit feature.
- after adjusting the seat.
- after the easy entry and exit feature is used.
- after the cargo compartment enlargement has been folded down.

⚠ WARNING Risk of injury due to seat backrest folded forwards

If the rear seat backrest is folded forwards, persons in the third row of seats could collide with parts of the seat adjustment mech-

anism, in particular in the event of an accident, sudden braking or an abrupt change of direction.

- ▶ If there is a person in the third row of seats, the rear seat in front of that person must be folded back into the driving position before starting the journey.
- ▶ People in the third row of seats must not place their legs on a rear seat backrest that has been folded forwards.

Always ensure that all vehicle occupants have their seat belts fastened correctly and are sitting properly. Particular attention must be paid to children.

If you no longer require the seat backrest to be folded down for loading or for getting in and out, fold it back into place.

⚠ WARNING Risk of becoming trapped if the seat is not engaged

The seat does not engage when folded forwards. The seat can fold backwards unex-

pectedly, e.g. when accelerating, braking or in the event of an abrupt change of direction or an accident.

People in the seat's sweep can become trapped.

- ▶ If a seat is folded forwards, always fold it back before driving off.
- ▶ Make sure that the seat is engaged.

If a seat in the second row of seats is not engaged, this is shown on the multifunction display on the instrument cluster.

Requirements:

- The area into which the seat is folded is clear.
- The seat has been folded up (→ page 119).
- Vehicles with comfort seating: the center armrest is folded up.
- Vehicles with an extended center console: the stowage compartment in the center console is closed (→ page 116).
- Vehicles with a center seat backrest: if the center seat backrest is in the cargo compart-

ment floor position, the left-hand seat backrest cannot be folded forwards (→ page 117).

You can fold the seats in the second row of seats forwards for the following situations:

- Vehicles with a third row of seats: for getting in or out
- For easier access to the cargo compartment

Vehicles with a center seat backrest: the center seat folds forwards and backwards, together with the left-hand seat.

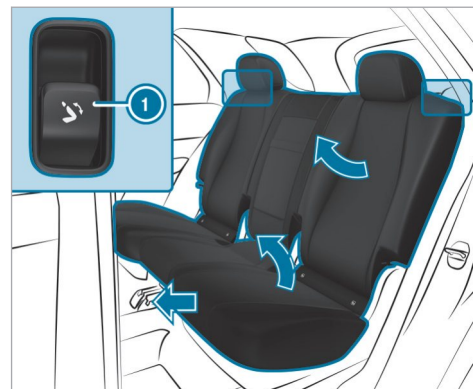

- ▶ **To fold the seat into the front position:** briefly pull on release button ①. The head restraint moves downwards. The seat backrest moves into the front position. The seat fore-and-aft adjustment moves forwards until the seat is unlocked. The seat then tips forwards.

- ▶ **To fold the seat back into the driving position:** press and hold the release button ❶ until the seat engages audibly. The seat tilts downwards and stops in the front position. The seat backrest remains in the cargo position.
- ▶ To interrupt the folding procedure before engagement, let go of release button ❶. To continue the folding procedure, press and hold the release button again.
- ▶ Set the backrest angle and seat fore-and-aft adjustment using the buttons on the door.
- ❶ To increase the size of the cargo compartment, you can move the rear seat backrests into the cargo compartment floor position (→ page 117).

Folding the rear seats forwards mechanically (emergency release)

The release loops are located on the outer sides and rear sides of the seats in the second row of seats.

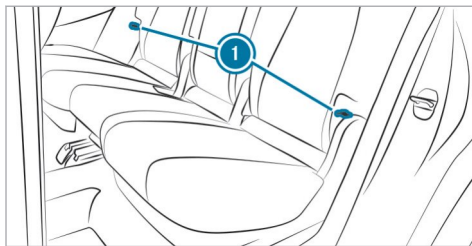

Side release loops

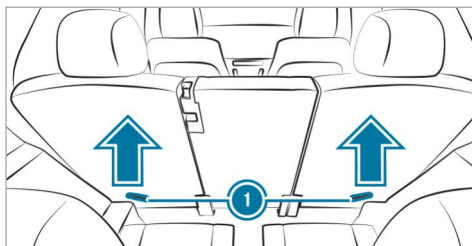

Release loops on the rear sides

- ▶ Pull one of release loops ❶.

- ▶ Fold the seat backrest forwards.
- ▶ Before starting the journey, make sure that the seat backrest and the rear bench seat are engaged.

Head restraints

Adjusting the front seat head restraints mechanically

⚠ WARNING Risk of injury from adjusting the vehicle settings while the vehicle is in motion

You could lose control of the vehicle in the following situations:

- if you adjust the driver's seat, the head restraint, the steering wheel or the mirror while the vehicle is in motion
 - if you fasten your seat belt while the vehicle is in motion
- ▶ Before starting the engine: adjust the driver's seat, the head restraint, the

steering wheel or the mirror and fasten your seat belt.

⚠ WARNING Risk of injury due to head restraints which are not installed or are adjusted incorrectly

If head restraints are not installed or are adjusted incorrectly, the head restraints cannot provide protection as intended.

There is an increased risk of injury in the head and neck area, e.g. in the event of an accident or when braking.

- ▶ Always drive with the head restraints installed.
- ▶ Before driving off, make sure for every vehicle occupant that the center of the head restraint supports the back of the head at about eye level.

Do not interchange the head restraints of the front and rear seats. Otherwise, you will not be able to adjust the height and angle of the head restraints correctly.

Adjust the head restraint fore-and-aft position so that it is as close as possible to the back of your head.

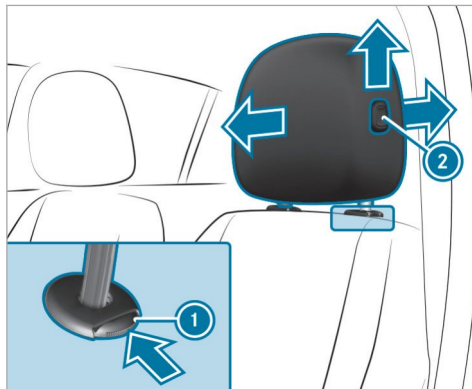

- ▶ **To raise:** pull the head restraint up.
- ▶ **To lower:** press release knob ① in the direction of the arrow and push the head restraint down.

- ▶ **To move forward:** press release knob ② and pull the head restraint forward.
- ▶ **To move backwards:** press release knob ② and push the head restraint backwards.

Adjusting the front seat luxury head restraints mechanically

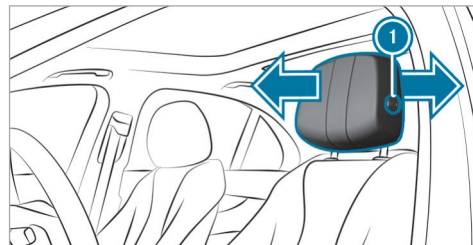

- ▶ **To move forward:** press release knob ① and pull the head restraint forward.
- ▶ **To move backwards:** press release knob ① and push the head restraint backwards.

Adjusting the head restraints of the rear seats mechanically

Depending on the vehicle equipment, the head restraints in the rear passenger compartment can be adjusted.

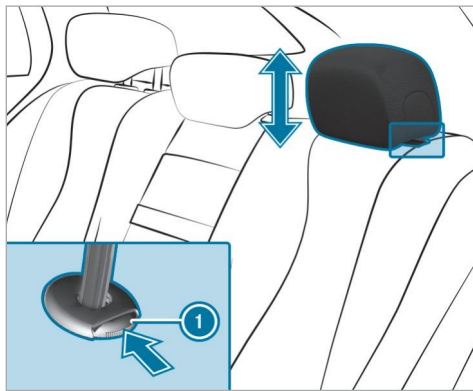

- ▶ **To raise:** pull the head restraint up.
- ▶ **To lower:** press release knob ① in the direction of the arrow and push the head restraint down.

Vehicles with a third row of seats

The head restraints on the third row of seats have a usage and non-usage position. The usage position is the extended, top position in which the head restraint engages; the non-usage position is the bottom, retracted position of the head restraint. If the seats on the third row of seats are being used, the head restraint must be in the top, engaged usage position.

- ▶ **If the third row of seats is occupied:** move the head restraints to the very top and have them engage there.
- ▶ **If the third row of seats is not occupied:** move the head restraints to the very bottom.

Installing/removing the rear seat head restraints

Removing

Depending on the vehicle equipment, the head restraints in the rear passenger compartment can be removed.

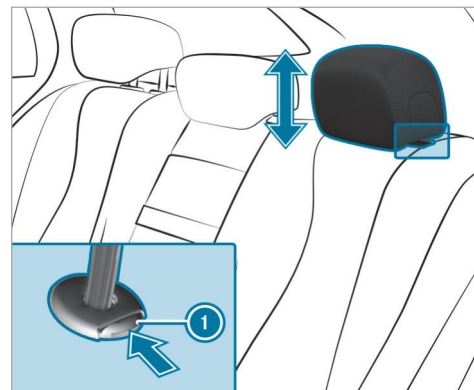

- ▶ Release the rear seat backrest and fold it forward slightly (→ page 117).
- ▶ Pull the head restraint upwards as far as it will go.
- ▶ Push release knob ① in the direction of the arrow and pull out the head restraint.

Installing

- ▶ Insert the head restraint such that the notches on the bar are on the left when viewed in the direction of travel.
- ▶ Push the head restraint down until it engages.
- ▶ Fold the rear seat backrest back until it engages.

Configuring the seat settings

Multimedia system:

→  ▶ [Comfort](#) ▶ [Seat Comfort](#)

Adjusting the backrest contour in the lumbar region of the seat backrest (lumbar)

- ▶ Select [Lumbar](#).
- ▶ Select the settings  for the desired seat.
- ▶ Adjust the air cushions.

Adjusting the backrest side bolsters

- ▶ Select [Side Bolsters](#).
- ▶ Adjust the air cushion for the desired seat.

Setting the seat heating balance

- ▶ Select [Seat Heating Balance](#).
- ▶ Adjust the heat distribution for the desired seat.

Setting automatic seat adjustment

⚠ WARNING Risk of becoming trapped during adjustment of the driver's seat after calling up a driver profile

Selecting a profile may trigger an adjustment of the driver's seat to the position saved under the profile. You or other vehicle occupants could be injured in the process.

- ▶ Make sure that when the position of driver's seat is being adjusted using the multimedia system, no people or body parts are in the seat's range of movement.

If there is a risk of someone becoming trapped, stop the adjustment process immediately:

- ▶ a) Tap the warning message on the media display.
- or
- ▶ b) Press a memory position button or a seat adjustment switch on the driver's door.
The adjustment process is stopped.

Requirements

- Adapting the driver's seat and steering wheel position to the body size: automatic seat adjustment has been switched on.

Multimedia system:

→  ▶ [Settings](#) ▶ [Vehicle](#)
▶ [Auto. Seat Adjustment](#)

Switching automatic seat adjustment on/off

When the active user profile is changed while the vehicle is stationary, the driver's seat, steering wheel, outside mirrors and seat contour are automatically adapted to the driver.

- ▶ Select [On](#) or [Off](#).

- i** This setting is available only for individual user profiles. For the guest profile, automatic seat adjustment cannot be switched on or off. Further information about user profiles (→ page 327).

Adjusting driver's seat and steering wheel position to body size

The vehicle calculates a suitable driver's seat and steering wheel position on the basis of the driver's body size and sets this directly.

- ▶ **To set the unit of measurement:** select **cm** or **ft/in.**
 - ▶ Set the size using the scale.
 - ▶ Select **Start Positioning.**
The driver's seat and steering wheel position is adjusted to the body size that has been set.
- i** If the driver's seat and steering wheel position calculated by the vehicle is not practical or comfortable, it can be manually changed at any time via the control buttons. The outside mirrors are not set via this function. Instead, they have to be set manually via the switches.

- i** You can also make these settings via the Mercedes me portal for your user profile. By synchronizing the profiles in the vehicle and the Mercedes me connect profiles, you can carry over these settings for your vehicle. Further information about synchronizing user profiles (→ page 329).

Setting the easy entry and exit feature

- ▶ Select **Steering Wheel & Seat, Steering Wheel Only** or **Off.**
- i** If you use an individual user profile and have set your body size, this information is carried over for the easy entry and exit feature. This causes the driver's seat and steering wheel to automatically move into the correct position (→ page 328).

Selecting the message program for the front seats

Multimedia system:

- ▶  ▶ **Comfort** ▶ **Message**
- ▶ Select a message program .

- ▶ Start the program for the desired seat .

- ▶ **To set the message intensity:** switch **High Intensity** on or off.

- i** For the rear seats, the message program can be selected on the following devices (if available):
- On the rear displays
The selection can be made for the rear seats on the second and third rows of seats.
 - On the MBUX rear tablet
The selection is made in the same way as on the rear displays for the rear seats on the second row of seats.

Resetting seat settings

Multimedia system:

- ▶  ▶ **Comfort** ▶ **Seat Comfort**

- ▶ Select **Reset.**
- ▶ Select  for the desired seat.
The settings for the selected seat are reset.

Switching the seat heating on/off

⚠ WARNING Risk of burns due to repeatedly switching on the seat heating

Repeatedly switching on the seat heating can cause the seat cushion and seat backrest padding to become very hot.

The health of persons with limited temperature sensitivity or a limited ability to react to high temperatures may be affected or they may even suffer burn-like injuries.

- ▶ Do not repeatedly switch on the seat heating.

To protect against overheating, the seat heating may be temporarily deactivated after it is switched on repeatedly.

! NOTE Damage to the seats caused by objects or documents when the seat heating is switched on

When the seat heating is switched on, overheating may occur due to objects or docu-

ments placed on the seats, e.g. seat cushions or child seats. This could cause damage to the seat surface.

- ▶ Make sure that no objects or documents are on the seats when the seat heating is switched on.

Requirements:

- The power supply is switched on.

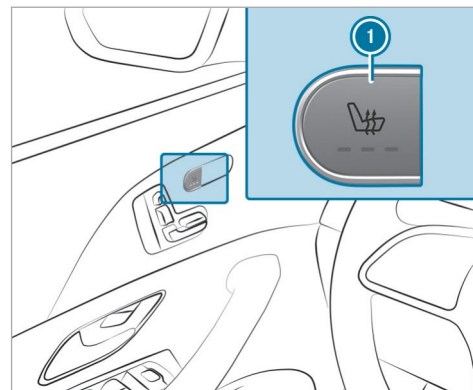

Seat heating in the cockpit

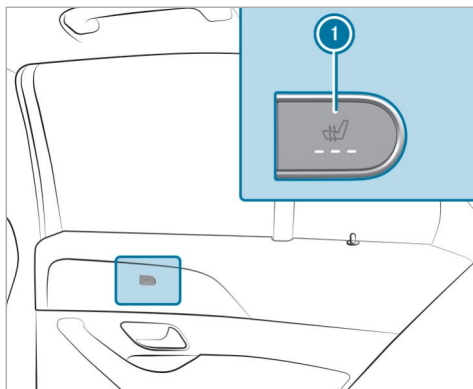

Seat heating in the rear passenger compartment

- ▶ **To switch on/increase the level:** press button ① repeatedly until the desired heating level is set. Depending on the heating level, up to three indicator lamps will light up.

- ▶ **To switch off/reduce the level:** press button ① repeatedly until the desired heating level is set. If all indicator lamps are off, the seat heating is switched off.
- ⓘ The seat heating will automatically switch down from the three heating levels after 8, 10 and 20 minutes until the seat heating is switched off.

Setting the panel heating

Multimedia system:

- ▶ ▶ Settings ▶ Vehicle
- ▶ Panel Heating

When the seat heating is switched on, the armrests, the center panels of the doors and the center console can be heated.

- ▶ Switch the function for the desired seats on or off.

Switching the seat ventilation on/off

Requirements:

- The power supply is switched on.

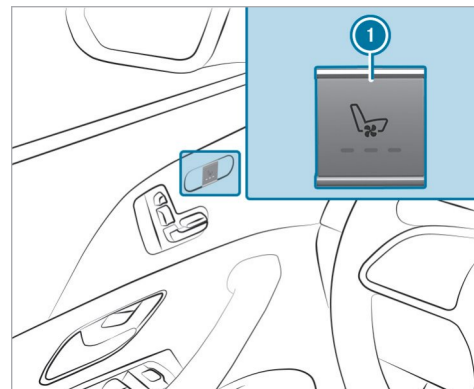

Seat ventilation in the cockpit

- ▶ **To switch on/increase the level:** press button ① repeatedly until the desired ventilation level is set. Depending on the ventilation level, up to three indicator lamps will light up.

- ▶ **To switch off/reduce the level:** press button ❶ repeatedly until the desired ventilation level is set.
If all indicator lamps are off, the seat ventilation is switched off.

Steering wheel

Adjusting the steering wheel mechanically

- ⚠ **WARNING** Risk of injury from adjusting the vehicle settings while the vehicle is in motion

You could lose control of the vehicle in the following situations:

- if you adjust the driver's seat, the head restraint, the steering wheel or the mirror while the vehicle is in motion
- if you fasten your seat belt while the vehicle is in motion
- ▶ Before starting the engine: adjust the driver's seat, the head restraint, the

steering wheel or the mirror and fasten your seat belt.

- ⚠ **WARNING** Risk of entrapment for children when adjusting the steering wheel

Children could injure themselves if they adjust the steering wheel.

- ▶ Never leave children unattended in the vehicle.
- ▶ When leaving the vehicle, always take the SmartKey with you and lock the vehicle.

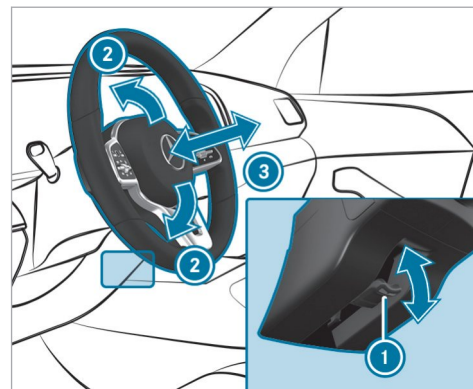

- ▶ Push release lever ❶ down as far as it will go.
The steering column is unlocked.
- ▶ Adjust height ❷ and distance ❸ to the steering wheel.
- ▶ Push release lever ❶ up as far as it will go.
The steering column is locked.
- ▶ Check and make sure that the steering column is locked by moving the steering wheel.

Adjusting the steering wheel electrically

The steering wheel can be adjusted when the ignition is switched off.

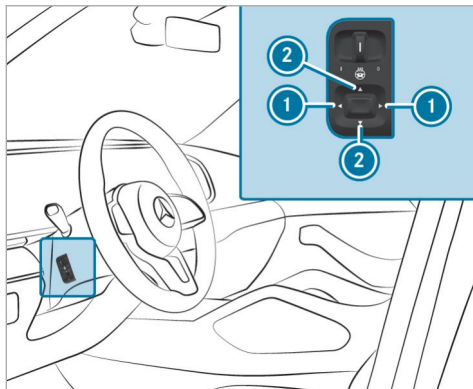

- ① Adjusts the distance to the steering wheel
 - ② Adjusts the height
- ▶ Save the settings with the memory function (→ page 113).

Switching the steering wheel heater on or off

Requirements:

- The ignition is switched on.

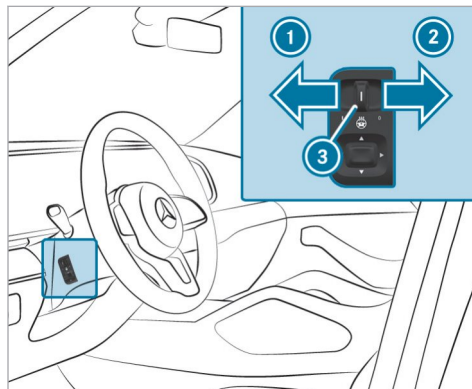

- ▶ **To switch on:** push the switch to position ①. Indicator lamp ③ lights up.

- ▶ **To switch off:** push the switch to position ②. Indicator lamp ③ goes out.

When you switch the ignition off, the steering wheel heater switches off.

Easy entry and exit feature

Using the easy entry and exit feature

⚠ WARNING Risk of accident when driving off while adjusting the easy exit feature

- If you drive off while the easy entry and exit feature is making adjustments, you could lose control of the vehicle.

- ▶ Always wait until the adjustment process is complete before driving off.

⚠ WARNING Risk of becoming trapped while adjusting the easy entry and exit feature

When the easy entry and exit feature adjusts the steering wheel and the driver's seat, you and other vehicle occupants – particularly children – could become trapped.

- ▶ During the adjustment process of the easy entry and exit feature, make sure that no one has any body parts in the sweep of the seat or the steering wheel.

If there is a risk of becoming trapped by the steering wheel:

- ▶ Move the adjustment lever of the steering wheel.
The adjustment process is stopped.

If there is a risk of becoming trapped by the driver's seat:

- ▶ Press the seat adjustment switch.
The adjustment process is stopped.

Vehicles with memory function: You can stop the adjustment process by pressing one of the memory function position switches.

⚠ WARNING Risk of becoming trapped during activation of the easy entry and exit feature by children

If children activate the easy entry and exit feature, they can become trapped, particularly when unattended.

- ▶ Never leave children unattended in the vehicle.
- ▶ When leaving the vehicle, always take the SmartKey with you and lock the vehicle.

If the easy entry and exit feature is active, the steering wheel will move upwards and the driver's seat will move back in the following situations:

- You switch the ignition off with the driver's door open
- You open the driver's door with the ignition switched off

- ⓘ The steering wheel will move upwards only if it is not already as high as it will go. The driver's seat will move backwards only if it is not already in the rearmost position. The driver's seat backrest will move forwards only if it is not already in the foremost position.

The steering wheel and the driver's seat will move back to the last drive position in the following cases:

- You switch the power supply or the ignition on when the driver's door is closed
- You close the driver's door with the ignition switched on.

The last drive position will be stored when:

- You switch the ignition off.
- **Vehicles with memory function:** You call up the seat settings via the memory function.
- **Vehicles with memory function:** You save the seat settings via the memory function.

Vehicles with memory function: Press one of the memory function saved position buttons to stop the adjustment process.

Operating the memory function

⚠ WARNING Risk of an accident if the memory function is used while driving

If you use the memory function on the driver's side while driving, you could lose control of the vehicle as a result of the adjustments being made.

- ▶ Only use the memory function on the driver's side when the vehicle is stationary.

⚠ WARNING Risk of entrapment when setting the seat with the memory function

When the memory function adjusts the seat, you and other vehicle occupants – particularly children – could become trapped.

- ▶ During the adjustment process of the memory function, make sure that no one has any body parts in the sweep of the seat.

- ▶ If someone becomes trapped, press a preset position button or seat adjustment switch immediately.

⚠ WARNING Risk of entrapment if the memory function is activated by children

Children could become trapped if they activate the memory function, particularly when unattended.

- ▶ Never leave children unattended in the vehicle.
- ▶ When leaving the vehicle, always take the SmartKey with you and lock the vehicle.

The memory function can be used when the ignition is switched off.

Storing

Seat adjustments for up to three people can be stored and called up using the memory function.

The following systems can be selected:

- Front seat

- Outside mirrors
- Head-up Display
- Steering column
- Seat contour

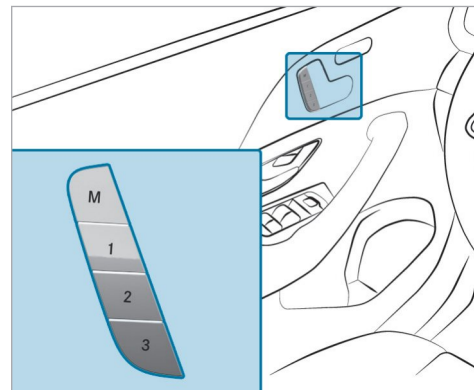

- ▶ Set the front seat, the outside mirrors, the Head-up Display, the steering column and the seat contour to the desired position.

- ▶ Press memory button M and then press preset position button 1, 2 or 3 within three seconds.
An acoustic signal sounds. The settings are stored.
- ▶ **To call up:** press and briefly hold preset position button 1, 2 or 3.
After releasing the button, the front seat, outside mirrors, Head-up Display, steering column, and seat contour are moved into the stored position automatically.

Stowage areas

Notes on loading the vehicle

▲ DANGER Risk of exhaust gas poisoning

Combustion engines emit poisonous exhaust gases such as carbon monoxide. Exhaust gases can enter the vehicle interior if the tailgate is open when the engine is running, especially if the vehicle is in motion.

- ▶ Always switch off the engine before opening the tailgate.

- ▶ Never drive with the tailgate open.

▲ WARNING Risk of injury from unsecured items in the vehicle

If objects, luggage or loads are not secured or not secured sufficiently, they could slip, tip over or be thrown around and thereby hit vehicle occupants.

There is a risk of injury, particularly in the event of sudden braking or a sudden change in direction.

- ▶ Always stow objects in such a way that they cannot be thrown around.
- ▶ Before the journey, secure objects, luggage or loads against slipping or tipping over.

▲ WARNING Risk of injury due to objects being stowed incorrectly

If you do not adequately stow objects in the vehicle interior, they could slip or be tossed around and thereby strike vehicle occupants.

In addition, cup holders, open stowage spaces and mobile phone brackets cannot always restrain the objects they contain in the event of an accident.

There is a risk of injury, particularly in the event of sudden braking or a sudden change in direction.

- ▶ Always stow objects in such a way that they cannot be tossed about in these or similar situations.
- ▶ Always make sure that objects do not project from stowage spaces, parcel nets or stowage nets.
- ▶ Close the lockable stowage spaces before starting a journey.
- ▶ Stow and secure objects that are heavy, hard, pointed, sharp-edged, fragile or too large in the cargo compartment.

⚠ WARNING Risk of burns from the tailpipe and tailpipe trims

The exhaust tailpipe and tailpipe trims can become very hot. If you come into contact with these parts of the vehicle, you could burn yourself.

- ▶ Always be particularly careful around the tailpipe and the tailpipe trims and supervise children especially closely in this area.
- ▶ Allow vehicle parts to cool down before touching them.

The driving characteristics of your vehicle are dependent on the distribution of the load within the vehicle. You should bear the following in mind when loading the vehicle:

- Never exceed the permissible gross mass or the gross axle weight rating for the vehicle (including occupants). The values are specified on the vehicle identification plate on the vehicle's B-pillar.
- The load must not protrude above the upper edge of the seat backrests.

- Always use the partition net when transporting objects in the cargo compartment.
- always place the load behind unoccupied seats if possible.
- secure the load using the tie-down eyes and distribute the load evenly.

Stowage spaces in the vehicle interior

Overview of the front stowage compartments

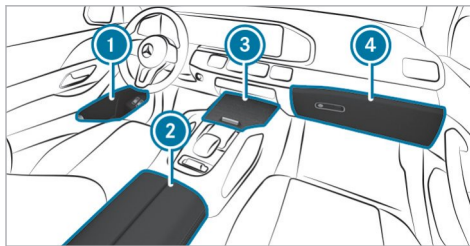

- ① Stowage space in the doors
- ② Stowage compartment in the armrest with USB ports (depending on vehicle equipment)

- ③ Stowage/telephone compartment with cup holder in the front of the center console
- ④ Glove box

Locking/unlocking the glove box

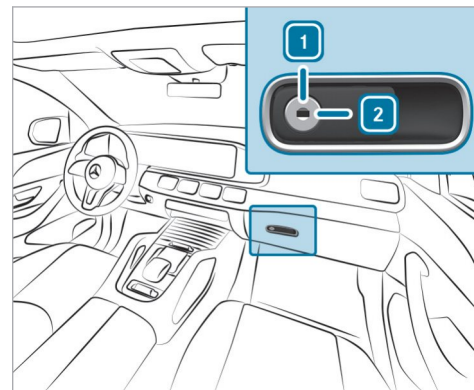

- ▶ Turn the emergency key a quarter turn clockwise **2** (to lock) or counter-clockwise **1** (to unlock).

Using the stowage compartment and MBUX rear tablet in the rear armrest

! **NOTE** Damage to the rear armrest due to body weight

When folded out, the rear armrest can be damaged by body weight.

- ▶ Do not sit or support yourself on the rear seat armrest.

In vehicles with a folding rear seat armrest, this can be folded down to allow the stowage compartments to be used. The available rear seat armrests and stowage compartments vary depending on the vehicle equipment.



- ▶ Pull handle ① and fold down the rear seat armrest.



- ▶ Depending on the vehicle equipment, use MBUX rear tablet ② (→ page 451).

Opening the stowage compartment in the rear passenger compartment center console

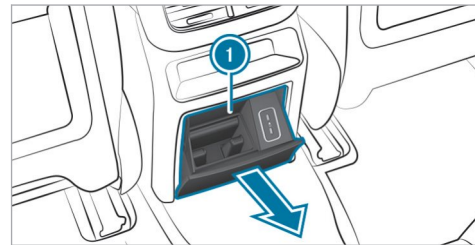

- ▶ Press stowage compartment ①. Stowage compartment ① opens in the direction of the arrow.

Using the stowage compartment in the rear seat armrest

! **NOTE** Damage to the rear armrest due to body weight

When folded out, the rear armrest can be damaged by body weight.

- ▶ Do not sit or support yourself on the rear seat armrest.

In vehicles with a foldable rear armrest, this can be folded down to allow the stowage compartments or the cup holders to be used. The available stowage compartments and cup holders vary depending on the vehicle equipment.

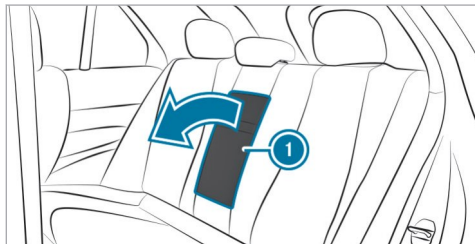

- ▶ Fold down rear seat armrest ①.

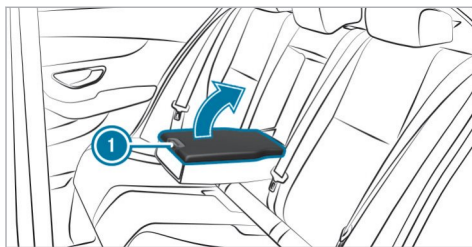

- ▶ Press release catch ① and swing the cover of the armrest upwards.

Through-loading facility to cargo compartment

Folding the rear seat backrest forwards

- ⚠ **WARNING** Risk of becoming trapped when adjusting the seats

When you adjust a seat, you may trap yourself or a vehicle occupant.

- ▶ When adjusting a seat, make sure that no one has any body parts in the sweep of the seat.

- ⚠ **WARNING** Risk of accident if seat and seat backrest are not engaged

If the seat and seat backrest are not engaged they could fold forwards, e.g. when braking or in the event of an accident.

This poses the following risks in particular:

- A seat or seat backrest that is not engaged can push the vehicle occupant against the seat belt. The seat belt would then not be able to provide the intended protection and could cause additional injury.
- A child restraint system would no longer be supported correctly or positioned correctly and would no longer perform its intended function.
- The seat backrest cannot restrain objects or goods in the cargo compartment.

Always ensure that the seat and seat backrest are engaged, especially:

- before passengers travel on a seat with the easy entry and exit feature.
- after adjusting the seat.
- after the easy entry and exit feature is used.
- after the cargo compartment enlargement has been folded down.

Always ensure that all vehicle occupants have their seat belts fastened correctly and are sitting properly. Particular attention must be paid to children.

If you no longer require the folded-down rear seat backrest as a loading area, fold the rear seat backrest back into place.

Make sure that the red marking of the lock verification indicator is no longer visible. Otherwise, the seat backrest is not locked.

Depending on the vehicle equipment, a message is displayed on the instrument cluster instead of the red lock verification indicator.

Folding the rear seats forwards mechanically

- ① Depending on the vehicle equipment, the outer rear seat backrests can be folded forwards mechanically.



- ▶ Move the driver's or front passenger seat forwards, if necessary.

- ▶ **To fold the left and right rear seat backrests forwards:** if necessary, insert the seat backrest head restraints (→ page 105).

- ▶ Pull release lever ①.

- ▶ Fold the corresponding rear seat backrest forwards.

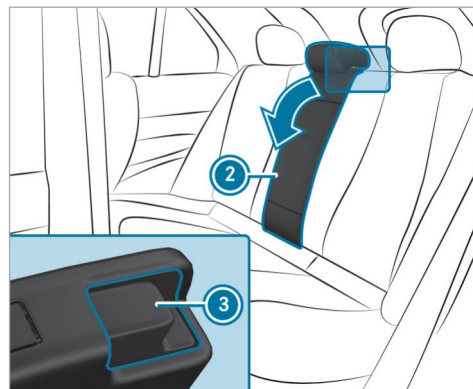

- ▶ **To fold the center seat backrest forwards:** press release catch ③.

▶ Fold seat backrest ② forwards.

① Observe the following recommendations:

- If you wish to fold only one of the outer rear seat backrests forwards, it is recommended that you fold the right rear seat backrest forwards.
- If you wish to fold one of the outer rear seat backrests and the center rear seat backrest forwards, it is recommended that you fold the left and center rear seat backrests forwards.

Folding the rear seats forwards electrically

If a seat in the second row of seats is not engaged and locked, this is shown on the multi-function display on the instrument cluster.

Requirements:

- When the center rear seat backrest is in the cargo compartment floor position, the left rear seat backrest cannot be folded forwards.

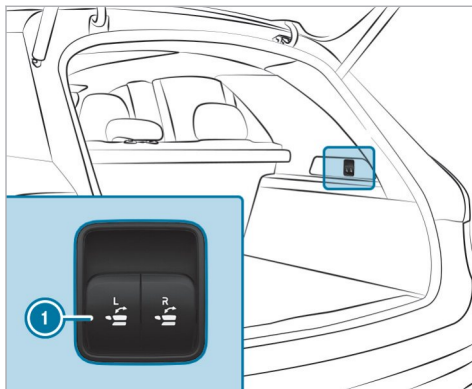

▶ Briefly press buttons ① to fold the left or right rear seat backrest forwards.

The rear seat head restraint moves into a suitable position. The rear seat folds forwards. The center rear seat backrest folds forwards together with the left rear seat backrest.

① Observe the following recommendations:

- If you wish to fold only one of the outer rear seat backrests forwards, it is recommended that you fold the right rear seat backrest forwards.
- If you wish to fold one of the outer rear seat backrests and the center rear seat backrest forwards, it is recommended that you fold the left and center rear seat backrests forwards.

Folding back the rear seat backrest

! **NOTE** Damage caused by trapping the seat belt when folding back the seat backrest

The seat belt could become trapped and thus damaged when the seat backrest is folded back.

▶ Make sure that the seat belt is not trapped when folding back the seat backrest.

Folding back the rear seat mechanically

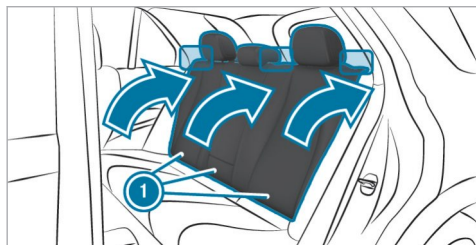

- ▶ Move the driver's or front passenger seat forwards, if necessary.
- ▶ Swivel rear seat backrest ① back until it engages.
- ▶ Make sure that the red marking of the lock verification indicator is no longer visible. Otherwise, the rear seat backrest is not locked.

Folding back the rear seat electrically

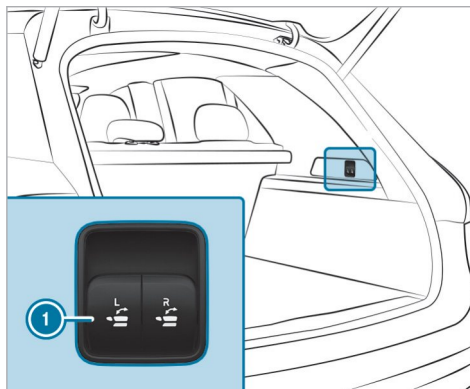

- ▶ Briefly pull buttons ① to fold back the left or right rear seat backrest. The rear seat folds back. The center rear seat backrest folds back together with the left rear seat backrest.
- If a rear seat backrest is not engaged and locked, this is shown on the multifunction display on the instrument cluster.

Folding the seat backrest on the third row of seats forwards

Requirements:

- The seats and the seat backrests of the second row of seats have been moved forwards sufficiently.

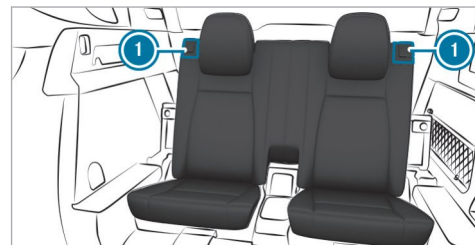

- ▶ Pull release catch ① for the seat backrest forwards.
- ▶ Fold the seat backrest forwards.

Folding back the seat backrest on the third row of seats

Requirements:

- The seats and the seat backrests of the second row of seats have been moved forwards sufficiently.
- ▶ Swivel the seat backrest back until it audibly engages.

EASY-PACK cargo compartment cover and partition net cassette

Notes on the cargo compartment cover

⚠ WARNING Risk of injury or death due to objects being poorly secured

On its own, the cargo compartment cover cannot secure or restrain heavy objects, items of luggage and heavy loads.

You could be hit by an unsecured load during sudden changes in direction, braking or in the event of an accident.

- ▶ Always stow objects in such a way that they cannot be thrown around.
- ▶ Secure objects, luggage or loads against slipping or tipping over, e.g. by

using tie-downs, even if you are using the cargo compartment cover.

⚠ NOTE Damage to the cargo compartment cover when loading the vehicle

The cargo compartment cover may be damaged when loading the vehicle.

- ▶ Do not place any objects above the lower edge of the side windows or on the cargo compartment cover.

Extending/retracting the cargo compartment cover

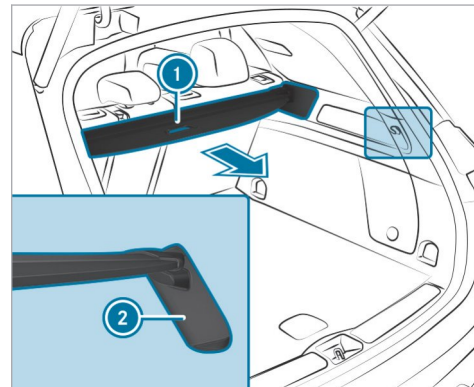

- ▶ **To extend:** pull cargo compartment cover back by grab handle ① and clip it into brackets ② on the left and right.

Retracting

- ▶ Remove the cargo compartment cover from the brackets on the left and right.

122 Seats and stowing

- ▶ Guide the cargo compartment cover forwards using the grab handle until it is fully retracted.

The rolled-up cargo compartment cover can be used in two positions:

- Folded 45° upwards for loading (fold down before commencing your journey)
- Horizontal position

Installing or removing the cargo compartment cover

Requirement:

- The cargo compartment cover is rolled up.

Removing the cargo compartment cover

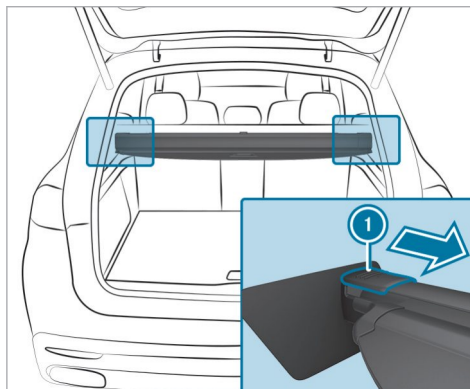

- ▶ Press end cap ① on the left or right inwards.
- ▶ Pull out the cargo compartment cover backwards.

Stowing the cargo compartment cover

Depending on the vehicle variant, the cargo compartment cover can be stowed under the cargo compartment floor.

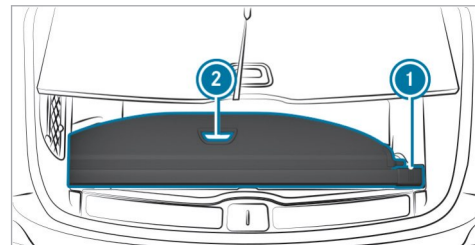

- ▶ Open the cargo compartment floor (→ page 126).
- ▶ **To insert:** first place the cargo compartment cover in brackets ① on the left and then the right. Comply with the instructions on the vehicle to ensure a correct seat.
- ▶ **To remove:** gently push the cargo compartment cover to the left using grab handle ②.
- ▶ Remove the cargo compartment cover from brackets ① on the right and then the left.

Installing the cargo compartment cover

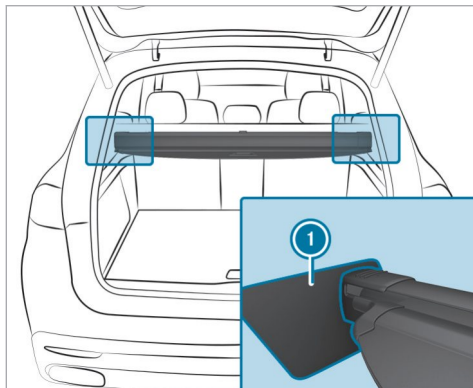

- ▶ Place the cargo compartment cover in brackets ❶ on the left and right. The end caps of the cargo compartment cover engage audibly.

Overview of the tie-down eyes in the cargo compartment

Observe the notes on loading the vehicle (→ page 114).

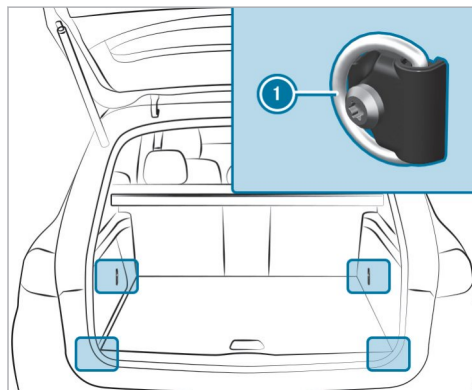

- ❶ Cargo tie-down rings

Overview of bag hooks

⚠ WARNING Risk of injury when using bag hooks with heavy objects

The bag hooks cannot restrain heavy objects or items of luggage.

Objects or items of luggage could be thrown around and thereby hit vehicle occupants when braking or abruptly changing directions.

- ▶ Only hang light objects on the bag hooks.
- ▶ Never hang hard, sharp-edged or fragile objects on the bag hooks.

Observe the notes on loading the vehicle (→ page 114).

Subject the bag hooks to a maximum load of 6.6 lbs (3 kg) and do not attach any goods to them.

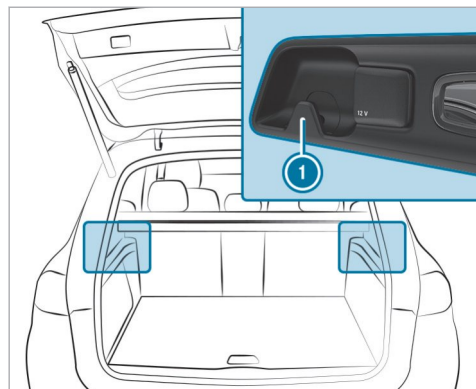

① Bag hook

Coat hook

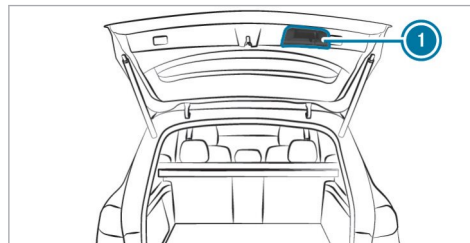

Coat hooks ① can be found in the interior on the B-pillar and on the tailgate.

Coat hooks are not suitable for heavy objects. Use the coat hooks only for light objects such as jackets.

EASY-PACK load-securing kit

Notes on the snap-in module for the cargo compartment (telescopic rods)

The EASY-PACK load-securing kit allows you to use your cargo compartment for a variety of purposes. The components are located in the stowage space under the cargo compartment floor.

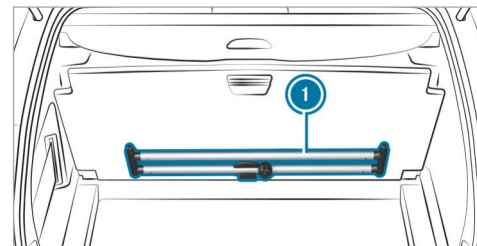

① Telescopic rod with mounting elements and holders

Installing a telescopic rod

⚠ WARNING Risk of injury due to an open cargo compartment floor

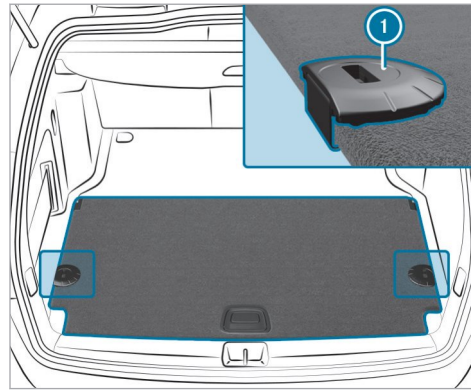

If you drive when the cargo compartment floor is open, objects could be thrown around and thereby strike vehicle occupants. There is a risk of injury, particularly in the event of sudden braking or a sudden change in direction.

▶ Always close the cargo compartment floor before a journey.

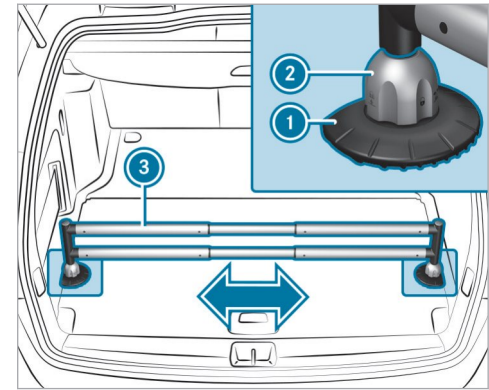

- ▶ Open the cargo compartment floor (→ page 126).
- ▶ Attach holders ① in the desired position to the side of the cargo compartment floor.
- ▶ Close the cargo compartment floor.



- ▶ Turn mounting elements ② to .
- ▶ Insert mounting elements ② into holders ①.
- ▶ Extend telescopic rod ③.
- ▶ Insert telescopic rod ③ into mounting elements ②.
- ▶ Turn both mounting elements ② to  until you feel them engage.

Opening or closing the stowage space under the cargo compartment floor

⚠ WARNING Risk of injury due to an open cargo compartment floor

If you drive when the cargo compartment floor is open, objects could be thrown around and thereby strike vehicle occupants. There is a risk of injury, particularly in the event of sudden braking or a sudden change in direction.

- ▶ Always close the cargo compartment floor before a journey.

Opening

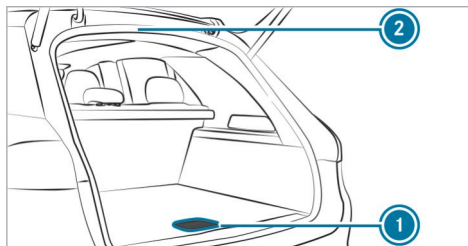

- ▶ Pull handle ① upwards.
- ▶ Lift the cargo compartment floor upwards using handle ①.
- ▶ Fold out hook on the underside of the cargo compartment floor.
- ▶ Clip hook onto drip rail ②.

Closing

- ▶ Unhook the hook from drip rail ② and fasten it to the bracket on the underside of the cargo compartment floor.

- ▶ Fold the cargo compartment floor downwards and then press handle ① down until it engages.

Locking and unlocking the cargo compartment floor

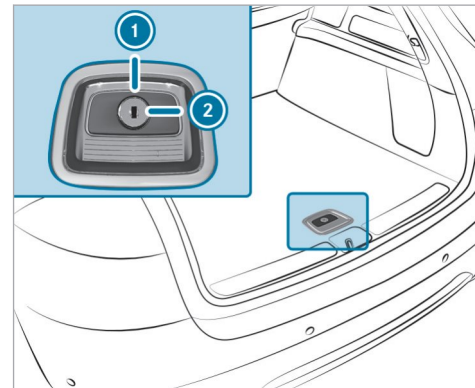

- ▶ Turn the emergency key a quarter turn clockwise **2** (to lock) or counter-clockwise **1** (to unlock).

Attaching a roof rack

⚠ WARNING Risk of injury if the maximum roof load is exceeded

When you load the roof, the center of gravity of the vehicle rises and the usual driving characteristics as well as the steering and braking characteristics change. During cornering, the vehicle tilts more strongly and may react more sluggishly to steering movements.

If you exceed the maximum roof load, the driving characteristics, as well as the steering and braking characteristics, will be greatly impaired.

- ▶ Always comply with the maximum roof load and adjust your driving style.

You will find information on the maximum roof load in the "Technical data" section.

! NOTE Vehicle damage from non-approved roof racks

The vehicle could be damaged by roof racks which have not been tested and approved by Mercedes-Benz.

- ▶ Use only roof racks tested and approved for Mercedes-Benz.
- ▶ Depending on the vehicle equipment, ensure that when the roof rack is installed, the sliding sunroof can be fully raised.
- ▶ Depending on the vehicle equipment, ensure that when the roof rack is installed, the tailgate can be fully opened.
- ▶ Position the load on the roof rack in such a way that the vehicle will not sustain damage even when it is in motion.

! NOTE Damage to the panorama roof with power tilt/sliding panel caused by a non-approved roof rack

The panorama roof with power tilt/sliding panel may be damaged by the roof rack if you attempt to open it when using a roof rack not tested and approved for Mercedes-Benz.

- ▶ When a roof rack is installed, open the panorama roof with power tilt/sliding panel only if this has been tested and approved for Mercedes-Benz.

The panorama roof with power tilt/sliding panel may be raised to allow ventilation of the vehicle interior.

- ▶ Secure the roof rack to the roof railing.
- ▶ Observe the manufacturer's installation instructions.

Cup holder

Using the cup holder

⚠ WARNING - Risk of accident or injury when using the cup holder while the vehicle is moving

The cup holder cannot secure containers while the vehicle is moving.

If you use a cup holder while the vehicle is moving, the container may be flung around and liquids may be spilled. The vehicle occupants may come into contact with the liquid and if it is hot, they could be scalded. You could be distracted from traffic conditions and you may lose control of the vehicle.

- ▶ Only use the cup holder when the vehicle is stationary.
- ▶ Only use the cup holder for containers of the right size.
- ▶ Close the container, particularly if the liquid is hot.

Depending on the vehicle's equipment, the following cup holders will be available:

- In the front stowage compartment of the center console
- In the rear passenger compartment center console
- In the rear armrest on the second row of seats
- Between the seats on the third row of seats

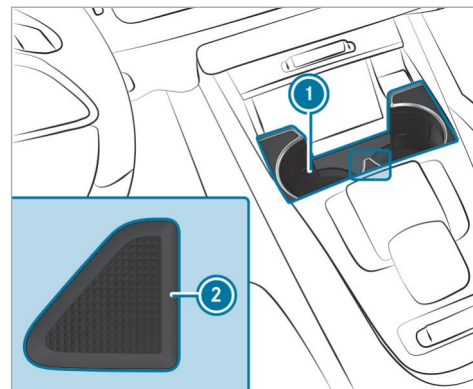

Vehicles without a temperature-controlled cup holder: the bracket arms of the front cup holder can be folded in or out.

- ▶ **To fold the bracket arm in:** push bracket arm ① outwards to the side until it engages. When the bracket arm is folded in, the cup holder cannot fulfill its holding function.
- ▶ **To fold the bracket arm out:** press button ②.

Opening or closing the cup holders in the rear armrest

! **NOTE** Damage to the rear armrest due to body weight

When folded out, the rear armrest can be damaged by body weight.

- ▶ Do not sit or support yourself on the rear seat armrest.

! **NOTE** Damage to the cup holder

When the rear armrest is folded back the cup holder could become damaged.

- ▶ Only fold the rear armrest back when the cup holder is closed.

- i** Depending on the equipment, the shape of the rear armrest and cup holders may differ.
- i** Depending on its equipment, your vehicle will have a rear armrest with a cup holder.

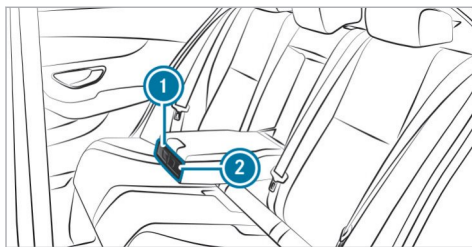

- ▶ **To open:** press cup holder ① or ②. Cup holder ① or ② will extend automatically.
- ▶ **To close:** push cup holder ① or ② back until it engages.

Switching the cooling or heating function for the temperature-controlled cup holder on or off

! **WARNING** Risk of injury by touching the heating elements

The cup holder's heating elements may be very hot.

You can burn yourself on them.

- ▶ Do not touch the cup holder's hot heating elements.
- ▶ Ensure that no children can access the cup holder's hot heating elements.
- ▶ Never leave children unattended in the vehicle.

! **NOTE** Damage to objects in the temperature-controlled cup holder

If you place objects into the temperature-controlled cup holder, they may become damaged.

- ▶ Do not place objects into the temperature-controlled cup holder.

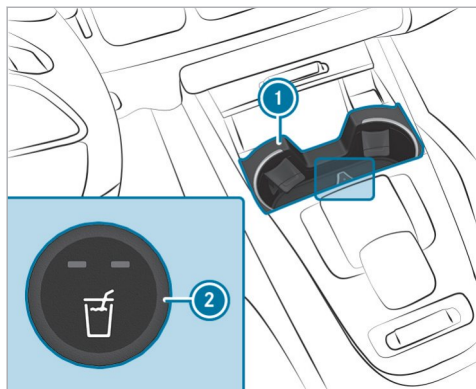

Cup holder in the front center console

- ▶ **To switch on:** on cup holder ①, press button ② repeatedly until the blue (keep cool) or red (keep warm) indicator lamp on the button lights up.

If you use the heating function, the metal insert of the cup holder is heated. Once a certain temperature has been reached, the warning lamp lights up. Do not reach into the

cup holder's metal insert when the warning lamp is lit.

- ▶ **To switch off:** press button ② repeatedly until the indicator lamp on the button goes out.
- ⓘ Clean the removable rubber mat only with clean, lukewarm water and the cup holder only with a damp cloth.

Ashtray and cigarette lighter

Using the ashtray

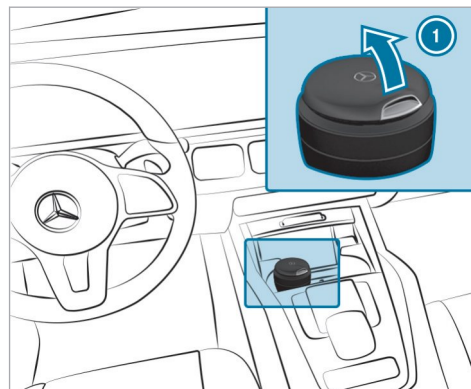

- ▶ **To use the ashtray:** place the ashtray in one of the cup holders in the center console or in the rear passenger compartment.
- ▶ Check that it is seated firmly.
- ▶ Comply with the notes on loading the vehicle (→ page 114).

▶ **To open the ashtray:** fold cover ① upwards.

① The top part of the ashtray can be removed for cleaning or emptying by twisting it. Clean the ashtray, e.g. with clean, lukewarm water.

Using the cigarette lighter

⚠ WARNING - Risk of fire and injury from hot cigarette lighter

You can burn yourself if you touch the hot heating element or the socket of the cigarette lighter.

In addition, flammable materials may ignite if:

- you drop the hot cigarette lighter
- a child holds the hot cigarette lighter to objects, for example

▶ Always hold the cigarette lighter by the knob.

▶ Always make sure that the cigarette lighter is out of reach of children.

▶ Never leave children unattended in the vehicle.

Requirements:

- The ignition is switched on.



▶ Press in cigarette lighter ①. The cigarette lighter will pop out automatically when the heating element is red-hot.

Sockets

Using the 12 V socket in the front center console

Requirements:

- Only connect devices up to a maximum of 240 W (20 A).

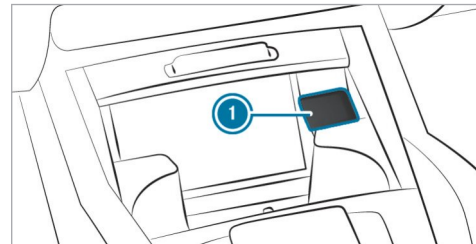

▶ Lift up cap ① of the socket and insert the plug of the device.

If you have connected a device to the 12 V socket, leave the cover of the stowage compartment open.

Using the 115 V socket in the rear passenger compartment

⚠ DANGER Risk of fatal injury due to damaged connecting cables or sockets

If a suitable device is connected, the 115 V socket will be carrying a high voltage. If the connecting cable or the 115 V socket is pulled out of the trim or is damaged or wet, you could receive an electric shock.

- ▶ Only use dry and damage-free connecting cables.
- ▶ When the ignition is switched off, ensure that the 115 V socket is dry.
- ▶ If the 115 V socket is damaged or gets pulled out of the paneling, immediately have the socket checked or replaced at a qualified specialized workshop.
- ▶ Never plug the connecting cable into a 115 V socket that is damaged or has been pulled out of the trim.

⚠ DANGER Risk of fatal injury due to incorrect handling of the socket

You could receive an electric shock:

- if you reach into the socket.
- if you insert unsuitable devices or objects into the socket.

- ▶ Do not reach into the socket.
- ▶ Only connect suitable devices to the socket.

Requirements:

- Only connect devices with a suitable plug which conforms to the standards specific to the country you are in.
- Only connect devices up to a maximum of 150 watts (1.30 A).
- Do not use multiple socket outlets.

Depending on the vehicle equipment, the design of the center console and stowage compartment may differ.

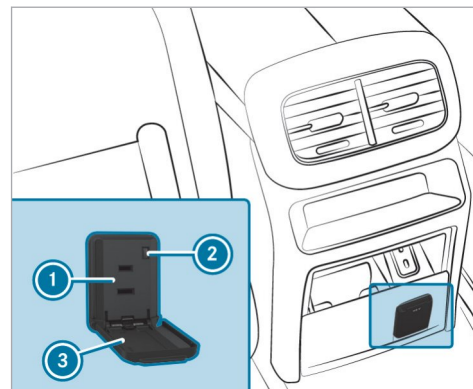

- ▶ Mercedes-Maybach vehicles with individual rear seats: open the stowage compartment of the center console of the rear passenger compartment (→ page 116).
- ▶ Open flap ③.
- ▶ Insert the plug of the device into 115 V socket ①.
When the on-board electrical system voltage is sufficient, indicator lamp ② lights up.

Using the 12 V socket in the cargo compartment

Requirements:

- Only devices up to a maximum of 240 W (20 A) are permissible.

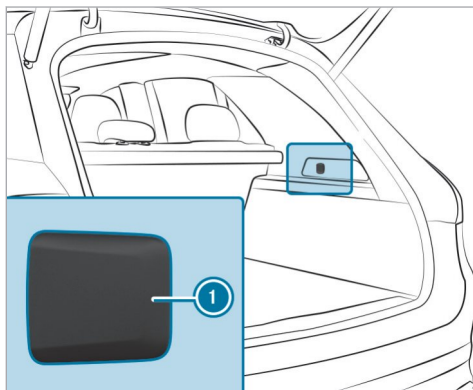

- ▶ Lift up cap ① of the socket and insert the plug of the device.

Overview of USB ports

Depending on the vehicle equipment, the vehicle has the following USB ports:

- In the stowage compartment of the cockpit armrest (→ page 115)
- In the front center console next to the mobile phone stowage compartment
- In the rear passenger compartment center console
- Vehicles with three rows of seats: between the seats of the third row of seats

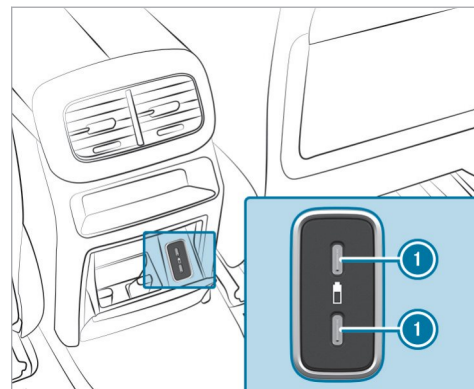

Example: USB ports in the center console in the rear passenger compartment

If the ignition is switched on you can charge USB devices, e.g. mobile phones, at USB ports ①. The charging voltage is approximately 5 V (up to 3 A).

Wireless charging of the mobile phone and connection with the exterior antenna

Notes on wirelessly charging the mobile phone

⚠ WARNING Risk of injury due to objects being stowed incorrectly

If objects in the vehicle interior are stowed incorrectly, they can slide or be thrown around and hit vehicle occupants. In addition, cup holders, open stowage spaces and mobile phone receptacles cannot always retain all objects they contain.

There is a risk of injury, particularly in the event of sudden braking or a sudden change in direction.

- ▶ Always stow objects so that they cannot be thrown around in such situations.
- ▶ Always make sure that objects do not protrude from stowage spaces, luggage nets or stowage nets.

- ▶ Close the lockable stowage spaces before starting a journey.
- ▶ Always stow and secure heavy, hard, pointed, sharp-edged, fragile or bulky objects in the trunk/load compartment.

Observe the notes on loading the vehicle.

⚠ WARNING Risk of fire from placing objects in the mobile phone stowage compartment

There is a risk of fire, in particular, if you place more than one mobile phone in the mobile phone stowage compartment.

- ▶ Apart from a mobile phone, do not place any other objects in the mobile phone stowage compartment, especially those made of metal.

! NOTE Damage to objects caused by placing them in the mobile phone stowage compartment

If objects are placed in the mobile phone stowage compartment, they may be damaged by electromagnetic fields.

- ▶ Do not place credit cards, storage media or other objects sensitive to electromagnetic fields in the mobile phone stowage compartment.

! NOTE Damage to the mobile phone stowage compartment caused by liquids

If liquids enter the mobile phone stowage compartment, the compartment may be damaged.

- ▶ Ensure that no liquids enter the mobile phone stowage compartment.

Always observe the notes for persons with electronic medical aids .

- Depending on the vehicle equipment, the mobile phone is connected to the vehicle's exterior antenna via the charging module.
- The charging function and wireless connection of the mobile phone to the vehicle's exterior antenna are only available if the ignition is switched on.
- Small mobile phones may not be able to be charged in every position of the mobile phone stowage compartment.
- Large mobile phones which do not rest flat in the mobile phone stowage compartment may not be able to be charged or connected with the vehicle's exterior antenna.
- The mobile phone may heat up during the charging process. This may also depend on the applications (apps) currently open in the background.
- To ensure more efficient charging and connection with the vehicle's exterior antenna, remove the protective cover from the mobile phone. Protective covers which are necessary for wireless charging are excluded.

Wireless charging of a mobile phone in the cockpit

Requirements:

- The mobile phone is suitable for wireless charging.
- ① A list of compatible mobile phones can be found at: <https://www.mercedes-benz.com/connect>

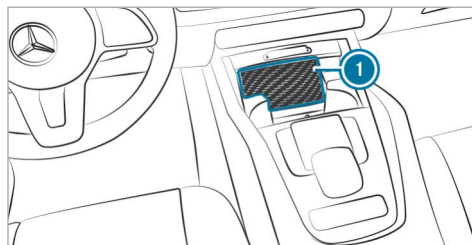

- ▶ Place the mobile phone as close to the center of mat ① as possible with the display facing upwards. When a message is shown in the multimedia system, the mobile phone is being charged.

Malfunctions detected during the charging process are shown in the multimedia system display.

- ① The mat can be removed for cleaning, e.g. using clean, lukewarm water.

Installing/removing the floor mats

⚠ WARNING Risk of accident due to objects in the driver's footwell

Objects in the driver's footwell may impede pedal travel or block a depressed pedal. This jeopardizes the operating and road safety of the vehicle.

- ▶ Stow all objects in the vehicle securely so that they cannot get into the driver's footwell.
- ▶ Always install the floor mats securely and as prescribed in order to ensure that there is always sufficient room for the pedals.

136 Seats and stowing

- ▶ Do not use loose floor mats and do not place floor mats on top of one another.

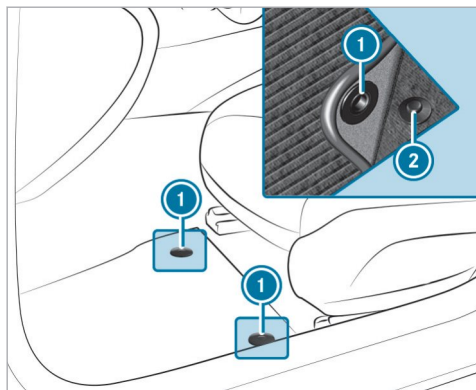

- ▶ **To install:** move the corresponding seat backwards and lay the floor mat in the footwell.
- ▶ Press studs ① onto holders ②.
- ▶ Adjust the corresponding seat.

- ▶ **To remove:** pull the floor mat off holders ②.
- ▶ Remove the floor mat.

① **Vehicles with a third row of seats:** to install and remove the floor mats on the third row of seats, slide the corresponding seat on the second row of seats forwards.

Exterior lighting

Information about lighting systems and your responsibility

The various lighting systems of the vehicle are only aids. The driver of the vehicle is responsible for correct vehicle illumination in accordance with the prevailing light and visibility conditions, legal requirements and traffic situation.

Light switch

Operating the light switch

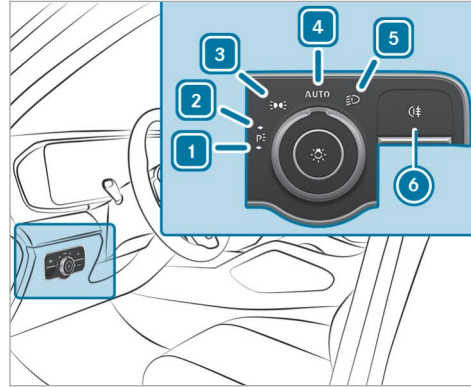

- 1 Left-hand standing lamps
- 2 Right-hand standing lamps
- 3 Parking lamps and license plate lamp
- 4 **AUTO** Automatic driving lights (preferred light switch position)

- 5 Low beam/high beam
- 6 Switches the rear fog light on/off

When low beam is activated, the parking lamps indicator lamp will be deactivated and replaced by the low beam indicator lamp.

- ▶ Always park your vehicle safely using sufficient lighting, in accordance with the relevant legal stipulations.

! **NOTE** Battery discharging by operating the standing lights

Operating the standing lights over a period of hours puts a strain on the battery.

- ▶ Where possible, switch on the right or left parking light.

In the case of severe battery discharging, the standing lights or parking lamps will automatically be switched off to facilitate the next engine start.

The exterior lighting (except standing and parking lamps) will switch off automatically when the driver's door is opened.

138 Light and visibility

- Observe the notes on surround lighting (→ page 142).

Automatic driving lights function

The parking lamps, low beam and daytime running lamps will be switched on automatically depending on the ignition status and the ambient light.

⚠ WARNING Risk of accident when the low beam is switched off in poor visibility

When the light switch is set to **AUTO**, the low beam may not be switched on automatically if there is fog, snow or other causes of poor visibility such as spray.

- ▶ In such cases, turn the light switch to .

The automatic driving lights are only an aid. You are responsible for vehicle lighting.

Switching the rear fog lights on or off

Requirements:

- The light switch is in the  or **AUTO** position.

- ▶ Press the  button.

Please observe the country-specific laws on the use of rear fog lamps.

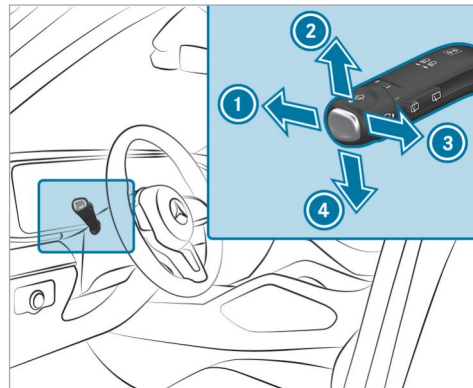

Operating the combination switch for the lights



- 1 High beam
- 2 Turn signal indicator, right
- 3 High-beam flasher
- 4 Turn signal indicator, left

- ▶ Use the combination switch to activate the desired function.

High beam

- ▶ **To switch on:** turn the light switch to the  or **AUTO** position.
- ▶ Push the combination switch in the direction of arrow ①. When the high beam is activated, the  low beam indicator lamp will be deactivated and replaced by the  high beam indicator lamp.
- ▶ **To switch off:** push the combination switch in the direction of arrow ① or pull in the direction of arrow ③.

High-beam flasher

- ▶ Pull the combination switch in the direction of arrow ③.

Turn signal light

- ▶ **To indicate briefly:** press the combination switch briefly to the point of resistance in the direction of arrow ② or ④. The corresponding turn signal indicator will flash three times.

▶ **To indicate permanently:** press the combination switch beyond the point of resistance in the direction of arrow ② or ④.

Vehicles with Active Lane Change Assist:

- Indicator operation activated by the driver can extend for the duration of the lane change.
- If the driver indicated directly beforehand but a lane change was not immediately possible, the turn signal indicator may activate automatically.

Activating/deactivating the hazard warning lamps

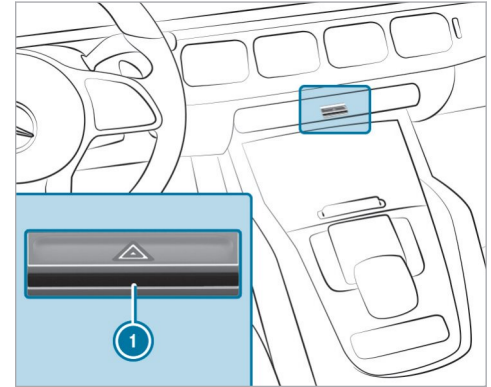

- ▶ Press button ①.

The hazard warning lamps will switch on automatically if:

- the airbag has been deployed.

When the turn indicator is activated, the hazard warning lamps are interrupted.

Cornering light

Cornering light function

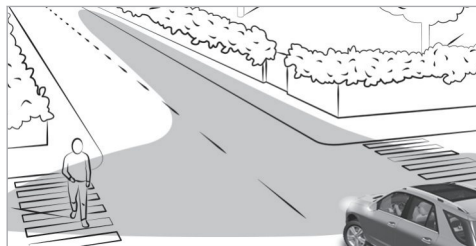

The cornering light function improves the illumination of the roadway over a wide angle in the turning direction, enabling better visibility on tight bends, for example. It can be activated only when the low beam is switched on.

The function is active under the following conditions:

- At speeds below 25 mph (40 km/h) when the turn signal light is switched on or the steering wheel is turned

- At speeds between 25 mph (40 km/h) and 45 mph (70 km/h) when the steering wheel is turned

Traffic circle and intersection function: the cornering light will be activated on both sides based on an evaluation of the current GPS position of the vehicle. It will remain active until after the vehicle has left the traffic circle or the intersection.

Adaptive Highbeam Assist

Adaptive Highbeam Assist function

⚠ WARNING Risk of accident despite Adaptive Highbeam Assist

Adaptive Highbeam Assist does not recognize the following road users:

- Road users without lights, e.g. pedestrians
- Road users with poor lighting, e.g. cyclists

- Road users whose lighting is obstructed, e.g. by a barrier

On very rare occasions, Adaptive Highbeam Assist may fail to recognize other road users with their own lighting, or may recognize them too late.

In these or similar situations, the automatic high beam is not deactivated or is activated despite the presence of other road users.

- ▶ Always observe the traffic carefully and switch off the high beam in good time.

System limits

Adaptive Highbeam Assist cannot take into account road, weather or traffic conditions.

Detection may be restricted in the following cases:

- In poor visibility, e.g. fog, heavy rain or snow
- If there is dirt on the sensors or the sensors are obscured

Adaptive Highbeam Assist is only an aid. You are responsible for adjusting the vehicle's lighting to

the prevailing light, visibility and traffic conditions.

- i Adaptive Highbeam Assist is only available in vehicles with LED high performance headlamps.

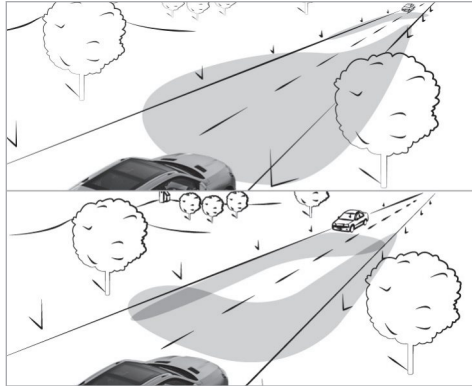

The Adaptive Highbeam Assist automatically switches between the following types of light:

- Low-beam headlamps

- High-beam headlamps

At speeds greater than 19 mph (30 km/h):

- If no other road users are detected, the high beam will be switched on automatically.

The high beam switches off automatically in the following cases:

- At speeds below 16 mph (25 km/h).
- If other road users are detected.
- If street lighting is sufficient.

At speeds greater than approximately 31 mph (50 km/h):

- The headlamp range of the low beam is regulated automatically based on the distance to other road users.

The system's optical sensor is located behind the windshield near the overhead control panel.

Switching Adaptive Highbeam Assist on/off



- ▶ **To switch on:** turn the light switch to the **AUTO** position.

- ▶ Switch on the high beam using the combination switch.
When the high beam is switched on automatically in the dark, the  indicator lamp on the multifunction display comes on.
- ▶ **To switch off:** switch off the high beam using the combination switch.

Switching the daytime running lamps on/off

Multimedia system:

- ▶  ▶▶ Settings ▶▶ Light ▶▶ Daytime Run. Lights

- ▶ Activate  or deactivate  the function.

Setting the exterior lighting switch-off delay time

Requirements:

- The light switch is in the **AUTO** position.

Multimedia system:

-  » Settings » Light
- » Exterior Lighting Delay

- ▶ Set the switch-off delay time.
The exterior lighting is activated for the set time when the vehicle is parked.

Switching the surround lighting on/off

Multimedia system:

-  » Settings » Light
- » Locator Lighting

When **Locator Lighting** is active, the exterior lighting lights up for 40 seconds after the vehicle is unlocked. When you start the vehicle, the surround lighting is deactivated and the automatic driving lights are activated.

Illuminated side running boards: when the surround lighting is switched on, the illumination of the running boards is activated when a door is opened. If the door is not closed, the running board courtesy lighting is automatically deactivated after 40 seconds.





- ▶ Activate or deactivate the function.

Interior lighting

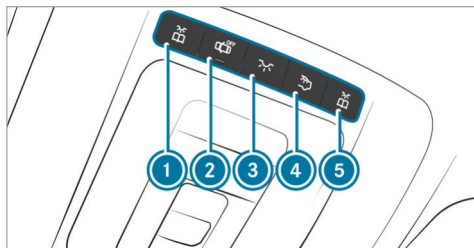
Adjusting the interior lighting

Front overhead control panel



- ①  Front left reading lamp
- ②  Automatic interior lighting control
- ③  Front interior lighting
- ④  Rear interior lighting
- ⑤  Front right reading lamp

- ▶ **To switch on or off:** press button ① - ⑤ accordingly.

Control panel in the grab handle

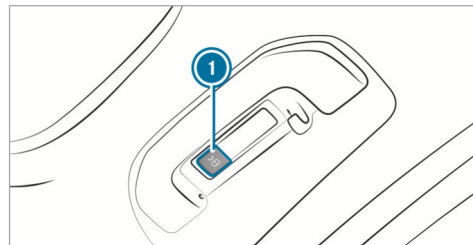

- ①  Rear passenger compartment reading lamp

- ▶ **To switch on or off:** press button ①.

Adjusting the ambient lighting

Multimedia system:

-  » Settings » Light
- » Ambient Lighting

Setting the color

- ▶ Select **Color**.

- ▶ Set the desired color.
- ⓘ There are 64 colors available.

Adjusting the brightness

- ▶ Select **Brightness**.

Adjust the brightness.

Activating the brightness for zones

- ▶ Select **Brightness**.
- ▶ Select **Brightness Zones**.
The **ACCENT** and **AMBIANCE** zones can be set separately.

Activating multi-color lighting

- ▶ Select **Color**.
- ▶ Select **Multi-color**.
There are ten preset color combinations available.
- ▶ Select a color combination.

Activating multi-color animation

- ▶ Select **Color**.

- ▶ Select **Multi-color Animation**.
The chosen color combination will change at predefined intervals.

Activating welcome lighting

- ▶ Select **Color**.
- ▶ Select **Welcome**.
When the vehicle is unlocked, a special ambient lighting sequence will run.

Activating dependency on air conditioning settings

- ▶ Select **Color**.
- ▶ Select **Climate**.
If changes are made to the temperature setting in the vehicle, the color of the ambient lighting will change briefly.

Switching the interior lighting switch-off delay time on/off

Multimedia system:

→  ▶ Settings ▶ Light
▶▶ Interior Lighting Delay

- ▶ Switch the lighting switch-off delay time on or off.
When this function is active, the interior lighting is lit up for short time after the vehicle has been locked.

Windshield wiper and windshield washer system

Switching the windshield wipers on/off

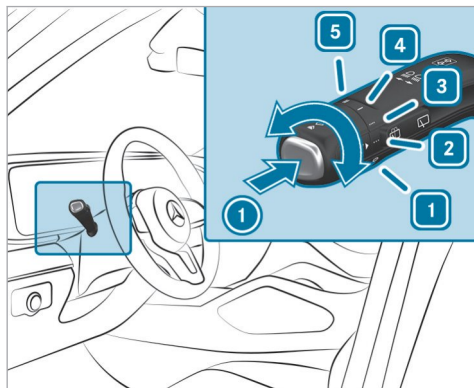



- 1 0 Windshield wipers off
- 2 ... Automatic wiper, normal
- 3 ... Automatic wiper, frequent

- 4 — Continuous wiping, slow
- 5 == Continuous wiping, fast

▶ Turn the combination switch to the correct position 1 - 5.



▶ **Single wipe/washing:** push the button on the combination switch in the direction of arrow 1.

-  Single wipe
-  Wipes with washer fluid

Vehicles with MAGIC VISION CONTROL: in position 2 or 3, the windshield washing process is automatically triggered if dirt is detected on the windshield.

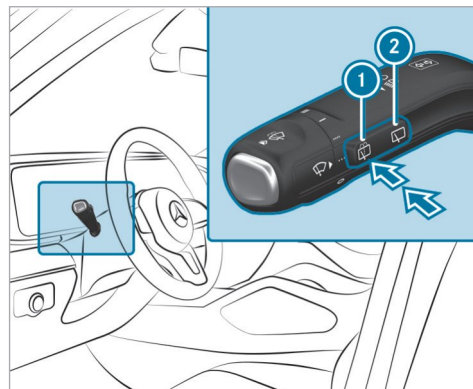
Switching the rear window wiper on/off



- 1  Single wipe/washing
- 2  Intermittent wiper

▶ **Single wipe:** press button 1 to the point of resistance.

▶ **To wipe with washer fluid:** press button 1 beyond the point of resistance.

- ▶ **To switch intermittent wiping on or off:** press button ②.
Vehicles with rain sensor: The wipe interval automatically adapts to the driving conditions.
 The  symbol will appear on the instrument cluster when the rear window wiper is switched on.

Changing the windshield wiper blades

⚠ WARNING Risk of becoming trapped if the windshield wipers are switched on while wiper blades are being replaced

If the windshield wipers begin to move while you are changing the wiper blades, you can be trapped by the wiper arm.

- ▶ Always switch off the windshield wipers and the ignition before changing the wiper blades.

Moving the wiper arms into the replacement position

- ▶ Switch the ignition on and switch off again immediately.
- ▶ Within around 15 seconds, press the  button on the combination switch for approximately three seconds (→ page 144). The wiper arms will move into the replacement position.

Removing the wiper blades

- ▶ Fold the wiper arms away from the windshield.

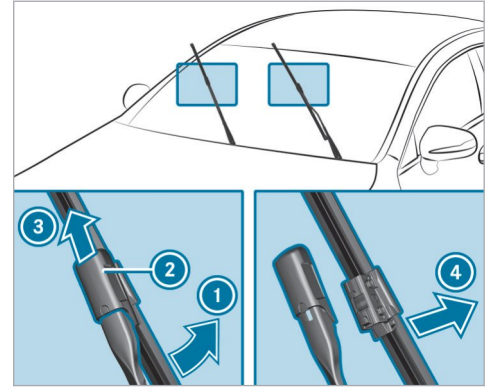

- ▶ Hold the wiper arm with one hand. With the other hand, turn the wiper blade in the direction of arrow ① away from the wiper arm as far as it will go.
- ▶ Slide catch ② in the direction of arrow ③ until it engages in the removal position.
- ▶ Remove the wiper blade from the wiper arm in the direction of arrow ④.

Installing the wiper blades

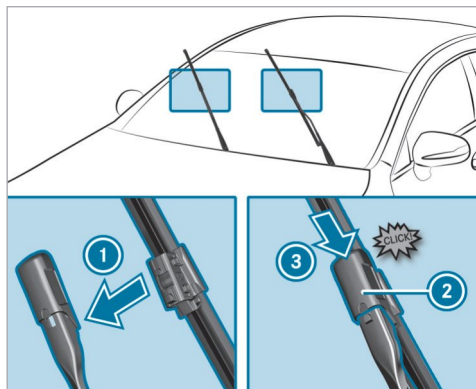

- ▶ Insert the new wiper blade into the wiper arm in the direction of arrow ①.
- ▶ Slide catch ② in the direction of arrow ③ until it engages in the locking position.
- ▶ Make sure that the wiper blade is seated correctly.

- ▶ Fold the wiper arms back onto the windshield.
- ▶ Switch on the ignition.
- ▶ Press the  button on the combination switch. The wiper arms will move into the original position.

Maintenance display

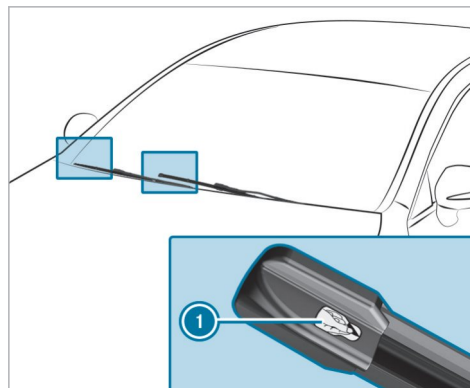

- ▶ Remove protective film ① from the maintenance display on the tip of the newly installed wiper blades.

If the color of the maintenance display changes from black to yellow, the wiper blades should be replaced.

- ① The duration until the color changes varies depending on the usage conditions.

Replacing the windshield wiper blades (MAGIC VISION CONTROL)

Moving the wiper arms into the replacement position

- ▶ Switch off the ignition.
- ▶ Within around 15 seconds, press the  button on the combination switch (→ page 144). The wiper arms will move into the replacement position.

Removing the wiper blades

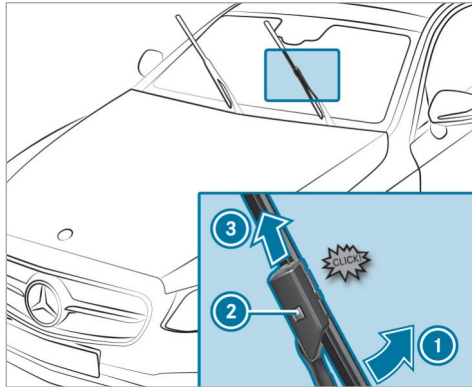

- ▶ **To bring the wiper blade into position to be removed:** hold the wiper arm firmly in one hand. With the other hand, turn the wiper blade in the direction of arrow ① beyond the point of resistance. The wiper blade will engage in the removal position with a click.

- ▶ **To remove the wiper blade:** press release knob ②, pull the wiper blade in the direction of arrow ③ and remove.

Installing the wiper blades

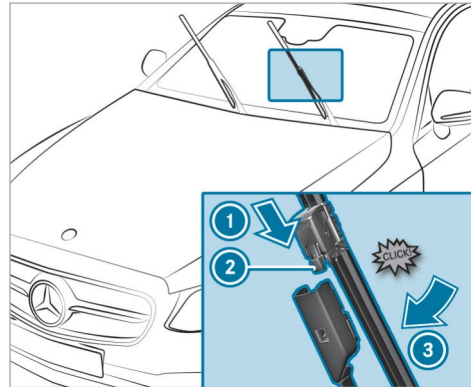

- ▶ Push the new wiper blade onto the wiper arm in the direction of arrow ① until release knob ② engages.

- ▶ Press the wiper blade onto the wiper arm in the direction of arrow ③ beyond the point of resistance. The wiper blade will engage with a noticeable click and move freely again.
- ▶ Fold the wiper arm back onto the windshield.

Replacing the rear window wiper blade

⚠ WARNING Risk of becoming trapped if the windshield wipers are switched on while wiper blades are being replaced

If the windshield wipers begin to move while you are changing the wiper blades, you can be trapped by the wiper arm.

- ▶ Always switch off the windshield wipers and the ignition before changing the wiper blades.

Removing the wiper blade

- ▶ Switch the ignition off.

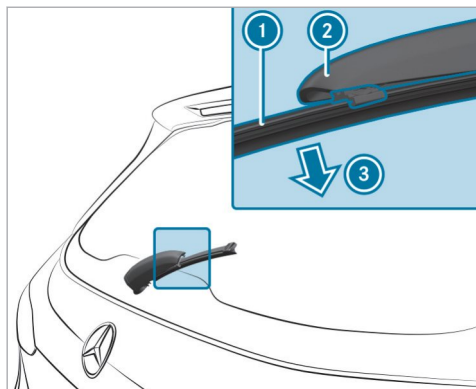

- ▶ Fold wiper arm ② away from the rear window until it engages in the replacement position.
- ▶ Unclip wiper blade ① from wiper arm ② and remove it in the direction of arrow ③.

Installing the wiper blade

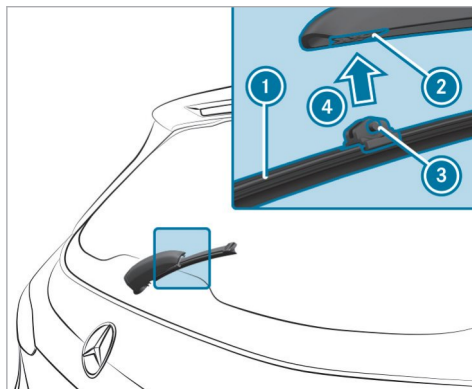

- ▶ Position wiper blade ① with both lugs ③ on holder ② on the wiper arm.
- ▶ Push wiper blade ① in the direction of arrow ④ until it engages in holder ②.
- ▶ Make sure that wiper blade ① is seated correctly.

- ▶ Fold the wiper arm from the replacement position back onto the rear window.

Mirrors

Operating the outside mirrors

⚠ WARNING Risk of injury from adjusting the vehicle settings while the vehicle is in motion

You could lose control of the vehicle in the following situations:

- if you adjust the driver's seat, the head restraint, the steering wheel or the mirror while the vehicle is in motion
 - if you fasten your seat belt while the vehicle is in motion
- ▶ Before starting the engine: adjust the driver's seat, the head restraint, the steering wheel or the mirror and fasten your seat belt.

⚠ WARNING Risk of accident due to misjudgment of distances when using the passenger mirror

The outside mirror on the front-passenger side reflects objects on a smaller scale. The objects in view are in fact closer than they appear.

As a result, you may misjudge the distance between you and the road user driving behind you, for example, when changing lanes.

▶ Therefore, always look over your shoulder in order to ensure that you are aware of the actual distance between you and the road users driving behind you.

Folding the outside mirrors in/out

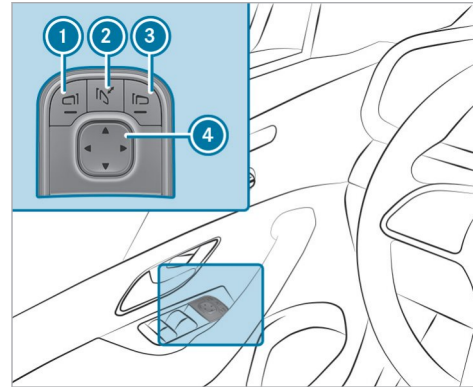

▶ Briefly press button ②.

ⓘ If the battery has been disconnected or has discharged, the outside mirrors must be moved briefly using button ②. Only then will the automatic mirror folding function work properly.

Adjusting the outside mirrors

- ▶ Press button ① or ③ to select the outside mirror to be adjusted.
- ▶ Use button ④ to adjust the position of the mirror glass.

Engaging the outside mirrors

If an outside mirror has been forcibly disengaged, proceed as follows.

- ▶ Vehicles without electrically folding outside mirrors: manually push the outside mirror into the correct position.
- ▶ Vehicles with electrically folding outside mirrors: press and hold button ②. You will hear a click and the mirror will audibly engage in position. The outside mirror will now be set to the correct position.

Automatic anti-glare mirrors function

⚠ WARNING Risk of acid burns and poisoning due to the anti-glare mirror electrolyte

Electrolyte may escape if the glass in an automatic anti-glare mirror breaks.

The electrolyte is hazardous to health and causes irritation. It must not come into contact with your skin, eyes, respiratory organs or clothing or be swallowed.

- ▶ If you come into contact with electrolyte, observe the following:
- Immediately rinse the electrolyte from your skin with water and seek medical attention.
 - If electrolyte comes into contact with your eyes, immediately rinse them thoroughly with clean water and seek medical attention.
 - If the electrolyte is swallowed, immediately rinse your mouth out thoroughly. Do not induce vomiting. Seek medical attention immediately.

- Immediately change out of clothing which has been contaminated with electrolyte.
- If an allergic reaction occurs, seek medical attention immediately.

The inside rearview mirror and the outside mirror on the driver's side will automatically go into anti-glare mode if light from a headlamp hits the sensor on the inside rearview mirror.

System limits

The system will not go into anti-glare mode if:

- The engine is switched off.
- Reverse gear is engaged.
- The interior lighting is switched on.

Front-passenger outside mirror parking position function

i The parking position is available only in vehicles with a memory function.

The parking position makes parking easier.

In the following situations, the front-passenger outside mirror will swivel downwards in the direction of the rear wheel on the front passenger's side:

- The parking position is stored (→ page 151)
- The front-passenger mirror is selected
- Reverse gear is engaged.

The front-passenger outside mirror will move back to its original position in the following situations:

- You shift the transmission to another transmission position
- You are traveling at speeds greater than 9 mph (15 km/h)
- You press the button for the outside mirror on the driver's side

Storing and calling up the parking position of the front-passenger outside mirror

Storing

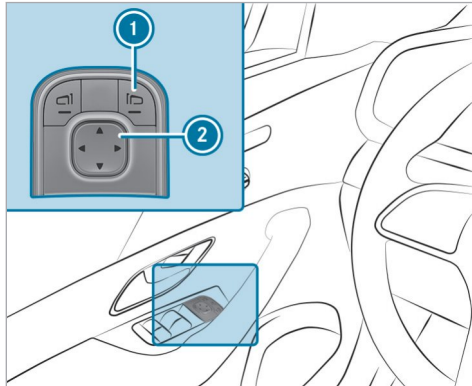

- ▶ Select the front-passenger outside mirror using button ①.
- ▶ Engage reverse gear.
- ▶ Move the front-passenger outside mirror into the desired parking position using button ②.

Calling up

- ▶ Select the front-passenger outside mirror using button ①.
- ▶ Engage reverse gear.
The front-passenger outside mirror will move to the stored parking position.

Activating/deactivating the automatic mirror folding function

Multimedia system:

- ▶  ▶ Settings ▶ Vehicle
- ▶ Switch **Automatic Folding** on or off.

Operating the sun visors

Using the single sun visor

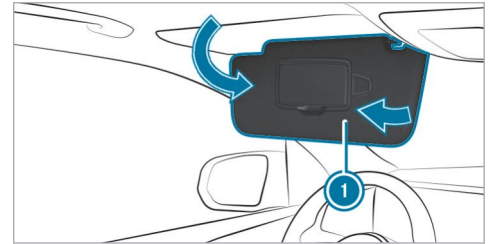

- ▶ **Glare from the front:** fold sun visor ① down.
- ▶ **Glare from the side:** release the catch and swing sun visor ① to the side.

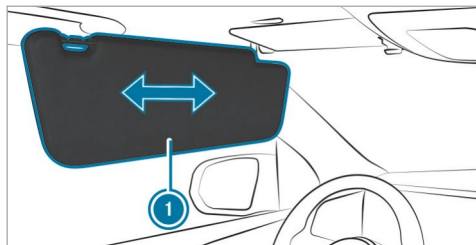

► Slide sun visor ❶ horizontally as required.

Using the additional sun visor

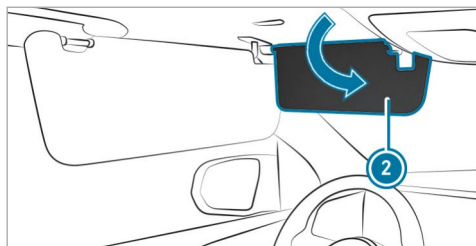

► Fold additional sun visor ❷ down.

Area permeable to radio waves on the windshield

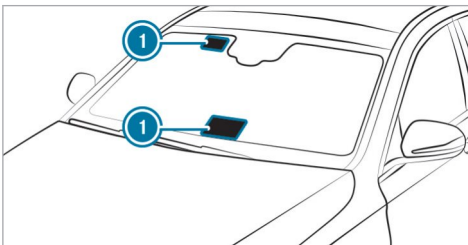

Radio-controlled equipment, such as toll systems, can be mounted only on areas ❶ of the windshield that are permeable to radio waves.

Areas permeable to radio waves ❶ are best visible from outside the vehicle when the windshield is illuminated with an external light source.

Note this position for vehicles with:

- Windshield heating
- Infrared reflective windshield

Infrared-reflective windshield function

The infrared-reflective windshield is coated and reduces the build-up of heat in the vehicle interior.

The coating shields the vehicle interior from radio waves.

Overview of climate control systems

Notes on climate control

An interior air filter in combination with the pre-filter in the engine compartment must always be used so that the air conditioning system, pollution level monitoring and the air filtration work correctly. Make sure that the filter is installed correctly and the filter housing in the engine compartment is closed correctly using the cap and always tightly sealed when in operation. Use filters recommended and approved by Mercedes-Benz. Always have service work carried out at a qualified specialist workshop.

Overview of the control panel for dual-zone automatic climate control

The indicator lamps on the buttons indicate that the corresponding function is activated.

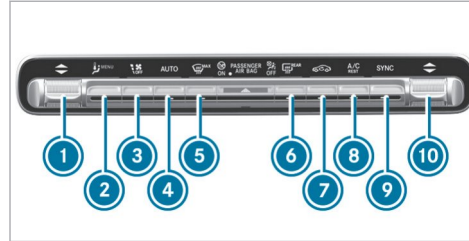

- ① Sets the temperature
- ② Calls up/exits the air conditioning menu
Pressing and holding the button (approx. four seconds); resets climate control to the basic settings
- ③ Sets the airflow or switches off climate control
- ④ Sets climate control to automatic (→ page 155)
- ⑤ Defrosts the windshield
- ⑥ Switches the rear window heater on/off

- ⑦ Switches air-recirculation mode on/off (→ page 157)
- ⑧ Switches the A/C function on/off (→ page 155)
Switches residual heat on/off (→ page 157)
- ⑨ Activates/deactivates synchronization (→ page 156)
- ⑩ Sets the front passenger side temperature

Overview of the control panel for 3-zone automatic climate control

The indicator lamps on the buttons indicate that the corresponding function is activated.

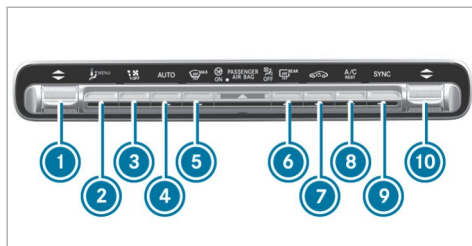

- ① Sets the temperature on the driver's side
- ② Calls up/exits the air conditioning menu
- ③ Sets the airflow or switches off climate control
- ④ **AUTO** Sets climate control to automatic (→ page 155)
- ⑤ Defrosts the windshield
- ⑥ Switches the rear window heater on/off
- ⑦ Switches air-recirculation mode on/off (→ page 157)

- ⑧ Switches the A/C function on/off (→ page 155)
Switches residual heat on/off (→ page 157)
- ⑨ **SYNC** Activates/deactivates synchronization (→ page 156)
- ⑩ Sets the temperature on the front passenger side

Overview of the rear operating unit

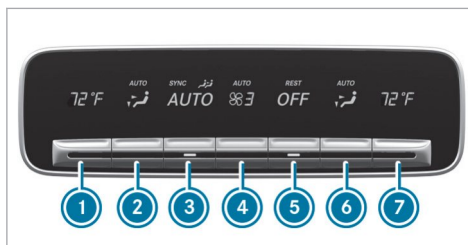

Example: USA

- ① Sets the temperature, left
- ② Sets the air distribution, left

- ③ Sets climate control to automatic mode (→ page 155)
- ④ Sets the airflow
- ⑤ Switches climate control on/off (→ page 155)
Switches the residual heat on/off (→ page 157)
- ⑥ Sets the air distribution, right
- ⑦ Sets the temperature, right

The settings for the second and third row of seats can be made via the rear operating unit, the multimedia system (→ page 156) or the MBUX rear tablet (→ page 451) depending on the vehicle's equipment.

Operating the climate control system

Switching climate control on/off

- ▶ **To switch on:** set the airflow to level 1 or higher using the button.
- ▶ **To switch off:** set the airflow to level 0 using the button.

- i** If climate control is switched off, the windows may fog up more quickly. Switch off climate control only briefly.

Switching the climate control in the rear passenger compartment on/off

- ▶ Press button **5**.

- i** When climate control in the second seat row is switched off, the indicator lamp is activated and **OFF** is shown on the rear display.

Switching the A/C function on or off via the control panel

The A/C function heats, cools and dehumidifies the vehicle's interior air.

- ▶ Press the  button.

Switch off the A/C function only briefly; otherwise, the windows may fog up more quickly.

Condensation may drip from the underside of the vehicle when cooling mode is active. This is not a sign that there is a malfunction.

Calling up the air conditioning menu

Calling up the air conditioning menu using the multimedia system

- ▶ Select one of the temperature displays at the lower edge of the media display.

Activating/deactivating the A/C function via the multimedia system

The A/C function heats, cools and dehumidifies the vehicle's interior air.

- ▶ Call up the air conditioning menu (→ page 155).
- ▶ Select **First Row of Seats**.
- ▶ Select **A/C**.
Depending on the previous status, the function is activated or deactivated.

Setting climate control to automatic mode

In automatic mode, the set temperature is controlled and maintained at a constant level by the air supply.

- ▶ Press the  button.

- ▶ **To switch to manual mode:** press the  button.

In automatic mode, you can choose between five different air quantities using the  button. Automatic mode is retained.





Automatically controlling the climate control in the rear passenger compartment





In automatic mode, the set temperature is regulated by the temperature of the dispensed air and the airflow.

- ▶ Press the  button (→ page 154).





Overview of air distribution settings

The symbols on the display indicate which vents the airflow is being directed through:

-  Defroster and side air vents
-  Center and side air vents
-  Footwell and side air vents
-  Center, side and footwell vents

-  Defroster, footwell and side air vents
-  All vents
-  Defroster, middle and side air vents
-  Automatic air distribution

Setting the air distribution

- ▶ Call up the air conditioning menu (→ page 155).
 - ▶ Select **First Row of Seats** or **Second Row of Seats**.
 - ▶ **To set the air distribution:** select ,  or .
 - ▶ Set the airflow.
- i** Several air distribution options can be selected at the same time, for example to set the temperature/air conditioning for the windshield and the footwells simultaneously. The  climate control for the windshield can only be selected for the first seat row.

Setting climate control for the rear passenger compartment (multimedia system)

Setting the temperature

- ▶ Call up the air conditioning menu (→ page 155).
- ▶ Select **Second Row of Seats**.
- ▶ Set the temperature.

Setting the airflow

- ▶ Call up the air conditioning menu (→ page 155).
- ▶ Select **Second Row of Seats**.
- ▶ Set the airflow.

Controlling the rear climate control automatically

- ▶ Select **REAR AUTO**.
Rear climate control is controlled automatically.

Deactivating rear climate control

- ▶ Select **REAR OFF**.
Rear climate control is deactivated.

Activating/deactivating the climate control synchronization function via the control panel

Climate control can be set centrally using the synchronization function. The temperature and air distribution setting for the driver side is adopted automatically for all climate control zones.

- ▶ Press the **SYNC** button.

The synchronization function is deactivated if the settings for one of the other climate zones are changed.

Activating/deactivating the climate control synchronization function using the multimedia system

Climate control can be set centrally using the synchronization function. The driver's settings for temperature, air quantity and air distribution are adopted automatically for all climate zones.

- ▶ Call up the air conditioning menu (→ page 155).
- ▶ Select **First Row of Seats**.

- ▶ Select **SYNC**.
Depending on the previous status, the function is activated or deactivated.

Removing condensation from the windows

Windows fogged up on the inside

- ▶ Press the **AUTO** button.
- ▶ If the windows continue to fog up: press the  button.

Windows fogged up on the outside

- ▶ Switch on the windshield wipers.
- ▶ Press the **AUTO** button.

Switching air-recirculation mode on/off

- ▶ Press the  button.
The interior air will be recirculated.

Air-recirculation mode automatically switches to fresh air mode after some time.

- ⓘ If air-recirculation mode is switched on, the windows may fog up more quickly. Switch on air-recirculation mode only briefly.

Switching the residual heat on or off

Requirements:

- The vehicle is parked.

It is possible to make use of the residual heat from the engine to continue heating or ventilating the front compartment of the vehicle for approximately 30 minutes, depending on the temperature set.

- ▶ **To activate:** press  button.

Residual heat will be switched off automatically.

Switching the residual heat in the rear passenger compartment on/off

Requirements:

- The vehicle is parked.

When the residual heat of the engine is activated in the rear passenger compartment, you can heat or ventilate the rear passenger compartment for approximately 30 minutes.

- ▶ Press button  (→ page 154).

Activating/deactivating ionization

The ionization improves the quality of the vehicle's interior air. The ionization of the interior air is odorless.

- ▶ Call up the air conditioning menu (→ page 155).
- ▶ Select **Air Quality**.
- ▶ Select **IONIZATION**.
Depending on the previous status, the function is activated or deactivated.

Fragrance system

Setting the fragrance system

Requirements:

- Automatic climate control is activated.
- The glove box is closed.

The fragrance system distributes a pleasant fragrance throughout the vehicle interior from a flacon located in the glove box.

- ▶ Call up the climate control menu (→ page 155).

- ▶ Select **Air Quality**.
 - ▶ Select **AIR FRESHENER**.
The fragrance system begins at the highest intensity.
 - ▶ Keep pressing until the desired intensity is reached.
- ① The intensity levels can be selected in the following order: Strong - Medium - Weak - Off

Inserting or removing the flacon of the fragrance system

⚠ WARNING Risk of injury from liquid perfume

If children open the flacon, they could drink the liquid perfume or it could come into contact with their eyes.

- ▶ Do not leave children unattended in the vehicle.
- ▶ Consult a doctor immediately if liquid perfume has been drunk.

- ▶ If liquid perfume comes into contact with your eyes or skin, rinse your eyes with clean water.
- ▶ If symptoms continue, consult a doctor.

🔥 ENVIRONMENTAL NOTE Environmental damage due to improper disposal of full flacons



Full flacons must not be disposed of with household waste.



Full flacons must be taken to a harmful substance collection point.

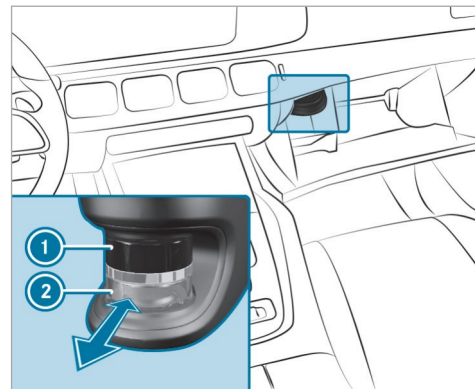

- ① Cap
- ② Flacon

- ▶ **To insert:** slide the flacon into the holder as far as it will go.
- ▶ **To remove:** after opening the glove box, wait for approximately seven seconds and pull out the flacon.

If you do not use genuine Mercedes-Benz interior perfumes, observe the manufacturers' safety notices on the perfume packaging.

Dispose of the genuine Mercedes-Benz interior perfume flacon when it is empty and do not refill it.

Refillable flacon

- ▶ Unscrew the cap of the empty flacon.
- ▶ Fill the flacon with a maximum of 0.5 fl. oz. (15 ml).
- ▶ Screw the cap back on to the flacon.

Always refill the empty refillable flacon with the same perfume. Observe the separate information sheet with the flacon.

Information on the windshield heater

The windshield heater is switched on automatically if the  button is activated.

In addition, it is automatically switched on when necessary.

Air vents

Adjusting the front air vents

⚠ WARNING - Danger of burns or frostbite due to being too close to the air vents

Very hot or very cold air can flow from the air vents.

This could result in burns or frostbite in the immediate vicinity of the air vents.



- ▶ Make sure that all vehicle occupants always maintain a sufficient distance to the air vents.
- ▶ If necessary, direct the airflow to another area of the vehicle interior.

To guarantee the flow of fresh air through the air vents into the vehicle interior, comply with the following:

- Always keep the vents and the ventilation grille in the vehicle interior free.
- Keep the air inlet free of deposits (→ page 461).

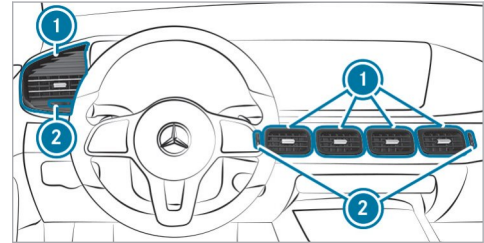
- Optimum climate comfort is achieved with the air vents in the center position.



- ▶ **To open or close center air vents:** turn controller  up or down as far as it will go.
- ▶ **To open or close side air vents:** turn controller  to the left or right as far as it will go.
- ▶ **To adjust the air direction:** hold air vent  in the center and move it up or down or to the left or right.

Adjusting the rear air vents

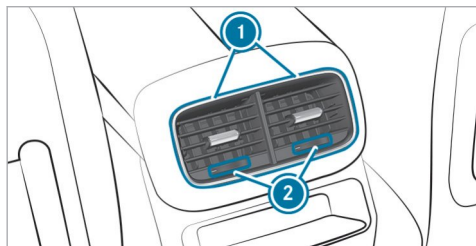

- ▶ **To open or close:** turn controller ② counter-clockwise or clockwise as far as it will go.
- ▶ **To adjust the air direction:** hold air vent ① in the center and move it up or down or to the left or right.

Opening or closing the air vent in the glove box

! **NOTE** Damage to temperature-sensitive objects in the glove box

Temperature-sensitive objects stored in the glove box may be damaged by the air vent located inside it.

- ▶ Close the air vent when you heat the vehicle.
- ▶ At high outside temperatures, open the air vent and switch on the A/C function.

The automatic climate control must be switched on to cool the glove box.

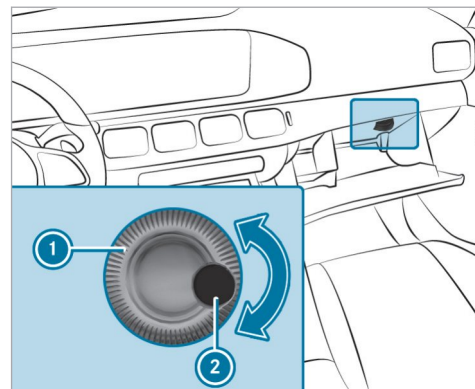

- ▶ **To open or close:** turn controller ① of air vent ② to the left or right.

Driving

Notes on Mercedes-AMG vehicles

Observe the notes on the following topics in the Supplement, as you may otherwise fail to recognize dangers:

- AMG adaptive sport suspension system
- (DYNAMIC SELECT switch) drive programs
- Functions of ESP®

Switching on the power supply or the ignition (without engine start)

⚠ WARNING Risk of accident and injury due to children left unattended in the vehicle

If children are left unattended in the vehicle, they could:

- Open doors, thereby endangering other persons or road users.
- Get out and be struck by oncoming traffic.

- Operate vehicle equipment and become trapped, for example.

In addition, the children could also set the vehicle in motion, for example by:

- Releasing the parking brake.
 - Changing the transmission position.
 - Starting the vehicle.
- ▶ Never leave children unattended in the vehicle.
- ▶ When leaving the vehicle, always take the key with you and lock the vehicle.
- ▶ Keep the vehicle key out of reach of children.

Also observe the "Notes on pets in the vehicle".

Requirements:

- The SmartKey is located in the vehicle and the SmartKey battery is not discharged.
- The brake pedal is not depressed.

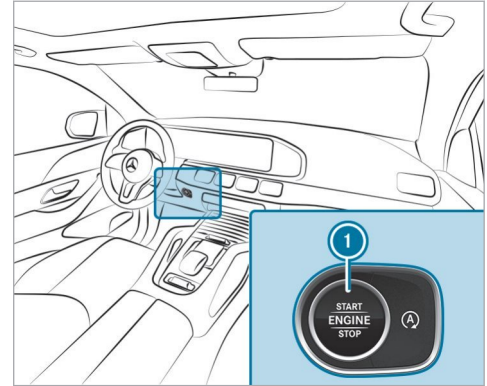

- ▶ **To switch on the power supply:** press button ① once. You can activate the windshield wipers, for example.

The power supply is switched off again if the following conditions are met:

- You open the driver's door.
- You press button ① twice more.

- ▶ **To switch on the ignition:** press button ❶ twice.
The indicator lamps in the instrument cluster light up.

The ignition is switched off again if one of the following conditions is met:

- You do not start the vehicle within 15 minutes and the transmission is in position **P** or the electric parking brake is applied.
- You press button ❶ once.

Starting the vehicle

Starting the vehicle with the start/stop button

⚠ DANGER Risk death caused by exhaust gases

Combustion engines emit poisonous exhaust gases such as carbon monoxide. Inhaling these exhaust gases is hazardous to health and leads to poisoning.

- ▶ Never leave the engine or, if present, the auxiliary heating running in an enclosed space without sufficient ventilation.

⚠ WARNING Risk of fire caused by flammable material on the exhaust system

Flammable materials brought in by either animals or environmental influences may ignite if they come into contact with hot parts of the engine or exhaust system.

- ▶ Therefore, check regularly that there are no flammable materials in the engine compartment or on the exhaust system.

Requirements:

- The SmartKey is located in the vehicle and the SmartKey battery is not discharged.
- ▶ Shift the transmission to position **P** or **N**.
- ▶ Depress the brake pedal and press button ❶ once.

- ▶ If the vehicle does not start: switch off non-essential consumers and press button ❶ once.

- ▶ If the vehicle still does not start and the [Place the Key in the Marked Space See Operator's Manual](#) display message also appears in the multifunction display: start the vehicle in emergency operation mode.

- ❶ You can switch off the engine while driving by pressing button ❶ for about three seconds or by pressing button ❶ three times within three seconds. Be sure to observe the safety notes under "Driving tips" (→ page 166).

Starting the vehicle with SmartKey in the marked space (emergency operation mode)

If the vehicle does not start and the [Place the Key in the Marked Space See Operator's Manual](#) message appears in the multifunction display, you can start the vehicle in emergency operation mode.

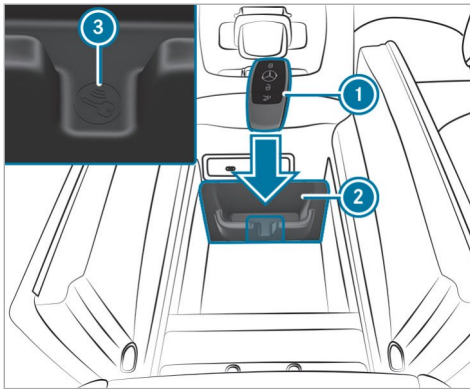

- ▶ Make sure that marked space ② is empty.
- ▶ Remove SmartKey ① from the key ring.
- ▶ Place SmartKey ① in marked space ② next to the symbol ③.
The vehicle will start after a short time.
If you remove SmartKey ① from marked space ② the engine continues running. For further vehicle starts however, SmartKey ①

must be located in marked space ② next to the symbol ③ during the entire journey.

- ▶ Have SmartKey ① checked at a qualified specialist workshop.

If the vehicle does not start:

- ▶ Place SmartKey ① in marked space ② and leave it there.
- ▶ Depress the brake pedal and start the vehicle using the start/stop button.
- ⓘ You can also switch on the power supply or the ignition with the start/stop button.

Starting the vehicle via Remote Online services

Cooling or heating the vehicle interior before commencing your journey

- ⓘ This function is not available in all countries.
If you start the vehicle via your smartphone, the previously selected air conditioning adjustment is active.

Ensure the following before starting the engine:

- The legal stipulations in the area where your vehicle is parked allow engine starting via smartphone.
- It is safe to start and run the engine where your vehicle is parked.
- The fuel tank is sufficiently filled.
- The starter battery is sufficiently charged.
- ⓘ You can also set the temperature with your smartphone. Information on Mercedes me connect and other services: <https://www.mercedes.me>
This function is not available for all models.

Charging the battery before commencing your journey

- ⓘ This function is not available in all countries.
If the vehicle battery is discharged, you receive a message on your smartphone. You can then start the vehicle with the smartphone to charge the battery. The vehicle is automatically switched off after ten minutes.

Ensure the following before starting the engine:

- The legal stipulations in the area where your vehicle is parked allow engine starting via smartphone.
- It is safe to start and run the engine where your vehicle is parked.
- The fuel tank is sufficiently filled.

Starting the vehicle (Remote Online)

⚠ WARNING Risk of crushing or entrapment due to unintentional starting of the engine

Limbs could be crushed or trapped if the engine is started unintentionally during service or maintenance work.

- ▶ Always secure the engine against unintentional starting before carrying out maintenance or repair work.

Requirements:

- Park position **P** is selected.
- The anti-theft alarm system is not activated.

- The panic alarm is not activated.
- The hazard warning lights are switched off.
- The hood is closed.
- The doors are closed and locked.
- The windows and sliding sunroof are closed.

- ▶ Start the vehicle using the smartphone. After every vehicle start, the engine runs for ten minutes.

You can carry out a maximum of two consecutive starting attempts. The vehicle must be started once with the SmartKey before trying to start the vehicle again with the smartphone. you can stop the vehicle again at any time.

- ⓘ Further information can be found in the smartphone app.

Securing the engine against starting before carrying out maintenance or repair work:

- ▶ Switch on the hazard warning lights.

or

- ▶ Unlock the doors.

or

- ▶ Open a side window or the sliding sunroof.

Breaking-in notes

Mercedes-AMG vehicles: observe the notes in the Supplement. Otherwise, you may fail to recognize dangers.

To preserve the engine during the first 1,000 miles (1,500 km):

- Drive at varying road speeds and engine speeds.
- Drive the vehicle in drive program **C** or **E**.
- Shift to the next highest gear at the very latest when the needle reaches the last third before the red area in the tachometer.
- Do not shift down a gear manually in order to brake.
- Avoid overstraining the vehicle, e.g. driving at full throttle.
- Do not depress the accelerator pedal past the pressure point (kickdown).

- Only increase the engine speed gradually and accelerate the vehicle to full speed after 1,000 miles (1,500 km).

This also applies when the engine or parts of the drivetrain have been replaced.

Please also observe the following breaking-in notes:

- In certain driving and driving safety systems, the sensors adjust automatically while a certain distance is being driven after the vehicle has been delivered or after repairs. Full system effectiveness is not reached until the end of this teach-in process.
- Brakepads, brake discs and tires that are either new or have been replaced only achieve optimum braking effect and grip after several hundred kilometers of driving. Compensate for the reduced braking effect by applying greater force to the brake pedal.

Notes on optimized acceleration

If all necessary requirements and activation conditions are fulfilled, the best possible acceleration can be achieved from a standstill.

Do not use the optimized acceleration on public roads. Individual wheels could spin and you could lose control of the vehicle. There is an increased risk of skidding and/or accident.

Be sure to observe the safety notes and information on ESP® (→ page 198).

Pulling away with optimized acceleration

⚠ WARNING Risk of skidding and having an accident from wheels spinning

When you use optimized acceleration, individual wheels could spin and you could lose control of the vehicle.

If ESP® is deactivated, there is a risk of skidding and accident.

- ▶ Make sure that no persons or obstacles are in the close vicinity of your vehicle.

Requirements:

- The vehicle has been broken in (→ page 164).
- The vehicle and tires are in good condition.
- You are on a high-grip roadway.
- The engine and transmission are at normal operating temperature.

! NOTE Increased wear due to optimized acceleration

When pulling away with optimized acceleration, all components of the drivetrain are subjected to a very high load.

This can lead to increased component wear.

- ▶ Do not always pull away with optimized acceleration.

- ▶ Engage the **[D]** drive position (→ page 181).
- ▶ Move the steering wheel to the straight-ahead position.
- ▶ Select the sportiest available drive program **[S⁺]** or **[S]** (→ page 177).

- ▶ Deactivate ESP® (→ page 202).
- ▶ Depress and hold the brake pedal firmly with your left foot.
- ▶ With your right foot, fully depress the accelerator pedal.
- ▶ After no more than five seconds, take your left foot quickly off the brake, but keep the accelerator pedal depressed. The vehicle pulls away at maximum acceleration.
- ▶ Switch on ESP® once the acceleration procedure is complete.

Ending optimized acceleration

- ▶ Remove your foot from the accelerator pedal.
- ▶ Reactivate the ESP®.
- ① After you pull away with optimized acceleration, components of the drivetrain can become very hot, which means that optimized acceleration values may be reached again only after a few minutes.

Notes on driving

⚠ WARNING Risk of accident due to objects in the driver's footwell

Objects in the driver's footwell may impede pedal travel or block a depressed pedal.

This jeopardizes the operating and road safety of the vehicle.

- ▶ Stow all objects in the vehicle securely so that they cannot get into the driver's footwell.
- ▶ Always install the floor mats securely and as prescribed in order to ensure that there is always sufficient room for the pedals.
- ▶ Do not use loose floor mats and do not place floor mats on top of one another.

⚠ WARNING Risk of accident due to unsuitable footwear

Operation of the pedals may be restricted due to unsuitable footwear such as:

- Shoes with platform soles
- Shoes with high heels
- Slippers

- ▶ When driving always wear suitable shoes in order to be able to operate the pedals safely.

⚠ WARNING Risk of accident when switching off the ignition when driving

If you switch off the ignition while driving, safety functions are restricted or no longer available. This may affect the power steering system and the brake force boosting, for example.

You will then need to use considerably more force to steer and brake.

- ▶ Do not switch off the ignition while driving.

⚠ DANGER Risk death caused by exhaust gases

Combustion engines emit poisonous exhaust gases such as carbon monoxide. Inhaling these exhaust gases is hazardous to health and leads to poisoning.

- ▶ Never leave the engine or, if present, the auxiliary heating running in an enclosed space without sufficient ventilation.

⚠ WARNING Risk of skidding and of an accident due to shifting down on slippery road surfaces

If you shift down on slippery road surfaces to increase the engine braking effect, the drive wheels may lose traction.

- ▶ Do not shift down on slippery road surfaces to increase the engine braking effect.

⚠ DANGER Risk of fatal injury due to poisonous exhaust gases

If the tailpipe is blocked or sufficient ventilation is not possible, poisonous exhaust gases such as carbon monoxide may enter the vehicle. This is the case when the vehicle becomes stuck in snow, for example.

- ▶ Keep the tailpipe and the area around the vehicle free from snow when the engine or the stationary heater are running.
- ▶ Open a window on the side of the vehicle facing away from the wind to ensure an adequate supply of fresh air.

⚠ WARNING Risk of accident and injury due to being under the influence of alcohol and drugs while driving

Driving when under the influence of alcohol and/or drugs is an extremely dangerous combination. Even small quantities of alcohol or drugs may affect your reflexes, perception and judgment.

The probability of a serious or even fatal accident greatly increases if you drive when under the influence of alcohol or drugs.

- ▶ Do not drink alcohol or take drugs while driving, and do not allow anyone to drive who has been drinking alcohol or taking drugs.

⚠ WARNING Risk of accident due to the brake system overheating

If you leave your foot on the brake pedal when driving, the brake system may overheat.

This increases the braking distance and the brake system may even fail.

- ▶ Never use the brake pedal as a footrest.
- ▶ Do not depress the brake pedal and the accelerator pedal at the same time while driving.

! **NOTE** Wearing out the brake linings by continuously depressing the brake pedal

- ▶ Do not depress the brake pedal continuously whilst driving.
- ▶ To use the braking effect of the engine, shift to a lower gear in good time.

! **NOTE** Damage to the drivetrain and engine when pulling away

- ▶ Do not warm up the engine while the vehicle is stationary. Pull away immediately.
- ▶ Avoid high engine speeds and driving at full throttle until the engine has reached its operating temperature.

! **NOTE** Damage to the catalytic converter due to non-combusted fuel

The engine is not running smoothly and is misfiring.
Non-combusted fuel may get into the catalytic converter.

▶ Only depress the accelerator pedal slightly.

▶ Have the cause rectified immediately at a qualified specialist workshop.

Notes on driving on salt-treated roads

The braking effect is limited on salt-treated roads.

Therefore, observe the following notes:

- due to salt build-up on the brake discs and brakepads, the braking distance can increase considerably or result in braking only on one side
- maintain a much greater safe distance to the vehicle in front

To remove salt build-up:

- brake occasionally while paying attention to the traffic conditions
- carefully depress the brake pedal at the end of the journey and when starting the next journey

Notes on hydroplaning

Hydroplaning can take place once a certain amount of water has accumulated on the road surface.

Observe the following notes during heavy precipitation or in conditions in which hydroplaning may occur:

- reduce speed
- avoid tire ruts
- avoid sudden steering movements
- brake carefully

i Also observe the notes on regularly checking wheels and tires (→ page 490).

Notes on driving through water on the road surface

Water which has entered into the vehicle can damage the engine, electrics and transmission. Water can also enter the air intake of the engine and cause engine damage.

Observe the following if you must drive through water:

- observe the maximum permissible fording depth (→ page 537)
- drive at walking pace at most, otherwise water can enter the vehicle interior or engine compartment
- vehicles traveling in front, or oncoming vehicles, can create waves which may exceed the maximum permissible height of the water

The braking effect of the brakes is reduced after fording. Brake carefully while paying attention to the traffic conditions until braking power has been fully restored.

Notes on off-road driving

⚠ WARNING Risk of accident if you do not keep to line of fall on inclines

If you drive at an angle or turn on an incline, the vehicle could slip sideways, tip and roll-over.

- ▶ Always drive on inclines in the line of fall (straight up or down) and do not turn.

⚠ WARNING Risk of fire due to flammable materials on hot parts of the exhaust system

Flammable material such as leaves, grass or twigs may ignite if they come into contact with hot parts of the exhaust system.

- ▶ When driving on unpaved roads or off-road, regularly check the vehicle underside.
- ▶ Remove trapped plants or other flammable material.
- ▶ If there is damage, consult a qualified specialist workshop immediately.

When driving off-road, substances such as sand, mud and water or water mixed with oil may get into the brakes. This may lead to a reduction in braking effect or total brake failure as a result of increased wear. The braking characteristics will vary depending on the material that has entered

the system. Clean the brakes after driving off-road. If you then notice reduced braking effect or hear scraping noises, have the brake system checked at a qualified specialist workshop. Adjust your driving style to the changed braking characteristics.

! NOTE Damage caused by driving over obstacles

The vehicle can be damaged by:

- Driving up on high curbs or unpaved roads.
 - Quickly driving over obstacles such as curbs, speed bumps or potholes.
 - Heavy objects hitting the underbody or chassis components.
- ▶ Do not drive over obstacles that could damage the vehicle.
 - ▶ Check the vehicle regularly for damage during off-road driving.
 - ▶ Adjust the vehicle speed to suit the road surface conditions.

- ▶ If there is damage, consult a qualified specialist workshop immediately.

 **ENVIRONMENTAL NOTE** Environmental damage due to non-observance of prohibition signs

Environmental protection has priority. Treat nature with respect.

- ▶ Be sure to observe prohibition signs.



Checklist before driving off-road

Check the following points before driving off-road:

- Fuel level
- Engine oil level: fill engine oil up to the maximum level to ensure full gradeability (→ page 457).
- Tire-change tool kit and spare wheel
- Tires and wheels
- ① Further information about special all-terrain tires for retrofitting can be obtained from a qualified specialist workshop.

Off-road driving

Read this section before driving your vehicle off-road. Practice by driving over more gentle off-road terrain first.

- Observe the notes on the cross-country ABS (→ page 197).
- If necessary, select the  or  drive program (vehicles with an Off-road package) before driving off-road (→ page 177).
- Select a vehicle level suitable for off-road terrain (→ page 231). To avoid damaging the vehicle, make sure there is always sufficient ground clearance.
- Always keep the engine running and in gear when driving on downhill gradients and slopes. Observe the notes on driving in mountainous terrain.
- Do not drive on unknown terrain that is not easily visible and stay on marked routes.
- Always keep the doors and windows closed while the vehicle is in motion.
- Deactivate Active Distance Assist DISTRONIC and cruise control.

- Adapt your driving style to the terrain.
- Do not use the HOLD function on steep downhill or uphill gradients with slippery or loose surfaces.

Driving on sand

When driving on sand, also observe the following instructions:

- Select the  drive program.
- Select a higher vehicle level.
- Shift to a lower gear.
- Drive quickly to overcome the rolling resistance, otherwise the vehicle may dig itself in.
- Drive in the tracks of other vehicles if possible. Make sure that the following prerequisites are met:
 - The tire ruts are not too deep
 - The sand is firm enough
 - the ground clearance is sufficient

Mercedes-AMG vehicles: observe the notes in the Supplement. Otherwise, you may fail to recognize dangers.

Fording

Also observe the following information when fording:

- Drive at no more than 6 mph (10 km/h).
- Observe the maximum permissible fording depth (→ page 537).
- Switch off automatic climate control (→ page 155).
- Ensure that a bow wave does not form as you drive.
- Do not stop in the water and do not switch off the engine. Ensure the ECO start/stop function is switched off (→ page 174).

Driving in mountainous terrain



Also observe the following information when driving in mountainous terrain:

- Observe the values of the approach/departure angle and of the maximum gradient (→ page 537).
- Avoid high engine speeds.
- Use the braking power of the engine when driving downhill.

- Shift to a lower gear on uphill gradients and on long, steep downhill gradients.
- Activate DSR before driving downhill, if necessary (→ page 211).

Checklist after driving off-road

Driving off-road places greater demands on your vehicle than driving on normal roads. Check the entire vehicle for damage and foreign bodies every time after driving off-road. Foreign bodies in the wheels or drivetrain can lead to imbalances and therefore vibrations.







- If the  or  drive program is selected: select another drive program.
- Switch DSR off.
- Lower the vehicle level again to a level suitable to the road conditions, e.g. to the normal level.
- Apply the brakes to dry them after fording.
- Check that the service brake is working normally after a long downhill stretch.
- Clean the following components every time after driving off-road:
 - License plate number

- Headlamps and tail lamps
- Tires, wheels and wheel arches
- underbody
- After driving through sand, mud, water or gravel, have the following components checked and cleaned:
 - Brake discs and brakepads
 - Tires and wheels
 - axle joints

ECO start/stop function

Operation of the ECO start/stop function

Vehicles without a 48 V on-board electrical system (EQ Boost technology)

-  The ECO start/stop function is available only in the , , ,  and  drive programs (depending on the setting).

The engine is switched off automatically in the following situations if all vehicle conditions for an automatic engine stop are met:

- You brake the vehicle to a standstill in transmission position **D** or **N**.

If you switch on the HOLD function in transmission position **D** or **N**, the engine will automatically stop in the following situations:

- you stop behind a vehicle that is pulling away.
 - you stop at a stop sign when there is no vehicle in front of you.
 - you turn the steering wheel hard at a low speed.
- i** In transmission position **R**, the engine is not switched off automatically even when the HOLD function is switched on.

The engine is restarted automatically if:

- You release the brake pedal in transmission position **D** when the HOLD function is not active.
- You engage transmission position **D** or **R**.

- You depress the accelerator pedal.
- An automatic engine start is necessary.

ECO start/stop function symbols in the multifunction display:

- The **(A)** symbol (green) appears when the vehicle is at a standstill: the engine was switched off by the ECO start/stop function.
- The **(P)** symbol (yellow) appears when the vehicle is at a standstill: not all vehicle conditions for an engine stop have been met.
- Neither the **(A)** nor **(P)** symbol appears when the vehicle is at a standstill: an intelligent stop inhibitor was detected, e.g. a stop sign.
- The **(A) OFF** symbol appears: the ECO start/stop function is deactivated or there is a malfunction.

- i** If, in spite of an intelligent stop inhibitor, the engine should be switched off by the ECO start/stop function, you have the following options:
- Switch on the HOLD function in transmission position **D** or **N**.

- You engage transmission position **P**.

If the engine was switched off by the ECO start/stop function and you leave the vehicle, a warning tone sounds and the engine is not restarted. The **Vehicle Ready to Drive Switch the Ignition Off Before Exiting** display message also appears in the multifunction display. If you do not switch off the ignition, the ignition is automatically switched off after three minutes.

Vehicles with a 48 V on-board electrical system (EQ Boost technology)

- i** The ECO start/stop function is available only in the **S**, **C**, **E**, **CV** and **I*** drive programs (depending on the setting).

The engine is switched off automatically in the following situations if all vehicle conditions for an automatic engine stop are met:

- You brake the vehicle to a standstill in transmission position **D** or **N**.
- You depress the brake pedal when traveling at a low speed.

If you switch on the HOLD function or select a different transmission position than **R**, the engine will automatically stop in the following situations:

- You stop behind a vehicle that is pulling away.
- You stop at a stop sign when there is no vehicle in front of you.
- You turn the steering wheel hard at a low speed.

The engine is restarted automatically if:

- You release the brake pedal in transmission position **D** when the HOLD function is not active and one of the following conditions are met:
 - Drive program **C** or **E** is not selected.
 - Drive program **C** or **E** is selected but the does not start to move.
 - Drive program **C** or **E** is selected, the vehicle is moving at a speed of more than 15 mph (20 km/h) and glide mode is not activated.

- You engage transmission position **D** or **R**.
- You release the brake pedal, the vehicle is not in glide mode and it starts to move on a gentle downhill gradient at a speed below 2 mph (3 km/h).
- You depress the accelerator pedal.
- An automatic engine start is necessary.

ECO start/stop function symbols in the multifunction display:

- The **A** symbol (green) appears when the vehicle is at a standstill: the engine was switched off by the ECO start/stop function.
- The **A** symbol (yellow) appears when the vehicle is at a standstill: not all vehicle conditions for an engine stop have been met.
- Neither the **A** nor **A** symbol appears when the vehicle is at a standstill: an intelligent stop inhibitor was detected, e.g. a stop sign.
- The **A** OFF symbol appears: the ECO start/stop function is deactivated or there is a malfunction.

- **i** If, in spite of an intelligent stop inhibitor, the engine should be switched off by the ECO start/stop function, activate the HOLD function or engage transmission position **P**.

If the engine was switched off by the ECO start/stop function and you leave the vehicle, a warning tone sounds and the engine is not restarted. The [Vehicle Ready to Drive Switch the Ignition Off Before Exiting](#) display message also appears in the multifunction display. If you do not switch off the ignition, the ignition is automatically switched off after three minutes.

Deactivating or activating the ECO start/stop function

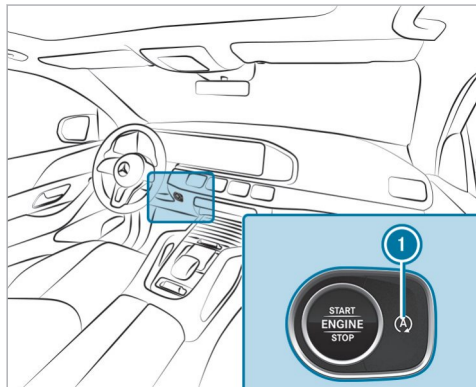

- ▶ Press button ①.
A display appears in the instrument cluster when switching the ECO start/stop function off/on.
- ① A continuous display appears in the instrument cluster while the ECO start/stop function is deactivated.

ECO display function

The ECO display summarizes your driving characteristics from the start of the journey to its completion and assists you in achieving the most economical driving style.

You can influence consumption if you:

- Drive with particular care.
- Drive the vehicle in drive program **E**.
- Observe the gearshift recommendations.

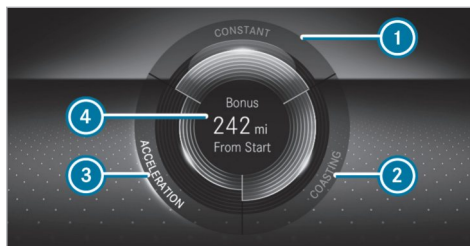

The lettering in the segment will light up brightly, the outer edge will light up and the segment will fill up when the following driving style is adopted:

- ① Steady speed
- ② Gentle deceleration and rolling
- ③ Moderate acceleration

The lettering in the segment will be gray, the outer edge will be dark and the segment will empty when the following driving style is adopted:

- ① Fluctuations in speed
- ② Heavy braking
- ③ Sporty acceleration

The ECO display will show you when you have driven economically:

- The three segments will fill up completely at the same time
- The edge around all three segments will light up

The additional range achieved as a result of your driving style in comparison with a driver with a very sporty driving style will be shown in the center of display ④. The range displayed does not indicate a fixed reduction in consumption.

ECO Assist function

Vehicles with a 48 V on-board electrical system (EQ Boost technology):

ECO Assist analyzes data for the vehicle's expected route. This allows the system to optimally adjust the driving style for the route ahead, save fuel and recuperate. If the system detects an event ahead (e.g. a speed limit or a traffic circle), it will appear on the multifunction display. The following symbols can be displayed:

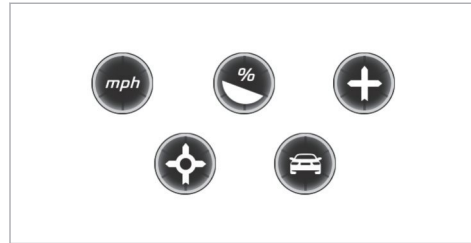

Examples of an event ahead

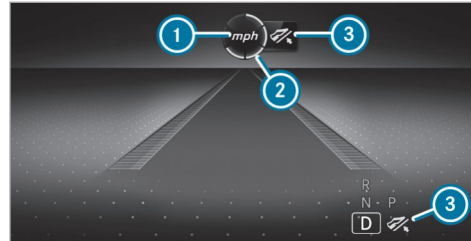

- ① Event ahead
- ② Distance to the event ahead
- ③ "Foot off the accelerator" prompt

The number of segments shown ② changes depending on the distance to the event ahead:

- A few segments: the event ahead is near.
- Many segments: the event ahead is further away.

When the vehicle nears the event, ECO Assist will calculate the optimal speed for maximum fuel economy and recuperative energy based on the distance, speed and downhill gradient. **Foot off the Accelerator** message ③ appears in the multifunction display. The first segments in front of the vehicle will turn green. The remaining segments will initially stay white. If the driver lifts off the accelerator pedal in good time, the remaining segments on the display will successively turn green until the event shown is reached. The drivetrain will be set for maximum fuel economy. Recuperation will charge the battery. Recuperation will be adapted to the selected drive program.

The event will be shown for a short time after it has been passed. If there is no response to the **Foot off the Accelerator** prompt, the segments will remain white.

If the event involves a vehicle in front, all segments will immediately turn green once there is a response to the **Foot off the Accelerator** prompt.

For active ECO Assist in drive program **E**, symbol **3** will appear on the multifunction display and on the head-up display beside transmission position **D**. Symbol **3** will also appear when the assistant display is not selected.

If the system does not intervene during the event ahead, nothing will be displayed. The system is passive.

ECO Assist is active only in drive programs **E** and **C**.

System limits

ECO Assist can function even more precisely if the route is adhered to when route guidance is active. The basic function is also available without active route guidance. Not all information and traffic situations can be foreseen. The quality depends on the map data.

ECO Assist is only an aid. The driver is responsible for keeping a safe distance from the vehicle in front, for vehicle speed and for braking in

good time. The driver must be ready to brake at all times irrespective of whether the system intervenes.

The system may be impaired or may not function in the following situations:

- If visibility is poor (e.g. due to insufficient illumination of the road, highly variable shade conditions, rain, snow, fog or heavy spray).
- If there is glare (e.g. from oncoming traffic, direct sunlight or reflections).
- If there is dirt on the windshield in the vicinity of the multifunction camera or the camera is fogged up, damaged or obscured.
- If traffic signs are hard to discern (e.g. due to dirt, snow or insufficient lighting, or because they are obscured).
- If the information on the navigation system's digital map is incorrect or out of date.
- If the signs are ambiguous, e.g. traffic signs in roadworks or in adjacent lanes.

DYNAMIC SELECT switch

Function of the DYNAMIC SELECT switch

Mercedes-AMG vehicles: observe the notes in the Supplement. Otherwise, you may fail to recognize dangers.

Depending on the engine and equipment, the vehicle has different drive programs.

Use the DYNAMIC SELECT switch to change between the following drive programs:

I* **(Individual):** individual settings

S* **(Sport +):** particularly sporty driving style

S **(Sport):** sporty driving style

C **(Comfort):** comfortable and economical driving style

E **(Eco):** particularly economical driving style

CV **(CURVE):** comfortable driving with curve inclination function (vehicles with E-ACTIVE BODY CONTROL)

 **(Offroad):** driving on less demanding off-road terrain

 **(Offroad +):** driving on difficult off-road terrain

i The drive program selected appears in the multifunction display of the on-board computer.

Depending on the drive program, the following systems change their characteristics:

- Drive
 - Engine and transmission management
 - Active Distance Assist DISTRONIC
- ESP®
- **Vehicles with AIRMATIC or E-ACTIVE BODY CONTROL:**
 - Suspension tuning
 - Vehicle level
- Electric power steering

Notes on the roof load display

Certain drive programs and ESP® settings are unsuitable for transporting a roof load.

If one of these drive programs is set or selected,

 the symbol is shown as a warning. When this symbol is shown, the selected drive program is not suitable for transporting a load on the roof.

The following drive programs are affected:

- **Sport** drive program
 - **Sport +** drive program
 - **Individual** drive program with the ESP® setting Sport or Sport+
- i** The symbol is also shown in the following situations:
- Within the themes if a corresponding drive program is saved
For more information on themes see (→ page 330).
 - Within the reset display if the previously active drive program is unsuitable for the transport of a roof load
For further information on the reset display, see (→ page 178).

Selecting the drive program

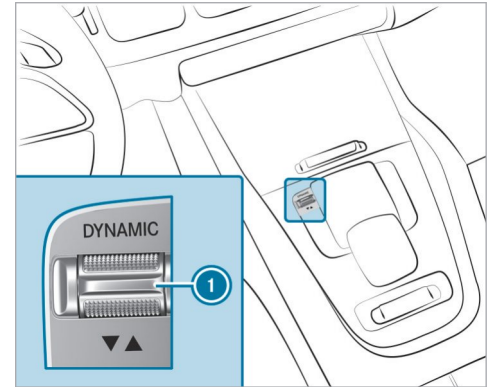

- ▶ Press DYNAMIC SELECT switch **1** forwards or backwards.
The drive program selected appears in the multifunction display.

Configuring DYNAMIC SELECT (multimedia system)

Multimedia system:

-  » Settings » Vehicle
- » DYNAMIC SELECT

Setting drive program I

- ▶ Select [Individual Config.](#).
- ▶ Select and set a category.

Switching the reset display on/off

- ▶ Switch [Request at Start](#) on or off.

Function on: the next time the vehicle is started a prompt appears asking whether the last active drive program should be restored. If the ECO start/stop function was deactivated, an additional prompt appears asking if the function should remain deactivated.

- ⓘ The prompt appears only if the previously active settings deviate from the standard settings.

Function off: the next time the vehicle is started the  drive program is set automatically.

The ECO start/stop function is activated automatically.

- ⓘ This function must be activated for each user profile separately. Only when this function is activated will the drive program and Eco start/stop setting for the previous journey be saved for the respective user profile.

Displaying vehicle data

Multimedia system:

-  » Info

- ▶ Select [Vehicle](#).
- ▶ The vehicle data is displayed.

Displaying engine data

Multimedia system:

-  » Info

- ▶ Select [Engine](#).
- ▶ The engine data is displayed.

- ⓘ The actual (maximum) values that can be achieved for engine output and engine torque may deviate from the certified values

within the country-specific guidelines for permissible tolerances (basis: UN-ECE No. 85 or country-specific guidelines).

Factors that can influence this are, for example:

- Sea level
- Fuel grade
- Outside temperature

- ⓘ The values displayed serve only as orientation. The values for engine output and engine torque shown in the media display may deviate from the actual values.

Calling up fuel consumption indicator

Multimedia system:

-  » Info

- ▶ Select [Consumption](#).
- ▶ The current and average fuel consumption is displayed.

Automatic transmission

DIRECT SELECT lever

Function of the DIRECT SELECT lever

⚠ WARNING Risk of accident due to incorrect gearshifting

If the engine speed is higher than the idle speed and you engage the transmission position **D** or **R**, the vehicle may accelerate sharply.

▶ If you engage the transmission position **D** or **R** when the vehicle is at a standstill, always depress the brake pedal firmly and do not accelerate at the same time.

⚠ WARNING Risk of accident and injury due to children left unattended in the vehicle

If children are left unattended in the vehicle, they could:

- Open doors, thereby endangering other persons or road users.
- Get out and be struck by oncoming traffic.
- Operate vehicle equipment and become trapped, for example.

In addition, the children could also set the vehicle in motion, for example by:

- Releasing the parking brake.
- Changing the transmission position.
- Starting the vehicle.

▶ Never leave children unattended in the vehicle.

▶ When leaving the vehicle, always take the key with you and lock the vehicle.

▶ Keep the vehicle key out of reach of children.

Use the DIRECT SELECT lever to shift the transmission position. The current transmission position is displayed in the multifunction display.

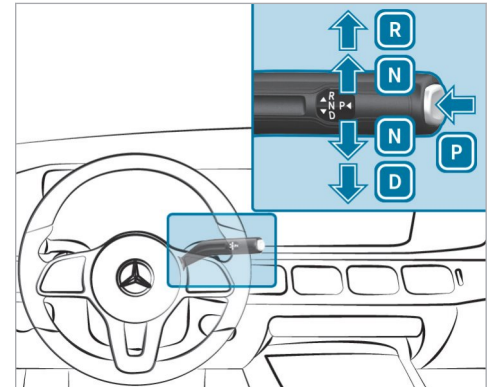

P Park position

R Reverse gear

N Neutral

D Drive position

Engaging reverse gear R

- ▶ Depress the brake pedal and push the DIRECT SELECT lever upwards past the first point of resistance.
The transmission position display **R** is shown in the multifunction display.

Engaging neutral N

- ▶ Depress the brake pedal and push the DIRECT SELECT lever up or down to the first point of resistance.
The transmission position display **N** is shown in the multifunction display.

Subsequently releasing the brake pedal will allow you to move the vehicle freely, e.g. to push it or tow it away.

Proceed as follows if you want the automatic transmission to remain in neutral **N even if the ignition is switched off or the driver's door is opened:**

- ▶ Start the vehicle.

- ▶ Depress the brake pedal and engage neutral **N** when the vehicle is stationary.
The **N Permanently Active Risk of Rolling Away** message appears in the instrument cluster.
- ▶ Release the brake pedal.
- ▶ Switch the ignition off.
- ⓘ If you then exit the vehicle leaving the SmartKey in the vehicle, the automatic transmission remains in neutral **N**.

The park position **P** is automatically re-engaged if one of the following conditions is met:

- You switch to transmission position **D** or **R**.
- You press the **P** button.

Engaging park position P

- ▶ Observe the notes on parking the vehicle (→ page 186).
- ▶ Depress the brake pedal until the vehicle is stationary.

- ▶ When the vehicle is stationary, press the **P** button.
Park position is only engaged when the transmission position display **P** is shown in the multifunction display. If no transmission position display **P** appears, secure the vehicle to prevent it from rolling away.
- ⓘ Depending on the situation, it may take some time until **P** is engaged. Therefore, always pay attention to the transmission position display.

Park position **P** is engaged automatically if one of the following conditions is met:

- You switch off the ignition when the vehicle is stationary and the transmission is in position **D** or **R**.
- You open the driver's door when the vehicle is stationary or when driving at a very low speed and the transmission is in position **D** or **R**.
- You switch off the engine and bring the vehicle to a standstill when the vehicle is rolling and the transmission is in position **D** or **R**.

- You switch off the engine, bring the vehicle to a standstill and open the driver's door when the vehicle is stationary or when the vehicle is rolling and the transmission is in position **N**.
 - Engaging park position **P** automatically is required by the vehicle.
- i** To maneuver with an open driver's door, open the driver's door while stationary and engage transmission position **D** or **R** again.

Engaging drive position D

- Depress the brake pedal and push the DIRECT SELECT lever down past the first point of resistance.
The transmission position display **D** is shown in the multifunction display.

When the automatic transmission is in transmission position **D**, it shifts the gears automatically. This depends, among other things, on the following factors:

- The selected drive program
- The position of the accelerator pedal
- The driving speed

Manual gearshifting

⚠ WARNING Risk of skidding and of an accident due to shifting down on slippery road surfaces

If you shift down on slippery road surfaces to increase the engine braking effect, the drive wheels may lose traction.

- Do not shift down on slippery road surfaces to increase the engine braking effect.

Permanent setting (vehicles with Offroad package or E-Active Body Control)

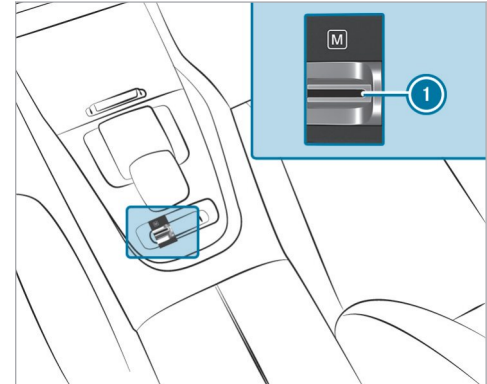

- To activate/deactivate:** pull rocker switch **1**.
If indicator lamp is lit, manual gearshifting is activated. The current gear is displayed in the multifunction display.

Temporary setting

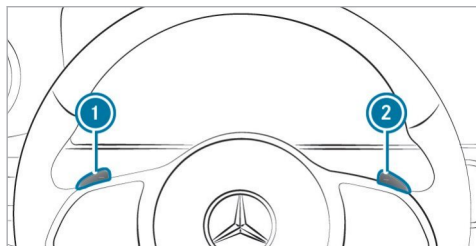

- ▶ **To activate:** pull steering wheel gearshift paddle ① or ②. Manual gearshifting is activated for a short time. Transmission position **M** and the current gear appear in the multifunction display.
 - ▶ **To deactivate:** pull steering wheel gearshift paddle ② and hold it in place. The transmission position **D** appears in the multifunction display.
- ① To permanently shift the gears manually in drive program **D** using the steering wheel gearshift paddles, select the **M** (manual) setting for the transmission.

Gearshifting

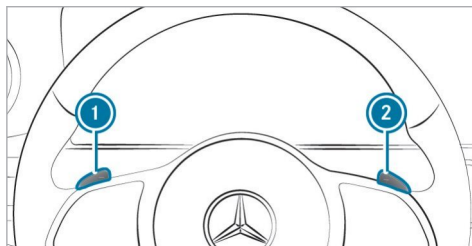

- ▶ **To shift up:** pull steering wheel gearshift paddle ②.
- ▶ **To shift down:** pull steering wheel gearshift paddle ①.

Mercedes-AMG vehicles: observe the notes in the Supplement. Otherwise, you may fail to recognize dangers.

Gearshift recommendation

Mercedes-AMG vehicles: observe the notes in the Supplement. Otherwise, you may fail to recognize dangers.

The gearshift recommendation assists you in adopting an economical driving style.

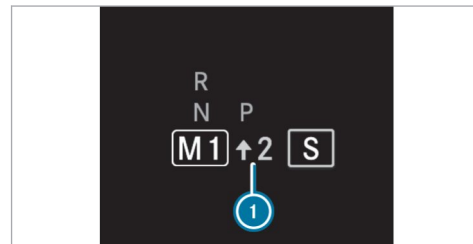

- ▶ If gearshift recommendation message ① is shown on the multifunction display, shift to the recommended gear.

Using kickdown

Mercedes-AMG vehicles: observe the notes in the Supplement. Otherwise, you may fail to recognize dangers.

- ▶ **Maximum acceleration:** depress the accelerator pedal beyond the pressure point.

The automatic transmission shifts up to the next gear when the maximum engine speed is reached to protect the engine from overrevving.

Glide mode function

Mercedes-AMG vehicles: observe the notes in the Supplement. Otherwise, you may fail to recognize dangers.

With an anticipatory driving style, glide mode helps you to reduce fuel consumption.

Glide mode is characterized by the following:

- The combustion engine is disconnected from the drivetrain and continues to run in neutral.
- The transmission position **D** is displayed in green in the multifunction display.
- **Vehicles with 48 V on-board electrical system (EQ-Boost technology):** the engine can be switched off. All of the vehicle functions remain active.

Glide mode is activated if the following conditions are met:

- Drive program **E** is selected.

- The speed is within a suitable range.
- The road's course is suitable, e.g. no steep uphill or downhill inclines or tight bends.
- There is no trailer coupled to the trailer hitch, and no bicycle rack installed.
- You do not depress the accelerator or brake pedal (except for light brake applications).

i Glide mode can also be activated if you have selected the "Eco" setting for the drive in the drive program **T**.

Glide mode is deactivated again if one of the conditions is no longer met.

Glide mode can also be prevented by the following parameters:

- Incline
- Downhill gradient
- Temperature
- Height
- Speed
- Operating status of the engine
- Traffic situation

Function of 4MATIC

4MATIC ensures that all four wheels are driven when needed. Together with ESP® and 4ETS, 4MATIC improves the traction of your vehicle whenever a driven wheel spins due to insufficient traction.

If you fail to adapt your driving style, 4MATIC can neither reduce the risk of an accident nor override the laws of physics. 4MATIC cannot take account of road, weather and traffic conditions. 4MATIC is only an aid. You are responsible especially for maintaining a safe distance from the vehicle in front, for vehicle speed, for braking in good time and for staying in lane.

i In wintry road conditions, the maximum effect of 4MATIC can be achieved only if you use winter tires (M+S tires), with snow chains if necessary.

Refueling

Refueling the vehicle

⚠ WARNING Risk of fire or explosion from fuel

Fuels are highly flammable.

- ▶ Fire, open flames, smoking and creation of sparks must be avoided.
- ▶ Switch off the ignition and, if available, the stationary heater, before and while refueling the vehicle.

⚠ WARNING Risk of injury from fuels

Fuels are poisonous and hazardous to your health.

- ▶ Do not swallow fuel or let it come into contact with skin, eyes or clothing.
- ▶ Do not inhale fuel vapor.
- ▶ Keep children away from fuel.
- ▶ Keep doors and windows closed during the refueling process.

If you or other people come into contact with fuel, observe the following:

- ▶ Immediately rinse fuel off your skin with soap and water.
- ▶ If fuel comes into contact with your eyes, immediately rinse them thoroughly with clean water. Seek medical attention immediately.
- ▶ If you swallow fuel, seek medical attention immediately. Do not induce vomiting.
- ▶ Change immediately out of clothing that has come into contact with fuel.

⚠ WARNING Risk of fire and explosion due to electrostatic charge

Electrostatic charge can create sparks and thereby ignite fuel vapors.

- ▶ Before you open the fuel filler cap or take hold of the pump nozzle, touch the metallic vehicle body. This discharges any electrostatic charge that may have built up.
- ▶ Do not get into the vehicle again during the refueling process. Otherwise, electrostatic charge can build up again.

! NOTE Damage caused by the wrong fuel

Vehicles with a gasoline engine:

Even small amounts of the wrong fuel could result in damage to the fuel system, the engine and the emission control system.

- ▶ The RON requirement is located in the fuel filler flap.
- ▶ Only refuel with low-sulfur unleaded fuel.

This fuel may contain up to 10% ethanol. Your vehicle is suitable for use with E10 fuel.

Never refuel using any of the following fuels:

- Diesel
- Gasoline with more than 10% ethanol by volume, e.g. E15, E85, E100
- Gasoline with more than 3% methanol by volume, e.g. M15, M30, M85, M100
- Gasoline with additives containing metal

If you accidentally refuel with the wrong fuel:

- ▶ Do not switch the ignition on.
- ▶ Consult a qualified specialist workshop.

! **NOTE** Do not use diesel to refuel vehicles with a gasoline engine

If you have accidentally refueled with the wrong fuel:

- Do not switch the ignition on. Otherwise fuel can enter the engine.
- Even small amounts of the wrong fuel could result in damage to the fuel system and the engine. The repair costs are high.

- ▶ Consult a qualified specialist workshop.
- ▶ Have the fuel tank and fuel lines drained completely.

! **NOTE** Damage to the fuel system caused by overfilled fuel tanks

- ▶ Only fill the fuel tank until the pump nozzle switches off.

If you have added too much fuel because of a defective filling pump, for instance:

- ▶ Do not switch the ignition on.
- ▶ Consult a qualified specialist workshop.

! **NOTE** Fuel may spray out when you remove the fuel pump nozzle

- ▶ Only fill the fuel tank until the pump nozzle switches off.

Requirements

- The vehicle is unlocked (→ page 68).

- ⓘ Do not get into the vehicle again during the refueling process. Otherwise, electrostatic charge could build up again.

Observe the notes on operating fluids (→ page 529).

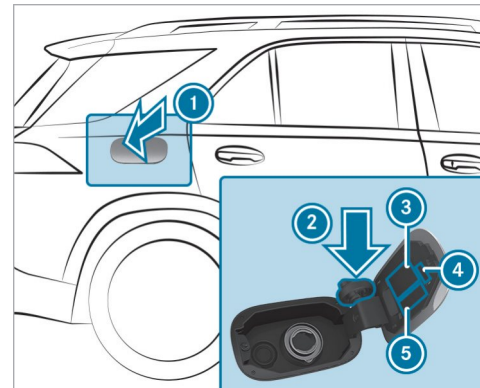

- ① Fuel filler flap
- ② Bracket for fuel filler cap
- ③ Tire pressure table

④ QR code for rescue card

⑤ Fuel type

- ▶ Press on the back area of fuel filler flap ①.
- ▶ Turn the fuel filler cap counter-clockwise and remove it.
- ▶ Insert the fuel filler cap from above into bracket ②.
- ▶ Completely insert the pump nozzle into the tank filler neck, hook in place and refuel.
- ▶ Only fill the fuel tank until the pump nozzle switches off.
- ▶ Replace the cap on the filler neck and turn clockwise until it engages audibly.
- ▶ Close fuel filler flap ①.
- ① Close the fuel filler flap before locking the vehicle.

Parking

Parking the vehicle

⚠ WARNING Risk of accident and injury caused by an insufficiently secured vehicle rolling away.

If the vehicle is not securely parked sufficiently, it can roll away in an uncontrolled way even at a slight downhill gradient.

- ▶ Ensure that the parked vehicle is always properly secured against rolling away as follows:
 - On uphill or downhill gradients, turn the front wheels so that the vehicle rolls towards the curb if it starts moving.
 - Apply the parking brake.
 - Switch the transmission to position **P**.

⚠ WARNING Risk of fire caused by hot exhaust system parts

Flammable material such as leaves, grass or twigs may ignite if they come into contact with hot parts of the exhaust system or exhaust gas flow.

- ▶ Park the vehicle so that no flammable material can come into contact with hot vehicle components.
- ▶ In particular, do not park on dry grass-land or harvested grain fields.

⚠ WARNING Risk of accident and injury due to children left unattended in the vehicle

If children are left unattended in the vehicle, they could:

- Open doors, thereby endangering other persons or road users.
- Get out and be struck by oncoming traffic.

- Operate vehicle equipment and become trapped, for example.

In addition, the children could also set the vehicle in motion, for example by:

- Releasing the parking brake.
- Changing the transmission position.
- Starting the vehicle.

- ▶ Never leave children unattended in the vehicle.
- ▶ When leaving the vehicle, always take the key with you and lock the vehicle.
- ▶ Keep the vehicle key out of reach of children.

! **NOTE** Damage to the vehicle due to it rolling away

- ▶ Always secure the vehicle against rolling away.

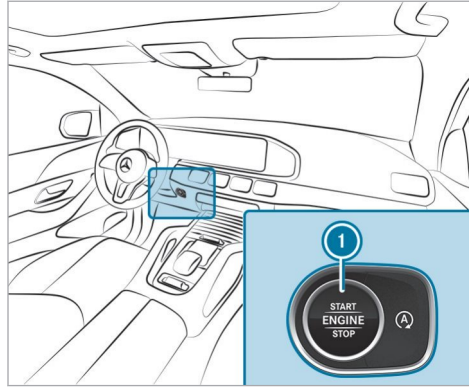

- ▶ Bring the vehicle to a standstill by applying the brake pedal.
- ▶ On uphill or downhill gradients, turn the front wheels so that the vehicle rolls towards the curb if it starts moving.
- ▶ Apply the electric parking brake.

- ▶ Engage transmission position **P** in a stationary vehicle with the brake pedal applied (→ page 180).
- ▶ Switch off the engine and the ignition by pressing button **1**.
- ▶ Release the service brake slowly.
- ▶ Get out of the vehicle and lock it.
- i** When you park the vehicle, you can still operate the side windows and the panoramic sliding sunroof for approximately five minutes if the driver's door is closed.
- i** When you park the vehicle, you can still operate the side windows and the sliding sunroof for approximately five minutes if the driver's door is closed.

Garage door opener

Programming buttons for the garage door opener

⚠ DANGER Risk death caused by exhaust gases

Combustion engines emit poisonous exhaust gases such as carbon monoxide. Inhaling these exhaust gases is hazardous to health and leads to poisoning.

- ▶ Never leave the engine or, if present, the auxiliary heating running in an enclosed space without sufficient ventilation.

⚠ WARNING Risk of injury when opening or closing a door with the garage door opener

When you operate or program the door with the integrated garage door opener, people in the range of movement of the door may become trapped or struck by the door.

- ▶ When using the integrated garage door opener, always make sure that nobody is within the range of movement of the door.

Only operate the following doors using the garage door opener:

- Doors with a safety stop and reversing feature.
- Doors which conform to the current U.S. safety standards.

Requirements:

- The vehicle has been parked outside the garage or outside the range of movement of the door.
- The engine is switched off.
- The ignition is switched on.

- ⓘ The garage door opener function is always available when the ignition is switched on.

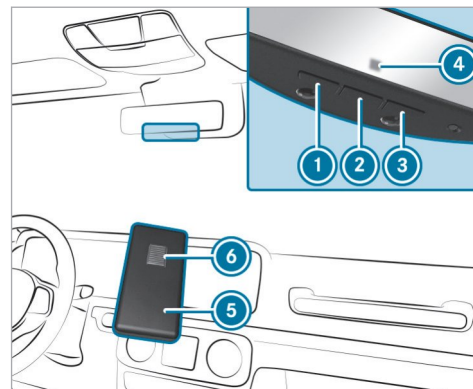

- ▶ Check if the transmission frequency of the remote control has the frequency range of 280 to 868 MHz.

Radio equipment approval number:

- NZLMUAHL5 (USA)
- 4112A-MUAHL5 (Canada)

- ▶ Press and hold button ①, ② or ③ that you wish to program.
Indicator lamp ④ flashes yellow.
- ⓘ It can take up to 20 seconds before the indicator lamp flashes yellow.
- ▶ Release the previously pressed button.
Indicator lamp ④ continues to flash yellow.
- ▶ Point remote control ⑤ from a distance of 0.4 in (1 cm) to 3 in (8 cm) towards button ①, ② or ③.
- ▶ Press and hold button ⑥ of remote control ⑤ until one of the following signals appears:
 - Indicator lamp ④ lights up green continuously. Programming is complete.
 - Indicator lamp ④ flashes green. Programming was successful. Additionally, synchronization of the rolling code with the door system must also be carried out.
- ▶ If indicator lamp ④ does not light up or flash green: repeat the procedure.
- ▶ Release all of the buttons.

- ⓘ The remote control for the door drive is not included in the scope of delivery of the garage door opener.

Synchronizing the rolling code Requirements:

- The door system uses a rolling code.
- The vehicle must be within range of the garage door or door drive.
- The vehicle as well as persons and objects, are located outside the range of movement of the door.

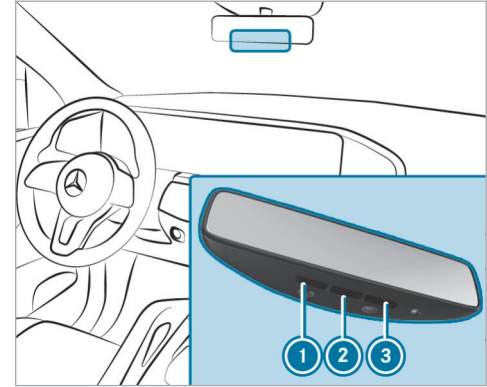

- ▶ Press the programming button on the door drive unit.
Initiate the next step within approximately 30 seconds.
- ▶ Press previously programmed button ①, ② or ③ repeatedly until the door closes.
When the door closes, programming is complete.

- Please also read the operating instructions for the door drive.

Troubleshooting when programming the remote control

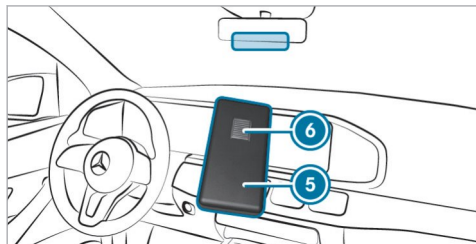

- Check if the transmitter frequency of remote control ⑤ is supported.
- Replace the batteries in remote control ⑤.
- Hold remote control ⑤ at various angles from a distance of 0.4 in (1 cm) to 3 in (8 cm) in front of the inside rearview mirror. You should test every position for at least 25 seconds before trying another position.

- Hold remote control ⑤ at the same angles at various distances in front of the inside rearview mirror. You should test every position for at least 25 seconds before trying another position.
- Note that some remote controls transmit only for a limited period, press button ⑥ on remote control ⑤ again before transmission ends.
- Align the antenna line of the door opener unit with the remote control.
- Support and additional information on programming:

- On the toll free HomeLink® Hotline on 1-800-355-3515.
- On the Internet at <https://www.homelink.com/mercedes>.

Opening or closing the door Requirements:

- The corresponding button is programmed to operate the door.

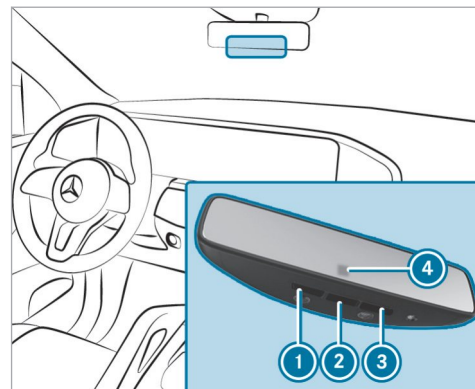

- Press and hold buttons ①, ② or ③ until the door opens or closes.
- If indicator lamp ④ flashes yellow after approximately 20 seconds: press and hold the previously pressed button again until the door opens or closes.

Clearing the garage door opener memory

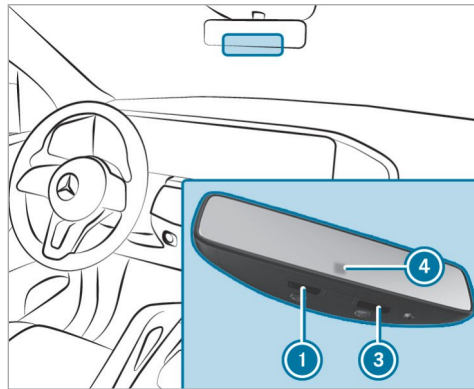

- ▶ Press and hold buttons ① and ③.
- ▶ Indicator lamp ④ lights up yellow.
- ▶ If indicator lamp ④ flashes green: release buttons ① and ③.
- ▶ The entire memory has been deleted.

Radio equipment approval numbers for the garage door opener

Radio equipment approval numbers



Brazil

Este equipamento opera em caráter secundário, isto é, não tem direito à proteção contra interferência prejudicial, mesmo de estações do mesmo tipo, e não pode causar interferência a sistemas operando em caráter primário.

Para maiores informações acessar www.anatel.gov.br

Radio equipment approval numbers

Country	Radio type approval number
Egypt	TAC.2511151293.WIR
Andorra	CE
Australia	R-NZ
Barbados	MED1578
Chile	2488/DFRS20576/F-74
European Union	CE
Gibraltar	CE
Iceland	CE
Jordan	TRC/LPD/2015/299
Canada	IC: 4112A-MUAHL5
Kuwait	CE
Liechtenstein	CE

Country	Radio type approval number
Mexico	RCPGEMU15-0448
Monaco	CE
New Zealand	R-NZ
Norway	CE
Russian Federation	Not required
Saudi Arabia	TA 10525
Switzerland	CE
South Africa	 TA-2015/1386
Turkey	Not required

Country	Radio type approval number
United Arab Emirates	ER41849/15 Dealer No: DA35176/14
United States	FCC ID: NZLMUAHL5

Further information on the declaration of conformity for wireless vehicle components (→ page 27).

Electric parking brake

Electric parking brake function (applying automatically)

⚠ WARNING Risk of accident and injury due to children left unattended in the vehicle

If children are left unattended in the vehicle, they could:

- Open doors, thereby endangering other persons or road users.
- Get out and be struck by oncoming traffic.
- Operate vehicle equipment and become trapped, for example.

In addition, the children could also set the vehicle in motion, for example by:

- Releasing the parking brake.
- Changing the transmission position.
- Starting the vehicle.

- ▶ Never leave children unattended in the vehicle.
- ▶ When leaving the vehicle, always take the key with you and lock the vehicle.
- ▶ Keep the vehicle key out of reach of children.

The electric parking brake is applied if the transmission is in position **P** and one of the following conditions is fulfilled:

- The engine is switched off.
- The seat belt tongue is not inserted in the seat belt buckle of the driver's seat and the driver's door is opened.
- The transfer case is in the **LOW RANGE** position.

i To prevent application: pull the handle of the electric parking brake.

In the following situations, the electric parking brake is also applied:

- Active Distance Assist DISTRONIC is bringing the vehicle to a standstill.

- The HOLD function is keeping the vehicle stationary.
- Active Parking Assist is keeping the vehicle stationary.

This is the case if one of the following conditions is also fulfilled:

- The engine is switched off.
- The seat belt tongue is not inserted in the seat belt buckle of the driver's seat and the driver's door is opened.
- There is a system malfunction.
- The power supply is insufficient.
- The vehicle is stationary for a lengthy period.

When the electric parking brake is applied, the red **PARK** (USA) or **(P)** (Canada) indicator lamp appears in the instrument cluster.

The electric parking brake is not automatically applied if the engine is switched off by the ECO start/stop function.

Electric parking brake function (releasing automatically)

The electric parking brake is released when the following conditions are fulfilled:

- The driver's door is closed.
- The engine is running.
- The transmission is in position **D** or **R** and you depress the accelerator pedal or you shift from transmission position **P** to **D** or **R** when on level ground with the driver's door closed.
- If the transmission is in position **R**, the tail-gate must be closed.
- The seat belt tongue is inserted into the seat belt buckle of the driver's seat.

If the seat belt tongue is not inserted into the seat belt buckle of the driver's seat, the following conditions must be fulfilled:

- You shift from transmission position **P**.
- You have previously driven at speeds greater than 2 mph (3 km/h).

When the electric parking brake is released, the red **PARK** (USA) or **(P)** (Canada) indicator lamp in the instrument cluster goes out.

Applying/releasing the electric parking brake manually

Applying

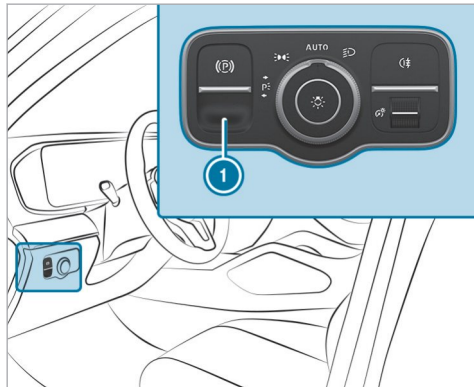

- ▶ Push handle ①.

The red **PARK** (USA) or **(P)** (Canada) indicator lamp appears in the instrument cluster.

- ① The electric parking brake is only securely applied if the indicator lamp is lit continuously.

Releasing

- ▶ Switch on the ignition.

- ▶ Pull handle ①.

The red **PARK** (USA) or **(P)** (Canada) indicator lamp in the instrument cluster goes out.

Emergency braking

- ▶ Press and hold handle ①.

As long as the vehicle is driving, the **Please Release Parking Brake** message is displayed.

When the vehicle has been braked to a standstill, the electric parking brake is applied. The red **PARK** (USA) or **(P)** (Canada) indicator lamp appears in the instrument cluster.

Information on detecting damage on a parked vehicle

If a collision is detected when the tow-away alarm is armed on a locked vehicle, you will receive a notification in the multimedia system when you switch on the ignition.

You will receive information about the following points:

- The area of the vehicle that may have been damaged.
- The force of the impact.

The following situations can lead to inadvertent activation:

- The parked vehicle is moved, e.g. in a two-story garage.

- ① Deactivate the tow-away alarm in order to prevent inadvertent activation. If you deactivate the tow-away alarm, damage detection will also be deactivated.

- ⓘ In the case of severe battery discharging, the function for detecting damage on a parked vehicle is automatically deactivated to facilitate the next engine start.

System limits

Detection may be restricted in the following situations:

- The vehicle is damaged without impact, e.g. if an outside mirror is torn off or the paint is damaged by a key.
- Impact occurs at low speed.
- The electric parking brake is not applied.

Notes on parking the vehicle for an extended period

If you leave the vehicle parked for longer than six weeks, it may suffer damage through disuse.

The 12 V battery may also be impaired or damaged by heavy discharging.

- ⓘ Further information can be obtained at a qualified specialist workshop.

Standby mode (extension of the starter battery's period out of use)

Standby mode function

ⓘ This function is not available for all models. If standby mode is activated, energy loss will be minimized during extended periods of non-operation.

Standby mode is characterized by the following:

- the starter battery is preserved.
- the maximum non-operational time appears in the media display.
- the connection to online services is interrupted.
- the ATA (anti-theft alarm system) is not available.
- the interior motion sensor and tow-away alarm functions are not available.
- the function for detecting damage on a parked vehicle is not available.

If the following conditions are fulfilled, standby mode can be activated or deactivated using the multimedia system:

- the engine is switched off.
- the ignition is switched on.

Exceeding the vehicle's displayed non-operational time may cause inconvenience, i.e. it cannot be guaranteed that the starter battery will reliably start the engine.

The starter battery must be charged first in the following situations:

- The vehicle's non-operational time must be extended.
- The **Battery Charge Insufficient for Standby Mode** message appears in the media display.

ⓘ Standby mode is automatically deactivated when the ignition is switched on.

Activating/deactivating standby mode (parking the vehicle for an extended period) Requirements:

- The engine is switched off.

Multimedia system:

→  → Settings → Vehicle

- ▶ Switch **Standby Mode** on or off. When you activate the function, a prompt appears.
- ▶ Select **Yes**. Standby mode is activated.

Driving and driving safety systems

Driving systems and your responsibility

Your vehicle is equipped with driving systems which assist you in driving, parking and maneuvering the vehicle. The driving systems are aids and do not relieve you of your responsibility pertaining to road traffic law. Pay attention to the traffic conditions at all times and intervene when necessary. Be aware of the limitations regarding the safe use of these systems.

Information on radar and ultrasonic sensors

Some driving and driving safety systems use radar or ultrasonic sensors to monitor the area

in front of, behind or next to the vehicle (depending on the vehicle's equipment).

Depending on the vehicle's equipment, the radar sensors are integrated behind the bumpers and/or behind the Mercedes star. The ultrasonic sensors are located in the front and rear bumpers. Keep these parts free of dirt, ice and slush (→ page 467). The sensors must not be covered, for example by bicycle racks, overhanging loads, stickers, foil or foils to protect against stone chipping. Additional license plate brackets can likewise impair the function of the ultrasonic sensors. In the event of damage to the bumpers or radiator grill, or following a collision impacting the bumpers or radiator grill, have the function of the sensors checked at a qualified specialist workshop. If the sensors are damaged, some driving systems and driving safety systems may no longer function properly.

Overview of driving systems and driving safety systems

In this section, you will find information about the following driving systems and driving safety systems:

- 360° Camera (→ page 256)
- ABS (**A**nti-**l**ock **B**raking **S**ystem) (→ page 197)
- Active Distance Assist DISTRONIC (→ page 213)
- AIRMATIC (→ page 228)
- Active Brake Assist (→ page 203)
- Active Lane Keeping Assist (→ page 272)
- Start-off assist
- ATTENTION ASSIST (→ page 265)
- BAS (**B**rake **A**ssist **S**ystem) (→ page 198)
- Hill Start Assist (→ page 226)
- DSR (**D**ownhill **S**peed **R**egulation) (→ page 211)
- E-ACTIVE BODY CONTROL (→ page 236)

- EBD (**E**lectronic **B**rakeforce **D**istribution) (→ page 203)
- ESP® (**E**lectronic **S**tability **P**rogram) (→ page 198)
- Off-road ESP® (→ page 201)
- ESP® Crosswind Assist (→ page 202)
- ESP® trailer stabilization (→ page 202)
- Active Speed Limit Assist (→ page 217)
- HOLD function (→ page 227)
- STEER CONTROL (→ page 203)
- Active Steering Assist with rescue lane function (→ page 220)
- Active Emergency Stop Assist (→ page 223)
- Active Parking Assist (→ page 259)
- Parking Assist PARKTRONIC (→ page 247)
- Rear view camera (→ page 252)
- Active Lane Change Assist (→ page 222)
- Active Traffic Jam Assist (→ page 224)
- Cruise control (→ page 209)

- Blind Spot Assist and Active Blind Spot Assist with exit warning (→ page 269)
- Traffic Sign Assist (→ page 267)

Function of ABS

The Anti-lock Brake System (ABS) regulates the brake pressure in critical driving situations:

- During braking, e.g. at full brake application or insufficient tire traction, the wheels are prevented from locking.
- Vehicle steerability while braking is ensured.



If ABS intervenes when braking, you will feel a pulsing in the brake pedal. The pulsating brake pedal can be an indication of hazardous road conditions and can serve as a reminder to take extra care while driving.

System limits

- ABS is active from speeds of approx. 5 mph (8 km/h).
- ABS may be impaired or may not function if a malfunction has occurred and the yellow  ABS warning lamp lights up contin-

uously in the instrument cluster after the engine is started.

Functions of Off-road ABS

 Off-road ABS is activated automatically when you select the  or  drive program.

Off-road ABS is specially adapted for driving off-road:

- The front wheels lock cyclically during braking.
- The braking distance is shortened due to the digging-in effect.

System limits

- Off-road ABS functions at speeds below 25 mph (40 km/h).
- If Off-road ABS intervenes, the ability to steer may be restricted.

Function of BAS (Brake Assist System)

⚠ WARNING Risk of an accident caused by a malfunction in BAS (Brake Assist System)

If BAS is malfunctioning, the braking distance in an emergency braking situation is increased.

- ▶ Depress the brake pedal with full force in emergency braking situations. ABS prevents the wheels from locking.

BAS supports your emergency braking situation with additional brake force.

If you depress the brake pedal quickly, BAS is activated:

- BAS automatically boosts the brake pressure.
- BAS can shorten the braking distance.
- ABS prevents the wheels from locking.

The brakes will function as usual once you release the brake pedal. BAS is deactivated.

Functions of ESP® (Electronic Stability Program)

⚠ WARNING Risk of skidding if ESP® is malfunctioning

If ESP® is malfunctioning, ESP® cannot carry out vehicle stabilization. In addition, other driving safety systems are switched off.

- ▶ Drive on carefully.
- ▶ Have ESP® checked at a qualified specialist workshop.

⚠ WARNING Risk of skidding if ESP® is deactivated

If you deactivate ESP®, ESP® cannot carry out vehicle stabilization.

- ▶ ESP® should only be deactivated in the following situations.

ESP® can monitor and improve driving stability and traction in the following situations, within physical limits:

- When pulling away on wet or slippery roadways.
- When braking.
- **Vehicles with trailer hitch:** in trailer operation from speeds of 40 mph (65 km/h), if the vehicle/trailer combination begins to sway from side to side.
- In strong side winds when you are driving faster than 47 mph (75 km/h).

If the vehicle deviates from the direction desired by the driver, ESP® can stabilize the vehicle by intervening in the following ways:

- One or more wheels are braked.
- The engine output is adapted according to the situation.

ESP® is deactivated if the  ESP® OFF warning lamp lights up continuously in the instrument cluster:

- Driving stability will no longer be improved.

- **Vehicles with trailer hitch:** stabilization of the vehicle/trailer combination is no longer active.
 - Crosswind Assist is no longer active.
 - The drive wheels could spin.
 - ETS/4ETS traction control is still active.
- i** When ESP® is deactivated, you are still assisted by ESP® when braking.

If the  ESP® warning lamp flashes in the instrument cluster, one or several vehicle wheels has reached its grip limit:

- Adapt your driving style to suit the current road and weather conditions.
- Do not deactivate ESP®.
- Only depress the accelerator pedal as far as is necessary when pulling away.

It can be advantageous to deactivate ESP® in the following situations to improve traction:

- When using snow chains.
 - In deep snow.
 - On sand or gravel.
- i** Spinning the wheels results in a cutting action, which enhances traction.



If the  ESP® warning lamp lights up continuously, ESP® is not available due to a malfunction.

Observe the following information:

- Warning and indicator lamps (→ page 592)
- Display messages (→ page 541)

ETS/4ETS (Electronic Traction System)

ETS/4ETS traction control is part of ESP® and makes it possible to pull away and accelerate on a slippery roadway.

If you select the  or  drive program, a special ETS system specifically suited to off-road terrain is automatically activated.

ETS/4ETS can improve the vehicle's traction by intervening in the following ways:







- The drive wheels are braked individually if they spin.
- More drive torque is transferred to the wheel or wheels with traction.

Influence of drive programs on ESP®



The drive programs enable ESP® to adapt to different weather and road conditions as well as the driver's preferred driving style. You can select the drive programs using the DYNAMIC SELECT switch (→ page 177).

ESP® characteristics per drive program

Drive program	ESP® mode	Characteristics
<p>C (Comfort)</p> <p>E (Economy)</p> <p>Vehicles with E-ACTIVE BODY CONTROL:</p> <p>CV (CURVE)</p>	ESP® Comfort	<p>These drive programs provide the ideal balance between traction and stability.</p> <p>Drive program C is the drive program recommended for all road conditions.</p> <p>Select drive program C, CV or E both in dry and particularly in difficult road conditions, such as snow or ice, or when the road is wet from rain.</p>
<p>S (Sport)</p>	ESP® Sport	<p>This drive program continues to offer stability but with a sporty setup which allows the enthusiastic driver a more active driving style.</p> <p>Select drive program S in good road conditions, for example on dry roads and clear stretches of road.</p>

Drive program	ESP® mode	Characteristics
 (Sport +)	ESP® Sport +	<p>The vehicle's own understeering and oversteering characteristics are accentuated. This allows a more active driving style to be adopted.</p> <p>Select drive program  in good road conditions, for example on dry roads and clear stretches of road.</p>
<p>Vehicles with Off-road package:</p>  (Off-road)  (Off-road +) <p>Vehicles without Off-road package:</p>  (Off-road)	<p>Off-road ESP®</p> <p>Off-road + ESP®</p>	<p>These drive programs assist you when driving off-road.</p> <p>Select the  drive program for easily negotiable off-road terrain, e.g. dirt tracks, gravel or sandy surfaces.</p> <p>Select the  drive program for rough terrain, e.g. for steep and/or uneven terrain or for driving on rocky terrain.</p>

Function of Off-road ESP®

Off-road ESP® is activated automatically when you select the  or  drive program. It intervenes later if there is oversteering or understeering, thus improving traction.

Activating/deactivating ESP® (Electronic Stability Program) (vehicles without Off-road package)

Multimedia system:

→  ▶▶ Settings ▶▶ Quick Access

- ❶ ESP® can only be activated/deactivated using quick access when at least one other function is available in quick access. ESP® can otherwise be found in the Assistance menu.

Mercedes-AMG vehicles: observe the notes in the Supplement. Otherwise, you may fail to recognize dangers.

- ▶ Select ESP.
A prompt appears.
- ▶ Select On or  Off.

ESP® is deactivated if the  ESP® OFF warning lamp lights up continuously in the instrument cluster.

Observe the information on warning lamps and display messages which may be shown in the instrument cluster.

Activating/deactivating ESP® (Electronic Stability Program) (vehicles with Off-road package or E-Active Body Control)

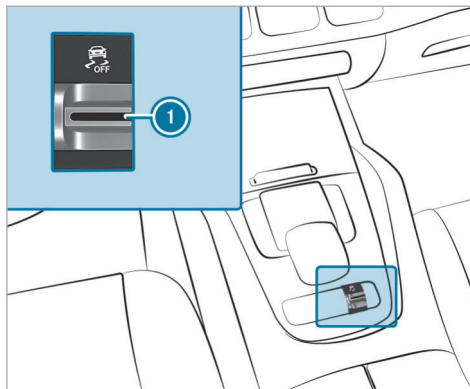

- ▶ Pull rocker switch ❶.

ESP® is deactivated if the  ESP® OFF warning lamp lights up continuously in the instrument cluster.

Observe the information on warning lamps and display messages which may be shown in the instrument cluster.

Function of ESP® Crosswind Assist

ESP® Crosswind Assist detects sudden gusts of side wind and helps the driver to keep the vehicle in the lane:

- ESP® Crosswind Assist is active at vehicle speeds between approx. 47 mph (75 km/h) and 125 mph (200 km/h) when driving straight ahead or cornering slightly.
- The vehicle is stabilized by means of individual brake application on one side.

Function of ESP® trailer stabilization

⚠ WARNING Risk of accident in poor road and weather conditions

In poor road and weather conditions, the trailer stabilization cannot prevent lurching of the vehicle/trailer combination. Trailers with

a high center of gravity may tip over before ESP® detects this.

- ▶ Always adapt your driving style to suit the current road and weather conditions.

When driving with a trailer, ESP® can stabilize your vehicle if the trailer begins to swerve from side to side:

- ESP® trailer stabilization is active above speeds of 40 mph (65 km/h).
- Slight swerving is reduced by means of a targeted, individual brake application on one side.
- In the event of severe swerving, the engine output is also reduced and all wheels are braked.

ESP® trailer stabilization may be impaired or may not function if:

- The trailer is not connected correctly or is not detected properly by the vehicle.

Function of EBD (electronic brake force distribution)

EBD is characterized by the following:

- Monitoring and regulating the brake pressure on the rear wheels.
- Improved driving stability when braking, especially on bends.

Function of STEER CONTROL

STEER CONTROL helps you by transmitting a noticeable steering force to the steering wheel in the direction required for vehicle stabilization.

This steering recommendation is given particularly in the following situations:

- Both right wheels or both left wheels are on a wet or slippery road surface when you brake
- The vehicle starts to skid

System limits

STEER CONTROL may be impaired or may not function in the following situations:

- ESP® is deactivated.
- ESP® is malfunctioning.
- The steering is malfunctioning.

If ESP® is malfunctioning, you will be assisted further by the electric power steering.

Function of Active Brake Assist

Active Brake Assist consists of the following functions:

- Distance warning function
- Autonomous braking function
- Situation-dependent braking assistance
- **Vehicles with Driving Assistance Package:** Evasive Steering Assist and cornering function

Active Brake Assist can help you to minimize the risk of a collision with vehicles, cyclists or

pedestrians, or reduce the effects of such a collision.

If Active Brake Assist has detected a risk of collision, a warning tone sounds and the  distance warning lamp lights up in the instrument cluster.

Vehicles with PRE-SAFE®: depending on the country, an additional haptic warning occurs in the form of slight, repeated tensioning of the seat belt.

If you do not react to the warning, autonomous braking can be initiated in critical situations.

In especially critical situations, Active Brake Assist can initiate autonomous braking directly. In this case, the warning lamp and warning tone occur simultaneously with the braking application.

If you apply the brake yourself in a critical situation or apply the brake during autonomous braking, situation-dependent braking assistance occurs. The brake pressure increases up to maximum full-stop braking if necessary.

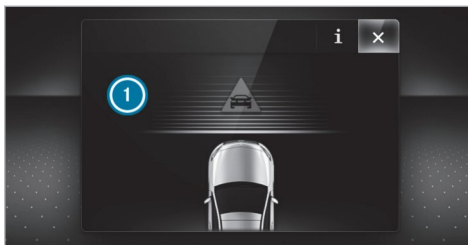

If autonomous braking or situation-dependent braking assistance has occurred, display  appears in the multifunction display and then automatically goes out after a short time.

If the autonomous braking function or the situation-dependent braking assistance is triggered, additional preventive measures for occupant protection (PRE-SAFE®) may also be initiated.

▲ WARNING Risk of an accident caused by limited detection performance of Active Brake Assist

Active Brake Assist cannot always clearly identify objects and complex traffic situations.

In such cases, Active Brake Assist might:

- Give a warning or brake without reason
- Not give a warning or not brake

▶ Always pay careful attention to the traffic situation; do not rely on Active Brake Assist alone. Active Brake Assist is only an aid. The driver is responsible for maintaining a suitable distance to the vehicle in front, vehicle speed and for braking in good time.

▶ Be prepared to brake or swerve if necessary.

 If the system is unavailable, the  display appears in the multifunction display.

Also observe the system limits of Active Brake Assist.

The individual subfunctions are available in the following speed ranges:

The distance warning function issues a warning in the following situations:

- From approximately 4 mph (7 km/h), if your vehicle is critically close to a vehicle or

pedestrian, you will hear an intermittent warning tone and the  distance warning lamp lights up in the instrument cluster.

Vehicles with PRE-SAFE®: depending on the country, an additional haptic warning

occurs in the form of slight, repeated tensioning of the seat belt.

Brake immediately or take evasive action, provided it is safe to do so and the traffic situation allows this.

The distance warning function can aid you in the following situations with an intermittent warning tone and a warning lamp:

	Vehicles traveling in front	Stationary vehicles	Crossing vehicles	Moving pedestrians	Stationary pedestrians	Crossing cyclists	Cyclists traveling in front	Stationary cyclists
Vehicles without Driving Assistance Package	Up to approx. 155 mph (250 km/h)	Up to approx. 50 mph (80 km/h)	No reaction	Up to approx. 50 mph (80 km/h)	No reaction	Up to approx. 37 mph (60 km/h)	Up to approx. 50 mph (80 km/h)	No reaction
Vehicles with Driving Assistance Package	Up to approx. 155 mph (250 km/h)	Up to approx. 62 mph (100 km/h)	Up to approx. 43 mph (70 km/h)	Up to approx. 50 mph (80 km/h)	Up to approx. 43 mph (70 km/h)	Up to approx. 43 mph (70 km/h)	Up to approx. 50 mph (80 km/h)	Up to approx. 43 mph (70 km/h)

The autonomous braking function may intervene at speeds starting from approximately 4 mph (7 km/h) in the following situations:

	Vehicles traveling in front	Stationary vehicles	Crossing vehicles	Moving pedestrians	Stationary pedestrians	Crossing cyclists	Cyclists traveling in front	Stationary cyclists
Vehicles without Driving Assistance Package	Up to approx. 124 mph (200 km/h)	Up to approx. 31 mph (50 km/h)	No reaction	Up to approx. 37 mph (60 km/h)	No reaction	Up to approx. 37 mph (60 km/h)	Up to approx. 50 mph (80 km/h)	No reaction
Vehicles with Driving Assistance Package	Up to approx. 155 mph (250 km/h)	Up to approx. 62 mph (100 km/h)	Up to approx. 43 mph (70 km/h)	Up to approx. 43 mph (70 km/h)	Up to approx. 43 mph (70 km/h)	Up to approx. 43 mph (70 km/h)	Up to approx. 50 mph (80 km/h)	Up to approx. 43 mph (70 km/h)

Situation-dependent braking assistance may intervene at speeds starting from approximately 4 mph (7 km/h) in the following situations:

	Vehicles traveling in front	Stationary vehicles	Crossing vehicles	Moving pedestrians	Stationary pedestrians	Crossing cyclists	Cyclists traveling in front	Stationary cyclists
Vehicles without Driving Assistance Package	Up to approx. 155 mph (250 km/h)	Up to approx. 50 mph (80 km/h)	No reaction	Up to approx. 37 mph (60 km/h)	No reaction	Up to approx. 37 mph (60 km/h)	Up to approx. 50 mph (80 km/h)	No reaction
Vehicles with Driving Assistance Package	Up to approx. 155 mph (250 km/h)	Up to approx. 62 mph (100 km/h)	Up to approx. 43 mph (70 km/h)	Up to approx. 43 mph (70 km/h)	Up to approx. 43 mph (70 km/h)	Up to approx. 43 mph (70 km/h)	Up to approx. 50 mph (80 km/h)	Up to approx. 43 mph (70 km/h)

Canceling a brake application of Active Brake Assist

You can cancel a brake application of Active Brake Assist at any time by:

- Fully depressing the accelerator pedal or with kickdown.
- Releasing the brake pedal.

Active Brake Assist may cancel the brake application when one of the following conditions is fulfilled:

- You maneuver to avoid the obstacle.
- There is no longer a risk of collision.
- An obstacle is no longer detected in front of your vehicle.

Evasive Steering Assist (only vehicles with Driving Assistance Package)

Evasive Steering Assist has the following characteristics:

- The ability to detect stationary or moving pedestrians.
- Assistance through power-assisted steering if it detects a swerving maneuver.

- Activation by an abrupt steering movement during a swerving maneuver.
- Assistance during swerving and straightening of the vehicle.
- Reaction from a speed of approximately 12 mph (20 km/h) up to a speed of approximately 43 mph (70 km/h).

You can prevent the assistance at any time by actively steering.

Cornering function (only vehicles with Driving Assistance Package)

If a danger of collision from an oncoming vehicle is detected when turning across an oncoming lane, autonomous braking can be initiated at speeds below 9 mph (15 km/h) before you have left the lane in which you are driving.

⚠ WARNING Risk of an accident despite Evasive Steering Assist

Evasive Steering Assist cannot always clearly identify objects and complex traffic situations.

In addition, the steering support of Evasive Steering Assist is generally not sufficient to avoid a collision.

In such cases Evasive Steering Assist can:

- give an unnecessary warning or provide assistance
- not give a warning or not provide assistance

▶ Always pay careful attention to the traffic situation; do not rely on Evasive Steering Assist alone.

▶ Be ready to brake and take evasive action if necessary.

▶ Prevent the assistance by actively steering in non-critical driving situations.

▶ Drive at an appropriate speed if pedestrians are close to the path of your vehicle.

System limits

Full system performance is not available for a few seconds after switching on the ignition or after driving off.

The system may be impaired or may not function in the following situations:

- In snow, rain, fog, heavy spray, if there is glare, in direct sunlight or in greatly varying ambient light.
- If the sensors are dirty, fogged up, damaged or covered.
- If the sensors are impaired due to interference from other radar sources, e.g. strong radar reflections in parking garages.
- If a loss of tire pressure or a faulty tire has been detected and displayed.
- If DSR is activated.
- In complex traffic situations where objects cannot always be clearly identified.
- If pedestrians or vehicles move quickly into the sensor detection range.
- If pedestrians are hidden by other objects.

- If the typical outline of a pedestrian cannot be distinguished from the background.
 - If a pedestrian is not detected as such, e.g. due to special clothing or other objects.
 - On bends with a tight radius.
- i** The Active Brake Assist sensors adjust automatically while a certain distance is being driven after the vehicle has been delivered. Active Brake Assist is unavailable or only partially available during this teach-in period.

Setting Active Brake Assist

Requirements:

- The ignition is switched on.

Multimedia system:

→  » Settings » Assistance
» Active Brake Assist

The following settings are available:

- Early
- Medium
- Late

- ▶ Select a setting.
The setting is retained when the engine is next started.

Deactivating Active Brake Assist

- i** It is recommended that you always leave Active Brake Assist activated.
- ▶ Select **Off**.
The distance warning function, the autonomous braking function and the Evasive Steering Assist are deactivated.
When the vehicle is next started, the middle setting is automatically selected.
- i** If Active Brake Assist is deactivated, the  symbol appears in the status bar of the multifunction display.

Speed control cruise control

Function of cruise control

Cruise control regulates the speed to the value selected by the driver.

If you accelerate to overtake, for example, the stored speed is not deleted. If you remove your

foot from the accelerator pedal after overtaking, cruise control will resume speed regulation back to the stored speed.

Cruise control is operated using the corresponding steering wheel buttons. You can store any speed above 15 mph (20 km/h) up to the maximum speed.

If you fail to adapt your driving style, cruise control can neither reduce the risk of an accident nor override the laws of physics. It cannot take into account road, weather or traffic conditions. Cruise control is only an aid. The driver is responsible for the distance to the vehicle in front, for vehicle speed, for braking in good time and for staying in lane.

Mercedes-AMG vehicles: Cruise control is available up to a maximum speed of 155 mph (250 km/h).

Displays on the multifunction display

The status of cruise control and the stored speed are shown in the multifunction display.

210 Driving and parking

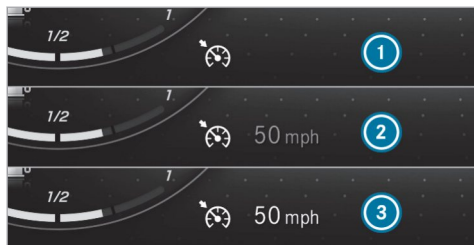

- 1 Cruise control is selected
 - 2 Speed is saved, cruise control is deactivated
 - 3 Speed is saved, cruise control is activated
- i The segments between the stored speed and the end of the segment display light up in the speedometer.

System limits

Cruise control may be unable to maintain the stored speed on uphill gradients. The stored speed is resumed when the gradient evens out.

Change into a lower gear in good time on long and steep downhill gradients. Take particular note of this when driving a laden vehicle. By

doing so, you will make use of the engine's braking effect. This relieves the load on the brake system and prevents the brakes from overheating and wearing too quickly.

Do not use cruise control in the following situations:

- In traffic situations which require frequent changes of speed, e.g. in heavy traffic, on winding roads.
- On slippery roads. Accelerating can cause the drive wheels to lose traction and the vehicle could then skid.
- If you are driving when visibility is poor.

Operating cruise control

⚠ WARNING Risk of accident due to stored speed

If you call up the stored speed and this is lower than your current speed, the vehicle decelerates.

- ▶ Take into account the traffic situation before calling up the stored speed.

Requirements:

- ESP® must be activated, but not intervening.
- The driven speed is at least 15 mph (20 km/h).
- The transmission is in position **D**.

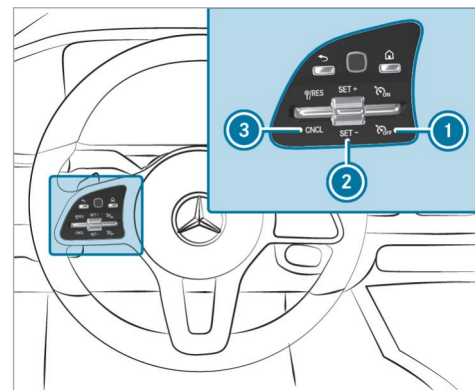

- ▶ **To activate cruise control:** press rocker switch 1 up.

▶ **To activate cruise control:** press rocker switch ② up (SET+) or down (SET-). The current speed is stored and maintained by the vehicle.

or

▶ Press rocker switch ③ up (RES). The last stored speed is called up and maintained by the vehicle.

If the last stored speed has previously been deleted, the currently driven speed is stored.

ⓘ When you switch off the vehicle, the last speed stored is cleared.

▶ **To increase/reduce speed:** press rocker switch ② up (SET+) or down (SET-) to the pressure point. The stored speed is increased or reduced by 1 mph (1 km/h).

or

▶ Press rocker switch ② up (SET+) or down (SET-) beyond the pressure point. The stored speed is increased or reduced by 5 mph (10 km/h).

or

▶ Accelerate the vehicle to the desired speed.

▶ Press rocker switch ② up (SET+). If cruise control is activated and Traffic Sign Assist has detected a speed restriction sign with a maximum permissible speed and this is displayed in the instrument cluster, you can choose between the following options:

▶ **To adopt the detected speed:** press rocker switch ③ up (RES). The maximum permissible speed shown by the traffic sign is stored and the vehicle maintains this speed.

▶ **To deactivate cruise control:** press rocker switch ③ down (CNCL).

▶ **To switch off cruise control:** press rocker switch ① down.

ⓘ If you brake, deactivate ESP® or if ESP® intervenes, cruise control is deactivated.

DSR (Downhill Speed Regulation)

Function of DSR (Downhill Speed Regulation)

DSR is an aid to assist you when driving downhill. It keeps the speed of travel at the selected

target speed. The steeper the downhill gradient, the greater the DSR braking effect on the vehicle. On flat stretches of road and uphill gradients, the DSR brakes the vehicle minimally or not at all.

When DSR is activated and the transmission is in position **D**, **R** or **N**, DSR controls the driving speed. The target speed can be set to a value between 1 mph (2 km/h) and 11 mph (18 km/h). By braking or accelerating, you can drive at a higher or lower speed than the target speed at any time.

DSR is deactivated automatically if you drive at speeds greater than 28 mph (45 km/h) or select drive program **S** or **S**. The  Off message then appears in the multifunction display. The status indicator in the multifunction display disappears. You also hear a warning tone.

Notes on DSR

⚠ WARNING Risk of skidding and having an accident when DSR is activated on slippery road surfaces

If the speed driven and the target speed differ, and you activate DSR on a slippery road surface, the wheels may lose traction.

- ▶ Take into account the road surface and the difference between the driving speed and target speed before activating DSR.

If you fail to adapt your driving style, DSR can neither reduce the risk of an accident nor override the laws of physics. It cannot take into account road, weather or traffic conditions. DSR is only an aid. You are responsible for maintaining a safe distance to the vehicle in front, for vehicle speed, for braking in good time and for staying in lane.



You are always responsible for keeping control of the vehicle and for assessing whether the downhill gradient can be managed. Depending on road surface and tires, DSR may not always be

able to keep to the target speed. Select a target speed suitable for the environmental conditions and also apply the brakes yourself if required.

Activating/deactivating DSR (vehicles with Off-road package or E-Active Body Control) Requirements:

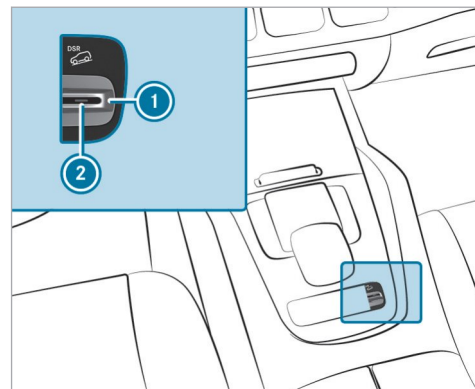
- You are driving at 24 mph (40 km/h) or slower.
If the current vehicle speed is too high, the **Max. Speed 24 mph** message appears in the multifunction display.
- You have not selected drive program **S** or **S⁺**.
- Active Distance Assist DISTRONIC is deactivated.



- ▶ **To activate:** pull rocker switch ①. Indicator lamp ② lights up. The  symbol appears in the multifunction display.
- ▶ **To deactivate:** pull rocker switch ①. Indicator lamp ② and the  symbol go out.

Activating/deactivating DSR (Downhill Speed Regulation) (vehicles without Off-road package)

Requirements:

- You are driving at 24 mph (40 km/h) or slower.
- If the current vehicle speed is too high, the **Max. Speed 24 mph** message appears in the multifunction display.
- Active Distance Assist DISTRONIC is deactivated.

Multimedia system:

-  → Settings
- Schnellzugriff (Quick access)



Select **DSR**.

The **DSR** symbol appears in the multifunction display when the function is activated.

Changing the target speed

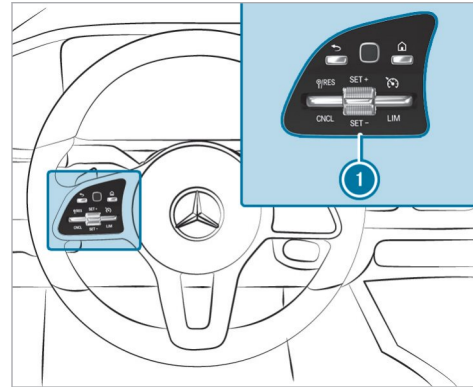

- ▶ **To increase or decrease the target speed:** press rocker switch ① up to the point of resistance for a higher target speed and down for a lower target speed. The selected target speed increases or decreases by 1 mph (1 km/h) and appears with the DSR symbol in the multifunction display.

- ① The target speed always adjusts in 1 mph (1 km/h) increments. This is regardless of whether you press the rocker switch to or beyond the point of resistance.

Active Distance Assist DISTRONIC

Function of Active Distance Assist DISTRONIC

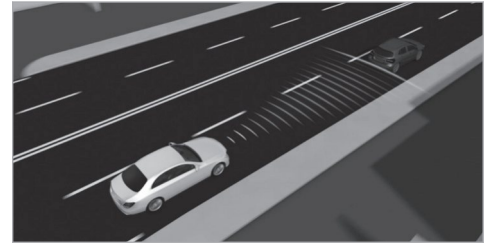

Active Distance Assist DISTRONIC maintains the set speed on free-flowing roads. If vehicles in front are detected, the set distance is maintained, if necessary, until the vehicle comes to a halt. The vehicle accelerates or brakes depending on the distance to the vehicle in front and

214 Driving and parking

the set speed. The speed and distance to the vehicle in front are set and saved on the steering wheel on vehicles without the Driving Assistance Package, in the range between 15 mph (20 km/h) and 120 mph (200 km/h) and, on vehicles with the Driving Assistance Package, in the range between 15 mph (20 km/h) and 130 mph (210 km/h).

Other features of Active Distance Assist DISTRONIC:

- Adjusts the driving style depending on the selected drive program (fuel efficient, comfortable or dynamic) (→ page 176)
- **Vehicles with Driving Assistance Package:** reacts to stationary vehicles detected in urban speed ranges (except bicycles and motorcycles)
- Initiates acceleration to the stored speed if the turn signal indicator is switched on to change to the overtaking lane
- **Vehicles with Driving Assistance Package:** takes one-sided overtaking restrictions into account on highways or on multi-lane

roads with separate roadways (country-dependent)

Vehicles with Active Parking Assist and Driving Assistance Package: if the vehicle has been braked to a standstill on multi-lane, separate roadways by Active Distance Assist DISTRONIC, it can automatically follow the vehicle in front driving off again within 30 seconds. If a critical situation is detected when driving off, a visual and acoustic warning is given indicating that the driver must now take control of the vehicle. The vehicle is not accelerated any further. Active Distance Assist DISTRONIC is only an aid. The driver is responsible for keeping a safe distance to the vehicle in front, for vehicle speed and for braking in good time.

System limits

The system may be impaired or may not function in the following situations:

- In snow, rain, fog, heavy spray, if there is glare, in direct sunlight or in greatly varying ambient light.

- If there is swirling dust, e.g. when driving off-road or on sandy surfaces.
- The windshield in the area of the camera is dirty, fogged up, damaged or covered.
- If the radar sensors are dirty or covered.
- In parking garages or on roads with steep uphill or downhill gradients.
- If there are narrow vehicles in front, such as bicycles or motorcycles.

In addition, on slippery roads, braking or accelerating can cause one or several wheels to lose traction and the vehicle could then skid.

Do not use Active Distance Assist DISTRONIC in these situations.

⚠ WARNING Risk of accident from acceleration or braking by Active Distance Assist DISTRONIC

Active Distance Assist DISTRONIC may accelerate or brake in the following cases, for example:

- If the vehicle pulls away using Active Distance Assist DISTRONIC.
- If the stored speed is called up and is considerably faster or slower than the currently driven speed.
- If Active Distance Assist DISTRONIC no longer detects a vehicle in front or does not react to relevant objects.

- ▶ Always carefully observe the traffic conditions and be ready to brake at all times.
- ▶ Take into account the traffic situation before calling up the stored speed.

⚠ WARNING Risk of accident due to insufficient deceleration by Active Distance Assist DISTRONIC

Active Distance Assist DISTRONIC brakes your vehicle with up to 50% of the maximum possible deceleration. If this deceleration is not sufficient, Active Distance Assist DISTRONIC alerts you with a visual and acoustic warning.

- ▶ In these cases, adjust your speed and keep a sufficient distance.
- ▶ Brake the vehicle yourself and/or take evasive action.

⚠ WARNING Risk of accident if detection function of Active Distance Assist DISTRONIC is impaired

Active Distance Assist DISTRONIC does not react or has a limited reaction:

- when driving on a different lane or when changing lanes

- to pedestrians, animals, bicycles or stationary vehicles, or unexpected obstacles
- to complex traffic conditions
- to oncoming vehicles and crossing traffic

As a result, Active Distance Assist DISTRONIC may neither give warnings nor intervene in such situations.

- ▶ Always observe the traffic conditions carefully and react accordingly.

Operating Active Distance Assist DISTRONIC Requirements:

- The vehicle has been started.
- The electric parking brake is released.
- ESP® is activated and is not intervening.
- The transmission is in position **[D]**.
- The driver's door is closed.
- Check of the radar sensor system has been successfully completed.
- Parking Assist PARKTRONIC is not being used to park the vehicle or to exit from a parking space.

- DSR is deactivated.
- **Vehicles with Off-road package:** the drive program is deactivated. 
- The vehicle does not skid.

Deactivating Active Distance Assist DISTRONIC:

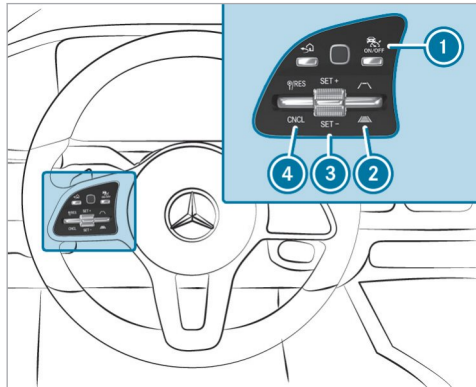

- ▶ Press button ①.

Activating Active Distance Assist DISTRONIC

- ▶ **To activate without a stored speed:** press rocker switch ③ up (SET+) or down (SET-), or press rocker switch ④ up (RES). Remove your foot from the accelerator pedal. The current speed is stored and maintained by the vehicle.

or

- ▶ **To activate with a stored speed:** press rocker switch ④ up (RES). Remove your foot from the accelerator pedal.

① By pressing rocker switch ④ up again, the speed limitation shown in the instrument cluster will be adopted by Active Distance Assist DISTRONIC or variable limiter.

- ▶ **To accept the displayed speed restriction when Active Distance Assist DISTRONIC is active:** press rocker switch ④ up (RES). The speed limit displayed in the instrument cluster is adopted as the stored speed. The vehicle adapts its speed to that of the vehicle in front, but only up to the stored speed.

Accepting the displayed speed restriction when Distance Assist DISTRONIC is activated

- ▶ Press rocker switch ④ up (RES). The speed limit displayed in the instrument cluster is adopted as the stored speed. The vehicle adapts its speed to that of the vehicle in front, but only up to the stored speed.

Pulling away with Active Distance Assist DISTRONIC

- ▶ Remove your foot from the brake pedal and activate Active Distance Assist DISTRONIC.
- ▶ Press rocker switch ④ up (RES).

or

- ▶ Depress the accelerator pedal briefly and firmly. The functions of Active Distance Assist DISTRONIC continue to be carried out.

Deactivating Active Distance Assist DISTRONIC

⚠ WARNING Risk of accident due to Active Distance Assist DISTRONIC still being activated when you leave the driver's seat

If you leave the driver's seat while the vehicle is being braked by Active Distance Assist DISTRONIC only, the vehicle can roll away.

- ▶ Always deactivate Active Distance Assist DISTRONIC and secure the vehicle to prevent it from rolling away before you leave the driver's seat.

- ▶ Press rocker switch ④ down (CNCL).

ⓘ If you brake, deactivate ESP® or if ESP® intervenes, Active Distance Assist DISTRONIC is deactivated.

Increasing or reducing the speed

- ▶ Press rocker switch ③ up (SET+) or down (SET-) to the pressure point. The stored speed is increased or reduced by 1 mph (1 km/h).

or

- ▶ Press rocker switch ③ up (SET+) or down (SET-) to the pressure point and hold. The stored speed is increased or reduced in increments of 1 mph (1 km/h).

or

- ▶ Press rocker switch ③ up (SET+) or down (SET-) beyond the pressure point. The stored speed is increased or reduced by 5 mph (10 km/h).

or

- ▶ Press rocker switch ③ up (SET+) or down (SET-) and hold beyond the pressure point. The stored speed is increased or reduced in increments of 5 mph (10 km/h).

Reducing or increasing the specified distance from the vehicle in front

- ▶ Press rocker switch ② up or down.

Function of Active Speed Limit Assist

ⓘ The following function is country-dependent and only available in conjunction with the Driving Assistance Package.

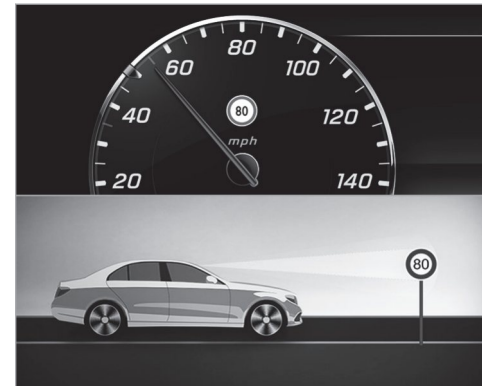

If a change in the speed limit is detected and automatic adoption of speed limits is activated, the new speed is automatically adopted as the stored speed (→ page 268).

The driven speed is adjusted when the vehicle is level with the traffic sign at the latest. In the case of signs indicating entry into an urban area, the speed is adapted according to the speed permitted within the urban area. The speed limit display in the Instrument Display is always updated when the vehicle is level with the traffic sign.

If there is no speed restriction on an unlimited stretch of road (e.g. on a freeway), the recommended speed is automatically adopted as the stored speed. The system uses the speed stored on an unlimited stretch of road as the recommended speed. If you do not alter the stored speed on an unlimited stretch of road, the recommended speed is 80 mph (130 km/h).

If Active Distance Assist DISTRONIC has been put into passive mode by pressing the accelerator pedal, only speed limits which are higher than the set speed are adopted.

Active Speed Limit Assist is only an aid. The driver is responsible for keeping a safe distance from the vehicle in front, for vehicle speed and for braking in good time. The maximum permissible speed also depends on factors such as the road surface and traffic conditions.

System limits

Temporary speed restrictions (e.g. for a certain time or due to weather conditions) cannot be properly detected by the system. The maximum permissible speed applying to a vehicle with a trailer is not detected by the system. In these situations you must adjust your speed yourself.

⚠ WARNING Risk of accident due to Active Speed Limit Assist adapting the vehicle's speed

The speed adopted by Active Speed Limit Assist may be too high or incorrect in some individual cases, such as:

- In the wet or in fog
- When towing a trailer
- ▶ Ensure that the driven speed complies with traffic regulations.
- ▶ Adjust the driving speed to suit current traffic and weather conditions.

Function of route-based speed adaptation

i The following function is country-dependent and only available in conjunction with the Driving Assistance Package.

When Active Distance Assist DISTRONIC is activated, the vehicle speed will be adjusted accordingly to the route events ahead. Depending on the drive program selected, the vehicle negotiates a route event ahead in a fuel-saving, comfortable or dynamic manner. When the route event has been passed, the vehicle accelerates again to the stored speed. The set distance to the vehicle in front, vehicles detected ahead and speed restrictions ahead are taken into account.

Route-based speed adaptation can be configured in the multimedia system (→ page 219).

The following route events are taken into account:

- Bends
- T-intersections, traffic circles and toll stations
- Turns and exits

- Traffic jams ahead (only with Live Traffic (→ page 384))

i When the toll station is reached, Active Distance Assist DISTRONIC adopts the speed as the stored speed.

Also, the speed is reduced if the turn signal indicator to change lanes is switched on and one of the following situations is detected:

- Turning off at intersections
- Driving on slowing-down lanes
- Driving on lanes adjacent to slowing-down lanes

The driver is responsible for choosing the right speed and observing other road users. This applies in particular to intersections, traffic circles and traffic lights, as route-based speed adaptation does not brake the vehicle to a standstill.

When route guidance is active, the first speed adjustment is carried out automatically. If the turn signal indicator is switched on, the selected route is confirmed and further speed adjustment is activated.

Speed adjustment is canceled in the following cases:

- If the turn signal indicator is switched off before the route event.
- If the driver depresses the accelerator or brake pedal during the process.

System limits

Route-based speed adaptation does not take right of way regulations into account. The driver is responsible for complying with road traffic regulations and driving at a suitable speed.

In difficult conditions, for example unclear roads, lane narrowing, wet road surfaces, snow or ice, or when driving with a trailer, the speed adjustment made by the system may not always be suitable. In these situations the driver must intervene accordingly.

⚠ WARNING Risk of accident in spite of route-based speed adjustment

Route-based speed adjustment might malfunction or be temporarily unavailable in the following situations:

- If the driver does not follow the calculated route
 - If map data is not up to date or available
 - In road construction areas
 - In bad weather or road conditions
 - If the accelerator pedal is depressed
 - In the event of electronically displayed speed limitations
- ▶ Adjust the speed to the traffic situation.

Setting route-based speed adaptation

Requirements:

- Active Distance Assist DISTRONIC is activated.

Multimedia system:

→  » Settings » Assistance
» Route-based Speed

▶ Activate or deactivate the function.
When the function is active, the vehicle speed is adjusted depending on the route events ahead.

❶ Further information on the route-based speed adaptation (→ page 218).

Active Steering Assist



Function of Active Steering Assist

❶ The following function is country-dependent and only available in conjunction with the Driving Assistance Package.

Active Steering Assist is only available up to a speed of 130 mph (210 km/h). The system helps you to stay in the center of the lane by means of moderate steering interventions. Depending on the speed driven, Active Steering Assist uses the vehicles ahead and lane markings as a reference.

❶ Depending on the country, in the lower speed range Active Steering Assist can use the surrounding traffic as a reference. If necessary, Active Steering Assist can then also provide assistance when driving away from the center of the lane to form a rescue lane, for example.

When the system is actively steering, the  symbol is shown in green in the multifunction display.

If the detection of lane markings and vehicles ahead is impaired, Active Steering Assist switches to passive mode. The system provides no support in this case. During the transition from active to passive status, the  symbol is shown as enlarged and flashing. Once the system is passive, the  symbol is shown as gray in the multifunction display.

Steering and touch detection

The driver is required to keep their hands on the steering wheel at all times and be able to intervene at any time to correct the course of the vehicle and keep it in lane. The driver must

expect a change from active to passive mode or vice versa at any time.



If the system detects that the driver has not steered the vehicle for a considerable period of time or has removed their hands from the steering wheel, an optical warning is given first. Display ❶ appears in the multifunction display. If the driver still does not steer the vehicle, or gives no confirmation to the system, a warning tone sounds in addition to the visual warning message.

The warning is not issued, or is stopped, when the driver gives confirmation to the system:

- The driver steers the vehicle.

- The driver presses a steering wheel button or operates Touch Control.

If Active Steering Assist detects that a system limit has been reached, a visual warning is issued and a warning tone sounds.

Active Steering Assist is only an aid. The driver is responsible for the distance to the vehicle in front, for vehicle speed, for braking in good time and for staying in lane. Before changing lanes, the driver must make sure that the neighboring lane is free (glance over the shoulder).

System limits

Active Steering Assist has a limited steering torque for lateral guidance. In some cases, the steering intervention is not sufficient to keep the vehicle in the lane or to drive through exits.

The system may be impaired or may not function in the following instances:

- There is poor visibility, e.g. due to snow, rain, fog, heavy spray, greatly varying ambient light or strong shadows on the roadway.
- There is glare, e.g. from oncoming traffic, direct sunlight or reflections.

- Insufficient road illumination.
- The windshield is dirty, fogged up, damaged or covered in the vicinity of the camera, e.g. by a sticker.
- No, or several unclear, lane markings are present for one lane, or the markings change quickly, e.g. in a construction area or at intersections.
- The lane markings are worn away, dark or covered up, e.g. by dirt or snow.
- The distance to the vehicle in front is too small and the lane markings thus cannot be detected.
- The road is narrow and winding.
- There are obstacles on the lane or projecting out into the lane, such as object markers.

The system does not provide assistance in the following conditions:

- On tight bends and when turning.
- When crossing intersections.
- At traffic circles or toll stations.
- When towing a trailer.

- When actively changing lane without switching on the turn signal indicator.
- When the tire pressure is too low.

Depending on the selected vehicle settings, Active Steering Assist may be unavailable. Observe the status display of Active Steering Assist in the multifunction display (→ page 225).

⚠ WARNING Risk of accident if Active Steering Assist unexpectedly stops functioning

If the system limits of Active Steering Assist are reached there is no guarantee that the system will remain active or will keep the vehicle in lane.

- ▶ Always keep your hands on the steering wheel and observe the traffic carefully.
- ▶ Always steer the vehicle paying attention to traffic conditions.

⚠ WARNING Risk of accident if Active Steering Assist unexpectedly intervenes

A malfunction in the detection of lane markings and objects can occur.

This could cause unexpected steering intervention.

▶ Steer according to traffic conditions.

Activating/deactivating Active Steering Assist

Requirements:

- ESP® is activated, but is not intervening.
- Active Distance Assist DISTRONIC is activated.

Multimedia system:

→ [Home] ▶▶ Settings ▶▶ Quick Access

▶ Select [Steering Assist].

Function of Active Lane Change Assist

- ① The following function is country-dependent and only available in conjunction with the Driving Assistance Package.

Active Lane Change Assist supports the driver when changing lanes by applying steering torque if the driver operates a turn signal indicator.

Assistance when changing lanes is provided if all the following conditions are met:

- You are driving on a freeway or road with multiple lanes in the direction of travel.
- The neighboring lane is separated by a broken lane marking.
- No vehicle is detected in the adjacent lane.
- The driven speed is between 50 mph (80 km/h) and 110 mph (180 km/h).
- Active Lane Change Assist is switched on in the multimedia system.
- Active Steering Assist is switched on and active.



If no vehicle is detected in the adjacent lane and a lane change is permitted, the lane change begins after the driver has activated the turn signal indicator. This is shown to the driver with a green arrow ② next to the steering wheel symbol. The **Lane Change to the Left** message also appears, for example. If Active Lane Change Assist has been activated with the turn signal indicator but a lane change is not immediately possible, a gray arrow ① appears next to the steering wheel symbol, which remains green.

When the lane change assistance starts, the turn signal indicator is automatically activated along with the display in the multifunction display.

If the assistance graphic is shown when changing lanes, the lane change display appears with an additional arrow pointing towards the adjacent lane (→ page 225).

If a lane change is not possible, the arrow fades out after a few seconds and a new lane change must be initiated. An immediate lane change is only possible on freeway sections without speed limits.

If the system is impaired, Active Lane Change Assist may be canceled. If it is canceled, the **Lane Change Canceled** message appears in the multifunction display and a warning tone sounds.

⚠ WARNING Risk of accident from changing lane to an occupied adjacent lane

Lane Change Assist cannot always detect clearly if the adjacent lane is free.

The lane change might be initiated although the adjacent lane is not free.

- ▶ Before changing lanes, make sure that the neighboring lane is free and there is no danger to other road users.

- ▶ Monitor the lane change.

⚠ WARNING Risk of accident if Lane Change Assist unexpectedly stops functioning

If the system limitations for Lane Change Assist have been reached, there is no guarantee that the system will remain active.

Lane Change Assist cannot then assist you by applying steering torques.

- ▶ Always monitor the lane change and keep your hands on the steering wheel. Observe the traffic conditions and steer and/or brake if necessary.

System limits

The system limitations of Active Steering Assist apply to Active Lane Change Assist (→ page 220).

The system may also be impaired or may not function in the following situations:

- The sensors in the rear bumper are dirty, damaged or covered by a sticker or ice and snow, for example.
- The exterior lighting shows a fault.
- ⓘ The Active Lane Change Assist sensors adjust automatically while a certain distance is being driven after the vehicle has been delivered. Active Lane Change Assist is unavailable or only partially available during this teach-in process; no arrow appears next to the  Active Steering Assist symbol when the turn signal indicator is activated.

Activating/deactivating Active Lane Change Assist

Multimedia system:

  **▶▶ Settings ▶▶ Assistance**
▶▶ Active Lane Change Assist

- ▶ Activate or deactivate the function.

Function of Active Emergency Stop Assist

If the driver continually ignores the visual or acoustic warning to put their hands on the steer-

ing wheel, the **Beginning Emergency Stop** message appears in the multifunction display. If the driver still does not respond, Active Distance Assist DISTRONIC reduces the speed. The vehicle is decelerated in stages to a standstill.

Depending on the country, at speeds below 40 mph (60 km/h) the hazard warning lights switch on automatically.

When the vehicle is stationary, the following actions are carried out:

- The vehicle is secured with the electric parking brake
- Active Distance Assist DISTRONIC is ended
- The vehicle is unlocked
- If possible, an emergency call is placed to the Mercedes-Benz emergency call center

The driver can cancel the deceleration at any time by performing one of the following actions:

- Steering
- Braking or accelerating
- Pressing a steering-wheel button
- Operating Touch Control

- Activating or deactivating Active Distance Assist DISTRONIC

Function of Active Traffic Jam Assist

i Active Traffic Jam Assist is country-dependent and only available for vehicles with the Driving Assistance Plus Package.

Active Traffic Jam Assist helps you when in traffic jams on multi-lane roads with separate roadways by automatically pulling away within up to 60 seconds and with moderate steering maneuvers. It orients itself using the vehicle in front and lane markings. Active Traffic Jam Assist automatically maintains a safe distance from the vehicle in front and vehicles cutting in.

Active Traffic Jam Assist requires you, as the driver, to keep your hands on the steering wheel at all times so that you are able to intervene at any time to correct the course of the vehicle and keep it in lane.

Active Traffic Jam Assist is only an aid. The driver is responsible for keeping a safe distance to the vehicle in front, for vehicle speed and for braking in good time.

Active Traffic Jam Assist activates automatically when all of the following conditions are met:

- You are in a traffic jam on a freeway or high-speed major road.
- Active Distance Assist DISTRONIC is switched on and active (→ page 215).
- Active Brake Assist is available (→ page 203).
- Active Steering Assist is switched on and active (→ page 222).
- Active Traffic Jam Assist is activated (→ page 225).
- You are traveling no faster than 35 mph (60 km/h).

The following symbol is displayed in the instrument cluster when the system is active:



System limits

The system limitations of Active Distance Assist DISTRONIC and Active Steering Assist apply to Active Traffic Jam Assist (→ page 220).

Activating/deactivating Active Traffic Jam Assist

Multimedia system:

→  >> Settings >> Quick Access

**Overview of Active Distance Assist DISTRONIC displays in the instrument cluster**

The assistance graphic and the status display show the status of the following functions in the instrument cluster:

- Active Distance Assist DISTRONIC
- Route-based speed adaptation

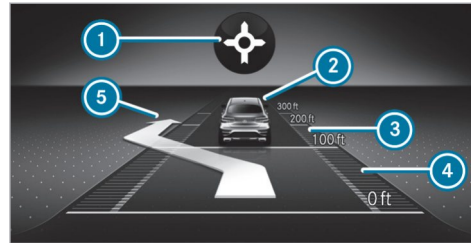

- Active Steering Assist

Assistant display

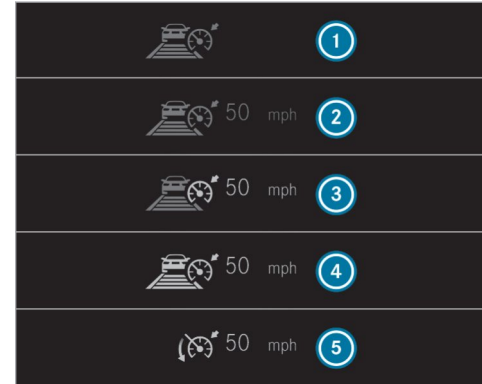
- ① Route-based speed adaptation: type of route event
- ② Vehicle in front
- ③ Distance indicator
- ④ Set specified distance
- ⑤ Active Lane Change Assist lane change display

Active Distance Assist DISTRONIC status display and route-based speed adaptation

- ① Active Distance Assist DISTRONIC selected, set specified distance (number of segments below the vehicle)
- ② Active Distance Assist DISTRONIC deactivated, speed stored

- ③ Active Distance Assist DISTRONIC active, speed stored, no vehicle detected (bright vehicle symbol)
- ④ Active Distance Assist DISTRONIC active, speed stored, vehicle detected (green vehicle symbol)
- ⑤ Active Distance Assist DISTRONIC and route-based speed adaptation active, speed stored
- ① On highways or high-speed major roads, the green  vehicle symbol is displayed cyclically when the vehicle is ready to pull away.
- ① If you depress the accelerator pedal beyond the setting of the Active Distance Assist DISTRONIC, the system is switched to passive mode. The  **Suspended** message appears in the multifunction display.

Speedometer

The stored speed is highlighted on the speedometer. If the speed of the vehicle in front or the speed adjustment is less than the stored speed due to the route event ahead, the segments in the speedometer light up. Deactivation of Active Distance Assist DISTRONIC, as well as alterations to the speed due to manual or automatic

adoption of the speed limit, are displayed in the control feedback of the multifunction display on a single line.

Active Steering Assist status display

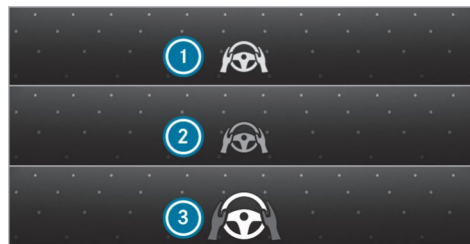

- ① Gray steering wheel: Active Steering Assist switched on and passive
- ② Green steering wheel: Active Steering Assist switched on and active
- ③ Flashing steering wheel: prompt to the driver to actively confirm or transition from active to passive status, system limits detected

During the transition from active to passive status, symbol ③ is shown as enlarged and flash-

ing. Once the system is passive, symbol ① is shown as gray in the multifunction display.

Function of Hill Start Assist

Hill Start Assist holds the vehicle for a short time when pulling away on a hill under the following conditions:

- The transmission is in position **D** or **R**.
- The electric parking brake is released.

This gives you enough time to move your foot from the brake pedal to the accelerator pedal and depress it before the vehicle begins to roll away.

WARNING Risk of accident and injury due to the vehicle rolling away

After a short time, Hill Start Assist no longer holds the vehicle and it can roll away.

- ▶ Therefore, swiftly move your foot from the brake pedal to the accelerator pedal. Never attempt to leave the vehicle if it is being held by Hill Start Assist.

HOLD function

HOLD function

The HOLD function holds the vehicle at a standstill without requiring you to depress the brake pedal, e.g. while waiting in traffic.

The HOLD function is only an aid. The responsibility for the vehicle safely standing still remains with the driver.

System limits

The HOLD function is only intended to provide assistance when driving and is not a sufficient means of safeguarding the vehicle against rolling away when stationary.

- The incline must not be greater than 30%.

Activating/deactivating the HOLD function

⚠ WARNING Risk of an accident due to the HOLD function being activated when you leave the vehicle

If you leave the vehicle while only the HOLD function is braking the vehicle, the vehicle can roll away in the following situations:

- If there is a malfunction in the system or in the power supply.
 - If the HOLD function is deactivated by depressing the accelerator pedal or brake pedal, e.g. by a vehicle occupant.
- ▶ Always deactivate the HOLD function and secure the vehicle against rolling away before leaving the vehicle.

! **NOTE** Damage from automatic braking

If one of the following functions is switched on, the vehicle brakes automatically in certain situations:

- Active Brake Assist
- Active Distance Assist DISTRONIC
- HOLD function
- Active Parking Assist

To avoid damage to the vehicle, deactivate these systems in the following or similar situations:

- ▶ During towing
- ▶ In a car wash

Requirements:

- The vehicle is stationary.
- The driver's door is closed or the seat belt on the driver's side is fastened.
- The engine is running or has been automatically switched off by the ECO start/stop function.

- The electric parking brake is released.
- Active Distance Assist DISTRONIC is deactivated.
- The transmission is in position **D**, **R** or **N**.

Activating the HOLD function

- ▶ Depress the brake pedal and after a short time quickly depress further until the **HOLD** display appears in the multifunction display.
- ▶ Release the brake pedal.

Deactivating the HOLD function

- ▶ Depress the accelerator pedal to pull away.
or
- ▶ Depress the brake pedal until the **HOLD** display disappears from the multifunction display.

The HOLD function is deactivated in the following situations:

- Active Distance Assist DISTRONIC is activated.

- The transmission is switched to position **P**.
- The vehicle is secured with the electric parking brake.

In the following situations, the vehicle is held by transmission position **P** and/or by the electric parking brake:

- The seat belt is unfastened and the driver's door is opened.
- The vehicle is switched off.
- There is a malfunction in the system or the power supply is insufficient.

AIRMATIC

Function of AIRMATIC

AIRMATIC is an air suspension system with variable damping for improved driving comfort and vehicle dynamics. The all-round level control system ensures the best possible suspension and constant ground clearance, even with a laden





vehicle. When driving at speed, the vehicle is lowered automatically to improve driving safety and to reduce fuel consumption. You also have the option of manually adjusting the vehicle level.

AIRMATIC is comprised of the following functions and components:

- Air suspension with automatic level control
- Speed-dependent lowering
- Manually selectable high level setting for greater ground clearance which can be adjusted using a level button
- ADS PLUS (Adaptive Damping System with constant adjustment of damping characteristics)

Suspension settings and vehicle level per drive program

Drive program	Suspension settings and vehicle level
<p>C (Comfort)</p> <p>E (Economy)</p>	<ul style="list-style-type: none"> • The suspension setting is comfortable. • The vehicle is set to the normal level. • When driving at speeds above approximately 87 mph (140 km/h), the vehicle is lowered. • When driving at speeds below approximately 25 mph (40 km/h), the vehicle is raised again. • Operation with a trailer or bicycle rack: if the electrical connection has been correctly established, the vehicle remains at normal level irrespective of speed.
<p>S (Sport)</p>	<ul style="list-style-type: none"> • The suspension setting is firmer. • The vehicle is set to Sport level. • Operation with a trailer or bicycle rack: if the electrical connection has been correctly established, the vehicle remains at normal level.
<p>S⁺ (Sport +)</p>	<ul style="list-style-type: none"> • The suspension setting is even firmer. • The vehicle is set to Sport + level. • Operation with a trailer or bicycle rack: if the electrical connection has been correctly established, the vehicle remains at normal level.

Drive program	Suspension settings and vehicle level
 (Off-road in vehicles without Off-road package)	<ul style="list-style-type: none"> The suspension setting is suitable for easily negotiable off-road terrain. The vehicle is set to off-road level +1. When driving at speeds above approximately 50 mph (80 km/h), the vehicle is lowered. When driving at speeds below approximately 28 mph (45 km/h), the vehicle is raised.
 (Off-road in vehicles with Off-road package)	<ul style="list-style-type: none"> The suspension setting is suitable for easily negotiable off-road terrain. The vehicle is set to off-road level +1. When driving at speeds above approximately 71 mph (115 km/h), the vehicle is lowered. When driving at speeds below approximately 47 mph (75 km/h), the vehicle is raised.
 (Off-road + in vehicles with Off-road package)	<ul style="list-style-type: none"> The suspension setting is suitable for difficult off-road terrain. The vehicle is set to off-road level +1. When driving at speeds above approximately 50 mph (80 km/h), the vehicle is lowered. When driving at speeds below approximately 28 mph (45 km/h), the vehicle is raised.
 (Individual)	<ul style="list-style-type: none"> You can call up individual suspension settings here.
Lower When Getting In On (Entry/exit level)	<ul style="list-style-type: none"> The active entry/exit level sets the vehicle to the Sport + level to facilitate entering/exiting the vehicle. When driving at speeds above approx. 19 mph (30 km/h), the entry/exit level is deactivated and the vehicle is raised.

Differences between different vehicle levels compared to the normal level

Vehicle level	Vehicles without Off-road package	Vehicles with Off-road package
Car wash	Approx. +3.5 in (+90 mm)	Approx. +3.5 in (+90 mm)
Off-road level +3	Unavailable	Approx. +3.5 in (+90 mm)
Off-road level +2	Unavailable	Approx. +2.4 in (+60 mm)
Off-road level +1	Approx. +2.4 in (+60 mm)	Approx. +1.2 in (+30 mm)
Sport	Approx. -0.6 in (-15 mm)	Approx. -0.6 in (-15 mm)
Sport +	Approx. -1.0 in (-25 mm)	Approx. -1.0 in (-25 mm)

System limits

AIRMATIC may not be available or have only limited availability:

- If the overheating protection is activated due to frequent level changes by depressing the level button within a short time. The  warning lamp appears in the multifunction display.

After the cooling phase, the system is again available without restriction.

Setting the vehicle level (vehicles with AIR-MATIC)

⚠ WARNING Risk of accident because vehicle level is too high

If you drive at a higher vehicle level, the driving characteristics may be impaired due to the higher vehicle center of gravity.

The vehicle can drift outwards, for example, when steering or cornering.

- ▶ Always choose a vehicle level which is suited to the driving style and the road surface conditions.

⚠ WARNING Risk of entrapment from vehicle lowering

When lowering the vehicle, people could become trapped if their limbs are between the vehicle body and the tires or underneath the vehicle.

- ▶ Make sure no one is underneath the vehicle or in the immediate vicinity of the wheel arches when the vehicle is being lowered.

⚠ WARNING Risk of becoming trapped due to the vehicle lowering

Vehicles with AIRMATIC or level control: when you unload luggage or leave the vehicle, the vehicle first rises slightly and then returns to the set level shortly afterwards.

You or anyone else in the vicinity of the wheel arches or the underbody could thus become trapped.

The vehicle can also be lowered after being locked.

232 Driving and parking

- ▶ When leaving the vehicle, make sure that nobody is in the vicinity of the wheel arches or the underbody.

! NOTE Damage due to vehicle lowering

Parts of the body could be damaged when the vehicle is lowered.

- ▶ Make sure that there are no obstacles such as curbs underneath or in the immediate vicinity of the body when the vehicle is being lowered.

Requirements:

- The vehicle has been started.
- **Vehicles without Off-road package:** the vehicle is not moving faster than 40 mph (65 km/h) or when being operated with a trailer or bicycle rack with a correctly established electrical connection 19 mph (30 km/h).
- **Vehicles with Off-road package:**
 - Off-road level +1: the vehicle is not moving faster than 62 mph (100 km/h) or

when being operated with a trailer or bicycle rack with a correctly established electrical connection 19 mph (30 km/h).

- Off-road level +2: the vehicle is not moving faster than 40 mph (65 km/h) or when being operated with a trailer or bicycle rack with a correctly established electrical connection 19 mph (30 km/h).
- Off-road level +3: the vehicle is not moving faster than 12 mph (20 km/h) and the rear fog lamp is not switched on.

Raising the vehicle (vehicles without Off-road package)

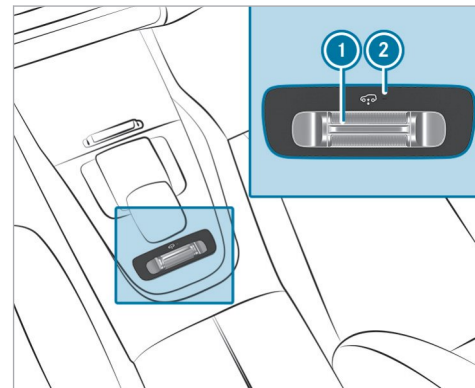

- ▶ Push rocker switch ❶ forwards. Indicator lamp ❷ flashes while the vehicle is being raised and lights up continuously when it has finished rising.

Your selection is saved. The off-road level set remains stored even after the ignition has been switched off.

Operation with a trailer or bicycle rack: if you are driving at speeds greater than 19 mph (30 km/h), the vehicle rises to the normal level in the drive programs Sport or Sport + if the electrical connection has been correctly established.

The vehicle is lowered again in the following situations:

- When driving faster than 50 mph (80 km/h).
- When driving briefly between 40 mph (65 km/h) and 50 mph (80 km/h).
- After selecting a different drive program using the DYNAMIC SELECT switch.

The vehicle is adjusted to the height of the active drive program.

Operation with a trailer or bicycle rack: if you are driving at speeds greater than 19 mph (30 km/h), the vehicle lowers to the normal level if the electrical connection has been correctly established.

Lowering the vehicle (vehicles without Off-road package)

- ▶ Pull rocker switch ①.
The vehicle is adjusted to the height of the active drive program.

Operation with a trailer or bicycle rack: the vehicle lowers to the normal level if the electrical connection has been correctly established.

Raising the vehicle (vehicles with Off-road package)

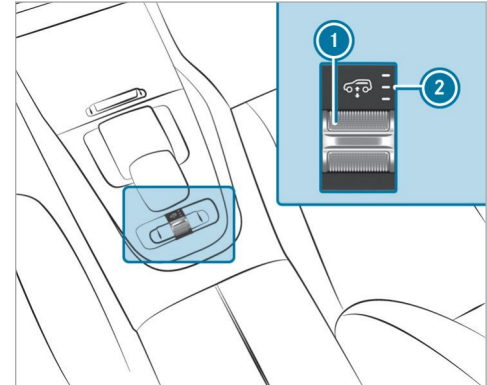

- ▶ Push rocker switch ① forwards.
 - Off-road level +1: one indicator lamp ② lights up continuously when the vehicle has finished rising.
 - Off-road level +2: two indicator lamps ② light up continuously when the vehicle has finished rising.

234 Driving and parking

- Off-road level +3: three indicator lamps ② light up continuously when the vehicle has finished rising.

Your selection is saved. The off-road level set remains stored even after the ignition has been switched off.

The vehicle is lowered again in the following situations:

- Off-road level +3: when driving faster than 12 mph (20 km/h) or when the rear fog lamp is switched on.

The vehicle is lowered to off-road level +2.

- Off-road level +2:
 - When driving faster than 50 mph (80 km/h).
 - When driving briefly between 40 mph (65 km/h) and 50 mph (80 km/h).

The vehicle is lowered to off-road level +1.

Operation with a trailer or bicycle rack: if you are driving at speeds greater than 19 mph (30 km/h), the vehicle lowers to the

normal level if the electrical connection has been correctly established.

- Off-road level +1:
 - When driving faster than 71 mph (115 km/h).
 - When driving briefly between 62 mph (100 km/h) and 71 mph (115 km/h).
 - **Operation with a trailer or bicycle rack:** you are driving at speeds greater than 19 mph (30 km/h).

The vehicle is lowered to the normal level.

- After selecting a different drive program using the DYNAMIC SELECT switch.

The vehicle is adjusted to the height of the active drive program.

Operation with a trailer or bicycle rack: the vehicle lowers to the normal level if the electrical connection has been correctly established.

Lowering the vehicle (vehicles with Off-road package)

- ▶ Pull rocker switch ①.
 - Off-road level +3: the vehicle is lowered to off-road level +2. Two indicator lamps ② light up continuously when the vehicle has finished lowering.
 - Off-road level +2: the vehicle is lowered to off-road level +1. One indicator lamp ② lights up continuously when the vehicle has finished lowering.
 - Off-road level +1: the vehicle is lowered to the normal level. No indicator lamp ② lights up when the vehicle has finished lowering.

Your selection is saved. The off-road level set remains stored even after the ignition has been switched off.

Setting the entering/exiting level (AIRMATIC) Requirements:

- The engine is running.
- The vehicle is moving at speeds less than 20 mph (30 km/h).

Multimedia system:



▶ **Schnellzugriff** (Quick access)

▶ Select **Lower When Getting In On**.

The vehicle is lowered to low level -2 to facilitate entering and exiting.

ⓘ Further information on AIRMATIC (→ page 228).

Lowering and raising the rear of the vehicle

⚠ WARNING Risk of entrapment from vehicle lowering

When lowering the vehicle, people could become trapped if their limbs are between the vehicle body and the tires or underneath the vehicle.

▶ Make sure no one is underneath the vehicle or in the immediate vicinity of the wheel arches when the vehicle is being lowered.

Requirements:

- All vehicle doors are closed

- There is no trailer coupled
- There is no bicycle rack installed
- The battery is sufficiently charged; if necessary, start the engine

Lowering the rear of the vehicle

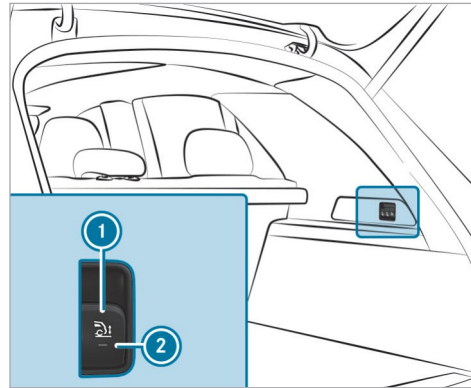

▶ Apply the electric parking brake.

▶ Shift the transmission to position **P** (→ page 180).

▶ Pull switch ① in the right-hand cargo compartment trim briefly. Indicator lamp ② flashes until the vehicle has been lowered.

The vehicle is lowered at the rear axle by approx. 1.5 in (40 mm). When the vehicle has been lowered, indicator lamp ② remains lit.

When the rear of the vehicle has been completely lowered, indicator lamp ② remains lit.

Lowering is interrupted in the following situations:

- A vehicle door is opened
 - Switch ① is pulled again
 - The vehicle is being driven faster than 1.2 mph (2 km/h)
- ⓘ The vehicle is automatically set to the level of the most recently selected drive program if you drive at speeds greater than 1.2 mph (2 km/h).

If indicator lamp ② flashes twice and the rear of the vehicle does not lower:

- ▶ Make sure that the requirements are met.
- ① Lowering the rear of the vehicle allows the vehicle to be loaded more easily. Observe the notes on loading the vehicle when doing this (→ page 114).

Raising the rear of the vehicle

- ▶ Check if the battery is sufficiently charged. If necessary, start the engine.
- ▶ Pull switch ① briefly. Indicator lamp ② goes out.
The vehicle will be raised to the currently selected level.
- ① The vehicle is automatically set to the level of the most recently selected drive program if you drive at speeds greater than 1.2 mph (2 km/h).

If the vehicle cannot be raised:

- ▶ Ensure that the battery is sufficiently charged; if necessary, start the engine. The raising process continues.

E-ACTIVE BODY CONTROL

Function of E-ACTIVE BODY CONTROL

E-ACTIVE BODY CONTROL is an electrohydraulic suspension system with variable damping for improved driving comfort. The all-round level control system ensures the best possible suspension and constant ground clearance, even with a laden vehicle. When driving at speed, the vehicle is lowered automatically to improve driving safety and to reduce fuel consumption. The suspension setting is adjusted depending on the road surface, vehicle load and the drive program selected.

The ROAD SURFACE SCAN function detects areas of unevenness in the road before you drive over them by means of a multifunction camera. This reduces chassis movements.

The damping is adjusted individually to each wheel and depends on the following factors:

- Driving style, e.g. sporty
- Road condition, e.g. bumps
- Drive program



E-ACTIVE BODY CONTROL is comprised of the following functions and components:



- ROAD SURFACE SCAN
- Curve inclination function CURVE
- Recovery mode
- Individual wheel control
- Air suspension with automatic level control
- Speed-dependent lowering to reduce fuel consumption
- Manual level adjustment
- ADS PLUS (Adaptive Damping System with constant adjustment of damping characteristics)
- DYNAMIC SELECT switch and level button

Suspension settings and vehicle level per drive program

Drive program	Suspension settings and vehicle level
S (Sport)	<ul style="list-style-type: none">• The suspension setting is firmer.• The vehicle is set to Sport level.• ROAD SURFACE SCAN is deactivated.• The curve inclination function is deactivated.• Operation with a trailer or bicycle rack: if the electrical connection has been correctly established, the vehicle remains at normal level.
S⁺ (Sport +)	<ul style="list-style-type: none">• The suspension setting is even firmer.• The vehicle is set to Sport + level.• ROAD SURFACE SCAN is deactivated.• The curve inclination function is active.• Operation with a trailer or bicycle rack: if the electrical connection has been correctly established, the vehicle remains at normal level.

Drive program	Suspension settings and vehicle level
C (Comfort)	<ul style="list-style-type: none">• The suspension setting is comfortable.• The vehicle is set to the normal level.• If the trailer socket is not contacted (trailer/bicycle rack): when driving at speeds above approximately 87 mph (140 km/h), the vehicle is lowered.• When driving at speeds below approximately 25 mph (40 km/h), the vehicle is raised.• ROAD SURFACE SCAN is active.• The curve inclination function is deactivated.• Operation with a trailer or bicycle rack: if the electrical connection has been correctly established, the vehicle remains at normal level.
CV (CURVE)	<ul style="list-style-type: none">• The suspension setting is comfortable.• The vehicle is set to the normal level.• When driving at speeds above approximately 87 mph (140 km/h), the vehicle is lowered.• When driving at speeds below approximately 25 mph (40 km/h), the vehicle is raised again.• ROAD SURFACE SCAN is active.• The curve inclination function is active.

Drive program	Suspension settings and vehicle level
 (Economy)	<ul style="list-style-type: none"> • The suspension setting is comfortable. • The vehicle is set to the normal level. • When driving at speeds above approximately 87 mph (140 km/h), the vehicle is lowered. • When driving at speeds below approximately 25 mph (40 km/h), the vehicle is raised again. • ROAD SURFACE SCAN is deactivated. • The curve inclination function is deactivated. • Operation with a trailer or bicycle rack: if the electrical connection has been correctly established, the vehicle remains at normal level.
 (Off-road in vehicles without Off-road package)	<ul style="list-style-type: none"> • The suspension setting is suitable for easily negotiable off-road terrain. • The vehicle is set to off-road level +1. • When driving at speeds above approximately 50 mph (80 km/h) the vehicle is lowered. • When driving at speeds below approximately 28 mph (45 km/h), the vehicle is raised. • ROAD SURFACE SCAN is deactivated. • The curve inclination function is deactivated. • Recovery mode and the individual wheel control function can be activated provided the necessary conditions are met.

Drive program	Suspension settings and vehicle level
 (Off-road in vehicles with Off-road package)	<ul style="list-style-type: none"> • The suspension setting is suitable for easily negotiable off-road terrain. • The vehicle is set to off-road level +1. • When driving at speeds above approximately 71 mph (115 km/h), the vehicle is lowered. • When driving at speeds below approximately 47 mph (75 km/h), the vehicle is raised. • ROAD SURFACE SCAN is deactivated. • The curve inclination function is deactivated. • Recovery mode and the individual wheel control function can be activated provided the necessary conditions are met.
 (Off-road + in vehicles with Off-road package)	<ul style="list-style-type: none"> • The suspension setting is suitable for difficult off-road terrain. • The vehicle is set to off-road level +1. • When driving at speeds above approximately 50 mph (80 km/h), the vehicle is lowered. • When driving at speeds below approximately 28 mph (45 km/h), the vehicle is raised. • ROAD SURFACE SCAN is deactivated. • The curve inclination function is deactivated. • Recovery mode and the individual wheel control function can be activated provided the necessary conditions are met.
 Individual	<ul style="list-style-type: none"> • You can call up individual suspension settings here.

Differences between different vehicle levels compared to the normal level

Vehicle level	Vehicles without Off-road package	Vehicles with Off-road package
Car wash	Approx. +3.5 in (+90 mm)	Approx. +3.5 in (+90 mm)
Off-road level +3	Unavailable	Approx. +3.5 in (+90 mm)
Off-road level +2	Unavailable	Approx. +2.4 in (+60 mm)
Off-road level +1	Approx. +2.4 in (+60 mm)	Approx. +1.2 in (+30 mm)
Sport	Approx. -0.6 in (-15 mm)	Approx. -0.6 in (-15 mm)
Sport +	Approx. -1.0 in (-25 mm)	Approx. -1.0 in (-25 mm)

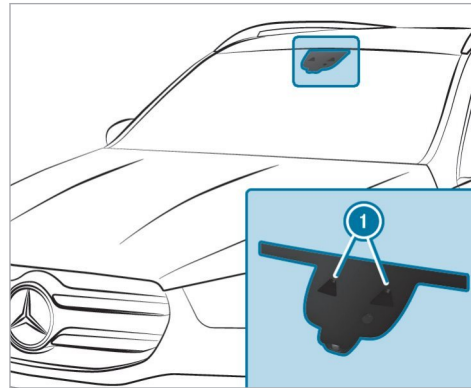

Function of ROAD SURFACE SCAN

 This function is not available in all countries.



The ROAD SURFACE SCAN function monitors the road in front of your vehicle using a multifunction camera . ROAD SURFACE SCAN detects unevenness in the road surface, e.g. bumps, before the vehicle drives over them. Chassis movements are reduced and driving comfort is increased.

ROAD SURFACE SCAN is automatically activated if the following conditions are met:

- Drive program  (Comfort) or  (CURVE) is selected.
- The vehicle is set to the normal level.
- You are driving at a speed between 4 mph (7 km/h) and 112 mph (180 km/h).

System limits

ROAD SURFACE SCAN can be impaired in the following situations or can stop functioning:

- If the roadway is insufficiently lit, e.g. at night.
- In snow, rain, fog, heavy spray, if there is glare, in direct sunlight or in greatly varying ambient light.
- If the windshield in the area of multifunction camera  is dirty, fogged up, damaged or covered.
- If the road surface has no optic structure or reflects light.
- If you are driving too close to the vehicle in front.

242 Driving and parking

- If sections of the route have a very small radius of curvature.
- During abrupt driving maneuvers, e.g. heavy braking or sudden acceleration.

Observe the notes on cleaning the multifunction camera (→ page 467).

Function of recovery mode

⚠ WARNING Risk of injury due to the vehicle moving up and down

When free driving mode is activated, the vehicle bounces up and down. Body parts could become trapped if they are between the vehicle body and the tires or underneath the vehicle.

- ▶ Make sure that nobody is under or in the immediate vicinity of the vehicle when free driving mode is activated.

! NOTE Risk of damage due to the vehicle moving up and down

When free driving mode is activated, the vehicle moves up and down. Vehicle parts may be damaged if the underbody bottoms out.

- ▶ Make sure that there is sufficient ground clearance when rocking free mode is activated.

Rocking free mode is a function of the suspension which can assist the driver on loose surfaces (e.g. sand, snow) when freeing a vehicle which has become stuck.

The vehicle body rocks in slow, vertical motions when recovery mode has been activated. This temporarily puts the wheels under greater load, which means they have increased traction and the vehicle is freed.

You can activate free driving mode via Off-road Assist (→ page 246).

Function of individual wheel control

⚠ WARNING Risk of becoming trapped due to the vehicle lowering

The vehicle can be lowered when the individual wheel control function has been activated. Body parts could become trapped if they are between the vehicle body and the tires or underneath the vehicle.

- ▶ Make sure that nobody is under the vehicle or in the immediate vicinity of the wheel arches when individual wheel control is activated.

! NOTE Risk of damage due to the vehicle moving up and down

The vehicle can be lowered or raised on one or more wheels when the individual wheel control function has been activated. Vehicle parts could be damaged due to contact with objects.

- ▶ Make sure that the vehicle has sufficient room to move when the individual

wheel control function has been activated.

Individual wheel control is a function of the suspension, which can be used to set the vehicle level for each wheel individually. This can help to improve alignment of the body when driving off-road.

You can activate individual wheel control via Off-road Assist (→ page 246).

Adjusting the vehicle level (vehicles with E-ACTIVE BODY CONTROL)

▲ WARNING Risk of accident because vehicle level is too high

If you drive at a higher vehicle level, the driving characteristics may be impaired due to the higher vehicle center of gravity.

The vehicle can drift outwards, for example, when steering or cornering.

▶ Always choose a vehicle level which is suited to the driving style and the road surface conditions.

▲ WARNING Risk of entrapment from vehicle lowering

When lowering the vehicle, people could become trapped if their limbs are between the vehicle body and the tires or underneath the vehicle.

▶ Make sure no one is underneath the vehicle or in the immediate vicinity of the wheel arches when the vehicle is being lowered.

▲ WARNING Risk of becoming trapped due to the vehicle lowering

Vehicles with AIRMATIC or level control: when you unload luggage or leave the vehicle, the vehicle first rises slightly and then returns to the set level shortly afterwards.

You or anyone else in the vicinity of the wheel arches or the underbody could thus become trapped.

The vehicle can also be lowered after being locked.

▶ When leaving the vehicle, make sure that nobody is in the vicinity of the wheel arches or the underbody.

Requirements:

- The vehicle has been started.
- **Vehicles without Off-road package:** the vehicle is being driven no faster than 40 mph (65 km/h) or when being operated with a trailer or bicycle rack with a correctly established electrical connection 19 mph (30 km/h).
- **Vehicles with Off-road package:**
 - Off-road level +1: the vehicle is not moving faster than 62 mph (100 km/h) or when being operated with a trailer or bicycle rack with a correctly established electrical connection 19 mph (30 km/h).
 - Off-road level +2: the vehicle is not moving faster than 40 mph (65 km/h) or when being operated with a trailer or bicycle rack with a correctly established electrical connection 19 mph (30 km/h).

- Off-road level +3: the vehicle is not moving faster than 12 mph (20 km/h).

Raising the vehicle (vehicles without Off-road package)

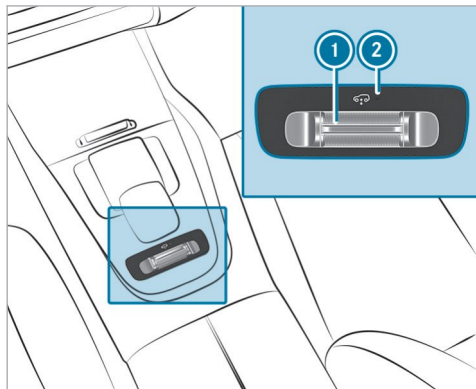

- ▶ Push rocker switch ① forwards. Indicator lamp ② flashes while the vehicle is being raised and lights up continuously when it has finished rising.

Your selection is saved. The off-road level set remains stored even after the ignition has been switched off.

Operation with a trailer or bicycle rack: if you are driving at speeds greater than 19 mph (30 km/h), the vehicle rises to the normal level in the drive programs Sport [S] or Sport + [S+] if the electrical connection has been correctly established.

The vehicle is lowered again in the following situations:

- When driving faster than 50 mph (80 km/h).
- When driving briefly between 40 mph (65 km/h) and 50 mph (80 km/h).
- After selecting a different drive program using the DYNAMIC SELECT switch.

The vehicle is adjusted to the height of the active drive program.

Operation with a trailer or bicycle rack: if you are driving at speeds greater than 19 mph (30 km/h), the vehicle lowers to the normal level if the electrical connection has been correctly established.

Lowering the vehicle (vehicles without Off-road package)

- ▶ Pull rocker switch ①.
The vehicle is adjusted to the height of the active drive program.

Operation with a trailer or bicycle rack: the vehicle lowers to the normal level if the electrical connection has been correctly established.

Raising the vehicle (vehicles with Off-road package)

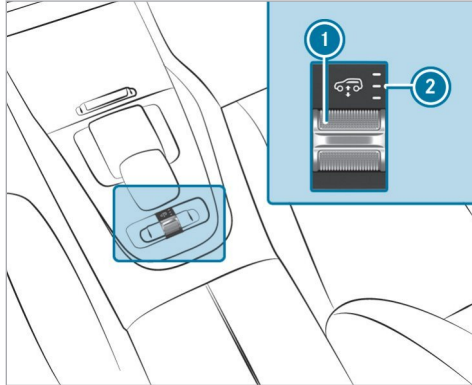

- ▶ Push rocker switch ① forwards.
 - Off-road level +1: one indicator lamp ② lights up continuously when the vehicle has finished rising.
 - Off-road level +2: two indicator lamps ② light up continuously when the vehicle has finished rising.

- Off-road level +3: three indicator lamps ② light up continuously when the vehicle has finished rising.

Your selection is saved. The off-road level set remains stored even after the ignition has been switched off.

The vehicle is lowered again in the following situations:

- Off-road level +3: when driving faster than 12 mph (20 km/h).
The vehicle is lowered to off-road level +2.
- Off-road level +2:
 - When driving faster than 50 mph (80 km/h).
 - When driving briefly between 40 mph (65 km/h) and 50 mph (80 km/h).

The vehicle is lowered to off-road level +1.

Operation with a trailer or bicycle rack: if you are driving at speeds greater than 19 mph (30 km/h), the vehicle lowers to the normal level if the electrical connection has been correctly established.

- Off-road level +1:
 - When driving faster than 71 mph (115 km/h).
 - When driving briefly between 62 mph (100 km/h) and 71 mph (115 km/h).
 - **Operation with a trailer or bicycle rack:** you are driving at speeds greater than 19 mph (30 km/h).

The vehicle is lowered to the normal level.

- After selecting a different drive program using the DYNAMIC SELECT switch.
The vehicle is adjusted to the height of the active drive program.
Operation with a trailer or bicycle rack: the vehicle lowers to the normal level if the electrical connection has been correctly established.

Lowering the vehicle (vehicles with Off-road package)

- ▶ Pull rocker switch ①.
 - Off-road level +3: the vehicle is lowered to off-road level +2. Two indicator lamps

- ② light up continuously when the vehicle has finished lowering.
- Off-road level +2: the vehicle is lowered to off-road level +1. One indicator lamp ② lights up continuously when the vehicle has finished lowering.
- Off-road level +1: the vehicle is lowered to the normal level. No indicator lamp ② lights up when the vehicle has finished lowering.

Your selection is saved. The off-road level set remains stored even after the ignition has been switched off.

Setting Off-road Assist Requirements:

- The vehicle is stationary
- The vehicle is set to off-road level 1 or 2
- The Off-road or Off-road Plus (only vehicles with Off-road package) drive program has been selected
- The ignition is switched on
- All doors and the hood are closed

- The transmission is not engaged in position **P**
- There is no trailer coupled
- The vehicle is outdoors
- The detected lateral inclination of the vehicle must not exceed approx. 15°
- The system is within its operating temperature
- The on-board voltage is sufficiently high

Multimedia system:

→  **▶ Settings ▶ Assistance**
▶▶ Offroad Assistant

Recovery mode

Recovery mode assists the driver when pulling away on rough terrain, such as sand or snow.

- ▶ Select **Free Driving Assist**.
- ▶ Select **Start**.
Recovery mode is activated.
- ▶ Select **Stop** to stop recovery mode.

Recovery mode is automatically deactivated in the following situations:

- You are actually traveling faster than 9 mph (15 km/h)
 - After a running time of 30 seconds
 - It is detected that an object has hit the underbody of the vehicle hard
 - Not all conditions are met
- ① Further information on recovery mode (→ page 242).

Individual wheel control

Individual wheel control enables the vehicle level to be set separately for each wheel.

- ▶ Select **Individual Wheel Ctrl.**
- ▶ Set the vehicle level for the desired wheel.

- ① You can also use the touch display to set the level for two or more wheels at the same time.
- ▶ Select **Reset** to set all wheels to the default setting.

Individual wheel control is automatically deactivated in the following situations:

- You are traveling faster than 9 mph (15 km/h)
 - It is detected that an object has hit the underbody of the vehicle hard
 - Not all conditions are met
- i** Further information on individual wheel control (→ page 242).

Parking Assist PARKTRONIC

Function of Parking Assist PARKTRONIC

Parking Assist PARKTRONIC is an electronic parking assistance system with ultrasound. It monitors the area around your vehicle using six sensors on the front bumper and six sensors on the rear bumper. Parking Assist PARKTRONIC shows you the distance between your vehicle and a detected obstacle visually and audibly.

Parking Assist PARKTRONIC is only an aid. It is not a substitute for your attention to the surroundings. The responsibility for safe maneuver-

ing and parking remains with you. Make sure that there are no persons, animals or objects in the maneuvering area while maneuvering and parking in/exiting parking spaces.

In the standard setting, an intermittent warning tone sounds from a distance of approximately 1.0 ft (0.3 m) to an obstacle in front and approximately 3.3 ft (1.0 m) to an obstacle behind. A continuous warning tone sounds from a distance of approximately 0.7 ft (0.2 m). Using the **Warn Early All Around** setting in the multimedia system, the warning tones for front and side impact protection can be set to sound at a greater distance of approximately 3.3 ft (1.0 m) in front and 2.0 ft (0.6 m) on the sides (→ page 252).

- i** The **Warn Early All Around** setting is always active for the rear of the vehicle.

If Parking Assist PARKTRONIC is deactivated, Active Parking Assist is unavailable.

Parking Assist PARKTRONIC display in the multimedia system



Vehicles with Active Parking Assist without a 360° Camera

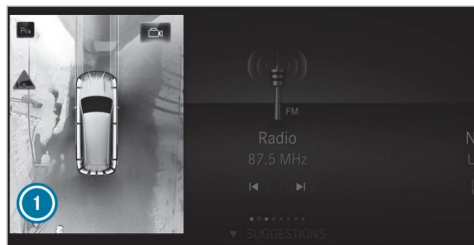

Vehicles with Active Parking Assist and a 360° Camera

If Active Parking Assist is deactivated and an obstacle is detected in the path of the vehicle, a pop-up window for Parking Assist PARKTRONIC ① appears in the multimedia system at speeds below 6 mph (10 km/h).

The color of the individual segments of the warning display is based on the distance to the detected obstacle:

- **Yellow segments:** obstacles at a distance between approx. 2.0 ft (0.6 m) and 3.3 ft (1.0 m)

- **Orange segments:** obstacles at a distance between approx. 1.0 ft (0.3 m) and 2.0 ft (0.6 m)
- **Red segments:** obstacles at a very short distance of approx. 1.0 ft (0.3 m) or less

Display of Active Parking Assist PARKTRONIC in the Head-up Display

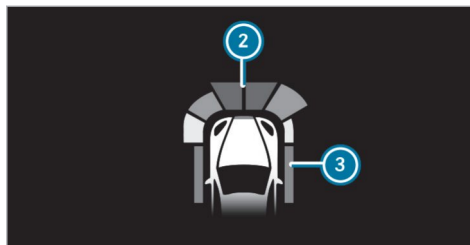

Optionally, obstacles detected by Active Parking Assist PARKTRONIC from a distance of approximately 3.3 ft (1.0 m) in front ② and 2.0 ft (0.6 m) on the sides ③ can also be displayed in the Head-up Display.

System limits

Parking Assist PARKTRONIC does not necessarily take into account the following obstacles:

- Obstacles below the detection range, e.g. persons, animals or objects.
- Obstacles above the detection range, e.g. overhanging loads, overhangs or loading ramps of trucks.

The sensors must be free of dirt, ice and slush. Otherwise, they may not function correctly. Clean the sensors regularly, especially after driving off-road, taking care not to scratch or damage them.

Vehicles with trailer hitch: Parking Assist PARKTRONIC is deactivated for the rear zone when you establish an electrical connection between your vehicle and a trailer.

Problems with Parking Assist PARKTRONIC

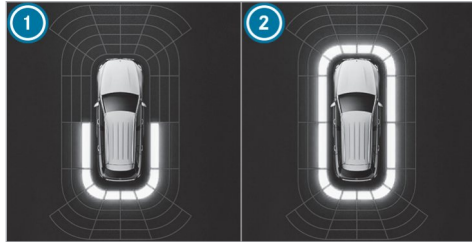

Vehicles without 360° Camera

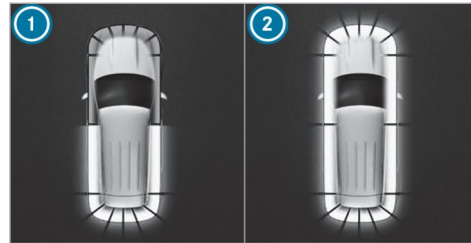

Vehicles with 360° Camera

Problem

Rear segments ① or all-round segments ② light up red. The  sym-

Possible causes/consequences and ► Solutions

Parking Assist PARKTRONIC is malfunctioning and has been deactivated due to signal interference.

- Start the vehicle again.
- Check if Parking Assist PARKTRONIC is working at a different location.

Problem	Possible causes/consequences and ► Solutions
bol appears in the multifunction display.	
Rear segments ① or all-round segments ② light up red. At the same time, a warning tone sounds for approximately two seconds every time the vehicle is started. The  symbol appears in the multifunction display.	<p>The sensors are dirty.</p> <ul style="list-style-type: none"> ► Clean the sensors and observe the notes on care of vehicle parts (→ page 467). <p>Parking Assist PARKTRONIC has been deactivated due to a malfunction.</p> <ul style="list-style-type: none"> ► Start the vehicle again. ► If the problem persists, consult a qualified specialist workshop.

Function of the passive side impact protection

Passive side impact protection is an additional Parking Assist PARKTRONIC function which warns the driver about obstacles at the side of the vehicle. A warning is issued when obstacles are detected between the front and rear detection range. In order for an object on the side to be detected, the sensors in the front and rear bumper must first detect the object while you are driving past it.

During the parking procedure or maneuvering, objects are detected as the vehicle drives past. If you steer in the direction of a detected obstacle and there is a risk of a lateral collision, a warning is issued. The segments on the sides light up yellow or red, depending on the distance to the obstacle.

Segment color depending on distance

Color	Lateral distance
Yellow	Approx. 1.0 - 2.0 ft (30 - 60 cm)
Red	Approx. < 1.0 ft (30 cm)

In order for lateral front or rear segments to be displayed, the vehicle must first travel a distance of at least half of the vehicle length. Once the vehicle has traveled the length of the vehicle, all

of the lateral front and rear segments can be displayed.

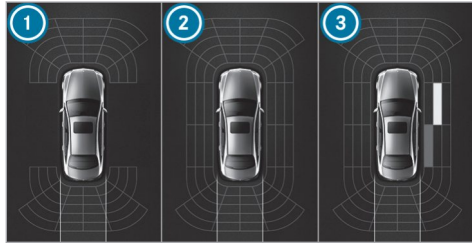

Parking Assist PARKTRONIC display: vehicles without a 360° Camera

- ① Operational front and rear
- ② Operational front, rear and sides
- ③ Obstacle detected at the front right (yellow) and rear (red)

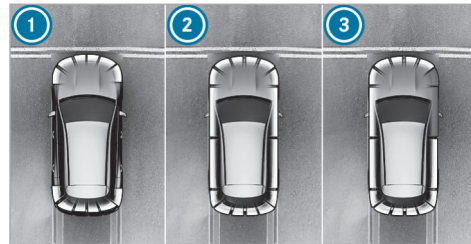

Parking Assist PARKTRONIC display: vehicles with a 360° Camera

- ① Operational front and rear
- ② Operational front, rear and sides
- ③ Obstacles detected at the front right (red)

Saved obstacles on the sides are deleted in the following situations, for example:

- You park the vehicle and switch off the ignition.
- You open the doors.

After the engine is restarted, obstacles on the sides must be detected again before a new warning can be issued.

System limits

The system limits for Parking Assist PARKTRONIC apply to passive side impact protection.

The following objects are not detected, for example:

- Pedestrians who approach the vehicle from the side
- Objects placed next to the vehicle

Activating/deactivating Parking Assist PARKTRONIC

! **NOTE** Risk of an accident from objects at close range

Parking Assist PARKTRONIC may not detect certain objects at close range.

▶ When parking or maneuvering the vehicle, pay particular attention to any objects which are above or below the sensors, e.g. flower pots or drawbars. The vehicle or other objects could otherwise be damaged.

If the  symbol is shown in the multifunction display, Parking Assist PARKTRONIC is not active.

Multimedia system:

➔ Settings ➤ Quick Access

➤ PARKTRONIC

▶ Activate or deactivate the function.

ⓘ Parking Assist PARKTRONIC is automatically activated when the vehicle is started.

Adjusting the warning tones of Parking Assist PARKTRONIC

Multimedia system:

➔  Settings ➤ Assistance

➤ Camera & Parking

Adjusting the volume of the warning tones

▶ Select **Warning Tone Volume**.

▶ Set a value.

Adjusting the pitch of the warning tones

▶ Select **Warning Tone Pitch**.

▶ Set a value.

Specifying the starting point for the warning tones

You can specify whether the Parking Assist PARKTRONIC warning tones should commence when the vehicle is further away from an obstacle.

▶ Select **Warn Early All Around**.

▶ Activate or deactivate the function.

Activating/deactivating audio fadeout

You can specify whether the volume of a media source in the multimedia system is to be reduced when Parking Assist PARKTRONIC sounds a warning tone.

▶ Select **Audio Fadeout During Warning Tones**.

▶ Activate or deactivate the function.

Reversing camera

Function of the rear view camera

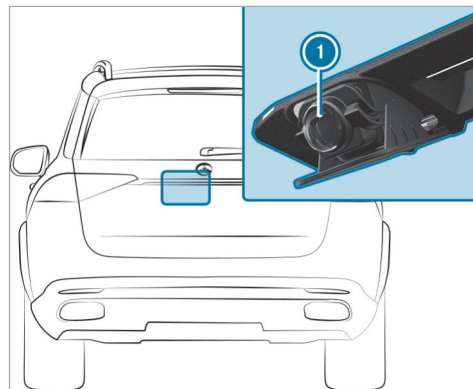

When you engage reverse gear, the image from rear view camera ① is shown in the media display. Dynamic guide lines show the path the vehicle will take with the steering wheel in its current position. This helps you to orient yourself and to avoid obstacles when backing up.

The rear view camera is only an aid. It is not a substitute for your attention to the surroundings. The responsibility for safe maneuvering and parking remains with you. Make sure that there are no persons, animals or objects etc., in the maneuvering area while maneuvering and parking.

The guide lines in the media display show the distances to your vehicle. The distances displayed only apply to road level.

Depending on the vehicle equipment, you can select from the following views:

- Normal view
- Wide-angle view
- Trailer view

The area behind the vehicle is displayed as a mirror image, as in the inside rearview mirror.

Vehicles without Active Parking Assist

The following camera views are available in the multimedia system:

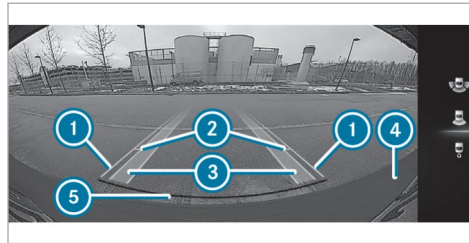

Normal view

- ① Yellow guide line, vehicle width (driven surface) depending on the current steering wheel angle (dynamic)
- ② Yellow guide line at a distance of approximately 3.3 ft (1.0 m) from the rear area
- ③ Yellow lane marking the course the tires will take at the current steering wheel angle (dynamic)
- ④ Bumper
- ⑤ Red guide line at a distance of approximately 1.0 in (0.3 m) from the rear area

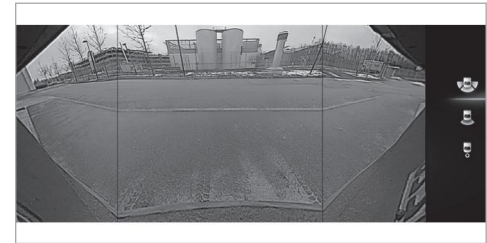

Wide-angle view

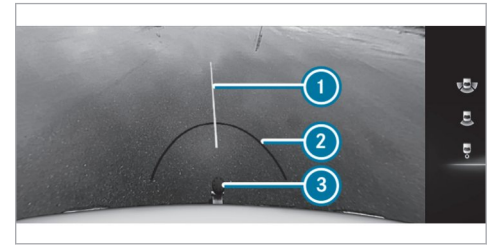

Trailer view (vehicles with a trailer hitch)

- ① Yellow guide line, locating aid

- ② Red guide line at a distance of approximately 1.0 in (0.3 m) from the ball head of the trailer hitch
- ③ Ball head of the trailer hitch

Vehicles with Active Parking Assist

The following camera views are available in the multimedia system:

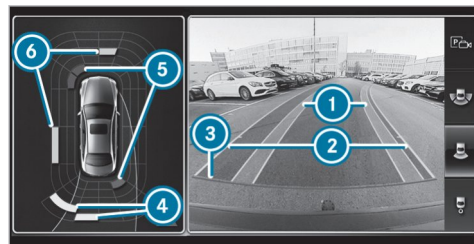

Normal view

- ① Yellow lane marking the course the tires will take at the current steering wheel angle (dynamic)

- ② Yellow guide line, vehicle width (driven surface) depending on the current steering wheel angle (dynamic)
- ③ Red guide line at a distance of approximately 1.0 in (0.3 m) from the rear area
- ④ Yellow warning indicator of Parking Assist PARKTRONIC: obstacles at a distance between approximately 2.0 ft (0.6 m) and 3.3 ft (1.0 m)
- ⑤ Red warning display of Parking Assist PARKTRONIC: obstacles are very close (approximately 1.0 ft (0.3 m) or less)
- ⑥ Orange warning display of Parking Assist PARKTRONIC: obstacles are a medium distance away (between approximately 1.0 ft (0.3 m) and 2.0 ft (0.6 m))
- ⓘ If the entire system fails, the segments of the warning display are shown in red. The indicator lamp on the PARKTRONIC button lights up and the  symbol appears in the multifunction display.

If the system fails at the rear, the display of the segments changes as follows:

- The rear segments are shown in red when backing up.
- The rear segments are hidden when driving forwards.

If Parking Assist PARKTRONIC is deactivated, the warning display fades out (→ page 249).



Wide-angle view

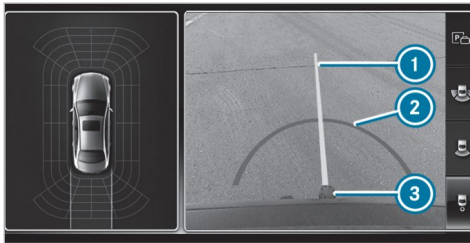

Trailer view (vehicles with a trailer hitch)

- ① Yellow guide line, locating aid
- ② Red guide line at a distance of approximately 1.0 in (0.3 m) from the ball head of the trailer hitch
- ③ Ball head of the trailer hitch

System failure

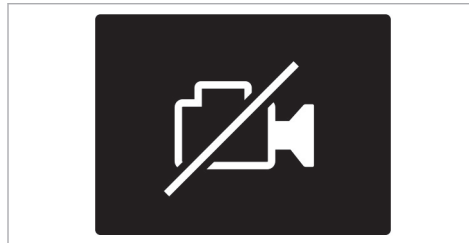

If the rear view camera is not operational, a message appears in the multimedia system.

System limits

The rear view camera will not function or will only partially function in the following situations:

- The tailgate is open.
- There is heavy rain, snow or fog.
- The ambient light conditions are poor, e.g. at night.
- The camera lens is obstructed, dirty or fogged up. Observe the notes on cleaning the rear view camera (→ page 467).

- The camera or rear of your vehicle is damaged. In this case, have the camera and its position and setting checked at a qualified specialist workshop.
- ① Do not use the rear view camera in these types of situation. You could otherwise injure others or collide with objects when parking the vehicle.

If the vehicle is carrying a heavy load, leaving the standard height can result in inaccuracies in the guide lines and in the display of the generated images, depending on technical conditions.

The field of vision and other functions of the rear view camera may be restricted due to additional accessories on the rear of the vehicle (e.g. license plate bracket or bicycle rack).

- ① The contrast of the display may be impaired by direct sunlight or by other light sources, e.g. when driving out of a garage. In this case, pay particular attention.
- ① Have the display repaired or replaced if, for example, pixel errors considerably restrict its use.

360° camera

Function of the 360° Camera

The 360° Camera is a system that consists of four cameras. The cameras cover the immediate vehicle surroundings. The system assists you, e.g. when parking or at exits with reduced visibility.

The views of the 360° Camera are always available when driving forwards up to a speed of approx. 10 mph (16 km/h) and when backing up.

The 360° Camera is only an aid and may show a distorted view of obstacles, show them incorrectly or not show them at all. It is not a substitute for your attention to the surroundings. The responsibility for safe maneuvering and parking remains with you. Make sure that there are no persons, animals or objects etc., in the maneuvering area while maneuvering and parking.

The system evaluates images from the following cameras:

- Rear view camera
- Front camera

- Two side cameras in the outside mirrors

Views of the 360° Camera

You can select from different views:



- 1 Wide-angle view, front
- 2 Top view with image from the front camera
- 3 Top view with images from the side cameras in the outside mirrors
- 4 Wide-angle view, rear
- 5 Top view with image from the rear view camera
- 6 Top view with trailer view (vehicles with a trailer hitch)

Top view

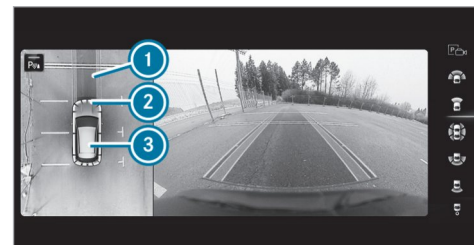

- 1 Lane indicating the route the vehicle will take at the current steering wheel angle
- 2 Warning display of Parking Assist PARKTRONIC
- 3 Your vehicle from above

The color of the individual segments of warning display 2 is based on the distance to the detected obstacle:

- **Yellow segments:** obstacles at a distance between approx. 2.0 ft (0.6 m) and 3.3 ft (1.0 m)

- **Orange segments:** obstacles at a distance between approx. 1.0 ft (0.3 m) and 2.0 ft (0.6 m)
- **Red segments:** obstacles at a very short distance of approx. 1.0 ft (0.3 m) or less

When Parking Assist PARKTRONIC is operational and no object is detected, the segments of the warning display are shown in gray.

i If the entire system fails, the segments of the warning display are shown in red. The indicator lamp on the PARKTRONIC button lights up and the  symbol appears in the multifunction display.

If the system fails at the rear, the display of the segments changes as follows:

- The rear segments are shown in red when backing up.
- The rear segments are hidden when driving forwards.

If Parking Assist PARKTRONIC is deactivated, the warning display fades out (→ page 249).

Guide lines

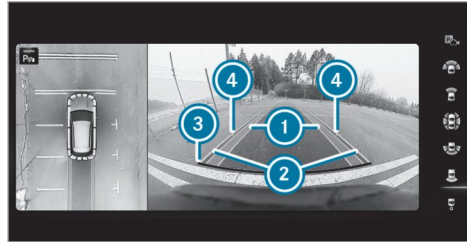

- ① Yellow lane marking the course the tires will take at the current steering wheel angle (dynamic)
 - ② Yellow guide line, vehicle width (driven surface) depending on the current steering wheel angle (dynamic)
 - ③ Red guide line at a distance of approximately 12 in (0.3 m) from the rear area
 - ④ Mark at a distance of approx. 3.3 ft (1.0 m)
- i** When Active Parking Assist is active, lane markings ① are displayed in green.

The guide lines in the media display show the distances to your vehicle. The distances apply to road level.

In trailer mode, the guide lines are shown at the level of the trailer hitch.

Trailer view (vehicles with a trailer hitch)

If you select trailer view and no trailer is coupled to the vehicle, the following display appears:

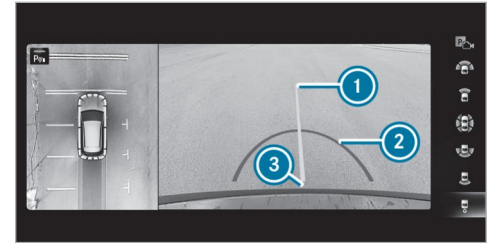

- ① Yellow guide line, locating aid
- ② Red guide line at a distance of approximately 12 in (0.3 m) to the ball head of the trailer hitch
- ③ Ball head of the trailer hitch



When the electrical connection is established between the vehicle and the trailer, the display changes to the side camera view.

This view supports maneuvering procedures with a trailer.

Side view of the mirror cameras

The sides of the vehicle can be seen in this view.

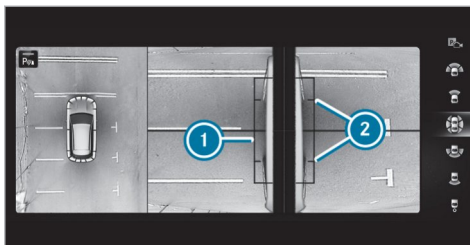

- 1 Guide line of external vehicle dimensions with outside mirrors folded out
- 2 Marker of the wheel contact points

System failure

If the 360° Camera is not ready for operation, the following message appears in the multimedia system:

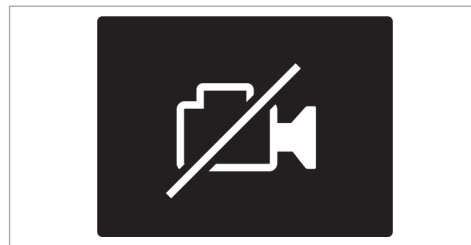

System limits

The 360° Camera will not function or will only partially function in the following situations:

- The doors are open.
- The side mirrors are folded in.
- The tailgate is open.
- There is heavy rain, snow or fog.
- The ambient light conditions are poor, e.g. at night.
- The camera lens is obstructed, dirty or fogged up.
- If cameras or vehicle components in which the cameras are installed are damaged. In

this event, have the cameras, their positions and their setting checked at a qualified specialist workshop.

- ⓘ Do not use the 360° Camera under such circumstances. You could otherwise injure others or collide with objects when parking the vehicle.

If the vehicle is carrying a heavy load, leaving the standard height can result in inaccuracies in the guide lines and in the display of the generated images, depending on technical conditions.

The field of vision and other functions of the camera system may be restricted due to additional attachments on the vehicle (e.g. license plate bracket, bicycle rack).

- ⓘ The contrast of the display may be impaired by abrupt direct sunlight or by other light sources, e.g. when driving out of a garage. In this case, pay particular attention.
- ⓘ Have the display repaired or replaced if, for example, pixel errors considerably restrict its use.

See the notes on cleaning the 360° Camera (→ page 467).

Selecting a view for the 360° Camera

- ▶ Engage reverse gear.
- ▶ Select the desired view in the multimedia system (→ page 256).

Opening the camera cover of the rear view camera

Multimedia system:

-  ▶ Settings ▶ Assistance
- ▶▶ Camera & Parking

- ▶ Select **Open Camera Cover**.

- ⓘ The camera cover closes automatically after some time or after an ignition cycle.

Active Parking Assist

Function of Active Parking Assist

Active Parking Assist is an electronic parking assistance system which uses ultrasound and is automatically activated during forward travel. The system is operational at speeds below approximately 22 mph (35 km/h).

If all requirements are met, the  display appears in the multifunction display. The system

then independently locates and measures parallel and perpendicular parking spaces on both sides of the vehicle.

When Active Parking Assist has detected parking spaces, the  display appears in the multifunction display. The arrows show on which side of the road detected parking spaces are located. They are then shown in the media display. The parking space and, if necessary, the parking direction can be selected as desired. Active Parking Assist calculates a suitable vehicle path, switches on the turn signal indicator and assists you in parking and exiting the parking space.

Active Parking Assist provides assistance when changing gear, accelerating, braking and steering the vehicle.

Active Parking Assist is only an aid. It is not a substitute for your attention to the surroundings. The responsibility for safe maneuvering and parking remains with you. Make sure that no persons, animals or objects etc. are in the maneuvering range.

260 Driving and parking

Active Parking Assist is canceled if, among other things, one of the following actions is carried out:

- Parking Assist PARKTRONIC is deactivated.
- Active Parking Assist is deactivated.
- You begin steering.
- You apply the parking brake.
- You engage transmission position **P**.
- ESP® intervenes.
- You open the doors or the tailgate while driving.

System limits

Objects located above or below the detection range of Parking Assist PARKTRONIC or Active Parking Assist are not detected when the parking space is being measured. These are also not taken into account when the parking maneuver is calculated, e.g. overhanging loads, overhangs or loading ramps of trucks or the boundaries of parking spaces. In some circumstances, Active Parking Assist may therefore guide you into the parking space prematurely.

⚠ WARNING Risk of accident due to objects located above or below the detection range of Active Parking Assist

If there are objects above or below the detection range, the following situations may arise:

- Active Parking Assist may steer too early.
- **Vehicles with automatic transmission:** The vehicle may not stop in front of these objects.

This could cause a collision.

▶ In these situations, do not use Active Parking Assist.

Snowfall or heavy rain may lead to a parking space being measured inaccurately. Parking spaces that are partially occupied by trailer drawbars might not be identified as such or be measured incorrectly. Only use Active Parking Assist on level, high-grip ground.

Do not use Active Parking Assist in the following situations:

- In extreme weather conditions such as ice, packed snow or in heavy rain.
- When transporting a load that protrudes beyond the vehicle.
- If the parking space is on a steep downhill or uphill gradient.
- When snow chains are installed.

Active Parking Assist may also display parking spaces that are not suitable for parking, e.g. the following:

- Parking spaces where parking is prohibited.
- Parking spaces on unsuitable surfaces.

Active Parking Assist will not assist you with parking spaces at right angles to the direction of travel in the following situations:

- If two parking spaces are located immediately next to each other.
- If the parking space is immediately next to a low obstacle such as a curb.

Active Parking Assist will not assist you with parking spaces parallel or at right angles to the direction of travel in the following situations:

- If the parking space is on a curb.
- If the parking space is bordered by an obstacle, e.g. a tree, a post or a trailer.

Parking with Active Parking Assist

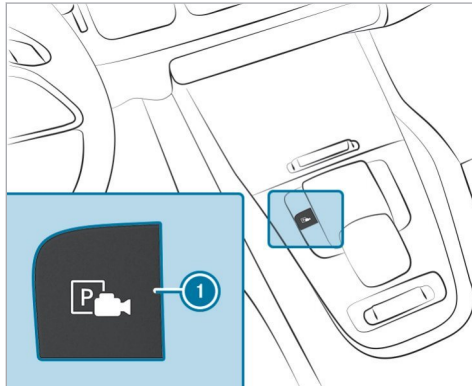

- ▶ Press button ①.

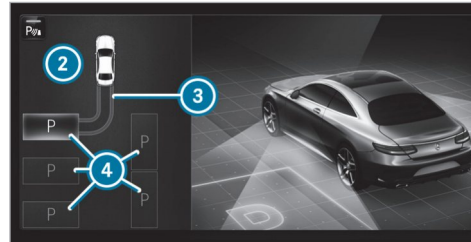

The media display shows the view of Active Parking Assist. Area ② displays detected parking spaces ④ and vehicle path ③.

- ① Vehicle path ③ shown on the media display may differ from the actual vehicle path.
- ▶ If you have driven past a parking space: bring the vehicle to a standstill.
- ▶ Select desired parking space ④.

- ▶ Where necessary, select the parking direction: forwards or reverse. Vehicle path ③ is shown, depending on selected parking space ④ and the parking direction.
- ▶ Confirm selected parking space ④.

- ① The turn signal indicator is switched on automatically when the parking procedure begins. The turn signal indicator is switched off automatically when you switch to **[D]**.

You are responsible for selecting the turn signal indicator in accordance with the traffic conditions. If necessary, select the turn signal indicator accordingly.

⚠ WARNING Risk of accident due to vehicle swinging out while parking or pulling out of a parking space

While parking or exiting a parking space, the vehicle swings out and can drive onto areas of the oncoming lane.

This could cause you to collide with objects or other road users.

- ▶ Pay attention to objects and other road users.
- ▶ Where necessary, stop the vehicle or cancel the parking procedure with Active Parking Assist.

- ▶ If, for example, the **Please Engage Reverse Gear** message appears in the media display: select the corresponding transmission position. The vehicle drives into the selected parking space.

On completion of the parking procedure, the **Parking Assist Finished, Take Control of Vehicle** display message appears. Further maneuvering may still be necessary.

- ▶ After completion of the parking procedure, safeguard the vehicle against rolling away. When required by legal requirements or local conditions: turn the wheels towards the curb.
- i** You can stop the vehicle and change the transmission position during the parking procedure. The system then calculates a new vehicle path. The parking procedure can

then be continued. If no new vehicle path is available, the transmission position will be changed again. If the vehicle has not yet reached the parking space, the parking procedure will be canceled, should a gear be changed.

Exiting a parking space with Active Parking Assist

Requirements:

- The vehicle has been parked with Active Parking Assist.

Please note that you are responsible for the vehicle and surroundings during the entire parking procedure.

- ▶ Start the vehicle.

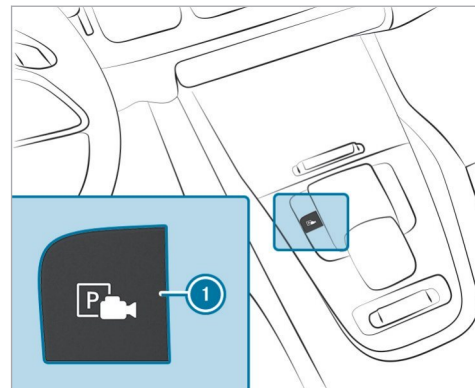

- ▶ Press button **1**. The media display shows the view of Active Parking Assist.

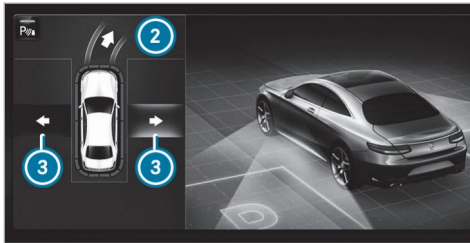

▶ If the vehicle has been parked at right angles to the direction of travel: in area ②, select direction of travel ③, **left** or **right**.

① The vehicle path shown on the media display may differ from the actual vehicle path.

▶ Confirm direction of exit ③ to drive out of the parking space.

① The turn signal indicator is switched on automatically when the exiting procedure begins.

You are responsible for selecting the turn signal indicator in accordance with the traffic conditions. If necessary, select the turn signal indicator accordingly.

⚠ WARNING Risk of accident due to vehicle swinging out while parking or pulling out of a parking space

While parking or exiting a parking space, the vehicle swings out and can drive onto areas of the oncoming lane.

This could cause you to collide with objects or other road users.

- ▶ Pay attention to objects and other road users.
- ▶ Where necessary, stop the vehicle or cancel the parking procedure with Active Parking Assist.

▶ If, for example, the **Please Engage Forward Gear** message appears in the media display: select the corresponding transmission position. The vehicle moves out of the parking space. The turn signal indicator is switched off automatically.

After the exiting procedure has been completed, the **Parking Assist Finished, Take Control of**

Vehicle message appears in the media display. A warning tone and the following display in the media display prompt you to take over control of the vehicle:



You have to accelerate, brake, steer and change gear yourself again.

Function of Drive Away Assist

Drive Away Assist can reduce the severity of an impact when pulling away. If an obstacle is detected in the direction of travel, the vehicle's speed is briefly reduced to approx. 1 mph (2 km/h). If a critical situation is detected, symbol  appears in the media display.

⚠ WARNING Risk of accident caused by limited detection performance of Drive Away Assist

Drive Away Assist cannot always clearly identify objects and traffic situations.

In such cases, Drive Away Assist might:

- Warn you without reason and limit the vehicle speed.
 - Not warn you or not limit the vehicle speed.
- ▶ Always pay careful attention to the traffic situation; do not rely on Drive Away Assist alone.
- ▶ Be prepared to brake or swerve as necessary, provided the traffic situation permits and that it is safe to take evasive action.

Drive Away Assist is only an aid. It is not a substitute for your attention to the surroundings. The responsibility for safe maneuvering and parking remains with you. Make sure that no persons, animals or objects etc. are in the maneuvering range.

A risk of a collision may arise in the following situations, for example:

- If the driver mixes up the accelerator and brake pedals.

- If the wrong gear is selected.

Drive Away Assist is active under the following conditions:

- If Parking Assist PARKTRONIC is activated.
- Every time the gear is changed to **R** or **D** when the vehicle is at a standstill.
- If the detected obstacle is less than approx. 3.3 ft (1.0 m) away.
- If the maneuvering assistant function is activated in the multimedia system.

System limits

The performance of Drive Away Assist is limited on inclines.

When driving with a trailer, Drive Away Assist is not available.

- ① Also observe the system limits of Parking Assist PARKTRONIC (→ page 247).

Function of Cross Traffic Alert

- ① Also read the instructions on Blind Spot Assist (→ page 269).



Vehicles with Blind Spot Assist: Cross Traffic Alert can warn drivers of any crossing traffic when backing up out of a parking space. The radar sensors in the bumper also monitor the area adjacent to the vehicle. If a critical situation is detected, symbol ① appears in the media display. If the driver does not respond to the warning, the vehicle's brakes can be applied automatically.

If the radar sensors are obstructed by vehicles or other objects, detection is not possible.

Cross Traffic Alert is active under the following conditions:

- If Blind Spot Assist is activated.

- If the vehicle is backing up at walking pace.
- If the maneuvering assistant function is activated in the multimedia system.

System limits

Cross Traffic Alert is not available on inclines.

Cross Traffic Alert is not available when driving with a trailer.

- ⓘ Also observe the system limits of Active Blind Spot Assist (→ page 269).

Activating/deactivating maneuvering assistance

Multimedia system:

→  » Settings » Assistance
» Camera & Parking

- ▶ Switch [Maneuvering Assistance](#) on or off.
- ⓘ Maneuvering assistance must be active for the function of Drive Away Assist (→ page 263) and Cross Traffic Alert (→ page 264).

ATTENTION ASSIST

Function of ATTENTION ASSIST

ATTENTION ASSIST assists you on long, monotonous journeys, e.g. on highways and trunk roads. If ATTENTION ASSIST detects indicators of fatigue or increasing lapses in concentration on the part of the driver, it suggests taking a break.

ATTENTION ASSIST is only an aid. It cannot always detect fatigue or lapses in concentration in time. The system is not a substitute for a well-rested and attentive driver. On long journeys, take regular breaks in good time that allow for adequate recuperation.

You can choose between two settings:

- **Standard:** normal system sensitivity.
- **Sensitive:** higher system sensitivity. The driver is warned earlier and the attention level detected by ATTENTION ASSIST is adapted accordingly.

If drowsiness or increasing lapses in concentration are detected, the **ATTENTION ASSIST: Take a Break!** warning appears in the Instrument Display. You can acknowledge the message and

take a break where necessary. If you do not take a break and ATTENTION ASSIST continues to detect increasing lapses in concentration, you will be warned again after a minimum of 15 minutes.

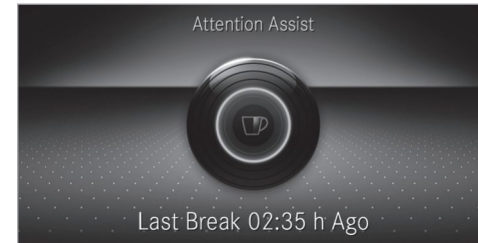

You can have the following status information for ATTENTION ASSIST displayed in the assistance menu of the on-board computer:

- The length of the journey since the last break.
- The attention level determined by ATTENTION ASSIST:
 - The fuller the circle, the higher the attentional level determined

- As your attention wanes, the circle in the center of the display becomes smaller

If ATTENTION ASSIST is unable to calculate the attention level and cannot issue a warning, the **System Suspended** message appears.

If a warning is given in the Instrument Display, the multimedia system offers to search for a rest area. You can select a rest area and start navigation to this rest area. This function can be activated and deactivated in the multimedia system.

If ATTENTION ASSIST is deactivated, the  symbol appears in the assistance graphic in the Instrument Display when the engine is running. ATTENTION ASSIST is activated automatically when the engine is re-started. The last selected sensitivity level remains stored.

System limits

ATTENTION ASSIST is active in the 37 mph (60 km/h) to 124 mph (200 km/h) speed range.

The functionality of ATTENTION ASSIST is restricted, and warnings may be delayed or not occur at all in the following situations:

- If you have been driving for less than approximately 30 minutes.
- If the road condition is poor (uneven road surface or potholes).
- If there is a strong side wind.
- If you adopt a sporty driving style (high cornering speeds or high rates of acceleration).
- If the Steering Assist function of Active Distance Assist DISTRONIC is active.
- If the time has been set incorrectly.
- In active driving situations, if you change lanes and vary your speed frequently.

The ATTENTION ASSIST tiredness or alertness assessment is deleted and restarted when continuing the journey in the following situations:

- If you switch off the engine.
- If you unfasten your seat belt and open the driver's door (e.g. changing drivers or taking a break).

Setting ATTENTION ASSIST



Multimedia system:

  **» Settings** **» Assistance**
» Attention Assist

Setting options

 Select **Standard**, **Sensitive** or **Off**.

Suggesting a rest area

-  Select **Suggest Rest Area**.
-  Activate or deactivate the function. If ATTENTION ASSIST detects fatigue or increasing lack of attention, it suggests a rest area in the vicinity.
-  Select the suggested rest area. You are guided to the selected rest area.

Traffic Sign Assist

Function of Traffic Sign Assist

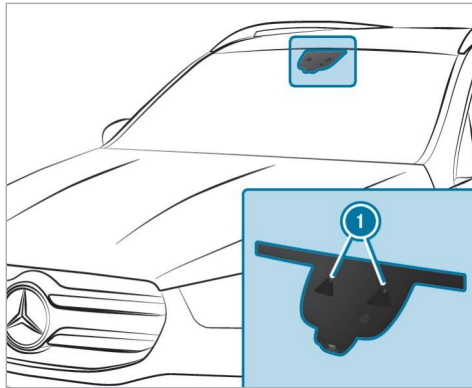

Traffic Sign Assist detects traffic signs with multifunction camera ①. It assists you by displaying detected speed limits and overtaking restrictions in the instrument cluster and optionally in the head-up display or central display.

Since Traffic Sign Assist also uses the data stored in the navigation system, it can update the display in the following situations without detecting traffic signs:

- When the vehicle changes roads, e.g. on a highway entry or exit road.
- When a village or city boundary which is stored in the digital map is passed.

The camera also detects traffic signs with a restriction indicated by an additional sign (e.g. in wet conditions).

Traffic Sign Assist is only an aid. The driver is responsible for keeping a safe distance from the vehicle in front, for vehicle speed and for braking in good time.

Warning when the maximum permissible speed is exceeded

The system can warn you if you unintentionally exceed the maximum permissible speed. To do this, you can specify in the multimedia system by how much the maximum permissible speed can be exceeded before a warning is issued. You can specify whether the warning is to be just a visual warning or an acoustic one as well.

Display in the Instrument Display

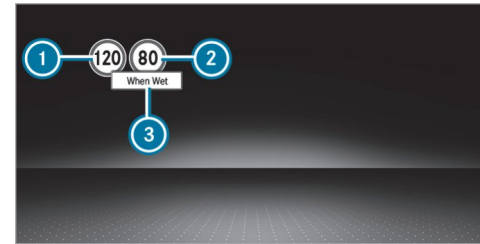

Instrument Display in the Widescreen Cockpit

- ① Permissible speed
- ② Permissible speed when there is a restriction
- ③ Additional sign with restriction

i Vehicles with a standard Instrument Display: a + symbol next to a traffic sign in the Instrument Display indicates that additional traffic signs have been detected. These can also be displayed in the media display and optionally in the head-up display.

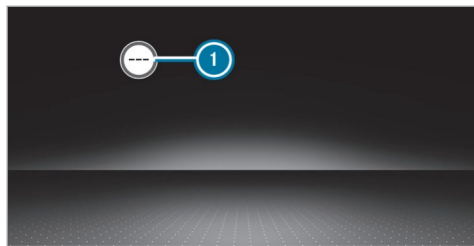

Traffic Sign Assist is not available in all countries. If it is unavailable, display ❶ is shown in the speedometer.

System limits

The system may be impaired or may not function in the following situations:

- If there is poor visibility, e.g. due to insufficient illumination of the road, if there are highly variable shade conditions or in rain, snow, fog or heavy spray.
- If there is glare, e.g. from oncoming traffic, direct sunlight or reflections.

- If the windshield in the area of the multifunction camera is dirty, or if the camera is fogged up, damaged or covered.
- If the traffic signs are hard to detect, e.g. due to dirt or snow, or because they are covered or due to insufficient lighting.
- If the information in the navigation system's digital map is incorrect or out-of-date.
- If the signs are ambiguous, e.g. traffic signs on construction sites or in adjacent lanes.
- If you turn sharply, when passing traffic signs outside the camera's field of vision.

Setting Traffic Sign Assist Requirements:

• Only vehicles with Driving Assistance Package:

Active Distance Assist DISTRONIC must be activated for the automatic adoption of speed limits.

Multimedia system:

→ » Settings » Assistance
» Traffic Sign Assist

Activating/deactivating automatic adoption of speed limits (only vehicles with Driving Assistance Package)

- ▶ Select [Limit Adoption](#).
- ▶ Activate or deactivate the function. The speed limits detected by Traffic Sign Assist are automatically adopted by Active Distance Assist DISTRONIC.

- ❶ If one of the following systems is activated, the speed detected can be manually adopted as the speed limit:
 - Active Distance Assist DISTRONIC
 - Cruise control
 - Variable limiter

Further information (→ page 215).

Displaying detected traffic signs in the media display

- ▶ Select [Display in Central Display](#).

- ▶ Activate or deactivate the function.

Adjusting the type of warning

- ▶ Select **Visual & Audible**, **Visual** or **Off**.

Adjusting the warning threshold

This value determines the speed at which a warning is issued when exceeded.

- ▶ Select **Warning Threshold**.
- ▶ Set the desired speed.

Blind Spot Assist and Active Blind Spot Assist with exit warning

Function of Blind Spot Assist and Active Blind Spot Assist with exit warning

Blind Spot Assist and Active Blind Spot Assist use two lateral, rear-facing radar sensors to monitor the area up to 130 ft (40 m) behind and 10 ft (3 m) next to your vehicle.

If a vehicle is detected at speeds above approximately 8 mph (12 km/h) and this vehicle subsequently enters the monitoring range directly next to your vehicle, the warning lamp in the outside mirror lights up red.

If a vehicle is detected close to the side of your vehicle, the red warning lamp in the outside mirror flashes. If you switch on the turn signal indicator in the corresponding direction, a warning tone sounds once. If the turn signal indicator remains switched on, all other detected vehicles are indicated only by the flashing of the red warning lamp.

If you overtake a vehicle quickly, no warning is given.

▲ WARNING Risk of accident despite Blind Spot Assist

Blind Spot Assist does not react to vehicles approaching and overtaking you at a greatly different speed.

As a result, Blind Spot Assist cannot warn drivers in this situation.

- ▶ Always pay careful attention to the traffic situation and maintain a safe distance at the side of the vehicle.

Blind Spot Assist and Active Blind Spot Assist are only aids. They may fail to detect some vehi-

cles and are no substitute for attentive driving. Always ensure that there is sufficient distance to the side for other road users and obstacles.

Exit warning

The exit warning is an additional function of Blind Spot Assist and can warn vehicle occupants about approaching vehicles when leaving the vehicle when stationary.

▲ WARNING Risk of accident despite exit warning

The exit warning reacts neither to stationary objects nor to vehicles approaching you at a greatly different speed.

As a result, the exit warning cannot warn drivers in these situations.

- ▶ Always pay particular attention to the traffic situation when opening the doors and make sure there is sufficient clearance.

If there is a vehicle in the monitoring range, this is indicated in the outside mirror. If a vehicle occupant opens the door on the side with the

warning, a warning tone sounds and the warning lamp in the outside mirror starts to flash.

This additional function is only available when Blind Spot Assist is activated and up to a maximum of three minutes after the ignition has been switched off. The exit warning is no longer available once the warning lamp in the outside mirror flashes three times.

The exit warning is only an aid and not a substitute for the attention of vehicle occupants. The responsibility for opening and closing the doors and for leaving the vehicle remains with the vehicle occupants.

System limits

Blind Spot Assist and Active Blind Spot Assist may be limited in the following situations:

- If there is dirt on the sensors or the sensors are obscured
- In poor visibility, e.g. due to fog, heavy rain or snow
- If there are narrow vehicles, e.g. bicycles or motorbikes
- If the road has very wide or narrow lanes

- If vehicles are not driving in the middle of their lane

Warnings may be issued in error when driving close to crash barriers or similar solid lane borders. Always make sure that there is sufficient distance to the side for other traffic or obstacles.

Warnings may be interrupted when driving alongside long vehicles, for example trucks, for a prolonged time.

Blind Spot Assist is not operational when reverse gear is engaged.

Blind Spot Assist is not operational when a trailer is coupled to the vehicle and the electrical connection has been correctly established.

The exit warning may be limited in the following situations:

- When the sensors are covered by adjacent vehicles in narrow parking spaces
- When people approach the vehicle
- In the event of stationary or slowly moving objects

Function of brake application (Active Blind Spot Assist)

- ① The brake application function is only available for vehicles with a Driving Assistance Package.

If Active Blind Spot Assist detects a risk of a side impact in the monitoring range, a course-correcting brake application is carried out. This is designed to help you avoid a collision.

The course-correcting brake application is available in the speed range between approximately 20 mph (30 km/h) and 125 mph (200 km/h).

⚠ WARNING Risk of accident despite brake application of Active Blind Spot Assist

A course-correcting brake application cannot always prevent a collision.

- ▶ Always steer, brake or accelerate yourself, especially if Active Blind Spot Assist warns you or makes a course-correcting brake application.

- ▶ Always maintain a safe distance at the sides.

⚠ WARNING Risk of accident despite Active Blind Spot Assist

Active Blind Spot Assist does not react to the following:

- If vehicles overtake too closely on the side, placing them in the blind spot area
- Vehicles approaching and overtaking you at a greatly different speed

As a result, Active Blind Spot Assist may neither give warnings nor intervene in such situations.

- ▶ Always pay careful attention to the traffic situation and maintain a safe distance at the side of the vehicle.

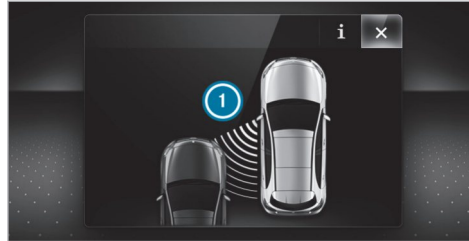

If a course-correcting brake application occurs, the red warning lamp flashes in the outside mirror and a warning tone sounds. In addition, a display ❶ indicating the danger of a side collision appears in the multifunction display.

In rare cases, the system may make an inappropriate brake application. This brake application may be interrupted at any time if you steer slightly in the opposite direction or accelerate.

System limits

Either a course-correcting brake application appropriate to the driving situation, or none at all, may occur in the following situations:

- Vehicles or obstacles, e.g. crash barriers, are located on both sides of your vehicle.
- A vehicle approaches too closely on the side.
- You have adopted a sporty driving style with high cornering speeds.
- You brake or accelerate significantly.
- A driving safety system intervenes, e.g. ESP® or Active Brake Assist.
- ESP® is deactivated.
- A loss of tire pressure or a faulty tire is detected.
- You are driving with a trailer and the electrical connection to the trailer hitch has been correctly established.

Activating/deactivating Blind Spot Assist or Active Blind Spot Assist

Multimedia system:

→  ► Settings ► Assistance

▶ Activate or deactivate **Blind Spot Assist**.

or

▶ Activate or deactivate **Act. Blind Spot Assist**.

ⓘ Depending on the vehicle's equipment, Blind Spot Assist or Active Blind Spot Assist is available.

Active Lane Keeping Assist

Function of Active Lane Keeping Assist

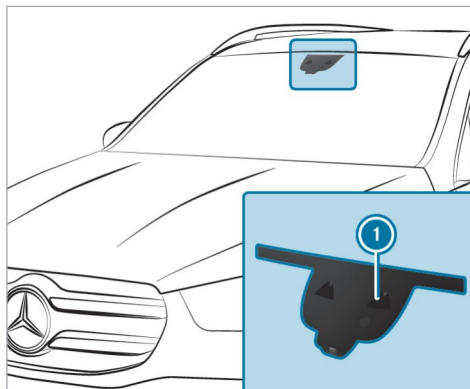

Active Lane Keeping Assist monitors the area in front of your vehicle by means of multifunction camera ①. It serves to protect you against unintentionally leaving your lane. You will be warned by vibration pulses in the steering wheel and gui-

ded by a course-correcting brake application back into your lane.

You are warned by vibration pulses in the steering wheel in the following circumstances:



- Active Lane Keeping Assist detects a lane marking.
- A front wheel drives over this lane marking.

You will also be guided back into your lane by means of a course-correcting brake application if the following conditions are met:

- Active Lane Keeping Assist detects lane markings on both edges of the lane.
- A front wheel drives over a solid lane marking.

You can activate or deactivate the Active Lane Keeping Assist warning.

The status of Active Lane Keeping Assist is displayed in the on-board computer:

-  (green): Active Lane Keeping Assist is activated and operating.
-  (gray): Active Lane Keeping Assist is activated, but not operating.

- : Active Lane Keeping Assist is deactivated or there is a malfunction.

Active Lane Keeping Assist can neither reduce the risk of an accident if you fail to adapt your driving style nor override the laws of physics. It cannot take into account road, weather or traffic conditions. Active Lane Keeping Assist is only an aid. You are responsible for maintaining a safe distance to the vehicle in front, for vehicle speed, for braking in good time and for staying in lane.

Active Lane Keeping Assist can bring the vehicle back into the lane with a lane-correcting brake application. In the case of a broken lane marking being detected, a brake application will only be made if a vehicle has been detected in the adjacent lane. Oncoming traffic can be detected.

Vehicles with Driving Assistance Package or Driving Assistance Plus Package: overtaking vehicles and vehicles in adjacent lanes can also be detected.

Vehicles without Driving Assistance Package or Driving Assistance Plus Package: a lane-correcting brake application also takes

place when, in addition to a broken lane marking, the edge of a firm road surface is detected (e.g. central reservation).

Active Lane Keeping Assist is available in the speed range between 37 mph (60 km/h) and 124 mph (200 km/h).



If a lane-correcting brake application occurs, display  appears in the multifunction display.

Sensitivity of Active Lane Keeping Assist

-  The availability of the following function is country-dependent.

A lane-correcting brake application also occurs in the **Sensitive** setting in the following situations:

- Active Lane Keeping Assist detects a solid lane marking.
- A front wheel drives over this lane marking.

System limits

No lane-correcting brake application occurs in the following situations:

- You clearly and actively steer, brake or accelerate.
- You have switched on the turn signal indicator (situation-dependent).
- A driving safety system intervenes, such as ESP[®], Active Brake Assist or Active Blind Spot Assist.
- You have adopted a sporty driving style with high cornering speeds or high rates of acceleration.
- When ESP[®] is deactivated.

274 Driving and parking

- When driving with a trailer, the electrical connection to the trailer has been correctly established.
- If a loss of tire pressure or a faulty tire has been detected and displayed.

The system may be impaired or may not function in the following situations:

- If there is poor visibility, e.g. due to insufficient illumination of the road, if there are highly variable shade conditions or in rain, snow, fog or heavy spray.
- If there is glare, e.g. from oncoming traffic, the sun or reflections.
- If the windshield in the area of the multifunction camera is dirty, or if the camera is fogged up, damaged or covered.
- If there are no lane markings, or several unclear lane markings are present for one lane, e.g. around roadworks.
- If the lane markings are worn, dark or covered.

- If the distance to the vehicle in front is too short and thus the lane markings cannot be detected.
- If the lane markings change quickly, e.g. lanes branch off, cross one another or merge.
- If the roadway is very narrow and winding.

Vehicles without Driving Assistance Package or Driving Assistance Plus Package:

Active Lane Keeping Assist uses radar sensors to monitor several areas around the vehicle. If the radar sensors in the rear bumper are dirty or covered with snow, the system may be impaired or may not function. If an obstacle in the lane in which you are driving has been detected, no lane-correcting brake application occurs.

Activating/deactivating Active Lane Keeping Assist

Multimedia system:

- ➔  **Settings** **Quick Access**
➔ **Active Lane Keeping Assist**
▶ Activate or deactivate the function.

Setting Active Lane Keeping Assist

Multimedia system:

- ➔  **Settings** **Assistance**
➔ **Active Lane Keeping Assist**

Setting the sensitivity

- ⓘ The availability of this function is dependent on the country.
▶ Select **Standard**, **Sensitive** or **Off**.

Activating/deactivating the haptic warning

- ▶ Select **Warning**.
▶ Activate or deactivate the function.

Trailer hitch

Notes on towing a trailer

Mercedes-AMG vehicles: be sure to observe the notes in the Supplement. Otherwise, you may fail to recognize dangers.

▲ WARNING Danger of accident due to unsuitable ball coupling

If you install an unsuitable ball coupling, overloading of the trailer hitch and rear axle will be the result. This is particularly the case if the ball coupling is relatively long or angled differently.

The handling characteristics may be heavily impaired and the trailer can become detached. There is a risk of fatal injury.

- ▶ Only install a ball coupling that meets the permitted dimensions and has been designed for the trailer operation requirements.
- ▶ Do not modify the ball coupling or the trailer hitch.

The values approved by the manufacturer can be found on the identification plates and in the "Technical data" section under "Trailer hitch" for the towing vehicle (→ page 539).

▲ WARNING Swerving of the vehicle/trailer combination due to increased speed

If the vehicle/trailer combination swerves, you can lose control of it.

The vehicle/trailer combination can even tip over.

- ▶ Under no circumstances should you try to increase the speed to straighten the vehicle/trailer combination.
- ▶ Reduce speed and do not counter-steer.
- ▶ If necessary, apply the brakes.

! NOTE Damage to the engine as a result of overheating

- ▶ If you retrofit a trailer hitch, modifications to the engine cooling system may be necessary, depending on the vehicle model.

When retrofitting a trailer hitch, observe the fastening points on the chassis.

Retrofitting a trailer hitch is permissible only if a trailer load is specified in your vehicle documents. If this is not the case, the vehicle is not approved for trailer operation.

Further information can be obtained at a qualified specialist workshop.

If the trailer coupling is removable, it is essential to comply with the operating instructions of the trailer coupling manufacturer.

Couple and uncouple the trailer carefully. If you do not connect the trailer to the towing vehicle correctly, the trailer may become detached.

Observe the following notes on the tongue weight:

- Do not use a tongue weight that exceeds or falls below the permissible tongue weight
- Use a tongue weight as close as possible to the maximum tongue weight

Do not exceed the following values:

- Permissible trailer load
- Permissible rear axle load of the towing vehicle

276 Driving and parking

- Permissible gross weight of the towing vehicle
- Permissible gross weight of the trailer
- Maximum permissible speed of the trailer

Ensure the following before starting a journey:

- The tire pressure on the rear axle of the towing vehicle is set for a maximum load
- The lighting of the connected trailer is operational

In the event of increased rear axle load, the vehicle/trailer combination may not exceed a maximum speed of 62 mph (100 km/h) for reasons concerning the operating permit. This also applies in countries in which the permissible maximum speed for vehicle/trailer combinations is above 62 mph (100 km/h).

Vehicles with AIRMATIC or E-ACTIVE BODY CONTROL: if the socket of the trailer hitch is occupied, e.g. by a trailer or rear bicycle rack, the vehicle is set to the normal level regardless of the drive program at speeds greater than 19 mph (30 km/h).

Attaching the ball neck

⚠ WARNING Risk of accident and injury due to an incorrectly installed ball coupling

If the ball coupling is not installed and engaged correctly, it may become detached during travel and endanger other road users. There is a risk of fatal injury.

- ▶ Install and secure the ball coupling as described in the ball coupling manufacturer's installation instructions.
- ▶ When the ball coupling has been installed, ensure that it is correctly secured before every trip.

⚠ WARNING Risk of accident due to an incorrectly installed and secured ball coupling

If the ball coupling has not been correctly installed and secured, the trailer can become detached.

- ▶ Install and secure the ball coupling as described in the ball coupling manufacturer's installation instructions.
- ▶ When the ball coupling has been installed, ensure that it is correctly secured before every trip.

Requirements:

- The vehicle is secured against rolling away.

Attaching the ball neck

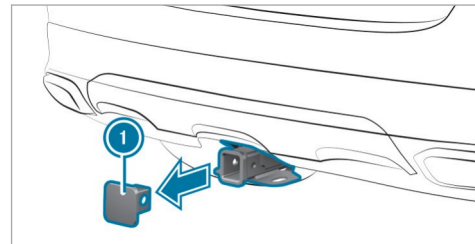

- ▶ Remove cover ① from the ball neck mount in the direction of the arrow.

- ▶ Store cover ❶ so that it cannot move around.
- ▶ Observe the manufacturer's installation instructions.

Observe the notes on loading the vehicle.

Coupling up/uncoupling a trailer

⚠ WARNING Risk of injury from the vehicle level being changed

Vehicles with level control system: the vehicle level may be changed unintentionally, e.g. by other persons. You may become trapped if you couple up or uncouple a trailer while the vehicle level is changing. In addition, other people could become trapped if their limbs are between the vehicle body and the tires or underneath the vehicle.

When coupling up or uncoupling a trailer, make sure that:

- ▶ The doors or tailgate are not opened or closed.

- ▶ You do not initiate the level control system and do not operate the DYNAMIC SELECT switch.
- ▶ Do not lock or unlock the vehicle.

Requirements:

- The vehicle is secured with the electric parking brake.
- The transmission is in position **P**.

The trailer will be correctly detected by the vehicle only if the following conditions are met:

- The trailer is connected correctly.
- The trailer lighting system is in working order.

The functions of the following systems are affected by a correctly connected trailer:

- Active Lane Keeping Assist
- ESP® trailer stabilization
- Parking Assist PARKTRONIC
- Active Parking Assist
- Blind Spot Assist or Active Blind Spot Assist

- Drive Away Assist
- Cross Traffic Alert
- Rear view camera
- 360° Camera

Vehicles without a level control system: the ball head height will change depending on the vehicle's load. In this case, use a trailer with a height-adjustable drawbar.

Coupling up a trailer

⚠ NOTE Damage to the battery due to full discharge

Charging the trailer battery using the power supply of the trailer can damage the vehicle battery.

- ▶ Do not use the vehicle's power supply to charge the trailer battery.

Information about a suitable ball neck for Mercedes-Benz vehicles can be obtained from a qualified specialist workshop, e.g. an authorized Mercedes-Benz Center.

- ▶ Remove the cover from the ball neck mount and store it in a safe place (→ page 276).
 - ▶ Position the trailer on a level surface behind the vehicle and couple it up to the vehicle.
 - ▶ Establish the electrical connection between the vehicle and the trailer.
- ⓘ Accessories can be connected to the permanent power supply up to 180 W and to the power supply that is switched on via the ignition lock.

Decoupling a trailer

⚠ WARNING Risk of being crushed and becoming trapped when uncoupling a trailer

When uncoupling a trailer with an engaged inertia-activated brake, your hand may become trapped between the vehicle and the trailer drawbar.

- ▶ Do not uncouple trailers with an engaged overrun brake.

! **NOTE** Damage when uncoupling in a state of overrun

Uncoupling in a state of overrun can damage the vehicle.

- ▶ Do not uncouple trailers with an engaged overrun brake.

⚠ WARNING Risk of becoming trapped when disconnecting the trailer cable

Vehicles with level control system: The vehicle may lower when the trailer cable is disconnected.

This could result in you or other people becoming trapped if your or their limbs are between the vehicle body and the tires or underneath the vehicle.

- ▶ Make sure that nobody is underneath the vehicle or in the immediate vicinity of the wheel arches when you disconnect the trailer cable.

- ▶ Disconnect the electrical connection between the vehicle and the trailer.

- ▶ Uncouple the trailer.
- ▶ Place the cover on the ball neck mount.

Vehicle towing instructions

The vehicle is not suitable for the use of tow bar systems that are used for flat towing or dinghy towing, for example. Attaching and using tow bar systems can lead to damage on the vehicle. When you are towing a vehicle with tow bar systems, safe driving characteristics cannot be guaranteed for the towing vehicle or the towed vehicle. The vehicle-trailer combination may swerve from side to side. Comply with the permitted towing methods (→ page 482) and the instructions for towing with both axles on the ground (→ page 483).

Instrument Display overview

Mercedes-AMG vehicles: be sure to observe the notes in the Supplement. Otherwise, you may fail to recognize dangers.

⚠ WARNING Risk of accident due to an instrument display malfunction

If the Instrument Display has failed or malfunctioned, you may not recognize function restrictions applying to safety relevant systems.

The operating safety of your vehicle may be impaired.

- ▶ Drive on carefully.
- ▶ Have the vehicle checked immediately at a qualified specialist workshop.

If the operating safety of your vehicle is impaired, park the vehicle immediately and safely. Contact a qualified specialist workshop.

Instrument Display in the Widescreen Cockpit

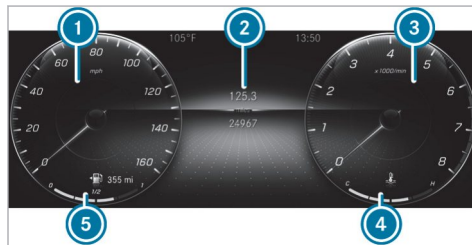

- ① Speedometer (example)
 - ② Multifunction display
 - ③ Tachometer (example)
 - ④ Coolant temperature display (example)
 - ⑤ Fuel level, fuel filler flap location indicator, range
- ① In addition to multifunction display ②, further content can be shown on displays ① and ③ (→ page 283).

The segments on speedometer ① indicate the system status for the following:

- Cruise control (→ page 209)
- Active Distance Assist DISTRONIC (→ page 213)

! NOTE Engine damage due to excessively high engine speeds

The engine will be damaged if you drive with the engine in the overrevving range.

- ▶ Do not drive with the engine in the overrevving range.

The fuel supply will be interrupted to protect the engine when the red mark on the tachometer (overrevving range) is reached.

During normal operating conditions, coolant temperature display ④ may rise to the red mark.

⚠ WARNING Danger of burns when opening the hood

If you open the hood when the engine has overheated or during a fire in the engine compartment, you could come into contact with hot gases or other escaping operating fluids.

- ▶ Before opening the hood, allow the engine to cool down.
- ▶ In the event of a fire in the engine compartment, keep the hood closed and call the fire service.

Vehicles with a 48 V on-board electrical system (EQ Boost technology)

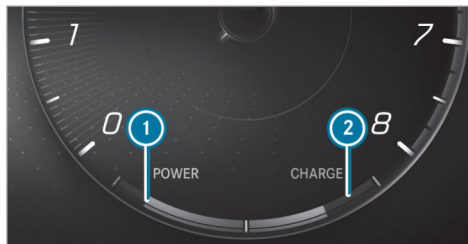



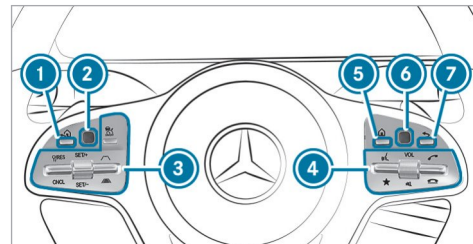

- ① POWER shows the electric drive support
- ② CHARGE shows the recuperation power of the electric motor

READY shows the drive system's operational readiness.

Overview of the buttons on the steering wheel



- ① Back/Home button, on-board computer
Press and hold: shows standard display
- ② Touch Control, on-board computer
- ③ Control panel for cruise control or Active Distance Assist DISTRONIC
- ④ Control panel for MBUX multimedia system:
 - Voice Control System
 - Displays favorites
 VOL: control knob, adjusts the volume or switches the sound off (press)

-  Makes/accepts a call
-  Rejects/ends a call
-  5 Calls up the home screen
-  6 Touch Control multimedia system
-  7 Back button

Operating the on-board computer

Mercedes-AMG vehicles: observe the notes in the Supplement. Otherwise, you may fail to recognize dangers.

⚠ WARNING Risk of distraction from information systems and communications equipment

If you operate information and communication equipment integrated in the vehicle when driving, you will be distracted from the traffic situation. This could also cause you to lose control of the vehicle.



- ▶ Only operate this equipment when the traffic situation permits.
- ▶ If you cannot be sure of this, stop the vehicle whilst paying attention to road

and traffic conditions and operate the equipment with the vehicle stationary.

Observe the legal requirements for the country in which you are currently driving when operating the on-board computer.

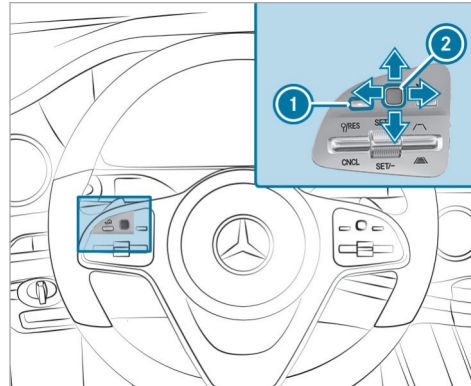
-  The on-board computer displays will appear on the multifunction display (→ page 284).



The on-board computer is operated using left-hand Touch Control  and left-hand back/home button .

When the on-board computer is being operated, different acoustic signals will sound as operating feedback, e.g. when the end of a list is reached or when you are scrolling through a list.

The following menus are available:

- Assistance
- Phone
- Navigation
- Trip
- Radio
- Media
- Designs & Disp.
- Service

The menus can be called up from the menu bar on the multifunction display.

- ▶ **To call up the menu bar:** briefly press back button on the left  until the menu bar is displayed.

- Vehicles without Active Distance Assist DISTRONIC:** press the  button to call up the menu bar of the on-board computer.

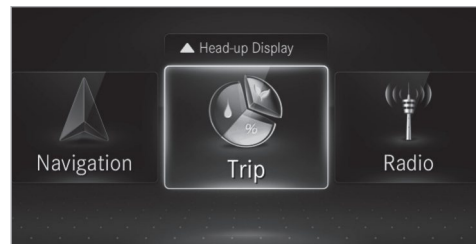

- The illustration shows the Instrument Display in the Widescreen Cockpit.

- To scroll in the menu bar:** swipe left or right on left-hand Touch Control ②.
- To call up a menu or confirm a selection:** press left-hand Touch Control ②.
- To scroll through displays or lists on the menu:** swipe upwards or downwards on left-hand Touch Control ②.

- To call up a submenu or confirm a selection:** press left-hand Touch Control ②.
- To exit a submenu:** press back button on the left ①.

Selecting the Head-up Display

- To switch on the Head-up Display:** switch on the Head-up Display via the multimedia system or activate it in the menu bar by swiping upwards on left-hand Touch Control ②. The Head-up Display menu has been selected on the Head-up Display.
- To switch to the Head-up Display:** press left-hand Touch Control ② or swipe upwards on left-hand Touch Control ②.
- To select what the Head-up Display shows:** swipe upwards or downwards on left-hand Touch Control ②.

Full-screen menu

You can display the following menus in full on the Instrument Display:

- Assistance
- Trip

- Navigation

- On the corresponding menu, use left-hand Touch Control ② to scroll to the end of the list.
- Press left-hand Touch Control ②. The selected menu will be displayed in full.

Adjusting the style of the Instrument Display

On-board computer:

- ↳ Designs & Disp.

Setting the style

- Swipe upwards or downwards on the left-hand Touch Control.
- Press the left-hand Touch Control. The Instrument Display will be shown in the selected style.

The following styles can be selected, depending on the vehicle equipment:

- Classic
- Sport

- Progressive
- Understated
- Standard Displays

Showing display content on the instrument cluster

Additional display content can also be shown on the instrument cluster.

- i** The display content on the instrument cluster adapts to the topic selected on the multimedia system.
- ▶ **To select display content:** swipe to the right or left on the left-hand Touch Control.
 - ▶ Swipe upwards or downwards on the left-hand Touch Control to select the required display content. When the display content is selected, it will briefly be highlighted.

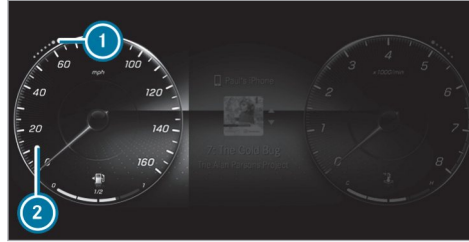

- 1 The index points show the selected display content.
- 2 Display content, left (example: speedometer)

When the display content is selected **2**, it will briefly be highlighted.

Display content selection, left:

- Speedometer
- Time/date
- Trip computer [From Start](#) and [From Reset](#)
- Range
- Audio

- Angle of incline and approach/departure angle

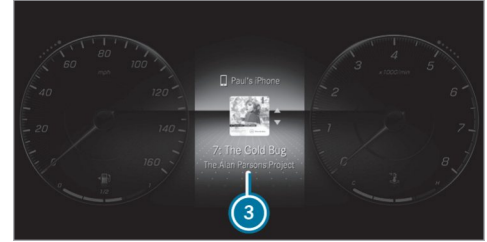

- 3 Display content, center (example: media menu)
The index points show the selected menu content

The display content in the center shows the menu content of the respective menus from the menu bar on the multifunction display.

Display content menu selection, center:

- Assistance
- Telephone

284 Instrument Display and on-board computer

- Navigation
- Trip
- Radio
- Media
- Styles and display
- Service

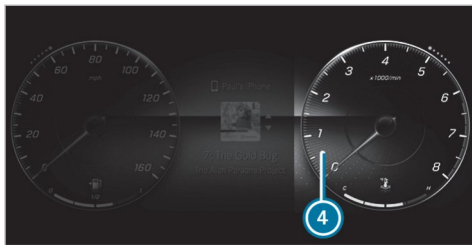

- ④ Display content, right (example: tachometer)

Display content selection, right:

- Tachometer
- Average fuel consumption
- ECO display





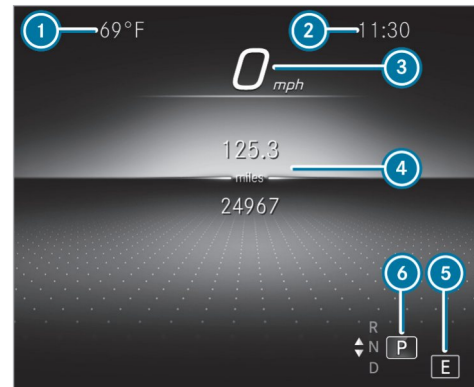





- Navigation
- G-meter
- Assistant display
- 4MATIC
- Suspension (equipment-dependent)

Overview of displays on the multifunction display



- ① Outside temperature
- ② Time
- ③ Digital speedometer
- ④ Display section
- ⑤ Drive program
- ⑥ Transmission position

Further displays on the multifunction display:

- ↑ Gearshift recommendation (→ page 182)
-  Active Parking Assist (→ page 261)
-  Parking Assist PARKTRONIC deactivated (→ page 251)
-  Cruise control (→ page 209)
-  Active Distance Assist DISTRONIC (→ page 213)
-  Active Brake Assist (→ page 209)
-  Active Steering Assist (→ page 220)
-  Active Lane Keeping Assist (→ page 272)
-  Active Lane Change Assist (→ page 222)
-  ECO start/stop function (→ page 171)
-  HOLD function (→ page 227)
-  Adaptive Highbeam Assist (→ page 140)

Vehicles with Traffic Sign Assist: Detected instructions and traffic signs (→ page 267).

For an overview of the indicator and warning lamps, see (→ page 592).

Adjusting the instrument lighting

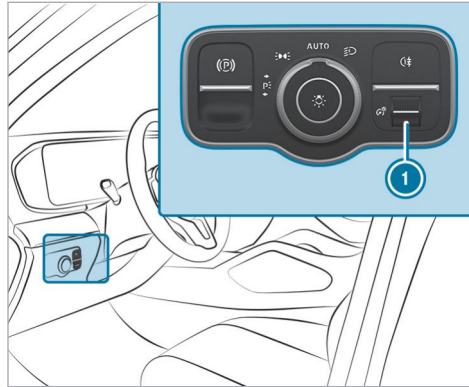

- ▶ Turn brightness control ① up or down. The lighting of the Instrument Display and in the control elements of the vehicle interior is adjusted.

Menus and submenus

Calling up functions on the Service menu of the on-board computer

On-board computer:

↳ Service

- ▶ **To select a function:** swipe upwards or downwards on the left-hand Touch Control.
- ▶ Press the left-hand Touch Control.

Functions on the **Service** menu:

- Message memory (→ page 541)
- **Tires:**
 - Restart the tire pressure loss warning system (→ page 498)
 - Check the tire pressure with the tire pressure monitor (→ page 496)
 - Restart the tire pressure monitor (→ page 497)
- **ASSYST PLUS:** call up the service due date (→ page 454)
- **Coolant:** coolant temperature display
- **Engine Oil Level:** engine oil level

286 Instrument Display and on-board computer

- **Consumption Info:** fuel life cycle consumption

Calling up displays on the Assistance menu

On-board computer:

↳ Assistance



The following displays are available on the Assistance menu:

- Assistance
- Attention level (→ page 265)
- Full screen

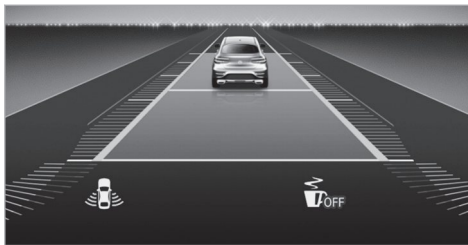
▶ **To switch between the displays:** swipe upwards or downwards on the left-hand Touch Control.



Status displays on the assistant display:

-  ATTENTION ASSIST: deactivated
- Gray lane markings: Active Lane Keeping Assist activated
- Green lane markings: Active Lane Keeping Assist active
-  Gray radar waves next to vehicle: Blind Spot Assist or Active Blind Spot Assist enabled
-  Green radar waves next to vehicle: Blind Spot Assist or Active Blind Spot Assist active

- Active Distance Assist DISTRONIC displays (→ page 213)
- ECO Assist displays

Calling up displays on the Trip menu

On-board computer:

↳ Trip

▶ **To select a display:** swipe upwards or downwards on the left-hand Touch Control.

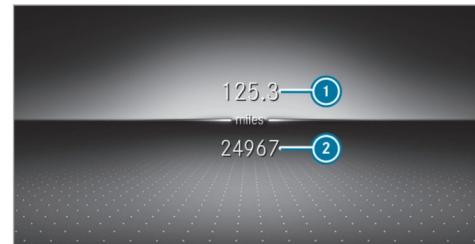

Standard display (example)

- ① Trip distance
- ② Total distance

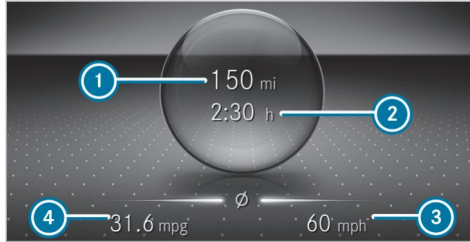

Trip computer (example)

- ① Total distance
- ② Driving time
- ③ Average speed
- ④ Average fuel consumption

Resetting values on the Trip menu of the on-board computer

On-board computer:



- ① The spelling on the main menu displayed may differ. Therefore, observe the menu

overview for the Instrument Display (→ page 281).

You can reset the values of the following functions:

- Trip distance
- Trip computer [From Start](#) and [From Reset](#)
- ECO display (→ page 174)

- ▶ **To select the function to be reset:** swipe upwards or downwards on the left-hand Touch Control.
- ▶ Press the left-hand Touch Control.
- ▶ Select **Yes**.
- ▶ Press the left-hand Touch Control.

If you press and hold the left-hand Touch Control, the values of the function will be reset immediately.

Calling up navigation instructions on the on-board computer

On-board computer:



The following displays are available in the navigation menu:

- Navigation view
- Map view
- Full-surface map view

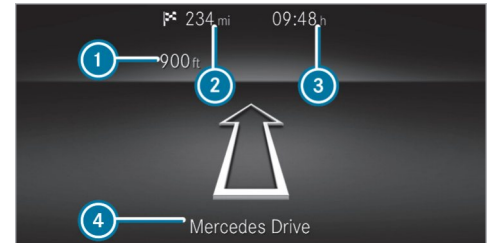

Example: no change of direction announced

- ① Distance to the next change of direction
- ② Distance to the next destination

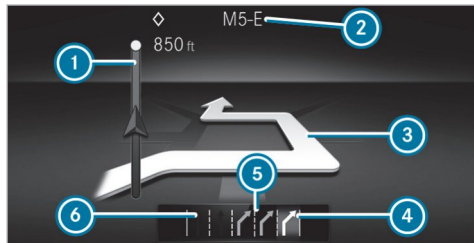

- ③ Estimated arrival time at next destination
- ④ Current road



Example: change of direction announced

- ① Distance to the change of direction
- ② Road to which the change of direction leads
- ③ Change-of-direction symbol
- ④ Recommended lane (white)
- ⑤ Possible lane
- ⑥ Lane not recommended (dark gray)

Further possible displays on the **Navigation** menu:

- **Direction of Travel:** display of direction of travel and road currently being traveled on.
- **New Route...** or **Calculating Route...:** a new route is being calculated.
- **Road Not Mapped:** the road is unknown, e.g. for newly built roads.
- **No Route:** no route could be calculated to the selected destination.
- **Off Map:** the map for the current location is not available.
- **Area of Dest. Reached:** when an intermediate destination is reached, the intermediate destination flag will be displayed with the number of the intermediate destination . After this, route guidance will continue. Once the destination is reached, the checkered flag  will be displayed. Route guidance will now be complete

▶ **To exit the menu:** press the back button on the left.

Vehicles with the MBUX multimedia system:

You can also start navigation to one of the recent destinations on the **Navigation** menu:

- ▶ Press the left-hand Touch Control.
- ▶ **To select a destination:** swipe upwards or downwards on the left-hand Touch Control.
- ▶ Press the left-hand Touch Control. Route guidance will start. If route guidance has already been activated, a query will appear asking whether you wish to end the current route guidance.
- ▶ Select **Yes**.
- ▶ Press the left-hand Touch Control. Route guidance will start.

Selecting radio stations using the on-board computer

On-board computer:

↳ Radio

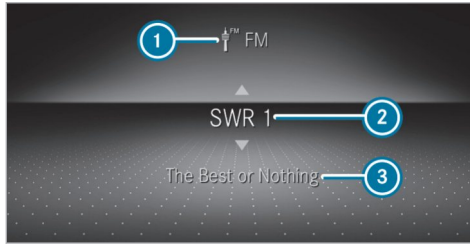

- ① Frequency range
- ② Station
- ③ Name of track

ⓘ The illustration shows the Instrument Display in the Widescreen Cockpit

When you select a station from the memory presets, the preset will appear next to the station name. When you select a saved station in the

frequency range, an asterisk will appear next to the station name.

▶ **To select a radio station:** swipe upwards or downwards on the left-hand Touch Control.

Selecting the frequency range or memory preset

- ▶ Press the left-hand Touch Control.
- ▶ Swipe upwards or downwards on the left-hand Touch Control.
- ▶ Press the left-hand Touch Control.

Operating media playback using the on-board computer

On-board computer:

↳ Media

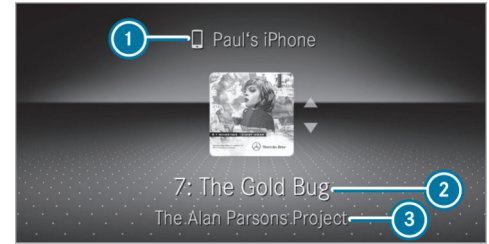

- ① Media source
- ② Track number and current track
- ③ Name of artist (example)

ⓘ The illustration shows the Instrument Display in the Widescreen Cockpit

▶ **To change tracks on an active media source:** swipe upwards or downwards on the left-hand Touch Control.

Changing a media source

- ▶ Press the left-hand Touch Control.
- ▶ **To select a media source:** swipe upwards or downwards on the left-hand Touch Control.
- ▶ Press the left-hand Touch Control.

Dialing telephone numbers using the on-board computer

⚠ WARNING Risk of distraction from information systems and communications equipment

If you operate information and communication equipment integrated in the vehicle when driving, you will be distracted from the traffic situation. This could also cause you to lose control of the vehicle.

- ▶ Only operate this equipment when the traffic situation permits.
- ▶ If you cannot be sure of this, stop the vehicle whilst paying attention to road

and traffic conditions and operate the equipment with the vehicle stationary.

When using the phone, observe the legal requirements for the country in which you are currently driving.

Requirements:

- The mobile phone is connected to the multimedia system.

On-board computer:

➔ [Phone](#)

The most recent telephone calls (dialed, received and missed calls) are displayed on the [Phone](#) menu.

- ▶ **To select an entry:** swipe upwards or downwards on the left-hand Touch Control.
- ▶ Press the left-hand Touch Control.
If there is only one telephone number saved to an entry: the telephone number will be selected.
- ▶ **If there are multiple telephone numbers saved to an entry:** swipe upwards or down-

wards on the left-hand Touch Control to select the desired telephone number.



- ▶ Press the left-hand Touch Control. The telephone number will be dialed.



The following displays may appear instead of the telephone numbers dialed:

- **Please Wait:** the application is starting. If a Bluetooth® connection to the mobile phone is not established, the menu for authorizing and connecting a mobile phone will be displayed on the multimedia system (→ page 402).
- **Updating Data...:** the call list is being updated.
- **Importing Contacts:** contacts are being imported from the mobile phone or a storage medium.

Accepting/rejecting an incoming call

Vehicles with Head-up Display: when you receive a call, the [Incoming Call](#) message will appear on the Head-up Display.

- ▶ Swipe upwards or downwards on the left-hand Touch Control and select  (Accept) or  (Reject).
- ▶ Press the left-hand Touch Control.

You may accept or reject the call using the  or  button on the steering wheel.

Setting the Head-up Display using the on-board computer

On-board computer:

➔ HEAD-UP DISPLAY

The following Head-up Display settings can be selected:



- Position
- Brightness
- Displays
- Messages
- Assistance status
- Telephone
- Audio
- Voice Control System

- ▶ **To choose a setting:** swipe to the right on the left-hand Touch Control. Settings menu  is selected.
- ▶ **To call up the Settings menu:** press the left-hand Touch Control.
- ▶ **To adjust the position:** swipe upwards or downwards on the left-hand Touch Control.
- ▶ **To adjust the brightness:** swipe to the left or right on the left-hand Touch Control.
- ▶ **To set messages, assistance status, telephone, audio and the Voice Control System:** press the left-hand Touch Control. The list of setting options will be displayed.
- ▶ Swipe upwards or downwards on the left-hand Touch Control and select a setting by pressing the left-hand Touch Control.

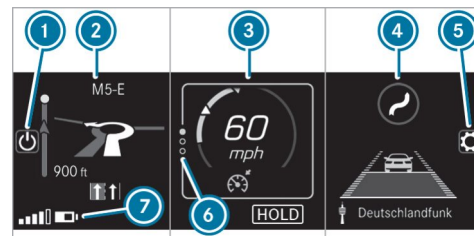
Selecting what the Head-up Display shows



(Example)

-  To switch the Head-up Display on/off
-  Left display area
Navigation system
Inclination, gradient and compass
Average consumption
G-meter
-  Central display area
Set speed in the driver assistance system, e.g. cruise control
Warnings from driver assistance systems, e.g. distance warning

- ④ Right display area
 - Traffic Sign Assist
 - Vehicle level
 - Differential
 - Assistant display
- ⑤ To adjust the position, brightness and lower display area
- ⑥ Index points
- ⑦ Lower display area

Display areas ② to ④ that are not required can be hidden.

- ① In audio mode, the station name, track or last calls will be shown temporarily when the audio source is being actively operated.

- ▶ **To select a display:** swipe upwards on the left-hand Touch Control.
- ▶ Press the left-hand Touch Control.

Head-up Display

Function of the Head-up Display

The Head-up Display projects information above the cockpit into the driver's field of vision, e.g. the speed of the vehicle, information from the navigation system or driver assistance systems and some warning messages.

Depending on the vehicle's equipment, different content can be shown in the three display areas of the Head-up Display (→ page 291).

Display elements

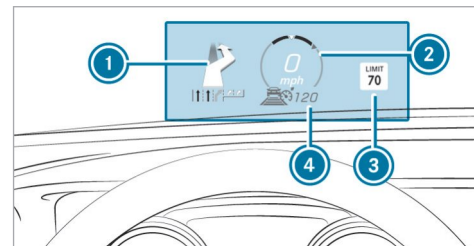

- ① Navigation instructions
- ② Current speed
- ③ Detected instructions and traffic signs
- ④ Set speed in the driver assistance system (e.g. cruise control)

System limits

The visibility of the displays will be affected by the following conditions:

- Seat position
- Image position setting
- Ambient light

- Wet roadway
 - Objects on the display cover
 - Polarization in sunglasses
- i** In extreme sunlight, sections of the display may appear washed out. You can correct this by switching the Head-up Display off and on again.

Switching the Head-up Display on/off via the multimedia system

Multimedia system:

→  >> Settings >> Quick Access

- ▶ Select **HUD**.
The Head-up Display is activated.

Notes on operating safety

⚠ WARNING Risk of distraction from information systems and communications equipment

If you operate information and communication equipment integrated in the vehicle when driving, you will be distracted from the traffic situation. This could also cause you to lose control of the vehicle.

- ▶ Only operate this equipment when the traffic situation permits.
- ▶ If you cannot be sure of this, stop the vehicle whilst paying attention to road and traffic conditions and operate the equipment with the vehicle stationary.

⚠ WARNING Risk of an accident from operating mobile communication equipment while the vehicle is in motion

Mobile communications devices distract the driver from the traffic situation. This could

also cause the driver to lose control of the vehicle.

- ▶ As the driver, only operate mobile communications devices when the vehicle is stationary.
- ▶ As a vehicle occupant, only use mobile communications devices in the areas intended for this purpose, e.g. in the rear passenger compartment.

⚠ WARNING Risk of injury due to objects being stowed incorrectly

If objects in the vehicle interior are stowed incorrectly, they can slide or be thrown around and hit vehicle occupants. In addition, cup holders, open stowage spaces and mobile phone receptacles cannot always retain all objects they contain.

There is a risk of injury, particularly in the event of sudden braking or a sudden change in direction.

- ▶ Always stow objects so that they cannot be thrown around in such situations.
- ▶ Always make sure that objects do not protrude from stowage spaces, luggage nets or stowage nets.
- ▶ Close the lockable stowage spaces before starting a journey.
- ▶ Always stow and secure heavy, hard, pointed, sharp-edged, fragile or bulky objects in the trunk/load compartment.

For your own safety, always observe the following points when operating mobile communications equipment and especially your voice control system:

- Observe the legal requirements for the country in which you are driving.
- While driving, only operate mobile communications equipment and your voice control system when the traffic conditions permit it. You may otherwise be distracted from the traffic conditions and cause an accident, injuring yourself and others.



- If you use the voice control system in an emergency your voice can change and your telephone call, e.g. an emergency call, can thereby be unnecessarily delayed.
- Familiarize yourself with the voice control system functions before starting the journey.
- Comply with the loading guidelines (→ page 114).

Operation

Overview of operating the multifunction steering wheel

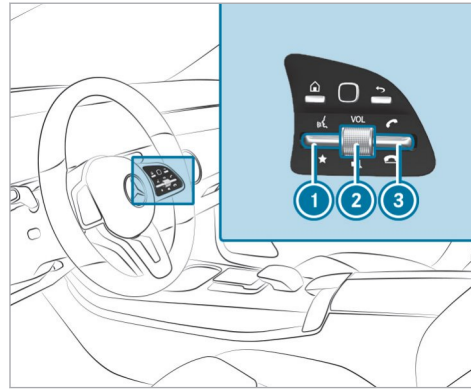
The Voice Control System is operational approximately thirty seconds after the ignition is switched on.



- 1 Press the rocker switch up:  starts the dialog
- 2 Press the control knob:  switches the sound off or on (ends the dialog)
Turn the control knob up/down: increases/decreases the volume
- 3 Press the rocker switch down:  rejects/ends a call (ends the dialog)



Conducting a dialog

For the dialog with the Voice Control System, you can use complete sentences of colloquial language as voice commands, such as, for example, "Please show me the list of the last calls" or "How warm is it outside?". It is not necessary to first change to the relevant application such as "Telephone" or "Vehicle function".

- ▶ **To activate or continue dialog by using a keyword:** say "Hello Mercedes" to activate the Voice Control System. Voice activation must be switched on in the multimedia system (→ page 296). For this, it is not necessary to press up the  rocker switch on the multifunction steering wheel. Voice activation can also be directly combined with a voice command, e.g. "Hi Mercedes, how fast can I drive?".

or

- ▶ Press the  rocker switch up on the multifunction steering wheel. You can say a voice command after an acoustic signal.

- ▶ **To correct an entry:** say the Correction voice command.
- ▶ **To select an entry from the selection list:** say the line number or the contents.
- ▶ **To browse the selection list:** say the Next or Back voice command.
- ▶ **To interrupt the dialog:** say the Pause voice command.
The dialog can be continued with the "Hello Mercedes" voice command or by pressing up the  rocker switch on the multifunction steering wheel.
- ▶ **To jump to the preceding dialog:** say the Back voice command.
- ▶ **To jump back to the top dialog level:** say the Home voice command.
- ▶ **To cancel the dialog:** say the Close voice command or press the  or  button on the multifunction steering wheel.

- ▶ **To interrupt a voice output:** speak in the middle of a voice dialog when the system is still answering.
The voice output is shortened and the conclusion is reached more quickly.
- ❗ The **Speak During Voice Output** option must be switched on in the multimedia system for this (→ page 296).

Overview of operable functions in the Voice Control System

You can use the Voice Control System to operate the following functions depending on the vehicle equipment:

- Telephone
- Text messages
- Navigation
- Address book
- Radio
- Media
- Vehicle functions
- Weather

Full functionality is only available for you with activation of online voice control (→ page 296).

Notes on the language setting

You can change the language of the Voice Control System via the system language settings. If the set system language is not supported by the Voice Control System, English will be selected.

The Voice Control System is available in English, French, Portuguese and Spanish.

Setting the Voice Control System (multimedia system)

Requirements:

- **For online voice control:** your vehicle is connected with your Mercedes me user account (→ page 423).
- There is an Internet connection (→ page 427).
- **For online use of contacts:** online voice control is activated.

Multimedia system:

→  » Settings » System
» LINGUATRONIC

Switching voice activation of the Voice Control System on/off

- ▶ Select **Voice Activation "Hey Mercedes"**. Depending on the previous status, the function is activated or deactivated.
When the function is active, the "Hi Mercedes" voice command can activate the dialog.

Activating/deactivating online voice control

- ▶ Activate **Online Voice Control**.
- ⓘ Online voice control is activated at the factory.
- ▶ Select **Online Voice Control Subscr..**
You will be connected with the Mercedes me portal.
- ▶ Activate online voice control in the Mercedes me portal.

Activating contacts for online use

- ▶ Select **Contacts for Online Use**.
When the function is active, contacts will be found more easily and accurately using voice input. The quality of the enunciation of contact names by the system will also be improved.

Switching on voice interruption

- ▶ Select **Speak During Voice Output**.
If the function is active, a command can be interjected during voice output of the system.



Using the Voice Control System effectively

Voice Control System audible help functions

Using the corresponding voice commands you receive the following information and assistance in the following cases:

- **For optimal operation:** say the Voice control tutorial voice command or call up the Digital Operator's Manual with Could you go to the Voice Control System tutorial please?,

for example. The full extent of the Digital Operator's Manual is available when the vehicle is stationary. Here you can also find explanatory videos which introduce you to the functions of the Voice Control System.

- **Current application:** on the multifunction steering wheel, press the  rocker switch up and say the Help voice command. You will receive suggestions and information about operation of the Voice Control System for the current application.
- **Continued dialog:** say the Help voice command during a voice dialog. For every step of the dialog you receive matching information.
- **Specific function:** say the voice command for the desired function, e.g. with "Hello Mercedes, I need help with the radio" or after pressing the  rocker switch on the multifunction steering wheel up, say the Help for the telephone voice command, for example.

Notes on optimal use of the Voice Control System

Notes on how to improve recognition:

- Activate online voice control (→ page 296).
- Only operate the Voice Control System from the driver's seat.
- Say the voice commands coherently and clearly, but do not exaggerate the words.
- Avoid loud noises that cause interference while making a voice command entry, e.g. the entertainment in the rear passenger compartment.
- **For telephone or address book entries:**
 - Only create sensible address book entries in the system/mobile phone, e.g. enter surname and first name in the correct field.
 - Do not use any abbreviations, unnecessary spaces or special characters.
- **For radio station names:** say the Read out station list voice command and say the desired station name in the way the voice output reads aloud to you.

- ① To improve recognition, depending on the outside temperature, either the blowers for ventilation or heating are reduced when the Voice Control System is started.

Information on online voice control

Online voice control improves recognition and makes additional results available as a result of external information, e.g. information about POIs and about the weather. We therefore recommend that you activate online voice control.

You will need a Mercedes me user account for this. If you do not yet have a user account you have to create one and connect it with your vehicle (→ page 328).

Then call up your Mercedes me user account. The Mercedes me services are shown and can be activated (→ page 329).

In addition, online voice control must be activated (→ page 296).

Essential voice commands

Notes on the voice commands

Aside from the exact voice commands (see the "Voice command" column in the following tables) to call up specific functions, in most cases the Voice Control System also understands a great many paraphrases from daily usage. Examples of these are listed in the "Colloquial examples" column. For some languages however these examples are only available to a limited extent.

- ① Content in angled brackets, e.g. <POI> or <contact>, is a placeholder which has to be completed by you with the desired term. The voice command Set <POI> as intermediate destination could, for example, be completed with: Set Mercedes-Benz Arena as intermediate destination.

Overview of switch voice commands

Switch voice commands can be used to open certain applications.

Switch voice commands

Voice command	Colloquial example	Function
Switch to navigation	I would like to go to navigation	Switches to navigation
Switch to address book	I would like to switch to the address book	Switches to the address book
Switch to telephone	I would like to switch to the phone	Switches to the telephone
Switch to messages	Can you switch to messages please?	Switches to the text message application
Switch to radio	I would like to switch to the radio	Switches to radio
Switch to media	I would like to switch to the media application	Switches to media
Switch to comfort	I would like to go to the comfort application	Switches to the comfort settings
Switch to vehicle info	I would like to go to the vehicle application	Switches to vehicle information
Switch to settings	I would like to go to the settings menu	Switches to the menu with the setting options

i It is not necessary to first call up a menu in order to operate a function it contains with the Voice Control System. You can operate the function directly using voice input, e.g. call a contact or enter a destination for navigation.

You can find further information in the overview tables for voice commands.

Overview of navigation voice commands

Using the navigation voice commands you can enter POIs and conventional addresses or navigation.

You can also carry out important navigation settings directly. The following list offers just a small selection of the possible navigation commands. You will receive additional suggestions if you say Help for navigation.

Navigation voice commands

Voice command	Colloquial example	Function
Navigate to <address>	Navigate to Canal Street, New York	Starts route guidance to the desired address.
Navigate to <contact>	Drive/bring me to the contact address of John Doe	Starts route guidance to a contact from the address book.

Voice command	Colloquial example	Function
Navigate to <3 word address>	<p>The example is for the English language: Drive to Parade.Help.Bleat</p>	<p>Starts route guidance to a 3 word address from what3words. The example mentioned navigates you to the Empire State Building. Observe the following information:</p> <ul style="list-style-type: none"> • 3 word addresses are language dependent. • Searching for a destination using 3 word addresses is not possible in all countries and in all languages. Additional information on 3 word addresses from what3words can be found in the Navigation section under "Entering the destination as a 3 word address". <p>The Empire State Building, for example, has the following 3 word addresses:</p> <ul style="list-style-type: none"> • English: parade.help.bleat • French: commun.verbe.bisquer • Spanish: suertes.diga.pesca
Home	I would like to go home/I want to drive to my home address	Starts route guidance to the home address.
Work	I would like to navigate to work	Starts route guidance to work.
Enter POI	Take me to a POI	Enters a POI, e.g. Brandenburg Gate.
Navigate to <POI>	Navigate to "McDonald's"	Starts route guidance to a POI.

Voice command	Colloquial example	Function
Navigate to the online POI <POI>	Navigate to online POI "McDonald's"	Searches online for a POI and starts route guidance.
Start route guidance	Begin route guidance/Can you start route guidance?	Starts route guidance to a destination.
Cancel route guidance	Can you quit route guidance?	Cancels route guidance.
Restart route guidance	I would like to resume route guidance	Continues route guidance after a break.
Set <address> as intermediate destination	Set "9 Euclid Avenue in Cleveland" as an intermediate destination	Selects an intermediate destination for the route.
Set <contact> as intermediate destination	Set "John Doe" as intermediate destination	Selects an intermediate destination from the contacts for the route.
Set <POI> as intermediate destination	Set "Trump Tower" as an intermediate destination	Selects a POI as an intermediate destination for the route.
Enter address in <country>	I would like to enter a new address in "France"	Selects a destination in another country.
Enter ZIP code	Start route guidance to a new ZIP code	Enters a ZIP code.
Last destinations	Show the previous destinations	Selects a destination from the previous destinations.

Voice command	Colloquial example	Function
Show alternative routes	Search for alternative routes	Shows one of the alternative routes calculated.
Driving recommendations on	Switch on driving recommendations	Switches on voice output for route guidance.
Driving recommendations off	Mute the driving instructions	Switches off voice output for route guidance.
Show traffic map	Switch on traffic jam info	Displays traffic information on the map.
Hide traffic map	Switch off the traffic jam messages	Hides the traffic information.
POI icons on	Show me point of interest icons on the map please	Displays the POI symbols on the map.
Hide POI icons	I would like to hide all POI symbols	Hides the POI symbols.

Overview of telephone voice commands

You can use the telephone voice commands to make phone calls or search through the address

book. The following list offers just a small selection of the possible telephone commands. You

will receive additional suggestions if you say Help for phone.

Telephone voice commands

Voice command	Colloquial example	Function
Call <telephone number>	I would like you to dial 0171xxxxxx	Makes a telephone call by entering the telephone number directly.
Call <contact>	Call Jane Smith on her mobile	Makes a telephone call directly by entering a name from the address book.
Call Mercedes-Benz emergency call center	Could you call the Mercedes-Benz emergency center?	Triggers an emergency call to the Mercedes-Benz emergency call center.
Call Mercedes me	I'd like you to call the MB breakdown assistance please	Places a call with Mercedes-Benz breakdown assistance.
Latest calls	Show me the list of missed calls	Shows the list of missed calls.
Previous calls	Show me the last calls	The list shows all outgoing, incoming and missed calls.
Incoming calls	Show me the calls received	Shows the list of incoming calls.
Outgoing calls	Show me the list of outgoing calls	Shows the list of outgoing calls.
Search for <contact>	Could you open the contact "John Doe"?	Opens the contact data of a contact in the address book.

Voice command	Colloquial example	Function
Redial	Redial/Call last phone number	Makes a call to the last telephone number dialed.
Change phone	Could you please switch to the second phone?	Changes the primary telephone

Overview of radio voice commands

Radio voice commands can also be used when the radio application runs in the background and

another application is visible in the foreground. The following list offers just a small selection of the possible radio voice commands. You will

receive additional suggestions if you say Help for radio.

Radio voice commands

Voice command	Colloquial example	Function
Station <station name>	I would like to select station "Cool FM"	To select the radio station mentioned
Frequency <frequency>	Go to station/radio frequency "eighty seven point five megahertz".	To enter a radio frequency, e.g. for the FM range
Next radio station	Call up the next radio station	The next radio station in a list is called up
Previous station	Switch to the last station/to the previous program	To switch to the previous station

Voice command	Colloquial example	Function
Save radio station	Save the radio station, please	To save a station name for a radio station
Show station list	Please show me the list of all stations	To show the list of stations that can be received
Read out radio station list	I'd like to listen to the station/ program list, please	To listen to the names of all receivable stations
Traffic information on	Switch on the traffic info	To switch on traffic announcements
Traffic information off	I'd like to switch off traffic info	To switch off traffic announcements
Radio info on	I want you to turn on additional radio station text	To switch on information about the current station
Radio info off	I want you to turn off additional radio station text	To switch off information about the current station

Overview of media player voice commands

Media player voice commands can also be used when the media player application runs in the

background and another application is visible in the foreground. The following list offers just a small selection of the possible media player

voice commands. You will receive additional suggestions if you say Help for media or Help for player.

Media player voice commands

Voice command	Colloquial example	Function
Play <track/albums/artists/composers/music genres>	Play "Yellow Submarine"	The names of all available tracks, albums, artists, composers or genres are accepted during the search. In the case of a clear search result the track found is played back immediately.
Play track <track>	Play song "So What"	The available tracks are played back.
Play album <album>	Play album "A Night at the Opera"	The available albums are played back.
Play artist <artist>	I want to listen to the artist "Madonna"	The available artists are played back.
Play composer <composer>	I'd like to hear the composer "Ludwig van Beethoven"	The available composers are played back.
Play music genre <music genre>	I'd like to hear the music genre "Bebop"	The available music genres are played back.
Search for track <track>	I would like to search for the song "Sailing"	The names of all available tracks are accepted during the search. A selection list appears from which you can select the desired music. If you wish to play all the tracks in a selection list, say "Play all tracks".
Search for album <album>	Search for album "A Night at the Opera"	The names of all available albums are accepted during the search. A selection list appears from which you can select the desired music. If you wish to play all the tracks in a selection list, say "Play all tracks".

Voice command	Colloquial example	Function
Search for artist <artist>	I would like to search for the artist "Elton John"	The names of all available artists are accepted during the search. A selection list appears from which you can select the desired music. If you wish to play all the tracks in a selection list, say "Play all tracks".
Search for composer <composer>	Search for composer "Beethoven"	The names of all available composers are accepted during the search. A selection list appears from which you can select the desired music. If you wish to play all the tracks in a selection list, say "Play all tracks".
Search for music genre <music genre>	Search for music genre "Classical"	The names of all available music genres are accepted during the search. A selection list appears from which you can select the desired music. If you wish to play all the tracks in a selection list, say "Play all tracks".
Next track	Start the next song/video clip/film	Plays back the next track.
Previous track	Play the last song/track/clip again	Plays back the previous track.
Repeat this track	I'd like to listen to this track again	The current track is played back from the beginning.
Play similar music	I'd like to hear similar music	Plays back similar tracks.
Play random music	Play me a random track	Plays back random tracks.
Random playback on	Turn random playback on	Switches to random mode.

Voice command	Colloquial example	Function
Random track list off	Switch off shuffle mode	Switches off random mode.
What am I listening to?	Which music is currently playing?	The information about the track currently playing is read aloud.

Overview of message voice commands

Messages can be created, edited and listened to using the message voice commands. The follow-

ing list offers just a small selection of the possible message commands. You will receive additional suggestions if you say Help for messaging.

Message voice commands

Voice command	Colloquial example	Function
Text message to <Name>	I would like to write a new text to "John Doe's mobile number"	Creates a text message. All address book names are available.
Text message to <Name> <Text>	I would like you to write a new text to "Jane Doe" with the following text: "I am running late"	Writes a text message to the person mentioned. The content of the text can be spoken immediately if online voice control has been activated.
Read out new text messages	I would like you to read out the new text messages	Reads out new text messages.
Read out the last text message from <Name>	I would like you to read out the last text message from "John Doe"	Reads out the last text message from the person mentioned.

Overview of vehicle voice commands

You can use the vehicle voice commands to directly call up the corresponding menus for the vehicle settings and operate vehicle functions.

The following list offers just a small selection of the possible vehicle voice commands. You will receive additional suggestions if you say Help for vehicle settings or Help for vehicle functions.

-  If no seat or side is mentioned for commands that relate to a seat or side of vehicle

then all actions are carried out automatically for the driver's seat.

Vehicle voice commands

Voice command	Colloquial example	Function
Temperature colder	I would like to reduce the temperature	Lowers the temperature of the air conditioning system.
Air recirculation on	I would like to activate the air circulation	Switches on air recirculation mode for the air conditioning system.
Automatic climate control driver on	I would like to switch on the automatic climate control for the driver's seat	Switches on automatic climate control for the driver's or front passenger side.
Ambient light blue	I would like to set the interior lighting to blue	Switches the ambient light, e.g. to blue.
Wave massage driver on	I would like to switch on the wave massage for the driver's seat	Switches on the wave massage for the driver's or front passenger seat.

Voice command	Colloquial example	Function
Massage driver's seat off	Switch the driver's side massage off	Switches off the massage function for the driver's or front passenger seat.
Seat heating driver on	I would like to switch on the seat heating for the driver's seat	Switches on the seat heating for the driver's or front passenger seat.
Seat heating front passenger level 2	Seat heating front-passenger on level 2	Sets the seat heating for the driver's or front passenger seat to level 2.
Current speed limit	I would like to hear the speed limit	Calls up the current speed limit.
Outside temperature	I would like to find out what the temperature outside is like	Calls up the outside temperature.
Average consumption	What is the current average consumption?	Calls up average consumption.
Vehicle data	Can you please display the vehicle data menu?	Calls up the vehicle data.
Range	Tell me the current range	Calls up the current range data.
Assistance menu	Show me the driver assistance settings	Displays the assistance settings.

312 Voice Control System

Voice command	Colloquial example	Function
Climate control menu	I would like to see the climate control menu	Displays the climate control settings.
Light menu	I would like to change the light settings	Displays the light settings.
Seats menu	I would like to switch to seat menu	Displays the seat adjustment settings.
Massage menu	I would like to switch to the massage seat menu	Displays the massage settings.
Next service	Tell me my next service appointment	Calls up the next service due date.

Overview and operation

Overview of the MBUX multimedia system

⚠ WARNING Risk of distraction from information systems and communications equipment

If you operate information and communication equipment integrated in the vehicle when driving, you will be distracted from the traffic situation. This could also cause you to lose control of the vehicle.

- ▶ Only operate this equipment when the traffic situation permits.
- ▶ If you cannot be sure of this, stop the vehicle whilst paying attention to road and traffic conditions and operate the equipment with the vehicle stationary.

You must observe the legal requirements for the country in which you are currently driving when operating the multimedia system.

MBUX stands for Mercedes-Benz User Experience.

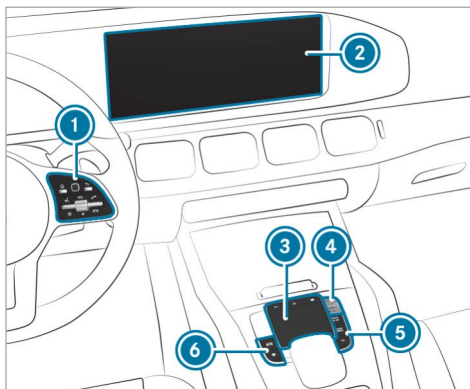

- ① Touch Control and control panel for the MBUX multimedia system
Operating Touch Control(→ page 316)
- ② Media display with touch functionality
Home screen overview(→ page 315)
Operating the touchscreen (→ page 317)
- ③ Touchpad
Operating the touchpad(→ page 318)



- ④ Control knob
Press and hold: switches the multimedia system or display on or off
Press briefly: switches the mute function on/off
Turn: adjusts the volume
- ⑤ Buttons for navigation, radio/media and telephone
Calling up applications(→ page 326)
- ⑥ Buttons for vehicle functions/system settings and favorites/themes
Calling up applications(→ page 326)

You can operate the multimedia system with the following central control elements:

- Touch Control ① and touchpad ③
The operation for both control elements is achieved by cursor control.
- Media display ②
- ① Alternatively, you can conduct a dialog with the Voice Control System (→ page 295).

- ① If the vehicle is equipped with the MBUX in-car assistant, selected functions of the multimedia system can be operated contact-free as well as turning the reading light on or off (→ page 321).

Numerous application, online services, services and apps are available for you. You can call these up using the home screen or using buttons ⑤ and ⑥ next to the touchpad.

You can conveniently call up and add favorites using the  rocker switch on the steering wheel or using the  button next to the touchpad. Quick-access in the home screen and in the applications serve to select functions more quickly.

If you use the learn function of the multimedia system, you will receive suggestions during operation of the most probable navigation destinations, media sources, radio stations and contacts. The configuration of the suggestions takes place in your profile. You can compile your profile from various vehicle settings and settings of the multimedia system. You can create themes for various driving situations in the home screen

as well as using the  rocker switch or the  button.

The Notifications Center collects incoming notifications, e.g. about an available software update. Depending on the type of notification it offers various actions. You can call up the Notifications Center on the home screen and in the application menus.

With the global search in the vehicle you can search on-board across many categories as well as online in the Internet. You can use the global search in the home screen and in the notifications.

Protection against theft

This device is equipped with technical provisions to protect it against theft. Further information on protection against theft can be obtained from an authorized Mercedes-Benz Center.

Notes on the media display

Observe the notes on caring for the interior (→ page 469).

Automatic temperature-controlled switch-off feature: if the temperature is too high, the brightness is initially reduced automatically. The media display may then switch off completely for a while.

- ① If you are wearing polarized sunglasses, it may be difficult to read the multimedia system display.

Home screen overview

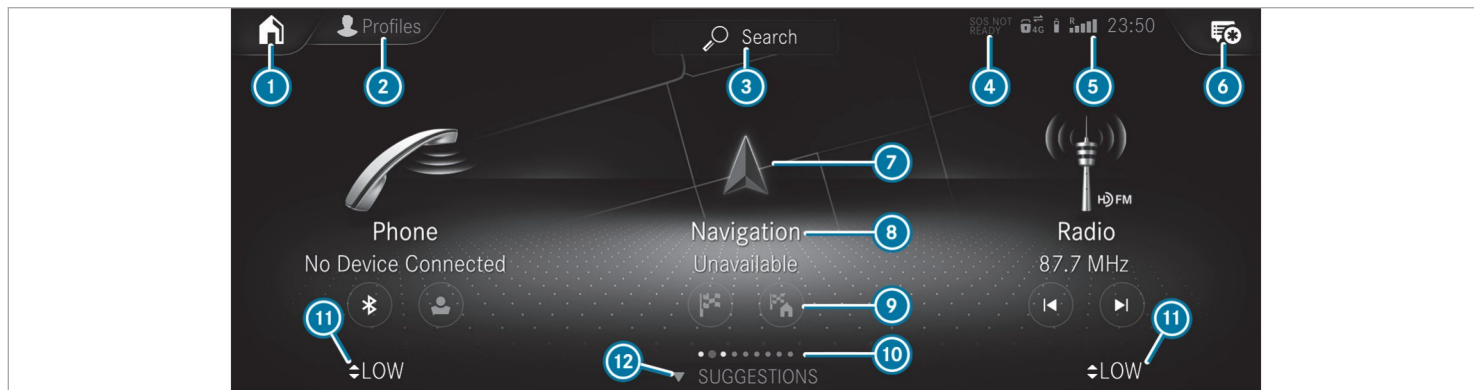

- ① On the home screen: displays the first three applications
In other displays: calls up the home screen
- ② Calls up the profile
- ③ Calls up the global search
- ④ SOS NOT READY display only when the Mercedes-Benz emergency call system is not available

- ⑤ Displays, for example network display, battery status of the mobile phone connected, signal strength of the mobile phone network, time
- ⑥ Calls up the Notifications Center
The star indicates new notifications.
- ⑦ Calls up an application using the symbol

- ⑧ Name of the application, beneath the current selection or information
- ⑨ Quick-access (in the example: calls up destination entry, enters the destination address for home)
- ⑩ Number of applications and currently selected display area

- ⑪ Calls up the air conditioning menu (→ page 155)
- ⑫ Calls up **SUGGESTIONS**, **THEMES** and **FAVORITES**

Central control elements overview

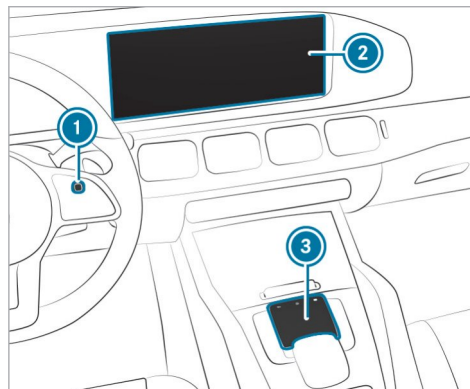

- ① Touch Control
- ② Media display with touch functionality
- ③ Touchpad

Touch Control

Operating Touch Control (MBUX multimedia system)

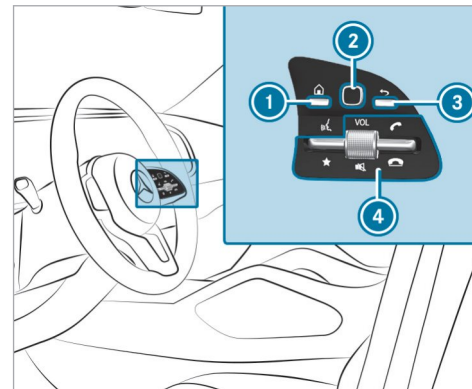

- ①  button
Shows the home screen and calls up applications

Shows suggestions, themes and favorites: when the home screen is shown, swipe down on Touch Control ②.

② Touch Control

③  button

Pressing briefly: returns to the previous display

④ Control panel for MBUX multimedia system:

 rocker switch

Press down briefly: shows favorites

Press down and hold: adds favorites and themes

Control knob

Turn: adjusts the volume VOL

Press: switches off the sound 

 rocker switch

Press up: makes or accepts a call

 rocker switch

Press down: rejects or ends a call

You can navigate in menus and lists via the touch-sensitive surface of Touch Control ② by using a **single-finger swipe**.

▶ **To select the menu item or entry:** swipe up, down, left or right.

▶ Press Touch Control ②.

▶ **To enter a character:** enter a character using the keyboard.

▶ **To move the digital map:** swipe in any direction.

Setting the sensitivity for the Touch Control

Multimedia system:

→  ▶ Settings ▶ System

▶▶ Controls ▶▶ Touch Control Sensitivity

▶ Select **Fast**, **Medium** or **Slow**.

Setting acoustic operating feedback for the Touch Control

Multimedia system:

→  ▶ Settings ▶ System

▶▶ Controls

The function is supported by the selection in a list.

▶ Select **Acoustic Operating Feedback**.

▶ Set **Normal**, **Loud** or **Off**.

If the function is activated you will hear a clicking sound when scrolling in a list. When the beginning or end of the list is reached you will hear another clicking sound.

Touchscreen

Operating the touchscreen

Tapping

▶ **To select a menu item or entry:** tap on a symbol or an entry.

▶ **To increase the map scale:** tap twice quickly with one finger.

▶ **To reduce the map scale:** tap with two fingers.

▶ **To enter characters with the keypad:** tap on a button.

Single-finger swipe

▶ **To navigate in menus:** swipe up, down, left or right.

- ▶ **To move the digital map:** swipe in any direction.
- ▶ **To use handwriting to enter characters:** write the character with one finger on the touchscreen.

Two-finger swipe

- ▶ **To zoom in and out of the map:** move two fingers together or apart.
- ▶ **To enlarge or reduce the size of a section of a website:** move two fingers together or apart.
- ▶ **To turn the map:** turn counter-clockwise or clockwise using two fingers.

Touching, holding and moving

- ▶ **To move the map:** touch the touchscreen and move your finger in any direction.
- ▶ **To set the volume on a scale:** touch the touchscreen and move the finger to the left or right.

Touching and holding

- ▶ **To save the destination in the map:** touch the touchscreen and hold until a message is shown.
- ▶ **To call up a global menu in the applications:** touch the touchscreen and hold until the **OPTIONS** menu appears.

Setting acoustic operation feedback for the touchscreen

Multimedia system:

- ▶  ▶ Settings ▶ System
- ▶ Controls



The function is supported by the selection in a list.

- ▶ Select **Acoustic Operating Feedback**.
- ▶ Set **Normal**, **Loud** or **Off**.
If the function is activated you will hear a clicking sound when scrolling in a list. When the beginning or end of the list is reached you will hear another clicking sound.

Touchpad

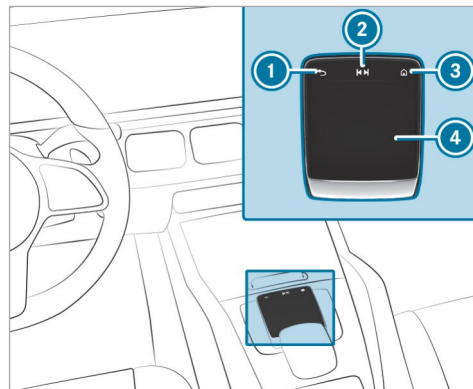
Operating the touchpad



- ①  button
Pressing briefly: returns to the previous display
- ②  button
Pressing: calls up the control menu of the last active audio source

Swiping to the left of right across : selects the previous or next radio station/ music track

3  button

Pressing: shows the home screen and calls up applications

4 Touchpad

i Calls up suggestions, themes and favorites: when the home screen is shown, swipe down on touchpad 4.

You can navigate in menus and lists via the touch-sensitive surface of touchpad 4 by using a **single-finger swipe**.

▶ **To select the menu item or entry:** move the selection by swiping up, down, left or right.

▶ Confirm the selection by pressing on touchpad 4.

or

▶ If **Touchpad Tap** is activated, tapping is sufficient (→ page 319).

▶ **To enter a character:** select a character on the keyboard (→ page 342).

or

▶ Write a character on the touchpad with hand-writing input.

▶ **To move the digital map:** when the digital map is shown with the navigation menu, swipe up with one finger.

▶ Press the touchpad.
The digital map can be moved.

▶ Swipe in all directions.

Use the following functions with a two-finger swipe:

▶ **To call up the Notifications Center:** swipe down with two fingers.

▶ **To close the Notifications Center:** swipe up with two fingers.

▶ **To call up the control menu of the last active audio source:** swipe up with two fingers.

▶ **To zoom in and out of the map:** move two fingers together or apart.

▶ **To enlarge or reduce the size of a section of a website:** move two fingers together or apart.

Setting the sensitivity for the touchpad

Multimedia system:

 ▶ Settings ▶ System

▶ Controls ▶ Touchpad Sensitivity

▶ Select **Fast**, **Medium** or **Slow**.

▶ **To set the pressure sensitivity:** switch **Touchpad Tap** on or off.

If the function is switched on, a tap on the touchpad is enough to select a menu item.

Switching the read-aloud function for hand-writing recognition on/off
Requirements:

- The multimedia system is equipped with a voice control system.
- The read-aloud function is available for the selected system language.

Multimedia system:

→  » Settings » System » Audio

- ▶ Switch **Read Out Handwriting Recognition** on or off.
If the function is activated, characters are read aloud as they are written on the touchpad.

Activating/deactivating haptic operating feedback for the touchpad

Multimedia system:

→  » Settings » System
» Controls

The function supports you when making entries on the touchpad and when selecting menus.

- ▶ Switch **Haptic Operating Feedback** on or off. When the function is activated, a tactile feedback in the form of a vibration is effected when the touchpad is operated.

Setting acoustic operating feedback for the touchpad

Multimedia system:

→  » Settings » System
» Controls

The function is supported by the selection in a list.

- ▶ Select **Acoustic Operating Feedback**.
- ▶ Set **Normal**, **Loud** or **Off**.
If the function is activated you will hear a clicking sound when scrolling in a list. When the beginning or end of the list is reached you will hear another clicking sound.

Selecting a station and track using the touchpad

- ▶ Swipe to the left or right over the  button.
Radio: the previous or next station is set.
Media source: the previous or next track is selected.

or

- ▶ **To show the control menu:** press the  button on the touchpad.

or

- ▶ Swipe upwards using two fingers on the touchpad.
The control menu appears for the audio source that was last selected.
- ▶ Swipe left or right using one finger.
Radio: the previous or next station is set.
Media source: the previous or next track is selected.
- ▶ **To hide the control menu:** swipe down on the touchpad using two fingers.

MBUX Interior Assistant

Notes on lasers and laser classification

⚠ WARNING Risk of injury from laser radiation from the camera

This product uses a laser system. If the housing is opened or damaged, invisible laser

beams can escape in an uncontrolled manner.

Laser radiation can damage your retina.

- ▶ Do not open the housing.
- ▶ Always have maintenance work and repairs carried out by a qualified specialist workshop.

This product complies with the requirements of the FDA 21 CFR 1040.10 and 1040.11 with exception of the variations according to the FDA Laser Notice No. 50 from 24. June 2007.

⚠ WARNING Risk of distraction from information systems and communications equipment

If you operate information and communication equipment integrated in the vehicle

when driving, you will be distracted from the traffic situation. This could also cause you to lose control of the vehicle.

- ▶ Only operate this equipment when the traffic situation permits.
- ▶ If you cannot be sure of this, stop the vehicle whilst paying attention to road and traffic conditions and operate the equipment with the vehicle stationary.

You must observe the legal requirements for the country in which you are currently driving when operating the multimedia system.

Overview of the MBUX Interior Assistant

If the vehicle is equipped with the MBUX Interior Assistant, selected functions of the multimedia system can be operated contact-free. In addition,

the reading light or search light can be switched on or off contact-free.

The MBUX Interior Assistant can differentiate between driver and front passenger interactions.

The MBUX Interior Assistant recognizes certain hand positions (poses).

The MBUX Interior Assistant supports the following interactions:

Interaction area	Interaction	Description
In front of the media display/above the touchpad	Proximity to the control element	The MBUX Interior Assistant recognizes the approach of the hand towards a control element. Depending on the active application, the display will be adjusted in the media display. Some functions differentiate between driver and front passenger. No specific hand position is required.
Above the center console	Defined poses	With defined poses a function is triggered depending on the application active.
Below the inside rearview mirror	Brief up and down movements	With brief vertical up and down movements below the inside rearview mirror the reading light for the driver or the front passenger is switched on and off.
Front passenger seat	Stretching out the hand above the front passenger seat	By stretching out the hand above the front passenger seat the search light is switched on. If the hand is withdrawn from this area, the search light is switched off again.

Operating functions by proximity of the hand to the touchscreen and touchpad Requirements:

- One of the following applications appears in the media display:
 - Seat settings with displays for the driver and front passenger seat, e.g. [Seat Comfort](#)
 - Home screen

- Radio menu or media menu
- Map in the navigation
- Active Parking Assist
- Recognition occurs as the hand approaches to approximately 4 in (10 cm) from the touchpad or the touchscreen.

Seat adjustments by the driver or front passenger

In the seat settings menu, the MBUX Interior Assistant detects proximity to various control elements of the multimedia system. In addition, the MBUX Interior Assistant detects from which seat the action emanates.

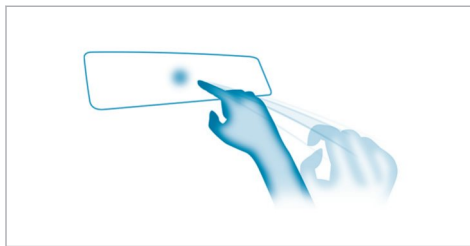

Hand approaching the touchscreen



Hand approaching the touchpad

▶ With the seat setting display active, move the hand towards the touchscreen or touchpad. The seat of the person operating, driver's seat or front passenger seat, is enlarged in the media display.

The appropriate control elements are pre-selected automatically.

▶ Depending on the function, the person operating can either switch the function on or off directly or make other settings.

Highlighting an application on the home screen

The MBUX Interior Assistant detects in which area the hand is in front of the touchscreen. The display of objects shown is adjusted to improve orientation.

▶ Move a hand towards the touchscreen. The symbol for the application is enlarged. The quick-access applications will be highlighted.

▶ Continue operation, e.g. select a quick-access application.

ⓘ Further information about the home screen (→ page 315).

Activating cover change in the radio menu and media menu

The MBUX Interior Assistant reduces the number of operating steps.

- ▶ Move a hand towards the touchscreen or touchpad.
The current information, e.g. about the radio station, track and artist are hidden. Cover change is activated.
- ▶ Continue operation and select a cover.
- ▶ As the hand is moved away from the touchscreen or touchpad, the current information is shown again.
- ① Further information on the radio menu (→ page 442) and the media menu (→ page 437).

Showing the navigation menu on the map

The MBUX Interior Assistant shows the navigation menu.

- ▶ Move a hand towards the touchscreen or touchpad.
The navigation menu is shown.
- ▶ Continue operation and select a symbol.

- ▶ As the hand is moved away from the touchscreen or touchpad, the media display hides the navigation menu.

- ① Further information on the navigation menu (→ page 358).

Showing operating symbols in the Active Parking Assist camera image (only from driver's seat)

The MBUX Interior Assistant facilitates quick-access for the driver to various camera views.

- ▶ With the Active Parking Assist display active, move the hand in the direction of the touchscreen.
The camera operation symbols are displayed.
- ▶ Continue operation and display the desired front, rear, left and right camera views.
- ① Further information on Active Parking Assist functions (→ page 259).

Operating a function with the favorites pose Requirements:

- **To call up favorites:** there is at least one favorite.

- The area for recognition of the favorite's pose is above the center console at the height of the climate control vents and the media display. The hand should have a distance of at least 4 in (10 cm) from the media display.
- The pose is held for a brief time.

Calling up favorites

A pose calls up a favorite.

The driver and front passenger can connect two different favorites with the V pose.

- ① If a favorite has not yet been saved and connected with the MBUX Interior Assistant, the multimedia system will assist you.

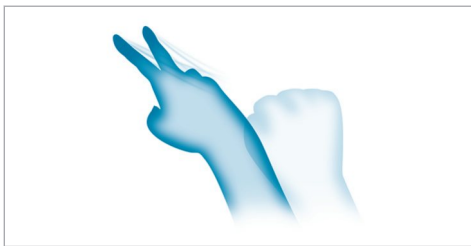

Carrying out the V pose

- ▶ Position the hand above the center console and in the direction of the media display. The back of the hand is facing upwards. In doing so the index and middle finger are extended with the other fingers bent inwards. The favorite is called up.

Switching the reading light for the driver and front passenger on/off using gesture mode Requirements:

- The function is available when it is dark.
- The gesture is carried out in the interaction area (under the inside rearview mirror).

Briefly moving the hand up and down under the inside rearview mirror switches the reading light specifically for the driver or front passenger on or off.

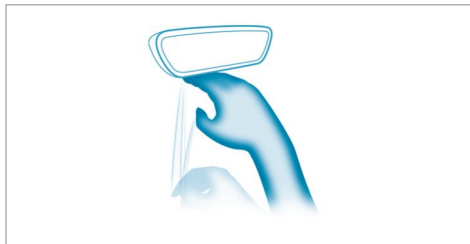

Carrying out operation of the reading light

- ▶ Move the hand up and down vertically under the reading light. The reading light is switched on or off.

Switching the search light for the driver on/off using gesture mode Requirements:

- The front passenger seat is not occupied.
- The function is available when it is dark.

- The gesture is completed in the interaction area (front-passenger seat).
- The seat belt on the front passenger seat must **not** be inserted in the seat belt buckle.

Stretching out with the hand over the front passenger seat when unoccupied switches a search light on for the driver when it is dark. Pulling the hand back switches the search light off again.

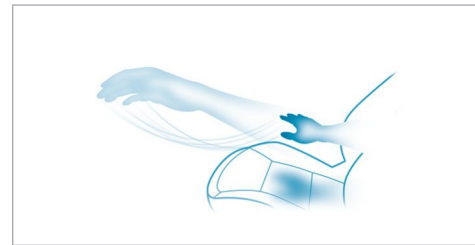

Interaction area for operating the search light

- ▶ **To switch on:** reach across the front passenger seat with your hand. The search light is switched on for the driver.

- ▶ **To switch off:** take your hand back away from the front passenger seat. The search light is switched off again.

Settings for the MBUX Interior Assistant

Multimedia system:

→  ▶ Settings ▶ System

▶ Interior Assistant





- ▶ **To switch on full functionality of the MBUX Interior Assistant:** select **On**. The option is activated ●.
- ▶ **To activate additional functions for reading and search lights:** select **Including Reading Light**.
When the option is switched on, the display button is activated.

The functions for the reading and search lights are activated in addition to the proximity functions.
- ▶ **To switch off the MBUX Interior Assistant:** select **Off**.
The option is activated ●.

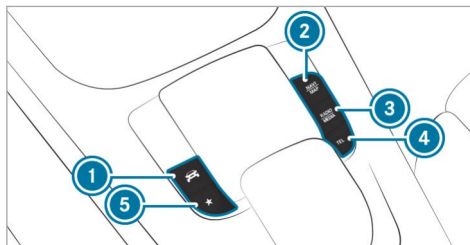
Main functions

Calling up applications



- 1  button
Calls up vehicle functions
- 2  button
Calls up navigation
- 3  button
Calls up radio or media
- 4  button
Calls up the telephone
- 5  button

Press briefly: calls up favorites
(→ page 334)
Press and hold: adds a favorite
(→ page 335) or creates a new theme
(→ page 331)

Alternatively in the home screen: when you start the vehicle the home screen is shown in the media display.

- ▶ Select the application by swiping and tapping.

or



- ▶ **In any display:** press the  button on the Touch Control or on the touchpad.

or

- ▶ Tap on the  symbol on the touchscreen. The applications are displayed.
- ▶ Select the application by swiping and tapping.

Changing the arrangement of applications on the home screen

- ▶ Call up the home screen.

- ▶ Touch and hold an application on the touchscreen until symbols appear.
- ▶ Tap on  or  and move the application in the menu.
- ▶ Tap on .

Profile

Notes on profiles

⚠ WARNING Risk of becoming trapped during adjustment of the driver's seat after calling up a driver profile

Selecting a profile may trigger an adjustment of the driver's seat to the position saved under the profile. You or other vehicle occupants could be injured in the process.

- ▶ Make sure that when the position of driver's seat is being adjusted using the multimedia system, no people or body parts are in the seat's range of movement.

If there is a risk of someone becoming trapped, stop the adjustment process immediately:

- ▶ a) Tap the warning message on the media display.
 - or
 - ▶ b) Press a memory position button or a seat adjustment switch on the driver's door.
- The adjustment process is stopped.

The driver's seat is equipped with an anti-entrapment feature.

If the driver's door is open, the driver's seat will **not** be set after calling up the driver's profile.

Overview of profiles

Using the multimedia system up to seven profiles can be created in the vehicle.

Profiles store your personal vehicle settings and settings for the multimedia system.

If the vehicle is used by several drivers, the driver can select their profile before the journey, without changing the settings of other drivers.

You can select the profile:

- When entering (→ page 330)
- Using the home screen (→ page 315)

The profile settings are activated as soon as a profile is selected.

- ⓘ When you call up your profile, the driver's seat, steering wheel and outside mirrors can be set.
- If you call up your profile when driving then the driver's seat position will not be adjusted.

You can cancel the setting process with the following actions:

- Tap on the [Positioning Seat and Steering Wheel... Please tap to cancel.](#) warning on the media display.
- Press one of the seat operating buttons in the driver's door.

Profile content

Depending on the vehicle equipment, the following settings can be stored in your profile, for example:

- Driver's seat, steering wheel and mirror settings
 - Driver's seat memory
 - Radio (including station list)
 - Last destinations
 - Climate control
 - Ambient lighting
 - DYNAMIC SELECT I (individual)
 - Instrument Display, Head-up Display and style (display style of the multimedia system)
 - Themes, suggestions and favorites
- i** Settings for driver assistance systems cannot be saved in the profile.

Mercedes me connect profile

If you use a profile from Mercedes me connect, the following online functions are available, for example:

- You can configure the settings in the vehicle using the Mercedes me app and the Mercedes me portal.
- You can synchronize your profile on Mercedes me connect with the profile in the vehicle (→ page 329).
- You can add a personal profile photo that is shown in the vehicle.
- You can take your profile and some of your settings with you in new vehicles.

Requirements for using Mercedes me connect profiles:

For the vehicle owner:

- You have a Mercedes me user account.
- The vehicle has been connected with the user account.
- The personalization service is activated.



For additional users of the vehicle:

- You have a Mercedes me user account.
- The vehicle owner has invited you to connect your user account on Mercedes me with that of his vehicle.
- You have accepted the invitation.

Creating a new profile

Multimedia system:

 Profiles

 Select  Create Profile.

 Select an avatar.

 Enter the name and confirm with .

 Select [Continue](#) .

 **To save the current settings in a profile:** select [Current Settings](#).

 Select [Save](#).

or

 **To adopt the factory settings:** select [Factory Settings](#).

 Select [Save](#).

i Further information on setting a user profile (→ page 329).

- ▶ Activate Bluetooth® and select **Connect Phone**, to connect a mobile phone with the user profile (→ page 402).

You can also set up a user profile without registering a mobile phone.

- ▶ Select **Finish**.
The user profile is saved.

Selecting profile options

Multimedia system:



- ▶ Select **...** for a profile.
- ▶ **To edit a profile:** select **Edit Profile**.
- ▶ Select an avatar.
- ▶ Change the name, if necessary.
- ▶ Select **Save**.
- ▶ **To configure suggestions:** select **Suggestion Settings** (→ page 333).

- ▶ **To reset favorites or themes:** select **Reset Favorite to Factory Settings** or **Reset Themes to Factory Settings**.

▶ Select **Yes**.

- ▶ **To reset a profile:** select **Reset Profile to Factory Settings**.

▶ Select **Yes**.

- ▶ **To delete a profile:** select **Delete Profile**.

▶ Select **Yes**.

i The guest profile cannot be deleted.

Protecting profile content

To protect your profile content and settings you can create a PIN in the Mercedes me portal for your profile. When PIN protection is active, you have to enter the PIN to select your profile.

- ▶ Select **Protect Content**.

▶ Select **Mercedes me Portal**.
The browser opens and you are transferred to the Mercedes me portal.

Selecting a profile

Multimedia system:



i When you call up your profile, the driver's seat, steering wheel and outside mirrors can be set.

You can cancel the setting process with the following actions:

- Tap on the **Positioning Seat and Steering Wheel... Please tap to cancel** warning on the media display.
- Press one of the seat operating buttons in the driver's door.

- ▶ Select a profile.

▶ Press the **OK** button to confirm the message.

The profile is loaded and activated.

i Alternatively, the profile can already be selected when the vehicle is entered (→ page 330).

Synchronizing a profile

Requirements:

- You have a Mercedes me user account.
- The vehicle is connected with your Mercedes me user account.
- The personalization service is activated on Mercedes me connect.

Multimedia system:



Synchronization enables the following:

- You can configure the vehicle settings using the Mercedes me app.
- The profile on Mercedes me connect and the profile in the vehicle are aligned (profile management).

- ▶ Activate **Synchronize Profiles Automatically**. The profiles in the vehicle are automatically synchronized with the profiles on Mercedes me connect when the ignition is switched on and off.

or

- ▶ Select **Synchronize Profiles Now**. After selecting this option, the profiles in the vehicle are synchronized with the profiles on Mercedes me connect.

ⓘ During synchronization the profile list and the profile functions are blocked.

- ⓘ **Note on data protection:** if you do not wish to share your data with Mercedes me, make sure that the automatic synchronization is switched off and do not select **Synchronize Profiles Now**.

Showing the profile selection when entering Requirements:

- At least one profile has been created.

Multimedia system:



If the option is activated, you can see a profile as soon as you get in.

- ▶ Select **General Settings**.

- ▶ Activate **Show Profile Selection When Getting In**.

When the vehicle is started, the media display shows the active profile.

Themes

Overview of themes

You can configure the vehicle settings according to your preferences and save as a theme. A theme can be called up any time via the home screen. There is then no need to make the desired settings again.

There are pre-defined themes available, e.g. Journey, Efficiency and Lounge.

Example for the use of themes

For recurring driving situations, such as long drives on the freeway, you can save your preferred settings in a theme in the vehicle.

You can save the following settings in a theme, for example:

- Displays (e.g. navigation map or tachometer)
- Preferred radio station

- Favored drive program

These settings are saved under the name you wish when setting up a theme (→ page 331). On the next freeway journey you can select this theme and thereby restore your settings.

Content of a theme

Depending on vehicle equipment the following settings can be saved in a theme:

- Setting of the Instrument Display (→ page 279)
- Setting of the Head-up Display (→ page 291)
- Setting of the ambient lighting (→ page 142)
- Active audio source, e.g. radio or USB
- Starting screen for the media display
- Visual style (→ page 348)
- DYNAMIC SELECT drive program (→ page 177)
- Eco start/stop setting (→ page 174)
- Navigation system settings

i A theme contains the currently active settings in the vehicle.

Calling up themes

Multimedia system:



- ▶ When the home screen is shown, swipe up until **THEMES** appears.
- ▶ Select a theme.

Creating new themes

Requirements:

- The settings which are to be saved in the theme are active.

The overview shows the settings which can be saved in a theme (→ page 330).

Multimedia system:



- ▶ Select **+** **Create Theme**. The settings which are saved in the theme are shown.
- ▶ Select **Continue** **>**.
- ▶ Select additional settings which are to be saved in the theme.
 - Select **Audio**, to save the active audio settings in the theme.



- Select **Navigation** (Navigation), to save the active navigation settings in the theme.

- ▶ Select **Continue** **>**.
- ▶ Select an entry screen.
- ▶ Select **Continue** **>**.
- ▶ Select an image.
- ▶ Enter the names into the entry field and confirm with **OK**.
- ▶ **To save a theme:** select **Save**.





When the maximum number that can be saved is reached:



- ▶ Select **OK** from the prompt.
- ▶ Select a theme that should be overwritten. The settings which are saved in the theme are shown.
- ▶ Select **Continue** **>**.
- ▶ Select additional settings which are to be saved in the theme.
 - Select **Audio**, to save the active audio settings in the theme.

- Select **Navigation** (Navigation), to save the active navigation settings in the theme.

- ▶ Select **Continue** .
- ▶ Select an entry screen.
- ▶ Select **Continue** .
- ▶ Select an image.
- ▶ Enter the names into the entry field and confirm with .
- ▶ **To save a theme:** select **Save**.



Creating using the rocker switch or button

- ▶ Press and hold the bottom section of the  rocker switch on the steering wheel.
- or
- ▶ Press and hold the  button next to the touchpad.
- ▶ Select  **Create Theme**. The settings which are saved in the theme are shown.
- ▶ Select **Continue** .

- ▶ Select additional settings which are to be saved in the theme.
 - Select **Audio**, to save the active audio settings in the theme.
 - Select **Navigation** (Navigation), to save the active navigation settings in the theme.
- ▶ Select **Continue** .
- ▶ Select an image.
- ▶ Enter the names into the entry field and confirm with .
- ▶ **To save a theme:** select **Save**.





Modifying themes

Multimedia system:





- ▶  → 
- ▶ When the home screen is shown, swipe up until **THEMES** appears.
- ▶ Press on a theme until the **OPTIONS** menu is shown.
- ▶ Select **Rename**.
- ▶ Enter the name.
- ▶ Select **Save** .

Moving themes

Multimedia system:

- ▶  → 
- ▶ When the home screen is shown, swipe up until **THEMES** appears.
- ▶ Press on a theme until the **OPTIONS** menu is shown.
- ▶ Select **Move**.
- ▶ Tap on  or .
- ▶ Tap on .

Moving the themes menu in the home screen

- ▶ Select .
- ▶ Swipe upwards and select **Set New Order**.
- ▶ Select **Themes**.
- ▶ Tap on  or .
- ▶ Tap on .

Deleting themes

Multimedia system:



- ▶ When the home screen is shown, swipe up until **THEMES** appears.
- ▶ Press on a theme until the **OPTIONS** menu is shown.
- ▶ Select **Delete**.
- ▶ Select **Yes**.

Suggestions

Suggestions overview

The vehicle can learn the habits of the driver. Based on previously used functions, the most likely navigation destinations, media sources, radio stations or contacts are offered under **SUGGESTIONS**.

Suggestions are shown when the following requirements are fulfilled:

- A profile has been created (→ page 328).
 - A profile has been selected.
 - You have accepted data recording.
- From the beginning of usage, the multimedia system must analyze the user habits. When sufficient data is collected then the suggestions are available.

If the requirements mentioned are not fulfilled, a preview with a description of the function appears in the **SUGGESTIONS** menu.

You can configure data recording (→ page 333) or delete the suggestions recorded (→ page 334).

Calling up suggestions

Requirements:

- A profile has been created and is selected (→ page 329).
- ▶ Tap on in the media display. The home screen is shown.
 - ▶ Swipe up until the **SUGGESTIONS** menu is shown.
 - ▶ Select a navigation destination, a media source, a radio station or a contact. If route guidance is already active, you cannot start a new route guidance or set an

intermediate destination for the existing route.

Configuring suggestions

Requirements:

- **To protect settings using a PIN:** your profile is connected with Mercedes me and your Mercedes me account is PIN protected.

Multimedia system:



- ▶ Select for a profile.
- ▶ Select **Suggestion Settings**.
- ▶ **To switch suggestions display on/off:** switch **Allow Destination Suggestions**, **Allow Music Suggestions** and **Allow Contact Suggestions** on or off. If an option is switched on, suggestions for navigation destinations, media sources, radio stations or contacts are shown. If the option is switched off, no suggestions are shown.

▶ **To deactivate the learn function for one day:** activate [24h Learning Deact.](#)

For 24 hours no new actions will be trained and no data recorded for the active profile. Suggestions will continue to be shown. The remaining time is shown next to [24h Learning Deact.](#)

Before the time runs out, a message is shown that the multimedia system will continue the learn function shortly.

Example: if the option is switched on and a route to a new destination has been calculated, this destination would not be taken into account for the learn function.

▶ **To reset the suggestion history:** select [Reset Suggestion History](#).

 This process cannot be reversed.

▶ Select [Yes](#).

▶ **To protect settings with a PIN:** switch on [PIN Protection](#).

If PIN protection is switched on, you must enter the Mercedes me PIN to set the suggestions. This PIN will be set in the Mercedes

me portal for the personalization service to protect your personal settings.

Renaming suggestions

Only navigation destinations can be renamed.

▶ Tap on the  symbol in the media display. The home screen is shown.

▶ Swipe up until the **SUGGESTIONS** menu is shown.

▶ Highlight a navigation destination and press until the **OPTIONS** menu is shown.

▶ Select [Rename](#).

▶ Enter the name.

▶ **To confirm the entry:** select [Yes](#).

Deleting a suggestion

▶ Tap on  in the media display. The home screen is shown.

▶ Swipe up until the **SUGGESTIONS** menu is shown.

▶ Highlight a suggestion and press until the **OPTIONS** menu is shown.

▶ Select [Delete](#).

The query as to whether the suggestion is deleted temporarily or permanently appears.

▶ **If the suggestion should be shown again at a later time:** select [Not Now](#).

▶ **If the suggestion should not be shown again:** select [Never](#).

Favorites

Overview of favorites

Favorites offer you quick access to frequently used applications. It is possible to create 20 favorites in total.

You can select favorites from categories or you add favorites directly from an application.

Calling up favorites

In the media display

▶ Tap on .

The home screen is shown.

▶ Swipe up until **FAVORITES** is shown.

On the steering wheel or the touchpad

▶ Press the  rocker switch on the steering wheel down.

or

▶ Press the  button next to the touchpad.

Adding favorites

Selecting favorites from categories

▶ Tap on  in the media display. The home screen is shown.

▶ Swipe up until **FAVORITES** is shown.

▶ Select  **Create Favorite**. The categories are displayed.

▶ Select the category. The favorites are displayed.

▶ Select a favorite. The favorite is stored at the next available position.

▶ **All positions in the favorites are taken:** confirm the message shown with **OK**. A list shows all the favorites.

▶ Select a favorite which should be overwritten.

Adding a favorite from an application

Examples of adding from an application are:

- Saving a contact.
- Storing a radio station.
- Adding a media source.
- Saving a navigation destination.
- Adding an ENERGIZING comfort program (if available).

▶ **To save a contact as a global favorite:** select a contact (→ page 407). The details are displayed.

▶ Press on a telephone number until the **OPTIONS** menu is shown.

▶ Select **Save as Favorite**. The contact is added as a favorite.

▶ **To store a radio station as a global favorite:** set a radio station (→ page 443).

▶ Press on the radio station until the **OPTIONS** menu is shown.

▶ Select **Save as Favorite**. The radio station is added as a favorite.

Renaming favorites

▶ Tap on  in the media display. The home screen is shown.

▶ Swipe up until **FAVORITES** is shown.

▶ Press on a favorite until the **OPTIONS** menu is shown.

▶ Select **Rename**.

▶ Enter the name.

▶ Select **OK**.

Moving favorites

Moving favorites in the favorites menu

▶ Tap on  in the media display. The home screen is shown.

▶ Swipe up until **FAVORITES** is shown.



▶ Press on a favorite until the **OPTIONS** menu is shown.

▶ Select **Move**.

▶ Move the favorite to the new position.

▶ Tap on .

Moving the favorites menu in the personalization

- ▶ Tap on  in the media display. The home screen is shown.
- ▶ Swipe up until **Set New Order** is shown.
- ▶ Select **Set New Order**.
- ▶ Move **Favorites** to the new position.
- ▶ Tap on .

Deleting favorites

- ▶ Tap on  in the media display. The home screen is shown.
- ▶ Swipe up until **FAVORITES** is shown.
- ▶ Press on a favorite until the **OPTIONS** menu is shown.
- ▶ Select **Delete**.
- ▶ Select **Yes**.

Notifications Center

Overview of the Notifications Center

The following communications are collected in the Notifications Center:

- Communications which are generated by the vehicle or from multimedia system.
- Communications which are received through the use of services.

The following notification types are available for you:

- Navigable destinations and routes
- Messages (text messages)
- System information, e.g. **Important Software Update Available**
- Other notifications, e.g. from additional online services that can be subscribed to

The  Notifications Center can be found on the home screen, in menus and at the top right of the navigation map (→ page 315).

Newly received messages will be indicated with a star in the  symbol.

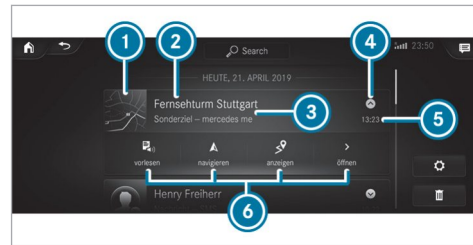

Notifications are normally briefly shown as they are received. This occurs for nearly every application that you are currently using. If you take no action, these are stored for future access in the Notifications Center.

The notifications are sorted chronologically. The most recent notifications are at the top.



A notification shows the following information:

- Symbol or image **1** for the application
- Title **2**, which contains the name, a telephone number or a navigation destination, for example
- The service and additional information **3**

- A time stamp 
- If several actions are available, symbol  to open or close the notification.

Depending on the type of notification, up to four different actions  are available.

Examples of actions include:

- Read aloud
- Placing a call
- Reply
- Calling up a web page
- Navigation

Some notifications, e.g. a navigation destination, are stored longer. Therefore, it is not necessary to carry out available actions directly on the receipt of the notifications. A route guidance can be started at a later time.

 You can start a global search in the Notifications Center (→ page 339).

Calling up notifications

Opening the Notifications Center

▶ **On the touchpad:** swipe down with two fingers.

or

▶ **On the touchscreen:** tap on the  symbol for the Notifications Center.

or

▶ **On the Touch Control and on the touchpad:** mark the  symbol for the Notifications Center by swiping.

▶ Press on the control element.

Selecting a notification

▶ Swipe up or down.

▶ Tap or press on the control element.

Calling up old notifications

If notifications have not been called up after four hours, these are stored in the archive.

▶ Swipe upwards and select [Archive](#).

▶ Select the notification.

Closing the Notifications Center

▶ **On the touchpad:** swipe up with two fingers.

Selecting actions for a notification

The following options are available:

- Select the action directly in an application after a notification is received and shown.
- Select the action later after calling up in the Notifications Center.

▶ **An action is available:** select the action.

▶ **Several actions are available:** if the notification is not open, select the  symbol.

▶ Select the action.

The notification is still available.

▶ If [Additional information](#) is available, select the action. Additional information is shown in a window as text, image or text and image.

▶ **To close the window:** select [OK](#).

Editing notifications

▶ Call up the Notifications Center (→ page 337).

▶ **To make settings:** select .

❗ If no settings can be made, a message appears.

▶ Select the service.

▶ Switch the options on or off.

The following options are available:

- [Allow Notifications](#)
- [Display in Notification Center](#)
- [Show Notifications](#)
- [Acoustic Notifications](#)

When [Allow Notifications](#) is switched on, the other options cannot be selected.

▶ **To delete:** touch a message on the touchscreen and slide to the left or right.

or

▶ Select .

▶ Select [Delete](#) or [Delete All](#).
[Delete](#) deletes a single notification.

[Delete All](#) deletes all notifications currently shown.

▶ With you will exit delete mode.

Global search

Global search overview

You can use the global search in the home screen and in the notifications.

The global search provides search results for the following categories:

- Navigation
- Entertainment
- Telephone, social media
- User interface and Digital Operator's Manual
- Internet

This enables you to search for cities, roads and tourist attractions with the navigation system, for example.

❗ You can also search for 3 word addresses (→ page 365).

When you enter a 3 word address in the global search, separate each of the words with a space or a full stop.

During the entry process the most likely suggestions are shown beneath the search field. When you enter "S", "Stuttgart", "Steak" and "Sandra"

are shown, for example. If you select "Stuttgart", you receive the suggestions "Starbucks", "Steak" and "City railway", for example.

The search results in the list are shown, sorted according to category. Next to the category is the number of results. You will be shown the best results from each category. Additional results can be found after selecting the respective category.

If you confirm an entry with [OK](#), all categories and the number of results will be shown in a summary. After selecting a category you can select the search results within the category. When you select a search result the detailed view opens. In the detailed view you can choose whether and which actions you want to carry out with the respective search result. For example, you can start route guidance or place a call to somebody. The actions are named correspondingly.

The search can be carried out with the following input methods:

- Entering characters using the on-screen keypad

- Entering characters with handwriting recognition
- Dictation function

Using the global search

Multimedia system:



Select Search.

or

- ▶ Call up the notifications (→ page 337).
- ▶ Select **Search**.
- ▶ Enter the search term into the search field. During the entry process the three most likely suggestions are offered beneath the search field.

In the list on the right, the top two search results are shown for each category.

- ① Use the character input function. Alternatively, you can use the dictation function for the search.

- ▶ **To accept a suggestion:** select the suggestion. The three most likely suggestions are offered.
- ▶ Continue the search or accept a suggestion.
- ▶ **To accept the second search result:** select the search result. An action starts or a list is shown.
- ▶ Select a search result or an action in the list.
- ▶ **To show all categories:** select **OK**.
- ▶ **To show search results for a category:** select a category.
- ▶ **To show details:** select a search result.
- ▶ **To start an action:** select an action. After selection of an action, a track is played back or the route to a destination is calculated, for example.

Switching the sound on/off

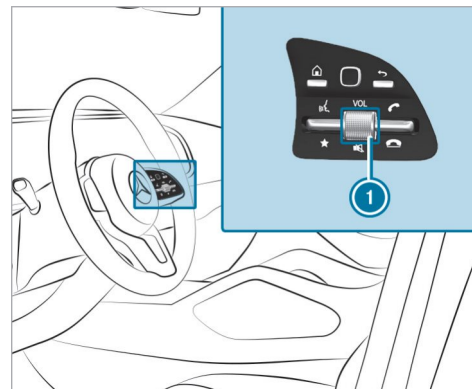

On the multifunction steering wheel

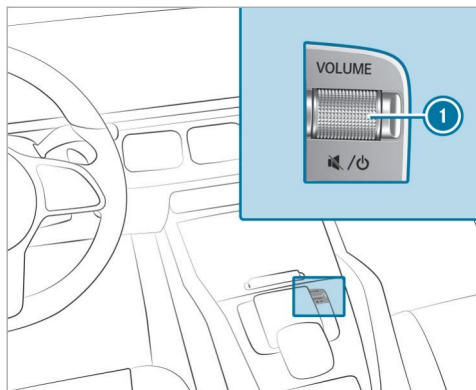

On the multimedia system

- ▶ **To mute:** press volume control ①.
The current audio source is switched off.
The  symbol appears in the status line of the media display.
If you are listening to a radio station, for example, and switch off the sound then all media sources will be muted.

Traffic and navigation announcements can still be heard in this case. Likewise, voice control and telephony are not affected.

- ▶ **To switch on:** turn volume control ① or change the media source.

Adjusting the volume

Adjusting with the control knob

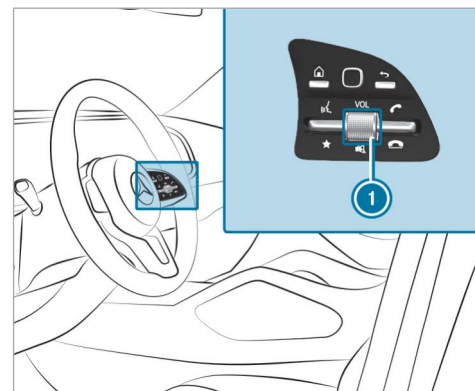

On the multifunction steering wheel

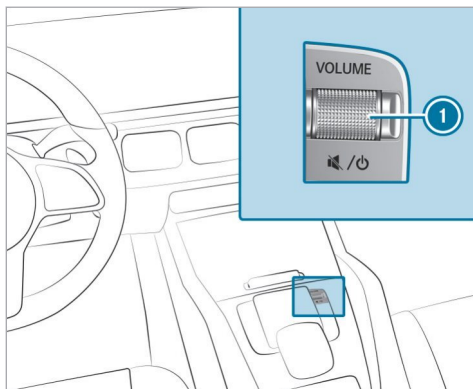

On the multimedia system

- ▶ Turn volume control ①. The volume of the current volume group (e.g. entertainment) is set. The volume of other groups can be adjusted separately. Adjust the volume in the following situations:
 - during a traffic announcement
 - during a navigation announcement

- during a telephone call

Setting in the menu

- ▶ Press the  button.
- ▶ Select **Settings**.
- ▶ Select **System**.
- ▶ Select **Audio**.
- ▶ Select a volume setting.
- ▶ Set the volume.

Entering characters

Using the character input function

⚠ WARNING Risk of distraction from information systems and communications equipment

If you operate information and communication equipment integrated in the vehicle when driving, you will be distracted from the traffic situation. This could also cause you to lose control of the vehicle.

- ▶ Only operate this equipment when the traffic situation permits.
- ▶ If you cannot be sure of this, stop the vehicle whilst paying attention to road and traffic conditions and operate the equipment with the vehicle stationary.

You must observe the legal requirements for the country in which you are currently driving when operating the multimedia system.

Requirements:

- **For the handwriting recognition read-aloud function:** the multimedia system is equipped with a voice control system.
- The read-aloud function is available for the selected system language.
- The handwriting recognition read-aloud function is activated.

Character entry can be carried out with these control elements:

- Touch Control
- Touchscreen (media display)
- Touchpad

Character input can be started with a control element and resumed with another.

▶ When the keypad is shown, enter the characters on the control element by swiping and pressing or by tapping (touchscreen).

or

▶ Write the characters on the touchpad or the touchscreen.

The touchpad supports character input with the following functions:

- Handwriting recognition offers character suggestions.
 - If the read aloud function is activated for handwriting recognition then the entered characters are read aloud.
- Examples of character entry:
- Renaming a favorite
 - Looking for search results in the global search.
 - Entering a destination address in the navigation system
 - Entering a web address

Entering characters on the touchpad Requirements:

- If you wish to have the character input read aloud: the read aloud function of the handwriting recognition is switched on (→ page 319).
- An online connection is required for some functions.



Using the keyboard

- ① Input line
- ② Shows suggestions during input (if available)
- ③ Deletes an entry
- ④ Deletes
Pressing or pressing briefly deletes the last character entered
Pressing and holding deletes the entry
- ⑤ Accepts an entry

- ⑥ Switches to handwriting input
- ⑦ Enters a space
- ⑧ Changes the keyboard language
- ⑨ Switches to special characters
- ⑩ Switches to digits and additional special characters
ABC Switches to letters (level 2)
- ⑪ Pressing or pressing briefly switches between upper-case and lower-case letters

Pressing and holding switches to upper-case letters permanently
If available, the  symbol allows you to change to voice input.

- ① When **Touchpad Tap** is switched on , tapping is sufficient to select a character or an option (→ page 319).
- ▶ Call up the character entry to rename a favorite, for example (→ page 335).

- ▶ Select the character by swiping and pressing. The character is entered in input line ①. Suggestions are shown in ②.
- ▶ **To select a suggestion:** select one of the entries.
- ▶ Resume character input.

- ▶ **To enter an alternative character:** press and hold a character.
- ▶ Select the character.
- ▶ **To end character input:** press the  button.

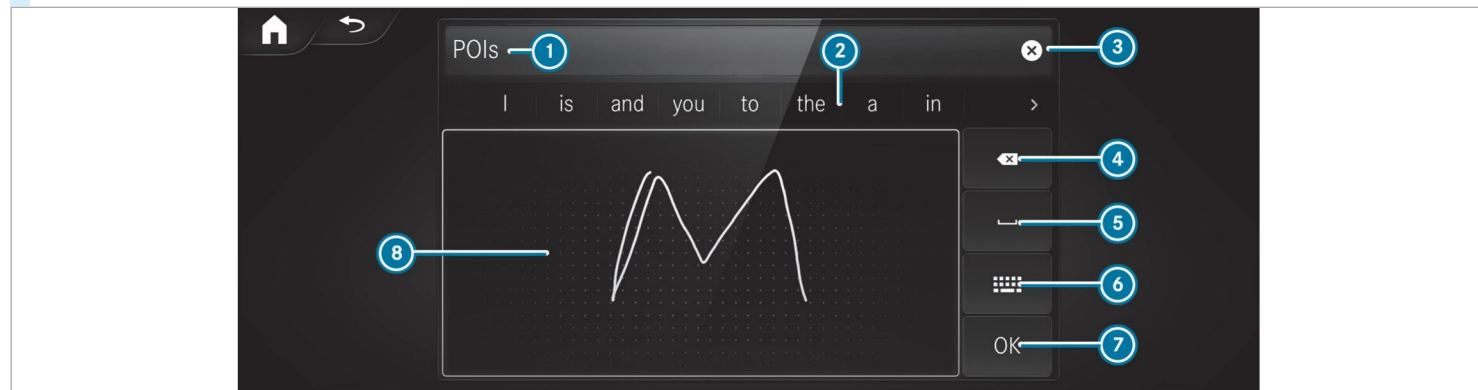

- ① The available editing functions depend on the editing task, the language set and the character level.
- ① Entry using the keyboard can also be completed using the Touch Control.





- ① Using handwriting input
- ① Input line
- ② Shows suggestions during input

- ③ Deletes an entry
- ④ Deletes

- Pressing or pressing briefly deletes the last character entered
- Pressing and holding deletes the entry

- 5 Enters a space
 - 6 Switches to input using the keyboard
 - 7 Accepts an entry
 - 8 Writes characters on the drawing surface
If available, the  symbol allows you to change to voice input.
- i** When **Touchpad Tap** is switched on , tapping is sufficient to select an option (→ page 319).
- ▶ Call up the character entry to rename a favorite, for example (→ page 335).

- ▶ When the keyboard is displayed, select .
- ▶ Write the character on the touchpad with a finger.
The character is entered in input line 1. Suggestions are shown in 2.
- ▶ **To select a suggestion:** select one of the entries.
- ▶ Resume character input. The letters can be written next to each other or above each other.

- ▶ **To end character input:** press the  button.

Entering characters on the touchscreen Requirements:

- If you wish to have the character input read aloud: the read aloud function of the handwriting recognition is switched on (→ page 319).
- An online connection is required for some functions.



Using the keyboard

- ① Input line
- ② Shows suggestions during input (if available)
- ③ Deletes an entry
- ④ Deletes
 - Pressing briefly deletes the last character entered
 - Pressing and holding deletes the entry
- ⑤ Accepts an entry

- ⑥ Switches to handwriting input
- ⑦ Enters a space
- ⑧ Changes the keyboard language
- ⑨ Switches to special characters
- ⑩ Switches to digits and additional special characters
 - ABC Switches to letters (level 2)
- ⑪ Pressing or pressing briefly switches between upper-case and lower-case letters

Pressing and holding switches to upper-case letters permanently

If available, the  symbol allows you to change to voice input.

- ▶ Call up the character entry to rename a favorite, for example (→ page 335). The keyboard is shown.

- ▶ Briefly press on a character. The character is entered in input line ❶. Suggestions are shown in ❷.
- ▶ **To select a suggestion:** select one of the entries.
- ▶ If available, display additional suggestions with ◀ or ▶.

- ▶ Resume character input.
- ▶ **To enter an alternative character:** press and hold a character.
- ▶ Select the character.
- ▶ **To end character entry:** press briefly on ↵.

- ❶ The available editing functions depend on the editing task, the language set and the character level.

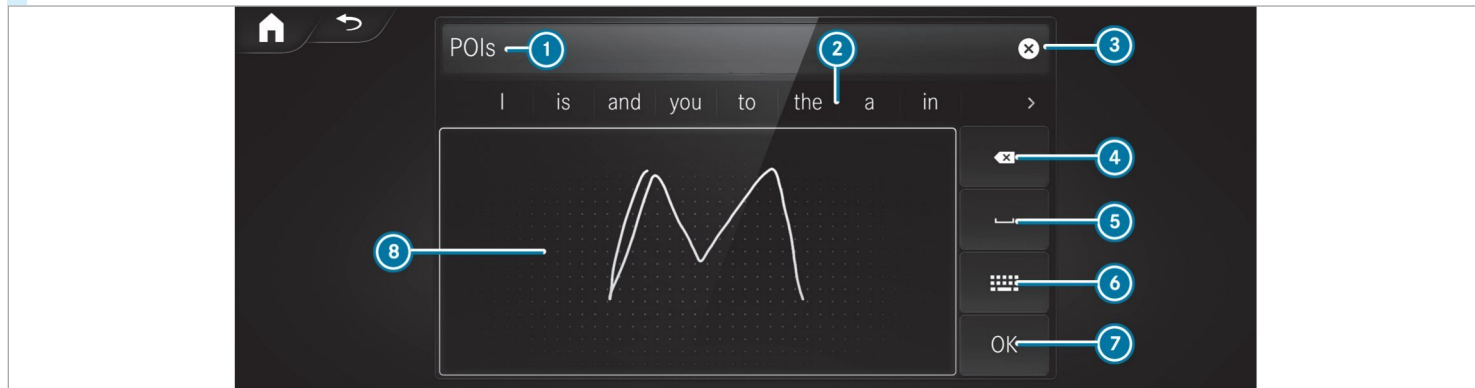

- Using handwriting input
- ❶ Input line



- ❷ Shows suggestions during input
- ❸ Deletes an entry

- ❹ Deletes

Pressing briefly deletes the last character entered

Pressing and holding deletes the entry

- 5 Enters a space
- 6 Switches to input using the keyboard
- 7 Accepts an entry
- 8 Writes characters on the drawing surface
If available, the  symbol allows you to change to voice input.

- ▶ Call up the character entry to rename a favorite, for example (→ page 335).
- ▶ When the keyboard is displayed, select .
- ▶ Write the character with one finger on the touchscreen.
The character is entered in input line ①.
Suggestions are shown in ②.
- ▶ **To select a suggestion:** select one of the entries.
- ▶ If available, display additional suggestions with  or .

- ▶ Resume character input. The letters can be written next to each other or above each other.

- ▶ **To end character entry:** press briefly on .

Setting the keyboard for character entry

Multimedia system:

- ↳  [Settings](#) ▶ [System](#) ▶ [Controls](#)
- ▶▶ [Keyboards and Handwriting](#)

- ▶ Confirm [Select keyboards](#).
Select the keyboard language in the list.

System settings

Display

Configuring display settings

Multimedia system:

- ↳  ▶ [Settings](#) ▶ [System](#)
- ▶▶ [Designs & Display](#)

Setting the design

- ▶ Select [Designs](#).

- ▶ Select [Classic](#), [Sport](#) or [Progressive](#).
The multimedia system display changes depending on the style selected. If you revert to the factory settings, the [Classic](#) style is set.

- ▶ **To adjust the ambient lighting to a style:** select [Ambient Lighting Adjustment](#).
This function adjusts the ambient lighting for the selected display style.

Setting the display brightness

- ▶ Select [Display Brightness](#).
- ▶ Select a brightness value.

Switching the display surround lighting on/off

- ▶ Select [Illuminate Display Indirectly](#).
The indirect lighting is switched on or off.

Switching the display off/on

- ▶ **Off:** select [Display Off](#).
- ▶ **On:** press a button, , for example.

Selecting the display design

- ▶ Select [Day/Night Design](#).

- ▶ Select [Automatic](#), [Day Design](#) or [Night Design](#).

Switching the temperature display on/off

- ▶ Select [Temperature Display](#).
- ▶ Select [Outside Temp.](#) or [Coolant Temp.](#).
The selected temperature is displayed in the instrument cluster.

Time and date

Setting the time and date automatically

Multimedia system:

- ▶  ▶ [Settings](#) ▶ [System](#) ▶ [Time and Date](#)

- ▶ Deactivate [Manual Time Adjustment](#).
The time and date are set automatically for the selected time zone and summer time option.

- ⓘ The correct time is required for the following functions:
 - Route guidance with time-dependent traffic guidance.
 - Calculation of expected time of arrival.

Setting the time zone

Requirements:

- For the manual time zone: [Automatic Time Zone](#) is switched off.

Multimedia system:

- ▶  ▶ [Settings](#) ▶ [System](#) ▶ [Time and Date](#)

Setting the time zone manually

- ▶ Select [Time Zone](#).
The list of countries is displayed.
- ⓘ If there are several time zones available in a country, these will be shown after the country is selected.
- ▶ Select a country and, if required, a time zone.
The time zone set is displayed after [Time Zone](#).

Setting the time zone automatically

- ▶ Activate [Automatic Time Zone](#).

Setting the time and date format

Multimedia system:

- ▶  ▶ [Settings](#) ▶ [System](#) ▶ [Time and Date](#) ▶ [Set Format](#)

- ▶ Set the date and time format •.

Setting the time and date manually

Requirements:

- The [Manual Time Adjustment](#) function is switched on.
- For setting the date manually: no GPS is installed in the vehicle.

Multimedia system:

- ▶  ▶ [Settings](#) ▶ [System](#) ▶ [Time and Date](#)

Setting the time (without time zone)

- ▶ Select [Set Time](#).
- ▶ Set a time.

Setting the time (with time zone)

- ▶ Select [Set Time](#).

If a time zone is set the time is set automatically using the time zone. The time can be adjusted by a maximum of plus or minus 60 minutes.

- ▶ Adjust the time using the slide control.

Setting the date

- ▶ Select **Set Date**.
- ▶ Set a date.
- ⓘ In vehicles with GPS, a date cannot be set even with active manual time adjustments. The date is then set automatically through the selected time zone.

Switching voice amplification to the rear on/off (vehicles with long wheelbase)

Requirements:

- Your vehicle is equipped with the Burmester® surround sound system or the Burmester® high-end 3D surround sound system.
- The ignition is switched on.
- Doors, side windows and the panorama roof with power tilt/sliding panel are closed.

- At least one seat belt is fastened on the rear bench seat.

Multimedia system:

- ▶  ▶ Settings ▶ System ▶ Audio ▶ Voice Amplification

The function supports communication between the driver and front passenger with passengers in the rear compartment. When voice amplification to the rear is activated, the signals picked up by the microphone are amplified and played back over the speakers in the rear compartment, depending upon vehicle noise levels. An automatic adjustment occurs based on speaker volume and ambient noise in order to improve speech intelligibility and maintain the naturalness of speech.

- ▶ Activate or deactivate the function.

Setting the intensity of the voice amplification

- ▶ Select **Voice Amplification - Intensity**.

- ▶ Set the intensity on the control. Depending on the intensity set, the voice amplification to the rear is increased or reduced.

Bluetooth®

Information about Bluetooth®

Bluetooth® technology is a standard for short-range wireless data transfer up to approximately 32.8 ft (10 m).

You can use Bluetooth® to connect your mobile phone to the multimedia system and use the following functions, for example:

- Hands-free system with access to the following options:
 - contacts (→ page 407)
 - call lists (→ page 410)
- Internet connection (→ page 427)
- Listening to music via Bluetooth® audio (→ page 438)
- Transferring business cards (vCards) into the vehicle

Bluetooth® is a registered trademark of Bluetooth Special Interest Group (SIG) Inc.

- ❶ Internet connection via Bluetooth® is not available in all countries.

Activating/deactivating Bluetooth®

Multimedia system:

→  » Settings » System
» Wi-Fi & Bluetooth

- ▶ Switch **Bluetooth** on or off.

Wi-Fi

Wi-Fi connection overview

You can use Wi-Fi to establish a connection with a Wi-Fi network and to access the Internet or other network devices.

The following connection options are available:

- Wi-Fi connection
The Wi-Fi connection to a Wi-Fi-capable device, e.g. the customer's mobile phone or a tablet PC is established.
- Multimedia system as a Wi-Fi hotspot

Using this function, a tablet PC or notebook can be connected, for example. The connected device can use the data tariff of the vehicle. A maximum of three devices can be connected with the hotspot at the same time.

- ❶ The use of the vehicle data tariff by external devices is not available in all countries.

To establish a connection, you can use the following methods:

- WPS PIN
The connection to a secure Wi-Fi network is made via a PIN.
- WPS PBC
The connection to a secure Wi-Fi network is made by pressing a button (push button).
- Security key
The connection to a secure Wi-Fi network is made via a security key.

Setting up Wi-Fi Requirements:

- **To set up the Wi-Fi connection of the multimedia system with new devices:** there is no communication module installed.
- The device to be connected supports one of the three means of connection described.

Multimedia system:

→  » Settings » System
» Wi-Fi & Bluetooth

Activating/deactivating Wi-Fi

- ▶ **Select Wi-Fi.**
If Wi-Fi is switched on, you can connect the multimedia system with external hotspots. If Wi-Fi is deactivated, communication via Wi-Fi to all devices is interrupted. This also means that a connection to the communication module cannot be established. Then some functions such as dynamic route guidance with Live Traffic Information are not available.

Connecting the multimedia system with a new device via Wi-Fi



This function is available if a communication module is not installed.

The type of connection established must be selected on the multimedia system and on the device to be connected.

i The connection procedure may differ depending on the device. Follow the instructions that are shown in the display. Further information (see the manufacturer's operating instructions).

- ▶ Select **Internet Settings**.
- ▶ Select **Connect via Wi-Fi**.
- ▶ Select **Add Hotspot**.

Connecting using a security key

- ▶ Select the options  of the desired Wi-Fi network.
- ▶ Select **Connect Using Security Key**.
- ▶ Have the security key displayed on the device to be connected (see the manufacturer's operating instructions).
- ▶ Enter this security key on the multimedia system.
- ▶ Confirm the entry with .

i All devices support a security key as a means of connection.

Connecting using a WPS PIN

- ▶ Select the options  of the desired Wi-Fi network.
- ▶ Select **Connect via WPS PIN Input**.
The multimedia system generates an eight-digit PIN.
- ▶ Enter this PIN on the device to be connected.
- ▶ Confirm the entry.

Connecting using a button

- ▶ Select the options  of the desired Wi-Fi network.
- ▶ Select **Connect via WPS PBC**.
- ▶ Select "Connect via WPS PBC" in the options on the device to be connected (see the manufacturer's operating instructions).
- ▶ Press the WPS button on the device to be connected.
- ▶ Select **Continue** in the multimedia system.

Activating automatic connection

- ▶ Select **Connect via Wi-Fi**.
- ▶ Select the options  of the desired Wi-Fi network.
- ▶ Activate **Permanent Internet Connection**.

Connecting with a known Wi-Fi

- ▶ Select **Connect via Wi-Fi**.
- ▶ Select a Wi-Fi network.
The connection is established again.

Setting up a Wi-Fi hotspot

Multimedia system:

- ▶  ▶ **Settings** ▶ **System**
- ▶ **Wi-Fi & Bluetooth**

Configuring the multimedia system as a Wi-Fi hotspot

The type of connection established depends on the device to be connected. The function must be supported by the multimedia system and by the device to be connected. The type of connection established must be selected on the multimedia system and on the device to be connected.

- ▶ Select [Vehicle Hotspot](#).
- ▶ Select [Connect Device to Vehicle Hotspot](#).

Connecting using WPS PIN generation

- ▶ Select [Connect via WPS PIN Generation](#).
- ▶ Enter the PIN shown in the media display on the device to be connected and confirm.

Connecting using WPS PIN entry

- ▶ Select [Connect via WPS PIN Input](#).
- ▶ Enter the PIN that is shown on the external device's display on the multimedia system.

Connecting using a button

- ▶ Select [Connect via WPS PBC](#).
- ▶ Press the push button on the device to be connected (see the manufacturer's operating instructions).
- ▶ Select [Continue](#).

Connecting using a security key

- ▶ Select [Connect Device to Vehicle Hotspot](#). A security key is displayed.

- ▶ Select the vehicle from the device to be connected. The vehicle is displayed with the [MB Hotspot XXXXX](#) network name.
- ▶ Enter the security key which is shown in the media display on the device to be connected.
- ▶ Confirm the entry.

Connecting using NFC

- ▶ Select [Connect via NFC](#).
- ▶ Activate NFC on the mobile device (see the manufacturer's operating instructions).
- ▶ Bring the mobile device into the NFC area of the vehicle (→ page 404).
- ▶ Select [Finished](#).
The mobile device is now connected to the multimedia system hotspot via NFC.

Generating a new security key

- ▶ Select [Vehicle Hotspot](#).
- ▶ Select [Generate Security Key](#).
A connection will be established with the newly created security key.

- ▶ **To save a security key:** select [Save](#).
When a new security key is saved, all existing Wi-Fi connections are then disconnected. If the Wi-Fi connections are being re-established, the new security key must be entered.

Switching rear displays and the child safety lock for the Rear Seat Entertainment System on/off

Multimedia system:

- ▶  ▶ [Settings](#) ▶ [System](#)
- ▶ [Parental Control](#)

Locking the MBUX rear tablet

- ▶ Select [MBUX Tablet in Rear](#).
- ▶ Select [Lock](#).
The MBUX rear tablet is locked or unlocked.

System language

Notes on the system language

This function allows you to determine the language for the menu displays and the navigation announcements. The selected language affects

the characters available for entry. The navigation announcements are not available in all languages. If a language is not available, the navigation announcements will be in English.

Setting the system language

Multimedia system:

→  » Settings » System
»  Language

▶ Set the language.

- ⓘ If you are using Arabic map data, the text information can also be shown in Arabic on the navigation map. To do so, select العربية as the language from the language list. Navigation announcements are then also made in Arabic.

Setting the distance unit

Multimedia system:

→  » Settings » System » Units

▶ Select km or mi.

- ▶ In the multifunction display of the Instrument Display, switch the [Additional Speedometer](#) display on.

Data import and export

Data import/export function

The following functions are possible:

- Transferring data from one system or vehicle to another system or vehicle.
 - Creating a backup copy of your personal data and loading it again.
 - Protecting your personal data against unwanted export with PIN protection.
- ⓘ Please note that the NTFS file system is not supported. The FAT32 file system is recommended.

Importing/exporting data

! **NOTE** Loss of data due to premature removal

▶ Do not remove the data storage medium when data is being exported.

Mercedes-Benz is not liable for any loss of data.

Requirements:

- The vehicle is stationary.
- The ignition is switched on.
- A USB device is connected.

Multimedia system:

→  » Settings » System
» System Backup

▶ Select [Import Data](#) or [Export Data](#).

Importing

▶ Select a data storage medium. A prompt appears asking whether you really wish to overwrite the current data. If data

originates from another vehicle, this is recognized during data reading.

- ▶ Confirm the prompt.

The files are imported. The multimedia system is restarted once the data has been imported.

- ⓘ Current vehicle settings can be edited after the import.

Exporting

If PIN protection is activated, your PIN is requested.

- ▶ Enter the four-digit PIN.
- ▶ Select a data storage medium.
A prompt appears asking whether you really wish to carry out the export.
- ▶ Confirm the prompt.
The data is exported. The data export may take several minutes.

- ⓘ After successful export, the data is saved in the "MyMercedesBackup" directory which can be found on the storage medium.

Activating/deactivating PIN protection

Requirements:

- **To unlock the PIN:** there is an Internet connection.
- A Mercedes me account exists at <http://www.mercedes.me>.
- An individual user profile is active (→ page 329).

Multimedia system:

- ➔  ▶ Settings ▶ System
- ▶▶ PIN Protection

Setting the PIN

- ▶ Select [Set PIN](#).
- ▶ Enter a four-digit PIN.
- ▶ Enter the four-digit PIN again.
If both PINs match, PIN protection is active.

Changing the PIN

- ▶ Select [Change Settings](#).
- ▶ Enter the current PIN.
- ▶ Select [Change PIN](#).

- ▶ Set a new PIN.

Activating PIN protection for data export

- ▶ Select [Protect Data Export](#).
Activate or deactivate the function.

Unblocking the PIN via the Mercedes me portal

If the PIN has been entered incorrectly three times, the PIN will be blocked. You can have a single-use password sent to you via the Mercedes me connect online portal to reset the PIN protection.

- ▶ Select [Unlock PIN](#).
- ▶ Enter the single-use password.
PIN protection is reset, and you can set a new PIN.

Software update

Information on software updates

A software update consists of three steps:

- Downloading or copying of the data required for installation
- Installation of the update

- Activation of the update by restarting the system

The multimedia system provides a message when an update is available.

Depending on the source, you can perform various updates:

Software updates

Source of the update	Update type
Internet	Navigation map, system updates, Digital Operator's Manual
External storage medium, e.g. USB flash drive	Navigation maps

- i** Installation can take several minutes and cancellation is not possible. If you do not install the software updates then the status of your vehicle will not be up-to-date. During the installation, individual functions or con-

trol elements are not available or only available to a limited degree.

Advantages of updating software

Software updates ensure your vehicle's technology is up-to-date.

In order to improve the quality of our services you will receive future updates for your multimedia system, the Mercedes me connect services and your vehicle's communication module. These will conveniently be sent to you via the mobile phone connection in your vehicle and, in many cases, installed automatically. You can monitor the status of your updates at any time on the Mercedes me portal and find information about potential innovations.

Your advantages at a glance:

- Conveniently receive software updates via the mobile phone network
- Improves the quality and availability of Mercedes me connect services
- Keeps your multimedia system and communication module up-to-date

Further information about software updates can be found at <https://me.mercedes-benz.com>

Performing a software update

Requirements:

- **For online updates:** an Internet connection is established (→ page 427).
- **For automatic online updates:** your vehicle has a permanently installed communication module.

Multimedia system:

➔  ➔ [Settings](#) ➔ [System](#)
➔ [Software Update](#)

Automatically

- ▶ Activate [Automatic Online Update](#). The updates will be downloaded and installed automatically. The current status of the updates is displayed.

Manually

- ▶ Switch off [Automatic Online Update](#).

- ▶ Select an update from the list and start the update.

Activating the software update

- ▶ Restart the system.
The modifications from the software update will be active.

Function of important system updates

Important system updates may be necessary for the security of your multimedia system's data. Install these updates, or else the security of your multimedia system cannot be ensured.

- ⓘ If automatic software updates are activated, the system updates will be downloaded automatically (→ page 356).

As soon as an update is available for download, a corresponding message appears on the media display.

You have the following selection options:

- **Accept and Install**
The update will be downloaded in the background.
- **Information**

Information about the pending system update is displayed.

- **Later**
The update can be downloaded manually at a later time (→ page 356).

Deep system updates

Deep system updates access vehicle or system settings and can therefore only be carried out when the vehicle is stationary and the ignition is switched off.

If the download of a deep system update is completed and the update is ready for installation, you will be informed of this after the next ignition cycle, for example.

- ⓘ Park the vehicle safely in a suitable location before starting the installation.

Requirements for the installation:

- The ignition is switched off.
- Notes and warnings have been read and accepted.
- The electric parking brake is applied.

If all requirements are met, the update will be installed. The multimedia system cannot be operated while the update is being installed and vehicle functions are restricted.

If errors should occur during the installation, the multimedia system automatically attempts to restore the previous version. If restoration of the previous version is not possible, a symbol appears on the media display. Please consult a qualified specialist workshop to resolve the problem.

Resetting the multimedia system (reset function)

Multimedia system:

➔  ➔ **Settings** ➔ **System** ➔ **Reset**

Personal data is deleted, for example:

- Station presets
- Connected mobile phones
- Individual user profiles
- ⓘ The guest profile is reset when the settings are restored to the factory settings.

A prompt appears again asking whether you really wish to reset.

- ▶ Select **Yes**.
The multimedia system is reset to the factory settings. If you have set a PIN for your system, this will also be reset.

Navigation

Switching navigation on

Multimedia system:

→  ▶▶ **Navigation** (Navigation)

- ▶ Alternatively: press the  button.
The map appears. The current vehicle position is shown. The navigation menu is shown.
The navigation menu is hidden if route guidance is active.

Showing/hiding the navigation menu

→  ▶▶ **Navigation**

If route guidance is not active the map appears. The navigation menu is shown.

The navigation menu is hidden if route guidance is active.

- ▶ **To show:** tap on the touchscreen.

or

- ▶ Press the Touch Control or the touchpad.
- ▶ **To hide:** the navigation menu is hidden automatically.

Navigation overview

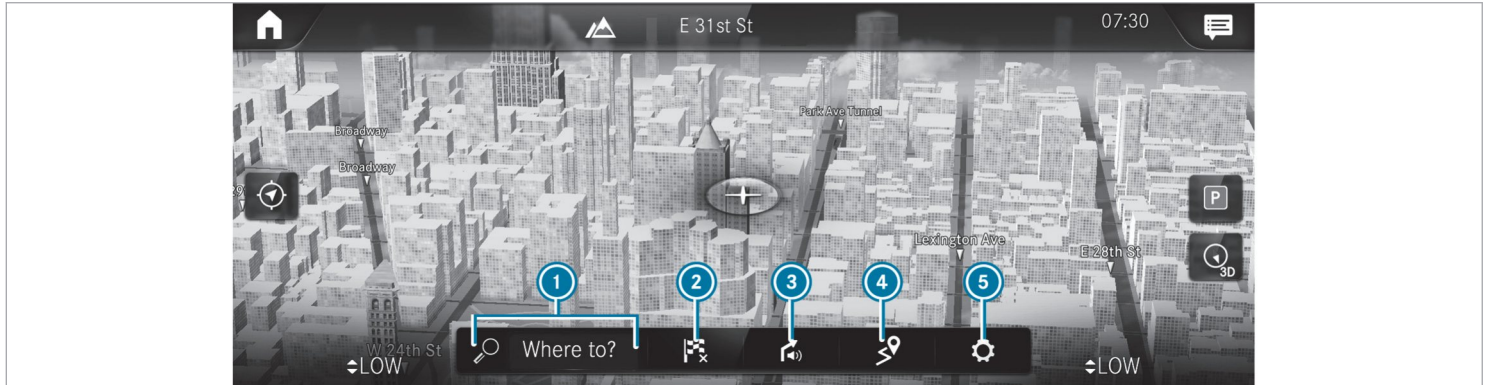

Example: digital map with navigation menu

- ① To enter a POI or address and additional destination entry options
- ② To interrupt route guidance (if route guidance is active)
- ③ To repeat a navigation announcement and switch navigation announcements on or off
- ④ To call up the **ON THE WAY** menu

- To show **Route Overview**
- To select **Alternative Routes**
- **Report Traffic Incident** (Car-to-X)
- To call up the **TRAFFIC** menu
 - ◇ To show **Traffic Announcements**
 - ◇ To show **Area Alerts**
 - ◇ To show **Live Traffic Subscription Info**

- To show **Route List**
- To call up the **POSITION** menu
 - ◇ **Save Position**
 - ◇ To show **Compass**
- ⑤ Quick-access and settings
 - To show **Traffic**
 - To show **Parking**

- To show [Highway Information](#)
- Via [Advanced](#) options to use [View](#), [Announcements](#) and [Route](#)

- ① The options are not available in all countries.
- ① You can enter 3 word addresses in the online search (→ page 365). This option is not available in all countries.

Destination entry

Notes on destination entry

⚠ WARNING Risk of distraction from operating integrated communication equipment while the vehicle is in motion

If you operate communication equipment integrated in the vehicle when driving, you will be distracted from the traffic situation. This could also cause you to lose control of the vehicle.

- ▶ Only operate this equipment when the traffic situation permits.
- ▶ If you cannot be sure of this, stop the vehicle whilst paying attention to road and traffic conditions and operate the equipment with the vehicle stationary.

You must observe the legal requirements for the country in which you are currently driving when operating the multimedia system.

Entering a POI or address

⚠ WARNING Risk of distraction from information systems and communications equipment

If you operate information and communication equipment integrated in the vehicle when driving, you will be distracted from the traffic situation. This could also cause you to lose control of the vehicle.

- ▶ Only operate this equipment when the traffic situation permits.
- ▶ If you cannot be sure of this, stop the vehicle whilst paying attention to road and traffic conditions and operate the equipment with the vehicle stationary.

You must observe the legal requirements for the country in which you are currently driving when operating the multimedia system.

Requirements:

- **For the online search:** Mercedes me connect is available.
- You have set up a user account in the Mercedes me portal.
- The vehicle has been activated for use of Mercedes me connect and you have accepted the terms and conditions for the service.
Further information can be found at: <http://www.mercedes.me>
- The service is available.

- The service has been activated at an authorized Mercedes-Benz Center.

Multimedia system:

→ [Home] ▶▶ Navigation ▶▶ [Search] Where to?



On-board search with the keypad
Destination entry uses the on-board search of the database stored in the multimedia system. The federal state or province in which the vehicle is located is set ①.

▶ Enter the POI or the address using the keyboard (in the image) or using handwriting

recognition ⑥ in input line ②. The entries can be made in any order. During destination entry, suggestions are offered in ③ by the multimedia system. Destination selection takes place in list ③ or with ⑤ [OK].

The following entries can be made, for example:

- City, street, house number
- Street, city
- ZIP code
- POI name

- POI categories, e.g. [Gas Station](#)
- City, POI name
- Telephone number, if this is available for the POI
- Contact name

▶ Alternatively, use voice input [8](#).

▶ **To switch to handwriting recognition:** select [6](#).

▶ Write the character on the touchpad. The letters can be written next to each other or above each other (→ page 342).

▶ **To return to entry using the keyboard:** select .

or

▶ Press the touchpad.

▶ **To delete an entry:** select [4](#).
The characters are deleted individually.

or

▶ If characters have been entered in [2](#), select  next to the input line.
The complete entry is deleted.

▶ **To switch to upper-case or lower-case letters:** select [11](#).

▶ **To switch to digits, special characters and symbols:** select [10](#).
123 changes to ABC.

Display [11](#) changes to #+=.

▶ Select [11](#) and switch to additional special characters.

▶ **To enter a space:** select [7](#).

▶ **To set the language:** select [9](#).

▶ Select the language.

[i](#) This function is useful for countries in which several character sets are supported. An example is Russia, which uses Cyrillic and Latin characters.

▶ **To change the state:** select indicator for federal state or province [1](#).

▶ Select the state in [1](#).

▶ Enter the country indicator, e.g. [CA](#) for Canada.
The list is filtered.

▶ Select the country on list [3](#).
The destination can be entered.

▶ **To change the state or province:** select the state or the province in list [3](#).

▶ **To accept a destination:** select the destination in list [3](#).

▶ If the destination is ambiguous, select the destination in the list.
The destination address is shown. The route can be calculated.

Using online search

[i](#) Requirements: the media display shows an Internet connection with a double-arrow symbol in the status line.

Online search is not available in all countries.

Destination entry uses online map services. If the on-board search finds no suitable destinations or if you change countries, the online search is available.

For the destination you can enter an address, a POI or a 3 word address.

[i](#) Enter a 3 word address (→ page 365).

- ▶ Select country indicator .
 - ▶ Select the provider for the online service from the countries list.
- or
- ▶ If the on-board search delivers no results, enter the destination in the input line. The entry order is not relevant, e.g. street and city. Use the functions described for the on-board search.
The search results are displayed.
 - ▶ Select the destination in the list.
The detailed view for the route is displayed.

Selecting previous destinations Requirements:

- Previous destinations are stored.
- **For destination suggestions:** you have created a profile (→ page 328).
- The [Allow Destination Suggestions](#) option is switched on (→ page 333).
- The multimedia system has already gathered sufficient data in order to show destination suggestions.

Multimedia system:

  ▶ Navigation ▶  Where to?
▶ PREV. DESTINATIONS

The following entries can be selected in the previous destinations:

- Destination suggestions (→ page 382)
 - Destinations
 - Routes
- ▶ Select the destination or route
The destination address is shown. The route can be calculated.
-  You can save a previous destination or a destination suggestion as a favorite (→ page 382).
Using the favorites, you have quick access to the destinations (→ page 366).

Selecting a POI Requirements:

- **For use of personal POIs:** a USB device is connected with the multimedia system.

- Personal POIs with the GPS Exchange format (.gpx) have been saved in the "PersonalPOI" folder on the USB device.

Multimedia system:

  ▶ Navigation ▶  Where to?
▶ POIS

Searching using categories (no route guidance)

- ▶ Select the category.
- or
- ▶ Select [All Categories](#).
 - ▶ Select the category and the sub-category (if available).
The search takes place in the vicinity of the vehicle's current position. The search result are sorted by distance in ascending order.
The POIs show the following information:
 - direction of the linear distance to the POI (arrow)
 - name of POI
 - linear distance to the POI

- ▶ **To filter according to categories or in search results:** enter a search entry in the  **Search** text field.
- ▶ Select a POI from the list.
The destination address is shown. The route can be calculated.

Searching using categories (route guidance active)

- ▶ Select the category.
- or
- ▶ Select **All Categories**.
- ▶ Select the category and the sub-category (if available).
- ▶ **To filter according to categories or in search results:** enter a search entry in the  **Search** text field.
- ▶ Select the search positions **In the Vicinity**, **Near Destination** or **Along the Route**.
- ▶ If there are intermediate destinations for the route and **Near Destination** has been selected, select the search position in the route overview.

- ▶ Select a POI from the list.
The destination address is shown. The route can be calculated.

Searching for personal POIs

- ▶ Select **Personal POIs**.
- ▶ Select a category.
- ▶ If route guidance is active, select a search position **In the Vicinity**, **Near Destination** or **Along the Route**.
- ▶ Select a personal POI.
The destination address is shown. The route can be calculated.
- or
- ▶ Enter a search entry into the search field and filter the list.
- ▶ Select a personal POI.

Editing personal POI categories





- ▶ Select a personal POI category from the list .
A menu opens.
- ▶ **To change a name:** select **Change Name**.

- ▶ Enter the name.
- ▶ Select .
- ▶ **To change a symbol:** select **Change Icon**.
- ▶ Select a symbol.
- ▶ **To delete a personal POI category:** select **Delete**.
- ▶ Select **Yes**.

Configuring categories for quick-access

You can configure the categories for quick-access.

If you calculate the route, for example, the first three of these categories can be selected as symbols.

- ▶ Select **All Categories**.
- ▶ Select the category and the sub-category (if available).
- ▶ Select  or .
- ▶  adds the category.
- ▶  removes the category.
- ▶ If all available quick-access positions are full, select the category to be replaced.

Selecting a contact for destination entry Requirements:

- A mobile phone is connected to the multimedia system (→ page 402).

Multimedia system:

→  » Navigation »  Where to?
» CONTACTS

Using the contact list

- ▶ Select a contact.
The contact details are displayed.
- ▶ Select the address.

Using search entry



- ▶ Enter a name or telephone number, for example, into the search field.
- ▶ Select .
- ▶ Select the contact.
- ▶ Select the address.
The destination address is shown. The route can be calculated.

- ① Route guidance to a contact address is reliable in the following cases:
 - the contact address is complete.
 - the contact data matches the map data in the digital map.

Entering geo-coordinates

Multimedia system:

→  » Navigation »  Where to?
» GEO-COORDINATES

- ▶ Select **Latitude** or **Longitude**.
- ▶ Select geo-coordinates as latitude and longitude coordinates in degrees, minutes and seconds. To do this swipe up or down respectively.
The map shows the position.
- ▶ Confirm the entry with .
- ▶ **To set the destination:** select  or .
- ▶ Calculate the route (→ page 367).

Entering the destination as a 3 word address Requirements:

- Searching for a destination using 3 word addresses is possible in the online search (→ page 360).
- The media display shows an Internet connection with a double-arrow symbol in the status line.
- ① Searching for a destination using 3 word addresses is not possible in all countries and in all languages.

Multimedia system:

→  » Navigation »  Where to?

- ▶ Select the country indicator.
 - ▶ Select the provider for the online service from the countries list.
- or
- ▶ If the on-board search delivers no search results, enter the destination address as a 3 word address. Separate each of the words with a full stop.
The search results are displayed.
 - ▶ Select the destination in the list.
The destination address is shown. The route can be calculated.

- i** 3 word addresses from what3words are an alternative addressing system for multilingual georeferencing of global locations with a resolution of three meters. Using this grid, locations on the Earth's surface are included which do not have a building address such as street and house number, for example.

The Empire State Building has this language dependent 3 word address:

- English: parade.help.bleat
- French: commun.verbe.bisquer
- Spanish: suertes.diga.pesca

3 word addresses are unique, easy to remember and suffice for most routine applications.

You can convert addresses to 3 word addresses and back again:

- at the website <http://what3words.com>
- in the what3words apps

Selecting a destination on the map

Multimedia system:



- ▶ Move the map (→ page 388).
- ▶ **Using the touchscreen:** press and hold on the touchscreen.
The destination address is shown.
If several destinations are located at the selected position, a list shows the available roads and POIs.
- ▶ Select the destination in the list.
The destination address is shown. The route can be calculated.
- ▶ **Using the touchpad:** when the crosshair marks the destination, press and hold on the control element.
The destination address is shown.
If several destinations are located around the crosshair, a list shows the available roads and POIs.
- ▶ Select the destination in the list.
The destination address is shown. The route can be calculated.

Showing POIs in the vicinity of the map

If several destinations are located around the crosshair, the function is available.

- ▶ Select .
 - ▶ Select **POIs in the Vicinity**.
The map appears.
 - ▶ Swipe left or right on the control element.
The previous or next POI is highlighted on the map. The name or the address is shown.
 - ▶ Select the POI symbol.
- or
- ▶ **To filter the display according to the POI category:** scroll on the control element.
 - ▶ Select the POI category.

Selecting a destination from favorites Requirements:

- Destinations are saved as favorites.
Save a previous destination or a destination suggestion as a favorite (→ page 382).

Multimedia system:

→  » Navigation »  Where to?
» FAVORITES

- ▶ Select a favorite.
The destination address is shown. The route can be calculated.

The following options are available in the favorites menu:

- Saving addresses for home and work
- Creating favorites
- Deleting favorites

▶ **If no address has been saved for home and work:** select [Home](#) or [Work](#).

- ▶ Confirm the prompt with [Yes](#).
- ▶ Enter the favorite as a POI or address (→ page 360).
- ▶ **To save a favorite:** select [Add Favorites](#).
- ▶ Enter the favorite as a POI or address (→ page 360).

or

- ▶ If all the positions in the favorites are full, first select a favorite which is to be overwritten (→ page 335).

- ▶ Follow the instructions provided.
- ▶ **To delete a favorite:** select  for a destination.
- ▶ Select [Delete](#).

or

- ▶ Press on a favorite until the [OPTIONS](#) menu is shown.
- ▶ Select [Delete](#).

Selecting received destinations Requirements:

- There is an Internet connection.
- A destination has been sent to the vehicle.

Multimedia system:



→  » Navigation »  Where to?
» REC. DESTINATIONS

The vehicle can receive destinations from services or apps.

- ▶ Select a destination.
The destination address is shown. The route can be calculated.

- ▶  You can save a received destination in the favorites (→ page 382).
You have fast access to the destinations via the favorites (→ page 366).

Deleting a received destination

- ▶ **To delete a destination:** select  for a destination.
- ▶ Select [Delete](#).
- ▶ Select [Yes](#).
- ▶ **To delete all destinations:** select .
- ▶ Select [Delete All](#).
- ▶ Select [Yes](#).

Route

Calculating a route Requirements:

- The destination has been entered.
- The destination address is shown.

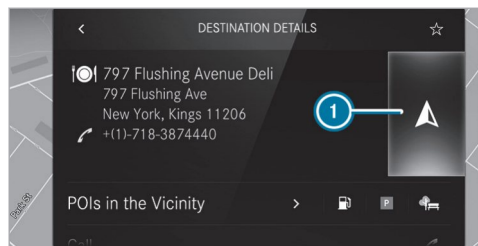

- ① No route yet
- A route has been mapped

▶ Select .

The route to the destination is calculated. The map shows the route. Route guidance then begins.

or

- ▶ Select .
- If a route is already mapped, a prompt is shown.
- ▶ Select **Set as Way Point**.
- The selected destination address is set as the next intermediate destination. Route guidance begins.

If there are already four intermediate destinations, the multimedia system asks whether intermediate destination 4 should be deleted. Confirm the prompt with **Yes**.

or

- ▶ Select **Start New Route Guidance**.
- The selected destination address is set as a new destination. The previous destination and the intermediate destinations are deleted. Route guidance to the new destination begins.

Searching for POIs in the vicinity of the destination shown

- ① The POI symbols to the right of **POIs in the Vicinity** show the first three categories for quick-access. You can configure these categories (→ page 363).
- ▶ Select a POI symbol.
- The search results are displayed.
- ▶ Select a POI.
- The destination address is shown. The route can be calculated.

or

- ▶ Select **POIs in the Vicinity** .
- ▶ Search using categories, enter a search entry or search for a personal POI (→ page 363).
- ▶ Select a POI.
- The destination address is shown. The route can be calculated.

Other menu functions

- ▶ **To save the destination:** select .
- ▶ Select an option.

The following options are available:

- **Save in "Previous Destinations"**
- **Save as Favorite**
- **Save as "Home"**
- **Save as "Work"**

- ▶ **To call the destination:** if a telephone number is available, select **Call**.
- ▶ **To share the destination using NFC or QR code:** select **Share via NFC or QR Code**.
- ▶ Hold the NFC area of the mobile phone (see manufacturer's operating instructions) on the

mat or place the mobile phone on it (→ page 404).

or

- ▶ Hold the mobile phone near to the multimedia system and scan the QR code.
- ▶ **To call up an Internet address:** if a web address is available, select [www](#).
- ▶ **To show on the map:** select [Show on Map](#).

Selecting a route type

Multimedia system:



▶▶ [Navigation](#) ▶▶ 
▶▶ [Advanced](#) ▶▶ [Route](#)

- ▶ Select the route type.
If no route has been created, the next route is calculated on the basis of the new route type.
If a route has already been created, the route is calculated on the basis of the new route type.

The following route types are available:

- [Fast](#)

A route with a quick journey time is calculated.

- [Short](#)

A route with a short driving distance is calculated.

- [Eco](#)

An economical route is calculated. The journey time may be somewhat longer than for quicker routes.

- [Trailer](#)

The option is available if a trailer has been coupled with the vehicle.

A prompt is shown in the multimedia system. Confirm the prompt.

The route is optimized for trailer operation with a maximum speed of 50 mph (80 km/h).

Traffic information can be taken into account for the route types:

- ▶ Select [Dynamic Route Guidance](#) .
- ▶ Select [Automatic](#), [On Request](#) or [Off](#).

Explanation of the options:

- [Automatic](#)

The route is calculated with the currently set route type.

Traffic reports via Live Traffic Information are taken into account (→ page 384).

Live Traffic Information is not available in all countries.

- [On Request](#)

A prompt appears when a new route is detected with a shorter journey time based on traffic reports. You can continue to use the current route or use the dynamic route instead (→ page 370).

- [Off](#)

No traffic reports are taken into account for the route.

Calculating alternative routes

- ▶ Activate [Suggest Alternative Route](#).
The display button is activated. Alternative routes are calculated for every route.
- ▶ Select an alternative route (→ page 373).

Accepting a detour recommendation after a prompt

Requirements:

- On Request is switched on (→ page 369) in the **DYNAMIC ROUTE GUIDANCE** menu.
- Route guidance is active.
- There are traffic reports for the current route.

If a new route with a shorter driving time is determined, the current and new routes will be shown.

The notification is shown in another application. Confirm the notification.

- ▶ **To accept the new route:** select **Accept Recommended Detour**.
- ▶ **To maintain the current route:** select **Keep to Current Route**.

Selecting route options

Multimedia system:



Avoiding areas

- ▶ Select **Avoid Options**.
- ▶ Select **Avoid Areas** (→ page 391).

Avoiding or using highways, ferries, tunnels, motorail trains, unpaved roads

- ▶ Select **Avoid Options**.
- ▶ Activate or deactivate the avoid option.
To avoid: the display button is activated. The route avoids highways, for example.
To use: the display button is off. The route takes highways into consideration, for example.

These route options are not available in every country.

The selected route options cannot always be taken into account. Therefore, a route may include a ferry, for instance, even though the **Avoid Ferries** avoid option is enabled. A mes-

sage then appears and you will hear a corresponding message.

Avoiding or using toll roads

- ▶ Select **Avoid Options**.
- ▶ Select **Toll Roads**.
- ▶ Switch **Avoid All** on or off.
To avoid: the display button is activated. The route avoids all toll roads.
To use: the display button is off. The route takes into account all roads that require the payment of a usage fee (toll).

or

- ▶ **To avoid a type of payment:** select **Avoid**. The route avoids all toll roads with the selected method of payment.
- ▶ **To use a type of payment:** select **Use**. The route takes into account all toll roads with the selected method of payment.
 These route options are not available in every country.

Using carpool lanes

When using carpool lanes, observe the applicable legal requirements as well as any conditions pertaining to when and where such lanes may be used. Carpool lanes may only be used if certain conditions are met.

Carpool lanes are not available in all countries.

- ▶ Select **Avoid Options**.
- ▶ Select **Carpool Lanes**.
- ▶ Select **For Two Occupants** or **For 3 Occupants or More** .

or

- ▶ Select **On Request** . When this option is selected and a carpool lane is available, a prompt appears. You can continue to use the current route or select a route with the carpool lane.

 If the **Avoid** option is selected, then no carpool lanes will be used for the route.

Selecting notifications for the route Requirements:

- **For an audible indication when approaching a personal POI:** the USB device contains personal POIs.
- The USB device is connected with the multimedia system.
- The category in which the personal POI belongs is activated.

Multimedia system:

- ▶  ▶ **Navigation** ▶ 
- ▶ **Advanced** ▶ **Announcements**

- ▶ Switch **No Driving Recomm.** on or off. No navigation announcements are issued when the display button is switched on.
- ▶ **To select a navigation announcement:** select an option • under the **DRIVING RECOMMENDATION** category.

The following options are available:

- **Tone Only**
In place of the spoken navigation announcement you hear a gong. The gong signals an upcoming driving maneuver

and also sounds during the driving maneuver.

- **Reduced Driving Recomm.**
If a navigation announcement is available, you hear a brief announcement, e.g. "turn right".
- **Detailed Driving Recomm.**

If a navigation announcement is available and the **Announce Street Names** option is switched on, you hear a complete announcement, e.g. "In 600 ft (200 m) at the end of the street turn right into Station Road".

- ▶ **To have street names announced during a driving maneuver:** switch on **Announce Street Names**.

- ▶ Select **Reduced Driving Recomm.** or **Detailed Driving Recomm.**
The name of the street into which you should turn is announced.

 The options in the **DRIVING RECOMMENDATION** category are not available in every country and in all languages.

Selecting messages for **TRAFFIC**

- ▶ Activate a message.
The display button is activated.
The following options are available:

- **Traffic Incidents**

Traffic incidents are announced, e.g. roadworks and road blocks.

This function is not available in all countries and languages.

- **Announce Traffic Warnings**

Warning messages are announced, e.g. before tailbacks that pose a risk (if available).

This function is not available in all countries and languages.

Audible indication when approaching a personal POI

- ▶ Select the **Personal POIs** option in the **ALERTS** category.

- ▶ Activate a category.
The display button is activated. When approaching a personal POI in this category an audible indication will be issued.

Showing destination information for the route

Requirements:

- A destination is entered.

Multimedia system:



- ▶ Select **Route Overview**.
When route guidance is active, the destination and intermediate destinations are shown, if these have been entered and not yet been passed.
The route can include up to four intermediate destinations.

- ▶ Select a destination or an intermediate destination.

The following information is displayed:

- Remaining driving distance
- Time of arrival

- Remaining journey time
- Name, destination address
- Phone number (if available)
- Web address (if available)

Planning routes

Multimedia system:



- ▶ Select **Set Way Point**.
- ▶ Enter the intermediate destination as a POI or address, for example (→ page 360).
- ▶ Select the intermediate destination.
After selection of an intermediate destination, the route overview is shown again.
- ▶ Calculate the route with intermediate destinations (→ page 373)
- ⓘ If there are already four intermediate destinations, delete an intermediate destination (→ page 372).







Editing a route with intermediate destinations

Requirements:

- The destination and at least one intermediate destination have been entered.

Multimedia system:

  >> Navigation
 >>  >> Route Overview

- ▶ **To change the sequence of destinations:** select  for a destination. A menu opens.
 - ▶ Select **Move**.
 is highlighted.
 - ▶ Move the intermediate destination or the destination with  or  to the desired position.
 - ▶ Tap on .
- ▶ **To delete a destination:** select  for an intermediate destination or destination.
- ▶ Select **Delete**.
The destination is deleted.

Calculating a route with intermediate destinations

Requirements:

- The destination and at least one intermediate destination have been entered.

Multimedia system:

  >> Navigation
 >>  >> Route Overview

- ▶ Select **Start Route Guidance**.
- or
- ▶ If the route has been edited, select **To Navigation** .
- ▶ Confirm the prompt with **Yes**.
The route is calculated. Route guidance begins.

Displaying the route list

Multimedia system:

  >> Navigation >> 

- ▶ Select **Route List**.
The route sections are displayed. The current vehicle position is marked on the map.
The current vehicle position is shown with the following information:
 - The  symbol for the current vehicle position is displayed.

- The name of the road on which you are currently driving is shown.
- The road number of the road on which you are currently driving is shown.

The route list is updated during the journey.

- ▶ **To show route sections:** swipe up or down on the control element.
The route section is shown on the map.

Selecting an alternative route Requirements:

- The **Suggest Alternative Route** option is switched on (→ page 369).

Multimedia system:

  >> Navigation >> 

- ▶ Select **Alternative Routes**.
The routes are displayed in accordance with the setting made in the route settings.
The routes are numbered.
- ▶ Select the alternative route.
- ▶ **To show the route on the map:** select **Show on Map**.

- ▶ Move the map (→ page 388).
- ▶ Set the map scale (→ page 388).
- ▶ **To avoid or use route options:** select .
- ▶ Switch the route option, e.g. [Highways](#), on or off.
 - To avoid:** the display button is activated. The alternative route avoids highways.
 - To use:** the display button is off. The alternative route uses highways.

Activating a commuter route Requirements:

- You have created a profile (→ page 328).
- The [Allow Destination Suggestions](#) option is switched on (→ page 333).
- The [Activate Commuter Route](#) option is switched on.
- The multimedia system has gathered sufficient data in order to show destination suggestions.
- Routes have been learned for these destination suggestions.

- ❗ This commuter route is not available in all countries.

Multimedia system:

→  ▶ [Navigation](#) ▶ 
▶ [Advanced](#) ▶ [Route](#)

- ▶ Activate [Activate Commuter Route](#).
The display button is activated. The navigation system automatically detects that the vehicle is on a commuter route. It automatically starts a route guidance without voice output.
For the daily commuter route, traffic incidents on the route are also reported when driving without active route guidance.

Switching the automatic gas station search on/off

Multimedia system:

→  ▶ [Settings](#) ▶ [Vehicle](#)

- ▶ Switch [Gas Station Search](#) on or off.
When the fuel reserve level is reached, and the display button is switched on, a message appears to start searching for gas stations.

Starting an automatic gas station search Requirements:

- The automatic gas station search is activated (→ page 374).

Driving situation

The fuel level in the fuel tank reaches the reserve fuel level.

The following notification is shown in the media display [Reserve Fuel Tap here to search for gas stations](#).

- ▶ Confirm the notification.
The automatic gas station search begins. The available gas stations along the route or in the vicinity of the vehicle's current position are displayed.
- ▶ Select a gas station.
The address of the gas station is displayed.
- ▶ Calculate the route (→ page 367).
The gas station is set as the destination or the next intermediate destination.

- ▶ **If there are already four intermediate destinations:** select **Yes** in the prompt. The gas station is entered in the route overview. Intermediate destination 4 is deleted. Route guidance begins.

Starting the automatic service station search

Requirements:

- ATTENTION ASSIST and the **Suggest Rest Area** function are activated (→ page 266).
- There are service stations along the route section ahead.

Driving situation

The following notification is shown in the media display **ATTENTION ASSIST Tap here to search for rest areas**.

- ▶ Confirm the notification. The service station search starts. The available service stations along the route or in the vicinity of the vehicle's current position are displayed.
- ▶ Select a service station. The service station address is displayed.

- ▶ Calculate the route (→ page 367). The service station is set as the destination or the next intermediate destination.

- ▶ **If there are already four intermediate destinations:** select **Yes** in the prompt. The service station is entered in the route overview. Intermediate destination 4 is deleted. Route guidance begins.

Showing a stored route on the map

Requirements:

- A USB device with stored routes is connected with the multimedia system (→ page 438).
- The route is stored in the "Routes" folder with the GPS Exchange format (.gpx).

Multimedia system:

 ▶▶ Navigation ▶▶ Where to? ▶▶ **SAVED ROUTES**

- ▶ Select a route.
- ▶ Select **Show on Map**.
- ▶ Move the map (→ page 388).



Starting a saved route

Requirements:

- A USB device with stored routes is connected with the multimedia system (→ page 438).
- The route is stored in the "Routes" folder with the GPS Exchange format (.gpx).

Multimedia system:

 ▶▶ Navigation ▶▶ Where to? ▶▶ **SAVED ROUTES**



- ▶ Select a route.
- ▶ Select **Start Route Guid. from Beginning of Route** or **Start Route Guidance from Curr. Position**. Route guidance starts.
- ▶  The route can be saved with  in the menu (→ page 367).

Recording a route

Requirements:

- A USB device is connected with the multimedia system (→ page 438).

Multimedia system:

→  » Navigation »  Where to?
 » SAVED ROUTES

▶ **To start recording:** select **Start Recording a New Route**.

A red recording symbol is shown.

The route is stored on the USB device.

▶ **To stop recording:** select **End Recording**.

Saving a recorded route

Requirements:

- A USB device is connected with the multimedia system (→ page 438).

Multimedia system:

→  » Navigation »  Where to?
 » SAVED ROUTES

▶ Select a route.

▶ Select .

▶ Select **Save in "Previous Destinations"**.



The route is stored in the "Previous destinations" memory and can be called up from there for route guidance.

Editing a stored route

Requirements:

- A USB device with stored routes is connected with the multimedia system (→ page 438).

Multimedia system:

→  » Navigation »  Where to?
 » SAVED ROUTES

▶ Select a route with .

▶ **To enter a name:** select **Change Name**.

▶ Enter the name.

▶ Select **OK**.

or

▶ When the name has been changed, press the  button.

▶ Select **Yes**.

▶ **To delete a route:** select **Delete**.

▶ Select **Yes**.

Route guidance

Notes on route guidance

⚠ WARNING Risk of distraction from operating integrated communication equipment while the vehicle is in motion

If you operate communication equipment integrated in the vehicle when driving, you will be distracted from the traffic situation. This could also cause you to lose control of the vehicle.

- ▶ Only operate this equipment when the traffic situation permits.
- ▶ If you cannot be sure of this, stop the vehicle whilst paying attention to road and traffic conditions and operate the equipment with the vehicle stationary.

You must observe the legal requirements for the country in which you are currently driving when operating the multimedia system. Route guidance begins once a route has been calculated.

The road and traffic rules and regulations always have priority over multimedia system driving instructions.

Driving instructions are:

- Navigation announcements
- Route guidance displays
- Lane recommendations

If you do not follow the driving instructions or if you leave the calculated route, a new route is calculated automatically.

Driving instructions may differ from the actual road and traffic conditions if:

- The route is diverted
- The direction of a one-way street has been changed

For this reason, you must always observe road and traffic rules and regulations during your journey as well as the prevailing traffic conditions.

The route may differ from the ideal route due to the following:

- Roadworks

- Incomplete digital map data

Notes on GPS reception

The correct function of the navigation system depends amongst other things on GPS reception. In certain situations GPS reception can be impaired, defective or even not possible, e.g. in tunnels or in parking garages.

Changing direction overview

Changes of direction are shown in the following displays:

- Detailed image of the intersection
The display appears when you drive into an intersection.
- 3D image
The display appears when driving on intersection-free, multi-lane roads, for example on freeway exits and freeway interchanges.

Detailed image of the intersection

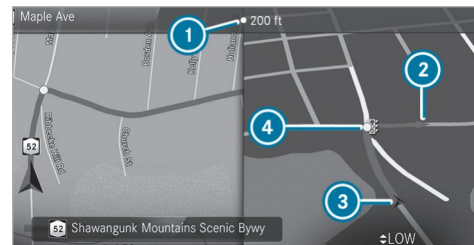

- ① Current distance to the change of direction
- ② Driving maneuver
- ③ Current vehicle position
- ④ Maneuver point

3D image

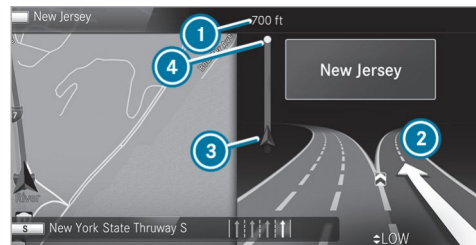

- ① Current distance to the change of direction
- ② Driving maneuver
- ③ Current vehicle position
- ④ Maneuver point

There are three phases when changing direction:

- Preparation phase

If there is enough time between the changes of direction, the multimedia system prepares you for the upcoming change of direction. A navigation announcement is issued depending on the settings for driving recommendations, e.g. "Prepare to turn right".

Select navigation announcements for driving recommendations (→ page 371).

The map appears in full-screen mode.

The status line shows: the direction information or the name of the road which is to be turned into and the distance to the change of direction.

- Announcement phase

The multimedia system announces the upcoming change of direction depending on the settings for driving recommendations, e.g. by announcing "In 600 ft (200 m) at the end of the street turn right into Station Road".

The display is split into two parts. The map is displayed on the left; on the right, there is a detailed image of the intersection or a 3D image of the upcoming change of direction.

- Change-of-direction phase

The multimedia system announces the imminent change of direction depending on the settings for driving recommendations, e.g. by announcing "Now turn right".

The display is split into two parts.

The change of direction takes place when the distance to maneuver point ② is shown with 0 ft (0 m) and the symbol for vehicle position ③ has reached maneuver point ②.

When the change of direction is complete, the map appears in full-screen mode.

- ① Changes of direction are also shown in the Instrument Display.

Lane recommendations overview

This display appears for multi-lane roads.

The multimedia system can show lane recommendations if the digital map contains the relevant data.



- ① Recommended lane (white arrow, blue background)
- ② Possible lane (white arrow)
- ③ Lane not recommended (gray arrow)

Explanation of the displayed lanes:

- Recommended lane ①
In this lane, you will be able to complete both the next change of direction and the one after that.
- Possible lane ②
In this lane, you will only be able to complete the next change of direction.
- Lane not recommended ③

In this lane, you will not be able to complete the next change of direction without changing lane.

During the change of direction, new lanes may be added.

Bus lanes are also shown.

- ① Lane recommendations can also be displayed in the Instrument Display and in the Head-up Display.

Using freeway information Requirements:

- The [Highway Information](#) option is switched on (→ page 390).

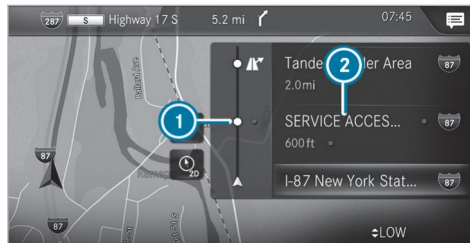

When driving on the freeway, upcoming freeway facilities ① and available service facilities ② are shown in the overview. These include parking lots, service stations and freeway exits, for example.

▶ **To open the display:** select .

The entries are sorted according to increasing distance from the current vehicle position.

▶ **To close the display:** tap on the map.

or

▶ **To use freeway information:** select an entry.

▶ If several service facilities are available, select a service facility from the list. The destination address and the map position are shown.

▶ Calculate the route (→ page 367).

or

▶ Search for a POI in the vicinity.

or

▶ Use other functions, e.g. save the destination address of the service facility.

Using quick-access for a destination information, alternative route and POIs

Requirements:

- The POI categories for quick-access are configured (→ page 363).
- ▶ If route guidance is active, select the  symbol with arrival time and distance to the destination on the map. The address of the destination or the next intermediate destination is shown.

Using alternative routes

- ▶ Select [Alternative Route](#). The routes are displayed in accordance with the setting made in the route settings. The routes are numbered.
- ▶ Select the alternative route.

Setting a POI as an intermediate destination

- ▶ Select a category symbol, e.g.  for a parking lot.

- ▶ Select a POI from the list. The selection takes place on the route. The destination address is shown. The route can be calculated.
 - ▶ **To use POI categories for quick-access:** select a search position [In the Vicinity, Near Destination](#) or [Along the Route](#).
 - ▶ Select a POI from the list.
- or
- ▶ Enter a search entry into the search field and filter the list.
 - ▶ Select a POI from the list. The destination address is shown. The route can be calculated.

Saving the current vehicle position

- ▶ Select [Save Position](#). The current vehicle position is saved to the "Previous destinations" memory.

Destination reached





Once the destination is reached, you will see the  checked flag. Route guidance is finished. The navigation menu is shown.

When an intermediate destination has been reached, you will see the intermediate destination flag with the number of your  intermediate destination. Route guidance is continued.

Switching navigation announcements on/off

- ▶ **To switch off:** turn the volume control on the steering wheel or next to the touchpad during a navigation announcement (→ page 339). The [Voice Guidance has been deactivated](#). message appears.

or



- ▶ Show the navigation menu (→ page 358).
- ▶ Select .
- ▶ The symbol changes to .
- ▶ **To activate:** select .
- ▶ The current navigation announcement is played. The symbol changes to .

- ▶  This function can be added and called up from the favorites within the navigation category.

Switching navigation announcements on or off during a phone call



- ▶ Press the  button on the steering wheel or on the touchpad.

or

- ▶ Tap on  in the media display.
- ▶ Select **Settings**.
- ▶ Select **System**.
- ▶ Select **Audio**.
- ▶ Select **Navigation and Traffic Announcements**.
- ▶ Switch **Voice Guidance During Call** on or off. When the option is switched on, the display button is activated.
- ▶ **To leave the menu:** select .

Adjusting the volume of navigation announcements

Multimedia system:

- ▶   ▶▶ **Settings** ▶▶ **System** ▶▶ **Audio**
- ▶▶ **Navigation and Traffic Announcements**
- ▶ Select **Voice Guidance Volume**.

- ▶ Set the volume.
- ▶ **To leave the menu:** select .



Route guidance is active

- ▶ Turn the volume control on the steering wheel or next to the touchpad during a navigation announcement.

Switching audio fadeout on or off during navigation announcements

- ▶ Press the  button on the steering wheel or on the touchpad.

or



- ▶ Tap on  in the media display.
- ▶ Select **Settings**.
- ▶ Select **System**.
- ▶ Select **Audio**.
- ▶ Switch **Audio Fadeout** on or off. When the option is switched on, the display button is activated.
- ▶ **To leave the menu:** select .

Repeating navigation announcements Requirements:

- A route has already been created.
- Route guidance is active.

Multimedia system:

 **Navigation** (Navigation)

- ▶ Select .
 - ▶ Select .
- The current navigation announcement is repeated.
-  This function can be added and called up from the favorites within the navigation category.

Canceling route guidance Requirements:

- a route has already been created.
- route guidance is active.
- ▶ Show the navigation menu.
- ▶ Select  in the navigation menu (→ page 359).

Overview of route guidance to an off-road destination

An off-road destination is within the digital map. The map contains no roads that lead to the destination.

You can enter geo-coordinates or a 3 word address for off-road destinations on the map.

Route guidance guides you for as long as possible with navigation announcements and displays on roads that are known to the multimedia system.

Shortly before you reach the last known position on the map, you will hear the "Please follow the direction arrow" announcement, for example. The display shows a direction arrow and the linear distance to the destination.

Overview of route guidance from an off-road location to a destination

In an off-road position, the current vehicle position is located within the digital map on roads that are not available.

The following displays appear when route guidance begins:

- A message appears that the road is not on the map.
- A direction arrow showing the linear direction to the POI.

When the vehicle is back on a road known to the multimedia system, route guidance continues as normal.

Overview of off-road status during route guidance

Due to roadworks, for example, there may be differences between the data on the digital map and the actual course of the road. In such cases, the multimedia system will temporarily be unable to locate the vehicle's current position on the digital map. The vehicle is off-road.

When the vehicle is off-road, the following displays are shown:

- A message appears that the road is not on the map.
- A direction arrow showing the linear direction to the POI.

When the vehicle is back on a road known to the multimedia system, route guidance continues as normal.

Destination

Saving the current vehicle position

Multimedia system:

  **»» Navigation**  **»» Position**

- ▶ Select **Save Position**.
The current vehicle position is saved to the "Last destinations" memory.

Using quick-access

- ▶ If route guidance is active, select the  symbol with arrival time and distance to the destination on the map.
The address of the destination or the next intermediate destination is shown.
- ▶ Select **Save Position**.

Editing the previous destinations Requirements:

- To edit destination suggestions: the [Allow Destination Suggestions](#) option is activated (→ page 333).
- The multimedia system has gathered sufficient data in order to show destination suggestions.

Multimedia system:





 » Navigation »
  Where to?

 » **PREV. DESTINATIONS**

The following entries can be edited:



- Destination suggestions
 - Destinations
 - Routes
- ▶ **To no longer display a destination suggestion:** select  for a destination suggestion.
- ▶ Select [No Longer Suggest](#).

Saving the last destination as a favorite

- ▶  After saving, the destination can be called up via the favorites (→ page 334).
- ▶ Select  for a destination.

- ▶ Select  [Save as Favorite](#).
- ▶ **To save as a favorite:** select [Save as Favorite](#).
- ▶ **To save as "Home" address:** select [Save as "Home"](#).
- ▶ **To save as "Work" address:** select [Save as "Work"](#).

Deleting a previous destination

- ▶ **To delete a destination:** select  for a destination.
- ▶ Select [Delete](#).
- ▶ Select [Yes](#).
- ▶ **To delete all destinations:** select .
- ▶ Select [Delete All](#).
- ▶ Select [Yes](#).

Using external destinations and routes

External destinations and routes can be received from the following sources, for example:

- Mercedes-Benz Apps

- door-to-door navigation with the Companion app (USA)
- a call with the Mercedes-Benz Customer Assistance Center via the me button (→ page 420)

A prompt appears on the media display. Received destinations and routes are saved in the previous destinations.

- ▶ **A destination has been received:** select [Yes](#).
 - ▶ Calculate the route.
 - ▶ If route guidance is already active, select [Set as Way Point](#) or [Start New Route Guidance](#).
- or
- ▶ If a destination was received with photo information, select [Start Route Guidance](#).
 - ▶ Calculate the route.
- or
- ▶ If a destination has been received from an app, select [Details](#).
 - ▶ Calculate the route.
 - ▶ **A route has been received:** select [Yes](#).

- ▶ Select **Start Route Guid. from Beginning of Route** or **Start Route Guidance from Curr. Position**.
Route guidance starts from the selected position.

Route guidance with current traffic reports

Traffic information overview

Traffic reports are received using Live Traffic Information and are used for route guidance.

This service is unavailable in some countries.

- ⓘ There may be differences between the traffic reports received and the actual road and traffic conditions.

Important information on Live Traffic Information:

- Current traffic reports are received via the Internet connection.
- The traffic situation is updated at short, regular intervals.
- Information from the service provider can be shown (→ page 384).

Information on the vehicle's position is regularly sent to Daimler AG. The data is immediately rendered anonymous by Daimler AG and forwarded to the traffic data provider. Using this data, traffic reports relevant to the vehicle's position are sent to the vehicle. The vehicle acts as a sensor for the flow of traffic and helps to improve the quality of the traffic reports.

If you do not want to transmit the vehicle position, you have the following options:

- You deactivate the service in the Mercedes me portal.
- You have the service deactivated at an authorized Mercedes-Benz Center.

Showing information from the service provider for Live Traffic Information Requirements:

- The vehicle is equipped with Live Traffic Information.

Multimedia system:

→  **Navigation** →  **Traffic**

- ▶ Select **Provider Information**.
The logo of the service provider for Live Traffic Information is shown.

- ⓘ Further information on Live Traffic Information can be called up on the home screen using **Mercedes me & Apps** (→ page 423).
- ⓘ You have the following options for extending the subscription:
 - at an authorized Mercedes-Benz Center
 - with a call to the Mercedes-Benz Customer Assistance Center via the me button

Showing traffic information Requirements:

- The **Traffic** display is switched on (→ page 386).
- The following traffic displays are switched on (→ page 386):

Traffic Incidents

Free Flowing Traffic

Delay

Multimedia system:



▶ Select **Navigation**.

The map shows the following traffic information:

- traffic incidents, for example:
 - roadworks
 - road blocks
 - warning messages

When route guidance is active, the symbols for traffic incidents will be shown in color on the route. Off the route they are gray.

- warning message symbols:
 - Symbol 
 - road safety notes, e.g. when approaching the end of a traffic jam

If the vehicle approaches a danger area on the route, a warning message is displayed on the map. In addition, an audible notification can follow a hazard warning.
- traffic flow information:

- traffic jam (red line)
- slow-moving traffic (orange line)
- heavy traffic (yellow line)
- free-flowing traffic (green line)
- display for traffic delays on the route lasting at least one minute

Displaying traffic incidents

Requirements:

- The **Traffic Incidents** display is switched on (→ page 386).

Multimedia system:



▶ Select **Traffic Announcements**.

If there are traffic reports, you will see a list. Traffic reports include accidents and other traffic events, for example. The list is sorted according to distance and shows the traffic reports received both on and off the route.

A traffic report shows the following information:



- Street number or street name

- Traffic incident symbol
 - On the route: color
 - Off the route: gray
 - Cause
 - Street symbol for a traffic incident on the route
 - Distance from current vehicle position
- ▶ Select a traffic report . The detailed information is shown, for example the route section.

Showing traffic incidents in the vicinity of the map

- ▶ Select a traffic incident symbol on the map. The details about the traffic incident are displayed.
- ▶ Select .
- ▶ Select **Traffic Incidents in Vicinity**. The map shows the traffic incident symbols in the vicinity. Traffic incident information is displayed in the status line:
- Traffic incident symbol

- Cause of the traffic incident, e.g. construction work
- Warning message (highlighted red)

▶ **To select a traffic incident symbol:** select  or .

▶ **To select a map section:** tap on the touchscreen.

or

▶ Press the Touch Control or the touchpad.

▶ Move the map.

▶ **To return to the navigation map:** tap on .

or

▶ Press the  button on the Touch Control or on the touchpad.

Switching the traffic information display on

Multimedia system:



▶ Activate **Traffic**.

The display button is activated.

Activating Incidents, Free Flow and Delay

▶ Select **Advanced**.

▶ Select **View**.

▶ Select **Map Elements**.

▶ In the **TRAFFIC** category, activate the **Traffic Incidents, Free Flowing Traffic** and **Delay** entries.

The display buttons are activated.

If traffic information has been received, then traffic incidents such as roadworks, road blocks, local area reports (e.g. fog) and warning messages are displayed.

The traffic delay is displayed for the current route. Traffic delays lasting one minute or longer are taken into consideration.

Showing local area messages

Multimedia system:



▶ Select **Area Alerts**.

Local area messages are shown, for example fog or heavy rain.

▶ Select a local area message. The details are displayed.

Car-to-X-Communication

Car-to-X-Communication overview

The following requirements apply for using Car-to-X-Communication:

- The vehicle is equipped with a multimedia system featuring navigation and a communication module with an activated, integrated SIM card.
- Car-to-X-Communication is activated.

 Car-to-X-Communication is available in selected countries.

The communication module automatically establishes an Internet connection once the ignition is switched on. If there are any hazard warnings, they will be provided shortly thereafter. Depending on the mobile phone connection, the provision takes place from within a second up to about a minute.

Benefits of Car-to-X-Communication:

- Hazards are recognized automatically in the background by the vehicle or may be reported by the driver. These are then sent to vehicles with Car-to-X-Communication in the immediate vicinity.
- If available, current details relating to hazard spots near the vehicle's current position are received.

This gives you sufficient time to adapt your driving style to the traffic conditions.

The use of Car-to-X-Communication requires the regular transmission of vehicle data to Daimler AG. The data is then immediately pseudonymized by Daimler AG. The vehicle data is deleted after an appropriate amount of time has elapsed (several weeks) and is not stored permanently.

- ① Data which serves as identification is replaced during the pseudonymization process. In this way, your identity is protected against access by unauthorized third parties.

Displaying hazard warnings

Multimedia system:

  **»» Navigation** (Navigation)

If hazard warnings are available these can be shown as symbols on the map. The display depends on the settings for the **Traffic** and **Traffic Incidents** options.

- ▶ Set the options (→ page 386).

The following displays are available:

- Show all symbols.
The **Traffic** and **Traffic Incidents** options are switched on.
- Only show symbols on the expected route.
The **Traffic** option is switched off, the **Traffic Incidents** option is switched on.
- Show no symbols.
The **Traffic Incidents** option is switched off.

The following hazard warnings are shown on the map:

- Broken-down vehicles
- Accidents

- Hazardous weather
- General hazards
- Hazard warning lights, when switched on
- Crosswind warning
- ① If the vehicle is approaching a hazard spot with a vehicle speed of at least 37 mph (60 km/h) the voice output "Traffic incident ahead" is issued.
The voice output is not issued for hazardous weather.

Sending hazard warnings

Automatically detected hazard warnings are sent by the vehicle.

- ▶ **To send a hazard warning yourself:** tap on the media display when the map is shown. The navigation menu is shown.
- ▶ Select .
- ▶ Select **Report Traffic Incident**.
A prompt is shown.
- ▶ Select **Yes**.
The **Thank You for Supporting Accident Prevention** message appears.

Map and compass

Setting the map scale

Multimedia system:



Zooming in

- ▶ When the map is shown, tap twice quickly with one finger on the media display or the touchpad.

or

- ▶ Move two fingers apart on the media display or on the touchpad.

Zooming out

- ▶ Tap with two fingers on the media display or the touchpad.

or

- ▶ Move two fingers together on the media display or on the touchpad.

- ① You can set the unit of measurement of the map scale (→ page 354).

Moving the map

Multimedia system:

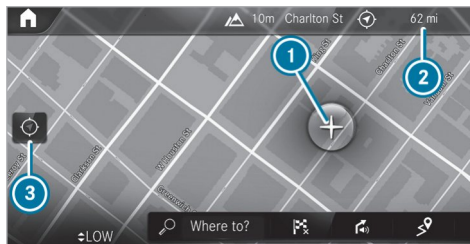

- ▶ **On the touchscreen:** move the finger in any direction when the map is shown.
- ▶ **On the touchpad:** call up the navigation menu by pressing.
- ▶ Swipe your finger up.
- ▶ Press the touchpad. Crosshair ① appears. The map can be moved.

- ▶ Touch the touchpad and move your finger in any direction. The map moves in the opposite direction under crosshair ①.

When the map has been moved the following information appears in the status line, for example:

- Distance ② from the vehicle's current position is shown.
- Information about the current map position is shown, e.g. the name of the road.

The following functions are available:

- Select a destination on the map (→ page 366).
- Select a POI (→ page 363).
- Show traffic incidents on the map (→ page 385).
- ▶ **To reset the map to the current vehicle position:** select ③.

Rotating the map

- ▶ With two fingers, rotate counter-clockwise or clockwise on the media display or the touchpad.

Selecting the map orientation

Multimedia system:



▶▶ Advanced

- ▶ Select **View**.
- ▶ Select **Map Orientation**.
- ▶ Select an option.

The ● dot indicates the current setting.

The following options are available:

- **2D Heading Up** option: the 2D map view is aligned to the direction of travel.
- **2D North Up** option: the 2D map view is displayed so that north is always at the top.
- **3D** option: the 3D map view is aligned to the direction of travel.

or

- ▶ **To use quick-access:** repeatedly tap or press on the  compass symbol on the map.
The view changes in the sequence **3D**, **2D Heading Up** to **2D North Up**.
If the map is moved, it can switch between **3D** and **2D North Up**.

Selecting POI symbols for the map display

Multimedia system:



POIs include restaurants and hotels, for example. These can be displayed as symbols on the map. Not all POIs are available everywhere.

Personal POIs are destinations which you have saved on a USB device, for example.

- ① The display of POI symbols on the map can be activated or deactivated as a favorite.
- ▶ **To switch on/off using quick-access:** if available, switch **POI Symbols** on or off. The POI symbols for the selected categories are shown on the map.

or

- ▶ **To switch on/off in the menu:** select **Advanced**.
- ▶ Select **View**.
- ▶ Select **Map Elements**.
- ▶ Select **POI Symbols** .
The **POI SYMBOLS** menu is shown.
- ▶ Switch **Display POIs** on or off.



Selecting categories

- ▶ Select  in the **POI SYMBOLS All Categories** menu.
- ▶ Switch **Show All** on or off.
When the option is switched on, the POI symbols for all categories are shown on the map.

or

- ▶ Select the categories and sub-categories (if available) .
- ▶ Activate or deactivate the categories. The POI symbols for the selected categories are shown on the map.

Selecting personal POI categories

- ▶ Select  in the **POI SYMBOLS Personal POIs** menu.
- ▶ Select a category .
- ▶ Switch **Show on Map** on or off. When the display is switched on and the vehicle approaches a personal POI in this category, a visual and audible notification can be issued.
- ▶ **To set a notification when approaching:** select a category or a personal POI .
- ▶ Switch **Visual Notification** and **Acoustic Notification** on or off.

Switching display of categories for quick-access on/off

- ▶ Switch a category on or off in the **POI SYMBOLS** menu.

Resetting the POI symbol display

- ▶ Select **POI SYMBOLS Reset POIs** in the menu. The settings are reset to the standard settings.

Selecting the display of text information in the map

Multimedia system:



- ▶ Select **View**.
- ▶ Select **Text Information**.
- ▶ Select an option in the **FOOTER** category. The • dot indicates the current setting.

The following options are available:

- **Current Street** option
The street you are currently on is shown in the bottom bar.
When the map is moved, the street name, the POI name or the area name appears under the crosshair.
- The **Geo-coordinates** option shows the following information in the bottom bar:
 - longitude and latitude
 - elevation
The elevation shown may deviate from the actual elevation.

- **None** option
The media display shows no text information in the bottom bar.

Switching freeway information on/off

Multimedia system:



- ▶ **Using quick-access:** switch **Highway Information** on or off. The display button is activated or off.

or

- ▶ **Using the menu:** select **Advanced**.
- ▶ Select **View**.
- ▶ Select **Text Information**.
- ▶ Switch **Highway Information** on or off. When the display button is switched on, additional information about the freeway facilities ahead appears during the freeway journey. These include parking lots, service stations and freeway exits, for example.

Displaying the next intersecting street Requirements:

- Route guidance is not active.

Multimedia system:



▶▶ Advanced

- ▶ Select **View**.
- ▶ Select **Text Information**.
- ▶ Activate **Next Intersecting Street**.
The display button is activated. If the option is switched on and the journey continues without route guidance, the name of the next intersecting street will be displayed at the upper edge of the display.

Displaying the map version

Multimedia system:



▶▶ Advanced

- ▶ Select **View**.
- ▶ Select **Map Version**.
The detail information is displayed.
- ▶ **i** The online map update service from Mercedes me connect can be used to update the map data (→ page 392).

A message is shown in the media display when a new map version is available.

- ▶ **i** Information about new versions of the digital map can be obtained from an authorized Mercedes-Benz Center.

Overview of avoiding an area for the route

You can define areas along a route that you would like to avoid.

Highways or multi-lane highways, which are routed through an area to be avoided are taken into account for the route.

Avoiding a new area for the route

Multimedia system:



▶▶ Advanced ▶▶ Route ▶▶ Avoid Options
▶▶ Avoid Areas

- ▶ Select **Avoid New Area**.
- ▶ **To start in the map:** select **Using Map**.
- ▶ Move the map (→ page 388).
- ▶ **To start via destination search:** select **Via Address Entry**.

- ▶ Enter the address (→ page 360).
- ▶ Select the destination in the list or accept with **OK**.
The map appears.
- ▶ **To show an area:** tap or press on the control element.
A red rectangle appears. This designates the area that should be avoided.
- ▶ **To change the map scale:** move two fingers apart or together on the media display or on the touchpad.
The map is zoomed in or out.
- ▶ **To set an area:** select **OK**.
The **Avoid area has been set.** message appears. The area is entered into the list.

Changing an area to be avoided

Multimedia system:



▶▶ Advanced ▶▶ Route ▶▶ Avoid Options
▶▶ Avoid Areas

- ▶ Select an area in the list.
- ▶ Select **Edit**.

- ▶ **To move an area on the map:** swipe in any direction on the control element.
- ▶ **To change the size of the area:** tap or press on the control element.
- ▶ Swipe up or down on the control element.
- ▶ Select **OK**.
The **Avoid area has been set.** message appears. The area is entered into the list.
- ▶ **To take account of an area for the route:** select an area from the list.
- ▶ Activate **Avoid Area**.
The display button is activated.
If route guidance is active, a new route is calculated.
If there is no route yet, the setting is carried over to the next route guidance.
The route can include an area that is to be avoided in the following cases:
 - the destination is located in an area that is to be avoided.
 - the route includes highways or multi-lane expressways which pass through an area to be avoided.

- there is no sensible alternative route.

Deleting an area

Multimedia system:

- 

 ▶▶ **Navigation** ▶▶ 
 ▶▶ **Advanced** ▶▶ **Route** ▶▶ **Avoid Options**
 ▶▶ **Avoid Areas**

- ▶ **To delete an area:** select an area in the list.
- ▶ Select **Delete**.
- ▶ Confirm the prompt with **Yes**.
- ▶ **To delete all areas:** if at least two areas to avoid are set, select **Delete All**.
- ▶ Confirm the prompt with **Yes**.

Map data update overview

Updating at the authorized Mercedes-Benz Center

The digital maps generated by the map software become outdated in the same way as conventional road maps. Optimal route guidance can only be provided by the navigation system in conjunction with the most up-to-date map data. Information about new versions of the digital

map can be obtained from an authorized Mercedes-Benz Center.

You can have updates to the digital map implemented there.

- ⓘ Additional costs can be incurred in this connection.

Online map update

The online map update service from Mercedes me connect can be used to update the map data.

Requirements:

- Mercedes me connect is available.
- You have a user account for the Mercedes me portal.
- The service is available.
- The service has been activated.

- ⓘ The online map update service is not available in all countries.

The following options are available for the update:

- For one region (automatic map update)

If the **Automatic Online Update** system setting is switched off (→ page 356), you receive a message that a map update is available. You can confirm the message and download the map update.

- For several or all regions (manual map update)

The map data will first be downloaded onto a storage medium and then updated on the multimedia system.

Further information on online map updates is available here:

- At an authorized Mercedes-Benz Center
- Under: <https://www.mercedes.me>

Further information on updates can be found at: https://manuals.daimler.com/baix/cars/connectme/en_US/index.html.

Overview of map data

Your vehicle is supplied with map data at the factory. Depending on the country, map data for your region is either pre-installed or the map data is supplied on a data storage medium.

If the map data on your vehicle has been installed at the factory and you wish to reinstall it, you do not need to enter the activation code.

For map data that you have purchased in the form of a data storage medium, you must enter the accompanying activation code.

- ① If you save the map data on a data storage medium with the online map update service, no entry is required. The activation code is stored on the data storage medium during the downloading process.

Observe the following when entering the activation code:

- The activation code can be used for one vehicle
- The activation code is not transferable
- The activation code has six digits

In the event of the following problems, please contact an authorized Mercedes-Benz Center:

- The multimedia system does not accept the activation code
- You have lost the activation code

Displaying the compass

Multimedia system:

→  » **Navigation** »  » **Position**

- ▶ Select **Compass**.

The compass display shows the following information:

- The current direction of travel with bearing (360° format) and compass direction
- Longitude and latitude coordinates in degrees, minutes and seconds
- Height (rounded)
- Number of satellites from which a signal can be received

Setting the map scale automatically

Multimedia system:

→  » **Navigation** » 

- ▶ **Advanced**

- ▶ Select **View**.

- ▶ Select **Map Orientation**.

- ▶ Activate [Auto Zoom](#).
The display button is activated. The map scale is set automatically depending on your driving speed and the type of road.
- ⓘ The automatically selected map scale can be changed manually. After a few seconds, this is automatically reset.

Displaying the satellite map

Multimedia system:



▶▶ [Advanced](#)

- ▶ Select [View](#).
- ▶ Select [Map Elements](#).
- ▶ Switch [Satellite Map](#) on or off.
If the display button is activated, satellite maps are displayed in map scales from 2 mi (2 km).
If the display button is deactivated, satellite maps are not displayed in map scales from 2 mi (2 km) to 20 mi (20 km).
- ⓘ The satellite maps for these map scales are not available in all countries.

Displaying the range

Requirements:

- The multimedia system supports the function.

Multimedia system:



▶▶ [Advanced](#)

- ▶ Select [View](#).
- ▶ Select [Map Elements](#).
- ▶ Activate [Range](#).
The display button is activated.

The range is shown on the map with the following displays:

- For gasoline and diesel vehicles: green display

When the lower reserve capacity is reached then the range display on the map is switched off.

- ⓘ The range display on the map is not available in all countries.

Displaying weather information and other map contents

Requirements:

- Mercedes me connect is available.
- You have a user account for the Mercedes me portal.
- The service is available.
- The service has been activated at an authorized Mercedes-Benz Center.

Multimedia system:



▶▶ [Advanced](#)

- ▶ Select [View](#).
- ▶ Select [Map Elements](#).
- ▶ Scroll up and show the [ONLINE MAP CONTENT](#) category.
The available services are displayed. The services are provided by Mercedes me connect.
- ▶ Switch on a service, e.g. [Weather](#).
Current weather information is displayed on the navigation map, e.g. temperature or

cloud cover. The service information is not shown in all map scales, e.g. weather symbols.

Further information about available services and about displaying information in the map scales can be found in the Mercedes me Portal: <https://me.secure.mercedes-benz.com>

Showing map view in the multifunction display of the instrument cluster

Multimedia system:



» Advanced

- ▶ Select **View**.
- ▶ Select **Map Orientation**.
- ▶ Scroll up and show the **INSTRUMENT CLUSTER VIEW** category.
- ▶ **To set the map scale automatically:** switch on **Auto Zoom**.
The display button is activated. The map scale is set automatically depending on your driving speed and the type of road.

▶ **To select map orientation:** select an option. The ● dot indicates the current selection.

The following options are available:

- **2D Heading Up** option: the 2D map view is aligned to the direction of travel.
- **2D North Up** option: the 2D map view is displayed so that north is always at the top.
- **3D** option: the 3D map view is aligned to the direction of travel.

Parking service

Notes on the parking service

⚠ WARNING Risk of accident and injury due to not observing the maximum permitted access height

If the vehicle height exceeds the maximum permitted access height for parking garages and underground parking lots, the vehicle roof as well as other vehicle parts could be damaged.

There could be a risk of injury to the vehicle occupants.

- ▶ Before driving into a parking garage or underground parking lot observe the locally signposted access height.
- ▶ If the vehicle height, including any additional equipment, exceeds the maximum permitted access height, do not drive into the parking garage or underground parking lot.

This service is not available in all countries.

Selecting parking options

! **NOTE** Before selecting the parking option

The data is based on information provided by the respective service provider.

Mercedes Benz accepts no liability for the accuracy of the information provided relating to the parking garage/parking lot.

- ▶ Always observe the local Information and conditions.

Requirements:

- The navigation services option is available, subscribed to and activated in the Mercedes me portal.
- The parking service is within the scope of the navigation service.
- **Parking** is activated (→ page 396).

Multimedia system:



Navigation

- ▶ Tap on **P** in the map.
- ▶ Select a parking option.
The map shows the parking options in the vicinity.
The following information is displayed (if available):
 - Destination address, distance from current vehicle position and arrival time
 - Information on the parking garage/parking lot
For example, opening times, parking charges, current occupancy, maximum parking time, **maximum access height**.

The maximum access height shown by the parking service does not replace the need for observation of the actual circumstances.

- Available payment options (Mercedes pay, coins, bank notes, cards)
- Details on parking tariffs
- Number of available parking spaces
- Payment method (e.g. at the parking machine)
- Services/facilities at the parking option
- Telephone number

▶ Calculate the route (→ page 367).

The following functions can also be selected (if available):

- Search for POIs in the vicinity.
- Save the destination.
- Place a call at the destination.
- Share the destination using NFC or QR code.
- Call up the web address.
- Show the destination on the map.

Displaying parking options on the map
Requirements:

- The navigation services option is available, subscribed to and activated in the Mercedes me portal.
- The parking service is within the scope of the navigation service.

Multimedia system:



- ▶ Activate **Parking**.
The display button is activated. The parking options within the vicinity of the current vehicle position are shown.

Dashcam**Notes on the dashcam****NOTE** Before using the dashcam

Before using any or all functions of the Dashcam, please read this Disclaimer carefully. If you do not accept, agree to or understand this Disclaimer, please do not use the Dash-

cam. By using the Dashcam, you are deemed to have accepted and agreed to the contents of this Disclaimer.

As manufacturer of the vehicle, we provide you with the device and associated software system of the Dashcam to provide you with the functionalities that we consider you may wish to have while using the Dashcam. We are unable to predict or verify whether any image(s) or geographic information captured or recorded during your use of the Dashcam is legitimate. As such, we are unable to take responsibility for any adverse consequences that may arise from the actual image(s) or geographic information captured or recorded during use of the Dashcam.

Warning: please comply with all applicable laws and regulations when you use the Dashcam. For example, please do not capture or record image(s) or geographic information which may be considered as state secret sensitive information (e.g. military areas). In case of any violations of the relevant laws and regulations, the actual user will be liable

for the corresponding responsibilities and we will not take responsibility for any misuse of the Dashcam.

- ▶ Observe the country-specific regulations.

The dashcam is available in the navigation system in combination with the augmented reality function.

Selecting a USB device for a video recording with the dashcam

Requirements:

- At least one USB device is connected with the multimedia system (→ page 438).

Multimedia system:

- ↳  ▶ Mercedes me & Apps
- ▶▶ Dashcam

- ▶ Select the USB device.

Starting/stopping video recording with the dashcam

Requirements:

- A USB device is connected with the multimedia system (→ page 438).
- The ignition is switched on.

Multimedia system:

- ↳  ▶ Mercedes me & Apps
- ▶▶ Dashcam

- ▶ If several USB devices are connected with the multimedia system, select the USB device (→ page 397).
- ▶ Select the [Individual Recording](#) or [Loop Recording](#) recording mode. If [Individual Recording](#) is selected and the memory is full the recording stops. An individual recording is automatically protected against being overwritten. If [Loop Recording](#) has been selected, several short video files are recorded. When the memory limit is reached, the oldest video file is deleted and recording is continued automatically.
- ▶ **To start:** select [Start Recording](#). The length of the recording is shown. The [Please do not remove the storage medium](#).

message appears. The video file is stored on the USB device.

▶ **To end:** select [End Recording](#).

A report may appear in the following cases:

- For the [Individual Recording](#) recording mode: the memory is full or there are only a few minutes recording time available. The video recording stops or will be stopped imminently.

Change the USB device or delete a video file.

- If a video recording has started and a national border is detected, the [National Border Crossed](#). Please observe the [country-specific regulations on video recording](#). message appears.

This function is not available in all countries.

- The camera is not functional, the [Camera Unavailable](#) message appears.

Have the camera checked at an authorized Mercedes-Benz Center.

Deleting a dashcam video recording Requirements:

- A USB device with video recordings is connected with the multimedia system (→ page 438).



 You are legally responsible for operation and use of the dashcam functions. The legal requirements relating to operation and use of the dashcam can vary depending on the country in which the dashcam is operated. Therefore, observe the legal requirements, in particular the data protection regulations, in your country.

For this reason, before using the dashcam inform yourself about the regulation details for the respective country.

This function is not permitted in all countries.

Multimedia system:

→  ▶ [Mercedes me & Apps](#)
▶ [Dashcam](#)

- ▶ Select the  symbol. The [RECORDINGS](#) menu appears.
- ▶ Select  for a video file.
- ▶ Select [Delete](#).
- ▶ Select [Yes](#).

▶ **To delete all video files:** select .

▶ Select [Delete All Entries](#).

Configuring dashcam settings Requirements:

- A USB device is connected with the multimedia system (→ page 438).

Multimedia system:

→  ▶ [Mercedes me & Apps](#)
▶ [Dashcam](#)

▶ Select .

▶ **To show messages after passing a national border:** switch on [National Borders Alert](#).

The display button is activated.

A message appears in the following situations:

- A video is being recorded.
- The vehicle has passed a national border.

 This function is not available in all countries.

▶ **To start automatic video recording:** select [Automatic Video Recording](#).

- ▶ Activate **Automatic Video Recording**. The display button is activated. When the vehicle is started, video recording starts automatically.

i This function is not available in all countries.

Telephone

Telephony

Notes on telephony

⚠ WARNING Risk of distraction from operating integrated communication equipment while the vehicle is in motion

If you operate communication equipment integrated in the vehicle when driving, you will be distracted from the traffic situation. This could also cause you to lose control of the vehicle.

- ▶ Only operate this equipment when the traffic situation permits.
- ▶ If you cannot be sure of this, stop the vehicle whilst paying attention to road

and traffic conditions and operate the equipment with the vehicle stationary.

⚠ WARNING Risk of an accident from operating mobile communication equipment while the vehicle is in motion

Mobile communications devices distract the driver from the traffic situation. This could also cause the driver to lose control of the vehicle.

- ▶ As the driver, only operate mobile communications devices when the vehicle is stationary.
- ▶ As a vehicle occupant, only use mobile communications devices in the areas intended for this purpose, e.g. in the rear passenger compartment.

You must observe the legal requirements for the country in which you are currently driving when operating mobile communication equipment in the vehicle.

⚠ WARNING Risk of injury due to objects being stowed incorrectly

If objects in the vehicle interior are stowed incorrectly, they can slide or be thrown around and hit vehicle occupants. In addition, cup holders, open stowage spaces and mobile phone receptacles cannot always retain all objects they contain.

There is a risk of injury, particularly in the event of sudden braking or a sudden change in direction.

- ▶ Always stow objects so that they cannot be thrown around in such situations.
- ▶ Always make sure that objects do not protrude from stowage spaces, luggage nets or stowage nets.
- ▶ Close the lockable stowage spaces before starting a journey.
- ▶ Always stow and secure heavy, hard, pointed, sharp-edged, fragile or bulky objects in the trunk/load compartment.

400 MBUX multimedia system

Observe the additional information on stowing mobile communications devices correctly:

- Loading the vehicle (→ page 114)

Further information can be obtained from an authorized Mercedes-Benz Center or at:
<https://www.mercedes-benz-mobile.com/>

Telephone menu overview

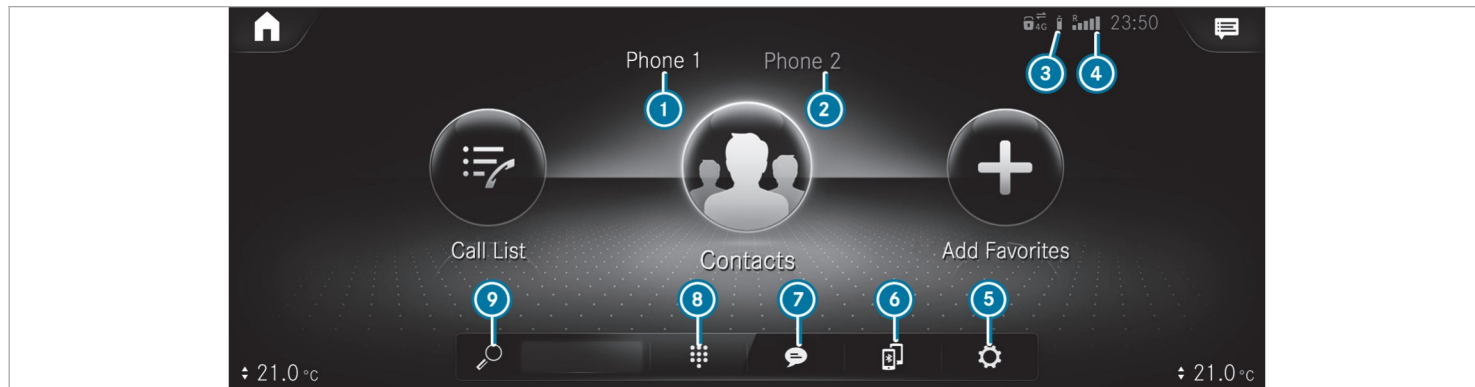

- ① Bluetooth® device name of the currently connected mobile phone/of the mobile phone
- ② Bluetooth® device name of the currently connected mobile phone/of the mobile phone (two phone mode)
- ③ Battery status of the connected mobile phone
- ④ Signal strength of the mobile phone network
- ⑤ Options
- ⑥ Device manager
- ⑦ Messages
- ⑧ Numerical pad
- ⑨ Contact search

Bluetooth® profile overview

Bluetooth® profile of the mobile phone	Function
PBAP (Phone Book Access Profile)	Contacts are automatically displayed in the multimedia system
MAP (Message Access Profile)	Message functions can be used

Telephony operating modes overview

Depending on your equipment, the following telephony operating modes are available:

- A mobile phone is connected to the multimedia system via Bluetooth® (→ page 402).
- Two mobile phones are connected with the multimedia system via Bluetooth® (two phone mode) (→ page 402).
 - You can use all the functions of the multimedia system with the mobile phone in the foreground.

- You can receive incoming calls and messages with the mobile phone in the background.

You can interchange the mobile phone in the foreground and background any time (→ page 402).

- ① Irrespective of this, Bluetooth® audio functionality can be used with any mobile phone (→ page 438).

Information on telephony

The following situations can lead to the call being disconnected while the vehicle is in motion:

- there is insufficient network coverage in the area
- you move from one transmission/reception station to another and no communication channels are free
- the SIM card used is not compatible with the network available
- a mobile phone with "Twincard" is logged into the network with the second SIM card at the same time

The multimedia system supports calls in HD Voice® for improved speech quality. A requirement for this is that the mobile phone and the mobile phone network provider of the person you are calling support HD Voice®.

Depending on the quality of the connection, the voice quality may fluctuate.

Connecting a mobile phone

Requirements:

- Bluetooth® is activated on the mobile phone (see the manufacturer's operating instructions).
- Bluetooth® is activated on the multimedia system (→ page 351).

Multimedia system:





Searching for a mobile phone

- ▶ Select .
- ▶ Select [Connect New Device](#).

Connecting a mobile phone (authorization using Secure Simple Pairing)

- ▶ Select a mobile phone.
- ▶ A code is displayed in the multimedia system and on the mobile phone.
- ▶ **If the codes match:** confirm the code on the mobile phone.

 For older mobile phone models, enter a one to sixteen-digit number code on the mobile phone and on the multimedia system for authorization.

 Up to 15 mobile phones can be authorized on the multimedia system. Authorized mobile phones are reconnected automatically.

 The connected mobile phone can also be used as Bluetooth® audio equipment (→ page 438).

Connecting a second mobile phone (two phone mode)

Requirements:

- At least one mobile phone is already connected to the multimedia system via Bluetooth®.

Multimedia system:



- ▶ Select .
- ▶ Select [Connect New Device](#).
- ▶ Select the mobile phone.
- ▶ Select [Device name 1 + Device name 2](#).
The selected mobile phone is connected to the multimedia system.

Interchanging mobile phones (two phone mode)

Multimedia system:



Both mobile phones are shown individually in separate tabs.

- ▶ Select the tab with the desired mobile phone.
The mobile phone in the selected tab is the mobile phone in the foreground.
With the exception of telephone settings, the submenus in the telephone menu relate to the mobile phone in the foreground. In the

telephone settings, settings can be made for both mobile phones.

Changing the function of a mobile phone Requirements:

- At least one mobile phone is connected to the multimedia system via Bluetooth® (→ page 402).

Multimedia system:



Activating a function

- Select the device manager.
- Select a gray symbol in the line of a mobile phone. The corresponding function is activated.

Deactivating a function

- Select the device manager.
- One function is active:** select the color symbol in the line of a mobile phone. The mobile phone is disconnected from the multimedia system.

- Several functions are active:** select a color symbol in the line of a mobile phone. The corresponding function is deactivated.

Replacing mobile phones

Multimedia system:



- Select .
- No authorized mobile phone available:** select **Connect New Device**.
- Select a mobile phone.
- Newly authorized mobile phone:** confirm the number code on the mobile phone.

Using in single telephone mode

- Select **Device name**. A newly authorized mobile phone is connected in single telephone mode. If the mobile phone has already been authorized and connected in single telephone mode, it is connected again in single telephone mode. If a mobile phone has already been authorized and connected in two phone mode with

another mobile phone, it will be connected in future in single telephone mode.

Using in two phone mode

- Select **Device name 1 + Device name 2**. A newly authorized mobile phone is connected with the selected mobile phone in two phone mode.

If the mobile phone has already been authorized and connected in single telephone mode, it will be connected in future with the selected mobile phone in two phone mode.

If the mobile phone was previously connected with another mobile phone, this connection is canceled.

Disconnecting/de-authorizing a mobile phone

Multimedia system:



- Select .
- Select in the line of the mobile phone.

- ▶ **To disconnect:** select [Disconnect](#).
If applicable, the mobile phone will be automatically reconnected when the vehicle is next started.
- ▶ **To de-authorize:** select [Deauthorize](#).

Information on Near Field Communication (NFC)

NFC enables short-range wireless data transfer or (re)connection of a mobile phone with the multimedia system.

The following functions are available without having authorized a mobile phone:

- Transferring a URL or a contact to be viewed in the multimedia system (see the manufacturer's operating instructions).
- Setting up the vehicle's Wi-Fi access data via the system settings (→ page 352).

Further information can be obtained at: <https://www.mercedes-benz-mobile.com/>

Using the mobile phone with Near Field Communication (NFC)

Requirements:

- NFC is activated on the mobile phone (see the manufacturer's operating instructions)
- The mobile phone's screen is switched on and unlocked (see the manufacturer's operating instructions)

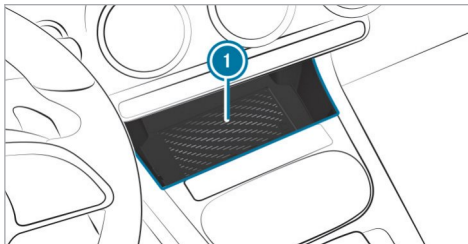

- ▶ **To connect a mobile phone:** hold the NFC area of the mobile phone (see manufacturer's operating instructions) on mat ① or place the mobile phone on it.
- ▶ Follow the additional prompts on the media display to connect the mobile phone. Connect the mobile phone in single telephone mode (→ page 402). Connect the mobile phone in two phone mode (→ page 402).

- ▶ **To replace a mobile phone:** hold the NFC area of the mobile phone (see manufacturer's operating instructions) on mat ① or place the mobile phone on it.
- ▶ Follow the additional prompts on the media display to replace the mobile phone in one or two phone mode (→ page 402).
- ▶ If required, confirm the prompts on your mobile phone (see the manufacturer's operating instructions).
- ⓘ If your mobile phone supports wireless charging, it will be automatically charged via NFC when it is connected or replaced. A requirement for this is that the mobile phone is on the mat (→ page 135).

If you want to charge a mobile phone without connecting it to the multimedia system, lay it on the mat without beforehand unblocking the screen.

Further information can be found at: <https://www.mercedes-benz-mobile.com/>

Setting the reception and transmission volume

Requirements:

- A mobile phone is connected (→ page 402).

Multimedia system:



This function ensures optimal language quality.

- ⓘ Please note that the respective mobile phone must be selected for adjustment of the reception and transmission volume.

- ▶ Select **Volume**.
- ▶ Set the reception and transmission volume using **Reception** and **Transmission**.

Further information on the recommended reception and transmission volume: <http://www.mercedes-benz.com/connect>

Setting the ringtone

Multimedia system:



- ▶ Select **Ringtones**.
- ▶ Set the ringtone.

- ⓘ If the mobile phone supports the transfer of the ringtone, you will hear the ringtone of the mobile phone instead of that of the vehicle audio system.

Starting/stopping mobile phone voice recognition

Requirements:

- The mobile phone in the foreground is connected with the multimedia system (→ page 402).

Starting mobile phone voice recognition

- ▶ Press and hold the  button on the multi-function steering wheel for more than one second.
You can use mobile phone voice recognition.

Stopping mobile phone voice recognition

- ▶ Press the  or  button on the multi-function steering wheel.

- ⓘ If a mobile phone is connected via Smartphone Integration, the voice recognition of this mobile phone is started or stopped.



Calls

Using the telephone

Multimedia system:



Making a call by entering the numbers

- ▶ Select .
- ▶ Enter a number.
- ▶ Select .
The call is made.

Accepting a call

- ▶ Select  **Accept**.

Rejecting a call





- ▶ Select  **Reject**.

Ending a call

- ▶ Select .

Activating functions during a call

The following functions are available during a call:

-  **End Call**
-  **Microphone Off**
-  **Numeric Keypad** (show to send DTMF tones)
-  **Add Call**
-  **Transfer to Phone** (an active call in hands-free mode is transferred over to the telephone)

- ▶ Select a function.

Conducting calls with several participants**Requirements:**

- There is an active call (→ page 405).
- Another call is being made.

Switching between calls

- ▶ Select the contact.
The selected call is active. The other call is on hold.



Activating a call on hold

- ▶ Select the contact of the call on hold.

Conducting a conference call

- ▶ Select  **Create Confer. Call**.
The new participant is included in the conference call.

Ending an active call

- ▶ Select  **End Call**.
-  On some mobile phones, the call on hold is activated as soon as the active call is ended.



Accepting/rejecting a waiting call**Requirements:**

- There is an active call (→ page 405).

If you receive a call while already in a call, a message is displayed.

Depending on the mobile phone and mobile network operator you will hear a call-waiting sound.

In addition, in two phone mode you will hear an acoustic signal when the call goes through to the other (not yet active) mobile phone.

- ▶ Select  **Accept**.
The incoming call is active.
If only one mobile phone is connected with the multimedia system, the previous call will be put on hold.
If during a call you accept a call with the other mobile phone when in two phone mode then the existing call is ended.
- ▶ Select  **Reject**.
-  This function and behavior depends on your mobile phone network provider and the mobile phone (see the manufacturer's operating instructions).

Contacts

Information about the contacts menu

The contacts menu contains all contacts from existing data sources, e.g. mobile phone or data storage medium.

Depending on the data source, it is possible to save/load the following number of contacts:

- Permanently saved contacts: 3,000 entries
- Contacts loaded from the mobile phone: 5,000 entries per mobile phone

From the contacts menu, you can perform the following actions:

- Make a call, for example call a contact (→ page 408)
- Navigation (→ page 365)
- Compose messages (→ page 412)
- Additional options (→ page 409)

If a mobile phone is connected to the multimedia system (→ page 402) and automatic calling up (→ page 407) is activated, the mobile phone's contacts are displayed in the address book.

The multimedia system can show suggestions based on frequently used contacts as well as incoming and outgoing calls (→ page 333). These are shown at the top of the contact list.

Downloading mobile phone contacts

Multimedia system:

→  >> Phone >> <device name>
 >> 

▶ Select **Contacts & Recent Calls**.

Automatically

▶ If the **Synchronize Contacts Automatically** function is not active: activate the function by pressing once.

Manually

▶ If the **Synchronize Contacts Automatically** function is active: deactivate the function by pressing once.

▶ Select **Synchronize Contacts**.

You can see from the status of controller to the right of the **Synchronize Contacts Automatically** display text whether the function is active.

Calling up contacts

Multimedia system:

→  >> Phone >> 

The following options can be used to search for contacts:

- searching by initials
- searching by name
- searching by phone number

▶ Enter characters into the search field.

▶ Select the contact.

A contact can contain the following details:

- phone numbers
- navigation addresses
- geo-coordinates
- Internet address
- e-mail addresses
- voice tag (if set)
- relation (if set)

Editing the format of a contact's name

Multimedia system:





- ▶ Select **General**.
- ▶ Select **Name Format**.

The following options are available:

- **Last Name, First Name**
 - **Last Name First Name**
 - **First Name Last Name**
- ▶ Select an option.

Overview of importing contacts

Contacts from various sources

Source	Requirements
 USB device	The USB device is connected with the USB port.
 Bluetooth® connection	If the sending of vCards via Bluetooth® is supported, vCards can be received on mobile phones or networks, for example. Bluetooth® is activated in the multimedia system and on the respective device (see the manufacturer's operating instructions).

Importing contacts into the contacts menu

Multimedia system:







▶▶ **Import Contacts**

- ▶ Select a mobile phone <device name>, from which the contacts should be imported.
- ▶ Select an option.

Saving a mobile phone contact

Multimedia system:



- ▶ Select   in the line of the mobile phone contact.
 - ▶ Select .
 - ▶ Select **Save to Vehicle**.
 - ▶ Select **Yes**.
- The contact saved in the multimedia system is identified by the  symbol.

Calling a contact

Multimedia system:



- ▶ Select  **Search for Contacts**.

- ▶ Enter characters into the search field.
- ▶ Select the contact.
- ▶ Select the telephone number.
The number is dialed.

Selecting further options in the contacts menu

Multimedia system:



- ▶ Select in the line of the contact.
- ▶ Select .

Depending on the stored data, the following options are available:

- [Add Voice Tag/Delete Voice Tag](#)
- [Set Relationship/Delete Relationship](#)
- [Send DTMF Tones](#) (for a number with DTMF tones)
The function is available when a call is active.
- ▶ Select an option.

Selecting options for suggestions in the contacts menu

Requirements:

- A profile has been created (→ page 328).
- The [Allow Contact Suggestions](#) setting is switched on (→ page 333).

Multimedia system:



- ▶ Select [Recent Calls](#).
- ▶ Select in the line of a suggested contact.

The following options are available:

- [Save as Favorite](#)
The suggestions are saved as global favorites and do not appear on the home screen.
- [No Longer Suggest](#)
- ▶ Select an option.

Deleting contacts

Requirements:

- The contacts are saved in the vehicle.

- To delete an individual contact, this has been imported manually into the vehicle.

Multimedia system:



Deleting all contacts

- ▶ Select .
- ▶ Select [General](#).
- ▶ Select [Delete Contacts](#).
- ▶ Select an option.

Deleting a contact

- ▶ Select .
- ▶ Select in the line of the contact.
- ▶ Select .
- ▶ Select [Delete Contact](#).
- ▶ Select [Yes](#).

Saving a contact as a favorite

Multimedia system:



- ▶ Select a contact.

- ▶ Select  in the line of the contact.
- ▶ Select the telephone number.
The contact is stored as a favorite in the telephone menu overview.



Deleting favorites in the telephone menu overview

Multimedia system:



- ▶ Select a favorite in the telephone menu overview (→ page 409).
- ▶ Press and hold the favorite.
- ▶ Select **Delete**.
- ▶ Select **Yes**.

Deleting all favorites

- ▶ Tap on  in the media display.
- ▶ Select **Phone**.
- ▶ Select .
- ▶ Select the connected telephone.
- ▶ Select **Contacts & Recent Calls**.

- ▶ Select **Delete All Favorites**.
A pop-up window appears: **Do you want to delete all favorites?**
- ▶ Select **Yes**.

Call list

Overview of the call list

Depending on whether your mobile phone supports the PBAP Bluetooth® profile or not, this can have different effects on the presentation and functions of the call list.

If the PBAP Bluetooth® profile is supported, the effects are as follows:

- The call lists from the mobile phone are displayed in the multimedia system.
- When connecting the mobile phone, you may have to confirm the connection for the PBAP Bluetooth® profile.

If the PBAP Bluetooth® profile is not supported, the effects are as follows:

- The multimedia system generates a call list independently as soon as calls are made in the vehicle.
- The call list is not synchronized with the call lists in the mobile phone.

The multimedia system can show suggestions based on frequently used contacts as well as incoming and outgoing calls (→ page 333). These are shown at the top of the call list.

Making a call from the call list

Multimedia system:





- ▶ Select  **Recent Calls**.
- ▶ Select an entry.
The call is made.

Calling up additional options in the call list

Multimedia system:



- ▶ Select  **Recent Calls**.

- ▶ For previously stored contacts: select  in the line of an entry. The search results are displayed.
- ▶ For contacts who have not been stored: select .



Selecting options for suggestions in the call list

Requirements:

- A profile has been created (→ page 328).
- The [Allow Contact Suggestions](#) setting is switched on (→ page 333).

Multimedia system:

  ▶▶ Phone

- ▶ Select  [Recent Calls](#).
- ▶ Select  in the line of a suggested entry. The following options are available:
 - [Save as Favorite](#)
 - [No Longer Suggest](#)
- ▶ Select an option.

Deleting the call list

Multimedia system:

  ▶▶ Phone ▶▶ <device name>

▶▶ 

- ▶ Select [Contacts & Recent Calls](#).
- ▶ Select [Delete Recent Calls](#).
- ▶ Select [Yes](#).

 This function is only available if your mobile does not support the PBAP Bluetooth® profile.

Text messages

Overview of message functions

In the messages menu you can receive and send text messages.

If the connected mobile phone supports the Bluetooth® MAP profile, the message function can be used on the multimedia system.

You can obtain further information about settings and supported functions of Bluetooth®-capable mobile phones from an authorized

Mercedes-Benz Center or at: <https://www.mercedes-benz-mobile.com/>

Some mobile phones require further settings after being connected to the multimedia system (see manufacturer's operating instructions).

Setting message displays

Multimedia system:

  ▶▶ Phone ▶▶ <device name>

▶▶ 

- ▶ Select [Message Display](#).

The following options are available:

- [All Messages](#)
- [New and Unread Messages](#)
- [Messages While Driving](#)
- [Off](#) (the message function is no longer available.)

- ▶ Select a setting.

Reading messages

Multimedia system:

- ▶  ▶ Phone ▶ <device name>
- ▶ 

Using the read-aloud function

- ▶ Select a contact.
- ▶ Select  to read aloud.
The message is read aloud.

Dictating and sending a new message**Requirements:**

- There is an Internet connection.

Multimedia system:

- ▶  ▶ Phone ▶ <device name>
- ▶ 

- ▶ Select a new message using .

Adding a recipient

- ▶ Select .
- ▶ Select a contact.

Dictating text

- ▶ Select .
The dictating function is started.
- ▶ Say the message.
After the voice message has been processed, it is shown as text.

Sending a message

- ▶ Select **Send**.
- ▶  When the vehicle is stationary you can use the keyboard to write a message. No Internet connection is required to use the keyboard.

Replying to a message in the messaging history

Multimedia system:

- ▶  ▶ Phone ▶ <device name>
- ▶ 

A message list is shown.

- ▶ Select  next to a contact.
The messaging history with this contact is shown.



- ▶ Select .
The dictating function is started.
- ▶ Say the message.
After the voice message has been processed, it is shown as text.
- ▶ Select **Send**.

Using message templates



Multimedia system:

- ▶  ▶ Phone ▶ <device name>
- ▶ 

Using a template as a new message

- ▶ Select  to write a new message.
- ▶ Add a recipient using .
- ▶ Select a  template.

Answering a message with a template

- ▶ Select a message sequence with a contact.
- ▶ Select a  template.
- ▶ Select a  template.

Forwarding a message

Multimedia system:



A message list is shown.

- ▶ Select [Message icon] next to a contact. The messaging history with this contact is shown.
- ▶ Press and hold on a message.
- ▶ **To forward a message:** select **Forward**.

Calling a message sender

Multimedia system:



A message list is shown.

- ▶ Select [Message icon] next to a contact. The messaging history with this contact is shown.
- ▶ Select [More options icon].
- ▶ Select **Call**.

Using telephone numbers or URLs from a text message

Requirements:

- An Internet connection is available to call up a URL.

Multimedia system:



A message list is shown.

- ▶ Select [Message icon] next to a contact. The messaging history with this contact is shown.
- ▶ Select a telephone number or a URL in the message. If a URL is selected the web browser opens. If a telephone number is selected the following options are available:
 - **Call**
 - **New Message**
- ▶ Select an option.

Deleting a message

Multimedia system:

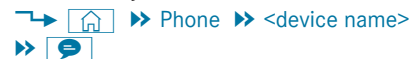

- ▶ Select a contact.
- ▶ Press and hold on a message.
- ▶ **To delete the message:** select **Delete**.

Mercedes-Benz link

Overview of Mercedes-Benz Link

⚠ WARNING Risk of distraction from information systems and communications equipment

If you operate information and communication equipment integrated in the vehicle when driving, you will be distracted from the traffic situation. This could also cause you to lose control of the vehicle.

- ▶ Only operate this equipment when the traffic situation permits.

▶ If you cannot be sure of this, stop the vehicle whilst paying attention to road and traffic conditions and operate the equipment with the vehicle stationary.

You must observe the legal requirements for the country in which you are currently driving when operating the multimedia system.

With Mercedes-Benz Link you can use mobile phone functions via the multimedia system. It is operated using the touchscreen or the voice-operated control system. You can activate the voice-operated control system by pressing and holding the  button on the multifunction steering wheel.

When using Mercedes-Benz Link via the voice-operated control system, the multimedia system can still be operated via the Voice Control System (→ page 295).

The Mercedes-Benz Link control box supplementary equipment is required for this. This is available at an authorized Mercedes-Benz Center.

Only one mobile phone at a time can be connected via Mercedes-Benz Link to the multimedia system.

When a mobile phone is connected with Mercedes-Benz Link, only one additional mobile phone can be connected using Bluetooth® with the multimedia system when in two phone mode.

- ❗ The Mercedes-Benz Link control box uses the Android operating system.
- ❗ The service provider is responsible for these apps and the services and content connected to it.

Notes on Mercedes-Benz Link

If a mobile phone is used with Mercedes-Benz Link, USB access using the media menu is possible for this mobile phone.

- ❗ Only one route guidance can be active at a time. If route guidance is active on the multimedia system, it is closed when route guidance is started on the mobile phone.

Connecting Mercedes-Benz Link with the multimedia system Requirements:

- The vehicle is equipped with the Mercedes-Benz Link control box.
- The Mercedes-Benz Link app is installed on the mobile phone.
- The mobile phone is switched on.
- Mercedes-Benz Link is connected to the multimedia system via the  USB port using a suitable cable (→ page 438).
- ❗ The first activation of Mercedes-Benz Link on the multimedia system must be carried out when the vehicle is stationary for safety reasons.

Multimedia system:

- ➔  ➔ Mercedes me & Apps
- ➔ Smartphone ➔ Mercedes-Benz Link
- ➔ Start Mercedes-Benz Link

Accepting/rejecting the data protection regulations

For the initial start of the application: a message with the data protection provisions appears.

- ▶ Select **Accept & Start**.

Quitting Mercedes-Benz Link



- ▶ Press the  button.

 Mercedes-Benz Link starts automatically when it is connected with the system using a cable. If Mercedes-Benz Link was not displayed in the foreground before disconnecting, the application starts in the background when reconnected. You can call up Mercedes-Benz Link using the main menu.

You can find more information in the Mercedes-Benz Link control box operating instructions.

Calling up Mercedes-Benz Link sound settings

Multimedia system:

- ➔  ➔ Mercedes me & Apps
- ➔ Smartphone ➔ Mercedes-Benz Link
- ➔ 

- ▶ Select sound settings.

Ending Mercedes-Benz Link

- ▶ Disconnect the connecting cable between Mercedes-Benz Link and the multimedia system.
-  Mercedes-Benz recommends disconnecting the connecting cable only when the vehicle is stationary.

Apple CarPlay®

Overview of Apple CarPlay®

 **WARNING** Risk of distraction from information systems and communications equipment

If you operate information and communication equipment integrated in the vehicle when driving, you will be distracted from the traffic situation. This could also cause you to lose control of the vehicle.

- ▶ Only operate this equipment when the traffic situation permits.
- ▶ If you cannot be sure of this, stop the vehicle whilst paying attention to road and traffic conditions and operate the equipment with the vehicle stationary.

You must observe the legal requirements for the country in which you are currently driving when operating the multimedia system.

iPhone® functions can be used via the multimedia system using Apple CarPlay®. They are operated using the touchscreen, touchpad, Touch

Control or the Siri® voice-operated control system. You can activate the voice-operated control system by pressing and holding the  button on the multifunction steering wheel.

When using Apple CarPlay® via the voice-operated control system, the multimedia system can still be operated via the Voice Control System (→ page 295).

Only one iPhone® at a time can be connected via Apple CarPlay® with the multimedia system.

Also for use of Apple CarPlay® with two phone mode, only one additional mobile phone can be connected using Bluetooth® with the multimedia system.

The availability of Apple CarPlay® may vary according to the country.

The service provider is responsible for this application and the services and content connected to it.

Apple CarPlay® is a registered trademark of Apple Inc.

Information on Apple CarPlay®

When Apple CarPlay® is being used, the iPod® media source is not available for the respective iPhone®.





Only one route guidance can be active at a time. If route guidance is active on the multimedia system, it is closed when route guidance is started on the mobile phone.



Connecting an iPhone® via Apple CarPlay® (cable)

Requirements:

- The current version of your device's operating system is being used (see the manufacturer's operating instructions).
- There is an Internet connection for the full range of functions for Apple CarPlay®.
- The iPhone® is connected to the multimedia system via the USB port  using a suitable cable (→ page 438).

Multimedia system:

  **Mercedes me & Apps**
 **Smartphone**  **Apple CarPlay**
 **Start Apple CarPlay**

▶ Alternative: If an Apple CarPlay® application is active (e.g. when music is being played or route guidance is active), you can call up the active application using the ,  or  application buttons (→ page 326).

ⓘ Control using the application buttons can be switched on or off (→ page 417).

Accepting/rejecting the data protection regulations

For the initial start of the application: a message with the data protection provisions appears.

▶ Select **Accept & Start**.







Exiting Apple CarPlay®

▶ Press the  button.

-  Apple CarPlay® starts automatically when the iPhone® is connected with the system using a cable. If Apple CarPlay® was not displayed in the foreground before disconnecting, the application starts in the background when reconnected. You can call up Apple CarPlay® in the main menu.







Calling up Apple CarPlay® sound settings

Multimedia system:



- 



-  Select sound settings.

Setting control of the application buttons (Apple CarPlay®)

Multimedia system:

- 



-  To switch on **Control via Application Buttons:** activate the display button.
-  To switch off **Control via Application Buttons:** deactivate the display button.

Ending Apple CarPlay®

-  **To end the connection of Apple CarPlay® (with cable):** disconnect the connection via the connecting cable between the mobile phone and multimedia system.
-  Mercedes-Benz recommends disconnecting the connecting cable only when the vehicle is stationary.

Android Auto

Android Auto overview

 **WARNING** Risk of distraction from information systems and communications equipment

If you operate information and communication equipment integrated in the vehicle when driving, you will be distracted from the traffic situation. This could also cause you to lose control of the vehicle.

-  Only operate this equipment when the traffic situation permits.

-  If you cannot be sure of this, stop the vehicle whilst paying attention to road and traffic conditions and operate the equipment with the vehicle stationary.

You must observe the legal requirements for the country in which you are currently driving when operating the multimedia system.

Mobile phone functions can be used with Android Auto using the Android operating system on the multimedia system. It is operated using the touchscreen or the voice-operated control system. You can activate the voice-operated control system by pressing and holding the  button on the multifunction steering wheel.

When using Android Auto via the voice-operated control system, the multimedia system can still be operated via the Voice Control System (→ page 295).

Only one mobile phone at a time can be connected via Android Auto with the multimedia system.

Also for use of Android Auto with two phone mode, only one additional mobile phone can be

connected using Bluetooth® with the multimedia system.

The availability of Android Auto and Android Auto apps may vary according to the country.

The service provider is responsible for this application and the services and content connected to it.

Information on Android Auto

If a mobile phone is used with Android Auto, USB access using the media menu is not possible for this mobile phone.

Only one route guidance can be active at a time. If route guidance is active on the multimedia system, it is closed when route guidance is started on the mobile phone.

Connecting a mobile phone via Android Auto (wired)

Requirements:



- The mobile phone supports Android Auto from Android 5.0.
- The Android Auto app is installed on the mobile phone.



- In order to use the telephone functions, the mobile phone must be connected to the multimedia system via Bluetooth® (→ page 402).

If there was no prior Internet connection, this is established with the use of the mobile phone with Android Auto.

- The mobile phone is connected to the multimedia system via the USB port  using a suitable cable (→ page 438).
- There is an Internet connection for the full range of functions for Android Auto.

Multimedia system:

  **Mercedes me & Apps**
Smartphone **Android Auto**
Start Android Auto

▶ Alternative: If an Android Auto application is active (e.g. when music is being played or route guidance is active), you can call up the active application using the ,  or  application buttons (→ page 326).

- Control using the application buttons can be switched on or off (→ page 419).

- The first activation of Android Auto on the multimedia system must be carried out when the vehicle is stationary for safety reasons.

Accepting/rejecting the data protection regulations

For the initial start of the application: a message with the data protection provisions appears.

- ▶ Select **Accept & Start**.

Exiting Android Auto

- ▶ Press the  button.

- Android Auto starts automatically when the mobile phone is connected with the system using a cable. If Android Auto was not displayed in the foreground before disconnecting, the application starts in the background when reconnected. You can call up Android Auto in the main menu.

Calling up the Android Auto sound settings

Multimedia system:

→  » Mercedes me & Apps
 » Smartphone » Android Auto » 

▶ Select sound settings.

Setting control of the application buttons (Android Auto)

Multimedia system:

→  » Mercedes me & Apps
 » Smartphone » Android Auto » 
 » General

▶ To switch on **Control via Application Buttons**: activate the display button.

▶ To switch off **Control via Application Buttons**: deactivate the display button.

Ending Android Auto

▶ **To end the connection of Android Auto (with cable)**: disconnect the connection via the connecting cable between the mobile phone and multimedia system.

 Mercedes-Benz recommends disconnecting the connecting cable only when the vehicle is stationary.

Transferred vehicle data with Android Auto and Apple CarPlay®

Overview of transferred vehicle data

When using Android Auto or Apple CarPlay®, certain vehicle data is transferred to the mobile phone. This enables you to get the best out of selected mobile phone services. Vehicle data is not directly accessible.

The following system information is transmitted:

- Software release of the multimedia system
- System ID (anonymized)

The transfer of this data is used to optimize communication between the vehicle and the mobile phone.

To do this, and to assign several vehicles to the mobile phone, a vehicle identifier is randomly generated.

This has no connection to the vehicle identification number (VIN) and is deleted when the multimedia system is reset (→ page 357).

The following driving status data is transmitted:

- Transmission position engaged
- Distinction between parked, standstill, rolling and driving
- Day/night mode of the instrument cluster

The transfer of this data is used to alter how content is displayed to correspond to the driving situation.

The following position data is transmitted:

- Coordinates
- Speed
- Compass direction
- Acceleration direction

This data is only transferred while the navigation system is active, in order to improve it (e.g. so it can continue functioning when in a tunnel).

Mercedes me calls

Making a call via the overhead control panel

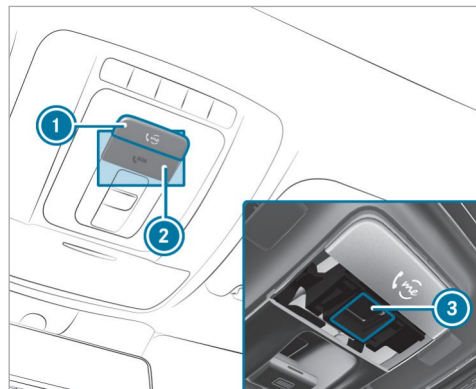

- ① me button for service, concierge or information calls
- ② SOS button cover
- ③ SOS button (emergency call system)

- ▶ **To make a Mercedes me call:** press me button ①.
- ▶ **To make an emergency call:** press SOS button cover ② briefly to open.
- ▶ Press and hold SOS button ③ for at least one second.

If a Mercedes me call is active, an emergency call can still be triggered. This has priority over all other active calls.

Information about the Mercedes me call using the me button

A call to the Mercedes-Benz Customer Center has been initiated via the me button in the overhead control panel or the multimedia system (→ page 420).

Using the voice dialog system you access the desired service:

- Concierge Service (if the service is activated)
- Accident and breakdown management (→ page 422)
- Mercedes-Benz Customer Center for general information about the vehicle

You can find information on the following topics:

- Activation of Mercedes me connect
- Operating the vehicle
- Nearest authorized Mercedes-Benz Center
- Other products and services from Mercedes-Benz

Data is transferred during the connection to the Mercedes-Benz Customer Center (→ page 421).

Calling the Mercedes-Benz Customer Center using the multimedia system Requirements:

- Access to a GSM network is available.
- The contract partner's GSM network coverage is available in the respective region.
- The ignition must be switched on so that vehicle data can be transferred automatically.

Multimedia system:



▶ Call **Mercedes me connect**.

After confirmation, the multimedia system sends the required vehicle data. The data transfer is shown in the media display.

Then, you can select a service and be connected to a specialist at the Mercedes-Benz Customer Center.

Further information on Mercedes me connect, the provided service scope and operation are available at: http://manuals.daimler.com/baix/cars/connectme/en_GB/index.html

Arranging a service appointment via a Mercedes me call

If you have activated the maintenance management service, relevant vehicle data is transferred automatically to the Mercedes-Benz Customer Center. You will then receive individual recommendations regarding the maintenance of your vehicle.

Regardless of whether you have consented to the maintenance management service, the multi-

media system reminds you after a certain amount of time that a service is due. A prompt appears asking if you would like to make an appointment.

▶ **To arrange a service appointment:** select **Call**.

After your agreement the vehicle data is sent and a Mercedes-Benz Customer Center employee deals with your appointment. The information is then sent to your desired service outlet.

This will contact you to confirm the appointment and if necessary consult about the details.

- ① If you select **Later** after the service message appears, the message is hidden and reappears after a certain period of time.

Transferred data during a Mercedes me call

The data transferred during a Mercedes me call depends on which service is selected in the voice control system and whether Mercedes me connect services are activated.

If no Mercedes me connect services are activated and the data protection prompt has been confirmed the following data is transmitted:

- Vehicle identification number
- Mercedes me customer identification number
- Reason for the initiation of the call
- Language set in the multimedia system
- Confirmation of the data protection prompt

If a call is made for a service appointment via the service reminder, the following data may be transmitted:

- Current mileage and maintenance data
- Transfer is possible assuming the required data transfer technology is supported by the mobile service operator and the quality of the mobile connection is sufficient.

422 MBUX multimedia system

If Accident and Breakdown Management is called via the voice control system and no service has been activated, but the data protection query has been confirmed, the following data can also be called up from the vehicle by the Mercedes-Benz Customer Center:

- Current vehicle location

 At the time of going to press, this function is technically not yet available but can be supported in the future.

If the data protection prompt has been rejected the following data is transmitted:

- Reason for the initiation of the call
- Rejection of the data protection prompt

Mercedes me connect

Notes on Mercedes me connect

Mercedes me connect consists of multiple services.

Depending on whether the services are activated and on the vehicle equipment, you can use the following services via the multimedia system and the overhead control panel, for example:

- Accident and breakdown management (me button)
- If the service is activated: Concierge Service (me button)
- Mercedes-Benz emergency call system (automatic emergency call or SOS button)

Mercedes me connect accident and breakdown management, the Mercedes me connect Concierge Service (if service is activated) and the Mercedes-Benz emergency call center are available for you around the clock.

The me button and the SOS button can be found on the vehicle's overhead control panel (→ page 420).

You can also call the Mercedes-Benz Customer Center using the multimedia system (→ page 420).

Please note that Mercedes me connect is a Mercedes-Benz service. In emergencies, always

call the national emergency services first using the standard national emergency service phone numbers. In emergencies, you can also use the Mercedes-Benz emergency call system (→ page 424).

Observe the conditions of use for Mercedes me connect and other services. These can be obtained in the Mercedes me portal: <https://me.secure.mercedes-benz.com>

Further information about Mercedes me connect services can be obtained in the Mercedes me portal: <https://me.secure.mercedes-benz.com>

Information on Mercedes me connect accident and breakdown management

The accident and breakdown management can include the following functions:

- Supplement to the Mercedes-Benz emergency call system (→ page 424)

If necessary, the contact person at the Mercedes-Benz emergency call center forwards the call to Mercedes me connect breakdown and accident management. Forwarding the call is however not possible in all countries.

- Breakdown assistance by a mechanic on location and/or the towing away of the vehicle to the nearest authorized Mercedes-Benz Center

You may be charged for these services.

More information about Mercedes me connect services can be obtained in the Mercedes me portal: <https://me.secure.mercedes-benz.com>

Data transferred during Mercedes me connect call services

The data transferred during a Mercedes me connect call depends on the reason the call was initiated, which service is selected in the voice control system and which Mercedes me connect services are activated.

Which data is transferred for the services can be taken from the currently valid terms of use. These can be obtained in the Mercedes me portal: <https://me.secure.mercedes-benz.com>

Mercedes me and apps

Information about Mercedes me

When you log in with a user account to the Mercedes me portal, then services and offers from Mercedes-Benz will be available to you.

Availability is country-dependent.

For more information consult an authorized Mercedes-Benz Center or visit the Mercedes me portal: <http://me.secure.mercedes-benz.com>

- ① Make sure you always keep the Mercedes me apps updated.

Calling up the Mercedes me user account Multimedia system:

→  → Mercedes me & Apps

Your vehicle is connected with a user account

- ▶ Select [Mercedes me](#). Information about the connected user account appears.

Your vehicle is not yet connected with a user account

- ▶ Select [Mercedes me](#).
- ▶ The instructions for creating a user account and connecting the vehicle with this follow on the media display.
- ① If the Mercedes me app is available on a mobile phone, the vehicle connection can be accomplished using the QR code shown.

Calling up the Mercedes me services Requirements:

- The vehicle is connected with the user account.

Multimedia system:

→  → Mercedes me & Apps

- ▶ Select [Services](#). Within the various categories you can see the Mercedes me services you have already purchased and also those still available to purchase.

To activate or deactivate the services, log in to your user account in the Mercedes me portal.

Deleting a connection between a user account and the vehicle

Requirements:

- The (vehicle) profile of the user account that was first connected with the vehicle is selected.
- The profile is synchronized (→ page 329).
- A PIN has been set.

Multimedia system:

→  » Mercedes me & Apps
» Mercedes me

▶ Select **Delete Vehicle Assignment**.

▶ Enter the PIN of the connected user account.

- ⓘ Only the user, whose user account was first connected with the vehicle can delete the connection between all user accounts and the vehicle.

Mercedes-Benz emergency call system

Information on the Mercedes-Benz emergency call system

Your vehicle is equipped with the Mercedes-Benz emergency call system ("eCall"). This feature can help save lives in the event of an accident. eCall in no way replaces assistance provided from dialing 911.

Mercedes-Benz eCall only functions in areas where mobile phone coverage is available from the wireless service providers. Insufficient network coverage from the wireless service providers may result in an emergency call not being transmitted.

eCall is a standard feature in your Mercedes-Benz vehicle. In order to function as intended, the system relies on the transmission of data detailed in the "Mercedes-Benz emergency call system data transmission" section that follows (→ page 426).

To disable eCall, a customer must visit an authorized Mercedes-Benz Service department to deactivate the vehicle's communication module.

Deactivation of this module prevents the activation of any and all Mercedes me connect services. After the deactivation of eCall, automatic emergency call and manual emergency call will not be available.

The ignition must be switched on before an automatic emergency call can be made.

ⓘ eCall is activated at the factory.

ⓘ eCall can be deactivated by an authorized Mercedes-Benz dealer. Please note that in the event ownership of the vehicle is transferred to another owner in its deactivated state, eCall will remain deactivated unless the new owner visits an authorized Mercedes-Benz dealership to reactivate the system.

Overview of the Mercedes-Benz emergency call system

eCall can help to reduce the time between an accident and the arrival of emergency services at the site of the accident. It helps locate an accident site in places that are difficult to access. However, even if a vehicle is equipped with eCall, this does not mean the system is ON.

As such, eCall does not replace dialing 911 in the event of an accident.

An emergency call can be made automatically (→ page 425) or manually (→ page 426). Only make emergency calls if you or others are in need of rescue.

Only make emergency calls if you or others are in need of rescue. Do not make an emergency call in the event of a breakdown or a similar situation.

Notification in the multimedia system display:

SOS NOT READY: the ignition is not on or eCall not available.

During an active emergency call,  appears in the display.

You can find more information on the regional availability of eCall at: <https://www.mercedes-benz-mobile.com/extra/ecall/>

-  If there is a malfunction in the Mercedes-Benz emergency call system (e.g. a malfunction with the speaker, microphone, airbag, SOS button), a corresponding message

appears in the multifunction display of the instrument cluster.

Triggering an automatic Mercedes-Benz emergency call Requirements

- The ignition is switched on.
- The starter battery is sufficiently charged.

The Mercedes-Benz emergency call system triggers an emergency call automatically in the following cases:

- After activation of the restraint systems such as airbags or Emergency Tensioning Devices after an accident.
- After an automatically initiated emergency stop by Active Emergency Stop Assist.

The emergency call has been made:

- A voice connection is made to the Mercedes-Benz emergency call center.
- A message with accident data is transmitted to the Mercedes-Benz emergency call center.

The Mercedes-Benz emergency call center can transmit the vehicle position data to one of the emergency call centers.

The SOS button in the overhead control panel flashes until the emergency call is finished.

It is not possible to immediately end an automatic emergency call.

If no connection can be made to the emergency services either, a corresponding message appears in the media display.

-  Dial the local emergency number on your mobile phone.

If an emergency call has been initiated:

- Remain in the vehicle if the road and traffic conditions permit you to do so until a voice connection is established with the emergency call center operator.
- Based on the call, the operator decides whether it is necessary to call rescue teams and/or the police to the accident site.
- If no vehicle occupant answers, an ambulance is sent to the vehicle immediately.

Triggering a manual Mercedes-Benz emergency call

- ▶ **To use the SOS button in the overhead control panel:** press the SOS button at least one second long .
- ▶ **To use voice control:** use the Voice Control System voice commands (→ page 303).

The emergency call has been made:

- A voice connection is made to the Mercedes-Benz emergency call center.
- A message with accident data is transmitted to the Mercedes-Benz emergency call center.

The Mercedes-Benz emergency call center can transmit the vehicle position data to one of the emergency call center.

- Remain in the vehicle if the road and traffic conditions permit you to do so until a voice connection is established with the emergency call center service provider.
- On the basis of the call, the service provider decides whether it is necessary to call rescue teams and/or the police to the accident site.

If no connection can be made to the emergency services either, a corresponding message appears in the media display.

- ▶ Dial the local emergency number on your mobile phone.

Ending an unintentionally triggered manual Mercedes-Benz emergency call

- ▶ Select  on the multifunction steering wheel. Depress the button for several seconds.

Data transfer of the Mercedes-Benz emergency call system

In the event of an automatic or manual emergency call the following data is transmitted, for example:

- Vehicle's GPS position data
- GPS position data on the route (a few (hundred meters)before the incident)
- Direction of travel
- Vehicle identification number
- Vehicle drive type

- Number of people determined to be in the vehicle
- Whether Mercedes me connect is available or not
- Whether the emergency call was initiated manually or automatically
- Time of the accident
- Language setting on the multimedia system

Data transmitted is vehicle information. For any questions about the collection, use and sharing of the eCall system data, please contact MBUSA's Customer Assistance Center at 800-FOR-MERC.

For Canada, please contact MBC's Customer Assistance Center at 1-800-387-0100.

Customer requests for covered information should be submitted via the same channels.

For accident clarification purposes, the following measures can be taken up to an hour after the emergency call has been initiated:

- The current vehicle position can be called up.

- A voice connection to the vehicle occupants can be established

Online and Internet functions

Internet connection

Information on connecting to the Internet

⚠ WARNING Risk of distraction from information systems and communications equipment

If you operate information and communication equipment integrated in the vehicle when driving, you will be distracted from the traffic situation. This could also cause you to lose control of the vehicle.

- ▶ Only operate this equipment when the traffic situation permits.
- ▶ If you cannot be sure of this, stop the vehicle whilst paying attention to road and traffic conditions and operate the equipment with the vehicle stationary.

You must observe the legal requirements for the country in which you are currently driving when operating the multimedia system.

⚠ WARNING Risk of an accident from operating mobile communication equipment while the vehicle is in motion

Mobile communications devices distract the driver from the traffic situation. This could also cause the driver to lose control of the vehicle.

- ▶ As the driver, only operate mobile communications devices when the vehicle is stationary.
- ▶ As a vehicle occupant, only use mobile communications devices in the areas intended for this purpose, e.g. in the rear passenger compartment.

You must observe the legal requirements for the country in which you are currently driving when operating mobile communication equipment in the vehicle.

The Internet functions can only be used to a limited degree whilst driving.

Function of the communication module

On vehicles with a built-in communication module, the Internet connection is established via an integrated SIM card.

To use Internet access via the communication module the following conditions must be met:

- Mercedes me connect is active and ready for operation.
- Mercedes me connect is activated for Internet access.
- In some countries: data volume via Mercedes me connect is available.

In some countries: if the data volume limit is reached, the availability of Mercedes me connect services is limited. The data volume must be purchased via Mercedes me connect.

- ① Contact an authorized Mercedes-Benz Center to find out whether it is possible to purchase data volume in your country.

Establishing an Internet connection

Multimedia system:

→ [Home] ▶ Mercedes me & Apps

▶ For example, select [Globe] **Browser**.

- ① The multimedia system usually establishes the Internet connection automatically. If the multimedia system is not connected to the Internet, the Internet connection is established when an Internet application is used.
- ① The availability of the function is dependent on the country.

Connection status

Connection status overview

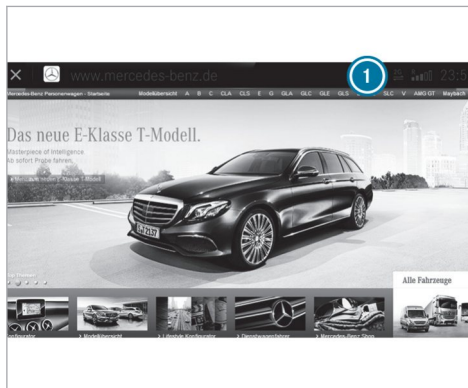

- ① Display of existing connection (double arrow) and reception field strength of the communication module

Displaying the connection status

Multimedia system:

→ [Home] ▶ Settings ▶ System

▶ Wi-Fi & Bluetooth

▶ Select **Internet Status**.

- ① In the case of a connection via the communication module the following status information is shown:
 - Type of network
 - Status online/offline

Web browser

Calling up a web page

⚠ WARNING Risk of distraction from information systems and communications equipment

If you operate information and communication equipment integrated in the vehicle when driving, you will be distracted from the traffic situation. This could also cause you to lose control of the vehicle.

- ▶ Only operate this equipment when the traffic situation permits.
- ▶ If you cannot be sure of this, stop the vehicle whilst paying attention to road and traffic conditions and operate the equipment with the vehicle stationary.

You must observe the legal requirements for the country in which you are currently driving when operating the multimedia system.

Multimedia system:

- ▶  ▶ Mercedes me & Apps
- ▶  Browser

Calling up a new web page

- ▶ Select .
- ▶ Entering a web address
- ▶ Select .
- ⓘ The function is country-dependent.
- ⓘ Websites cannot be shown while the vehicle is in motion.

Calling up a website from the browser history

- ▶ To call up the previous or next page from the history: select ◀ or ▶.

Web browser overview

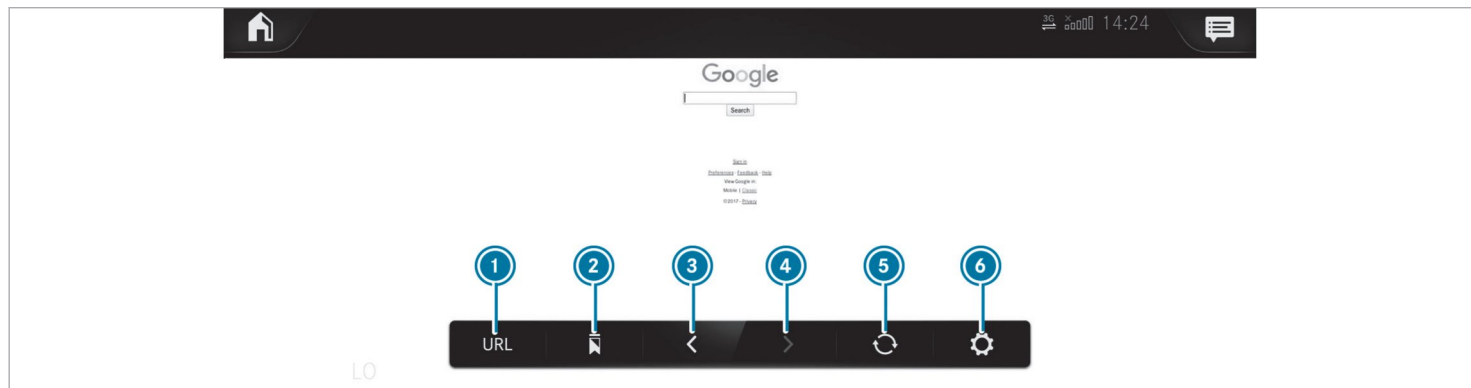

- ① URL entry
- ② Bookmarks
- ③ Web page, back
- ④ Web page, forwards
- ⑤ To refresh/stop
- ⑥ Options

Calling up web browser options

Multimedia system:



The following functions are available:

- [Bookmarks](#)
- [Options](#) with the settings:

- [Browser Settings](#)
- [Delete Browser Data](#)

- ▶ Select an option.
- ▶ Change the settings.

Calling up the web browser settings

Multimedia system:

- ▶ ▶ Mercedes me & Apps
- ▶ ▶ Browser ▶ ▶
- ▶ ▶ Browser Settings

The following functions are available:

- Block Pop-ups
- Activate Javascript
- Allow Cookies

- ▶ **To switch a function on:** activate the display button.
- ▶ **To switch a function off:** deactivate the display button.

Deleting Internet history

Multimedia system:

- ▶ ▶ Mercedes me & Apps
- ▶ ▶ Browser ▶ ▶
- ▶ ▶ Delete Browser Data

The following options are available:

- All
- Cache

- Cookies
- History
- Entered URLs
- Form Data

- ▶ Select an option.
- ▶ Select **Yes**.

Managing bookmarks

Multimedia system:

- ▶ ▶ Mercedes me & Apps
- ▶ ▶ Browser
- ▶ Select .

Selecting a bookmark

- ▶ Select an entry.

Creating a bookmark

- ▶ Select **Add Current Page to Bookmarks**.
The bookmark is created.

Editing a bookmark

- ▶ Select .
- ▶ Select **Edit**.

- ▶ Enter the name.
- ▶ Select **OK**.

Deleting a bookmark

- ▶ Select .
- ▶ Select **Delete**.
- ▶ Select **Yes**.

Closing the browser

Multimedia system:

- ▶ ▶ Mercedes me & Apps
- ▶ ▶ Browser
- ▶ Select .

Tuneln radio

Calling up Tuneln radio Requirements:

- The vehicle is connected with the Mercedes me account.
- The Tuneln radio service is activated in the Mercedes me portal.
- The data volume is available.

432 MBUX multimedia system

Depending on the country, data volume may need to be purchased.

- A fast Internet connection for data transmission free of interference.
- ① New data volumes can be purchased in the Mercedes me portal
- ① The functions and services are country-dependent. For more information, consult an authorized Mercedes-Benz Center.

Multimedia system:

→  → Radio

- ▶ Select **TuneIn Radio**.
The TuneIn menu appears. The last station set starts playing.
- ① The connection quality depends on the local mobile phone reception.

Overview of Tuneln radio

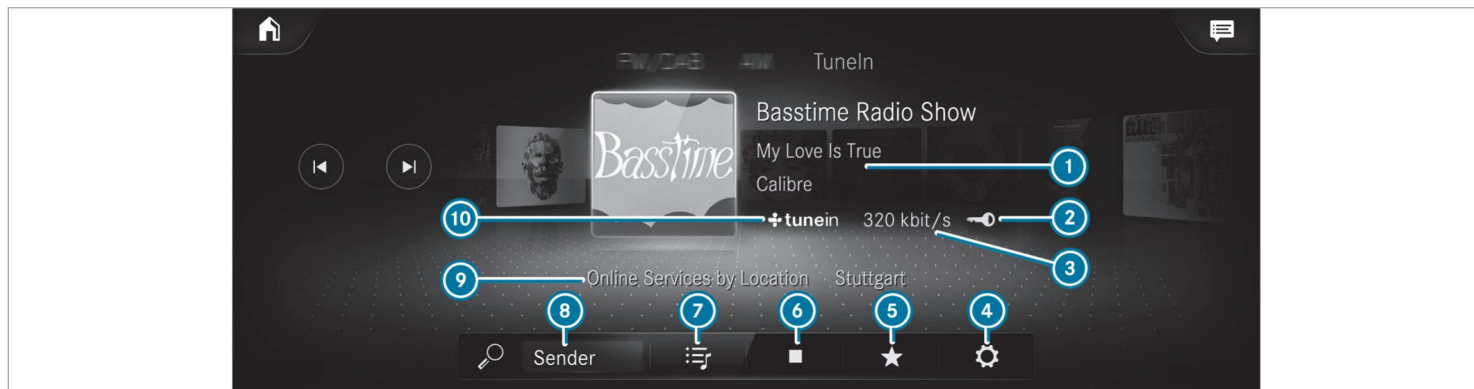

- | | |
|--|---------------------------|
| ① Additional information on the current station | ⑦ To browse |
| ② Display (if connected to private user account) | ⑧ Search |
| ③ Data transfer rate | ⑨ Selected category |
| ④ Options | ⑩ Internet Radio provider |
| ⑤ Favorites | |
| ⑥ To start/end | |

Selecting and connecting to a Tuneln radio station

Multimedia system:

→ → Radio → Tuneln Radio

- ▶ Select .
- ▶ Select a category.

- ▶ Select a station.
The connection is established automatically.
- or

- ▶ Select the search field.
- ▶ Enter a station name.

 A relatively large volume of data can be transmitted when using Tuneln radio.

Saving/deleting a Tuneln radio station as a favorite

Multimedia system:

 ▶▶ Radio ▶▶ Tuneln Radio

- ▶ Select a station.
- ▶ Select .
- ▶ The list of saved favorite stations appears.
- ▶ Select [Add to Favorites](#).

or

- ▶ Create an account for the online provider (Tuneln radio) and then log in on the multimedia system.
Your favorites are imported to the multimedia system.

Deleting favorites

- ▶ Select a station.
- ▶ Select .
- ▶ Select [Delete Favorite](#).

Setting the Tuneln radio options

Multimedia system:

 ▶▶ Radio ▶▶ Tuneln Radio ▶▶ 

▶▶ Tuneln Radio

The following options are available:

- [Select Stream](#): select the stream quality.
 - [Login to Tuneln Account](#): log in to your Tuneln user account.
 - [Log Out of Account](#): log out of your Tuneln user account.
- ▶ Select an option.

Showing the station list for the last category selected

Multimedia system:

 ▶▶ Radio ▶▶ Tuneln Radio

- ▶ Press the cover of the current station.
Depending on how the station was selected, a station list is shown.

Media

Information about media mode

Information about supported formats and data storage media

 **WARNING** Risk of distraction when handling data storage media

If you handle a data storage medium while driving, your attention is diverted from the traffic conditions. This could also cause you to lose control of the vehicle.

- ▶ Only handle a data storage medium when the vehicle is stationary.

The multimedia system supports the following formats and data media:

Permissible file systems	FAT32, exFAT, NTFS
Permissible data carriers	USB devices, iPod®/iPhone®, MTP devices, Bluetooth® audio equipment
Supported audio formats	MP3, WMA, AAC, WAV, FLAC, ALAC

i Observe the following notes:

- The multimedia system supports a total of up to 50,000 files.
- Data storage media up to 2 TB are supported (32-bit address space).
- Due to the large variety of available music and video files regarding encoders, sampling rates and data transfer rates, playback cannot be guaranteed.

- Due to the wide range of USB devices available on the market, playback cannot be guaranteed for all USB devices.
- Videos up to FullHD (1920x1080) are supported.
- Copy-protected music and video files or DRM (Digital Rights Management) encrypted files cannot be played back.
- MP3 players must support Media Transfer Protocol (MTP).

Information on copyright protection and trademarks

Audio files which you create yourself (e.g. copies of data storage media you make yourself) are generally subject to copyright protection. In many countries, reproductions are not permitted without the prior consent of the copyright holder, even for private use. Make sure that you know about the applicable copyright regulations and that you comply with these.



Manufactured under license from Dolby Laboratories. Dolby, Dolby Audio and the double-D symbol are trademarks of Dolby Laboratories.



TIDAL and TIDAL logo are registered trademark of Aspiro AB in the European Union and other countries.

Overview of the media menu

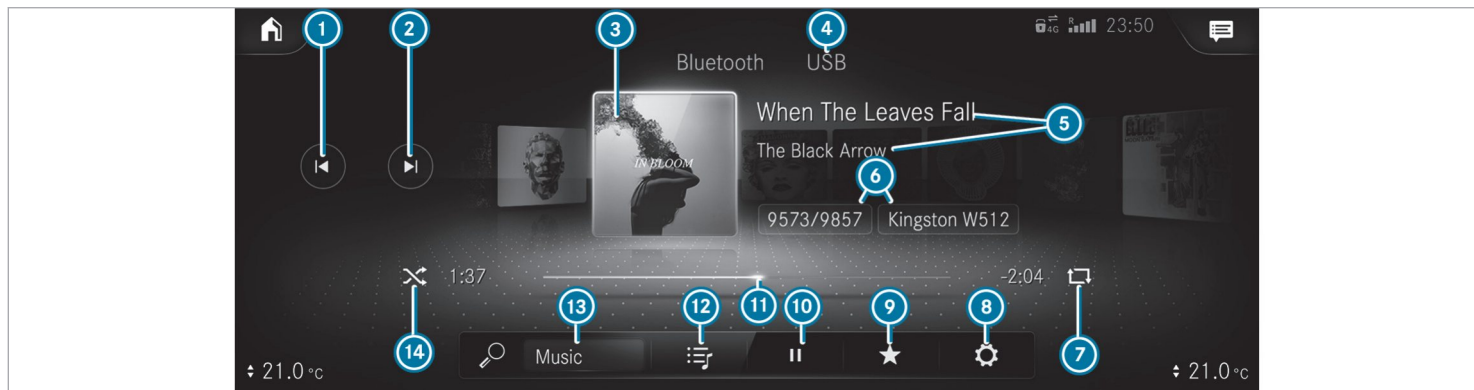

① Previous track or fast rewind

② Next track or fast forward

③ Album cover

④ Active media source

⑤ Track and artist

⑥ Current track number/track in playback list and active data storage medium

⑦ Repeat

⑧ Settings

⑨ Additional options

⑩ Controls playback

⑪ Timeline

⑫ Categories

⑬ Music search

⑭ Random playback

Connecting the data storage medium to the multimedia system

Connecting USB devices

! **NOTE** Damage caused by high temperatures

High temperatures can damage USB devices.

- ▶ Remove the USB device after use and take it out of the vehicle.

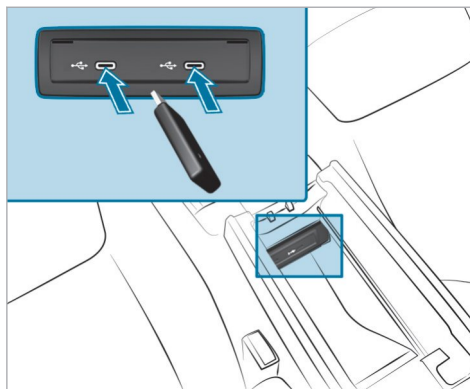

The multimedia connection unit is found in the stowage compartment under the armrest and has two type C USB ports. Depending on the vehicle's equipment, additional USB ports can be found in the stowage compartment of the center console or rear folding compartment.

- ▶ Connect the USB device to the USB port.

i USB hubs cannot be connected with the multimedia system.

i When connecting several Apple® devices simultaneously, pay attention to the order in which the devices are connected. The multimedia system only connects with the device that is connected first. Additional Apple® devices that are connected at the same time are only supplied with power.

Searching for and authorizing a Bluetooth® audio device

Requirements:

- Bluetooth® is activated on the multimedia system and audio equipment.
- The audio equipment supports the Bluetooth® audio profiles A2DP and AVRCP.
- The audio equipment is "visible" for other devices.

Multimedia system:



Authorizing a new Bluetooth® audio device

- ▶ Select **Connect New Device**.
Detected equipment is displayed in the device list.
- ▶ Select an audio device.
Authorization starts. A code is displayed on the multimedia system and on the mobile phone.
- ▶ If the codes are identical, confirm on the audio equipment.
- ▶ Select **Only as Bluetooth Audio Device**.
The Bluetooth® audio equipment is connected with the multimedia system.

Connecting previously authorized Bluetooth® audio equipment

- ▶ Select a Bluetooth® audio device from the list.
The connection is established.

Starting media playback

Requirements:

- A data storage medium is connected to the multimedia system.

Multimedia system:





- ▶ Select **USB** or **Bluetooth** as the media source.

Controlling media playback

Multimedia system:







- ▶ **To pause playback:** select .
- ▶ **To continue playback:** select .
- ▶ **To repeat a track:** select .

For the repeat function there are the following settings:

- **Select once:** the active playlist is repeated.

- **Select twice:** the current track is repeated.

- **Select three times:** the repeat function is deactivated.

- ▶ **To play back tracks in random order:** select .
- ▶ **To wind a track forwards or backwards:** tap on the desired point on the timeline.
- ▶ **To select the next track:** select .
- ▶ **To select the previous track:** select .
- ▶ **To scroll through tracks quickly:** press and hold  or .
- ▶ **To show the current track list:** select the track image shown.

Additional options for setting media playback

Multimedia system:



Calling up additional options

- ▶ Select . The additional options are shown.

The following options are available:

- [Surprise Mix](#)
A playlist with randomly selected tracks is created.
- [Add to Favorite Songs](#)
The current track is added to the favorite songs.
- [Remove from Favorite Songs](#)
The current track is removed from the favorite songs.
- ▶ Select an option.

Media search

Notes about the search function in categories

Under  you can search through all available media files. There are several categories available for selection. The categories shown depend on the connected device and data format.

Available categories with Bluetooth® audio:

- [Current Tracklist](#)
The folders and categories of the connected device are shown.

Available categories with audio files:

- [Current Tracklist](#)
- [Playlists](#)
- [Folder](#)
- [Albums](#)
- [Artists](#)
- [Tracks](#)
- [Favorite Songs](#)
- [Often Played](#)
- [Most Recently Added](#)

- [Music Genres](#)
- [Year](#)
- [Composers](#)
- [Select By Cover](#)
- [Podcasts](#) (Apple® devices)
- [Audiobooks](#) (Apple® devices)

Available categories with video files:

- [Folder](#)
- [Videos](#)

 The categories are available as soon as the entire media content has been read in and analyzed.



Starting a search in categories

Multimedia system:



- ▶ Select a category.
- ▶ Select  and enter a search term.

Sorting results shown or playing back all media found

- ▶ Select .
 - ▶ **To play back all results found in the category:** select [Play All](#).
If, for example, the [Albums](#) category is active, all albums found by the desired artist will be played back.
 - ▶ **To sort results alphabetically:** select [Sort from A-Z](#).
 - ▶ **To sort results in reverse alphabetical order:** select [Sort from Z-A](#).
-  The available options depend on the selected category and the connected device.

Using the keyword search

Multimedia system:

  [Media](#)

You can look for content using the keyword search with free text input.

- ▶ Select .
- ▶ A keyboard for character entry appears.
- ▶ Enter the term searched for.

-  The search begins with the first character entered. The more characters entered the more concrete the search results become.
- ▶ Select the desired entry from the result list. If the selected result is an album, song or a playback list then playback is started. If the selected result is a new category then this is opened in the search.

Radio

Switching on the radio

Multimedia system:

  [Radio](#)

- ▶ Alternatively: press the  button.
The radio display appears. You will hear the last station played on the last frequency band selected.

Radio overview

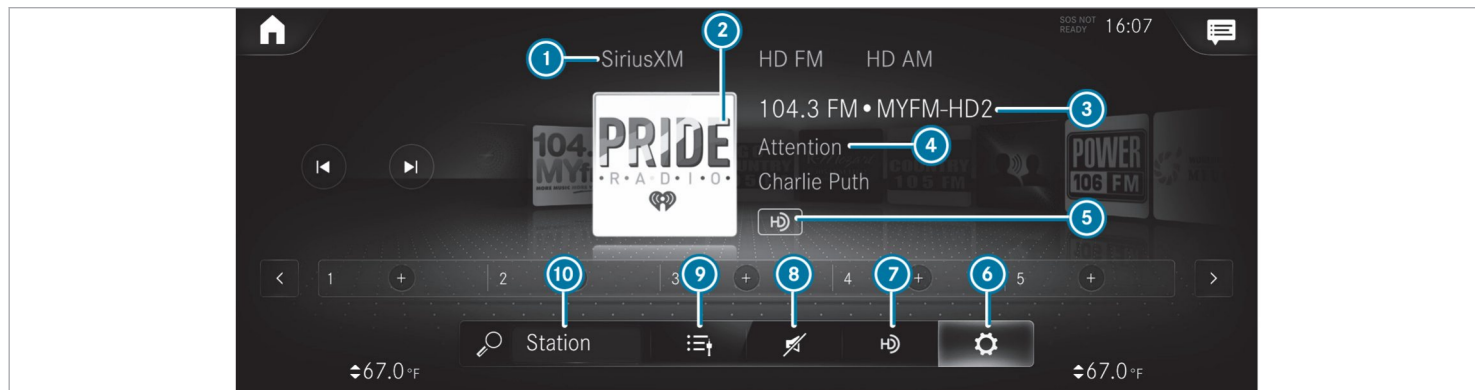

- ① Selects an active frequency band
- ② Station logo
- ③ Station name or set frequency
- ④ Artist, title, album and radio text
- ⑤ HD Radio logo
- ⑥ Options
- ⑦ Switches the HD Radio function on or off
- ⑧ Mute function
- ⑨ Calls up the station list
- ⑩ Search

Switching the HD Radio function on/off

Multimedia system:

→ [Home] » Radio » HD FM



▶ Switch **HD** on or off.

ⓘ HD Radio Technology manufactured under license from iBiquity Digital Corporation. U.S. and Foreign Patents. For patents see DTS website. HD Radio and the HD, HD Radio, and "ARC" logos are registered trademarks or trademarks of iBiquity Digital Corporation in the United States and/or other countries.

Setting the waveband

Multimedia system:

→ [Home] » Radio

The following frequency bands are available:

- SiriusXM
- HD FM
- HD AM

▶ Select a frequency band.

Selecting a radio station

Multimedia system:

→ [Home] » Radio

▶ Swipe to the left or right on the control element.

Calling up the radio station list

Multimedia system:

→ [Home] » Radio

- ▶ Select [List].
The station list appears.
- ▶ Select a station.

Searching for radio stations using station names or frequency entry

Multimedia system:

→ [Home] » Radio

- ▶ Select [Search].
- ▶ Enter a station name or frequency.
- ▶ Select a station.

Storing radio stations

Multimedia system:

→ [Home] » Radio

- ▶ Select a radio station.

Memory slots are available in station presets

- ▶ Select .
- or
- ▶ Press and hold on the radio station.

Replacing an entry in the station presets

- ▶ Press and hold on an entry in the station presets.
- ▶ Select **Yes**.

Editing station presets

Multimedia system:

**Moving stations**

- ▶ Press and hold a stored station.
- ▶ Select **Move**.
- ▶ Move the station to the new position.

Deleting stations

- ▶ Press and hold a station.
- ▶ Select **Delete**.

Replacing a station

- ▶ Press and hold a station.
- ▶ Select **Replace Radio Station**.

Showing accident reports

Multimedia system:



- ▶  The availability of the function is dependent on the country.
- ▶ Switch **Display Emergency Warnings** on or off.

Displaying radio text

Multimedia system:



- ▶ Switch **Radio Text Information** on or off.

Satellite radio**Information on the satellite radio**

SIRIUS XM[®] satellite radio offers more than 175 digital-quality radio channels providing 100% commercial-free music, sports, news and entertainment, for example. SIRIUS XM satellite radio employs a fleet of high-performance satellites to broadcast around the clock throughout the USA and Canada. The satellite radio program is available for a monthly fee. Information about this can be obtained from a Sirius XM[®] Service Center and at <http://www.siriusxm.com> (USA) or <http://www.siriusxm.ca> (Canada).

- ▶  Sirius, XM and all related marks and logos are trademarks of Sirius XM Radio Inc. and its subsidiaries. All other marks, channel names and logos are the property of their respective owners. All rights reserved.

Satellite radio restrictions

Satellite radio mode may be temporarily unavailable or interrupted for a variety of reasons. These include environmental or topographical conditions beyond the control of Mercedes-Benz

USA, LLC. Thus, operation at certain locations may not be possible.

Registering satellite radio

Requirements:

- Satellite radio equipment is available.
- Registration with a satellite radio provider has been completed.
- If registration is not included when purchasing the system, your credit card details will be required to activate your account

Multimedia system:

Radio >> SiriusXM
 >> Options

Select **Service Information**.

The service information screen appears showing the radio ID and the current subscription status.

Establish a telephone connection.

Follow the service staff's instructions.

The activation process may take up to ten minutes.

- You can also have the satellite service activated online. To do so, please visit <http://www.siriusxm.com> (USA) or <http://www.siriusxm.ca> (Canada).

Switching on satellite radio

Multimedia system:

Radio

- Select **SiriusXM**.

Overview of the satellite radio



- ① Active frequency band
- ② Logo or album art (if available)
- ③ Channel name
- ④ Track information
- ⑤ Traffic & Weather Now and Sports Flash
- ⑥ Options
- ⑦ Shows or hides playback controls

- ⑧ Stops playback controls
- ⑨ Station list
- ⑩ Search

Selecting a satellite radio category

Multimedia system:

- ▶ Select .
- ▶ Select **Category**.
- ▶ Select a category.

Selecting a satellite radio channel

Multimedia system:

→  »  Radio » SiriusXM



Select .

- ▶ Select a channel.

Saving or deleting a satellite radio channel

Multimedia system:

→  » Radio » SiriusXM

Storing the current channel

- ▶ Press and hold the logo of the current station until the Options menu appears.
- ▶ Select **Add to Presets**.

Moving a channel

- ▶ Press and hold a channel in the presets until the Options menu appears.
- ▶ Select **Move Highlighted Station**.
- ▶ Move the channel to a new position.

Deleting a channel

- ▶ Press and hold a channel in the presets until the Options menu appears.
- ▶ Select **Delete Highlighted Station**.

Displaying EPG information for the current channel

Multimedia system:

→  »  Radio » SiriusXM
» 

- ▶ Select **Electr. Program Guide**.

Setting parental control for radio

Multimedia system:

→  »  Radio » SiriusXM
» 

- ▶ Select **Parental Control**.
- ▶ Determine a four-digit character sequence and select **ok**.
All channels with adult content are locked.

Unlocking a channel

- ▶ Enter the four-digit character sequence and select **ok**.
All channels with adult content are unlocked.

Music and sport alerts function

This function enables you to program an alert for your favorite artists, tracks or sporting events. Music alerts can be saved whilst a track is being played and sport alerts can be saved during a live game. You can also specify sport alerts via the menu option. The system then continuously searches through all the channels. If a match is found with a stored alert, you will be informed.

Setting music and sport alerts

Multimedia system:

→  » Radio » SiriusXM » 
» Alerts

Activating the music information function

- ▶ Activate **Music Alerts** .

Setting a music alert

- ▶ Select **Add Alert**.

- ▶ Select [Artists](#) or [Song](#) in the dialog window. The alert is set for the current artist or track. If a match is found, a prompt appears asking whether you wish to change to the station.

Activating sports information

- ▶ Activate [Activate Sports Alerts](#).

Setting a sport alert

- ▶ Select [Add Alert](#).
- ▶ Select the team name or league in the dialog window.

Deleting individual sports and music alerts

- ▶ Select [Manage Music Alerts](#).

or

- ▶ Select [Manage Sports Alerts](#).
- ▶ Select an artist or track.

or

- ▶ Select a team.
- ▶ Select [Delete Selected Entries](#). All highlighted alerts are deleted.

Deleting all sports and music alerts

- ▶ Select [Manage Music Alerts](#).

or

- ▶ Select [Manage Sports Alerts](#).
- ▶ Select [Delete All Entries](#). All alerts are deleted.

Information about Smart Favorites and TuneStart

From the station presets you can set up to eight stations as Smart Favorites. Smart Favorites stations are automatically saved to temporary storage in the background. If you change to a Smart Favorites station, you can replay, pause or actively skip forward or back to broadcasts which you have missed. If Tune Start is activated and you change to another Smart Favorites station, the music track currently playing on the station is automatically restarted from the beginning of the track.

Adding a channel to Smart Favorites

Multimedia system:

➔  ➔ [Radio](#) ➔ [SiriusXM](#)

- ▶ Press and hold on the station logo until the Options menu appears.
- ▶ **To add a channel:** select [Add to Smart Favorites](#) in the menu.
- ▶ **To remove a channel:** select [Delete from Smart Favorites](#) in the menu.

Creating a TuneMix list

Multimedia system:

➔  ➔  [Radio](#) ➔ [SiriusXM](#)
 ➔  ➔ [TuneMix Lists](#)

In order to listen to seamless music, you can put together a TuneMix list from various stations.

- ▶ Select [Create TuneMix List](#).
- ▶ If necessary, limit the number of stations shown using the [Category](#) entry.
- ▶ Select the station shown .
- ▶ Press  to confirm. A TuneMix station logo is created in the radio menu.

Activating/deactivating TuneStart

Multimedia system:



- ▶ Switch **TuneStart** on or off.

Switching on satellite radio playback control

Multimedia system:



You can pause the playback of the current station or skip forward or backward in the timeline. This leaves live mode to access the internal temporary storage.

- ▶ **To show the timeline:** press
- ▶ **To fast forward/rewind:** tap anywhere on the timeline.
- ▶ **To pause playback:** select
- ▶ **To return to live mode:** navigate to the end of the timeline.

Displaying satellite radio service information

Multimedia system:



- ▶ Select **Service Information**.

Sound

Tone settings

Information about the sound system

The sound system has a total output of 125 W and is equipped with seven speakers. It is available for all functions in the radio and media modes.

Calling up the sound menu

Multimedia system:



The following functions are available:

- Equalizer
 - Balance and Fader
 - Volume
- ▶ Select a function.

Adjusting treble, mid-range and bass settings

Multimedia system:



- ▶ Set **TREBLE**, **MID** or **BASS**.

Activating/deactivating automatic volume adjustment

Multimedia system:



Automatic volume adjustment compensates for differing volumes when changing between audio sources and within an audio source.

- ▶ Switch **Automatic Adjustment** on or off.

Adjusting the balance/fader

Multimedia system:

  **Media**  **Sound**
Balance and Fader

Adjusting the balance

- ▶ Move the volume distribution between the right and left sides of the vehicle in the grid shown.
The volume is distributed between the speakers on the left and right sides in the vehicle.

Adjusting the fader

- ▶ Move the volume distribution between the front and rear of the vehicle in the grid shown.
The volume is distributed between the speakers in the front and rear of the vehicle.

Burmester® surround sound system

Information about the Burmester® surround sound system

The Burmester® surround sound system has a total output of 590 W and is equipped with 13

speakers. It is available for all functions in the radio and media modes.

Calling up the sound menu in the Burmester® surround sound system

Multimedia system:

  **Media**  **Burmester**

The following functions are available:

- Equalizer
- Balance and Fader
- Sound Focus
- Sound Profiles
- Volume

- ▶ Select a function.

Adjusting the treble, mid and bass settings on the Burmester® surround sound system

Multimedia system:

  **Media**  **Burmester**

Equalizer

- ▶ Set **TREBLE**, **MID** or **BASS**.

Activating/deactivating volume adjustment in the Burmester® surround sound system

Multimedia system:

  **Media**  **Burmester**
Volume

Automatic volume adjustment compensates for differing volumes when changing between audio sources and within an audio source.

- ▶ Switch **Automatic Adjustment** on or off.

Adjusting the balance/fader in the Burmester® surround sound system

Multimedia system:

  **Media**  **Burmester**
Balance and Fader

Adjusting the balance

- ▶ Move the volume distribution between the right and left sides of the vehicle in the grid shown.
The volume is distributed between the speakers on the left and right sides in the vehicle.

Adjusting the fader

- ▶ Move the volume distribution between the front and rear of the vehicle in the grid shown.
The volume is distributed between the speakers in the front and rear of the vehicle.

Selecting a sound profile in the Burmester® surround sound system

Multimedia system:

-  ▶ Media ▶  ▶ Burmester
- ▶ Sound Profiles

The following profiles are available:

- Pure
 - Surround
- ▶ Select a sound profile.

Adjusting the sound focus in the Burmester® surround sound system

Multimedia system:

-  ▶ Media ▶  ▶ Burmester
- ▶ Sound Focus

- ▶ Select a position for the sound focus or **All Seats**.

MBUX rear tablet

Overview of the MBUX rear tablet

- ⚠ **WARNING** Risk of an accident from operating mobile communication equipment while the vehicle is in motion

Mobile communications devices distract the driver from the traffic situation. This could also cause the driver to lose control of the vehicle.

- ▶ As the driver, only operate mobile communications devices when the vehicle is stationary.
- ▶ As a vehicle occupant, only use mobile communications devices in the areas

intended for this purpose, e.g. in the rear passenger compartment.

- ⚠ **WARNING** Risk of distraction from operating the multimedia system with the MBUX rear tablet

Other vehicle occupant can make changes to the multimedia system with the MBUX rear tablet, e.g. adjust the volume of the multimedia system, change radio station or adjust die ambient lighting.

The driver could be distracted from the traffic situation by undesired changes and thereby cause an accident.

- ▶ If required lock access of the MBUX rear tablet to the multimedia system.
- ▶ Activate the child safety lock in the multimedia system to limit operation of the MBUX rear tablets.

⚠ WARNING Risk of becoming trapped through operation of the MBUX rear tablet outside the vehicle

If the MBUX rear tablet is operated outside the vehicle, seats can be moved using the seat control. Vehicle occupants and animals could become trapped by the seat adjustment.

- ▶ Only operate the seat control when inside the vehicle.

⚠ WARNING Risk of injury as a result of the MBUX rear tablet not being secured in the vehicle

If the MBUX rear tablet is loose in the vehicle interior, it could be thrown around and thereby hit vehicle occupants.

- ▶ Always securely lock the MBUX rear tablet in the bracket intended for that purpose.

The MBUX rear tablet consists of a tablet (→ page 452) and a bracket integrated in the backrest (→ page 453).

If the tablet has been paired with the multimedia system, the MBUX rear tablet can make settings on the multimedia system from the rear passenger compartment.

- ⓘ The function of operating the multimedia system with the paired tablet, can be blocked in the multimedia system.

The MBUX rear tablet can also be used outside the vehicle.

Overview of the MBUX rear tablet

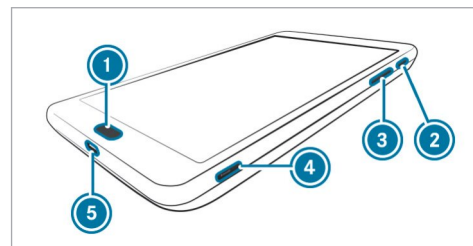

- ① Home button
- ② On/off button
- ③ Louder/quieter button
- ④ SD card slot
- ⑤ USB port

The MBUX rear tablet is an Android Samsung tablet. The vehicle's multimedia system can be operated with the MBUX rear tablet. Operation of the tablet is carried out using the touch display (see the manufacturer's operating instructions).

The MBUX rear tablet can also be used without the vehicle.

- ❶ Do not make any changes to the seat settings or multimedia system with the MBUX rear tablet when outside the vehicle.
- ❷ You can update the tablet operating system in the device settings (see the manufacturer's operating instructions). An Internet connection is required for the update, for example using the private network at home. Updates can also be installed at an authorized Mercedes-Benz Center. Software from the manufacturer can also be used to download and install updates (see the manufacturer's Internet page).

Overview of the MBUX rear tablet bracket

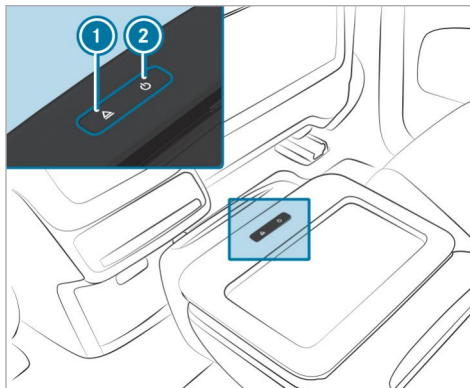

- ❶ Releases the MBUX rear tablet from the bracket
- ❷ Pressing and holding the button: switches the MBUX rear tablet on or off
Pressing the button briefly: activates or deactivates the screen of the MBUX rear tablet

The MBUX rear tablet is charged when it is locked into the bracket.

- ❶ If it is not being used during the journey, lock the MBUX rear tablet in the holder designed for this purpose.

ASSYST PLUS service interval display

Function of the ASSYST PLUS service interval display

The ASSYST PLUS service interval display on the Instrument Display provides information on the remaining time or distance before the next service due date.

You can hide this service display using the back button on the left-hand side of the steering wheel.

Depending on how the vehicle is used, the ASSYST PLUS service interval display may shorten the service interval, e.g. in the following cases:

- Mainly short-distance driving
- When the engine is often left idling for long periods
- In the event of frequent cold start phases

Mercedes-Benz recommends avoiding such operating conditions.

You can obtain information concerning the servicing of your vehicle from a qualified specialist

workshop, e.g. an authorized Mercedes-Benz Center.

Displaying the service due date

On-board computer:

↪ Service ▶ ASSYST PLUS

The next service due date is displayed.

▶ **To exit the display:** press the back button on the left-hand side of the steering wheel.

Be sure to also pay attention to the following related topic:

- Operating the on-board computer (→ page 281).

Information on regular maintenance work

! **NOTE** Premature wear through failure to observe service due dates

Service work which is not carried out at the right time or incompletely can lead to increased wear and damage to the vehicle.

- ▶ Always observe the prescribed service intervals.
- ▶ Always have the prescribed service work carried out at a qualified specialist workshop.

Special service requirements

The prescribed service interval is based on normal operation of the vehicle. Maintenance work will need to be performed more often if the vehicle is operated under arduous conditions or increased loads.

The ASSYST PLUS service interval display is only an aid. The driver of the vehicle bears responsibility as regards to whether maintenance work needs to be performed more often than specified based on the actual operating conditions and/or loads.

Examples of arduous operating conditions:

- regular city driving with frequent intermediate stops
- mainly short-distance driving

- frequent operation in mountainous terrain or on poor road surfaces
- when the engine is often left idling for long periods
- operation in particularly dusty conditions and/or if air-recirculation mode is frequently used

In these or similar operating conditions, have the interior air filter, engine air cleaner, engine oil and oil filter etc. changed more frequently. The tires must be checked more frequently if the vehicle is operated under increased loads. Further information can be obtained at a qualified specialist workshop.

Battery disconnection periods

The ASSYST PLUS service interval display can only calculate the service due date when the battery is connected.

- ▶ Note down the service due date displayed on the instrument display before disconnecting the battery (→ page 454).

Engine compartment

Opening/closing the hood

⚠ WARNING Risk of accident if the engine hood is unlatched while driving

An unlocked engine hood may open up when the vehicle is in motion and block your view.

- ▶ Never unlatch the engine hood while driving.
- ▶ Before every trip, ensure that the engine hood is latched.

⚠ WARNING Risk of accident and injury when opening and closing the engine hood

When opening or closing the engine hood, it may suddenly drop into the end position.

There is a risk of injury for anyone in the engine hood's range of movement.

- ▶ Only open or close the engine hood when there are no persons in the engine hood's range of movement.

⚠ WARNING Danger of burns when opening the hood

If you open the hood when the engine has overheated or during a fire in the engine compartment, you could come into contact with hot gases or other escaping operating fluids.

- ▶ Before opening the hood, allow the engine to cool down.
- ▶ In the event of a fire in the engine compartment, keep the hood closed and call the fire service.

⚠ WARNING Risk of injury due to moving parts

Certain components in the engine compartment may continue to move or suddenly move again even after the ignition has been switched off, e.g. the cooler fan.

Make sure of the following before performing tasks in the engine compartment:

- ▶ Switch the ignition off.

- ▶ Never touch the danger zone surrounding moving component parts, e.g. the rotation area of the fan.
- ▶ Remove jewelry and watches.
- ▶ Keep items of clothing and hair away from moving parts.

⚠ WARNING Risk of injury from touching component parts under voltage

The ignition system and the fuel injection system work under high voltage. If you touch component parts which are under voltage, you could receive an electric shock.

- ▶ Never touch component parts of the ignition system or the fuel injection system when the ignition is switched on.

⚠ WARNING Risk of burns from hot component parts in the engine compartment

Certain components in the engine compartment can be very hot, e.g. the engine, the radiator and parts of the exhaust system.

- ▶ Allow the engine to cool down and only touch component parts described in the following.

⚠ WARNING Risk of injury from using the windshield wipers while the engine hood is open

When the engine hood is open and the windshield wipers are set in motion, you can be trapped by the wiper linkage.

- ▶ Always switch off the windshield wipers and ignition before opening the engine hood.

Opening the hood

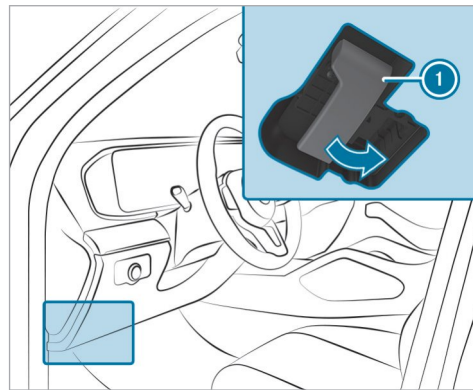

- ▶ To release the hood, pull on handle ①.

Closing the hood

! **NOTE** Damage to the hood

If the hood is closed manually, there is a risk of dents.

- ▶ Do not close the hood manually.

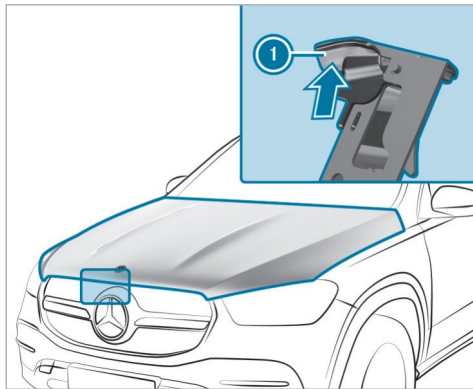

- ▶ Push handle ① of the hood catch upwards and lift the hood by approximately 15 in (40 cm).
- ▶ Lower the hood to a height of around 8 in (20 cm) and then allow it to fall, applying a little force as you let it go.

- ▶ If the hood can still be lifted slightly, open the hood again and close it with a little more force until it engages correctly.

Engine oil

Checking the engine oil level using the on-board computer Requirements:

- The engine has warmed up.
- The vehicle is parked on a level surface.
- The engine is running at idle speed.

The engine oil level is determined during driving. Determining the engine oil level can take up to 30 minutes with a normal driving style and even longer with an active driving style.

On-board computer:

➔ Service ➔ Engine Oil Level

You will see one of the following messages on the multifunction display:

- **Measuring Engine Oil Level...:** measurement of the oil level is not yet possible.

- ▶ Repeat the request after a maximum of 30 minutes driving.
 - **Engine Oil Level OK** and the bar display for indicating the oil level on the multifunction display is green and is between "min" and "max": the oil level is correct.
 - **Engine Oil Level Add 1,1 qts.** and the bar display for indicating the oil level on the multifunction display is orange and is below "min":
 - ▶ Add 1.1 US qt (1 l) of engine oil.
 - **Reduce Engine Oil Level** and the bar display for indicating the oil level on the multifunction display is orange and is above "max":
 - ▶ Drain off any excess engine oil that has been added. To do so, consult a qualified specialist workshop.
 - **For Engine Oil Level Switch Ignition On:**
 - ▶ Switch on the ignition to check the engine oil level.
 - **Engine Oil Level System Inoperative:** sensor faulty or not inserted.

- ▶ Consult a qualified specialist workshop.
 - [Engine Oil Level System Currently Unavail.:](#)
- ▶ Close the hood.

Refilling engine oil

⚠ WARNING Risk of burns from hot component parts in the engine compartment

Certain components in the engine compartment can be very hot, e.g. the engine, the radiator and parts of the exhaust system.

- ▶ Allow the engine to cool down and only touch component parts described in the following.

⚠ WARNING Risk of fire and injury from engine oil

If engine oil comes into contact with hot component parts in the engine compartment, it may ignite.

- ▶ Make sure that no engine oil is spilled next to the filler opening.

- ▶ Allow the engine to cool off and thoroughly clean the engine oil from component parts before starting the vehicle.

! NOTE Engine damage caused by an incorrect oil filter, incorrect oil or additives

- ▶ Do not use engine oils or oil filters which do not correspond to the specifications explicitly prescribed for the service intervals.
- ▶ Do not alter the engine oil or oil filter in order to achieve longer change intervals than prescribed.
- ▶ Do not use additives.
- ▶ Follow the instructions in the service interval display regarding the oil change.

! NOTE Damage caused by refilling too much engine oil

Too much engine oil can damage the engine or the catalytic converter.

- ▶ Have excess engine oil removed at a qualified specialist workshop.

i Depending on the engine, the cap may be installed in the engine compartment in different locations.

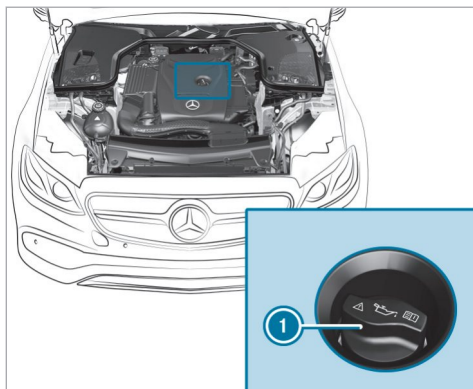

- ▶ Turn cap ① counter-clockwise and remove it.
- ▶ Add engine oil.
- ▶ Replace cap ① and turn it clockwise as far as it will go.
- ▶ Check the oil level again (→ page 457).

Checking coolant level

⚠ WARNING Risk of burns from hot component parts in the engine compartment

Certain components in the engine compartment can be very hot, e.g. the engine, the radiator and parts of the exhaust system.

- ▶ Allow the engine to cool down and only touch component parts described in the following.

⚠ WARNING Risk of scalding from hot coolant

The engine cooling system is pressurized, particularly when the engine is warm. If you open the cap, you could be scalded by hot coolant spraying out.

- ▶ Let the engine cool down before opening the cap.
- ▶ When opening the cap, wear protective gloves and safety glasses.
- ▶ Open the cap slowly to release pressure.

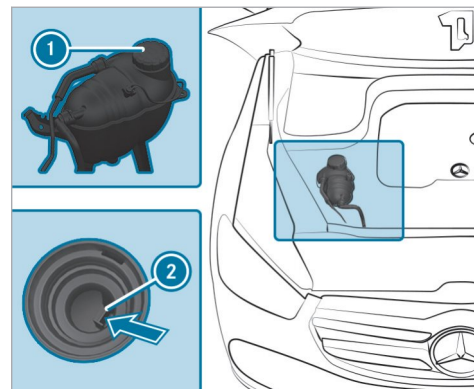

- ▶ Park the vehicle on a level surface.
- ▶ Check the coolant temperature display in the instrument cluster. The coolant temperature must be in the bottom quarter of the temperature display.
- ▶ Slowly turn cap ① counter-clockwise to relieve overpressure.

- ▶ Continue turning cap ① counter-clockwise and remove it.

The coolant level is correct in the following cases:

- If the engine is cold, up to marker bar ②
 - If the engine is warm, up to 0.6 in (1.5 cm) over marker bar ②
- ▶ If necessary, add coolant that has been approved for Mercedes-Benz.
- Further information on coolant (→ page 533)

Adding washer fluid to the windshield washer system

⚠ WARNING Risk of burns from hot component parts in the engine compartment

Certain components in the engine compartment can be very hot, e.g. the engine, the radiator and parts of the exhaust system.

- ▶ Allow the engine to cool down and only touch component parts described in the following.

⚠ WARNING Danger of burns when opening the hood

If you open the hood when the engine has overheated or during a fire in the engine compartment, you could come into contact with hot gases or other escaping operating fluids.

- ▶ Before opening the hood, allow the engine to cool down.
- ▶ In the event of a fire in the engine compartment, keep the hood closed and call the fire service.

⚠ WARNING - Risk of fire and injury from windshield washer concentrate

Windshield washer concentrate is highly flammable. It could ignite if it comes into contact with hot engine component parts or the exhaust system.

- ▶ Make sure that no windshield washer concentrate spills out next to the filler opening.

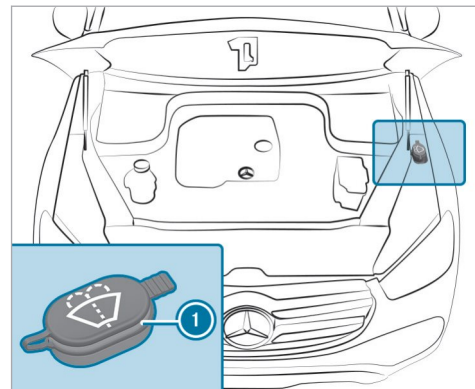

- ▶ Remove cap ① by the tab.
- ▶ Add washer fluid.
- Further information about the washer fluid (→ page 534)

Keeping the air-water duct free

- ▶ Keep the area between the hood and the windshield free of deposits, e.g. ice, snow and leaves.

Cleaning and care

Notes on washing the vehicle in a car wash

⚠ WARNING Risk of accident due to reduced braking effect after washing the vehicle

The braking effect is reduced after washing the vehicle.

- ▶ After the vehicle has been washed, brake carefully while paying attention to the traffic conditions until the braking effect has been fully restored.

! **NOTE** Damage due to unsuitable car wash

- ▶ Before driving into a car wash make sure that the car wash is suitable for the vehicle dimensions.
- ▶ Ensure there is sufficient ground clearance between the underbody and the guide rails of the car wash.
- ▶ Ensure that the clearance width of the car wash, in particular the width of the guide rails, is sufficient.

To avoid damage to your vehicle when using a car wash, ensure the following beforehand:

- Active Distance Assist DISTRONIC and the HOLD function are deactivated.
- the 360° Camera or the rear view camera is switched off.
- the side windows and sliding sunroof are completely closed.
- the outside mirrors are folded in.
- the blower for the ventilation/heating is switched off.

- the windshield wiper switch is in position **0**.
- the SmartKey is at a minimum distance of 10 ft (3 m) away from the vehicle, otherwise the tailgate could open unintentionally.
- in car washes with a conveyor system: neutral **N** is engaged.
- ① Drive straight and in the center of the guide rails of the car wash to prevent damage to the tires and rims.
- ① In car washes with a conveyor system: if you would like to leave the vehicle while it is being washed, make sure the SmartKey is located in the vehicle. The park position **P** is otherwise automatically engaged.
- ① If, after the car wash, you remove the wax from the windshield and wiper rubbers, this will prevent smearing and reduce wiper noise.

Automatic car wash mode

In car wash mode, the vehicle is prepared for driving into the automatic car wash. Car wash mode can be activated at a speed of up to 12 mph (20 km/h) (→ page 462).

The following settings are made when car wash mode is activated:

- The outside mirrors are folded down.
- The rain sensor is deactivated to prevent the windshield washer system from starting up automatically.
- The rear window wiper is deactivated.
- The air conditioning system is set to air-recirculation mode.
- Parking Assist PARKTRONIC is deactivated.
- **Vehicles with 360° Camera:** the front image is activated after approx. eight seconds.
- **Vehicles with AIRMATIC:** the vehicle is raised to the maximum possible chassis level (→ page 231).

If rising takes longer than 25 seconds, the following message appears on the multifunction display:

[Preparation for Automatic Car Wash Incomplete See Media Display](#). After some time, the vehicle automatically continues rising.

- **Vehicles with E-ACTIVE BODY CONTROL:** the vehicle is raised to the maximum possible chassis level (→ page 243).
If rising takes longer than 25 seconds, the following message appears on the multifunction display:
[Preparation for Automatic Car Wash Incomplete See Media Display](#). After some time, the vehicle automatically continues rising.

If one of the settings cannot be selected, this is displayed by a  behind the respective setting.

Above a speed of 12 mph (20 km/h) car wash mode is automatically deactivated.

The following settings are reset when car wash mode is deactivated:

- The outside mirrors are folded out.
- The rain sensor is activated.
- The rear window wiper is activated.
- The air conditioning system is set to fresh air mode.

- Parking Assist PARKTRONIC is reset to the previously selected setting.
- **Vehicles with 360° Camera:** the front image is deactivated at speeds above 11 mph (18 km/h).
- **Vehicles with AIRMATIC:** the vehicle is lowered to the previously set chassis level.
- **Vehicles with E-ACTIVE BODY CONTROL:** the vehicle is lowered to the previously set chassis level.

Activating/deactivating automatic car wash mode



Requirements:

- The vehicle is stationary.
- The engine is running.

Multimedia system:

  **» Settings** **» Quick Access**



Activating automatic car wash mode

-  Select [Automatic Car Wash Mode](#).
-  Select [Start](#).

If one of the settings cannot be selected, this is displayed by a  behind the respective setting.

 For an overview of the settings made when activating automatic car wash mode (→ page 461).

Deactivating automatic car wash mode



-  Select **Stop**.
The automatic car wash settings are reset.
-  The automatic car wash mode is automatically deactivated as soon as a speed of 12 mph (20 km/h) is exceeded.

Information on using a power washer

 **WARNING** Risk of accident when using high-pressure cleaning equipment with round-spray nozzles

The water jet from a round-spray nozzle (dirt grinder) may cause damage to tires and suspension components that is not visible.

Components damaged in this way may fail unexpectedly.

-  Do not use high-pressure cleaning equipment with round-spray nozzles to clean your vehicle.
-  Damaged tires or suspension components must be replaced immediately.



To avoid damage to your vehicle, observe the following when using a power washer:

- Keep the SmartKey at least 10 ft (3 m) away from the vehicle. Otherwise the tailgate could open unintentionally.
- Maintain a distance of at least 11.8 in (30 cm) to the vehicle.
- **Vehicles with decorative foil:** parts of your vehicle are covered with a decorative foil. Maintain a distance of at least 27.6 in (70 cm) between the foil-covered parts of the vehicle and the nozzle of the power washer. Move the power washer nozzle around whilst cleaning. The water temperature of the power washer must not exceed 124 °F (60 °C).

- Observe the information on the correct distance in the equipment manufacturer's operating instructions.
- Do not point the nozzle of the power washer directly at sensitive parts such as tires, slits, electrical components, batteries, light bulbs and ventilation slots.

Washing the vehicle by hand

Observe the legal requirements, e.g. in a number of countries, washing by hand is only permitted in specially designated wash bays.

-  Use a mild cleaning agent, e.g. car shampoo.
-  Wash the vehicle with lukewarm water using a soft car sponge. When doing so, do not expose the vehicle to direct sunlight.
-  Carefully hose the vehicle off with water and dry using a chamois. Take care not to point the water jet directly towards the air inlet grille below the hood.

Notes on paintwork/matte finish paintwork care

Observe the following information:

Cleaning and care		Avoiding paintwork damage and interference to the driver assistance systems
Paintwork	<ul style="list-style-type: none">• Insect remains: soak with insect remover and rinse off the treated areas afterwards.• Bird droppings: soak with water and rinse off afterwards.• Tree resin, oils, fuels and greases: remove by rubbing gently with a cloth soaked in petroleum ether or lighter fluid.• Coolant and brake fluid: remove with a damp cloth and clean water.• Tar stains: use tar remover.• Wax: use silicone remover.	<ul style="list-style-type: none">• Do not attach stickers, films or similar materials. Only have film attached to the bumper at a qualified specialist workshop.• Remove dirt immediately, where possible.

Cleaning and care		Avoiding paintwork damage and interference to the driver assistance systems
Matte finish	Only use care products approved for Mercedes-Benz.	<ul style="list-style-type: none"> • Do not attach stickers, films or similar materials. Only have film attached to the bumper at a qualified specialist workshop. • Do not polish the vehicle and alloy wheels. • Only use car washes that correspond to the latest engineering standards. • Do not use car wash program with a final hot wax treatment. • Do not use paint cleaners, buffing or polishing products, gloss preservers, e.g. wax.

In the event of paintwork damage:

- Always have paintwork repairs carried out at a qualified specialist workshop.
- Make sure the radar sensors function (→ page 196).

Notes on cleaning decorative foils

Observe the notes on matte finish care in the chapter "Notes on paintwork/matte finish paintwork care" (→ page 464). They also apply to matte decorative foils.

Observe the following information:

Cleaning	Avoiding damage to the decorative foil
<ul style="list-style-type: none"> • For cleaning, use plenty of water and a mild cleaning agent without additives or abrasive substances, e.g. a car shampoo approved for Mercedes-Benz. • Remove dirt immediately, where possible, whilst avoiding rubbing too hard. There is otherwise a risk of damaging the decorative foil irreparably. • If there is dirt on the finish or if the decorative foil is dull: use the Paint Cleaner recommended and approved for Mercedes-Benz. • Insect remains: soak with insect remover and rinse off the treated areas afterwards. • Bird droppings: soak with water and rinse off afterwards. • To prevent water stains, dry a foil-wrapped vehicle with a soft, absorbent cloth after every car wash. 	<ul style="list-style-type: none"> • The service life and color of decorative foils are impaired by: <ul style="list-style-type: none"> - Sunlight - Temperature, e.g. hot air blower - Weather conditions - Stone chippings and dirt - Chemical cleaning agents - Oily products • Do not use polish on matte decorative foil. Polishing will have the effect of shining the foil-wrapped surface. • Do not treat matte or structured decorative foils with wax. Permanent stains may occur.

Scratches, corrosive deposits, areas affected by corrosion and damage caused by incorrect care cannot always be completely repaired. In such cases, visit a qualified specialist workshop.

You can obtain more information on care and cleaning products from the manufacturer.

In the case of foil-wrapped surfaces, optical differences may occur between the surfaces that were not protected by a decorative foil after removing a decorative foil.

i Have work or repairs to decorative foils carried out at a qualified specialist workshop, e.g. in an authorized Mercedes-Benz Center.

Notes on care of vehicle parts

▲ WARNING Risk of entrapment if the windshield wipers are switched on while the windshield is being cleaned

If the windshield wipers are set in motion while you are cleaning the windshield or wiper blades, you can be trapped by the wiper arm.

▶ Always switch off the windshield wipers and the ignition before cleaning the windshield or wiper blades.

▲ WARNING Risk of burns from the tailpipe and tailpipe trims

The exhaust tailpipe and tailpipe trims can become very hot. If you come into contact

with these parts of the vehicle, you could burn yourself.

▶ Always be particularly careful around the tailpipe and the tailpipe trims and supervise children especially closely in this area.

▶ Allow vehicle parts to cool down before touching them.

Observe the following information:

	Notes on cleaning and care	Avoiding vehicle damage
Wheels/rims	Use water and acid-free wheel cleaners.	<ul style="list-style-type: none"> • Do not use acidic wheel cleaners to remove brake dust. This could damage wheel bolts and brake components. • To avoid corrosion of the brake discs and brakepads, drive the vehicle for a few minutes after cleaning before parking it. The brake discs and brakepads warm up and dry out.
Windows	Clean windows inside and outside with a damp cloth and with a cleaning agent recommended for Mercedes-Benz.	Do not use dry cloths or abrasive or solvent-based cleaning agents to clean the inside of windows.
Wiper blades	Fold out the wiper blades and clean them using a damp cloth.	Do not clean the wiper blades too often.

	Notes on cleaning and care	Avoiding vehicle damage
Exterior lighting	Clean the lenses with a wet sponge and mild cleaning agent, e.g. car shampoo.	Only use cleaning agents or cleaning cloths that are suitable for plastic lenses.
Sensors	Clean the sensors in the front and rear bumper and in the radiator grill with a soft cloth and car shampoo.	When using a power washer, maintain a minimum distance of 11.8 in (30 cm).
Running boards	Use water and acid-free cleaning agents.	Do not clean the aluminum trim insert of the running board with alkaline or acidic cleaning agents such as wheel cleaners. Do not use acidic wheel cleaners to remove brake dust. The aluminum trim inserts could otherwise be damaged.
Rear view camera and 360° Camera	<ul style="list-style-type: none"> • Open the camera cover with the multimedia system (→ page 259). • Use clean water and a soft cloth to clean the camera lens. 	Do not use a power washer.
Tailpipes	Clean with a cleaning agent recommended for Mercedes-Benz, especially in the winter and after washing the vehicle.	Do not use acidic cleaning agents.
Trailer hitch	<ul style="list-style-type: none"> • Remove traces of rust on the ball, e.g. with a wire brush. • Remove dirt with a lint-free cloth. • After cleaning, oil or grease the ball head lightly. • Observe the notes on care in the trailer hitch manufacturer's operating instructions. 	Do not clean the ball neck with a power washer or solvent.

Notes on care of the interior

▲ WARNING Risk of injury from plastic parts breaking off after the use of solvent-based care products

Care and cleaning products containing solvents can cause surfaces in the cockpit to become porous.

When the airbags are deployed, plastic parts may break away.

- ▶ Do not use any care or cleaning products containing solvents to clean the cockpit.

▲ WARNING Risk of injury or death from bleached seat belts

Bleaching or dyeing seat belts can severely weaken them.

This can, for example, cause seat belts to tear or fail in an accident.

- ▶ Never bleach or dye seat belts.

Observe the following information:

	Cleaning and care	Avoiding vehicle damage
Seat belts	Clean with lukewarm and soapy water.	<ul style="list-style-type: none"> • Do not use chemical cleaning agents. • Do not dry seat belts by heating them to over 176 °F (80 °C) or exposing them to direct sunlight.
Display	Clean the surface carefully with a microfiber cloth and a suitable display care product (TFT/LCD).	<ul style="list-style-type: none"> • Switch off the display and let it cool down. • Do not use any other cleaning products.
Plastic trim	<ul style="list-style-type: none"> • Clean with a damp microfiber cloth. • For heavy soiling: use care product recommended for Mercedes-Benz. 	<ul style="list-style-type: none"> • Do not attach stickers, films or similar materials. • Do not allow cosmetics, insect repellent or sun cream to come in contact with the plastic trim.

	Cleaning and care	Avoiding vehicle damage
Real wood/trim elements	<ul style="list-style-type: none"> • Clean with a microfiber cloth. • Black piano-lacquer look: clean with a damp cloth and soapy water. • For heavy soiling: use care product recommended for Mercedes-Benz. 	Do not use solvent-based cleaning agents, polishes or waxes.
Headliner	Clean with a brush or dry shampoo.	
Carpet	Use carpet and textile cleaning agents recommended for Mercedes-Benz.	
Genuine leather seat covers	<ul style="list-style-type: none"> • Clean with a damp cloth and then wipe with a dry cloth. • Leather care: use leather care agents that have been recommended for Mercedes-Benz. 	<ul style="list-style-type: none"> • Do not allow the leather to become too damp. • Do not use a microfiber cloth.
DINAMICA seat covers	Clean with a damp cloth.	Do not use a microfiber cloth.
Imitation leather seat covers	Clean with a damp cloth and 1% soapy water.	Do not use a microfiber cloth.
Cloth seat covers	Clean with a damp microfiber cloth and 1% soapy water and allow to dry.	

Flat tire

Notes on flat tires

⚠ WARNING Risk of accident due to a flat tire

A flat tire severely affects the driving characteristics as well as the steering and braking of the vehicle.

Tires without run-flat characteristics:

- ▶ Do not drive on with a flat tire.
- ▶ Change the flat tire immediately with an emergency spare wheel or spare wheel. Alternatively, consult a qualified specialist workshop.

Tires with run-flat characteristics:

- ▶ Observe the information and warning notes on MOExtended tires (run-flat tires).

In the event of a flat tire, the following options are available depending on your vehicle's equipment:

- **Vehicles with MOExtended tires:** it is possible to continue the journey for a short period of time. Make sure you observe the notes on MOExtended tires (run-flat tires) (→ page 471).
 - **Vehicles with a TIREFIT kit:** you can repair the tire so that it is possible to continue the journey for a short period of time. To do this, use the TIREFIT kit (→ page 473).
 - **Vehicles with Mercedes me connect:** you can make a call for breakdown assistance via the overhead control panel in the case of a breakdown (→ page 420).
 - **All vehicles:** change the wheel (→ page 515).
- i** The emergency spare wheel is only available in certain countries.

Notes on MOExtended tires (run-flat tire)

⚠ WARNING Risk of accident when driving in emergency mode

When driving in emergency mode, the handling characteristics are impaired. e.g. when cornering, when accelerating strongly and when braking.

- ▶ Do not exceed the permissible maximum speed for MOExtended tires.
- ▶ Avoid any abrupt steering and driving maneuvers as well as driving over obstacles (curbs, pot holes, off-road). This applies, in particular, to a loaded vehicle.
- ▶ Stop driving in the emergency mode if you notice:
 - banging noise
 - vehicle vibration
 - smoke which smells like rubber
 - continuous ESP® intervention
 - cracks in tire side walls

- ▶ After driving in emergency mode have the rims checked by a qualified specialist workshop with regard to their further use.
- ▶ The defective tire must be replaced in every case.

With MOExtended tires (run-flat tire), you can continue to drive your vehicle even if there is a total loss of pressure in one or more tires. However, the tire affected must not show any clearly visible damage.

You can recognize MOExtended tires by the MOExtended marking which appears on the side wall of the tire.

Vehicles with tire pressure loss warning system: MOExtended tires may only be used in conjunction with an activated tire pressure loss warning system.

Vehicles with tire pressure monitoring system: MOExtended tires may only be used in conjunction with an activated tire pressure monitoring system.

If a pressure loss warning message appears in the multifunction display, proceed as follows:

- Check the tire for damage.
- If driving on, observe the following notes.

Driving distance possible in emergency mode after the pressure loss warning:

Load condition	Driving distance possible in emergency mode
Partially laden	50 miles (80 km)
Fully laden	19 miles (30 km)

The driving distance possible in emergency mode may vary depending on the driving style. Observe the maximum permissible speed of 50 mph (80 km/h).

If a tire has gone flat and cannot be replaced with an MOExtended tire, you can use a standard tire as a temporary measure.

TIREFIT kit storage location

The TIREFIT kit is located under the cargo compartment floor.

Vehicles with two rows of seats

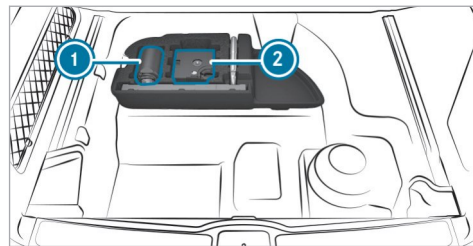

- ① Tire sealant bottle
- ② Tire inflation compressor

Vehicles with three rows of seats

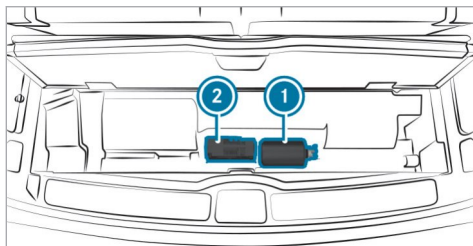

- ① Tire sealant bottle
- ② Tire inflation compressor

Using the TIREFIT kit

Requirements:

- Tire sealant bottle and tire inflation compressor (→ page 472).
- TIREFIT sticker
- Gloves (depending on the vehicle equipment)

You can use TIREFIT tire sealant to seal perforation damage of up to 0.16 in (4 mm), particularly

those in the tire contact surface. You can use TIREFIT in outside temperatures down to -4°F (-20°C).

⚠ WARNING Risk of accident when using tire sealant

In the following situations in particular, the tire sealant is unable to provide sufficient breakdown assistance, as it is unable to seal the tire properly:

- There are cuts or punctures in the tire larger than those previously mentioned.
 - The wheel rim is damaged.
 - You have driven at very low tire pressure or on a flat tire.
- ▶ Do not drive on.
 - ▶ Consult a qualified specialist workshop.

⚠ WARNING Risk of injury and poisoning from tire sealant

The tire sealant is harmful and causes irritation. Do not allow it to come into contact

with the skin, eyes or clothing, and do not swallow it. Do not inhale tire sealant fumes. Keep the tire sealant away from children.

If you come into contact with the tire sealant, observe the following:

- ▶ Rinse off the tire sealant from your skin immediately using water.
- ▶ If tire sealant gets into your eyes, thoroughly rinse out the eyes using clean water.
- ▶ If tire sealant has been swallowed, immediately rinse out the mouth thoroughly and drink plenty of water. Do not induce vomiting and seek medical attention immediately.
- ▶ Change out of any clothes contaminated with tire sealant immediately.
- ▶ If allergic reactions occur, seek medical attention immediately.

1 NOTE Overheating due to the tire inflation compressor running too long

▶ Do not run the tire inflation compressor for longer than ten minutes without interruption.

Comply with the manufacturer's safety notes on the sticker on the tire inflation compressor.

Have the tire sealant bottle replaced at a qualified specialist workshop every five years.

▶ Do not remove any foreign objects which have entered the tire.



- ▶ Affix part ① of the TIREFIT sticker to the instrument cluster within the driver's field of vision.
- ▶ Affix part ② of the TIREFIT sticker near the valve on the wheel with the faulty tire.

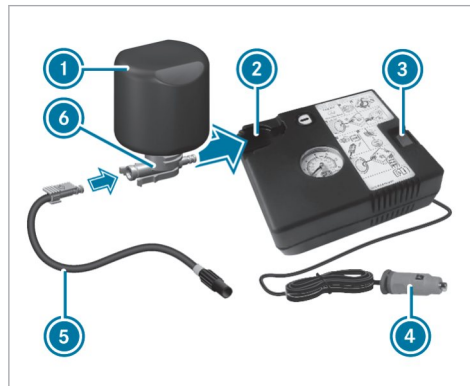

- ▶ Pull plug ④ with the cable and hose ⑤ out of the tire inflation compressor housing.

- ▶ Push the plug of hose ⑤ into flange ⑥ of tire sealant bottle ① until the plug engages.
- ▶ Place tire sealant bottle ① head downwards into recess ② of the tire inflation compressor.



- ▶ Remove the valve cap from valve ⑦ on the faulty tire.
- ▶ Screw filling hose ⑧ onto valve ⑦.
- ▶ Insert plug ④ into a 12 V socket in your vehicle.
- ▶ Switch on the ignition.

- ▶ Press on and off switch ③ on the tire inflation compressor.
The tire inflation compressor is switched on. The tire is inflated. First, tire sealant is pumped into the tire. The pressure may briefly rise to approximately 500 kPa (5 bar/73 psi).

Do not switch off the tire inflation compressor during this phase.

- ▶ Let the tire inflation compressor run for a maximum of ten minutes.
The tire should then have attained a tire pressure of at least 200 kPa (2.0 bar/29 psi).

If tire sealant leaks out, make sure you clean the affected area as quickly as possible. It is preferable to use clean water.

If you get tire sealant on your clothing, have it cleaned as soon as possible with perchloroethylene.

If, after ten minutes, a tire pressure of 200 kPa (2.0 bar/29 psi) has not been attained:

- ▶ Switch off the tire inflation compressor.
- ▶ Unscrew the filling hose from the valve of the faulty tire.

Please note that tire sealant may leak out when unscrewing the filling hose.

- ▶ Drive forwards or reverse very slowly for approximately 33 ft (10 m).
- ▶ Pump up the tire again.
After a maximum of ten minutes the tire pressure must be at least 200 kPa (2.0 bar/29 psi).

⚠ WARNING Risk of accident due to the specified tire pressure not being achieved

If the specified tire pressure is not achieved after the specified time, the tire is too badly damaged. The tire sealant cannot repair the tire in this instance.

Damaged tires and a tire pressure that is too low can significantly impair braking and handling characteristics.

- ▶ Do not drive on.
- ▶ Consult a qualified specialist workshop.

If, after ten minutes, a tire pressure of 200 kPa (2.0 bar/29 psi) has been attained:

- ▶ Switch off the tire inflation compressor.
- ▶ Unscrew the filling hose from the valve of the faulty tire.

⚠ WARNING Risk of accident from driving with sealed tires

A tire temporarily sealed with tire sealant impairs driving characteristics and is not suitable for higher speeds.

- ▶ Adapt your driving style accordingly and drive carefully.
- ▶ Do not exceed the maximum speed limit with a tire that has been repaired using tire sealant.

- ▶ Observe the maximum permissible speed for a tire sealed with tire sealant 50 mph (80 km/h).
- ▶ Affix the upper section of the TIREFIT sticker to the instrument cluster in a location where it will be easily seen by the driver.

! **NOTE** Staining caused by leaking tire sealant

After use, excess tire sealant may leak out from the filling hose.

- ▶ Therefore, place the filling hose in the plastic bag that contained the TIREFIT kit.

🔥 ENVIRONMENTAL NOTE Environmental pollution caused by environmentally irresponsible disposal

Tire sealant contains pollutants.

- ▶ Have the tire sealant bottle disposed of professionally, e.g. at an authorized Mercedes-Benz Center.

- ▶ Stow the tire sealant bottle and the tire inflation compressor.
- ▶ Pull away immediately.
- ▶ Stop driving after approximately ten minutes and check the tire pressure using the tire inflation compressor. The tire pressure must now be at least 130 kPa (1.3 bar/ 19 psi).

⚠️ WARNING Risk of accident due to the specified tire pressure not being reached

If the specified tire pressure is not reached after a brief drive, the tire is too badly damaged. The tire sealant cannot repair the tire in this instance.

Damaged tires and tire pressure that is too low can significantly impair the braking properties and the handling characteristics.

- ▶ Do not continue driving.
- ▶ Consult a qualified specialist workshop.

In cases such as the one mentioned above, contact an authorized Mercedes-Benz Center. Or

call 1-800-FOR-MERCEdes (in the USA) or 1-800-387-0100 (in Canada).

- ▶ **To increase the tire pressure:** switch on the tire inflation compressor.

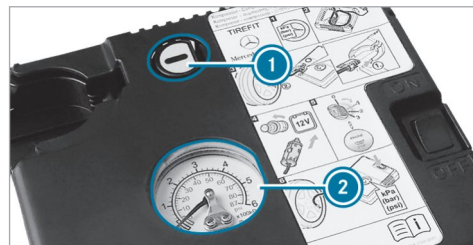

- ▶ **To reduce the tire pressure:** press pressure release button ① next to manometer ②.
- ▶ When the tire pressure is correct, unscrew the filling hose from the valve of the sealed tire.
- ▶ Screw the valve cap onto the valve of the sealed tire.

- ▶ Pull the tire sealant bottle out of the tire inflation compressor. The filling hose stays on the tire sealant bottle.
- ▶ Drive to the nearest qualified specialist workshop and have the tire, tire sealant bottle and filling hose replaced there.

Battery (vehicle)

Notes on the 12 V battery

⚠ WARNING Risk of an accident due to work carried out incorrectly on the battery

Work carried out incorrectly on the battery can, for example, lead to a short circuit. This can lead to function restrictions in safety-relevant systems, for example the lighting system, ABS (anti-lock braking system) or ESP® (Electronic Stability Program). The operating safety of your vehicle may be restricted.

You could lose control of the vehicle in the following situations:

- when braking
 - in the event of abrupt steering maneuvers and/or when the vehicle's speed is not adapted to the road conditions
- ▶ In the event of a short circuit or a similar incident, contact a qualified specialist workshop immediately.
 - ▶ Do not continue driving.
 - ▶ Always have work on the battery carried out at a qualified specialist workshop.

- Further information on ABS (→ page 197)
- Further information on ESP® (→ page 198)

For safety reasons, Mercedes-Benz recommends that you only use batteries which have been tested and approved for your vehicle by Mercedes-Benz. These batteries provide increased impact protection to prevent vehicle occupants from suffering acid burns should the battery be damaged in the event of an accident.

All vehicles except vehicles with a lithium-ion battery

⚠ WARNING Risk of explosion due to electrostatic charge

Electrostatic charge can cause sparks which may ignite the highly flammable gas mixture in the battery.

- ▶ To discharge any electrostatic charge that may have built up, touch the metal vehicle body before handling the battery.

The highly flammable gas mixture is created while the battery is charging and during starting assistance.

⚠ WARNING Danger of chemical burns from the battery acid

Battery acid is caustic.

- ▶ Avoid contact with the skin, eyes or clothing.
- ▶ Do not lean over the battery.

- ▶ Do not inhale battery gases.
- ▶ Keep children away from the battery.
- ▶ Immediately rinse battery acid off thoroughly with plenty of clean water and seek medical attention immediately.

All vehicles

 **ENVIRONMENTAL NOTE** Environmental damage caused by improper disposal of batteries



Batteries contain pollutants. It is illegal to dispose of them with the household rubbish.



▶ Dispose of batteries in an environmentally responsible manner. Take discharged batteries to a qualified

specialist workshop or to a collection point for used batteries.

If you have to disconnect the 12 V battery, contact a qualified specialist workshop.

Comply with safety notes and take protective measures when handling batteries.



Risk of explosion.



Fire, open flames and smoking are prohibited when handling the battery. Avoid creating sparks.



Electrolyte or battery acid is corrosive. Avoid contact with the skin, eyes or clothing. Wear suitable protective clothing, in particular gloves, an apron and a face mask. Immediately rinse electrolyte or acid splashes off with clean water. Consult a doctor if necessary.



Wear safety glasses.



Keep children away.



Observe this Operator's Manual.

Observe the following if you do not intend to use the vehicle over an extended period of time:

- Activate standby mode.
- Alternatively: connect the battery to a battery charger approved by Mercedes-Benz or consult a qualified specialist workshop to disconnect the battery.

Notes on starting assistance and on charging the 12 V battery

Vehicles with a lithium-ion battery

When charging the battery and during starting assistance, always use the jump-start connection point in the engine compartment.

! **NOTE** Damaging the battery through overvoltage

When charging using a battery charger without a maximum charging voltage, the battery or the vehicle electronics may be damaged.

- ▶ Only use battery chargers with a maximum charging voltage of 14.8 V.

All other vehicles

When charging the battery and during starting assistance, always use the jump-start connection point in the engine compartment.

! **NOTE** Damaging the battery through overvoltage

When charging using a battery charger without a maximum charging voltage, the battery or the vehicle electronics may be damaged.

- ▶ Only use battery chargers with a maximum charging voltage of 14.8 V.

⚠ **WARNING** Risk of explosion from hydrogen gas igniting

A battery generates hydrogen gas during the charging process. If there is a short circuit or sparks start to form, there is a danger of the hydrogen gas igniting.

- ▶ Make sure that the positive terminal of the connected battery does not come into contact with vehicle parts.
- ▶ Never place metal objects or tools on a battery.
- ▶ When connecting and disconnecting the battery, you must observe the described order for the battery clamps.

- ▶ When giving starting assistance, always make sure that you only connect battery terminals with identical polarity.
- ▶ During starting assistance, you must observe the described order for connecting and disconnecting the jumper cables.
- ▶ Do not connect or disconnect the battery clamps while the engine is running.

⚠ **WARNING** Risk of explosion during charging process and starting assistance

During the charging process and starting assistance, the battery may release an explosive gas mixture.

- ▶ Avoid fire, open flames, creating sparks and smoking.
- ▶ Make sure that there is sufficient ventilation during the charging process and during starting assistance.
- ▶ Do not lean over a battery.

⚠ WARNING Risk of explosion from a frozen battery

A discharged battery may freeze at temperatures slightly above or below freezing point.

During starting assistance or battery charging, battery gas may be released.

- ▶ Always thaw a frozen battery out first before charging it or performing starting assistance.

If the indicator/warning lamps in the instrument cluster do not light up at low temperatures, it is very likely that the discharged battery has frozen. In this case you may neither jump-start the vehicle nor charge the battery.

The service life of a battery that has been thawed may be dramatically shortened. The starting characteristics may be impaired, especially at low temperatures.

It is recommended that you have a thawed battery checked at a qualified specialist workshop.

All vehicles

! NOTE Damage caused by numerous or extended attempts to start the engine

Numerous or extended attempts to start the engine may damage the catalytic converter due to non-combusted fuel.

- ▶ Avoid numerous and extended attempts to start the engine.

Observe the following points during starting assistance and when charging the battery:

- Only use undamaged jumper cables/charging cables with a sufficient cross-section and insulated terminal clamps.
- Non-insulated parts of the terminal clamps must not come into contact with other metal parts while the jumper cable/charging cable is connected to the battery/jump-start connection point.
- The jumper cable/charging cable must not come into contact with any parts which may move when the engine is running.

- Always make sure that neither you nor the battery is electrostatically charged.
- Keep away from fire and open flames.
- Do not lean over the battery.

Observe the additional following points when charging the battery:

- Only use battery chargers tested and approved for Mercedes-Benz.
- Read the battery charger's operating instructions before charging the battery.

Observe the additional following points during starting assistance:

- Starting assistance may be performed using only batteries with a nominal voltage of 12 V.
- The vehicles must not touch.
- **Vehicles with a gasoline engine:** Jump-start the vehicle only when the engine and exhaust system are cold.

Starting assistance and charging the 12 V battery

Requirements:

- The vehicle is secured with the electric parking brake.
- **Vehicles with automatic transmission:**
The transmission is in position **P**.
- The ignition and all electrical consumers are switched off.
- The hood is open.

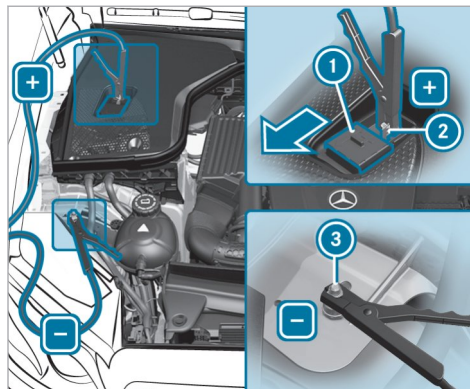

Example: engine compartment

- ▶ Slide cover **1** of positive clamp **2** on the jump-starting connection point in the direction of the arrow.
- ▶ Connect positive clamp **2** on your vehicle to the positive pole of the donor battery using the jumper cable/charging cable. Always

begin with positive clamp **2** on your own vehicle first.

- ▶ **During starting assistance:** start the engine of the donor vehicle and run at idle speed.
- ▶ Connect the negative pole of the donor battery and ground point **3** of your own vehicle by using the jumper cable/charging cable. Begin with the donor battery first.
- ▶ **During starting assistance:** start the engine of your own vehicle.
- ▶ **During the charging process:** start the charging process.
- ▶ **During starting assistance:** let the engines run for several minutes.
- ▶ **During starting assistance:** before disconnecting the jumper cable, switch on an electrical consumer in your own vehicle, e.g. the rear window heater or lighting.

When the starting assistance/charging process is complete, perform the following steps:

- ▶ First, remove the jumper cable/charging cable from ground point ③ and the negative pole of the donor battery, then from positive clamp ② and the positive pole of the donor battery. Begin each time with the contacts on your own vehicle first.
- ▶ After removing the jumper cable/charging cable, close cover ① of positive clamp ②.

Further information can be obtained at a qualified specialist workshop.

Replacing the 12 V battery

- ▶ Observe the notes on the 12 V battery (→ page 477).

Mercedes-Benz recommends that you have the 12 V battery replaced at a qualified specialist workshop, e.g. at an authorized Mercedes-Benz Center.

Observe the following notes if you want to replace the battery yourself:

- Always replace a faulty battery with a battery which meets the specific vehicle requirements.

The vehicle is equipped with an AGM technology battery (Absorbent Glass Mat) or a lithium-ion battery. Full vehicle functionality is only guaranteed with an AGM battery or lithium-ion battery. For safety reasons, Mercedes-Benz recommends that you only use batteries which have been tested and approved for your vehicle by Mercedes-Benz.

- Carry over detachable parts, such as vent hoses, elbow fitting or terminal covers from the battery being replaced.
- Make sure that the vent hose is always connected to the original opening on the side of the battery.

Install any existing or supplied cell caps.

Otherwise, gases or battery acid could escape.

- Make sure that detachable parts are reconnected in the same way.

Tow starting or towing away

Permitted towing methods



Mercedes-Benz recommends transporting your vehicle in the case of a breakdown, rather than towing it away.

For towing, use a tow rope or tow bar with both axles on the ground. Do not use tow bar systems.

! **NOTE** Damage to the vehicle due to towing away incorrectly

- ▶ Observe the instructions and notes on towing away.

Permitted towing methods

Vehicle equipment/towing method	 Both axles on the ground	 Front axle raised	 Rear axle raised
4MATIC vehicles	Yes, maximum 31 miles (50 km) at 31 mph (50 km/h)	No	No
Vehicles with rear wheel drive	Yes, maximum 31 miles (50 km) at 31 mph (50 km/h)	No	Yes, if the steering wheel is fixed in the center position with a steering wheel lock.

Towing with a raised axle: towing should be performed by a towing company.

Towing away the vehicle with both axles on the ground

- ▶ Observe the notes on the permitted towing methods (→ page 482).
- ▶ Make sure that the battery is connected and charged.

A discharged battery has the following effects:

- The engine cannot be started
 - The electric parking brake cannot be released or applied
 - The automatic transmission cannot be shifted to position **N** or **P**
- ⓘ If the automatic transmission cannot be shifted to position **N**, or the multifunction display in the instrument cluster does not show

anything, have the vehicle transported away (→ page 485). A towing vehicle with lifting equipment is required for vehicle transportation.

! **NOTE** Damage due to towing away at excessively high speeds or over long distances

The drivetrain could be damaged when towing at excessively high speeds or over long distances.

- ▶ A towing speed of 30 mph (50 km/h) must not be exceeded.
- ▶ A towing distance of 30 miles (50 km) must not be exceeded.

! **WARNING** Risk of accident when towing a vehicle which is too heavy

If the vehicle being tow-started or towed away is heavier than the permissible gross mass of your vehicle, the following situations can occur:

- The towing eye may become detached.
- The vehicle/trailer combination may swerve or even overturn.
- ▶ If another vehicle is tow-started or towed away, its weight must not exceed

the permissible gross mass of your own vehicle.

- ▶ Information on the permissible gross mass of the vehicle can be found on the vehicle identification plate (→ page 527).
- ▶ Do not open the driver's door or front passenger door as the automatic transmission may otherwise shift to position **P** automatically.
- ▶ Install the towing eye (→ page 487).
- ▶ Fasten the tow bar.

! **NOTE** Damage due to incorrect connection of the tow bar

- ▶ Only connect the tow rope or tow bar to the towing eyes.

i You can also attach the tow bar to the trailer hitch.

- ▶ Deactivate the automatic locking mechanism (→ page 74).
- ▶ Do not activate the HOLD function.

- ▶ Deactivate the tow-away alarm (→ page 95).
- ▶ Deactivate Active Brake Assist (→ page 209).
- ▶ Shift the automatic transmission to position **N** (→ page 180).
- ▶ Release the electric parking brake.

! **WARNING** Risk of accident due to limited safety-related functions during the towing process

Safety-related functions are limited or no longer available in the following situations:

- the ignition is switched off.
- the brake system or power steering system is malfunctioning.
- the energy supply or the on-board electrical system is malfunctioning.

When your vehicle is then towed away, significantly more effort may be required to steer and brake than is normally required.

- ▶ Use a tow bar.

- ▶ Make sure that the steering wheel can move freely, before towing the vehicle away.

! **NOTE** Damage due to excessive tractive power

If you pull away sharply, the tractive power may be too high and the vehicles could be damaged.

- ▶ Pull away slowly and smoothly.

Loading the vehicle for transport

- ▶ Observe the notes on towing away (→ page 483).
- ▶ Connect the tow bar to the towing eye in order to load the vehicle.
- i** You can also attach the tow bar to the trailer hitch.
- ▶ Shift the automatic transmission to position **N**.

i The automatic transmission may be locked in position **P** in the event of damage to the electrics. To shift to **N**, provide the on-board electrical system with power (→ page 481).

- ▶ Load the vehicle onto the transporter.
- ▶ Shift the automatic transmission to position **P**.
- ▶ Use the electric parking brake to secure the vehicle against rolling away.
- ▶ Only secure the vehicle by the wheels.

Vehicles with ADS PLUS (Adaptive Damping System PLUS)

! **WARNING** Risk of an accident when transporting vehicles with Adaptive Damping System PLUS

The reduced damping forces on the vehicle being transported can cause the vehicle/trailer combination to start to swing. As a result, when transporting vehicles with the Adaptive Damping System PLUS, the

vehicle/trailer combination may start to skid. Consequently, you could lose control of your vehicle.

- ▶ When transporting, ensure that:
 - The vehicle has been loaded onto the transporter correctly
 - The vehicle is secured at all four wheels with suitable tensioning straps
 - The maximum permissible speed of 35 mph (60 km/h) is not exceeded when transporting

! **NOTE** Damage to the vehicle from securing it incorrectly

- ▶ After loading, the vehicle must be secured on all four wheels. Otherwise, the vehicle could be damaged.
- ▶ A minimum distance of 8 in (20 cm) upwards and 4 in (10 cm) downwards must be kept to the transport platform.

- ▶ Secure the vehicle on all four wheels after loading.

4MATIC vehicles/vehicles with automatic transmission

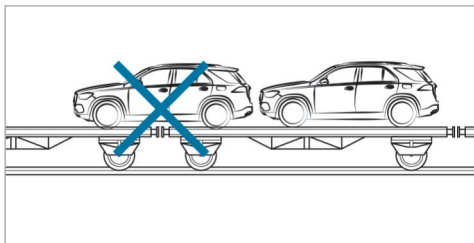

- ▶ Make sure that the front and rear axles come to rest on the same transportation vehicle.

1 NOTE Damage to the drivetrain due to incorrect positioning

- ▶ Do not position the vehicle above the connection point of the transport vehicle.

Towing eye storage location

Vehicles with two rows of seats

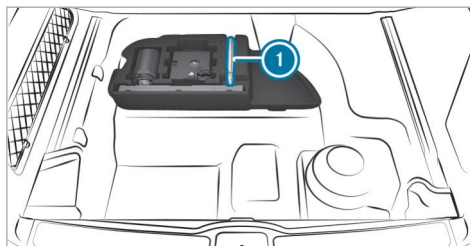

Towing eye ① is located under the cargo compartment floor with the tire-change tool kit.

Vehicles with three rows of seats

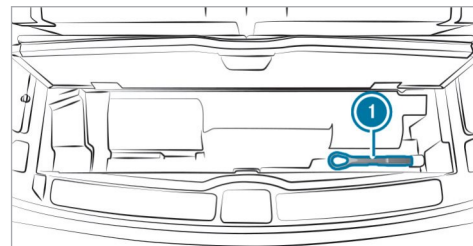

Towing eye ① is located under the cargo compartment floor.

Installing the towing eye

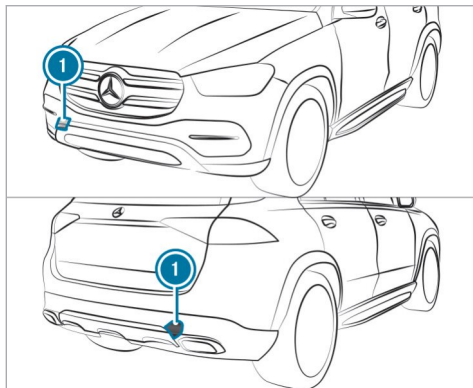

- ▶ Press the mark on cover ❶ inwards and remove.
- ▶ Screw in the towing eye clockwise as far as it will go and tighten.

Vehicles with a trailer hitch: Vehicles with a trailer hitch do not have a rear bracket for the

towing eye. Fasten the tow bar to the trailer hitch.

- ❶ Make sure that cover ❶ engages in the bumper when you remove the towing eye.

! **NOTE** Damage to the vehicle due to incorrect use of the towing eye

When a towing eye is used to recover a vehicle, the vehicle may be damaged in the process.

- ▶ Only use the towing eye to tow away or tow start the vehicle.

Tow starting the vehicle (emergency engine start)

Vehicles with automatic transmission

! **NOTE** Damage to the automatic transmission due to tow starting

The automatic transmission may be damaged in the process of tow starting vehicles with automatic transmission.

- ▶ Vehicles with automatic transmission must not be tow started.

- ▶ Vehicles with automatic transmission must not be tow-started.

Electrical fuses

Notes on electrical fuses

! **WARNING** Risk of accident and injury due to overloaded lines

If you manipulate or bridge a faulty fuse or if you replace it with a fuse with a higher amperage, the electric line could be overloaded.

This could result in a fire.

- ▶ Always replace faulty fuses with specified new fuses containing the correct amperage.

! NOTE Damage due to incorrect fuses

Electrical components or systems may be damaged by incorrect fuses, or their functionality may be significantly impaired.

- ▶ Only use fuses that have been approved by Mercedes-Benz and which have the correct fuse rating.

Blown fuses must be replaced with fuses of the same rating, which you can recognize by the color and fuse rating. The fuse ratings and further information to be observed can be found in the fuse assignment diagram.

Fuse assignment diagram: on the fuse box in the cargo compartment (→ page 489).

! NOTE Damage or malfunctions caused by moisture

Moisture may cause damage to the electrical system or cause it to malfunction.

- ▶ When the fuse box is open, make sure that no moisture can enter the fuse box.
- ▶ When closing the fuse box, make sure that the seal of the lid is positioned correctly on the fuse box.

If the newly inserted fuse also blows, have the cause traced and rectified at a qualified specialist workshop.

Ensure the following before replacing a fuse:

- The vehicle is secured against rolling away.
- All electrical consumers are switched off.
- The ignition is switched off.

The electrical fuses are located in various fuse boxes:

- Fuse box in the engine compartment on the left-hand side of the vehicle, when viewed in the direction of travel (→ page 488)
- Fuse box on the driver's side of the cockpit (→ page 489)

- Fuse box in the front passenger footwell (→ page 489)
- Fuse box in the cargo compartment on the right-hand side of the vehicle, when viewed in the direction of travel (→ page 489)

Opening and closing the fuse box in the engine compartment

Requirement:

- You need a dry cloth and a screwdriver.

Observe the notes on electrical fuses (→ page 487).

Opening

! WARNING Risk of injury from using the windshield wipers while the engine hood is open

When the engine hood is open and the windshield wipers are set in motion, you can be trapped by the wiper linkage.

- ▶ Always switch off the windshield wipers and ignition before opening the engine hood.

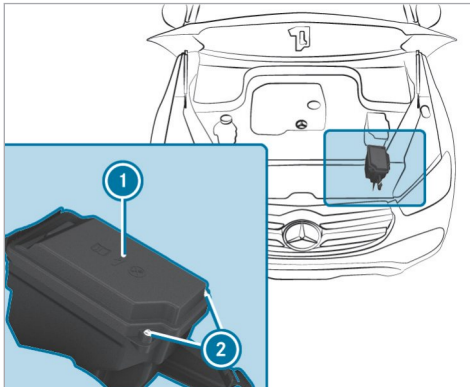

- ▶ Remove any existing moisture from the fuse box using a dry cloth.
- ▶ Loosen screws ② and remove fuse box lid ① from the top.

Closing

- ▶ Check whether the seal is positioned correctly in the lid.
- ▶ Insert the lid into the bracket at the rear of the fuse box.
- ▶ Fold down the lid of the fuse box and tighten screws ②.
- ▶ Close the hood.

Opening and closing the fuse box in the cockpit

The fuse box is on the side of the dashboard under a cover.

- ▶ Contact an authorized Mercedes-Benz Center for further information.

Opening and closing the fuse box in the front passenger footwell

- ▶ Contact an authorized Mercedes-Benz Center for further information.

Opening and closing the fuse box in the cargo compartment

Observe the notes on electrical fuses (→ page 487).

- ▶ Open the side cover.

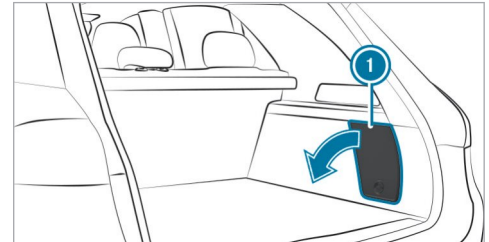

- ▶ Remove cover ①.

The fuse allocation chart is on the side of the fuse box.

Notes on noise or unusual handling characteristics

While driving, pay attention to vibrations, noises and unusual handling characteristics, e.g. pulling to one side. This may indicate that the wheels or tires are damaged. If you suspect that a tire is defective, reduce your speed immediately. Stop the vehicle as soon as possible to check the wheels and tires for damage. Hidden tire damage could also be causing the unusual handling characteristics. If you find no signs of damage, have the tires and wheels checked at a qualified specialist workshop.

Notes on regularly inspecting wheels and tires

⚠ WARNING Risk of accident from damaged tires

Damaged tires can cause tire pressure loss. As a result, you could lose control of your vehicle.

▶ Check the tires regularly for signs of damage and replace any damaged tires immediately.

⚠ WARNING Risk of aquaplaning due to insufficient tire tread

Insufficient tire tread will result in reduced tire grip. The tire tread is no longer able to dissipate water.

This means that in heavy rain or slush the risk of hydroplaning is increased, in particular if vehicle speed is not adapted to suit the conditions.

If the tire pressure is too high or too low, tires may exhibit different levels of wear at different locations on the tire contact surface.

▶ Thus, you should regularly check the tread depth and the condition of the tire contact surface across the entire width of all tires.

Minimum tread depth for:

- Summer tires: $\frac{1}{8}$ in (3 mm)
- M+S tires: $\frac{1}{8}$ in (4 mm)

▶ For safety reasons, replace the tires before the legally prescribed limit for the minimum tread depth is reached.

Carry out the following checks on all wheels regularly, at least once a month or as required, e.g. prior to a long journey or driving off-road:

- Check the tire pressure (→ page 492).
- Visually inspect wheels and tires for damage.
- Check the valve caps.

The valves must be protected against moisture and dirt by the valve caps approved especially for your vehicle by Mercedes-Benz.

- Visual check of the tire tread depth and the tire contact surface across the entire width. The minimum tread depth for summer tires is $\frac{1}{8}$ in (3 mm) and for winter tires $\frac{1}{8}$ in (4 mm).

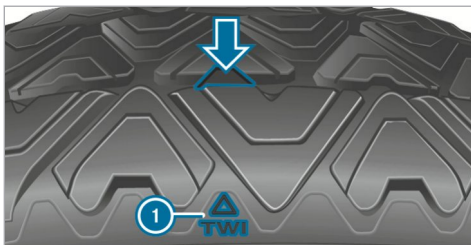

Six marks ① show where the bar indicators (arrow) are integrated into the tire tread. They are visible once a tread depth of approximately $\frac{1}{16}$ in (1.6 mm) has been reached.

Notes on snow chains

⚠ WARNING Risk of accident due to incorrect mounting of snow chains

If you have mounted snow chains to the front wheels, the snow chains may drag against the vehicle body or chassis components.

This could cause damage to the vehicle or the tires.

- ▶ Never mount snow chains on the front wheels.
- ▶ Only mount snow chains on the rear wheels in pairs.

❗ NOTE Damage to components of the vehicle body or chassis due to fitted snow chains

If you fit snow chains to the front wheels of 4MATIC vehicles, you may damage components of the vehicle body or chassis.

- ▶ Only fit snow chains to the rear wheels of 4MATIC vehicles.

- Snow chains are only permissible for certain wheel/tire combinations. You can obtain information about this from an authorized Mercedes-Benz Center.
- For safety reasons, only use snow chains that have been specifically approved for your

vehicle by Mercedes-Benz, or snow chains with the same quality standard.

- If snow chains are installed, the maximum permissible speed is 30 mph (50 km/h).
 - **Vehicles with Active Parking Assist:** Do not use Active Parking Assist when snow chains are installed.
 - **Vehicles with AIRMATIC or E-ACTIVE BODY CONTROL:** If snow chains are installed, only drive at raised vehicle level .
- ① You can deactivate ESP® to pull away (→ page 202). This allows the wheels to spin, achieving an increased driving force.

Tire pressure

Notes on tire pressure

⚠ WARNING Risk of accident due to insufficient or excessive tire pressure

Underinflated or overinflated tires pose the following risks:

- The tires may burst, especially as the load and vehicle speed increase.
 - The tires may wear excessively and/or unevenly, which may greatly impair tire traction.
 - The driving characteristics, as well as steering and braking, may be greatly impaired.
- ▶ Comply with the recommended tire pressure and check the tire pressure of all tires including the spare wheel regularly:
- at least once a month
 - when the load changes

- before embarking on a longer journey
 - if operating conditions change, e.g. off-road driving
- ▶ Adjust the tire pressure as necessary.

Tire pressure which is too high or too low can:

- Shorten the service life of the tires.
- Cause increased tire damage.
- Adversely affect driving characteristics and thus driving safety, e.g. due to hydroplaning.

⚠ WARNING Risk of an accident due to insufficient tire pressure

Tires with pressure that is too low can overheat and burst as a result.

In addition, they also suffer from excessive and/or irregular wear, which can significantly impair the braking properties and the handling characteristics.

- ▶ Avoid excessively low tire pressures in all the tires, including the spare wheel.

Tire pressure which is too low can cause:

- Tire defects as a result of overheating.
- Impaired handling characteristics.
- Irregular wear.
- Increased fuel consumption.

⚠ WARNING Risk of accident from excessive tire pressure

Tires with excessively high pressure can burst because they are damaged more easily by highway fill, pot holes etc.

In addition, they also suffer from irregular wear, which can significantly impair the braking properties and the handling characteristics.

- ▶ Avoid excessively high tire pressures in all the tires, including the spare wheel.

Tire pressure which is too high can cause:

- Increased braking distance.
- Impaired handling characteristics.
- Irregular wear.

- Impaired driving comfort.
- Susceptibility to damage.

▲ WARNING Risk of accident caused by repeated drop in tire pressure

If the tire pressure drops repeatedly, the wheel, valve or tire may be damaged.

Insufficient tire pressure can cause the tires to burst.

- ▶ Inspect the tire for signs of foreign objects.
- ▶ Check whether the wheel or valve has a leak.
- ▶ If you are unable to rectify the damage, contact a qualified specialist workshop.

You can find information on tire pressure for the vehicle's factory-installed tires on the following labels:

- Tire and Loading Information placard on the B-pillar of your vehicle (→ page 499).
- Tire pressure table on the inside of the fuel filler flap (→ page 493).

Observe the maximum tire pressure (→ page 505).

Use a suitable pressure gauge to check the tire pressure. The outer appearance of a tire does not permit any reliable conclusion about the tire pressure.

Vehicles with a tire pressure monitoring system: You can also check the tire pressure using the on-board computer.

Only correct tire pressure when the tires are cold. Conditions for cold tires:

- The vehicle has been parked with the tires out of direct sunlight for at least three hours.
- The vehicle has traveled less than 1 mile (1.6 km).

A rise in the tire temperature of 18 °F (10 °C) increases the tire pressure by approx. 10 kPa (0.1 bar/1.5 psi). Take this into account when checking the tire pressure of warm tires.

The tire pressure recommended for increased load/speed in the tire pressure table can affect the ride comfort.

▲ WARNING Risk of accident due to unsuitable accessories on tire valve

If you mount unsuitable accessories onto tire valves, the tire valves may be overloaded and malfunction, which can cause a loss of tire pressure. Aftermarket tire pressure monitoring systems will cause the tire valve to remain open, depending on the design. This can also result in a loss of tire pressure.

- ▶ Only screw standard valve caps or valve caps specifically approved by Mercedes-Benz for your vehicle onto the tire valve.

Trailer operation notes

Always inflate the rear axle tires to the recommended tire pressure on the tire pressure table for increased load.

Tire pressure table

The tire pressure table is on the inside of the fuel filler flap.

494 Wheels and tires

- ⓘ The data shown in the images is example data.

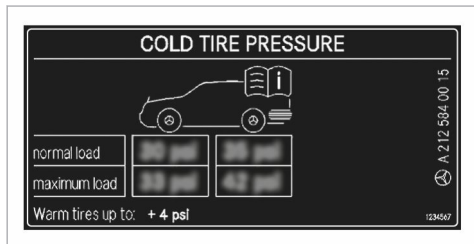

The tire pressure table shows the recommended tire pressure for all tires approved for this vehicle. The recommended tire pressures apply for cold tires under various operating conditions, i.e. loading and/or speed of the vehicle.

If one or more tire sizes precede a tire pressure, the tire pressure information following is only valid for those tire sizes.

The load conditions "partially laden" and "fully laden" are defined in the table for different numbers of passengers and amounts of luggage. The actual number of seats may differ from this.

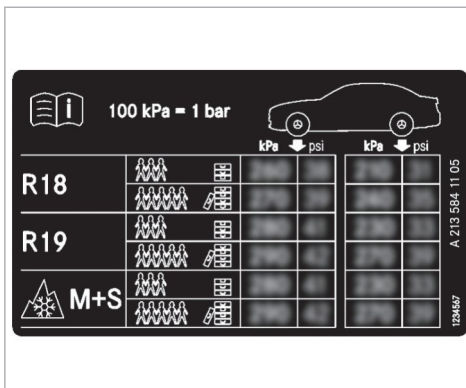

Some tire pressure tables only show the rim diameter instead of the complete tire size, e.g. **R18**. The rim diameter is part of the tire size and can be found on the tire side wall (→ page 506).

Be sure to also observe the following further related subjects:

- Notes on tire pressure (→ page 492)
- Tire and Loading Information placard (→ page 499)

- Maximum tire pressure (→ page 505)

Checking tire pressures manually

- ▶ Read the tire pressure for the current operating conditions from the Tire and Loading Information placard or the tire pressure table. Observe the notes on tire pressure.
- ▶ Remove the valve cap of the tire to be checked.
- ▶ Press the tire pressure gauge securely onto the valve.
- ▶ Read the tire pressure.
- ▶ If the tire pressure is lower than the recommended value, increase the tire pressure to the recommended value.
- ▶ If the tire pressure is higher than the recommended value, release air. To do so, press down the metal pin in the valve, e.g. using the tip of a pen for example. Then check the tire pressure again using the tire pressure gauge.
- ▶ Screw the valve cap onto the valve.

Further related subjects:

- Notes on tire pressure (→ page 492)
- Tire pressure table (→ page 493)
- Tire and Loading Information placard (→ page 499)

Tire pressure monitoring system

Function of the tire pressure monitoring system

▲ DANGER Risk of accident due to incorrect tire pressure

Each tire, including the spare tire (if present), should be checked at least once a month when cold and then inflated to the pressure recommended by the vehicle manufacturer (see the Tire and Loading Information placard on the driver's side B-pillar or the tire pressure table on the inside of the fuel filler flap of your vehicle). If your vehicle has tires of a different size than the size indicated on the Tire and Loading Information placard or

the tire pressure table, you must find out the correct tire pressures for these tires.

As an added safety feature, your vehicle has been equipped with a tire pressure monitoring system (TPMS) that illuminates a low tire pressure indicator lamp when one or more of your tires are significantly underinflated. Accordingly, if the low tire pressure indicator lamp lights up, you should stop and check your tires as soon as possible, and inflate them to the correct pressure. Driving on a significantly underinflated tire causes the tire to overheat and can lead to tire failure. Underinflation also increases fuel consumption, reduces the life expectancy of the tire and may adversely affect the handling and braking characteristics of the vehicle. Please note that the TPMS is not a substitute for proper tire maintenance, and it is the driver's responsibility to maintain correct tire pressure, even if underinflation has not reached the level to trigger illumination of the TPMS low tire pressure indicator lamp.

Your vehicle has also been equipped with a TPMS malfunction indicator to indicate when the system is not operating properly. The TPMS malfunction indicator is combined with the low tire pressure indicator lamp. When the system detects a malfunction, the indicator lamp will flash for approximately a minute and then remain continuously illuminated. This sequence will continue upon subsequent vehicle start-ups as long as the malfunction exists.

When the malfunction indicator is illuminated, the system may not be able to detect or signal low tire pressure as intended. TPMS malfunctions may occur for a variety of reasons, including the installation of incompatible replacement or alternate tires or wheels on the vehicle that prevent the TPMS from functioning properly.

Always check the TPMS malfunction warning lamp after replacing one or more tires or wheels on your vehicle to ensure that the replacement or alternate tires and wheels

allow the TPMS to continue to function properly.

The system checks the tire pressure and the tire temperature of the tires installed on the vehicle by means of a tire pressure sensor.

New tire pressure sensors, e.g. in winter tires, are automatically taught-in during the first journey they are used.

The tire pressure and the tire temperature appear in the multifunction display (→ page 496).

If there is a substantial pressure loss or if the tire temperature is excessive, you will be warned in the following ways:

- Via display messages (→ page 585)
- Via the  warning lamp in the instrument cluster (→ page 605)

The tire pressure monitoring system is only an aid. It is the driver's responsibility to set the tire pressure to the recommended cold tire pressure suitable for the operating situation. Set the tire pressure for cold tires using a tire pressure

gauge. Note that the correct tire pressure for the current operating situation must first be taught-in to the tire pressure monitoring system.

In most cases, the tire pressure monitoring system will automatically update the new reference values after you have changed the tire pressure. You can, however, also update the reference values by restarting the tire pressure monitoring system manually (→ page 497).

System limits

The system may be impaired or may not function in the following situations:

- The tire pressure has been set incorrectly
- There is a sudden pressure loss caused, for example, by a foreign object penetrating the tire
- There is a malfunction caused by another radio signal source

Be sure to also pay attention to the following related topic:

- Notes on tire pressure (→ page 492)

Checking the tire pressure with the tire pressure monitoring system Requirements:

- The ignition is switched on.

On-board computer:

→ [Service](#) → [Tires](#)

One of the following displays appears:

- Current tire pressure and tire temperature of the individual wheels:

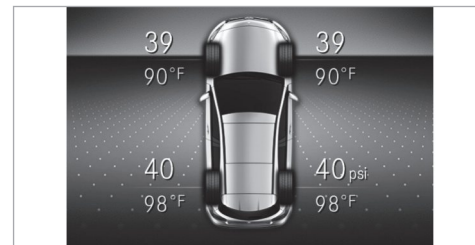

- **Tire pressure will be displayed after driving a few minutes**
- **Tire Pressure Monitor Active:** the teach-in process of the system is not yet complete.

The tire pressures are already being monitored.

- ▶ Compare the tire pressure with the recommended tire pressure for the current operating condition (→ page 493). Observe the notes on tire temperature (→ page 492).

i The values displayed in the multifunction display may deviate from those of the tire pressure gauge as they refer to sea level. At high altitudes, the tire pressure value indicated by a pressure gauge are higher than those shown by the on-board computer. In this case, do not reduce the tire pressure.

Make sure to observe the following further related subject:

- Notes on tire pressure (→ page 492)

Restarting the tire pressure monitoring system

Requirements:

- The recommended tire pressure is correctly set for the respective operating status on each of the four wheels (→ page 492).

Restart the tire pressure monitoring system in the following situations:

- The tire pressure has changed.
- The wheels or tires have been changed or newly installed.

On-board computer:

↳ **Service** ▶ **Tires**

- ▶ Swipe downwards on Touch Control on the left-hand side of the steering wheel. The **Use Current Pressures as New Reference Values** message is shown in the multifunction display.
- ▶ To begin restart, press Touch Control on the left-hand side of the steering wheel. The **Tire Press. Monitor Restarted** message is shown in the multifunction display.

Current warning messages are deleted and the yellow  warning lamp goes out.

After you have been driving for a few minutes, the system checks whether the current tire pressures are within the specified range. The current tire pressures are then accepted as reference values and monitored.

Make sure to observe the following further related subject:

- Notes on tire pressure (→ page 492)

Radio-equipment approval of the tire pressure monitoring system

Radio equipment approval numbers

Country	Radio type approval number
USA	FCC ID: YGOTSSRE4A
Canada	IC: 4008C-TSSRE4A

Further information on the declaration of conformity for wireless vehicle components (→ page 27).

Tire pressure loss warning system

Function of the tire pressure loss warning system

The tire pressure loss warning system warns the driver by means of display messages when there is a severe tire pressure loss.

After a change in tire pressure, a wheel rotation or a tire change, or if you have re-installed wheels or tires, the tire pressure loss warning system has to be restarted (→ page 498).

The tire pressure loss warning system does not replace the need to regularly check the tire pressure.

System limitations

The system may be impaired or may not function particularly in the following situations:

- Incorrectly set tire pressure
- Sudden pressure loss caused, for example, by a foreign object penetrating the tire
- Steady pressure loss in several tires

The system has a restricted or delayed function particularly in the following situations:

- Poor ground conditions, e.g. snow or gravel
- Driving with snow chains
- When adopting a very sporty driving style with high cornering speeds or sudden acceleration
- Driving with a very heavy or large trailer

- Driving with a high load

Be sure to also observe the following further related subjects:

- Notes on tire pressure (→ page 492)
- Display messages about the tires (→ page 585)

Restarting the tire pressure loss warning system

Requirements:

- The recommended tire pressure is correctly set for the respective operating status on each of the four wheels (→ page 492).

Restart the tire pressure loss warning system in the following situations:

- The tire pressure has changed.
- The wheels or tires have been changed or newly installed.

On-board computer:

→ [Service](#) ▶ [Tires](#)

- ▶ Swipe downwards on Touch Control on the left-hand side of the steering wheel. The [Tire Pressure Control System Active Restart](#) message is shown in the multifunction display.

Restart the tire pressure loss warning system in the following situations:

- The tire pressure has changed.
- The wheels or tires have been changed or newly installed.
- ▶ To begin restart, press Touch Control on the left-hand side of the steering wheel. The [Tire Pressure Now OK?](#) message is shown in the multifunction display.
- ▶ Select [Yes](#).
- ▶ To confirm restart, press Touch Control on the left-hand side of the steering wheel. The [Run Flat Indicator Restarted](#) message is shown in the multifunction display.

After you have driven for a few minutes, the tire pressure loss warning system monitors the set tire pressure of all the tires.

Be sure to also observe the following further related subjects:

- Notes on tire pressure (→ page 492)

Loading the vehicle

Notes on Tire and Loading Information placard

⚠ WARNING Risk of accident from overloaded tires

Overloaded tires may overheat and burst as a consequence. Overloaded tires can also impair the steering and handling characteristics and lead to brake failure.

- ▶ Observe the load-bearing capacity of the tires.
- ▶ The load-bearing capacity must be at least half the gross axle weight rating of the vehicle.

▶ Never overload the tires by exceeding the maximum load.

The Tire and Loading Information placard is on the B-pillar on the driver's side of the vehicle.

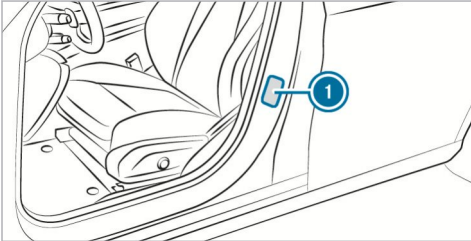

① Tire and Loading Information placard

TIRE AN RENSEIGNEMENTS		LOADING INFORMATION	
SEATING CAPACITY / NOMBRE DE PLACES		TOTAL	FRONT / AVANT
7		7	2
MIDDLE / MOYEN		REAR / ARRIÈRE	
		3	2
The combined weight of occupants and cargo should never exceed / Le poids total des occupants et du chargement ne doit jamais dépasser		xxxx kg or	xxxx lbs.
TIRE / PNEU	SIZE / DIMENSIONS	COLD TIRE PRESSURE / PRESSION DES PNEUS À FROID	SEE OWNER'S MANUAL FOR ADDITIONAL INFORMATION
FRONT / AVANT	285/40 ZR18 99Y XL	200 KPA, 29 PSI	VOIR LE MANUEL DE L'USAGER POUR PLUS DE RENSEIGNEMENTS
REAR / ARRIÈRE	285/35 ZR18 101Y XL	200 KPA, 29 PSI	
SPARE / DE SECOURS	175/55-18 95P	420 KPA, 60 PSI	

① The data shown in the illustration is example data.

The Tire and Loading Information placard shows:

- Maximum number of seats ② according to the maximum number of people permitted to travel in the vehicle.
- Maximum permissible load ③ comprises the gross weight of all vehicle occupants, load and luggage.

- Recommended tire pressures  for cold tires. The recommended tire pressures are valid for the maximum permissible load and up to the maximum permissible vehicle speed.

Please also note:

- Information on permissible weights and loads on the vehicle identification plate (→ page 527).
- Information on tire pressure in the tire pressure table (→ page 493).

Further related subjects:

- Determining the maximum permissible load (→ page 500)
- Notes on tire pressure (→ page 492).

Steps for Determining Correct Load Limit

The following steps have been developed as required of all manufacturers under Title 49, Code of U.S. Federal Regulations, Part 575, pursuant to the "National Traffic and Motor Vehicle Safety Act of 1966".

- ▶ **(1):** Locate the statement "The combined weight of occupants and cargo should never exceed XXX kg or XXX lbs." on your vehicle's placard.
- ▶ **(2):** Determine the combined weight of the driver and passengers that will be riding in your vehicle.
- ▶ **(3):** Subtract the combined weight of the driver and passengers from XXX kg or XXX lbs.
- ▶ **(4):** The resulting figure equals the available amount of cargo and luggage load capacity. For example, if the "XXX" amount equals 1400 lbs. and there will be five 150 lb passengers in your vehicle, the amount of available cargo and luggage load capacity is 650 lbs. $(1400 - 750 (5 \times 150) = 650 \text{ lbs.})$
- ▶ **(5):** Determine the combined weight of luggage and cargo being loaded on the vehicle. The weight may not safely exceed the available cargo and luggage load capacity calculated in Step 4.
- ▶ **(6):** If your vehicle will be towing a trailer, load from your trailer will be transferred to

your vehicle. Consult this manual to determine how this reduces the available cargo and luggage load capacity of your vehicle.

-  Not all vehicles are permitted to tow a trailer. Towing a trailer is only permitted if a trailer-hitch is installed. Please consult an authorized Mercedes-Benz dealer if you have any questions about towing a trailer with your vehicle.

Even if you have calculated the total load carefully, you should still make sure that the maximum permissible gross weight and the maximum gross axle weight rating of your vehicle are not exceeded. Details can be found on the vehicle identification plate.

- ▶ Have your loaded vehicle – including driver, occupants and load – weighed on a vehicle weighbridge. The measured values may not exceed the maximum permissible values stated on the vehicle identification plate.

Further related subjects:

- Calculation example for determining the maximum load (→ page 501)

- Tire and Loading Information placard (→ page 499)
- Tire pressure table (→ page 493)
- Vehicle identification plate

Calculation example for determining the maximum load

The following table shows examples of how to calculate total and load capacities with varying seating configurations and different numbers and sizes of occupants. The following examples use a maximum load of 1500 lbs (680 kg). **This**

is for illustration purposes only. Make sure you are using the actual load limit for your vehicle stated on your vehicle's Tire and Loading Information placard (→ page 499).

The higher the weight of all the occupants, the smaller the maximum load for luggage.

Step 1

	Example 1	Example 2
Combined maximum weight of occupants and load (data from the Tire and Loading Information placard)	1500 lbs (680 kg)	1500 lbs (680 kg)

Step 2

	Example 1	Example 2
Number of people in the vehicle (driver and occupants)	5	1
Distribution of the occupants	Front: 2 Rear: 3	Front: 1

502 Wheels and tires

	Example 1	Example 2
Weight of occupants	Occupant 1: 150 lbs (68 kg) Occupant 2: 180 lbs (82 kg) Occupant 3: 160 lbs (73 kg) Occupant 4: 140 lbs (63 kg) Occupant 5: 120 lbs (54 kg)	Occupant 1: 200 lbs (91 kg)
Total weight of all occupants	750 lbs (340 kg)	200 lbs (91 kg)

Step 3

	Example 1	Example 2
Permissible load (maximum gross vehicle weight rating from the Tire and Loading Information placard minus the gross weight of all occupants)	1500 lbs (680 kg) - 750 lbs (340 kg) = 750 lbs (340 kg)	1500 lbs (680 kg) - 200 lbs (91 kg) = 1300 lbs (589 kg)

Tire labeling

Overview of tire labeling

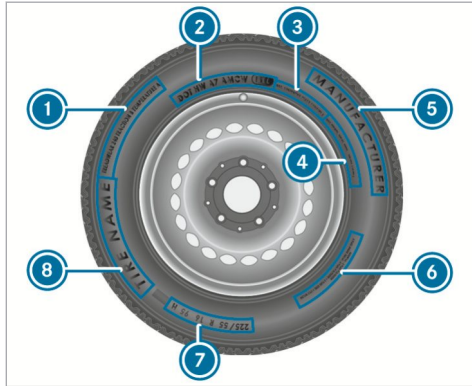

- ① Uniform Tire Quality Grading Standard (→ page 503)
- ② DOT, Tire Identification Number (→ page 504)
- ③ Maximum tire load (→ page 505)
- ④ Maximum tire pressure (→ page 505)

- ⑤ Manufacturer
 - ⑥ Characteristics of the tire (→ page 506)
 - ⑦ Tire size designation, load-bearing capacity, speed rating and load index (→ page 506)
 - ⑧ Tire name
- ① The data shown in the image is example data.

Tire Quality Grading

In accordance with the US Department of Transportation's "Uniform Tire Quality Grading Standards", tire manufacturers are required to grade their tires on the basis of the following three performance factors:

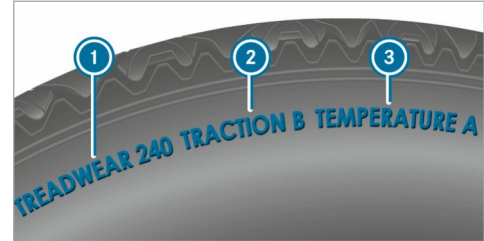

- ① Tread wear grade
 - ② Traction grade
 - ③ Temperature grade
- ① The data shown in the illustration is example data.
- ① The classification is not legally stipulated for Canada, but it is generally stated.

Tread wear grade

The tread wear grade is a comparative rating based on the wear rate of the tire when tested under controlled conditions on a specified test track of the US Department of Transportation. For example, a tire graded 150 would wear one

and one-half times as well on the government test track as a tire graded 100.

The relative performance of tires depends upon the actual conditions of their use, however, and may depart significantly from the norm due to variations in driving habits, service practices and differences in road characteristics and climate conditions.

Traction grade

⚠ DANGER Risk of accident due to inadequate traction

The traction grade assigned to this tire is based on straight-ahead braking traction tests, and does not include either acceleration, cornering, hydroplaning or peak traction characteristics.

- ▶ Always adapt your driving style and drive at a speed to suit the prevailing traffic and weather conditions.

! **NOTE** Damage to the drivetrain from wheelspin

- ▶ Avoid wheelspin.

The traction classes, from highest to lowest, are AA, A, B and C. Those grades represent the tire's ability to stop on wet pavement as measured under controlled conditions on specified government test surfaces of asphalt and concrete. A tire marked C may have poor traction performance.

Temperature grade

⚠ WARNING Risk of accident from tire overheating and tire failure

The temperature grade for this tire is established for a tire that is properly inflated and not overloaded. Excessive speed, underinflation, or excessive loading, either separately or in combination, can cause excessive heat build-up and possible tire failure.

- ▶ Observe the recommended tire pressures and regularly check the tire pres-

sure of all tires including the spare wheel.

- ▶ Adjust the tire pressure as necessary.

The temperature grades are A (the highest), B and C. They represent the tire's resistance to the generation of heat and its ability to dissipate heat when tested under controlled conditions on a specified indoor laboratory test wheel. Sustained high temperature can cause the material of the tire to degenerate and reduce tire life, and excessive temperature can lead to sudden tire failure. Grade C corresponds to a level of performance which all passenger car tires must meet under the Federal Motor Safety Standard No. 109. Grades B and A represent higher levels of performance on the laboratory test wheel than the minimum required by law.

DOT, Tire Identification Number (TIN)

US tire regulations stipulate that every tire manufacturer or retreader must imprint a TIN in or on the side wall of each tire produced.

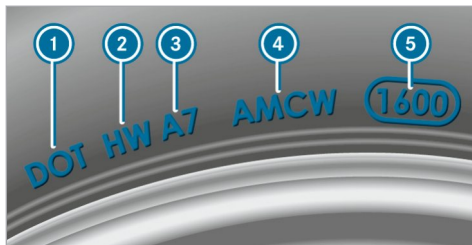

i The data shown in the image is example data.

The TIN is a unique identification number to identify tires and comprises the following:

- **DOT (Department of Transportation):** tire symbol marks **1** indicating that the tire complies with the requirements of the US Department of Transportation.
- **Manufacturer identification code:** manufacturer identification code **2** contains details of the tire manufacturer. New tires have a code with two symbols. Retreaded tires have a code with four symbols. Further information on retreaded tires (→ page 511).

- **Tire size:** identifier **3** describes the tire size.
- **Tire type code:** tire type code **4** can be used by the manufacturer as a code to describe specific characteristics of the tire.
- **Manufacturing date:** manufacturing date **5** provides information about the age of a tire. The 1st and 2nd positions represent the calendar week and the 3rd and 4th positions state the year of manufacture (e.g. "3208" represents the 32nd week of 2008).

Information on the maximum tire load



i The data shown in the image is example data.

Maximum tire load **1** is the maximum permissible weight for which the tire is approved.

Do not overload the tires by exceeding the specified load limit. The maximum permissible load can be found on the vehicle's Tire and Loading Information placard on the B-pillar on the driver's side (→ page 499).

Specifications for maximum tire pressure



i The data shown in the image is example data.

Never exceed maximum tire pressure ❶ specified for the tire.

Information on tire characteristics



❶ The data shown in the image is example data.

This information describes the type of tire cord and the number of layers in side wall ❶ and under tire tread ❷.

Tire size designation, load-bearing capacity, speed rating and load index

⚠ WARNING Risk of injury through exceeding the specified tire load rating or the permissible speed rating

Exceeding the specified tire load rating or the permissible speed rating may lead to tire damage and to the tires bursting.

- ▶ Therefore, only use tire types and sizes approved for your vehicle model.
- ▶ Observe the tire load rating and speed rating required for your vehicle.

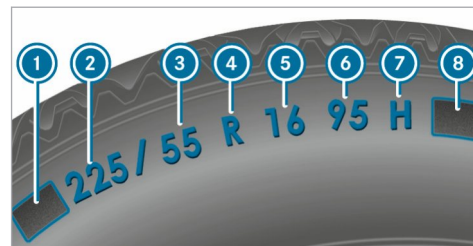

- ❶ Preceding letter
- ❷ Nominal tire width in millimeters
- ❸ Aspect ratio in %
- ❹ Tire code
- ❺ Rim diameter
- ❻ Load-bearing index
- ❼ Speed rating
- ❽ Load index

❶ The data shown in the image is example data.

Information about reading tire data can be obtained from any qualified specialist workshop.

Preceding letter 1:

- Without: passenger vehicle tires according to European manufacturing standards.
- "P": passenger vehicle tires according to US manufacturing standards.
- "LT": light truck tires according to US manufacturing standards.
- "T": compact emergency spare wheels with high tire pressure that are only designed for temporary use in an emergency.

Aspect ratio 3:

Ratio between tire height and tire width in percent (tire height divided by tire width).

Tire code 4 (tire type):

- "R": radial tire
- "D": bias ply tire
- "B": bias belted tires
- "ZR": radial tire with a maximum speed above 149 mph (240 km/h) (optional)

Rim diameter 5:

The diameter of the bead seat (not the diameter of the rim flange). The rim diameter is specified in inches (in).

Load-bearing index 6:

Numerical code that specifies the maximum load-bearing capacity of a tire (e.g. "91" corresponds to 1356 lbs (615 kg)).

The load-bearing capacity of the tire must be at least half the permissible axle load of your vehicle. Do not overload the tires by exceeding the specified load limit.

See also:

- Maximum permissible load on the Tire and Loading Information placard (→ page 499)
- Maximum tire load (→ page 505)
- Load index

Speed rating 7:

Specifies the approved maximum speed of the tire.

- **i** An electronic speed limiter prevents your vehicle from exceeding a speed of 130 mph (210 km/h).

Make sure that your tires have the required speed rating. You can obtain information on the required speed rating from an authorized Mercedes-Benz Center.

Summer tires

Index	Speed rating
Q	up to 100 mph (160 km/h)
R	up to 106 mph (170 km/h)
S	up to 112 mph (180 km/h)
T	up to 118 mph (190 km/h)
H	up to 130 mph (210 km/h)
V	up to 149 mph (240 km/h)
W	up to 168 mph (270 km/h)
Y	up to 186 mph (300 km/h)

Index	Speed rating
ZR...Y ¹	up to 186 mph (300 km/h)
ZR...(..Y) ¹	over 186 mph (300 km/h)
ZR ¹	over 149 mph (240 km/h)

- Specifying the speed rating as the "ZR" index in tire code ④ is optional for tires up to 186 mph (300 km/h).
- If your tire code ④ includes "ZR" and there is no speed rating ⑦, find out what the maximum speed is from the tire manufacturer.
- If load-bearing index ⑥ and speed rating ⑦ are in brackets, the maximum speed rating of your tire is above 186 mph (300 km/h). To find out the maximum speed, ask the tire manufacturer.

¹ "ZR" stated in the tire code.

² Or "M+S"  " for winter tires

All-weather tires and winter tires

Index	Speed rating
Q M+S ²	up to 100 mph (160 km/h)
T M+S ²	up to 118 mph (190 km/h)
H M+S ²	up to 130 mph (210 km/h)
V M+S ²	up to 149 mph (240 km/h)

Winter tires bear the  snowflake symbol and fulfill the requirements of the Rubber Manufacturers Association (RMA) and the Rubber Association of Canada (RAC) regarding the tire traction on snow.

Load index ⑧:

- No specification given: standard load (SL) tire
- "XL" or "Extra Load": extra load tire or reinforced tire
- "Light Load": light load tire

- "C", "D", "E": a load range that depends on the maximum load that the tire can carry at a certain pressure

Definition of terms for tires and loading

Tire structure and characteristics: describes the number of layers or the number of rubber-coated belts in the tire contact surface and the tire wall. These are made of steel, nylon, polyester and other materials.

Bar: metric unit for tire pressure.

14.5038 pounds per square inch (psi) and 100 kilopascal (kPa) is the equivalent of one bar.

DOT (Department of Transportation): DOT-marked tires fulfill the requirements of the US Department of Transportation.

Average weight of the vehicle occupants: the number of vehicle occupants for which the vehicle is designed, multiplied by 150 lb (68 kg).

Uniform Tire Quality Grading Standards: a uniform standard to grade the quality of tires with regard to tread quality, tire traction and temperature characteristics. The quality grading assessment is made by the manufacturer following specifications from the U.S. government. The quality grade of a tire is imprinted on the side wall of the tire.

Recommended tire pressure: the recommended tire pressure is the tire pressure specified for the tires mounted to the vehicle at the factory.

The tire and information table contains the recommended tire pressures for cold tires, the maximum permissible load and the maximum permissible vehicle speed.

The tire pressure table contains the recommended tire pressures for cold tires under various operating conditions, i.e. loading and/or speed of the vehicle.

Increased vehicle weight due to optional equipment: the combined weight of all standard and optional equipment available for the vehicle,

regardless of whether it is actually installed on the vehicle or not.

Rim: the part of the wheel on which the tire is installed.

GAWR (Gross Axle Weight Rating): the GAWR is the maximum permissible axle load. The actual load on an axle must never exceed the gross axle weight rating. The gross axle weight rating can be found on the vehicle identification plate on the B-pillar on the driver's side.

Speed rating: the speed rating is part of the tire identification. It specifies the speed range for which a tire is approved.

GVW (Gross Vehicle Weight): the gross vehicle weight comprises the weight of the vehicle including fuel, tools, the spare wheel, accessories installed, occupants, luggage and the trailer drawbar noseweight, if applicable. The gross vehicle weight must not exceed the gross vehicle weight rating GVWR as specified on the vehicle identification plate on the B-pillar on the driver's side.

GVWR (Gross Vehicle Weight Rating): the GVWR is the maximum permitted gross weight

of the fully laden vehicle (weight of the vehicle including all accessories, occupants, fuel, luggage and the trailer drawbar noseweight if applicable). The gross vehicle weight rating is specified on the vehicle identification plate on the B-pillar on the driver's side.

Maximum weight of the laden vehicle: the maximum weight is the sum of the curb weight of the vehicle, the weight of the accessories, the maximum load and the weight of optional equipment installed at the factory.

Kilopascal (kPa): metric unit for tire pressure. 6.9 kPa corresponds to 1 psi. Another unit for tire pressure is bar. 100 kilopascal (kPa) equals 1 bar.

Load index: in addition to the load-bearing index, the load index may also be imprinted on the side wall of the tire. This specifies the load-bearing capacity of the tire more precisely.

Curb weight: the weight of a vehicle with standard equipment including the maximum capacity of fuel, oil and coolant. It also includes the air conditioning system and optional equipment if

these are installed on the vehicle, but does not include passengers or luggage.

Maximum tire load: the maximum tire load is the maximum permissible weight in kilograms or lbs for which a tire is approved.

Maximum permissible tire pressure: maximum permissible tire pressure for one tire.

Maximum load on one tire: maximum load on one tire. This is calculated by dividing the maximum axle load of one axle by two.

PSI (pounds per square inch): standard unit of measurement for tire pressure.

Aspect ratio: ratio between tire height and tire width in percent.

Tire pressure: pressure inside the tire applying an outward force to every square inch of the tire. The tire pressure is specified in pounds per square inch (psi), in kilopascals (kPa) or in bar. The tire pressure should only be corrected when the tires are cold.

Cold tire pressure: the tires are cold when the vehicle has been parked for at least 3 hours

without direct sunlight on the tires or the vehicle has been driven for less than 1 mile (1.6 km).

Tire contact surface: the part of the tire that comes into contact with the road.

Tire bead: the purpose of the tire bead is to ensure that the tire sits securely on the wheel rim. There are several wire cores in the tire bead to prevent the tire from changing length on the wheel rim.

Side wall: the part of the tire between the tread and the tire bead.

Weight of optional equipment: the combined weight of the optional equipment weighing more than the replaced standard parts and more than 5 lbs (2.3 kg). This optional equipment, such as high-performance brakes, level control system, a roof luggage rack or high-performance batteries, is not included in the curb weight and the weight of the accessories.

TIN (Tire Identification Number): a unique identification number which can be used by a tire manufacturer to identify tires, for example, in a product recall, and thus identify the purchasers. The TIN is made up of the manufactur-

er's identity code, tire size, tire type code and the manufacturing date.

Load-bearing index: the load-bearing index is a code that contains the maximum load-bearing capacity of a tire.

Traction: traction is the grip resulting from friction between the tires and the road surface.

Wear indicator: narrow bars (tread wear bars) that are distributed over the tire contact surface. If the tire tread is level with the bars, the wear limit of 1/16 in (1.6 mm) has been reached.

Distribution of vehicle occupants: distribution of vehicle occupants over designated seat positions in a vehicle.

Maximum permissible payload weight: nominal load and luggage load plus 150 lb (68 kg) multiplied by the number of seats in the vehicle.

Changing a wheel

Notes on selecting, installing and replacing tires

Mercedes-AMG vehicles: observe the notes in the Supplement. Otherwise, you may fail to recognize dangers.

You can ask for information regarding permitted wheel/tire combinations at an authorized Mercedes-Benz Center.

⚠ WARNING Risk of accident due to incorrect dimensions of wheels and tires

If wheels and tires of the wrong size are installed, the wheel brakes or wheel suspension components may be damaged.

- ▶ Always replace wheels and tires with those that fulfill the specifications of the original part.

When replacing wheels, make sure to fit the correct:

- Designation

- Model

When replacing tires, make sure to install the correct:

- Designation
- Manufacturer
- Model

⚠ WARNING Risk of injury through exceeding the specified tire load rating or the permissible speed rating

Exceeding the specified tire load rating or the permissible speed rating may lead to tire damage and to the tires bursting.

- ▶ Therefore, only use tire types and sizes approved for your vehicle model.
- ▶ Observe the tire load rating and speed rating required for your vehicle.

! NOTE Vehicle and tire damage through tire types and sizes that have not been approved

For safety reasons, only use tires, wheels and accessories which have been specially approved by Mercedes-Benz for your vehicle.

These tires are specially adapted to the control systems, such as ABS, ESP[®] and 4MATIC, and marked as follows:

- MO = Mercedes-Benz Original
- MOE = Mercedes-Benz Original Extended (run-flat tire only for certain wheels)
- MO1 = Mercedes-Benz Original (only certain AMG tires)

Certain characteristics, such as handling, vehicle noise emissions, fuel consumption, etc. may otherwise be adversely affected. Furthermore, other tire sizes could result in the tires rubbing against the body and axle components when loaded. This could result in damage to the tire or the vehicle.

Only use tires, wheels and accessories that have been checked and recommended by Mercedes-Benz.

! **NOTE** Risk to driving safety from retreaded tires

Retreaded tires are neither tested nor recommended by Mercedes-Benz, since previous damage cannot always be detected on retreaded tires.

For this reason driving safety cannot be guaranteed.

- ▶ Do not use used tires if you have no information about their previous usage.

! **NOTE** Possible damage to wheels or tires when driving over obstacles

Large wheels have a lower tire section width. The lower the tire section width, the greater is the risk of damage to wheels or tires when driving over obstacles.

- ▶ Avoid obstacles or drive particularly carefully.

! **NOTE** Damage to electronic component parts from the use of tire-mounting tools

Vehicles with a tire pressure monitoring system:

Electronic component parts are located in the wheel. Tire-mounting tools should not be used in the area of the valve.

This could otherwise damage the electronic component parts.

- ▶ Have the tires changed at a qualified specialist workshop only.

! **NOTE** Damage to summer tires at low ambient temperatures

At low ambient temperatures, tears could form when driving with summer tires, causing permanent damage to the tires.

- ▶ At temperatures below 45 °F (7 °C), use M+S tires .

Accessory parts that are not approved for your vehicle by Mercedes-Benz or are not being used correctly can impair the operating safety.

Before purchasing and using non-approved accessories, visit a qualified specialist workshop and inquire about:

- Suitability
- Legal stipulations
- Factory recommendations

! **WARNING** Risk of accident with high performance tires

The special tire tread in combination with the optimized tire compound means that the risk of skidding or hydroplaning on wet roads is increased.

In addition, the tire grip is greatly reduced at a low outside temperature and tire running temperature.

- ▶ Switch on the ESP® and adapt your driving style accordingly.
- ▶ Use M+S tire at outside temperatures of less than 10 °C (50 °F).

Observe the following when selecting, installing and replacing tires:

- Only use tires and wheels of the same type (summer tires, winter tires, MOExtended tires) and the same make.
- Only install wheels of the same size on one axle (left and right).
It is only permissible to install a different wheel size in the event of a flat tire in order to drive to the specialist workshop.
- Only install tires of the correct size onto the wheels.
- **Vehicles with a tire pressure monitoring system:** All installed wheels must be equipped with functioning sensors for the tire pressure monitoring system.
- At temperatures below 45 °F (7 °C), use winter tires or all-season tire marked M+S for all wheels.

Winter tires bearing the  snowflake symbol in addition to the M+S marking provide the best possible grip in wintry road conditions.

- For M+S tires, only use tires with the same tread.
- Observe the maximum permissible speed for the M+S tires installed.
If this is below the vehicle's maximum speed, this must be indicated by an appropriate label in the driver's field of vision.
- Break in new tires at moderate speeds for the first 60 miles (100 km).
- Replace the tires after six years at the latest, regardless of wear.
- **When replacing with tires that do not feature run-flat characteristics:** vehicles with MOExtended tires are not equipped with a TIREFIT kit at the factory. Equip the vehicle with a TIREFIT kit after replacing with tires that do not feature run-flat characteristics, e.g. winter tires.

For more information on wheels and tires, contact a qualified specialist workshop.

Be sure to also observe the following further related subjects:

- Notes on tire pressure (→ page 492)
- Tire and Loading Information placard (→ page 499)
- Tire size designation, load-bearing capacity, speed rating and load index (→ page 506)
- Tire pressure table (→ page 493)
- Notes on the emergency spare wheel (→ page 520)

Notes on rotating wheels

 **WARNING** Risk of injury through different wheel sizes

Interchanging the front and rear wheels if the wheels or tires have different dimensions may severely impair the driving characteristics.

The wheel brakes or wheel suspension components may also be damaged.

 Rotate front and rear wheels only if the wheels and tires are of the same dimensions.

514 Wheels and tires

The wear patterns on the front and rear wheels differ:

- Front wheels wear more on the shoulder of the tire
- Rear wheels wear more at the center of the tire

Do not drive with tires that have too little tread depth. This significantly reduces traction on wet roads (hydroplaning).

On vehicles that have the same size front and rear wheels, rotate the wheels according to the intervals in the tire manufacturer's warranty book in your vehicle documents. If this is not available, rotate the tires every 3,000 to 6,000 miles (5,000 to 10,000 km), depending on the wear. Ensure that the direction of rotation is maintained.

Observe the instructions and safety notes on "Changing a wheel" when doing so (→ page 515).

Notes on storing wheels

When storing wheels, observe the following notes:

- After removing wheels, store them in a cool, dry and preferably dark place.
- Protect the tires from contact with oil, grease or fuel.

Overview of the tire-change tool kit

Apart from some country-specific variants, vehicles are not equipped with a tire-change tool kit. For more information on which tools are required and approved to perform a wheel change on your vehicle, consult a qualified specialist workshop.

Required tire-change tools may include, for example:

- Jack
- Chock
- Lug wrench

Tire-change tool kit  is located under the cargo compartment floor.

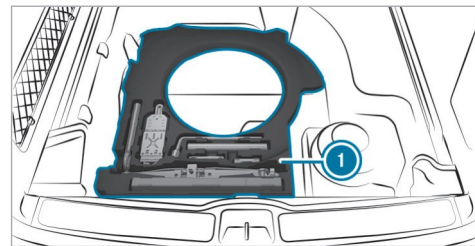

The tire-change tool kit includes the following:

- Jack
- Lug wrench
- Wheel studs
- Extension attachment for wheel studs, if necessary (depending on vehicle version)
- Folding chock
- Ratchet wrench

Setting up the folding chock

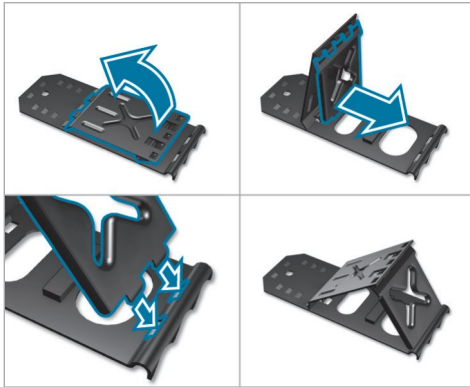

Preparing the vehicle for a wheel change

Requirements:

- The required tire-change tool kit is available. If your vehicle is not equipped with the tire-change tool kit, consult a qualified specialist workshop to find out about suitable tools.

- The vehicle is not on a slope.
 - The vehicle is on solid, non-slippery and level ground.
- Apply the electric parking brake manually.
 - Move the front wheels to the straight-ahead position.
 - Vehicles with automatic transmission:** Shift into position **P**.
 - Vehicles with level control system:** Set the normal vehicle level (→ page 231).
 - Switch off the engine.
 - Make sure that the engine cannot be started.
 - Place chocks or other suitable items under the front and rear of the wheel that is diagonally opposite the wheel you wish to change.
 - Raise the vehicle (→ page 516).

Removing and installing hub caps

Requirements:

- The vehicle is prepared for a wheel change (→ page 515).

Plastic hub cap

- To remove:** turn the center cover of the hub cap counter-clockwise and remove the hub cap.
- To install:** make sure that the center cover of the hub cap is turned counter-clockwise.
- Position the hub cap and turn the center cover clockwise until the hub cap engages physically and audibly.

Aluminum hub cap

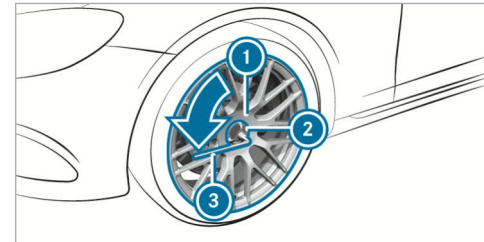

- To remove:** position socket ② on hub cap ①.

❶ The socket can be found in the tire-change tool kit.

▶ Position wheel wrench ❸ on socket ❷.

▶ Using wheel wrench ❸, turn hub cap ❶ counter-clockwise and remove it.

▶ **To install:** position hub cap ❶ and turn until it is completely flush with the wheel.

▶ Position socket ❷ on hub cap ❶.

▶ Attach wheel wrench ❸ to socket ❷ and tighten the hub cap clockwise.

Specified tightening torque: 18 lb-ft (25 Nm).

Raising the vehicle when changing a wheel

Requirements:

- There are no persons in the vehicle.
- The vehicle has been prepared for a wheel change (→ page 515).

Important notes on using the jack:

- Use only a vehicle-specific jack that has been approved by Mercedes-Benz to raise the vehicle.

- The jack is only designed for raising and holding the vehicle for a short time while a wheel is being changed and not for maintenance work under the vehicle.
- The jack must be placed on a firm, flat and non-slip surface. If necessary, use a large, flat, load-bearing, non-slip underlay.
- The foot of the jack must be positioned vertically under the jack support point.

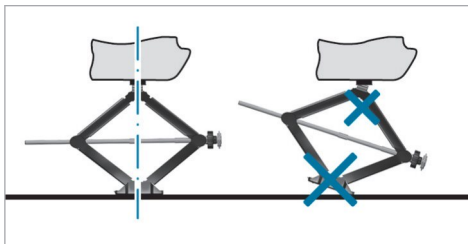

Rules of conduct when the vehicle is raised:

- Never place your hands or feet under the vehicle.
- Never lie under the vehicle.

- Do not start the engine and do not release the electric parking brake.
- Do not open or close any doors or the tail-gate.

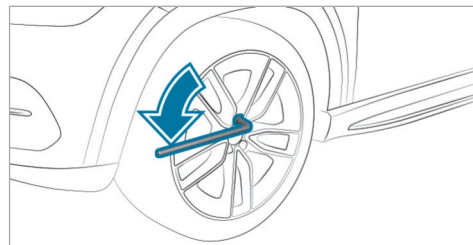

- ▶ Using the lug wrench, loosen the wheel bolts on the wheel you wish to change by about one full turn. Do not unscrew the bolts completely.

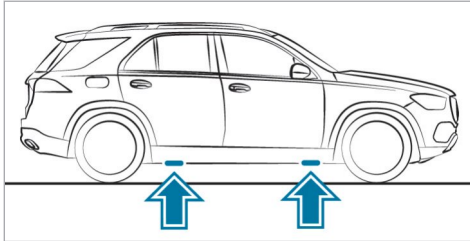

Position of jack support points

⚠ WARNING Risk of injury from incorrect positioning of the jack

If you do not position the jack correctly at the appropriate jacking point of the vehicle, the jack could tip with the vehicle raised.

- ▶ Only position the jack at the appropriate jacking point of the vehicle. The base of the jack must be positioned vertically under the jacking point of the vehicle.

! **NOTE** Vehicle damage from the jack

If you do not position the jack correctly at the appropriate jack support point of the vehicle, the jack could tip over with the vehicle raised.

- ▶ The jack is designed exclusively for jacking up the vehicle at the jack support points.
- ▶ Take the ratchet wrench out of the tire-change tool kit and place it on the hexagon nut of the jack so that the letters "AUF" are visible.

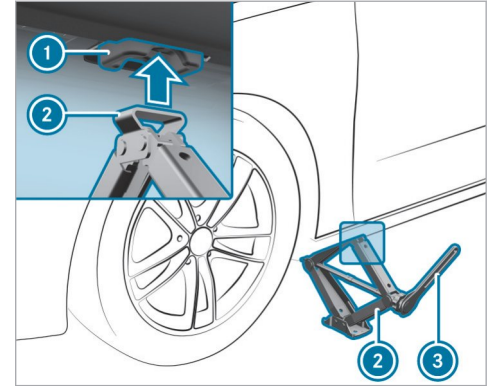

- ▶ Position jack **2** at jack support point **1**.
- ▶ Turn ratchet wrench **3** clockwise until jack **2** sits completely on jack support point **1** and the base of the jack lies evenly on the ground.
- ▶ Continue to turn ratchet wrench **3** until the tire is raised a maximum of 1.2 in (3 cm) off the ground.
- ▶ Loosen and remove the wheel (→ page 518).

Removing a wheel

Requirements:

- The vehicle is raised (→ page 516).

Mercedes-AMG vehicles: observe the notes in the Supplement. Otherwise, you may not recognize dangers.

When changing a wheel, avoid applying any force to the brake discs, since this could impair the level of comfort when braking.

NOTE Damage to threading from dirt on wheel bolts

- ▶ Do not place wheel bolts in sand or on a dirty surface.

- ▶ Completely unscrew the wheel bolts.
- ▶ Remove the wheel.
- ▶ Install the new wheel (→ page 518).

Mounting a new wheel

Requirements:

- The wheel is removed (→ page 518).

Mercedes-AMG vehicles: observe the notes in the Supplement. Otherwise, you may not recognize dangers.

WARNING Risk of accident from losing a wheel

Oiled, greased or damaged wheel bolt/wheel nut threads or wheel hub/wheel mounting bolt threads can cause the wheel bolts/wheel nuts to come loose.

As a result, you could lose a wheel while driving.

- ▶ Never oil or grease the threads.
- ▶ In the event of damage to the threads, contact a qualified specialist workshop immediately.
- ▶ Have the damaged wheel bolts or damaged hub threads replaced.
- ▶ Do not continue driving.

- ▶ Observe the information on the choice of tires (→ page 511).

For tires with a specified direction of rotation, an arrow on the side wall of the tire indicates the correct direction of rotation. Observe the direction of rotation when installing.

WARNING Risk of injury from tightening wheel bolts and nuts

If you tighten the wheel bolts or wheel nuts when the vehicle is raised, the jack could tip.

- ▶ Only tighten wheel bolts or wheel nuts when the vehicle is on the ground.

- ▶ Be sure to observe the instructions and safety notes on "Changing a wheel" (→ page 511).
- ▶ For safety reasons, only use wheel bolts which have been approved by Mercedes-Benz and for the wheel in question.

NOTE Damage to paintwork of the wheel rim when screwing on the first wheel bolt

If the wheel has too much play when screwing in the first wheel bolt, the wheel rim paint can be damaged.

- ▶ Press the wheel firmly against the wheel hub when screwing on the first wheel bolt.

- ▶ Tighten the wheel bolts evenly in a diagonal pattern in the order indicated until they are finger-tight.
- ▶ If the collapsible spare wheel has been installed, inflate the collapsible spare wheel (→ page 523).
- ▶ Lower the vehicle (→ page 519).

Lowering the vehicle after a wheel change

Requirements:

- The new wheel has been installed (→ page 518).

Observe the information on tire pressure (→ page 492).

- ▶ Place the ratchet wrench onto the hexagon nut of the jack so that the lettering "AB" is visible.

- ▶ **To lower the vehicle:** turn the ratchet wrench of the jack counter-clockwise.

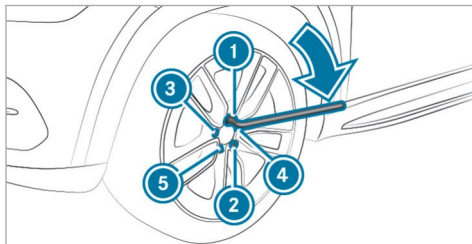

- ▶ Tighten the wheel bolts evenly in a diagonal pattern in the order indicated ① to ⑤ with a maximum of 59 lb-ft (80 Nm).
- ▶ Then tighten the wheel bolts evenly in a diagonal pattern in the order indicated ① to ⑤ to the specified tightening torque of 111 lb-ft (150 Nm).

- ▶ **WARNING** Risk of injury through incorrect tightening torque

The wheels could come loose if the wheel bolts or wheel nuts are not tightened to the prescribed tightening torque.

- ▶ Make sure the wheel bolts or wheel nuts are tightened to the prescribed tightening torque.
- ▶ If you are not sure, do not move the vehicle. Consult a qualified specialist workshop and have the tightening torque checked immediately.
- ▶ Check the tire pressure of the newly mounted wheel and adjust accordingly.
- ▶ **Vehicles with tire pressure loss warning system:** Restart the tire pressure loss warning system (→ page 498).
- ▶ **Exception:** the new wheel is an emergency spare wheel.

- ▶ **Vehicles with a tire pressure monitoring system:** Restart the tire pressure monitoring system (→ page 497).
Exception: the new wheel is an emergency spare wheel.

Emergency spare wheel

Notes on the emergency spare wheel

⚠ WARNING Risk of accident caused by incorrect wheel and tire dimensions

The wheel or tire size and the tire type of the emergency spare wheel or spare wheel and the wheel to be replaced may differ. Mounting an emergency spare wheel/spare wheel may severely impair the driving characteristics.

To prevent hazardous situations:

- ▶ Adapt your driving style accordingly and drive carefully.

- ▶ Never mount more than one emergency spare wheel or spare wheel that differs in size.
- ▶ Only use an emergency spare wheel or spare wheel of a different size briefly.
- ▶ Do not switch off ESP®.
- ▶ >Have the emergency spare wheel or spare wheel of a different size replaced at the nearest qualified specialist workshop. The new wheel must have the correct dimensions.

Check the tire pressure of the emergency spare wheel installed. Correct the pressure as necessary.

The maximum permissible speed with an emergency spare wheel installed is 50 mph (80 km/h).

Do not install the emergency spare wheel with snow chains.

Replace the emergency spare wheel after six years at the latest, regardless of wear.

- i** **Vehicles with a tire pressure loss warning system:** If an emergency spare wheel is installed the tire pressure loss warning system cannot function reliably. Only restart the system again when the emergency spare wheel has been replaced with a new wheel.
- Vehicles with a tire pressure monitoring system:** If an emergency spare wheel is installed the tire pressure monitoring system cannot function reliably. For a few minutes after an emergency spare wheel is installed, the system may still display the tire pressure of the removed wheel. Only restart the system again when the emergency spare wheel has been replaced with a new wheel.

Be sure to also observe the following further related subjects:

- Notes on tire pressure (→ page 492)
- Tire and Loading Information placard (→ page 499)
- Tire pressure table (→ page 493)

Removing the emergency spare wheel

The emergency spare wheel is located under the cargo compartment floor.

i Not for Mercedes-Maybach vehicles.

- ▶ Observe the information on mounting tires (→ page 511).
- ▶ Open the tailgate.
- ▶ Open the cargo compartment floor (→ page 126).
- ▶ Remove the emergency spare wheel bag with the emergency spare wheel.
- ▶ Open the emergency spare wheel bag and remove the emergency spare wheel.

Inflating the emergency spare wheel

! **NOTE** Overheating due to the tire inflation compressor running too long

- ▶ Do not run the tire inflation compressor for longer than ten minutes without interruption.

Requirements:

- Comply with the manufacturer's safety notes on the sticker of the emergency spare wheel and on the tire inflation compressor.
- Remove the tire inflation compressor from the stowage space under the cargo compartment floor (→ page 472).



- ▶ Remove sticker **1** from the tire inflation compressor housing and affix it to the instrument cluster within the driver's field of vision.

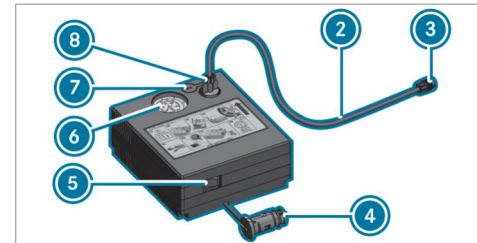

- ▶ Pull filler hose **2** and plug **4** out of the tire inflation compressor housing.
- ▶ Insert plug **8** of filler hose **2** in the socket on the tire inflation compressor and then turn it until plug **8** engages.
- ▶ Unscrew the cap from the valve on the emergency spare wheel.
- ▶ Screw union nut **3** of filler hose **2** onto the valve.
- ▶ Make sure on and off switch **5** of the tire inflation compressor is set to **0**.
- ▶ Insert plug **4** in a socket in your vehicle.
 - Cigarette lighter socket: (→ page 131)

- 12 V socket: (→ page 131)
 - Observe the notes on the cigarette lighter: (→ page 131)
 - Observe the notes on sockets: (→ page 131)
- ▶ Turn the SmartKey to position **1** in the ignition lock.
 - ▶ Press on and off switch **5** on the tire inflation compressor to I. The tire inflation compressor is switched on. The tire is inflated. The tire pressure is shown on pressure gauge **6**.
 - ▶ Pump the tire to the specified tire pressure. The specified tire pressure is stated on the label of the emergency spare wheel.
 - ▶ When the specified tire pressure has been reached, press on and off switch **5** on the tire inflation compressor to 0. The tire inflation compressor is switched off.
 - ▶ Turn the SmartKey to position **0** in the ignition lock.
 - ▶ If the tire pressure is higher than the specified pressure, press pressure release valve

button **7** until the correct tire pressure has been reached.

- ▶ Unscrew union nut **3** of filler hose **2** from the valve.
- ▶ Screw the valve cap of the emergency spare wheel onto the valve again.
- ▶ Stow filler hose **2** and plug **4** in the lower section of the compressor housing.
- ▶ Stow the tire inflation compressor in the vehicle.

Collapsible spare wheel

Notes on the collapsible spare wheel

⚠ WARNING Risk of accident caused by incorrect wheel and tire dimensions

The wheel or tire size and the tire type of the emergency spare wheel or spare wheel and the wheel to be replaced may differ. Mounting an emergency spare wheel/spare wheel may severely impair the driving characteristics.

To prevent hazardous situations:

- ▶ Adapt your driving style accordingly and drive carefully.
- ▶ Never mount more than one emergency spare wheel or spare wheel that differs in size.
- ▶ Only use an emergency spare wheel or spare wheel of a different size briefly.
- ▶ Do not switch off ESP®.
- ▶ >Have the emergency spare wheel or spare wheel of a different size replaced at the nearest qualified specialist workshop. The new wheel must have the correct dimensions.

The collapsible spare wheel is an emergency spare wheel which is only suitable for use for a limited period of time and in a restricted manner in the event of a flat tire (e.g. until the nearest workshop).

The tire sidewalls are folded when in transport mode. Before use, the collapsible spare wheel

has to be inflated with the accompanying compressor.

Check the tire pressure of the collapsible spare wheel once installed. Correct the pressure as necessary.

The maximum permissible speed with a collapsible spare wheel installed is 50 mph (80 km/h).

Do not install snow chains on the collapsible spare wheel.

Replace the collapsible spare wheel after six years at the latest, regardless of wear.

- i Vehicles with a tire pressure loss warning system:** If a collapsible spare wheel is installed, the tire pressure loss warning system cannot function reliably. Only restart the system again when the collapsible spare wheel has been replaced with a new wheel.
- Vehicles with a tire pressure monitoring system:** If a collapsible spare wheel is installed the tire pressure monitoring system cannot function reliably. For a few minutes after an emergency spare wheel is installed, the system may still display the tire pressure of the removed wheel. Only restart the system

again when the collapsible spare wheel has been replaced with a new wheel.

Be sure to also observe the following further related subjects:

- Notes on tire pressure (→ page 492)
- Tire pressure table (→ page 493)

Removing the collapsible spare wheel

The collapsible spare wheel is located under the cargo compartment floor.

- ▶ Observe the information on mounting tires (→ page 511).
- ▶ Open the tailgate.
- ▶ Open the cargo compartment floor (→ page 126).
- ▶ Remove the collapsible spare wheel.

Inflating the collapsible spare wheel

Requirements:

- Mount the collapsible spare wheel as described (→ page 518).

- Remove the tire inflation compressor from the stowage space under the trunk floor (→ page 472).

! **NOTE** Damage to the collapsible spare wheel when lowering the vehicle

Lowering the vehicle without previously inflating the collapsible spare wheel can damage its rim.

- ▶ Inflate the collapsible spare wheel using the tire inflation compressor before lowering the vehicle.

! **NOTE** Overheating due to the tire inflation compressor running too long

- ▶ Do not run the tire inflation compressor for longer than ten minutes without interruption.

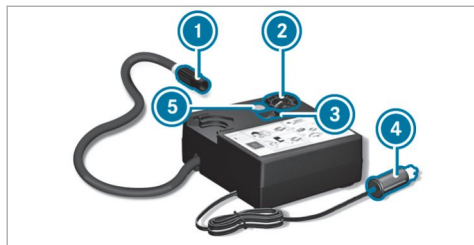

- ▶ Pull connector ④ and the hose out of the housing.
- ▶ Unscrew the cap from the valve on the collapsible spare wheel.
- ▶ Screw union nut ① of the hose onto the valve.
Make sure on and off switch ③ of the tire inflation compressor is set to **0**.
- ▶ Insert plug ④ into the cigarette lighter socket (→ page 131) or into a 12 V socket (→ page 131) in your vehicle.
- ▶ Switch on the power supply (→ page 161).

- ▶ Press on and off switch ③ on the tire inflation compressor to **I**.
The tire inflation compressor is switched on. The tire is inflated. The tire pressure is shown on manometer ②.
- ▶ Pump the tire to the specified tire pressure. The specified tire pressure is printed on the yellow label of the collapsible spare wheel.
- ▶ When the specified tire pressure has been reached, press on and off switch ③ on the tire inflation compressor to **0**.
- ▶ If the tire pressure is higher than the specified pressure, press pressure release valve button ⑤ until the correct tire pressure has been reached.

Notes on technical data

Mercedes-AMG vehicles: be sure to observe the notes in the Supplement. Otherwise, you may fail to recognize dangers.

The data stated only applies to vehicles with standard equipment. You can obtain further information from an authorized Mercedes-Benz Center.

Vehicle electronics

Two-way radios

Notes on installing two-way radios

⚠ WARNING Risk of accident due to improper work on two-way radios

The electromagnetic radiation from two-way radios can interfere with the on-board electronics if RF transmitters are manipulated or retrofitted incorrectly.

This could jeopardize the operating safety of the vehicle.

- ▶ You should have all work on electrical and electronic components carried out at a qualified specialist workshop.

⚠ WARNING Risk of accident from incorrect operation of two-way radios

If you operate two-way radios incorrectly in the vehicle, the electromagnetic radiation could interfere with the on-board electronics, e.g.:

- if the two-way radio is not connected to an exterior antenna
- if the exterior antenna is not correctly mounted or is not of low reflection

This could jeopardize the operating safety of the vehicle.

- ▶ Have the low-reflection exterior antenna installed at a qualified specialist workshop.
- ▶ When operating two-way radios in the vehicle, always connect them to the low-reflection exterior antenna.

! NOTE Invalidation of the operating permit due to failure to comply with the instructions for installation and use

The operating permit may be invalidated if the instructions for installation and use of two-way radios are not observed.

- ▶ Only use approved frequency bands.
- ▶ Observe the maximum permissible output power in these frequency bands.
- ▶ Only use approved antenna positions.

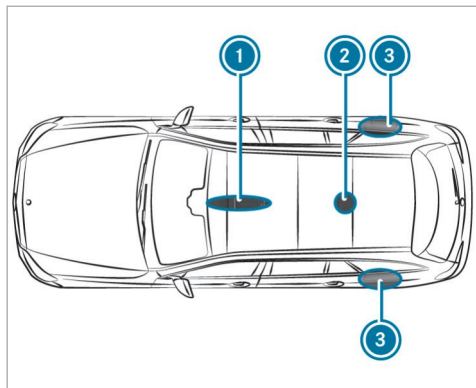

- ① Front roof area
- ② Rear roof area
- ③ Rear fenders

On vehicles with a panoramic sliding sunroof, installing an antenna to the front or rear roof area is not permitted.

On the rear fenders, it is recommended that you install the antenna on the side of the vehicle closest to the center of the road.

Use Technical Specification ISO/TS 21609 (Road Vehicles - "EMCs for installation of aftermarket radio frequency transmitting equipment") when retrofitting two-way radios. Comply with the legal requirements for detachable parts.

If your vehicle has installations for two-way radio equipment, use the power supply and antenna connectors provided in the pre-installation. Be sure to observe the manufacturer's supplements when installing.

Two-way radio transmission output

The maximum transmission output (PEAK) at the base of the antenna must not exceed the values in the following table.

Frequency band and maximum transmission output

Frequency band	Maximum transmission output
Short wave 3 - 54 MHz	(100 W)
4 m frequency band 74 - 88 MHz	(30 W)
2 m frequency band 144 - 174 MHz	(50 W)
trunked radio system/Tetra 380 - 460 MHz	(10 W)
70 cm frequency band 420 - 450 MHz	(35 W)
Two-way radio (2G/3G/4G)	(10 W)

The following can be used in the vehicle without restrictions:

- Two-way radios with a maximum transmission output of up to 100 mW
- RF transmitters with transmitter frequencies in the 380 - 410 MHz frequency band and a maximum transmission output of up to 2 W (trunked radio system/Tetra)
- Mobile phones (2G/3G/4G)

There are no restrictions when positioning the antenna on the outside of the vehicle for some wavebands.

This applies to the following wavebands:

- Trunked radio system/Tetra
- 70 cm frequency band
- 2G/3G/4G

Vehicle identification plate, VIN and engine number overview

Vehicle identification plate

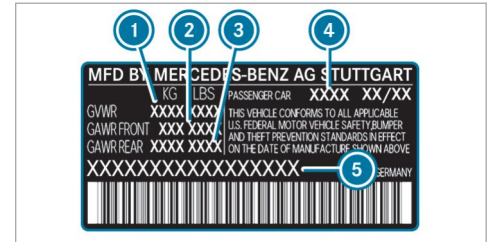
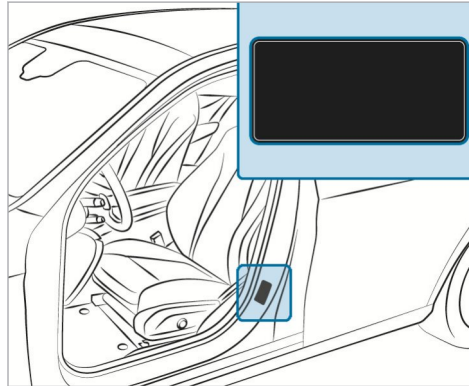

Vehicle identification plate (USA only)

- 1 Maximum permissible gross vehicle weight
- 2 Maximum permissible front axle load
- 3 Maximum permissible rear axle load
- 4 Paint code
- 5 VIN (vehicle identification number)

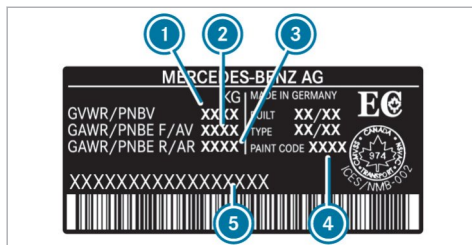

Vehicle identification plate (Canada only)

- ① Maximum permissible gross vehicle weight
- ② Maximum permissible front axle load
- ③ Maximum permissible rear axle load
- ④ Paint code
- ⑤ VIN (vehicle identification number)

The maximum permissible gross vehicle weight is made up of the vehicle weight, all vehicle occupants, the fuel and the load. The maximum gross axle weight rating is the maximum weight that can be carried on one axle (front or rear axle).

Do not exceed the maximum permissible gross vehicle weight or the maximum gross axle weight rating for the front or rear axle.

VIN in front of the front seat

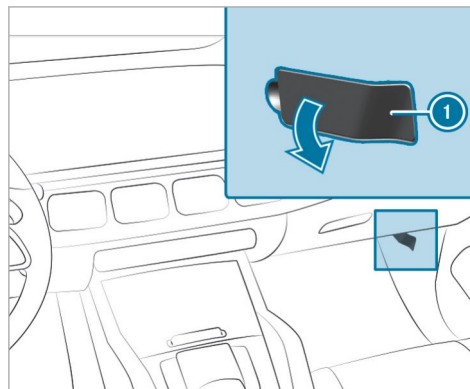

- ① VIN (vehicle identification number)

Additional plates

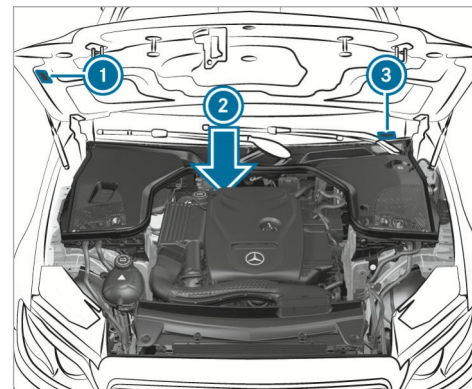

- ① Plate with information about emissions testing, including confirmation of emissions guidelines at the U.S. federal level as well as for California
- ② Engine number stamped into the crankcase
- ③ VIN (vehicle identification number) as a label at the lower edge of the windshield

Operating fluids

Notes on operating fluids

Mercedes-AMG vehicles: be sure to observe the notes in the Supplement. Otherwise, you may fail to recognize dangers.

⚠ WARNING Risk of injury from operating fluids harmful to your health

Operating fluids may be poisonous and harmful to your health.

- ▶ Observe the text on the original containers when using, storing or disposing of operating fluids.
- ▶ Always store operating fluids sealed in their original containers.
- ▶ Always keep children away from operating fluids.



ENVIRONMENTAL NOTE Environmental pollution caused by environmentally irresponsible disposal

- ▶ Dispose of operating fluids in an environmentally responsible manner.

Operating fluids include the following:

- Fuels
- Lubricants
- Coolant
- Brake fluid
- Windshield washer fluid
- Climate control system refrigerant

Only use products approved by Mercedes-Benz. Damage caused by the use of products that have not been approved is not covered by the Mercedes-Benz warranty or goodwill gestures.

You can identify operating fluids approved by Mercedes-Benz by the following inscriptions on the container:

- MB-Freigabe (e.g. MB-Freigabe 229.51)

- MB-Approval (e.g. MB-Approval 229.51)

Further information on approved operating fluids is available at the following locations:

- In the Mercedes-Benz Specifications for Operating Fluids by entering the designation
 - At <https://bevo.mercedes-benz.com>
 - In the Mercedes-Benz BeVo app
- At a qualified specialist workshop

⚠ WARNING Risk of fire or explosion from fuel

Fuels are highly flammable.

- ▶ Fire, open flames, smoking and creation of sparks must be avoided.
- ▶ Switch off the ignition and, if available, the stationary heater, before and while refueling the vehicle.

⚠ WARNING Risk of injury from fuels

Fuels are poisonous and hazardous to your health.

- ▶ Do not swallow fuel or let it come into contact with skin, eyes or clothing.
- ▶ Do not inhale fuel vapor.
- ▶ Keep children away from fuel.
- ▶ Keep doors and windows closed during the refueling process.

If you or other people come into contact with fuel, observe the following:

- ▶ Immediately rinse fuel off your skin with soap and water.
- ▶ If fuel comes into contact with your eyes, immediately rinse them thoroughly with clean water. Seek medical attention immediately.
- ▶ If you swallow fuel, seek medical attention immediately. Do not induce vomiting.
- ▶ Change immediately out of clothing that has come into contact with fuel.

Fuel

Notes on fuel grades for vehicles with gasoline engines

Observe the notes on operating fluids (→ page 529).

! NOTE Damage caused by the wrong fuel

Even small amounts of the wrong fuel could result in damage to the fuel system, the engine and the emission control system.

- ▶ Only refuel with low-sulfur unleaded fuel.

This fuel may contain up to 10% ethanol by volume. Your vehicle is suitable for use with E10 fuel.

Never refuel with one of the following fuels:

- Diesel
- Gasoline with more than 10% ethanol by volume, e.g. E15, E85, E100
- Gasoline with more than 3% methanol by volume, e.g. M15, M30, M85, M100

- Gasoline with additives containing metal

If you have accidentally refueled with the wrong fuel:

- ▶ Do not switch on the ignition.
- ▶ Consult a qualified specialist workshop.

If the available fuel is not sufficiently low in sulfur, this can produce unpleasant odors.

Only refuel with fuel that has at least the octane number specified in the information label in the fuel filler flap (→ page 184). Otherwise engine output can be reduced and fuel consumption increased.

If you want maximum engine output: only refuel with unleaded premium grade gasoline with an octane number of at least 91 AKI/95 RON.

As a temporary measure, if the recommended fuel is not available, you may also refuel with unleaded regular gasoline with at least 87 AKI/91 RON. This may reduce engine output and increase fuel consumption.

Never refuel using gasoline with an even lower RON.

! **NOTE** Premature wear caused by unleaded regular gasoline

Unleaded regular gasoline can cause the engine to wear more quickly and impair longevity and performance.

If unleaded premium grade gasoline is unavailable and you have to refuel using unleaded regular gasoline:

- ▶ Only fill the fuel tank to half full with unleaded regular gasoline and refill as soon as possible with unleaded premium grade gasoline.
- ▶ Do not drive at the maximum speed.
- ▶ Avoid sudden acceleration and engine speeds over 3,000 rpm.

Further information on fuel is available at the following locations:

- At a gas station
- At a qualified specialist workshop

- On the <https://www.mbusa.com> (USA only)

Information on additives in gasoline

Observe the notes on operating fluids (→ page 529).

! **NOTE** Damage from use of unsuitable additives

Even small amounts of the wrong additive may lead to malfunctions occurring.

- ▶ Only add cleaning additives recommended by Mercedes-Benz to the fuel.

Mercedes-Benz recommends that you use fuel brands that have additives.

In some countries, the fuel available may not have sufficient additives. Residue could build up in the fuel injection system as a result. In this case, in consultation with an authorized Mercedes-Benz Center, the fuel may be mixed with the cleaning additive recommended by Mercedes-Benz. Be sure to observe the notes and mixing ratios specified on the container.

Tank content and fuel reserve

Capacity

Model	Total capacity
All models	22.5 gal (85.0 liters)
Model	Of which reserve
All models	2.4 gal (9.0 liters)

Engine oil

Notes on engine oil

Observe the notes on operating fluids (→ page 529).



! **NOTE** Engine damage caused by an incorrect oil filter, incorrect oil or additives

- ▶ Do not use engine oils or oil filters other than those which meet the specifications necessary for the prescribed service intervals.
- ▶ Do not alter the engine oil or oil filter in order to achieve longer change intervals than prescribed.
- ▶ Do not use additives.
- ▶ Have the engine oil changed after the prescribed intervals.

Mercedes-Benz recommends that you have the oil change carried out at a qualified specialist workshop.

Further information on engine oil and oil filters is available at the following locations:

- In the Mercedes-Benz Specifications for Operating Fluids by entering the designation
 - At <https://bevo.mercedes-benz.com>
 - In the Mercedes-Benz BeVo app

- At a qualified specialist workshop

Quality and capacity of engine oil

MB-Freigabe or MB-Approval

Gasoline engines	Engine oil specifications
GLE 580 4MATIC	229.52 229.61*
All other models	229.51, 229.52, 229.61 229.71*

* Recommended for lowest possible fuel consumption (lowest SAE viscosity class in each case; observe possible restrictions of the approved SAE viscosity classes).

To achieve the lowest possible fuel consumption, it is recommended to use the engine oil specifications marked in the table for the lowest SAE viscosity class. Possible restrictions of the approved SAE viscosity classes must be observed.

The following values refer to an oil change, including the oil filter.

Capacity

Model	Capacity
GLE 450 4MATIC	Approx. 8.9 US qt (8.5 liters)
GLE 580 4MATIC	Approx. 10.0 US qt (9.5 liters)
All other models	Approx. 7.4 US qt (7.0 liters)

Notes on brake fluid

Observe the notes on operating fluids (→ page 529).

! **WARNING** Risk of an accident due to vapor pockets forming in the brake system

The brake fluid constantly absorbs moisture from the air. This lowers the boiling point of

the brake fluid. If the boiling point is too low, vapor pockets may form in the brake system when the brakes are applied hard.

This causes the braking effect to be impaired.

- ▶ Have the brake fluid renewed at the specified intervals.

Have the brake fluid regularly replaced at a qualified specialist workshop.
Only use brake fluid approved by Mercedes-Benz according to MB-Freigabe or MB-Approval 331.0.
You can obtain further information on brake fluid in the following places:

- In the Mercedes-Benz Specifications for Operating Fluids
 - At <https://bevo.mercedes-benz.com>
 - In the Mercedes-Benz BeVo app
- At a qualified specialist workshop

Coolant

Notes on coolant

Observe the notes on operating fluids (→ page 529).

⚠ WARNING - Risk of fire and injury from antifreeze

If antifreeze comes into contact with hot component parts in the engine compartment, it may ignite.

- ▶ Allow the engine to cool down before adding antifreeze.
- ▶ Make sure that no antifreeze spills out next to the filler opening.
- ▶ Thoroughly clean off any antifreeze from component parts before starting the vehicle.

! NOTE Damage caused by incorrect coolant

- ▶ Only add coolant that has been pre-mixed with the required antifreeze protection.

Information on coolant is available at the following locations:

- In the Mercedes-Benz Specifications for Operating Fluids 310.1:
 - At <https://bevo.mercedes-benz.com>
 - In the Mercedes-Benz BeVo app
- At a qualified specialist workshop

! NOTE Overheating at high outside temperatures

If an inappropriate coolant is used, the engine cooling system is not sufficiently protected against overheating and corrosion at high outside temperatures.

- ▶ Always use coolant approved by Mercedes-Benz.

- ▶ Observe the instructions in the Mercedes-Benz Specifications for Operating Fluids 310.1.

Have the coolant regularly replaced at a qualified specialist workshop.

The proportion of corrosion inhibitor/antifreeze concentrate in the engine cooling system should be:

- A minimum of 50% (antifreeze protection down to approximately -35 °F (-37 °C))
- A maximum of 55% (antifreeze protection down to -49 °F (-45 °C))

Coolant capacity

Capacity

Model	Capacity
GLE 350 4MATIC	13.7 US qt (13.0 liters)
GLE 450 4MATIC	20.0 US qt (18.9 liters)
GLE 580 4MATIC	16.6 US qt (15.7 liters)

Notes on windshield washer fluid

Observe the notes on operating fluids (→ page 529).

⚠ WARNING - Risk of fire and injury from windshield washer concentrate

Windshield washer concentrate is highly flammable. It could ignite if it comes into contact with hot engine component parts or the exhaust system.

- ▶ Make sure that no windshield washer concentrate spills out next to the filler opening.

! **NOTE** Damage to the exterior lighting due to unsuitable windshield washer fluid

Unsuitable windshield washer fluid may damage the plastic surface of the exterior lighting.

- ▶ Only use windshield washer fluid which is also suitable for use on plastic surfaces, e.g. MB SummerFit or MB WinterFit.

! **NOTE** Blocked spray nozzles caused by mixing windshield washer fluids

- ▶ Do not mix MB SummerFit and MB WinterFit with other windshield washer fluids.

Do not use distilled or de-ionized water as the fill level sensor may be triggered erroneously.

Recommended windshield washer fluid:

- Above freezing point: e.g. MB SummerFit
- Below freezing point: e.g. MB WinterFit

For the correct mixing ratio, refer to the information on the antifreeze container.

Mix the washer fluid with the windshield washer fluid all year round.

Refrigerant

Notes on refrigerant

Observe the notes on operating fluids (→ page 529).

! **NOTE** Damage due to incorrect refrigerant

If a non-approved refrigerant is used, the climate control system may be damaged.

▶ Only use the refrigerant R-134a

! **NOTE** Damage to the climate control system due to incorrect refrigerant compressor oil

- ▶ Only use refrigerant compressor oil that has been approved by Mercedes-Benz.
- ▶ Do not mix the approved refrigerant compressor oil with a different refrigerant compressor oil.

Work on the climate control system may be carried out only by a qualified specialist workshop. All applicable regulations, as well as SAE standard J639, must be adhered to.

The instruction label on the climate control system for the refrigerant type and the refrigerant compressor oil is located on the inside of the hood.

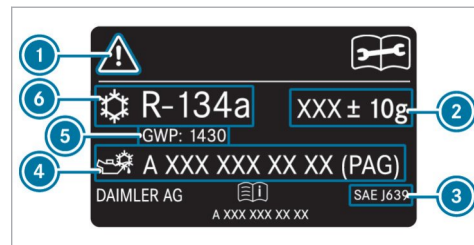

- ① Hazard and service warning symbols
- ② Refrigerant filling capacity
- ③ Applicable standards
- ④ PAG oil part number
- ⑤ GWP (Global Warming Potential) of the refrigerant used
- ⑥ Refrigerant type

Symbols ① warn of the following:

- Possible dangers
- The need to have service work carried out at a qualified specialist workshop only

Refrigerant filling capacity**Filling capacity for refrigerant and PAG oil**

Model	Refrigerant
All models	25.4 ± 0.4 oz (720 ± 10 g)
Model	PAG oil
All models	3.8 ± 0.4 oz (110 ± 10 g)

Vehicle data**Vehicle dimensions**

The heights specified may vary as a result of the following factors:

- Tires
- Load
- Condition of the suspension
- Optional equipment

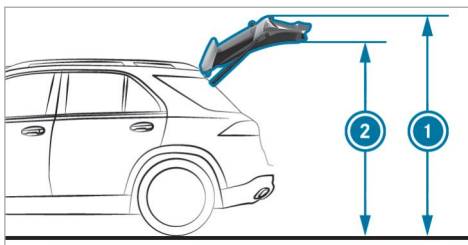
**Height when opened**

	① Height when opened*	② Head- room*
Vehicles with steel suspension	87.2 in (2217 mm) - 87.4 in (2219 mm)	78.1 in (1986 mm) - 78.3 in (1988 mm)
Vehicles with AIR-MATIC	86.7 in (2153 mm) - 89.1 in (2263 mm)	75.6 in (1922 mm) - 80.0 in (2032 mm)

*When the rear-end lowering is activated, the values are correspondingly lower.

Vehicle dimensions

All models	
Vehicle length	193.9 in (4924 mm)
Vehicle length, AMG Styling	194.1 in (4930 mm)
Vehicle width including outside mirrors	84.9 in (2157 mm)
Vehicle width excluding outside mirrors, min. to max.	76.6 in (1947 mm) - 79.6 in (2022 mm)
Vehicle height	70.6 in (1794 mm) - 70.7 in (1795 mm)
Maximum vehicle height (AIR-MATIC)	72.7 in (1848 mm)

All models	
Wheelbase	117.9 in (2995 mm)
Maximum ground clearance (steel suspension)	7.9 in (203 mm)
Maximum ground clearance (AIRMATIC)	9.2 in (233 mm)
Minimum ground clearance (AIRMATIC)	5.7 in (145 mm)

Weights and loads

Please observe the following notes for the specified vehicle data:

- Items of optional equipment increase the curb weight and reduce the payload.

Roof load

All models	
Maximum roof load	220.5 lb (100 kg)

Vehicle data for off-road driving

Fording depth

! **NOTE** Damage caused by water when fording

Water can enter the engine compartment and vehicle interior if:

- you exceed the maximum permissible fording depth when driving through standing water
- a bow wave forms during fording
- water accumulates during fording of flowing water

▶ Do not exceed the maximum permissible fording depth and drive slowly through the water.

The specified value indicates the maximum permissible fording depth for:

- Vehicles that are ready to drive
- Slow driving through standing water

Driving through flowing water reduces the permissible fording depth due to the accumulation of water.

Observe the notes on off-road driving and fording (→ page 169).

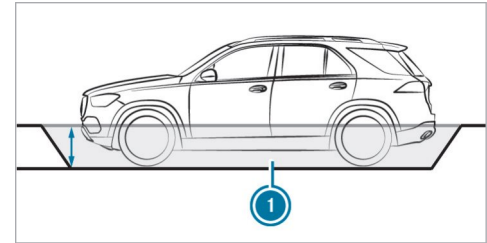

Model	1 Fording depth
Vehicles with steel suspension	19.7 in (50 cm)
Vehicles with AIRMATIC	
Raised level	19.7 in (50 cm)

Approach/departure angle

The specified values are maximum values for vehicles that are ready to drive.

Observe the notes on driving in mountainous terrain .

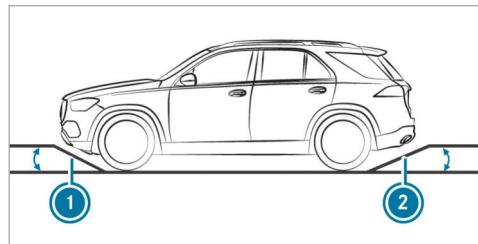
**Approach/departure angle**

All models (vehicles without AMG Styling)

① Front

② Rear

Vehicles with steel suspension*

25°

24° - 25°

Vehicles with AIRMATIC*

Normal level

22° - 25°

22° - 24°

Raised level

28° - 30°

26° - 28°

All models (vehicles with AMG Styling)

① Front

② Rear

Vehicles with steel suspension

21°

24°

Vehicles with AIRMATIC

All models (vehicles with AMG Styling)

① Front

② Rear

Normal level

21°

24°

Raised level

25°

27°

*Depending on the tire size

Maximum gradient climbing ability

The vehicle's gradient climbing ability depends on the weight distribution in the vehicle, the terrain conditions and the road surface conditions.

The specified value applies when:

- the vehicle is ready to drive
- the road surfaces conditions and thus the traction are good

A gradient climbing ability of 100% corresponds to an incline of 45°.

Observe the notes on driving in mountainous terrain .

Model	Maximum gradient climbing ability
All models	80%

Trailer hitch

General notes on the trailer hitch

Modifications to the engine cooling system may be necessary, depending on the vehicle model. The retrofitting of a trailer hitch is only permissible if a towing capacity is specified in your vehicle documents.

Further information can be obtained at a qualified specialist workshop.

Permissible trailer load

Missing values were not available at the time of going to press.

The tongue weight is not included in the towing capacity.

Model	Permissible towing capacity, braked
GLE 350	
All models with 4MATIC	7716.2 lbs (3500 kg)

Model	Permissible towing capacity, unbraked
All models	

Maximum tongue weight

! **NOTE** Damage caused by the trailer coming loose

If the tongue weight used is too low, the trailer may come loose.

▶ The tongue weight must not be below 110.2 lb (50 kg).

▶ Use a tongue weight that is as close as possible to the maximum permissible tongue weight.

Missing values were not available at the time of going to press.

Tongue weight

Model	Maximum tongue weight
GLE 350	
All models with 4MATIC	617.3 lbs (280 kg)

Permissible rear axle load (trailer operation)

Missing values were not available at the time of going to press.

540 Technical data

Permissible rear axle load during trailer operation 5-seat/7-seat vehicles	
GLE 350	
GLE 350 4MATIC	3637.6 lbs (1650 kg) / 3637.6 lbs (1650 kg)
GLE 450 4MATIC	3703.7 lbs (1680 kg) / 3858.0 lbs (1750 kg)
GLE 580 4MATIC	

Display messages

Introduction



Notes on display messages

Display messages appear on the multifunction display.

Display messages with graphic symbols are simplified in the Operator's Manual and may differ from the symbols on the multifunction display. The multifunction display shows high-priority display messages in red. Certain display messages are accompanied by a warning tone.

Please act in accordance with the display messages and follow the additional notes in the Operator's Manual.

For some display messages, a symbol will also be shown:

-  Further information
-  Hide display message

You can select the desired symbol by swiping left or right on the left-hand Touch Control. Press the  symbol to show further information

on the multifunction display. Press the  symbol to hide the display message.

You can hide low-priority display messages by pressing the  button or the left-hand Touch Control. The display messages will then be stored in the message memory.

Rectify the cause of a display message as quickly as possible.

High-priority display messages cannot be hidden. The multifunction display shows these display messages continuously until the cause of the display message has been rectified.



Calling up stored display messages

On-board computer:





 [Service](#)  [1 Message](#)



If there are no display messages, [No Messages](#) will appear on the multifunction display.

 Scroll through the display messages by swiping upwards or downwards on the left-hand Touch Control.

 **To exit the message memory:** press the  button.

Occupant safety

Display messages	Possible causes/consequences and ► Solutions
 <p data-bbox="144 381 395 433">SRS Malfunction Service Required</p>	<p data-bbox="476 288 1018 313">* The restraint system is malfunctioning (→ page 36).</p> <div data-bbox="500 332 1646 503" style="border: 1px solid gray; padding: 5px;"> <p data-bbox="513 339 1240 365">▲ WARNING Risk of injury due to malfunctions in the restraint system</p> <p data-bbox="513 381 1618 456">If the restraint system is malfunctioning, restraint system components may be triggered unintentionally or may not deploy as intended during an accident. This may affect the Emergency Tensioning Devices or airbags, for example.</p> <p data-bbox="513 467 1498 493">► Have the restraint system checked and repaired immediately at a qualified specialist workshop.</p> </div> <p data-bbox="500 519 962 544">Recognition of a restraint system malfunction:</p> <ul data-bbox="513 555 1480 617" style="list-style-type: none"> • The  restraint system warning lamp does not light up when the ignition is switched on. • The  restraint system warning lamp lights up continuously or repeatedly during a journey. <p data-bbox="500 617 1055 643">► Consult a qualified specialist workshop immediately.</p>
 <p data-bbox="144 754 421 806">Front Left Malfunction Service Required (example)</p>	<p data-bbox="476 660 1166 686">* The corresponding restraint system is malfunctioning (→ page 36).</p> <div data-bbox="500 705 1646 876" style="border: 1px solid gray; padding: 5px;"> <p data-bbox="513 712 1240 738">▲ WARNING Risk of injury due to malfunctions in the restraint system</p> <p data-bbox="513 754 1618 829">If the restraint system is malfunctioning, restraint system components may be triggered unintentionally or may not deploy as intended during an accident. This may affect the Emergency Tensioning Devices or airbags, for example.</p> <p data-bbox="513 840 1498 866">► Have the restraint system checked and repaired immediately at a qualified specialist workshop.</p> </div>

Display messages	Possible causes/consequences and ► Solutions
	<p>Recognition of a restraint system malfunction:</p> <ul style="list-style-type: none"> • The  restraint system warning lamp does not light up when the ignition is switched on. • The  restraint system warning lamp lights up continuously or repeatedly during a journey. <p>► Consult a qualified specialist workshop immediately.</p>
 <p>Left Side Curtain Airbag Malfunction Service Required (example)</p>	<p>* The corresponding window curtain airbag is malfunctioning (→ page 36).</p> <p>▲ WARNING Risk of injury or fatal injury due to malfunctions in the window airbag</p> <p>If the window airbag is malfunctioning, it might be triggered unintentionally or might not be triggered at all in the event of an accident with high deceleration.</p> <p>► Have the window airbag checked and repaired immediately at a qualified specialist workshop.</p> <p>► Consult a qualified specialist workshop immediately.</p>
<p>Front Passenger Airbag Disabled See Operator's Manual</p>	<p>* The front passenger airbag has been disabled even though an adult or a person with an adult stature is on the front passenger seat. If additional forces are applied to the seat, the weight the system detects may be too low.</p> <p>▲ WARNING Risk of injury or fatal injury due to a disabled front passenger airbag</p> <p>If the front passenger airbag is disabled, the front passenger airbag will not be deployed in the event of an accident and cannot perform its intended protective function.</p>



544 Display messages and warning/indicator lamps

Display messages	Possible causes/consequences and ► Solutions
	<p>A person in the front passenger seat could then, for example, come into contact with the vehicle's interior, especially if the person is sitting too close to the cockpit.</p> <p>► Make sure, both before and during the journey, that the status of the front passenger airbag is correct.</p> <ul style="list-style-type: none">► Stop the vehicle immediately in accordance with the traffic conditions.► Check the status of the automatic front passenger airbag actuation (→ page 47).► If necessary, consult a qualified specialist workshop immediately.
Front Passenger Airbag Enabled See Operator's Manual	<p>* The front passenger airbag is enabled while the vehicle is in motion:</p> <ul style="list-style-type: none">• even when a child, a person of small stature or an object weighing less than the system weight threshold is located on the front passenger seat• even when the front passenger seat is not occupied <p>The system may detect objects or forces that are adding to the weight applied to the seat.</p> <p>▲ WARNING Risk of injury or fatal injury if a child restraint system is used while the front passenger front airbag is enabled</p> <p>If you secure a child in a child restraint system on the front passenger seat and the front passenger airbag is enabled, the front passenger airbag can deploy in the event of an accident. The child could be struck by the airbag.</p> <p>► Ensure, both before and during the journey, that the status of the front passenger airbag is correct.</p>

Display messages	Possible causes/consequences and ► Solutions
	<p>NEVER use a rearward facing child restraint on a seat protected by an ACTIVE AIRBAG in front of it, DEATH or SERIOUS INJURY to the CHILD can occur.</p> <ul style="list-style-type: none"> ► Stop the vehicle immediately in accordance with the traffic conditions. ► Check the status of the automatic front passenger airbag actuation (→ page 47). ► If necessary, consult a qualified specialist workshop immediately.
<p>PRE-SAFE Inoperative See Operator's Manual</p>	<p>* The PRE-SAFE® functions are malfunctioning.</p> <ul style="list-style-type: none"> ► Consult a qualified specialist workshop.
<p>PRE-SAFE Impulse Side Inoperative See Operator's Manual</p>	<p>* The PRE-SAFE® Impulse Side system is malfunctioning or inoperative after having already been triggered.</p> <ul style="list-style-type: none"> ► Consult a qualified specialist workshop.

SmartKey





Display messages	Possible causes/consequences and ► Solutions
 <p>Obtain a New Key</p>	<p>* The SmartKey needs to be replaced.</p> <ul style="list-style-type: none"> ► Consult a qualified specialist workshop.



Display messages	Possible causes/consequences and ► Solutions
 <p data-bbox="144 342 347 366">Replace Key Battery</p>	<p data-bbox="469 249 857 273">* The SmartKey battery is discharged.</p> <ul style="list-style-type: none"> <li data-bbox="495 283 866 307">► Replace the battery (→ page 69).
 <p data-bbox="144 484 399 533">Key Not Detected (white display message)</p>	<p data-bbox="469 391 875 415">* The SmartKey is currently undetected.</p> <ul style="list-style-type: none"> <li data-bbox="495 425 1042 449">► Change the location of the SmartKey in the vehicle. <li data-bbox="495 459 1504 508">► If the SmartKey is still not recognized, place it in the marked space for starting with the SmartKey (→ page 162).
 <p data-bbox="144 650 417 699">Key Not Detected (red display message)</p>	<p data-bbox="469 557 1203 616">* The SmartKey cannot be detected and may no longer be in the vehicle. The SmartKey is no longer in the vehicle and you switch off the engine:</p> <ul style="list-style-type: none"> <li data-bbox="500 626 875 650">• You can no longer start the engine. <li data-bbox="500 660 901 684">• You cannot centrally lock the vehicle. <p data-bbox="495 702 953 726">► Ensure that the SmartKey is in the vehicle.</p> <p data-bbox="495 754 1382 778">If the SmartKey detection function has a malfunction due to a strong radio signal source:</p> <ul style="list-style-type: none"> <li data-bbox="495 788 1234 812">► Stop the vehicle immediately in accordance with the traffic conditions. <li data-bbox="495 822 1504 846">► Place the SmartKey in the marked space for starting the engine with the SmartKey (→ page 162).

Display messages	Possible causes/consequences and ► Solutions
<p>Place the Key in the Marked Space See Operator's Manual</p>	<ul style="list-style-type: none"> * SmartKey detection is malfunctioning. <ul style="list-style-type: none"> ► Change the location of the SmartKey in the vehicle. ► Place the SmartKey in the marked space for starting the engine with the SmartKey (→ page 162).
<div style="text-align: center;">  <p>Don't Forget Your Key</p> </div>	<ul style="list-style-type: none"> * A warning tone also sounds. This message reminds you to take your key with you when you leave the vehicle.

Lights



Display messages	Possible causes/consequences and ► Solutions
<div style="text-align: center;">  <p>Check Left Low Beam (example)</p> </div>	<ul style="list-style-type: none"> * The corresponding light source is faulty. <ul style="list-style-type: none"> ► Drive on carefully. ► Consult a qualified specialist workshop immediately. ⓘ LED light bulbs: the display message for the corresponding lamp appears only when all the light-emitting diodes in the lamp are faulty.



Display messages	Possible causes/consequences and ► Solutions
 <p data-bbox="144 342 384 391">Malfunction See Operator's Manual</p>	<ul style="list-style-type: none"> <li data-bbox="467 249 925 273">* The exterior lighting is malfunctioning. <li data-bbox="495 283 925 307">► Consult a qualified specialist workshop.
 <p data-bbox="144 511 421 560">Automatic Headlamp Mode Inoperative</p>	<ul style="list-style-type: none"> <li data-bbox="467 418 838 442">* The light sensor is malfunctioning. <li data-bbox="495 452 925 476">► Consult a qualified specialist workshop.
 <p data-bbox="144 680 417 729">Active Headlamps Inoperative</p>	<ul style="list-style-type: none"> <li data-bbox="467 587 912 611">* The active headlamps are malfunctioning. <li data-bbox="495 621 925 645">► Consult a qualified specialist workshop.
 <p data-bbox="144 849 369 873">Switch On Headlamps</p>	<ul style="list-style-type: none"> <li data-bbox="467 756 949 780">* You are driving without low-beam headlamps. <li data-bbox="495 790 1033 814">► Turn the light switch to the  or AUTO position.



Display messages	Possible causes/consequences and ► Solutions
 Switch Off Lights	<ul style="list-style-type: none"> * You are leaving the vehicle and the lights are still switched on. <ul style="list-style-type: none"> ► Turn the light switch to the AUTO position.
 Intell. Light System Inoperative	<ul style="list-style-type: none"> * The Intelligent Light System is faulty. The lighting system continues to function properly without the functions of the Intelligent Light System. <ul style="list-style-type: none"> ► Consult a qualified specialist workshop.
Adaptive Highbeam Assist Currently Unavailable See Operator's Manual	<ul style="list-style-type: none"> * Adaptive Highbeam Assist is temporarily unavailable. The system limits have been reached (→ page 140). <ul style="list-style-type: none"> ► Drive on. Once the cause of the problem is no longer present, the system will be available again. The Adaptive Highbeam Assist Now Available display message will appear.
Adaptive Highbeam Assist Inoperative	<ul style="list-style-type: none"> * Adaptive Highbeam Assist is malfunctioning. <ul style="list-style-type: none"> ► Consult a qualified specialist workshop.
Hazard Warning Flashers Malfunctioning	<ul style="list-style-type: none"> * The hazard warning lamp switch is malfunctioning. <ul style="list-style-type: none"> ► Consult a qualified specialist workshop.

Vehicle



Display messages	Possible causes/consequences and ► Solutions
Update Successfully Completed	* Installation of the software update has been successfully completed (→ page 355).
Update Failed Software Remains Unchanged	* An error occurred during the installation of the software update (→ page 355). The current software release remains in place.
Update Failed	* An error occurred during the installation of the software update (→ page 355). Make a Mercedes me call via the overhead control panel (→ page 420).
 Vehicle Ready to Drive Switch the Ignition Off Before Exiting	* You are leaving the vehicle when it is in a ready-to-drive state. <ul style="list-style-type: none"> ► When you leave the vehicle, switch off the ignition, secure the vehicle against rolling away and take the Smart-Key with you. ► If you do not leave the vehicle, switch off the electrical consumers, e.g. the seat heating. Otherwise, the 12 V battery may discharge and it will then be possible to start the vehicle only with the aid of a second battery (starting assistance).



Display messages	Possible causes/consequences and ► Solutions
 <p data-bbox="195 344 449 418">Steering Malfunction Increased Physical Effort See Operator's Manual</p>	<p data-bbox="524 249 1031 273">* The power steering assistance is malfunctioning.</p> <div data-bbox="561 298 1698 443" style="border: 1px solid gray; padding: 5px;"> <p data-bbox="569 301 1295 325">▲ WARNING Risk of an accident due to altered steering characteristics</p> <p data-bbox="561 339 1633 363">If the power assistance of the steering fails partially or completely, you will need to use more force to steer.</p> <ul style="list-style-type: none"> <li data-bbox="561 376 1045 399">▶ If safe steering is possible, drive on carefully. <li data-bbox="561 412 1193 436">▶ Visit or consult a qualified specialist workshop immediately. </div> <ul style="list-style-type: none"> <li data-bbox="543 464 1027 487">▶ If safe steering is possible, drive on carefully. <li data-bbox="543 500 1175 524">▶ Visit or consult a qualified specialist workshop immediately.
 <p data-bbox="195 632 460 706">Steering Malfunction Stop Immediately See Operator's Manual</p>	<p data-bbox="524 537 1289 561">* The steering is malfunctioning. Steering capability is significantly impaired.</p> <div data-bbox="561 586 1698 757" style="border: 1px solid gray; padding: 5px;"> <p data-bbox="569 589 1203 613">▲ WARNING Risk of accident if steering capability is impaired</p> <p data-bbox="561 627 1461 651">If the steering does not function as intended, the vehicle's operating safety is jeopardized.</p> <ul style="list-style-type: none"> <li data-bbox="561 664 1633 712">▶ Pull over and stop the vehicle safely as soon as possible, paying attention to road and traffic conditions. Do not continue driving under any circumstances. <li data-bbox="561 725 994 749">▶ Consult a qualified specialist workshop. </div> <ul style="list-style-type: none"> <li data-bbox="543 777 1670 825">▶ Stop the vehicle immediately in accordance with the traffic conditions. Do not continue driving under any circumstances. <li data-bbox="543 838 975 861">▶ Consult a qualified specialist workshop.

Display messages	Possible causes/consequences and ► Solutions
	<ul style="list-style-type: none"> * At least one door is open. <ul style="list-style-type: none"> ► Close all doors.
	<ul style="list-style-type: none"> * The hood is open. <div style="border: 1px solid black; padding: 5px; margin-top: 10px;"> <p>▲ WARNING Risk of accident if the engine hood is unlatched while driving</p> <p>An unlocked engine hood may open up when the vehicle is in motion and block your view.</p> <ul style="list-style-type: none"> ► Never unlatch the engine hood while driving. ► Before every trip, ensure that the engine hood is latched. </div> <ul style="list-style-type: none"> ► Stop the vehicle immediately, paying attention to road and traffic conditions. ► Close the hood.
	<ul style="list-style-type: none"> * The tailgate is open. <div style="border: 1px solid black; padding: 5px; margin-top: 10px;"> <p>▲ DANGER Risk of exhaust gas poisoning</p> <p>Combustion engines emit poisonous exhaust gases such as carbon monoxide. Exhaust gases can enter the vehicle interior if the tailgate is open when the engine is running, especially if the vehicle is in motion.</p> <ul style="list-style-type: none"> ► Always switch off the engine before opening the tailgate. ► Never drive with the tailgate open. </div>

Display messages	Possible causes/consequences and ► Solutions
 <p data-bbox="195 384 432 433">2nd Seat Row, Left Not Locked</p>	<ul style="list-style-type: none"> <li data-bbox="543 249 765 273">► Close the tailgate. <li data-bbox="524 291 1360 314">* The left-hand seat or the seat backrest in the second row of seats is not engaged. <ul style="list-style-type: none"> <li data-bbox="543 325 1637 349">► Fold the corresponding seat backrest back until it engages and push the row of seats back (→ page 101). <li data-bbox="543 359 1082 383">► Make sure that the seat is engaged (→ page 101).
 <p data-bbox="195 553 445 601">2nd Seat Row, Right Not Locked</p>	<ul style="list-style-type: none"> <li data-bbox="524 459 1374 483">* The right-hand seat or the seat backrest in the second row of seats is not engaged. <ul style="list-style-type: none"> <li data-bbox="543 494 1637 518">► Fold the corresponding seat backrest back until it engages and push the row of seats back (→ page 101). <li data-bbox="543 528 1082 552">► Make sure that the seat is engaged (→ page 101).
 <p data-bbox="195 721 395 744">Check Washer Fluid</p>	<ul style="list-style-type: none"> <li data-bbox="524 627 1387 651">* The washer fluid level in the washer fluid reservoir has dropped below the minimum. <ul style="list-style-type: none"> <li data-bbox="543 662 912 685">► Refill washer fluid (→ page 460).

Engine

Display messages	Possible causes/consequences and ► Solutions
 <p data-bbox="144 381 399 433">Check Coolant Level See Operator's Manual</p>	<p data-bbox="476 291 772 311">* The coolant level is too low.</p> <div data-bbox="500 332 1646 418" style="border: 1px solid gray; padding: 5px;"> <p data-bbox="513 342 1042 363">! NOTE Engine damage due to insufficient coolant</p> <p data-bbox="513 384 994 405">► Avoid long journeys with insufficient coolant.</p> </div> <ul data-bbox="495 436 1282 493" style="list-style-type: none"> <li data-bbox="495 436 805 456">► Add coolant (→ page 459). <li data-bbox="495 467 1282 493">► Have the engine cooling system checked at a qualified specialist workshop.
 <p data-bbox="144 605 421 656">Coolant Too Hot Stop Vehicle Turn Engine Off</p>	<p data-bbox="476 511 717 532">* The coolant is too hot.</p> <ul data-bbox="495 542 1493 568" style="list-style-type: none"> <li data-bbox="495 542 1493 568">► Stop the vehicle immediately in accordance with the traffic conditions and switch off the engine. <div data-bbox="500 594 1646 774" style="border: 1px solid gray; padding: 5px;"> <p data-bbox="513 605 1071 625">! WARNING Danger of burns when opening the hood</p> <p data-bbox="513 646 1589 698">If you open the hood when the engine has overheated or during a fire in the engine compartment, you could come into contact with hot gases or other escaping operating fluids.</p> <ul data-bbox="513 708 1500 765" style="list-style-type: none"> <li data-bbox="513 708 1108 729">► Before opening the hood, allow the engine to cool down. <li data-bbox="513 739 1500 765">► In the event of a fire in the engine compartment, keep the hood closed and call the fire service. </div> <ul data-bbox="495 791 1130 848" style="list-style-type: none"> <li data-bbox="495 791 916 812">► Wait until the engine has cooled down. <li data-bbox="495 822 1130 848">► Make sure that the air supply to the radiator is not impaired.

Display messages	Possible causes/consequences and ► Solutions
	<ul style="list-style-type: none"> ► Avoiding high loads on the engine, drive to the nearest qualified specialist workshop. In doing so, ensure that the coolant temperature display remains below the red marking.
	<ul style="list-style-type: none"> * The fan motor is faulty. ► Avoiding high loads on the engine, drive to the nearest qualified specialist workshop. In doing so, ensure that the coolant temperature display remains below the red marking.
<p>To switch engine off, press and hold Start/Stop button for at least 3 seconds or press 3 times.</p>	<ul style="list-style-type: none"> * You have pressed the start/stop button while driving. ► Information about switching off the engine while driving (→ page 162).
 <p>Fuel Level Low</p>	<ul style="list-style-type: none"> * The fuel supply has dropped into the reserve range. ► Refuel.
 <p>Gas Cap Loose</p>	<ul style="list-style-type: none"> * The fuel filler cap is not closed correctly or the fuel system is leaking. ► Close the fuel filler cap. ► If the fuel filler cap was already properly closed: consult a qualified specialist workshop.

Transmission





Display messages	Possible causes/consequences and ► Solutions
Apply Brake to Shift from 'P'	<ul style="list-style-type: none"> * You have attempted to shift the transmission out of park position P and into another transmission position. <ul style="list-style-type: none"> ► Depress the brake pedal. ► Select transmission position D, R or neutral N.
To Deselect P or N, Depress Brake and Start Engine	<ul style="list-style-type: none"> * You have attempted to shift the transmission out of park position P or neutral N and into another transmission position. <ul style="list-style-type: none"> ► Depress the brake pedal. ► Change the transmission position. ► Start the engine.
Only Shift to 'P' when Vehicle is Stationary	<ul style="list-style-type: none"> * Park position P can be engaged only when the vehicle is stationary. <ul style="list-style-type: none"> ► To stop, depress the brake pedal. ► Shift the transmission to park position P while the vehicle is stationary.
Apply Brake to Shift to 'R'	<ul style="list-style-type: none"> * You have attempted to select transmission position R. <ul style="list-style-type: none"> ► Depress the brake pedal. ► Select transmission position R.
Driver's Door Open & Transmission Not in P Risk of Vehicle Rolling Away	<ul style="list-style-type: none"> * The driver's door is not fully closed and transmission position D, R or neutral N is selected. <ul style="list-style-type: none"> ► Select park position P when switching off the vehicle.









Display messages	Possible causes/consequences and ► Solutions
<p>N Permanently Active Risk of Rolling Away</p>	<ul style="list-style-type: none"> * While the vehicle is rolling or while you are driving, neutral N has been engaged. <ul style="list-style-type: none"> ► To stop, depress the brake pedal. ► Shift the transmission to park position P while the vehicle is stationary. ► To continue driving, select transmission position D or R.
<p>Service Required Do Not Shift Gears Visit Dealer</p>	<ul style="list-style-type: none"> * The transmission is malfunctioning. The transmission position can no longer be changed. <ul style="list-style-type: none"> ► When transmission position D is selected, consult a qualified specialist workshop and do not change the transmission position. ► For all other transmission positions, park the vehicle safely. ► Consult a qualified specialist workshop or breakdown service.
<p>Reversing Not Possible Service Required</p>	<ul style="list-style-type: none"> * The transmission is malfunctioning. The transmission position R cannot be selected. <ul style="list-style-type: none"> ► Consult a qualified specialist workshop.
<p>Transmission Malfunction Stop</p>	<ul style="list-style-type: none"> * The transmission is malfunctioning. The transmission shifts to neutral N automatically. <ul style="list-style-type: none"> ► Stop the vehicle immediately in accordance with the traffic conditions. ► Depress the brake pedal. ► Engage park position P. ► Consult a qualified specialist workshop.

558 Display messages and warning/indicator lamps





Display messages	Possible causes/consequences and ► Solutions
<p>Stop Vehicle Leave Engine Running Wait Transmission Cooling</p>	<p>* The transmission is overheating. Pulling away may be temporarily impaired or not possible.</p> <ul style="list-style-type: none">► Stop the vehicle immediately in accordance with the traffic conditions. Do not continue driving under any circumstances.► Leave the engine running.► Wait until the display message disappears before pulling away.
<p>Auxiliary Battery Malfunction</p>	<p>* The auxiliary battery for the transmission is no longer being charged.</p> <ul style="list-style-type: none">► Consult a qualified specialist workshop.► Until then, always select park position P manually before you switch off the engine.► Before leaving the vehicle, apply the electric parking brake.



Brakes

Display messages	Possible causes/consequences and ► Solutions
<div data-bbox="203 295 360 378" data-label="Image"> </div> <p data-bbox="203 383 304 409">(USA only)</p> <div data-bbox="203 419 360 502" data-label="Image"> </div> <p data-bbox="203 507 341 533">(Canada only)</p> <p data-bbox="194 543 462 595">Parking Brake See Operator's Manual</p>	<p data-bbox="526 290 1358 315">* The yellow  indicator lamp is lit. The electric parking brake is malfunctioning.</p> <p data-bbox="545 326 646 347">To apply:</p> <ul data-bbox="545 357 1145 419" style="list-style-type: none"> ► Switch the ignition off and switch it back on. ► Apply the electric parking brake manually (→ page 194). <p data-bbox="545 445 1081 466">If it is not possible to apply the electric parking brake:</p> <ul data-bbox="545 476 1275 538" style="list-style-type: none"> ► Consult a qualified specialist workshop. ► Where necessary, also secure the parked vehicle against rolling away. <p data-bbox="526 549 1690 595">* The yellow  indicator lamp and the red  (USA only) or  (Canada only) indicator lamp are lit. The electric parking brake is malfunctioning.</p> <p data-bbox="545 606 665 626">To release:</p> <ul data-bbox="545 642 1173 704" style="list-style-type: none"> ► Switch the ignition off and switch it back on. ► Release the electric parking brake manually (→ page 194). <p data-bbox="545 714 572 735">or</p> <ul data-bbox="545 745 1210 771" style="list-style-type: none"> ► Release the electric parking brake automatically (→ page 193). <p data-bbox="545 777 1145 797">If it is still not possible to release the electric parking brake:</p> <ul data-bbox="545 808 1478 833" style="list-style-type: none"> ► Do not continue driving under any circumstances. Consult a qualified specialist workshop.

Display messages	Possible causes/consequences and ► Solutions
	<p>* The yellow  indicator lamp is lit and the red  (USA only) or  (Canada only) indicator lamp is flashing. The electric parking brake is malfunctioning.</p> <p>The electric parking brake could not be applied or released.</p> <ul style="list-style-type: none">► Switch the ignition off and switch it back on. <p>To apply:</p> <ul style="list-style-type: none">► Release and then apply the electric parking brake manually (→ page 194). <p>To release:</p> <ul style="list-style-type: none">► Apply and then release the electric parking brake manually. <p>If the electric parking brake cannot be applied or the red  (USA only) or  (Canada only) indicator lamp continues to flash:</p> <ul style="list-style-type: none">► Do not continue driving under any circumstances. Consult a qualified specialist workshop.► Where necessary, also secure the parked vehicle against rolling away. <p>* The yellow  indicator lamp is lit and the red  indicator lamp (USA only) or  indicator lamp (Canada only) flashes for approximately ten seconds after the electric parking brake has been applied or released. It then remains lit or goes out. The electric parking brake is malfunctioning.</p> <p>If the battery charge level is too low:</p> <ul style="list-style-type: none">► Charge the battery.



Display messages	Possible causes/consequences and ► Solutions
	<p>To apply:</p> <ul style="list-style-type: none">► Switch off the ignition. The electric parking brake will be applied automatically. <p>If the electric parking brake is not to be applied, e.g. at an automatic car wash or when the vehicle is being towed, leave the ignition switched on. This does not include having the vehicle towed with the rear axle raised.</p> <p>If the electric parking brake is not applied automatically:</p> <ul style="list-style-type: none">► Switch the ignition off and switch it back on.► Release and then apply the electric parking brake manually (→ page 194). <p>If it is still not possible to apply the electric parking brake:</p> <ul style="list-style-type: none">► Consult a qualified specialist workshop.► Where necessary, also secure the parked vehicle against rolling away. <p>To release:</p> <ul style="list-style-type: none">► If the conditions for automatic release are fulfilled and the electric parking brake is not released automatically, release the electric parking brake manually (→ page 194). <p>If it is still not possible to release the electric parking brake:</p> <ul style="list-style-type: none">► Do not continue driving under any circumstances. Consult a qualified specialist workshop.



Display messages	Possible causes/consequences and ► Solutions
 <p>(USA only)</p>  <p>(Canada only)</p> <p>Please Release Parking Brake</p>	<p>* The red  indicator lamp (USA only) or  indicator lamp (Canada only) is flashing.</p> <p>The electric parking brake is applied while you are driving:</p> <ul style="list-style-type: none">• A condition for automatic release of the electric parking brake has not been fulfilled (→ page 193).• You are performing emergency braking using the electric parking brake (→ page 194). <p>► Check the conditions for automatic release of the electric parking brake.</p> <p>► Release the electric parking brake manually.</p>

Display messages	Possible causes/consequences and ► Solutions
<div data-bbox="205 252 362 335"></div> <div data-bbox="199 342 310 368">(USA only)</div> <div data-bbox="205 381 362 464"></div> <div data-bbox="199 471 343 497">(Canada only)</div> <div data-bbox="194 505 463 557">Turn On the Ignition to Release the Parking Brake</div>	<p>* The red  (USA only) or  indicator lamp (Canada only) is lit. You have attempted to release the electric parking brake with the ignition switched off.</p> <ul style="list-style-type: none"> ► Switch on the ignition.
<div data-bbox="205 584 362 667"></div> <div data-bbox="194 674 304 700">(USA only)</div> <div data-bbox="205 712 362 795"></div> <div data-bbox="194 802 338 828">(Canada only)</div> <div data-bbox="194 837 439 857">Check Brake Fluid Level</div>	<p>* There is insufficient brake fluid in the brake fluid reservoir.</p> <div style="background-color: #e0e0e0; padding: 5px; margin: 10px 0;"> <p>▲ WARNING Risk of an accident due to low brake fluid level</p> </div> <p>If the brake fluid level is too low, the braking effect and the braking characteristics may be impaired.</p> <ul style="list-style-type: none"> ► Pull over and stop the vehicle safely as soon as possible, paying attention to road and traffic conditions. Do not continue driving under any circumstances. ► Consult a qualified specialist workshop. ► Do not add brake fluid.



Display messages	Possible causes/consequences and ► Solutions
	<ul style="list-style-type: none">► Stop the vehicle immediately in accordance with the traffic conditions. Do not continue driving under any circumstances.► Do not add brake fluid.► Consult a qualified specialist workshop.
 <p>Check Brake Pads See Operator's Manual</p>	<p>* The brakepads have reached the wear limit.</p> <div data-bbox="495 425 1648 581" style="border: 1px solid gray; padding: 5px;"><p>▲ WARNING Risk of accident due to restricted braking power</p><p>When the brake pads have reached their wear limit, the braking power may be restricted.</p><ul style="list-style-type: none">► Drive on carefully.► Have the brake system checked immediately at a qualified specialist workshop.</div> <ul style="list-style-type: none">► Consult a qualified specialist workshop.

Driving systems

Display messages	Possible causes/consequences and ► Solutions
 <p data-bbox="195 384 469 433">ATTENTION ASSIST Inoperative</p>	<ul style="list-style-type: none"> <li data-bbox="519 291 924 313">* ATTENTION ASSIST is malfunctioning. <li data-bbox="543 325 975 348">► Consult a qualified specialist workshop.
 <p data-bbox="195 553 469 601">ATTENTION ASSIST: Take a Break!</p>	<ul style="list-style-type: none"> <li data-bbox="519 459 1578 508">* ATTENTION ASSIST has detected fatigue or an increasing lack of concentration on the part of the driver (→ page 265). <li data-bbox="543 520 842 542">► If necessary, take a break.
 <p data-bbox="195 724 454 772">Malfunction Drive at Max. 50 mph</p>	<ul style="list-style-type: none"> <li data-bbox="519 630 1578 653">* AIRMATIC is functioning only to a limited extent. The vehicle's handling characteristics may be affected. <li data-bbox="543 665 1474 687">► Drive in a manner appropriate for the current level, but do not exceed 50 mph (80 km/h). <li data-bbox="543 699 975 722">► Consult a qualified specialist workshop.

Display messages	Possible causes/consequences and ► Solutions
 <p data-bbox="144 342 242 366">Lowering</p>	<p data-bbox="473 249 1082 273">* The vehicle level may be lowered for the following reasons:</p> <ul data-bbox="500 283 1646 472" style="list-style-type: none"> <li data-bbox="500 283 972 307">• You have selected a different drive program. <li data-bbox="500 318 883 341">• You have exceeded the speed limit. <li data-bbox="500 352 1114 376">• You have changed the vehicle level by pressing the button. <li data-bbox="500 386 1646 438">• Operation with a trailer or bicycle rack: if an electrical connection has been correctly made, you have exceeded the speed limit. <li data-bbox="500 448 1162 472">• You have switched on the rear fog lamp in the off-road level +3.
 <p data-bbox="144 586 288 610">Vehicle Rising</p>	<p data-bbox="473 493 1045 516">* Your vehicle is adjusting to the level you have selected.</p>
 <p data-bbox="144 727 408 774">Malfunction Drive at Max. 50 mph</p>	<p data-bbox="473 634 1350 688">* At least one main function of the E-ACTIVE BODY CONTROL system is malfunctioning. The system is deactivated.</p> <div data-bbox="500 709 1646 857" style="border: 1px solid gray; padding: 5px;"> <p data-bbox="513 720 1613 767">! NOTE The vehicle's suspension and damping behavior has changed significantly, the vehicle body may tilt heavily to the side during cornering.</p> <ul data-bbox="513 785 1162 844" style="list-style-type: none"> <li data-bbox="513 785 959 809">► Reduce vehicle speed. Drive on carefully. <li data-bbox="513 819 1162 844">► Reduce the vehicle speed considerably before taking a curve. </div>

Display messages	Possible causes/consequences and ► Solutions
	<ul style="list-style-type: none"> ► Avoid sudden steering movements. ► Continue driving carefully at maximum 50 mph (80 km/h). ► If possible, stop the vehicle when safe to do so in the traffic conditions and switch the ignition off and on again. ► If the display message continues to be displayed, consult a qualified specialist workshop.
<div style="text-align: center;">  <p data-bbox="195 513 371 536">Malfunction Stop</p> </div>	<p data-bbox="528 420 1504 477">* There is a serious malfunction affecting the hydraulics of the E-ACTIVE BODY CONTROL system. The system is deactivated.</p> <div style="border: 1px solid gray; padding: 5px; margin: 5px 0;"> <p data-bbox="565 503 1304 529">! NOTE The vehicle's driving characteristics have changed significantly.</p> </div> <ul style="list-style-type: none"> ► Pull over and stop the vehicle safely as soon as possible in accordance with the traffic conditions. Do not continue driving under any circumstances. ► Stop the vehicle immediately in accordance with the traffic conditions. Do not continue driving under any circumstances. ► Consult a qualified specialist workshop.
<p data-bbox="195 726 380 752">Drive More Slowly</p>	<p data-bbox="528 726 1073 752">* You are driving too fast for the selected vehicle level.</p> <ul style="list-style-type: none"> ► Drive more slowly and then select the desired vehicle level again. <p data-bbox="547 809 1618 835">You are driving too quickly with a trailer or the trailer hitch socket is being used, e.g. for a rear bicycle rack.</p> <ul style="list-style-type: none"> ► Read the information on trailer operation.

Display messages	Possible causes/consequences and ► Solutions
 <p>Vehicle Rising Please Wait</p>	<ul style="list-style-type: none"> * The vehicle level is too low. The vehicle will be raised to the selected vehicle level. <ul style="list-style-type: none"> ► Wait until the display message disappears before pulling away.
 <p>Compressor Is Cooling</p>	<ul style="list-style-type: none"> * Due to frequent level changes within a short space of time, the compressor first needs to cool down in order to set the selected vehicle level. <ul style="list-style-type: none"> ► Drive on in a manner appropriate for the current level. Make sure that there is sufficient ground clearance. When the compressor has cooled down, the vehicle will continue rising to the selected vehicle level.
<p>Active Steering Assist Currently Unavailable See Operator's Manual</p>	<ul style="list-style-type: none"> * Active Steering Assist is temporarily unavailable. The ambient conditions are outside the system limits (→ page 220). <ul style="list-style-type: none"> ► Drive on. As soon as the ambient conditions are within the system limits, the system will become available again. ► If necessary, clean the windshield in the camera's field of vision. ► Check the tire pressure if necessary.
<p>Active Steering Assist Inoperative</p>	<ul style="list-style-type: none"> * Active Steering Assist is malfunctioning. Active Distance Assist DISTRONIC remains available. <ul style="list-style-type: none"> ► Consult a qualified specialist workshop.

Display messages	Possible causes/consequences and ► Solutions
	<ul style="list-style-type: none"> * Active Steering Assist has reached the system limits (→ page 220). You have not steered independently for a considerable period of time. <ul style="list-style-type: none"> ► Take over the steering and drive on in accordance with the traffic conditions.
Beginning Emergency Stop	<ul style="list-style-type: none"> * Your hands are not on the steering wheel. An emergency stop is initiated (→ page 223). <ul style="list-style-type: none"> ► Put your hands back on the steering wheel. <p>You can cancel the deceleration at any time by performing one of the following actions:</p> <ul style="list-style-type: none"> • Steering • Braking or accelerating • Pressing a steering-wheel button • Operating Touch Control • Deactivating Active Distance Assist DISTRONIC
Active Steering Asst. Currently Unavailable Due to Multiple Emergency Stops	<ul style="list-style-type: none"> * Active Steering Assist is temporarily unavailable due to multiple emergency stops. <ul style="list-style-type: none"> ► Take over the steering and stop in accordance with the traffic conditions. ► Switch the ignition off and switch it back on. Active Steering Assist is available once more.
Active Lane Keeping Assist Currently Unavailable See Operator's Manual	<ul style="list-style-type: none"> * Active Lane Keeping Assist is temporarily unavailable. The ambient conditions are outside the system limits (→ page 272).

570 Display messages and warning/indicator lamps



Display messages	Possible causes/consequences and ► Solutions
	<ul style="list-style-type: none"> ► Drive on. As soon as the ambient conditions are within the system limits, the system will become available again.
Active Lane Keeping Assist Inoperative	<ul style="list-style-type: none"> * Active Lane Keeping Assist is malfunctioning. <ul style="list-style-type: none"> ► Consult a qualified specialist workshop.
Active Stop & Go Assist Currently Unavailable See Operator's Manual	<ul style="list-style-type: none"> * Active Traffic Jam Assist is temporarily not available. Active Distance Assist DISTRONIC and Active Steering Assist are still available. The ambient conditions are outside the system limits (→ page 224). <ul style="list-style-type: none"> ► Drive on. As soon as the ambient conditions are within the system limits, the system will become available again.
Active Stop & Go Assist Inoperative See Operator's Manual	<ul style="list-style-type: none"> * Active Traffic Jam Assist is malfunctioning. Active Traffic Jam Assist is deactivated. Active Distance Assist DISTRONIC and Active Steering Assist are still available. <ul style="list-style-type: none"> ► Consult a qualified specialist workshop.
Blind Spot Assist Currently Unavailable See Operator's Manual	<ul style="list-style-type: none"> * Blind Spot Assist is temporarily unavailable. The system limits have been reached (→ page 269). <ul style="list-style-type: none"> ► Drive on. Once the cause of the problem is no longer present, the system will be available again. or



Display messages	Possible causes/consequences and ► Solutions
	<ul style="list-style-type: none"> ► If the display message does not disappear, stop the vehicle in accordance with the traffic conditions and restart the engine.
Blind Spot Assist Inoperative	<ul style="list-style-type: none"> * Blind Spot Assist is malfunctioning. <ul style="list-style-type: none"> ► Consult a qualified specialist workshop.
Blind Spot Assist Not Available When Towing a Trailer See Operator's Manual	<ul style="list-style-type: none"> * When you establish the electrical connection to the trailer, Blind Spot Assist is unavailable. <ul style="list-style-type: none"> ► Press the left-hand Touch Control and acknowledge the display message.
Active Blind Spot Assist Currently Unavailable See Operator's Manual	<ul style="list-style-type: none"> * Active Blind Spot Assist is temporarily unavailable. The system limits have been reached (→ page 269). <ul style="list-style-type: none"> ► Drive on. Once the cause of the problem is no longer present, the system will be available again. or ► If the display message does not disappear, stop the vehicle in accordance with the traffic conditions and restart the engine.
Active Blind Spot Assist Inoperative	<ul style="list-style-type: none"> * Active Blind Spot Assist is malfunctioning. <ul style="list-style-type: none"> ► Consult a qualified specialist workshop.

572 Display messages and warning/indicator lamps

Display messages	Possible causes/consequences and ► Solutions
Active Blind Spot Asst. Not Available When Towing a Trailer See Operator's Manual	<ul style="list-style-type: none">* When you establish the electrical connection to the trailer, Active Blind Spot Assist is unavailable.<ul style="list-style-type: none">► Press the left-hand Touch Control and acknowledge the display message.
Active Parking Assist and PARKTRONIC Inoperative See Operator's Manual	<ul style="list-style-type: none">* Active Parking Assist and Parking Assist PARKTRONIC are malfunctioning.<ul style="list-style-type: none">► Stop the vehicle in accordance with the traffic conditions and restart the engine.► If the display message continues to be displayed, consult a qualified specialist workshop.
Traffic Sign Assist Currently Unavailable See Operator's Manual	<ul style="list-style-type: none">* Traffic Sign Assist is temporarily unavailable.<ul style="list-style-type: none">► Drive on.► Once the cause of the problem is no longer present, the system will be available again.
Traffic Sign Assist Inoperative	<ul style="list-style-type: none">* Traffic Sign Assist is malfunctioning.<ul style="list-style-type: none">► Stop the vehicle in accordance with the traffic conditions and restart the engine.► If the display message continues to be displayed, consult a qualified specialist workshop.

Display messages	Possible causes/consequences and ► Solutions
 <p data-bbox="195 598 413 646">Currently Unavailable Radar Sensors Dirty</p>	<p data-bbox="528 249 1147 272">* The radar sensor system is malfunctioning. Possible causes:</p> <ul data-bbox="550 285 1221 377" style="list-style-type: none"> <li data-bbox="550 285 774 308">• Dirt on the sensors <li data-bbox="550 319 774 341">• Heavy rain or snow <li data-bbox="550 352 1221 377">• Extended country driving without other traffic, e.g. in the desert <p data-bbox="547 394 1480 417">Driving systems and driving safety systems may be malfunctioning or temporarily unavailable.</p> <p data-bbox="547 427 1702 477">Once the cause of the problem is no longer present, the driving systems and driving safety systems will be available again.</p> <p data-bbox="547 487 972 510">If the display message does not disappear:</p> <ul data-bbox="547 524 1156 615" style="list-style-type: none"> <li data-bbox="547 524 1156 547">► Stop the vehicle in accordance with the traffic conditions. <li data-bbox="547 557 903 580">► Clean all sensors (→ page 467). <li data-bbox="547 590 774 615">► Restart the engine.

Display messages	Possible causes/consequences and ► Solutions
 <p data-bbox="144 681 421 731">Currently Unavailable Camera View Restricted</p>	<p data-bbox="476 249 966 270">* The camera view is restricted. Possible causes:</p> <ul data-bbox="500 283 1073 373" style="list-style-type: none"> <li data-bbox="500 283 1049 304">• Dirt on the windshield in the camera's field of vision <li data-bbox="500 318 765 338">• Heavy rain, snow or fog <li data-bbox="500 352 1073 372">• Condensation on the windshield in front of the camera <p data-bbox="495 394 1622 443">❗ Condensation detected on the windshield will be automatically removed using a built-in heater within approximately 12 minutes.</p> <p data-bbox="495 456 1428 477">Driving systems and driving safety systems may be malfunctioning or temporarily unavailable.</p> <p data-bbox="495 491 1650 539">Once the cause of the problem is no longer present, the driving systems and driving safety systems will be available again.</p> <p data-bbox="495 553 924 573">If the display message does not disappear:</p> <ul data-bbox="495 587 1105 643" style="list-style-type: none"> <li data-bbox="495 587 1105 608">► Stop the vehicle in accordance with the traffic conditions. <li data-bbox="495 620 870 641">► Clean the windshield if necessary.
 <p data-bbox="144 850 181 871">Off</p>	<p data-bbox="476 760 1567 781">* The HOLD function is deactivated because the vehicle is slipping or a condition for activation is not fulfilled.</p> <ul data-bbox="495 794 1604 815" style="list-style-type: none"> <li data-bbox="495 794 1604 815">► Reactivate the HOLD function later or check the activation conditions for the HOLD function (→ page 227).

Display messages	Possible causes/consequences and ► Solutions
 <p data-bbox="195 346 279 366">--- mph</p>	<ul style="list-style-type: none"> * Active Distance Assist DISTRONIC cannot be activated as not all activation conditions are fulfilled. <ul style="list-style-type: none"> ► Comply with the activation conditions of Active Distance Assist DISTRONIC (→ page 215).
 <p data-bbox="195 487 310 508">Suspended</p>	<ul style="list-style-type: none"> * If you depress the accelerator pedal beyond the Active Distance Assist DISTRONIC setting, the system will be put into passive mode (→ page 225).
 <p data-bbox="195 627 229 648">Off</p>	<ul style="list-style-type: none"> * Active Distance Assist DISTRONIC was deactivated. If a warning tone also sounds, Active Distance Assist DISTRONIC has deactivated automatically (→ page 215).
<p data-bbox="195 674 469 750">Active Distance Assist Currently Unavailable See Operator's Manual</p>	<ul style="list-style-type: none"> * Active Distance Assist DISTRONIC is temporarily unavailable. The ambient conditions are outside the system limits (→ page 213). <ul style="list-style-type: none"> ► Drive on. As soon as the ambient conditions are within the system limits, the system will become available again.
<p data-bbox="195 811 476 857">Active Distance Assist Inoperative</p>	<ul style="list-style-type: none"> * Active Distance Assist DISTRONIC is malfunctioning. Other driving systems and driving safety systems may also be malfunctioning.

576 Display messages and warning/indicator lamps

Display messages	Possible causes/consequences and ► Solutions
	<ul style="list-style-type: none">► Consult a qualified specialist workshop.
Active Distance Assist Now Available	* Active Distance Assist DISTRONIC is operational again and can be activated (→ page 215).
 --- mph	* Cruise control cannot be activated as not all activation conditions are fulfilled. <ul style="list-style-type: none">► Observe the activation conditions for cruise control (→ page 210).
Cruise Control Inoperative	* Cruise control is malfunctioning. <ul style="list-style-type: none">► Consult a qualified specialist workshop.
Cruise Control Off	* Cruise control has been deactivated. If there is an additional warning tone, cruise control has been deactivated automatically (→ page 209).

Driving safety systems

Display messages	Possible causes/consequences and ► Solutions
 <p data-bbox="197 469 458 519">Currently Unavailable See Operator's Manual</p>	<p data-bbox="528 291 972 319">* ABS and ESP® are temporarily unavailable.</p> <p data-bbox="545 326 1404 354">Other driving systems and driving safety systems may also be temporarily unavailable.</p> <p data-bbox="545 361 1683 412">The brake system will continue to operate normally. Braking distance may increase in an emergency braking situation.</p> <div data-bbox="545 429 1696 678" style="border: 1px solid gray; padding: 5px;"> <p data-bbox="569 440 1240 468">▲ WARNING Risk of skidding if ABS and ESP® are malfunctioning</p> <p data-bbox="563 481 1637 532">If ABS and ESP® are malfunctioning, the wheels could lock when braking and ESP® cannot carry out vehicle stabilization.</p> <p data-bbox="563 545 1674 596">The steering capability and braking characteristics are thus severely impaired. The braking distance in an emergency braking situation can increase. In addition, other driving safety systems are switched off.</p> <ul style="list-style-type: none"> <li data-bbox="563 610 778 638">► Drive on carefully. <li data-bbox="563 645 1360 673">► Have ABS and ESP® checked immediately at a qualified specialist workshop. </div> <ul style="list-style-type: none"> <li data-bbox="545 697 1622 747">► Drive carefully on a suitable stretch of road, making slight steering movements at a speed above 19 mph (30 km/h). <li data-bbox="545 761 1683 789">► If the display message does not disappear, consult a qualified specialist workshop immediately. Drive carefully.

Display messages	Possible causes/consequences and ► Solutions
<div data-bbox="153 251 312 329" data-label="Image"> </div> <div data-bbox="153 335 312 420" data-label="Image"> </div> <p data-bbox="144 425 417 474">Inoperative See Operator's Manual</p>	<p data-bbox="473 246 838 275">* ABS and ESP® are malfunctioning.</p> <p data-bbox="491 282 1269 311">Other driving systems and driving safety systems may also be malfunctioning.</p> <p data-bbox="491 319 1633 367">The brake system will continue to operate normally. Braking distance may increase in an emergency braking situation.</p> <div data-bbox="500 389 1646 638" style="border: 1px solid gray; padding: 5px;"> <p data-bbox="513 396 1190 425">▲ WARNING Risk of skidding if ABS and ESP® are malfunctioning</p> <p data-bbox="510 441 1589 490">If ABS and ESP® are malfunctioning, the wheels could lock when braking and ESP® cannot carry out vehicle stabilization.</p> <p data-bbox="510 503 1626 552">The steering capability and braking characteristics are thus severely impaired. The braking distance in an emergency braking situation can increase. In addition, other driving safety systems are switched off.</p> <ul style="list-style-type: none"> <li data-bbox="510 565 728 594">▶ Drive on carefully. <li data-bbox="510 601 1310 630">▶ Have ABS and ESP® checked immediately at a qualified specialist workshop. </div> <ul style="list-style-type: none"> <li data-bbox="491 653 709 682">▶ Drive on carefully. <li data-bbox="491 689 1053 718">▶ Consult a qualified specialist workshop immediately.
<div data-bbox="153 733 312 814" data-label="Image"> </div> <p data-bbox="144 819 408 868">Currently Unavailable See Operator's Manual</p>	<p data-bbox="473 728 814 757">* ESP® is temporarily unavailable.</p> <p data-bbox="491 764 1269 793">Other driving systems and driving safety systems may also be malfunctioning.</p>

Display messages	Possible causes/consequences and ► Solutions
	<p>▲ WARNING Risk of skidding if ESP® is malfunctioning</p> <p>If ESP® is malfunctioning, ESP® cannot carry out vehicle stabilization. In addition, other driving safety systems are switched off.</p> <ul style="list-style-type: none"> ▶ Drive on carefully. ▶ Have ESP® checked at a qualified specialist workshop. <p>▶ Drive carefully on a suitable stretch of road, making slight steering movements at a speed above 19 mph (30 km/h).</p> <p>▶ If the display message does not disappear, consult a qualified specialist workshop immediately. Drive carefully.</p>
 <p>Inoperative See Operator's Manual</p>	<p>* ESP® is malfunctioning.</p> <p>Other driving systems and driving safety systems may also be malfunctioning.</p> <p>The brake system will continue to operate normally. Braking distance may increase in an emergency braking situation.</p> <p>▲ WARNING Risk of skidding if ESP® is malfunctioning</p> <p>If ESP® is malfunctioning, ESP® cannot carry out vehicle stabilization. In addition, other driving safety systems are switched off.</p> <ul style="list-style-type: none"> ▶ Drive on carefully. ▶ Have ESP® checked at a qualified specialist workshop.

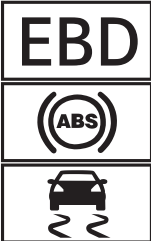
Display messages	Possible causes/consequences and ► Solutions
 <p data-bbox="144 586 417 636">Inoperative See Operator's Manual</p>	<ul style="list-style-type: none"> ► Drive on carefully. ► Consult a qualified specialist workshop immediately. <p data-bbox="476 325 1271 385">* EBD, ABS and ESP® are malfunctioning. Other driving systems and driving safety systems may also be malfunctioning.</p> <div data-bbox="495 405 1648 650" style="border: 1px solid gray; padding: 5px;"> <p data-bbox="513 412 1245 441">▲ WARNING Risk of skidding if EBD, ABS and ESP® are malfunctioning</p> <p data-bbox="513 456 1626 506">If EBD, ABS and ESP® are malfunctioning, the wheels can lock when braking and ESP® cannot carry out vehicle stabilization.</p> <p data-bbox="513 519 1626 568">The steering capability and braking characteristics are thus severely impaired. The braking distance in an emergency braking situation can increase. In addition, other driving safety systems are switched off.</p> <ul style="list-style-type: none"> ► Drive on carefully. ► Have the brake system checked immediately at a qualified specialist workshop. </div> <ul style="list-style-type: none"> ► Drive on carefully. ► Consult a qualified specialist workshop immediately.
<p data-bbox="144 743 417 816">Active Brake Assist Functions Currently Limited See Operator's Manual</p>	<p data-bbox="476 743 1626 793">* Vehicles with the Driving Assistance Package: Active Brake Assist with cross-traffic function, Evasive Steering Assist or PRE-SAFE® PLUS are temporarily unavailable or only partially available.</p> <p data-bbox="495 806 1648 855">Vehicles without the Driving Assistance Package: Active Brake Assist is temporarily unavailable or only partially available.</p>

Display messages	Possible causes/consequences and ► Solutions
	<p>The ambient conditions are outside the system limits (→ page 203).</p> <ul style="list-style-type: none"> ► Drive on. As soon as the ambient conditions are within the system limits, the system will become available again. ► If the display message does not disappear, stop the vehicle in accordance with the traffic conditions and restart the engine.
<p>Active Brake Assist Functions Limited See Operator's Manual</p>	<p>* Vehicles with Driving Assistance Package: Active Brake Assist with cross-traffic function, Evasive Steering Assist or PRE-SAFE® PLUS is malfunctioning.</p> <p>Vehicles without Driving Assistance Package: Active Brake Assist is malfunctioning.</p> <ul style="list-style-type: none"> ► Consult a qualified specialist workshop.



Mercedes me connect



Display messages	Possible causes/consequences and ► Solutions
<p>Mercedes me connect Services Limited See Operator's Manual</p>	<p>* Service limited.</p> <p>At least one of the main functions of the Mercedes me connect system is malfunctioning.</p> <ul style="list-style-type: none"> ► Observe the notes on the diagnostics connection (→ page 27). ► Consult a qualified specialist workshop.



582 Display messages and warning/indicator lamps

Display messages	Possible causes/consequences and ► Solutions
 <p>Inoperative</p>	<ul style="list-style-type: none">* At least one of the main functions of the Mercedes me connect system or of the SOS emergency call system is malfunctioning.<ul style="list-style-type: none">► Consult a qualified specialist workshop.

Battery

Display messages	Possible causes/consequences and ► Solutions
 <p>12 V Battery See Operator's Manual</p>	<ul style="list-style-type: none">* The engine is off and the charge level is too low.<ul style="list-style-type: none">► Switch off electrical consumers that are not required.To charge the battery:<ul style="list-style-type: none">► Leave the engine running for a few minutes, or drive an extended distance.* If the message appears while the engine is running, this indicates an on-board electrical system malfunction.<ul style="list-style-type: none">► Consult a qualified specialist workshop.
 <p>See Operator's Manual</p>	<ul style="list-style-type: none">* The battery is not being charged.<div data-bbox="495 788 1646 876" style="border: 1px solid gray; padding: 5px;"><ul style="list-style-type: none">! NOTE Possible engine damage if you continue driving► Do not continue driving under any circumstances.</div>



Display messages	Possible causes/consequences and ► Solutions
	<ul style="list-style-type: none"> ► Consult a qualified specialist workshop. ► Pull over and stop the vehicle safely and switch off the engine, paying attention to road and traffic conditions. ► Consult a qualified specialist workshop.
<div style="text-align: center;">  </div> <p>Stop Vehicle See Operator's Manual</p>	<p>* The battery is no longer being charged and the charge level is too low.</p> <div style="border: 1px solid black; padding: 5px; margin: 5px 0;"> <p>! NOTE Possible engine damage if you continue driving</p> </div> <ul style="list-style-type: none"> ► Do not continue driving under any circumstances. ► Consult a qualified specialist workshop. ► Stop the vehicle immediately in accordance with the traffic conditions. Do not continue driving under any circumstances. ► Switch off the engine. ► Consult a qualified specialist workshop.
<div style="text-align: center;">  </div> <p>Stop Vehicle Leave Engine Running</p>	<p>* The battery charge level is too low.</p> <ul style="list-style-type: none"> ► Stop the vehicle immediately in accordance with the traffic conditions. Do not continue driving under any circumstances. ► Leave the engine running. ► Wait until the display message disappears before pulling away.



Display messages	Possible causes/consequences and ► Solutions
 <p>48 V Battery See Operator's Manual</p>	<p>► If the display message does not disappear: consult a qualified specialist workshop.</p> <p>* The 48 V on-board electrical system has function restrictions. Convenience functions may be restricted.</p> <p>► Consult a qualified specialist workshop immediately.</p>
<p>Cannot Start Engine See Operator's Manual</p>	<p>* The charge level of the 48 V battery is too low. You can no longer start the engine.</p> <p>► Switch off electrical consumers that are not required.</p> <p>► Connect a suitable charger approved for Mercedes-Benz with sufficient charge output to the jump-start connection point of the 12 V battery (→ page 481). The 48 V battery is charged via the voltage converter in the vehicle.</p>
<p>Engine Can Now Be Started</p>	<p>* The 48 V battery has been charged automatically via the voltage converter.</p> <p>► Start the engine and drive the vehicle for a while to charge the 12 V battery and the 48 V battery.</p>
 <p>Please Wait Charging 48 V Battery...</p>	<p>* The 48 V battery is discharged. You have switched on the ignition while the 12 V battery was being charged with a suitable charger or while another vehicle was providing starting assistance.</p> <p>The discharged 48 V battery is charged automatically via the voltage converter. After a few minutes, the Engine Can Now Be Started display message will be shown on the multifunction display.</p> <p>► Start the engine.</p>

Display messages	Possible causes/consequences and ► Solutions
	<ul style="list-style-type: none"> ► Drive the vehicle for a while to charge the 12 V battery and the 48 V battery after disconnecting the charger from the vehicle. <p>If the Engine Can Now Be Started display message does not appear after a few minutes:</p> <ul style="list-style-type: none"> ► Try to start the engine again. ► If the engine does not start, consult a qualified specialist workshop.

Tire pressure monitor

Display messages	Possible causes/consequences and ► Solutions
Tire Press. Monitor Currently Unavailable	<ul style="list-style-type: none"> * There is interference from a powerful radio signal source. As a result, no signals from the tire pressure sensors are being received. The tire pressure monitor is temporarily unavailable. <ul style="list-style-type: none"> ► Drive on. ► The tire pressure monitor will restart automatically as soon as the cause has been rectified.
Tire Press. Monitor Inoperative	<ul style="list-style-type: none"> * The tire pressure monitor is malfunctioning. <div style="border: 1px solid gray; padding: 5px; margin-top: 10px;"> <p>⚠ WARNING There is a risk of an accident if the tire pressure monitoring system is malfunctioning</p> <p>If the tire pressure monitoring system is malfunctioning, it is not able to issue a warning if there is pressure loss in one or more of the tires.</p> <p>Underinflated tires may, for example, impair the driving, steering and braking characteristics.</p> </div>

Display messages	Possible causes/consequences and ► Solutions
	<p>► Have the tire pressure monitoring system checked at a qualified specialist workshop.</p> <p>► Consult a qualified specialist workshop.</p>
Tire Pressure Monitor Inoperative No Wheel Sensors	<p>* The wheels installed do not have suitable tire pressure sensors. The tire pressure monitor is deactivated.</p> <p>► Install wheels with suitable tire pressure sensors.</p>
 Wheel Sensor(s) Missing	<p>* There is no signal from the tire pressure sensor of one or more wheels. No pressure value is displayed for the affected tire.</p> <p>► Have the faulty tire pressure sensor replaced at a qualified specialist workshop.</p>
 Check Tires	<p>* The tire pressure in one or more tires has dropped significantly. The wheel position is displayed.</p> <p>▲ WARNING Risk of an accident due to insufficient tire pressure</p> <p>Tire pressures that are too low pose the following hazards:</p> <ul style="list-style-type: none"> • The tires may burst, especially as the load and vehicle speed increase. • The tires may wear excessively and/or unevenly, which may greatly impair tire traction. • The driving characteristics, as well as steering and braking, may be greatly impaired. <p>You could then lose control of the vehicle.</p> <p>► Observe the recommended tire pressure.</p>

Display messages	Possible causes/consequences and ► Solutions
	<ul style="list-style-type: none"> ► Adjust the tire pressure if necessary. ► Stop the vehicle in accordance with the traffic conditions. ► Check the tire pressure (→ page 492) and the tires.
 <p data-bbox="195 477 445 526">Please Correct Tire Pressure</p>	<p data-bbox="528 384 1646 436">* The tire pressure is too low in at least one of the tires, or the difference in tire pressure between the individual wheels is too great.</p> <ul style="list-style-type: none"> ► Check the tire pressure and add air, if necessary. ► When the tire pressure is correct, restart the tire pressure monitor (→ page 497).
 <p data-bbox="195 646 445 671">Warning Tire Malfunction</p>	<p data-bbox="528 553 1471 578">* The tire pressure in one or more tires has dropped suddenly. The wheel position is displayed.</p> <div data-bbox="547 594 1702 636" style="background-color: #e0e0e0; padding: 5px;"> <p data-bbox="565 605 1184 629">▲ WARNING Risk of an accident from driving with a flat tire</p> </div> <p data-bbox="565 646 1018 671">Flat tires are dangerous in the following ways:</p> <ul style="list-style-type: none"> • The tires can overheat and cause a fire. • The driving characteristics, as well as steering and braking, may be greatly impaired. <p data-bbox="565 754 981 779">You could then lose control of the vehicle.</p> <ul style="list-style-type: none"> ► Do not drive with a flat tire. ► Observe the notes on flat tires.

588 Display messages and warning/indicator lamps

Display messages	Possible causes/consequences and ► Solutions
	<p>Notes on flat tires (→ page 471).</p> <ul style="list-style-type: none">► Stop the vehicle in accordance with the traffic conditions.► Check the tires.
Tires Overheated	<p>* At least one tire is overheating. The affected tires are displayed in red. At temperatures close to the limit value, the tires are displayed in yellow.</p> <ul style="list-style-type: none">► Drive more slowly.
Decrease Speed	<p>* At least one tire is overheating. The affected tires are displayed in red. At temperatures close to the limit value, the tires are displayed in yellow.</p> <div style="border: 1px solid gray; padding: 5px;"><p>▲ WARNING Risk of an accident from driving with overheated tires</p><p>Overheated tires may burst, particularly at high speeds.</p><ul style="list-style-type: none">► Reduce speed so that the tires cool down.</div> <ul style="list-style-type: none">► Reduce speed so that the tires cool down.

Tire pressure loss warning system



Display messages	Possible causes/consequences and ► Solutions
Check Tire Pressure Soon	<p>* Canada only:</p>



Display messages	Possible causes/consequences and ► Solutions
	<p>The tire pressure loss warning system has detected a significant loss of pressure.</p> <p>▲ WARNING Risk of an accident due to insufficient tire pressure</p> <p>Tire pressures that are too low pose the following hazards:</p> <ul style="list-style-type: none"> • The tires may burst, especially as the load and vehicle speed increase. • The tires may wear excessively and/or unevenly, which may greatly impair tire traction. • The driving characteristics, as well as steering and braking, may be greatly impaired. <p>You could then lose control of the vehicle.</p> <ul style="list-style-type: none"> ► Observe the recommended tire pressure. ► Adjust the tire pressure if necessary. <ul style="list-style-type: none"> ► Stop the vehicle in accordance with the traffic conditions. ► Check the tire pressure (→ page 492) and the tires. ► When the tire pressure is correct, restart the tire pressure loss warning system (→ page 497).
Check Tire Pressure Then Restart Run Flat Indicator	<p>* Canada only: The tire pressure loss warning system generated a display message and has not been restarted since.</p> <ul style="list-style-type: none"> ► When the tire pressure is correct, restart the tire pressure loss warning system (→ page 497).
Run Flat Indicator Inoperative	<p>* Canada only: The tire pressure loss warning system is malfunctioning.</p>

590 Display messages and warning/indicator lamps

Display messages	Possible causes/consequences and ► Solutions
	<ul style="list-style-type: none">► Consult a qualified specialist workshop.

Engine oil

Display messages	Possible causes/consequences and ► Solutions
 <p>Check Engine Oil Level (Add 1 quart)</p>	<p>* Display message only for certain engines: The engine oil level has dropped to the minimum level.</p> <div data-bbox="498 495 1648 580"><p>! NOTE Engine damage caused by driving with insufficient engine oil</p><p>► Avoid long journeys with insufficient engine oil.</p></div> <p>► When next refueling, add 1.1 US qt (1 l) of engine oil (→ page 458). Notes on engine oil (→ page 531).</p>
 <p>Engine Oil Reduce Oil Level</p>	<p>* Display message only for certain engines: The engine oil level is too high.</p> <div data-bbox="498 758 1648 843"><p>! NOTE Engine damage caused by driving with excess engine oil</p><p>► Avoid long journeys with excess engine oil.</p></div> <p>► Consult a qualified specialist workshop immediately and have the engine oil level reduced.</p>

Display messages	Possible causes/consequences and ► Solutions
 <p data-bbox="195 342 463 394">Engine Oil Level Low Stop Vehicle Turn Engine Off</p>	<p data-bbox="528 249 962 306">* Display message only for certain engines: The engine oil level is too low.</p> <div data-bbox="565 327 1696 368" style="border: 1px solid black; padding: 5px;"> <p data-bbox="565 337 1276 363">! NOTE Engine damage caused by driving with insufficient engine oil</p> </div> <div data-bbox="565 373 1696 415" style="border: 1px solid black; padding: 5px;"> <p data-bbox="565 379 1064 405">► Avoid long journeys with insufficient engine oil.</p> </div> <ul data-bbox="547 430 1674 586" style="list-style-type: none"> <li data-bbox="547 430 1674 482">► Stop the vehicle immediately in accordance with the traffic conditions. Do not continue driving under any circumstances. <li data-bbox="547 487 796 513">► Switch off the engine. <li data-bbox="547 519 1045 544">► Add 1.1 US qt (1 l) of engine oil (→ page 458). <li data-bbox="547 550 842 576">► Check the engine oil level. <p data-bbox="547 601 888 627">Notes on engine oil (→ page 531).</p>
 <p data-bbox="195 736 445 788">Engine Oil Pressure Stop Switch Off Engine</p>	<p data-bbox="528 643 962 700">* Display message only for certain engines: The oil pressure is too low.</p> <div data-bbox="565 721 1696 762" style="border: 1px solid black; padding: 5px;"> <p data-bbox="565 731 1295 757">! NOTE Engine damage caused by driving with insufficient oil pressure</p> </div> <div data-bbox="565 767 1696 809" style="border: 1px solid black; padding: 5px;"> <p data-bbox="565 772 1018 798">► Avoid driving with insufficient oil pressure.</p> </div> <ul data-bbox="547 824 1674 876" style="list-style-type: none"> <li data-bbox="547 824 1674 876">► Stop the vehicle immediately in accordance with the traffic conditions. Do not continue driving under any circumstances.

592 Display messages and warning/indicator lamps

Display messages	Possible causes/consequences and ► Solutions
 <p data-bbox="144 381 417 430">Engine Oil Level Cannot Be Measured</p>	<ul style="list-style-type: none"><li data-bbox="495 249 925 272">► Consult a qualified specialist workshop.<li data-bbox="476 291 1489 313">* The electrical connection to the oil level sensor has been interrupted or the oil level sensor is faulty.<li data-bbox="495 324 925 347">► Consult a qualified specialist workshop.

Warning and indicator lamps

Overview of indicator and warning lamps





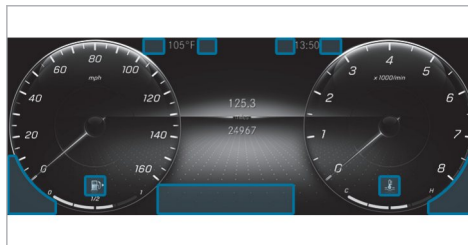





Some systems will perform a self-test when the ignition is switched on. Some indicator and warning lamps may briefly light up or flash. This behavior is non-critical. These indicator and warning lamps indicate a malfunction only if they light up or flash after the engine has been started or during a journey.













Instrument Display





Depending on the display setting, the positions of the indicator lamps on the Instrument Display may differ from the example shown.

Indicator and warning lamps:

-  Low beam (→ page 137)
-  Parking lamps (→ page 137)
-  High beam (→ page 138)
-  Turn signal lights (→ page 138)
-  Rear fog light (→ page 137)
-  Restraint system (→ page 594)
-  Seat belt not fastened (→ page 594)
-  USA: brakes (red) (→ page 599)
-  Canada: brakes (red) (→ page 599)
-  Electric parking brake (yellow) (→ page 599)

- 
USA: electric parking brake applied (red) (→ page 599)
- 
Canada: electric parking brake applied (red) (→ page 599)
- 
ABS malfunction (→ page 602)
- 
ESP® (→ page 602)
- 
ESP® OFF (→ page 602)
- 
Distance warning (→ page 601)
- 
Electric power steering malfunction (→ page 595)
- 
AIRMATIC/E-ACTIVE BODY CONTROL malfunction (→ page 601)
- 
Check Engine (→ page 596)
- 
Electrical malfunction (→ page 596)
- 
Fuel reserve with fuel filler cap location indicator (→ page 596)
- 
Coolant too hot or cold (→ page 596)
- 
Tire pressure monitor (→ page 605)

Occupant safety

Warning/indicator lamp	Possible causes/consequences and ► Solutions
 <p data-bbox="144 381 402 433">Restraint system warning lamp</p>	<p data-bbox="452 288 1166 313">The red restraint system warning lamp is lit while the engine is running.</p> <p data-bbox="463 322 999 348">*The restraint system is malfunctioning (→ page 36).</p> <div data-bbox="482 365 1646 536" style="border: 1px solid gray; padding: 5px;"> <p data-bbox="495 373 1221 399">⚠ WARNING Risk of injury due to malfunctions in the restraint system</p> <p data-bbox="495 415 1604 493">If the restraint system is malfunctioning, restraint system components may be triggered unintentionally or may not deploy as intended during an accident. This may affect the Emergency Tensioning Devices or airbags, for example.</p> <p data-bbox="495 503 1483 529">► Have the restraint system checked and repaired immediately at a qualified specialist workshop.</p> </div> <ul data-bbox="476 555 1036 648" style="list-style-type: none"> ► Drive on carefully. ► Note the messages on the multifunction display. ► Consult a qualified specialist workshop immediately.
 <p data-bbox="144 757 376 809">Seat belt warning lamp flashes</p>	<p data-bbox="452 664 1258 689">The red seat belt warning lamp flashes and an intermittent warning tone sounds.</p> <p data-bbox="463 698 1387 724">* The driver or front passenger has not fastened their seat belt while the vehicle is in motion.</p> <ul data-bbox="476 732 1023 825" style="list-style-type: none"> ► Fasten your seat belt(→ page 40). * There are objects on the front passenger seat. ► Remove the objects from the front passenger seat.

Warning/indicator lamp	Possible causes/consequences and ► Solutions
 <p data-bbox="195 342 426 394">Seat belt warning lamp lights up</p>	<p data-bbox="504 249 1382 275">The red seat belt warning lamp will light up for six seconds once the engine has started.</p> <p data-bbox="504 283 892 309">In addition, a warning tone may sound.</p> <p data-bbox="513 318 1452 343">* The seat belt warning lamp reminds the driver and front passenger to fasten their seat belts.</p> <ul style="list-style-type: none"> <li data-bbox="526 352 916 378">► Fasten your seat belt (→ page 40). <p data-bbox="526 394 1504 420">If you have placed objects on the front passenger seat, the seat belt warning lamp may remain lit.</p>



Vehicle

Warning/indicator lamp	Possible causes/consequences and ► Solutions
 <p data-bbox="195 653 449 705">Warning lamp for electric power steering</p>	<p data-bbox="504 560 1282 586">The red electric power steering warning lamp is lit while the engine is running.</p> <p data-bbox="513 594 1199 620">* The power-assisted steering or the steering itself is malfunctioning.</p> <div style="border: 1px solid gray; padding: 5px; margin-top: 10px;"> <p data-bbox="541 646 1190 672">▲ WARNING Risk of accident if steering capability is impaired</p> <p data-bbox="541 687 1446 713">If the steering does not function as intended, the vehicle's operating safety is jeopardized.</p> <ul style="list-style-type: none"> <li data-bbox="547 722 1655 773">► Pull over and stop the vehicle safely as soon as possible, paying attention to road and traffic conditions. Do not continue driving under any circumstances. <li data-bbox="547 782 981 808">► Consult a qualified specialist workshop. </div> <ul style="list-style-type: none"> <li data-bbox="526 833 1045 859">► Note the messages on the multifunction display.

Engine

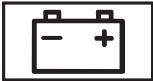
Warning/indicator lamp	Possible causes/consequences and ► Solutions
 <p data-bbox="144 381 365 407">Coolant warning lamp</p>	<p data-bbox="454 288 1079 313">The red coolant warning lamp is lit while the engine is running.</p> <p data-bbox="465 324 643 350">*Possible causes:</p> <ul data-bbox="484 360 938 484" style="list-style-type: none"><li data-bbox="484 360 938 386">• The temperature sensor is malfunctioning<li data-bbox="484 396 724 422">• Coolant level too low<li data-bbox="484 433 938 458">• The air supply to the radiator is obstructed<li data-bbox="484 469 761 495">• The radiator fan is faulty <p data-bbox="476 505 1641 531">If there is an additional warning tone, the coolant temperature has exceeded the maximum permissible temperature.</p> <div data-bbox="484 547 1646 728"><p data-bbox="491 557 1057 583">▲ WARNING Danger of burns when opening the hood</p><p data-bbox="495 598 1574 645">If you open the hood when the engine has overheated or during a fire in the engine compartment, you could come into contact with hot gases or other escaping operating fluids.</p><ul data-bbox="495 655 1482 717" style="list-style-type: none"><li data-bbox="495 655 1094 681">► Before opening the hood, allow the engine to cool down.<li data-bbox="495 692 1482 717">► In the event of a fire in the engine compartment, keep the hood closed and call the fire service.</div> <p data-bbox="476 743 1646 790">► Stop the vehicle immediately in accordance with the traffic conditions and switch off the engine. Do not continue driving under any circumstances.</p> <p data-bbox="476 800 994 826">► Note the messages on the multifunction display.</p> <p data-bbox="476 847 1271 873">If the coolant temperature display is at the lower end of the temperature scale:</p>

Warning/indicator lamp	Possible causes/consequences and ► Solutions
	<ul style="list-style-type: none"> ► Consult a qualified specialist workshop. or ► Exit the vehicle and keep a safe distance from it until the engine has cooled down. ► Check the coolant level (→ page 459). ► Make sure that the air supply to the radiator is not impaired. ► Avoiding high loads on the engine, drive to the nearest qualified specialist workshop. In doing so, ensure that the coolant temperature display remains below the red area.
 <p data-bbox="195 583 454 629">Engine diagnosis warning lamp</p>	<p data-bbox="504 490 1221 513">The yellow Check Engine warning lamp is lit while the engine is running.</p> <p data-bbox="504 524 1341 548">*A malfunction has occurred in the engine, the exhaust system or the fuel system.</p> <p data-bbox="504 558 1402 582">The emission limit values may be exceeded and the engine may be in emergency mode.</p> <p data-bbox="504 592 1665 641">In some states, legal requirements stipulate that you must immediately consult a qualified specialist workshop as soon as the yellow Check Engine warning lamp lights up.</p> <ul style="list-style-type: none"> ► Have the vehicle checked as soon as possible at a qualified specialist workshop.
 <p data-bbox="195 785 476 833">Electrical malfunction warning lamp</p>	<p data-bbox="504 692 999 715">The red electrical malfunction warning lamp is lit.</p> <p data-bbox="504 726 912 750">* There is a malfunction in the electrics.</p> <ul style="list-style-type: none"> ► Observe the messages on the multifunction display.

Warning/indicator lamp	Possible causes/consequences and ► Solutions
 <p data-bbox="144 342 412 365">Fuel reserve warning lamp</p>	<p data-bbox="452 249 1055 272">The yellow fuel reserve warning lamp lights up while driving.</p> <p data-bbox="467 282 1631 334">*There has been pressure loss in the fuel system. The fuel filler cap is not closed correctly or the fuel system is leaking.</p> <ul data-bbox="476 344 753 367" style="list-style-type: none"><li data-bbox="476 344 753 367">► Close the fuel filler cap. <p data-bbox="476 394 1018 417">If the fuel filler cap has already been closed correctly:</p> <ul data-bbox="476 427 879 450" style="list-style-type: none"><li data-bbox="476 427 879 450">► Visit a qualified specialist workshop.
 <p data-bbox="144 563 412 586">Fuel reserve warning lamp</p>	<p data-bbox="452 470 1153 493">The yellow fuel reserve warning lamp is lit while the engine is running.</p> <p data-bbox="462 503 994 526">* The fuel supply has dropped into the reserve range.</p> <ul data-bbox="476 536 587 559" style="list-style-type: none"><li data-bbox="476 536 587 559">► Refuel.

Brakes

Warning/indicator lamp	Possible causes/consequences and ► Solutions
<div data-bbox="203 295 360 372" data-label="Image"> </div> <p data-bbox="194 383 471 461">Red indicator lamp, electric parking brake applied (USA only)</p> <div data-bbox="203 466 360 543" data-label="Image"> </div> <p data-bbox="194 554 471 631">Red indicator lamp, electric parking brake applied (Canada only)</p> <div data-bbox="203 637 360 714" data-label="Image"> </div> <p data-bbox="194 725 471 802">Yellow electric parking brake indicator lamp is malfunctioning</p>	<p data-bbox="508 290 1690 336">The red electric parking brake indicator lamp flashes or is lit. The yellow indicator lamp is also lit if the electric parking brake malfunctions.</p> <ul data-bbox="508 347 1081 378" style="list-style-type: none"> * ► Observe the messages on the multifunction display.

Warning/indicator lamp



Brake warning lamp (USA)



Brakes warning lamp (Canada)

Possible causes/consequences and ► Solutions

The red brake system warning lamp is lit while the engine is running.

*Possible causes:

- The brake force boosting is malfunctioning and the braking characteristics may be affected.
- There is insufficient brake fluid in the brake fluid reservoir.

▲ WARNING Risk of accident and injury if brake force boosting is malfunctioning

If brake force boosting is malfunctioning, increased brake pedal force may be necessary for braking. The braking characteristics may be impaired. The braking distance can increase in emergency braking situations.

- Stop in a safe location immediately. Do not continue driving.
- Consult a qualified specialist workshop.

▲ WARNING Risk of an accident due to low brake fluid level



If the brake fluid level is too low, the braking effect and the braking characteristics may be impaired.

- Pull over and stop the vehicle safely as soon as possible, paying attention to road and traffic conditions. Do not continue driving under any circumstances.
- Consult a qualified specialist workshop.
- Do not add brake fluid.

- Stop the vehicle immediately in accordance with the traffic conditions. Do not continue driving under any circumstances.

Warning/indicator lamp	Possible causes/consequences and ► Solutions
	<ul style="list-style-type: none"> ► Note the messages on the multifunction display. ► Consult a qualified specialist workshop.

Driving systems



Warning/indicator lamp	Possible causes/consequences and ► Solutions
 <p data-bbox="194 543 462 595">Warning lamp for distance warning function</p>	<p data-bbox="508 450 1201 471">The red distance warning lamp lights up while the vehicle is in motion.</p> <p data-bbox="508 481 1228 502">* The distance to the vehicle in front is too small for the speed selected.</p> <p data-bbox="508 512 1432 543">If there is an additional warning tone, you are approaching an obstacle at too high a speed.</p> <ul style="list-style-type: none"> ► Be prepared to brake immediately. ► Increase the distance. <p data-bbox="508 626 988 652">Function of Active Brake Assist (→ page 203).</p>
 <p data-bbox="194 766 462 787">Suspension warning lamp</p>	<p data-bbox="508 673 1182 694">The yellow AIRMATIC/E-ACTIVE BODY CONTROL warning lamp is lit.</p> <p data-bbox="508 704 1238 725">* A malfunction has occurred with AIRMATIC/E-ACTIVE BODY CONTROL.</p> <ul style="list-style-type: none"> ► Note the messages on the multifunction display.

602 Display messages and warning/indicator lamps

Warning/indicator lamp	Possible causes/consequences and ► Solutions
 <p data-bbox="144 339 408 366">Suspension warning lamp</p>	<p data-bbox="452 249 999 272">The red E-ACTIVE BODY CONTROL warning lamp is on.</p> <p data-bbox="465 282 1036 305">*There is a malfunction in the E-ACTIVE BODY CONTROL.</p> <div data-bbox="482 325 1646 439" style="border: 1px solid gray; padding: 5px;"><p data-bbox="495 335 1234 358">! NOTE The vehicle's driving characteristics have changed significantly.</p><ul data-bbox="495 377 1581 428" style="list-style-type: none"><li data-bbox="495 377 1581 428">► Pull over and stop the vehicle safely as soon as possible in accordance with the traffic conditions. Do not continue driving under any circumstances.</div> <ul data-bbox="476 456 1615 573" style="list-style-type: none"><li data-bbox="476 456 994 479">► Note the messages on the multifunction display.<li data-bbox="476 490 1615 541">► Pull over and stop the vehicle safely as soon as possible in accordance with the traffic conditions. Do not continue driving under any circumstances.<li data-bbox="476 552 907 573">► Consult a qualified specialist workshop.

Driving safety systems

Warning/indicator lamp	Possible causes/consequences and ► Solutions
 <p data-bbox="144 811 328 838">ABS warning lamp</p>	<p data-bbox="452 721 1073 743">The yellow ABS warning lamp is lit while the engine is running.</p> <p data-bbox="465 754 704 777">*ABS is malfunctioning.</p> <p data-bbox="476 787 1082 810">If there is an additional warning tone, EBD is malfunctioning.</p> <p data-bbox="476 820 1252 843">Other driving systems and driving safety systems may also be malfunctioning.</p>

Warning/indicator lamp	Possible causes/consequences and ► Solutions
	<p>▲ WARNING There is a risk of skidding if EBD or ABS is malfunctioning</p> <p>If EBD or ABS is malfunctioning, the wheels may lock when braking. The steering capability and braking characteristics are thus severely impaired. The braking distance in an emergency braking situation can increase. In addition, other driving safety systems are switched off.</p> <ul style="list-style-type: none"> ▶ Drive on carefully. ▶ Have the brake system checked immediately at a qualified specialist workshop. <ul style="list-style-type: none"> ▶ Drive on carefully. ▶ Note the messages on the multifunction display. ▶ Visit a qualified specialist workshop.
 <p>ESP® warning lamp flashes</p>	<p>The yellow ESP® warning lamp flashes while the vehicle is in motion.</p> <p>* One or more wheels has reached its grip limit (→ page 198).</p> <ul style="list-style-type: none"> ▶ Adapt your driving style to suit the road and weather conditions.
 <p>ESP® warning lamp lights up</p>	<p>The yellow ESP® warning lamp is lit while the engine is running.</p> <p>*ESP® is malfunctioning.</p> <p>Other driving systems and driving safety systems may also be malfunctioning.</p>

Warning/indicator lamp	Possible causes/consequences and ► Solutions
	<p>▲ WARNING Risk of skidding if ESP® is malfunctioning</p> <p>If ESP® is malfunctioning, ESP® cannot carry out vehicle stabilization. In addition, other driving safety systems are switched off.</p> <ul style="list-style-type: none"> ▶ Drive on carefully. ▶ Have ESP® checked at a qualified specialist workshop. <p>► Drive on carefully.</p> <p>► Note the messages on the multifunction display.</p> <p>► Consult a qualified specialist workshop.</p>
 <p>ESP® OFF warning lamp</p>	<p>The yellow ESP® OFF warning lamp is lit while the engine is running.</p> <p>*ESP® is deactivated.</p> <p>▲ WARNING Risk of skidding when driving with ESP® deactivated</p> <p>If ESP® is deactivated, ESP® cannot carry out vehicle stabilization. The availability of further driving safety systems is also limited.</p> <ul style="list-style-type: none"> ▶ Drive on carefully. ▶ Only deactivate ESP® for as long as the situation requires.

Warning/indicator lamp	Possible causes/consequences and ► Solutions
	<p>If ESP® cannot be activated, ESP® is malfunctioning.</p> <ul style="list-style-type: none"> ► Have ESP® checked immediately at a qualified specialist workshop. <p>► Observe the notes on deactivating ESP® (→ page 198).</p>

Tire pressure monitor

Warning/indicator lamp	Possible causes/consequences and ► Solutions
 <p>Tire pressure monitoring system warning lamp flashes</p>	<p>The yellow tire pressure monitoring system warning lamp (pressure loss/malfunction) flashes for approximately one minute and then remains lit.</p> <p>*The tire pressure monitoring system is defective.</p> <div style="background-color: #f0f0f0; padding: 5px; border: 1px solid #ccc;"> <p>⚠ WARNING There is a risk of an accident if the tire pressure monitoring system is malfunctioning</p> <p>If the tire pressure monitoring system is malfunctioning, it is not able to issue a warning if there is pressure loss in one or more of the tires.</p> <p>Underinflated tires may, for example, impair the driving, steering and braking characteristics.</p> <ul style="list-style-type: none"> ► Have the tire pressure monitoring system checked at a qualified specialist workshop. </div> <p>► Visit a qualified specialist workshop.</p>

Warning/indicator lamp



Tire pressure monitoring system warning lamp lights up

Possible causes/consequences and ► Solutions

The yellow tire pressure monitoring system warning lamp (pressure loss/malfunction) is lit.

*The tire pressure monitoring system has detected tire pressure loss in at least one of the tires.

▲ WARNING Risk of an accident due to insufficient tire pressure

Tire pressures that are too low pose the following hazards:

- The tires may burst, especially as the load and vehicle speed increase.
- The tires may wear excessively and/or unevenly, which may greatly impair tire traction.
- The driving characteristics, as well as steering and braking, may be greatly impaired.

You could then lose control of the vehicle.

- Observe the recommended tire pressure.
- Adjust the tire pressure if necessary.

- Stop the vehicle, paying attention to road and traffic conditions.
- Check the tire pressure and the tires.

1, 2, 3 ...

4MATIC	183
Function	183
12 V battery	
see Battery (vehicle)	
12 V socket	
see Socket (12 V)	
48 V on-board electrical system	
Operating safety	25
115 V socket	
see Socket (115 V)	
360° Camera	256
Care	467
Function	256
Opening the camera cover (rear view camera)	259
Selecting a view	259

A

A/C function

Activating/deactivating (multimedia system)	155
Switching on/off (control panel)	155

ABS (Anti-lock Braking System)	197
---	-----

Acceleration

 see Kickdown

Accident and breakdown management

Mercedes me connect	422
---------------------------	-----

Acoustic locking verification signal

Activating/deactivating	68
-------------------------------	----

Activating/deactivating automatic volume adjustment

Burmester® surround sound system ...	450
--------------------------------------	-----

Active Blind Spot Assist	269
---------------------------------------	-----

Activating/deactivating	272
Brake application	270
Function	269
System limitations	269
Trailer operation	270

Active Brake Assist

Function/notes	203
Setting	209

Active Distance Assist DISTRONIC	213
---	-----

Active Emergency Stop Assist	223
Active Lane Change Assist	222

Calling up a speed	215
Displays in the Instrument Display	225
Function	213
Increasing/decreasing speed	215
Requirements	215
Route-based speed adaptation	218
Steering wheel buttons	215
Storing a speed	215
Switching off/deactivating	215
Switching on/activating	215
System limitations	213

Active Emergency Stop Assist	223
---	-----

Active Lane Change Assist	222
--	-----

Activating/deactivating	223
Function	222

Active Lane Keeping Assist	272
---	-----

Activating/deactivating	274
Activating/deactivating the warning ...	274
Function	272
Setting the sensitivity	274
System limits	272
Trailer operation	272

Active Parking Assist	259
------------------------------------	-----

Cross Traffic Alert	264
---------------------------	-----

- Drive Away Assist 263
 Exiting a parking space 262
 Function 259
 Maneuvering assistance 265
 Parking 261
 System limitations 259
- Active Service System PLUS**
 see ASSYST PLUS
- Active Speed Limit Assist** 217
 Display 217
 Function 217
- Active Steering Assist** 220
 Activating/deactivating 222
 Active Emergency Stop Assist 223
 Active Lane Change Assist 222
 Displays in the Instrument Display 225
 Function 220
 System limitations 220
- Active Traffic Jam Assist**
 Activating/deactivating 225
 Function 224
- Adaptive cruise control**
 see Active Distance Assist DISTRONIC
- Adaptive Highbeam Assist**
 Function 140
 Switching on/off 141
- Additives** 531
 Engine oil 531
 Fuel 531
- Additives (engine oil)**
 see Additives
- Additives (fuel)**
 see Fuel
- Address book**
 see Contacts
- Adjusting the balance/fader**
 Burmester® surround sound system ... 450
- Adjusting the bass, mid-range and treble**
 Burmester® surround sound system ... 450
- Adjusting the mid-range, treble and bass**
 Burmester® surround sound system ... 450
- Adjusting the sound focus**
 Burmester® surround sound system 451
- Adjusting treble, mid-range and bass settings**
 Burmester® surround sound system ... 450
- ADS PLUS damping system**
 see AIRMATIC
- After-sales service center**
 see ASSYST PLUS
- Air bag**
 Reduced protection 44
- Air conditioning menu**
 Calling up 155
- Air conditioning system**
 see Climate control
- Air distribution**
 Setting 153
 Setting (multimedia system) 156
- Air freshener system**
 see Perfume atomizer
- Air inlet**
 see Air-water duct
- Air pressure**
 see Tire pressure

- Air suspension**
see AIRMATIC
- Air vents** 159
Adjusting (front) 159
Adjusting (rear) 160
Glove box 160
- Air vents**
see Air vents
- Air-recirculation mode** 157
- Air-water duct** 461
Keeping free 461
- Airbag** 42
Activation 36
Front airbag (driver, front passenger) 42
Installation locations 42
Knee airbag 42
Overview 42
PASSENGER AIR BAG indicator lamp 47
Protection 43
Side airbag 42
Window curtain airbag 42
- Airflow**
Setting 153
- AIRMATIC** 228
Setting 231
Suspension 228
- Alarm**
see Panic alarm
- Alarm system**
see ATA (anti-theft alarm system)
- All-wheel drive**
see 4MATIC
- Alternative route**
see Route
- Ambient lighting**
Setting (multimedia system) 142
- Android Auto** 417
Connecting a mobile phone 418
Control using the application buttons .. 419
Ending 419
Information 418
Overview 417
Sound settings 419
Transferred vehicle data 419
- Animals**
Pets in the vehicle 66
- Anti-lock braking system**
see ABS (Anti-lock Braking System)
- Anti-skid chains**
see Snow chains
- Anti-theft alarm system**
see ATA (anti-theft alarm system)
- Anti-theft protection**
Immobilizer 93
- Anticipatory occupant protection**
see PRE-SAFE® (anticipatory occupant protection)
see PRE-SAFE® PLUS (anticipatory occupant protection plus)
- Apple CarPlay®** 415
Connecting an iPhone® 416
Control using the application buttons .. 417
Ending 417
Notes 416
Overview 415
Sound settings 417
Transferred vehicle data 419
- Ashtray**
Front center console 130

- Assistance**
 Menu (on-board computer) 286
- Assistance systems**
 see Driving safety system
- ASSYST PLUS** 454
 Battery disconnection periods 455
 Displaying the service due date 454
 Function/notes 454
 Regular maintenance work 454
 Special service requirements 454
- ATA (anti-theft alarm system)** 93
 Activating/deactivating the interior motion sensor 96
 Arming/disarming the tow-away alarm 95
 Deactivating the alarm 94
 Function 93
 Function of the interior motion sensor .. 95
 The tow-away alarm function 94
- ATTENTION ASSIST** 265, 266
 Function 265
 Setting 266
 System limitations 265
- Attention assistant**
 see ATTENTION ASSIST
- Authorized Mercedes-Benz Center**
 see Qualified specialist workshop
- Authorized workshop**
 see Qualified specialist workshop
- Automatic car wash mode**
 Activating 462
- Automatic distance control**
 see Active Distance Assist DISTRONIC
- Automatic driving lights** 138
- Automatic engine start (ECO start/stop function)** 171
- Automatic engine stop (ECO start/stop function)** 171
- Automatic front passenger front air-bag shutoff** 45, 47
 Function of the automatic front passenger front airbag shutoff 45
 PASSENGER AIR BAG indicator lamp 47
- Automatic front passenger front air-bag shutoff**
 see Automatic front passenger front airbag shutoff
- Automatic mirror folding function**
 Activating/deactivating 151
- Automatic seat adjustment**
 Setting 106
- Automatic transmission**
 DIRECT SELECT lever 179
 Drive program display 177
 Drive programs 176
 DYNAMIC SELECT switch 176
 Engaging drive position 181
 Engaging neutral 180
 Engaging park position 180
 Engaging reverse gear 180
 Kickdown 182
 Manual gearshifting 181
 Steering wheel paddle shifters 181
 Transmission position display 179
 Transmission positions 179
- Axle load**
 Towing a trailer 539























- B**
- Bag hook** 123
- Ball neck**
Installing 276
- BAS (Brake Assist System)** 198
- Battery**
Charging (Remote Online) 163
SmartKey 69
- Battery**
see Battery (vehicle)
- Battery (vehicle)** 482
Charging 481
Charging (Remote Online) 163
Notes 477
Notes (starting assistance and charging) 479
Replacing 482
Starting assistance 481
- Belt**
see Seat belt
- Blind Spot Assist** 269
Activating/deactivating 272
Function 269
- System limitations 269
- Blower**
see Climate control
- Bluetooth®** 351
Activating/deactivating 351
Information 350
- Bracket**
MBUX rear tablet 453
- Brake Assist System**
see BAS (Brake Assist System)
- Brake fluid**
Notes 532
- Brake force distribution**
EBD (electronic brake force distribution) 203
- Brakes**
ABS (Anti-lock Braking System) 197
Active Brake Assist 203
BAS (Brake Assist System) 198
Driving tips 166
EBD (electronic brake force distribution) 203
HOLD function 227
- Limited braking effect (salt-treated roads) 166
New/replaced brakepads/brake discs 164
Notes on breaking-in a new vehicle 164
- Braking assistance**
see BAS (Brake Assist System)
- Breakdown**
Changing a wheel 515
Overview of the help functions 18
Roadside Assistance 24
Tow-starting 487
Towing away 483
Transporting the vehicle 485
- Breakdown**
see Flat tire
- Burmester® surround sound system** 450
Adjusting the balance/fader 450
Adjusting the sound focus 451
Adjusting treble, mid-range and bass settings 450
Automatic volume adjustment 450
Calls up the sound menu 450
Information 450





































- Selecting the sound profile 451
- Buttons**
- Steering wheel 280
- C**
- Call list**
- Deleting 411
- Making a call 410
- Overview 410
- Selecting options 410
- Selecting options for suggestions 411
- Calls** 405
- Accepting 405
- Activating functions during a call 406
- Calls with several participants 406
- Declining 405
- Ending a call 405
- Incoming call during an existing call ... 406
- Making 405
- Mercedes me 420
- Calls up the sound menu**
- Burmester® surround sound system ... 450
- Camera**
- see 360° Camera
- see Rear view camera
- Car key**
- see SmartKey
- Car wash**
- see Care
- Car wash (care)** 461
- Car-to-X-Communication**
- Displaying hazard warnings 387
- Overview 386
- Sending hazard warnings 387
- Care** 469
- Air-water duct 461
- Automatic car wash 461
- Carpet 469
- Decorative foil 465
- Display 469
- Exterior lighting 467
- Headliner 469
- Paintwork 464
- Plastic trim 469
- Power washer 463
- Real wood/trim elements 469
- Rear view camera/360° Camera 467
- Running boards 467
- Seat belts 469
- Seat cover 469
- Sensors 467
- Tailpipes 467
- Trailer tow hitch 467
- Washing by hand 463
- Wheels/rims 467
- Windows 467
- Wiper blades 467
- Cargo compartment cover**
- Extending/retracting 121
- Notes 121
- Removing/installing 122
- Cargo compartment floor**
- Locking/unlocking 126
- Opening/closing 126
- Cargo tie-down rings** 123
- Carpet (Care)** 469
- Change of address** 24
- Change of ownership** 24
- Changing a wheel**
- Preparation 515
- Raising the vehicle 516

- Changing a wheel**
 see Emergency spare wheel
- Changing gears** 181
 Manually 181
- Changing hub caps** 515
- Character entry**
 On the touchpad 342
- Charging**
 Battery (vehicle) 481
 Mobile phone (wireless) 134
 USB port 133
- Child safety lock**
 Rear door 64
 Rear side windows 66
 Switching on/off (Rear Seat Entertainment System) 353
- Child seat**
 Attaching (notes) 55
 Basic instructions 51
 Front-passenger seat (notes) 63
 LATCH-type (ISOFIX) (installing) 57
 Notes on risks and dangers 52
 Securing on the front passenger seat 63
 Securing on the rear seat 61
 Top Tether 60
- Children**
 Avoiding dangers in the vehicle 52
 Basic instructions 51
 Special seat belt retractor 57
- Chock** 514
 Storage location 514
- Chock**
 see Chock
- Cigarette lighter**
 Front center console 131
- Cleaning**
 see Care
- Climate control** 153
 Activating/deactivating 154
 Activating/deactivating the A/C function (control panel) 155
 Activating/deactivating the A/C function (multimedia system) 155
 Activating/deactivating the synchronization function (control panel) 156
 Activating/deactivating the synchronization function (multimedia system) 156
- Air distribution settings 155
 Air-recirculation mode 157
 Automatic control 155
 Automatic control (rear passenger compartment) 155
 Calling up the air conditioning menu ... 155
 Control panel for 3-zone automatic climate control 153
 Control panel for dual-zone automatic climate control 153
 Defrosting the windshield 153
 Filling capacity for PAG oil 536
 Front air vents 159
 Glove box air vent 160
 Inserting/removing the flacon (fragrance system) 158
 Ionization 157
 Note 153
 Rear air vents 160
 Rear operating unit 154
 Rear passenger compartment residual heat 157
 Refrigerant 535
 Refrigerant filling capacity 536
 Removing condensation from the windows 157

- Residual heat 157
- Setting (multimedia system) 155
- Setting the air distribution 153
- Setting the airflow 153
- Setting the fragrance system 157
- Setting the temperature 153
- Switching on/off (rear passenger compartment) 155
- Switching the rear window defroster on/off 153
- Ventilating the vehicle (convenience opening) 83
- Windshield heater 159
- Coat hook** 124
- Cockpit** 6
 - Overview 6
- Coffee cup symbol**
 - see ATTENTION ASSIST
- Collapsible spare wheel** 522
 - Inflating 523
 - Notes 522
 - Removing 523
- Combination switch** 138
- Compass** 393
- Computer**
 - see On-board computer
- Connection status**
 - Displaying 428
 - Overview 428
- Contacts** 407
 - Calling up 407
 - Deleting 409
 - Deleting favorites 410
 - Downloading (from mobile phone) 407
 - Importing 408
 - Importing (overview) 408
 - Information 407
 - Making a call 408
 - Name format 408
 - Options 409
 - Saving as a favorite 409
 - Selecting options for suggestions 409
 - Storing 408
- Convenience closing feature** 83
- Convenience opening** 83
- Coolant (engine)**
 - Check level 459
 - Filling capacity 534
- Notes 533
- Cooling**
 - see Climate control
- Copyrights**
 - License 33
 - Trademarks 33
- Cornering light function** 140
- Cover**
 - see Side windows
- Cross Traffic Alert** 264
- Crosswind Assist**
 - Function/notes 202
- Cruise control** 209
 - Buttons 210
 - Calling up a speed 210
 - Function 209
 - Requirements: 210
 - Selecting 210
 - Setting a speed 210
 - Storing a speed 210
 - Switching off 210
 - Switching on 210
 - System limitations 209

- Cup holder** 128
 Rear passenger compartment 116, 129
 Switching the cooling/heating function on/off 129
 Using (cockpit) 128
- Customer Assistance Center (CAC)** 29
- Customer Relations Department** 29
- D**
- Damage detection (parked vehicle)** 194
- Dashboard**
 see Cockpit
- Dashboard lighting**
 see Instrument cluster lighting
- Dashcam**
 Configuring the settings 398
 Deleting a video recording 398
 Notes 396
 Selecting a USB device 397
 Starting/stopping video recording 397
- Data acquisition**
 Vehicle 30
- Data import/export** 354
 Function/notes 354
 Importing/exporting 354
- Data storage**
 Electronic control units 30
 Online services 31
 Vehicle 30
- Date**
 Setting the time and date automatically 349
- Daytime running lamp mode**
 see Daytime running lights
- Daytime running lights** 141
 Switching on/off 141
- Deactivating the alarm (ATA)** 94
- Dealership**
 see Qualified specialist workshop
- Declaration of conformity**
 Wireless vehicle components 27
- Decorative foil (cleaning instructions)**
 465
- Definitions (tires and loading)** 508
- Designs**
 Menu (on-board computer) 282
- Destination** 382
 Editing intermediate destinations 372
 Editing the previous destinations 382
 External 383
 Quick-access to destination information 380
 Saving (current vehicle position) 382
 Saving as global favorite 382
- Destination entry** 360
 Entering 3 word addresses 365
 Entering a POI or address 360
 Entering an intermediate destination ... 372
 Entering geo-coordinates 365
 Notes 360
 Selecting a contact 365
 Selecting a POI 363
 Selecting a received destination 367
 Selecting from favorites 366
 Selecting from the map 366
 Selecting previous destinations 363
- Detecting inattentiveness**
 see ATTENTION ASSIST

- Diagnostics connection** 27
- Digital Operator's Manual** 20
- Digital speedometer** 286
- Dinghy towing**
see Tow-bar system
- DIRECT SELECT lever** 179
Engaging drive position 181
Engaging neutral 180
Engaging park position 180
Engaging park position automatically .. 180
Engaging reverse gear 180
Function 179
- Display (Care)** 469
- Display (multimedia system)** 317
Home screen 315
Operating 317
Setting acoustic operating feedback 318
Settings 348
- Display (on-board computer)**
Displays on the multifunction display .. 284
- Display content**
Displaying 283
- Display message** 541
Calling up (on-board computer) 541
Notes 541
- Display messages**
-  --- mph 576
 -  --- mph 575
 -  2nd Seat Row, Left Not Locked
..... 553
 -  2nd Seat Row, Right Not
Locked 553
 -  12 V Battery See Operator's
Manual 582
 -  48 V Battery See Operator's
Manual 584
 -  Active Headlamps Inoperative 548
 -  ATTENTION ASSIST Inoperative
..... 565
 -  ATTENTION ASSIST: Take a
Break! 565
 -  Automatic Headlamp Mode
Inoperative 548
-  Check Brake Fluid Level 563
-  Check Brake Pads See Opera-
tor's Manual 564
-  Check Coolant Level See Oper-
ator's Manual 554
-  Check Engine Oil Level (Add 1
quart) 590
-  Check Left Low Beam (exam-
ple) 547
-  Check Tires 586
-  Check Washer Fluid 553
-  Compressor Is Cooling 568
-  Coolant Too Hot Stop Vehicle
Turn Engine Off 554
-  Currently Unavailable Camera
View Restricted 574
-  Currently Unavailable Radar
Sensors Dirty 573
-  Currently Unavailable See
Operator's Manual 577

-  Currently Unavailable See Operator's Manual 578
-  Don't Forget Your Key 547
-  Engine Oil Level Cannot Be Measured 592
-  Engine Oil Level Low Stop Vehicle Turn Engine Off 591
-  Engine Oil Pressure Stop Switch Off Engine 591
-  Engine Oil Reduce Oil Level 590
-  Front Left Malfunction Service Required (example) 542
-  Fuel Level Low 555
-  Gas Cap Loose 555
-  Inoperative See Operator's Manual 578
-  Inoperative See Operator's Manual 579
-  Inoperative See Operator's Manual 580
-  Inoperative 582
-  Intell. Light System Inoperative 549
-  Key Not Detected (red display message) 546
-  Key Not Detected (white display message) 546
-  Left Side Curtain Airbag Malfunction Service Required (example) ... 543
-  Lowering 566
-  Malfunction Drive at Max. 50 mph 565, 566
-  Malfunction See Operator's Manual 548
-  Obtain a New Key 545
-  Off 575
-  Off 574
-  Parking Brake See Operator's Manual 559
-  Please Correct Tire Pressure 587
-  Please Release Parking Brake 562
-  Please Wait Charging 48 V Battery... 584
-  Replace Key Battery 546
-  See Operator's Manual 582
-  SRS Malfunction Service Required 542
-  Steering Malfunction Increased Physical Effort See Operator's Manual 551
-  Steering Malfunction Stop Immediately See Operator's Manual 551
-  Stop Vehicle Leave Engine Running 583
-  Stop Vehicle See Operator's Manual 583
-  Suspended 575
-  Switch Off Lights 549
-  Switch On Headlamps 548

 Turn On the Ignition to Release the Parking Brake	563	Active Distance Assist Currently Unavailable See Operator's Manual	575	Active Stop & Go Assist Inoperative See Operator's Manual	570
 Vehicle Ready to Drive Switch the Ignition Off Before Exiting	550	Active Distance Assist Inoperative	575	Adaptive Highbeam Assist Currently Unavailable See Operator's Manual	549
 Vehicle Rising Please Wait	568	Active Distance Assist Now Available ..	576	Adaptive Highbeam Assist Inoperative	549
 Vehicle Rising	566	Active Lane Keeping Assist Currently Unavailable See Operator's Manual	569	Apply Brake to Shift from 'P'	556
 Warning Tire Malfunction	587	Active Lane Keeping Assist Inoperative	570	Apply Brake to Shift to 'R'	556
 Wheel Sensor(s) Missing	586	Active Parking Assist and PARKTRONIC Inoperative See Operator's Manual	572	Auxiliary Battery Malfunction	558
Active Blind Spot Assist Currently Unavailable See Operator's Manual	571	Active Steering Assist Currently Unavailable See Operator's Manual	568	Beginning Emergency Stop	569
Active Blind Spot Assist Inoperative	571	Active Steering Assist Inoperative	568	Blind Spot Assist Currently Unavailable See Operator's Manual	570
Active Blind Spot Asst. Not Available When Towing a Trailer See Operator's Manual	572	Active Steering Asst. Currently Unavailable Due to Multiple Emergency Stops	569	Blind Spot Assist Inoperative	571
Active Brake Assist Functions Currently Limited See Operator's Manual	580	Active Stop & Go Assist Currently Unavailable See Operator's Manual	570	Blind Spot Assist Not Available When Towing a Trailer See Operator's Manual	571
Active Brake Assist Functions Limited See Operator's Manual	581			Cannot Start Engine See Operator's Manual	584
				Check Tire Pressure Soon	588

- Check Tire Pressure Then Restart
 Run Flat Indicator 589
 Cruise Control Inoperative 576
 Cruise Control Off 576
 Decrease Speed 588
 Drive More Slowly 567
 Driver's Door Open & Transmission
 Not in P Risk of Vehicle Rolling Away .. 556
 Engine Can Now Be Started 584
 Front Passenger Airbag Disabled See
 Operator's Manual 543
 Front Passenger Airbag Enabled See
 Operator's Manual 544
 Hazard Warning Flashers Malfunctioning 549
 Mercedes me connect Services Limited See Operator's Manual 581
 N Permanently Active Risk of Rolling
 Away 557
 Only Shift to 'P' when Vehicle is Stationary 556
 Place the Key in the Marked Space
 See Operator's Manual 547
 PRE-SAFE Impulse Side Inoperative
 See Operator's Manual 545
 PRE-SAFE Inoperative See Operator's Manual 545
 Reversing Not Possible Service
 Required 557
 Run Flat Indicator Inoperative 589
 Service Required Do Not Shift Gears
 Visit Dealer 557
 Stop Vehicle Leave Engine Running
 Wait Transmission Cooling 558
 Tire Press. Monitor Currently
 Unavailable 585
 Tire Press. Monitor Inoperative 585
 Tire Pressure Monitor Inoperative No
 Wheel Sensors 586
 Tires Overheated 588
 To Deselect P or N, Depress Brake
 and Start Engine 556
 To switch engine off, press and hold
 Start/Stop button for at least 3 seconds or press 3 times. 555
 Traffic Sign Assist Currently Unavailable See Operator's Manual 572
 Traffic Sign Assist Inoperative 572
 Transmission Malfunction Stop 557
 Update Failed 550
 Update Failed Software Remains
 Unchanged 550
 Update Successfully Completed 550
Display on the windshield
 see Head-up Display
Distance control
 see Active Distance Assist DISTRONIC
Distance recorder
 see Trip distance

DISTRONIC

see Active Distance Assist DISTRONIC

Door

Child safety lock (rear door) 64
 Locking (emergency key) 75
 Opening (from the inside) 72
 Power closing function 75
 Unlocking (emergency key) 75
 Unlocking (from the inside) 72

Door control panel 14

Door control panel (rear passenger compartment) 16

DOT, Tire Identification Number (TIN) ... 504

Downhill driving assistance

see DSR

Drawbar

see Tow-bar system

Drinking and driving 166

Drinks holder

see Cup holder

Drive Away Assist 263

Drive position

Inserting 181

Drive program display 177

Drive programs

see DYNAMIC SELECT

Driver's seat

see Seat

Driving lights

see Automatic driving lights

Driving safety system 196

ABS (Anti-lock Braking System) 197

Active Brake Assist 203

BAS (Brake Assist System) 198

EBD (electronic brake force distribution) 203

ESP® Crosswind Assist 202

ESP® trailer stabilization 202

Off-road ABS 197

Off-road ESP® 201

Overview 196

Radar and ultrasonic sensors 196

Responsibility 196

STEER CONTROL 203

Driving system

see 360° Camera

see Active Blind Spot Assist

see Active Distance Assist DISTRONIC

see Active Emergency Stop Assist

see Active Lane Change Assist

see Active Lane Keeping Assist

see Active Parking Assist

see Active Speed Limit Assist

see Active Steering Assist

see AIRMATIC

see ATTENTION ASSIST

see Blind Spot Assist

see Cruise control

see Driving safety system

see DSR

see E-ACTIVE BODY CONTROL

see HOLD function

see Parking Assist PARKTRONIC

see Rear view camera

see Traffic Sign Assist

Driving tips

Drinking and driving 166

General driving tips 166

Notes on breaking-in a new vehicle 164

- Drowsiness detection**
see ATTENTION ASSIST
- DSR** 211
 Activating/deactivating 213
 Changing the target speed 213
 Function 211
 Notes 212
 Switching on/off 212
- Dynamic handling control system**
see ESP® (Electronic Stability Program)
- DYNAMIC SELECT** 176
 Configuring drive program I 178
 Displaying engine data 178
 Displaying vehicle data 178
 Drive program display 177
 Drive programs 176
 Function 176
 Operating (DYNAMIC SELECT switch)
 177
 Selecting the drive program 177
- E**
- E-ACTIVE BODY CONTROL** 236
 Individual wheel control 242
- Recovery mode 242
 Setting the level 243
 Suspension 236
- E10** 530
- Easy entry feature**
Function/notes 111
- Easy exit feature**
Function/notes 111
- EASY-PACK load-securing kit** 124
 Installing/removing the telescopic
 rod 125
 Notes 124
- EBD (electronic brake force distribu-
tion)**
Function/notes 203
- ECO Assist**
Function/notes 175
- ECO display**
Function 174
 Resetting 287
- ECO start/stop function** 171
 Automatic engine start 171
 Automatic engine stop 171
- Method of operation 171
 Switching off/on 174
- Electric parking brake** 192
 Applying automatically 192
 Applying or releasing manually 194
 Emergency braking 194
 Releasing automatically 193
- Electrohydraulic suspension**
see E-ACTIVE BODY CONTROL
- Electronic Stability Program**
see ESP® (Electronic Stability Program)
- Emergency**
Overview of the help functions 18
- Emergency braking** 194
- Emergency braking**
see BAS (Brake Assist System)
- Emergency call system**
see Mercedes-Benz emergency call system
- Emergency engine start** 487
- Emergency key**
Locking a door 75
 Unlocking a door 75

Emergency operation mode

Starting the vehicle 162

Emergency spare wheel 520

Inflating 521

Notes 520

Removing 521

Emergency Tensioning Devices

Activation 36

Engine

ECO start/stop function 171

Engine number 527

Starting (emergency operation mode) 162

Starting (Remote Online) 164

Starting (start/stop button) 162

Starting assistance 481

Switching off (start/stop button) 186

Engine data

Displaying 178

Engine number 527**Engine oil** 458

Additives 531

Capacity 532

Checking the oil level using the on-

board computer 457

MB-Freigabe or MB-Approval 532

Quality 532

Topping up 458

Entering characters 341

Function/notes 341

On the touchscreen (media display) 345

Setting the keyboard 348

Entering/exiting level

Setting 234

EQ boost

Operating safety 25

ESC (Electronic Stability Control)

see ESP® (Electronic Stability Program)

ESP®

Crosswind Assist 202

Off-road 201

Trailer stabilization 202

ESP® (Electronic Stability Program) 198

Activating/deactivating 202

Function/notes 198

Exterior lighting

see Lights

Exterior lighting (Care) 467**Exterior mirrors** 148, 150

Anti-glare mode (automatic) 150

Automatic mirror folding function 151

Folding in/out 148

Operating the memory function 113

Parking position 150

Setting 148

External device

Locking (child safety lock) 353

F**Fatigue detection**

see ATTENTION ASSIST

Favorites

Adding 335

Adding a destination 366

Calling up 334

Deleting 336

Home address 366

Moving 335

Overview 334

- Renaming 335
 - Work address 366
 - Flacon**
 - Inserting/removing 158
 - Flat tire** 471
 - Changing a wheel 515
 - MOExtended tires 471
 - Notes 471
 - TIREFIT kit 473
 - Flat towing**
 - see Tow-bar system
 - Floor mats** 135
 - Foil covering**
 - Radar and ultrasonic sensors 196
 - Fragrance**
 - see Perfume atomizer
 - Free driving mode**
 - Starting 246
 - Free software** 33
 - Frequencies**
 - Two-way radio 526
 - Frequency band**
 - Dialing (on-board computer) 289
 - Front airbag (driver, front passenger)** 42
 - Front passenger seat** 99
 - Adjusting from the driver's seat 99
 - Front passenger seat**
 - see Seat
 - Fuel** 531
 - Additives 531
 - E10 530
 - Fuel reserve 531
 - Gasoline 530
 - Quality (gasoline) 530
 - Refueling 184
 - Sulfur content 530
 - Tank content 531
 - Fuel consumption**
 - On-board computer 286
 - Fuel consumption indicator**
 - Calling up 178
 - Function seat**
 - see Door control panel
 - Function seat (rear passenger compartment)**
 - see Seat (rear passenger compartment)
 - Fuses** 487
 - Before replacing a fuse 487
 - Dashboard fuse box 489
 - Fuse assignment diagram 487
 - Fuse box in the cargo compartment 489
 - Fuse box in the engine compartment .. 488
 - Fuse box in the front-passenger footwell 489
 - Notes 487
 - Fuses**
 - see Fuses
- G**
- Garage door opener**
 - Clearing the memory 191
 - Opening or closing the door 190
 - Programming buttons 188
 - Radio equipment approval numbers 191
 - Resolving problems 190
 - Synchronizing the rolling code 189
 - Gas station search**
 - Starting automatic search 374
 - Switching automatic search on/off 374
 - Gasoline** 530

- Gearshift recommendation** 182
- Genuine parts** 23
- Glide mode** 183
- Global search**
- Function 339
 - Overview 338
- Glove box**
- Air vent 160
 - Locking/unlocking 115
- H**
- Handbrake**
- see Electric parking brake
- Handling characteristics (unusual)** 490
- HANDS-FREE ACCESS** 79
- Hazard warning lights** 139
- Hazardous substances**
- Information 25
- Head restraint**
- Front (adjusting mechanically) 103
 - Front (luxury head restraint) 104
 - Rear (installing/removing) 105
- Rear passenger compartment (adjusting) 105
- Head-up Display** 291
- Adjusting display elements (on-board computer) 291
 - Adjusting the brightness (on-board computer) 291
 - Function 292
 - Menu (on-board computer) 291
 - Operating the memory function 113
 - Setting the position (on-board computer) 291
 - Switching on/off 293
- Headliner (care)** 469
- Heating**
- see Climate control
- High beam**
- Switching on/off 138
- High-beam flasher** 138
- High-beam headlamps**
- Adaptive Highbeam Assist 140
- Hill start assist** 226
- HOLD function** 227
- Function/notes 227
 - Switching on/off 227
- Home screen (media display)**
- Overview 315
- Hood**
- Opening/closing 455
- Hotspot**
- Setting up (Wi-Fi) 352
- I**
- Identification plate**
- Engine 527
 - Refrigerant 535
 - Vehicle 527
- Ignition**
- Switching on (Start/Stop button) 161
- Ignition key**
- see SmartKey
- Immobilizer** 93
- Indicator lamps**
- see Warning/indicator lamps

- Individual drive program**
 Configuring 178
 Selecting 177
- Inside rearview mirror**
 see Exterior mirrors
- Inspection**
 see ASSYST PLUS
- Instrument cluster**
 see Instrument Display
- Instrument cluster lighting** 285
- Instrument Display** 279
 Adjusting the lighting 285
 Function/notes 279
 Instrument cluster 10
 Warning/indicator lamps 592
- Intelligent Light System**
 Adaptive Highbeam Assist 140
 Cornering light function 140
- Interior lighting** 142
 Ambient lighting 142
 Reading light 142
 Setting 142
 Switch-off delay time 143
- Interior motion sensor**
 Activating/deactivating 96
 Function 95
- Intermediate destination**
 Calculating a route with intermediate destinations 373
 Entering 372
 Modifying 372
 Starting an automatic gas station search 374
 Starting the automatic service station search 375
- Internet**
 Calling up a web page 428
 Closing the browser 431
 Deleting a bookmark 431
 Deleting history 431
 Managing bookmarks 431
- Internet connection**
 Communication module function 427
 Connection status 428
 Displaying the connection status 428
 Establishing 428
 Information 427
 Restrictions 427
- Ionization**
 Activating/deactivating (multimedia system) 157
- iPhone®**
 see Apple CarPlay®
 see Mercedes-Benz Link
- J**
- Jack**
 Storage location 514
- Jump-start connection** 481
 General notes 479
- K**
- KEYLESS-GO**
 Locking the vehicle 72
 Problem 74
 Unlocking setting 68
 Unlocking the vehicle 72
- Kickdown** 182
 Using 182
- Knee airbag** 42

- L**
- Labeling (tires)**
see Tire labeling
- Lamp**
see Interior lighting
- Lamps (Instrument Display)**
see Warning/indicator lamps
- Lane detection (automatic)**
see Active Lane Keeping Assist
- Lane Keeping Assist**
see Active Lane Keeping Assist
- Language** 353
Notes 353
Setting 354
- LATCH-type (ISOFIX) child seat securing system**
Installing 57
- Level control system**
see AIRMATIC
see E-ACTIVE BODY CONTROL
- Light switch**
Overview 137
- Lighting**
see Interior lighting
see Lights
- Lights** 137
Adaptive Highbeam Assist 140
Adjusting the instrument lighting 285
Automatic driving lights 138
Combination switch 138
Cornering light function 140
Hazard warning lights 139
High beam 138
High-beam flasher 138
Light switch 137
Low-beam headlamps 137
Parking lights 137
Rear fog lamp 137
Responsibility for lighting systems 137
Setting the exterior lighting switch-off delay time 141
Standing lights 137
Switching the surround lighting on/off 142
Turn signals 138
- Limited Warranty**
Vehicle 29
- Limiting the opening angle (tailgate)** 81
- Live Traffic Information**
Displaying the traffic map 384
Displaying traffic incidents 385
Provider information 384
Showing local area messages 386
Switching the traffic information display on 386
- Load index (tires)** 506
- Load-bearing capacity (tires)** 506
- Loading** 123
Bag hook 123
Cargo tie-down rings 123
Coat hook 124
Definitions 508
Notes 114
Roof carrier 127
Stowage space underneath the cargo compartment floor 126
- Loading**
see EASY-PACK load-securing kit
- Loading guidelines** 114
- Loading information table** 499

Loads	
Securing	114
Locking/unlocking	
Activating/deactivating the auto- locking feature	74
Emergency key	75
KEYLESS-GO	72
Opening the tailgate	76
Unlocking and opening doors from the inside	72
Low-beam headlamps	
Switching on/off	137
Lowering the vehicle	
Rear of the vehicle	235
Lubricant additives	
see Additives	
Luggage	
Securing	114
Lumbar support	
see Lumbar support (4-way)	
Lumbar support (4-way)	100

M**MAGIC VISION CONTROL**

Windshield wipers	146
-------------------------	-----

Maintenance

Menu (on-board computer)	285
Vehicle	24

Maintenance

 see ASSYST PLUS

Malfunction

Parking Assist PARKTRONIC	249
Restraint system	36

Malfunction message

 see Display message

Map	384, 388
Avoiding an area	391
Avoiding an area (overview)	391
Changing an area	391
Deleting an area	392
Displaying the compass	393
Displaying the map version	391
Displaying the next intersecting street	390
Displaying the range	394

Displaying the satellite map	394
Displaying the traffic map	384
Displaying weather information	394
Map data	393
Moving	388
Selecting POI symbols	389
Selecting text information	390
Selecting the map orientation	389
Setting the map scale	388
Setting the map scale automatically	393
Showing in the multifunction display of the instrument cluster	395
Switching freeway information on/off	390
Updating	392

Message program

Resetting the settings	107
------------------------------	-----

Message programs

Selecting the front seats	107
---------------------------------	-----

Message settings

Resetting	107
-----------------	-----

Maximum load rating 505**Maximum permissible load**

Calculation example	501
---------------------------	-----

- Determining 500
- Maximum tire pressure** 505
- MBUX Interior Assistant (multimedia system)** 321
- Notes 320
- Operating a function with the favorites pose 324
- Operating functions through proximity of the hand 322
- Overview 321
- Selecting settings 326
- Switching the reading light for the driver and front passenger on/off 325
- Switching the search light for the driver on/off 325
- MBUX rear tablet**
- Bracket 453
- Locking (child safety lock) 353
- Notes 451
- Overview 451
- Scope 451
- Tablet 452
- Mechanical key**
- Inserting/removing 69
- Unlocking the tailgate 81
- Media**
- Menu (on-board computer) 289
- Media display**
- Notes 314
- Media mode**
- Adding a favorite song 440
- Connecting Bluetooth® audio equipment 438
- Connecting USB devices 438
- Controlling media playback 439
- Copyright and trademarks 435
- Notes about the search function in categories 440
- Overview of the media menu 437
- Playing back similar music tracks 440
- Removing a favorite song 440
- Starting a search in categories 440
- Starting media playback 439
- Supported format and data storage media 434
- Surprise mix 440
- Using the keyword search 441
- Media playback**
- Operating (on-board computer) 289
- Media source**
- Selecting (on-board computer) 289
- Memory function**
- Head-up Display – Calling up stored settings 113
- Head-up Display – Storing settings 113
- Operating 113
- Outside mirrors – Calling up stored settings 113
- Outside mirrors – Storing settings 113
- Seat – Calling up stored settings 113
- Seat – Storing settings 113
- Menu (on-board computer)**
- Assistance 286
- Designs 282
- Head-up Display 291
- Maintenance 285
- Media 289
- Navigation 287
- Overview 281
- Radio 289
- Telephone 290
- Trip 286

- Mercedes me app**
 Calling up services 423
 Calling up your user account 423
 Deleting the connection to the user account 424
 Information 423
- Mercedes me calls**
 Arranging a service appointment 421
 Calling the Mercedes-Benz Customer Center 420
 Information 420
 Making a call via the overhead control panel 420
 Transferred data 421
- Mercedes me connect**
 Accident and breakdown management 422
 Information 422
 Transferred data 423
- Mercedes-AMG vehicles**
 Notes 161
- Mercedes-Benz emergency call system** 424
 Automatic emergency call 425
 Information 424
 Information on data transfer 426
 Manual emergency call 426
 Overview 424
- Mercedes-Benz Link** 413
 Connecting 414
 Ending 415
 Note 414
 Overview 413
 Sound settings 415
- Message (multifunction display)**
 see Display message
- Message memory** 541
- Messages** 411
 Calling a message sender 413
 Composing 412
 Configuring the displayed text messages 411
 Deleting 413
 Forwarding 413
 Overview 411
 Reading 412
 Replying 412
 Sending 412
- Using a number/URL 413
 Using templates 412
 Voice commands (Voice Control System) 309
- Mirrors**
 see Exterior mirrors
- Mobile phone**
 Damage detection (parked vehicle) 194
 Wireless charging 135
- Mobile phone**
 see Android Auto
 see Apple CarPlay®
 see Mercedes-Benz Link
 see Telephone
- Mobile phone voice recognition**
 Starting 405
 Stopping 405
- Model series**
 see Vehicle identification plate
- MOExtended tires** 471
- Multifunction camera**
 ROAD SURFACE SCAN 241

Multifunction display	
Overview of displays	284
Multifunction steering wheel	
Overview of buttons	280
Multifunction steering wheel	
see Steering wheel	
Multimedia system	
Activating/deactivating DSR	213
Activating/deactivating standby mode	195
Activating/deactivating voice amplification to rear passenger compartment	350
Adjusts the volume	340
Central control elements	316
Configuring display settings	348
Configuring drive program I	178
Favorites	334
Main functions	326
MBUX Interior Assistant (notes)	320
Overview	313
Restoring the factory settings	357
Setting the rear climate control	156
Standby mode function	195
Switching the sound on/off	339

Multimedia system

see Display (multimedia system)
see Entering characters
see MBUX Interior Assistant (multimedia system)
see Notifications Center
see Profile
see Suggestions
see Themes
see Touch Control
see Touchpad

N**Navigation**

Menu (on-board computer)	287
Overview	359
Showing/hiding the menu	358
Switching on	358
Updating the map data	392
Voice commands (Voice Control System)	300

Navigation

see Destination
see Destination entry
see Map

see Parking service
see Route
see Route guidance
see Traffic information

Navigation announcements

Activating/deactivating	380
Adjusting the volume	381
Repeating	381
Switching audio fadeout on/off	381

Navigation messages

On-board computer	287
-------------------------	-----

Near Field Communication (NFC)

Connecting the mobile phone to the multimedia system	404
General information	404
Switching mobile phones	404
Using a mobile phone	404

Neutral

Inserting	180
-----------------	-----

NFC

see Near Field Communication (NFC)

Non-operational time

Activating/deactivating standby mode	195
--	-----

- Standby mode function 195
 - Notes** 165
 - Optimized acceleration 165
 - Notes on breaking-in a new vehicle** 164
 - Notifications Center** 336
 - Calling up a notification 337
 - Editing a notification 337
 - Global search (overview) 338
 - Notification types 336
 - Overview 336
 - Selecting actions for a notification 337
 - Using the global search 339
- O**
- Occupant safety**
 - Pets in the vehicle 66
 - Occupant safety**
 - see Airbag
 - see Automatic front passenger front airbag shutoff
 - see PRE-SAFE® (anticipatory occupant protection)
 - see PRE-SAFE® Impulse Side
 - see PRE-SAFE® PLUS (anticipatory occupant protection plus)
 - see Restraint system
 - see Seat belt
 - Odometer**
 - see Total distance
 - Off-road Assist**
 - Setting 246
 - Off-road driving** 169
 - Off-road driving**
 - see Off-road driving
 - Off-road ESP®**
 - Function/notes 201
 - Off-road ESP® (Electronic Stability Program)**
 - Switching on/off 202
 - Oil**
 - see Engine oil
 - On-board computer** 281
 - Assistance menu 286
 - Displaying the service due date 454
 - Head-up Display menu 291
 - Media menu 289
 - Menu designs 282
 - Menu overview 281
 - Multifunction display 284
 - Navigation system menu 287
 - Operating 281
 - Radio menu 289
 - Service menu 285
 - Telephone menu 290
 - Trip menu 286
 - On-board diagnostics interface**
 - see Diagnostics connection
 - Online services**
 - Data storage 31
 - Open-source software** 33
 - Opening the tailgate using your foot**
 - see HANDS-FREE ACCESS
 - Operating fluids**
 - Additives (fuel) 531
 - Brake fluid 532
 - Coolant (engine) 533
 - Engine oil 531
 - Fuel (gasoline) 530
 - Notes 529
 - Refrigerant (air conditioning system) ... 535

- Windshield washer fluid 534
- Operating safety**
- 48 V on-board electrical system 25
 - Declaration of conformity (wireless vehicle components) 27
 - EQ boost 25
 - Information 25
- Operating system**
- see On-board computer
- Operator's Manual**
- Vehicle equipment 23
- Operator's Manual (digital)** 20
- Optimized acceleration** 165
- Activating 165
- Overhead control panel**
- Overview 12
- P**
- Paint code** 527
- Paintwork (cleaning instructions)** 464
- Panel heating**
- Setting 109
- Panic alarm** 68
- Activating/deactivating 68
- Panoramic roof**
- Adjusting the roller sunblind 92
 - Operating the roller sunblind 91
- Panoramic sliding sunroof**
- see Sliding sunroof
- Park position**
- Inserting 180
 - Selecting automatically 180
- Parking**
- see Electric parking brake
- Parking aid**
- see Parking Assist PARKTRONIC
- Parking Assist PARKTRONIC** 247
- Activating 251
 - Adjusting warning tones 252
 - Function 247
 - Problems 249
 - Side impact protection 250
 - Switching off 251
 - System limitations 247
- Parking assistance systems**
- see Active Parking Assist
- Parking brake**
- see Electric parking brake
- Parking for an extended period** 195
- Parking lights** 137
- Parking options**
- see Parking service
- Parking position**
- Exterior mirrors 150
 - Storing the position of the front-passenger outside mirror using reverse gear 151
- Parking service** 395
- Notes 395
 - Selecting parking options 395
 - Showing a parking option on the map 396
- PARKTRONIC**
- Malfunction 249
- PASSENGER AIR BAG status display**
- see Automatic front passenger front airbag shutoff

- Payload**
Calculation example 501
Determining the maximum 500
- Perfume**
see Perfume atomizer
- Perfume atomizer** 158
Inserting/removing the flacon 158
Setting 157
- Perfume vial**
see Perfume atomizer
- Permitted towing methods** 482
- Pets in the vehicle** 66
- Phone book**
see Contacts
- PIN protection**
Activating/deactivating 355
- Plastic trim (Care)** 469
- POI**
Quick access 380
Selecting 363
- POI symbols**
Selecting 389
- Power closing function**
Door 75
- Power supply**
Switching on (Start/Stop button) 161
- Power washer (care)** 463
- Power windows**
see Side windows
- PRE-SAFE® (anticipatory occupant protection)** 49
Function 49
PRE-SAFE® Sound 49
Reversing measures 50
- PRE-SAFE® Impulse Side** 50
Activation 36
Function 50
- PRE-SAFE® PLUS (anticipatory occupant protection plus)** 50
Function 50
Reversing measures 50
- Preventative occupant protection system**
see PRE-SAFE® (anticipatory occupant protection)
- Previous destinations**
Selecting 363
- Profile** 327
Creating a new profile 328
Maximum number of profiles 327
Notes 327
Overview 327
Selecting a profile 329
Selecting profile options 329
Showing the profile selection when entering 330
Synchronizing 329
- Programs**
see DYNAMIC SELECT
- Protecting the environment**
Notes 22
- Protection against collision**
see Drive Away Assist
- Protection against theft**
see ATA (anti-theft alarm system)
- Pulling away**
see Notes

- Q**
- QR code**
 Rescue card 30
- Qualified specialist workshop** 28
- R**
- Radar and ultrasonic sensors**
 Damage 196
- Radio**
 Activating 441
 Activating/deactivating radio text 444
 Calling up the station list 443
 Deleting stations 444
 Direct frequency entry 443
 Displaying information 444
 Displaying radio text 444
 Editing station presets 444
 Menu (on-board computer) 289
 Moving stations 444
 Overview 442
 Searching for stations 443
 Setting a channel 443
 Setting the waveband 443
 Showing accident reports 444
- Storing radio stations 443
 Switching the HD Radio function on/off 443
 Voice commands (Voice Control System) 305
- Radio stations**
 Dialing (on-board computer) 289
- Rain closing function**
 Sliding sunroof 88
- Raising the vehicle**
 Rear of the vehicle 235
- Range**
 Displaying 286
- Reading light**
 Switching on/off using poses 325
- Reading light**
 see Interior lighting
- Real wood (Care)** 469
- Rear climate control**
 Setting (MBUX) 156
- Rear compartment seat**
 see Third row of seats
- Rear door (child safety lock)** 64
- Rear fog lamp**
 Switching on/off 138
- Rear of the vehicle**
 Lowering 235
 Raising 235
- Rear seat**
 see Seat
 see Third row of seats
- Rear view camera** 252
 Care 467
 Function 252
 Opening the camera cover (360° Camera) 259
- Rear window**
 Changing the wiper blade 147
- Rear window defroster** 153
- Rear window wipers**
 Activating/deactivating 144
- Refrigerant (air conditioning system)**
 Notes 535
- Refueling**
 Refueling the vehicle 184

- Remote Online**
 Charging the battery 163
 Cooling or heating the vehicle interior 163
 Starting the vehicle 164
- Reporting safety defects** 29
- Rescue card** 30
- Reserve**
 Fuel 531
- Reset function (multimedia system)** 357
- Residual heat** 157
 Rear passenger compartment 157
- Restoring (factory settings)**
 see Reset function (multimedia system)
- Restraint system** 35
 Basic instructions for children 51
 Function in an accident 36
 Functionality 36
 Malfunction 36
 Protection 35
 Reduced protection 35
 Self-test 36
 Warning lamp 36
- Reverse gear**
 Inserting 180
- Rims (Care)** 467
- ROAD SURFACE SCAN**
 Multifunction camera 241
- Roadside Assistance (breakdown)** 24
- Roll away protection**
 see HOLD function
- Roller sunblind**
 Panoramic roof 91
 Side windows (electric) 90
- Roof carrier**
 Attaching 127
 Loading 127
- Roof load** 537
- Roof load display**
 Information 177
- Route** 367, 373
 Accepting a detour recommendation after a prompt 370
 Activating a commuter route 374
 Alternative route (quick-access) 380
 Calculating 367
 Displaying destination information 372
 Displaying the route list 373
 Editing a stored route 376
 External 383
 Planning 372
 Recording a route 375
 Saving a recorded route 376
 Selecting a type 369
 Selecting an alternative route 373
 Selecting notifications 371
 Selecting options 370
 Showing a stored route on the map 375
 Starting a saved route 375
 Starting the automatic service station search 375
 Switching the automatic gas station search on/off 374
 With intermediate destinations 373
- Route guidance** 376
 Canceling 381
 Changing direction 377
 Destination reached 380
 Freeway information 379
 From an off-road location 382
 Lane recommendations 378

- Notes 376
 - Off-road 382
 - To an off-road destination 382
 - Route-based speed adaptation**
 - Displays in the Instrument Display 225
 - Function 218
 - Route-based speed adjustment**
 - Setting 219
 - Run-flat characteristics**
 - MOExtended tires 471
 - Running boards (Care)** 467
- S**
- Safety systems**
 - see Driving safety system
 - Satellite map** 394
 - Satellite radio**
 - Activating/deactivating TuneStart 449
 - Adding a channel to Smart Favorites ... 448
 - Deleting a channel 447
 - Displaying EPG information 447
 - Displaying service information 449
 - Information 444
 - Information about Smart Favorites and TuneStart 448
 - Logging in 445
 - Moving a channel 447
 - Music and sport alerts function 447
 - Overview 446
 - Pause and playback function 449
 - Restrictions 444
 - Selecting a category 446
 - Selecting a channel 447
 - Setting music and sport alerts 447
 - Setting the parental control 447
 - Storing a channel 447
 - Switching on 445
 - Search light**
 - Switching on/off using poses 325
 - Seat** 97, 101, 117
 - 4-way lumbar support 100
 - Adjusting (electrically) 97
 - Automatic seat adjustment 106
 - Configuring the settings 106
 - Correct driver's seat position 97
 - Folding the backrest (rear passenger compartment) back 119
 - Folding the backrest (rear passenger compartment) forwards to get in 101
 - Folding the backrest (rear) forwards 117
 - Operating the memory function 113
 - Panel heating 109
 - Rear (seat comfort) 100
 - Rear passenger compartment (adjusting electrically) 100
 - Resetting the settings 107
 - Setting options 14
 - Seat**
 - see Front passenger seat
 - Seat (rear passenger compartment)** 16
 - Setting options 16
 - Seat belt** 37
 - Protection 37
 - Seat belt adjustment**
 - Activating/deactivating 41
 - Function 41
 - Seat belt warning**
 - see Seat belts
 - Seat belts** 41
 - Activating/deactivating seat belt adjustment 41

- Adjusting the height 40
- Care 469
- Fastening 40
- Reduced protection 39
- Releasing 41
- Seat belt adjustment (function) 41
- Warning lamp 41
- Seat cover (Care)** 469
- Seat heating**
 - Activating/deactivating 108
- Seat ventilation**
 - Activating/deactivating 109
- Second telephone**
 - Connecting 402
- Selecting a gear**
 - see Changing gears
- Selecting the sound profile**
 - Burmester® surround sound system 451
- Selector lever**
 - see DIRECT SELECT lever
- Self-test**
 - Automatic front passenger front air-bag shutoff 47
- Sensors (Care)** 467
- Service center**
 - see Qualified specialist workshop
- Service interval display**
 - see ASSYST PLUS
- Service station search**
 - Starting automatic search 375
- Setting a speed**
 - see Cruise control
- Setting the date format** 349
- Setting the distance unit** 354
- Setting the map scale**
 - see Map
- Shift paddles**
 - see Steering wheel paddle shifters
- Shifting gears**
 - Gearshift recommendation 182
- Short messages**
 - see Messages
- Side airbag** 42
- Side impact protection** 250
- Side windows** 81, 90
 - Child safety lock in the rear
 - passenger compartment 66
 - Closing 81
 - Closing using the SmartKey 83
 - Convenience closing feature 83
 - Convenience opening 83
 - Opening 81
 - Opening with the SmartKey 83
 - Problem 84
 - Roller sunblind (electric) 90
- Size designation (tires)** 506
- Sliding sunroof** 85
 - Automatic functions 88
 - Closing 85
 - Closing using the SmartKey 83
 - Opening 85
 - Opening with the SmartKey 83
 - Problem 88
 - Rain closing function 88
- SmartKey** 67
 - Acoustic locking verification signal 68
 - Battery 69
 - Energy consumption 68
 - Features 67

- Key ring attachment 69
- Mechanical key 69
- Overview 67
- Panic alarm 68
- Problem 71
- Unlocking setting 68
- SmartKey functions**
 - Deactivating 68
- Smartphone**
 - see Android Auto
 - see Apple CarPlay®
 - see Mercedes-Benz Link
 - see Telephone
- Snow chains** 491
- Socket (12 V)** 131
 - Cargo compartment 133
 - Front center console 131
- Socket (115 V)** 132
 - Rear passenger compartment 132
- Software update** 355
 - Information 355
 - Performing 356
 - System updates 357
- Sound**
 - PRE-SAFE® Sound 49
 - Wheels and tires 490
- Sound**
 - see Burmester® surround sound system
 - see Sound settings
- Sound settings** 449
 - Adjusting the balance/fader 450
 - Adjusting treble, mid-range and bass settings 449
 - Automatic volume adjustment 449
 - Calls up the sound menu 449
 - Information 449
- Spare wheel**
 - see Collapsible spare wheel
 - see Emergency spare wheel
- Special seat belt retractor** 57
- Specialist workshop** 28
- Speech dialog system**
 - see Voice Control System
- Speed index (tires)** 506
- Speedometer**
 - Digital 286
- Standby mode**
 - Activating/deactivating 195
 - Function 195
- Standing lights** 137
- Start-off assist**
 - see Optimized acceleration
- Start/Stop button**
 - Parking the vehicle 186
 - Starting the vehicle 162
 - Switching on the power supply or ignition 161
- Start/stop function**
 - see ECO start/stop function
- Starting assistance**
 - see Jump-start connection
- Starting the engine**
 - see Vehicle
- Starting-off aid**
 - see Hill start assist
- Station**
 - Deleting 444
 - Direct frequency entry 443
 - Moving 444

- Searching 443
- Setting 443
- Storing 443
- Station list**
- Calling up 443
- Station presets**
- Modifying 444
- STEER CONTROL**
- Function/notes 203
- Steering wheel** 280
- Adjusting (electrically) 111
- Adjusting (manually) 110
- Buttons 280
- Steering wheel heater 111
- Steering wheel heater**
- Switching on/off 111
- Steering wheel paddle shifters** 181
- Stowage areas**
- see Loading
- see Stowage compartment
- Stowage compartment** 115
- Armrest 115
- Center console 115
- Door 115
- Glove box 115
- Rear passenger compartment center
 armrest 116
- Rear seat backrest 116
- Stowage compartments**
- see Loading
- see Stowage compartment
- Stowage space underneath the cargo
compartment floor** 126
- Suggestions** 333
- Calling up 333
- Configuring 333
- Deleting 334
- Overview 333
- Renaming 334
- Sulfur content** 530
- Sun visor**
- Operating 151
- Surround lighting**
- Switching on/off 142
- Surround View**
- see 360° Camera
- Suspension**
- Individual wheel control (E-ACTIVE
 BODY CONTROL) 242
- Rocking free mode (E-ACTIVE BODY
 CONTROL) 242
- Setting the suspension level (AIR-
 MATIC) 231
- Setting the suspension level (E-
 ACTIVE BODY CONTROL) 243
- Suspension**
- see AIRMATIC
- see E-ACTIVE BODY CONTROL
- Suspension level (AIRMATIC)**
- Setting 231
- Suspension level (E-ACTIVE BODY
CONTROL)**
- Setting 243
- Switch-off delay time**
- Exterior 141
- Interior 143
- Synchronization function**
- Activating/deactivating (multimedia
 system) 156
- Switching on/off (control panel) 156

System settings

Activating/deactivating PIN protection	355
Activating/deactivating voice amplification to rear passenger compartment	350
Reset function (multimedia system)	357
Setting the distance unit	354
Setting the time and date automatically	349
Setting the time zone	349
Setting the time/date format	349

System settings

see Bluetooth®	
see Data import/export	
see Language	
see Software update	
see Wi-Fi	

T

Tailgate	76
Closing	77
HANDS-FREE ACCESS	79
Limiting the opening angle	81
Opening	76

Opening dimensions	536
Unlocking (mechanical key)	81

Tailpipes (Care)

467

Tank content

Fuel	531
Reserve (fuel)	531

Technical data

Axle load (trailer operation)	539
Information	525
Notes (trailer hitch)	539
Tongue weight	539
Towing capacity (trailer operation)	539
Vehicle identification plate	527

Telephone

290, 400

Activating functions during a call	406
Calls with several participants	406
Changing a function	403
Connecting a mobile phone (Near Field Communication (NFC))	404
Connecting a mobile phone (Pass-key)	402
Connecting a mobile phone (Secure Simple Pairing)	402
Disconnecting a mobile phone	403

Importing contacts	408
Importing contacts (overview)	408
Incoming call during an existing call	406
Information	401
Interchanging mobile phones	402
Menu (on-board computer)	290
Mobile phone voice recognition	405
Notes	399
Operating modes	401
Reception and transmission volume	405
Replacing mobile phones	403
Setting the ringtone	405
Switching mobile phones (Near Field Communication (NFC))	404
Telephone menu overview	400
Telephone operation	405
Using Near Field Communication (NFC)	404
Voice commands (Voice Control System)	303
Wireless charging (mobile phone)	135

Telephone number

Dialing (on-board computer)	290
-----------------------------------	-----

Telephony operating modes

Bluetooth® Telephony	401
----------------------------	-----

- Temperature** 153
- Temperature grade** 503
- Text messages**
 Voice commands (Voice Control System) 309
- Text messages**
 see Messages
- Themes** 330
 Calling up 331
 Deleting 333
 Fastening 331
 Modifying 332
 Moving 332
 Overview 330
- Third row of seats** 120
 Folding back the backrest on the third row of seats 120
 Folding the backrest on the third row of seats forwards 120
- Third row of seats**
 see Seat
- Through-loading feature**
 see Seat
- see Third row of seats
- Time**
 Manual time setting 349
 Setting the time and date automatically 349
 Setting the time zone 349
 Setting the time/date format 349
- TIN (Tire Identification Number)** 504
- Tire and Loading Information placard** ... 499
- Tire characteristics** 506
- Tire inflation compressor**
 see TIREFIT kit
- Tire information table** 499
- Tire labeling** 503
 Characteristics 506
 DOT, Tire Identification Number (TIN) 504
 Load index 506
 Load-bearing capacity 506
 Maximum tire load 505
 Maximum tire pressure 505
 Overview 503
 Speed rating 506
- Temperature grade 503
 Tire Quality Grading 503
 Tire size designation 506
 Traction grade 503
 Tread wear grade 503
- Tire load (maximum)** 505
- Tire pressure** 493, 494
 Checking (manually) 494
 Checking (tire pressure monitoring system) 496
 Maximum 505
 Notes 492
 Restarting the tire pressure loss warning system 498
 Restarting the tire pressure monitoring system 497
 Tire pressure loss warning system (function) 497
 Tire pressure monitoring system (function) 495
 Tire pressure table 493
 TIREFIT kit 473
- Tire pressure loss warning system**
 Function 497
 Restarting 498

- Tire pressure monitor** 497
 Function 495
 Restarting 497
- Tire pressure monitoring system**
 Checking the tire pressure 496
 Checking the tire temperature 496
- Tire pressure table** 493
- Tire Quality Grading** 503
- Tire temperature**
 Checking (tire pressure monitoring system) 496
 Tire pressure monitoring system (function) 495
- Tire tread** 490
- Tire-change tool kit**
 Overview 514
- TIREFIT kit** 472
 Storage location 472
 Using 473
- Tires**
 Changing hub caps 515
 Characteristics 506
 Checking 490
 Checking the tire pressure (manually) 494
 Checking the tire pressure (tire pressure monitoring system) 496
 Definitions 508
 DOT, Tire Identification Number (TIN) 504
 Flat tire 471
 Installing 518
 Load index 506
 Load-bearing capacity 506
 Maximum tire load 505
 Maximum tire pressure 505
 MOExtended tires 471
 Noise 490
 Notes on installing 511
 Overview of tire labeling 503
 Removing 518
 Replacing 511, 515
 Restarting the tire pressure loss warning system 498
 Restarting the tire pressure monitoring system 497
 Rotating 513
 Selection 511
 Snow chains 491
 Speed rating 506
 Storing 514
 Temperature grade 503
 Tire and Loading Information placard 499
 Tire pressure (notes) 492
 Tire pressure loss warning system (function) 497
 Tire pressure monitoring system (function) 495
 Tire pressure table 493
 Tire Quality Grading 503
 Tire size designation 506
 TIREFIT kit 473
 Traction grade 503
 Tread wear grade 503
 Unusual handling characteristics 490
- Toll system**
 Windshield 152
- Tongue weight** 539
- Tool**
 see Vehicle tool kit
- Top Tether** 60

- Total distance** 286
 - Displaying 286
- Touch Control** 316
 - On-board computer 281
 - Operating 316
 - Setting acoustic operating feedback ... 317
 - Setting the sensitivity 317
- Touchpad** 318
 - Activating/deactivating haptic operating feedback 320
 - Operating 318
 - Reading the handwriting recognition aloud 319
 - Selecting a station and track 320
 - Setting acoustic operating feedback ... 320
 - Setting the sensitivity 319
- Touchscreen (media display)**
 - Entering characters 345
 - Operating 317
 - Setting acoustic operating feedback ... 318
- Tow-away alarm**
 - Activating/deactivating 95
 - Function 94
- Tow-bar system** 278
- Tow-starting** 487
- Towing a trailer**
 - Notes 274
- Towing away** 483
- Towing eye**
 - Installing 487
 - Storage location 486
- Towing methods** 482
- Traction grade** 503
- Traffic information** 384
 - Car-to-X-Communication 386
 - Displaying the traffic map 384
 - Displaying traffic incidents 385
 - Live Traffic Information 384
 - Overview 384
 - Switching on the display 386
- Traffic map**
 - see Map
- Traffic Sign Assist** 267
 - Function/notes 267
 - Setting 268
 - System limitations 267
- Trailer hitch**
 - Attaching the ball neck 276
 - Coupling up/uncoupling a trailer 277
- Trailer operation**
 - Active Blind Spot Assist 270
 - Active Lane Keeping Assist 272
 - Attaching the ball neck 276
 - Coupling up/uncoupling a trailer 277
- Trailer stabilization**
 - Function/notes 202
- Trailer tow hitch**
 - Axle load 539
 - Care 467
 - General notes 539
 - Notes 274
 - Tongue weight 539
 - Towing capacity 539
- Transferred vehicle data**
 - Android Auto 419
 - Apple CarPlay® 419
- Transmission position display** 179
- Transporting**
 - Vehicle 485

- Tread wear grade** 503
- Trim element (Care)** 469
- Trip**
Menu (on-board computer) 286
- Trip computer**
Displaying 286
Resetting 287
- Trip distance** 286
Displaying 286
Resetting 287
- Trip odometer**
see Trip distance
- Trunk lid**
see Tailgate
- Tuneln**
Calling up 431
Calling up the station list (category last selected) 434
Deleting stations 434
Logging out 434
Overview 433
Registering 434
Saving stations 434
- Selecting and connecting to a station 433
Selecting stream 434
Setting options 434
Terms of use 434
- TuneMix**
Creating a list 448
- Turn signal indicator**
see Turn signals
- Turn signals** 138
Switching on/off 138
- Two-way radios**
Frequencies 526
Notes on installation 525
Transmission output (maximum) 526
- U**
- Units of measurement**
Setting 354
- Unlocking setting** 68
- USB port** 133
- User profile**
see Profile
- Using the telephone**
see Calls
- V**
- Vehicle** 162
Activating/deactivating standby mode 195
Correct use 28
Damage detection (parking) 194
Data acquisition 30
Data storage 30
Diagnostics connection 27
Equipment 23
Limited Warranty 29
Locking (automatically) 74
Locking (from the inside) 72
Locking (KEYLESS-GO) 72
Locking/unlocking (emergency key) 75
Lowering 519
Maintenance 24
Parking for an extended period 195
Problem notification 29
QR code rescue card 30
Qualified specialist workshop 28
Raising 516

- Standby mode function 195
- Starting (emergency operation mode) 162
- Starting (Remote Online) 164
- Starting (start/stop button) 162
- Switching off (start/stop button) 186
- Towing 278
- Unlocking (from the inside) 72
- Unlocking (KEYLESS-GO) 72
- Ventilating (convenience opening) 83
- Voice commands (Voice Control System) 310
- Vehicle data**
- Angle of approach/departure 537
- Displaying (DYNAMIC SELECT) 178
- Fording depth 537
- Maximum gradient-climbing capability 537
- Roof load 537
- Transferring to Android Auto 419
- Transferring to Apple CarPlay® 419
- Turning radius 536
- Vehicle height 536
- Vehicle length 536
- Vehicle width 536
- Wheelbase 536
- Vehicle data storage**
- Event data recorders 32
- MBUX multimedia system/ Mercedes me connect 32
- Vehicle dimensions** 536
- Vehicle electronics**
- Notes 525
- Two-way radios 525
- Vehicle identification number**
see VIN
- Vehicle identification plate** 527
- Paint code 527
- VIN 527
- Vehicle interior**
- Cooling or heating (Remote Online) 163
- Vehicle key**
see SmartKey
- Vehicle level**
- Setting individual wheel control 246
- Vehicle maintenance**
see ASSYST PLUS
- Vehicle operation**
- Outside the USA or Canada 24
- Vehicle tool kit** 472
- TIREFIT kit 472
- Towing eye 486
- Ventilating**
- Convenience opening 83
- Ventilation**
see Climate control
- Vents**
see Air vents
- VIN** 527
- Identification plate 527
- Seat 527
- Windshield 527
- Vision**
- Removing condensation from the windows 157
- Windshield heater 159
- Voice amplification to the rear passenger compartment**
- Activating/deactivating 350

Voice Control System	295
Audible help functions	297
Improving speech quality	298
Language setting	296
Media player voice commands	306
Message voice commands	309
Multifunction steering wheel (operating)	295
Navigation voice commands	300
Notes on the voice commands	298
Online voice control	298
Operable functions	296
Operating safety	294
Radio voice commands	305
Setting (multimedia system)	296
Switch voice commands	298
Telephone voice controls	303
Text message voice commands	309
Vehicle voice commands	310
Voice prompting	295

Voice control system
see Voice Control System

W











Warning lamps











see Warning/indicator lamps

Warning system

see ATA (anti-theft alarm system)

Warning/indicator lamp

 ABS warning lamp	602
 Brake warning lamp (USA)	600
 Brakes warning lamp (Canada) ...	600
 Coolant warning lamp	596
 Electrical malfunction warning lamp	597
 Engine diagnosis warning lamp ..	597
 ESP® OFF warning lamp	604
 ESP® warning lamp flashes	603
 ESP® warning lamp lights up	603
 Fuel reserve warning lamp	598
 Red indicator lamp, electric parking brake applied (Canada only) ...	599

 Red indicator lamp, electric parking brake applied (USA only)	599
 Restraint system warning lamp ..	594
 Seat belt warning lamp flashes ..	594
 Seat belt warning lamp lights up	595
 Suspension warning lamp ..	601, 602
 Tire pressure monitoring system warning lamp flashes	605
 Tire pressure monitoring system warning lamp lights up	606
 Warning lamp for distance warning function	601
 Warning lamp for electric power steering	595
 Yellow electric parking brake indicator lamp is malfunctioning	599
Warning/indicator lamps	592
Overview	592
PASSENGER AIR BAG	47

- Warranty** 29
- Washer fluid**
 - see Windshield washer fluid
- Washing by hand (care)** 463
- Water tank**
 - see Air-water duct
- Weather information** 394
- Web browser**
 - Calling up a web page 428
 - Calling up options 430
 - Calling up the settings 431
 - Deleting a bookmark 431
 - Deleting Internet history 431
 - Ending 431
 - Managing bookmarks 431
 - Overview 430
- Website**
 - Calling up 428
- Wheel change**
 - Lowering the vehicle 519
 - Mounting a new wheel 518
 - Removing a wheel 518
 - Removing/installing hub caps 515
- Wheel rotation** 513
- Wheels**
 - Care 467
 - Changing hub caps 515
 - Checking 490
 - Checking the tire pressure (manually) 494
 - Checking the tire pressure (tire pressure monitoring system) 496
 - Definitions 508
 - DOT, Tire Identification Number (TIN) 504
 - Flat tire 471
 - Installing 518
 - Load index 506
 - Load-bearing capacity 506
 - Maximum tire load 505
 - Maximum tire pressure 505
 - MOExtended tires 471
 - Noise 490
 - Notes on installing 511
 - Overview of tire labeling 503
 - Removing 518
 - Replacing 511, 515
- Restarting the tire pressure loss warning system 498
- Restarting the tire pressure monitoring system 497
- Rotating 513
- Selection 511
- Snow chains 491
- Speed rating 506
- Storing 514
- Temperature grade 503
- Tire and Loading Information placard 499
- Tire characteristics 506
- Tire pressure (notes) 492
- Tire pressure loss warning system (function) 497
- Tire pressure monitoring system (function) 495
- Tire pressure table 493
- Tire Quality Grading 503
- Tire size designation 506
- TIREFIT kit 473
- Traction grade 503
- Tread wear grade 503
- Unusual handling characteristics 490

- Wi-Fi** 351
 - Overview 351
 - Setting 351
 - Setting up a hotspot 352
- Window curtain airbag** 42
- Windows**
 - see Side windows
- Windows (Care)** 467
- Windshield** 145, 146, 153
 - Defrosting 153
 - Infrared reflective 152
 - Radio waves 152
 - Replacing the wiper blades 145
 - Replacing wiper blades (MAGIC VISION CONTROL) 146
- Windshield**
 - see Windshield
- Windshield heater** 159
- Windshield heating**
 - see Windshield heater
- Windshield washer fluid** 534
 - Notes 534
- Windshield washer system**
 - Topping up 460
- Windshield wipers**
 - Activating/deactivating 144
 - Replacing the wiper blades 145
 - Replacing wiper blades (MAGIC VISION CONTROL) 146
- Winter operation**
 - Snow chains 491
- Wiper blades**
 - Care 467
 - Replacing 145
 - Replacing (MAGIC VISION CONTROL) 146
- Wireless charging**
 - Function/notes 134
 - Mobile phone 135
- Wireless vehicle components**
 - Declaration of conformity 27
- Workshop**
 - see Qualified specialist workshop