

Pictorial index	Search by illustration	
1 For safety and security	Make sure to read through them	
2 Instrument cluster	How to read the gauges and meters, the variety of warning lights and indicators, etc.	
3 Operation of each component	Opening and closing the doors and windows, adjustment before driving, etc.	
4 Driving	Operations and advice which are necessary for driving	
5 Interior features	Usage of the interior features, etc.	
6 Maintenance and care	Caring for your vehicle and maintenance procedures	
7 When trouble arises	What to do in case of malfunction or emergency	
8 Vehicle specifications	Vehicle specifications, customizable features, etc.	
9 For owners	Reporting safety defects for U.S. owners, and seat belt and SRS airbag instructions for Canadian owners	
Index	Search by symptom	
	Search alphabetically	

For your information..... 8
 Reading this manual..... 14
 How to search..... 15
 Pictorial index 16

1 For safety and security

1-1. For safe use
 Before driving 26
 For safe driving 28
 Seat belts 30
 SRS airbags 36
 Front passenger occupant
 classification system 49
 Exhaust gas precautions..... 54

1-2. Child safety
 Riding with children 55
 Child restraint systems..... 56

1-3. Emergency assistance
 Safety Connect..... 75

1-4. Theft deterrent system
 Engine immobilizer
 system..... 80
 Alarm..... 82

2 Instrument cluster

2. Instrument cluster
 Warning lights and
 indicators 88
 Gauges and meters 94
 Multi-information display
 (4.2-inch display) 98
 Multi-information display
 (7-inch display) 111
 Head-up display..... 128
 Fuel consumption
 information..... 134

3 Operation of each component

3-1. Key information	
Keys	140
3-2. Opening, closing and locking the doors	
Doors.....	147
Trunk	156
Smart key system.....	161
3-3. Adjusting the seats	
Front seats	167
Rear seats	169
Head restraints.....	171
3-4. Adjusting the steering wheel and mirrors	
Steering wheel	173
Inside rear view mirror.....	175
Outside rear view mirrors.....	177
3-5. Opening and closing the windows	
Power windows	179
Moon roof	183
Panoramic moon roof.....	187

4 Driving

4-1. Before driving	
Driving the vehicle	194
Cargo and luggage	203
Vehicle load limits.....	206
Trailer towing	207
Dinghy towing	208
4-2. Driving procedures	
Engine (ignition) switch (vehicles without a smart key system)	209
Engine (ignition) switch (vehicles with a smart key system)	211
Automatic transmission	217
Turn signal lever	223
Parking brake	224
Electric parking brake	225
Brake Hold.....	229
4-3. Operating the lights and wipers	
Headlight switch	231
AHB (Automatic High Beam).....	236
Windshield wipers and washer.....	240
4-4. Refueling	
Opening the fuel tank cap.....	244

4-5. Using the driving support systems

Toyota Safety Sense 2.5+	248
PCS (Pre-Collision System)	254
LTA (Lane Tracing Assist)	270
RSA (Road Sign Assist)	285
Dynamic radar cruise control with full-speed range	290
Dynamic radar cruise control	306
Driving assist systems	322
BSM (Blind Spot Monitor)	330
Intuitive parking assist	336
RCTA (Rear Cross Traffic Alert)	345
RCD (Rear Camera Detection)	354
PKSB (Parking Support Brake)	360
Parking Support Brake function (static objects)	368
Parking Support Brake function (rear-crossing vehicles)	372
Driving mode select switches	375

4-6. Driving tips

Winter driving tips	377
---------------------------	-----

5 Interior features

5-1. Using the air conditioning system and defogger

Manual air conditioning system	382
Automatic air conditioning system (without "SYNC" button)	387
Automatic air conditioning system (with "SYNC" button)	394
Heated steering wheel/ seat heaters/ seat ventilators	402

5-2. Using the interior lights

Interior lights list	405
• Interior lights	406
• Personal lights	407

5-3. Using the storage features

List of storage features	409
• Glove box	410
• Console box	410
• Coin holder	410
• Bottle holders	411
• Cup holders	412
• Auxiliary boxes	413
• Open tray	414
Trunk features	415

5-4. Other interior features

Other interior features 416

- Sun visors 416
- Vanity mirrors 416
- Power outlet 417
- USB charging ports 418
- Wireless charger 420
- Armrest 430
- Assist grips 430
- Coat hooks 431

Garage door opener 432

6 Maintenance and care

6-1. Maintenance and care

Cleaning and protecting the vehicle exterior 440

Cleaning and protecting the vehicle interior 444

6-2. Maintenance

Maintenance requirements 447

General maintenance 450

Emission inspection and maintenance (I/M) programs 454

6-3. Do-it-yourself maintenance

Do-it-yourself service precautions 455

Hood 457

Positioning a floor jack 459

Engine compartment 460

Tires 473

Tire inflation pressure 487

Wheels 490

Air conditioning filter 492

Wireless remote control/ electronic key battery 494

Checking and replacing fuses 499

Light bulbs 502



7 When trouble arises

7-1. Essential information
 Emergency flashers 516
 If your vehicle has
 to be stopped in
 an emergency 517
 If the vehicle is submerged
 or water on the road is
 rising 519

**7-2. Steps to take in
 an emergency**
 If your vehicle needs
 to be towed 520
 If you think something
 is wrong..... 526
 Fuel pump shut off
 system..... 527
 If a warning light turns
 on or a warning
 buzzer sounds..... 528
 If a warning message
 is displayed 538
 If you have a flat tire..... 543
 If the engine will not
 start 557
 If the electronic key does
 not operate properly 559
 If the vehicle battery
 is discharged..... 562
 If your vehicle
 overheats 567
 If the vehicle becomes
 stuck..... 570

8 Vehicle specifications

8-1. Specifications
 Maintenance data
 (fuel, oil level, etc.) 574
 Fuel information..... 590
 Tire information..... 593

8-2. Customization
 Customizable features..... 606

8-3. Items to initialize
 Items to initialize 614

9 For owners

Reporting safety defects
 for U.S. owners 616
 Reporting safety defects
 for Canadian owners..... 617
 Seat belt instructions
 for Canadian owners
 (in French)..... 618
 SRS airbag instructions
 for Canadian owners
 (in French)..... 619

Index

What to do if...
(Troubleshooting) 630
Alphabetical index..... 634

1

2

3

4

5

6

7

8

9

For information regarding the equipment listed below, refer to “NAVIGATION AND MULTIMEDIA SYSTEM OWNER’S MANUAL”.

- Navigation system
- Audio system
- Rear view monitor system
- Toyota parking assist monitor
- Panoramic view monitor
- Connected Services

For your information

Main Owner's Manual

Please note that this manual applies to all models and explains all equipment, including options. Therefore, you may find explanations for equipment not installed on your vehicle and the illustrations used may differ from your vehicle.

All specifications provided in this manual are current at the time of printing. Over time, your vehicle may receive updates that modify the vehicle and make material in this manual incomplete and/or inaccurate. Because of Toyota's interest in continual product improvement, Toyota reserves the right to make changes to this manual at any time without notice.

If Toyota chooses to update the manual, updated versions can be viewed by selecting your vehicle by model and year at the following URL or on your mobile device if you have access to the Toyota app.

www.toyota.com/owners

Noise from under vehicle after turning off the engine

Approximately five hours after the engine is turned off, you may hear sound coming from under the vehicle for several minutes. This is the sound of a fuel evaporation leakage check and, it does not indicate a malfunction.

Accessories, spare parts and modification of your Toyota

A wide variety of non-genuine spare parts and accessories for Toyota vehicles are currently available in the market. You should know that Toyota does not warrant these products and is not responsible for their performance, repair, or replacement, or for any damage they may cause to, or adverse effect they may have on, your Toyota vehicle.

This vehicle should not be modified with non-genuine Toyota products. Modification with non-genuine Toyota products could affect its performance, safety or durability, and may even violate governmental regulations. In addition, damage or performance problems resulting from the modification may not be covered under warranty.

Also, remodeling like this will have an effect on advanced safety equipment such as Toyota Safety Sense 2.5+ and there is a danger that it will not work properly or the danger that it may work in situations where it should not be working.

Cyber Attack Risk

Installing electronic devices and radios increases the risk of cyber attacks through the installed parts, which may lead to unexpected accidents and leakage of personal information. Toyota does not make any guarantees for problems caused by installing non-genuine Toyota products.

Installation of a mobile two-way radio system

The installation of a mobile two-way radio system in your vehicle could affect electronic systems such as:

- Multiport fuel injection system/sequential multiport fuel injection system
- Toyota Safety Sense 2.5+
- Anti-lock brake system
- SRS airbag system
- Seat belt pretensioner system

Be sure to check with your Toyota dealer for precautionary measures or special instructions regarding installation of a mobile two-way radio system.

Vehicle data recording

The vehicle is equipped with sophisticated computers that will record certain data, such as:

- Engine speed/Electric motor speed (traction motor speed)
- Accelerator status
- Brake status
- Vehicle speed
- Operation status of the driving assist systems
- Images from the cameras

Your vehicle is equipped with cameras. Contact your Toyota dealer for the location of recording cameras.

The recorded data varies according to the vehicle grade level and options with which it is equipped.

These computers do not record conversations or sounds, and only record images outside of the vehicle in certain situations.

- **Data Transmission**

Your vehicle may transmit the data recorded in these computers to Toyota without notification to you.

- Data usage

Toyota may use the data recorded in this computer to diagnose malfunctions, conduct research and development, and improve quality.

Toyota will not disclose the recorded data to a third party except:

- With the consent of the vehicle owner or with the consent of the lessee if the vehicle is leased
- In response to an official request by the police, a court of law or a government agency
- For use by Toyota in a lawsuit
- For research purposes where the data is not tied to a specific vehicle or vehicle owner

- Recorded image information can be erased by your Toyota dealer.

The image recording function can be disabled. However, if the function is disabled, data from when the system operates will not be available.

- To learn more about the vehicle data collected, used and shared by Toyota, please visit www.toyota.com/privacyvts/.

Usage of data collected through Safety Connect (U.S. mainland only)

If your Toyota has Safety Connect and if you have subscribed to those services, please refer to the Safety Connect Telematics Subscription Service Agreement for information on data collected and its usage.

- To learn more about the vehicle data collected, used and shared by Toyota, please visit www.toyota.com/privacyvts/.

Statement on Warranty Coverage for Aftermarket and Recycled Parts (For U.S. Owners)

The Magnuson-Moss Warranty Act, 15 U.S.C. s.2301 et seq., makes it illegal for motor vehicle manufacturers to void a motor vehicle warranty or deny warranty coverage solely because an aftermarket or recycled part has been used to repair the vehicle or someone other than the authorized service provider performed service on the vehicle. This provision does not apply to a new motor vehicle purchased solely for commercial or industrial use.

Under federal law, a manufacturer may deny warranty coverage and charge for repairs to a vehicle if it is discovered that an aftermarket or recycled part installed on the vehicle is defective or was installed incorrectly and caused damage to another part of the vehicle otherwise covered under warranty. The Federal Trade Commission requires that a manufacturer demonstrate that an aftermarket or recycled part or service performed by a person other than an authorized service provider caused damage to another part of the vehicle otherwise covered under warranty before denying warranty coverage. Additionally, federal law allows a manufacturer to void a motor vehicle warranty or deny warranty coverage if the manufacturer provides the article or service to consumers free of charge under the warranty or the manufacturer has secured a waiver from the Federal Trade Commission.

Event data recorder

This vehicle is equipped with an event data recorder (EDR). The main purpose of an EDR is to record, in certain crash or near crash-like situations, such as an air bag deployment or hitting a road obstacle, data that will assist in understanding how a vehicle's systems performed. The EDR is designed to record data related to vehicle dynamics and safety systems for a short period of time, typically 30 seconds or less.

The EDR in this vehicle is designed to record such data as:

- How various systems in your vehicle were operating;
- Whether or not the driver and passenger safety belts were buckled/fastened;
- How far (if at all) the driver was depressing the accelerator and/or brake pedal; and,
- How fast the vehicle was traveling.

These data can help provide a better understanding of the circumstances in which crashes and injuries occur.

NOTE: EDR data are recorded by your vehicle only if a non-trivial crash situation occurs; no data are recorded by the EDR under normal driving conditions and no personal data (e.g., name, gender, age, and crash location) are recorded. However, other parties, such as law enforcement, could combine the EDR data with the type of personally identifying data routinely acquired during a crash investigation.

To read data recorded by an EDR, special equipment is required, and access to the vehicle or the EDR is needed. In addition to the vehicle manufacturer, other parties, such as law enforcement, that have the special equipment, can read the information if they have access to the vehicle or the EDR.

● Disclosure of the EDR data

Toyota will not disclose the data recorded in an EDR to a third party except when:

- An agreement from the vehicle's owner (or the lessee for a leased vehicle) is obtained
- In response to an official request by the police, a court of law or a government agency
- For use by Toyota in a lawsuit

However, if necessary, Toyota may:

- Use the data for research on vehicle safety performance
- Disclose the data to a third party for research purposes without disclosing information about the specific vehicle or vehicle owner

Scrapping of your Toyota

The SRS airbag and seat belt pretensioner devices in your Toyota contain explosive chemicals. If the vehicle is scrapped with the airbags and seat belt pretensioners left as they are, this may cause an accident such as fire. Be sure to have the systems of the SRS airbag and seat belt pretensioner removed and disposed of by a qualified service shop or by your Toyota dealer before you scrap your vehicle.

Perchlorate Material

Special handling may apply, See www.dtsc.ca.gov/hazardouswaste/perchlorate. Your vehicle has components that may contain perchlorate. These components may include the airbags, seat belt pretensioners, wireless remote control batteries, and the batteries in the tire pressure warning valve and transmitters.

“QR code”

The word “QR Code” is registered trademark of DENSO WAVE INCORPORATED in Japan and other countries.

WARNING

■ General precautions while driving

Driving under the influence: Never drive your vehicle when under the influence of alcohol or drugs that have impaired your ability to operate your vehicle. Alcohol and certain drugs delay reaction time, impair judgment and reduce coordination, which could lead to an accident that could result in death or serious injury.

Defensive driving: Always drive defensively. Anticipate mistakes that other drivers or pedestrians might make and be ready to avoid accidents.

Driver distraction: Always give your full attention to driving. Anything that distracts the driver, such as adjusting controls, talking on a cellular phone or reading can result in a collision with resulting death or serious injury to you, your occupants or others.

■ General precaution regarding children's safety

Never leave children unattended in the vehicle, and never allow children to have or use the key.

Children may be able to start the vehicle or shift the vehicle into neutral. There is also a danger that children may injure themselves by playing with the windows, the moon roof or panoramic moon roof, or other features of the vehicle. In addition, heat build-up or extremely cold temperatures inside the vehicle can be fatal to children.

Reading this manual



WARNING:

Explains something that, if not obeyed, could cause death or serious injury to people.



NOTICE:

Explains something that, if not obeyed, could cause damage to or a malfunction in the vehicle or its equipment.



Indicates operating or working procedures. Follow the steps in numerical order.



Indicates the action (pushing, turning, etc.) used to operate switches and other devices.



Indicates the outcome of an operation (e.g. a lid opens).

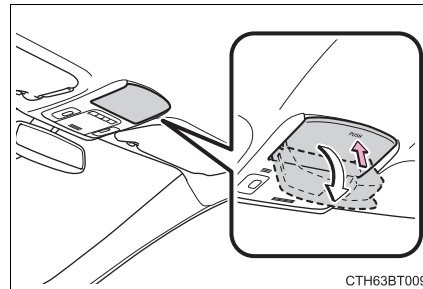

Indicates the component or position being explained.



Means “Do not”, “Do not do this”, or “Do not let this happen”.

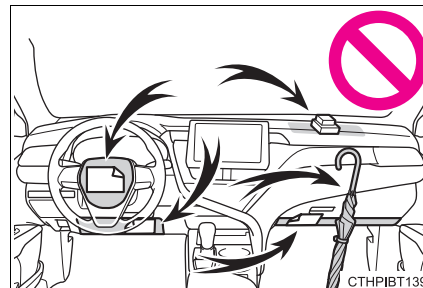

How to search

■ Searching by name

- Alphabetical indexP. 634

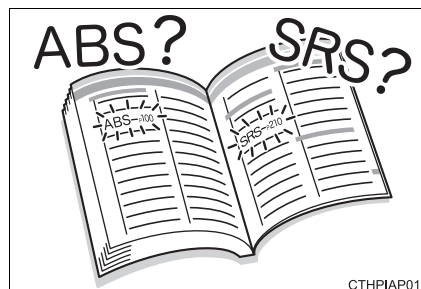

CTHPIAP015

■ Searching by installation position

- Pictorial indexP. 16

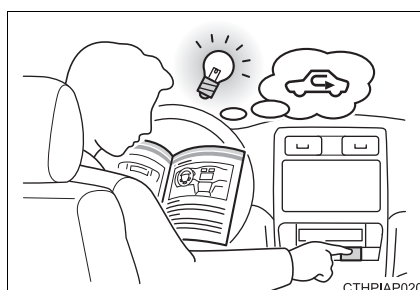

CTHPIAP020

■ Searching by symptom or sound

- What to do if...
(Troubleshooting)P. 630



CTHPIAP017

■ Searching by title

- Table of contentsP. 2

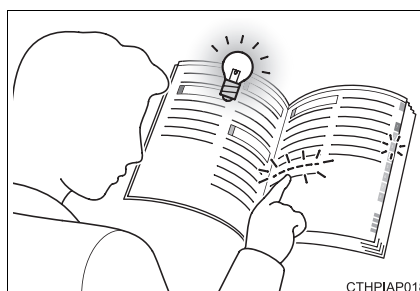

CTHPIAP018

Pictorial index

■ Exterior

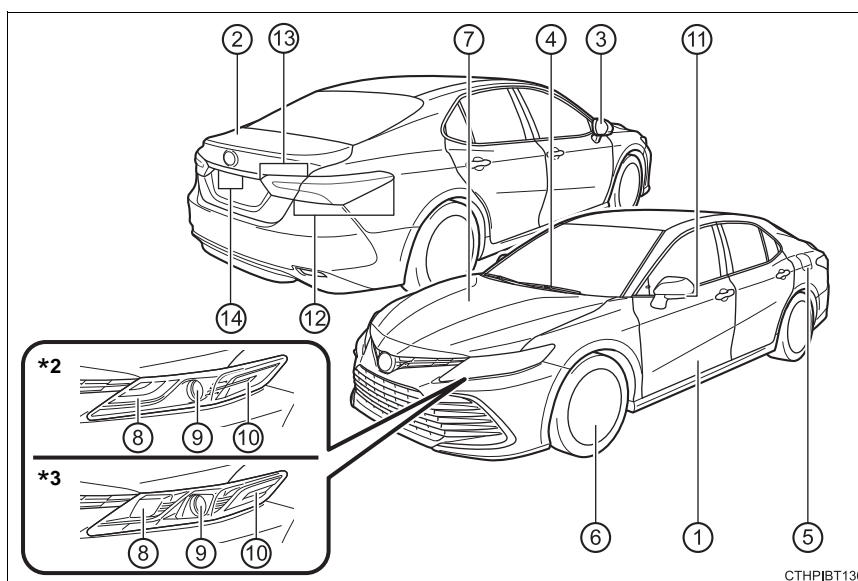

①	Doors	P. 147
	Locking/unlocking	P. 147
	Opening/closing the door windows	P. 179
	Locking/unlocking by using the mechanical key*1	P. 559
②	Trunk	P. 156
	Opening from inside	P. 156
	Opening from outside	P. 156
③	Outside rear view mirrors	P. 177
	Adjusting the mirror angle	P. 177
	Folding the mirrors	P. 177
	Defogging the mirrors*1	P. 383, 389, 397

- ④ **Windshield wipers** **P. 240**
 Precautions for winter season P. 377
- ⑤ **Fuel filler door** **P. 244**
 Refueling method P. 244
 Fuel type/fuel tank capacity P. 577, 590
- ⑥ **Tires** **P. 473**
 Tire size/inflation pressure P. 584
 Winter tires/tire chains P. 377
 Checking/rotation/tire pressure warning system P. 473
 Coping with flat tires P. 543
- ⑦ **Hood** **P. 457**
 Opening P. 457
 Engine oil P. 578
 Coping with overheat P. 567

Light bulbs of the exterior lights for driving

(Replacing method: P. 502, Watts: P. 589)

- ⑧ **Front turn signal lights/
 parking lights/daytime running lights^{*2}** **P. 231**
- ⑨ **Headlights/daytime running lights^{*3}** **P. 231**
- ⑩ **Front side marker lights** **P. 231**
- ⑪ **Side turn signal lights^{*1}** **P. 231**
- ⑫ **Rear turn signal lights/rear side marker lights/
 tail lights/stoplights** **P. 223, 231**
- ⑬ **Tail lights^{*1}** **P. 231**
 Back-up lights
 Shifting the shift lever to R P. 217
- ⑭ **License plate lights** **P. 231**

^{*1}: If equipped

^{*2}: Vehicles with LED type front side marker lights

^{*3}: Vehicles with bulb type front side marker lights

■ Instrument panel

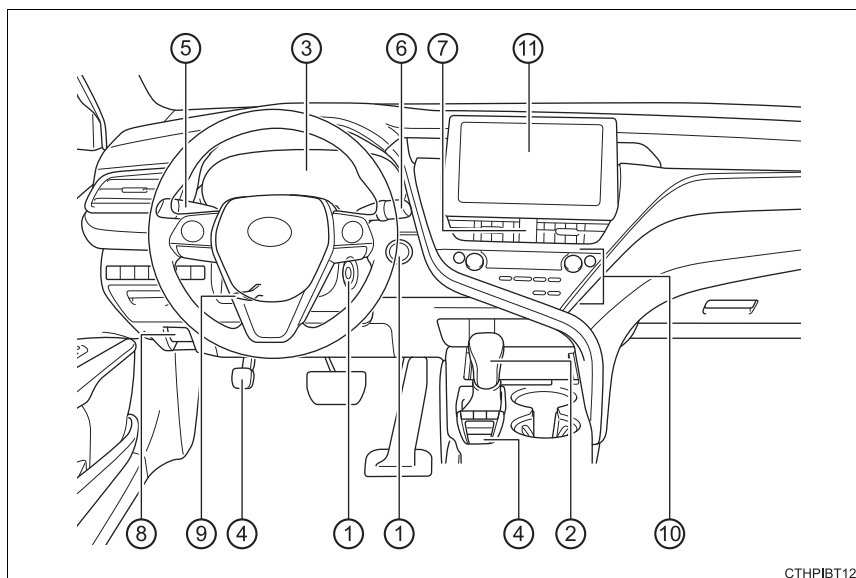

CTHPIBT129

- ① **Engine switch** **P. 209, 211**
 Starting the engine/changing the positions or modes . . . P. 209, 211
 Emergency stop of the engine P. 517
 When the engine will not start P. 557
- ② **Shift lever** **P. 217**
 Changing the shift position P. 217
 Precautions for towing P. 520
 When the shift lever does not move P. 221
- ③ **Meters** **P. 94**
 Reading the meters/adjusting the instrument panel lights P. 94
 Warning lights/indicator lights P. 88
 When a warning light comes on P. 528
Multi-information display **P. 98, 111**
 Display P. 98, 111
 When the warning messages are displayed P. 538

- ④ **Parking brake** **P. 224, 225**
 - Applying/releasing P. 224, 225, 226
 - Precautions for winter season P. 378
 - Warning light/warning buzzer/
warning message P. 224, 228, 528
- ⑤ **Turn signal lever** **P. 223**
 - Headlight switch** **P. 231**
 - Headlights/side marker lights/parking lights/tail lights/
license plate lights/daytime running lights P. 231
- ⑥ **Windshield wiper and washer switch** **P. 240**
 - Usage P. 240
 - Adding washer fluid P. 472
- ⑦ **Emergency flasher switch** **P. 516**
- ⑧ **Hood lock release lever** **P. 457**
- ⑨ **Tilt and telescopic steering lock release lever** **P. 173**
- ⑩ **Air conditioning system** **P. 382, 387, 394**
 - Usage P. 382, 387, 394
 - Rear window defogger P. 383, 389, 397
- ⑪ **Audio**^{*1, 2}
 - Audio Plus**^{*1, 2}
 - Premium Audio**^{*1, 2}
 - Clock**^{*2}

*1: If equipped

*2: Refer to "NAVIGATION AND MULTIMEDIA SYSTEM OWNER'S MANUAL".

■ Switches

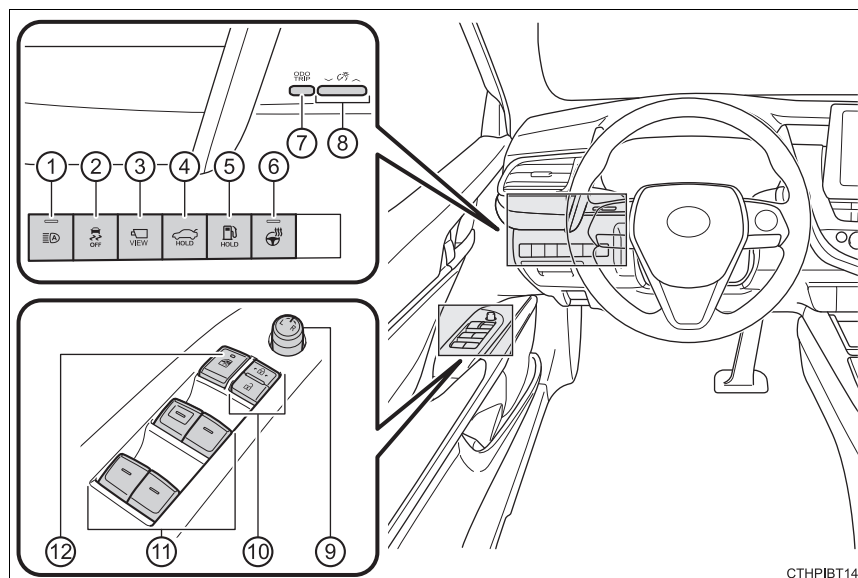

- ① Automatic High Beam switch P. 236
- ② VSC OFF switch P. 324
- ③ Camera switch *1, 2
- ④ Trunk opener switch P. 156
- ⑤ Fuel filler door opener switch. P. 246
- ⑥ Heated steering wheel switch*1 P. 402
- ⑦ “ODO/TRIP” switch P. 99, 113
- ⑧ Instrument panel light control switch P. 95
- ⑨ Outside rear view mirror switch. P. 177
- ⑩ Door lock switches P. 151
- ⑪ Power window switches P. 179
- ⑫ Window lock switch. P. 179

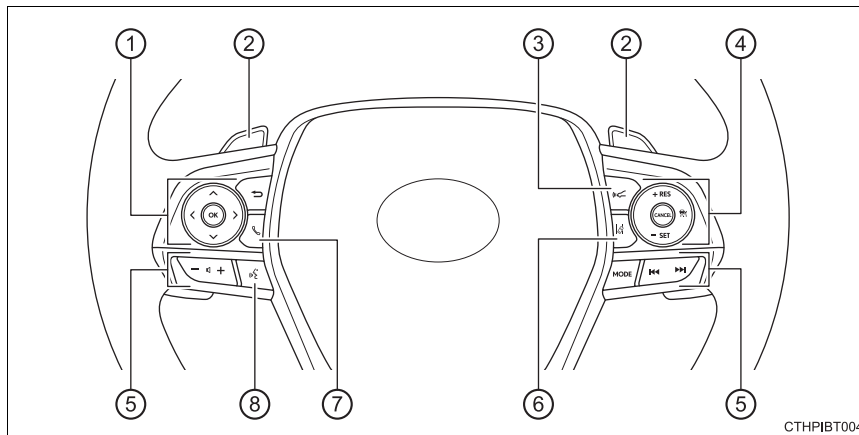

- ① **Meter control switches** P. 99, 113
- ② **Paddle shift switches**^{*1} P. 217
- ③ **Vehicle-to-vehicle distance switch**^{*1} P. 297, 314
- ④ **Cruise control switches**
 Dynamic radar cruise control with full-speed range^{*1} P. 290
 Dynamic radar cruise control^{*1} P. 306
- ⑤ **Audio remote control switches**^{*2}
- ⑥ **LTA (Lane Tracing Assist) switch** P. 270
- ⑦ **Phone switch**^{*2}
- ⑧ **Talk switch**^{*2}

^{*1}: If equipped

^{*2}: Refer to "NAVIGATION AND MULTIMEDIA SYSTEM OWNER'S MANUAL".

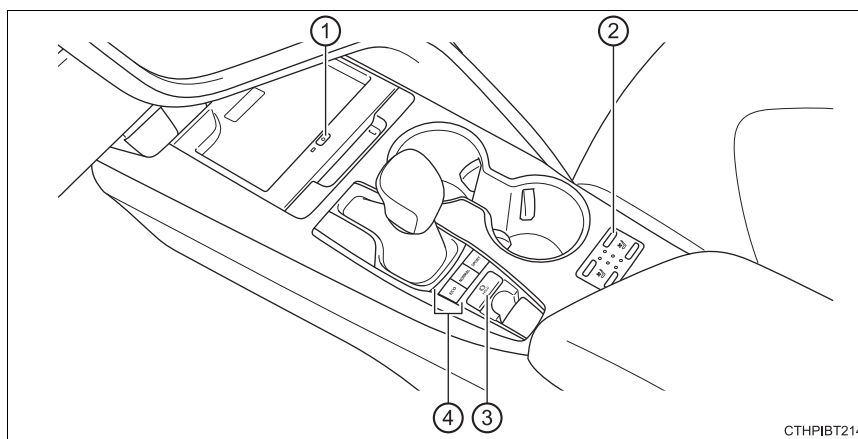

- ① **Wireless charger switch*** P. 420
- ② **Seat heater switches*** P. 402
Seat ventilator switches* P. 402
- ③ **Brake hold switch*** P. 229
- ④ **Driving mode select switches*** P. 375

*: If equipped

Interior

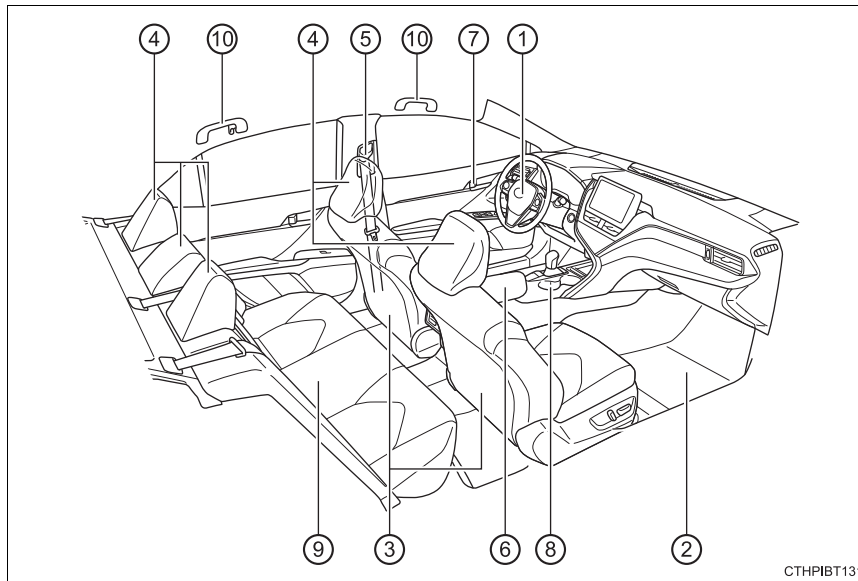

CTHPIBT131

① SRS airbags	P. 36
② Floor mats	P. 26
③ Front seats	P. 167
④ Head restraints.....	P. 171
⑤ Seat belts	P. 30
⑥ Console box	P. 410
⑦ Inside lock buttons	P. 151
⑧ Cup holders	P. 412
⑨ Rear seats.....	P. 169
⑩ Assist grips	P. 430

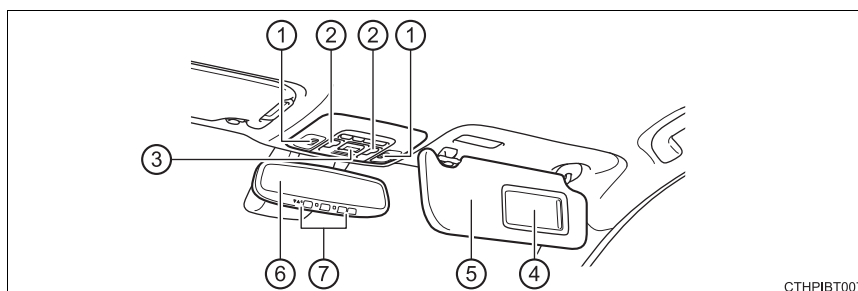

CTHPIBT007

- ① Interior lights/personal lights^{*1} P. 405
- ② Moon roof switches^{*2} P. 183
Panoramic moon roof switches^{*2} P. 187
- ③ “SOS” button^{*2} P. 75
- ④ Vanity mirrors P. 416
- ⑤ Sun visors P. 416
- ⑥ Inside rear view mirror P. 175
- ⑦ Garage door opener switches^{*2} P. 432

^{*1}: The illustration shows the front, but they may also be equipped in the rear.

^{*2}: If equipped

For safety and security**1****1-1. For safe use**

Before driving.....	26
For safe driving	28
Seat belts	30
SRS airbags.....	36
Front passenger occupant classification system	49
Exhaust gas precautions.....	54

1-2. Child safety

Riding with children.....	55
Child restraint systems.....	56

1-3. Emergency assistance

Safety Connect	75
----------------------	----

1-4. Theft deterrent system

Engine immobilizer system	80
Alarm.....	82

Before driving

Floor mat

Use only floor mats designed specifically for vehicles of the same model and model year as your vehicle. Fix them securely in place onto the carpet.

- 1 Insert the retaining hooks (clips) into the floor mat eyelets.

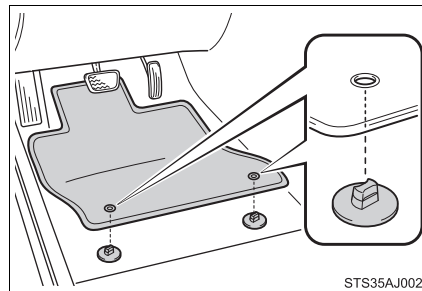

- 2 Turn the upper knob of each retaining hook (clip) to secure the floor mats in place.

*: Always align the \triangle marks.

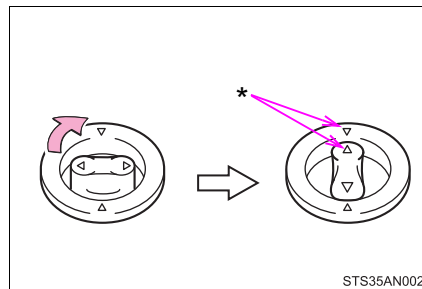

The shape of the retaining hooks (clips) may differ from that shown in the illustration.

⚠ WARNING

Observe the following precautions.

Failure to do so may cause the driver's floor mat to slip, possibly interfering with the pedals while driving. An unexpectedly high speed may result or it may become difficult to stop the vehicle. This could lead to an accident, resulting in death or serious injury.

■ When installing the driver's floor mat

- Do not use floor mats designed for other models or different model year vehicles, even if they are Toyota Genuine floor mats.
- Only use floor mats designed for the driver's seat.
- Always install the floor mat securely using the retaining hooks (clips) provided.
- Do not use two or more floor mats on top of each other.
- Do not place the floor mat bottom-side up or upside-down.

■ Before driving

- Check that the floor mat is securely fixed in the correct place with all the provided retaining hooks (clips). Be especially careful to perform this check after cleaning the floor.
- With the engine stopped and the shift lever in P, fully depress each pedal to the floor to make sure it does not interfere with the floor mat.

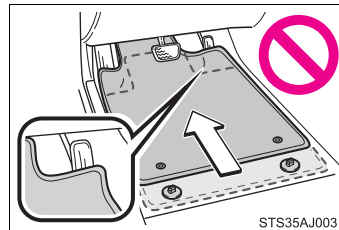

For safe driving

For safe driving, adjust the seat and mirror to an appropriate position before driving.

Correct driving posture

- ① Adjust the angle of the seat-back so that you are sitting straight up and so that you do not have to lean forward to steer. (→P. 167)
- ② Adjust the seat so that you can depress the pedals fully and so that your arms bend slightly at the elbow when gripping the steering wheel. (→P. 167)
- ③ Lock the head restraint in place with the center of the head restraint closest to the top of your ears. (→P. 171)
- ④ Wear the seat belt correctly. (→P. 30)

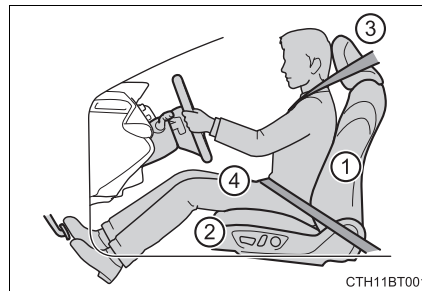

Correct use of the seat belts

Make sure that all occupants are wearing their seat belts before driving the vehicle. (→P. 30)

Use a child restraint system appropriate for the child until the child becomes large enough to properly wear the vehicle's seat belt. (→P. 56)

Adjusting the mirrors

Make sure that you can see backward clearly by adjusting the inside and outside rear view mirrors properly. (→P. 175, 177)

WARNING

Observe the following precautions.

Failure to do so may result in death or serious injury.

- Do not adjust the position of the driver's seat while driving.
Doing so could cause the driver to lose control of the vehicle.
- Do not place a cushion between the driver or passenger and the seatback.
A cushion may prevent correct posture from being achieved, and reduce the effectiveness of the seat belt and head restraint.
- Do not place anything under the front seats.
Objects placed under the front seats may become jammed in the seat tracks and stop the seat from locking in place. This may lead to an accident and the adjustment mechanism may also be damaged.
- Always observe the legal speed limit when driving on public roads.
- When driving over long distances, take regular breaks before you start to feel tired.
Also, if you feel tired or sleepy while driving, do not force yourself to continue driving and take a break immediately.

Seat belts

Make sure that all occupants are wearing their seat belts before driving the vehicle.

Correct use of the seat belts

- Extend the shoulder belt so that it comes fully over the shoulder, but does not come into contact with the neck or slide off the shoulder.
- Position the lap belt as low as possible over the hips.
- Adjust the position of the seat-back. Sit up straight and well back in the seat.
- Do not twist the seat belt.

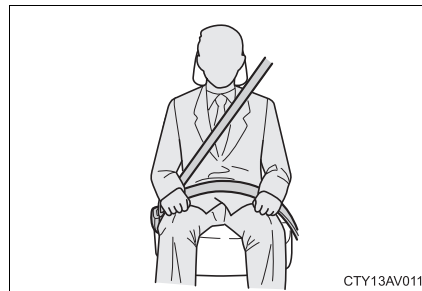

Fastening and releasing the seat belt

- ① To fasten the seat belt, push the plate into the buckle until a click sound is heard.
- ② To release the seat belt, press the release button.

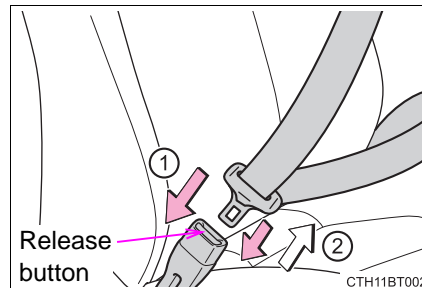

Adjusting the seat belt shoulder anchor height (front seats)

- ① Push the seat belt shoulder anchor down while pressing the release button.
- ② Push the seat belt shoulder anchor up while pressing the release button.

Move the height adjuster up and down as needed until you hear a click.

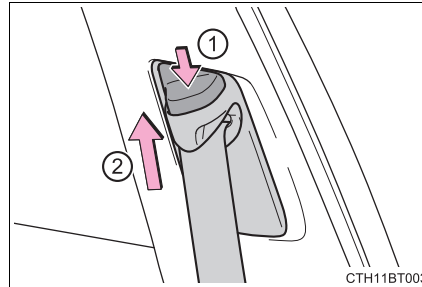
**Seat belt pretensioners (front and outboard rear seats)**

The pretensioners help the seat belts to quickly restrain the occupants by retracting the seat belts when the vehicle is subjected to certain types of severe frontal or side collision or a vehicle rollover.

The pretensioners do not activate in the event of a minor frontal impact, a minor side impact or a rear impact.

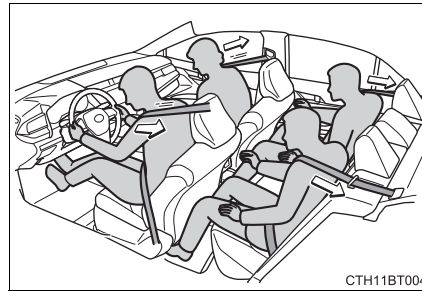

■ Emergency locking retractor (ELR)

The retractor will lock the belt during a sudden stop or on impact. It may also lock if you lean forward too quickly. A slow, easy motion will allow the belt to extend so that you can move around fully.

■ Automatic locking retractor (ALR)

When a passenger's shoulder belt is completely extended and then retracted even slightly, the belt is locked in that position and cannot be extended. This feature is used to hold the child restraint system (CRS) firmly. To free the belt again, fully retract the belt and then pull the belt out once more. (→P. 58)

■ Child seat belt usage

The seat belts of your vehicle were principally designed for persons of adult size.

- Use a child restraint system appropriate for the child, until the child becomes large enough to properly wear the vehicle's seat belt. (→P. 56)
- When the child becomes large enough to properly wear the vehicle's seat belt, follow the instructions regarding seat belt usage. (→P. 30)

■ Replacing the belt after the pretensioner has been activated

If the vehicle is involved in multiple collisions, the pretensioner will activate for the first collision, but will not activate for the second or subsequent collisions.

■ Seat belt extender

If your seat belts cannot be fastened securely because they are not long enough, a personalized seat belt extender is available from your Toyota dealer free of charge.

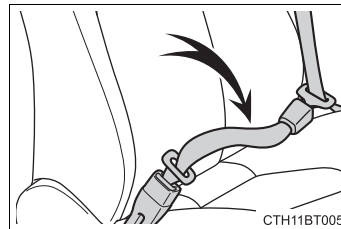

■ Rear seat belt

Use the seat belt after passing it through the guide if the seat belt comes free from the guide.

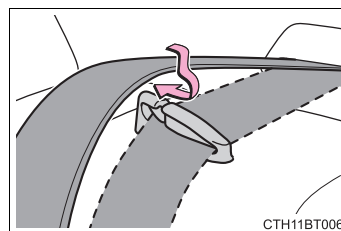

⚠ WARNING

Observe the following precautions to reduce the risk of injury in the event of sudden braking, sudden swerving or an accident. Failure to do so may cause death or serious injury.

■ Wearing a seat belt

- Ensure that all passengers wear a seat belt.
- Always wear a seat belt properly.
- Each seat belt should be used by one person only. Do not use a seat belt for more than one person at once, including children.
- Toyota recommends that children be seated in the rear seat and always use a seat belt and/or an appropriate child restraint system.
- To achieve a proper seating position, do not recline the seat more than necessary. The seat belt is most effective when the occupants are sitting up straight and well back in the seats.
- Do not wear the shoulder belt under your arm.
- Always wear your seat belt low and snug across your hips.

■ Pregnant women

Obtain medical advice and wear the seat belt in the proper way. (→P. 30)

Women who are pregnant should position the lap belt as low as possible over the hips in the same manner as other occupants, extending the shoulder belt completely over the shoulder and avoiding belt contact with the rounding of the abdominal area.

If the seat belt is not worn properly, not only the pregnant woman, but also the fetus could suffer death or serious injury as a result of sudden braking or a collision.

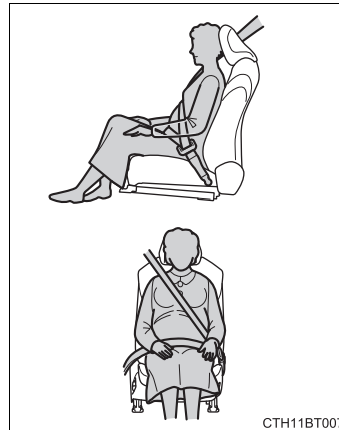
**■ People suffering illness**

Obtain medical advice and wear the seat belt in the proper way. (→P. 30)

 **WARNING****■ When children are in the vehicle**

→P. 68

■ Seat belt pretensioners

- Do not place anything, such as a cushion, on the front passenger's seat. Doing so will disperse the passenger's weight, which prevents the sensor from detecting the passenger's weight properly. As a result, the seat belt pretensioner for the front passenger's seat may not activate in the event of a collision.
- If the pretensioner has activated, the SRS warning light will come on. In that case, the seat belt cannot be used again and must be replaced at your Toyota dealer.

■ Adjustable shoulder anchor

Always make sure the shoulder belt is positioned across the center of your shoulder. The belt should be kept away from your neck, but not falling off your shoulder. Failure to do so could reduce the amount of protection in an accident and cause death or serious injuries in the event of a sudden stop, sudden swerve or accident. (→P. 31)

■ Seat belt damage and wear

- Do not damage the seat belts by allowing the belt, plate, or buckle to be jammed in the door.
- Inspect the seat belt system periodically. Check for cuts, fraying, and loose parts. Do not use a damaged seat belt until it is replaced. Damaged seat belts cannot protect an occupant from death or serious injury.
- Ensure that the belt and plate are locked and the belt is not twisted. If the seat belt does not function correctly, immediately contact your Toyota dealer.
- Replace the seat assembly, including the belts, if your vehicle has been involved in a serious accident, even if there is no obvious damage.
- Do not attempt to install, remove, modify, disassemble or dispose of the seat belts. Have any necessary repairs carried out by your Toyota dealer. Inappropriate handling may lead to incorrect operation.
- Always make sure the shoulder belt passes through the guide when using the seat belt. Failure to properly position the belt may reduce the amount of protection in an accident and could lead to death or serious injury in a collision or sudden stop.
- Always make sure that the seat belt is not twisted, does not get caught in the guide or the seatback and is arranged in the proper position.

 **WARNING****■ Using a seat belt extender**

- Do not wear the seat belt extender if you can fasten the seat belt without the extender.
- Do not use the seat belt extender when installing a child restraint system because the belt will not securely hold the child restraint system, increasing the risk of death or serious injury in the event of an accident.
- The personalized extender may not be safe on another vehicle, when used by another person, or at a different seating position other than the one originally intended.

 **NOTICE****■ When using a seat belt extender**

When releasing the seat belt, press on the buckle release button on the extender, not on the seat belt.
This helps prevent damage to the vehicle interior and the extender itself.

SRS airbags

The SRS airbags inflate when the vehicle is subjected to certain types of severe impacts that may cause significant injury to the occupants. They work together with the seat belts to help reduce the risk of death or serious injury.

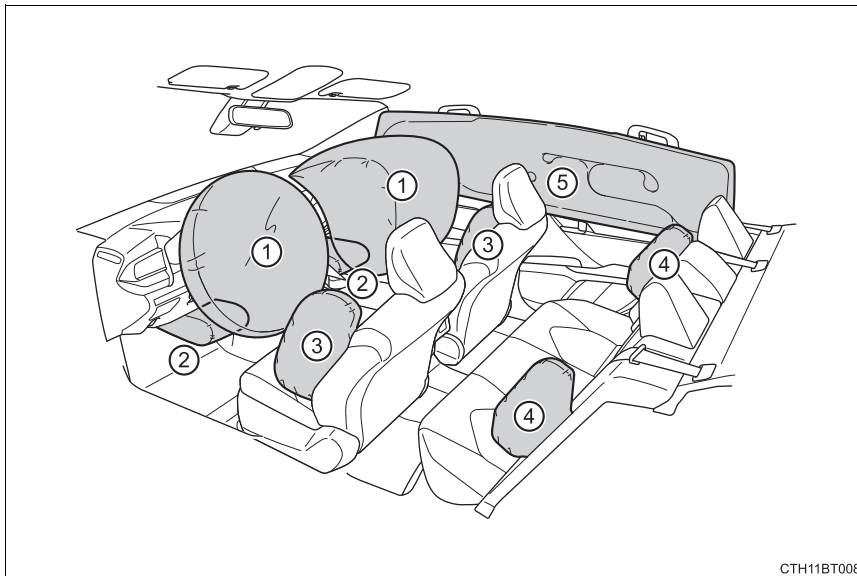

◆ SRS front airbags

- ① SRS driver airbag/front passenger airbag
Can help protect the head and chest of the driver and front passenger from impact with interior components
- ② SRS knee airbags
Can help provide driver and front passenger protection

◆ **SRS side and curtain shield airbags**

- ③ SRS front side airbags
Can help protect the torso of the front seat occupants
- ④ SRS rear side airbags
Can help protect the torso of occupants in the rear outer seats
- ⑤ SRS curtain shield airbags
 - Can help protect primarily the head of occupants in the outer seats
 - Can help prevent the occupants from being thrown from the vehicle in the event of vehicle rollover

1

For safety and security

SRS airbag system components

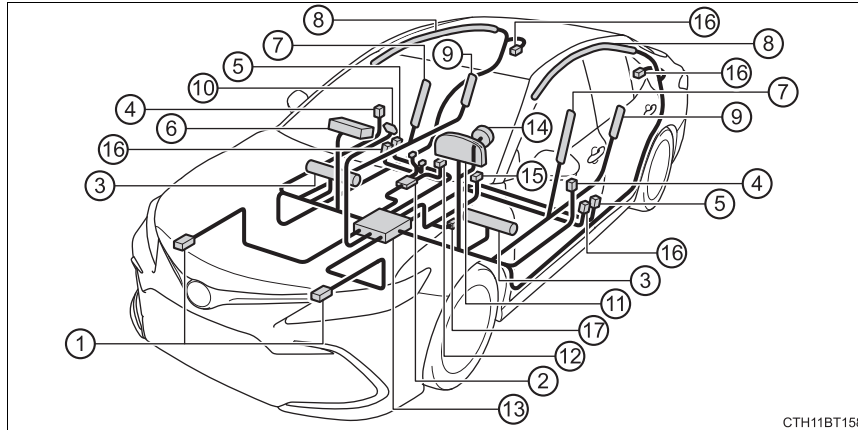

- | | |
|--|---|
| ① Front impact sensors | ⑩ "AIRBAG ON" and "AIRBAG OFF" indicator lights |
| ② Front passenger occupant classification system (ECU and sensors) | ⑪ SRS warning light |
| ③ Knee airbags | ⑫ Front passenger's seat belt buckle switch |
| ④ Side impact sensors (front doors) | ⑬ Airbag sensor assembly |
| ⑤ Side impact sensors (front) | ⑭ Driver airbag |
| ⑥ Front passenger airbag | ⑮ Driver's seat belt buckle switch |
| ⑦ Front side airbags | ⑯ Seat belt pretensioners and force limiters |
| ⑧ Curtain shield airbags | ⑰ Driver's seat position sensor |
| ⑨ Rear side airbags | |

Your vehicle is equipped with ADVANCED AIRBAGS designed based on the US motor vehicle safety standards (FMVSS208). The airbag sensor assembly (ECU) controls airbag deployment based on information obtained from the sensors etc. shown in the system components diagram above. This information includes crash severity and occupant information. As the airbags deploy, a chemical reaction in the inflators quickly fills the airbags with non-toxic gas to help restrain the motion of the occupants.

 **WARNING****■ SRS airbag precautions**

Observe the following precautions regarding the SRS airbags. Failure to do so may cause death or serious injury.

- The driver and all passengers in the vehicle must wear their seat belts properly.

The SRS airbags are supplemental devices to be used with the seat belts.

- The SRS driver airbag deploys with considerable force, and can cause death or serious injury especially if the driver is very close to the airbag. The National Highway Traffic Safety Administration (NHTSA) advises:

Since the risk zone for the driver's airbag is the first 2 - 3 in. (50 - 75 mm) of inflation, placing yourself 10 in. (250 mm) from your driver airbag provides you with a clear margin of safety. This distance is measured from the center of the steering wheel to your breastbone. If you sit less than 10 in. (250 mm) away now, you can change your driving position in several ways:

- Move your seat to the rear as far as you can while still reaching the pedals comfortably.
- Slightly recline the back of the seat.
Although vehicle designs vary, many drivers can achieve the 10 in. (250 mm) distance, even with the driver seat all the way forward, simply by reclining the back of the seat somewhat. If reclining the back of your seat makes it hard to see the road, raise yourself by using a firm, non-slippery cushion, or raise the seat if your vehicle has that feature.
- If your steering wheel is adjustable, tilt it downward. This points the airbag toward your chest instead of your head and neck.

The seat should be adjusted as recommended by NHTSA above, while still maintaining control of the foot pedals, steering wheel, and your view of the instrument panel controls.

⚠ WARNING**■ SRS airbag precautions**

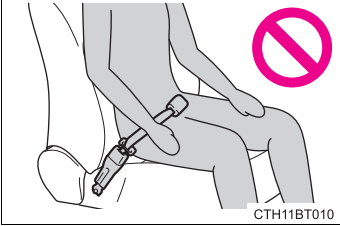
- If the seat belt extender has been connected to the front seat belt buckles but the seat belt extender has not also been fastened to the latch plate of the seat belt, the SRS front airbags will judge that the driver and front passenger are wearing the seat belt even though the seat belt has not been connected. In this case, the SRS front airbags may not activate correctly in a collision, resulting in death or serious injury in the event of a collision. Be sure to wear the seat belt with the seat belt extender.
- 
- The SRS front passenger airbag also deploys with considerable force, and can cause death or serious injury especially if the front passenger is very close to the airbag. The front passenger seat should be as far from the airbag as possible with the seatback adjusted, so the front passenger sits upright.
 - Improperly seated and/or restrained infants and children can be killed or seriously injured by a deploying airbag. An infant or child who is too small to use a seat belt should be properly secured using a child restraint system. Toyota strongly recommends that all infants and children be placed in the rear seats of the vehicle and properly restrained. The rear seats are safer for infants and children than the front passenger seat. (→P. 56)

⚠ WARNING

■ **SRS airbag precautions**

- Do not sit on the edge of the seat or lean against the dashboard.

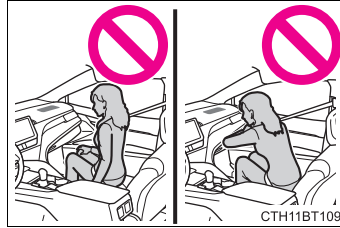

- Do not allow a child to stand in front of the SRS front passenger airbag unit or sit on the knees of a front passenger.
- Do not allow the front seat occupants to hold items on their knees.

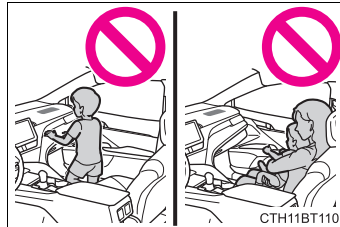

- Do not lean against the door, the roof side rail or the front, side and rear pillars.

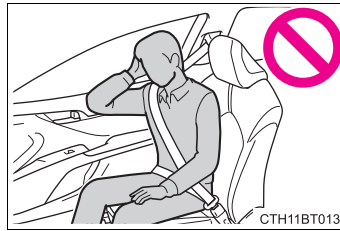

- Do not allow anyone to kneel on the passenger seats toward the door or put their head or hands outside the vehicle.

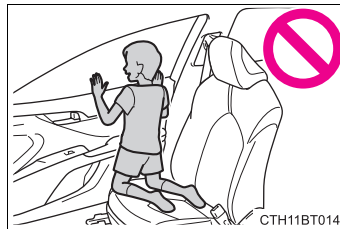

⚠ WARNING

■ **SRS airbag precautions**

- Do not attach anything to or lean anything against areas such as the dashboard, steering wheel pad and lower portion of the instrument panel. These items can become projectiles when the SRS driver, front passenger and knee airbags deploy.

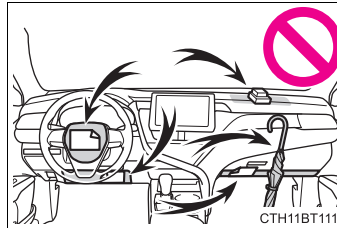

- Do not attach anything to areas such as a door, windshield, windows, front or rear pillar, roof side rail and assist grip.

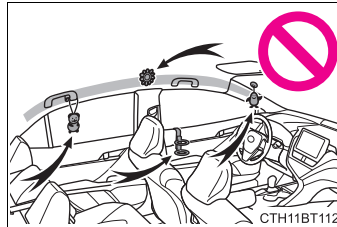

- Vehicles without a smart key system: Do not attach any heavy, sharp or hard objects such as keys and accessories to the key. The objects may restrict the SRS knee airbag inflation or be thrust into the driver's seat area by the force of the deploying airbag, thus causing a danger.

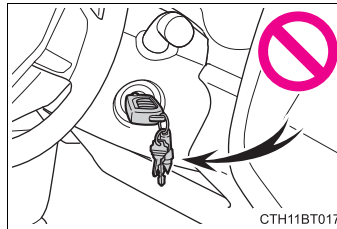

- Do not hang coat hangers or other hard objects on the coat hooks. All of these items could become projectiles and may cause death or serious injury, should the SRS curtain shield airbags deploy.

 **WARNING****■ SRS airbag precautions**

- If a vinyl cover is put on the area where the SRS knee airbag will deploy, be sure to remove it.
- Do not use seat accessories which cover the parts where the SRS side airbags inflate as they may interfere with inflation of the airbags. Such accessories may prevent the side airbags from activating correctly, disable the system or cause the side airbags to inflate accidentally, resulting in death or serious injury.
- Do not strike or apply significant levels of force to the area of the SRS airbag components or the front doors.
Doing so can cause the SRS airbags to malfunction.
- Do not touch any of the component parts immediately after the SRS airbags have deployed (inflated) as they may be hot.
- If breathing becomes difficult after the SRS airbags have deployed, open a door or window to allow fresh air in, or leave the vehicle if it is safe to do so. Wash off any residue as soon as possible to prevent skin irritation.
- If the areas where the SRS airbags are stored, such as the steering wheel pad and front and rear pillar garnishes, are damaged or cracked, have them replaced by your Toyota dealer.
- Do not place anything, such as a cushion, on the front passenger's seat. Doing so will disperse the passenger's weight, which prevents the sensor from detecting the passenger's weight properly. As a result, the SRS front airbags for the front passenger may not deploy in the event of a collision.

 **WARNING****■ Modification and disposal of SRS airbag system components**

Do not dispose of your vehicle or perform any of the following modifications without consulting your Toyota dealer. The SRS airbags may malfunction or deploy (inflate) accidentally, causing death or serious injury.

- Installation, removal, disassembly and repair of the SRS airbags
- Repairs, modifications, removal or replacement of the steering wheel, instrument panel, dashboard, seats or seat upholstery, front, side and rear pillars, roof side rails, front door panels, front door trims or front door speakers
- Modifications to the front door panel (such as making a hole in it)
- Repairs or modifications of the front fender, front bumper, or side of the occupant compartment
- Installation of a grille guard (bull bars, kangaroo bar, etc.), snow plows, winches or roof luggage carrier
- Modifications to the vehicle's suspension system
- Installation of electronic devices such as mobile two-way radios and CD players
- Modifications to your vehicle for a person with a physical disability

■ If the SRS airbags deploy (inflate)

- Slight abrasions, burns, bruising etc., may be sustained from SRS airbags, due to the extremely high speed deployment (inflation) by hot gases.
- A loud noise and white powder will be emitted.
- Parts of the airbag module (steering wheel hub, airbag cover and inflator) as well as the front seats, parts of the front and rear pillars, and roof side rails, may be hot for several minutes. The airbag itself may also be hot.
- The windshield may crack.
- All of the doors will be unlocked. (→P. 154)
- The brakes and stop lights will be controlled automatically. (→P. 322)
- The interior lights will turn on automatically. (→P. 408)
- The emergency flashers will turn on automatically. (→P. 516)
- Fuel supply to the engine will be stopped. (→P. 527)

- For Safety Connect subscribers, if any of the following situations occur, the system is designed to send an emergency call to the response center, notifying them of the vehicle's location (without needing to push the "SOS" button) and an agent will attempt to speak with the occupants to ascertain the level of emergency and assistance required. If the occupants are unable to communicate, the agent automatically treats the call as an emergency and helps to dispatch the necessary emergency services. (→P. 75)

- An SRS airbag is deployed.
- A seat belt pretensioner is activated.
- The vehicle is involved in a severe rear-end collision.

■ SRS airbag deployment conditions (SRS front airbags)

- The SRS front airbags will deploy in the event of an impact that exceeds the set threshold level (the level of force corresponding to an approximately 12 - 18 mph [20 - 30 km/h] frontal collision with a fixed wall that does not move or deform).

However, this threshold velocity will be considerably higher in the following situations:

- If the vehicle strikes an object, such as a parked vehicle or sign pole, which can move or deform on impact
- If the vehicle is involved in an underride collision, such as a collision in which the front of the vehicle "underrides", or goes under, the bed of a truck

- Depending on the type of collision, it is possible that only the seat belt pretensioners will activate.
- The SRS front airbags for the front passenger will not activate if there is no passenger sitting in the front passenger seat. However, the SRS front airbags for the front passenger may deploy if luggage is put in the seat, even if the seat is unoccupied.

■ SRS airbag deployment conditions (SRS side and curtain shield airbags)

- The SRS side and curtain shield airbags will deploy in the event of an impact that exceeds the set threshold level (the level of force corresponding to the impact force produced by an approximately 3300 lb. [1500 kg] vehicle colliding with the vehicle cabin from a direction perpendicular to the vehicle orientation at an approximate speed of 12 - 18 mph [20 - 30 km/h]).
- Both SRS curtain shield airbags may deploy in the event of a severe side collision.
- Both SRS curtain shield airbags will deploy in the event of vehicle rollover.
- Both SRS curtain shield airbags may also deploy in the event of a severe frontal collision.

■ Conditions under which the SRS airbags may deploy (inflate), other than a collision

The SRS front airbags and SRS curtain shield airbags may also deploy if a serious impact occurs to the underside of your vehicle.

Some examples are shown in the illustration.

- Hitting a curb, edge of pavement or hard surface
- Falling into or jumping over a deep hole
- Landing hard or falling

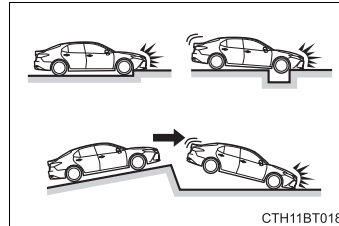

The SRS curtain shield airbags may also deploy under the situations shown in the illustration.

- The angle of vehicle tip-up is marginal.
- The vehicle skids and hits a curb stone.

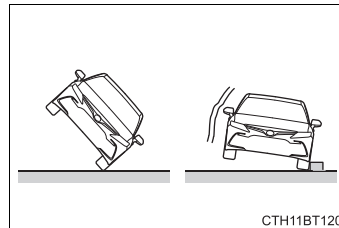

■ Types of collisions that may not deploy the SRS airbags (SRS front airbags)

The SRS front airbags do not generally inflate if the vehicle is involved in a side or rear collision, if it rolls over, or if it is involved in a low-speed frontal collision. But, whenever a collision of any type causes sufficient forward deceleration of the vehicle, deployment of the SRS front airbags may occur.

- Collision from the side
- Collision from the rear
- Vehicle rollover

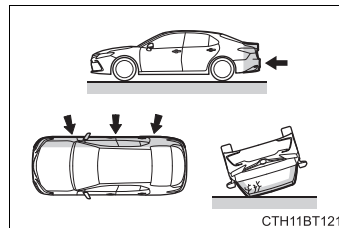

■ Types of collisions that may not deploy the SRS airbags (SRS side and curtain shield airbags)

The SRS side and curtain shield airbags may not activate if the vehicle is subjected to a collision from the side at certain angles, or a collision to the side of the vehicle body other than the passenger compartment.

- Collision from the side to the vehicle body other than the passenger compartment
- Collision from the side at an angle

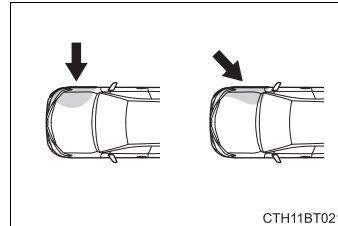

The SRS side airbags do not generally inflate if the vehicle is involved in a frontal or rear collision, if it rolls over, or if it is involved in a low-speed side collision.

- Collision from the front
- Collision from the rear
- Vehicle rollover

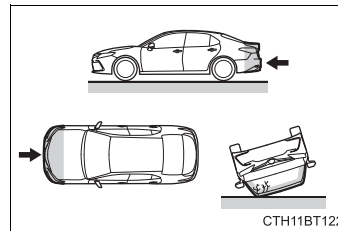

The SRS curtain shield airbags do not generally inflate if the vehicle is involved in a rear collision, if it pitches end over end, or if it is involved in a low-speed side or low-speed frontal collision.

- Collision from the rear
- Pitching end over end

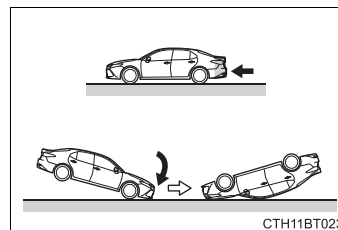

■ When to contact your Toyota dealer

In the following cases, the vehicle will require inspection and/or repair. Contact your Toyota dealer as soon as possible.

- Any of the SRS airbags have been inflated.
- The front of the vehicle is damaged or deformed, or was involved in an accident that was not severe enough to cause the SRS front airbags to inflate.

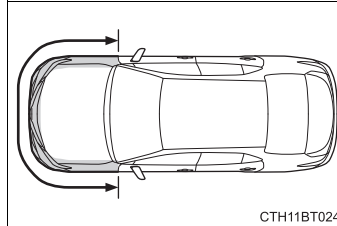

- A portion of a door or its surrounding area is damaged, deformed or has had a hole made in it, or the vehicle was involved in an accident that was not severe enough to cause the SRS side and curtain shield airbags to inflate.

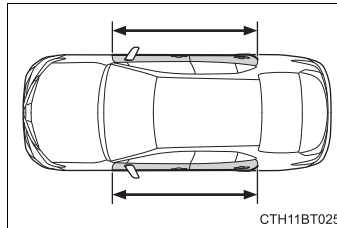

- The pad section of the steering wheel, dashboard near the front passenger airbag or lower portion of the instrument panel is scratched, cracked, or otherwise damaged.

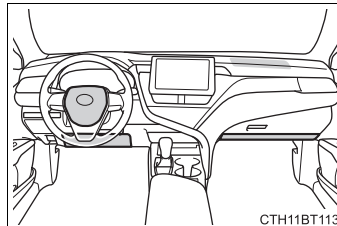

- The surface of the seats with the SRS side airbag is scratched, cracked, or otherwise damaged.

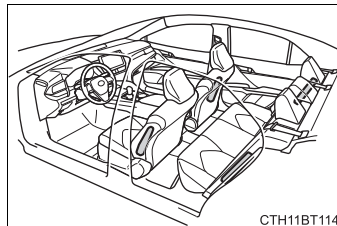

- The portion of the front pillars, rear pillars or roof side rail garnishes (padding) containing the SRS curtain shield airbags inside is scratched, cracked, or otherwise damaged.

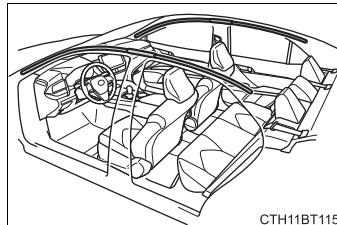

Front passenger occupant classification system

Your vehicle is equipped with a front passenger occupant classification system. This system detects the conditions of the front passenger seat and activates or deactivates the front passenger airbag and front passenger knee airbag.

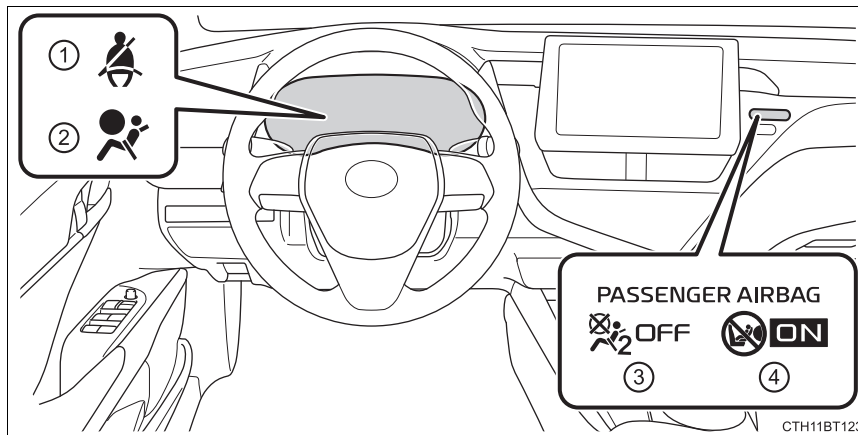

- ① Driver's and front passenger's seat belt reminder light
- ② SRS warning light
- ③ "AIRBAG OFF" indicator light
- ④ "AIRBAG ON" indicator light

Condition and operation in the front passenger occupant classification system

■ Adult*1

Indicator/ warning light	“AIRBAG ON” and “AIRBAG OFF” indicator lights	“AIRBAG ON”
	SRS warning light	Off
	Driver’s and front passenger’s seat belt reminder light	Off*2 or flashing*3
Devices	Front passenger airbag	Activated
	Front passenger knee airbag	

■ Child*4

Indicator/ warning light	“AIRBAG ON” and “AIRBAG OFF” indicator lights	“AIRBAG OFF” or “AIRBAG ON”*4
	SRS warning light	Off
	Driver’s and front passenger’s seat belt reminder light	Off*2 or flashing*3
Devices	Front passenger airbag	Deactivated or activated*4
	Front passenger knee airbag	

■ Child restraint system with infant*5

Indicator/ warning light	“AIRBAG ON” and “AIRBAG OFF” indicator lights	“AIRBAG OFF”*6
	SRS warning light	Off
	Driver’s and front passenger’s seat belt reminder light	Off*2 or flashing*3
Devices	Front passenger airbag	Deactivated
	Front passenger knee airbag	

■ Unoccupied

Indicator/ warning light	“AIRBAG ON” and “AIRBAG OFF” indicator lights	“AIRBAG OFF”
	SRS warning light	Off
	Driver’s and front passenger’s seat belt reminder light	
Devices	Front passenger airbag	Deactivated
	Front passenger knee airbag	

■ There is a malfunction in the system

Indicator/ warning light	“AIRBAG ON” and “AIRBAG OFF” indicator lights	“AIRBAG OFF”
	SRS warning light	On
	Driver’s and front passenger’s seat belt reminder light	
Devices	Front passenger airbag	Deactivated
	Front passenger knee airbag	

*1: The system judges a person of adult size as an adult. When a smaller adult sits in the front passenger seat, the system may not recognize him/her as an adult depending on his/her physique and posture.

*2: In the event the front passenger is wearing a seat belt.

*3: In the event the front passenger does not wear a seat belt.

*4: For some children, child in seat, child in booster seat or child in convertible seat, the system may not recognize him/her as a child. Factors which may affect this can be the physique or posture.

*5: Never install a rear-facing child restraint system on the front passenger seat. A forward-facing child restraint system should only be installed on the front passenger seat when it is unavoidable. (→P. 56)

*6: In case the indicator light is not illuminated, consult this manual on how to install the child restraint system properly. (→P. 58)

 **WARNING****■ Front passenger occupant classification system precautions**

Observe the following precautions regarding the front passenger occupant classification system.

Failure to do so may cause death or serious injury.

- Wear the seat belt properly.
- Make sure the front passenger's seat belt plate has not been left inserted into the buckle before someone sits in the front passenger seat.
- Make sure the "AIRBAG OFF" indicator light is not illuminated when using the seat belt extender for the front passenger seat. If the "AIRBAG OFF" indicator light is illuminated, disconnect the extender tongue from the seat belt buckle, and reconnect the seat belt. Reconnect the seat belt extender after making sure the "AIRBAG ON" indicator light is illuminated. If you use the seat belt extender while the "AIRBAG OFF" indicator light is illuminated, the SRS airbags for the front passenger will not activate, which could cause death or serious injury in the event of a collision.
- Do not apply a heavy load to the front passenger seat or equipment (e.g. seatback pocket).
- Do not put weight on the front passenger seat by putting your hands or feet on the front passenger seat seatback from the rear passenger seat.
- Do not let a rear passenger lift the front passenger seat with their feet or press on the seatback with their legs.
- Do not put objects under the front passenger seat.

 **WARNING****■ Front passenger occupant classification system precautions**

- Do not recline the front passenger seatback so far that it touches a rear seat. This may cause the “AIRBAG OFF” indicator light to be illuminated, which indicates that the SRS airbags for the front passenger will not activate in the event of a severe accident. If the seatback touches the rear seat, return the seatback to a position where it does not touch the rear seat. Keep the front passenger seatback as upright as possible when the vehicle is moving. Reclining the seatback excessively may lessen the effectiveness of the seat belt system.
- If an adult sits in the front passenger seat, the “AIRBAG ON” indicator light is illuminated. If the “AIRBAG OFF” indicator is illuminated, ask the passenger to sit up straight, well back in the seat, feet on the floor, and with the seat belt worn correctly. If the “AIRBAG OFF” indicator still remains illuminated, either ask the passenger to move to the rear seat, or if that is not possible, move the front passenger seat fully rearward.
- When it is unavoidable to install a forward-facing child restraint system on the front passenger seat, install the child restraint system on the front passenger seat in the proper order. (→P. 60)
- Do not modify or remove the front seats.
- Do not kick the front passenger seat or subject it to severe impact. Otherwise, the SRS warning light may come on to indicate a malfunction of the front passenger occupant classification system. In this case, contact your Toyota dealer immediately.
- Child restraint systems installed on the rear seat should not contact the front seatbacks.
- Do not use a seat accessory, such as a cushion and seat cover, that covers the seat cushion surface.
- Do not modify or replace the upholstery of the front seat.
- Do not place anything between the console box and front passenger seat. Otherwise, the system may not detect the front passenger properly, leading to improper operation of the airbags.
- Adjust the front passenger seat so that the head restraint does not touch the ceiling. If the head restraint is left in contact with the ceiling, the system may not detect the front passenger properly, leading to improper operation of the airbags.

Exhaust gas precautions

Harmful substance to the human body is included in exhaust gases if inhaled.

WARNING

Exhaust gases include harmful carbon monoxide (CO), which is colorless and odorless. Observe the following precautions.

Failure to do so may cause exhaust gases enter the vehicle and may lead to an accident caused by light-headedness, or may lead to death or a serious health hazard.

■ Important points while driving

- Keep the trunk lid closed.
- If you smell exhaust gases in the vehicle even when the trunk lid is closed, open the windows and have the vehicle inspected at your Toyota dealer as soon as possible.

■ When parking

- If the vehicle is in a poorly ventilated area or a closed area, such as a garage, stop the engine.
- Do not leave the vehicle with the engine on for a long time.
If such a situation cannot be avoided, park the vehicle in an open space and ensure that exhaust fumes do not enter the vehicle interior.
- Do not leave the engine running in an area with snow build-up, or where it is snowing. If snowbanks build up around the vehicle while the engine is running, exhaust gases may collect and enter the vehicle.

■ Exhaust pipe

The exhaust system needs to be checked periodically. If there is a hole or crack caused by corrosion, damage to a joint or abnormal exhaust noise, be sure to have the vehicle inspected and repaired by your Toyota dealer.

Riding with children

Observe the following precautions when children are in the vehicle.

Use a child restraint system appropriate for the child, until the child becomes large enough to properly wear the vehicle's seat belt.

- It is recommended that children sit in the rear seats to avoid accidental contact with the shift lever, wiper switch etc.
- Use the rear door child-protector lock or the window lock switch to avoid children opening the door while driving or operating the power window accidentally.
- Do not let small children operate equipment which may catch or pinch body parts, such as the power window, hood, trunk, seats etc.



WARNING

Never leave children unattended in the vehicle, and never allow children to have or use the key.

Children may be able to start the vehicle or shift the vehicle into neutral. There is also a danger that children may injure themselves by playing with the windows, the moon roof or panoramic moon roof, or other features of the vehicle. In addition, heat build-up or extremely cold temperatures inside the vehicle can be fatal to children.

Child restraint systems

Before installing a child restraint system in the vehicle, there are precautions that need to be observed, different types of child restraint systems, as well as installation methods, etc., written in this manual.

Use a child restraint system when riding with a small child that cannot properly use a seat belt. For the child's safety, install the child restraint system to a rear seat. Be sure to follow the installation method that is in the operation manual enclosed with the restraint system.

Table of contents

Points to remember.....	P. 56
Child restraint system	P. 58
When using a child restraint system	P. 60
Child restraint system installation method	
• Fixed with a seat belt	P. 63
• Fixed with a child restraint LATCH anchor	P. 69
• Using an anchor bracket (for top tether strap)	P. 72

Points to remember

The laws of all 50 states of the U.S.A. as well as Canada now require the use of child restraint systems.

- Prioritize and observe the warnings, as well as the laws and regulations for child restraint systems.
- Use a child restraint system until the child becomes large enough to properly wear the vehicle's seat belt.
- Choose a child restraint system that suits your vehicle and is appropriate to the age and size of the child.

 **WARNING****■ When a child is riding**

Observe the following precautions.

Failure to do so may result in death or serious injury.

- For effective protection in automobile accidents and sudden stops, a child must be properly restrained, using a seat belt or child restraint system which is correctly installed. For installation details, refer to the operation manual enclosed with the child restraint system. General installation instruction is provided in this manual.
- Toyota strongly urges the use of a proper child restraint system that conforms to the weight and size of the child, installed on the rear seat. According to accident statistics, the child is safer when properly restrained in the rear seat than in the front seat.
- Holding a child in your or someone else's arms is not a substitute for a child restraint system. In an accident, the child can be crushed against the windshield or between the holder and the interior of the vehicle.

■ Handling the child restraint system

If the child restraint system is not properly fixed in place, the child or other passengers may be seriously injured or even killed in the event of sudden braking, sudden swerving, or an accident.

- If the vehicle were to receive a strong impact from an accident, etc., it is possible that the child restraint system has damage that is not readily visible. In such cases, do not reuse the restraint system.
- Make sure you have complied with all installation instructions provided with the child restraint system manufacturer and that the system is properly secured.
- Keep the child restraint system properly secured on the seat even if it is not in use. Do not store the child restraint system unsecured in the passenger compartment.
- If it is necessary to detach the child restraint system, remove it from the vehicle or store it securely in the trunk.

Child restraint system

■ Types of child restraint system installation methods

Confirm with the operation manual enclosed with the child restraint system about the installation of the child restraint system.

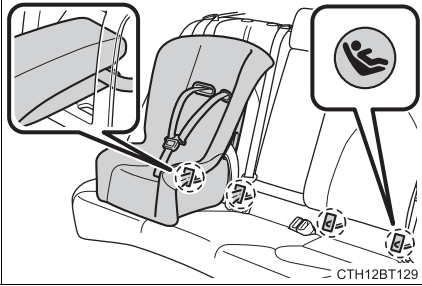
	Installation method	Page
Seat belt attachment		P. 63
Child restraint LATCH anchors attachment		P. 69

	Installation method	Page
<p>Anchor brackets (for top tether strap) attachment</p>	<ul style="list-style-type: none"> ▶ Seats with an adjustable type head restraint <div data-bbox="630 555 1054 842"> </div> ▶ Seats with an integrated type head restraint <div data-bbox="630 943 1054 1229"> </div> 	<p>P. 72</p>

When using a child restraint system**■ When installing a child restraint system to a front passenger seat**

For the safety of a child, install child restraint systems to a rear seats. When installing child restraint system to a front passenger seat is unavoidable, adjust the seat as follows and install the child restraint system.

- Raise the seatback as much as possible
- Move the seat to the rear-most position
- Raise the seat to the highest position
- If the head restraint interferes with the child restraint system installation and the head restraint can be removed, remove the head restraint

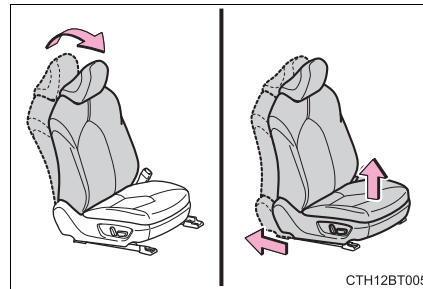

⚠ WARNING

■ When using a child restraint system

Observe the following precautions.

Failure to do so may result in death or serious injury.

- Never install a rear-facing child restraint system on the front passenger seat even if the "AIRBAG OFF" indicator light is illuminated. In the event of an accident, the force of the rapid inflation of the front passenger airbag can cause death or serious injury to the child if the rear-facing child restraint system is installed on the front passenger seat.
- A forward-facing child restraint system may be installed on the front passenger seat only when it is unavoidable. A child restraint system that requires a top tether strap should not be used in the front passenger seat since there is no top tether strap anchor for the front passenger seat.

- A forward-facing child restraint system may be installed on the front passenger seat only when it is unavoidable. When installing a forward-facing child restraint system on the front passenger seat, move the seat as far back as possible, and raise the seat to the upper most position, even if the "AIRBAG OFF" indicator light is illuminated.

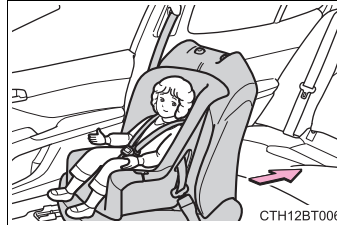

If the head restraint interferes with the child restraint system installation and the head restraint can be removed, remove the head restraint.

- Do not allow the child to lean his/her head or any part of his/her body against the door or the area of the seat, front or rear pillars, or roof side rails from which the SRS side airbags or SRS curtain shield airbags deploy even if the child is seated in the child restraint system. It is dangerous if the SRS side airbags and curtain shield airbags inflate, and the impact could cause death or serious injury to the child.

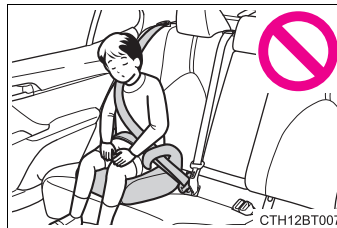

⚠ WARNING**■ When using a child restraint system**

- When a booster seat is installed, always ensure that the shoulder belt is positioned across the center of the child's shoulder. The belt should be kept away from the child's neck, but not so that it could fall off the child's shoulder.
- Use child restraint system suitable to the age and size of the child and install it to the rear seat.
- If the driver's seat interferes with the child restraint system and prevents it from being attached correctly, attach the child restraint system to the right-hand rear seat.
- Adjust the front passenger seat so that it does not interfere with the child restraint system.

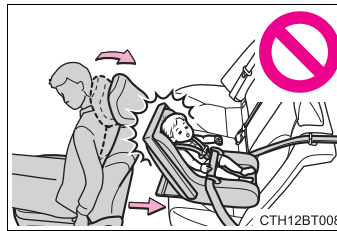

Child restraint system fixed with a seat belt

A child restraint system for a small child or baby must itself be properly restrained on the seat with the lap portion of the lap/shoulder belt.

◆ Installing child restraint system using a seat belt (child restraint lock function belt)

Install the child restraint system in accordance to the operation manual enclosed with the child restraint system.

■ Rear-facing — Infant seat/convertible seat

- 1 Place the child restraint system on the rear seat facing the rear of the vehicle.

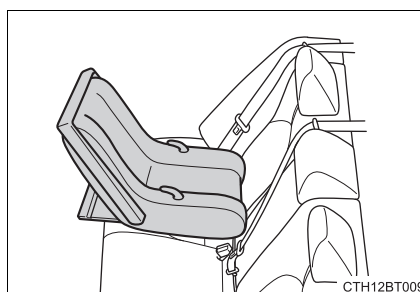

- 2 Run the seat belt through the child restraint system and insert the plate into the buckle. Make sure that the belt is not twisted.

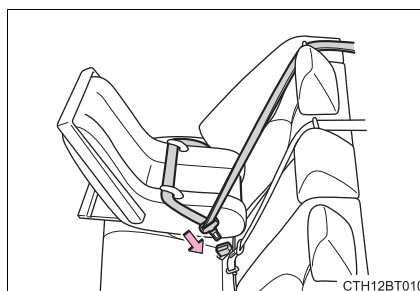

- 3 Fully extend the shoulder belt and allow it to retract to put it in lock mode. In lock mode, the belt cannot be extended.

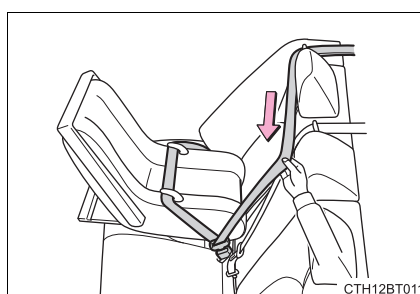

- 4 While pushing the child restraint system down into the rear seat, allow the shoulder belt to retract until the child restraint system is securely in place.

After the shoulder belt has retracted to a point where there is no slack in the belt, pull the belt to check that it cannot be extended.

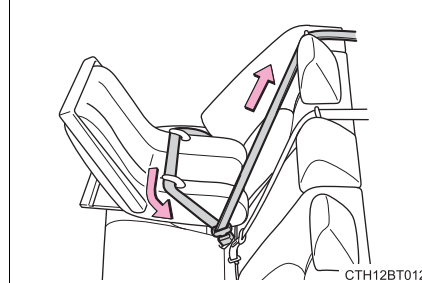

- 5 After installing the child restraint system, rock it back and forth to ensure that it is installed securely. (→P. 68)

■ Forward-facing — Convertible seat

- 1 When using the front passenger seat: Adjust the seatback

If installing the child restraint system to the front passenger seat is unavoidable, refer to P. 60 for the front passenger seat adjustment.

- 2 If the head restraint interferes with the child restraint system installation and the head restraint can be removed, remove the head restraint. (→P. 171)

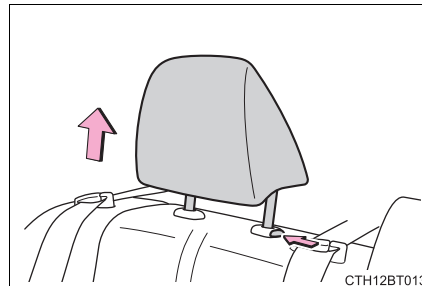

- 3 Place the child restraint system on the seat facing the front of the vehicle.



- 4 Run the seat belt through the child restraint system and insert the plate into the buckle. Make sure that the belt is not twisted.



- 5 Fully extend the shoulder belt and allow it to retract to put it in lock mode. In lock mode, the belt cannot be extended.

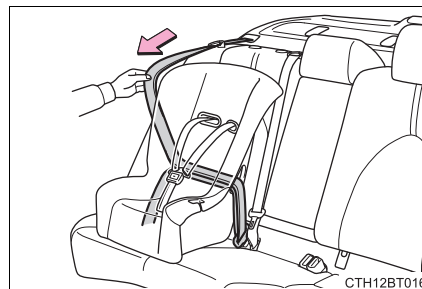

- 6 While pushing the child restraint system into the rear seat, allow the shoulder belt to retract until the child restraint system is securely in place.

After the shoulder belt has retracted to a point where there is no slack in the belt, pull the belt to check that it cannot be extended.

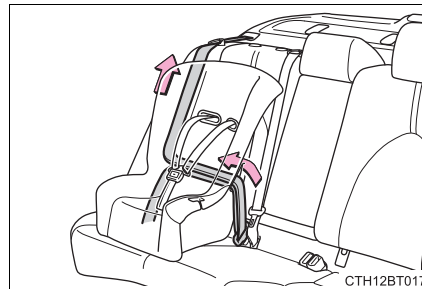

- 7 If the child restraint has a top tether strap, follow the child restraint manufacturer's operation manual regarding the installation, using the top tether strap to latch onto the top tether strap anchor. (→P. 72)
- 8 After installing the child restraint system, rock it back and forth to ensure that it is installed securely. (→P. 68)

■ Booster seat

- 1 If installing the child restraint system to the front passenger seat is unavoidable, refer to P. 60 for the front passenger seat adjustment.
- 2 High back type: If the head restraint interferes with your child restraint system, and the head restraint can be removed, remove the head restraint. (→P. 171)

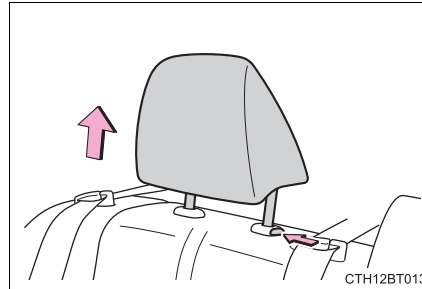

- 3 Place the child restraint system on the seat facing the front of the vehicle.

▶ Booster type

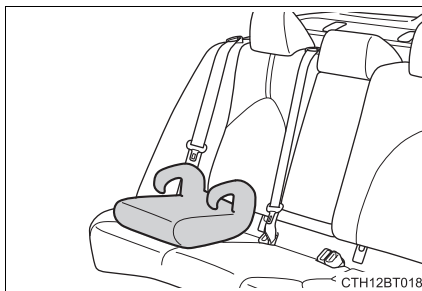

▶ High back type

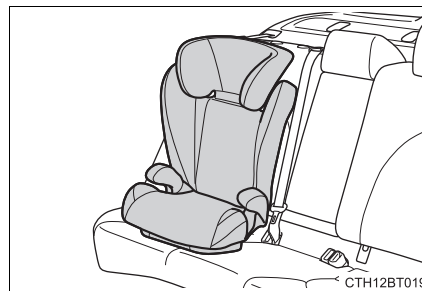

- 4 Sit the child in the child restraint system. Fit the seat belt to the child restraint system according to the manufacturer's instructions and insert the plate into the buckle. Make sure that the belt is not twisted.



Check that the shoulder belt is correctly positioned over the child's shoulder and that the lap belt is as low as possible. (→P. 30)

◆ Removing a child restraint system installed with a seat belt

Press the buckle release button and fully retract the seat belt.

When releasing the buckle, the child restraint system may spring up due to the rebound of the seat cushion. Release the buckle while holding down the child restraint system.

Since the seat belt automatically reels itself, slowly return it to the stowing position.

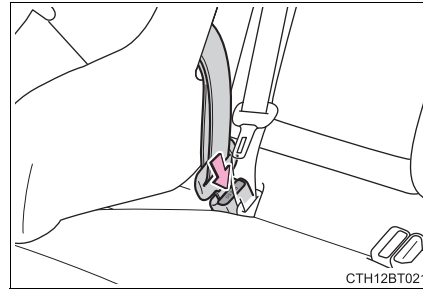

1

For safety and security

 **WARNING****■ When installing a child restraint system**

Observe the following precautions.

Failure to do so may result in death or serious injury.

- Do not allow children to play with the seat belt. If the seat belt becomes twisted around a child's neck, it may lead to choking or other serious injuries that could result in death.
If this occurs and the buckle cannot be unfastened, scissors should be used to cut the belt.
- Ensure that the belt and plate are securely locked and the seat belt is not twisted.
- Shake the child restraint system left and right, and forward and backward to ensure that it has been securely installed.
- After securing a child restraint system, never adjust the seat.
- When a booster seat is installed, always ensure that the shoulder belt is positioned across the center of the child's shoulder. The belt should be kept away from the child's neck, but not so that it could fall off the child's shoulder.
- Follow all installation instructions provided by the child restraint system manufacturer.
- When securing some types of child restraint systems in rear seats, it may not be possible to properly use the seat belts in positions next to the child restraint without interfering with it or affecting seat belt effectiveness. Be sure your seat belt fits snugly across your shoulder and low on your hips. If it does not, or if it interferes with the child restraint, move to a different position. Failure to do so may result in death or serious injury.

■ When installing a booster seat

To prevent the belt from going into ALR lock mode, do not fully extend the shoulder belt. ALR mode causes the belt to tighten only. This could cause injury or discomfort to the child. (→P. 32)

■ Do not use a seat belt extender

If a seat belt extender is used when installing a child restraint system, the seat belt will not securely hold the child restraint system, which could cause death or serious injury to the child or other passengers in the event of sudden braking, sudden swerving or an accident.

Child restraint system fixed with a child restraint LATCH anchor

■ Child restraint LATCH anchors

LATCH anchors are provided for the outboard rear seats. (Marks displaying the location of the anchors are attached to the seats.)

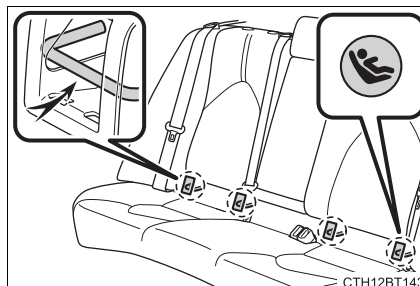

■ When installing in the rear outboard seats

Install the child restraint system in accordance to the operation manual enclosed with the child restraint system.

- 1 If the head restraint interferes with the child restraint system installation and the head restraint can be removed, remove the head restraint. (→P. 171)

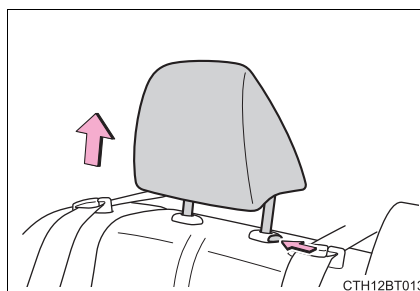

- 2 Remove the cover.

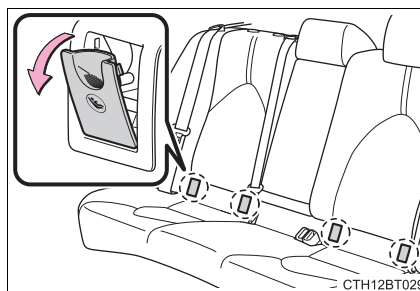

► With flexible lower attachments

- 3 Latch the hooks of the lower attachments onto the LATCH anchors.

For owners in Canada:
The symbol on a child restraint system indicates the presence of a lower connector system.

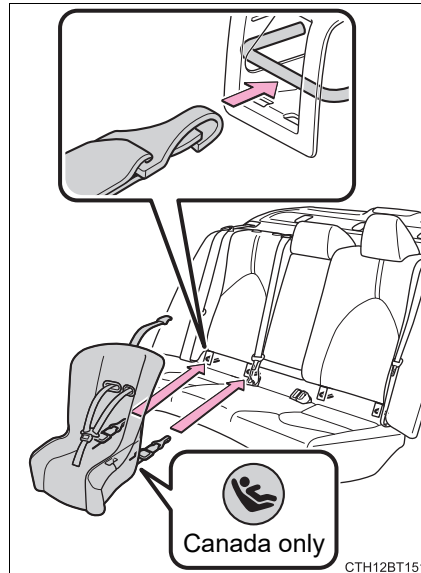

► With rigid lower attachments

- 3 Latch the buckles onto the LATCH anchors.

For owners in Canada:
The symbol on a child restraint system indicates the presence of a lower connector system.

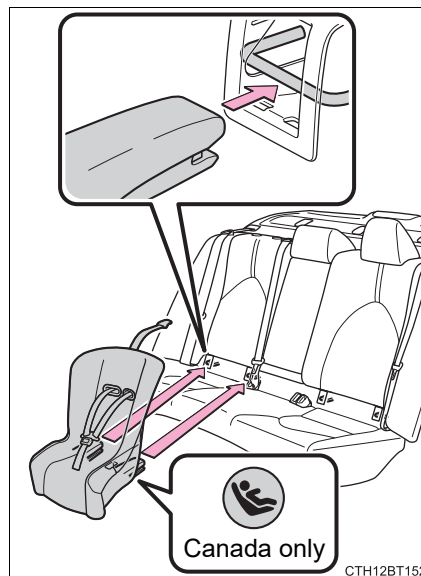

- 4 If the child restraint has a top tether strap, follow the child restraint manufacturer's operation manual regarding the installation, using the top tether strap to latch onto the top tether strap anchor. (→P. 72)

- 5 After installing the child restraint system, rock it back and forth to ensure that it is installed securely. (→P. 68)

■ When installing in the rear center seat

There are no LATCH anchors behind the rear center seat. However, the inboard LATCH anchors of the outboard seats, which are 16.1 in. (410 mm) apart, can be used if the child restraint system manufacturer's instructions permit use of those anchors with the anchor spacing stated.

Child restraint systems with rigid lower attachments cannot be installed in the center seat. This type of child restraint system can only be installed in the outboard seat.

■ Laws and regulations pertaining to anchors

The LATCH system conforms to FMVSS225 or CMVSS210.2.

Child restraint systems conforming to FMVSS213 or CMVSS213 specifications can be used.

This vehicle is designed to conform to SAE J1819.

WARNING

■ When installing a child restraint system

Observe the following precautions.

Failure to do so may result in death or serious injury.

- When using the LATCH anchors, be sure that there are no foreign objects around the anchors and that the seat belt is not caught behind the child restraint system.
- Follow all installation instructions provided by the child restraint system manufacturer.
- Never attach two child restraint system attachments to the same anchor. In a collision, one anchor may not be strong enough to hold two child restraint system attachments and may break.
If the LATCH anchors are already in use, use the seat belt to install a child restraint system in the center seat.
- When securing some types of child restraint systems in rear seats, it may not be possible to properly use the seat belts in positions next to the child restraint without interfering with it or affecting seat belt effectiveness. Be sure your seat belt fits snugly across your shoulder and low on your hips. If it does not, or if it interferes with the child restraint, move to a different position. Failure to do so may result in death or serious injury.
- If the seat is adjusted, reconfirm the security of the child restraint system.

Using an anchor bracket (for top tether strap)

■ Anchor brackets (for top tether strap)

Anchor brackets are provided for each rear seat.
Use anchor brackets when fixing the top tether strap.

- ▶ Seats with an adjustable type head restraint
- ▶ Seats with an integrated type head restraint

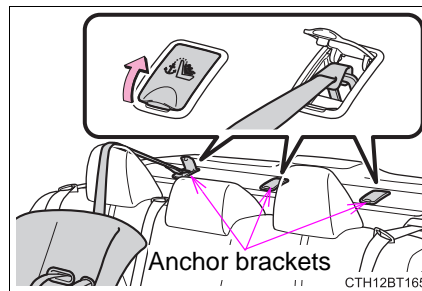
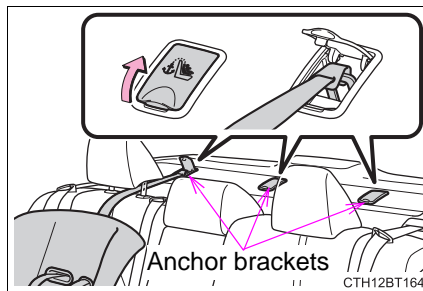

■ Fixing the top tether strap to the anchor bracket

Install the child restraint system in accordance to the operation manual enclosed with the child restraint system.

- 1 Adjust the head restraint to the upmost position.

If the head restraint interferes with the child restraint system installation and the head restraint can be removed, remove the head restraint.
(→P. 171)

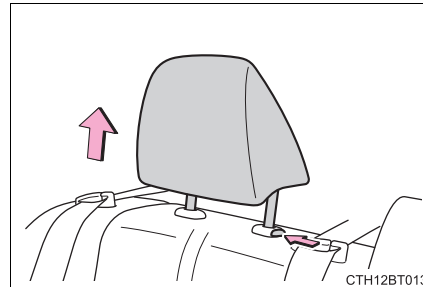

- 2 Open the anchor bracket cover, latch the hook onto the anchor bracket and tighten the top tether strap.

Make sure the top tether strap is securely latched. (→P. 68)

When installing the child restraint system with the head restraint being raised, be sure to have the top tether strap pass underneath the head restraint.

- ▶ Seats with an adjustable type head restraint ▶ Seats with an integrated type head restraint

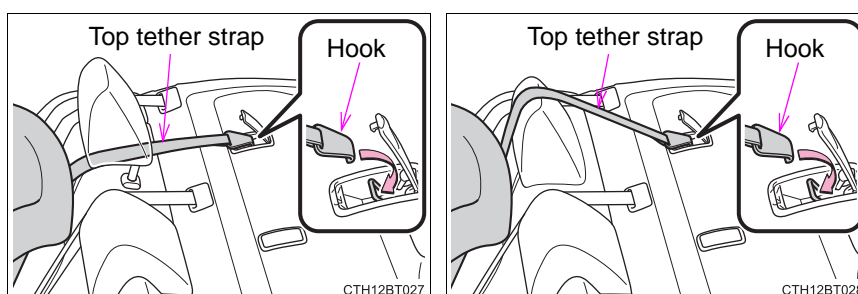

■ Laws and regulations pertaining to anchors

The LATCH system conforms to FMVSS225 or CMVSS210.2.

Child restraint systems conforming to FMVSS213 or CMVSS213 specifications can be used.

This vehicle is designed to conform to SAE J1819.

 **WARNING****■ When installing a child restraint system**

Observe the following precautions.

Failure to do so may result in death or serious injury.

- Firmly attach the top tether strap and make sure that the belt is not twisted.
- Do not attach the top tether strap to anything other than the anchor bracket.
- After securing a child restraint system, never adjust the seat.
- Follow all installation instructions provided by the child restraint system manufacturer.
- When installing the child restraint system with the head restraint being raised, after the head restraint has been raised and then the anchor bracket has been fixed, do not lower the head restraint.

 **NOTICE****■ Anchor brackets (for top tether strap)**

When not in use, make certain to close the lid. If it remains open, the lid may be damaged.

Safety Connect*

Safety Connect is a subscription-based telematics service that uses Global Positioning System (GPS) data and embedded cellular technology to provide safety and security features to subscribers. Safety Connect is supported by Toyota's designated response center, which operates 24 hours per day, 7 days per week.

Safety Connect service is available by subscription on select, telematics hardware-equipped vehicles.

By using the Safety Connect service, you are agreeing to be bound by the Telematics Subscription Service Agreement and its Terms and Conditions, as in effect and amended from time to time, a current copy of which is available at Toyota.com in the United States, Toyotapr.com in Puerto Rico and Toyota.ca in Canada. All use of the Safety Connect service is subject to such then-applicable Terms and Conditions.

■ System components

- ① Microphone
- ② LED light indicators
- ③ "SOS" button

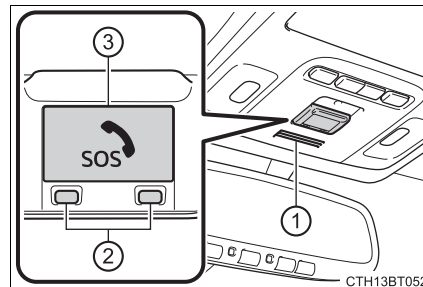

*: If equipped

■ Services

Subscribers have the following Safety Connect services available:

● Automatic Collision Notification*

Helps drivers receive necessary response from emergency service providers. (→P. 78)

*: U.S. Patent No. 7,508,298 B2

● Stolen Vehicle Location

Helps drivers in the event of vehicle theft. (→P. 78)

● Emergency Assistance Button (“SOS”)

Connects drivers to response-center support. (→P. 78)

● Enhanced Roadside Assistance

Provides drivers various on-road assistance. (→P. 79)

■ Subscription

After you have signed the Telematics Subscription Service Agreement and are enrolled, you can begin receiving services.

A variety of subscription terms are available for purchase. Contact your Toyota dealer, call the following appropriate Customer Experience Center or push the “SOS” button in your vehicle for further subscription details.

- The United States
1-800-331-4331
- Canada
1-888-869-6828
- Puerto Rico
1-877-855-8377

■ Safety Connect Services Information

- Phone calls using the vehicle's Bluetooth® technology will not be possible when Safety Connect is active and in use.
- Safety Connect is available beginning Fall 2009 on select Toyota models (in the contiguous United States only). Contact with the Safety Connect response center is dependent upon the telematics device being in operative condition, cellular connection availability, and GPS satellite signal reception, which can limit the ability to reach the response center or receive emergency service support. Enrollment and Telematics Subscription Service Agreement are required. A variety of subscription terms are available; charges vary by subscription term selected and location.
- Automatic Collision Notification, Emergency Assistance and Stolen Vehicle Location are available in the United States, including Hawaii and Alaska, Puerto Rico and Canada, and Enhanced Roadside Assistance are available in the United States, Puerto Rico and Canada.
- Automatic Collision Notification, Emergency Assistance, Stolen Vehicle and Enhanced Road Assistance are not available in the U.S. Virgin Islands. For vehicles first sold in the U.S. Virgin Islands, no Safety Connect services will function in or outside the U.S. Virgin Islands.
- Safety Connect services are not subject to section 255 of the Telecommunications Act and the device is not TTY compatible.

■ Languages

The Safety Connect response center will offer support in multiple languages. The Safety Connect system will offer voice prompts in English, Spanish, and French. Please indicate your language of choice when enrolling.

■ When contacting the response center

You may be unable to contact the response center if the network is busy.

Safety Connect LED light Indicators

When the engine switch is turned to IGNITION ON mode, the red indicator light comes on for 2 seconds then turns off. Afterward, the green indicator light comes on, indicating that the service is active.

The following indicator light patterns indicate specific system usage conditions:

- Green indicator light on = Active service
- Green indicator light flashing = Safety Connect call in process
- Red indicator light (except at vehicle start-up) = System malfunction (contact your Toyota dealer)
- No indicator light (off) = Safety Connect service not active

Safety Connect services

■ Automatic Collision Notification

In case of either airbag deployment or severe rear-end collision, the system is designed to automatically call the response center. The responding agent receives the vehicle's location and attempts to speak with the vehicle occupants to assess the level of emergency. If the occupants are unable to communicate, the agent automatically treats the call as an emergency, contacts the nearest emergency services provider to describe the situation, and requests that assistance be sent to the location.

■ Stolen Vehicle Location

If your vehicle is stolen, Safety Connect can work with local authorities to assist them in locating and recovering the vehicle. After filing a police report, call the Customer Experience Center at 1-800-331-4331 in the United States, 1-877-855-8377 in Puerto Rico or 1-888-869-6828 in Canada, and follow the prompts for Safety Connect to initiate this service.

In addition to assisting law enforcement with recovery of a stolen vehicle, Safety-Connect-equipped vehicle location data may, under certain circumstances, be shared with third parties to locate your vehicle. Further information is available at Toyota.com in the United States, Toyotapr.com in Puerto Rico and Toyota.ca in Canada.

■ Emergency Assistance Button (“SOS”)

In the event of an emergency on the road, push the “SOS” button to reach the Safety Connect response center. The answering agent will determine your vehicle's location, assess the emergency, and dispatch the necessary assistance required.

If you accidentally press the “SOS” button, tell the response-center agent that you are not experiencing an emergency.

■ Enhanced Roadside Assistance

Enhanced Roadside Assistance adds GPS data to the already included warranty-based Toyota roadside service.

Subscribers can press the “SOS” button to reach a Safety Connect response-center agent, who can help with a wide range of needs, such as: towing, flat tire, fuel delivery, etc. For a description of the Enhanced Roadside Assistance services and their limitations, please see the Safety Connect Terms and Conditions, which are available at Toyota.com in the United States, Toyotapr.com in Puerto Rico and Toyota.ca in Canada.

Safety information for Safety Connect

Important! Read this information before using Safety Connect.

■ Exposure to radio frequency signals

The Safety Connect system installed in your vehicle is a low-power radio transmitter and receiver. It receives and also sends out radio frequency (RF) signals.

In August 1996, the Federal Communications Commission (FCC) adopted RF exposure guidelines with safety levels for mobile wireless phones. Those guidelines are consistent with the safety standards previously set by the following U.S. and international standards bodies.

- ANSI (American National Standards Institute) C95.1 [1992]
- NCRP (National Council on Radiation Protection and Measurement) Report 86 [1986]
- ICNIRP (International Commission on Non-Ionizing Radiation Protection) [1996]

Those standards were based on comprehensive and periodic evaluations of the relevant scientific literature. Over 120 scientists, engineers, and physicians from universities, and government health agencies and industries reviewed the available body of research to develop the ANSI Standard (C95.1).

The design of Safety Connect complies with the FCC guidelines in addition to those standards.

Engine immobilizer system

The vehicle's keys have built-in transponder chips that prevent the engine from starting if a key has not been previously registered in the vehicle's on-board computer.

Never leave the keys inside the vehicle when you leave the vehicle.

This system is designed to help prevent vehicle theft but does not guarantee absolute security against all vehicle thefts.

Vehicles without a smart key system:

The indicator light flashes after the key has been removed from the engine switch to indicate that the system is operating.

The indicator light stops flashing after the registered key has been inserted into the engine switch to indicate that the system has been canceled.

Vehicles with a smart key system:

The indicator light flashes after the engine switch has been turned off to indicate that the system is operating.

The indicator light stops flashing after the engine switch has been turned to ACCESSORY or IGNITION ON mode to indicate that the system has been canceled.

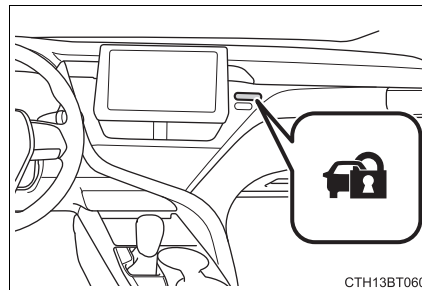

■ System maintenance

The vehicle has a maintenance-free type engine immobilizer system.

■ Conditions that may cause the system to malfunction

- If the grip portion of the key is in contact with a metallic object
- If the key is in close proximity to or touching a key to the security system (key with a built-in transponder chip) of another vehicle

 NOTICE

■ **To ensure the system operates correctly**

Do not modify or remove the system. If modified or removed, the proper operation of the system cannot be guaranteed.

Alarm

The alarm

The alarm uses light and sound to give an alert when an intrusion is detected.

The alarm is triggered in the following situations when the alarm is set:

- ▶ Vehicles without a smart key system
 - A locked door is unlocked or opened in any way other than using the wireless remote control or key. (The doors will lock again automatically.)
 - The trunk is opened in any way other than using the wireless remote control.
 - The hood is opened.
- ▶ Vehicles with a smart key system
 - A locked door is unlocked or opened in any way other than using the entry function, wireless remote control or mechanical key. (The doors will lock again automatically.)
 - The trunk is opened in any way other than using the entry function or wireless remote control.
 - The hood is opened.

Setting the alarm system

Close the doors, trunk and hood, and lock all the doors. The system will be set automatically after 30 seconds.

The indicator light changes from being on to flashing when the system is set.

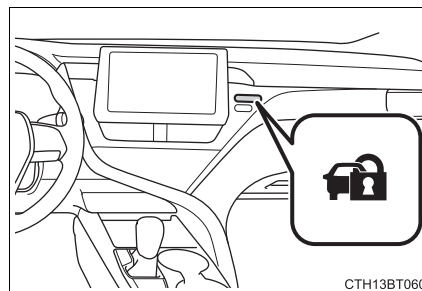

Deactivating or stopping the alarm

Do one of the following to deactivate or stop the alarm:

- ▶ Vehicles without a smart key system
 - Unlock the doors.
 - Open the trunk using the wireless remote control.
 - Turn the engine switch to the “ACC” or “ON” position, or start the engine. (The alarm will be deactivated or stopped after a few seconds.)
- ▶ Vehicles with a smart key system
 - Unlock the doors.
 - Open the trunk using the entry function or wireless remote control.
 - Turn the engine switch to ACCESSORY or IGNITION ON mode, or start the engine. (The alarm will be deactivated or stopped after a few seconds.)

■ System maintenance

The vehicle has a maintenance-free type alarm system.

■ Items to check before locking the vehicle

To prevent unexpected triggering of the alarm and vehicle theft, make sure of the following:

- Nobody is in the vehicle.
- The windows and moon roof or panoramic moon roof are closed before the alarm is set.
- No valuables or other personal items are left in the vehicle.

■ Triggering of the alarm

The alarm may be triggered in the following situations:
(Stopping the alarm deactivates the alarm system.)

- For Canada: The doors are unlocked using the key or mechanical key.

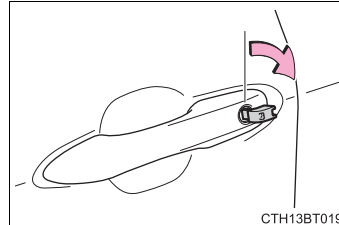

- Except for Canada: The trunk is opened using the key or mechanical key.

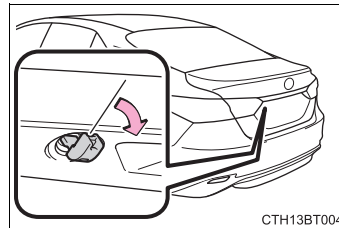

- A person inside the vehicle opens a door or the trunk or hood, or unlocks the vehicle.

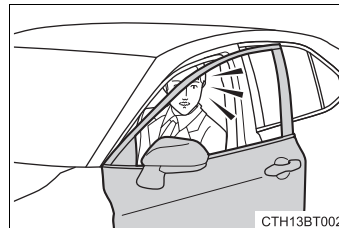

- The battery is recharged or replaced when the vehicle is locked. (→P. 565)

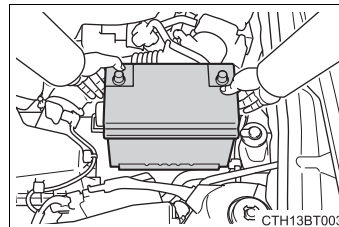

■ Alarm-operated door lock

In the following cases, depending on the situation, the door may automatically lock to prevent improper entry into the vehicle:

- When a person remaining in the vehicle unlocks the door and the alarm is activated.
- While the alarm is activated, a person remaining in the vehicle unlocks the door.
- When recharging or replacing the battery

 NOTICE

■ **To ensure the system operates correctly**



















Do not modify or remove the system. If modified or removed, the proper operation of the system cannot be guaranteed.









Instrument cluster**2****2. Instrument cluster**

Warning lights and indicators	88
Gauges and meters	94
Multi-information display (4.2-inch display)	98
Multi-information display (7-inch display)	111
Head-up display	128
Fuel consumption information	134

Warning lights

Warning lights inform the driver of malfunctions in the indicated vehicle's systems.

* ₁  (U.S.A.)	Brake system warning light (→P. 528)	* ₁  (U.S.A.)	ABS warning light (→P. 529)
* ₁  (Canada) (Red)	Brake system warning light (→P. 528)	* ₁  (Canada)	ABS warning light (→P. 529)
* ₁  (If equipped) (Yellow)	Brake system warning light (→P. 528)	* ₂ 	Inappropriate pedal operation warning light (→P. 529)
* ₂ 	High coolant temperature warning light (→P. 528)	 (U.S.A.)	Parking brake indicator (→P. 529)
* ₂ 	Charging system warning light (→P. 528)	 (Canada)	Parking brake indicator (→P. 529)
* ₂ 	Low engine oil pressure warning light (→P. 528)	* _{1, 3}  (If equipped)	Brake hold operated indicator (→P. 529)
* ₁  (U.S.A.)	Malfunction indicator lamp (→P. 529)	* ₁  (Red/yellow)	Electric power steering system warning light (→P. 530)
* ₁  (Canada)	Malfunction indicator lamp (→P. 529)	 (Yellow)	LTA indicator (→P. 530)
* ₁ 	SRS warning light (→P. 529)	* ₁  (Flashes or illuminates)	PCS warning light (→P. 530)

<p>^{*1, 3}</p>  <p>PKSB OFF indicator (→P. 530)</p> <p>(If equipped)</p>	 <p>Driver's and front passenger's seat belt reminder light (→P. 531)</p>
 <p>Intuitive parking assist OFF indicator (→P. 530)</p> <p>(If equipped)</p>	<p>^{*4}</p>  <p>Rear passengers' seat belt reminder lights (→P. 531)</p>
 <p>RCD OFF indicator (→P. 531)</p> <p>(If equipped)</p>	<p>^{*1}</p>  <p>Master warning light (→P. 532)</p>
<p>^{*1}</p>  <p>Slip indicator (→P. 531)</p>	<p>^{*1}</p>  <p>Tire pressure warning light (→P. 532)</p>
 <p>Low fuel level warning light (→P. 531)</p>	

^{*1}: These lights turn on when the engine switch is turned to the "ON" position (vehicles without a smart key system) or IGNITION ON mode (vehicles with a smart key system) to indicate that a system check is being performed. They will turn off after the engine is started, or after a few seconds. There may be a malfunction in a system if a light does not come on, or turn off. Have the vehicle inspected by your Toyota dealer.



















^{*2}: This light illuminates on the multi-information display with a message.













^{*3}: This light flashes to indicate a malfunction.

^{*4}: This light illuminates on the center panel.

Indicators

The indicators inform the driver of the operating state of the vehicle's various systems.

	Turn signal indicator (→P. 223)	^{*1} 	Brake hold standby indicator (→P. 229) (If equipped)
	Headlight indicator (→P. 231) (U.S.A.)		Cruise control indicator (→P. 290, 306)
	Tail light indicator (→P. 231) (Canada)		Dynamic radar cruise control indicator (→P. 290, 306)
	Headlight high beam indicator (→P. 232)		Cruise control "SET" indicator (→P. 290, 306)
^{*1} 	Automatic High Beam indicator (→P. 236)	^{*1, 3} 	PCS warning light (→P. 254)
^{*1, 2} 	Eco driving indicator (→P. 109, 126)	^{*1, 3} 	PKSB OFF indicator (→P. 361) (If equipped)
	Parking brake indicator (→P. 224, 225) (U.S.A.)		LTA indicator (→P. 279) (White)
	Parking brake indicator (→P. 224, 225) (Canada)		LTA indicator (→P. 255, 279) (Green)
^{*1} 	Brake hold operated indicator (→P. 229) (If equipped)	^{*4} 	LTA indicator (→P. 279) (Yellow)

<p>*1, 4</p> 	Slip indicator (→P. 323)	<p>*7</p> 	Security indicator (→P. 80, 82)
<p>*1, 3</p> 	VSC OFF indicator (→P. 325)	 <p>(If equipped)</p>	Intuitive parking assist OFF indicator (→P. 336)
 <p>(If equipped)</p>	“BSM” indicator (→P. 330)	 <p>(If equipped)</p>	RCD OFF indicator (→P. 354)
 <p>(If equipped)</p>	“RCTA” indicator (→P. 345)	 <p>(If equipped)</p>	“SPORT” indicator (→P. 375)
<p>*5, 6</p>  <p>(If equipped)</p>	BSM (Blind Spot Monitor) outside rear view mirror indicators (→P. 330)	 <p>(If equipped)</p>	“ECO MODE” indicator (→P. 375)
<p>*1, 7</p> 	“AIRBAG ON/OFF” indicator (→P. 49)	<p>*8</p> 	Low outside temperature indicator (→P. 94)

- *1: These lights turn on when the engine switch is turned to the “ON” position (vehicles without a smart key system) or IGNITION ON mode (vehicles with a smart key system) to indicate that a system check is being performed. They will turn off after the engine is started, or after a few seconds. There may be a malfunction in a system if a light does not come on, or turn off. Have the vehicle inspected by your Toyota dealer.
- *2: This light does not turn on when the system is disabled.
- *3: This light turns on when the system is off.
- *4: This light flashes to indicate that the system is operating.
- *5: These indicators will illuminate in the following situations to indicate that the system initial check is being performed:
- When the BSM function or RCTA function is enabled and the engine switch is turned to the “ON” position (vehicles without a smart key system) or IGNITION ON mode (vehicles with a smart key system).
 - When the engine switch is in the “ON” position (vehicles without a smart key system) or IGNITION ON mode (vehicles with a smart key system) and the BSM function is enabled.
 - When the engine switch is in the “ON” position (vehicles without a smart key system) or IGNITION ON mode (vehicles with a smart key system) and the RCTA function is enabled. (At this time, a buzzer will also sound.)
- The indicators will turn off after a few seconds. If the indicators do not illuminate or turn off, or if a buzzer does not sound when the RCTA function is enabled, the system may be malfunctioning. Have the vehicle inspected by your Toyota dealer.
- *6: This light illuminates on the outside rear view mirrors.
- *7: This light illuminates on the center panel.
- *8: When the outside temperature is approximately 37°F (3°C) or lower, this indicator will flash for approximately 10 seconds, then stay on.

 **WARNING**

■ If a safety system warning light does not come on

Should a safety system light such as the ABS and SRS warning lights not come on when you start the engine, this could mean that these systems are not available to help protect you in an accident, which could result in death or serious injury. Have the vehicle inspected by your Toyota dealer immediately if this occurs.

Gauges and meters

► 4.2-inch display

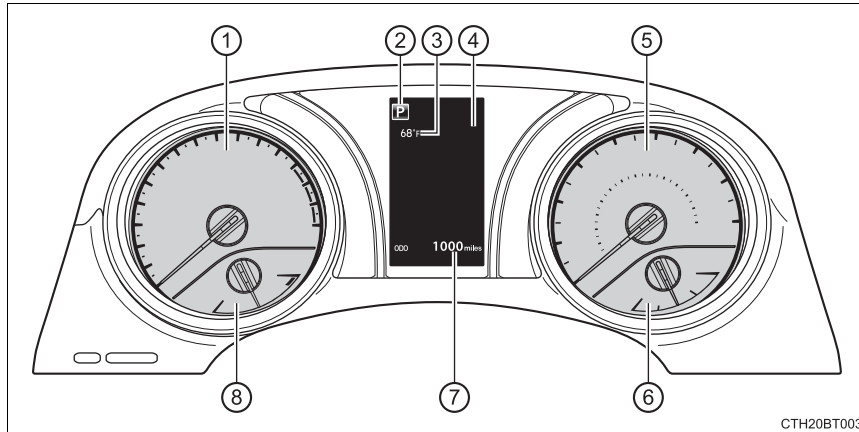

CTH20BT003

► 7-inch display

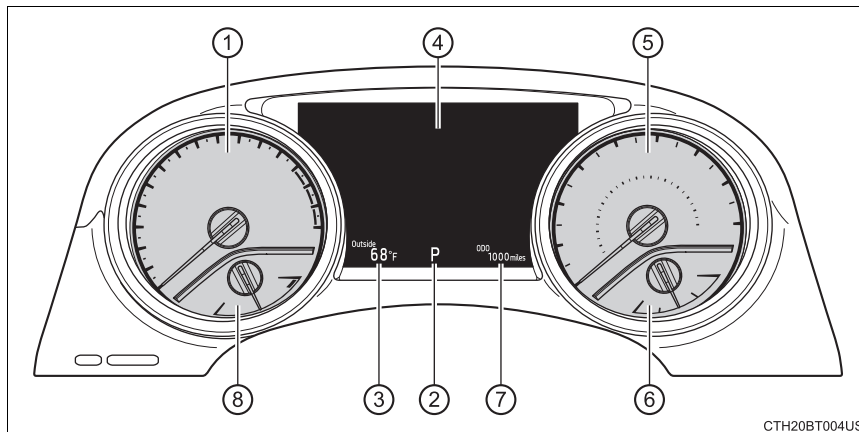

CTH20BT004US

- ① Tachometer
Displays the engine speed in revolutions per minute
- ② Shift position (→P. 217)
- ③ Outside temperature
Displays the outside temperature within the range of -40°F (-40°C) to 122°F (50°C). Low outside temperature indicator comes on when the ambient temperature is 37°F (3°C) or lower.
- ④ Multi-information display
Presents the driver with a variety of vehicle data (→P. 98, 111)
Displays warning messages in case of a malfunction (→P. 538)
- ⑤ Speedometer
- ⑥ Fuel gauge
Displays the fuel level. In the following situations, the actual fuel level may not be displayed correctly:
 - After refueling only a small amount (approximately 5 L or less)
 - When stopped on a hill or other slope
 - When driving on a slope or around a curve
- ⑦ Odometer and trip meter (→P. 108, 125)
- ⑧ Engine coolant temperature gauge
Displays the engine coolant temperature

Instrument panel light control

The brightness of the instrument panel lights can be adjusted.

- ① Darker
- ② Brighter
 - The brightness of the instrument panel lights can be adjusted individually for day mode and night mode*.
 - If the brightness is adjusted when the surroundings are bright and the tail lights are on (day mode brightness adjustment), the brightness level of night mode will be adjusted at the same time.

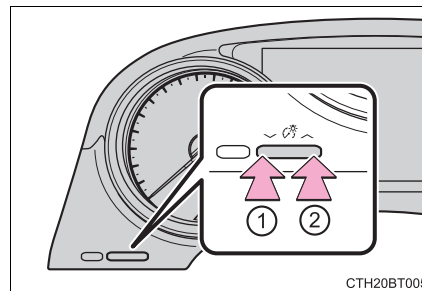

CTH20BT005

*: Day mode and night mode: →P. 96

■ The meters and display illuminate when

- ▶ Vehicles without a smart key system

The engine switch is in the "ON" position.

- ▶ Vehicles with a smart key system

The engine switch is in IGNITION ON mode.

■ Brightness of the meters (day mode and night mode)

- The brightness of the meters is changed between day mode and night mode.
 - Day mode: When the tail lights are off or when the tail lights are on but the surrounding area is bright
 - Night mode: When the tail lights are on and the surrounding area is dark
- When in night mode, the brightness will be reduced slightly unless the meters are set to the maximum brightness level.

■ Outside temperature display

In the following situations, the correct outside temperature may not be displayed, or the display may take longer than normal to change:

- When stopped, or driving at low speeds (less than 16 mph [25 km/h])
- When the outside temperature has changed suddenly (at the entrance/exit of a garage, tunnel, etc.)
- When "—" or "E" is displayed, the system may be malfunctioning.
Take your vehicle to your Toyota dealer.

■ Fuel gauge and driving range display

The fuel gauge and driving range display are linked. If the fuel gauge and driving range display do not update after refueling a small amount, they can be updated by performing the following procedure:

- 1 Stop the vehicle on a level surface.
Wait until the fuel in the fuel tank stabilizes.
- 2 Press the ODO/TRIP switch to change the odometer and trip meter display to the odometer.
- 3 Turn the engine switch off.
- 4 Vehicles without a smart key system:
While pressing and holding the ODO/TRIP switch, turn the engine switch to the "ON" position.

Vehicles with a smart key system:
While pressing and holding the ODO/TRIP switch, turn the engine switch to IGNITION ON mode.
- 5 Continue holding the ODO/TRIP switch for approximately 5 seconds.
Release the switch when the odometer begins blinking.
Updating will be complete when the odometer blinks for approximately 5 seconds and then returns to the normal display.

 NOTICE**■ To prevent damage to the engine and its components**

- Do not let the indicator needle of the tachometer enter the red zone, which indicates the maximum engine speed.
- The engine may be overheating if the engine coolant temperature gauge is in the red zone (H). In this case, immediately stop the vehicle in a safe place, and check the engine after it has cooled completely. (→P. 567)

Multi-information display (4.2-inch display)

Summary of functions

The multi-information display presents the driver with a variety of driving-related data, such as the current outside temperature. The multi-information display can also be used to change the display settings and other settings.

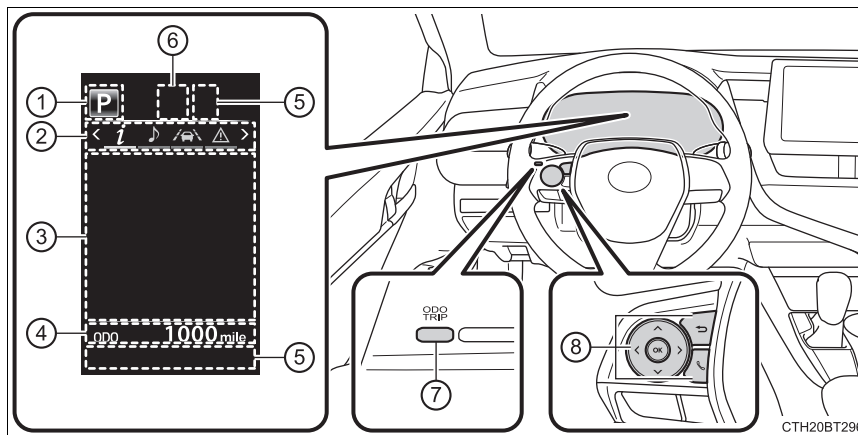

① Shift position (→P. 217)

② Menu icon display area

Displays the following items.

When a menu icon is not selected, the outside temperature and clock are displayed.

- Menu icons (→P. 100)
- Outside temperature (→P. 94)
- Clock*

*: For clock settings, refer to “NAVIGATION AND MULTIMEDIA SYSTEM OWNER’S MANUAL”.

③ Content display area

A variety of information can be displayed by selecting a menu icon. Additionally, warning or suggestion/advice pop-up displays will be displayed in some situations.

- Menu icon content (→P. 100)
- Suggestion function (→P. 108)
- Warning message (→P. 538)

④ Odometer/trip meter (→P. 108)

⑤ Indicators (→P. 88)

- ⑥ RSA (Road Sign Assist) (if equipped) (→P. 285)
- ⑦ “ODO/TRIP” switch (→P. 99)
- ⑧ Meter control switches (→P. 99)

Using the multi-information display

◆ Using the content display area

The content display area is operated using the meter control switches.

- ① Scroll screens*, change the displayed content* and move the cursor
- ② Press: Enter/Set
Press and hold: Reset
- ③ Return to the previous screen

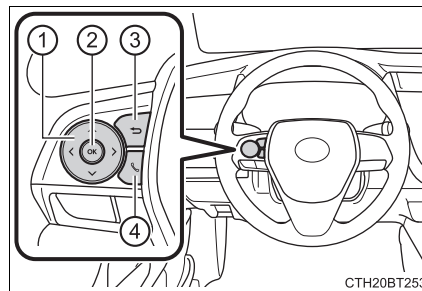

Pressing and holding the switch will display the first screen of the selected menu icon.

- ④ Call sending/receiving and history display

Linked with the hands-free system, sending or receiving call is displayed. For details regarding the hands-free system, refer to “NAVIGATION AND MULTIMEDIA SYSTEM OWNER’S MANUAL”.

*: When the screen can be scrolled or different content can be displayed, a mark, such as an arrow, will be displayed to suggest which switch to operate.

◆ Using the odometer/trip meter

Items in this area are operated using the “ODO/TRIP” switch.

Press: Change displayed item

Each time the switch is pressed, the displayed item will be changed.

Press and hold: Reset

Display the desired trip meter and press and hold the switch to reset the trip meter.

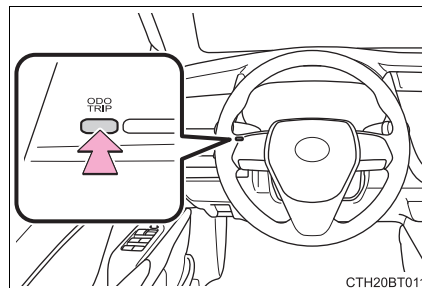

Menu icons

Select a menu icon to display its content.



Drive information (→P. 101)

Select to display various drive data.



Audio system-linked display

Select to enable selection of an audio source or track on the meter using the meter control switches.



Driving assist system information

Select to display the operational status of the following systems:

- Dynamic radar cruise control with full-speed range (if equipped) (→P. 290)
- Dynamic radar cruise control (if equipped) (→P. 306)
- LTA (Lane Tracing Assist) (→P. 270)
- RSA (Road Sign Assist) (if equipped) (→P. 285)



Warning message display (→P. 538)

Select to display warning messages and measures to be taken if a malfunction is detected.



Settings display (→P. 103)

Select to change the meter display settings and other settings.

Drive information (i)

■ Trip (after start)

- ① Average fuel economy*
Displays the average fuel consumption since engine start.
- ② Average vehicle speed
Displays the average vehicle speed since engine start.
- ③ Elapsed time
Displays the time elapsed since engine start.

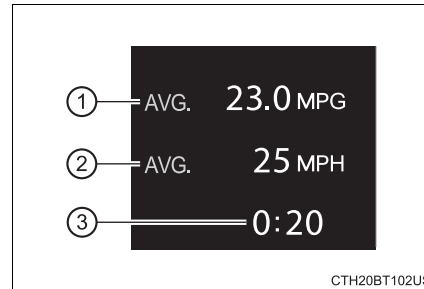

*: Use the displayed fuel consumption as a reference only.

■ Total (after reset)

- ① Current fuel consumption
Displays the instantaneous current fuel consumption.
- ② Average fuel economy*^{1, 2}
Displays the average fuel consumption since the display was reset.
- ③ Average vehicle speed/
Elapsed time*¹

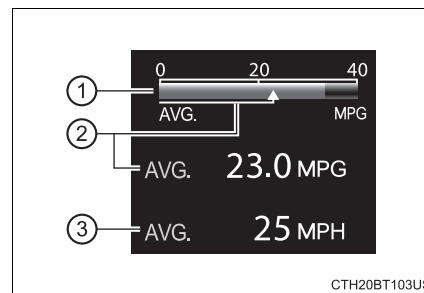

Displays the average vehicle speed since reset or elapsed time since reset, as selected in . (→P. 103)

*1: Pressing and holding will reset the average fuel consumption and average vehicle speed/elapsed time.

*2: Use the displayed fuel consumption as a reference only.

2

Instrument cluster

■ Tank (after refuel)

① Driving range*^{1, 2}

Displays the driving range with remaining fuel.

② Average fuel economy*^{1, 3}

Displays the average fuel consumption since the vehicle was refueled.

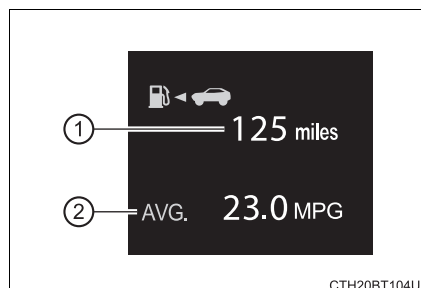

*1: When only a small amount of fuel is added to the tank, the display may not be updated.

When refueling, turn the engine switch off. If the vehicle is refueled without turning the engine switch off, the display may not be updated.

*2: This distance is computed based on your average fuel consumption. As a result, the actual distance that can be driven may differ from that displayed.

*3: Use the displayed fuel consumption as a reference only.

■ Eco Driving Indicator

→P. 109

■ Speedometer

Displays the vehicle speed.

■ Tire pressure (vehicles with a tire inflation pressure display function)

→P. 474

■ Blank (No items)

Displays no drive information contents.

Settings display (⚙️)

◆ Changing settings

Use the meter control switches on the steering wheel to change settings.

- 1 Press < or > to select ⚙️.
- 2 Operate the switches to select a desired item.
- 3 Change the setting by referring to the message displayed on the screen.

◆ Setting items



■ 🚗 LTA (Lane Tracing Assist) (→P. 270)

The following LTA system settings can be changed:



Item	Settings	Details
Lane center	On	Select to enable/disable the lane centering function.
	Off	
Alert sensitivity	High	Select to set the warning sensitivity.
	Std.	
Sway warning	On	Select to enable/disable the vehicle sway warning.
	Off	
Sway sensitivity	High	Select to set the vehicle sway warning sensitivity.
	Std.	
	Low	

■  **PCS (Pre-Collision System) (→P. 254)**

The following pre-collision system settings can be changed:

Item	Settings	Details
PCS	On	Select to enable/disable the pre-collision system.
	Off	
Warning sensitivity	 Early	Select to change the warning timing.
	 Middle	
	 Late	

■  **DRCC (Dynamic Radar Cruise Control) (→P. 290, 306)**

Item	Settings	Details
Curve speed reduction	 Strong	Select to change the vehicle speed reduction strength.
	 Weak	
	Off	

■  **BSM (Blind Spot Monitor) function (if equipped) (→P. 330)**

Item	Settings	Details
BSM	On	Select to enable/disable the Blind Spot Monitor function.
	Off	

■ **RCTA (Rear Cross Traffic Alert) function (if equipped) (→P. 345)**

Item	Settings	Details
RCTA	On	Select to enable/disable the Rear Cross Traffic Alert function.
	Off	

■ **RCD (Rear Camera Detection) function (if equipped) (→P. 354)**





Item	Settings	Details
RCD	On	Select to enable/disable the rear camera detection.
	Off	

■  **RSA (Road Sign Assist) (if equipped) (→P. 285)**

The following RSA settings can be changed:

Item	Settings	Details
RSA	On	Select to enable/disable the RSA.
	Off	
Notification method	Excess speed notification	Select a notification method used to warn the driver if the vehicle speed exceeds the speed displayed on the speed limit sign on the multi-information display. Available methods: <ul style="list-style-type: none"> • No notification • Display only • Display and buzzer
	Other notifications	Select a notification method used to warn the driver if the system detects the vehicle approaching to the no-entry road when a do not enter sign is displayed on the multi-information display. Available methods: <ul style="list-style-type: none"> • No notification • Display only • Display and buzzer
Excess speed notification level	5 mph (10 km/h)	Select a speed threshold over which the excess speed notification will start to operate when a speed limit sign is displayed on the multi-information display.
	3 mph (5 km/h)	
	1 mph (2 km/h)	

■ Vehicle settings

Item	Settings	Details
 BSM (Blind Spot Monitor) (if equipped) (→P. 330)		
Outside rear view mirror indicator brightness	Bright	Select to change the brightness of the outside rear view mirror indicators.
	Dim	
Notification timing for presence of approaching vehicle (sensitivity)	 Early	Select to change the notification timing for an approaching vehicle.
	 Middle	
	 Late	
	Only when vehicle detected in blind spot	
RCTA (Rear Cross Traffic Alert) (if equipped) (→P. 345)		
RCTA buzzer volume	1 (Low)	Select to change the volume of the RCTA buzzer.
	2 (Medium)	
	3 (Loud)	
TPWS (Tire pressure warning system) (→P. 474)		
Set pressure (tire pressure warning system initialization)		Select to initialize the tire pressure warning system. To perform initialization, press and hold the  switch. Before performing initialization, make sure to adjust the inflation pressure of each tire to the specified level. (→P. 475)
Change wheel (change the tire pressure warning system sensor ID code set) (vehicles without a tire inflation pressure display function)		Select to change the tire pressure warning system sensor ID code set. To enable this function, a second set of tire pressure warning system sensor ID codes must be registered by a Toyota dealer. For information regarding changing the registered ID code set, contact your Toyota dealer. (→P. 477)

Item	Settings	Details
Change wheel (register tire pressure warning system sensor ID codes) (vehicles with a tire inflation pressure display function)		Select to register the ID codes of the tire pressure sensors to the tire pressure warning system. To register the ID codes, press and hold the  switch. (→P. 477)
Rear seat reminder (→P. 154)	On	Select to enable/disable the rear seat reminder.
	Off	
Scheduled maintenance display (if equipped)		
Maintenance data reset		Select to reset the message indicating maintenance is required, after the required maintenance is performed. (→P. 448)

■ Meter settings

Item	Settings	Details
Language		Select to change the language displayed.
Units		Select to change the units of measure displayed.
 (Eco Driving Indicator Light)	On	Select to enable/disable the Eco Driving Indicator Light. (→P. 109)
	Off	
Drive information (total [after reset])	Average vehicle speed	Select to change the display between average speed/elapsed time.
	Elapsed time	
Pop-up display	Incoming calls	Select to enable/disable the pop-up display.
	Brightness adjustment	
Default setting		Select to reset the meter display settings to the default setting.

Odometer/trip meter

■ **Odometer**

Displays the total distance the vehicle has been driven.

■ **Trip meter A/trip meter B**

Displays the distance the vehicle has been driven since the meter was last reset. Trip meters A and B can be used to record and display different distances independently.

To reset, display the desired trip meter and press and hold the “ODO/TRIP” switch.

Suggestion function

Displays suggestions to the driver in the following situations. To select a response to a displayed suggestion, use the meter control switches.

The suggestion function can be turned on/off.
(Customizable features: →P. 606)

■ **Suggestion to turn off the headlights**

If the headlights are left on for a certain amount of time after the engine switch has been turned off, if the headlight switch is in the “AUTO” position, a suggestion message will be displayed asking if you wish to turn the headlights off. To turn the headlights off, select “Yes”.

If a front door is opened after the engine switch is turned off, this suggestion message will not be displayed.

■ Eco Driving Indicator

- ① Eco Driving Indicator Light
During Eco-friendly acceleration (Eco driving), the Eco Driving Indicator Light will turn on. When the acceleration exceeds the Zone of Eco driving, or when the vehicle is stopped, the light turns off.
- ② Eco Driving Indicator Zone Display
Suggests the Zone of Eco driving with current Eco driving ratio based on acceleration.
- ③ Eco driving ratio based on acceleration
If the acceleration exceeds the Zone of Eco driving, the right side of the Eco Driving Indicator Zone Display will illuminate.
- ④ Zone of Eco driving

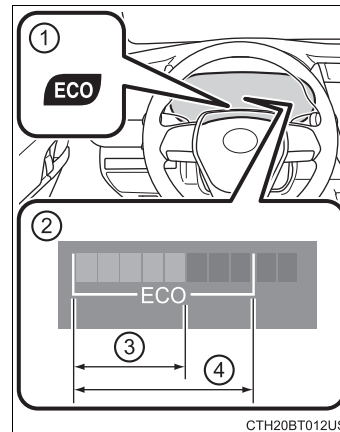

Eco Driving Indicator will not operate under the following conditions:

- The shift lever is in any position other than D.
- A paddle shift switch (if equipped) is operated.
- The vehicle speed is approximately 80 mph (130 km/h) or higher.

■ Suspension of the settings display

- Some settings cannot be changed while driving. When changing settings, park the vehicle in a safe place.
- If a warning message is displayed, operation of the settings display will be suspended.

■ Tire pressure (vehicles with a tire inflation pressure display function)

- It may take a few minutes to display the tire inflation pressure after the engine switch is turned to the "ON" position (vehicles without a smart key system) or IGNITION ON mode (vehicles with a smart key system). It may also take a few minutes to display the tire inflation pressure after inflation pressure has been adjusted.
- "--" may be displayed if the tire position information cannot be determined due to unfavorable radio wave conditions.
- Tire inflation pressure changes with temperature. The displayed values may also be different from the values measured using a tire pressure gauge.

■ Liquid crystal display

Small spots or light spots may appear on the display. This phenomenon is characteristic of liquid crystal displays, and there is no problem continuing to use the display.

■ Customization

Some functions can be customized. (→P. 103, 606)

 **WARNING****■ Caution for use while driving**

- When operating the multi-information display while driving, pay extra attention to the safety of the area around the vehicle.
- Do not look continuously at the multi-information display while driving as you may fail to see pedestrians, objects on the road, etc. ahead of the vehicle.

■ The information display at low temperatures

Allow the interior of the vehicle to warm up before using the liquid crystal information display. At extremely low temperatures, the information display monitor may respond slowly, and display changes may be delayed.

For example, there is a lag between the driver's shifting and the new gear number appearing on the display. This lag could cause the driver to down-shift again, causing rapid and excessive engine braking and possibly an accident resulting in death or injury.

■ Cautions during setting up the display

As the engine needs to be running during setting up the display, ensure that the vehicle is parked in a place with adequate ventilation. In a closed area such as a garage, exhaust gases including harmful carbon monoxide (CO) may collect and enter the vehicle. This may lead to death or a serious health hazard.

 **NOTICE****■ While setting up the display**

To prevent battery discharge, ensure that the engine is running while setting up the display features.

Multi-information display (7-inch display)

Summary of functions

The multi-information display presents the driver with a variety of driving-related data, such as the current outside temperature. The multi-information display can also be used to change the display settings and other settings.

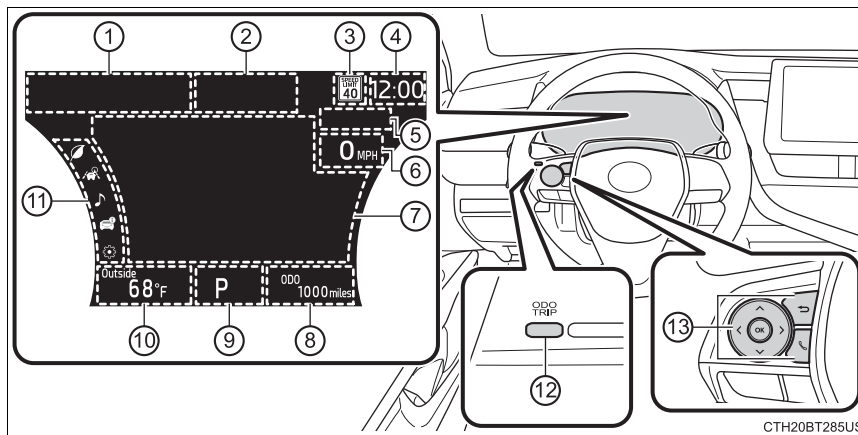

- ① Indicators (→P. 91)
- ② Driving assist system status display area

Displays the operational status of the following systems:

 - Dynamic radar cruise control with full-speed range (if equipped) (→P. 290)
 - Dynamic radar cruise control (if equipped) (→P. 306)
 - LTA (Lane Tracing Assist) (→P. 270)
- ③ Speed limit display (vehicles with a navigation system) (U.S.A. only) /RSA (Road Sign Assist) (if equipped) (→P. 285)
- ④ Clock

For clock settings, refer to “NAVIGATION AND MULTIMEDIA SYSTEM OWNER’S MANUAL”.
- ⑤ RSA (Road Sign Assist) (if equipped) (→P. 285)
- ⑥ Speedometer

The speedometer display can be enabled/disabled in  on the multi-information display. (→P. 117)

⑦ Content display area

A variety of information can be displayed by selecting a menu icon. Additionally, warning or suggestion/advice pop-up displays will be displayed in some situations.

- Menu icon content (→P. 114)
- Suggestion function (→P. 125)
- Warning message (→P. 538)

⑧ Odometer/trip meter (→P. 125)

⑨ Shift position (→P. 217)

⑩ Outside temperature (→P. 94)

⑪ Menu icons (→P. 114)

⑫ “ODO/TRIP” switch (→P. 113)

⑬ Meter control switches (→P. 113)

Using the multi-information display

◆ Using the content display area

The content display area is operated using the meter control switches.

- ① Scroll screens*, change the displayed content* and move the cursor
- ② Press: Enter/Set
Press and hold: Reset/Display the next screen
- ③ Return to the previous screen

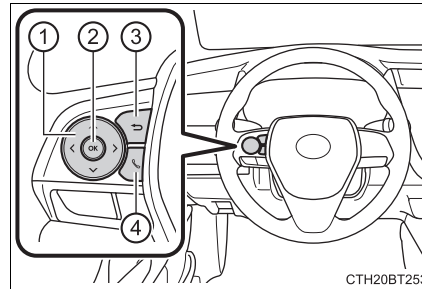

Pressing and holding the switch will display the first screen of the selected menu icon.

- ④ Call sending/receiving and history display

Linked with the hands-free system, sending or receiving call is displayed. For details regarding the hands-free system, refer to "NAVIGATION AND MULTIMEDIA SYSTEM OWNER'S MANUAL".

*: When the screen can be scrolled or different content can be displayed, a mark, such as an arrow, will be displayed to suggest which switch to operate.

◆ Using the odometer/trip meter

Items in this area are operated using the "ODO/TRIP" switch.

Press: Change displayed item

Each time the switch is pressed, the displayed item will be changed.

Press and hold: Reset

Display the desired trip meter and press and hold the switch to reset the trip meter.

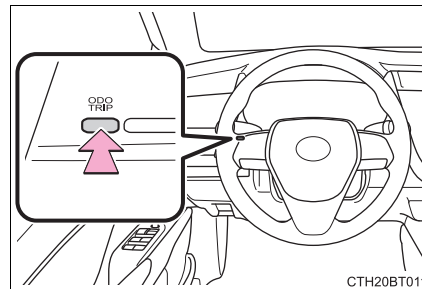

Menu icons

Select a menu icon to display its content.



Warning message display (→P. 538)

This menu icon will be displayed only when a warning message can be displayed.

Select to display warning messages and measures to be taken if a malfunction is detected.



Eco-friendly driving information (→P. 115)

Select to display fuel consumption data in various forms.



Driving assist system information

Select to perform the following:

Display the operational status of the following systems:

- Dynamic radar cruise control with full-speed range (if equipped) (→P. 290)
- Dynamic radar cruise control (if equipped) (→P. 306)
- LTA (Lane Tracing Assist) (→P. 270)
- RSA (Road Sign Assist) (if equipped) (→P. 285)

Display the following navigation system-linked information (if equipped):

- Route guidance
- Compass display



Audio system-linked display

Select to enable selection of an audio source or track on the meter using the meter control switches.



Vehicle information

Select to perform the following:

Display the following information:

- Tire inflation pressure (→P. 474)

Enable/Disable the following systems:

- Intuitive parking assist (if equipped) (→P. 336)
- BSM (Blind Spot Monitor) function (if equipped) (→P. 330)
- RCTA (Rear Cross Traffic Alert) function (if equipped) (→P. 345)

This function can also be enabled/disabled on .



Settings display (→P. 117)

Select to change the meter display settings and other settings.

Eco-friendly driving information ()

Fuel consumption

- ① Current fuel consumption
Displays the instantaneous current fuel consumption.
- ② Average fuel economy (after start)
Displays the average fuel consumption since engine start.*1
- ③ Driving range
Displays the driving range with remaining fuel.*2, 3
- ④ Gadget*4
The following items can be displayed by changing the settings for gadget content and fuel economy type on . (→P. 117)

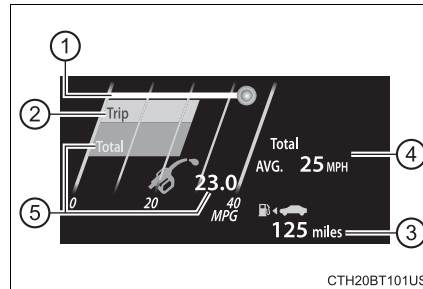

2

Instrument cluster

Displayable item		Content
Gadget content	Fuel economy type	
Average vehicle speed	Trip (after start)	Displays the average vehicle speed since engine start.
	Total (after reset)	Displays the average vehicle speed since the display was reset.*5
Distance	Trip (after start)	Displays the distance driven since vehicle start.
	Total (after reset)	Displays the distance driven since the display was reset.*5
Elapsed time	Trip (after start)	Displays the elapsed time since engine start.
	Total (after reset)	Displays the elapsed time since the display was reset.*5

⑤ Average fuel economy

Displayed item (listed below) can be changed on the fuel economy type screen of . (→P. 117)

● Total (after reset)

Displays the average fuel consumption since the display was reset. *1, 5

● Tank (after refuel)

Displays the average fuel consumption since the vehicle was refueled. *1, 2

*1: Use the displayed fuel consumption as a reference only.

*2: When only a small amount of fuel is added to the tank, the display may not be updated.

When refueling, turn the engine switch off. If the vehicle is refueled without turning the engine switch off, the display may not be updated.

*3: This distance is computed based on your average fuel consumption. As a result, the actual distance that can be driven may differ from that displayed.

*4: The default setting is no display.

*5: This display can be reset by pressing and holding  while it is displayed.

■ Eco indicator

• Eco Driving Indicator

→P. 126

• Driving range

Displays the driving range with remaining fuel.

When only a small amount of fuel is added to the tank, the display may not be updated.

When refueling, turn the engine switch off. If the vehicle is refueled without turning the engine switch off, the display may not be updated.

This distance is computed based on your average fuel consumption. As a result, the actual distance that can be driven may differ from that displayed.

■ Speedometer display/Driving range

① Speedometer display

Displays the vehicle speed.

② Driving range

Displays the driving range with remaining fuel.

When only a small amount of fuel is added to the tank, the display may not be updated.

When refueling, turn the engine switch off. If the vehicle is refueled without turning the engine switch off, the display may not be updated.

This distance is computed based on your average fuel consumption. As a result, the actual distance that can be driven may differ from that displayed.



2

Instrument cluster

Settings display (⚙️)

◆ Changing settings

Use the meter control switches on the steering wheel to change settings.

1 Press or to select .

2 Operate the switches to select a desired item.

3 Press or press and hold .

The available settings will differ depending on if is pressed or pressed and held. Follow the instructions on the display.

◆ Setting items



■ LTA (Lane Tracing Assist) (→P. 270)

Press and hold  to change the settings of the following items:

Item	Settings	Details
Lane center	On	Select to enable/disable the lane centering function.
	Off	
Alert sensitivity	High	Select to set the warning sensitivity.
	Std.	
Sway warning	On	Select to enable/disable the vehicle sway warning.
	Off	
Sway sensitivity	High	Select to set the vehicle sway warning sensitivity.
	Std.	
	Low	



■ PCS (Pre-Collision System) (→P. 254)

Press and hold  to change the settings of the following items:

Item	Settings	Details
PCS	On	Select to enable/disable the pre-collision system.
	Off	
Warning sensitivity	 Early	Select to change the warning timing.
	 Middle	
	 Late	

■ DRCC (Dynamic Radar Cruise Control) (→P. 290, 306)

Press and hold  to change the settings of the following item:



Item	Settings	Details
Curve speed reduction	 Strong	Select to change the vehicle speed reduction strength.
	 Weak	
	Off	

■  **BSM (Blind Spot Monitor) (if equipped) (→P. 330)**

Press  to enable/disable the Blind Spot Monitor function.

Item	Settings	Details
BSM	On	Select to enable/disable the Blind Spot Monitor function.
	Off	

Press and hold  to change the settings of the following item:

Item	Settings	Details
Outside rear view mirror indicator brightness	Bright	Select to change the brightness of the outside rear view mirror indicators.
	Dim	
Notification timing for presence of approaching vehicle (sensitivity)	 Early	Select to change the notification timing for an approaching vehicle.
	 Middle	
	 Late	
	Only when vehicle detected in blind spot	

■  **RCTA (Rear Cross Traffic Alert) (if equipped) (→P. 345)**

Press  to enable/disable the Rear Cross Traffic Alert function.

Item	Settings	Details
RCTA	On	Select to enable/disable the Rear Cross Traffic Alert function.
	Off	

Press and hold  to change the settings of the following item:

Item	Settings	Details
RCTA buzzer volume	1 (Low)	Select to change the volume of the RCTA buzzer.
	2 (Medium)	
	3 (Loud)	

■ **RCD (Rear Camera Detection) function (if equipped) (→P. 354)**

Press  to enable/disable the rear camera detection function.

Item	Settings	Details
RCD	On	Select to enable/disable the rear camera detection.
	Off	

■  **PKSB (Parking Support Brake) (if equipped) (→P. 360)**

Press  to enable/disable the Parking Support Brake.

Item	Settings	Details
PKSB	On	Select to enable/disable the Parking Support Brake system.
	Off	

■  **Intuitive parking assist (if equipped) (→P. 336)**

Press  to enable/disable the Intuitive parking assist.

Item	Settings	Details
Intuitive parking assist	On	Select to enable/disable the intuitive parking assist.
	Off	

Press and hold  to change the settings of the following item:

Item	Settings	Details
Volume	1 (Low)	Select to change the volume of the intuitive parking assist buzzer.
	2 (Medium)	
	3 (Loud)	

■  **HUD (Head-up display) (if equipped) (→P. 128)**

Press  to enable/disable the head-up display.

Item	Settings	Details
HUD	On	Select to enable/disable the head-up display.
	Off	

Press and hold  to change the settings of the following items:

Item	Settings	Details
HUD Brightness/Position		Select to adjust the brightness/position of the head-up display. <ul style="list-style-type: none"> • Press the < / > switch to adjust the display brightness. • Press the ^ / v switch to adjust the display position.
HUD Driving support	Tachometer settings	Select to change the display between the following: <ul style="list-style-type: none"> • Eco Driving Indicator • Tachometer • No content
	Navigation system (if equipped)	Select to enable/disable head-up display content.
	Driving Assist	
	Compass (if equipped)	
Rotation		Select to adjust the angle of the head-up display. <p>Press the < / > switch to adjust the display angle.</p>



■  **RSA (Road Sign Assist) (if equipped) (→P. 285)**

Press and hold  to change the settings of the following items:

Item	Settings	Details
RSA	On	Select to enable/disable the RSA.
	Off	
Notification method	Excess speed notification	Select a notification method used to warn the driver if the vehicle speed exceeds the speed displayed on the speed limit sign on the multi-information display. Available methods: <ul style="list-style-type: none"> • No notification • Display only • Display and buzzer
	Other notifications	Select a notification method used to warn the driver if the system detects the vehicle approaching to the no-entry road when a do not enter sign is displayed on the multi-information display. Available methods: <ul style="list-style-type: none"> • No notification • Display only • Display and buzzer
Excess speed notification level	5 mph (10 km/h)	Select a speed threshold over which the excess speed notification will start to operate when a speed limit sign is displayed on the multi-information display.
	3 mph (5 km/h)	
	1 mph (2 km/h)	





■ Vehicle settings

Press and hold  to change the settings of the following items:

Item	Settings	Details
TPWS (Tire pressure warning system) (→P. 474)		
Set pressure (tire pressure warning system initialization)		Select to initialize the tire pressure warning system. To perform initialization, press and hold the  switch. Before performing initialization, make sure to adjust the inflation pressure of each tire to the specified level. (→P. 475)
Change wheel (change the tire pressure warning system sensor ID code set) (vehicles without a tire inflation pressure display function)		Select to change the tire pressure warning system sensor ID code set. To enable this function, a second set of tire pressure warning system sensor ID codes must be registered by a Toyota dealer. For information regarding changing the registered ID code set, contact your Toyota dealer. (→P. 477)
Change wheel (register tire pressure warning system sensor ID codes) (vehicles with a tire inflation pressure display function)		Select to register the ID codes of the tire pressure sensors to the tire pressure warning system. To register the ID codes, press and hold the  switch. (→P. 477)
Rear seat reminder (→P. 154)	On Off	Select to enable/disable the rear seat reminder.
Scheduled maintenance display (if equipped)		
Maintenance data reset		Select to reset the message indicating maintenance is required, after the required maintenance is performed. (→P. 448)

■ Meter settings

Press and hold  to change the settings of the following items:

Item	Settings	Details
Language		Select to change the language displayed.
Units		Select to change the units of measure displayed.
 (Eco Driving Indicator Light)	On	Select to enable/disable the Eco Driving Indicator Light. (→P. 126)
	Off	
Speedometer	On	Select to enable/disable the speedometer display.
	Off	
Gadget content	Off	No display
	Average vehicle speed	Select to turn the display of a gadget.
	Distance	
	Elapsed time	
Fuel economy type	Trip (after start) ^{*1}	Select to change the average fuel consumption display and an item to be displayed as gadget.
	Total (after reset)	
	Tank (after refuel) ^{*2}	
Multi-information display off		Select to turn the multi-information display off. To turn the multi-information display on again, press any direction switch ( /  /  / ).
Pop-up display	Intersection guidance (if equipped)	Select to enable/disable the pop-up display.
	Incoming calls	
	Brightness adjustment	
Default setting		Select to reset the meter display settings to the default setting.

*1: Selecting this item will only change the gadget.

*2: Selecting this item will turn the display of the gadget off.

Odometer/trip meter

■ Odometer

Displays the total distance the vehicle has been driven.

■ Trip meter A/trip meter B

Displays the distance the vehicle has been driven since the meter was last reset. Trip meters A and B can be used to record and display different distances independently.

To reset, display the desired trip meter and press and hold the “ODO/TRIP” switch.

Suggestion function

Displays suggestions to the driver in the following situations. To select a response to a displayed suggestion, use the meter control switches.

The suggestion function can be turned on/off.
(Customizable features: →P. 606)

■ Suggestion to turn off the headlights

If the headlights are left on for a certain amount of time after the engine switch has been turned off, if the headlight switch is in the “AUTO” position, a suggestion message will be displayed asking if you wish to turn the headlights off. To turn the headlights off, select “Yes”.

If a front door is opened after the engine switch is turned off, this suggestion message will not be displayed.

■ Eco Driving Indicator

- ① Eco Driving Indicator Light
During Eco-friendly acceleration (Eco driving), the Eco Driving Indicator Light will turn on. When the acceleration exceeds the Zone of Eco driving, or when the vehicle is stopped, the light turns off.
- ② Eco Driving Indicator Zone Display
Suggests the Zone of Eco driving with current Eco driving ratio based on acceleration.
- ③ Eco driving ratio based on acceleration
If the acceleration exceeds the Zone of Eco driving, the right side of the Eco Driving Indicator Zone Display will illuminate.
- ④ Zone of Eco driving

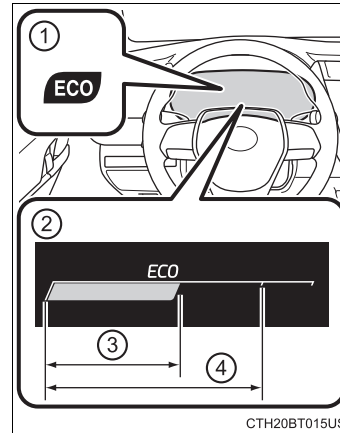

Eco Driving Indicator will not operate under the following conditions:

- The shift lever is in any position other than D.
- A paddle shift switch (if equipped) is operated.
- Neither normal mode nor Eco drive mode is selected. (→P. 375)
- The vehicle speed is approximately 80 mph (130 km/h) or higher.

■ Suspension of the settings display

- Some settings cannot be changed while driving. When changing settings, park the vehicle in a safe place.
- If a warning message is displayed, operation of the settings display will be suspended.

■ Tire pressure

- It may take a few minutes to display the tire inflation pressure after the engine switch is turned to IGNITION ON mode. It may also take a few minutes to display the tire inflation pressure after inflation pressure has been adjusted.
- “---” may be displayed if the tire position information cannot be determined due to unfavorable radio wave conditions.
- Tire inflation pressure changes with temperature. The displayed values may also be different from the values measured using a tire pressure gauge.

■ Liquid crystal display

Small spots or light spots may appear on the display. This phenomenon is characteristic of liquid crystal displays, and there is no problem continuing to use the display.

■ Customization

Some functions can be customized. (→P. 117, 606)

 **WARNING****■ Caution for use while driving**

- When operating the multi-information display while driving, pay extra attention to the safety of the area around the vehicle.
- Do not look continuously at the multi-information display while driving as you may fail to see pedestrians, objects on the road, etc. ahead of the vehicle.

■ The information display at low temperatures

Allow the interior of the vehicle to warm up before using the liquid crystal information display. At extremely low temperatures, the information display monitor may respond slowly, and display changes may be delayed.

For example, there is a lag between the driver's shifting and the new gear number appearing on the display. This lag could cause the driver to down-shift again, causing rapid and excessive engine braking and possibly an accident resulting in death or injury.

■ Cautions during setting up the display

As the engine needs to be running during setting up the display, ensure that the vehicle is parked in a place with adequate ventilation. In a closed area such as a garage, exhaust gases including harmful carbon monoxide (CO) may collect and enter the vehicle. This may lead to death or a serious health hazard.

 **NOTICE****■ While setting up the display**

To prevent battery discharge, ensure that the engine is running while setting up the display features.

Head-up display*

Summary of functions

The head-up display is linked to the meters and navigation system (if equipped) and projects a variety of information in front of the driver, such as the current vehicle speed.

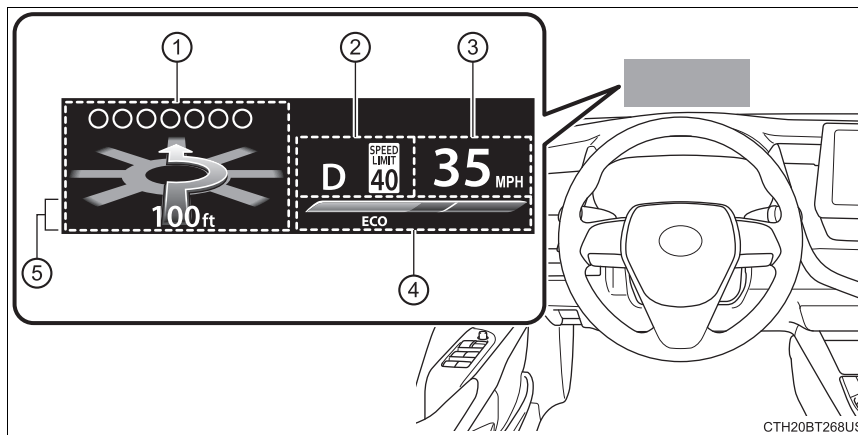

- ① Driving assist system status/navigation system-linked display area (if equipped) (→P. 130)

The following pop-up displays will be displayed in certain situations:

- Pre-collision warning (pre-collision system)
- Alert from the Parking Support Brake system (if equipped)

- ② Shift position/speed limit/RSA (Road Sign Assist) display area

- Shift position (→P. 217)
- Speed limit (vehicles with a navigation system) (U.S.A. only)
- RSA (Road Sign Assist) display (if equipped) (→P. 285)

- ③ Vehicle speed display

- ④ Eco Driving Indicator/Tachometer (→P. 131)



- ⑤ Information display area (→P. 131)

The following pop-up displays will be displayed in certain situations:

- Warning/message
- Hands-free system status
- Audio system operation status

*: If equipped

Using the head-up display

Select  on the multi-information display (→P. 117) and then .

◆ Enabling/disabling the head-up display

Press  to enable/disable the head-up display.

◆ Changing the head-up display settings

Press and hold  to change the following settings:

■ Eco Driving Indicator/Tachometer

Select to display Eco Driving Indicator/tachometer/no content.

■ Display brightness/position

Select to adjust the brightness and position of the head-up display.

■ Display content

Select to enable/disable the following items:

- Route guidance to destination (if equipped)
- Driving assist system status
- Compass (if equipped)

■ Display angle

Select to adjust the angle of the head-up display.

Driving assist system status/navigation system-linked display area (if equipped)**◆ Driving assist system status display**

Displays the operational status of the following systems:

- Dynamic radar cruise control with full-speed range (→P. 290)
- LTA (Lane Tracing Assist) (→P. 270)
- RSA (Road Sign Assist) (if equipped) (→P. 285)
- Intuitive parking assist (if equipped) (→P. 336)

◆ Navigation system-linked display area (if equipped)

Displays the following items, which are linked to the navigation system:

■ Street name

When the navigation system is performing route guidance, the name of the next street will be displayed on the top of the display area.

■ Route guidance to destination

Displayed when the navigation system is performing route guidance. When approaching an intersection, an arrow will be displayed to indicate the suggested direction of travel.

■ Compass

Displays the direction of travel.

Eco Driving Indicator/Tachometer

■ Eco Driving Indicator

- ① Eco Driving Indicator Zone Display
- ② Eco driving ratio based on acceleration
- ③ Zone of Eco driving
Displayed content is the same as that displayed on the multi-information display (Eco Driving Indicator). For details, refer to P. 126.

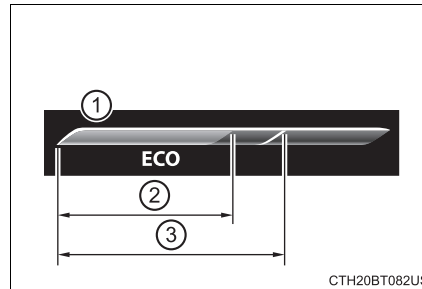

■ Tachometer

Displays the engine speed in revolutions per minute.

Information display area

Displays the following items in the appropriate situation:

■ Warning/Message

- Alert from the LTA (Lane Tracing Assist)
- Dynamic radar cruise control with full-speed range
- Brake Override System/Drive-Start Control
-  message

Displayed when a suggestion/advice pop-up display is displayed on the multi-information display. (→P. 125)

-  message

Displayed when a warning message is displayed on the multi-information display. (→P. 538)

- Outside temperature

Displayed in the following situations:

- When the engine switch is turned to IGNITION ON mode
- When the low outside temperature indicator is flashing

Displayed content is the same as that displayed on the multi-information display. For details, refer to the explanation of the outside temperature display on the multi-information display. (→P. 94)

■ Hands-free system status

Displayed when the hands-free system is operated.

■ Audio system operation status

Displayed when the audio system is operated.

■ Head-up display

The head-up display may seem dark or hard to see when viewed through sunglasses, especially polarized sunglasses.

Adjust the brightness of the head-up display or remove your sunglasses.

■ Display brightness

The brightness of the head-up display can be adjusted on  of the multi-information display. Also, it is automatically adjusted according to the ambient brightness.

■ Enabling/disabling of the head-up display

If the head-up display is disabled, it will remain disabled when the engine switch is turned off then back to IGNITION ON mode.

■ Street name display (vehicles with a navigation system)

Only street names which are included in the map data will be displayed.

**WARNING****■ Before using the head-up display**

- Check that the position and brightness of the head-up display image does not interfere with safe driving. Incorrect adjustment of the image's position or brightness may obstruct the driver's view and lead to an accident, resulting in death or serious injury.
- Do not continuously look at the head-up display while driving as you may fail to see pedestrians, objects on the road, etc. ahead of the vehicle.

■ Caution for changing settings of the head-up display

As the engine needs to be running while changing the settings of the head-up display, ensure that the vehicle is parked in a place with adequate ventilation. In a closed area such as a garage, exhaust gases including harmful carbon monoxide (CO) may collect and enter the vehicle. This may lead to death or a serious health hazard.

 NOTICE**■ To prevent damage to components**

- Do not place any drinks near the head-up display projector. If the projector gets wet, electrical malfunctions may result.
- Do not place anything on or put stickers onto the head-up display projector. Doing so could interrupt head-up display indications.
- Do not touch the inside of the head-up display projector or thrust sharp edges or the like into the projector. Doing so could cause mechanical malfunctions.

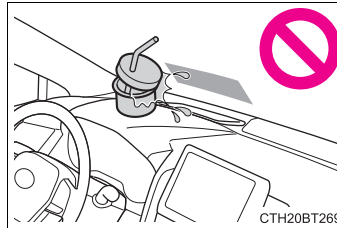
**■ When changing the settings of the head-up display**

To prevent battery discharge, ensure that the engine is running while the changing the settings of the head-up display.

Fuel consumption information

Fuel consumption information can be displayed on the audio system screen.

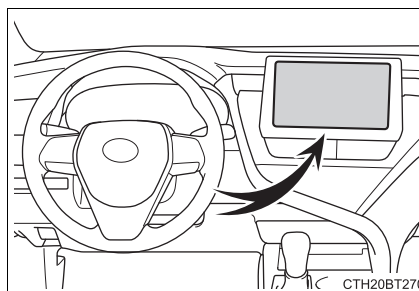

Trip information

- ▶ Audio (vehicles without Data Communication Module) or Audio Plus (vehicles without Data Communication Module)

- 1 Press the “MENU” button.
- 2 Select “Info” on the “Menu” screen.

If the “History” screen is displayed, select “Trip Information”.

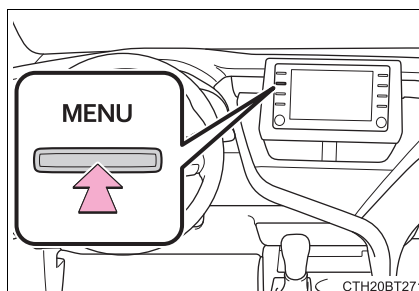

- ▶ Audio (vehicles with Data Communication Module), Audio Plus (vehicles with Data Communication Module) and Premium Audio

- 1 Press the "MENU" button.
- 2 Select "Info" on the "Menu" screen.
- 3 Select "ECO" on the "Information" screen.

If the "History" screen is displayed, select "Trip Information".

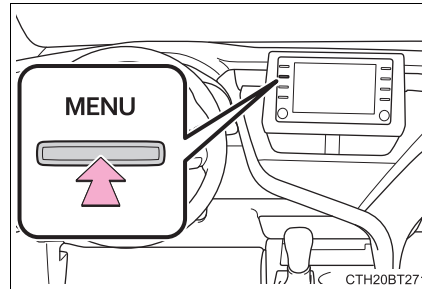

- 1 Resetting the consumption data
- 2 Average vehicle speed since the engine was started
- 3 Elapsed time since the engine was started
- 4 Fuel consumption in the past 15 minutes
- 5 Cruising range (→P. 137)
- 6 Current fuel consumption



Vehicles without a smart key system:

Average fuel consumption for the past 15 minutes is divided by color into past averages and averages attained since the engine switch was last turned to the "ON" position. Use the displayed average fuel consumption as a reference.

Vehicles with a smart key system:

Average fuel consumption for the past 15 minutes is divided by color into past averages and averages attained since the engine switch was last turned to IGNITION ON mode. Use the displayed average fuel consumption as a reference.

This image is an example only.

History

- ▶ Audio (vehicles without Data Communication Module) or Audio Plus (vehicles without Data Communication Module)

- 1 Press the "MENU" button.
- 2 Select "Info" on the "Menu" screen.

If the "Trip Information" screen is displayed, select "History".

- ▶ Audio (vehicles with Data Communication Module), Audio Plus (vehicles with Data Communication Module) and Premium Audio

- 1 Press the "MENU" button.
- 2 Select "Info" on the "Menu" screen.
- 3 Select "ECO" on the "Information" screen.

If the "Trip Information" screen is displayed, select "History".

- 1 Resetting the past record data
- 2 Best recorded fuel consumption
- 3 Current fuel economy
- 4 Previous fuel consumption record

- ▶ Audio and Audio Plus

Displays the daily average fuel consumption. (Instead of the date, "Trip 1" through "Trip 5" will be displayed.)

- ▶ Premium Audio

Displays the daily average fuel consumption.

- 5 Updating the average fuel consumption data

The average fuel consumption history is divided by color into past averages and the average fuel consumption since the last updated. Use the displayed average fuel consumption as a reference.

This image is an example only.

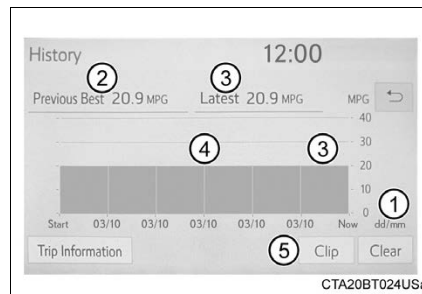

■ Updating the past record data

Update the average fuel consumption by selecting “Clip” to measure the current fuel consumption again.

■ Resetting the data

The fuel consumption data can be deleted by selecting “Clear”.

■ Cruising range

Displays the estimated maximum distance that can be driven with the quantity of fuel remaining.

This distance is computed based on your average fuel consumption.

As a result, the actual distance that can be driven may differ from that displayed.

**Operation of
each component****3****3-1. Key information**

Keys 140

**3-2. Opening, closing and
locking the doors**

Doors 147

Trunk..... 156

Smart key system 161

3-3. Adjusting the seats

Front seats 167

Rear seats..... 169

Head restraints..... 171

**3-4. Adjusting the steering
wheel and mirrors**

Steering wheel 173

Inside rear view mirror 175

Outside rear view
mirrors..... 177**3-5. Opening and closing
the windows**

Power windows 179

Moon roof..... 183

Panoramic moon roof..... 187

Keys

The keys

The following keys are provided with the vehicle.

► Vehicles without a smart key system

① Keys

Operating the wireless remote control function (→P. 141)

② Key number plate

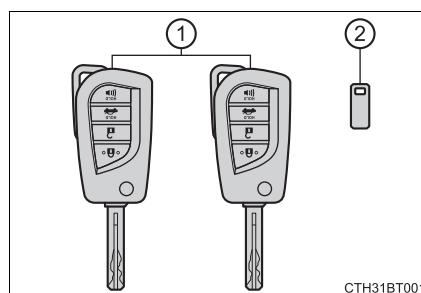

► Vehicles with a smart key system

① Electronic keys

- Operating the smart key system (→P. 161)
- Operating the wireless remote control function (→P. 141)

② Mechanical keys

③ Key number plate

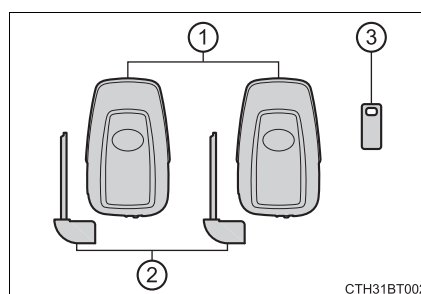

Wireless remote control

► Vehicles without a smart key system

- ① Locks all the doors (→P. 148)
- ② Unlocks all the doors (→P. 148)
Pressing the button unlocks the driver's door. Pressing the button again within 3 seconds unlocks the other doors.
- ③ Opens the windows*¹ and the moon roof*^{1, 2} (→P. 148)
- ④ Opens the trunk (→P. 157)
- ⑤ Sounds the alarm (→P. 143)

*1: This setting must be customized at your Toyota dealer.

*2: If equipped

► Vehicles with a smart key system

- ① Locks all the doors (→P. 148)
- ② Unlocks all the doors (→P. 148)
Pressing the button unlocks the driver's door. Pressing the button again within 3 seconds unlocks the other doors.
- ③ Opens the windows*¹ and the moon roof*^{1, 2} or panoramic moon roof*^{1, 2} (→P. 148)
- ④ Opens the trunk (→P. 157)
- ⑤ Sounds the alarm (→P. 143)

*1: This setting must be customized at your Toyota dealer.

*2: If equipped

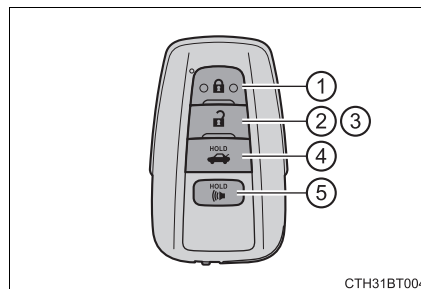
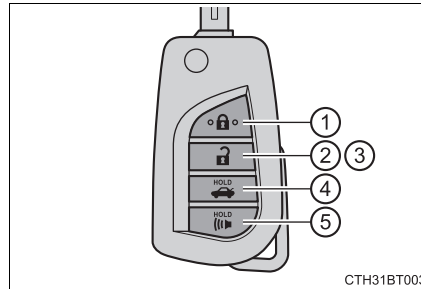

Using the key (vehicles without a smart key system)

- ① Releasing
To release the key, press the button.
- ② Folding
To stow the key, press the button then fold the key.

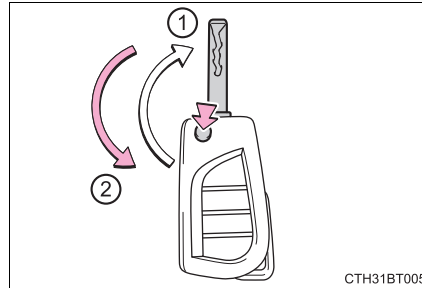

CTH31BT005

Using the mechanical key (vehicles with a smart key system)

To take out the mechanical key, slide the release lever and take the key out.

The mechanical key can only be inserted in one direction, as the key only has grooves on one side. If the key cannot be inserted in a lock cylinder, turn it over and re-attempt to insert it.

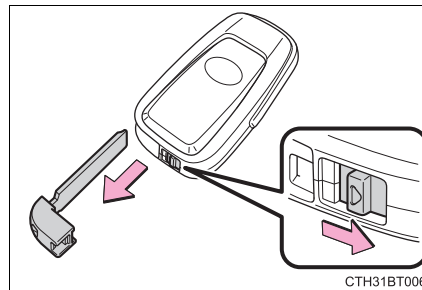

CTH31BT006

After using the mechanical key, store it in the electronic key. Carry the mechanical key together with the electronic key. If the electronic key battery is depleted or the entry function does not operate properly, you will need the mechanical key. (→P. 559)

■ Panic mode**▶ Vehicles without a smart key system**

When  is pressed for longer than about one second, an alarm will sound intermittently and the vehicle lights will flash to deter any person from trying to break into or damage your vehicle.

To stop the alarm, press any button on the wireless remote control.

**▶ Vehicles with a smart key system**

When  is pressed for longer than about one second, an alarm will sound intermittently and the vehicle lights will flash to deter any person from trying to break into or damage your vehicle.

To stop the alarm, press any button on the electronic key.



■ If you lose your keys

New genuine keys can be made by your Toyota dealer using the other key (vehicles without a smart key system) or the other mechanical key (vehicles with a smart key system) and the key number stamped on your key number plate. Keep the plate in a safe place such as your wallet, not in the vehicle.

■ When riding in an aircraft

When bringing a key with wireless remote control function onto an aircraft, make sure you do not press any button on the key while inside the aircraft cabin. If you are carrying the key in your bag etc., ensure that the buttons are not likely to be pressed accidentally. Pressing a button may cause the key to emit radio waves that could interfere with the operation of the aircraft.

■ Conditions affecting operation**▶ Vehicles without a smart key system**

The wireless remote control function may not operate normally in the following situations:

- When the wireless key battery is depleted
- Near a TV tower, electric power plant, gas station, radio station, large display, airport or other facility that generates strong radio waves or electrical noise
- When carrying a portable radio, cellular phone or other wireless communication devices
- When the wireless key is in contact with, or is covered by a metallic object
- When other wireless key (that emit radio waves) is being used nearby
- If window tint with a metallic content or metallic objects are attached to the rear window

▶ Vehicles with a smart key system

→P. 163

■ Key battery depletion

- ▶ Vehicles without a smart key system
 - The standard battery life is 1 to 2 years.
 - Even if the key is not used, the battery may become depleted and the following symptoms may occur. Replace the battery with a new one when necessary. (→P. 494)
 - The wireless remote control function does not operate.
 - The area in which the wireless remote control function can be operated becomes smaller.
- ▶ Vehicles with a smart key system
 - The standard battery life is 1 to 2 years.
 - If the battery becomes low, an alarm will sound in the cabin when the engine stops.
 - As the electronic key always receives radio waves, the battery will become depleted even if the electronic key is not used. The following symptoms indicate that the electronic key battery may be depleted. Replace the battery when necessary. (→P. 494)
 - The smart key system or the wireless remote control does not operate.
 - The detection area becomes smaller.
 - The LED indicator on the key surface does not turn on.
 - To reduce key battery depletion when the electronic key is to not be used for long periods of time, set the electronic key to the battery-saving mode. (→P. 163)
 - To avoid serious deterioration, do not leave the electronic key within 3 ft. (1 m) of the following electrical appliances that produce a magnetic field:
 - TVs
 - Personal computers
 - Cellular phones, cordless phones and battery chargers
 - Recharging cellular phones or cordless phones
 - Table lamps
 - Induction cookers

■ Replacing the battery

→P. 494

■ Confirmation of the registered key number

The number of keys already registered to the vehicle can be confirmed. Ask your Toyota dealer for details.

■ If a wrong key is used

The key cylinder rotates freely to isolate inside mechanism.



NOTICE

■ To prevent key damage

- Do not drop the keys, subject them to strong shocks or bend them.
- Do not expose the keys to high temperatures for long periods of time.
- Do not get the keys wet or wash them in an ultrasonic washer etc.
- Do not attach metallic or magnetic materials to the keys or place the keys close to such materials.
- Do not disassemble the keys.
- Do not attach a sticker or anything else to the surface of the electronic key and key (with a wireless remote control function).
- Vehicles with a smart key system: Do not place the keys near objects that produce magnetic fields, such as TVs, audio systems and induction cookers, or medical electrical equipment, such as low-frequency therapy equipment.

■ Carrying the electronic key on your person (vehicles with a smart key system)

Carry the electronic key 3.9 in. (10 cm) or more away from electric appliances that are turned on. Radio waves emitted from electric appliances within 3.9 in. (10 cm) of the electronic key may interfere with the key, causing the key to not function properly.

■ In case of a smart key system malfunction or other key-related problems (vehicles with a smart key system)

Take your vehicle with all the electronic keys provided with your vehicle to your Toyota dealer.

■ When an electronic key is lost (vehicles with a smart key system)

If the electronic key remains lost, the risk of vehicle theft increases significantly. Visit your Toyota dealer immediately with all remaining electronic keys that were provided with your vehicle.

Doors

Unlocking and locking the doors from the outside

◆ Smart key system (if equipped)

Carry the electronic key to enable this function.

- ① Grip the driver's door handle to unlock the door. Holding the driver's door handle for approximately 2 seconds unlocks all the doors. Grip the front passenger's door handle to unlock all the doors.*

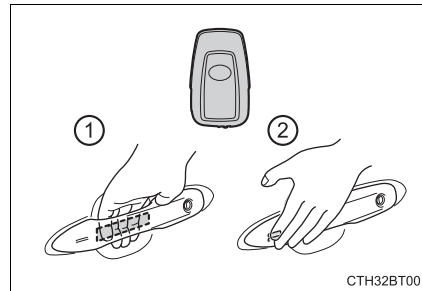

Make sure to touch the sensor on the back of the handle.

The doors cannot be unlocked for 3 seconds after the doors are locked.

*: The door unlock settings can be changed. (→P. 153)

- ② Touch the lock sensor (the indentation on the side of the door handle) to lock the doors.
Check that the door is securely locked.

◆ **Wireless remote control**

▶ Vehicles without a smart key system

▶ Vehicles with a smart key system

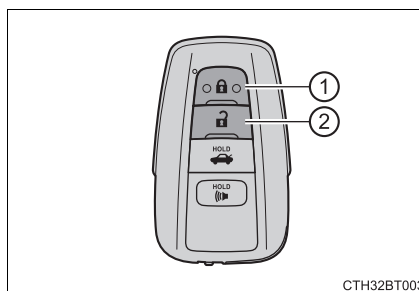
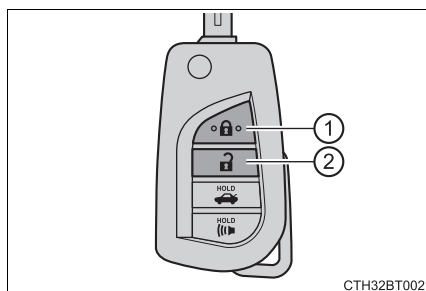

① Locks all the doors

Check that the door is securely locked.

② Unlocks all the doors

Pressing the button unlocks the driver's door. Pressing the button again within 3 seconds unlocks the other doors.

Press and hold to open the windows^{*1} and the moon roof^{*1, 2} or panoramic moon roof.^{*1, 2} (→P. 180, 184, 188)

*1: This setting must be customized at your Toyota dealer.

*2: If equipped

◆ Key

Turning the key operates the doors as follows:

▶ Vehicles without a smart key system

① Locks all the doors

Turn and hold to close the windows^{*1} and moon roof.^{*1, 2}
(→P. 180, 184)

② Unlocks the door

Turning the key unlocks the driver's door. Turning the key again unlocks the other doors.

Turn and hold to open the windows^{*1} and moon roof.^{*1, 2}
(→P. 180, 184)

*1: This setting must be customized at your Toyota dealer.

*2: If equipped

▶ Vehicles with a smart key system

The doors can also be locked and unlocked with the mechanical key. (→P. 559)

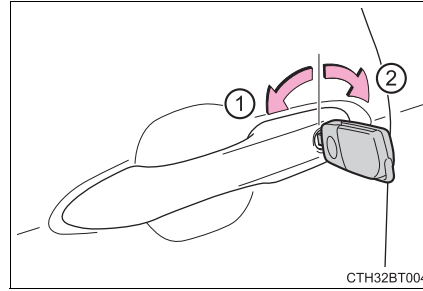

3

Operation of each component

■ **Operation signals**

Doors:

A buzzer sounds and the emergency flashers flash to indicate that the doors have been locked/unlocked. (Locked: Once; Unlocked: Twice)

Windows and moon roof or panoramic moon roof:

A buzzer sounds to indicate that the windows and moon roof or panoramic moon roof are operating.

■ **Security feature**

If a door is not opened within approximately 60 seconds after the vehicle is unlocked, the security feature automatically locks the vehicle again.

■ **When the door cannot be locked by the lock sensor on the surface of the door handle (vehicles with a smart key system)**

When the door cannot be locked even if the lock sensor on the surface of the door handle is touched by a finger, touch the lock sensor with the palm.

When gloves are being worn, remove the gloves.

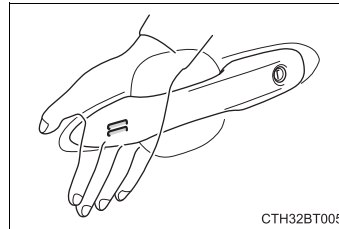

■ **Door lock buzzer**

If an attempt to lock the doors using the smart key system is made when a door is not fully closed, a buzzer sounds continuously. Fully close the door to stop the buzzer, and lock the vehicle once more.

■ **Alarm**

Locking the doors will set the alarm system. (→P. 82)

■ **If the smart key system or the wireless remote control does not operate properly (vehicles with a smart key system)**

Use the mechanical key to lock and unlock the doors. (→P. 559)

Replace the key battery with a new one if it is depleted. (→P. 494)

Unlocking and locking the doors from the inside

◆ Door lock switches

- ① Locks all the doors
- ② Unlocks all the doors

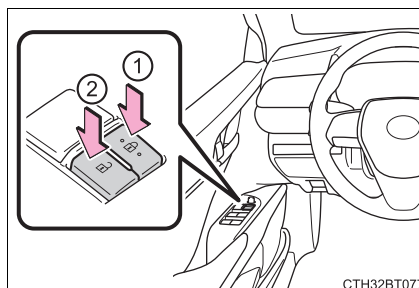

CTH32BT077

◆ Inside lock buttons

- ① Locks the door
- ② Unlocks the door

The front doors can be opened by pulling the inside handle even if the lock buttons are in the lock position.

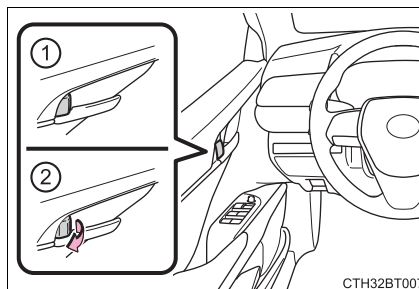

CTH32BT007

Locking the front doors from the outside without a key

- 1 Move the inside lock button to the lock position.
- 2 Close the door.

▶ Vehicles without a smart key system

The door cannot be locked if either of the front doors is open and the key is in the engine switch.

▶ Vehicles with a smart key system

The door cannot be locked if the engine switch is in ACCESSORY or IGNITION ON mode, or the electronic key is left inside the vehicle.

The key may not be detected correctly and the door may be locked.

Rear door child-protector lock

The door cannot be opened from inside the vehicle when the lock is set.

- ① Unlock
- ② Lock

These locks can be set to prevent children from opening the rear doors. Push down on each rear door switch to lock both rear doors.

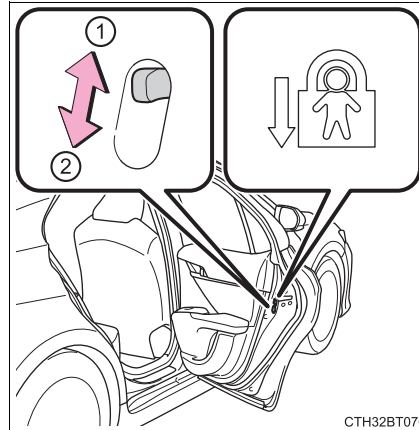

CTH32BT076

Automatic door locking and unlocking systems





The following functions can be set or cancelled:

For instructions on customizing, refer to P. 608.





Function	Operation
Speed linked door locking function	All doors are automatically locked when vehicle speed is approximately 12 mph (20 km/h) or higher.
Shift position linked door locking function	All doors are automatically locked when shifting the shift lever out of P.
Shift position linked door unlocking function	All doors are automatically unlocked when shifting the shift lever to P.
Driver's door linked door unlocking function	All doors are automatically unlocked when driver's door is opened.

■ Switching the door unlock function (vehicles with a smart key system)

It is possible to set which doors the entry function unlocks using the wireless remote control.

- 1 Turn the engine switch off.
- 2 When the indicator light on the key surface is not on, press and hold  ,  or  for approximately 5 seconds while pressing and holding  .

The setting changes each time an operation is performed, as shown below. (When changing the setting continuously, release the buttons, wait for at least 5 seconds, and repeat step 2.)

Multi-information display	Unlocking function	Beep
 *1  *2	Holding the driver's door handle unlocks only the driver's door.	Exterior: Beeps 3 times Interior: Pings once
	Holding the front passenger's door handle unlocks all the doors.	
 *1  *2	Holding either front door handle unlocks all the doors.	Exterior: Beeps twice Interior: Pings once

*1: 4.2-inch display

*2: 7-inch display

To prevent unintended triggering of the alarm, unlock the doors using the wireless remote control and open and close a door once after the settings have been changed. (If a door is not opened within 60 seconds after  is pressed, the doors will be locked again and the alarm will automatically be set.)

In case that the alarm is triggered, immediately stop the alarm. (→P. 83)

■ **Impact detection door lock release system**

In the event that the vehicle is subject to a strong impact, all the doors are unlocked. Depending on the force of the impact or the type of accident, however, the system may not operate.

■ **Open door warning buzzer**

If the vehicle reaches a speed of 3 mph (5 km/h), the master warning light flashes and a buzzer sounds to indicate that the door(s) are not yet fully closed.

The open door(s) is displayed on the multi-information display.

■ **Conditions affecting the operation of the smart key system or wireless remote control**

▶ Vehicles without a smart key system

→P. 144

▶ Vehicles with a smart key system

→P. 163

■ **Rear seat reminder function**

In order to remind you not to forget luggage, etc. in the rear seat, when the engine switch is turned off after any of the following conditions are met, a buzzer will sound and a message will be displayed on the multi-information display for approximately 6 seconds.

● The engine is started within 10 minutes after opening and closing a rear door.

● A rear door has been opened and closed after the engine was started.

However, if a rear door is opened and then closed within approximately 2 seconds, the rear seat reminder function may not operate.

The rear seat reminder function determines that luggage, etc. has been placed in a rear seat based on opening and closing of a rear door. Therefore, depending on the situation, the rear seat reminder function may not operate and you may still forget luggage, etc. in the rear seat, or it may operate unnecessarily.

The rear seat reminder function can be enabled/disabled. (→P. 106, 123)

■ **Customization**

Some functions can be customized. (→P. 606)

 **WARNING****■ To prevent an accident**

Observe the following precautions while driving the vehicle.

Failure to do so may result in a door opening and an occupant falling out, resulting in death or serious injury.

- Ensure that all doors are properly closed.

- Do not pull the inside handle of the doors while driving.

Be especially careful for the front doors, as the doors may be opened even if the inside lock buttons are in locked position.

- Set the rear door child-protector locks when children are seated in the rear seats.

■ When opening or closing a door

Check the surroundings of the vehicle such as whether the vehicle is on an incline, whether there is enough space for a door to open and whether a strong wind is blowing.

When opening or closing the door, hold the door handle tightly to prepare for any unpredictable movement.

Trunk

The trunk can be opened using the trunk opener switch, entry function (vehicles with a smart key system), wireless remote control or key.

Opening the trunk from inside the vehicle

Press and hold the trunk opener switch.

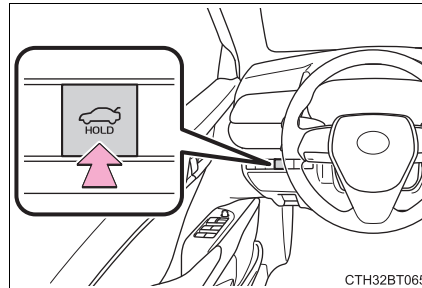

Opening the trunk from outside the vehicle

◆ Smart key system (if equipped)

While carrying the electronic key, press the button on the trunk lid.

When all the doors are unlocked using one of the following methods, the trunk can be opened without the electronic key:

- Entry function
- Wireless remote control
- Door lock switches
- Automatic door unlocking system
- Mechanical key

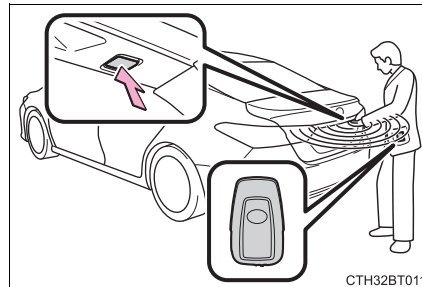

◆ **Wireless remote control**

▶ Vehicles without a smart key system

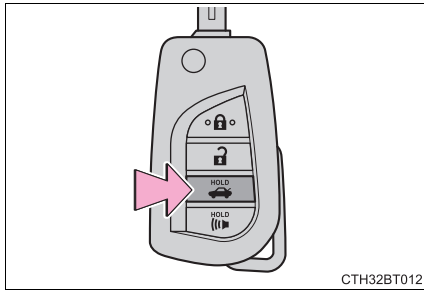

▶ Vehicles with a smart key system

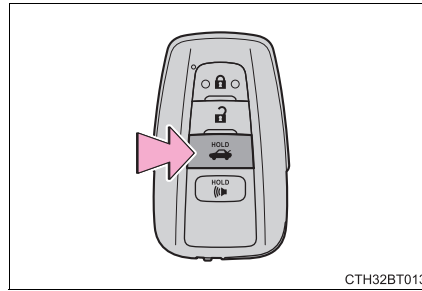

Press and hold the switch.
A buzzer sounds.

◆ **Key**

▶ Vehicles without a smart key system

Turn the key clockwise to release the trunk lid.

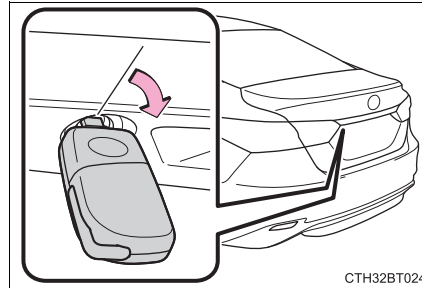

▶ Vehicles with a smart key system

The trunk can be also opened using the mechanical key. (→P. 560)

■ Trunk light

The trunk light turns on when the trunk is opened.

■ Function to prevent the trunk being locked with the electronic key inside (vehicles with a smart key system)

● When all doors are locked, closing the trunk lid with the electronic key left inside the trunk will sound an alarm.

In this case, the trunk lid can be opened by pressing the trunk release button on the trunk lid.

● If the spare electronic key is put in the trunk with all the doors locked, the key confinement prevention function is activated so the trunk can be opened. In order to prevent theft, take all electronic keys with you when leaving the vehicle.

● If the electronic key is put in the trunk with all the doors locked, the key may not be detected depending on the location of the key and the surrounding radio wave conditions. In this case, the key confinement prevention function cannot be activated, causing the doors to lock when the trunk is closed. Make sure to check where the key is before closing the trunk.

● The key confinement prevention function cannot be activated if any one of the doors is unlocked. In this case, open the trunk using the trunk opener.

■ Open trunk warning buzzer

If the vehicle reaches a speed of 3 mph (5 km/h), the master warning light flashes and a buzzer sounds to indicate that the trunk is not yet fully closed.

■ Internal trunk release lever

The trunk lid can be opened by pulling up the glow-in-the-dark lever located on the inside of the trunk lid.

The lever will continue to glow for some time after the trunk lid is closed.

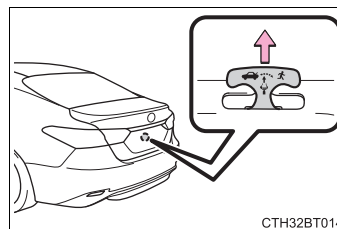

■ If the smart key system or the wireless remote control does not operate properly (vehicles with a smart key system)

Use the mechanical key to unlock the trunk. (→P. 560)

Replace the key battery with a new one if it is depleted. (→P. 494)

■ Customization

Some functions can be customized. (→P. 606)

 **WARNING**

Observe the following precautions.

Failure to do so may result in death or serious injury.

■ **Before driving**

● Make sure that the trunk lid is fully closed. If the trunk lid is not fully closed, it may open unexpectedly while driving and hit near-by objects or luggage in the trunk may be thrown out, causing an accident.

● Do not allow children to play in the trunk.
If a child is accidentally locked in the trunk, they could suffer from heat exhaustion, suffocation or other injuries.

● Do not allow a child to open or close the trunk lid.
Doing so may cause the trunk lid to open unexpectedly, or cause the child's hands, head, or neck to be caught by the closing trunk lid.

■ **Important points while driving**

Never let anyone sit in the trunk. In the event of sudden braking or a collision, they are susceptible to death or serious injury.

⚠ WARNING**■ Using the trunk**

Observe the following precautions.

Failure to do so may cause parts of the body to be caught, resulting in serious injury.

- Remove any heavy loads, such as snow and ice, from the trunk lid before opening it. Failure to do so may cause the trunk lid to suddenly shut again after it is opened.
- When opening or closing the trunk lid, thoroughly check to make sure the surrounding area is safe.
- If anyone is in the vicinity, make sure they are safe and let them know that the trunk is about to open or close.
- Use caution when opening or closing the trunk lid in windy weather as it may move abruptly in strong wind.
- On an incline it is more difficult to open or close the trunk lid than on a level surface, so beware of the trunk lid unexpectedly opening or closing by itself. Make sure that the trunk lid is fully open and secure before using the trunk.

- When opening the trunk lid, take care so that it does not hit anyone in the face or any other part of the body.

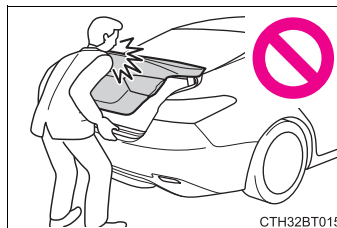

- When closing the trunk lid, take extra care to prevent your fingers etc. from being caught.
- When closing the trunk lid, make sure to press it lightly on its outer surface.

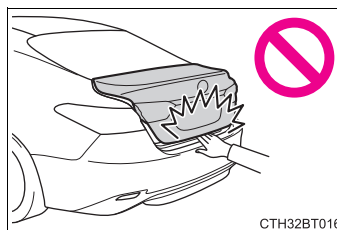

- Do not attach any accessories other than genuine Toyota parts to the trunk lid. Such additional weight on the trunk lid may cause the lid to suddenly shut again after it is opened.

Smart key system*

The following operations can be performed simply by carrying the electronic key on your person, for example in your pocket. (The driver should always carry the electronic key.)

- Locks and unlocks the doors (→P. 147)
- Opens the trunk (→P. 156)
- Starts the engine (→P. 211)

Antenna location

- ① Antennas outside the cabin
- ② Antennas inside the cabin
- ③ Antenna inside the trunk
- ④ Antenna outside the trunk

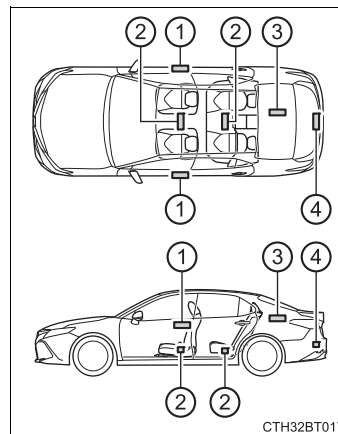

Effective range (areas within which the electronic key is detected)

- When locking or unlocking the doors

The system can be operated when the electronic key is within about 2.3 ft. (0.7 m) of either of the front outside door handles. (Only the doors detecting the key can be operated.)

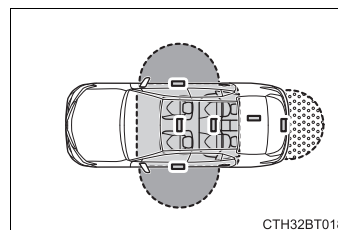

- When starting the engine or changing engine switch modes

The system can be operated when the electronic key is inside the vehicle.

- When opening the trunk

The system can be operated when the electronic key is within about 2.3 ft. (0.7 m) of the trunk release button.

*: If equipped

■ Alarms and warning indicators

A combination of exterior and interior alarms as well as warning messages shown on the multi-information display are used to prevent theft of the vehicle and accidents resulting from erroneous operation. Take appropriate measures in response to any warning message on the multi-information display. (→P. 538)

When only an alarm sounds, circumstances and correction procedures are as follows.

Alarm	Situation	Correction procedure
Exterior alarm sounds once for 5 seconds	An attempt was made to lock the vehicle while a door was open.	Close all of the doors and lock the doors again.
	The trunk was closed while the electronic key was still inside the trunk and all the doors were locked.	Retrieve the electronic key from the trunk and close the trunk lid.
Interior alarm pings repeatedly	The engine switch was turned to ACCESSORY mode while the driver's door was open (The driver's door was opened when the engine switch was in ACCESSORY mode).	Turn the engine switch off and close the driver's door.
	The engine switch was turned off while the driver's door was open.	Close the driver's door.



■ Battery-saving function

The battery-saving function will be activated in order to prevent the electronic key battery and the vehicle battery from being discharged while the vehicle is not in operation for a long time.

- In the following situations, the smart key system may take some time to unlock the doors.
 - The electronic key has been left in an area of approximately 6 ft. (2 m) of the outside of the vehicle for 10 minutes or longer.
 - The smart key system has not been used for 5 days or longer.
- If the smart key system has not been used for 14 days or longer, the doors cannot be unlocked at any doors except the driver's door. In this case, take hold of the driver's door handle, or use the wireless remote control or the mechanical key, to unlock the doors.

■ Electronic Key Battery-Saving Function

When battery-saving mode is set, battery depletion is minimized by stopping the electronic key from receiving radio waves.

Press  twice while pressing and holding . Confirm that the electronic key indicator flashes 4 times.

While the battery-saving mode is set, the smart key system cannot be used. To cancel the function, press any of the electronic key buttons.

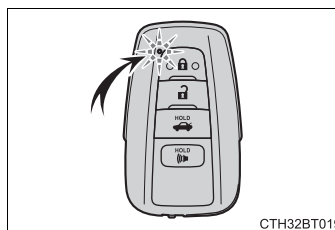

■ Conditions affecting operation

The smart key system, wireless remote control and engine immobilizer system use weak radio waves. In the following situations, the communication between the electronic key and the vehicle may be affected, preventing the smart key system, wireless remote control and engine immobilizer system from operating properly. (Ways of coping: →P. 559)

- When the electronic key battery is depleted
- Near a TV tower, electric power plant, gas station, radio station, large display, airport or other facility that generates strong radio waves or electrical noise
- When the electronic key is in contact with, or is covered by the following metallic objects
 - Cards to which aluminum foil is attached
 - Cigarette boxes that have aluminum foil inside
 - Metallic wallets or bags
 - Coins
 - Hand warmers made of metal
 - Media such as CDs and DVDs

- When other wireless keys (that emit radio waves) are being used nearby
- When carrying the electronic key together with the following devices that emit radio waves
 - Portable radio, cellular phone, cordless phone or other wireless communication devices
 - Another vehicle's electronic key, another electronic key of your vehicle, or a wireless key that emits radio waves
 - Personal computers or personal digital assistants (PDAs)
 - Digital audio players
 - Portable game systems
- If window tint with a metallic content or metallic objects are attached to the rear window
- When the electronic key is placed near a battery charger or electronic devices
- When the vehicle is parked in a pay parking spot where radio waves are emitted.

■ **Note for the entry function**

- Even when the electronic key is within the effective range (detection areas), the system may not operate properly in the following cases:
 - The electronic key is too close to the window or outside door handle, near the ground, or in a high place when the doors are locked or unlocked.
 - The electronic key is near the ground or in a high place, or too close to the rear bumper center when the trunk is opened.
 - The electronic key is on the instrument panel, rear package tray or floor, or in the door pockets or glove box when the engine is started or engine switch modes are changed.
- Do not leave the electronic key on top of the instrument panel or near the door pockets when exiting the vehicle. Depending on the radio wave reception conditions, it may be detected by the antenna outside the cabin and the door will become lockable from the outside, possibly trapping the electronic key inside the vehicle.
- As long as the electronic key is within the effective range, the doors may be locked or unlocked by anyone. However, only the doors detecting the electronic key can be used to unlock the vehicle.
- Even if the electronic key is not inside the vehicle, it may be possible to start the engine if the electronic key is near the window.
- The doors may unlock or lock if a large amount of water splashes on the door handle, such as in the rain or in a car wash, when the electronic key is within the effective range. (The doors will automatically be locked after approximately 60 seconds if the doors are not opened and closed.)

- If the wireless remote control is used to lock the doors when the electronic key is near the vehicle, there is a possibility that the door may not be unlocked by the entry function. (Use the wireless remote control to unlock the doors.)
 - Touching the door lock sensor while wearing gloves may delay or prevent lock operation. Remove the gloves and touch the lock sensor again.
 - When the lock operation is performed using the lock sensor, recognition signals will be shown up to two consecutive times. After this, no recognition signals will be given.*
 - If the door handle becomes wet while the electronic key is within the effective range, the door may lock and unlock repeatedly. In this case, follow the following correction procedures to wash the vehicle:
 - Place the electronic key in a location 6 ft. (2 m) or more away from the vehicle. (Take care to ensure that the key is not stolen.)
 - Set the electronic key to battery-saving mode to disable the smart key system. (→P. 163)
 - If the electronic key is inside the vehicle and a door handle becomes wet during a car wash, a message may be shown on the multi-information display and a buzzer will sound outside the vehicle. To turn off the alarm, lock all the doors.
 - The lock sensor may not work properly if it comes into contact with ice, snow, mud, etc. Clean the lock sensor and attempt to operate it again.
 - A sudden approach to the effective range or door handle may prevent the doors from being unlocked. In this case, return the door handle to the original position and check that the doors unlock before pulling the door handle again.
 - If there is another electronic key in the detection area, it may take slightly longer to unlock the doors after the door handle is gripped.
 - Fingernails may scrape against the door during operation of the door handle. Be careful not to injure fingernails or damage the surface of the door.
- *: This setting can be customized at your Toyota dealer.

■ When the vehicle is not driven for extended periods

- To prevent theft of the vehicle, do not leave the electronic key within 6 ft. (2 m) of the vehicle.
- The smart key system can be deactivated in advance. (→P. 606)
- Setting the electronic key to battery-saving mode helps to reduce key battery depletion. (→P. 163)

■ To operate the system properly

Make sure to carry the electronic key when operating the system. Do not get the electronic key too close to the vehicle when operating the system from the outside of the vehicle.

Depending on the position and holding condition of the electronic key, the key may not be detected correctly and the system may not operate properly. (The alarm may go off accidentally, or the door lock prevention function may not operate.)

■ If the smart key system does not operate properly

- Locking and unlocking the doors and trunk: Use the mechanical key. (→P. 559)
- Starting the engine: →P. 560

■ Customization

Some functions can be customized. (→P. 606)

■ If the smart key system has been deactivated in a customized setting

- Locking and unlocking the doors and opening the trunk:
Use the wireless remote control or mechanical key. (→P. 148, 157, 559)
- Starting the engine and changing engine switch modes: →P. 560
- Stopping the engine: →P. 212

**WARNING****■ Caution regarding interference with electronic devices**

- People with implantable cardiac pacemakers, cardiac resynchronization therapy-pacemakers or implantable cardioverter defibrillators should keep away from the smart key system antennas. (→P. 161)

The radio waves may affect the operation of such devices. If necessary, the entry function can be disabled. Ask your Toyota dealer for details, such as the frequency of radio waves and timing of the emitted radio waves. Then, consult your doctor to see if you should disable the entry function.

- Users of any electrical medical device other than implantable cardiac pacemakers, cardiac resynchronization therapy-pacemakers or implantable cardioverter defibrillators should consult the manufacturer of the device for information about its operation under the influence of radio waves.

Radio waves could have unexpected effects on the operation of such medical devices.

Ask your Toyota dealer for details for disabling the entry function.

Front seats

Adjustment procedure

► Manual seat

- ① Seat position adjustment lever
- ② Seatback angle adjustment lever
- ③ Vertical height adjustment lever

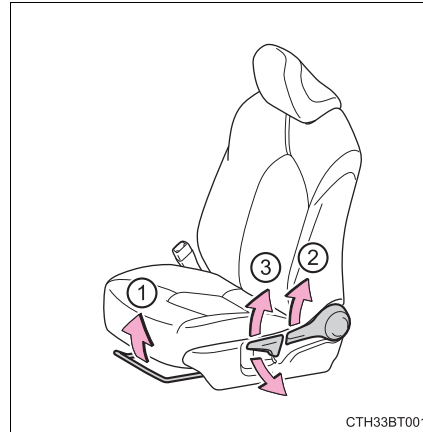

► Power seat

- ① Seat position adjustment switch
- ② Seatback angle adjustment switch
- ③ Seat cushion (front) angle adjustment switch
- ④ Vertical height adjustment switch
- ⑤ Lumbar support adjustment switch (driver's side only)

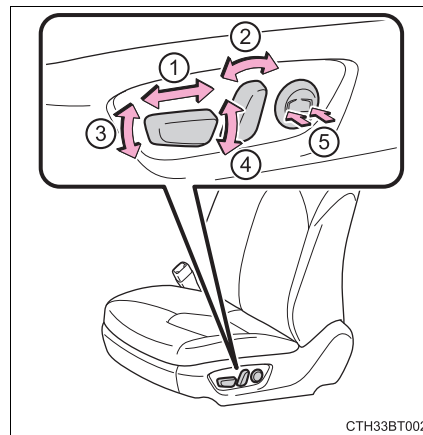

3

Operation of each component

 **WARNING****■ When adjusting the seat position**

- Take care when adjusting the seat position to ensure that other passengers are not injured by the moving seat.
- Do not put your hands under the seat or near the moving parts to avoid injury.
Fingers or hands may become jammed in the seat mechanism.
- Make sure to leave enough space around the feet so they do not get stuck.

■ Seat adjustment

- Be careful that the seat does not hit passengers or luggage.
- To reduce the risk of sliding under the lap belt during a collision, do not recline the seat more than necessary.
If the seat is too reclined, the lap belt may slide past the hips and apply restraint forces directly to the abdomen, or your neck may contact the shoulder belt, increasing the risk of death or serious injury in the event of an accident.
Adjustments should not be made while driving as the seat may unexpectedly move and cause the driver to lose control of the vehicle.
- Manual seat only: After adjusting the seat, make sure that the seat is locked in position.

 **NOTICE****■ When adjusting a front seat**

When adjusting a front seat, make sure that the head restraint does not contact the headliner. Otherwise, the head restraint and headliner may be damaged.

Rear seats (folding type)*

The seatbacks of the rear seats can be folded down.

Folding down the rear seatbacks

Pull the seatback lever in the trunk for the seatback you wish to fold down and then fold the seatback down.

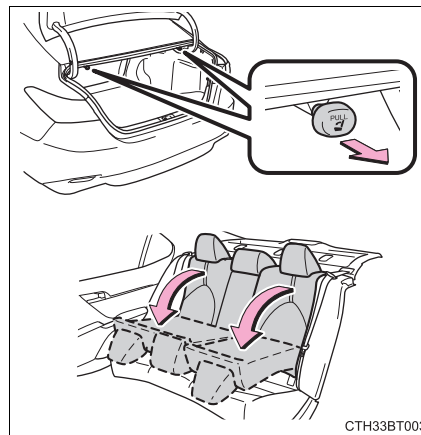

3

Operation of each component

*: If equipped

 **WARNING****■ When folding the seatbacks down**

Observe the following precautions. Failure to do so may result in death or serious injury.

- Do not fold the seatbacks down while driving.
- Stop the vehicle on level ground, set the parking brake and shift the shift lever to P.
- Do not allow anyone to sit on a folded seatback or in the trunk while driving.
- Do not allow children to enter the trunk.

■ When returning the seat to its original position

- Ensure that the seat belt does not get caught between or behind the seats.
- If the seat belt has been released from its guide, pass the seat belt through its guide. (→P. 32)

■ Seat adjustment

Be careful not to get hands or feet pinched between the rear console box and the rear seat when folding down the rear seatback.

■ After returning the seatback to the upright position

Observe the following precautions. Failure to do so may result in death or serious injury.

- Make sure the seatback is securely locked by pressing it forward and rearward on the top.
- Check that the seat belts are not twisted or caught in the seatback.
- Make sure that the seat belt is passed through its guide.

 **NOTICE****■ When the right seatback is folded down**

Make sure the luggage loaded in the enlarged trunk will not damage the webbing of the rear center seat belt.

Head restraints

Head restraints are provided for all seats.

▶ Adjustable type

- ① Up
Pull the head restraint up.
- ② Down
Push the head restraint down while pressing the lock release button.

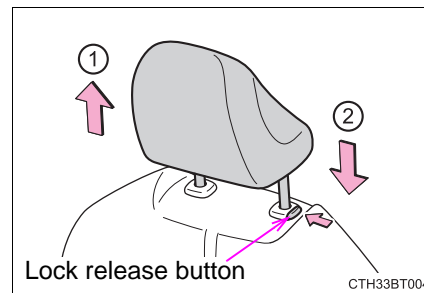

▶ Integrated type

Head restraints cannot be adjusted or removed.

■ Removing the head restraints

Pull the head restraint up while pressing the lock release button.

Front seats: If the head restraint touches the ceiling, making the removal difficult, change the seat height or angle.
(→P. 167)

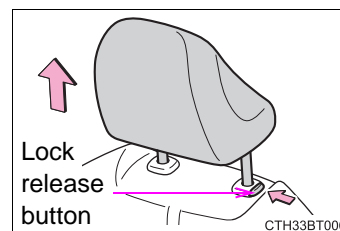

3

Operation of each component

■ Installing the head restraints

▶ Front seats

Align the head restraint with the installation holes and push it down to the lock position.

Press and hold the lock release button when lowering the head restraint.

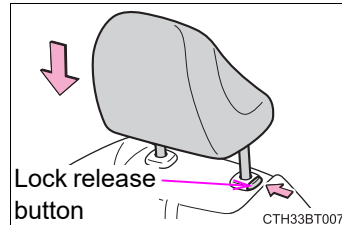

▶ Rear seats

Align the head restraint with the installation holes and push it down to the lowest lock position while pressing the lock release button.

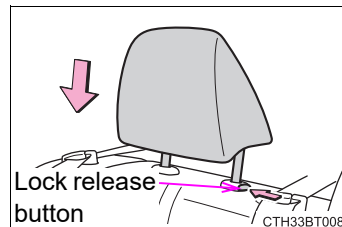

■ Adjusting the height of the head restraints

Make sure that the head restraints are adjusted so that the center of the head restraint is closest to the top of your ears.

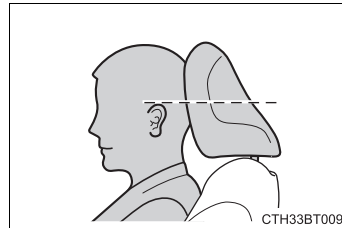

⚠ WARNING

■ Head restraint precautions

Observe the following precautions regarding the head restraints. Failure to do so may result in death or serious injury.

- Use the head restraints designed for each respective seat.
- Adjust the head restraints to the correct position at all times.
- After adjusting the head restraints, push down on them and make sure they are locked in position.
- Do not drive with the head restraints removed.
(However, if a head restraint interferes with installation of a child restraint system, the head restraint can be removed to accommodate the child restraint system: →P. 56)

Steering wheel

Adjustment procedure

- 1 Hold the steering wheel and push the lever down.

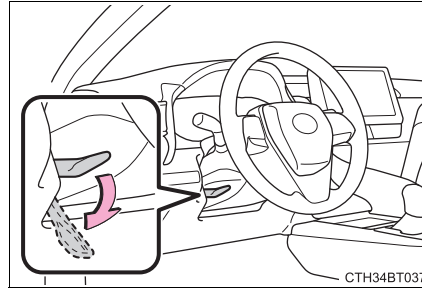

- 2 Adjust to the ideal position by moving the steering wheel horizontally and vertically. After adjustment, pull the lever up to secure the steering wheel.

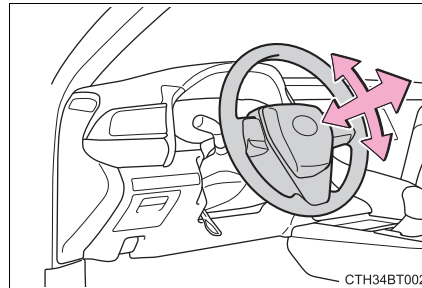

Horn

To sound the horn, press on or close to the  mark.

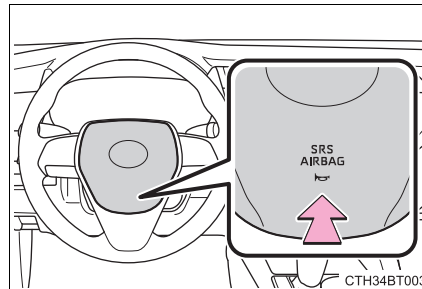

3

Operation of each component

**WARNING****■ Caution while driving**

Do not adjust the steering wheel while driving.

Doing so may cause the driver to mishandle the vehicle and cause an accident, resulting in death or serious injury.

■ After adjusting the steering wheel

Make sure that the steering wheel is securely locked.

Otherwise, the steering wheel may move suddenly, possibly causing an accident, and resulting in death or serious injury. Also, the horn may not sound if the steering wheel is not securely locked.

Inside rear view mirror

The rear view mirror's position can be adjusted to enable sufficient confirmation of the rear view.

Adjusting the height of rear view mirror

The height of the rear view mirror can be adjusted to suit your driving posture.

Adjust the height of the rear view mirror by moving it up and down.

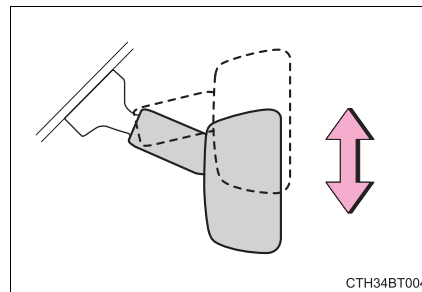

Anti-glare function

► Manual anti-glare inside rear view mirror

Reflected light from the headlights of vehicles behind can be reduced by operating the lever.

- ① Normal position
- ② Anti-glare position

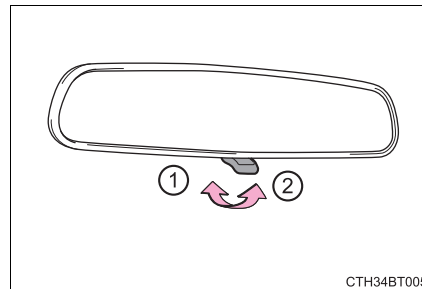

3

Operation of each component

▶ Auto anti-glare inside rear view mirror

Responding to the level of brightness of the headlights of vehicles behind, the reflected light is automatically reduced.

Changing automatic anti-glare function mode

On/off

When the automatic anti-glare function is in ON mode, the indicator illuminates.

The function will set to ON mode each time the engine switch is turned to IGNITION ON mode.

Pressing the button turns the function to OFF mode. (The indicator also turns off.)

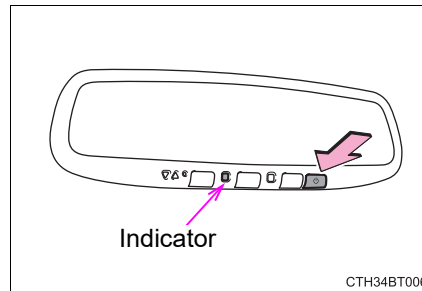

■ To prevent sensor error (vehicles with an auto anti-glare inside rear view mirror)

To ensure that the sensors operate properly, do not touch or cover them.

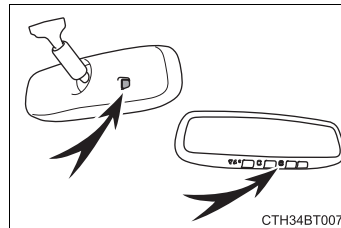

⚠ WARNING

Do not adjust the position of the mirror while driving.
Doing so may lead to mishandling of the vehicle and cause an accident, resulting in death or serious injury.

Outside rear view mirrors

The rear view mirror's position can be adjusted to enable sufficient confirmation of the rear view.

■ When using the outside rear view mirrors in a cold weather

When it is cold and the outside rear view mirrors are frozen, it may not be possible to fold/extend them or adjust the mirror surface. Remove the ice, snow, etc. covering the outside rear view mirrors.

Adjustment procedure

- 1 To select a mirror to adjust, turn the switch.

- ① Left
- ② Right

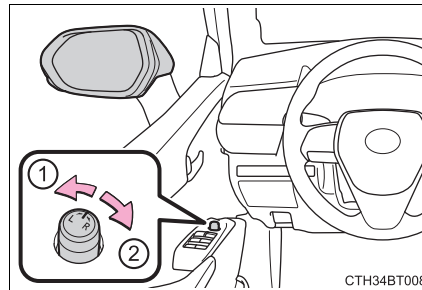

- 2 To adjust the mirror, operate the switch.

- ① Up
- ② Right
- ③ Down
- ④ Left

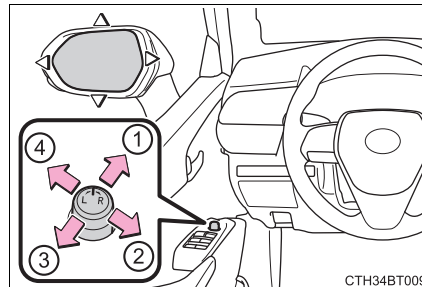

Folding the mirrors

Push the mirror back in the direction of the vehicle's rear.

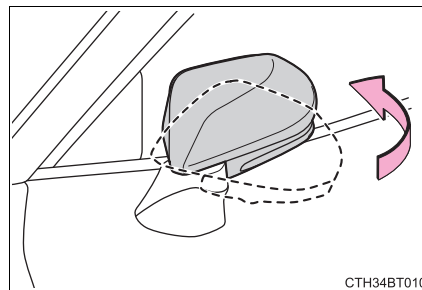

3

Operation of each component

■ Mirror angle can be adjusted when

- ▶ Vehicles without a smart key system

The engine switch is in the “ACC” or “ON” position.

- ▶ Vehicles with a smart key system

The engine switch is in ACCESSORY or IGNITION ON mode.

■ When the mirrors are fogged up (vehicles with outside rear view mirror defoggers)

The outside rear view mirrors can be cleared using the mirror defoggers. Turn on the rear window defogger to turn on the outside rear view mirror defoggers. (→P. 383, 389, 397)

**WARNING****■ Important points while driving**

Observe the following precautions while driving.

Failure to do so may result in loss of control of the vehicle and cause an accident, resulting in death or serious injury.

- Do not adjust the mirrors while driving.
- Do not drive with the mirrors folded.
- Both the driver and passenger side mirrors must be extended and properly adjusted before driving.

■ When a mirror is moving

To avoid personal injury and mirror malfunction, be careful not to get your hand caught by the moving mirror.

■ When the mirror defoggers are operating (vehicles with outside rear view mirror defoggers)

Do not touch the rear view mirror surfaces, as they can become very hot and burn you.

Power windows

Opening and closing procedures

The power windows can be opened and closed using the switches. Operating the switch moves the windows as follows:

- ① Closing
- ② One-touch closing*
- ③ Opening
- ④ One-touch opening*

*: To stop the window partway, operate the switch in the opposite direction.

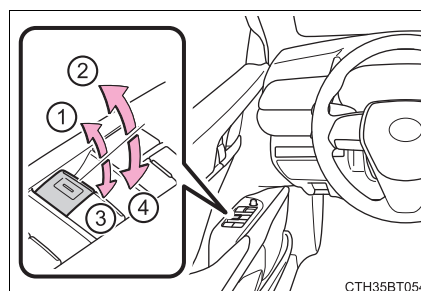

Preventing accidental operation (window lock switch)

This function can be used to prevent children from accidentally opening or closing a passenger window.

Press the switch.

The indicator will come on and the passenger windows will be locked.

The passenger windows can still be opened and closed using the driver's switch even if the lock switch is on.

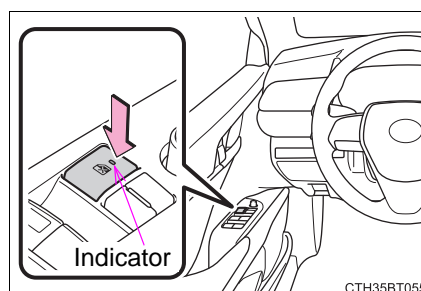

■ The power windows can be operated when

- ▶ Vehicles without a smart key system

The engine switch is in the "ON" position.

- ▶ Vehicles with a smart key system

The engine switch is in IGNITION ON mode.

■ **Operating the power windows after turning the engine off**

▶ Vehicles without a smart key system

The power windows can be operated for approximately 45 seconds even after the engine switch is turned to the “ACC” or “LOCK” position. They cannot, however, be operated once either front door is opened.

▶ Vehicles with a smart key system

The power windows can be operated for approximately 45 seconds even after the engine switch is turned to ACCESSORY mode or turned off. They cannot, however, be operated once either front door is opened.

■ **Jam protection function**

If an object becomes jammed between the window and the window frame while the window is closing, window movement is stopped and the window is opened slightly.

■ **Catch protection function**

If an object becomes caught between the door and window while the window is opening, window movement is stopped.

■ **When the window cannot be opened or closed**

When the jam protection function or catch protection function operates unusually and the door window cannot be opened or closed, perform the following operations with the power window switch of that door.

- Vehicles without a smart key system: Stop the vehicle. With the engine switch in the “ON” position, within 4 seconds of the jam protection function or catch protection function activating, continuously operate the power window switch in the one-touch closing direction or one-touch opening direction so that the door window can be opened and closed.

Vehicles with a smart key system: Stop the vehicle. With the engine switch in IGNITION ON mode, within 4 seconds of the jam protection function or catch protection function activating, continuously operate the power window switch in the one-touch closing direction or one-touch opening direction so that the door window can be opened and closed.

- If the door window cannot be opened and closed even when performing the above operations, perform the following procedure for function initialization.

- 1 Vehicles without a smart key system:
Turn the engine switch to the "ON" position.
Vehicles with a smart key system:
Turn the engine switch to IGNITION ON mode.
- 2 Pull and hold the power window switch in the one-touch closing direction and completely close the door window.
- 3 Release the power window switch for a moment, resume pulling the switch in the one-touch closing direction, and hold it there for approximately 6 seconds or more.
- 4 Press and hold the power window switch in the one-touch opening direction. After the door window is completely opened, continue holding the switch for an additional 1 second or more.
- 5 Release the power window switch for a moment, resume pushing the switch in the one-touch opening direction, and hold it there for approximately 4 seconds or more.
- 6 Pull and hold the power window switch in the one-touch closing direction again. After the door window is completely closed, continue holding the switch for a further 1 second or more.

If you release the switch while the window is moving, start again from the beginning.

If the window reverses and cannot be fully closed or opened, have the vehicle inspected by your Toyota dealer.

■ Door lock linked window operation

- Vehicles without a smart key system: The power windows can be opened and closed using the key.* (→P. 149)
Vehicles with a smart key system: The power windows can be opened and closed using the mechanical key.* (→P. 559)
- The power windows can be opened using the wireless remote control.* (→P. 148)

*: These settings must be customized at your Toyota dealer.

■ Alarm

The alarm may be triggered if the alarm is set and a power window is closed using the door lock linked power window operation function. (→P. 83)

■ Power windows open warning buzzer

A buzzer sounds and a message is shown on the multi-information display in the instrument cluster when the engine switch is turned off and the driver's door is opened with the power windows open.

■ Customization

Some functions can be customized. (→P. 606)

⚠ WARNING

Observe the following precautions.
Failure to do so may result in death or serious injury.

■ **Closing the windows**

- The driver is responsible for all the power window operations, including the operation for the passengers. In order to prevent accidental operation, especially by a child, do not let a child operate the power windows. It is possible for children and other passengers to have body parts caught in the power window. Also, when riding with a child, it is recommended to use the window lock switch. (→P. 179)
- Check to make sure that all passengers do not have any part of their body in a position where it could be caught when a window is being operated.

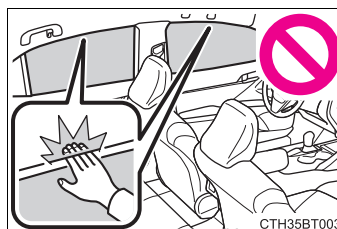

- When using the wireless remote control, key or mechanical key and operating the power windows, operate the power window after checking to make sure that there is no possibility of any passenger having any of their body parts caught in the window. Also do not let a child operate window by the wireless remote control, key or mechanical key. It is possible for children and other passengers to get caught in the power window.
- When exiting the vehicle, turn the engine switch off, carry the key and exit the vehicle along with the child. There may be accidental operation, due to mischief, etc., that may possibly lead to an accident.

■ **Jam protection function**

- Never use any part of your body to intentionally activate the jam protection function.
- The jam protection function may not work if something gets jammed just before the window is fully closed. Be careful not to get any part of your body jammed in the window.

■ **Catch protection function**

- Never use any part of your body or clothing to intentionally activate the catch protection function.
- The catch protection function may not work if something gets caught just before the window is fully opened. Be careful not to get any part of your body or clothing caught in the window.

Moon roof*

Use the overhead switches to open and close the moon roof and tilt it up and down.

Opening and closing

- ① Opens the moon roof*
The moon roof stops slightly before the fully open position to reduce wind noise.
Press the switch again to fully open the moon roof.
- ② Closes the moon roof*
*: Lightly press either side of the moon roof switch to stop the moon roof partway.

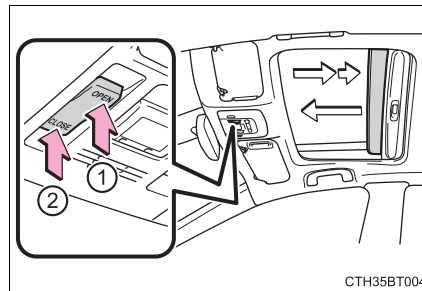

Tilting up and down

- ① Tilts the moon roof up*
 - ② Tilts the moon roof down*
- *: Lightly press either side of the moon roof switch to stop the moon roof partway.

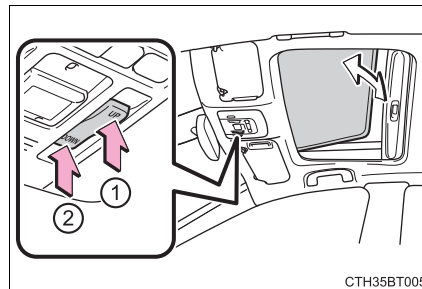

*: If equipped

■ **The moon roof can be operated when**

- ▶ Vehicles without a smart key system

The engine switch is in the “ON” position.

- ▶ Vehicles with a smart key system

The engine switch is in IGNITION ON mode.

■ **Operating the moon roof after turning the engine off**

- ▶ Vehicles without a smart key system

The moon roof can be operated for approximately 45 seconds after the engine switch is turned to the “ACC” or “LOCK” position. It cannot, however, be operated once either front door is opened.

- ▶ Vehicles with a smart key system

The moon roof can be operated for approximately 45 seconds after the engine switch is turned to ACCESSORY mode or turned off. It cannot, however, be operated once either front door is opened.

■ **Jam protection function**

If an object is detected between the moon roof and the frame while the moon roof is closing or tilting down, travel is stopped and the moon roof opens slightly.

■ **Sunshade**

The sunshade can be opened and closed manually. However, the sunshade will open automatically when the moon roof is opened.

■ **Door lock linked moon roof operation**

- Vehicles without a smart key system: The moon roof can be opened and closed using the key.* (→P. 149)

Vehicles with a smart key system: The moon roof can be opened and closed using the mechanical key.* (→P. 559)

- The moon roof can be opened using the wireless remote control.* (→P. 148)

*: These settings must be customized at your Toyota dealer.

■ When the moon roof does not close normally

Perform the following procedure:

- If the moon roof closes but then re-opens slightly

- 1 Stop the vehicle.
- 2 Press and hold the "CLOSE" switch.*1
The moon roof will close, reopen and pause for approximately 10 seconds.*2 Then it will close again, tilt up and pause for approximately 1 second. Finally, it will tilt down, open and close.
- 3 Check to make sure that the moon roof is completely closed and then release the switch.

- If the moon roof tilts down but then tilts back up

- 1 Stop the vehicle.
- 2 Press and hold the "UP" switch*1 until the moon roof moves into the tilt up position and stops.
- 3 Release the "UP" switch once and then press and hold the "UP" switch again.*1
The moon roof will pause for approximately 10 seconds in the tilt up position.*2 Then it will adjust slightly and pause for approximately 1 second. Finally, it will tilt down, open and close.
- 4 Check to make sure that the moon roof is completely closed and then release the switch.

*1: If the switch is released at the incorrect time, the procedure will have to be performed again from the beginning.

*2: If the switch is released after the above mentioned 10 second pause, automatic operation will be disabled. In that case, press and hold the "CLOSE" or "UP" switch, and the moon roof will tilt up and pause for approximately 1 second. Then it will tilt down, open and close. Check to make sure that the moon roof is completely closed and then release the switch.

If the moon roof does not fully close even after performing the above procedure correctly, have the vehicle inspected by your Toyota dealer.

■ Alarm

The alarm may be triggered if the alarm is set and the moon roof is closed using the door lock linked moon roof operation function. (→P. 83)

■ Moon roof open warning buzzer

A buzzer sounds and a message is shown on the multi-information display in the instrument cluster when the engine switch is turned off and the driver's door is opened with the moon roof open.

■ Customization

Some functions can be customized. (→P. 606)

⚠ WARNING

Observe the following precautions.
Failure to do so may cause death or serious injury.

■ Opening the moon roof

- Do not allow any passengers to put their hands or heads outside the vehicle while it is moving.
- Do not sit on top of the moon roof.

■ Closing the moon roof

- The driver is responsible for moon roof opening and closing operations. In order to prevent accidental operation, especially by a child, do not let a child operate the moon roof. It is possible for children and other passengers to have body parts caught in the moon roof.

- Check to make sure that all passengers do not have any part of their body in a position where it could be caught when the moon roof is being operated.

- When using the wireless remote control, key or mechanical key and operating the moon roof, operate the moon roof after checking to make sure that there is no possibility of any passenger having any of their body parts caught in the moon roof. Also, do not let a child operate moon roof by the wireless remote control, key or mechanical key. It is possible for children and other passengers to get caught in the moon roof.

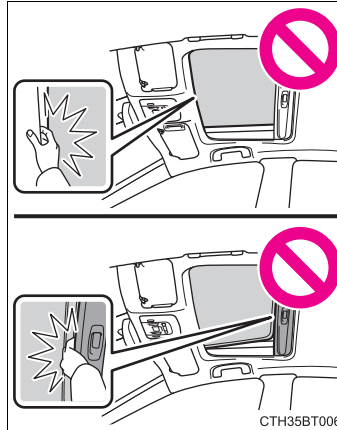

- When exiting the vehicle, turn the engine switch off, carry the key and exit the vehicle along with the child. There may be accidental operation, due to mischief, etc., that may possibly lead to an accident.

■ Jam protection function

- Never use any part of your body to intentionally activate the jam protection function.
- The jam protection function may not work if something gets caught just before the moon roof is fully closed. Also, the jam protection function is not designed to operate while the switch is being pressed. Take care so that your fingers, etc. do not get caught.

Panoramic moon roof*

Use the overhead switches to operate the panoramic moon roof and electronic sunshade.

Opening and closing the electronic sunshade

① Opens the electronic sunshade

Slide and hold the  switch backward. The electronic sunshade will fully open automatically.*

② Closes the electronic sunshade

Slide and hold the  switch forward. The electronic sunshade will fully close automatically.*

*: Quickly slide and release the  switch in either direction to stop the electronic sunshade partway.

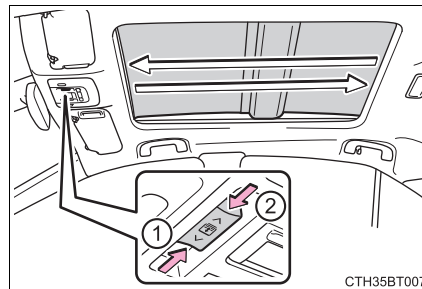

Tilting the panoramic moon roof up and down

Tilts the panoramic moon roof up (press)*

When the panoramic moon roof is tilted up, the electronic sunshade will open to the half-open position of the roof.

*: Lightly press the  switch again to stop the panoramic moon roof partway.

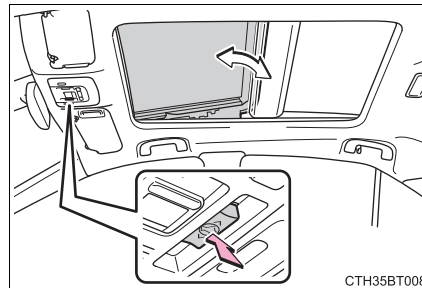

Tilts the panoramic moon roof down (press and hold)

The panoramic moon roof can be tilted down only when it is in the tilt-up position.

3

Operation of each component

*: If equipped

Opening and closing the panoramic moon roof

Opens the panoramic moon roof*

Slide and hold the  switch backward. The panoramic moon roof and electronic sunshade will open automatically.

The panoramic moon roof can be opened from the tilt-up position.

*: Quickly slide and release the  switch in either direction to stop the panoramic moon roof partway.

Closes the panoramic moon roof

Slide and hold the  switch forward. The panoramic moon roof will fully close automatically.

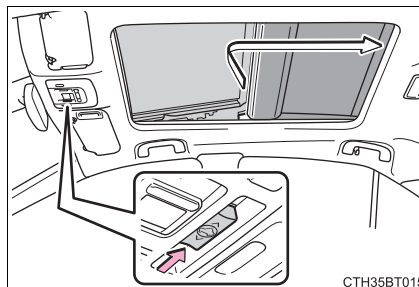

CTH35BT015

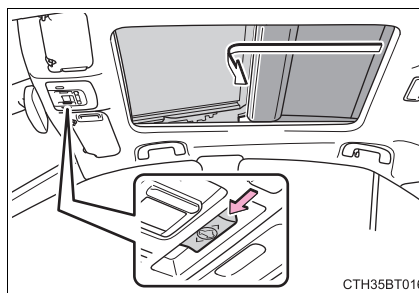

CTH35BT016

■ The panoramic moon roof can be operated when

The engine switch is in IGNITION ON mode.

■ Operating the panoramic moon roof after turning the engine off

The panoramic moon roof and electronic sunshade can be operated for approximately 45 seconds after the engine switch is turned to ACCESSORY mode or turned off. They cannot, however, be operated once either front door is opened.

■ Jam protection function

If an object is detected between the panoramic moon roof and the frame in the following situations, travel is stopped and the panoramic moon roof opens slightly:

- The panoramic moon roof is closing or tilting down.
- The electronic sunshade is closing.

■ Door lock linked panoramic moon roof operation

- The panoramic moon roof can be opened and closed using the mechanical key.* (→P. 559)
- The panoramic moon roof can be opened using the wireless remote control.* (→P. 148)

*: These settings must be customized at your Toyota dealer.



■ Closing both the panoramic moon roof and electronic sunshade

Slide the  switch forward.

The electronic sunshade will close to the half-open position and pause. The panoramic moon roof will then fully close. Then the electronic sunshade will fully close.

■ When the panoramic moon roof or electronic sunshade does not close normally

Perform the following procedure:

- 1 Stop the vehicle.
- 2 Turn the engine switch to IGNITION ON mode.
- 3 Slide and hold the  switch or  switch forward. Continue pressing the switch for approximately 10 seconds after the panoramic moon roof or electronic sunshade closes and reopens. The panoramic moon roof and electronic sunshade will start to close.*
- 4 Check that the panoramic moon roof and electronic sunshade are fully closed and release the switch.

*: If the switch is released at the incorrect time, the procedure will have to be performed again from the beginning.

If the panoramic moon roof or electronic sunshade does not fully close even after performing the above procedure correctly, have the vehicle inspected by your Toyota dealer.

■ Alarm

The alarm may be triggered if the alarm is set and the panoramic moon roof is closed using the door lock linked panoramic moon roof operation function. (→P. 83)

■ Panoramic moon roof open warning buzzer

A buzzer sounds and a message is shown on the multi-information display in the instrument cluster when the engine switch is turned off and the driver's door is opened with the panoramic moon roof open.

■ Customization

Some functions can be customized. (→P. 606)

⚠ WARNING

Observe the following precautions.
Failing to do so may cause death or serious injury.

■ **Opening and closing the electronic sunshade**

- Check to make sure that all passengers do not have any part of their body in a position where it could be caught when the electronic sunshade is being operated.
- Do not let a child operate the electronic sunshade. Closing the electronic sunshade on someone can cause death or serious injury.

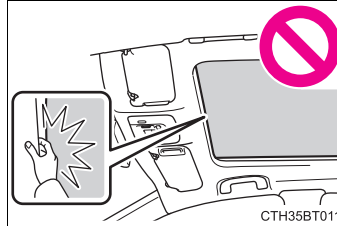

■ **Opening and closing the panoramic moon roof**

- The driver is responsible for panoramic moon roof opening and closing operations.
In order to prevent accidental operation, especially by a child, do not let a child operate the panoramic moon roof. It is possible for children and other passengers to have body parts caught in the panoramic moon roof.
- Check to make sure that all passengers do not have any part of their body in a position where it could be caught when the panoramic moon roof is being operated.
- When using the wireless remote control or mechanical key and operating the panoramic moon roof, operate the panoramic moon roof after checking to make sure that there is no possibility of any passenger having any of their body parts caught in the panoramic moon roof. Also, do not let a child operate panoramic moon roof by the wireless remote control or mechanical key. It is possible for children and other passengers to get caught in the panoramic moon roof.
- When exiting the vehicle, turn the engine switch off, carry the key and exit the vehicle along with the child. There may be accidental operation, due to mischief, etc., that may possibly lead to an accident.

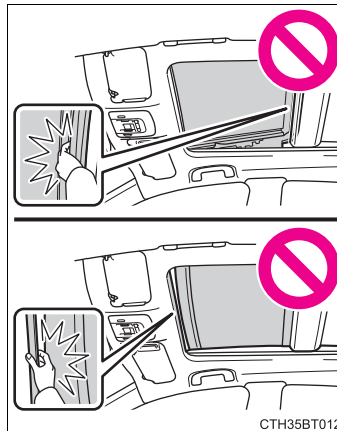

⚠ WARNING**■ Jam protection function**

- Never use any part of your body to intentionally activate the jam protection function.
- The jam protection function may not work if something gets caught just before the panoramic moon roof or electronic sunshade is fully closed. Also, the jam protection function is not designed to operate while the switch is being pressed. Take care so that your fingers, etc. do not get caught.

■ To prevent burns or injuries

Do not touch the area between the underside of the panoramic moon roof and the electronic sunshade. Your hand may get caught and you could injure yourself. Also, if the vehicle is left in direct sunlight for a long time, the underside of the panoramic moon roof could become very hot and could cause burns.

⚠ NOTICE**■ To prevent damage to the panoramic moon roof**

- Before opening the panoramic moon roof, make sure that there are no foreign objects, such as stones or ice, around the opening.
- Do not hit the surface or edge of the panoramic moon roof with hard objects.
- Do not continuously press the  switch after the panoramic moon roof has been fully opened or closed.

■ After the vehicle has been washed or rained on

Before opening the panoramic moon roof, wipe any water off the panoramic moon roof. Otherwise, water may enter the cabin when the panoramic moon roof is opened.

Driving

4

- 4-1. Before driving**
 - Driving the vehicle..... 194
 - Cargo and luggage 203
 - Vehicle load limits 206
 - Trailer towing..... 207
 - Dinghy towing 208
- 4-2. Driving procedures**
 - Engine (ignition) switch
(vehicles without a
smart key system)..... 209
 - Engine (ignition) switch
(vehicles with a
smart key system)..... 211
 - Automatic transmission 217
 - Turn signal lever..... 223
 - Parking brake 224
 - Electric parking brake..... 225
 - Brake Hold 229
- 4-3. Operating the lights
and wipers**
 - Headlight switch 231
 - AHB (Automatic High
Beam) 236
 - Windshield wipers and
washer 240
- 4-4. Refueling**
 - Opening the fuel tank
cap 244
- 4-5. Using the driving
support systems**
 - Toyota Safety
Sense 2.5+..... 248
 - PCS (Pre-Collision
System)..... 254
 - LTA (Lane Tracing
Assist) 270
 - RSA (Road Sign Assist).... 285
 - Dynamic radar cruise
control with full-speed
range..... 290
 - Dynamic radar cruise
control 306
 - Driving assist systems 322
 - BSM (Blind Spot
Monitor)..... 330
 - Intuitive parking assist..... 336
 - RCTA (Rear Cross Traffic
Alert) 345
 - RCD (Rear Camera
Detection) 354
 - PKSB (Parking Support
Brake) 360
 - Parking Support Brake
function (static
objects) 368
 - Parking Support Brake
function (rear-crossing
vehicles)..... 372
 - Driving mode select
switches 375
- 4-6. Driving tips**
 - Winter driving tips 377

Driving the vehicle

The following procedures should be observed to ensure safe driving:

Starting the engine

→P. 209, 211

Driving

- 1 With the brake pedal depressed, shift the shift lever to D.
(→P. 217)
- 2 Release the parking brake. (→P. 224, 225)
- 3 Gradually release the brake pedal and gently depress the accelerator pedal to accelerate the vehicle.

Stopping

- 1 With the shift lever in D, depress the brake pedal.
- 2 If necessary, set the parking brake.
If the vehicle is to be stopped for an extended period of time, shift the shift lever to P or N. (→P. 217)

Parking the vehicle

- 1 With the shift lever in D, depress the brake pedal.
- 2 Set the parking brake (→P. 224, 225), and shift the shift lever to P (→P. 217).
- 3 Vehicles without a smart key system:
Turn the engine switch to the "LOCK" position to stop the engine.
Vehicles with a smart key system:
Press the engine switch to stop the engine.
- 4 Lock the door, making sure that you have the key on your person.
If parking on a hill, block the wheels as needed.

Starting off on a steep uphill

- 1 Make sure that the parking brake is set and shift the shift lever to D.
- 2 Gently depress the accelerator pedal.
- 3 Release the parking brake.

Sudden start restraint control (Drive-Start Control [DSC])

When the following unusual operation is performed with the accelerator pedal depressed, the engine output may be restrained.

- When the shift lever is shifted to R*.
- When the shift lever is shifted from P or R to forward drive shift position such as D*.

When the system operates, a message appears on the multi-information display. Read the message and follow the instruction.

*: Depending on the situation, the shift position may not be changed.

■ When starting off on a uphill

The hill-start assist control will activate. (→P. 323)

■ Driving in the rain

- Drive carefully when it is raining, because visibility will be reduced, the windows may become fogged-up, and the road will be slippery.
- Drive carefully when it starts to rain, because the road surface will be especially slippery.
- Refrain from high speeds when driving on an expressway in the rain, because there may be a layer of water between the tires and the road surface, preventing the steering and brakes from operating properly.

■ Engine speed while driving

In the following conditions, the engine speed may become high while driving. This is due to automatic up-shifting control or down-shifting implementation to meet driving conditions. It does not indicate sudden acceleration.

- The vehicle is judged to be driving uphill or downhill
- When the accelerator pedal is released

■ Restraining the engine output (Brake Override System)

- When the accelerator and brake pedals are depressed at the same time, the engine output may be restrained.
- A warning message is displayed on the multi-information display while the system is operating.

■ Drive-Start Control (DSC)

When the TRAC is turned off (→P. 325), sudden start restraint control also does not operate. If your vehicle have trouble escaping from the mud or fresh snow due to sudden start restraint control operation, deactivate TRAC (→P. 325) so that the vehicle may become able to escape from the mud or fresh snow.

■ **Breaking in your new Toyota**

To extend the life of the vehicle, observing the following precautions is recommended:

- For the first 186 miles (300 km):
Avoid sudden stops.
- For the first 621 miles (1000 km):
 - Do not drive at extremely high speeds.
 - Avoid sudden acceleration.
 - Do not drive continuously in low gears.
 - Do not drive at a constant speed for extended periods.

■ **Drum-in-disc type parking brake system**

Your vehicle has a drum-in-disc type parking brake system. This type of brake system needs bedding-down of the brake shoes periodically or whenever the parking brake shoes and/or drum are replaced. Have your Toyota dealer perform the bedding down operation.

■ **Operating your vehicle in a foreign country**

Comply with the relevant vehicle registration laws and confirm the availability of the correct fuel. (→P. 590)

■ **Eco-friendly driving**

→P. 109, 126, 131

⚠ WARNING

Observe the following precautions.

Failure to do so may result in death or serious injury.

■ **When starting the vehicle**

Always keep your foot on the brake pedal while stopped with the engine running. This prevents the vehicle from creeping.

■ **When driving the vehicle**

- Do not drive if you are unfamiliar with the location of the brake and accelerator pedals to avoid depressing the wrong pedal.
 - Accidentally depressing the accelerator pedal instead of the brake pedal will result in sudden acceleration that may lead to an accident.
 - When backing up, you may twist your body around, leading to a difficulty in operating the pedals. Make sure to operate the pedals properly.
 - Make sure to keep a correct driving posture even when moving the vehicle only slightly. This allows you to depress the brake and accelerator pedals properly.
 - Depress the brake pedal using your right foot. Depressing the brake pedal using your left foot may delay response in an emergency, resulting in an accident.
- Do not drive the vehicle over or stop the vehicle near flammable materials. The exhaust system and exhaust gases can be extremely hot. These hot parts may cause a fire if there is any flammable material nearby.
- During normal driving, do not turn off the engine. Turning the engine off while driving will not cause loss of steering or braking control, but the power assist to these systems will be lost. This will make it more difficult to steer and brake, so you should pull over and stop the vehicle as soon as it is safe to do so.
However, in the event of an emergency, such as if it becomes impossible to stop the vehicle in the normal way: →P. 517
- Use engine braking (downshift) to maintain a safe speed when driving down a steep hill.
Using the brakes continuously may cause the brakes to overheat and lose effectiveness. (→P. 218)
- Do not adjust the display, the positions of the steering wheel, the seat, or the inside or outside rear view mirrors while driving.
Doing so may result in a loss of vehicle control.
- Always check that all passengers' arms, heads or other parts of their body are not outside the vehicle.
- AWD models: Do not drive the vehicle off-road.
This is not an AWD vehicle designed for off-road driving. Proceed with all due caution if it becomes unavoidable to drive off-road.

 **WARNING**

Observe the following precautions.

Failure to do so may result in death or serious injury.

■ **When driving the vehicle**

- Do not drive in excess of the speed limit. Even if the legal speed limit permits it, do not drive over 85 mph (140 km/h) unless your vehicle has high-speed capability tires. Driving over 85 mph (140 km/h) may result in tire failure, loss of control and possible injury. Be sure to consult a tire dealer to determine whether the tires on your vehicle are high-speed capability tires or not before driving at such speeds.

■ **When driving on slippery road surfaces**

- Sudden braking, acceleration and steering may cause tire slippage and reduce your ability to control the vehicle.
- Sudden acceleration, engine braking due to shifting, or changes in engine speed could cause the vehicle to skid.
- After driving through a puddle, lightly depress the brake pedal to make sure that the brakes are functioning properly. Wet brake pads may prevent the brakes from functioning properly. If the brakes on only one side are wet and not functioning properly, steering control may be affected.

■ **When shifting the shift lever**

- Do not let the vehicle roll backward while the shift lever is in a driving position, or roll forward while the shift lever is in R.
Doing so may cause the engine to stall or lead to poor brake and steering performance, resulting in an accident or damage to the vehicle.
- Do not shift the shift lever to P while the vehicle is moving.
Doing so can damage the transmission and may result in a loss of vehicle control.
- Do not shift the shift lever to R while the vehicle is moving forward.
Doing so can damage the transmission and may result in a loss of vehicle control.
- Do not shift the shift lever to a driving position while the vehicle is moving backward.
Doing so can damage the transmission and may result in a loss of vehicle control.
- Shifting the shift lever to N while the vehicle is moving will disengage the engine from the transmission. Engine braking is not available when N is selected.
- Be careful not to shift the shift lever with the accelerator pedal depressed. Shifting the shift lever to a gear other than P or N may lead to unexpected rapid acceleration of the vehicle that may cause an accident and result in death or serious injury.

 **WARNING**

Observe the following precautions.

Failure to do so may result in death or serious injury.

■ **If you hear a squealing or scraping noise (brake pad wear limit indicators)**

Have the brake pads checked and replaced by your Toyota dealer as soon as possible.

Rotor damage may result if the pads are not replaced when needed.

It is dangerous to drive the vehicle when the wear limits of the brake pads and/or those of the brake discs are exceeded.

■ **When the vehicle is stopped**

- Do not race the engine.

If the shift lever is any position other than P or N, the vehicle may accelerate suddenly and unexpectedly, causing an accident.

- In order to prevent accidents due to the vehicle rolling away, always keep depressing the brake pedal while the engine is running, and apply the parking brake as necessary.

- If the vehicle is stopped on an incline, in order to prevent accidents caused by the vehicle rolling forward or backward, always depress the brake pedal and securely apply the parking brake as needed.

- Avoid revving or racing the engine.

Running the engine at high speed while the vehicle is stopped may cause the exhaust system to overheat, which could result in a fire if combustible material is nearby.

 **WARNING**

Observe the following precautions.

Failure to do so may result in death or serious injury.

■ **When the vehicle is parked**

- Do not leave glasses, cigarette lighters, spray cans, or soft drink cans in the vehicle when it is in the sun.
Doing so may result in the following:
 - Gas may leak from a cigarette lighter or spray can, and may lead to a fire.
 - The temperature inside the vehicle may cause the plastic lenses and plastic material of glasses to deform or crack.
 - Soft drink cans may fracture, causing the contents to spray over the interior of the vehicle, and may also cause a short circuit in the vehicle's electrical components.
- Do not leave cigarette lighters in the vehicle. If a cigarette lighter is in a place such as the glove box or on the floor, it may be lit accidentally when luggage is loaded or the seat is adjusted, causing a fire.
- Do not attach adhesive discs to the windshield or windows. Do not place containers such as air fresheners on the instrument panel or dashboard. Adhesive discs or containers may act as lenses, causing a fire in the vehicle.
- Do not leave a door or window open if the curved glass is coated with a metallized film such as a silver-colored one. Reflected sunlight may cause the glass to act as a lens, causing a fire.
- Always apply the parking brake, shift the shift lever to P, stop the engine and lock the vehicle.
Do not leave the vehicle unattended while the engine is running.
If the vehicle is parked with the shift lever in P but the parking brake is not set, the vehicle may start to move, possibly leading to an accident.
- Do not touch the exhaust pipes while the engine is running or immediately after turning the engine off.
Doing so may cause burns.

 **WARNING**

Observe the following precautions.
Failure to do so may result in death or serious injury.

■ When taking a nap in the vehicle

Always turn the engine off. Otherwise, if you accidentally move the shift lever or depress the accelerator pedal, this could cause an accident or fire due to engine overheating. Additionally, if the vehicle is parked in a poorly ventilated area, exhaust gases may collect and enter the vehicle, leading to death or a serious health hazard.

■ When braking

- When the brakes are wet, drive more cautiously.
Braking distance increases when the brakes are wet, and this may cause one side of the vehicle to brake differently than the other side. Also, the parking brake may not securely hold the vehicle.
- If the brake booster device does not operate, do not follow other vehicles closely and avoid hills or sharp turns that require braking.
In this case, braking is still possible, but the brake pedal should be depressed more firmly than usual. Also, the braking distance will increase. Have your brakes fixed immediately.
- Do not pump the brake pedal if the engine stalls.
Each push on the brake pedal uses up the reserve for the power-assisted brakes.
- The brake system consists of 2 individual hydraulic systems; if one of the systems fails, the other will still operate. In this case, the brake pedal should be depressed more firmly than usual and the braking distance will increase.
Have your brakes fixed immediately.

■ If the vehicle becomes stuck (AWD models)

Do not spin the wheels excessively when any of the tires is up in the air, or the vehicle is stuck in sand, mud, etc. This may damage the driveline components or propel the vehicle forward or backward, causing an accident.

 NOTICE**■ When driving the vehicle**

- Do not depress the accelerator and brake pedals at the same time during driving, as this may restrain the engine output.
- Do not use the accelerator pedal or depress the accelerator and brake pedals at the same time to hold the vehicle on a hill.

■ When parking the vehicle

Always set the parking brake and shift the shift lever to P. Failure to do so may cause the vehicle to move or the vehicle may accelerate suddenly if the accelerator pedal is accidentally depressed.

■ Avoiding damage to vehicle parts

- Do not turn the steering wheel fully in either direction and hold it there for an extended period of time.
Doing so may damage the power steering.
- When driving over bumps on the road, drive as slowly as possible to avoid damaging the wheels, underside of the vehicle, etc.

■ If you get a flat tire while driving

A flat or damaged tire may cause the following situations. Hold the steering wheel firmly and gradually depress the brake pedal to slow down the vehicle.

- It may be difficult to control your vehicle.
- The vehicle will make abnormal sounds or vibrations.
- The vehicle will lean abnormally.

Information on what to do in case of a flat tire (→P. 543)

■ When encountering flooded roads

Do not drive on a road that has flooded after heavy rain etc. Doing so may cause the following serious damage to the vehicle:

- Engine stalling
- Short in electrical components
- Engine damage caused by water immersion

In the event that you drive on a flooded road and the vehicle is flooded, be sure to have your Toyota dealer check the following:

- Brake function
- Changes in quantity and quality of oil and fluid used for the engine, transaxle, transfer (AWD models), rear differential (AWD models), etc.
- Lubricant condition for the bearings and suspension joints (where possible), and the function of all joints, bearings, etc.

Cargo and luggage

Take notice of the following information about storage precautions, cargo capacity and load:

Capacity and distribution

Cargo capacity depends on the total weight of the occupants.

(Cargo capacity) = (Total load capacity) — (Total weight of occupants)

Steps for Determining Correct Load Limit —

- (1) Locate the statement “The combined weight of occupants and cargo should never exceed XXX kg or XXX lbs.” on your vehicle’s placard.
- (2) Determine the combined weight of the driver and passengers that will be riding in your vehicle.
- (3) Subtract the combined weight of the driver and passengers from XXX kg or XXX lbs.
- (4) The resulting figure equals the available amount of cargo and luggage load capacity.

For example, if the “XXX” amount equals 1400 lbs. and there will be five 150 lb passengers in your vehicle, the amount of available cargo and luggage load capacity is 650 lbs. (1400 – 750 (5 × 150) = 650 lbs.)

- (5) Determine the combined weight of luggage and cargo being loaded on the vehicle. That weight may not safely exceed the available cargo and luggage load capacity calculated in Step 4.
- (6) If your vehicle will be towing a trailer, load from your trailer will be transferred to your vehicle. Consult this manual to determine how this reduces the available cargo and luggage load capacity of your vehicle.

(→P. 206)

Toyota does not recommend towing a trailer with your vehicle. Your vehicle is not designed for trailer towing.

Calculation formula for your vehicle

- ① Cargo capacity
- ② Total load capacity (vehicle capacity weight) (→P. 574)

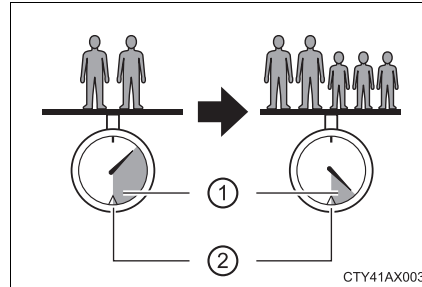

When 2 people with the combined weight of A lb. (kg) are riding in your vehicle, which has a total load capacity (vehicle capacity weight) of B lb. (kg), the available amount of cargo and luggage load capacity will be C lb. (kg) as follows:

$$B^{*2} \text{ lb. (kg)} - A^{*1} \text{ lb. (kg)} = C^{*3} \text{ lb. (kg)}$$

*1: A =Weight of people

*2: B =Total load capacity

*3: C =Available cargo and luggage load

In this condition, if 3 more passengers with the combined weight of D lb. (kg) get on, the available cargo and luggage load will be reduced E lb. (kg) as follows:

$$C \text{ lb. (kg)} - D^{*4} \text{ lb. (kg)} = E^{*5} \text{ lb. (kg)}$$

*4: D =Additional weight of people

*5: E =Available cargo and luggage load

As shown in the example above, if the number of occupants increases, the cargo and luggage load will be reduced by an amount that equals the increased weight due to the additional occupants. In other words, if an increase in the number of occupants causes an excess of the total load capacity (combined weight of occupants plus cargo and luggage load), you must reduce the cargo and luggage on your vehicle.

 **WARNING****■ Things that must not be carried in the trunk**

The following things may cause a fire if loaded in the trunk:

- Receptacles containing gasoline
- Aerosol cans

■ Storage precautions

Observe the following precautions.

Failure to do so may prevent the pedals from being depressed properly, may block the driver's vision, or may result in items hitting the driver or passengers, possibly causing an accident.

- Stow cargo and luggage in the trunk whenever possible.
- To prevent cargo and luggage from sliding forward during braking, do not stack anything in the enlarged trunk. Keep cargo and luggage low, as close to the floor as possible.
- Do not place cargo or luggage in or on the following locations.
 - At the feet of the driver
 - On the front passenger or rear seats (when stacking items)
 - On the package tray
 - On the instrument panel
 - On the dashboard
 - Tray that has no lid
- Secure all items in the occupant compartment.
- Fold-down type rear seat: When you fold down the rear seats, long items should not be placed directly behind the front seats.
- Fold-down type rear seat: Never allow anyone to ride in the enlarged trunk. It is not designed for passengers. They should ride in their seats with their seat belts properly fastened.

■ Capacity and distribution

- Do not exceed the maximum axle weight rating or the total vehicle weight rating.
- Even if the total load of occupant's weight and the cargo load is less than the total load capacity, do not apply the load unevenly. Improper loading may cause deterioration of steering or braking control which may cause death or serious injury.

Vehicle load limits

Vehicle load limits include total load capacity, seating capacity, towing capacity and cargo capacity.

◆ **Total load capacity (vehicle capacity weight): →P. 574**

Total load capacity means the combined weight of occupants, cargo and luggage.

◆ **Seating capacity: →P. 575**

Seating capacity means the maximum number of occupants whose estimated average weight is 150 lb. (68 kg) per person.

◆ **Towing capacity**

Toyota does not recommend towing a trailer with your vehicle.

◆ **Cargo capacity**

Cargo capacity may increase or decrease depending on the weight and the number of occupants.

■ **Total load capacity and seating capacity**

These details are also described on the tire and loading information label. (→P. 487)

 **WARNING**

■ **Overloading the vehicle**

Do not overload the vehicle.
It may not only cause damage to the tires, but also degrade steering and braking ability, resulting in an accident.

Trailer towing

Toyota does not recommend towing a trailer with your vehicle. Toyota also does not recommend the installation of a tow hitch or the use of a tow hitch carrier for a wheelchair, scooter, bicycle, etc. Your vehicle is not designed for trailer towing or for the use of tow hitch mounted carriers.

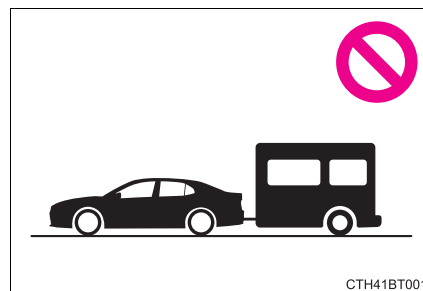

4

Driving

Dinghy towing

Your vehicle is not designed to be dinghy towed (with 4 wheels on the ground) behind a motor home.

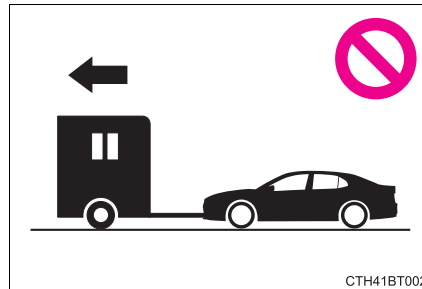

NOTICE

■ **To avoid serious damage to your vehicle**

Do not tow your vehicle with four wheels on the ground.

■ **To prevent causing serious damage to the transmission (2WD models)**

Never tow this vehicle from the rear with the front wheels on the ground.

This may cause serious damage to the transmission.

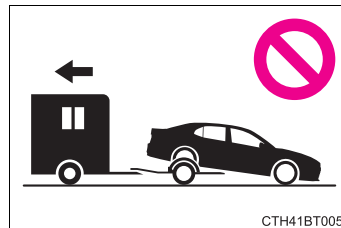

■ **To prevent causing serious damage to the transmission and AWD system (AWD models)**

Never tow this vehicle with any of the wheels on the ground.

This may cause serious damage to the transmission and AWD system.

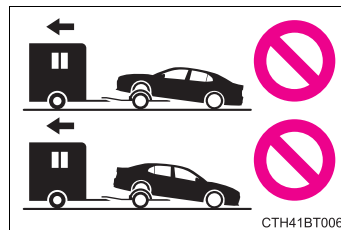

Engine (ignition) switch (vehicles without a smart key system)

Starting the engine

- 1 Check that the parking brake is set.
- 2 Check that the shift lever is in P.
- 3 Firmly depress the brake pedal.
- 4 Turn the engine switch to the "START" position and start the engine.

Changing the engine switch positions

- 1 "LOCK"
The steering wheel is locked and the key can be removed. (The key can be removed only when the shift lever is in P.)
- 2 "ACC"
Some electrical components such as the audio system can be used.
- 3 "ON"
All electrical components can be used.
- 4 "START"
For starting the engine.

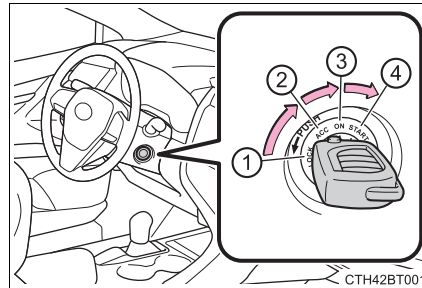

4

Driving

Turning the key from "ACC" to "LOCK"

- 1 Shift the shift lever to P. (→P. 217)
- 2 Push in the key and turn it to the "LOCK" position.

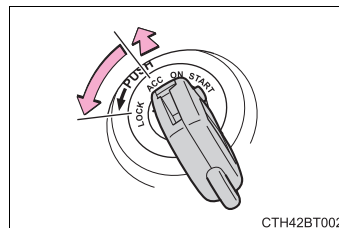

If "Not Ready to Drive" is displayed on the multi-information display

Depress the brake pedal and then turn the engine switch to the "START" position to start the engine.

■ When “Check Fuel Cap” is displayed on the multi-information display

→P. 247

■ If the engine does not start

The engine immobilizer system may not have been deactivated. (→P. 80)
Contact your Toyota dealer.

■ When the steering lock cannot be released

When starting the engine, the engine switch may seem stuck in the “LOCK” position. To free it, turn the key while turning the steering wheel slightly left and right.

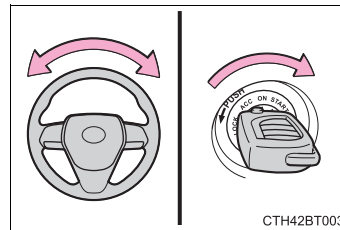

■ Key reminder function

A buzzer sounds if the driver’s door is opened while the engine switch is in the “LOCK” or “ACC” position to remind you to remove the key.

⚠ WARNING

■ **When starting the engine**
Always start the engine while sitting in the driver’s seat. Do not depress the accelerator pedal while starting the engine under any circumstances. Doing so may cause an accident resulting in death or serious injury.

■ **Caution when driving**
Do not turn the engine switch to the “LOCK” position while driving. If, in an emergency, you must turn the engine off while the vehicle is moving, turn the engine switch only to the “ACC” position to stop the engine. An accident may result if the engine is stopped while driving. (→P. 517)

⚠ NOTICE

■ **To prevent battery discharge**
Do not leave the engine switch in the “ACC” or “ON” position for long periods of time without the engine running.

■ **When starting the engine**

- Do not crank the engine for more than 30 seconds at a time. This may overheat the starter and wiring system.
- Do not race a cold engine.
- If the engine becomes difficult to start or stalls frequently, have your vehicle checked by your Toyota dealer immediately.

Engine (ignition) switch (vehicles with a smart key system)

Performing the following operations when carrying the electronic key on your person starts the engine or changes engine switch modes.

Starting the engine

- 1 Check that the parking brake is set.
- 2 Check that the shift lever is in P.
- 3 Firmly depress the brake pedal.
 and a message will be displayed on the multi-information display. If it is not displayed, the engine cannot be started.

- 4 Press the engine switch shortly and firmly.

When operating the engine switch, one short, firm press is enough. It is not necessary to press and hold the switch.

The engine will crank until it starts or for up to 30 seconds, whichever is less.

Continue depressing the brake pedal until the engine is completely started.

The engine can be started from any engine switch mode.

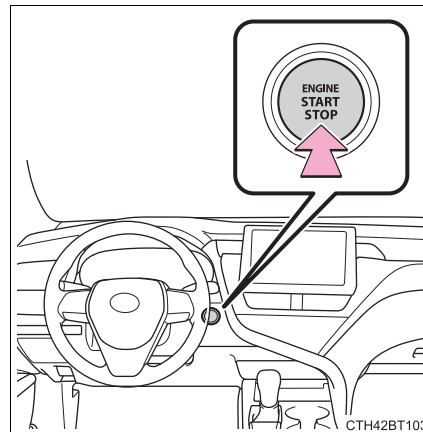

Stopping the engine

- 1 Stop the vehicle.
- 2 Set the parking brake (→P. 224, 225), and shift the shift lever to P.
- 3 Press the engine switch.

Driving-related data will be displayed on the multi-information display.

Automatic engine shut off feature

- The vehicle is equipped with a feature that automatically shuts off the engine when the shift lever is in P with the engine running for an extended period.
- The engine will automatically shut off after approximately 1 hour if it has been left running while the shift lever is in P.
- The timer for the automatic engine shut off feature will reset if the brake pedal is depressed or if the shift lever is in a position other than P.
- After the vehicle is parked, if the door is locked with the door lock switch (→P. 151) from the inside or the mechanical key (→P. 559) from the outside, the automatic engine shut off feature will be disabled. The timer for the automatic engine shut off feature will be re-enabled if the driver's door is opened.

Changing engine switch modes

Modes can be changed by pressing the engine switch with the brake pedal released. (The mode changes each time the switch is pressed.)

① Off*

The emergency flashers can be used.

The multi-information display will not be displayed.

② ACCESSORY mode

Some electrical components such as the audio system can be used.

A message indicating how to start the engine will be displayed on the multi-information display.

③ IGNITION ON mode

All electrical components can be used.

*: If the shift lever is in a position other than P when turning off the engine, the engine switch will be turned to ACCESSORY mode, not to off.

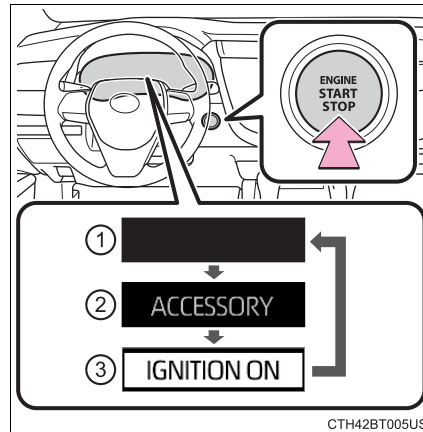

4

Driving

When stopping the engine with the shift lever in a position other than P

If the engine is stopped with the shift lever in a position other than P, the engine switch will not be turned off but instead be turned to ACCESSORY mode. Perform the following procedure to turn the switch off:

- ① Check that the parking brake is set.
- ② Shift the shift lever to P.
- ③ Check that "Turn Power Off" is displayed on the multi-information display and then press the engine switch once.
- ④ Check that "Turn Power Off" on the multi-information display is turned off.

■ Auto power off function

If the vehicle is left in ACCESSORY mode for more than 20 minutes or IGNITION ON mode (with the engine is not running) for more than an hour with the shift lever in P, the engine switch will automatically turn off. However, this function cannot entirely prevent battery discharge. Do not leave the vehicle with the engine switch in ACCESSORY or IGNITION ON mode for long periods of time when the engine is not running.

■ Electronic key battery depletion

→P. 145

■ Conditions affecting operation

→P. 163

■ Notes for the entry function

→P. 164

■ If the engine does not start

- The engine immobilizer system may not have been deactivated. (→P. 80)
Contact your Toyota dealer.
- Check that the shift lever is securely set in P. The engine may not start if the shift lever is displaced out of P.

■ When “Check Fuel Cap” is displayed on the multi-information display

→P. 247

■ When a message requesting the smart key system be inspected is displayed on the multi-information display

The system may be malfunctioning. Have the vehicle inspected by your Toyota dealer immediately.

■ If the electronic key battery is depleted

→P. 494

■ Operation of the engine switch

- If the switch is not pressed shortly and firmly, the engine switch mode may not change or the engine may not start.
- If attempting to restart the engine immediately after turning the engine switch off, the engine may not start in some cases. After turning the engine switch off, wait a few seconds before restarting the engine.

■ If the smart key system has been deactivated in a customized setting

→P. 559

 **WARNING****■ When starting the engine**

Always start the engine while sitting in the driver's seat. Do not depress the accelerator pedal while starting the engine under any circumstances. Doing so may cause an accident resulting in death or serious injury.

■ Stopping the engine in an emergency

● If you want to stop the engine in an emergency while driving the vehicle, press and hold the engine switch for more than 2 seconds, or press it briefly 3 times or more in succession. (→P. 517)

However, do not touch the engine switch while driving except in an emergency. Turning the engine off while driving will not cause loss of steering or braking control, but the power assist to these systems will be lost. This will make it more difficult to steer and brake, so you should pull over and stop the vehicle as soon as it is safe to do so.

● If the engine switch is operated while the vehicle is running, a warning message will be shown on the multi-information display and a buzzer sounds.

● When restarting the engine after it was turned off while driving, shift the shift lever to N and press the engine switch.

■ When parking

Exhaust gases include harmful carbon monoxide (CO), which is colorless and odorless. Observe the following precautions.

Failure to do so may cause exhaust gases to enter the vehicle and may lead to an accident caused by light-headedness, or may lead to death or a serious health hazard.

● If the vehicle is in a poorly ventilated area or a closed area, such as a garage, stop the engine.

● Do not leave the vehicle with the engine running for a long time. If such a situation cannot be avoided, park the vehicle in an open space and ensure that exhaust fumes do not enter the vehicle interior.

● Do not leave the engine running in an area with snow build-up, or where it is snowing. If snowbanks build up around the vehicle while the engine is running, exhaust gases may collect and enter the vehicle.



NOTICE

■ To prevent battery discharge

- Do not leave the engine switch in ACCESSORY or IGNITION ON mode for long periods of time without the engine running.
- Do not stop the engine when the shift lever is in a position other than P. If the engine is stopped in another shift lever position, the engine switch will not be turned off but instead be turned to ACCESSORY mode. If the vehicle is left in ACCESSORY mode, battery discharge may occur.

■ When starting the engine

- Do not race a cold engine.
- If the engine becomes difficult to start or stalls frequently, have your vehicle checked by your Toyota dealer immediately.

■ Symptoms indicating a malfunction with the engine switch

If the engine switch seems to be operating somewhat differently than usual, such as the switch sticking slightly, there may be a malfunction. Contact your Toyota dealer immediately.

Automatic transmission

Shifting the shift lever

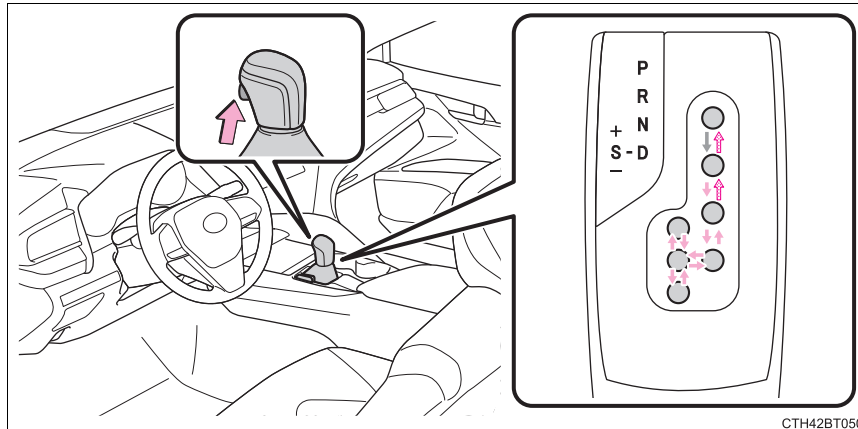

- ← Vehicles without a smart key system:
While the engine switch is in the “ON” position and the brake pedal depressed*, shift the shift lever while pushing the shift release button on the shift knob.
 - Vehicles with a smart key system:
While the engine switch is in IGNITION ON mode and the brake pedal depressed*, shift the shift lever while pushing the shift release button on the shift knob.
 - ← Shift the shift lever while pushing the shift release button on the shift knob.
 - ← Shift the shift lever normally.
When shifting the shift lever between P and D, make sure that the vehicle is completely stopped and the brake pedal is depressed.
- *: For the vehicle be able to be shifted from P, the brake pedal must be depressed before the shift release button is pushed. If the shift release button is pushed first, the shift lock will not be released.

Shift position purpose

Shift position	Objective or function
P	Parking the vehicle/starting the engine
R	Reversing
N	Neutral
D	Normal driving ^{*1}
S	S mode driving ^{*2} (→P. 218)

^{*1}: Shifting to the D position allows the system to select a gear suitable for the driving conditions. Setting the shift lever to the D position is recommended for normal driving.

^{*2}: Selecting shift ranges using S mode restricts the upper limit of the possible gear ranges, controls engine braking force, and prevents unnecessary upshifting.

Changing shift ranges in S mode

When the shift lever is in the S position, the shift lever or paddle shift switches (if equipped) can be operated as follows:

▶ Shift lever

▶ Paddle shift switches (if equipped)

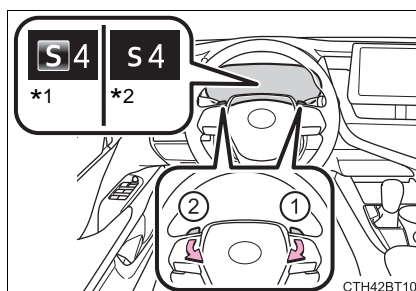
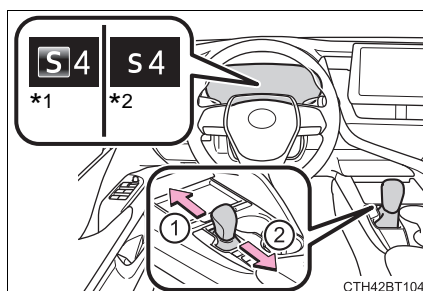

- ① Upshifting
- ② Downshifting

The initial shift range in S mode is set automatically to 4, 5 or 6 according to vehicle speed. However, the initial shift range may be set to 3 if AI-SHIFT has operated while the shift lever was in the D position. (→P. 221)

^{*1}: Vehicles with 4.2-inch display

^{*2}: Vehicles with 7-inch display

■ Shift ranges and their functions

Meter display	Function
S2 - S8	A gear in the range between 1 and the selected gear is automatically chosen depending on vehicle speed and driving conditions
S1	Setting the gear at 1

A lower shift range will provide greater engine braking forces than a higher shift range.

Selecting shift ranges in the D position (vehicles with paddle shift switches)

To drive using temporary shift range selection, operate the paddle shift switch. The shift range can then be selected by operating the “-” and “+” paddle shift switches. Changing the shift range allows restriction of the highest gear, preventing upshifting and enabling the level of engine braking force to be selected.

- ① Upshifting
- ② Downshifting

The selected shift range, from 1 to 8, or D will be displayed on the multi-information display.

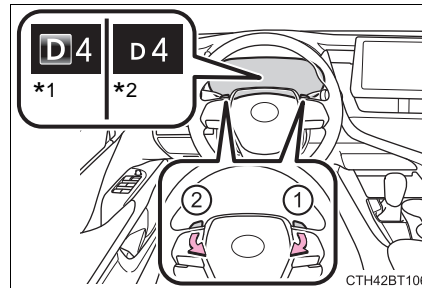

*1: Vehicles with 4.2-inch display

*2: Vehicles with 7-inch display

■ Automatic deactivation of shift range selection in the D position (vehicles with paddle shift switches)

Shift range selection in the D position will be deactivated in the following situations:

- The “+” paddle shift switch is held down for a period of time
- When the vehicle comes to a stop
- If the accelerator pedal is depressed for more than a certain period of time
- When the shift lever is shifted to a position other than D

■ S mode

- When the shift range is 7 or lower, holding the shift lever toward “+” sets the shift range to 8.
- To prevent the engine from over-revving, upshifting may automatically occur.
- To protect the automatic transmission, a function is adopted that automatically selects a higher shift range when the fluid temperature is high.

■ Downshift restriction warning buzzer (S mode or paddle shifting)

To help ensure safety and driving performance, downshifting operation may sometimes be restricted. In some circumstances, downshifting may not be possible even when the shift lever or paddle shift switches are operated. (A buzzer will sound twice.)

■ When driving with dynamic radar cruise control with full-speed range or dynamic radar cruise control activated

Even when performing the following actions with the intent of enabling engine braking, engine braking will not occur because dynamic radar cruise control with full speed range or dynamic radar cruise control will not be canceled.

- While driving in D or S mode, downshifting to 7, 6, 5 or 4. (→P. 290, 306)
- When switching the driving mode to sport mode while driving in the D position. (→P. 375)

■ Restraining sudden start (Drive-start Control)

→P. 195

■ Shift lock system

The shift lock system is a system to prevent accidental operation of the shift lever in starting.

The shift lever can be shifted from P only when the engine switch is in the “ON” position (vehicles without a smart key system) or IGNITION ON mode (vehicles with a smart key system), the brake pedal is depressed and the shift release button is pushed.

■ If the shift lever cannot be shifted from P

First, check whether the brake pedal is being depressed.

If the shift lever cannot be shifted even though the brake pedal is depressed and the shift release button is pushed, there may be a problem with the shift lock system. Have the vehicle inspected by your Toyota dealer immediately.

The following steps may be used as an emergency measure to ensure that the shift lever can be shifted.

Releasing the shift lock:

- 1 Set the parking brake.
- 2 Vehicles without a smart key system: Turn the engine switch to the "LOCK" position.
Vehicles with a smart key system: Turn the engine switch off.
- 3 Depress the brake pedal.

- 4 Pry the cover up with a flathead screwdriver or equivalent tool.

To prevent damage to the cover, cover the tip of the screwdriver with a rag.

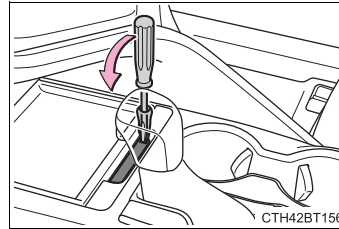

- 5 Press and hold the shift lock override button and then push the button on the shift knob.

The shift lever can be shifted while both buttons are pressed.

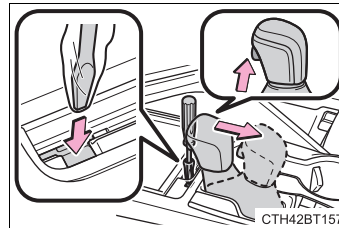

■ If the S indicator does not come on or the D indicator is displayed even after shifting the shift lever to S

This may indicate a malfunction in the automatic transmission system. Have the vehicle inspected by your Toyota dealer immediately.

(In this situation, the transmission will operate in the same manner as when the shift lever is in D.)

■ AI-SHIFT

The AI-SHIFT automatically selects the suitable gear according to driver performance and driving conditions.

The AI-SHIFT automatically operates when the shift lever is in D. (Shifting the shift lever to the S position or paddle shifting cancels the function.)

**WARNING****■ When driving on slippery road surfaces**

Do not accelerate or shift gears suddenly.

Sudden changes in engine braking may cause the vehicle to spin or skid, resulting in an accident.

■ To prevent an accident when releasing the shift lock

Before pressing the shift lock override button, make sure to set the parking brake and depress the brake pedal.

If the accelerator pedal is accidentally depressed instead of the brake pedal when the shift lock override button is pressed and the shift lever is shifted out of P, the vehicle may suddenly start, possibly leading to an accident resulting in death or serious injury.

Turn signal lever

Operating instructions

- ① Right turn
- ② Lane change to the right (move the lever partway and release it)
The right hand signals will flash 3 times.
- ③ Lane change to the left (move the lever partway and release it)
The left hand signals will flash 3 times.
- ④ Left turn

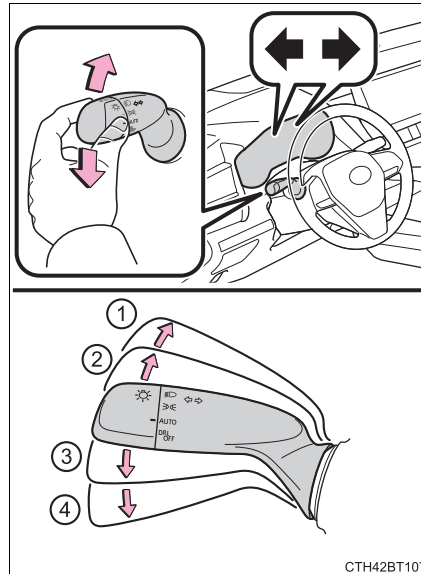

■ Turn signals can be operated when

Vehicles without a smart key system:

The engine switch is in the "ON" position.

Vehicles with a smart key system:

The engine switch is in IGNITION ON mode.

■ If the indicator flashes faster than usual

Check that a light bulb in the front or rear turn signal lights has not burned out.

■ If the turn signals stop flashing before a lane change has been performed

Operate the lever again.

■ To discontinue flashing of the turn signals during a lane change

Operate the lever in the opposite direction.

Parking brake*

Operating instructions

To set the parking brake, fully depress the parking brake pedal with your left foot while depressing the brake pedal with your right foot.

(Depressing the pedal again releases the parking brake.)

*1: For U.S.A.

*2: For Canada

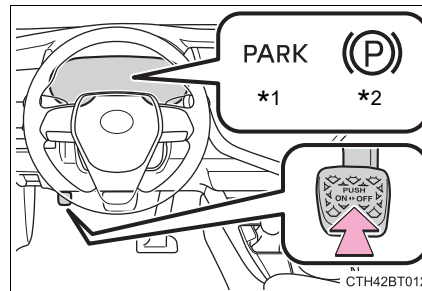

■ Parking the vehicle

→P. 194

■ Parking brake engaged warning buzzer

A buzzer will sound if the vehicle is driven with the parking brake engaged. "Release Parking Brake" is displayed on the multi-information display.

■ Usage in winter time

→P. 377

NOTICE

■ Before driving

Fully release the parking brake.

Driving the vehicle with the parking brake set will lead to brake components overheating, which may affect braking performance and increase brake wear.

*: If equipped

Electric parking brake*

A mode can be selected from the following modes.

Automatic mode

The parking brake is set or released automatically according to the shift lever operation.

Even when in automatic mode, the parking brake can be set and released manually. (→P. 226)

- ① Turns automatic mode on (while the vehicle is stopped, pull and hold the parking brake switch until a message is shown on the multi-information display)

- When the shift lever is moved out of P, the parking brake will be released, and the parking brake indicator light and parking brake light turn off.
- When the shift lever is moved into P, the parking brake will be set, and the parking brake indicator light and parking brake light turn on.

Operate the shift lever with the brake pedal depressed.

- ② Turns automatic mode off (while the vehicle is stopped, press and hold the parking brake switch until a message is shown on the multi-information display)

Operate the parking brake switch while depressing the brake pedal.

*1: For U.S.A.

*2: For Canada

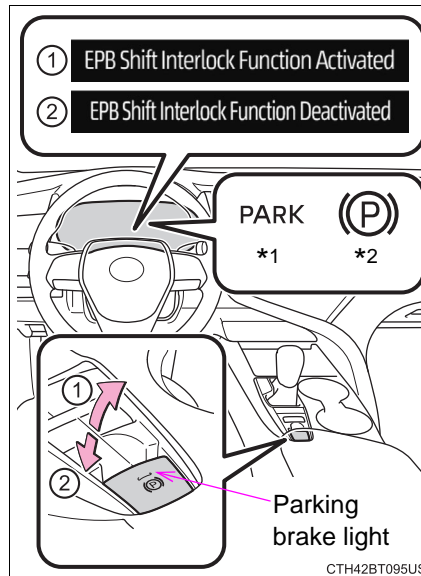

4

Driving

*: If equipped

Manual mode

The parking brake can be set and released manually.

① Sets the parking brake

The parking brake indicator light and parking brake light will turn on.

Pull and hold the parking brake switch if an emergency occurs and it is necessary to operate the parking brake while driving.

② Releases the parking brake

Operate the parking brake switch while depressing the brake pedal. Make sure that the parking brake indicator light or parking brake light turn off.

If the parking brake indicator light or parking brake light flashes, operate the switch again.

(→P. 529)

*1: For U.S.A.

*2: For Canada

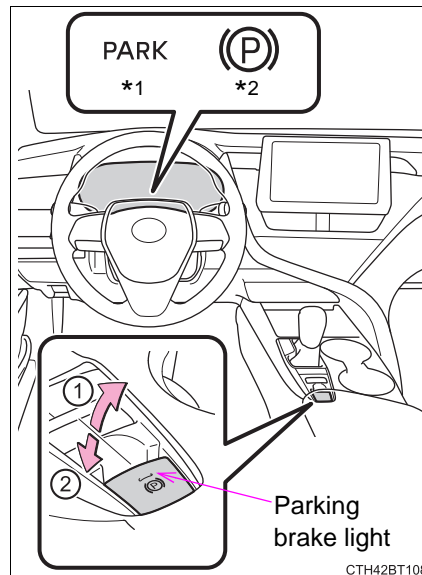

CTH42BT108

■ Parking the vehicle

→P. 194

■ Parking brake operation

- When the engine switch is not in IGNITION ON mode, the parking brake cannot be released using the parking brake switch.
- When the engine switch is not in IGNITION ON mode, automatic mode (automatic brake setting and releasing) is not available.

■ Automatic release function

The parking brake is automatically released when slowly depress the accelerator pedal.

The parking brake will be released automatically under the following conditions:

- The driver's door is closed.
- The driver's seatbelt is fastened.
- Shift the shift lever is in a forward or reverse position.
- The malfunction indicator lamp or brake system warning light is not illuminated.

If the automatic release function does not operate, manually release the parking brake.

■ If “Parking Brake Temporarily Unavailable” is displayed on the multi-information display

If the parking brake is operated repeatedly over a short period of time, the system may restrict operation to prevent overheating. If this happens, refrain from operating the parking brake. Normal operation will return after about 1 minute.

■ If “Parking Brake Unavailable” is displayed on the multi-information display

Operate the parking brake switch. If the message does not disappear after operating the switch several times, the system may be malfunctioning. Have the vehicle inspected by your Toyota dealer immediately.

■ Parking brake operation sound

When the parking brake operates, a motor sound (whirring sound) may be heard. This does not indicate a malfunction.

■ Parking brake indicator light and parking brake light

- Depending on the engine switch mode, the parking brake indicator light and parking brake light will turn on and stay on as described below:
IGNITION ON mode: Comes on until the parking brake is released.
Not in IGNITION ON mode: Stays on for approximately 15 seconds.
- When the engine switch is turned off with the parking brake set, the parking brake indicator light and parking brake light will stay on for about 15 seconds. This does not indicate a malfunction.

■ **Parking brake engaged warning buzzer**

A buzzer will sound if the vehicle is driven with the parking brake engaged. "Release Parking Brake" is displayed on the multi-information display.

■ **Warning messages and buzzers**

Warning messages and buzzers are used to indicate a system malfunction or to inform the driver of the need for caution. If a warning message is shown on the multi-information display, read the message and follow the instructions.

■ **If the brake system warning light comes on**

→P. 528

■ **Usage in winter time**

→P. 377



WARNING

■ **When parking the vehicle**

Do not leave a child in the vehicle alone. The parking brake may be released unintentionally and there is the danger of the vehicle moving that may lead to an accident resulting in death or serious injury.

■ **Parking brake switch**

Do not set any objects near the parking brake switch. Objects may interfere with the switch and may lead the parking brake to unexpectedly operate.



NOTICE

■ **When parking the vehicle**

Before you leave the vehicle, shift the shift lever to P, set the parking brake and make sure that the vehicle does not move.

■ **When the system malfunctions**

Stop the vehicle in a safe place and check the warning messages.

■ **When the parking brake cannot be released due to a malfunction**

Driving the vehicle with the parking brake set will lead to brake components overheating, which may affect braking performance and increase brake wear. Contact your Toyota dealer immediately if this occurs.

Brake Hold*

The brake hold system keeps the brake applied when the shift lever is in D, S or N with the system on and the brake pedal has been depressed to stop the vehicle. The system releases the brake when the accelerator pedal is depressed with the shift lever in D or S to allow smooth start off.

Turns the brake hold system on

The brake hold standby indicator (green) comes on. While the system is holding the brakes, the brake hold operated indicator (yellow) will illuminate.

*1: Brake hold standby indicator

*2: Brake hold operated indicator

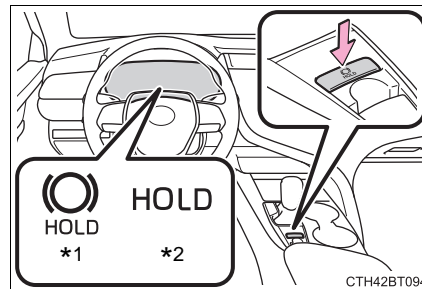

4

Driving

■ Brake hold system operating conditions

The brake hold system cannot be turned on in the following conditions:

- The driver's door is not closed.
- The driver's seat belt is not buckled.

If either of the above is detected when the brake hold system is enabled, the system will turn off and the brake hold standby indicator light will go off. In addition, if any of the conditions are detected while the system is holding the brakes, a warning buzzer will sound and a message will be shown on the multi-information display. The parking brake will then be set automatically.

■ Brake hold function

- If the brake pedal is left released for a period of about 3 minutes after the system has started holding the brakes, the parking brake will be set automatically. In this case, a warning buzzer sounds and a message is shown on the multi-information display.
- To turn the system off while the system is holding the brakes, firmly depress the brake pedal and press the switch again.
- The brake hold function may not hold the vehicle when the vehicle is on a steep incline. In this situation, it may be necessary for the driver to apply the brakes. A warning buzzer will sound and the multi-information display will inform the driver of this situation. If a warning message is shown on the multi-information display, read the message and follow the instructions.

*: If equipped

■ **When the parking brake is set automatically while the system is holding the brakes**

Perform any of the following operations to release the parking brake.

- Depress the accelerator pedal. (The parking brake will not be released automatically if the seat belt is not fastened.)
- Operate the parking brake switch with the brake pedal depressed.

Make sure that the parking brake indicator light goes off. (→P. 225)

■ **When an inspection at your Toyota dealer is necessary**

When the brake hold standby indicator (green) does not illuminate even when the brake hold switch is pressed with the brake hold system operating conditions met, the system may be malfunctioning. Have the vehicle inspected at your Toyota dealer.

■ **Warning messages and buzzers**

Warning messages and buzzers are used to indicate a system malfunction or to inform the driver of the need for caution. If a warning message is shown on the multi-information display, read the message and follow the instructions.

■ **If the brake hold operated indicator flashes**

→P. 529



WARNING

■ **When the vehicle is on a steep incline**

When using the brake hold system on a steep incline, exercise caution. The brake hold function may not hold the vehicle in such a situation.

■ **When stopped on a slippery road**

The system cannot stop the vehicle when the gripping ability of the tires has been exceeded. Do not use the system when stopped on a slippery road.



NOTICE

■ **When parking the vehicle**

The brake hold system is not designed for use when parking the vehicle for a long period of time. Turning the engine switch off while the system is holding the brakes may release the brakes, which would cause the vehicle to move. When operating the engine switch, depress the brake pedal, shift the shift lever to P and set the parking brake.



Headlight switch

The headlights can be operated manually or automatically.

Operating instructions

Operating the  switch turns on the lights as follows:

► For U.S.A.

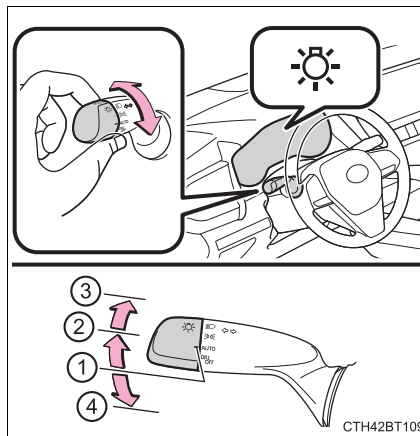

- ① **AUTO** The headlights, daytime running lights (→P. 233) and all the lights listed below turn on and off automatically. (Vehicles without a smart key system: When the engine switch is in the "ON" position)
(Vehicles with a smart key system: When the engine switch is in IGNITION ON mode)
- ②  The side marker, parking, tail, license plate, instrument panel lights, and daytime running lights (→P. 233) turn on.
- ③  The headlights and all the lights listed above (except daytime running lights) turn on.
- ④  The daytime running lights turn off.

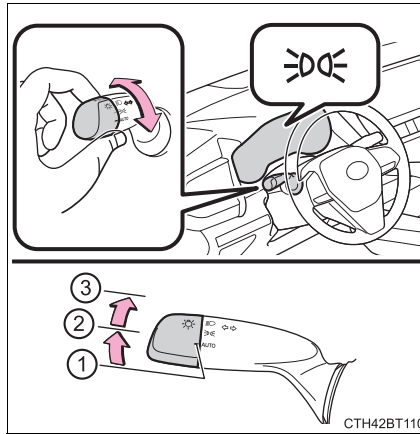

► For Canada

- ① **AUTO** The headlights, daytime running lights (→P. 233) and all the lights listed below turn on and off automatically.
(Vehicles without a smart key system: When the engine switch is in the “ON” position)
(Vehicles with a smart key system: When the engine switch is in IGNITION ON mode)



- ②  The side marker, parking, tail, license plate, instrument panel lights, and daytime running lights (→P. 233) turn on.
- ③  The headlights and all the lights listed above (except daytime running lights) turn on.

Turning on the high beam headlights

- ① With the headlights on, push the lever away from you to turn on the high beams.
Pull the lever toward you to the center position to turn the high beams off.
- ② Pull the lever toward you and release it to flash the high beams once.

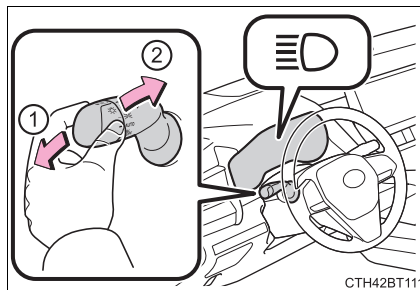

You can flash the high beams with the headlights on or off.

■ Daytime running light system

- Type A:
The daytime running lights illuminate using the same lights as the headlights and illuminate darker than the headlights.
- Type B:
The daytime running lights illuminate using the same lights as the parking lights and illuminate brighter than the parking lights.
- To make your vehicle more visible to other drivers during daytime driving, the daytime running lights turn on automatically when all of the following conditions are met. (The daytime running lights are not designed for use at night.)
 - The engine is running
 - The parking brake is released
 - The headlight switch is in the  or **AUTO** * position

*: When the surroundings are bright

The daytime running lights remain on after they illuminate, even if the parking brake is set again.

- For U.S.A.: Daytime running lights can be turned off by operating the switch.
- Compared to turning on the headlights, the daytime running light system offers greater durability and consumes less electricity, so it can help improve fuel economy.

■ Headlight control sensor

The sensor may not function properly if an object is placed on the sensor, or anything that blocks the sensor is affixed to the windshield.

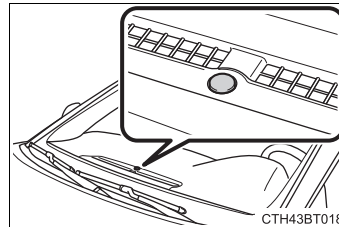

Doing so interferes with the sensor detecting the level of ambient light and may cause the automatic headlight system to malfunction.



■ **Automatic light off system**

▶ Vehicles without a smart key system



- When the headlights are on: The headlights and tail lights turn off 30 seconds after the engine switch is turned to the “ACC” or “LOCK” position and a door is opened and closed. (The lights turn off immediately if  on the key is pressed twice after all the doors are closed.)
- When only the tail lights are on: The tail lights turn off automatically if the engine switch is turned to the “ACC” or “LOCK” position and the driver’s door is opened.

To turn the lights on again, turn the engine switch to “ON” position, or turn the light switch off once and then back to  or .

If any of the doors or trunk lid is kept open, the lights automatically turn off after 20 minutes.

▶ Vehicles with a smart key system

- When the headlights are on: The headlights and tail lights turn off 30 seconds after the engine switch is turned to ACCESSORY mode or turned off and a door is opened and closed. (The lights turn off immediately if  on the key is pressed twice after all the doors are closed.)
- When only the tail lights are on: The tail lights turn off automatically if the engine switch is turned to ACCESSORY mode or turned off and the driver’s door is opened.

To turn the lights on again, turn the engine switch to IGNITION ON mode, or turn the light switch off once and then back to  or .

If any of the doors or trunk lid is kept open, the lights automatically turn off after 20 minutes.

■ **Light reminder buzzer (except when the light switch is in AUTO)**

Vehicles without a smart key system:

A buzzer sounds when the engine switch is turned to the “LOCK” or “ACC” position and the driver’s door is opened with the key removed from the engine switch while the lights are turned on.

Vehicles with a smart key system:

A buzzer sounds when the engine switch is turned off or turned to ACCESSORY mode and the driver’s door is opened while the lights are turned on.

■ Windshield wiper linked headlight illumination

When driving during daytime with the headlight switch turned to **AUTO**, if the windshield wipers are used, the headlights will turn on automatically after several seconds to help enhance the visibility of your vehicle.

■ Battery-saving function

In the following conditions, the remaining lights will go off automatically after 20 minutes in order to prevent the vehicle battery from being discharged:

- The headlights and/or tail lights are on.
- Vehicles without a smart key system:
The engine switch is in the "ACC" or "LOCK" position.
- Vehicles with a smart key system:
The engine switch is in ACCESSORY mode or turned off.

This function will be canceled in any of the following situations:

- Vehicles without a smart key system:
When the engine switch is turned to the "ON" position.
- Vehicles with a smart key system:
When the engine switch is turned to IGNITION ON mode.
- When the light switch is operated
- When a door or the trunk is opened or closed

■ Customization

Some functions can be customized. (→P. 606)



NOTICE

■ To prevent battery discharge

Do not leave the lights on longer than necessary when the engine is not running.

AHB (Automatic High Beam)

The Automatic High Beam uses a front camera located behind the upper portion of the windshield to assess the brightness of the lights of vehicles ahead, streetlights, etc., and automatically turns the high beams on or off as necessary.

WARNING

■ Limitations of the Automatic High Beam

Do not overly rely on the Automatic High Beam. Always drive safely, taking care to observe your surroundings and turning the high beams on or off manually if necessary.

■ To prevent incorrect operation of the Automatic High Beam system

Do not overload the vehicle.

Activating the Automatic High Beam

- 1 Turn the headlight switch to the  or **AUTO** position. (→P. 231)
- 2 Press the Automatic High Beam switch.

When the headlight switch lever is in the low beam position, the AHB system will be enabled and the AHB indicator will illuminate.

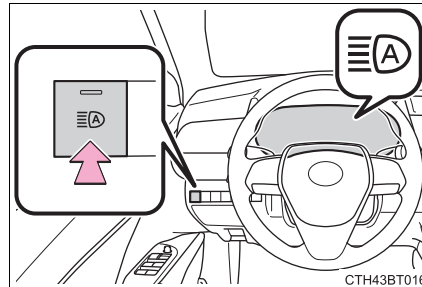

Turning the high beams on/off manually

■ Switching to the high beams

Push the lever away from you.

The Automatic High Beam indicator will turn off and the high beam indicator will turn on.

Pull the lever to its original position to activate the Automatic High Beam system again.

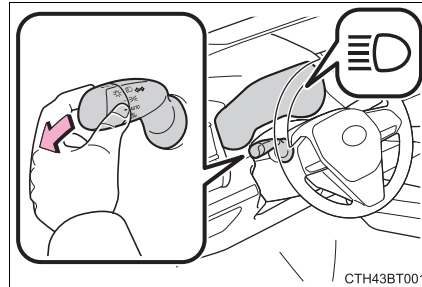

■ Switching to the low beams

Press the Automatic High Beam switch.

The Automatic High Beam indicator will turn off.

Press the switch to activate the Automatic High Beam system again.

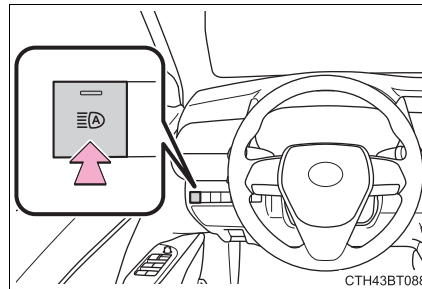

■ Temporarily switching to the low beams

Pull the lever toward you and then return it to its original position.

The high beams are on while the lever is pulled toward you. However, after the lever is returned to its original position, the low beams remain on for a certain amount of time. Afterwards, the Automatic High Beam will be activated again.

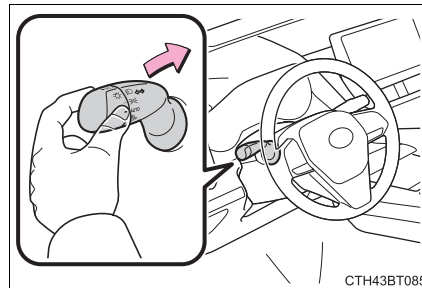

■ Temporarily switching to the low beams

It is recommended to switch to the low beams when the high beam may cause problems or distress to other drivers or pedestrians nearby.

■ Conditions to turn the high beams on/off automatically

- When all of the following conditions are met, the high beams will be turned on automatically (after approximately 1 second):
 - The vehicle speed is approximately 21 mph (34 km/h) or more.
 - The area ahead of the vehicle is dark.
 - There are no vehicles ahead with headlights or tail lights turned on.
 - There are few streetlights on the road ahead.
- If any of the following conditions is met, the high beams will turn off automatically:
 - The vehicle speed is below approximately 17 mph (27 km/h).
 - The area ahead of the vehicle is not dark.
 - Vehicles ahead have their headlights or tail lights turned on.
 - There are many streetlights on the road ahead.

■ Front camera detection information

- The high beams may not be automatically turned off in the following situations:
 - When a vehicle suddenly appears from around a curve
 - When the vehicle is cut in front of by another vehicle
 - When vehicles ahead cannot be detected due to repeated curves, road dividers or roadside trees
 - When vehicles ahead appear in a faraway lane on a wide road
 - When the lights of vehicles ahead are not on
- The high beams may be turned off if a vehicle ahead that is using fog lights without its headlights turned on is detected.
- House lights, street lights, traffic signals, and illuminated billboards or signs and other reflective objects may cause the high beams to change to the low beams, or the low beams to remain on.
- The following factors may affect the amount of time taken for the high beams to turn on or off:
 - The brightness of the headlights, fog lights, and tail lights of vehicles ahead
 - The movement and direction of vehicles ahead
 - When a vehicle ahead only has operational lights on one side
 - When a vehicle ahead is a two-wheeled vehicle
 - The condition of the road (gradient, curve, condition of the road surface, etc.)
 - The number of passengers and amount of luggage in the vehicle
- The high beams may turn on or off unexpectedly.
- Bicycles or similar vehicles may not be detected.

- In the following situations the system may not be able to correctly detect the surrounding brightness level. This may cause the low beams to remain on or the high beams to flash or dazzle pedestrians or vehicles ahead. In such a case, it is necessary to manually switch between the high and low beams.
 - When driving in inclement weather (heavy rain, snow, fog, sandstorms, etc.)
 - When the windshield is obscured by fog, mist, ice, dirt, etc.
 - When the windshield is cracked or damaged
 - When the front camera is deformed or dirty
 - When the temperature of the front camera is extremely high
 - When the surrounding brightness level is equal to that of headlights, tail lights or fog lights
 - When headlights or tail lights of vehicles ahead are turned off, dirty, changing color, or not aimed properly
 - When the vehicle is hit by water, snow, dust, etc. from a preceding vehicle
 - When driving through an area of intermittently changing brightness and darkness
 - When frequently and repeatedly driving ascending/descending roads, or roads with rough, bumpy or uneven surfaces (such as stone-paved roads, gravel roads, etc.)
 - When frequently and repeatedly taking curves or driving on a winding road
 - When there is a highly reflective object ahead of the vehicle, such as a sign or mirror
 - When the back of a preceding vehicle is highly reflective, such as a container on a truck
 - When the vehicle's headlights are damaged or dirty, or are not aimed properly
 - When the vehicle is listing or titling due to a flat tire, a trailer being towed, etc.
 - When the headlights are changed between the high beams and low beams repeatedly in an abnormal manner
 - When the driver believes that the high beams may be flashing or dazzling pedestrians or other drivers

■ Temporarily lowering sensor sensitivity





The sensitivity of the sensor can be temporarily lowered.

- 1 Turn the engine switch off while the following conditions are met.
 - The headlight switch is in the  or AUTO position.
 - The headlight switch lever is in the original position.
- 2 Turn the engine switch to the "ON" position (vehicles without a smart key system) or IGNITION ON mode (vehicles with a smart key system).
- 3 Within 60 seconds after 2, repeat pushing the headlight switch lever to the high beam position then pulling it to the original position quickly 10 times, then leave the lever in the original position.

Windshield wipers and washer

Operating the wiper lever

Operating the  lever operates the wipers or washer as follows. When intermittent windshield wiper operation is selected, the wiper interval can be also adjusted.

- ① **INT** *1 or  *2
Intermittent windshield wiper operation
The intermittent windshield wiper operates more frequently as vehicle speed becomes higher.
- ② **LO** *1 or  *2
Low speed windshield wiper operation
- ③ **HI** *1 or  *2
High speed windshield wiper operation
- ④ **MIST** *1 or  *2
Temporary operation

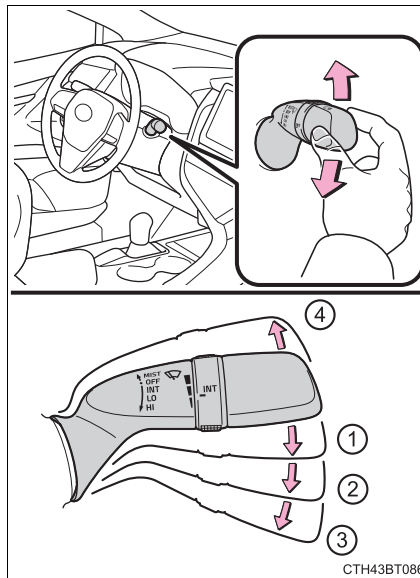



*1: For U.S.A.

*2: For Canada

Wiper intervals can be adjusted when intermittent operation is selected.

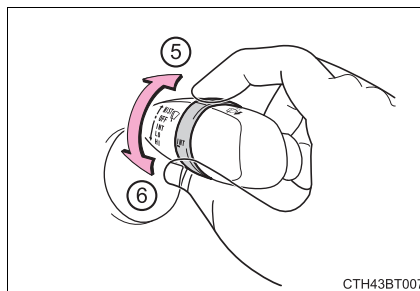
- ⑤ Increases the intermittent windshield wiper frequency
- ⑥ Decreases the intermittent windshield wiper frequency



⑦  Washer/wiper dual operation

Pulling the lever operates the wipers and washer.

Wipers will automatically operate a couple of times after the washer squirts.

(After operating several times, the wipers operate once more time after a short delay to prevent dripping. However, the dripping prevention does not operate while the vehicle is moving.)

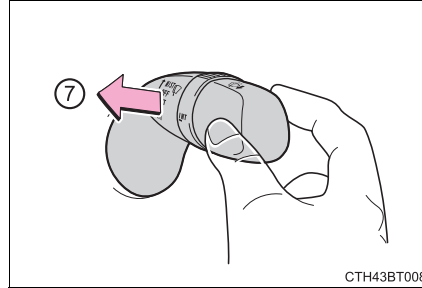

■ **The windshield wiper and washer can be operated when**

Vehicles without a smart key system:
The engine switch is in the “ON” position.

Vehicles with a smart key system:
The engine switch is in IGNITION ON mode.

■ **If no windshield washer fluid sprays**

Check that the washer nozzles are not blocked if there is washer fluid in the windshield washer fluid reservoir.

■ **When stopping the engine in an emergency while driving**

If the windshield wipers are operating when the engine is stopped, the windshield wipers will operate in high speed operation. After the vehicle is stopped, operation will return to normal when the engine switch is turned to “ON” position (vehicles without a smart key system) or IGNITION ON mode (vehicles with a smart key system), or operation will stop when the driver’s door is opened.

 **WARNING**

■ **Caution regarding the use of washer fluid**

When it is cold, do not use the washer fluid until the windshield becomes warm. The fluid may freeze on the windshield and cause low visibility. This may lead to an accident, resulting in death or serious injury.

 NOTICE

■ **When the windshield is dry**

Do not use the wipers, as they may damage the windshield.

■ **When the washer fluid tank is empty**

Damage to the washer fluid pump may be caused if the lever is pulled toward you and held continually.

■ **When a nozzle becomes blocked**

In this case, contact your Toyota dealer.

Do not try to clear it with a pin or other object. The nozzle will be damaged.

Changing the windshield wiper rest position/Lifting the windshield wipers

When the windshield wipers are not being used, they retract to below the hood. To enable the windshield wipers to be lifted when parking in cold conditions or when replacing a windshield wiper insert, change the rest position of the windshield wipers to the service position using the wiper lever.

■ Raising the wipers to the service position

Within approximately 45 seconds of turning the engine switch off, move the wiper lever to the **MIST** *1 or **Δ** *2 position and hold it for approximately 2 seconds or more.

The wipers will move to the service position.

*1: For U.S.A.

*2: For Canada

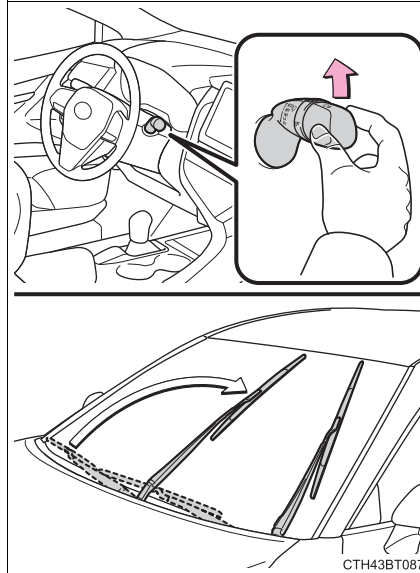

■ Lifting the windshield wipers

While holding the hook portion of the wiper arm, lift the windshield wiper from the windshield.

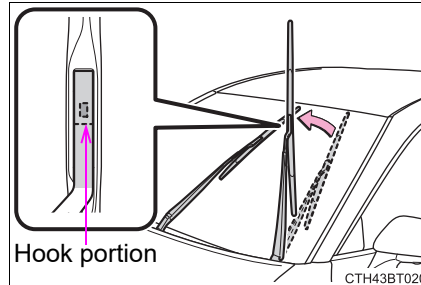

■ Lowering the windshield wipers to the retracted position

With the windshield wipers placed on the windshield, turn the engine switch to "ON" position (vehicles without a smart key system) or IGNITION ON mode (vehicles with a smart key system) and then move the wiper lever to an operating position. When the wiper switch is turned off, the windshield wipers will stop at the retracted position.

⚠ NOTICE

■ When lifting the windshield wipers

- Do not lift the windshield wipers when they are in the retracted position below the hood. Otherwise, they may contact the hood, possibly resulting in damage to a windshield wiper and/or the hood.
- Do not operate the wiper lever when the windshield wipers are lifted. Otherwise, the windshield wipers may contact the hood, possibly resulting in damage to the windshield wipers and/or hood.

Opening the fuel tank cap

Perform the following steps to open the fuel tank cap:

Before refueling the vehicle

- Close all the doors and windows, and turn the engine switch off.
- Confirm the type of fuel.

■ **Fuel types**

→P. 590

■ **Fuel tank opening for unleaded gasoline**

To help prevent incorrect fueling, your vehicle has a fuel tank opening that only accommodates the special nozzle on unleaded fuel pumps.

■ **If the malfunction indicator lamp illuminates**

The malfunction indicator lamp may illuminate erroneously if refueling is performed repeatedly when the fuel tank is nearly full.

 **WARNING**
■ When refueling the vehicle

Observe the following precautions while refueling the vehicle. Failure to do so may result in death or serious injury.

- After exiting the vehicle and before opening the fuel door, touch an unpainted metal surface to discharge any static electricity. It is important to discharge static electricity before refueling because sparks resulting from static electricity can cause fuel vapors to ignite while refueling.
- Always hold the grips on the fuel tank cap and turn it slowly to remove it. A whooshing sound may be heard when the fuel tank cap is loosened. Wait until the sound cannot be heard before fully removing the cap. In hot weather, pressurized fuel may spray out the filler neck and cause injury.
- Do not allow anyone that has not discharged static electricity from their body to come close to an open fuel tank.
- Do not inhale vaporized fuel.
Fuel contains substances that are harmful if inhaled.
- Do not smoke while refueling the vehicle.
Doing so may cause the fuel to ignite and cause a fire.
- Do not return to the vehicle or touch any person or object that is statically charged.
This may cause static electricity to build up, resulting in a possible ignition hazard.

■ When refueling

Observe the following precautions to prevent fuel overflowing from the fuel tank:

- Securely insert the fuel nozzle into the fuel filler neck.
- Stop filling the tank after the fuel nozzle automatically clicks off.
- Do not top off the fuel tank.

 **NOTICE**
■ Refueling

Do not spill fuel during refueling.

Doing so may damage the vehicle, such as causing the emission control system to operate abnormally or damaging fuel system components or the vehicle's painted surface.

Opening the fuel tank cap

- 1 Press and hold the opener switch to open the fuel filler door.

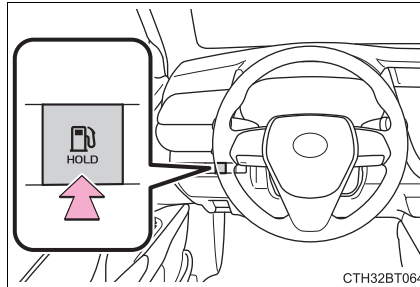

- 2 Turn the fuel tank cap slowly to remove it and hang it on the back of the fuel filler door.

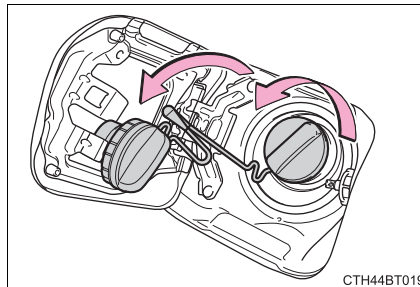

Closing the fuel tank cap

After refueling, turn the fuel tank cap until you hear a click. Once the cap is released, it will turn slightly in the opposite direction.

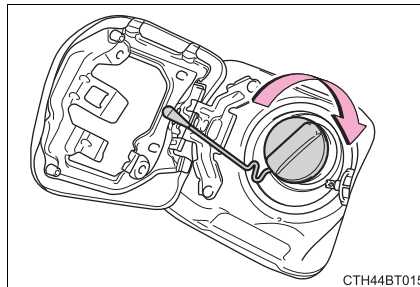

■ If the fuel filler door cannot be opened

Remove the cover inside the trunk and pull the lever.

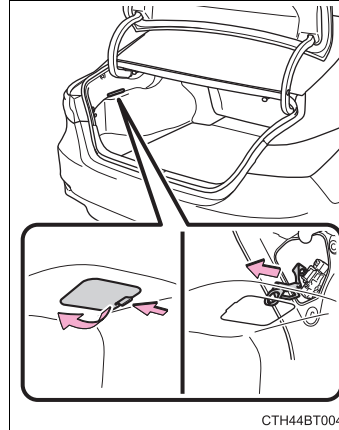
**■ When “Check Fuel Cap” is displayed on the multi-information display**

The fuel tank cap may be unfastened or loose. Turn the engine switch off, check the cap and tighten it securely. If the message remains, wait a few seconds and then turn the engine switch off once again.

⚠ WARNING**■ When replacing the fuel tank cap**

Do not use anything but a genuine Toyota fuel tank cap designed for your vehicle. Doing so may cause a fire or other incident which may result in death or serious injury.

Toyota Safety Sense 2.5+

The Toyota Safety Sense 2.5+ consists of the following drive assist systems and contributes to a safe and comfortable driving experience:

Driving assist system

◆ **PCS (Pre-Collision System)**

→P. 254

◆ **LTA (Lane Tracing Assist)**

→P. 270

◆ **AHB (Automatic High Beam)**

→P. 236

◆ **RSA (Road Sign Assist) (if equipped)**

→P. 285

◆ **Dynamic radar cruise control with full-speed range (if equipped)**

→P. 290

◆ **Dynamic radar cruise control (if equipped)**

→P. 306

 **WARNING**

■ **Toyota Safety Sense 2.5+**

The Toyota Safety Sense 2.5+ is designed to operate under the assumption that the driver will drive safely, and is designed to help reduce the impact to the occupants and the vehicle in the case of a collision or assist the driver in normal driving conditions.

As there is a limit to the degree of recognition accuracy and control performance that this system can provide, do not overly rely on this system. The driver is always responsible for paying attention to the vehicle's surroundings and driving safely.

Sensors

Two types of sensors, located behind the front grille and windshield, detect information necessary to operate the drive assist systems.

- ① Radar sensor
- ② Front camera

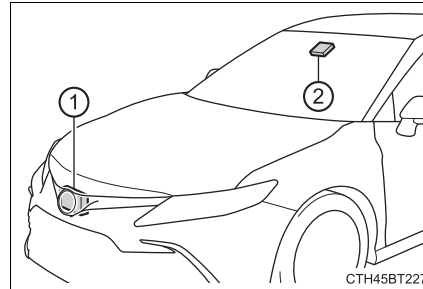

⚠ WARNING

■ To avoid malfunction of the radar sensor

Observe the following precautions.

Otherwise, the radar sensor may not operate properly, possibly leading to an accident resulting in death or serious injury.

● Keep the radar sensor and the radar sensor cover clean at all times.

- ① Radar sensor
- ② Radar sensor cover

If the front of the radar sensor or the front or back of the radar sensor cover is dirty or covered with water droplets, snow, etc., clean it.

Clean the radar sensor and radar sensor cover with a soft cloth to avoid damaging them.

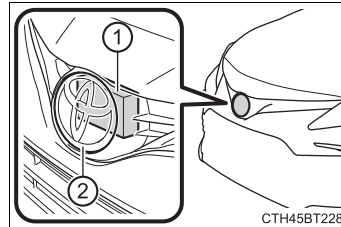

- Do not attach accessories, stickers (including transparent stickers) or other items to the radar sensor, radar sensor cover or surrounding area.
- Do not subject the radar sensor or its surrounding area to a strong impact. If the radar sensor, front grille, or front bumper has been subjected to a strong impact, have the vehicle inspected by your Toyota dealer.
- Do not disassemble the radar sensor.
- Do not modify or paint the radar sensor or radar sensor cover.
- In the following cases, the radar sensor must be recalibrated. Contact your Toyota dealer for details.
 - When the radar sensor or front grille are removed and installed, or replaced
 - When the front bumper is replaced

⚠ WARNING

■ **To avoid malfunction of the front camera**

Observe the following precautions.

Otherwise, the front camera may not operate properly, possibly leading to an accident resulting in death or serious injury.

- Keep the windshield clean at all times.
 - If the windshield is dirty or covered with an oily film, water droplets, snow, etc., clean the windshield.
 - If a glass coating agent is applied to the windshield, it will still be necessary to use the windshield wipers to remove water droplets, etc. from the area of the windshield in front of the front camera.
 - If the inner side of the windshield where the front camera is installed is dirty, contact your Toyota dealer.
- Do not attach objects, such as stickers, transparent stickers, etc., to the outer side of the windshield in front of the front camera (shaded area in the illustration).

A: From the top of the windshield to approximately 0.4 in. (1 cm) below the bottom of the front camera

B: Approximately 7.9 in. (20 cm) (Approximately 4.0 in. [10 cm] to the right and left from the center of the front camera)
- If the part of the windshield in front of the front camera is fogged up or covered with condensation or ice, use the windshield defogger to remove the fog, condensation or ice. (→P. 383, 389, 397)
- If water droplets cannot be properly removed from the area of the windshield in front of the front camera by the windshield wipers, replace the wiper insert or wiper blade.
- Do not attach window tint to the windshield.
- Replace the windshield if it is damaged or cracked.
After replacing the windshield, the front camera must be recalibrated. Contact your Toyota dealer for details.
- Do not allow liquids to contact the front camera.
- Do not allow bright lights to shine into the front camera.
- Do not dirty or damage the front camera.
When cleaning the inside of the windshield, do not allow glass cleaner to contact the lens of the front camera. Also, do not touch the lens.
If the lens is dirty or damaged, contact your Toyota dealer.

 **WARNING**

- Do not subject the front camera to a strong impact.
- Do not change the installation position or direction of the front camera or remove it.
- Do not disassemble the front camera.
- Do not modify any components of the vehicle around the front camera (inside rear view mirror, etc.) or ceiling.
- Do not attach any accessories to the hood, front grille or front bumper that may obstruct the front camera. Contact your Toyota dealer for details.
- If a surfboard or other long object is to be mounted on the roof, make sure that it will not obstruct the front camera.
- Do not modify the headlights or other lights.

■ **If a warning message is displayed on the multi-information display**

A system may be temporarily unavailable or there may be a malfunction in the system.

- In the following situations, perform the actions specified in the table. When the normal operating conditions are detected, the message will disappear and the system will become operational.

If the message does not disappear, contact your Toyota dealer.

Situation	Action
When the area around a camera is covered with dirt, moisture (fogged up, covered with condensation, ice, etc.), or other foreign matter	Using the wiper and A/C function, remove the dirt and other attached matter. (→P. 383, 389, 397)
When the temperature around the front camera is outside of the operational range, such as when the vehicle is in the sun or in an extremely cold environment	If the front camera is hot, such as after the vehicle had been parked in the sun, use the air conditioning system to decrease the temperature around the front camera. If a sunshade was used when the vehicle was parked, depending on its type, the sunlight reflected from the surface of the sunshade may cause the temperature of the front camera to become excessively high.
	If the front camera is cold, such after the vehicle is parked in an extremely cold environment, use the air conditioning system to increase the temperature around the front camera.
The area in front of the front camera is obstructed, such as when the hood is open or a sticker is attached to the part of the windshield in front of the front camera.	Close the hood, remove the sticker, etc. to clear the obstruction.
When "Pre-Collision System Radar In Self Calibration Unavailable See Owner's Manual" is displayed	Check whether there is attached materials on the radar sensor and radar sensor cover, and if there is, remove it.

- In the following situations, if the situation has changed (or the vehicle has been driven for some time) and the normal operating conditions are detected, the message will disappear and the system will become operational.

If the message does not disappear, contact your Toyota dealer.

- When the temperature around the radar sensor is outside of the operational range, such as when the vehicle is in the sun or in an extremely cold environment
- When the front camera cannot detect objects in front of the vehicle, such as when driving in the dark, snow, or fog, or when bright lights are shining into the front camera
- Depending on the conditions in the vicinity of the vehicle, the radar may judge the surrounding environment cannot be properly recognized. In that case, "Pre-Collision System Unavailable See Owner's Manual" is displayed.

PCS (Pre-Collision System)

The pre-collision system uses a radar sensor and front camera to detect objects (→P. 254) in front of the vehicle. When the system determines that the possibility of a frontal collision with an object is high, a warning operates to urge the driver to take evasive action and the potential brake pressure is increased to help the driver avoid the collision. If the system determines that the possibility of a frontal collision with an object is extremely high, the brakes are automatically applied to help avoid the collision or help reduce the impact of the collision.

The pre-collision system can be disabled/enabled and the warning timing can be changed. (→P. 259)

Detectable objects

The system can detect the following (The detectable objects differs depending on the function.):

- Vehicles
- Bicyclists
- Pedestrians

System functions

■ Pre-collision warning

When the system determines that the possibility of a frontal collision is high, a buzzer will sound and a warning message will be displayed on the multi-information display to urge the driver to take evasive action.

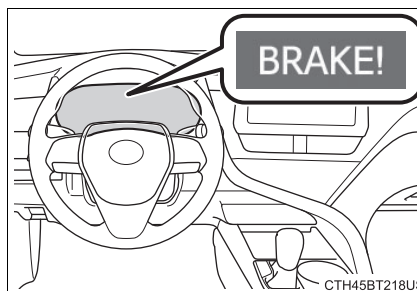

■ Pre-collision brake assist

When the system determines that the possibility of a frontal collision is high, the system applies greater braking force in relation to how strongly the brake pedal is depressed.

■ Pre-collision braking

If the system determines that the possibility of a frontal collision is extremely high, the brakes are automatically applied to help avoid the collision or reduce the impact of the collision.

■ Emergency steering assist

If the system determines that the possibility of a frontal collision is high and that there is sufficient space for the vehicle to be steered into within its lane, and the driver has begun evasive maneuver or steering, emergency steering assist will assist the steering movements to help enhance the vehicle stability and for lane departure prevention.

During operation, the indicator will illuminate in green.

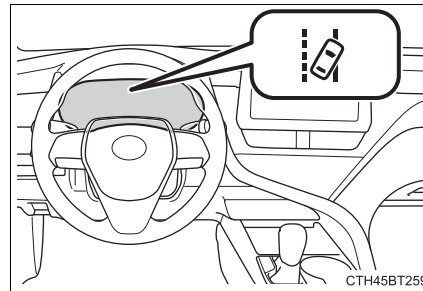

4

Driving

■ Intersection right/left turn assistance

If the system determines that there is a high possibility of a collision in the following situations, it will assist with Pre-collision warning and, if necessary Pre-collision braking.

Depending on the configuration of the intersection, it may not be possible to support.

- When you turn right/left at an intersection and cross the path of an oncoming vehicle

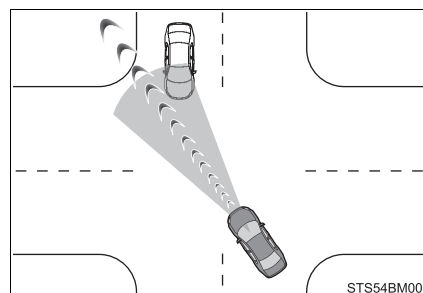

- When you turn right/left, pedestrian is detected in the forward direction and estimated to enter your vehicle's path (bicyclists are not detected.)

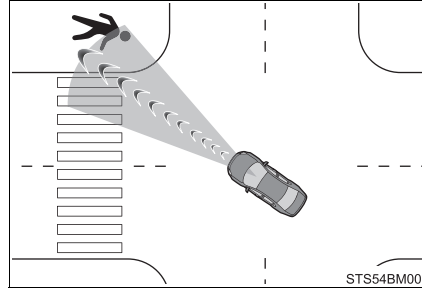

STS54BM009

WARNING

■ Limitations of the pre-collision system

- The driver is solely responsible for safe driving. Always drive safely, taking care to observe your surroundings. Do not use the pre-collision system instead of normal braking operations under any circumstances. This system will not prevent collisions or lessen collision damage or injury in every situation. Do not overly rely on this system. Failure to do so may lead to an accident, resulting in death or serious injury.
- Although this system is designed to help avoid a collision or help reduce the impact of the collision, its effectiveness may change according to various conditions, therefore the system may not always be able to achieve the same level of performance. Read the following conditions carefully. Do not overly rely on this system and always drive carefully.
 - Conditions under which the system may operate even if there is no possibility of a collision: →P. 264
 - Conditions under which the system may not operate properly: →P. 266
- Do not attempt to test the operation of the pre-collision system yourself. Depending on the objects used for testing (dummies, cardboard objects imitating detectable objects, etc.), the system may not operate properly, possibly leading to an accident.

 **WARNING****■ Pre-collision braking**

- When the pre-collision braking function is operating, a large amount of braking force will be applied.
- If the vehicle is stopped by the operation of the pre-collision braking function, the pre-collision braking function operation will be canceled after approximately 2 seconds. Depress the brake pedal as necessary.
- The pre-collision braking function may not operate if certain operations are performed by the driver. If the accelerator pedal is being depressed strongly or the steering wheel is being turned, the system may determine that the driver is taking evasive action and possibly prevent the pre-collision braking function from operating.
- In some situations, while the pre-collision braking function is operating, operation of the function may be canceled if the accelerator pedal is depressed strongly or the steering wheel is turned and the system determines that the driver is taking evasive action.
- If the brake pedal is being depressed, the system may determine that the driver is taking evasive action and possibly delay the operation timing of the pre-collision braking function.

■ Emergency steering assist

- As emergency steering assist operation will be canceled when the system determines that lane departure prevention function has been completed.
- Emergency steering assist may not operate or may be cancel in the following cases as the system may determine the driver is taking actions.
 - If the accelerator pedal is being depressed strongly, the steering wheel is being operated sharply, the brake pedal is being depressed or the turn signal lever is being operated. In this case, the system may determine that the driver is taking evasive action and the emergency steering assist may not operate.
 - In some situations, while the emergency steering assist is operating, operation of the function may be canceled if the accelerator pedal is depressed strongly, the steering wheel is operated sharply or the brake pedal is being depressed and the system determines that the driver is taking evasive action.
 - When the emergency steering assist is operating, if the steering wheel is held firmly or is operated in the opposite direction to that which the system is generating torque, the function may be canceled.



 **WARNING****■ When to disable the pre-collision system**

In the following situations, disable the system, as it may not operate properly, possibly leading to an accident resulting in death or serious injury:

- When the vehicle is being towed
- When your vehicle is towing another vehicle
- When transporting the vehicle via truck, boat, train or similar means of transportation
- When the vehicle is raised on a lift with the engine running and the tires are allowed to rotate freely
- When inspecting the vehicle using a drum tester such as a chassis dynamometer or speedometer tester, or when using an on vehicle wheel balancer
- When a strong impact is applied to the front bumper or front grille, due to an accident or other reasons
- If the vehicle cannot be driven in a stable manner, such as when the vehicle has been in an accident or is malfunctioning
- When the vehicle is driven in a sporty manner or off-road
- When the tires are not properly inflated
- When the tires are very worn
- When tires of a size other than specified are installed
- When tire chains are installed
- When a compact spare tire or an emergency tire puncture repair kit is used
- If equipment (snow plow, etc.) that may obstruct the radar sensor or front camera is temporarily installed to the vehicle

Changing settings of the pre-collision system

■ Enabling/disabling the pre-collision system

The pre-collision system can be enabled/disabled on  (4.2-inch display) or  (7-inch display) (→P. 103, 117) of the multi-information display.



Vehicles without a smart key system: The system is automatically enabled each time the engine switch is turned to the "ON" position.

Vehicles with a smart key system: The system is automatically enabled each time the engine switch is turned to IGNITION ON mode.

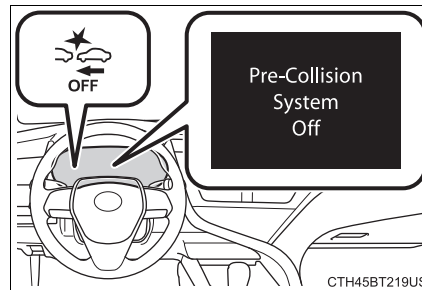
If the system is disabled, the PCS warning light will turn on and a message will be displayed on the multi-information display.



■ Changing the pre-collision warning timing

The pre-collision warning timing can be changed on  (4.2-inch display) or  (7-inch display) (→P. 103, 117) of the multi-information display.

The warning timing setting is retained when the engine switch is turned off. However, if the pre-collision system is disabled and re-enabled, the operation timing will return to the default setting (middle).

If the pre-collision warning timing is changed, emergency steering assist timing will also be changed accordingly.

If late is selected, emergency steering assist would not operate in case of an emergency.

- ① Early
- ② Middle
This is the default setting.
- ③ Late

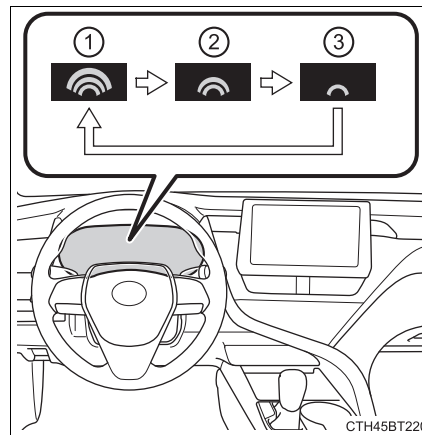

■ Operational conditions for each pre-collision function

The pre-collision system is enabled and the system determines that the possibility of a frontal collision with a detected object is high.

The system may not operate in the following situations:

- If a battery terminal has been disconnected and reconnected and then the vehicle has not been driven for a certain amount of time
- If the shift lever is in R
- When the VSC OFF indicator is illuminated (only the pre-collision warning function will be operational)

The operation speeds and operation cancellation for each function is listed below.

● Pre-collision warning

Detectable objects	Vehicle speed	Relative speed between your vehicle and object
Preceding and stopped vehicles	Approx. 7 to 110 mph (10 to 180 km/h)	Approx. 7 to 110 mph (10 to 180 km/h)
Oncoming vehicles	Approx. 7 to 110 mph (10 to 180 km/h)	Approx. 13 to 110 mph (20 to 180 km/h)
Bicyclists and pedestrians	Approx. 7 to 50 mph (10 to 80 km/h)	Approx. 7 to 50 mph (10 to 80 km/h)

While the pre-collision warning function is operating, if the steering wheel is operated heavily or suddenly, the pre-collision warning may be cancelled.

● Pre-collision brake assist

Detectable objects	Vehicle speed	Relative speed between your vehicle and object
Preceding and stopped vehicles	Approx. 20 to 110 mph (30 to 180 km/h)	Approx. 20 to 110 mph (30 to 180 km/h)
Bicyclists and pedestrians	Approx. 20 to 50 mph (30 to 80 km/h)	Approx. 20 to 50 mph (30 to 80 km/h)

● Pre-collision braking

Detectable objects	Vehicle speed	Relative speed between your vehicle and object
Preceding and stopped vehicles	Approx. 7 to 110 mph (10 to 180 km/h)	Approx. 7 to 110 mph (10 to 180 km/h)
Oncoming vehicles	Approx. 7 to 110 mph (10 to 180 km/h)	Approx. 13 to 110 mph (20 to 180 km/h)
Bicyclists and pedestrians	Approx. 7 to 50 mph (10 to 80 km/h)	Approx. 7 to 50 mph (10 to 80 km/h)

If either of the following occur while the pre-collision braking function is operating, it will be canceled:

- The accelerator pedal is depressed strongly.
- The steering wheel is turned sharply or abruptly.

● Emergency steering assist

When the turn signal lights are flashing, emergency steering assist will not operate in case of an emergency.

Detectable objects	Vehicle speed	Relative speed between your vehicle and object
Preceding and stopped vehicles, bicyclists and pedestrians	Approx. 25 to 50 mph (40 to 80 km/h)	Approx. 25 to 50 mph (40 to 80 km/h)

If any of the following occur while the emergency steering assist function is operating, it will be canceled:

- The accelerator pedal is depressed strongly.
- The steering wheel is turned sharply or abruptly.
- The brake pedal is depressed.

- Intersection right/left turn assistance (pre-collision warning)

When the turn signal lights are not flashing, support for turning left or right at an intersection which targets oncoming vehicles does not work.

Detectable objects	Vehicle speed	Oncoming vehicle speed	Relative speed between your vehicle and object
Oncoming vehicles	Approx. 7 to 15 mph (10 to 25 km/h)	Approx. 20 to 35 mph (30 to 55 km/h)	Approx. 25 to 50 mph (40 to 80 km/h)
Pedestrians	Approx. 7 to 15 mph (10 to 25 km/h)	—	Approx. 7 to 15 mph (10 to 25 km/h)

- Intersection right/left turn assistance (pre-collision braking)

When the turn signal lights are not flashing, support for turning left or right at an intersection which targets oncoming vehicles does not work.

Detectable objects	Vehicle speed	Oncoming vehicle speed	Relative speed between your vehicle and object
Oncoming vehicles	Approx. 10 to 15 mph (15 to 25 km/h)	Approx. 20 to 28 mph (30 to 45 km/h)	Approx. 28 to 43 mph (45 to 70 km/h)
Pedestrians	Approx. 7 to 15 mph (10 to 25 km/h)	—	Approx. 7 to 15 mph (10 to 25 km/h)

- Object detection function

The system detects objects based on their size, profile, motion, etc. However, an object may not be detected depending on the surrounding brightness and the motion, posture, and angle of the detected object, preventing the system from operating properly. (→P. 266)

The illustration shows an image of detectable objects.

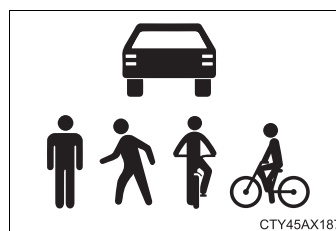

■ **Conditions under which the system may operate even if there is no possibility of a collision**

● In some situations such as the following, the system may determine that there is a possibility of a frontal collision and operate.

- When passing a detectable object, etc.
- When changing lanes while overtaking a detectable object, etc.
- When approaching a detectable object in an adjacent lane or on the roadside, such as when changing the course of travel or driving on a winding road

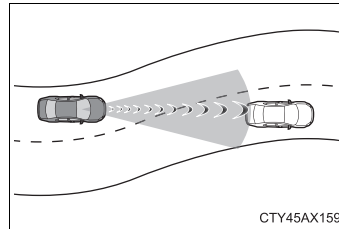

- When rapidly closing on a detectable object, etc.
- When approaching objects on the roadside, such as detectable objects, guardrails, utility poles, trees, or walls
- When there is a detectable object or other object by the roadside at the entrance of a curve

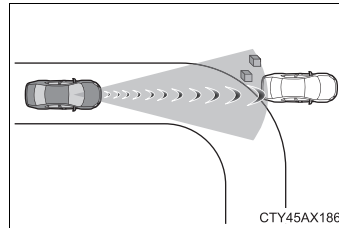

- When there are patterns or paint in front of your vehicle that may be mistaken for a detectable object
- When the front of your vehicle is hit by water, snow, dust, etc.
- When overtaking a detectable object that is changing lanes or making a right/left turn

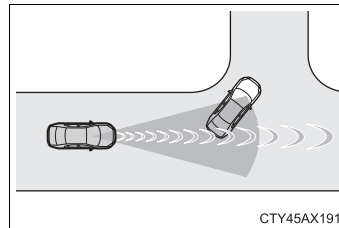

- When passing a detectable object in an oncoming lane that is stopped to make a right/left turn

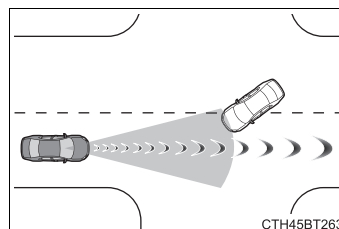

- When a detectable object approaches very close and then stops before entering the path of your vehicle
- If the front of your vehicle is raised or lowered, such as when on an uneven or undulating road surface
- When driving on a road surrounded by a structure, such as in a tunnel or on an iron bridge
- When there is a metal object (manhole cover, steel plate, etc.), steps, or a protrusion in front of your vehicle
- When passing under an object (road sign, billboard, etc.)

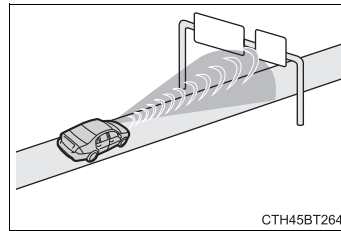

- When approaching an electric toll gate barrier, parking area barrier, or other barrier that opens and closes
- When using an automatic car wash
- When driving through or under objects that may contact your vehicle, such as thick grass, tree branches, or a banner

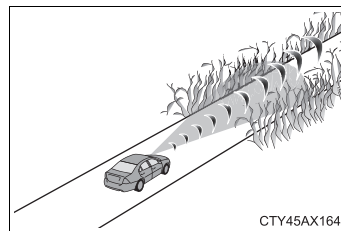

- When driving through steam or smoke
- When driving near an object that reflects radio waves, such as a large truck or guardrail
- When driving near a TV tower, broadcasting station, electric power plant, radar equipped vehicles, etc., or other location where strong radio waves or electrical noise may be present
- When there are many things which can reflect the radio waves of the radar in the vicinity (tunnels, truss bridges, gravel roads, snow covered road that have tracks, etc.)
- While making a right/left turn, when an oncoming vehicle or a crossing pedestrian has already exited the path of your vehicle
- While making a right/left turn, closely in front of an oncoming vehicle or a crossing pedestrian.
- While making a right/left turn, when an oncoming vehicle or a crossing pedestrian stops before entering the path of your vehicle

- While making a right/left turn, when an oncoming vehicle turns right/left in front of your vehicle

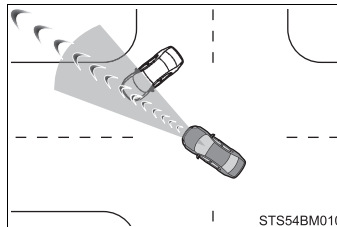

- While steering into the direction of oncoming traffic

■ **Situations in which the system may not operate properly**

- In some situations such as the following, an object may not be detected by the radar sensor and front camera, preventing the system from operating properly:

- When a detectable object is approaching your vehicle
- When your vehicle or a detectable object is wobbling
- If a detectable object makes an abrupt maneuver (such as sudden swerving, acceleration or deceleration)
- When your vehicle approaches a detectable object rapidly
- When a detectable object is not directly in front of your vehicle

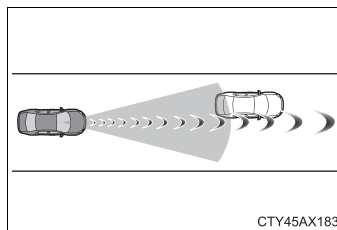

- When a detectable object is near a wall, fence, guardrail, manhole cover, vehicle, steel plate on the road, etc.
- When a detectable object is under a structure
- When part of a detectable object is hidden by an object, such as large baggage, an umbrella, or guardrail
- When there are many things which can reflect the radio waves of the radar in the vicinity (tunnels, truss bridges, gravel roads, snow covered road that have tracks, etc.)
- When there is an effect on the radio waves to the radar that is installed on another vehicle
- When multiple detectable objects are close together
- If the sun or other light is shining directly on a detectable object
- When a detectable object is a shade of white and looks extremely bright
- When a detectable object appears to be nearly the same color or brightness as its surroundings
- If a detectable object cuts or suddenly emerges in front of your vehicle
- When the front of your vehicle is hit by water, snow, dust, etc.
- When a very bright light ahead, such as the sun or the headlights of oncoming traffic, shines directly into the front camera
- When approaching the side or front of a vehicle ahead
- If a vehicle ahead is a motorcycle

- If a vehicle ahead is narrow, such as a personal mobility vehicle
- If a preceding vehicle has a small rear end, such as an unloaded truck
- If a preceding vehicle has a low rear end, such as a low bed trailer

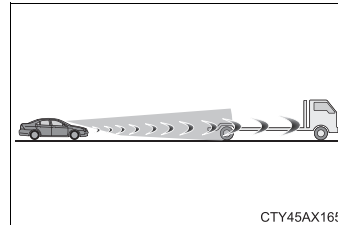

- If a vehicle ahead has extremely high ground clearance

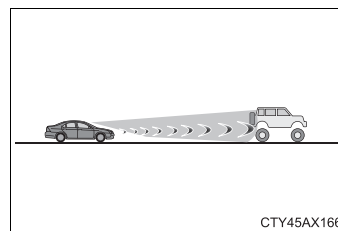

- If a vehicle ahead is carrying a load which protrudes past its rear bumper
- If a vehicle ahead is irregularly shaped, such as a tractor or side car
- If a vehicle ahead is a child sized bicycle, a bicycle that is carrying a large load, a bicycle ridden by more than one person, or a uniquely shaped bicycle (bicycle with a child seat, tandem bicycle, etc.)
- If a pedestrian/ or the riding height of a bicyclist ahead is shorter than approximately 3.2 ft. (1 m) or taller than approximately 6.5 ft. (2 m)
- If a pedestrian/bicyclist is wearing oversized clothing (a rain coat, long skirt, etc.), making their silhouette obscure
- If a pedestrian is bending forward or squatting or bicyclist is bending forward
- If a pedestrian/bicyclist is moving fast
- If a pedestrian is pushing a stroller, wheelchair, bicycle or other vehicle
- When driving in inclement weather such as heavy rain, fog, snow or a sandstorm
- When driving through steam or smoke
- When the surrounding area is dim, such as at dawn or dusk, or while at night or in a tunnel, making a detectable object appear to be nearly the same color as its surroundings
- When driving in a place where the surrounding brightness changes suddenly, such as at the entrance or exit of a tunnel
- After the engine has started the vehicle has not been driven for a certain amount of time
- While making a left/right turn and for a few seconds after making a left/right turn
- While driving on a curve and for a few seconds after driving on a curve
- If your vehicle is skidding

- If the front of the vehicle is raised or lowered

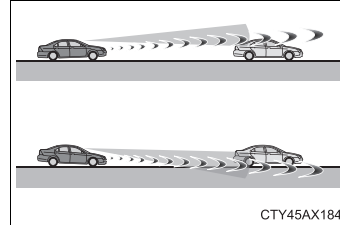

- If the wheels are misaligned
- If a wiper blade is blocking the front camera
- The vehicle is being driven at extremely high speeds
- When driving on a hill
- If the radar sensor or front camera is misaligned
- When driving in a traffic lane separated by more than one lane where oncoming vehicles are driving while making a right/left turn
- When largely out of place with the opposite facing targeted oncoming vehicle during a right/left turn

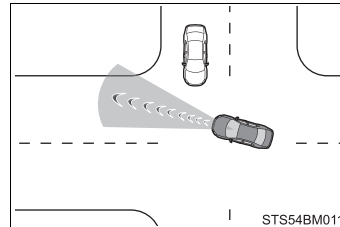

- While making a right/left turn, when a pedestrian approaches from behind or side of your vehicle

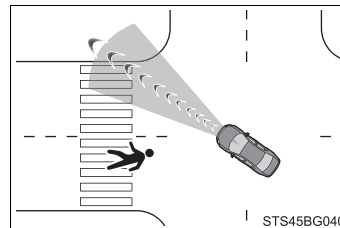

- In addition to the above, in some situations, such as the following, the emergency steering assist may not operate.
 - When the white (yellow) lane lines are difficult to see, such as when they are faint, diverging/merging, or a shadow is cast upon them
 - When the lane is wider or narrower than normal
 - When there is a light and dark pattern on the road surface, such as due to road repairs
 - When the target is too close
 - When there is insufficient safe or unobstructed space for the vehicle to be steered into
 - If oncoming vehicle is present
 - If VSC function is operating

- In some situations such as the following, sufficient braking force or steering force may not be obtained, preventing the system from performing properly:
 - If the braking functions cannot operate to their full extent, such as when the brake parts are extremely cold, extremely hot, or wet
 - If the vehicle is not properly maintained (brakes or tires are excessively worn, improper tire inflation pressure, etc.)
 - When the vehicle is being driven on a gravel road or other slippery surface
 - When the road surface has deep wheel tracks
 - When driving on a hill road
 - When driving on a road that has inclines to the left or right
- **If VSC is disabled**
 - If VSC is disabled (→P. 324), the pre-collision brake assist and pre-collision braking functions are also disabled.
 - The PCS warning light will turn on and “VSC Turned Off Pre-Collision Brake System Unavailable” will be displayed on the multi-information display.

LTA (Lane Tracing Assist)

Summary of functions

While driving on a road with clear white (yellow) lane lines, the LTA system warns the driver if the vehicle may deviate from the current lane or course*, and also can slightly operate the steering wheel to help avoid deviation from the lane or course*. Also, while the dynamic radar cruise control with full-speed range or dynamic radar cruise control is operating, this system will operate the steering wheel to maintain the vehicle's lane position.

The LTA system recognizes white (yellow) lane lines or a course* using the front camera. Additionally, it detects preceding vehicles using the front camera and radar.

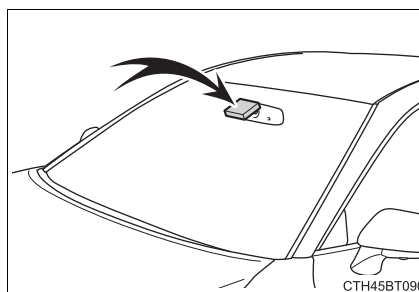

*: Boundary between asphalt and the side of the road, such as grass, soil, or a curb

WARNING

■ Before using LTA system

- Do not rely solely upon the LTA system. The LTA system does not automatically drive the vehicle or reduce the amount of attention that must be paid to the area in front of the vehicle. The driver must always assume full responsibility for driving safely by paying careful attention to the surrounding conditions and operating the steering wheel to correct the path of the vehicle. Also, the driver must take adequate breaks when fatigued, such as from driving for a long period of time.
- Failure to perform appropriate driving operations and pay careful attention may lead to an accident, resulting in death or serious injury.

 **WARNING****■ Situations unsuitable for LTA system**

In the following situations, use the LTA switch to turn the system off. Failure to do so may lead to an accident, resulting in death or serious injury.

- Vehicle is driven on a road surface which is slippery due to rainy weather, fallen snow, freezing, etc.
- Vehicle is driven on a snow-covered road.
- White (yellow) lines are difficult to see due to rain, snow, fog, dust, etc.
- Vehicle is driven in a temporary lane or restricted lane due to construction work.
- Vehicle is driven in a construction zone.
- A spare tire, tire chains, etc. are equipped.
- When the tires have been excessively worn, or when the tire inflation pressure is low.
- During emergency towing

■ Preventing LTA system malfunctions and operations performed by mistake

- Do not modify the headlights or place stickers, etc. on the surface of the lights.
- Do not modify the suspension etc. If the suspension etc. needs to be replaced, contact your Toyota dealer.
- Do not install or place anything on the hood or grille. Also, do not install a grille guard (bull bars, kangaroo bar, etc.).
- If your windshield needs repairs, contact your Toyota dealer.

⚠ WARNING

■ Conditions in which functions may not operate properly

In the following situations, the functions may not operate properly and the vehicle may depart from its lane. Drive safely by always paying careful attention to your surroundings and operate the steering wheel to correct the path of the vehicle without relying solely on the functions.

- When the follow-up cruising display is displayed (→P. 280) and the preceding vehicle changes lanes. (Your vehicle may follow the preceding vehicle and also change lanes.)

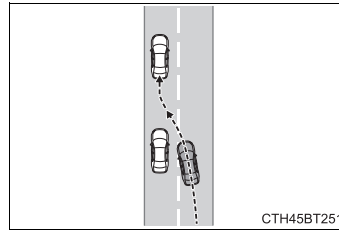

- When the follow-up cruising display is displayed (→P. 280) and the preceding vehicle is swaying. (Your vehicle may sway accordingly and depart from the lane.)
- When the follow-up cruising display is displayed (→P. 280) and the preceding vehicle departs from its lane. (Your vehicle may follow the preceding vehicle and depart from the lane.)
- When the follow-up cruising display is displayed (→P. 280) and the preceding vehicle is being driven extremely close to the left/right lane line. (Your vehicle may follow the preceding vehicle and depart from the lane.)
- Vehicle is being driven around a sharp curve.
- Objects or patterns that could be mistaken for white (yellow) lines are present on the side of the road (guardrails, reflective poles, etc.).

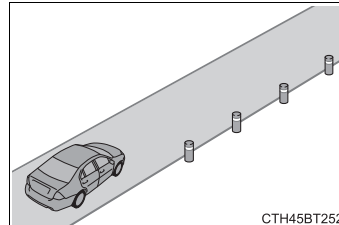

⚠ WARNING

- Vehicle is driven where the road diverges, merges, etc.

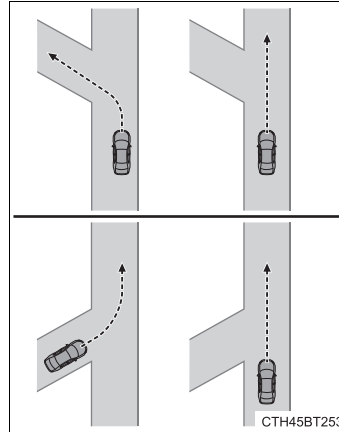

- Repair marks of asphalt, white (yellow) lines, etc. are present due to road repair.

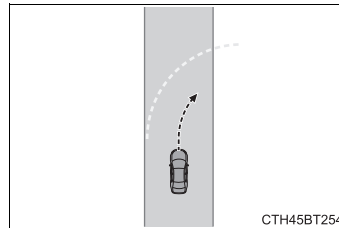

- There are shadows on the road that run parallel with, or cover, the white (yellow) lines.
- The vehicle is driven in an area without white (yellow) lines, such as in front of a tollgate or checkpoint, or at an intersection, etc.
- The white (yellow) lines are cracked, "Botts' dots", "Raised pavement marker" or stones are present.
- The white (yellow) lines cannot be seen or are difficult to see due to sand, etc.
- The vehicle is driven on a road surface that is wet due to rain, puddles, etc.
- The traffic lines are yellow (which may be more difficult to recognize than lines that are white).
- The white (yellow) lines cross over a curb, etc.
- The vehicle is driven on a bright surface, such as concrete.
- If the edge of the road is not clear or straight.
- The vehicle is driven on a surface that is bright due to reflected light, etc.
- The vehicle is driven in an area where the brightness changes suddenly, such as at the entrances and exits of tunnels, etc.

 WARNING

- Light from the headlights of an oncoming vehicle, the sun, etc. enters the camera.
- The vehicle is driven on a slope.
- The vehicle is driven on a road which tilts left or right, or a winding road.
- The vehicle is driven on an unpaved or rough road.
- The traffic lane is excessively narrow or wide.
- The vehicle is extremely tilted due to carrying heavy luggage or having improper tire pressure.
- The distance to the preceding vehicle is extremely short.
- The vehicle is moving up and down a large amount due to road conditions during driving (poor roads or road seams).
- When driving in a tunnel or at night with the headlights off or when a headlight is dim due to its lens being dirty or it being misaligned.
- The vehicle is struck by a crosswind.
- The vehicle is affected by wind from a vehicle driven in a nearby lane.
- The vehicle has just changed lanes or crossed an intersection.
- Tires which differ by structure, manufacturer, brand or tread pattern are used.
- When tires of a size other than specified are installed.
- Snow tires, etc. are equipped.
- The vehicle is being driven at extremely high speeds.

Functions included in LTA system**◆ Lane departure alert function**

When the system determines that the vehicle might depart from its lane or course*, a warning is displayed on the multi-information display, and a warning buzzer will sound to alert the driver.

When the warning buzzer sounds, check the area around your vehicle and carefully operate the steering wheel to move the vehicle back to the center of the lane.

Vehicle with BSM: When the system determines that the vehicle might depart from its lane and that the possibility of a collision with an overtaking vehicle in the adjacent lane is high, the lane departure alert will operate even if the turn signals are operating.

*: Boundary between asphalt and the side of the road, such as grass, soil, or a curb

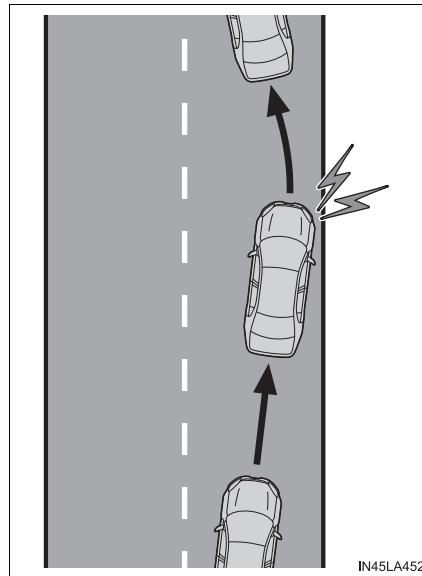

◆ Steering assist function

When the system determines that the vehicle might depart from its lane or course*, the system provides assistance as necessary by operating the steering wheel in small amounts for a short period of time to keep the vehicle in its lane.

Vehicle with BSM: When the system determines that the vehicle might depart from its lane and that the possibility of a collision with an overtaking vehicle in the adjacent lane is high, the steering assist function will operate even if the turn signals are operating.

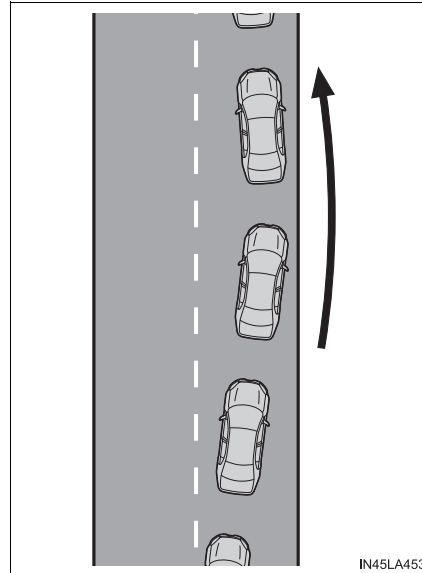

*: Boundary between asphalt and the side of the road, such as grass, soil, or a curb

◆ Vehicle sway warning function

When the vehicle is swaying within a lane, the warning buzzer will sound and a message will be displayed on the multi-information display to alert the driver.

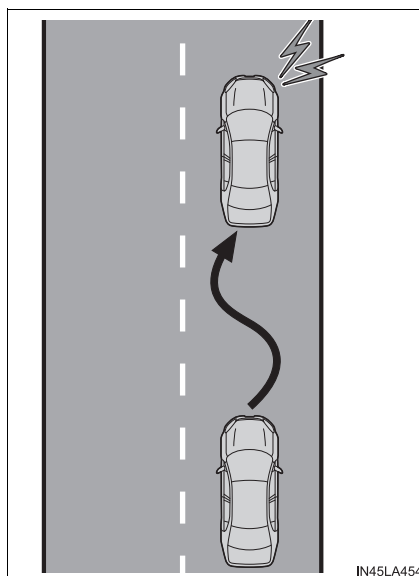

◆ Lane centering function

This function is linked with dynamic radar cruise control with full-speed range or dynamic radar cruise control and provides the required assistance by operating the steering wheel to keep the vehicle in its current lane.

When dynamic radar cruise control with full-speed range or dynamic radar cruise control is not operating, the lane centering function does not operate.

In situations where the white (yellow) lane lines are difficult to see or are not visible, such as when in a traffic jam, this function will operate to help follow a preceding vehicle by monitoring the position of the preceding vehicle.

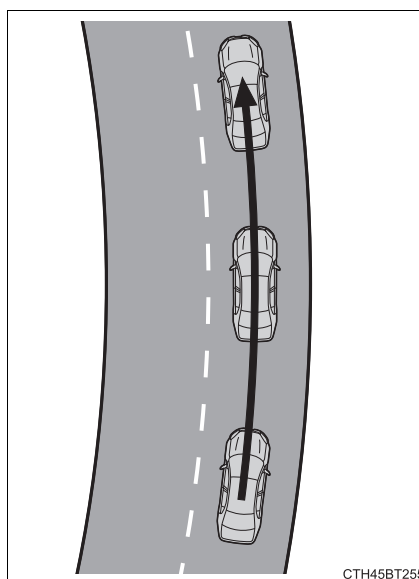

Turning LTA system on

Press the LTA switch to turn the LTA system on.

The LTA indicator illuminates and a message is displayed on the multi-information display.

Press the LTA switch again to turn the LTA system off.

When the LTA system is turned on or off, operation of the LTA system continues in the same condition the next time the engine is started.

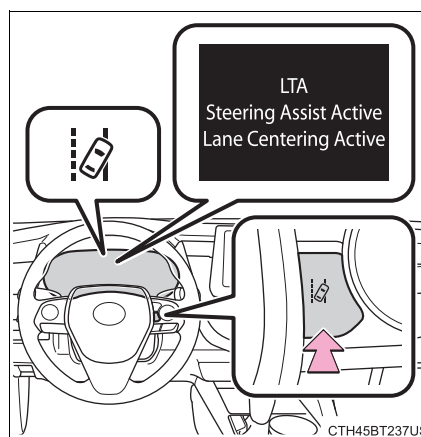

Indications on multi-information display

The illustration used is intended as an example, and may differ from the image that is actually displayed on the multi-information display.

① LTA indicator

The illumination condition of the indicator informs the driver of the system operation status.

Illuminated in white:
LTA system is operating.

Illuminated in green:
Steering wheel assistance of the steering assist function or lane centering function is operating.

Flashing in yellow:
Lane departure alert function is operating.

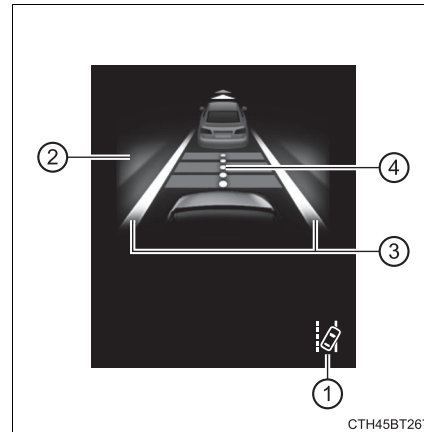

② Operation display of steering wheel operation support

Displayed when the multi-information display is switched to the driving assist system information display.

Indicates that steering wheel assistance of the steering assist function or lane centering function is operating.

Both outer sides of the lane are displayed: Indicates that steering wheel assist of the lane centering function is operating.

One outer side of the lane is displayed: Indicates that steering wheel assist of the steering assist function is operating.

Both outer sides of the lane are flashing: Alerts the driver that their input is necessary to stay in the center of the lane (lane centering function).

③ Lane departure alert function display

Displayed when the multi-information display is switched to the driving assist system information display.

- ▶ Inside of displayed lines is white
- ▶ Inside of displayed lines is black

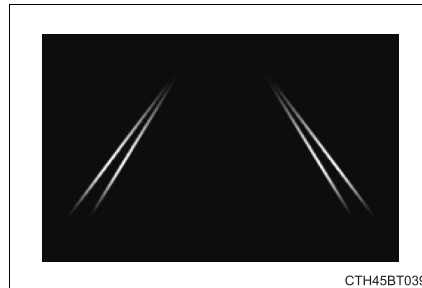
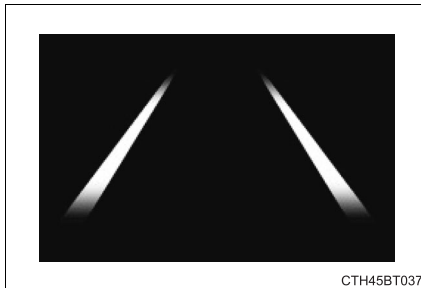

Indicates that the system is recognizing white (yellow) lines or a course*. When the vehicle departs from its lane, the white line displayed on the side the vehicle departs from flashes yellow.

Indicates that the system is not able to recognize white (yellow) lines or a course* or is temporarily canceled.

*: Boundary between asphalt and the side of the road, such as grass, soil, or a curb

④ Follow-up cruising display

Displayed when the multi-information display is switched to the driving assist system information display.

Indicates that steering assist of the lane centering function is operating by monitoring the position of a preceding vehicle.

When the follow-up cruising display is displayed, if the preceding vehicle moves, your vehicle may move in the same way. Always pay careful attention to your surroundings and operate the steering wheel as necessary to correct the path of the vehicle and ensure safety.

■ Operation conditions of each function

● Lane departure alert function

This function operates when all of the following conditions are met.

- LTA is turned on.
- Vehicle speed is approximately 32 mph (50 km/h) or more.*1
- System recognizes white (yellow) lane lines or a course*2. (When a white [yellow] line or course*2 is recognized on only one side, the system will operate only for the recognized side.)
- Width of traffic lane is approximately 9.8 ft. (3 m) or more.
- Turn signal lever is not operated. (Vehicle with BSM: Except when another vehicle is in the lane on the side where the turn signal was operated)
- Vehicle is not being driven around a sharp curve.
- No system malfunctions are detected. (→P. 284)

*1: The function operates even if the vehicle speed is less than approximately 32 mph (50 km/h) when the lane centering function is operating.

*2: Boundary between asphalt and the side of the road, such as grass, soil, or a curb



● Steering assist function

This function operates when all of the following conditions are met in addition to the operation conditions for the lane departure alert function.

- Vehicle is not accelerated or decelerated by a fixed amount or more.
- Steering wheel is not operated with a steering force level suitable for changing lanes.
- ABS, VSC, TRAC and PCS are not operating.
- TRAC or VSC is not turned off.



● Vehicle sway warning function

This function operates when all of the following conditions are met.

- Setting for "Sway Warning" in  (4.2-inch display) or  (7-inch display) of the multi-information display is set to "On". (→P. 98, 111)
- Vehicle speed is approximately 32 mph (50 km/h) or more.
- Width of traffic lane is approximately 9.8 ft. (3 m) or more.
- No system malfunctions are detected. (→P. 284)

● Lane centering function

This function operates when all of the following conditions are met.

- LTA is turned on.
- Setting for "Lane Center" in  (4.2-inch display) or  (7-inch display) of the multi-information display is set to "On". (→P. 98, 111)
- This function recognizes white (yellow) lane lines or the position of a preceding vehicle (except when the preceding vehicle is small, such as a motorcycle).

- The dynamic radar cruise control with full-speed range or dynamic radar cruise control is operating in vehicle-to-vehicle distance control mode.
- Width of traffic lane is approximately 10 to 13 ft. (3 to 4 m).
- Turn signal lever is not operated.
- Vehicle is not being driven around a sharp curve.
- No system malfunctions are detected. (→P. 284)
- Vehicle does not accelerate or decelerate by a fixed amount or more.
- Steering wheel is not operated with a steering force level suitable for changing lanes.
- ABS, VSC, TRAC and PCS are not operating.
- TRAC or VSC is not turned off.
- Hands off steering wheel warning is not displayed. (→P. 283)
- The vehicle is being driven in the center of a lane.
- Steering assist function is not operating.

■ Temporary cancelation of functions

- When operation conditions are no longer met, a function may be temporarily canceled. However, when the operation conditions are met again, operation of the function is automatically restored. (→P. 281)
- If the operation conditions (→P. 281) are no longer met while the lane centering function is operating, the buzzer may sound to indicate that the function has been temporarily canceled.

■ Steering assist function/lane centering function

- Depending on the vehicle speed, lane departure situation, road conditions, etc., the driver may not feel the function is operating or the function may not operate at all.
- The steering control of the function is overridden by the driver's steering wheel operation.
- Do not attempt to test the operation of the steering assist function.

■ Lane departure alert function

- The warning buzzer may be difficult to hear due to external noise, audio playback, etc.
- If the edge of the course* is not clear or straight, the lane departure alert function may not operate.
- Vehicle with BSM: It may not be possible for the system to determine if there is a danger of a collision with a vehicle in an adjacent lane.
- Do not attempt to test the operation of the lane departure alert function.

*: Boundary between asphalt and the side of the road, such as grass, soil, or a curb

■ Hands off steering wheel warning

In the following situations, a warning message urging the driver to hold the steering wheel and the symbol shown in the illustration are displayed on the multi-information display to warn the driver. The warning stops when the system determines that the driver holds the steering wheel. Always keep your hands on the steering wheel when using this system, regardless of warnings.



CTH45BT187

- When the system determines the driver is not holding the steering wheel while the lane centering function is operating.

If the driver continues to keep their hands off of the steering wheel, the buzzer sounds, the driver is warned and the function is temporarily canceled. This warning also operates in the same way when the driver continuously operates the steering wheel only a small amount.

- When the system determines that the vehicle may deviate from the lane while driving around a curve while the lane centering function is operating.

Depending on the vehicle condition and road conditions, the warning may not operate. Also, if the system determines that the vehicle is driving around a curve, warnings will occur earlier than during straight-lane driving.

- When the system determines that the driver is driving without holding the steering wheel while the steering wheel assist of the steering assist function is operating.

If the driver continues to keep their hands off of the steering wheel and the steering wheel assist is operating, the buzzer sounds and the driver is warned. Each time the buzzer sounds, the continuing time of the buzzer becomes longer.

■ Vehicle sway warning function

When the system determines that the vehicle is swaying while the vehicle sway warning function is operating, a buzzer sounds and a warning message urging the driver to rest and the symbol shown in the illustration are simultaneously displayed on the multi-information display.



CTH45BT188

Depending on the vehicle and road conditions, the warning may not operate.

■ **Warning message**

If the following warning message is displayed on the multi-information display and the LTA indicator illuminates in yellow, follow the appropriate troubleshooting procedure. Also, if a different warning message is displayed, follow the instructions displayed on the screen.

● “LTA Malfunction Visit Your Dealer”

The system may not be operating properly. Have the vehicle inspected by your Toyota dealer.

● “LTA Unavailable”

The system is temporarily canceled due to a malfunction in a sensor other than the front camera. Turn the LTA system off, wait for a little while, and then turn the LTA system back on.

● “LTA Unavailable at Current Speed”

The function cannot be used as the vehicle speed exceeds the LTA operation range. Drive slower.

■ **Customization**

Function settings can be changed. (→P. 103, 117)

RSA (Road Sign Assist)*

Summary of function

The RSA system recognizes specific road signs using the front camera and/or navigation system (when speed limit information is available) to provide information to the driver via the display.

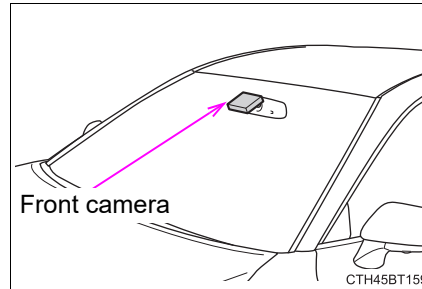

If the system judges that the vehicle is being driven over the speed limit, performing prohibited actions, etc. according to the recognized road signs, it notifies the driver through a visual notification and notification buzzer*.

*: This setting needs to be customized.

WARNING

■ Before using the RSA

Do not rely solely upon the RSA system. RSA is a system which supports the driver by providing information, but it is not a replacement for a driver's own vision and awareness. Drive safely by always paying careful attention to the traffic rules.

*: If equipped

Indication on the multi-information display

When the front camera recognizes a sign and/or information of a sign is available from the navigation system, the sign will be displayed on the multi-information display.

- When the driving assist system information is selected, a maximum of 3 signs can be displayed. (→P. 98, 111)

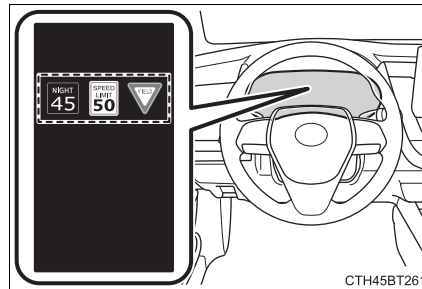

CTH45BT261

- When a tab other than the driving assist system information is selected, the following types of road signs will be displayed. (→P. 98, 111)

- Speed limit sign
- Do Not Enter sign (when notification is necessary)

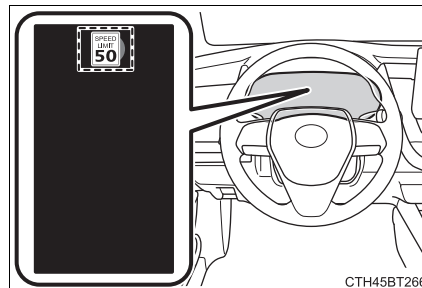

CTH45BT266

If signs other than speed limit signs are recognized, they will be displayed in an overlapping stack under the current speed limit sign.

Supported types of road signs

The following types of road signs, including electronic signs and blinking signs, are recognized.

A non-official or a recently introduced traffic sign may not be recognized.

Type	Multi-information display
Speed limit	
Do Not Enter	
Stop	
Yield	

Notification function





In the following situations, the RSA system will notify the driver.

- When the vehicle speed exceeds the speed notification threshold of the speed limit sign displayed, the sign display will be emphasized and a buzzer will sound.
- When the RSA system recognizes a do not enter sign and determines that your vehicle has entered a no-entry area, the displayed sign will flash and a buzzer will sound.





Depending on the situation, a notification function may not operate properly.

Setting procedure

▶ Vehicles with 4.2-inch multi-information display

- 1 Press < / > of the meter control switches, select .
- 2 Press ^ / v of the meter control switches, select .
- 3 Press  of the meter control switch.
Each time  is pressed, the function changes on/off.

▶ Vehicles with 7-inch multi-information display

- 1 Press ^ / v of the meter control switches, select .
- 2 Press < / > of the meter control switches, select .
- 3 Press  of the meter control switch.
Each time  is pressed, the function changes on/off.

Automatic turn-off of RSA sign display

In the following situations, a displayed speed limit sign and/or do not enter sign will stop being displayed automatically:

- No sign has been recognized for a certain distance.
- The road changes due to a left or right turn, etc.

In the following situations, stop and yield signs will stop being displayed automatically:

- The system determines that your vehicle has passed the sign.
- The road changes due to a left or right turn, etc.

■ **Conditions in which the function may not operate or detect correctly**

In the following situations, RSA does not operate normally and may not recognize signs, display the incorrect sign, etc. However, this does not indicate a malfunction.

- The front camera is misaligned due to a strong impact being applied to the sensor, etc.
- Dirt, snow, stickers, etc. are on the windshield near the front camera.
- In inclement weather such as heavy rain, fog, snow or sand storms
- Light from an oncoming vehicle, the sun, etc. enters the front camera.
- The sign is dirty, faded, tilted or bent.
- The contrast of electronic sign is low.
- All or part of the sign is hidden by the leaves of a tree, a pole, etc.
- The sign is only visible to the front camera for a short amount of time.
- The driving scene (turning, lane change, etc.) is judged incorrectly.
- If a sign not appropriate for the currently traveled lane, but the sign exists directly after a freeway branches, or in an adjacent lane just before merging.
- Stickers are attached to the rear of the preceding vehicle.
- A sign resembling a system compatible sign is recognized.
- Side road speed signs may be detected and displayed (if positioned in sight of the front camera) while the vehicle is traveling on the main road.
- Roundabout exit road speed signs may be detected and displayed (if positioned in sight of the front camera) while traveling on a roundabout.
- The front of the vehicle is raised or lowered due to the carried load
- The surrounding brightness is not sufficient or changes suddenly.
- When a sign intended for trucks, etc. is recognized.
- The navigation system map data is outdated.
- The navigation system is not operating.
- The speed information displayed on the meter and on the navigation system may be different due to the navigation system using map data.

■ **Speed limit sign display**

If the engine switch was last turned off while a speed limit sign was displayed on the multi-information display, the same sign displays again when the engine switch is turned to ON.

■ **If “Road Sign Assist System Malfunction” is shown**

The system may be malfunctioning. Have the vehicle inspected by your Toyota dealer.

■ **Customization**

Some functions can be customized. (→P. 103, 117)

Dynamic radar cruise control with full-speed range*

Summary of functions

In vehicle-to-vehicle distance control mode, the vehicle automatically accelerates, decelerates and stops to match the speed changes of the preceding vehicle even if the accelerator pedal is not depressed. In constant speed control mode, the vehicle runs at a fixed speed.

Use the dynamic radar cruise control with full-speed range on free-ways and highways.

- Vehicle-to-vehicle distance control mode (→P. 294)
- Constant speed control mode (→P. 301)

System Components

■ Meter display

- ① Multi-information display
- ② Set speed
- ③ Indicators

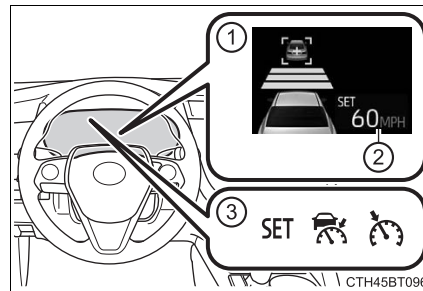

■ Operation switches

- ① Vehicle-to-vehicle distance switch
- ② "+ RES" switch
- ③ Cruise control main switch
- ④ Cancel switch
- ⑤ "- SET" switch

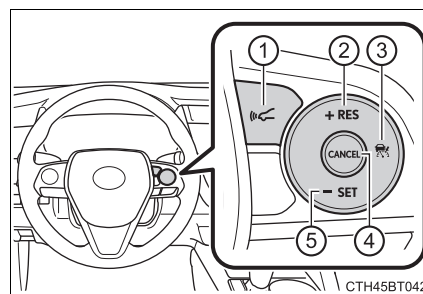

*: If equipped

 **WARNING****■ Before using dynamic radar cruise control with full-speed range**

- Driving safely is the sole responsibility of the driver. Do not rely solely on the system, and drive safely by always paying careful attention to your surroundings.
- The dynamic radar cruise control with full-speed range provides driving assistance to reduce the driver's burden. However, there are limitations to the assistance provided.
Read the following conditions carefully. Do not overly rely on this system and always drive carefully.
 - When the sensor may not be correctly detecting the vehicle ahead:
→P. 304
 - Conditions under which the vehicle-to-vehicle distance control mode may not function correctly: →P. 305
- Set the speed appropriately depending on the speed limit, traffic flow, road conditions, weather conditions, etc. The driver is responsible for checking the set speed.
- Even when the system is functioning normally, the condition of the preceding vehicle as detected by the system may differ from the condition observed by the driver. Therefore, the driver must always remain alert, assess the danger of each situation and drive safely. Relying solely on this system or assuming the system ensures safety while driving can lead to an accident, resulting in death or serious injury.
- Switch the dynamic radar cruise control with full-speed range setting to off, using the cruise control main switch when not in use.

 **WARNING****■ Cautions regarding the driving assist systems**

Observe the following precautions, as there are limitations to the assistance provided by the system.

Failure to do so may cause an accident resulting in death or serious injury.

● Assisting the driver to measure following distance

The dynamic radar cruise control with full-speed range is only intended to help the driver in determining the following distance between the driver's own vehicle and a designated vehicle traveling ahead. It is not a mechanism that allows careless or inattentive driving, and it is not a system that can assist the driver in low-visibility conditions.

It is still necessary for driver to pay close attention to the vehicle's surroundings.

● Assisting the driver to judge proper following distance

The dynamic radar cruise control with full-speed range determines whether the following distance between the driver's own vehicle and a designated vehicle traveling ahead is within a set range. It is not capable of making any other type of judgement. Therefore, it is absolutely necessary for the driver to remain vigilant and to determine whether or not there is a possibility of danger in any given situation.

● Assisting the driver to operate the vehicle

The dynamic radar cruise control with full-speed range does not include functions which will prevent or avoid collisions with vehicles ahead of your vehicle. Therefore, if there is ever any possibility of danger, the driver must take immediate and direct control of the vehicle and act appropriately in order to ensure the safety of all involved.

 **WARNING****■ Situations unsuitable for dynamic radar cruise control with full-speed range**

Do not use dynamic radar cruise control with full-speed range in any of the following situations.

Doing so may result in inappropriate speed control and could cause an accident resulting in death or serious injury.

- Roads where there are pedestrians, cyclists, etc.
- In heavy traffic
- On roads with sharp bends
- On winding roads
- On slippery roads, such as those covered with rain, ice or snow
- On steep downhills, or where there are sudden changes between sharp up and down gradients
Vehicle speed may exceed the set speed when driving down a steep hill.
- At entrances to freeways and highways
- When weather conditions are bad enough that they may prevent the sensors from detecting correctly (fog, snow, sandstorm, heavy rain, etc.)
- When there is rain, snow, etc. on the front surface of the radar or front camera
- In traffic conditions that require frequent repeated acceleration and deceleration
- During emergency towing
- When an approach warning buzzer is heard often

Driving in vehicle-to-vehicle distance control mode

This mode employs a radar to detect the presence of vehicles up to approximately 328 ft. (100 m) ahead, determines the current vehicle-to-vehicle following distance, and operates to maintain a suitable following distance from the vehicle ahead. The desired vehicle-to-vehicle distance can also be set by operating the vehicle-to-vehicle distance switch.

When driving on downhill slopes, the vehicle-to-vehicle distance may become shorter.

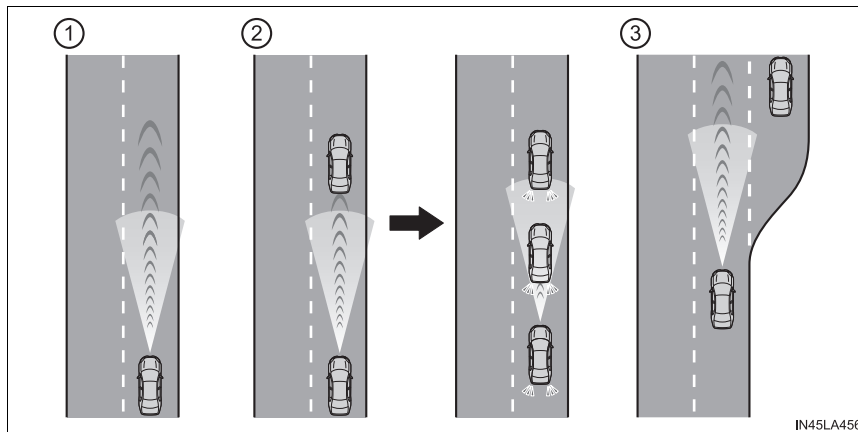

① Example of constant speed cruising

When there are no vehicles ahead

The vehicle travels at the speed set by the driver.

② Example of deceleration cruising and follow-up cruising

When a preceding vehicle driving slower than the set speed appears

When a vehicle is detected running ahead of you, the system automatically decelerates your vehicle. When a greater reduction in vehicle speed is necessary, the system applies the brakes (the stop lights will come on at this time). The system will respond to changes in the speed of the vehicle ahead in order to maintain the vehicle-to-vehicle distance set by the driver. Approach warning warns you when the system cannot decelerate sufficiently to prevent your vehicle from closing in on the vehicle ahead.

When the vehicle ahead of you stops, your vehicle will also stop (vehicle is stopped by system control). After the vehicle ahead starts off, pressing the "+ RES" switch or depressing the accelerator pedal (start-off operation) will resume follow-up cruising. If the start-off operation is not performed, system control continues to keep your vehicle stopped.

When the turn signal lever is operated and your vehicle moves to an overtaking lane while driving at 50 mph (80 km/h) or more, the vehicle will accelerate to help to overtake a passing vehicle.

The system's identification of what is an overtaking lane may be determined solely based on the location of the steering wheel in the vehicle (left side driver position versus right side driver position.) If the vehicle is driven to a region where the overtaking lane is on a different side from where the vehicle is normally driven, the vehicle may accelerate when the turn signal lever is operated in the opposite direction to the overtaking lane (e.g., if the driver normally operates the vehicle in a region where the overtaking lane is to the right but then drives to a region where the overtaking lane is to the left, the vehicle may accelerate when the right turn signal is activated).

③ Example of acceleration

When there are no longer any preceding vehicles driving slower than the set speed

The system accelerates until the set speed is reached. The system then returns to constant speed cruising.

Setting the vehicle speed (vehicle-to-vehicle distance control mode)

- 1 Press the cruise control main switch to activate the cruise control.

Dynamic radar cruise control indicator will come on and a message will be displayed on the multi-information display.

Press the switch again to deactivate the cruise control.

If the cruise control main switch is pressed and held for 1.5 seconds or more, the system turns on in constant speed control mode. (→P. 301)

- 2 Accelerate or decelerate, with accelerator pedal operation, to the desired vehicle speed (at or above approximately 20 mph [30 km/h]) and press the “- SET” switch to set the speed.

Cruise control “SET” indicator will come on.

The vehicle speed at the moment the switch is released becomes the set speed.

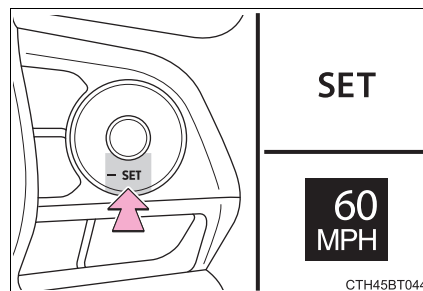
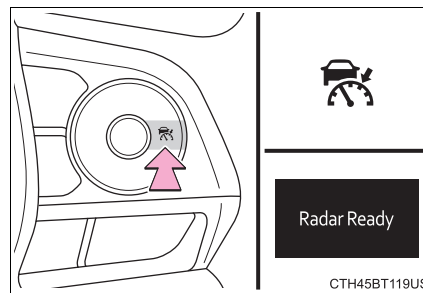

Adjusting the set speed

● Adjusting the set speed by the switch

To change the set speed, press the “+ RES” or “- SET” switch until the desired set speed is displayed.

① Increases the speed

(Except when the vehicle has been stopped by system control in vehicle-to-vehicle distance control mode)

② Decreases the speed

Fine adjustment: Press the switch.
 Large adjustment: Press and hold the switch to change the speed, and release when the desired speed is reached.

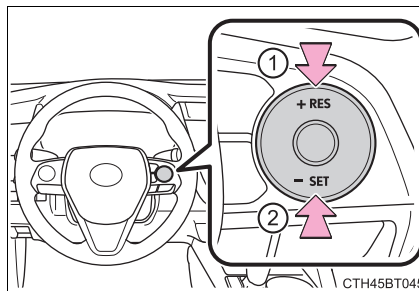

In the vehicle-to-vehicle distance control mode, the set speed will be increased or decreased as follows:

► For U.S. mainland and Hawaii

Fine adjustment: By 1 mph (1.6 km/h)^{*1} or 1 km/h (0.6 mph)^{*2} each time the switch is pressed

Large adjustment: Increases or decreases in 1 mph (1.6 km/h)^{*1} or 1 km/h (0.6 mph)^{*2} increments for as long as the switch is held

► For Canada, Guam and Puerto Rico

Fine adjustment: By 1 mph (1.6 km/h)^{*1} or 1 km/h (0.6mph)^{*2} each time the switch is pressed

Large adjustment: Increases or decreases in 5 mph (8 km/h)^{*1} or 5 km/h (3.1 mph)^{*2} increments for as long as the switch is held

In the constant speed control mode (→P. 301), the set speed will be increased or decreased as follows:

Fine adjustment: By 1 mph (1.6 km/h)^{*1} or 1 km/h (0.6 mph)^{*2} each time the switch is pressed

Large adjustment: The speed will continue to change while the switch is held.

*1: When the set speed is shown in “MPH”

*2: When the set speed is shown in “km/h”

● Increasing the set speed by the accelerator pedal

- 1 Accelerate with accelerator pedal operation to the desired vehicle speed
- 2 Press the “- SET” switch

Changing the vehicle-to-vehicle distance (vehicle-to-vehicle distance control mode)

Pressing the switch changes the vehicle-to-vehicle distance as follows:

- ① Long
- ② Medium
- ③ Short

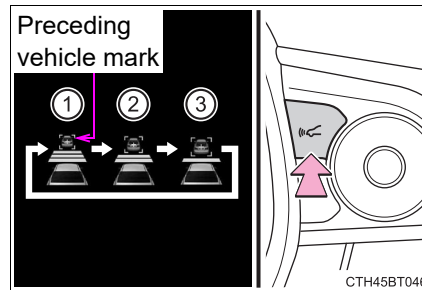

Vehicle-to-vehicle distance settings (vehicle-to-vehicle distance control mode)

Select a distance from the table below. Note that the distances shown correspond to a vehicle speed of 50 mph (80 km/h). Vehicle-to-vehicle distance increases/decreases in accordance with vehicle speed. When the vehicle is stopped by system control, the vehicle stops at a certain vehicle-to-vehicle distance depending on the situation.

Distance options	Vehicle-to-vehicle distance
Long	Approximately 160 ft. (50 m)
Medium	Approximately 130 ft. (40 m)
Short	Approximately 100 ft. (30 m)

Resuming follow-up cruising when the vehicle has been stopped by system control (vehicle-to-vehicle distance control mode)

After the vehicle ahead of you starts off, press the “+ RES” switch.

Your vehicle will also resume follow-up cruising if the accelerator pedal is depressed after the vehicle ahead of you starts off.

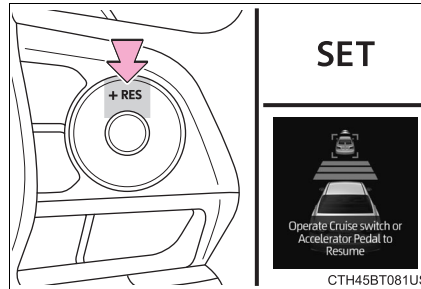

Canceling and resuming the speed control

- ① Pressing the cancel switch cancels the speed control.

The speed control is also canceled when the brake pedal is depressed.

(When the vehicle has been stopped by system control, depressing the brake pedal does not cancel the setting.)

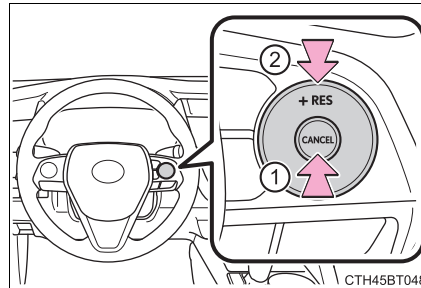

- ② Pressing the “+ RES” switch resumes the cruise control and returns vehicle speed to the set speed.

Approach warning (vehicle-to-vehicle distance control mode)

When your vehicle is too close to a vehicle ahead, and sufficient automatic deceleration via the cruise control is not possible, the display will flash and the buzzer will sound to alert the driver. An example of this would be if another driver cuts in front of you while you are following a vehicle. Depress the brake pedal to ensure an appropriate vehicle-to-vehicle distance.

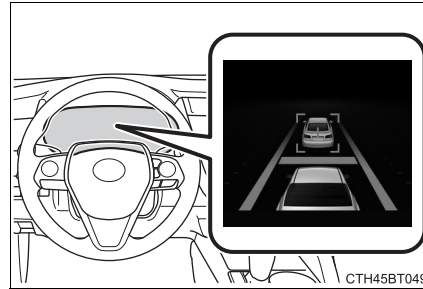

■ Warnings may not occur when

In the following instances, warnings may not occur even when the vehicle-to-vehicle distance is small.

- When the speed of the preceding vehicle matches or exceeds your vehicle speed
- When the preceding vehicle is traveling at an extremely slow speed
- Immediately after the cruise control speed was set
- When depressing the accelerator pedal

Curve speed reduction function

While driving in vehicle-to-vehicle distance control mode, this function will reduce the vehicle speed, if it is determined to be necessary.

■ Function operation

When the steering wheel begins to be turned, the vehicle speed will begin being reduced. When the steering wheel is returned to the center position, the vehicle speed reduction will end.

Depending on the situation, the vehicle speed will then return to the vehicle-to-vehicle distance control mode set speed.

In situations where vehicle-to-vehicle distance control needs to operate, such as when a preceding vehicle cuts in front of your vehicle, the curve speed reduction function will be canceled.



■ **Operation display**

Displayed when the vehicle speed is being reduced.

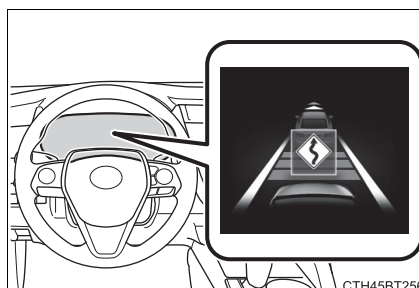
When the vehicle speed reduction ends, the display will disappear.



■ **Changing the settings of the curve speed reduction function**

The curve speed reduction function can be enabled/disabled and the vehicle speed reduction strength can be adjusted on  (4.2-inch display) or  (7-inch display) (→P. 103, 117) of the multi-information display.

The setting will change each time  of the meter control switch is pressed.

Selecting constant speed control mode

When constant speed control mode is selected, your vehicle will maintain a set speed without controlling the vehicle-to-vehicle distance. Select this mode only when vehicle-to-vehicle distance control mode does not function correctly due to a dirty radar, etc.

- 1 With the cruise control off, press and hold the cruise control main switch for 1.5 seconds or more.

Immediately after the switch is pressed, the dynamic radar cruise control indicator will come on. Afterwards, it switches to the cruise control indicator.

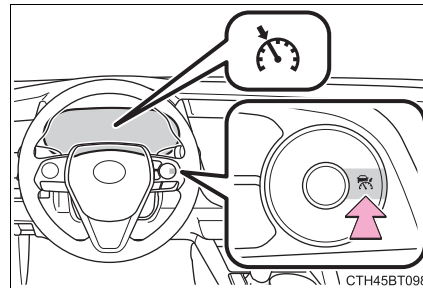

Switching to constant speed control mode is only possible when operating the switch with the cruise control off.

- 2 Accelerate or decelerate, with accelerator pedal operation, to the desired vehicle speed (at or above approximately 20 mph [30 km/h]) and press the “- SET” switch to set the speed.

Cruise control “SET” indicator will come on.

The vehicle speed at the moment the switch is released becomes the set speed.

Adjusting the speed setting: →P. 296

Canceling and resuming the speed setting: →P. 298

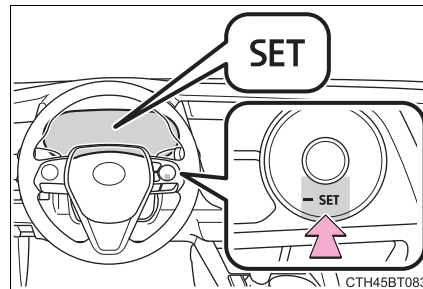

■ Dynamic radar cruise control with full-speed range can be set when

- The shift lever is in D.
- The desired set speed can be set when the vehicle speed is approximately 20 mph (30 km/h) or more.
(However, when the vehicle speed is set while driving at below approximately 20 mph [30 km/h], the set speed will be set to approximately 20 mph [30 km/h].)

■ Accelerating after setting the vehicle speed

The vehicle can accelerate by operating the accelerator pedal. After accelerating, the set speed resumes. However, during vehicle-to-vehicle distance control mode, the vehicle speed may decrease below the set speed in order to maintain the distance to the preceding vehicle.

■ When the vehicle stops while follow-up cruising

- Pressing the "+ RES" switch while the vehicle ahead stops will resume follow-up cruising if the vehicle ahead starts off within approximately 3 seconds after the switch is pressed.
- If the vehicle ahead starts off within 3 seconds after your vehicle stops, follow-up cruising will be resumed.

■ Automatic cancelation of vehicle-to-vehicle distance control mode

Vehicle-to-vehicle distance control mode is automatically canceled in the following situations:

- VSC is activated.
- TRAC is activated for a period of time.
- When the VSC or TRAC system is turned off.
- The sensor cannot detect correctly because it is covered in some way.
- When the brake control or output restriction control of a driving support system operates. (For example: Pre-Collision System, Drive-Start Control)
- The parking brake is operated.
- The vehicle is stopped by system control on a steep incline.
- The following are detected when the vehicle has been stopped by system control:
 - The driver is not wearing a seat belt.
 - The driver's door is opened.
 - The vehicle has been stopped for about 3 minutes

If vehicle-to-vehicle distance control mode is automatically canceled for any reasons other than the above, there may be a malfunction in the system. Contact your Toyota dealer.

■ Automatic cancelation of constant speed control mode

Constant speed control mode is automatically canceled in the following situations:

- Actual vehicle speed is more than approximately 10 mph (16 km/h) below the set vehicle speed.
- Actual vehicle speed falls below approximately 20 mph (30 km/h).
- VSC is activated.
- TRAC is activated for a period of time.
- When the VSC or TRAC system is turned off.
- When the brake control or output restriction control of a driving support system operates. (For example: Pre-Collision System, Drive-Start Control)
- The parking brake is operated.

If constant speed control mode is automatically canceled for any reasons other than the above, there may be a malfunction in the system. Contact your Toyota dealer.

■ Situations in which the curve speed reduction function may not operate

In situations such as the following, the curve speed reduction function may not operate:

- When the vehicle is being driven around a gentle curve
- When the accelerator pedal is being depressed
- When the vehicle is being driven around an extremely short curve

■ Brake operation

A brake operation sound may be heard and the brake pedal response may change, but these are not malfunctions.

■ Warning messages and buzzers for dynamic radar cruise control with full-speed range

Warning messages and buzzers are used to indicate a system malfunction or to inform the driver of the need for caution while driving. If a warning message is shown on the multi-information display, read the message and follow the instructions. (→P. 252, 538)

■ **When the sensor may not be correctly detecting the vehicle ahead**

In the case of the following and depending on the conditions, operate the brake pedal when deceleration of the system is insufficient or operate the accelerator pedal when acceleration is required.

As the sensor may not be able to correctly detect these types of vehicles, the approach warning (→P. 299) may not be activated.

- Vehicles that cut in suddenly
- Vehicles traveling at low speeds
- Vehicles that are not moving in the same lane
- Vehicles with small rear ends (trailers with no load on board, etc.)

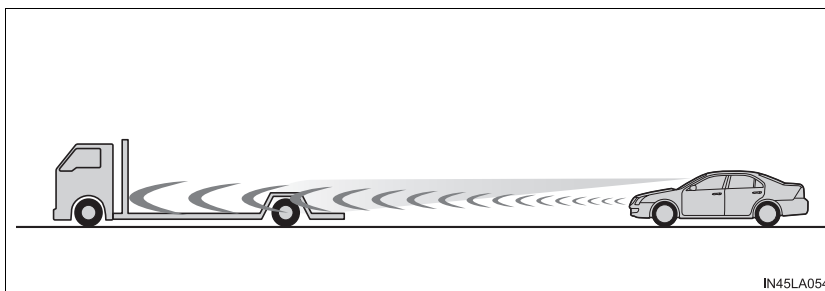

- Motorcycles traveling in the same lane
- When water or snow thrown up by the surrounding vehicles hinders the detecting of the sensor
- When your vehicle is pointing upwards (caused by a heavy load in the luggage compartment, etc.)

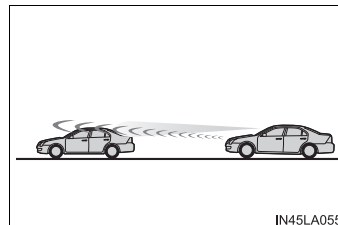

- Preceding vehicle has an extremely high ground clearance

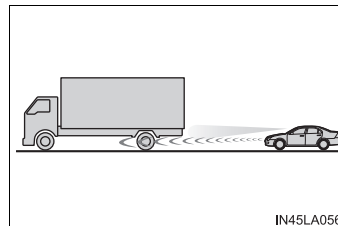

■ **Conditions under which the vehicle-to-vehicle distance control mode may not function correctly**

In the case of the following conditions, operate the brake pedal (or accelerator pedal, depending on the situation) as necessary.

As the sensor may not be able to correctly detect vehicles ahead, the system may not operate properly.

- When the road curves or when the lanes are narrow

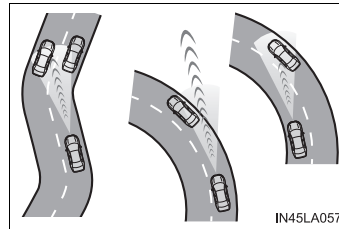

- When steering wheel operation or your position in the lane is unstable

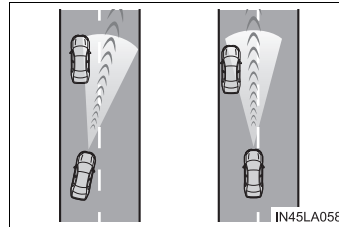

- When the vehicle ahead of you decelerates suddenly
- When driving on a road surrounded by a structure, such as in a tunnel or on a bridge
- While the vehicle speed is decreasing to the set speed after the vehicle accelerates by depressing the accelerator pedal

■ **Situations in which the curve speed reduction function may not operate properly**

In situations such as the following, the curve speed reduction function may not operate properly:

- When the vehicle is being driven around a curve on an incline/decline
- When the course of the vehicle differs from the shape of the curve
- When the vehicle speed is excessively high when entering a curve
- When the steering wheel is suddenly operated

Dynamic radar cruise control*

Summary of functions

In vehicle-to-vehicle distance control mode, the vehicle automatically accelerates and decelerates to match the speed changes of the preceding vehicle even if the accelerator pedal is not depressed. In constant speed control mode, the vehicle runs at a fixed speed.

Use the dynamic radar cruise control on freeways and highways.

- Vehicle-to-vehicle distance control mode (→P. 310)
- Constant speed control mode (→P. 317)

System Components

■ Meter display

- ① Multi-information display
- ② Set speed
- ③ Indicators

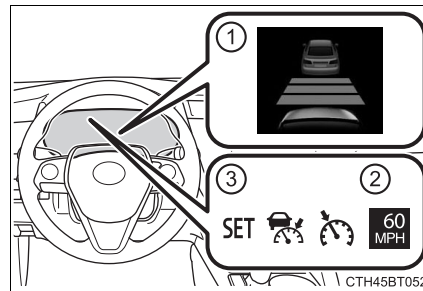

■ Operation switches

- ① Vehicle-to-vehicle distance switch
- ② "+ RES" switch
- ③ Cruise control main switch
- ④ Cancel switch
- ⑤ "- SET" switch

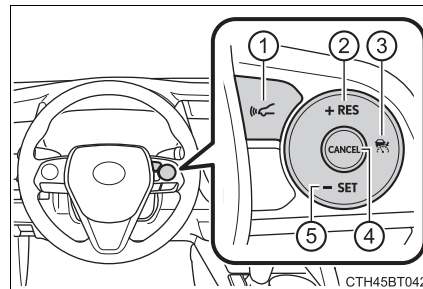

*: If equipped

 **WARNING****■ Before using dynamic radar cruise control**

- Driving safely is the sole responsibility of the driver. Do not rely solely on the system, and drive safely by always paying careful attention to your surroundings.
- The dynamic radar cruise control provides driving assistance to reduce the driver's burden. However, there are limitations to the assistance provided. Read the following conditions carefully. Do not overly rely on this system and always drive carefully.
 - When the sensor may not be correctly detecting the vehicle ahead:
→P. 320
 - Conditions under which the vehicle-to-vehicle distance control mode may not function correctly: →P. 321
- Set the speed appropriately depending on the speed limit, traffic flow, road conditions, weather conditions, etc. The driver is responsible for checking the set speed.
- Even when the system is functioning normally, the condition of the preceding vehicle as detected by the system may differ from the condition observed by the driver. Therefore, the driver must always remain alert, assess the danger of each situation and drive safely. Relying solely on this system or assuming the system ensures safety while driving can lead to an accident, resulting in death or serious injury.
- Switch the dynamic radar cruise control setting to off, using the cruise control main switch when not in use.

 **WARNING****■ Cautions regarding the driving assist systems**

Observe the following precautions, as there are limitations to the assistance provided by the system.

Failure to do so may cause an accident resulting in death or serious injury.

● Assisting the driver to measure following distance

The dynamic radar cruise control is only intended to help the driver in determining the following distance between the driver's own vehicle and a designated vehicle traveling ahead. It is not a mechanism that allows careless or inattentive driving, and it is not a system that can assist the driver in low-visibility conditions.

It is still necessary for driver to pay close attention to the vehicle's surroundings.

● Assisting the driver to judge proper following distance

The dynamic radar cruise control determines whether the following distance between the driver's own vehicle and a designated vehicle traveling ahead is within a set range. It is not capable of making any other type of judgement. Therefore, it is absolutely necessary for the driver to remain vigilant and to determine whether or not there is a possibility of danger in any given situation.

● Assisting the driver to operate the vehicle

The dynamic radar cruise control does not include functions which will prevent or avoid collisions with vehicles ahead of your vehicle. Therefore, if there is ever any possibility of danger, the driver must take immediate and direct control of the vehicle and act appropriately in order to ensure the safety of all involved.

 **WARNING****■ Situations unsuitable for dynamic radar cruise control**

Do not use dynamic radar cruise control in any of the following situations. Doing so may result in inappropriate speed control and could cause an accident resulting in death or serious injury.

- Roads where there are pedestrians, cyclists, etc.
- In heavy traffic
- On roads with sharp bends
- On winding roads
- On slippery roads, such as those covered with rain, ice or snow
- On steep downhill, or where there are sudden changes between sharp up and down gradients
Vehicle speed may exceed the set speed when driving down a steep hill.
- At entrances to freeways and highways
- When weather conditions are bad enough that they may prevent the sensors from detecting correctly (fog, snow, sandstorm, heavy rain, etc.)
- When there is rain, snow, etc. on the front surface of the radar or front camera
- In traffic conditions that require frequent repeated acceleration and deceleration
- During emergency towing
- When an approach warning buzzer is heard often

Driving in vehicle-to-vehicle distance control mode

This mode employs a radar to detect the presence of vehicles up to approximately 328 ft. (100 m) ahead, determines the current vehicle-to-vehicle following distance, and operates to maintain a suitable following distance from the vehicle ahead. The desired vehicle-to-vehicle distance can also be set by operating the vehicle-to-vehicle distance switch.

When driving on downhill slopes, the vehicle-to-vehicle distance may become shorter.

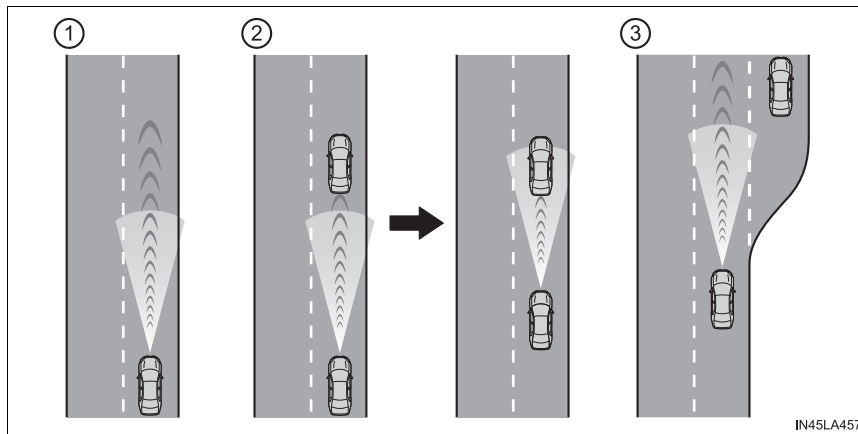

- ① Example of constant speed cruising
When there are no vehicles ahead
The vehicle travels at the speed set by the driver.

- ② Example of deceleration cruising and follow-up cruising
When a preceding vehicle driving slower than the set speed appears

When a vehicle is detected running ahead of you, the system automatically decelerates your vehicle. When a greater reduction in vehicle speed is necessary, the system applies the brakes (the stop lights will come on at this time). The system will respond to changes in the speed of the vehicle ahead in order to maintain the vehicle-to-vehicle distance set by the driver. Approach warning warns you when the system cannot decelerate sufficiently to prevent your vehicle from closing in on the vehicle ahead.

When the turn signal lever is operated and your vehicle moves to an overtaking lane while driving at 50 mph (80 km/h) or more, the vehicle will accelerate to help to overtake a passing vehicle.

The system's identification of what is an overtaking lane may be determined solely based on the location of the steering wheel in the vehicle (left side driver position versus right side driver position.) If the vehicle is driven to a region where the overtaking lane is on a different side from where the vehicle is normally driven, the vehicle may accelerate when the turn signal lever is operated in the opposite direction to the overtaking lane (e.g., if the driver normally operates the vehicle in a region where the overtaking lane is to the right but then drives to a region where the overtaking lane is to the left, the vehicle may accelerate when the right turn signal is activated).

- ③ Example of acceleration
When there are no longer any preceding vehicles driving slower than the set speed

The system accelerates until the set speed is reached. The system then returns to constant speed cruising.

Setting the vehicle speed (vehicle-to-vehicle distance control mode)

- 1 Press the cruise control main switch to activate the cruise control.

Dynamic radar cruise control indicator will come on and a message will be displayed on the multi-information display.

Press the switch again to deactivate the cruise control.

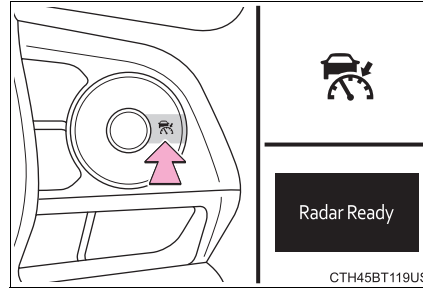

If the cruise control main switch is pressed and held for 1.5 seconds or more, the system turns on in constant speed control mode. (→P. 317)

- 2 Accelerate or decelerate, with accelerator pedal operation, to the desired vehicle speed (at or above approximately 20 mph [30 km/h]) and press the “-SET” switch to set the speed.

Cruise control “SET” indicator will come on.

The vehicle speed at the moment the switch is released becomes the set speed.

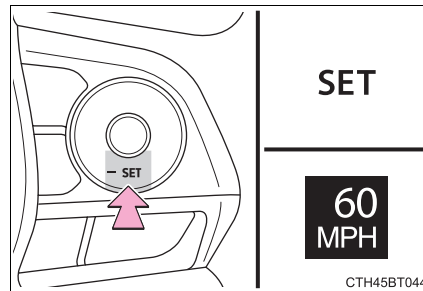

Adjusting the set speed

● Adjusting the set speed by the switch

To change the set speed, press the “+ RES” or “- SET” switch until the desired set speed is displayed.

① Increases the speed

② Decreases the speed

Fine adjustment: Press the switch.

Large adjustment: Press and hold the switch to change the speed, and release when the desired speed is reached.

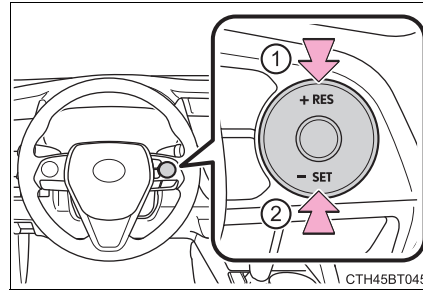

In the vehicle-to-vehicle distance control mode, the set speed will be increased or decreased as follows:

► For U.S. mainland and Hawaii

Fine adjustment: By 1 mph (1.6 km/h)^{*1} or 1 km/h (0.6 mph)^{*2} each time the switch is pressed

Large adjustment: Increases or decreases in 1 mph (1.6 km/h)^{*1} or 1 km/h (0.6 mph)^{*2} increments for as long as the switch is held

► For Canada, Guam and Puerto Rico

Fine adjustment: By 1 mph (1.6 km/h)^{*1} or 1 km/h (0.6 mph)^{*2} each time the switch is pressed

Large adjustment: Increases or decreases in 5 mph (8 km/h)^{*1} or 5 km/h (3.1 mph)^{*2} increments for as long as the switch is held

In the constant speed control mode (→P. 317), the set speed will be increased or decreased as follows:

Fine adjustment: By 1 mph (1.6 km/h)^{*1} or 1 km/h (0.6 mph)^{*2} each time the switch is pressed

Large adjustment: The speed will continue to change while the switch is held.

*1: When the set speed is shown in “MPH”

*2: When the set speed is shown in “km/h”

● Increasing the set speed by the accelerator pedal

① Accelerate with accelerator pedal operation to the desired vehicle speed

② Press the “- SET” switch

Changing the vehicle-to-vehicle distance (vehicle-to-vehicle distance control mode)

Pressing the switch changes the vehicle-to-vehicle distance as follows:

- ① Long
- ② Medium
- ③ Short

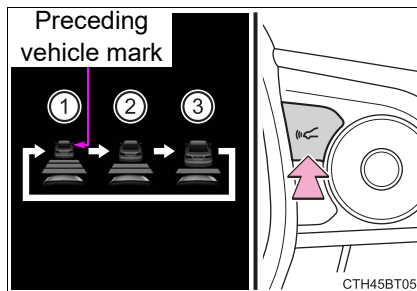

Vehicle-to-vehicle distance settings (vehicle-to-vehicle distance control mode)

Select a distance from the table below. Note that the distances shown correspond to a vehicle speed of 50 mph (80 km/h). Vehicle-to-vehicle distance increases/decreases in accordance with vehicle speed.

Distance options	Vehicle-to-vehicle distance
Long	Approximately 160 ft. (50 m)
Medium	Approximately 130 ft. (40 m)
Short	Approximately 100 ft. (30 m)

Canceling and resuming the speed control

- ① Pressing the cancel switch cancels the speed control.

The speed control is also canceled when the brake pedal is depressed.

- ② Pressing the "+ RES" switch resumes the cruise control and returns vehicle speed to the set speed.

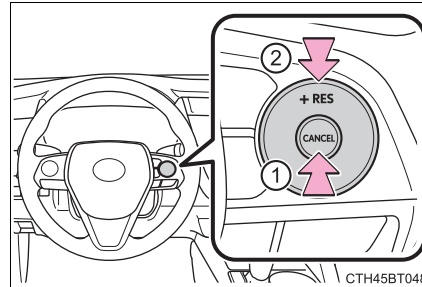

However, cruise control does not resume when the vehicle speed is approximately 16 mph (25 km/h) or less.

Approach warning (vehicle-to-vehicle distance control mode)

When your vehicle is too close to a vehicle ahead, and sufficient automatic deceleration via the cruise control is not possible, the display will flash and the buzzer will sound to alert the driver. An example of this would be if another driver cuts in front of you while you are following a vehicle. Depress the brake pedal to ensure an appropriate vehicle-to-vehicle distance.

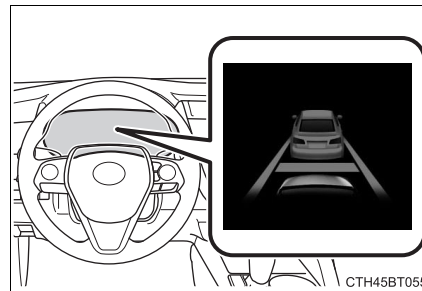

■ Warnings may not occur when

In the following instances, warnings may not occur even when the vehicle-to-vehicle distance is small.

- When the speed of the preceding vehicle matches or exceeds your vehicle speed
- When the preceding vehicle is traveling at an extremely slow speed
- Immediately after the cruise control speed was set
- When depressing the accelerator pedal

Curve speed reduction function

While driving in vehicle-to-vehicle distance control mode, this function will reduce the vehicle speed, if it is determined to be necessary.

■ Function operation

When the steering wheel begins to be turned, the vehicle speed will begin being reduced. When the steering wheel is returned to the center position, the vehicle speed reduction will end.

Depending on the situation, the vehicle speed will then return to the vehicle-to-vehicle distance control mode set speed.

In situations where vehicle-to-vehicle distance control needs to operate, such as when a preceding vehicle cuts in front of your vehicle, the curve speed reduction function will be canceled.



■ Operation display

Displayed when the vehicle speed is being reduced.

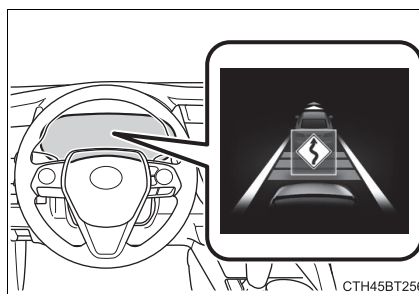
When the vehicle speed reduction ends, the display will disappear.



■ Changing the settings of the curve speed reduction function

The curve speed reduction function can be enabled/disabled and the vehicle speed reduction strength can be adjusted on  (4.2-inch display) or  (7-inch display) (→P. 103, 117) of the multi-information display.

The setting will change each time  of the meter control switch is pressed.

Selecting constant speed control mode

When constant speed control mode is selected, your vehicle will maintain a set speed without controlling the vehicle-to-vehicle distance. Select this mode only when vehicle-to-vehicle distance control mode does not function correctly due to a dirty radar, etc.

- 1 With the cruise control off, press and hold the cruise control main switch for 1.5 seconds or more.

Immediately after the switch is pressed, the dynamic radar cruise control indicator will come on. Afterwards, it switches to the cruise control indicator.

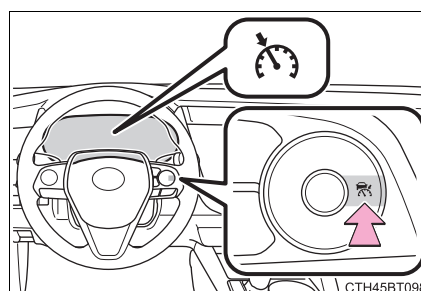

Switching to constant speed control mode is only possible when operating the switch with the cruise control off.

- 2 Accelerate or decelerate, with accelerator pedal operation, to the desired vehicle speed (at or above approximately 20 mph [30 km/h]) and press the “-SET” switch to set the speed.

Cruise control “SET” indicator will come on.

The vehicle speed at the moment the switch is released becomes the set speed.

Adjusting the speed setting: →P. 313

Canceling and resuming the speed setting: →P. 315

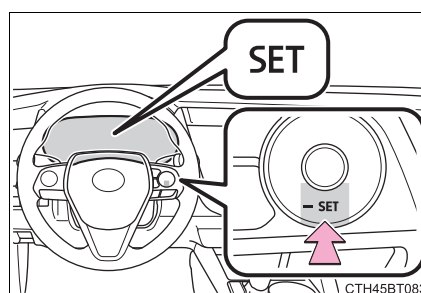

■ Dynamic radar cruise control can be set when

- The shift lever is in D.
- Depending on the control mode, this item can be set at the following speeds.
 - Vehicle-to-vehicle distance control mode: Approximately 20 mph (30 km/h) or more
 - Constant speed control mode: Approximately 20 mph (30 km/h) or more

■ Accelerating after setting the vehicle speed

The vehicle can accelerate by operating the accelerator pedal. After accelerating, the set speed resumes. However, during vehicle-to-vehicle distance control mode, the vehicle speed may decrease below the set speed in order to maintain the distance to the preceding vehicle.

■ Automatic cancelation of vehicle-to-vehicle distance control mode

Vehicle-to-vehicle distance control mode is automatically canceled in the following situations:

- Actual vehicle speed falls below approximately 16 mph (25 km/h).
- VSC is activated.
- TRAC is activated for a period of time.
- When the VSC or TRAC system is turned off.
- The sensor cannot detect correctly because it is covered in some way.
- When the brake control or output restriction control of a driving support system operates. (For example: Pre-Collision System, Drive-Start Control)
- The parking brake is operated.

If vehicle-to-vehicle distance control mode is automatically canceled for any reasons other than the above, there may be a malfunction in the system. Contact your Toyota dealer.

■ Automatic cancelation of constant speed control mode

Constant speed control mode is automatically canceled in the following situations:

- Actual vehicle speed is more than approximately 10 mph (16 km/h) below the set vehicle speed.
- Actual vehicle speed falls below approximately 20 mph (30 km/h).
- VSC is activated.
- TRAC is activated for a period of time.
- When the VSC or TRAC system is turned off.
- When the brake control or output restriction control of a driving support system operates. (For example: Pre-Collision System, Drive-Start Control)
- The parking brake is operated.

If constant speed control mode is automatically canceled for any reasons other than the above, there may be a malfunction in the system. Contact your Toyota dealer.

■ Situations in which the curve speed reduction function may not operate

In situations such as the following, the curve speed reduction function may not operate:

- When the vehicle is being driven around a gentle curve
- When the accelerator pedal is being depressed
- When the vehicle is being driven around an extremely short curve

■ Brake operation

A brake operation sound may be heard and the brake pedal response may change, but these are not malfunctions.

■ Warning messages and buzzers for dynamic radar cruise control

Warning messages and buzzers are used to indicate a system malfunction or to inform the driver of the need for caution while driving. If a warning message is shown on the multi-information display, read the message and follow the instructions. (→P. 252, 538)

■ **When the sensor may not be correctly detecting the vehicle ahead**

In the case of the following and depending on the conditions, operate the brake pedal when deceleration of the system is insufficient or operate the accelerator pedal when acceleration is required.

As the sensor may not be able to correctly detect these types of vehicles, the approach warning (→P. 315) may not be activated.

- Vehicles that cut in suddenly
- Vehicles traveling at low speeds
- Vehicles that are not moving in the same lane
- Vehicles with small rear ends (trailers with no load on board, etc.)

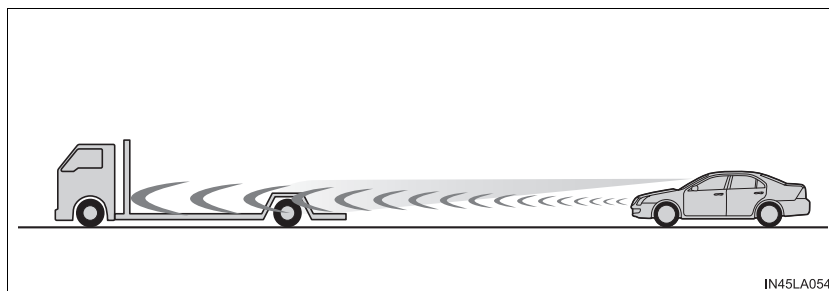

- Motorcycles traveling in the same lane
- When water or snow thrown up by the surrounding vehicles hinders the detecting of the sensor
- When your vehicle is pointing upwards (caused by a heavy load in the luggage compartment, etc.)

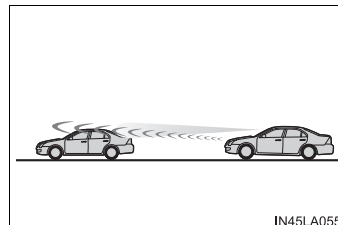

- Preceding vehicle has an extremely high ground clearance

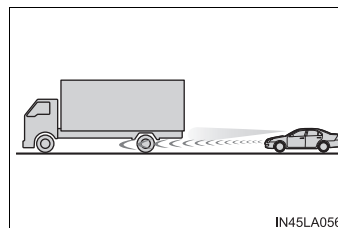

■ **Conditions under which the vehicle-to-vehicle distance control mode may not function correctly**

In the case of the following conditions, operate the brake pedal (or accelerator pedal, depending on the situation) as necessary.

As the sensor may not be able to correctly detect vehicles ahead, the system may not operate properly.

- When the road curves or when the lanes are narrow

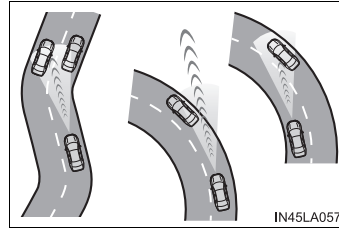

- When steering wheel operation or your position in the lane is unstable

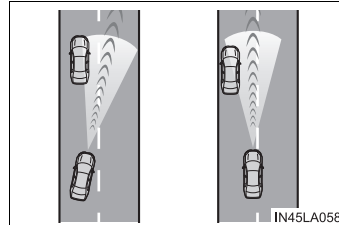

- When the vehicle ahead of you decelerates suddenly
- When driving on a road surrounded by a structure, such as in a tunnel or on a bridge
- While the vehicle speed is decreasing to the set speed after the vehicle accelerates by depressing the accelerator pedal

■ **Situations in which the curve speed reduction function may not operate properly**

In situations such as the following, the curve speed reduction function may not operate properly:

- When the vehicle is being driven around a curve on an incline/decline
- When the course of the vehicle differs from the shape of the curve
- When the vehicle speed is excessively high when entering a curve
- When the steering wheel is suddenly operated

Driving assist systems

To keep driving safety and performance, the following systems operate automatically in response to various driving situations. Be aware, however, that these systems are supplementary and should not be relied upon too heavily when operating the vehicle.

◆ ABS (Anti-lock Brake System)

Helps to prevent wheel lock when the brakes are applied suddenly, or if the brakes are applied while driving on a slippery road surface

◆ Brake assist

Generates an increased level of braking force after the brake pedal is depressed when the system detects a panic stop situation

◆ VSC (Vehicle Stability Control)

Helps the driver to control skidding when swerving suddenly or turning on slippery road surfaces.

◆ Enhanced VSC (Enhanced Vehicle Stability Control)

Provides cooperative control of the ABS, TRAC, VSC and EPS. Helps to maintain directional stability when swerving on slippery road surfaces by controlling steering performance.

◆ Secondary Collision Brake

When the airbag sensor detects a collision and the system operates, the brakes and stop lights are automatically controlled to reduce the vehicle speed and help reduce the possibility of further damage due to a secondary collision

◆ TRAC (Traction Control)

Helps to maintain drive power and prevent the drive wheels from spinning when starting the vehicle or accelerating on slippery roads

◆ Active Cornering Assist (ACA) (if equipped)

Helps to prevent the vehicle from sliding to the outer side by performing inner wheel brake control when attempting to accelerate while turning

◆ Hill-start assist control

Helps to reduce the backward movement of the vehicle when starting on an uphill

◆ EPS (Electric Power Steering)

Employs an electric motor to reduce the amount of effort needed to turn the steering wheel

◆ BSM (Blind Spot Monitor) (if equipped)

→P. 330

◆ Dynamic Torque Control AWD system (if equipped)

Automatically switches from front-wheel drive to all-wheel drive (AWD) according to the driving conditions, helping to ensure reliable handling and stability. Examples of conditions where the system will switch to AWD are when cornering, going uphill, starting off or accelerating, and when the road surface is slippery due to snow, rain, etc.

When the TRAC/VSC systems are operating

The slip indicator light will flash while the TRAC/VSC systems are operating.

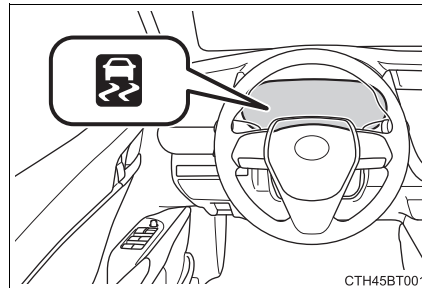

Disabling the TRAC system

If the vehicle gets stuck in mud, dirt or snow, the TRAC system may reduce power from the engine to the wheels. Pressing  to turn the system off may make it easier for you to rock the vehicle in order to free it.

To turn the TRAC system off, quickly press and release .

“Traction Control Turned Off” will be shown on the multi-information display.

Press  again to turn the system back on.

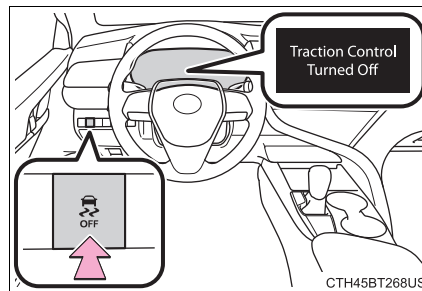

■ Turning off both TRAC and VSC systems

To turn the TRAC and VSC systems off, press and hold  for more than 3 seconds while the vehicle is stopped.

The VSC OFF indicator light will come on and the “Traction Control Turned Off” will be shown on the multi-information display*.

Press  again to turn the systems back on.

*: PCS (Pre-Collision System) will also be disabled (only Pre-Collision warning is available). The pre-collision system warning light will come on and the message will be shown on the multi-information display. (→P. 269)

■ When the message is displayed on the multi-information display showing that TRAC has been disabled even if has not been pressed

TRAC is temporary deactivated. If the information continues to show, contact your Toyota dealer.

■ Operating conditions of hill-start assist control

When the following four conditions are met, the hill-start assist control will operate:

- The shift lever is in a position other than P or N (when starting off forward/backward on an upward incline)
- The vehicle is stopped
- The accelerator pedal is not depressed
- The parking brake is not engaged

■ Automatic system cancelation of hill-start assist control

The hill-start assist control will turn off in any of the following situations:

- The shift lever is shifted to P or N
- The accelerator pedal is depressed
- The parking brake is engaged
- 2 seconds at maximum elapsed after the brake pedal is released

■ Sounds and vibrations caused by the ABS, brake assist, VSC, TRAC and hill-start assist control systems

- A sound may be heard from the engine compartment when the brake pedal is depressed repeatedly, when the engine is started or just after the vehicle begins to move. This sound does not indicate that a malfunction has occurred in any of these systems.
- Any of the following conditions may occur when the above systems are operating. None of these indicates that a malfunction has occurred.
 - Vibrations may be felt through the vehicle body and steering.
 - A motor sound may be heard also after the vehicle comes to a stop.
 - The brake pedal may pulsate slightly after the ABS is activated.
 - The brake pedal may move down slightly after the ABS is activated.

■ Active Cornering Assist operation sounds and vibrations

When the Active Cornering Assist is operated, operation sounds and vibrations may be generated from the brake system, but this is not a malfunction.

■ Automatic reactivation of TRAC and VSC systems

After turning the TRAC and VSC systems off, the systems will be automatically re-enabled in the following situations:

- When the engine switch is turned off
 - If only the TRAC system is turned off, the TRAC will turn on when vehicle speed increases
- If both the TRAC and VSC systems are turned off, automatic re-enabling will not occur when vehicle speed increases.

■ Operating conditions of Active Cornering Assist

The system operates when the following occurs.

- TRAC/VSC can operate
- The driver is attempting to accelerate while turning
- The system detects that the vehicle is sliding to the outer side
- The brake pedal is released

■ Secondary Collision Brake operating conditions

The system operates when the SRS airbag sensor detects a collision while the vehicle is in motion.

However, the system does not operate in any of the following situations.

- The vehicle speed is below 6 mph (10 km/h)
- Components are damaged

■ Secondary Collision Brake automatic cancellation

The Secondary Collision Brake is automatically canceled in the following situations:

- The vehicle speed drops below approximately 6 mph (10 km/h)
- A certain amount of time elapses during operation
- The accelerator pedal is depressed a large amount

■ Reduced effectiveness of the EPS system

The effectiveness of the EPS system is reduced to prevent the system from overheating when there is frequent steering input over an extended period of time. The steering wheel may feel heavy as a result.

Should this occur, refrain from excessive steering input or stop the vehicle and turn the engine off. The EPS system should return to normal within 10 minutes.

■ If a message about AWD is shown on the multi-information display

Perform the following actions.

Message	Details/Actions
“AWD System Overheated Switching to 2WD Mode”	<p>AWD system is overheating. → Perform the following actions.</p> <ul style="list-style-type: none"> • Reduce the vehicle speed until the message disappears. • Stop the vehicle in a safe place and let the engine idle. <p>Once the display message on the multi-information display turns off, there is no problem continuing to drive. If the message does not disappear, have your vehicle checked by your Toyota dealer immediately.</p>
“AWD System Overheated 2WD Mode Engaged”	<p>The vehicle switched from all-wheel drive (AWD) to front wheel drive due to overheating. → Perform the following actions.</p> <ul style="list-style-type: none"> • Reduce the vehicle speed until the message disappears. • Stop the vehicle in a safe place and let the engine idle. <p>Once the display message on the multi-information display turns off, the AWD system returns to normal. If the message does not disappear, have your vehicle checked by your Toyota dealer immediately.</p>
“AWD System Malfunction 2WD Mode Engaged Visit Your Dealer”	<p>A malfunction occurred in the AWD system. → Have your vehicle checked by your Toyota dealer immediately.</p>

 **WARNING****■ The ABS does not operate effectively when**

- The limits of tire gripping performance have been exceeded (such as excessively worn tires on a snow covered road).
- The vehicle hydroplanes while driving at high speed on wet or slick roads.

■ Stopping distance when the ABS is operating may exceed that of normal conditions

The ABS is not designed to shorten the vehicle's stopping distance. Always maintain a safe distance from the vehicle in front of you, especially in the following situations:

- When driving on dirt, gravel or snow-covered roads
- When driving with tire chains
- When driving over bumps on the road
- When driving over roads with potholes or uneven surfaces

■ TRAC/VSC may not operate effectively when

Directional control and power may not be achievable while driving on slippery road surfaces, even if the TRAC/VSC system is operating.

Drive the vehicle carefully in conditions where stability and power may be lost.

■ Active Cornering Assist does not operate effectively when

- Do not overly rely on Active Cornering Assist. Active Cornering Assist may not operate effectively when accelerating down slopes or driving on slippery road surfaces.
- When Active Cornering Assist frequently operates, Active Cornering Assist may temporarily stop operating to ensure proper operation of the brakes, TRAC and VSC.

 **WARNING****■ Hill- start assist control does not operate effectively when**

- Do not overly rely on hill-start assist control. Hill-start assist control may not operate effectively on steep inclines and roads covered with ice.
- Unlike the parking brake, hill-start assist control is not intended to hold the vehicle stationary for an extended period of time. Do not attempt to use hill-start assist control to hold the vehicle on an incline, as doing so may lead to an accident.

■ When the TRAC/VSC is activated

The slip indicator light flashes. Always drive carefully. Reckless driving may cause an accident. Exercise particular care when the indicator light flashes.

■ When the TRAC/VSC systems are turned off

Be especially careful and drive at a speed appropriate to the road conditions. As these are the systems to help ensure vehicle stability and driving force, do not turn the TRAC/VSC systems off unless necessary.

■ Secondary Collision Brake

Do not overly rely solely upon the Secondary Collision Brake. This system is designed to help reduce the possibility of further damage due to a secondary collision, however, that effect changes according to various conditions. Overly relying on the system may result in death or serious injury.

■ Replacing tires

Make sure that all tires are of the specified size, brand, tread pattern and total load capacity. In addition, make sure that the tires are inflated to the recommended tire inflation pressure level.

The ABS, TRAC and VSC systems will not function correctly if different tires are installed on the vehicle.

Contact your Toyota dealer for further information when replacing tires or wheels.

■ Handling of tires and the suspension

Using tires with any kind of problem or modifying the suspension will affect the driving assist systems, and may cause a system to malfunction.

BSM (Blind Spot Monitor)*

The Blind Spot Monitor is a system that uses rear side radar sensors installed on the inner side of the rear bumper on the left and right side to assist the driver in confirming safety when changing lanes.

System components

- ① Multi-information display
Turning the BSM function on/off.
(→P. 331)
- ② Outside rear view mirror indicators
When a vehicle is detected in a blind spot of the outside rear view mirrors or approaching rapidly from behind into a blind spot, the outside rear view mirror indicator on the detected side will illuminate. If the turn signal lever is operated toward the detected side, the outside rear view mirror indicator flashes.
- ③ “BSM” indicator
When the BSM function is turned on, the indicator illuminates.

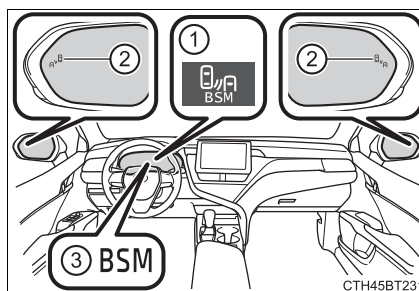

*: If equipped

Turning the BSM function on/off

▶ Vehicles with 4.2-inch multi-information display

- 1 Press / of the meter control switches, select .
- 2 Press / of the meter control switches, select .
- 3 Press of the meter control switch.
Each time is pressed, the function changes on/off.

▶ Vehicles with 7-inch multi-information display

- 1 Press / of the meter control switches, select .
- 2 Press / of the meter control switches, select .
- 3 Press of the meter control switch.
Each time is pressed, the function changes on/off.

Setting the outside rear view mirror indicator brightness

The brightness of the indicators on the outside rear view mirrors can be changed on (4.2-inch display) or (7-inch display) (→P. 106, 119) of the multi-information display.

■ The outside rear view mirror indicators visibility

When under strong sunlight, the outside rear view mirror indicator may be difficult to see.

■ When “Blind Spot Monitor Unavailable” is shown on the multi-information display

Ice, snow, mud, etc., may be attached to the rear bumper around the sensors. (→P. 332)

The system should return to normal operation after removing the ice, snow, mud, etc. from the rear bumper.

Additionally, the sensors may not operate normally when driving in extremely hot or cold environments.

■ When there is a malfunction in the Blind Spot Monitor

If a system malfunction is detected due to any of the following reasons, a warning message will be displayed:

- There is a malfunction with the sensors
- The sensors have become dirty
- The outside temperature is extremely high or low
- The sensor voltage has become abnormal

⚠ WARNING**■ To ensure the system can operate properly**

Blind Spot Monitor sensors are installed behind the left and right sides of the rear bumper respectively. Observe the following to ensure the Blind Spot Monitor can function correctly.

- Keep the sensor and its surrounding area on the bumper clean at all times. If a sensor or its surrounding area on the rear bumper is dirty or covered with snow, the Blind Spot Monitor may not operate and a warning message (→P. 331) will be displayed.

In this situation, clear off the dirt or snow and drive the vehicle with the operation conditions of the BSM function (→P. 334) satisfied for approximately 10 minutes.

If the warning message does not disappear, have the vehicle inspected by your Toyota dealer

- Do not subject a sensor or its surrounding area on the rear bumper to a strong impact.

If a sensor is moved even slightly off position, the system may malfunction and vehicles may not be detected correctly.

In the following situations, have your vehicle inspected by your Toyota dealer.

- A sensor or its surrounding area is subject to a strong impact.
- If the surrounding area of a sensor is scratched or dented, or part of them has become disconnected.

- Do not disassemble the sensor.
- Do not attach accessories or stickers to the sensor or surrounding area on the bumper.
- Do not modify the sensor or surrounding area on the bumper.
- If a sensor or the rear bumper needs to be removed/installed or replaced, contact your Toyota dealer.
- Do not paint the rear bumper any color other than an official Toyota color.

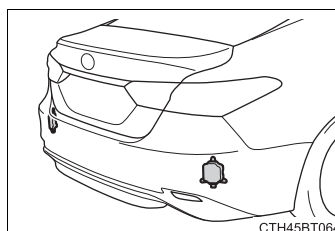

BSM function

The BSM function uses radar sensors to detect the following vehicles traveling in an adjacent lane in the area that is usually not reflected in the outside rear view mirror (the blind spot), and advises the driver of the presence of such vehicles via the indicators on the outside rear view mirrors.

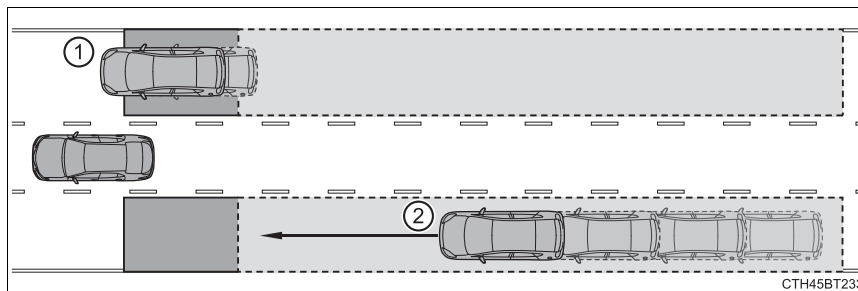

- ① Vehicles that are traveling in areas that are not visible using the outside rear view mirrors (the blind spots)
- ② Vehicles that are approaching rapidly from behind in areas that are not visible using the outside rear view mirrors (the blind spots)

BSM function detection areas

The areas that vehicles can be detected in are outlined below.

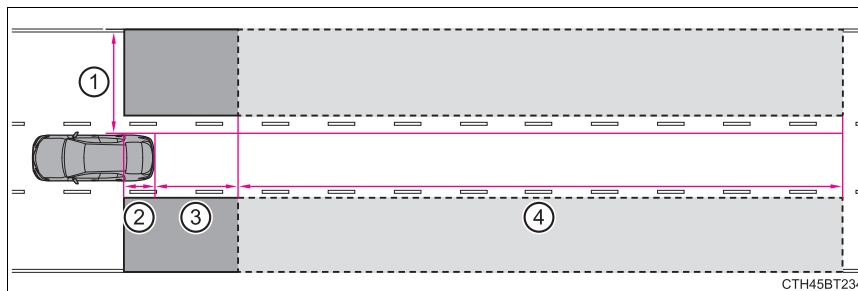

The range of the detection area extends to:

- ① Approximately 1.6 ft. (0.5 m) to 11.5 ft. (3.5 m) from either side of the vehicle
The area between the side of the vehicle and 1.6 ft. (0.5 m) from the side of the vehicle cannot be detected
- ② Approximately 3.3 ft. (1 m) forward of the rear bumper
- ③ Approximately 9.8 ft. (3 m) from the rear bumper

- ④ Approximately 9.8 ft. (3 m) to 197 ft. (60 m) from the rear bumper
The greater the difference in speed between your vehicle and the detected vehicle is, the farther away the vehicle will be detected, causing the outside rear view mirror indicator to illuminate or flash

 **WARNING**

■ Cautions regarding the use of the system

The driver is solely responsible for safe driving. Always drive safely, taking care to observe your surroundings.

The BSM function is a supplementary function which alerts the driver that a vehicle is present in the blind spot. Do not overly rely on the BSM function. The function cannot judge if it is safe to change lanes, therefore over reliance could cause an accident resulting in death or serious injury.

According to conditions, the system may not function correctly. Therefore the driver's own visual confirmation of safety is necessary.

■ The BSM function is operational when

- The BSM function is turned on
- Vehicle speed is greater than approximately 10 mph (16 km/h).

■ The BSM function will detect a vehicle when

- A vehicle in an adjacent lane overtakes your vehicle.
- Your vehicle overtakes a vehicle in an adjacent lane slowly.
- Another vehicle enters the detection area when it changes lanes.

■ Conditions under which the system will not detect a vehicle

The BSM function is not designed to detect the following types of vehicles and/or objects:

- Small motorcycles, bicycles, pedestrians, etc.*
- Vehicles traveling in the opposite direction
- Guardrails, walls, signs, parked vehicles and similar stationary objects*
- Following vehicles that are in the same lane*
- Vehicles driving 2 lanes across from your vehicle*
- Vehicles which are being overtaken rapidly by your vehicle

*: Depending on the conditions, detection of a vehicle and/or object may occur.

■ Conditions under which the system may not function correctly

- The BSM function may not detect vehicles correctly in the following conditions:
 - When the sensor is misaligned due to a strong impact to the sensor or its surrounding area
 - When driving on a road surface that is wet with standing water during bad weather, such as heavy rain, snow, or fog
 - When mud, snow, ice, a sticker, etc. is covering the sensor or surrounding area on the rear bumper
 - When there is a significant difference in speed between your vehicle and the vehicle that enters the detection area
 - When a vehicle is in the detection area from a stop and remains in the detection area as your vehicle accelerates
 - When driving up or down consecutive steep inclines, such as hills, a dip on the road, etc.
 - When driving on roads with sharp bends, consecutive curves, or uneven surfaces
 - When multiple vehicles are approaching with only a small gap between each vehicle
 - When vehicle lanes are wide, or when driving on the edge of a lane, and the vehicle in an adjacent lane is far away from your vehicle
 - When the vehicle that enters the detection area is traveling at about the same speed as your vehicle
 - When there is a significant difference in height between your vehicle and the vehicle that enters the detection area
 - Directly after the BSM function is turned on
- Instances of the BSM function unnecessarily detecting a vehicle and/or object may increase under the following conditions:
 - When the sensor is misaligned due to a strong impact to the sensor or its surrounding area
 - When the distance between your vehicle and a guardrail, wall, etc. that enters the detection area is short
 - When there is only a short distance between your vehicle and a following vehicle
 - When vehicle lanes are narrow, or when driving on the edge of a lane, and a vehicle traveling in a lane other than the adjacent lanes enters the detection area
 - When items such as a bicycle carrier are installed on the rear of the vehicle
 - When driving up and down consecutive steep inclines, such as hills, dips on the road, etc.
 - When driving on roads with sharp bends, consecutive curves, or uneven surfaces

Intuitive parking assist*



The distance from your vehicle to nearby objects when parallel parking or maneuvering into a garage is measured by the sensors and communicated via the multi-information display and a buzzer. Always check the surrounding area when using this system.

Types of sensors

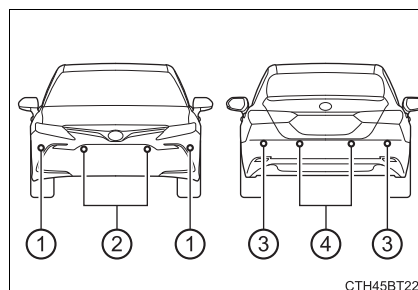
- ① Front corner sensors
- ② Front center sensors
- ③ Rear corner sensors
- ④ Rear center sensors



Turning the intuitive parking assist on/off

- 1 Press \wedge / \vee of the meter control switches, select .
- 2 Press \leftarrow / \rightarrow of the meter control switches, select .
- 3 Press  of the meter control switch.

When the intuitive parking assist function is disabled, the intuitive parking assist OFF indicator (→P. 91) illuminates.

To re-enable the system, select  on the multi-information display, select  and turn it on.

If the system is disabled, it will remain off even if the engine switch is turned to IGNITION ON mode after the engine switch has been turned off.

*: If equipped

Display

When the sensors detect an object, the following displays inform the driver of the position and distance to the object.

- ① Front corner sensor operation
- ② Front center sensor operation
- ③ Rear corner sensor operation
- ④ Rear center sensor operation
- ⑤ Select to mute the buzzer sounds.

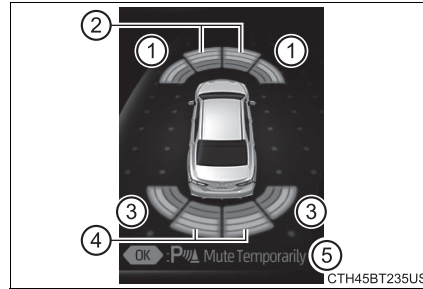

Muting the buzzer sound

- To mute the buzzer sound

The buzzer can be temporarily muted by pressing  of the meter control switches while an object detection display is shown on the multi-information display.







- To cancel the mute

Mute will be automatically cancelled in the following situations.

- When the shift position is changed
- When the vehicle speed exceeds a certain speed.
- When the intuitive parking assist is turned off once and turned on again
- When the engine switch is turned off once and turned to IGNITION ON mode again
- When a sensor is malfunctioning

Sensor detection display, object distance

■ **Distance display**

Display	Approximate distance to object		
	Front and rear center sensor	Front and rear corner sensor	
	Far	Front center sensor: 3.3 ft. (100 cm) to 2.0 ft. (60 cm) Rear center sensor: 4.9 ft. (150 cm) to 2.0 ft. (60 cm)	—
		2.0 ft. (60 cm) to 1.5 ft. (45 cm)	2.0 ft. (60 cm) to 1.5 ft. (45 cm)
		1.5 ft. (45 cm) to 1.0 ft. (30 cm)	1.5 ft. (45 cm) to 1.0 ft. (30 cm)
		1.0 ft. (30 cm) to 0.5 ft. (15 cm)	1.0 ft. (30 cm) to 0.5 ft. (15 cm)
		Less than 0.5 ft. (15 cm)	Less than 0.5 ft. (15 cm)
		Near	

■ Buzzer operation and distance to an object

A buzzer sounds when the sensors are operating.

- The buzzer sounds faster as the vehicle approaches an object.
When the vehicle comes within the following distance of the object, the buzzer sounds continuously: Approximately 1.0 ft. (30 cm).
- When 2 or more objects are detected simultaneously, the buzzer system responds to the nearest object. If one or both come within the above distances, the beep will repeat a long tone, followed by fast beeps.
- Automatic buzzer mute function
After a buzzer begins sounding, if the distance between the vehicle and the detected object does not become shorter, the buzzer will be muted automatically.
(However, if the distance between the vehicle and object is 1.0 ft. (30 cm) or less, this function will not operate.)

Detection range of the sensors

- ① Approximately 3.3 ft. (100 cm)
- ② Approximately 4.9 ft. (150 cm)
- ③ Approximately 2.0 ft. (60 cm)

The diagram shows the detection range of the sensors. Note that the sensors cannot detect objects that are extremely close to the vehicle.

The range of the sensors may change depending on the shape of the object, etc.

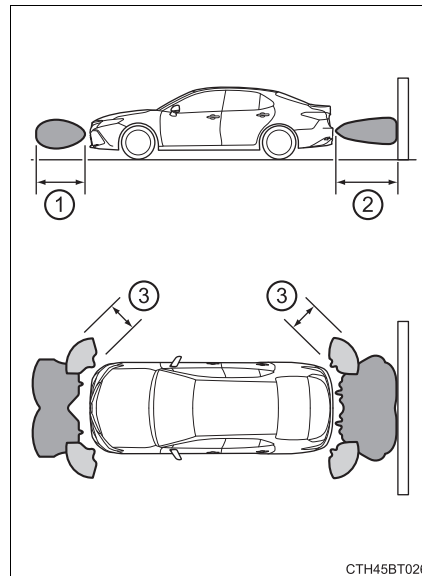

Changing the buzzer sounds volume

The buzzer volume can be changed on the multi-information display (→P. 120) when the engine switch is in IGNITION ON mode.

■ The system can be operated when

- The engine switch is in IGNITION ON mode.
- Intuitive parking assist function is on.
- The vehicle speed is less than about 6 mph (10 km/h).
- The shift lever is in other than P.

■ If “Parking Assist Unavailable Clean Parking Assist Sensor” is displayed on the multi-information display

A sensor may be dirty or covered with snow or ice. In such cases, if it is removed from the sensor, the system should return to normal.

Also, due to the sensor being frozen at low temperatures, a malfunction display may appear or an object may not be detected. If the sensor thaws out, the system should return to normal.

■ If “Parking Assist Unavailable” is displayed on the multi-information display

Water may be continuously flowing over the sensor surface, such as in a heavy rain. When the system determines that it is normal, the system will return to normal.

■ Sensor detection information

- The sensor’s detection areas are limited to the areas around the vehicle’s front and rear bumpers.
- The following situations may occur during use.
 - Depending on the shape of the object and other factors, the detection distance may shorten, or detection may be impossible.
 - Detection may be impossible if static objects draw too close to the sensor.
 - There will be a short delay between static object detection and display (warning buzzer sounds). Even at low speeds, there is a possibility that the object will come within 1.0 ft. (30 cm) before the display is shown and the warning buzzer sounds.
 - It might be difficult to hear the buzzer due to the volume of the audio system or air flow noise of the air conditioning system.
 - It may be difficult to hear the sound of this system due to the buzzers of other systems.

■ Objects which the system may not be properly detected

The shape of the object may prevent the sensor from detecting it. Pay particular attention to the following objects:

- Wires, fences, ropes, etc.
- Cotton, snow and other materials that absorb sound waves
- Sharply-angled objects
- Low objects
- Tall objects with upper sections projecting outwards in the direction of your vehicle

■ Situations in which the system may not operate properly

Certain vehicle conditions and the surrounding environment may affect the ability of a sensor to correctly detect objects. Particular instances where this may occur are listed below.

- There is dirt, snow, water drops or ice on a sensor. (Cleaning the sensors will resolve this problem.)
- A sensor is frozen. (Thawing the area will resolve this problem.)
In especially cold weather, if a sensor is frozen the sensor display may be displayed abnormally, or objects, such as a wall, may not be detected.
- When a sensor or the area around a sensor is extremely hot or cold.

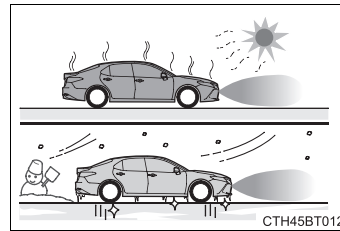

- On an extremely bumpy road, on an incline, on gravel, or on grass.
- When vehicle horns, vehicle detectors, motorcycle engines, air brakes of large vehicles, the clearance sonar of other vehicles or other devices which produce ultrasonic waves are near the vehicle
- A sensor is coated with a sheet of spray or heavy rain.
- If objects draw too close to the sensor.
- When a pedestrian is wearing clothing that does not reflect ultrasonic waves (ex. skirts with gathers or frills).
- When objects that are not perpendicular to the ground, not perpendicular to the vehicle traveling direction, uneven, or waving are in the detection range.
- Strong wind is blowing
- When driving in inclement weather such as fog, snow or a sandstorm
- When an object that cannot be detected is between the vehicle and a detected object
- If an object such as a vehicle, motorcycle, bicycle or pedestrian cuts in front of the vehicle or runs out from the side of the vehicle

- If the orientation of a sensor has been changed due to a collision or other impact
- When equipment that may obstruct a sensor is installed, such as a towing eyelet, bumper protector (an additional trim strip, etc.), bicycle carrier, or snow plow
- If the front of the vehicle is raised or lowered due to the carried load
- If the vehicle cannot be driven in a stable manner, such as when the vehicle has been in an accident or is malfunctioning
- When a tire chains or compact spare tire is used

■ **Situations in which the system may operate even if there is no possibility of a collision**

In some situations, such as the following, the system may operate even though there is no possibility of a collision.

- When driving on a narrow road

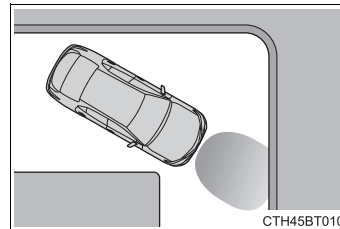

- When driving toward a banner, flag, low-hanging branch or boom barrier (such as those used at railroad crossings, toll gates and parking lots)
- When there is a rut or hole in the surface of the road
- When driving on a metal cover (grating), such as those used for drainage ditches
- When driving up or down a steep slope
- If a sensor is hit by a large amount of water, such as when driving on a flooded road
- There is dirt, snow, water drops or ice on a sensor. (Cleaning the sensors will resolve this problem.)
- A sensor is coated with a sheet of spray or heavy rain
- When driving in inclement weather such as fog, snow or a sandstorm
- When strong winds are blowing

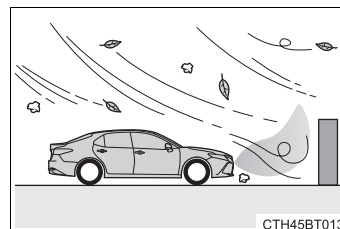

- When vehicle horns, vehicle detectors, motorcycle engines, air brakes of large vehicles, the clearance sonar of other vehicles or other devices which produce ultrasonic waves are near the vehicle

- If the front of the vehicle is raised or lowered due to the carried load
- If the orientation of a sensor has been changed due to a collision or other impact
- The vehicle is approaching a tall or curved curb
- Driving close to columns (H-shaped steel beams, etc.) in multi-story parking garages, construction sites, etc.
- If the vehicle cannot be driven in a stable manner, such as when the vehicle has been in an accident or is malfunctioning
- On an extremely bumpy road, on an incline, on gravel, or on grass

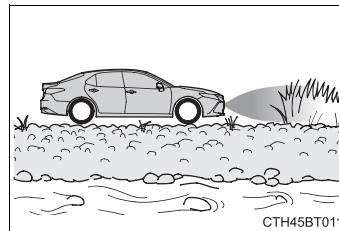

- When a tire chains or compact spare tire is used

 **WARNING****■ Cautions regarding the use of the system**

There is a limit to the degree of recognition accuracy and control performance that this system can provide, do not overly rely on this system. The driver is always responsible for paying attention to the vehicle's surroundings and driving safely.

■ To ensure the system can operate properly

Observe the following precautions.

Failing to do so may result in the vehicle being unable to be driven safely and possibly cause an accident.

- Do not damage the sensors, and always keep them clean.
- Do not attach a sticker or install an electronic component, such as a backlit license plate (especially fluorescent type), fog lights, fender pole or wireless antenna near a radar sensor.
- Do not subject the surrounding area of the sensor to a strong impact. If subjected to an impact, have the vehicle inspected by your Toyota dealer. If the front or rear bumper needs to be removed/installed or replaced, contact your Toyota dealer.
- Do not modify, disassemble or paint the sensors.
- Do not attach a license plate cover.
- Keep your tires properly inflated.

■ When to disable the function

In the following situations, disable the function as it may operate even though there is no possibility of a collision.

- Failing to observe the warnings above.
- A non-genuine Toyota suspension (lowered suspension, etc.) is installed.

■ Notes when washing the vehicle

Do not apply intensive bursts of water or steam to the sensor area.

Doing so may result in the sensor malfunctioning.

- When using a high pressure washer to wash the vehicle, do not spray the sensors directly, as doing so may cause a sensor to malfunction.
- When using steam to clean the vehicle, do not direct steam too close to the sensors as doing so may cause a sensor to malfunction.
- When using an automatic car wash, disable the intuitive parking assist

RCTA (Rear Cross Traffic Alert)*

The RCTA function uses the BSM rear side radar sensors installed behind the rear bumper. This function is intended to assist the driver in checking areas that are not easily visible when backing up.

System components

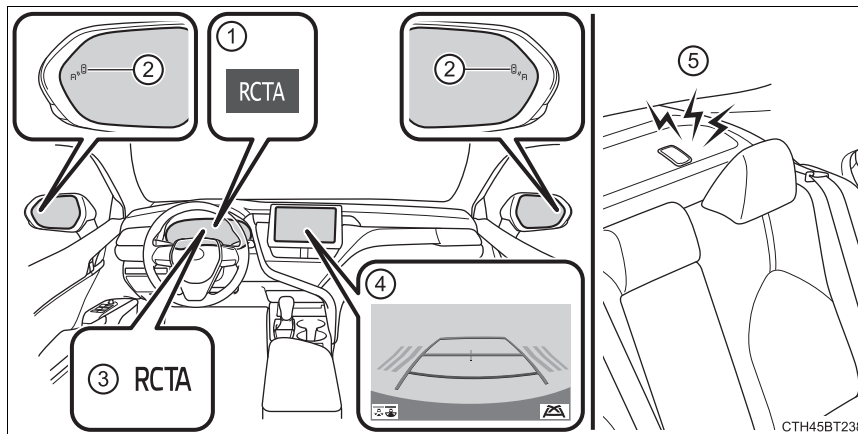

- ① Multi-information display
Turning the RCTA function on/off. (→P. 346)
- ② Outside rear view mirror indicators
When a vehicle approaching from the right or left rear of the vehicle is detected, the outside rear view mirror indicators flash.
- ③ “RCTA” indicator
When the RCTA function is turned on, the indicator illuminates.
- ④ Audio system screen
If a vehicle approaching from the right or left at the rear of the vehicle is detected, the RCTA icon (→P. 347) for the detected side will be displayed. This illustration shows an example of a vehicle approaching from both sides of the vehicle.
- ⑤ RCTA buzzer
When a vehicle approaching from the right or left rear of the vehicle is detected, a buzzer sounds from behind the rear seat.

*: If equipped

Turning the RCTA function on/off

▶ Vehicles with 4.2-inch multi-information display

- 1 Press / of the meter control switches, select .
 - 2 Press / of the meter control switches, select .
 - 3 Press of the meter control switch.
- Each time is pressed, the function changes on/off.

▶ Vehicles with 7-inch multi-information display

- 1 Press / of the meter control switches, select .
 - 2 Press / of the meter control switches, select .
 - 3 Press of the meter control switch.
- Each time is pressed, the function changes on/off.

Setting the buzzer volume

The volume of the RCTA buzzer can be changed on (4.2-inch display) or (7-inch display) (→P. 106, 119) of the multi-information display.

■ The outside rear view mirror indicators visibility

When under strong sunlight, the outside rear view mirror indicator may be difficult to see.

■ RCTA buzzer hearing

RCTA function may be difficult to hear over loud noises such as high audio volume.

■ Muting the buzzer sound

The buzzer can be temporarily muted by pressing of the meter control switches while an object detection display is shown on the multi-information display.

■ When “Rear Cross Traffic Alert Unavailable” is shown on the multi-information display

Ice, snow, mud, etc., may be attached to the rear bumper around the sensors. (→P. 332)

The system should return to normal operation after removing the ice, snow, mud, etc. from the rear bumper.

Additionally, the sensors may not operate normally when driving in extremely hot or cold environments.

■ Rear side radar sensors

→P. 332

RCTA function

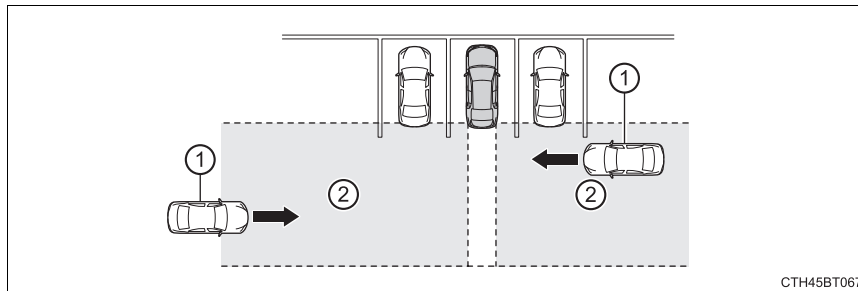

The RCTA functions when your vehicle is in reverse. It can detect other vehicles approaching from the right or left rear of the vehicle. It uses radar sensors to alert the driver of the other vehicle's existence through flashing the outside rear view mirror indicators and sounding a buzzer.



① Approaching vehicles ② Detection areas

■ **RCTA icon display (if equipped)**

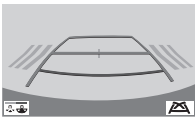
When a vehicle approaching from the right or left at the rear of the vehicle is detected, the following will be displayed on the audio system screen.

Toyota parking assist monitor	Panoramic view monitor	Content
		<p>A vehicle is approaching from the left or right at the rear of the vehicle</p>

 **WARNING**

■ **Cautions regarding the use of the system**

There is a limit to the degree of recognition accuracy and control performance that this system can provide, do not overly rely on this system. The driver is always responsible for paying attention to the vehicle's surroundings and driving safely. (→P. 334)

■ **To ensure the system can operate properly**

→P. 332

RCTA function detection areas

The areas that vehicles can be detected in are outlined below.

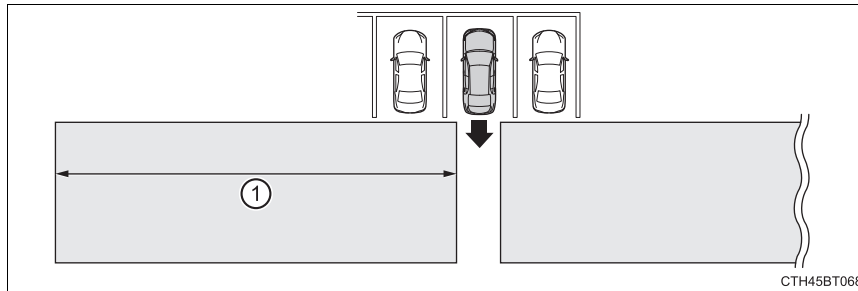

To give the driver a more consistent time to react, the buzzer can alert for faster vehicles from farther away.

Example:

Approaching vehicle	Speed	① Approximate alert distance
Fast	18 mph (28 km/h)	65 ft. (20 m)
Slow	5 mph (8 km/h)	18 ft. (5.5 m)

4

Driving

■ The RCTA function is operational when

- Vehicles without a smart key system: The engine switch is in the "ON" position.
- Vehicles with a smart key system: The engine switch is in IGNITION ON mode.
- The RCTA function is turned on.
- The shift lever is in R.
- The vehicle speed is approximately 5 mph (8 km/h) or less.
- The approaching vehicle speed is between approximately 5 mph (8 km/h) and 18 mph (28 km/h).

■ **Conditions under which the system will not detect a vehicle**

The RCTA function is not designed to detect the following types of vehicles and/or objects:

- Vehicles approaching from directly behind
- Vehicles backing up in the parking space next to your vehicle*
- Vehicles that the sensors cannot detect due to obstructions

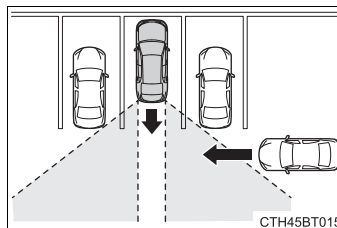

- Guardrails, walls, signs, parked vehicles and similar stationary objects*
- Small motorcycles, bicycles, pedestrians, etc.*
- Vehicles moving away from your vehicle
- Vehicles approaching from the parking spaces next to your vehicle*
- The distance between the sensor and approaching vehicle gets too close

*: Depending on the conditions, detection of a vehicle and/or object may occur.

■ Situations in which the system may not operate properly

The RCTA function may not detect vehicles correctly in the following situations:

- When the sensor is misaligned due to a strong impact to the sensor or its surrounding area
- When mud, snow, ice, a sticker, etc., is covering the sensor or surrounding area on the position above the rear bumper
- When driving on a road surface that is wet with standing water during bad weather, such as heavy rain, snow, or fog
- When multiple vehicles are approaching with only a small gap between each vehicle
- When a vehicle is approaching at high speed
- When equipment that may obstruct a sensor is installed, such as a towing eyelet, bumper protector (an additional trim strip, etc.), bicycle carrier, or snow plow
- When backing up on a slope with a sharp change in grade

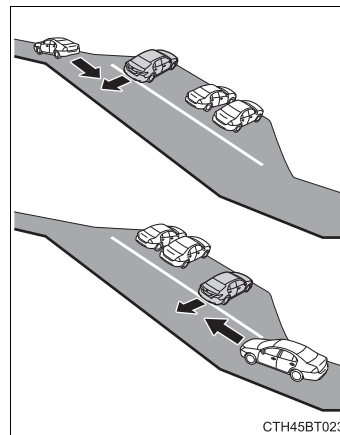

CTH45BT023

- When backing out of a sharp angle parking spot

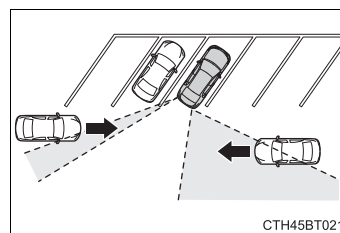

CTH45BT021

- When towing a trailer
- When there is a significant difference in height between your vehicle and the vehicle that enters the detection area
- When a sensor or the area around a sensor is extremely hot or cold
- If the suspension has been modified or tires of a size other than specified are installed
- If the front of the vehicle is raised or lowered due to the carried load

- When turning while backing up

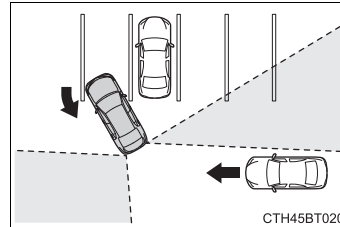

- When a vehicle turns into the detection area

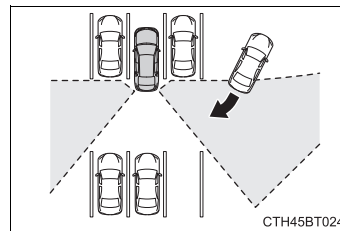

■ Situations in which the system may operate even if there is no possibility of a collision

Instances of the RCTA function unnecessarily detecting a vehicle and/or object may increase in the following situations:

- When the parking space faces a street and vehicles are being driven on the street

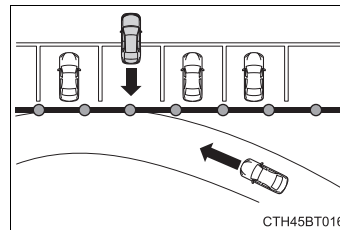

- When the distance between your vehicle and metal objects, such as a guardrail, wall, sign, or parked vehicle, which may reflect electrical waves toward the rear of the vehicle, is short

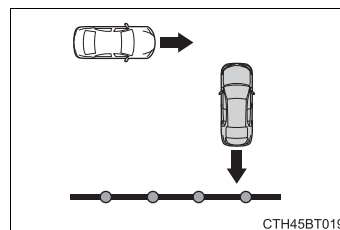

- When equipment that may obstruct a sensor is installed, such as a towing eyelet, bumper protector (an additional trim strip, etc.), bicycle carrier, or snow plow

- When a vehicle passes by the side of your vehicle

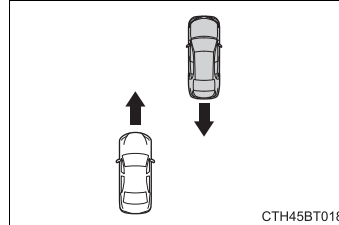

- When a detected vehicle turns while approaching the vehicle

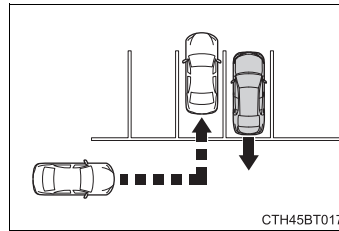

- When there are spinning objects near your vehicle such as the fan of an air conditioning unit
- When water is splashed or sprayed a sprinkler
- Moving objects (flags, exhaust fumes, large rain droplets or snowflakes, rain water on the road surface, etc.)
- When the distance between your vehicle and a guardrail, wall, etc., that enters the detection area is short
- Gratings and gutters
- When a sensor or the area around a sensor is extremely hot or cold
- If the suspension has been modified or tires of a size other than specified are installed
- If the front of the vehicle is raised or lowered due to the carried load

RCD (Rear Camera Detection)*

When the vehicle is backing up, the rear camera detection function can detect pedestrians in the detection area behind the vehicle. If a pedestrian is detected, a buzzer will sound and an icon on the audio system screen will be displayed to inform the driver of the pedestrian.

Display

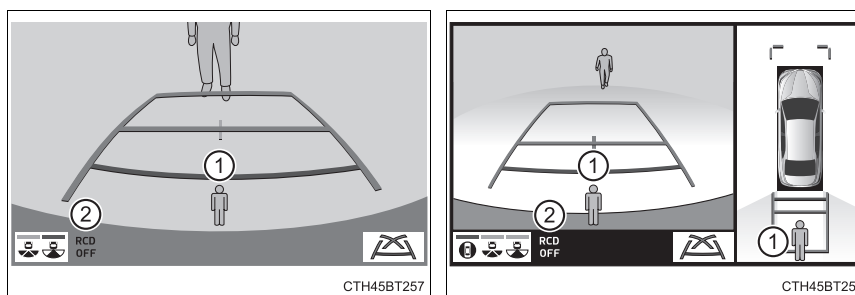

- ▶ Toyota parking assist monitor
- ▶ Panoramic view monitor



- ① Pedestrian detection icon
Displayed automatically when a pedestrian is detected.
- ② RCD OFF icon
When the RCD function is disabled, the RCD OFF icon illuminates.

Turning the rear camera detection function on/off



- ▶ Vehicles with 4.2-inch multi-information display

- 1 Press < / > of the meter control switches, select .
- 2 Press ^ / v of the meter control switches, select **RCD**.
- 3 Press  of the meter control switch.

When the RCD function is disabled, the RCD OFF indicator (→P. 91) illuminates.

*: If equipped

► Vehicles with 7-inch multi-information display

- 1 Press \wedge / \vee of the meter control switches, select .
- 2 Press \lt / \gt of the meter control switches, select **RCD**.
- 3 Press  of the meter control switch.

When the RCD function is disabled, the RCD OFF indicator (\rightarrow P. 91) illuminates.

When a pedestrian is detected

If the rear camera detection function detects a pedestrian in the detection area, the buzzer and icon will operate as shown in the following table:

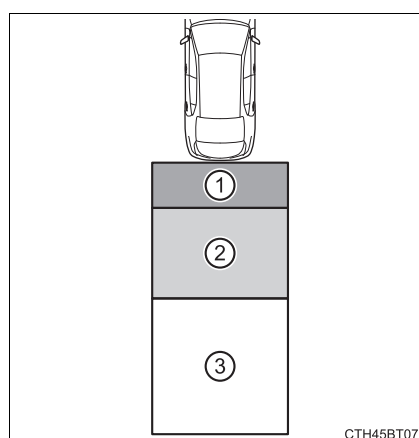

Area	Buzzer	Icon
①	Sounds repeatedly	Blinks 3 times and then stays on
②	When the vehicle is stationary: Sounds 3 times When the vehicle is backing up: Sounds repeatedly	
③	When it is determined that a pedestrian will enter area ① within a few seconds: Sounds repeatedly	When it is determined that a pedestrian will enter area ① within a few seconds: Blinks 3 times and then stays on

■ The rear camera detection function is operational when

The rear camera detection function is operational when the following conditions are met:

- The engine switch is in the “ON” position (vehicles without a smart key system) or in IGNITION ON mode (vehicles with a smart key system).
- RCD function is on.
- The shift lever is in R.

■ Setting the buzzer volume

The buzzer volume can be adjusted with the RCTA buzzer volume on the multi-information display. (→P. 106, 119)

■ Muting the buzzer sound

The buzzer can be temporarily muted by pressing  of the meter control switches while an object detection display is shown on the multi-information display.

■ If “Rear Camera Detection Unavailable Remove the Dirt of Rear Camera” is displayed on the multi-information display

A rear camera lens may be dirty or covered with snow or ice. In such cases, if it is removed from the rear camera lens, the system should return to normal. (It may be necessary to drive the vehicle for some time before the system returns to normal.)

■ If “Rear Camera Detection Unavailable” is displayed on the multi-information display

- If this message is displayed after the battery has been disconnected and reconnected, fully turn the steering wheel to the left and then the right on level ground.
- If this message is displayed only when the R shift position is selected, the rear camera lens may be dirty. Clean the rear camera lens.

■ Situations in which the system may not operate properly

- Some pedestrians, such as the following, may not be detected by the rear camera detection function, preventing the function from operating properly:
 - Pedestrians who are squatting
 - Pedestrians who are lying down
 - Pedestrians who are running
 - Pedestrians who suddenly enter the detection area
 - Pedestrians riding a bicycle, skateboard, or other light vehicle
 - Pedestrians wearing unusual clothing, such as a costume
 - Pedestrians whose body is partially hidden by a cart or other object
 - Pedestrians which are obscured by darkness, such as at night
- In some situations, such as the following, pedestrians may not be detected by the rear camera detection function, preventing the function from operating properly:
 - When backing up in inclement weather (rain, snow, fog, etc.)
 - When the rear camera is obscured (dirt, snow, ice, etc. are attached) or scratched
 - When a very bright light, such as the sun, or the headlights of another vehicle, shines directly into the rear camera
 - When backing up in a place where the surrounding brightness changes suddenly, such as at the entrance or exit of a garage or underground parking lot
 - When backing up in a dim environment such as during dusk or in an underground parking lot
 - When the camera position and direction are deviated
 - When a towing hook is attached
 - When water droplets are flowing on the camera lens
 - When the vehicle height is extremely changed (nose up, nose down)
 - When tire chains is used

■ Situations in which the system may operate unexpectedly

- Even though there are no pedestrians in the detection area, some objects, such as the following, may be detected, possibly causing the rear camera detection function to operate.
 - Three dimensional objects, such as a pole, traffic cone, fence, or parked vehicle
 - Moving objects, such as a car or motorcycle
 - Objects moving toward your vehicle when backing up, such as flags or puddles (or airborne matter, such as smoke, steam, rain, or snow)
 - Cobblestone or gravel roads, tram rails, road repairs, white lines, pedestrian crossings or fallen leaves on the road
 - Metal covers (gratings), such as those used for drainage ditches
 - Objects reflected in a puddle or on a wet road surface
 - Shadows on the road
- In some situations, such as the following, the rear camera detection function may operate even though there are no pedestrians in the detection area.
 - When backing up toward the roadside or a bump on the road
 - When backing up toward an incline/decline
 - If the rear of the vehicle is raised or lowered due to the carried load
 - If a bumper protector, such as an additional trim strip, is installed to the rear bumper
 - If the orientation of the rear camera has been changed
 - If a towing eyelet is installed to the rear of the vehicle
 - When the rear camera is obscured (dirt, snow, ice, etc. are attached) or scratched
 - When water is flowing over the rear camera lens
 - If there is a flashing light in the detection area, such as the emergency flashers of another vehicle
 - When a tire chains is used
- Situations in which the rear camera detection function may be difficult to notice
 - If buzzer may be difficult to hear if the surrounding area is noisy, the volume of the audio system volume is high, the air conditioning system is being used, etc.
 - If the temperature in the cabin is extremely high or low, the audio system screen may not operate correctly.

 **WARNING****■ Cautions regarding the use of the system**

The recognition and control capabilities for this system are limited.

The driver should always drive safely by always being responsible without over relying on the system and have a understanding of the surrounding situations.

■ To ensure the system can operate properly

Observe the following, otherwise there is the danger that could lead to an accident.

- Always clean the camera without damaging it.
- Do not install market electronic parts (such as illuminated license plate, fog lamps, etc.) in the camera vicinity.
- Do not subject the camera vicinity to strong impacts. If the vicinity is subjected to a strong impact, have the vehicle inspected at your Toyota dealer.
- Do not disassemble, remodel or paint the camera.
- Do not attach accessories or stickers to the camera.
- Do not install market protection parts (bumper trim, etc.) to the rear bumper.
- Maintain suitable tire air pressure.
- Make sure the trunk is completely closed.

■ RCD function is turned off

In the following situations the system turns off. The RCD function may not operate properly and thus there is the danger that an accident may occur.

- The contents mentioned above are not observed.
- Suspensions other than Toyota genuine parts are installed.

PKSB (Parking Support Brake)*

The Parking Support Brake system consists of the following functions that operate when driving at a low speed or backing up, such as when parking. When the system determines that the possibility of a collision with a detected object is high, a warning operates to urge the driver to take evasive action. If the system determines that the possibility of a collision with a detected object is extremely high, the brakes are automatically applied to help avoid the collision or help reduce the impact of the collision.

PKSB (Parking Support Brake) system

■ Parking Support Brake function (static objects)

Ultrasonic sensors are used to detect static objects, such as a wall, in the detection area when driving at a low speed or backing up. (→P. 368)

■ Parking Support Brake function (rear-crossing vehicles)

Rear radar sensors are used to detect approaching vehicles in the detection area behind the vehicle when backing up. (→P. 372)

*: If equipped

Types of sensors



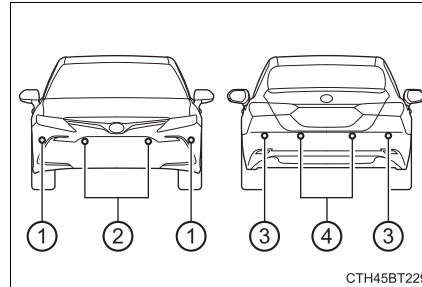

- ① Front corner sensors
- ② Front center sensors
- ③ Rear corner sensors
- ④ Rear center sensors





Turning the Parking Support Brake on/off

The Parking Support Brake can be enabled/disabled on the multi-information display. All of the Parking Support Brake functions (static objects and rear-crossing vehicles) are enabled/disabled simultaneously.

Use the meter control switches to enable/disable the parking support brake. (→P. 103, 117)

- 1 Press \wedge / \vee of the meter control switches, select .
- 2 Press \leftarrow / \rightarrow of the meter control switches, select .
- 3 Press  of the meter control switch.
- 4 Select the "Yes" and push .

When the Parking Support Brake is disabled, the PKSB OFF indicator illuminates.

To re-enable the system when it was disabled, select  on the multi-information display, select  and then "On". If disabled using this method, the system will not be re-enabled by turning the engine switch off and then to IGNITION ON mode.

Displays and buzzers for engine output restriction control and brake control

If the engine output restriction control or brake control operates, a buzzer will sound and a message will be displayed on the multi-information display to alert the driver.

Depending on the situation, engine output restriction control will operate to either limit acceleration or restrict output as much as possible.

Control	Situation	Multi-information display	PKSB OFF Indicator	Buzzer
Engine output restriction control is operating (acceleration restriction)	Acceleration greater than a certain amount is not possible.	"Object Detected Acceleration Reduced"	Not illuminated	No beep
Engine output restriction control is operating (output restricted as much as possible)	Stronger-than-normal brake operation is necessary.	"Brake!"	Not illuminated	Short beep
Brake control is operating	Emergency braking is necessary.			
Vehicle stopped by system operation (When accelerator is stepped on)	The vehicle has been stopped by brake control operation.	"Switch to Brake"	Illuminated	Short beep
Vehicle stopped by system operation (When accelerator is not stepped on)	The vehicle has been stopped by brake control operation.	"Brake"	Illuminated	Short beep

Parking Support Brake function

If the Parking Support Brake detects that a collision with an object is possible, the engine output will be restricted to restrain any increase in the vehicle speed. (Engine output restriction control: See A below.)

Additionally, if the accelerator pedal continues to be depressed, the brakes will be applied automatically to reduce the vehicle speed. (Brake control: See B below.)

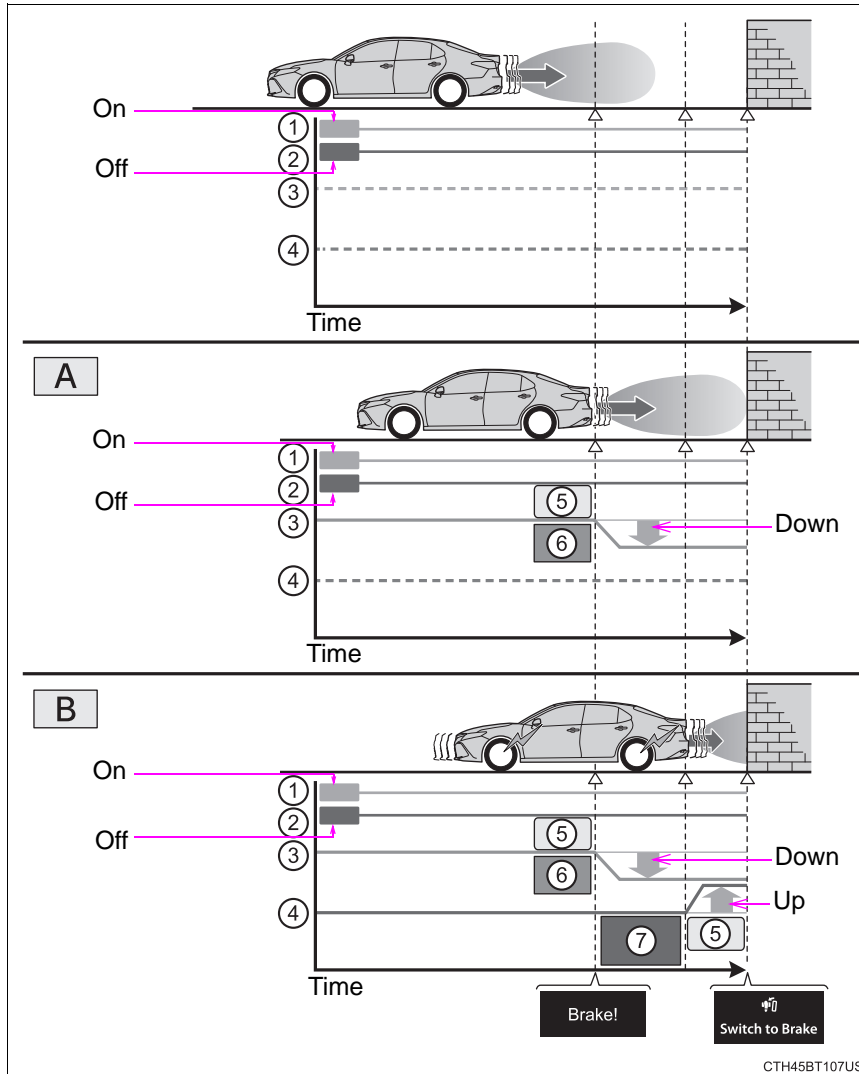

CTH45BT107US

- ① Accelerator pedal
- ② Brake pedal
- ③ Engine output
- ④ Braking force
- ⑤ Start of control
- ⑥ High possibility of a collision
- ⑦ Extremely high possibility of a collision

■ If the Parking Support Brake function has operated

If the vehicle is stopped due to operation of the Parking Support Brake function, the Parking Support Brake system will be disabled and the PKSB OFF indicator will illuminate. If the Parking Support Brake operates unnecessarily, brake control can be canceled by depressing the brake pedal or waiting for approximately 2 seconds for it to automatically be canceled. Then, the vehicle can be operated by depressing the accelerator pedal.

■ Re-enabling the Parking Support Brake system

To re-enable the Parking Support Brake system when it is disabled due to operation of the Parking Support Brake function, either enable the system again (→P. 361), or turn the engine switch off and then back to IGNITION ON mode.

Additionally, if the object becomes no longer in the traveling direction of the vehicle or if the traveling direction of the vehicle changes (such as changing from moving forward to backing up, or from backing up to moving forward), the system will be re-enabled automatically.

■ If “PKSB Unavailable” and “Parking Assist Unavailable Clean Parking Assist Sensor” are displayed on the multi-information display and the PKSB OFF indicator is illuminating

- A sensor may be covered with ice, snow, dirt, etc. In this case, remove the ice, snow, dirt, etc., from the sensor to return the system to normal. If this message is shown even after removing dirt from the sensor, or shown when the sensor was not dirty to begin with, have the vehicle inspected at your Toyota dealer.
- A sensor may be frozen. Once the ice melts, the system will return to normal.
- Water may be continuously flowing over the sensor surface, such as in a heavy rain. When the system determines that it is normal, the system will return to normal.

 **WARNING****■ Cautions regarding the use of the system**

Do not overly rely on the system, as doing so may lead to an accident.

Always drive while checking the safety of the surroundings of the vehicle.

Depending on the vehicle and road conditions, weather, etc., the system may not operate.

The detection capabilities of sensors and radars are limited. Always drive while checking the safety of the surroundings of the vehicle.

- The driver is solely responsible for safe driving. Always drive carefully, taking care to observe your surroundings. The Parking Support Brake system is designed to provide support to lessen the severity of collisions. However, it may not operate in some situations.
- The Parking Support Brake system is not designed to stop the vehicle completely. Additionally, even if the system has stopped the vehicle, it is necessary to depress the brake pedal immediately as brake control will be canceled after approximately 2 seconds.
- It is extremely dangerous to check the system operations by intentionally driving the vehicle into the direction of a wall, etc. Never attempt such actions.

■ When to disable the Parking Support Brake

In the following situations, disable the Parking Support Brake as the system may operate even though there is no possibility of a collision.

- When inspecting the vehicle using a chassis roller, chassis dynamo or free roller
- When loading the vehicle onto a boat, truck or other transport vessel
- If the suspension has been modified or tires of a size other than specified are installed
- If the front of the vehicle is raised or lowered due to the carried load
- When equipment that may obstruct a sensor is installed, such as a towing eyelet, bumper protector (an additional trim strip, etc.), bicycle carrier, or snow plow
- When using automatic car washing devices
- If the vehicle cannot be driven in a stable manner, such as when the vehicle has been in an accident or is malfunctioning
- When the vehicle is driven in a sporty manner or off-road
- When the tires are not properly inflated
- When the tires are very worn
- When a tire chains or compact spare tire is used

 NOTICE**■ If “PKSB Unavailable” is displayed on the multi-information display and the PKSB OFF indicator is illuminating**

If this message is displayed immediately after the engine switch is changed to ON, operate the vehicle carefully, paying attention to your surroundings. It may be necessary to drive the vehicle for a certain amount of time before the system returns to normal. (If the system is not return to normal after driving for a while, clean the sensors and their surrounding area on the bumpers.)

Parking Support Brake function (static objects)*

If a collision with an object may occur due to the vehicle suddenly moving forward due to an accidental accelerator pedal operation, the vehicle moving the unintended direction due to the wrong shift position being selected, or while parking or traveling at low speeds, the sensors detect objects, such as a wall, in the traveling direction of the vehicle, and the system operates to lessen an impact with an object and reduce the resulting damage.

Examples of system operation

The system will operate in situations such as the following if an object is detected in the traveling direction of the vehicle.

- **When traveling at a low speed and the brake pedal is not depressed, or is depressed late**

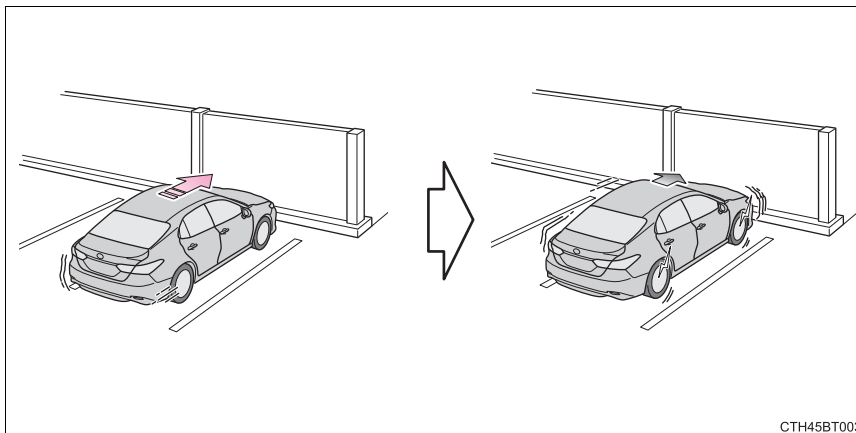

CTH45BT003

*: If equipped

■ When the accelerator pedal is depressed excessively

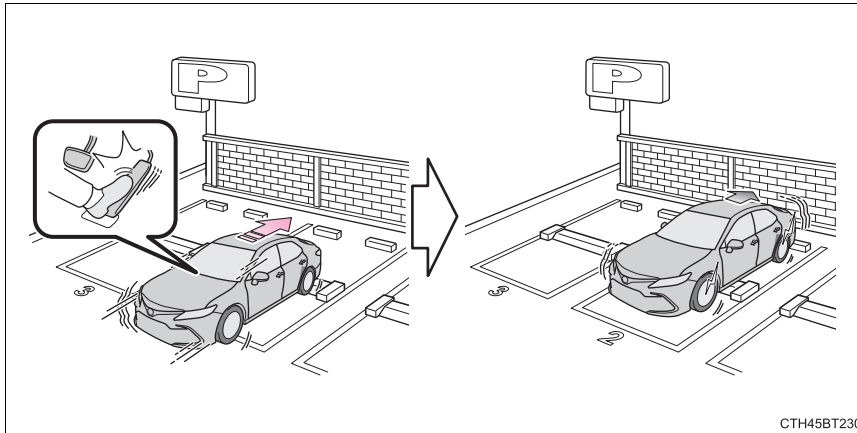

■ When the vehicle moves in the unintended direction due to the wrong shift position being selected

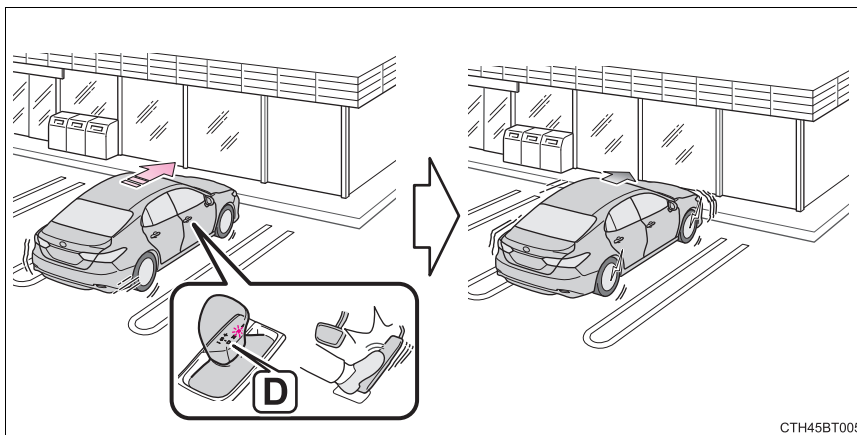

■ The Parking Support Brake function (static objects) will operate when

The function will operate when the PKSB OFF indicator is not illuminated (→P. 361, 365) and all of the following conditions are met:

● Engine output restriction control

- The Parking Support Brake system is enabled.
- The vehicle speed is approximately 10 mph (15 km/h) or less.
- There is an object in the traveling direction of the vehicle and approximately 6 to 13 ft. (2 to 4 m) away.
- The system determines that a stronger-than-normal brake operation is necessary to avoid a collision.

● Brake control

- Engine output restriction control is operating.
- The system determines that an emergency brake operation is necessary to avoid a collision.

■ The Parking Support Brake function (static objects) will stop operating when

The function will stop operating if any of the following conditions are met:

● Engine output restriction control

- The Parking Support Brake system is disabled.
- The collision becomes avoidable with normal brake operation.
- The object is no longer approximately 6 to 13 ft. (2 to 4 m) away in the traveling direction of the vehicle.

● Brake control

- The Parking Support Brake system is disabled.
- Approximately 2 seconds elapse after the vehicle is stopped by brake control.
- The brake pedal is depressed after the vehicle is stopped by brake control.
- The object is no longer approximately 6 to 13 ft. (2 to 4 m) away in the traveling direction of the vehicle.

■ Detection range of the Parking Support Brake function (static objects)

The detection range of the Parking Support Brake function differs from the detection range of the intuitive parking assist. (→P. 339)

Therefore, even if the intuitive parking assist detects an object and provides a warning, the Parking Support Brake function may not start operating.

■ Situations in which the system may not operate properly

→P. 341

■ Situations in which the system may operate even if there is no possibility of a collision

→P. 342

 **WARNING****■ To ensure the system can operate properly**

→P. 344

■ If the Parking Support Brake function (static objects) operates unnecessarily, such as at a railroad crossing

→P. 365

■ Notes when washing the vehicle

→P. 344

Parking Support Brake function (rear-crossing vehicles)*

If a radar sensor detects a vehicle approaching from the right or left at the rear of the vehicle and the system determines that the possibility of a collision is high, this function will perform brake control to reduce the likelihood of an impact with the approaching vehicle.

Examples of system operation

The system will operate in situations such as the following if an object is detected in the traveling direction of the vehicle.

- When reversing, a vehicle is approaching and the brake pedal is not depressed, or is depressed late

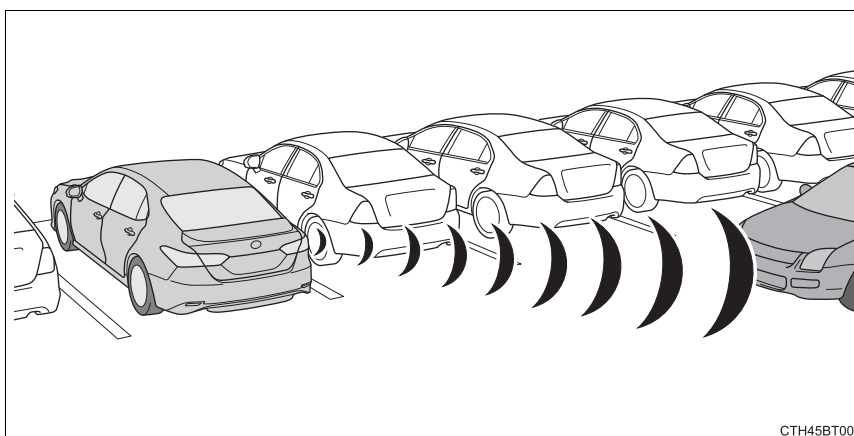

CTH45BT006

*: If equipped

■ The Parking Support Brake function (rear-crossing vehicles) will operate when

The function will operate when the PKSB OFF indicator is not illuminated (→P. 361, 365) and all of the following conditions are met:

- Engine output restriction control
 - The Parking Support Brake is enabled.
 - The vehicle speed is approximately 9 mph (15 km/h) or less.
 - Vehicles which are approaching from the right or left at the rear of the vehicle at a traveling speed of approximately 5 mph (8 km/h) or more.
 - The shift lever is in R.
 - The system determines that a stronger than normal brake operation is necessary to avoid a collision with an approaching vehicle.
- Brake control
 - Engine output restriction control is operating.
 - The system determines that an emergency brake operation is necessary to avoid a collision with an approaching vehicle.

■ The Parking Support Brake function (rear-crossing vehicles) will stop operating when

The function will stop operating if any of the following conditions are met:

- Engine output restriction control
 - The Parking Support Brake is disabled.
 - The collision becomes avoidable with normal brake operation.
 - A vehicle is no longer approaching from the right or left at the rear of the vehicle.
- Brake control
 - The Parking Support Brake is disabled.
 - Approximately 2 seconds elapse after the vehicle is stopped by brake control.
 - The brake pedal is depressed after the vehicle is stopped by brake control.
 - A vehicle is no longer approaching from the right or left at the rear of the vehicle.

■ Detection area of the Parking Support Brake function (rear-crossing vehicles)

The detection area of the Parking Support Brake function (rear-crossing vehicles) differs from the detection area of the RCTA function (→P. 345).

Therefore, even if the RCTA function detects a vehicle and provides an alert, the Parking Support Brake function (rear-crossing vehicles) may not start operating.

■ Situations in which the system may not operate properly

→P. 351

■ Situations in which the system may operate even if there is no possibility of a collision

→P. 352

 **WARNING**

■ To ensure the system can operate properly

→P. 332

Driving mode select switches*

The driving modes can be selected to suit driving condition.

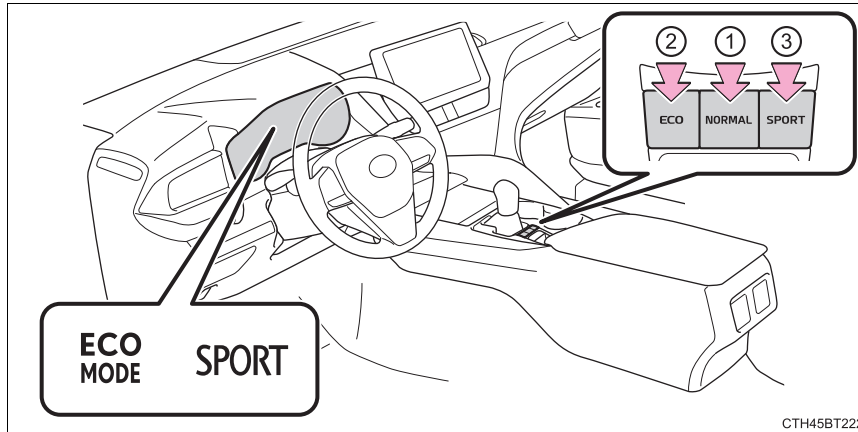

① Normal mode

Use for normal driving.

While in Eco drive mode or sport mode, press the switch to change the driving mode to normal mode.

② Eco drive mode

Use Eco drive mode to help achieve low fuel consumption during trips that involve frequent accelerating.

When the "ECO" switch is pressed, the "ECO MODE" indicator comes on in the instrument cluster.

③ Sport mode

Use sport mode when increased acceleration response and precise handling is desired, for example, when driving on mountain roads.

When the "SPORT" switch is pressed, the "SPORT" indicator comes on in the instrument cluster.

*: If equipped

■ **Operation of the air conditioning system in Eco drive mode**

Eco drive mode controls the heating/cooling operations and fan speed of the air conditioning system to enhance fuel efficiency (→P. 387, 394). To improve air conditioning performance, adjust the fan speed or turn off Eco drive mode.

■ **Sport mode automatic deactivation**

Sport mode is automatically deactivated if the engine switch is turned off after driving in sport mode.

Winter driving tips

Carry out the necessary preparations and inspections before driving the vehicle in winter. Always drive the vehicle in a manner appropriate to the prevailing weather conditions.

Preparation for winter

- Use fluids that are appropriate to the prevailing outside temperatures.
 - Engine oil
 - Engine coolant
 - Washer fluid
- Have a service technician inspect the condition of the battery.
- Have the vehicle fitted with four snow tires or purchase a set of tire chains for the front tires.*

Ensure that all tires are the same size and brand, and that chains match the size of the tires.

*: Tire chains cannot be mounted on vehicles with 18 and 19-inch tires.

Before driving the vehicle

Perform the following according to the driving conditions:

- Do not try to forcibly open a window or move a wiper that is frozen. Pour warm water over the frozen area to melt the ice. Wipe away the water immediately to prevent it from freezing.
- To ensure proper operation of the climate control system fan, remove any snow that has accumulated on the air inlet vents in front of the windshield.
- Check for and remove any excess ice or snow that may have accumulated on the exterior lights, outside rear view mirrors, windows, vehicle's roof, chassis, around the tires or on the brakes.
- Remove any snow or mud from the bottom of your shoes before getting in the vehicle.

When driving the vehicle

Accelerate the vehicle slowly, keep a safe distance between you and the vehicle ahead, and drive at a reduced speed suitable to road conditions.

When parking the vehicle

- Turn automatic mode of the parking brake off. Otherwise, the parking brake may freeze and not be able to be released automatically. Also, avoid using the following as the parking brake may operate automatically, even if automatic mode is off.
 - Brake hold system
- Park the vehicle and shift the shift lever to P without setting the parking brake. The parking brake may freeze up, preventing it from being released. If the vehicle is parked without setting the parking brake, make sure to block the wheels. Failure to do so may be dangerous because it may cause the vehicle to move unexpectedly, possibly leading to an accident. When the parking brake is in automatic mode, release the parking brake after shifting the shift lever to P. (→P. 225)
- If the vehicle is parked without setting the parking brake, confirm that the shift lever cannot be moved out of P*.

*: The shift lever will be locked if it is attempted to be shifted from P to any other position without depressing the brake pedal. If the shift lever can be shifted from P, there may be a problem with the shift lock system. Have the vehicle inspected by your Toyota dealer immediately.

Selecting tire chains

- ▶ Vehicles with 16 and 17-inch tires

Use the correct tire chain size when mounting the snow chains. Chain size is regulated for each tire size.

Side chain:

- ① 0.12 in. (3 mm) in diameter
- ② 0.39 in. (10 mm) in width
- ③ 1.18 in. (30 mm) in length

Cross chain:

- ④ 0.16 in. (4 mm) in diameter
- ⑤ 0.55 in. (14 mm) in width
- ⑥ 0.98 in. (25 mm) in length

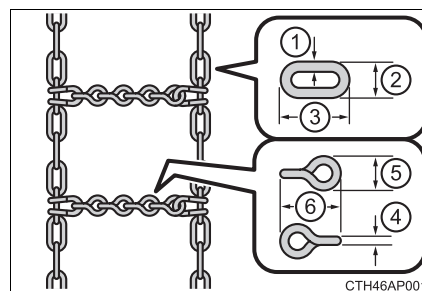

- ▶ Vehicles with 18 and 19-inch tires

Tire chains cannot be mounted.

Snow tires should be used instead.

Regulations on the use of tire chains

Regulations regarding the use of tire chains vary depending on location and type of road. Always check local regulations before installing chains.

■ Tire chain installation

Observe the following precautions when installing and removing chains:

- Install and remove tire chains in a safe location.
- Install tire chains on the front tires. Do not install tire chains on the rear tires.
- Install tire chains on front tires as tightly as possible. Retighten chains after driving 1/4 — 1/2 mile (0.5 — 1.0 km).
- Install tire chains following the instructions provided with the tire chains.

⚠ WARNING

■ Driving with snow tires

Observe the following precautions to reduce the risk of accidents. Failure to do so may result in a loss of vehicle control and cause death or serious injury.

- Use tires of the size specified.
- Maintain the recommended level of air pressure.
- Do not drive in excess of 75 mph (120 km/h), regardless of the type of snow tires being used.
- Use snow tires on all, not just some wheels.

■ Driving with tire chains (vehicles with 16 and 17-inch tires)

Observe the following precautions to reduce the risk of accidents. Failure to do so may result in the vehicle being unable to be driven safely, and may cause death or serious injury.

- Do not drive in excess of the speed limit specified for the tire chains being used, or 30 mph (50 km/h), whichever is lower.
- Avoid driving on bumpy road surfaces or over potholes.
- Avoid sudden acceleration, abrupt steering, sudden braking and shifting operations that cause sudden engine braking.
- Slow down sufficiently before entering a curve to ensure that vehicle control is maintained.
- Do not use LTA (Lane Tracing Assist) system.



NOTICE

■ Repairing or replacing snow tires

Request repairs or replacement of snow tires from Toyota dealers or legitimate tire retailers.

This is because the removal and attachment of snow tires affects the operation of the tire pressure warning valve and transmitters.

■ Fitting tire chains (vehicles with 16 and 17-inch tires)

The tire pressure warning valve and transmitters may not function correctly when tire chains are fitted.

Interior features

5

5-1. Using the air conditioning system and defogger

- Manual air conditioning system..... 382
- Automatic air conditioning system (without “SYNC” button)..... 387
- Automatic air conditioning system (with “SYNC” button)..... 394
- Heated steering wheel/ seat heaters/ seat ventilators..... 402

5-2. Using the interior lights

- Interior lights list 405
 - Interior lights 406
 - Personal lights 407

5-3. Using the storage features

- List of storage features 409
 - Glove box..... 410
 - Console box..... 410
 - Coin holder 410
 - Bottle holders..... 411
 - Cup holders 412
 - Auxiliary boxes..... 413
 - Open tray 414
- Trunk features 415

5-4. Other interior features

- Other interior features 416
 - Sun visors 416
 - Vanity mirrors..... 416
 - Power outlet..... 417
 - USB charging ports..... 418
 - Wireless charger..... 420
 - Armrest 430
 - Assist grips 430
 - Coat hooks..... 431
- Garage door opener..... 432

Manual air conditioning system*

Air conditioning controls

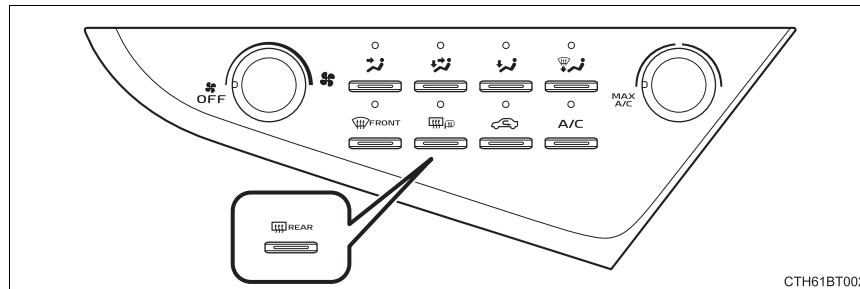

■ Adjusting the temperature setting

To adjust the temperature setting, turn  clockwise to increase the temperature and counterclockwise to decrease the temperature.

If  is not pressed, the system will blow ambient temperature air or heated air.

■ Fan speed setting

To adjust the fan speed, turn * clockwise to increase the fan speed and counterclockwise to decrease the fan speed.

Turning the dial to “OFF” turns off the fan.

■ Change the airflow mode

To change the airflow mode, press .

or .

- ① Air flows to the upper body.
- ② Air flows to the upper body and feet.
- ③ Air flows to the feet.
- ④ Air flows to the feet and the windshield defogger operates.

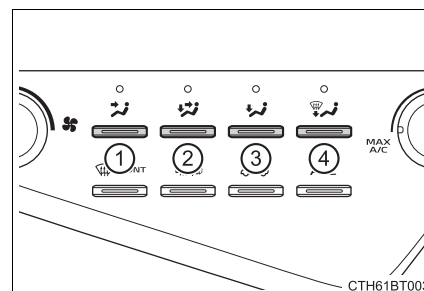

*: If equipped

Other functions

■ Switching between outside air and recirculated air modes

Press .

The mode switches between outside air mode (indicator off) and recirculated air mode (indicator on) each time  is pressed.

■ Defogging the windshield

Defoggers are used to defog the windshield and front side windows.

1 Press .

If the recirculated air mode is used, it will automatically switch to the outside air mode.

2 Perform the following operations accordingly:

- To adjust the fan speed, turn .

- To adjust the temperature setting, turn .

- If the dehumidification function is not operating, press  to operate the dehumidification function.

To defog the windshield and the side windows early, turn the air flow and temperature up.

■ Defogging the rear window and outside rear view mirrors

▶ Vehicles without outside rear view mirror defoggers

A defogger is used to defog the rear window.

Press .

The defogger will automatically turn off after a period of time.

▶ Vehicles with outside rear view mirror defoggers

Defoggers are used to defog the rear window, and to remove raindrops, dew and frost from the outside rear view mirrors.

Press .

The defoggers will automatically turn off after a period of time.

Air outlets

■ Location of air outlets

The air outlets and air volume change according to the selected airflow mode.

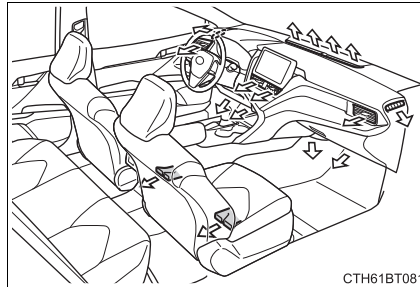



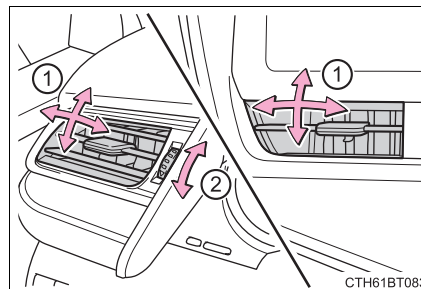

■ Adjusting the position of and opening and closing the air outlets

- ① Direct air flow to the left or right, up or down.
- ② Turn the knob to open or close the vent.



■ For quick cooling

Turn  to "MAX A/C". The air conditioning will automatically turn on.

 will be set for recirculated air mode when  or  is selected. It is not possible to turn to the outside air mode.

■ Fogging up of the windows

- The windows will easily fog up when the humidity in the vehicle is high.

Turning  on will dehumidify the air from the outlets and defog the windshield effectively.

- If you turn  off, the windows may fog up more easily.
- The windows may fog up if the recirculated air mode is used.

■ When driving on dusty roads



Close all windows. If dust thrown up by the vehicle is still drawn into the vehicle after closing the windows, it is recommended that the air intake mode be set to outside air mode and the fan speed to any setting except off.

■ Outside/recirculated air mode

- Setting to the recirculated air mode temporarily is recommended in preventing dirty air from entering the vehicle interior and helping to cool the vehicle when the outside air temperature is high.
- Outside/recirculated air mode may automatically switch depending on the temperature setting or the inside temperature.

■ When the outside temperature exceeds 75°F (24°C) and the air conditioning system is on

- In order to reduce the air conditioning power consumption, the air conditioning system may switch to recirculated air mode automatically. This may also reduce fuel consumption.
- Vehicles without a smart key system:
Recirculated air mode is selected as a default mode when the engine switch is turned to the "ON" position.
- Vehicles with a smart key system:
Recirculated air mode is selected as a default mode when the engine switch is turned to IGNITION ON mode.

- It is possible to switch to outside air mode at any time by pressing  .

■ When the outside temperature is low

The dehumidification function may not operate even when  is pressed.

■ Ventilation and air conditioning odors

- To let fresh air in, set the air conditioning system to the outside air mode.
- During use, various odors from inside and outside the vehicle may enter into and accumulate in the air conditioning system. This may then cause odor to be emitted from the vents.
- To reduce potential odors from occurring:
It is recommended that the air conditioning system be set to outside air mode prior to turning the vehicle off.

■ Air conditioning filter

→P. 492

■ Air conditioning system refrigerant

- A label regarding the refrigerant of the air conditioning system is attached to the hood at the location shown in the illustration.

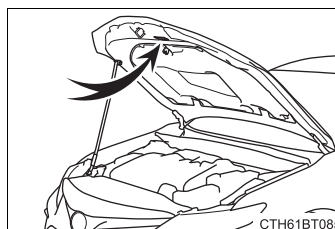

CTH61BT085

- The meaning of each symbol on the label are as follows:



Caution



Requires registered technician to service air conditioning system



Air conditioning system



Flammable refrigerant



Air conditioning system lubricant type

WARNING

■ To prevent the windshield from fogging up

- Do not use during cool air operation in extremely humid weather.

The difference between the temperature of the outside air and that of the windshield can cause the outer surface of the windshield to fog up, blocking your vision.

- Do not place anything on the instrument panel which may cover the air outlets. Otherwise, air flow may be obstructed, preventing the windshield defoggers from defogging.

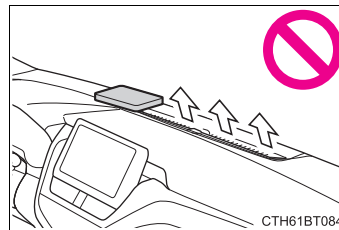

■ To prevent burns (vehicles with outside rear view mirror defoggers)

Do not touch the rear view mirror surfaces when the outside rear view mirror defoggers are on.

NOTICE

■ To prevent battery discharge

Do not leave the air conditioning system on longer than necessary when the engine is stopped.

■ When repairing/replacing parts of the air conditioning system

Have repair/replacement performed by your Toyota dealer.

When a part of the air conditioning system, such as the evaporator, is to be replaced, it must be replaced with a new one.

Automatic air conditioning system (without "SYNC" button)*

Air outlets and fan speed are automatically adjusted according to the temperature setting.

Air conditioning controls

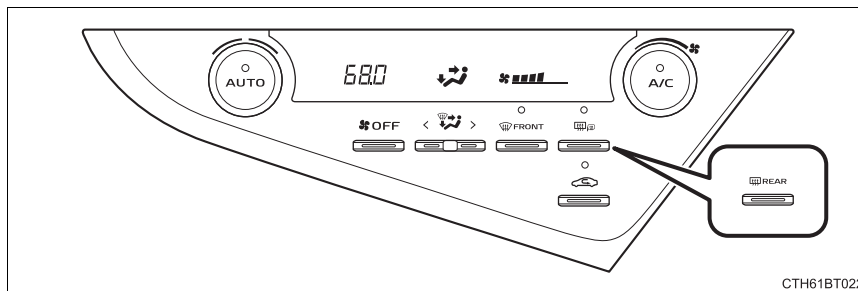



■ Adjusting the temperature setting

To adjust the temperature setting, turn  clockwise to increase the temperature and counterclockwise to decrease the temperature.

If  is not pressed, the system will blow ambient temperature air or heated air.

■ Fan speed setting

To adjust the fan speed, turn  clockwise to increase the fan speed and counterclockwise to decrease the fan speed.

Press  to turn the fan off.

*: If equipped

■ Change the airflow mode

To change the airflow mode, press “<” or “>” on .

- ① Air flows to the upper body.
- ② Air flows to the upper body and feet.
- ③ Air flows to the feet.
- ④ Air flows to the feet and the windshield defogger operates.

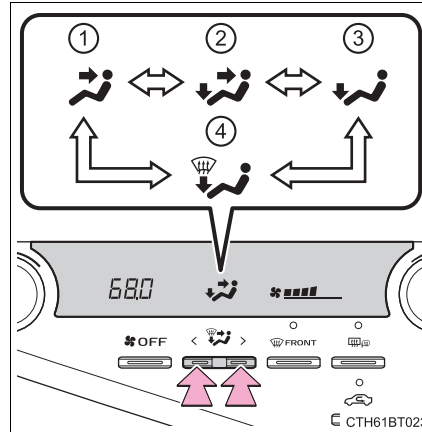

Using automatic mode

- 1 Press .

The dehumidification function begins to operate. Air outlets and fan speed are automatically adjusted according to the temperature setting.

- 2 Adjust the temperature setting.
- 3 To stop the operation, press .

■ Automatic mode indicator

If the fan speed setting or air flow modes are operated, the automatic mode indicator goes off. However, automatic mode for functions other than that operated is maintained.

Other functions

■ Switching between outside air and recirculated air modes

Press .

The mode switches between outside air mode (indicator off) and recirculated air mode (indicator on) each time  is pressed.

■ Defogging the windshield

Defoggers are used to defog the windshield and front side windows.

Press .

The dehumidification function operates and fan speed increases. Set the outside/recirculated air mode button to the outside air mode if the recirculated air mode is used. (It may switch automatically.) To defog the windshield and the side windows early, turn the air flow and temperature up.

To return to the previous mode, press  again when the windshield is defogged.

■ Defogging the rear window and outside rear view mirrors

▶ Vehicles without outside rear view mirror defoggers

A defogger is used to defog the rear window.

Press .

The defogger will automatically turn off after a period of time.

▶ Vehicles with outside rear view mirror defoggers

Defoggers are used to defog the rear window, and to remove raindrops, dew and frost from the outside rear view mirrors.

Press .

The defoggers will automatically turn off after a period of time.

Air outlets

■ Location of air outlets

The air outlets and air volume change according to the selected airflow mode.

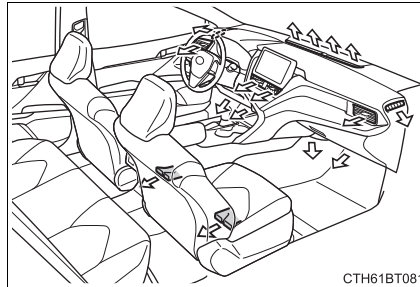

■ Adjusting the position of and opening and closing the air outlets

- ① Direct air flow to the left or right, up or down.
- ② Turn the knob to open or close the vent.

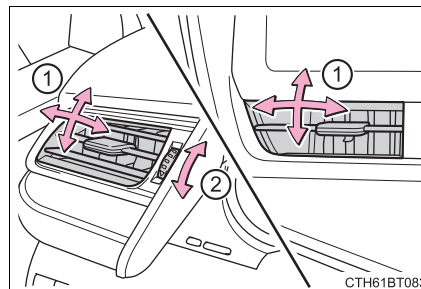

■ Using automatic mode

Fan speed is adjusted automatically according to the temperature setting and the ambient conditions.

Therefore, the fan may stop for a while until warm or cool air is ready to flow

immediately after  is pressed.

■ Fogging up of the windows

- The windows will easily fog up when the humidity in the vehicle is high.

Turning  on will dehumidify the air from the outlets and defog the windshield effectively.

- If you turn  off, the windows may fog up more easily.
- The windows may fog up if the recirculated air mode is used.

■ When driving on dusty roads

Close all windows. If dust thrown up by the vehicle is still drawn into the vehicle after closing the windows, it is recommended that the air intake mode be set to outside air mode and the fan speed to any setting except off.

■ Outside/recirculated air mode

- Setting to the recirculated air mode temporarily is recommended in preventing dirty air from entering the vehicle interior and helping to cool the vehicle when the outside air temperature is high.
- Outside/recirculated air mode may automatically switch depending on the temperature setting or the inside temperature.

■ When the outside temperature exceeds 75°F (24°C) and the air conditioning system is on

- In order to reduce the air conditioning power consumption, the air conditioning system may switch to recirculated air mode automatically. This may also reduce fuel consumption.
- Vehicles without a smart key system:
Recirculated air mode is selected as a default mode when the engine switch is turned to the "ON" position.
Vehicles with a smart key system:
Recirculated air mode is selected as a default mode when the engine switch is turned to IGNITION ON mode.

- It is possible to switch to outside air mode at any time by pressing  .

■ When the outside temperature is low

The dehumidification function may not operate even when  is pressed.

■ Operation of the air conditioning system in Eco drive mode (if equipped)

- In the Eco drive mode, the air conditioning system is controlled as shown below to prioritize fuel efficiency.
Fan speed restricted when automatic mode is selected
- To improve air conditioning performance, perform the following operations:
 - Adjust the fan speed
 - Turn off Eco drive mode

■ **Ventilation and air conditioning odors**

- To let fresh air in, set the air conditioning system to the outside air mode.
- During use, various odors from inside and outside the vehicle may enter into and accumulate in the air conditioning system. This may then cause odor to be emitted from the vents.
- To reduce potential odors from occurring:
 - It is recommended that the air conditioning system be set to outside air mode prior to turning the vehicle off.
 - The start timing of the blower may be delayed for a short period of time immediately after the air conditioning system is started in automatic mode.

■ **Air conditioning filter**

→P. 492

■ **Air conditioning system refrigerant**

- A label regarding the refrigerant of the air conditioning system is attached to the hood at the location shown in the illustration.

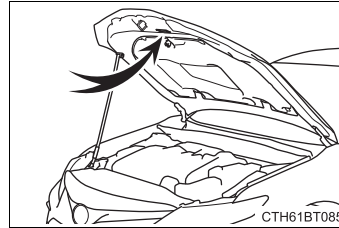

- The meaning of each symbol on the label are as follows:



Caution



Requires registered technician to service air conditioning system



Air conditioning system



Flammable refrigerant



Air conditioning system lubricant type

■ **Customization**

Some functions can be customized. (→P. 612)

⚠ WARNING**■ To prevent the windshield from fogging up**

- Do not use  during cool air operation in extremely humid weather.

The difference between the temperature of the outside air and that of the windshield can cause the outer surface of the windshield to fog up, blocking your vision.

- Do not place anything on the instrument panel which may cover the air outlets. Otherwise, air flow may be obstructed, preventing the windshield defoggers from defogging.

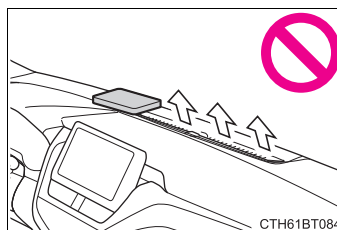
**■ To prevent burns (vehicles with outside rear view mirror defoggers)**

Do not touch the rear view mirror surfaces when the outside rear view mirror defoggers are on.

⚠ NOTICE**■ To prevent battery discharge**

Do not leave the air conditioning system on longer than necessary when the engine is stopped.

■ When repairing/replacing parts of the air conditioning system

Have repair/replacement performed by your Toyota dealer.

When a part of the air conditioning system, such as the evaporator, is to be replaced, it must be replaced with a new one.

Automatic air conditioning system (with "SYNC" button)*

Air outlets and fan speed are automatically adjusted according to the temperature setting.

Air conditioning controls

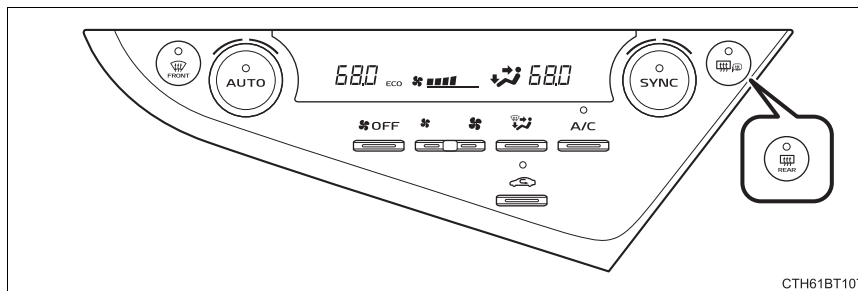

*: If equipped



■ Adjusting the temperature setting

To adjust the temperature setting, turn  clockwise to increase the temperature and counterclockwise to decrease the temperature.

If  is not pressed, the system will blow ambient temperature air or heated air.

The air conditioning system switches between individual and synchronized modes each time  is pressed.



Synchronized modes (indicator on):

The driver's side  dial can be used to adjust the temperature for the driver's and front passenger's side. At this time, operate the front passenger's side  dial to enter individual mode.

Individual modes (indicator off):

The temperature for the driver's and front passenger's side can be adjusted separately.

■ Fan speed setting

To adjust the fan speed, press  to increase the fan speed and  to decrease the fan speed.

Press  to turn the fan off.

■ Change the airflow mode

To change the airflow mode, press  .

The air outlets used are switched each time the button is pressed.

- ① Air flows to the upper body.
- ② Air flows to the upper body and feet.
- ③ Air flows to the feet.
- ④ Air flows to the feet and the windshield defogger operates.

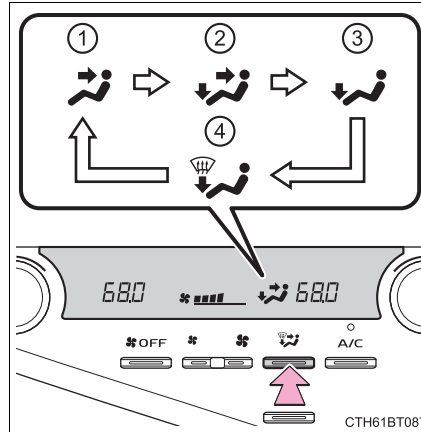

Using automatic mode

- 1 Press .

The dehumidification function begins to operate. Air outlets and fan speed are automatically adjusted according to the temperature setting.

- 2 Adjust the temperature setting.
- 3 To stop the operation, press .

■ Automatic mode indicator

If the fan speed setting or air flow modes are operated, the automatic mode indicator goes off. However, automatic mode for functions other than that operated is maintained.

Other functions

■ Switching between outside air and recirculated air modes

Press .

The mode switches between outside air mode (indicator off) and recirculated air mode (indicator on) each time  is pressed.

■ Defogging the windshield

Defoggers are used to defog the windshield and front side windows.

Press .

The dehumidification function operates and fan speed increases. Set the outside/recirculated air mode button to the outside air mode if the recirculated air mode is used. (It may switch automatically.) To defog the windshield and the side windows early, turn the air flow and temperature up.

To return to the previous mode, press  again when the windshield is defogged.

■ Defogging the rear window and outside rear view mirrors

- ▶ Vehicles without outside rear view mirror defoggers

A defogger is used to defog the rear window.

Press .

The defogger will automatically turn off after a period of time.

- ▶ Vehicles with outside rear view mirror defoggers

Defoggers are used to defog the rear window, and to remove rain-drops, dew and frost from the outside rear view mirrors.

Press .

The defoggers will automatically turn off after a period of time.

Air outlets

■ Location of air outlets

The air outlets and air volume change according to the selected airflow mode.

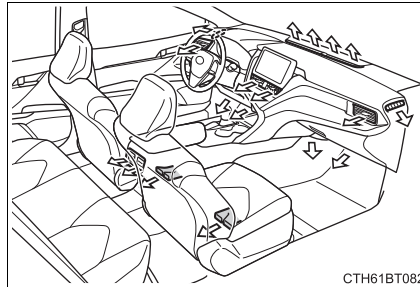

CTH61BT082

■ Adjusting the position of and opening and closing the air outlets

► Front

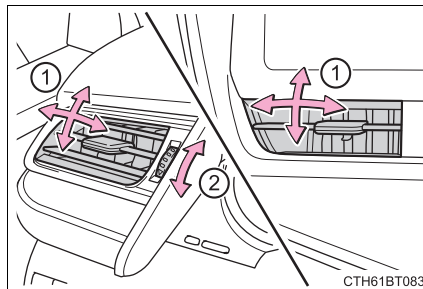

CTH61BT083

► Rear

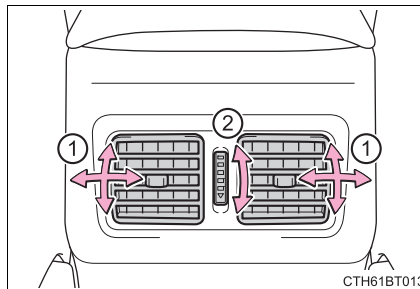

CTH61BT013

- ① Direct air flow to the left or right, up or down.
- ② Turn the knob to open or close the vent.

■ Using automatic mode

Fan speed is adjusted automatically according to the temperature setting and the ambient conditions.

Therefore, the fan may stop for a while until warm or cool air is ready to flow

immediately after  is pressed.

■ Fogging up of the windows

- The windows will easily fog up when the humidity in the vehicle is high.

Turning  on will dehumidify the air from the outlets and defog the windshield effectively.

- If you turn  off, the windows may fog up more easily.
- The windows may fog up if the recirculated air mode is used.

■ When driving on dusty roads

Close all windows. If dust thrown up by the vehicle is still drawn into the vehicle after closing the windows, it is recommended that the air intake mode be set to outside air mode and the fan speed to any setting except off.

■ Outside/recirculated air mode

- Setting to the recirculated air mode temporarily is recommended in preventing dirty air from entering the vehicle interior and helping to cool the vehicle when the outside air temperature is high.
- Outside/recirculated air mode may automatically switch depending on the temperature setting or the inside temperature.

■ When the outside temperature exceeds 75°F (24°C) and the air conditioning system is on

- In order to reduce the air conditioning power consumption, the air conditioning system may switch to recirculated air mode automatically. This may also reduce fuel consumption.
- Recirculated air mode is selected as a default mode when the engine switch is turned to IGNITION ON mode.

- It is possible to switch to outside air mode at any time by pressing .

■ When the outside temperature is low

The dehumidification function may not operate even when  is pressed.

■ **Operation of the air conditioning system in Eco drive mode**

- In the Eco drive mode, “ECO” is displayed on the air conditioning screen and the air conditioning system is controlled as shown below to prioritize fuel efficiency.

Fan speed restricted when automatic mode is selected

- To improve air conditioning performance, perform the following operations:
 - Adjust the fan speed
 - Turn off Eco drive mode

■ **Ventilation and air conditioning odors**

- To let fresh air in, set the air conditioning system to the outside air mode.
- During use, various odors from inside and outside the vehicle may enter into and accumulate in the air conditioning system. This may then cause odor to be emitted from the vents.
- To reduce potential odors from occurring:
 - It is recommended that the air conditioning system be set to outside air mode prior to turning the vehicle off.
 - The start timing of the blower may be delayed for a short period of time immediately after the air conditioning system is started in automatic mode.

■ **Air conditioning filter**

→P. 492

■ **Air conditioning system refrigerant**

- A label regarding the refrigerant of the air conditioning system is attached to the hood at the location shown in the illustration.

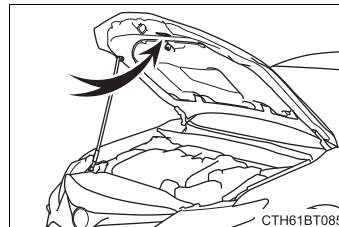

- The meaning of each symbol on the label are as follows:



Caution



Requires registered technician to service air conditioning system



Air conditioning system



Flammable refrigerant



Air conditioning system lubricant type

■ Customization

Some functions can be customized. (→P. 612)

⚠ WARNING

■ To prevent the windshield from fogging up

- Do not use  during cool air operation in extremely humid weather.

The difference between the temperature of the outside air and that of the windshield can cause the outer surface of the windshield to fog up, blocking your vision.

- Do not place anything on the instrument panel which may cover the air outlets. Otherwise, air flow may be obstructed, preventing the windshield defoggers from defogging.

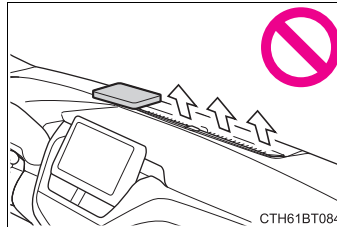

■ To prevent burns (vehicles with outside rear view mirror defoggers)

Do not touch the rear view mirror surfaces when the outside rear view mirror defoggers are on.

⚠ NOTICE

■ To prevent battery discharge

Do not leave the air conditioning system on longer than necessary when the engine is stopped.

■ When repairing/replacing parts of the air conditioning system

Have repair/replacement performed by your Toyota dealer.

When a part of the air conditioning system, such as the evaporator, is to be replaced, it must be replaced with a new one.

Heated steering wheel*/seat heaters*/seat ventilators*

Heated steering wheel and seat heaters heat the side grips of the steering wheel and seats, respectively. Seat ventilators maintain good ventilation by pulling air through the seat upholstery.

WARNING

■ To prevent minor burn injuries

Care should be taken to prevent injury if anyone in the following categories comes in contact with the steering wheel and seats when the heater is on:

- Babies, small children, the elderly, the sick and the physically challenged
- Persons with sensitive skin
- Persons who are fatigued
- Persons who have taken alcohol or drugs that induce sleep (sleeping drugs, cold remedies, etc.)

■ To prevent damage to the seat heaters

Observe the following precautions to prevent the minor burns or overheating

- Do not cover the seat with a blanket or cushion when using the seat heater.
- Do not use seat heater more than necessary.

NOTICE

- Do not put heavy objects that have an uneven surface on the seat and do not stick sharp objects (needles, nails, etc.) into the seat.
- To prevent battery discharge, do not use the functions when the engine is not running.

*: If equipped

Heated steering wheel

Turns the heated steering wheel on/off

The indicator light comes on when the heated steering wheel is operating.

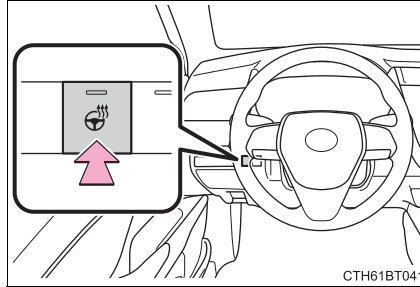

Operation condition

Vehicles without a smart key system:

The heated steering wheel can be used when the engine switch is in the "ON" position.

Vehicles with a smart key system:

The heated steering wheel can be used when the engine switch is in IGNITION ON mode.

Seat heaters

Without seat ventilators

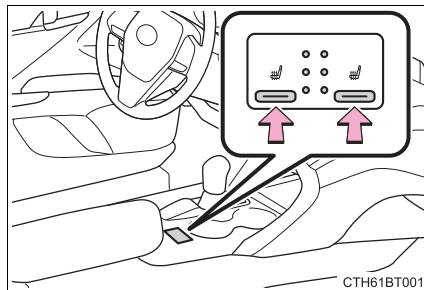

With seat ventilators

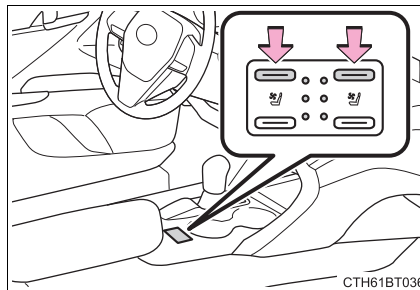

Each time the switch is pressed, the operation condition changes as follows.

Hi (3 segments lit) → Mid (2 segments lit) → Lo (1 segment lit) → Off

The level indicator (amber) lights up during operation.

Operation condition

Vehicles without a smart key system:

The seat heaters can be used when the engine switch is in the "ON" position.

Vehicles with a smart key system:

The seat heaters can be used when the engine switch is in IGNITION ON mode.

Seat ventilators

Each time the switch is pressed, the operation condition changes as follows.

Hi (3 segments lit) → Mid (2 segments lit) → Lo (1 segment lit) → Off

The level indicator (green) lights up during operation.

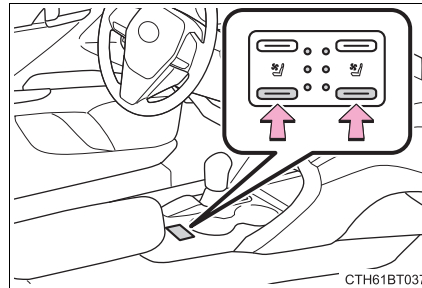

■ **The seat ventilators can be used when**

The engine switch is in IGNITION ON mode.

■ **Air conditioning system-linked control mode**

When a seat ventilator is set to Hi, the fan speed of the seat ventilator may increase according to the fan speed of the air conditioning system

Interior lights list

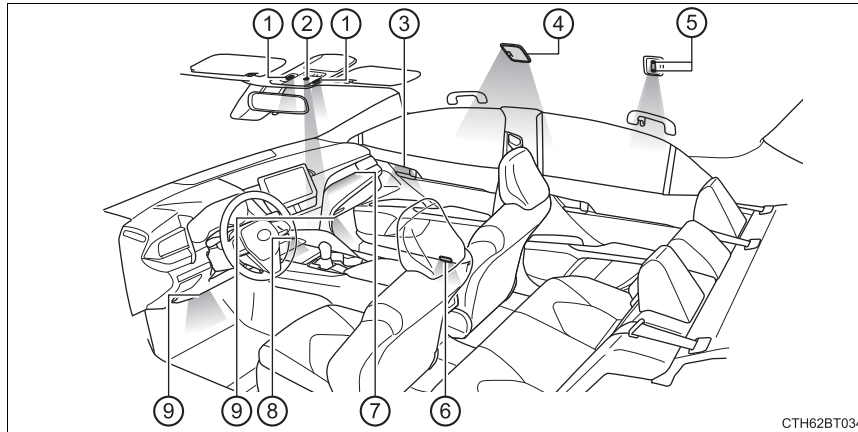

- ① Front interior/personal lights (→P. 406, 407)
- ② Shift lever light (if equipped)
- ③ Inside door handle lights (if equipped)
- ④ Rear interior light (if equipped) (→P. 406)
- ⑤ Rear personal lights (if equipped) (→P. 407)
- ⑥ Door courtesy lights (if equipped)
- ⑦ Instrument panel ornament light (if equipped)
- ⑧ Front center console light (if equipped)
- ⑨ Footwell lights (if equipped)

Interior lights

■ Front (if equipped)

The rear personal lights (if equipped) turn on/off together with the front interior light.

- ① Turns the lights on/off linked to door positions
- ② Turns the lights on/off

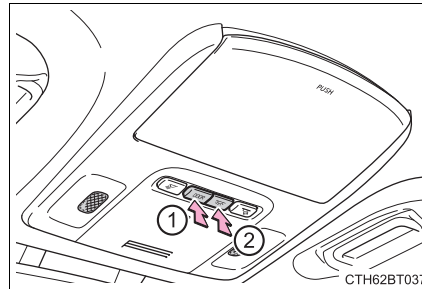

■ Rear (if equipped)

- ① Turns the light off
- ② Turns the light on/off linked to door positions
- ③ Turns the light on

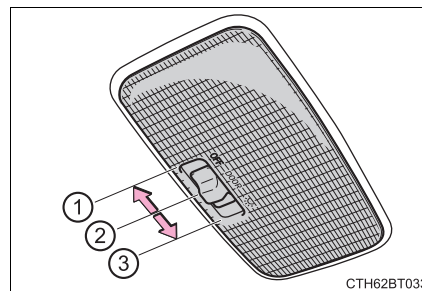

Personal lights

■ **Front**

Turns the lights on/off

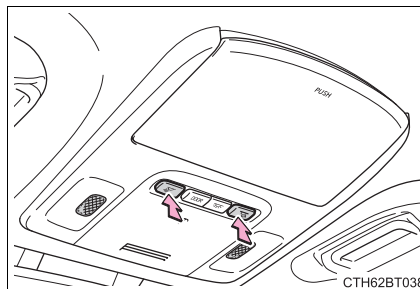

■ **Rear (if equipped)**

Turns the lights on/off

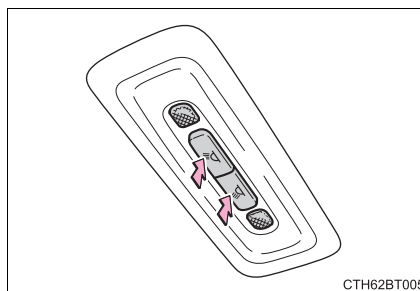

■ **Illuminated entry system**

Vehicles without a smart key system:

The lights automatically turn on/off according to the engine switch position, whether the doors are locked/unlocked, and whether the doors are open/closed.

Vehicles with a smart key system:

The lights automatically turn on/off according to the engine switch mode, the presence of the electronic key, whether the doors are locked/unlocked, and whether the doors are open/closed.

■ **To prevent the battery from being discharged**

If the interior lights remain on when the engine switch is turned off, the lights will go off automatically after 20 minutes.

■ **The interior lights may turn on automatically when**

If any of the SRS airbags deploy (inflate) or in the event of a strong rear impact, the interior lights will turn on automatically.

The interior lights will turn off automatically after approximately 20 minutes.

The interior lights can be turned off manually. However, in order to help prevent further collisions, it is recommended that they be left on until safety can be ensured.

(The interior lights may not turn on automatically depending on the force of the impact and conditions of the collision.)

■ **Customization**

Some functions can be customized. (→P. 612)

List of storage features

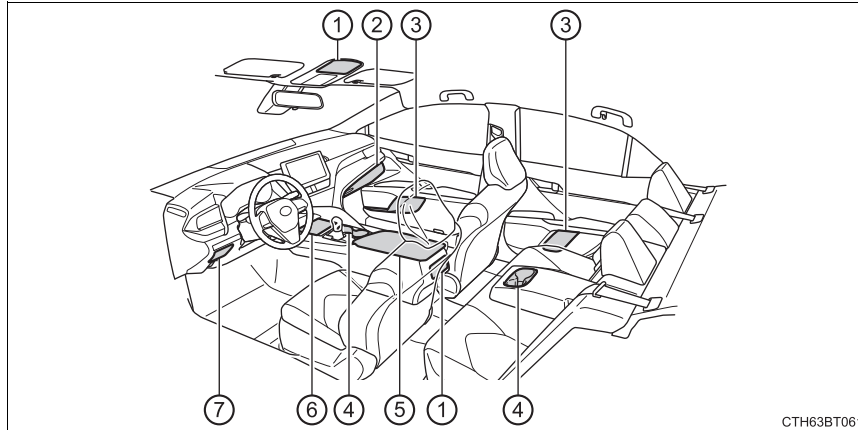

- | | | | |
|-------------------------------|-----------|---------------------------|-----------|
| ① Auxiliary boxes | (→P. 413) | ⑤ Console box | (→P. 410) |
| ② Glove box | (→P. 410) | ⑥ Auxiliary box/open tray | |
| ③ Bottle holders/door pockets | (→P. 411) | ⑦ Coin holder | (→P. 410) |
| ④ Cup holders | (→P. 412) | | |

WARNING

- Do not leave glasses, lighters or spray cans in the storage spaces, as this may cause the following when cabin temperature becomes high:
 - Glasses may be deformed by heat or cracked if they come into contact with other stored items.
 - Lighters or spray cans may explode. If they come into contact with other stored items, the lighter may catch fire or the spray can may release gas, causing a fire hazard.
- When driving or when the storage compartments are not in use, keep the lids closed.
In the event of sudden braking or sudden swerving, an accident may occur due to an occupant being struck by an open lid or the items stored inside.

Glove box

Pull up the lever to open the glove box.

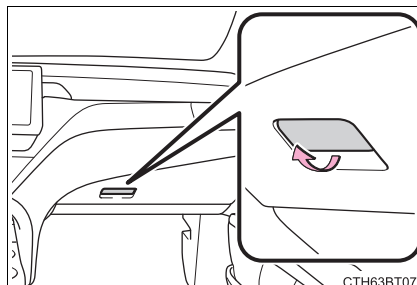

The glove box light turns on when the tail lights are on.

Console box

Push the knob.



Coin holder

Pull the lever to open.

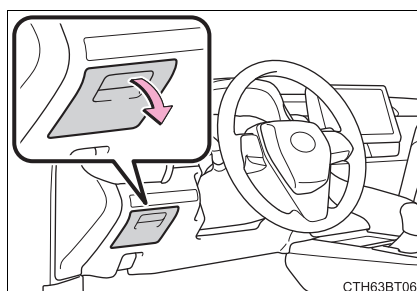

Bottle holders

► Front

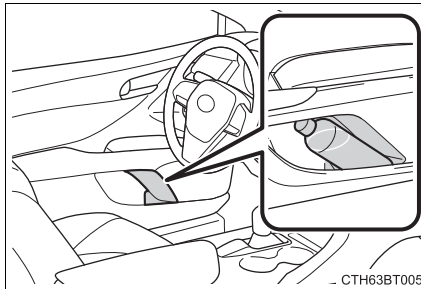

► Rear

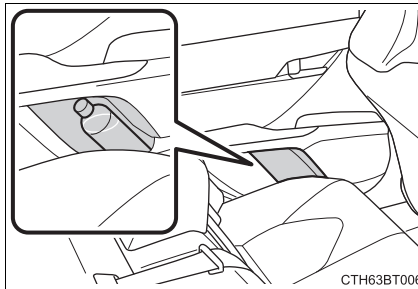

- When storing a bottle, close the cap.
- The bottle may not be stored depending on its size or shape.

⚠ WARNING

Do not place anything other than a bottle in the bottle holders. Other items may be thrown out of the holders in the event of an accident or sudden braking and cause injury.

⚠ NOTICE

Put the cap on before stowing a bottle. Do not place open bottles in the bottle holders, or glass or paper cups containing liquid. The contents may spill and glass cups may break.

Cup holders

► Front

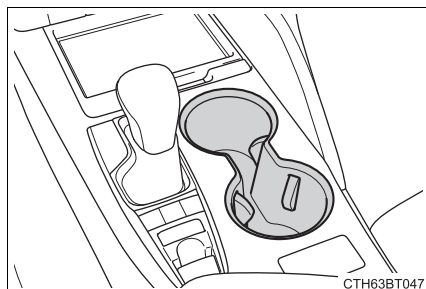

► Rear (if equipped)

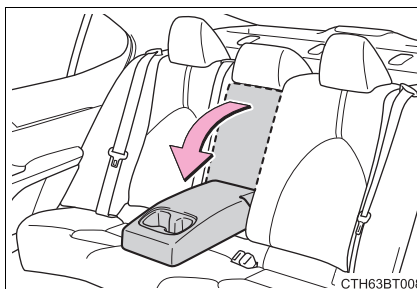

Pull the armrest down.

⚠ WARNING

■ **Items unsuitable for the cup holder**

Do not place anything other than cups or aluminum cans in the cup holders. Other items may be thrown out of the holders in the event of an accident or sudden braking, causing injury.

■ **To prevent burns**

To prevent burns, cover hot drinks when placed in the cup holders.

Auxiliary boxes

▶ Type A (if equipped)

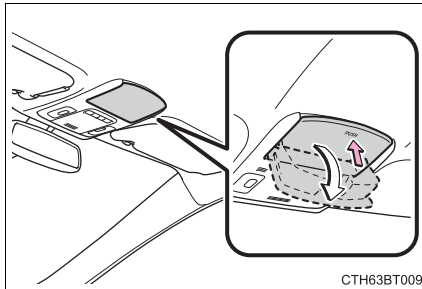

▶ Type B (if equipped)

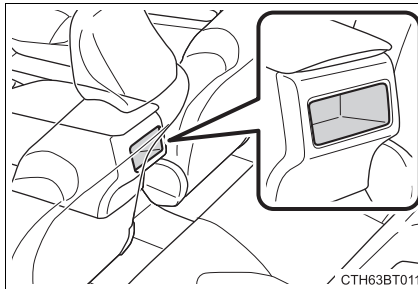

Push the lid.

▶ Type C

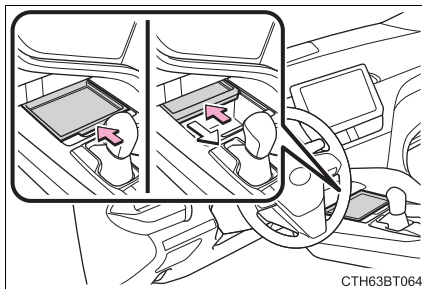

Opening:

Push the tray forward until it locks.

Closing:

Push the tray forward to release the lock and the tray will automatically close.

■ When small items are placed on top of the tray (type C)

The tray can be opened while small items are placed on it.

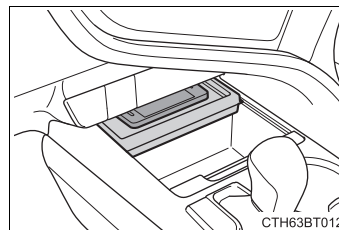

⚠ WARNING

■ **Items unsuitable for storing (type A)**

Do not store items heavier than 0.4 lb. (0.2 kg).
Doing so may cause the auxiliary box to open and the items inside may fall out, resulting in an accident.

⚠ NOTICE

■ **When opening or closing the tray (type C)**

- To prevent damaging small items, when opening the tray while small items are placed on it, make sure the items will not get caught.
- To prevent damaging the tray, do not pull the tray to close it. Doing so may damage the tray.

Open tray

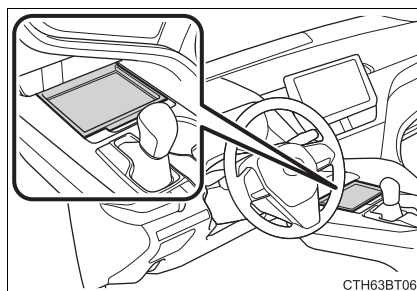

■ **When using wireless charger (if equipped)**

→P. 420

⚠ WARNING

Observe the following precautions when putting items in the open tray. Failure to do so may cause items to be thrown out of the tray in the event of sudden braking or steering. In these cases, the items may interfere with pedal operation or cause driver distraction, resulting in an accident.

- Do not store items in the tray that can easily shift or roll out.
- Do not stack items in the tray higher than the tray's edge.
- Do not put items in the tray that may protrude over the tray's edge.

Trunk features

Grocery bag hooks

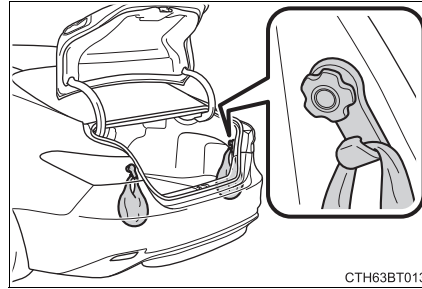

 NOTICE

To prevent damage to the hooks, do not apply too much load to the hooks.

Other interior features

Sun visors

- ① To set the visor in the forward position, flip it down.
- ② To set the visor in the side position, flip down, unhook, and swing it to the side.
- ③ To use the side extender, place the visor in the side position, then slide it backward.

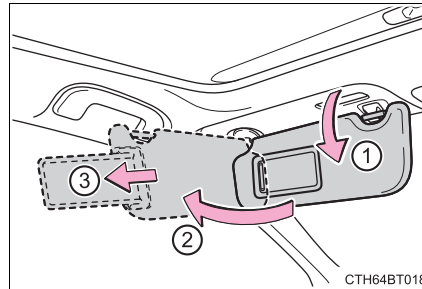

Vanity mirrors

Slide the cover to open.

Vehicles with vanity lights: The light turns on when the cover is opened.

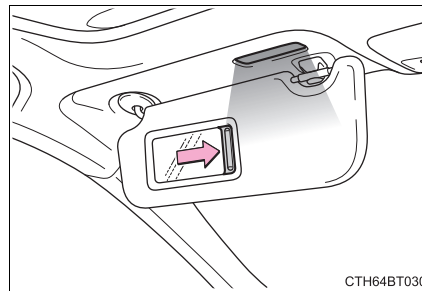

Vehicles with vanity lights: If the vanity lights remain on for 20 minutes while the engine is off, the lights will turn off automatically.

Power outlet

Please use as a power supply for electronic goods that use less than 12 VDC/10 A (power consumption of 120 W).

Open the lid.

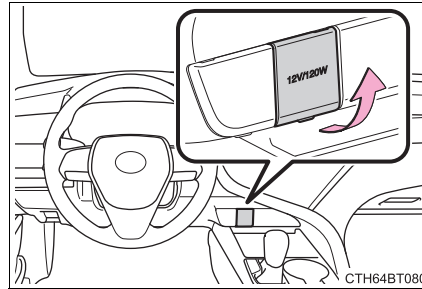

■ The power outlet can be used when

Vehicles without a smart key system:

The engine switch is in the "ACC" or "ON" position.

Vehicles with a smart key system:

The engine switch is in ACCESSORY or IGNITION ON mode.

■ When turning the engine switch off

Disconnect electrical devices with charging functions, such as mobile battery packs.

If such devices are left connected, the engine switch may not be turned off normally.

⚠ NOTICE

- To avoid damaging the power outlet, close the power outlet lid when it is not in use.
Foreign objects or liquids that enter the power outlet may cause a short circuit.
- To prevent battery discharge, do not use the power outlet longer than necessary when the engine is not running.

USB charging ports

The USB charging ports are used to supply 2.5 A (USB Type-A port) or 3.0 A (USB Type-C port) of electricity at 5 V to external devices. The USB charging ports are for charging only. They are not designed for data transfer or other purposes.

Depending on the external device, it may not charge properly. Refer to the manual included with the device before using a USB charging port.

■ Using the USB charging ports

Open the console box lid and open the lid.

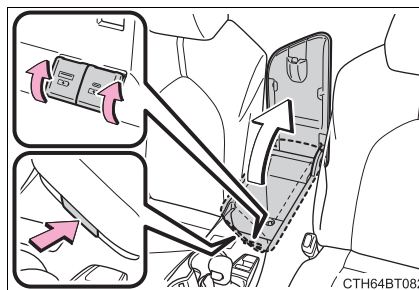

■ The USB charging ports can be used when

Vehicles without a smart key system:

The engine switch is in the “ACC” or “ON” position.

Vehicles with a smart key system:

The engine switch is in ACCESSORY or IGNITION ON mode.

■ Situations in which the USB charging ports may not operate correctly

- If a device which consumes more than 2.5 A at 5 V (USB Type-A port) or 3.0 A at 5 V (USB Type-C port) is connected
- If a device designed to communicate with a personal computer, such as a USB memory device, is connected
- If the connected external device is turned off (depending on device)
- If the temperature inside the vehicle is high, such as after the vehicle has been parked in the sun

■ About connected external devices

Depending on the connected external device, charging may occasionally be suspended and then start again. This is not a malfunction.

■ Cable pass through

The shape of the console box rim allows power cables to be passed through when the console box lid is closed.

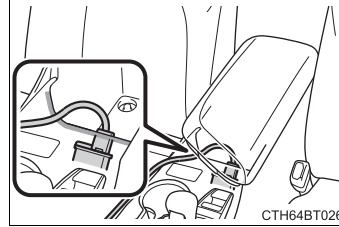
 **NOTICE****■ To prevent damage to the USB charging ports**

- Do not insert foreign objects into the ports.
- Do not spill water or other liquids into the ports.
- When the USB charging ports are not in use, close the lids. If a foreign object or liquid enters a port may cause a short circuit.
- Do not apply excessive force to or impact the USB charging ports.
- Do not disassemble or modify the USB charging ports.

■ To prevent damage to external devices

- Do not leave external devices in the vehicle. The temperature inside the vehicle may become high, resulting in damage to an external device.
- Do not push down on or apply unnecessary force to an external device or the cable of an external device while it is connected.

■ To prevent battery discharge

Do not use the USB charging ports for a long period of time with the engine stopped.

Wireless charger (if equipped)

A portable device, such as a smartphone or mobile battery, can be charged by just placing it on the charging area, provided the device is compatible with the Qi wireless charging standard created by the Wireless Power Consortium.

The wireless charger cannot be used with a portable device that is larger than the charging area. Additionally, depending on the portable device, the wireless charger may not operate properly. Refer to the operation manual of the portable device.

■ The “Qi” logo

The “Qi” logo is a trademark of the Wireless Power Consortium.



■ Name for all parts

- ① Power supply switch
- ② Operation indicator light
- ③ Charging tray
- ④ Charging area*

*: Compatible portable devices and the wireless charger contain charging coils. The charging coil inside the wireless charger can move within the area around the center of the charging tray. When the charging coil inside a portable device is detected within the charging area, the charging coil in the wireless charger will move near the other coil and charging will begin. If the charging coil inside the portable device is moved out of the charging area, charging will be stopped automatically.

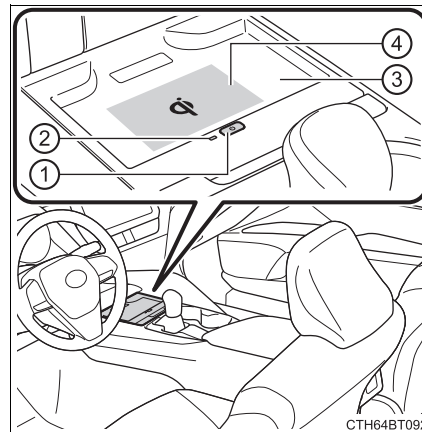

Additionally, if 2 or more portable devices are placed on the charging tray at the same time, each charging coil may not be detected correctly and charging may not be possible.

■ Using the wireless charger

- 1 Press the power supply switch of the wireless charger.

Pressing the switch again turns the wireless charger off.

When turned on, the operation indicator light (green) comes on.

When the engine switch is turned off, the on/off state of the wireless charger will be memorized.

If the power supply switch is pressed 3 times while charging is being performed, the rapid charging function will turn on. To turn the wireless charger off, press the power supply switch when a portable device is not being charged.

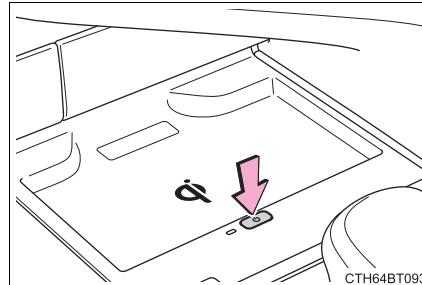

CTH64BT093

- 2 Place a portable device on the charging tray.

Place the portable device so that it is centered in the charging area with its charging surface facing the portable charger. Depending on the portable device, its charging coil may not be in the center of the device. In this case, place the portable device so that its charging coil is centered in the charging area.

While charging, the operation indicator light (orange) will be illuminated.

If charging does not begin, move the portable device as close to the center of the charging area as possible.

When charging is complete, the operation indicator light (green) will illuminate.

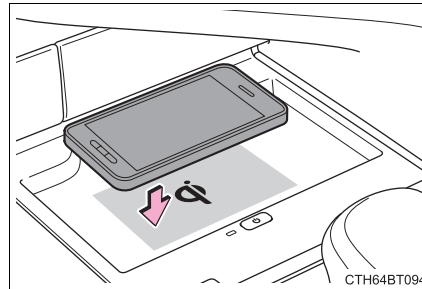

CTH64BT094

■ Recharging function

- If a certain amount of time has elapsed since charging completed and the portable device has not been moved, the wireless charger will restart charging.
- If a portable device is moved significantly within the charging area, the charging coil may disconnect and charging may temporarily be stopped. However, if a charging coil is detected within the charging area, the charging coil inside the wireless charger will move near the other coil and charging will resume.

■ Rapid charging function

- Portable devices, such as the following, can be rapidly charged.
 - Rapid charging capable devices which conform to WPC Ver 1.2.4.
 - 7.5 W charging capable iPhones (iPhone 8 and later)
- To turn the rapid charging function on, press the power supply switch 3 times while charging is being performed. If rapid charging is possible, the operation indicator will change from illuminated (orange) to alternating between (green) and (orange).
- When charging is finished, the rapid charging function will turn off. To perform rapid charging again, turn the rapid charging function back on.

■ Operation indicator light status

Operation indicator light	State
Off	The Wireless charger is off
Green (illuminated)	Standby (charging is possible) ^{*1}
	Charging is complete ^{*2}
Orange (illuminated)	A portable device has been placed on the charging area (identifying the portable device)
	Charging in progress
Illuminated between green and orange alternately	<p>A portable device, such as the following, is being rapidly charged</p> <ul style="list-style-type: none"> • Rapid charging capable device which conforms to WPC Ver 1.2.4. • 7.5 W charging capable iPhone (iPhone 8 and later)

^{*1}: While in standby, charging power is not output. If a metal object is placed on the charging tray in this state, the object will not heat up.

^{*2}: Depending on the portable device, the operation indicator light may stay illuminated (orange) after charging has completed.

● If the operation indicator light blinks

If an error is detected, the operation indicator light will blink (orange). Take the appropriate measures according to the table below.

Operation indicator light	Suspected causes	Measure
Continuously blinks 1 time per second	Communication malfunction between the wireless charger and smart key system	If the engine is running, stop the engine and then restart it. If the engine switch is in ACCESSORY mode, start the engine. (→P. 211)
Continuously flashes 3 times (orange)	Foreign matter detected If a metallic foreign object is detected in the charge area, the overheat prevention function of the charging coil will operate	Remove the foreign object from the charge area.
	Portable device not aligned correctly If the charging coil of a portable device is not properly positioned on the charging area, the overheat prevention function of the charging coil will operate	Remove the portable device from the charging tray, check that the operation indicator light changes back to green, and then place the portable device so that it is near the center of the charging tray. Also, if a case or cover is installed to the portable device, remove it.
Continuously flashes 4 times (orange)	Temperature inside wireless charger exceeded a certain amount	Stop charging, remove the portable device from the charging tray, and wait for the temperature to decrease before attempting to begin charging again.

■ The wireless charger can be operated when

The engine switch is in ACCESSORY or IGNITION ON mode.

■ Portable devices that can be charged

- Portable devices compatible with the Qi wireless charging standard can be charged by the wireless charger. However, compatibility with all devices which meet the Qi wireless charging standard is not guaranteed.
- The wireless charger is designed to supply low power electricity (5 W or less) to a cellular phone, smartphone, or other portable device.
- However, portable devices, such as the following, can be charged with more than 5 W.
 - 7.5 W charging compatible iPhones can be charged at 7.5 W or less.
 - Portable devices which conform to WPC Ver 1.2.4 can be charged at 10 W or less.

■ Using the smart key system

During charging, when the smart key system searches for an electronic key, charging may be temporarily suspended.

■ If a cover or accessory is attached to the portable device

Do not charge a portable device if a cover or accessory which is not Qi compatible is attached. Depending on the type of cover and/or accessory attached, it may not be possible to charge the portable device. If the portable device is placed on the charging area and does not charge, remove the cover and/or accessories.

■ If interference is heard in AM radio broadcasts while charging

- Turn off the wireless charger and check if the noise is reduced. If noise is reduced, press and hold the power supply switch of the wireless charger for 2 seconds. The frequency of the wireless charger is changed and noise may be reduced. When the frequency is changed, the operation indicator light will blink (orange) 2 times.
- Rapid charging for iPhones is performed using a specific radio wave frequency.
Depending on the version of iOS installed, while the frequency is being changed, rapid charging may not be performed.

■ Charging precautions

While charging, the wireless charger and the portable device will become warm. This is not a malfunction.

If a portable device becomes warm while charging and charging stops due to the protection function of the portable device, wait until the portable device cools down and charge it again.

Also, to decrease the temperature inside the wireless charger, a fan may operate. This does not indicate a malfunction.

■ Sound generated during operation

Operation sounds may be heard when the power supply switch is pressed to turn the wireless charger on, when the engine switch is pressed to change to ACCESSORY mode or IGNITION ON mode while the wireless charger is on, or when a portable device is being detected. This does not indicate a malfunction.

■ Situations in which the wireless charger may not operate correctly

In the following situations, the wireless charger may not operate correctly:

- When a portable device is fully charged
- When a portable device is being charged by a wired connection.
- When there is foreign matter between the charging area and portable device
- When the temperature of a portable device becomes high while charging
- When the temperature near the charging tray is 95°F (35°C) or more due to being in direct sunlight, etc.
- When a portable device is placed with its charging surface facing up
- When a portable device is not centered on the charging area
- When a portable device is larger than the charging tray
- When a foldable portable device is placed outside of the charging area
- When the vehicle is near a TV tower, electric power plant, fuel station, radio station, large display, airport, or other facility that generates strong radio waves or electrical noise
- When any of the following objects, with a thickness of 0.08 in. (2 mm) or more, are between the charging surface of a portable device and the charging area:
 - Thick cases or covers
 - Thick decorations
 - Accessories, such as finger rings, straps, etc.
- When the portable device is in contact with, or is covered by any of the following metallic objects:
 - Cards covered with metal, such as aluminum foil
 - Cigarette boxes that have aluminum foil inside
 - Metallic wallets or bags
 - Coins
 - Heat packs
 - Recorded media such as CDs and DVDs
 - Metallic decorations
 - Metallic cases or covers
- When wireless keys (that emit radio waves) other than those of your vehicle are being used nearby

- When 2 or more portable devices are placed on the charging tray at the same time

In situations other than above, if the wireless charger does not operate properly or the operation indicator light blinks continuously, the wireless charger may be malfunctioning.
Contact your Toyota dealer.

■ **Cleaning the wireless charger**

→P. 445

 **WARNING**

■ **Caution while driving**

When charging a portable device while driving, for safety reasons, the driver should not operate the portable device.

■ **Precautions for when driving**

Do not charge small, lightweight portable devices, such as wireless earbuds, while driving. Lightweight devices may fly off of the charging tray, possibly leading to an accident.

■ **Caution regarding interference with electronic devices**

People with implantable cardiac pacemakers, cardiac resynchronization therapy pacemakers or implantable cardioverter defibrillators, as well as any other electrical medical device, should consult their physician about the usage of the wireless charger.

Operations of the wireless charger may have an affect on medical devices.

 **WARNING****■ To prevent damage or burns**

Observe the following precautions.

Failure to do so may result in the possibility of fire, equipment failure or damage, or burns due to heat.

- Do not put any metallic objects between the charging area and the portable device while charging.
- Do not attach metallic objects, such as aluminum stickers, to the charging area.
- Do not charge portable devices with aluminum stickers or other metallic objects attached to the side which touches the charging area.
- Do not store items on the wireless charger instead of in an auxiliary box.
- Do not apply force or impact to the wireless charger.
- Do not disassemble, modify or remove the wireless charger.
- Do not attempt to charge portable devices which are not compatible with the Qi wireless charging standard.
- Do not allow magnetic objects to come near the wireless charger
- Do not perform charging if the charging area is dirty
- Do not cover the wireless charger with a cloth or other object while charging.

 NOTICE**■ To prevent failure or damage to data**

- Do not place magnetic cards, such as a credit card, or magnetic recording media, close to the wireless charger while charging. Otherwise, data may be erased due to the influence of magnetism. Additionally, do not bring precision instruments such as wrist watches, close to the wireless charger, as such objects may malfunction.
- Do not perform charging with a contactless smart card, such as a credit card, between the charging surface of a portable device and the charging area. The IC chip in the card may become extremely hot, possibly damaging the portable device or smart card. Be extra careful to not charge a portable device with a case or cover which a contactless smart card can be inserted.
- Do not leave portable devices in the cabin. The temperature inside the cabin may become high when parked in the sun, and cause damage to the device.

■ When the OS of a smartphone has been updated

When the OS version of a smartphone has been changed, the charging specifications may have changed. If the WPC compatibility version is changed, the rapid charging function may no longer be able to be used. For details, check for information on the website for the smartphone manufacturer.

■ To prevent battery discharge

Do not use the wireless charger for a long period of time with the engine stopped.

Armrest (if equipped)

Fold down the armrest for use.

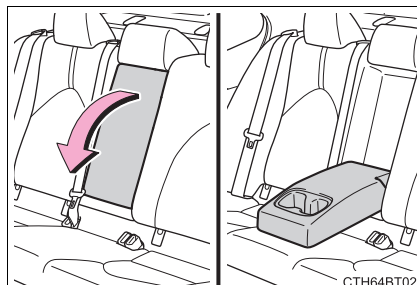

NOTICE

To prevent damage to the armrest, do not apply too much load on the armrest.

Assist grips

An assist grip installed on the ceiling can be used to support your body while sitting on the seat.

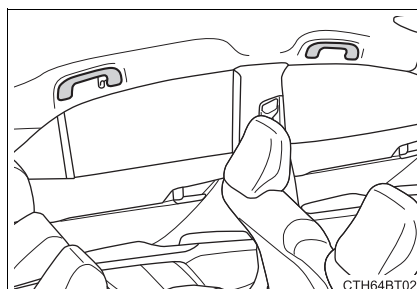

WARNING

Do not use the assist grip when getting in or out of the vehicle or rising from your seat. Doing so may cause it to break, possibly leading to serious injury.

NOTICE

To prevent damage to the assist grip, do not put a heavy load on the assist grip.

Coat hooks

Coat hooks are provided on the rear assist grips.

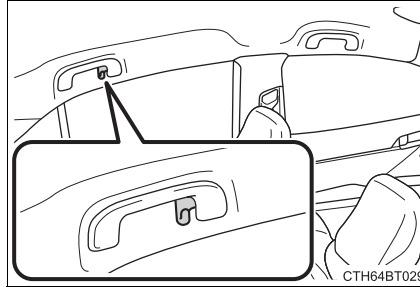
**⚠ WARNING**

Do not hang coat hangers or other hard or sharp objects on the hook. If the SRS curtain shield airbags deploy, these items may become projectiles, causing death or serious injury.

Garage door opener*

The garage door opener can be programmed to operate garage doors, gates, entry doors, door locks, home lighting systems, security systems, and other devices.

System components

The HomeLink® wireless control system in your vehicle has 3 buttons which can be programmed to operate 3 different devices. Refer to the programming methods on the following pages to determine the method which is appropriate for the device.

- ① HomeLink® indicator light
- ② Garage door operation indicators
- ③ Buttons

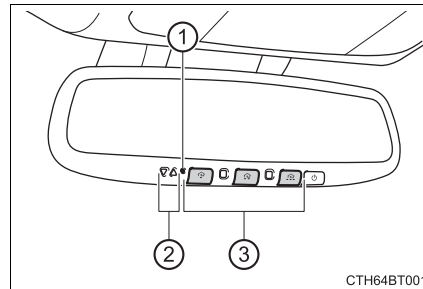

*: If equipped

■ Before programming the HomeLink®

- During programming, it is possible that garage doors, gates, or other devices may operate. For this reason, make sure that people and objects are clear of the garage door or other devices to prevent injury or other potential harm.
- It is recommended that a new battery be placed in the remote control transmitter for more accurate programming.
- Garage door opener motors manufactured after 1995 may be equipped with rolling code protection. If this is the case, you may need a stepladder or other sturdy, safe device to reach the “Learn” or “Smart” button on the garage door opener motor.

■ HomeLink® programming procedure

The programming procedures can also be found at the following URL.

Website: www.homelink.com/toyota

For support, contact customer support at the following.

Help Line: 1-800-355-3515



■ **Programming the HomeLink®**

Steps 1 through 3 must be performed within 60 seconds, otherwise the indicator light will stop flashing and programming will not be able to be completed.

- 1 Press and release the HomeLink® button you want to program and check that the HomeLink® indicator light flashes orange.

- 2 Point the remote control transmitter for the device at the rear view mirror, 1 to 3 in. (25 to 75 mm) from the HomeLink® buttons.

Keep the HomeLink® indicator light in view while programming.

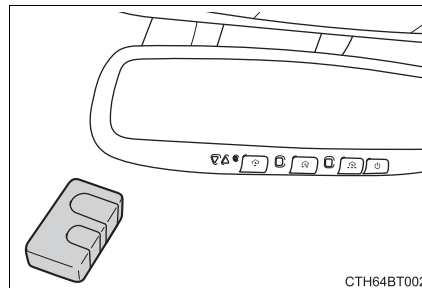

- 3 Program a device.

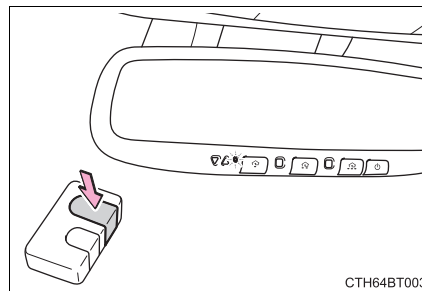

- ▶ Programming a device other than an entry gate (for U.S.A. owners)

Press and hold the remote control transmitter button until the HomeLink® indicator light changes from slowly flashing orange to rapidly flashing green (rolling code) or continuously lit green (fixed code), then release the button.

- ▶ Programming an entry gate (for U.S.A. owners)/Programming a device in the Canadian market

Press and release the remote control transmitter button at 2 second intervals, repeatedly, until the HomeLink® indicator light changes from slowly flashing orange to rapidly flashing green (rolling code) or continuously lit green (fixed code).

- 4 Test the HomeLink® operation by pressing the newly programmed button and observing the indicator light:
 - Indicator light illuminates: Programming of a fixed code device has completed. The garage door or other device should operate when a HomeLink® button is pressed and released.
 - Indicator light flashes rapidly: The garage door opener motor or other device is equipped with a rolling code. To complete programming, firmly press and hold the HomeLink® button for 2 seconds then release it.
 - If the garage door or other device does not operate, proceed to “Programming a rolling code system”.
- 5 Repeat the steps above to program another device for any of the remaining HomeLink® buttons.

■ Programming a rolling code system

2 or more people may be necessary to complete rolling code programming.

- 1 Locate the “Learn” or “Smart” button on the garage door opener motor in the garage.

This button can usually be found where the hanging antenna wire is attached to the unit. The name and color of the button may vary by manufacturer. Refer to the Owner’s manual supplied with the garage door opener motor for details.

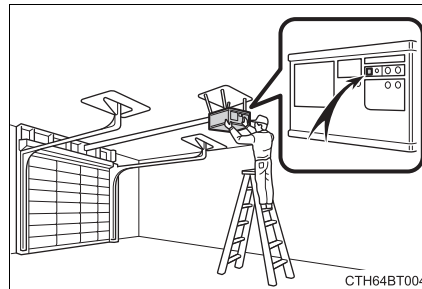

- 2 Press and release the “Learn” or “Smart” button. Perform 3 within 30 seconds after performing 2.

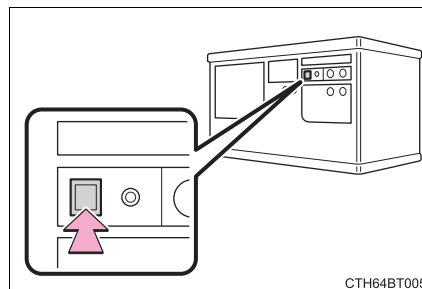

- 3 Press and hold the desired HomeLink® button (inside the vehicle) for 2 seconds and release it. Repeat this sequence (press/hold/release) up to 3 times to complete programming.

If the garage door opener motor operates when the HomeLink® button is pressed, the garage door opener motor recognizes the HomeLink® signal.

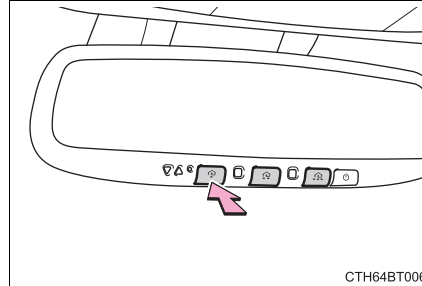

■ Enabling 2-way communication with a garage door (only available for compatible devices)

When enabled, 2-way communication allows you to check the status of the opening and closing of a garage door through indicators in your vehicle.

2-way communication is only available if the garage door opener motor used is a compatible device. (To check device compatibility, refer to www.HomeLink.com.)

- 1 Within 5 seconds after programming the garage door opener has been completed, if the garage door opener motor is trained to HomeLink®, both garage door operation indicators will flash rapidly green and the light on the garage door opener motor will blink twice, indicating that 2-way communication is enabled.

If the indicators do not flash, perform 2 and 3 within the first 10 presses of the HomeLink® button after programming has been completed.

- 2 Press a programmed HomeLink® button to operate a garage door.
- 3 Within 1 minute of pressing the HomeLink® button, after the garage door operation has stopped, press the “Learn” or “Smart” button on the garage door opener motor. Within 5 seconds of the establishment of 2-way communication with the garage door opener, both garage door operation indicators in the vehicle will flash rapidly green and the light on the garage door opener motor will blink twice, indicating that 2-way communication is enabled.

■ Reprogramming a single HomeLink® button

When the following procedure is performed, buttons which already have devices registered to them can be overwritten:

- 1 With one hand, press and hold the desired HomeLink® button.
- 2 When the HomeLink® indicator starts flashing orange, continue to hold the HomeLink® button and perform “Programming the HomeLink®” 1 (it takes 20 seconds for the HomeLink® indicator to start flashing).

Operating the HomeLink®

Press the appropriate HomeLink® button. The HomeLink® indicator light should turn on.

Garage door operation indicators

The status of the opening and closing of a garage door is shown by the indicators.



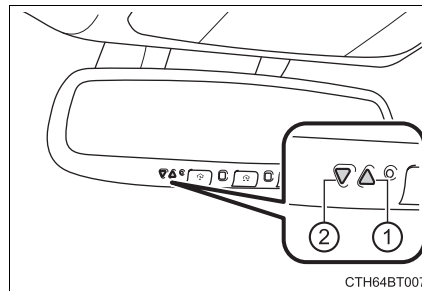

- 1 Opening
- 2 Closing

This function is only available if the garage door opener motor used is a compatible device. (To check device compatibility, refer to www.HomeLink.com.)



Color	Status
Orange (flashing)	Currently opening/closing
Green	Opening/closing has completed
Red (flashing)	Feedback signals cannot be received

The indicators can operate within approximately 820 ft. (250 m) of the garage door. However, if there are obstructions between the garage door and the vehicle, such as houses and trees, feedback signals from the garage door may not be received. To recall the previous door operation status, press and release either HomeLink®

buttons  and  or  and  simultaneously. The last recorded status will be displayed for 3 seconds.

Erasing the entire HomeLink® memory (all three codes)

Press and hold the 2 outside buttons for 10 seconds until the HomeLink® indicator light changes from continuously lit orange to rapidly flashing green.

If you sell your vehicle, be sure to erase the programs stored in the HomeLink® memory.

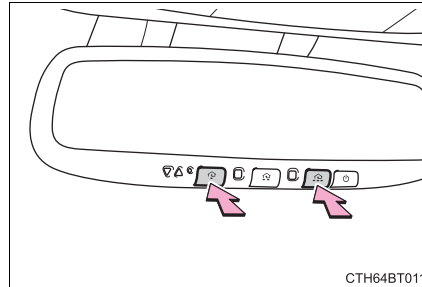

Codes stored in the HomeLink® memory

- The registered codes are not erased even if the battery cable is disconnected.
- If learning failed when registering a different code to a HomeLink® button that already has a code registered to it, the already registered code will not be erased.

Before programming

- Install a new battery in the transmitter.
- The battery side of the transmitter must be pointed away from the HomeLink®.

WARNING

■ When programming a garage door or other remote control device

The garage door or other device may operate, so ensure people and objects are out of danger to prevent potential harm.

■ Conforming to federal safety standards

Do not use the HomeLink® compatible transceiver with any garage door opener or device that lacks safety stop and reverse features as required by federal safety standards. This includes any garage door that cannot detect an interfering object. A door or device without these features increases the risk of death or serious injury.

■ When operating or programming HomeLink®

Never allow a child to operate or play with the HomeLink® buttons.

Maintenance and care

6

6-1. Maintenance and care	
Cleaning and protecting the vehicle exterior.....	440
Cleaning and protecting the vehicle interior.....	444
6-2. Maintenance	
Maintenance requirements.....	447
General maintenance.....	450
Emission inspection and maintenance (I/M) programs.....	454
6-3. Do-it-yourself maintenance	
Do-it-yourself service precautions	455
Hood	457
Positioning a floor jack.....	459
Engine compartment.....	460
Tires	473
Tire inflation pressure	487
Wheels	490
Air conditioning filter.....	492
Wireless remote control/ electronic key battery.....	494
Checking and replacing fuses	499
Light bulbs.....	502

Cleaning and protecting the vehicle exterior

Perform the following to protect the vehicle and maintain it in prime condition:

- Working from top to bottom, liberally apply water to the vehicle body, wheel wells and underside of the vehicle to remove any dirt and dust.
- Wash the vehicle body using a sponge or soft cloth, such as a chamois.
- For hard-to-remove marks, use car wash soap and rinse thoroughly with water.
- Wipe away any water.
- Wax the vehicle when the waterproof coating deteriorates.

If water does not bead on a clean surface, apply wax when the vehicle body is cool.

■ Automatic car washes

- Fold the mirrors before washing the vehicle. Start washing from the front of the vehicle. Make sure to extend the mirrors before driving.
- Brushes used in automatic car washes may scratch the vehicle surface, parts (wheel, etc.) and harm your vehicle's paint.
- Vehicles with a rear spoiler: In certain automatic car washes, the rear spoiler may interfere with machine operation. This may prevent the vehicle from being cleaned properly or result in damage to the rear spoiler.

■ High pressure car washes

As water may enter the cabin, do not bring the nozzle tip near the gaps around the doors or perimeter of the windows, or spray these areas continuously.

■ When using a car wash (vehicles with a smart key system)

If the door handle becomes wet while the electronic key is within the effective range, the door may lock and unlock repeatedly. In that case, follow the following correction procedures to wash the vehicle:

- Place the key in a position 6 ft. (2 m) or more separate from the vehicle while the vehicle is being washed. (Take care to ensure that the key is not stolen.)
- Set the electronic key to battery-saving mode to disable the smart key system. (→P. 163)

■ Wheels and wheel ornaments

- Remove any dirt immediately by using a neutral detergent.
- Wash detergent off with water immediately after use.
- To protect the paint from damage, make sure to observe the following precautions.
 - Do not use acidic, alkaline or abrasive detergent
 - Do not use hard brushes
 - Do not use detergent on the wheels when they are hot, such as after driving or parking in hot weather

■ Brake pads and calipers

Rust may form if the vehicle is parked with wet brake pads or disc rotors, causing them to stick. Before parking the vehicle after it is washed, drive slowly and apply the brakes several times to dry the parts.

■ Bumpers

Do not scrub with abrasive cleaners.

■ Plated portions

If dirt cannot be removed, clean the parts as follows:

- Use a soft cloth dampened with an approximately 5% solution of neutral detergent and water to clean the dirt off.
- Wipe the surface with a dry, soft cloth to remove any remaining moisture.
- To remove oily deposits, use alcohol wet wipes or a similar product.

 **WARNING****■ When washing the vehicle**

Do not apply water to the inside of the engine compartment. Doing so may cause the electrical components, etc. to catch fire.

■ Precautions regarding the exhaust pipes

Exhaust gasses cause the exhaust pipes to become quite hot.

When washing the vehicle, be careful not to touch the pipes until it has cooled sufficiently, as touching a hot exhaust pipes can cause burns.

■ Precaution regarding the rear bumper with Blind Spot Monitor (if equipped)

If the paint of the rear bumper is chipped or scratched, the system may malfunction. If this occurs, avoid using the system and consult your Toyota dealer.

 **NOTICE****■ To prevent paint deterioration and corrosion on the body and components (aluminum wheels, etc.)**

● Wash the vehicle immediately in the following cases:

- After driving near the sea coast
- After driving on salted roads
- If coal tar or tree sap is present on the paint surface
- If dead insects, insect droppings or bird droppings are present on the paint surface
- After driving in an area contaminated with soot, oily smoke, mine dust, iron powder or chemical substances
- If the vehicle becomes heavily soiled with dust or mud
- If liquids such as benzene and gasoline are spilled on the paint surface

● If the paint is chipped or scratched, have it repaired immediately.

● To prevent the wheels from corroding, remove any dirt and store in a place with low humidity when storing the wheels.

■ Cleaning the exterior lights

● Wash carefully. Do not use organic substances or scrub with a hard brush. This may damage the surfaces of the lights.

● Do not apply wax to the surfaces of the lights. Wax may cause damage to the lenses.

 NOTICE**■ When using a high pressure car wash**

- When washing the vehicle, do not spray the camera or its surrounding area directly with a high pressure washer. Shock applied from high pressure water may cause the device to not operate normally.
- Do not spray water directly on the radar which is equipped behind the emblem. Otherwise it may cause the device to be damaged.
- Do not bring the nozzle tip close to boots (rubber or resin manufactured cover), connectors or the following parts. The parts may be damaged if they come into contact with high-pressure water.
 - Traction related parts
 - Steering parts
 - Suspension parts
 - Brake parts
- Keep the cleaning nozzle at least 11.9 in. (30 cm) away from the vehicle body. Otherwise resin section, such as moldings and bumpers, may be deformed and damaged. Also, do not continuously hold the nozzle in the same place.
- Do not spray the lower part of the windshield continuously.
If water enters the air conditioning system intake located near the lower part of the windshield, the air conditioning system may not operate correctly.
- Do not wash the underside of the vehicle using a high pressure car washer.

Cleaning and protecting the vehicle interior

The following procedures will help protect your vehicle's interior and keep it in top condition:

Protecting the vehicle interior

- Remove dirt and dust using a vacuum cleaner. Wipe dirty surfaces with a cloth dampened with lukewarm water.
- If dirt cannot be removed, wipe it off with a soft cloth dampened with neutral detergent diluted to approximately 1%.
Wring out any excess water from the cloth and thoroughly wipe off remaining traces of detergent and water.

Cleaning the areas with satin-finish metal accents

- Remove dirt using a soft cloth or synthetic chamois dampened in a baking soda (sodium bicarbonate) solution.
Use a solution of approximately 9% baking soda dissolved in water.
- Wipe the surface with a dry, soft cloth to remove any remaining moisture.

Cleaning the leather areas

- Remove dirt and dust using a vacuum cleaner.
- Wipe off any excess dirt and dust with a soft cloth dampened with diluted detergent.
Use a diluted water solution of approximately 5% neutral wool detergent.
- Wring out any excess water from the cloth and thoroughly wipe off all remaining traces of detergent.
- Wipe the surface with a dry, soft cloth to remove any remaining moisture. Allow the leather to dry in a shaded and ventilated area.

Cleaning the synthetic leather areas

- Remove dirt and dust using a vacuum cleaner.
- Wipe it off with a soft cloth dampened with neutral detergent diluted to approximately 1%.
- Wring out any excess water from the cloth and thoroughly wipe off remaining traces of detergent and water.

■ Caring for leather areas

Toyota recommends cleaning the interior of the vehicle at least twice a year to maintain the quality of the vehicle's interior.

■ Shampooing the carpets

There are several commercial foaming-type cleaners available. Use a sponge or brush to apply the foam. Rub in overlapping circles. Do not use water. Wipe dirty surfaces and let them dry. Excellent results are obtained by keeping the carpet as dry as possible.

■ Seat belts

Clean with mild soap and lukewarm water using a cloth or sponge. Also check the belts periodically for excessive wear, fraying or cuts.

⚠ WARNING**■ Water in the vehicle**

- Do not splash or spill liquid in the vehicle.
Doing so may cause electrical components, etc., to malfunction or catch fire.
- Do not get any of the SRS components or wiring in the vehicle interior wet.
(→P. 38)
An electrical malfunction may cause the airbags to deploy or not function properly, resulting in death or serious injury.
- Vehicles with wireless charger:
Do not let the wireless charger (→P. 420) get wet. Failure to do so may cause the charger to become hot and cause burns or could cause electric shock resulting in death or serious injury.

■ Cleaning the interior (especially instrument panel)

Do not use polish wax or polish cleaner. The instrument panel may reflect off the windshield, obstructing the driver's view and leading to an accident, resulting in death or serious injury.

 NOTICE**■ Cleaning detergents**

- Do not use the following types of detergent, as they may discolor the vehicle interior or cause streaks or damage to painted surfaces:
 - Areas other than the seats and steering wheel: Organic substances such as benzene or gasoline, alkaline or acidic solutions, dye, and bleach
 - Seats: Alkaline or acidic solutions, such as thinner, benzene, and alcohol
 - Steering wheel: Organic substances, such as thinner, and cleaner that contains alcohol
- Do not use polish wax or polish cleaner. The instrument panel's or other interior part's painted surface may be damaged.

■ Preventing damage to leather surfaces

Observe the following precautions to avoid damage to and deterioration of leather surfaces:

- Remove any dust or dirt from leather surfaces immediately.
- Do not expose the vehicle to direct sunlight for extended periods of time. Park the vehicle in the shade, especially during summer.
- Do not place items made of vinyl, plastic, or containing wax on the upholstery, as they may stick to the leather surface if the vehicle interior heats up significantly.

■ Water on the floor

Do not wash the vehicle floor with water.

Vehicle systems such as the audio system may be damaged if water comes into contact with electrical components such as the audio system above or under the floor of the vehicle. Water may also cause the body to rust.

■ When cleaning the inside of the windshield

Do not allow glass cleaner to contact the lens. Also, do not touch the lens. (→P. 249)

■ Cleaning the inside of the rear window

- Do not use glass cleaner to clean the rear window, as this may cause damage to the rear window defogger heater wires or antenna. Use a cloth dampened with lukewarm water to gently wipe the window clean. Wipe the window in strokes running parallel to the heater wires or antenna.
- Be careful not to scratch or damage the heater wires or antenna.

Maintenance requirements

To ensure safe and economical driving, day-to-day care and regular maintenance are essential. It is the owner's responsibility to perform regular checks. Toyota recommends the following maintenance:

General maintenance

General maintenance should be performed on a daily basis. This can be done by yourself or by a Toyota dealer.

Scheduled maintenance

Scheduled maintenance should be performed at specified intervals according to the maintenance schedule.

For details about maintenance items and schedules, refer to the "Scheduled Maintenance Guide" or "Owner's Manual Supplement".

Do-it-yourself maintenance

You can perform some maintenance procedures by yourself.

Please be aware that do-it-yourself maintenance may affect warranty coverage.

The use of Toyota Repair Manuals is recommended.

For details about warranty coverage, refer to the separate "Owner's Warranty Information Booklet" or "Owner's Manual Supplement".







■ Repair and replacement

It is recommended that genuine Toyota parts be used for repairs to ensure performance of each system. If non-Toyota parts are used in replacement or if a repair shop other than a Toyota dealer performs repairs, confirm the warranty coverage.

■ Resetting the message indicating maintenance is required (on some models)

After the required maintenance is performed according to the maintenance schedule, please reset the message.

To reset the message, perform the following procedure:

- 1 Select  (4.2-inch display) or  (7-inch display) on the multi-information display using the meter control switches on the steering wheel. (→P. 103, 117)
- 2 4.2-inch display: Select "Vehicle Settings" and then press  .
7-inch display: Select  and then press and hold  .
- 3 Select "Scheduled Maintenance" and then press  .
- 4 Select "Yes" and then press  .
- 5 A message will be displayed on the multi-information display when the reset procedure has been completed.

■ Allow inspection and repairs to be performed by a Toyota dealer

- Toyota technicians are well-trained specialists and are kept up to date with the latest service information. They are well informed about the operations of all systems on your vehicle.
- Keep a copy of the repair order. It proves that the maintenance that has been performed is under warranty coverage. If any problem should arise while your vehicle is under warranty, your Toyota dealer will promptly take care of it.

 **WARNING****■ If your vehicle is not properly maintained**

Improper maintenance could result in serious damage to the vehicle and possible death or serious injury.

■ Important health and safety information

- Engine exhaust, some of its constituents, and a wide variety of automobile components contain or emit chemicals known to the State of California to cause cancer and birth defects and other reproductive harm. Work in a well ventilated area.
- Oils, fuels and fluids contained in vehicles as well as waste produced by component wear contain or emit chemicals known to the State of California to cause cancer and birth defects or other reproductive harm. Avoid exposure and wash any affected area immediately.
- Battery posts, terminals and related accessories contain lead and lead compounds which are known to cause brain damage. Wash your hands after handling. (→P. 469)

General maintenance

Listed below are the general maintenance items that should be performed at the intervals specified in the “Owner’s Warranty Information Booklet” or “Owner’s Manual Supplement/Scheduled Maintenance Guide”. It is recommended that any problem you notice should be brought to the attention of your Toyota dealer or qualified service shop for advice.

Engine compartment

Items	Check points
Battery	Check the connections. (→P. 469)
Brake fluid	Is the brake fluid at the correct level? (→P. 468)
Engine coolant	Is the engine coolant at the correct level? (→P. 466)
Engine oil	Is the engine oil at the correct level? (→P. 462)
Exhaust system	There should not be any fumes or strange sounds.
Radiator/condenser	The radiator and condenser should be free from foreign objects. (→P. 467)
Washer fluid	Is there sufficient washer fluid? (→P. 472)

Vehicle interior

Items	Check points
Accelerator pedal	<ul style="list-style-type: none"> The accelerator pedal should move smoothly (without uneven pedal effort or catching).
Automatic transmission mechanism "Park"	<ul style="list-style-type: none"> When parked on a slope and the shift lever is in P, is the vehicle securely stopped?
Brake pedal	<ul style="list-style-type: none"> Does the brake pedal move smoothly? Does the brake pedal have appropriate clearance from the floor? (→P. 583) Does the brake pedal have the correct amount of free play? (→P. 583)
Brakes	<ul style="list-style-type: none"> The vehicle should not pull to one side when the brakes are applied. The brakes should work effectively. The brake pedal should not feel spongy. The brake pedal should not get too close to the floor when the brakes are applied.
Head restraints (adjustable type)	<ul style="list-style-type: none"> Do the head restraints move smoothly and lock securely?
Indicators/buzzers	<ul style="list-style-type: none"> Do the indicators and buzzers function properly?
Lights	<ul style="list-style-type: none"> Do all the lights come on?
Parking brake	<ul style="list-style-type: none"> Does the parking brake operate normally? When parked on a slope and the parking brake is on, is the vehicle securely stopped?

Items	Check points
Seat belts	<ul style="list-style-type: none"> • Do the seat belts operate smoothly? • The seat belts should not be damaged.
Seats	<ul style="list-style-type: none"> • Do the seat controls operate properly?
Steering wheel	<ul style="list-style-type: none"> • Does the steering wheel rotate smoothly? • Does the steering wheel have the correct amount of free play? • There should not be any strange sounds coming from the steering wheel.

Vehicle exterior

Items	Check points
Doors/trunk	<ul style="list-style-type: none"> • Do the doors/trunk operate smoothly?
Engine hood	<ul style="list-style-type: none"> • Does the engine hood lock system work properly?
Fluid leaks	<ul style="list-style-type: none"> • There should not be any signs of fluid leakage after the vehicle has been parked.
Tires	<ul style="list-style-type: none"> • Is the tire inflation pressure correct? • The tires should not be damaged or excessively worn. • Have the tires been rotated according to the maintenance schedule? • The wheel nuts should not be loose.
Windshield wipers	<ul style="list-style-type: none"> • The wiper blades should not show any signs of cracking, splitting, wear, contamination or deformation. • The wiper blades should clear the windshield without streaking or skipping.

 **WARNING****■ If the engine is running**

Turn the engine off and ensure that there is adequate ventilation before performing maintenance checks.

Emission inspection and maintenance (I/M) programs

Some states have vehicle emission inspection programs which include OBD (On Board Diagnostics) checks. The OBD system monitors the operation of the emission control system.

If the malfunction indicator lamp comes on

The OBD system determines that a problem exists somewhere in the emission control system. Your vehicle may not pass the I/M test and may need to be repaired. Contact your Toyota dealer to service the vehicle.

Your vehicle may not pass the I/M test in the following situations:

- When the battery is disconnected or discharged
Readiness codes that are set during ordinary driving are erased. Also, depending on your driving habits, the readiness codes may not be completely set.
- When the fuel tank cap is loose
The malfunction indicator lamp comes on indicating a temporary malfunction and your vehicle may not pass the I/M test.

When the malfunction indicator lamp still remains on after several driving trips

The error code in the OBD system will not be cleared unless the vehicle is driven 40 or more times.

If your vehicle does not pass the I/M test

Contact your Toyota dealer to prepare the vehicle for re-testing.

Do-it-yourself service precautions

If you perform maintenance by yourself, be sure to follow the correct procedure as given in these sections.

Items	Parts and tools
Battery condition (→P. 469)	<ul style="list-style-type: none"> • Warm water • Baking soda • Grease • Conventional wrench (for terminal clamp bolts)
Brake fluid level (→P. 468)	<ul style="list-style-type: none"> • FMVSS No.116 DOT 3 or SAE J1703 brake fluid • Rag or paper towel • Funnel (used only for adding brake fluid)
Engine coolant level (→P. 466)	<ul style="list-style-type: none"> • “Toyota Super Long Life Coolant” or a similar high quality ethylene glycol-based non-silicate, non-amine, non-nitrite and non-borate coolant with long-life hybrid organic acid technology U.S.A.: “Toyota Super Long Life Coolant” is pre-mixed with 50% coolant and 50% deionized water. Canada: “Toyota Super Long Life Coolant” is pre-mixed with 55% coolant and 45% deionized water. • Funnel (used only for adding engine coolant)
Engine oil level (→P. 462)	<ul style="list-style-type: none"> • “Toyota Genuine Motor Oil” or equivalent • Rag or paper towel • Funnel (used only for adding engine oil)
Fuses (→P. 499)	<ul style="list-style-type: none"> • Fuse with same amperage rating as original
Light bulbs (→P. 502)	<ul style="list-style-type: none"> • Bulb with same number and wattage rating as original • Flathead screwdriver • Wrench
Radiator/condenser (→P. 467)	—
Tire inflation pressure (→P. 487)	<ul style="list-style-type: none"> • Tire pressure gauge • Compressed air source
Washer fluid (→P. 472)	<ul style="list-style-type: none"> • Water or washer fluid containing antifreeze (for winter use) • Funnel (used only for adding water or washer fluid)

 **WARNING**

The engine compartment contains many mechanisms and fluids that may move suddenly, become hot, or become electrically energized. To avoid death or serious injury, observe the following precautions.

■ When working on the engine compartment

- Keep hands, clothing and tools away from the moving fan and engine drive belt.
- Be careful not to touch the engine, radiator, exhaust manifold, etc. right after driving as they may be hot. Oil and other fluids may also be hot.
- Do not leave anything that may burn easily, such as paper and rags, in the engine compartment.
- Do not smoke, cause sparks or expose an open flame to fuel or the battery. Fuel and battery fumes are flammable.
- Be extremely cautious when working on the battery. It contains poisonous and corrosive sulfuric acid.

■ When working near the electric cooling fan or radiator grille

Vehicles without a smart key system:

Be sure the engine switch is off. With the engine switch in the "ON" position, the electric cooling fan may automatically start to run if the air conditioning is on and/or the coolant temperature is high. (→P. 467)

Vehicles with a smart key system:

Be sure the engine switch is off. With the engine switch in IGNITION ON mode, the electric cooling fan may automatically start to run if the air conditioning is on and/or the coolant temperature is high. (→P. 467)

■ Safety glasses

Wear safety glasses to prevent flying or falling material, fluid spray, etc. from getting in your eyes.

 **NOTICE****■ If you remove the air cleaner filter**

Driving with the air cleaner filter removed may cause excessive engine wear due to dirt in the air.

Hood

Release the lock from the inside of the vehicle to open the hood.

- 1 Pull the hood lock release lever.
The hood will pop up slightly.

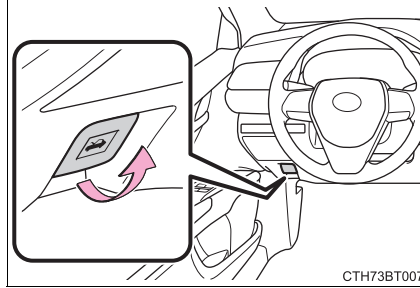

- 2 Pull up the auxiliary catch lever and lift the hood.

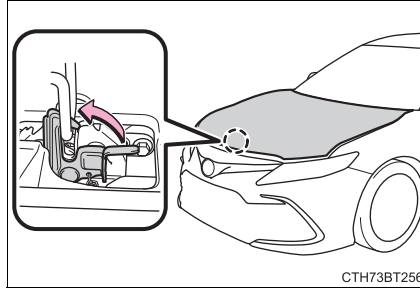

- 3 Hold the hood open by inserting the support rod into the slot.

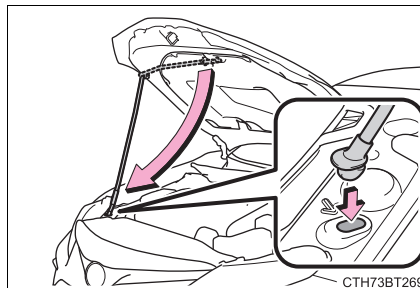

■ Open hood warning buzzer

If the vehicle reaches a speed of 3 mph (5 km/h), the master warning light flashes and a buzzer sounds to indicate that the hood is not fully closed.

 **WARNING****■ Pre-driving check**

Check that the hood is fully closed and locked.

If the hood is not locked properly, it may open while the vehicle is in motion and cause an accident, which may result in death or serious injury.

■ After installing the support rod into the slot

Make sure the rod supports the hood securely preventing it from falling down onto your head or body.

 **NOTICE****■ When closing the hood**

Be sure to return the support rod to its clip before closing the hood. Closing the hood with the support rod not clipped could cause the hood to bend.

Positioning a floor jack

When using a floor jack, follow the instructions in the manual provided with the jack and perform the operation safely.

When raising your vehicle with a floor jack, position the jack correctly. Improper placement may damage your vehicle or cause injury.

◆ Front

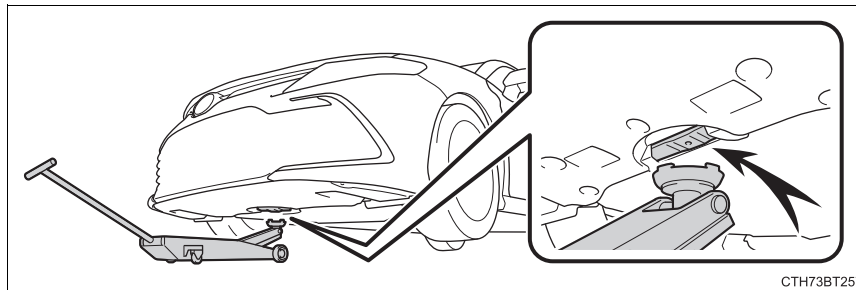

◆ Rear

▶ 2WD models

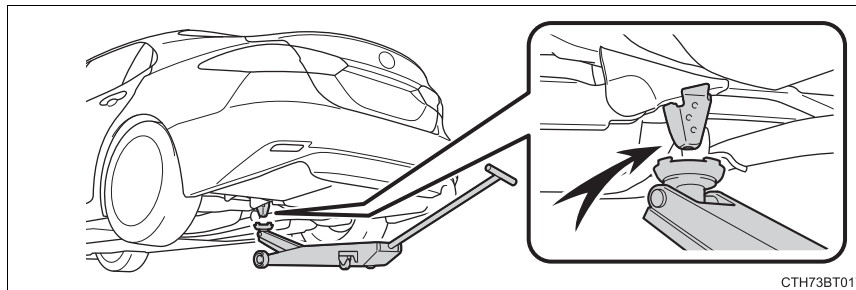

▶ AWD models

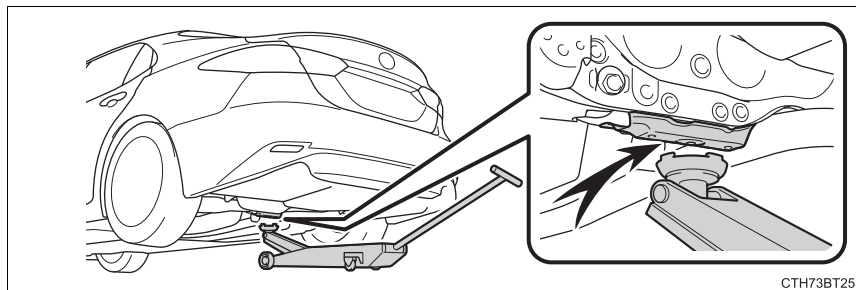

Engine compartment

► 2.5 L 4-cylinder (A25A-FKS) engine

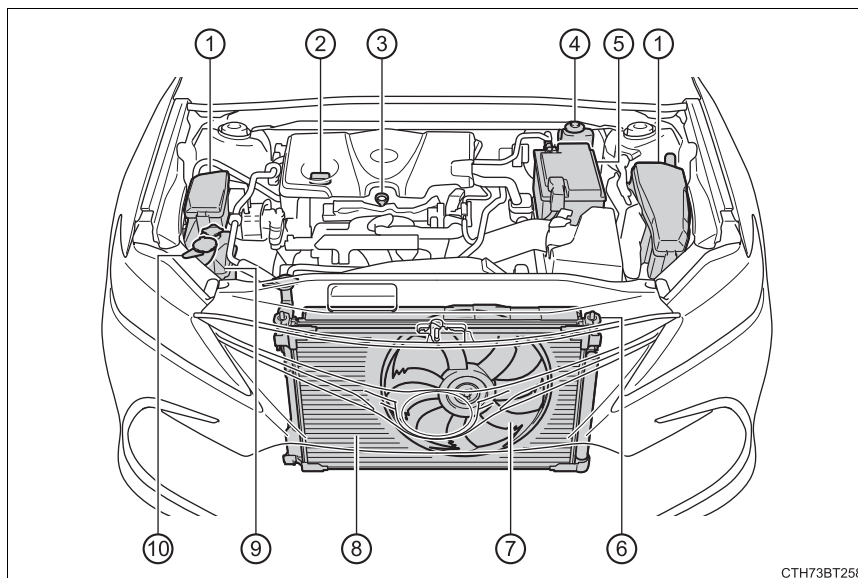

- | | |
|--|---|
| ① Fuse boxes (if equipped)
(→P. 499) | ⑤ Battery
(→P. 469) |
| ② Engine oil filler cap (→P. 464) | ⑥ Radiator
(→P. 467) |
| ③ Engine oil level dipstick
(→P. 462) | ⑦ Electric cooling fan |
| ④ Brake fluid reservoir
(→P. 468) | ⑧ Condenser
(→P. 467) |
| | ⑨ Engine coolant reservoir
(→P. 466) |
| | ⑩ Washer fluid tank (→P. 472) |

▶ 3.5 L V6 (2GR-FKS) engine

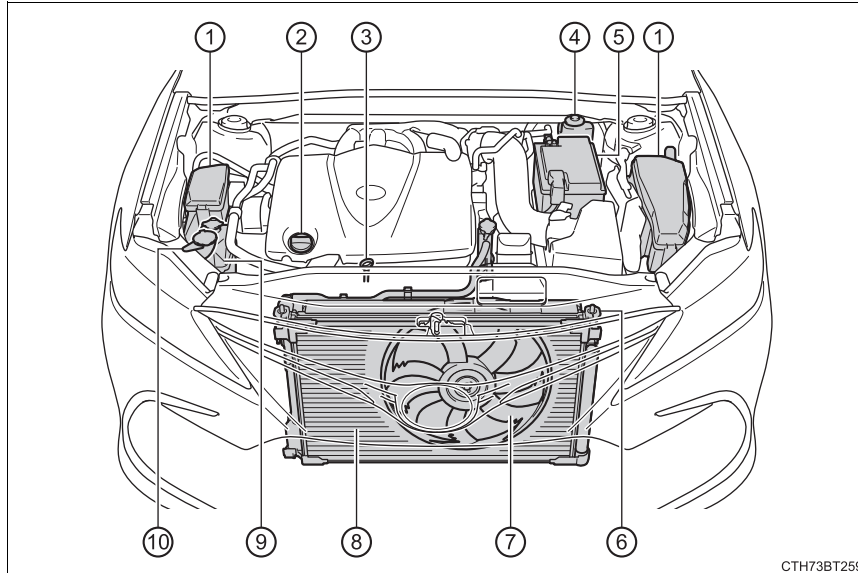

CTH73BT259

- | | |
|--|---|
| ① Fuse boxes (if equipped)
(→P. 499) | ⑥ Radiator
(→P. 467) |
| ② Engine oil filler cap (→P. 464) | ⑦ Electric cooling fan |
| ③ Engine oil level dipstick
(→P. 462) | ⑧ Condenser (→P. 467) |
| ④ Brake fluid reservoir
(→P. 468) | ⑨ Engine coolant reservoir
(→P. 466) |
| ⑤ Battery (→P. 469) | ⑩ Washer fluid tank (→P. 472) |

Checking the engine oil

With the engine at operating temperature and turned off, check the oil level on the dipstick.

- 1 Park the vehicle on level ground. After warming up the engine and turning it off, wait about 5 minutes for the oil to drain back into the bottom of the engine.
- 2 Holding a rag under the end, pull the dipstick out.
 - ▶ 2.5 L 4-cylinder (A25A-FKS) ▶ 3.5 L V6 (2GR-FKS) engine engine

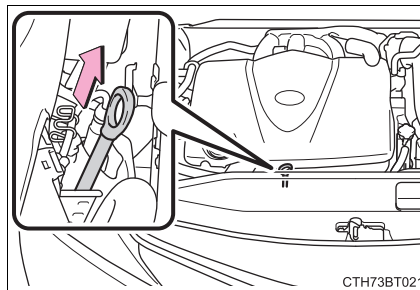
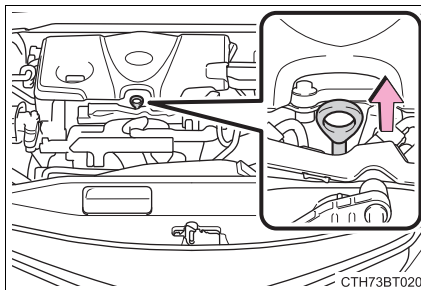

- 3 Wipe the dipstick clean.
- 4 Reinsert the dipstick fully.
- 5 Holding a rag under the end, pull the dipstick out and check whether the oil level is above low level mark.

▶ Flat dipstick

▶ Twist dipstick

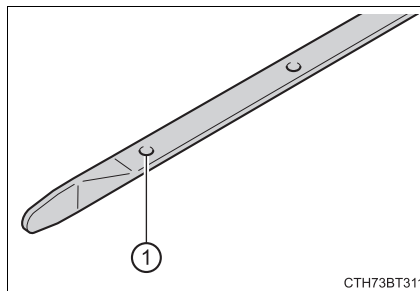
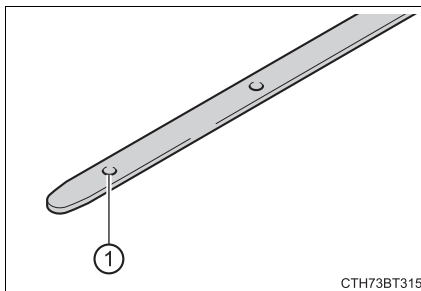

① Low level mark

The shape of the dipstick may differ depending on the type of vehicle or engine.

- 6 Wipe the dipstick and reinsert it fully.

 NOTICE**■ To prevent serious engine damage**

Check the oil level on a regular basis.

■ Engine oil consumption

A certain amount of engine oil will be consumed while driving. In the following situations, oil consumption may increase, and engine oil may need to be refilled in between oil maintenance intervals.

- When the engine is new, for example directly after purchasing the vehicle or after replacing the engine
- If low quality oil or oil of an inappropriate viscosity is used
- When driving at high engine speeds or with a heavy load, or when driving while accelerating or decelerating frequently
- When leaving the engine idling for a long time, or when driving frequently through heavy traffic

■ Engine oil level rise

If the vehicle is repeatedly driven without the engine warmed up, moisture caused by dew condensation inside the engine or fuel which did not burn mixes into the engine oil, resulting in a rise in engine oil level. However, this is not a malfunction. For example, the engine become difficult to be warmed up in the following situations.

- When driving a short distance
- When driving at a low speed
- When the outside temperature is low

When checking the engine oil, make sure that the engine is warmed up. If the engine oil level exceeds the refill upper limit mark, contact your Toyota dealer.

Adding engine oil

■ Checking the oil type and preparing the item needed

Make sure to check the oil type and prepare the items needed before adding oil.

Engine oil selection	→P. 578
Oil quantity (Low level mark → Refill upper limit mark)	▶ 2.5 L 4-cylinder (A25A-FKS) engine 1.6 qt. (1.5 L, 1.3 Imp. qt.) ▶ 3.5 L V6 (2GR-FKS) engine 1.9 qt. (1.8 L, 1.6 Imp. qt.)
Items	Clean funnel

■ Adding engine oil

If the oil level is below or near the low level mark, add engine oil of the same type as that already in the engine.

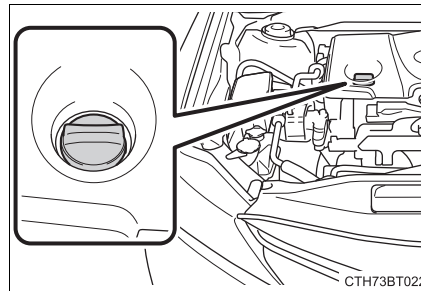

1 Remove the oil filler cap by turning it counterclockwise.

2 Add engine oil slowly, checking the dipstick.

Make sure that the oil level does not exceed the refill upper limit mark and is between the low level mark and refill upper limit mark.

▶ Flat dipstick

▶ Twist dipstick

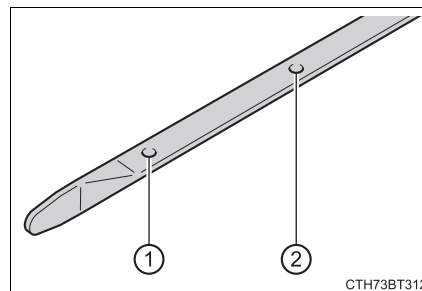
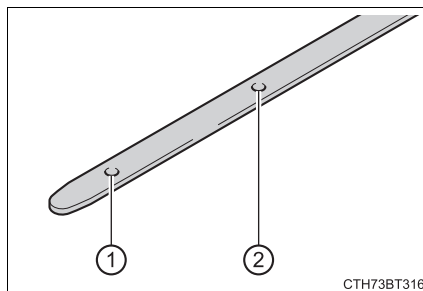

① Low level mark

② Refill upper limit mark

The shape of the dipstick may differ depending on the type of vehicle engine.

- 3 Install the oil filler cap by turning it clockwise.

 **WARNING****■ Used engine oil**

- Used engine oil contains potentially harmful contaminants which may cause skin disorders such as inflammation and skin cancer, so care should be taken to avoid prolonged and repeated contact. To remove used engine oil from your skin, wash thoroughly with soap and water.
- Dispose of used oil and filters only in a safe and acceptable manner. Do not dispose of used oil and filters in household trash, in sewers or onto the ground.
Call your Toyota dealer, service station or auto parts store for information concerning recycling or disposal.
- Do not leave used engine oil within the reach of children.

 **NOTICE****■ When replacing the engine oil**

- Be careful not to spill engine oil on the vehicle components.
- Avoid overfilling, or the engine could be damaged.
- Check the oil level on the dipstick every time you refill the vehicle.
- Be sure the engine oil filler cap is properly tightened.

■ If oil is spilled on the engine cover

To prevent the engine cover from being damaged, remove any engine oil from the engine cover as soon as possible using a neutral detergent.
Do not use an organic solvent such as brake cleaner.

Engine coolant

The coolant level is satisfactory if it is between the “F” and “L” lines on the reservoir when the engine is cold.

- ① Reservoir cap
- ② “F” line
- ③ “L” line

If the level is on or below the “L” line, add coolant up to the “F” line.
(→P. 567)

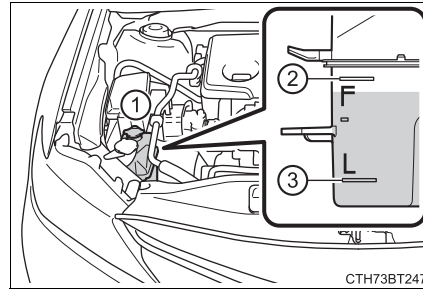

■ Coolant selection

Only use “Toyota Super Long Life Coolant” or a similar high quality ethylene glycol based non-silicate, non-amine, non-nitrite, and non-borate coolant with long-life hybrid organic acid technology.

U.S.A.:

“Toyota Super Long Life Coolant” is a mixture of 50% coolant and 50% deionized water. (Minimum temperature: -31°F [-35°C])

Canada:

“Toyota Super Long Life Coolant” is a mixture of 55% coolant and 45% deionized water. (Minimum temperature: -44°F [-42°C])

For more details about engine coolant, contact your Toyota dealer.

■ If the coolant level drops within a short time of replenishing

Visually check the radiator, hoses, engine coolant reservoir caps, drain cock and water pump.

If you cannot find a leak, have your Toyota dealer test the cap and check for leaks in the cooling system.

 **WARNING****■ When the engine is hot**

Do not remove the engine coolant reservoir cap or the radiator cap. The cooling system may be under pressure and may spray hot coolant if the cap is removed, causing serious injuries, such as burns.

 **NOTICE****■ When adding coolant**

Coolant is neither plain water nor straight antifreeze. The correct mixture of water and antifreeze must be used to provide proper lubrication, corrosion protection and cooling. Be sure to read the antifreeze or coolant label.

■ If you spill coolant

Be sure to wash it off with water to prevent it from damaging parts or paint.

Radiator and condenser

Check the radiator and condenser and clear away any foreign objects. If either of the above parts is extremely dirty or you are not sure of their condition, have your vehicle inspected by your Toyota dealer.

 **WARNING****■ When the engine is hot**

Do not touch the radiator or condenser as they may be hot and cause serious injuries, such as burns.

Brake fluid

■ Checking fluid level

The brake fluid level should be between the “MAX” and “MIN” lines on the tank.

- ① “MAX”
- ② “MIN”

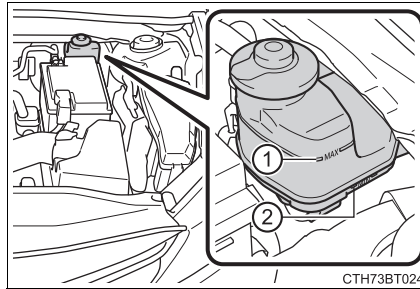

■ Adding fluid

Make sure to check the fluid type and prepare the necessary item.

Fluid type	FMVSS No.116 DOT 3 or SAE J1703 brake fluid
Item	Clean funnel

■ Brake fluid can absorb moisture from the air

Excess moisture in the brake fluid can cause a dangerous loss of braking efficiency. Use only newly opened brake fluid.

⚠ WARNING

■ When filling the reservoir

Take care as brake fluid can harm your hands and eyes and damage painted surfaces.

If fluid gets on your hands or in your eyes, flush the affected area with clean water immediately.

If you still experience discomfort, see a doctor.

⚠ NOTICE

■ If the fluid level is low or high

It is normal for the brake fluid level to go down slightly as the brake pads wear out or when the fluid level in the accumulator is high.

If the reservoir needs frequent refilling, there may be a serious problem.

Battery

Check the battery as follows.

■ Battery exterior

Make sure that the battery terminals are not corroded and that there are no loose connections, cracks, or loose clamps.

- ① Terminals
- ② Hold-down clamp

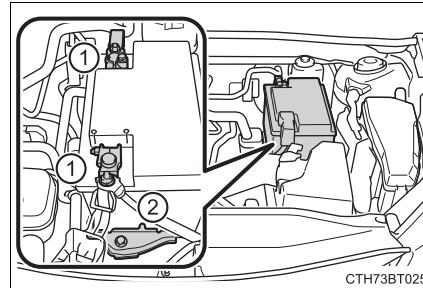

■ Before recharging

When recharging, the battery produces hydrogen gas which is flammable and explosive. Therefore, observe the following before recharging:

- If recharging with the battery installed on the vehicle, be sure to disconnect the ground cable.
- Make sure the power switch on the charger is off when connecting and disconnecting the charger cables to the battery.

■ After recharging/reconnecting the battery (vehicles with a smart key system)

- Unlocking the doors using the smart key system may not be possible immediately after reconnecting the battery. If this happens, use the wireless remote control or the mechanical key to lock/unlock the doors.
- Start the engine with the engine switch in ACCESSORY mode. The engine may not start with the engine switch turned off. However, the engine will operate normally from the second attempt.
- The engine switch mode is recorded by the vehicle. If the battery is reconnected, the vehicle will return the engine switch mode to the status it was in before the battery was disconnected. Make sure to turn off the engine before disconnecting the battery. Take extra care when connecting the battery if the engine switch mode prior to discharge is unknown.

If the system will not start even after multiple attempts, contact your Toyota dealer.

 **WARNING****■ Chemicals in the battery**

Batteries contain poisonous and corrosive sulfuric acid and may produce hydrogen gas which is flammable and explosive. To reduce the risk of death or serious injury, take the following precautions while working on or near the battery:

- Do not cause sparks by touching the battery terminals with tools.
- Do not smoke or light a match near the battery.
- Avoid contact with eyes, skin and clothes.
- Never inhale or swallow electrolyte.
- Wear protective safety glasses when working near the battery.
- Keep children away from the battery.

■ Where to safely charge the battery

Always charge the battery in an open area. Do not charge the battery in a garage or closed room where there is insufficient ventilation.

■ How to recharge the battery

Only perform a slow charge (5 A or less). The battery may explode if charged at a quicker rate.

■ Emergency measures regarding electrolyte

- If electrolyte gets in your eyes
Flush your eyes with clean water for at least 15 minutes and get immediate medical attention. If possible, continue to apply water with a sponge or cloth while traveling to the nearest medical facility.
- If electrolyte gets on your skin
Wash the affected area thoroughly. If you feel pain or burning, get medical attention immediately.
- If electrolyte gets on your clothes
It can soak through clothing on to your skin. Immediately take off the clothing and follow the procedure above if necessary.
- If you accidentally swallow electrolyte
Drink a large quantity of water or milk. Get emergency medical attention immediately.

■ When disconnecting the battery

Do not disconnect the negative (-) terminal on the body side. The disconnected negative (-) terminal may touch the positive (+) terminal, which may cause a short and result in death or serious injury.

 NOTICE**■ When recharging the battery**

Never recharge the battery while the engine is running. Also, be sure all accessories are turned off.

Washer fluid

Add washer fluid in the following situations:

- A washer does not work.
- “Windshield Washer Fluid Low” is displayed on the multi-information display.

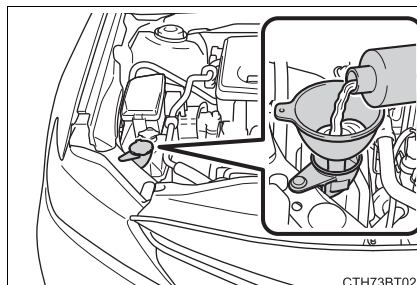
**⚠ WARNING****■ When adding washer fluid**

Do not add washer fluid when the engine is hot or running as washer fluid contains alcohol and may catch fire if spilled on the engine, etc.

⚠ NOTICE**■ Do not use any fluid other than washer fluid**

Do not use soapy water or engine antifreeze instead of washer fluid. Doing so may cause streaking on the vehicle's painted surfaces, as well as damaging the pump leading to problems of the washer fluid not spraying.

■ Diluting washer fluid

Dilute washer fluid with water as necessary. Refer to the freezing temperatures listed on the label of the washer fluid bottle.

Tires

Replace or rotate tires in accordance with maintenance schedules and treadwear.

Checking tires

Check if the treadwear indicators are showing on the tires. Also check the tires for uneven wear, such as excessive wear on one side of the tread.

Check the spare tire condition and pressure if not rotated.

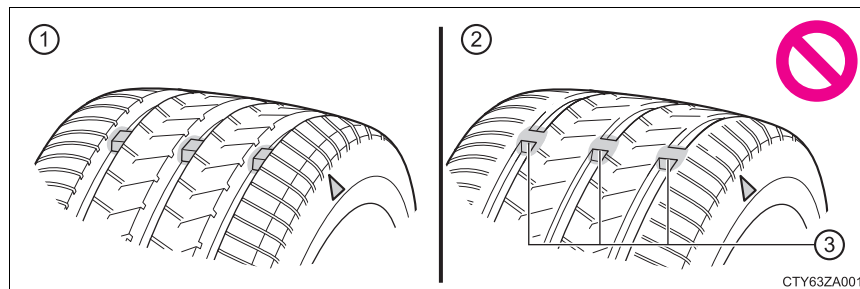

- ① New tread
- ② Worn tread
- ③ Treadwear indicator

The location of treadwear indicators is shown by a "TWI" or "Δ" mark, etc., molded into the sidewall of each tire.

Replace the tires if the treadwear indicators are showing on a tire.

Tire rotation

Rotate the tires in the order shown.

To equalize tire wear and extend tire life, Toyota recommends that tire rotation is carried out at the same interval as tire inspection.

Do not fail to initialize the tire pressure warning system after tire rotation.

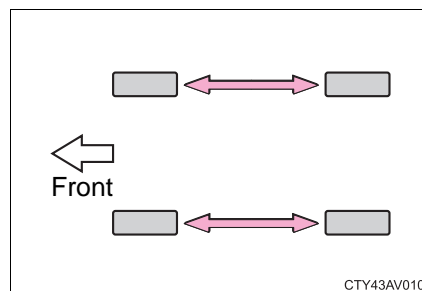

Tire pressure warning system

Your vehicle is equipped with a tire pressure warning system that uses tire pressure warning valve and transmitters to detect low tire inflation pressure before serious problems arise.

- ▶ Vehicles without a tire inflation pressure display function

If the tire pressure drops below a predetermined level, the driver is warned by a warning light. (→P. 532)

- ▶ Vehicles with a tire inflation pressure display function

- The tire pressure detected by the tire pressure warning system can be displayed on the multi-information display.

- ▶ 4.2-inch display

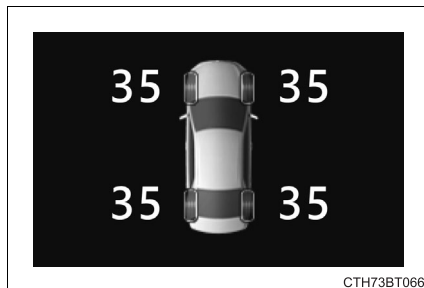

- ▶ 7-inch display

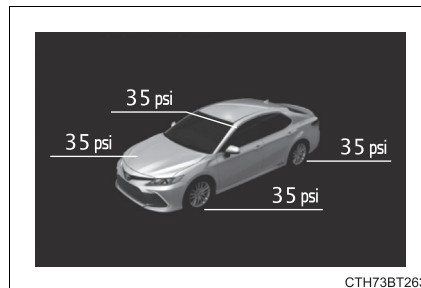

- If the tire pressure drops below a predetermined level, the driver is warned by a screen display and a warning light. (→P. 532)

- ▶ 4.2-inch display

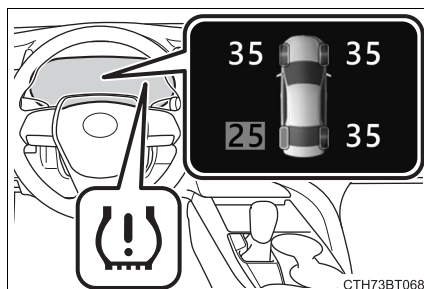

- ▶ 7-inch display

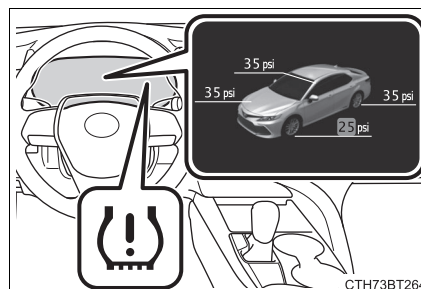

◆ Installing tire pressure warning valve and transmitters

When replacing the tires or wheels, the tire pressure warning valve and transmitters must be installed to the wheels which will be installed to the vehicle.

When new tire pressure warning valve and transmitters are installed, new ID codes must be registered in the tire pressure warning computer and the tire pressure warning system must be initialized. (→P. 477)

◆ Initializing the tire pressure warning system

■ The tire pressure warning system must be initialized in the following circumstances:

- When the tire inflation pressure is changed such as when changing traveling speed or load weight.
- When the tire inflation pressure is changed such as when the tire size is changed.
- When rotating the tires.
- Vehicles with a tire inflation pressure display function: After performing the transmitter ID code registration procedure. (→P. 477)

When the tire pressure warning system is initialized, the current tire inflation pressure is set as the benchmark pressure.



■ How to initialize the tire pressure warning system





- 1 Park the vehicle in a safe place and stop the engine for 20 minutes or more.

The initialization procedure cannot be started while the vehicle is moving.

- 2 Adjust the tire inflation pressure to the specified cold tire inflation pressure level. (→P. 584)

Make sure to adjust the tire pressure to the specified cold tire inflation pressure level. The tire pressure warning system will operate based on this pressure level.

- 3 Start the engine. (→P. 209, 211)
- 4 Select  (4.2-inch display) or  (7-inch display) on the multi-information display using the meter control switches on the steering wheel. (→P. 103, 117).

- 5 4.2-inch display: Select “Vehicle Settings” and then press  .
7-inch display: Select  and then press and hold  .
- 6 Select “TPWS” and then press  .

- 7 Select “Set Pressure” then press and hold  until the tire pressure warning light blinks 3 times.

Then a message will be displayed on the multi-information display.

Vehicles with a tire inflation pressure display function: “- -” will be displayed on the multi-information display for the inflation pressure of each tire while initialization is being performed.

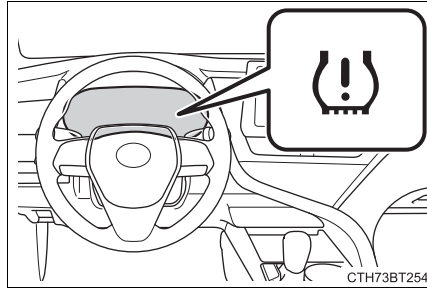

- 8 Vehicles with a tire inflation pressure display function: Drive at approximately 25 mph (40 km/h) or more for approximately 10 to 30 minutes.

When initialization is complete, the inflation pressure of each tire will be displayed on the multi-information display.

Even if the vehicle is not driven at approximately 25 mph (40 km/h) or more, initialization can be completed by driving for a long time. However, if initialization does not complete after driving for 1 hour or more, park the vehicle in a safe place for approximately 20 minutes and then drive the vehicle again.

◆ Registering ID codes



▶ Vehicles without a tire inflation pressure display function

Every tire pressure warning valve and transmitter has a unique ID code. In addition to the set of tire pressure warning system sensor ID codes initially registered to the vehicle, a second set of ID codes can be registered.



A second set of tire pressure warning system sensor ID codes can be registered at your Toyota dealer. When 2 sets of ID codes have been registered, either ID code set can be selected.

▶ Vehicles with a tire inflation pressure display function

Every tire pressure warning valve and transmitter has a unique ID code. When replacing a tire pressure warning valve and transmitter, it is necessary to register the ID codes.







The ID codes can be registered on  (4.2-inch display) or  (7-inch display) of the multi-information display.

■ Changing the available set of ID codes (vehicles without a tire inflation pressure display function)

When 2 sets of ID codes are registered, the corresponding ID code set for the installed wheels can be selected on  (4.2-inch display) or  (7-inch display) of the multi-information display. It is not necessary to reregister the ID codes each time the wheels are changed.

For information regarding changing the registered ID codes for an ID code set, contact your Toyota dealer.

■ How to register the ID codes (vehicles with a tire inflation pressure display function)

- 1 Park the vehicle in a safe place, wait for approximately 20 minutes, and then start the engine. (→P. 209, 211)
- 2 Select  (4.2-inch display) or  (7-inch display) on the multi-information display using the meter control switches on the steering wheel. (→P. 103, 117)
- 3 4.2-inch display: Select “Vehicle Settings” and then press  .
7-inch display: Select  and then press and hold  .
- 4 Select “TPWS” and then press  .

- 5 Select “Change Wheel” then press and hold  until the tire pressure warning light blinks slowly 3 times.

Then a message will be displayed on the multi-information display.

When registration is being performed, the tire pressure warning light will blink for approximately 1 minute then illuminate and “- -” will be displayed for the inflation pressure of each tire on the multi-information display.

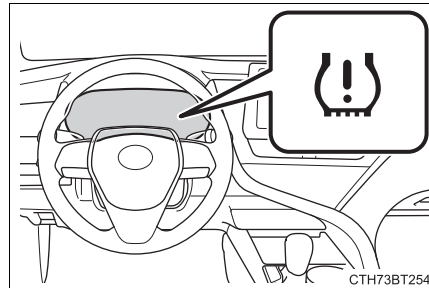

- 6 Drive at approximately 25 mph (40 km/h) or more for approximately 10 to 30 minutes.

Registration is complete when the tire pressure warning light turns off and the inflation pressure of each tire is displayed on the multi-information display.

Even if the vehicle is not driven at approximately 25 mph (40 km/h) or more, registration can be completed by driving for a long time. However, if registration does not complete after driving for 1 hour or more, perform the procedure again from the beginning.

- 7 Initialize the tire pressure warning system. (→P. 475)

■ When to replace your vehicle's tires

Tires should be replaced if:

- The treadwear indicators are showing on a tire.
- You have tire damage such as cuts, splits, cracks deep enough to expose the fabric, and bulges indicating internal damage
- A tire goes flat repeatedly or cannot be properly repaired due to the size or location of a cut or other damage

If you are not sure, consult with your Toyota dealer.

■ Replacing tires and wheels

If the ID codes of the tire pressure warning valve and transmitters are not registered, the tire pressure warning system will not work properly. In this case, after driving for about 20 minutes, the tire pressure warning light will blink for approximately 1 minute and then illuminate to indicate a system malfunction.

■ Tire life

Any tire over 6 years old must be checked by a qualified technician even if it has seldom or never been used or damage is not obvious.

■ Routine tire inflation pressure checks

The tire pressure warning system does not replace routine tire inflation pressure checks. Make sure to check tire inflation pressure as part of your routine of daily vehicle checks.

■ Low profile tires (vehicles with 18 or 19-inch wheels)

Generally, low profile tires will wear more rapidly and tire grip performance will be reduced on snowy and/or icy roads when compared to standard tires. Be sure to use snow tires on snowy and/or icy roads and drive carefully at a speed appropriate for road and weather conditions.

■ Maximum load of tire

Check that the maximum load of the replacement tire is greater than 1/2 of the Gross Axle Weight Ratings (GAWR) of either the front axle or the rear axle, whichever is greater.

For the GAWR, see the Certification Label. For the maximum load of the tire, see the load limit at maximum cold tire inflation pressure mentioned on the sidewall of the tire. (→P. 593)

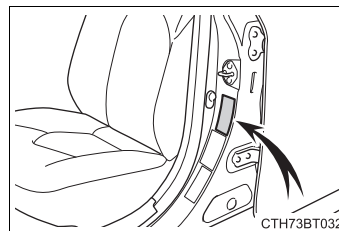

■ Tire types**● Summer tires**

Summer tires are high-speed performance tires best suited to highway driving under dry conditions. Since summer tires do not have the same traction performance as snow tires, summer tires are inadequate for driving on snow-covered or icy roads. For driving on snow-covered roads or icy roads, the use of snow tires is recommended. When installing snow tires, be sure to replace all four tires.

● All season tires

All season tires are designed to provide better traction in snow and to be adequate for driving in most winter conditions as well as for use year-round. All season tires, however, do not have adequate traction performance compared with snow tires in heavy or loose snow. Also, all season tires fall short in acceleration and handling performance compared with summer tires in highway driving.

● Snow tires

For driving on snow-covered roads or icy roads, we recommend using snow tires. If you need snow tires, select tires of the same size, construction and load capacity as the originally installed tires. Since your vehicle has radial tires as original equipment, make sure your snow tires also have radial construction. Do not install studded tires without first checking local regulations for possible restrictions. Snow tires should be installed on all wheels. (→P. 377)

■ If the tread on snow tires wears down below 0.16 in. (4 mm)

The effectiveness of the tires as snow tires is lost.

■ Situations in which the tire pressure warning system may not operate properly

- In the following situations, the tire pressure warning system may not operate properly.
 - If non-genuine Toyota wheels are used.
 - If a tire has been replaced with a tire that is not an OE (Original Equipment) tire.
 - If a tire has been replaced with a tire that is not of the specified size.
 - If tire chains, etc. are installed.
 - If a window tint that affects radio wave signals is installed.
 - If there is a lot of snow or ice on the vehicle, particularly around the wheels or wheel housings.
 - If the tire inflation pressure is much higher than the specified level.
 - If wheels not equipped with tire pressure warning valve and transmitter are used.
 - If the ID codes of the tire pressure warning valve and transmitters are not registered in the tire pressure warning computer.

- Performance may be affected in the following situations.
 - When driving near a TV tower, electric power plant, gas station, radio station, large display, airport or other facility that generates strong radio waves or electrical noise
 - When carrying a portable radio, cellular phone, cordless phone or other wireless communication device

Vehicles with a tire inflation pressure display function: If tire position information is not correctly displayed due to the radio wave conditions, the display may be corrected by changing the location of the vehicle as the radio wave conditions may change.
- When the vehicle is stopped, the time taken for the warning to start or turn off may be longer.
- When the inflation pressure of a tire drops rapidly, for example when a tire has burst, the warning may not operate.

■ Initialization procedure

- Make sure to perform the initialization procedure after adjusting the tire inflation pressure.
Also, make sure the tires are cold before performing the initialization procedure or adjusting the tire inflation pressure.
- If the engine switch is turned to the “LOCK” position (vehicles without a smart key system) or off (vehicles with a smart key system) during initialization, it is not necessary to restart the initialization procedure from the beginning as it will begin automatically when the engine switch is turned back to the “ON” position (vehicles without a smart key system) or IGNITION ON mode (vehicles with a smart key system).
- If initialization has accidentally been started when it is not necessary, adjust the tire inflation pressure to the specified level when the tires are cold and then perform the initialization procedure again.
- Vehicles with a tire inflation pressure display function: While the position of each tire is being determined and the inflation pressures are not being displayed on the multi-information display, if the inflation pressure of a tire drops, the tire pressure warning light will come on.

■ Warning performance of the tire pressure warning system

The warning of the tire pressure warning system will change in accordance with the conditions under which it was initialized. For this reason, the system may give a warning even if the tire pressure does not reach a low enough level, or if the pressure is higher than the pressure that was adjusted to when the system was initialized.

■ If the tire pressure warning system is not initialized properly**▶ Vehicles without a tire inflation pressure display function**

Initialization can be completed in a few minutes. However, in the following cases, the settings have not been recorded and the system will not operate properly. If repeated attempts to record tire inflation pressure settings are unsuccessful, have the vehicle inspected by your Toyota dealer.

- If initialization is attempted and the tire pressure warning light does not blink 3 times.
- If, when the vehicle has been driven for about 20 minutes after performing initialization, the tire pressure warning light blinks for approximately 1 minute and then illuminates.

▶ Vehicles with a tire inflation pressure display function

- In the following situations, initialization may take longer than usual to be completed or may not be possible. (Usually, the vehicle will need to be driven for approximately 10 to 30 minutes to complete initialization.) If initialization is not complete after driving approximately 30 minutes, continue driving for a while.

- If the vehicle is driven on an unpaved road, it may take longer to complete initialization.
- If the vehicle is backed up while performing initialization, data collected during initialization will be cleared and it will take longer than normal to complete.
- If the vehicle is driven in heavy traffic or another situation where other vehicles are driven close by, it may take time for the system to recognize the tire pressure warning valve and transmitters of your vehicle over those of other vehicles.

If initialization is not complete after driving for approximately 1 hour, park the vehicle in a safe place for approximately 20 minutes and then drive the vehicle again.

- In the following situations, initialization will not be started or was not completed properly and the system will not operate properly. Perform the initialization procedure again.
 - If, when attempting to start initialization, the tire pressure warning light does not blink 3 times.
 - If, when the vehicle has been driven for about 20 minutes after performing initialization, the tire pressure warning light blinks for approximately 1 minute and then illuminates.
- If initialization cannot be completed after performing the above procedure, contact your Toyota dealer.

■ When registering ID codes (vehicles with a tire inflation pressure display function)

- Before performing ID code registration, make sure that no wheels with tire pressure warning valve and transmitters installed are near the vehicle.
- Make sure to initialize the tire pressure warning system after registering the ID codes. If the system is initialized before registering the ID codes, the initialized values will be invalid.
- As the tires will be warm when registration is completed, make sure to allow the tires to cool before performing initialization.

■ Canceling ID code registration (vehicles with a tire inflation pressure display function)

- To cancel ID code registration after it has been started, turn the engine switch off before driving the vehicle.
If the vehicle is driven after ID code registration is started, to cancel registration, perform the ID code registration start procedure again and turn the engine switch off before driving.
- If ID code registration has been canceled, the tire pressure warning light will blink for approximately 1 minute when the engine switch is turned to the "ON" position (vehicles without a smart key system) or IGNITION ON mode (vehicles with a smart key system) and then illuminate. The tire pressure warning system will be operational when the tire pressure warning light turns off.
- If the warning light does not turn off even after several minutes have elapsed, ID code registration may not have been cancelled correctly. To cancel registration, perform the ID code registration start procedure again and then turn the engine switch off before driving.

■ If ID codes are not registered properly (vehicles with a tire inflation pressure display function)

- In the following situations, ID code registration may take longer than usual to be completed or may not be possible. (Usually, the vehicle will need to be driven for approximately 10 to 30 minutes to complete ID code registration.)

If ID code registration is not complete after driving for approximately 30 minutes, continue driving for a while.

- If the vehicle is driven on an unpaved road, it may take longer than normal to complete registration.
- If the vehicle is backed up while performing registration, data collected during registration will be cleared, and it will take longer than normal to complete.
- If the vehicle is driven in heavy traffic or another situation where other vehicles are driven close by, it may take time for the system to recognize the tire pressure warning valve and transmitters of your vehicle over those of other vehicles.
- If a wheel with a tire pressure warning valve and transmitter installed is inside or near the vehicle, registration of the ID codes for the installed wheels may not be possible.

If ID registration is not complete after driving for approximately 1 hour, park the vehicle in a safe place for approximately 20 minutes and then perform the ID code registration procedure again.

- In the following situations, ID code registration will not be started or was not completed properly and the system will not operate properly. Perform the ID code registration procedure again.
 - If, when attempting to start ID code registration, the tire pressure warning light does not blink slowly 3 times.
 - If, when the vehicle has been driven for about 20 minutes after performing ID code registration, the tire pressure warning light blinks for approximately 1 minute and then illuminates.
- If ID code registration cannot be completed after performing the above procedure, contact your Toyota dealer.

 **WARNING****■ When inspecting or replacing tires**

Observe the following precautions to prevent accidents. Failure to do so may cause damage to parts of the drive train as well as dangerous handling characteristics, which may lead to an accident resulting in death or serious injury.

- Do not mix tires of different makes, models or tread patterns. Also, do not mix tires of remarkably different treadwear.
- Do not use tire sizes other than those recommended by Toyota.
- Do not mix differently constructed tires (radial, bias-belted or bias-ply tires).
- Do not mix summer, all season and snow tires.
- Do not use tires that have been used on another vehicle. Do not use tires if you do not know how they were used previously.

■ When initializing the tire pressure warning system

Do not initialize the tire pressure warning system without first adjusting the tire inflation pressure to the specified level. Otherwise, the tire pressure warning light may not come on even if the tire inflation pressure is low, or it may come on when the tire inflation pressure is actually normal.

 NOTICE**■ Repairing or replacing tires, wheels, tire pressure warning valve and transmitters and tire valve caps**

- When removing or fitting the wheels, tires or the tire pressure warning valve and transmitters, contact your Toyota dealer as the tire pressure warning valve and transmitters may be damaged if not handled correctly.
- Make sure to install the tire valve caps. If the tire valve caps are not installed, water may enter the valves of the tire pressure warning valve and transmitters and the valves may become stuck.
- When replacing tire valve caps, do not replace them with metal caps or any tire valve caps other than specified, as they may become stuck.

■ To avoid damage to the tire pressure warning valve and transmitters

When a tire is repaired with liquid sealants, the tire pressure warning valve and transmitter may not operate properly. If a liquid sealant is used, contact your Toyota dealer or other qualified service shop as soon as possible. Make sure to replace the tire pressure warning valve and transmitter when replacing the tire. (→P. 475)

■ Driving on rough roads

Take particular care when driving on roads with loose surfaces or potholes.

These conditions may cause losses in tire inflation pressure, reducing the cushioning ability of the tires. In addition, driving on rough roads may cause damage to the tires themselves, as well as the vehicle's wheels and body.

■ Low profile tires (vehicles with 18 or 19-inch wheels)

Low profile tires may cause greater damage than usual to the tire wheel when sustaining impact from the road surface. Therefore, pay attention to the following:

- Be sure to use proper tire inflation pressure. If tires are under-inflated, they may be damaged more severely.
- Avoid potholes, uneven pavement, curbs and other road hazards. Failure to do so may lead to severe tire and wheel damage.

■ If tire inflation pressure of each tire becomes low while driving

Do not continue driving, or your tires and/or wheels may be ruined.

Tire inflation pressure

Tire inflation pressure

The recommended cold tire inflation pressure and tire size are displayed on the tire and loading information label. (→P. 584)

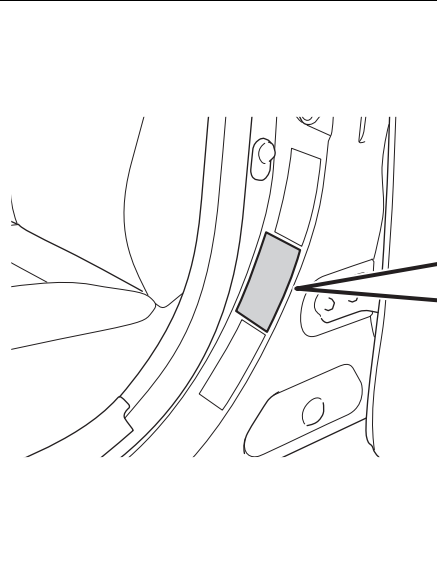

► Type A

TIRE AND LOADING INFORMATION RENSEIGNEMENTS SUR LES PNEUS ET LE CHARGEMENT			
SEATING CAPACITY TOTAL		FRONT REAR	
NOMBRE DE PLACES TOTAL		AVANT ARRIERE	
The combined weight of occupants and cargo should never exceed XXXX kg or XXXX lbs. Le poids total des occupants et du chargement ne doit jamais dépasser XXXX kg ou XXXX lbs.			
TIRE PNEU	SIZE DIMENSIONS	COLD TIRE PRESSURE PRESSION DES PNEUS A FROID	SEE OWNERS MANUAL FOR ADDITIONAL INFORMATION
FRONT AVANT	XXXX/XXXX	XXX kPa, XX PSI	VOIR LE MANUEL DE L'USAGER POUR PLUS DE RENSEIGNEMENTS
REAR ARRIERE	XXXX/XXXX	XXX kPa, XX PSI	
SPARE RESERVE	XXXX/XXXX	XXX kPa, XX PSI	

► Type B

TIRE AND LOADING INFORMATION RENSEIGNEMENTS SUR LES PNEUS ET LE CHARGEMENT			
SEATING CAPACITY TOTAL		FRONT REAR	
NOMBRE DE PLACES TOTAL		AVANT ARRIERE	
The combined weight of occupants and cargo should never exceed XXX kg or XXX lbs. Le poids total des occupants et du chargement ne doit jamais dépasser XXX kg ou XXX lbs.			
TIRE PNEU	SIZE DIMENSIONS	COLD TIRE PRESSURE PRESSION DES PNEUS A FROID	SEE OWNERS MANUAL FOR ADDITIONAL INFORMATION
FRONT AVANT	XXXXXXXX	XXXXPa, XXPSI	VOIR LE MANUEL DE L'USAGER POUR PLUS DE RENSEIGNEMENTS
REAR ARRIERE	XXXXXXXX	XXXXPa, XXPSI	
SPARE RESERVE	XXXXXXXX	XXXXPa, XXPSI	

CTH73BT009

Inspection and adjustment procedure

- ① Tire valve
- ② Tire pressure gauge

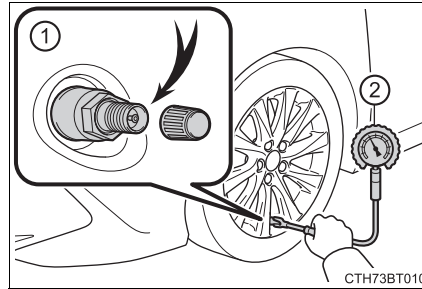

- 1 Remove the tire valve cap.
- 2 Press the tip of the tire pressure gauge onto the tire valve.
- 3 Read the pressure using the gauge gradations.
- 4 If the tire inflation pressure is not at the recommended level, adjust the pressure.
If you add too much air, press the center of the valve to deflate.
- 5 After completing the tire inflation pressure measurement and adjustment, apply soapy water to the valve and check for leakage.
- 6 Put the tire valve cap back on.

■ Tire inflation pressure check interval

You should check tire inflation pressure every two weeks, or at least once a month.

Do not forget to check the spare.

■ Effects of incorrect tire inflation pressure

Driving with incorrect tire inflation pressure may result in the following:

- Reduced fuel economy
- Reduced driving comfort and poor handling
- Reduced tire life due to wear
- Reduced safety
- Damage to the drivetrain

If a tire needs frequent inflating, have it checked by your Toyota dealer.

■ Instructions for checking tire inflation pressure

When checking tire inflation pressure, observe the following:

- Check only when the tires are cold.
If your vehicle has been parked for at least 3 hours or has not been driven for more than 1 mile or 1.5 km, you will get an accurate cold tire inflation pressure reading.
- Always use a tire pressure gauge.
It is difficult to judge if a tire is properly inflated based only on its appearance.
- It is normal for the tire inflation pressure to be higher after driving as heat is generated in the tire. Do not reduce tire inflation pressure after driving.
- Never exceed the vehicle capacity weight.
Passengers and luggage weight should be placed so that the vehicle is balanced.

WARNING

■ Proper inflation is critical to save tire performance

Keep your tires properly inflated.

If the tires are not properly inflated, the following conditions may occur which could lead to an accident resulting in death or serious injury:

- Excessive wear
- Uneven wear
- Poor handling
- Possibility of blowouts resulting from overheated tires
- Air leaking from between tire and wheel
- Wheel deformation and/or tire damage
- Greater possibility of tire damage while driving (due to road hazards, expansion joints, sharp edges on the road, etc.)

NOTICE

■ When inspecting and adjusting tire inflation pressure

Be sure to put the tire valve caps back on.

If a valve cap is not installed, dirt or moisture may get into the valve and cause an air leak, resulting in decreased tire inflation pressure.

Wheels

If a wheel is bent, cracked or heavily corroded, it should be replaced. Otherwise, the tire may separate from the wheel or cause a loss of handling control.

Wheel selection

When replacing wheels, care should be taken to ensure that they are equivalent to those removed in load capacity, diameter, rim width and inset*.

Replacement wheels are available at your Toyota dealer.

*: Conventionally referred to as "offset".

Toyota does not recommend using the following:

- Wheels of different sizes or types
- Used wheels
- Bent wheels that have been straightened

Aluminum wheel precautions (if equipped)

- Use only Toyota wheel nuts and wrenches designed for use with your aluminum wheels.
- When rotating, repairing or changing your tires, check that the wheel nuts are still tight after driving 1000 miles (1600 km).
- Be careful not to damage the aluminum wheels when using tire chains.
- Use only Toyota genuine balance weights or equivalent and a plastic or rubber hammer when balancing your wheels.

■ When replacing wheels

The wheels of your vehicle are equipped with tire pressure warning valve and transmitters that allow the tire pressure warning system to provide advance warning in the event of a loss in tire inflation pressure. Whenever wheels are replaced, tire pressure warning valve and transmitters must be installed. (→P. 475)

 **WARNING****■ When replacing wheels**

- Do not use wheels that are a different size from those recommended in the Owner's Manual, as this may result in a loss of handling control.
- Never use an inner tube in a leaking wheel which is designed for a tubeless tire. Doing so may result in an accident, causing death or serious injury.

■ When installing the wheel nuts

- Be sure to install the wheel nuts with the tapered ends facing inward. (→P. 553) Installing the nuts with the tapered ends facing outward can cause the wheel to break and eventually cause the wheel to come off while driving, which could lead to an accident resulting in death or serious injury.
- Never use oil or grease on the wheel bolts or wheel nuts. Oil and grease may cause the wheel nuts to be excessively tightened, leading to bolt or disc wheel damage. In addition, the oil or grease can cause the wheel nuts to loosen and the wheel may fall off, causing an accident and resulting in death or serious injury. Remove any oil or grease from the wheel bolts or wheel nuts.

 **NOTICE****■ Replacing tire pressure warning valve and transmitters**

- Because tire repair or replacement may affect the tire pressure warning valve and transmitters, make sure to have tires serviced by your Toyota dealer or other qualified service shop. In addition, make sure to purchase your tire pressure warning valve and transmitters at your Toyota dealer.
- Ensure that only genuine Toyota wheels are used on your vehicle. Tire pressure warning valve and transmitters may not work properly with non-genuine wheels.

Air conditioning filter

The air conditioning filter must be changed regularly to maintain air conditioning efficiency.

Removal method

- 1 Turn the engine switch off.
- 2 Open the glove box and remove the glove box cover inside the glove box.

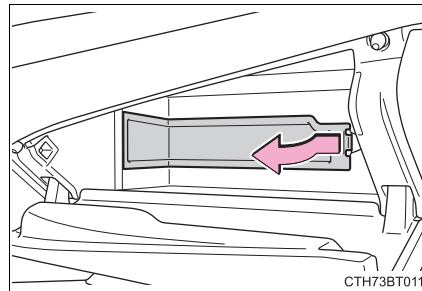

- 3 Remove the filter cover.
 - 1 Unlock the filter cover.
 - 2 Move the filter cover in the direction of the arrow, and then pull it out of the claws.

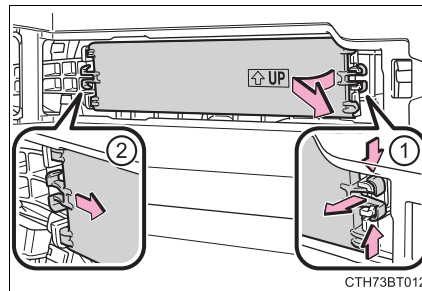

- 4 Remove the filter case.

There may be foreign objects on top of the air conditioning filter.

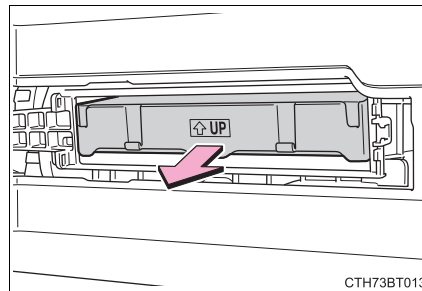

- 5 Remove the air conditioning filter from the filter case and replace it with a new one.

The “↑UP” marks shown on the filter and the filter case should be pointing up.

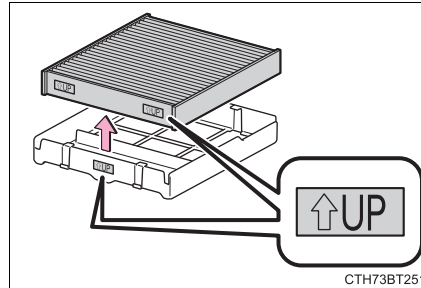

■ Checking interval

Inspect and replace the air conditioning filter according to the maintenance schedule. In dusty areas or areas with heavy traffic flow, early replacement may be required. (For scheduled maintenance information, please refer to the “Scheduled Maintenance Guide” or “Owner’s Manual Supplement”.)

■ If air flow from the vents decreases dramatically

The filter may be clogged. Check the filter and replace if necessary.

■ Air conditioning filter with deodorizing function

When fragrances are placed in your vehicle, the deodorizing effect may become significantly weakened in a short period.

When an air conditioning odor comes out continuously, replace the air conditioning filter.

⚠ NOTICE

■ When using the air conditioning system

Make sure that a filter is always installed.

Using the air conditioning system without a filter may cause damage to the system.

■ To prevent damage to the filter cover

When moving the filter cover in the direction of arrow to release the fitting, pay attention not to apply excessive force to the claws. Otherwise, the claws may be damaged.

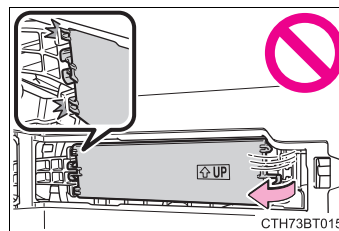

Wireless remote control/electronic key battery

Replace the battery with a new one if it is depleted.

You will need the following items:

- Flathead screwdriver
- Small flathead screwdriver
- Lithium battery CR2032

Replacing the battery

► Vehicles without a smart key system

1 Remove the key cover.

To prevent damage to the key, cover the tip of the flathead screwdriver with a rag.

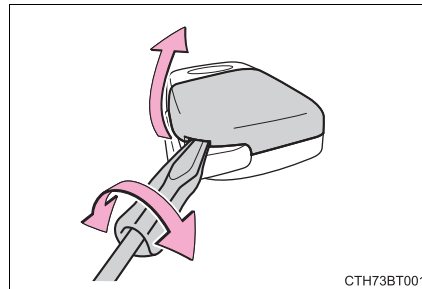

CTH73BT001

2 Remove the battery cover.

If the battery cover is difficult to remove, lift the edge to remove it.

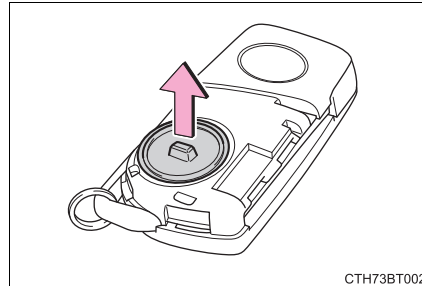

CTH73BT002

3 Remove the depleted battery using a small flathead screwdriver.

Insert a new battery with the “+” terminal facing up.

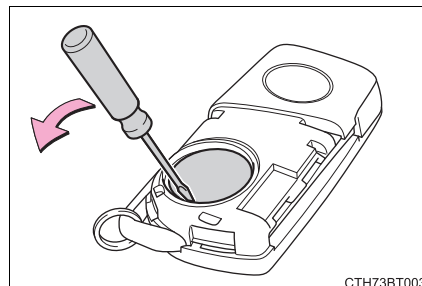

CTH73BT003

- 4 Install the battery cover with the tab facing up.

Push the entire edge of the battery cover into the key.

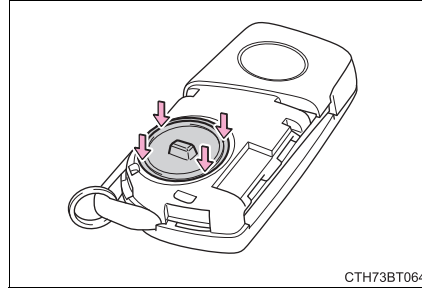



- 5 Install the key cover.

Align the key cover with the key and then press it straight into the key.

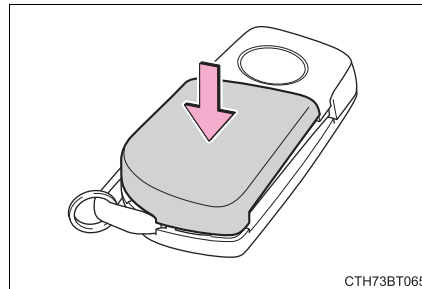
Make sure that the key cover is securely installed without any gaps between it and the key.



- 6 Operate the  or  switch and check that the doors can be locked/unlocked.

► Vehicles with a smart key system

- 1 Release the lock and remove the mechanical key.

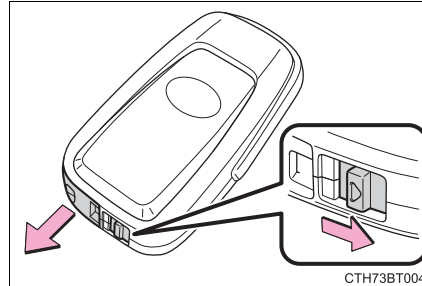

- 2 Remove the key cover.
To prevent damage to the key, cover the tip of the flathead screwdriver with a rag.

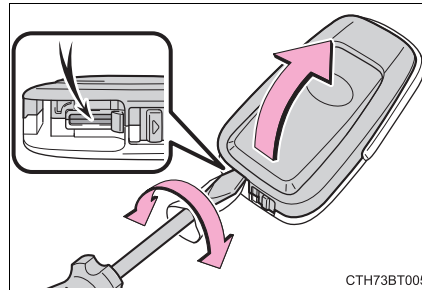

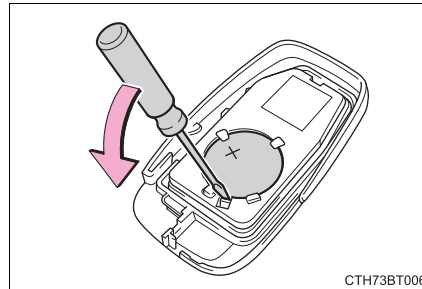

- 3 Remove the depleted battery using a small flathead screwdriver.

When removing the cover, the electronic key module may stick to the cover and the battery may not be visible. In this case, remove the electronic key module in order to remove the battery.



Insert a new battery with the "+" terminal facing up.

- 4 When installing the key cover and mechanical key, install by conducting 2 and 1 with the directions reversed.
- 5 Operate the  or  switch and check that the doors can be locked/unlocked.

■ When replacing the key battery

Be careful not to lose the battery or any other small parts.

■ Use a CR2032 lithium battery

- Batteries can be purchased at your Toyota dealer, local electrical appliance shops or camera stores.
- Replace only with the same or equivalent type recommended by the manufacturer.
- Dispose of used batteries according to local laws.

■ If the key battery is depleted

The following symptoms may occur:

- The smart key system (if equipped) and wireless remote control will not function properly.
- The operational range will be reduced.

WARNING

■ Battery precautions

Observe the following precautions. Failure to do so may result in death or serious injury.

- Do not swallow the battery. Doing so may cause chemical burns.
- Vehicles without a smart key system: A coin battery or button battery is used in the key. If a battery is swallowed, it may cause severe chemical burns in as little as 2 hours and may result in death or serious injury.
- Vehicles with a smart key system: A coin battery or button battery is used in the electronic key. If a battery is swallowed, it may cause severe chemical burns in as little as 2 hours and may result in death or serious injury.
- Keep away new and removed batteries from children.
- Vehicles without a smart key system: If the cover cannot be firmly closed, stop using the key and stow the key in the place where children cannot reach, and then contact your Toyota dealer.
- Vehicles with a smart key system: If the cover cannot be firmly closed, stop using the electronic key and stow the key in the place where children cannot reach, and then contact your Toyota dealer.
- If you accidentally swallow a battery or put a battery into a part of your body, get emergency medical attention immediately.

 **WARNING****■ To prevent battery explosion or leakage of flammable liquid or gas**

- Replace the battery with a new battery of the same type. If a wrong type of battery is used, it may explode.
- Do not expose batteries to extremely low pressure due to high altitude or extremely high temperatures.
- Do not burn, break or cut a battery.

 **NOTICE****■ For normal operation after replacing the battery**

Observe the following precautions to prevent accidents:

- Always work with dry hands.
Moisture may cause the battery to rust.
- Do not touch or move any other component inside the remote control.
- Do not bend either of the battery terminals.

■ When removing the battery cover (vehicles without a smart key system)

Do not forcibly remove the battery cover, otherwise it may be damaged.
If the battery cover is difficult to remove, lift the edge to remove it.

Checking and replacing fuses

If any of the electrical components do not operate, a fuse may have blown. If this happens, check and replace the fuses as necessary.

1 Turn the engine switch off.

2 Open the fuse box cover.

▶ Engine compartment (type A)

▶ Engine compartment (type B)
(if equipped)

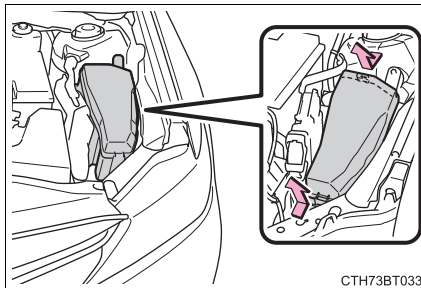

Push the tabs in and lift the lid off.

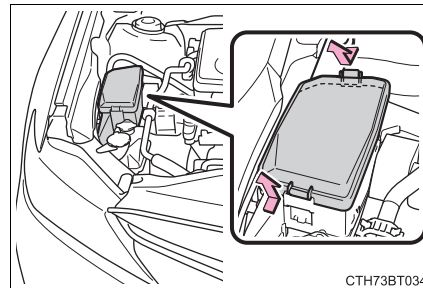

Push the tabs in and lift the lid off.

▶ Under the driver's side instrument panel

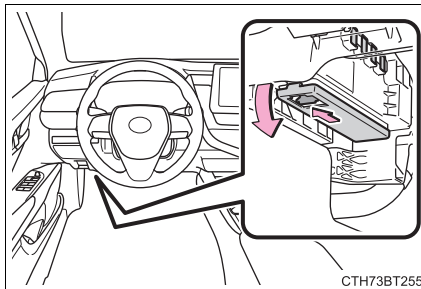

Remove the lid.

Make sure to push the claw when removing/installing the lid.

- 3 Remove the fuse with the pull-out tool.
Only type A fuses can be removed using the pullout tool.

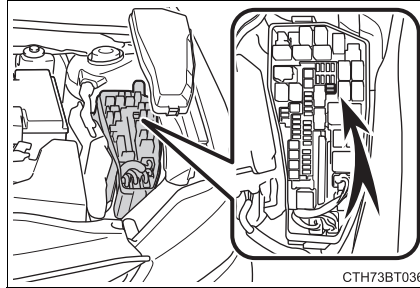

- 4 Check if the fuse is blown.

► Type A

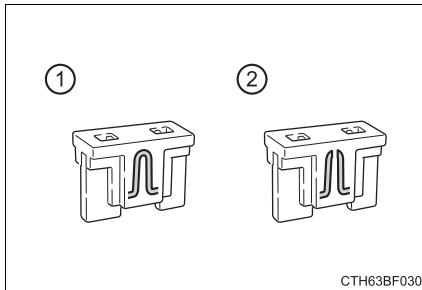

► Type B

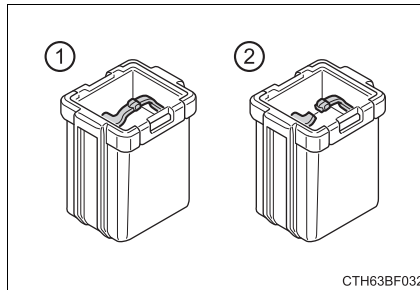

► Type C

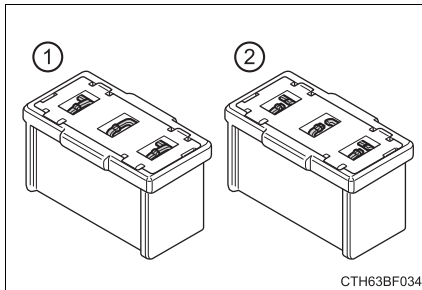

- ① Normal fuse
- ② Blown fuse

Replace the blown fuse with a new fuse of an appropriate amperage rating. The amperage rating can be found on the fuse box lid.

■ After a fuse is replaced

- If the lights do not turn on even after the fuse has been replaced, a bulb may need replacement. (→P. 502)
- If the replaced fuse blows again, have the vehicle inspected by your Toyota dealer.

■ If there is an overload in a circuit

The fuses are designed to blow, protecting the wiring harness from damage.

 **WARNING****■ To prevent system breakdowns and vehicle fire**

Observe the following precautions.

Failure to do so may cause damage to the vehicle, and possibly a fire or injury.

- Never use a fuse of a higher amperage rating than that indicated, or use any other object in place of a fuse.
- Always use a genuine Toyota fuse or equivalent.
Never replace a fuse with a wire, even as a temporary fix.
- Do not modify the fuses or fuse boxes.

 **NOTICE****■ Before replacing fuses**

Have the cause of electrical overload determined and repaired by your Toyota dealer as soon as possible.

Light bulbs

You may replace the following bulbs yourself. The difficulty level of replacement varies depending on the bulb. If necessary bulb replacement seems difficult to perform, contact your Toyota dealer.

For more information about replacing other light bulbs, contact your Toyota dealer.

Preparing for light bulb replacement

Check the wattage of the light bulb to be replaced. (→P. 589)

Bulb locations

► Front

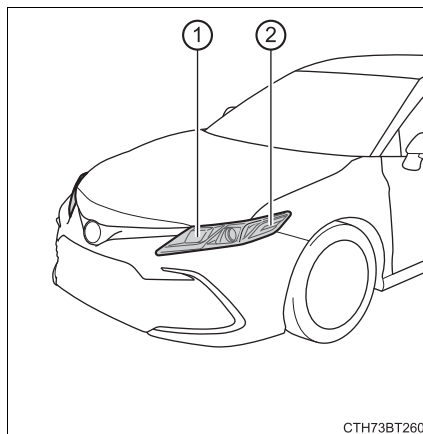

► Rear

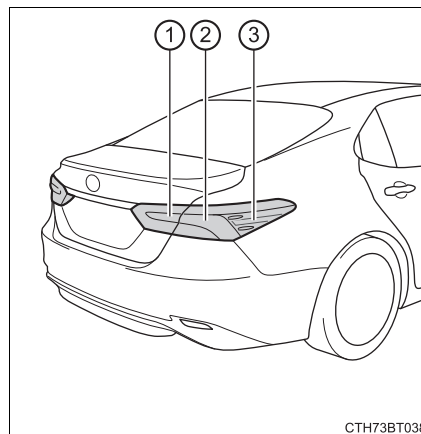

- | | |
|--|---------------------------------------|
| ① Front turn signal/parking lights (bulb type) | ① Back-up lights (bulb type) |
| ② Front side marker lights (bulb type) | ② Rear turn signal lights (bulb type) |
| | ③ Rear side marker lights (bulb type) |

Replacing light bulbs**■ Front turn signal/parking lights (bulb type)**

- 1 Turn the bulb base counter-clockwise.

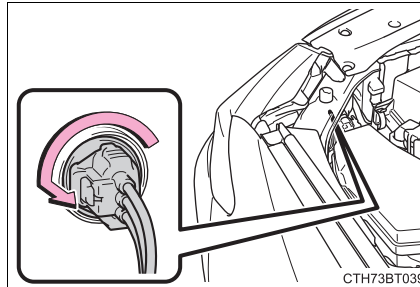

- 2 Remove the light bulb.

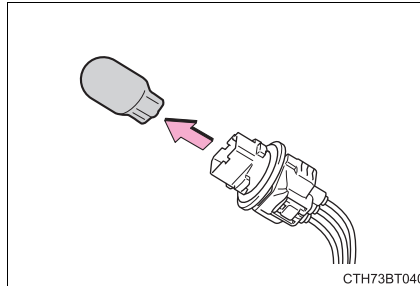

- 3 Install a new light bulb and then install the bulb base to the light unit by inserting it and turning it clockwise.

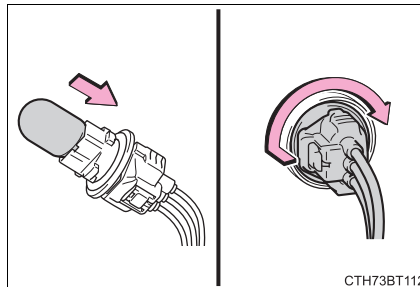

■ Front side marker lights (bulb type)

- 1 To ensure enough space to perform work, turn the steering wheel to move the front wheel away from the light bulb to be replaced.

Turn the steering wheel to the left when replacing the right side light bulb, and turn the steering wheel to the right when replacing the left side light bulb.

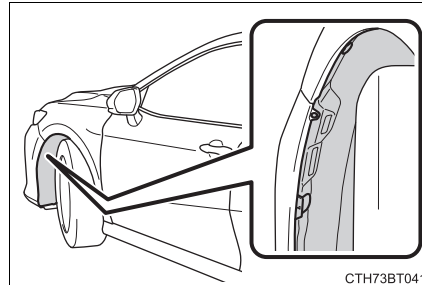

- 2 Remove the fender liner clips.

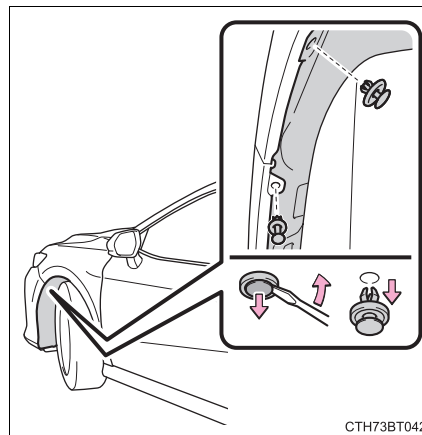

- 3 To protect the front bumper from being damaged, apply protective tape around the clip as shown in the illustration.

Use masking tape, etc. Do not use duct tape, as it may leave residue or damage the paint when removed.

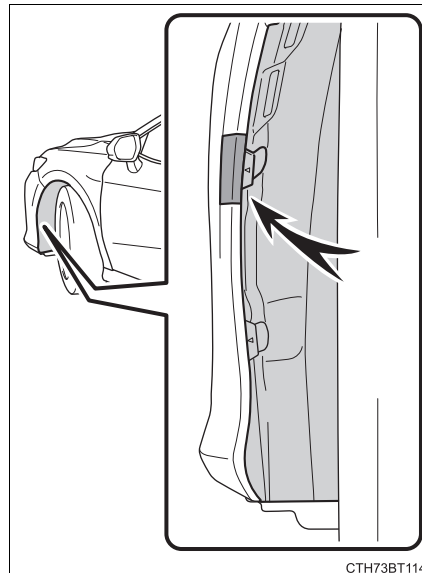

- 4 Insert a small flathead screwdriver between the front bumper and fender liner at the position marked with a “▽” and then separate the front bumper from the fender liner.

To separate the front bumper from the fender liner, pry up the fender liner while pulling the front bumper outward as shown in the illustration.

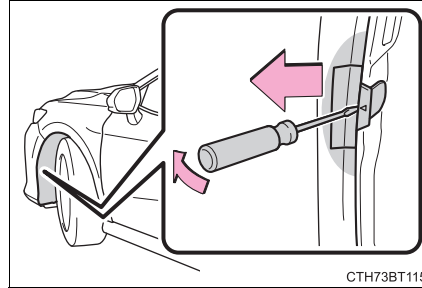

- 5 Pull back the fender liner and turn the bulb base counter-clockwise.

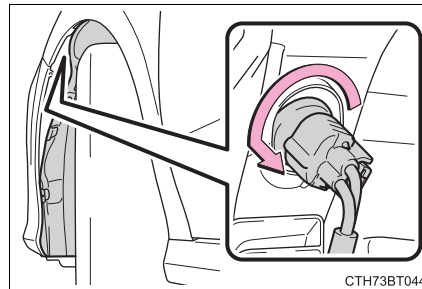

- 6 Remove the light bulb.

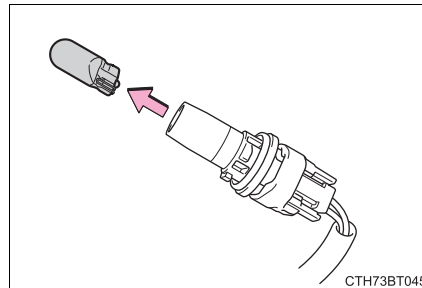

- 7 Install a new light bulb and then install the bulb base to the light unit by inserting it and turning it clockwise.

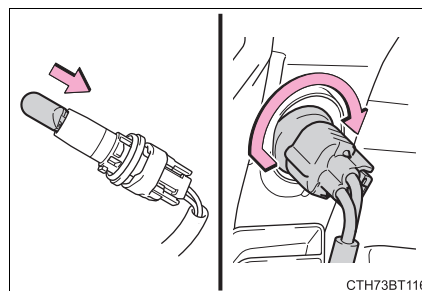

- 8** Return the fender liner to its original position, and install the clips.

Make sure that the fender liner is correctly positioned on the inner side of the front bumper.

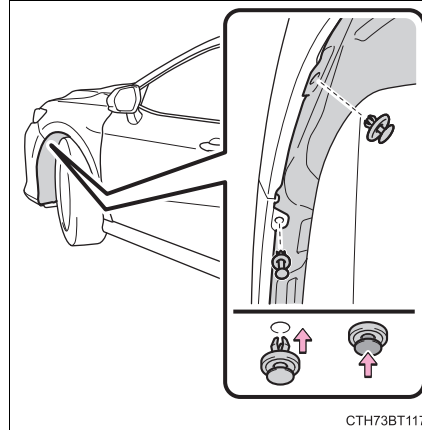

- 9** To install the fender liner to the front bumper, engage the clip to the front bumper.

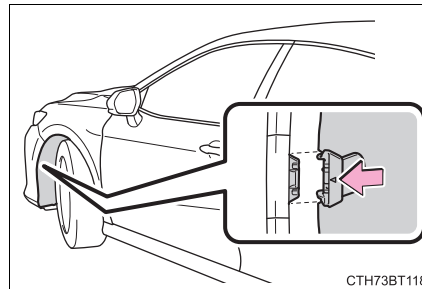

- 10** Remove the protective tape.

■ Back-up lights (bulb type)

- 1 Open the trunk lid and remove the clips.

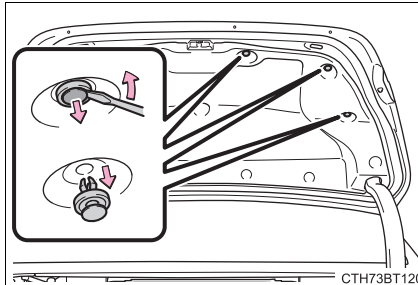

- 2 Partly remove the trunk lid cover.

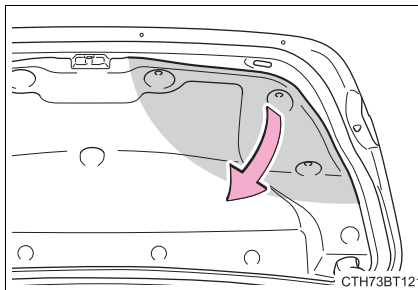

- 3 Disconnect the connector while depressing the lock release. (When replacing right side bulb only.)

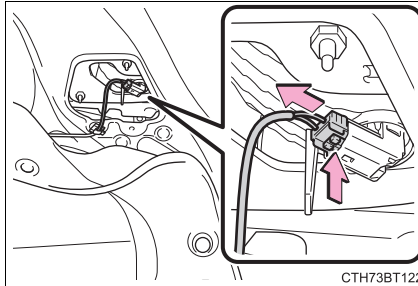

- 4 Turn the bulb base counter-clockwise.

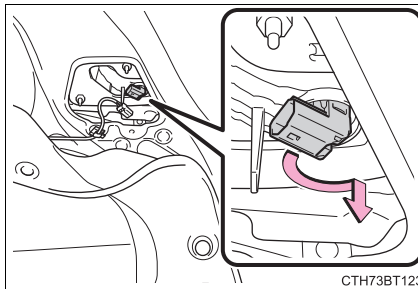

- 5 Remove the light bulb.

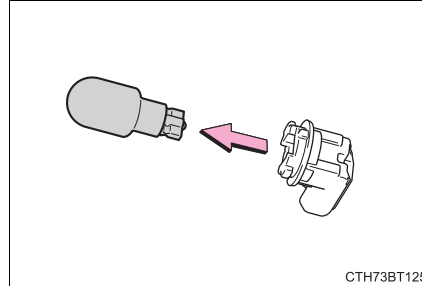

- 6 Install a new light bulb and then install the bulb base to the light unit by inserting it and turning it clockwise.

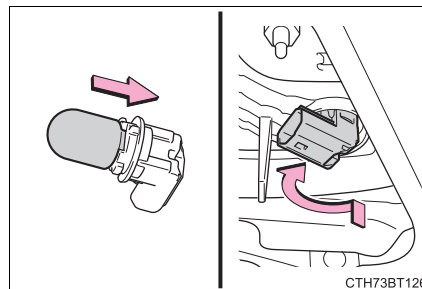

- 7 Connect the connector. (When replacing right side bulb only.)

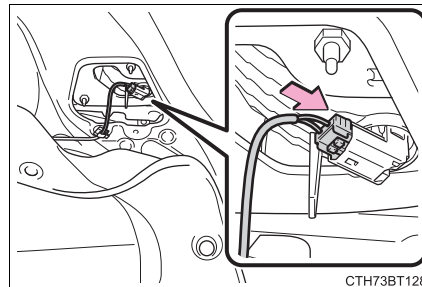

- 8 Reinstall the trunk lid cover with the clips.

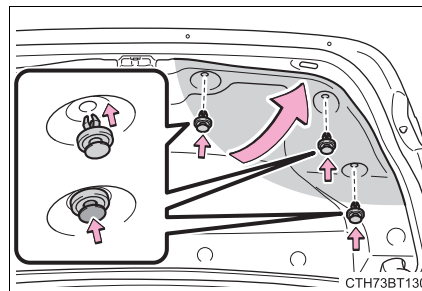

■ Rear turn signal lights (bulb type) and rear side marker lights (bulb type)

- 1 Open the trunk and apply protective tape to the vehicle body around the light unit.

Use masking tape, etc. Do not use duct tape, as it may leave residue or damage the paint when removed.

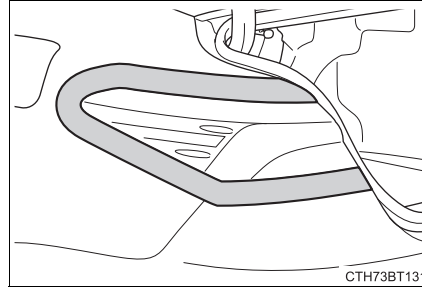

- 2 Remove the cover.

- ① Insert a flathead screwdriver between the cover and the light unit and pry up the cover in several positions as shown in the illustration to disengage the claws (indicated by a dotted line).

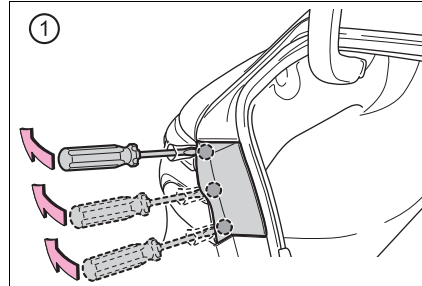

- ② Pull the cover toward the rear of the vehicle to disengage the claws (indicated by a dotted line) and remove the cover.

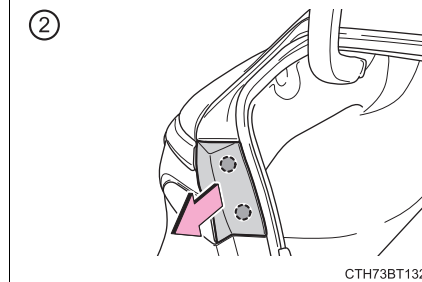

To prevent scratching the vehicle, wrap the tip of the flathead screwdriver with a cloth, etc.

- 3 Remove the 2 bolts.

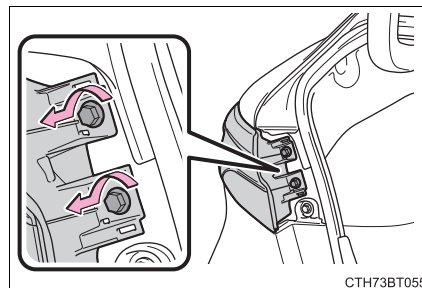

4 Remove the light unit.

- ① Attach a long piece of packing tape to the light unit and fold the excess in half.
- ② Hold the folded portion and pull it toward the rear of the vehicle to remove the light unit.

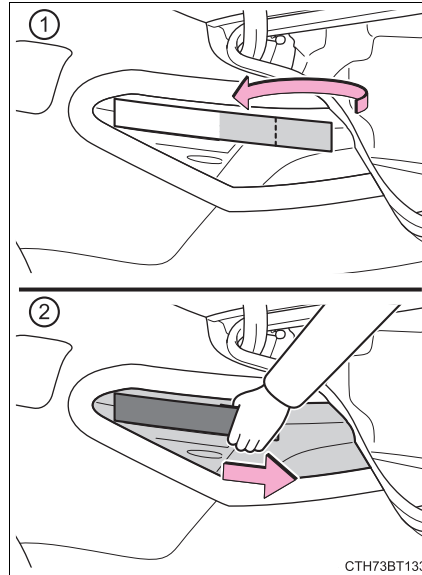

CTH73BT133

5 Turn the bulb base counterclockwise.

▶ Rear turn signal lights

▶ Rear side marker lights

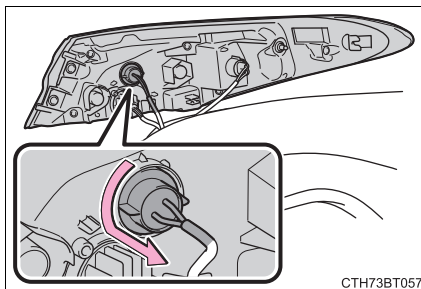

CTH73BT057

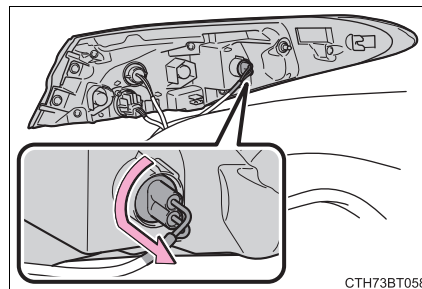

CTH73BT058

6 Remove the light bulb.

▶ Rear turn signal lights

▶ Rear side marker lights

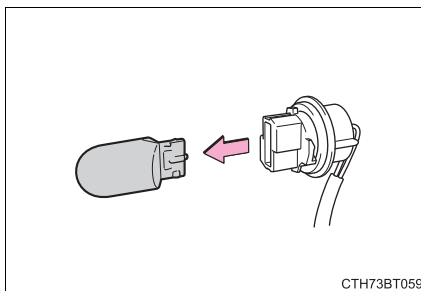

CTH73BT059

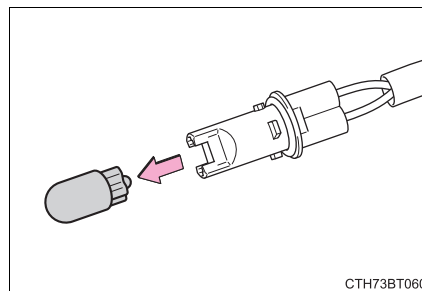

CTH73BT060

- 7** Install a new light bulb and then install the bulb base to the light unit by inserting it and turning it clockwise.

▶ Rear turn signal lights

▶ Rear side marker lights

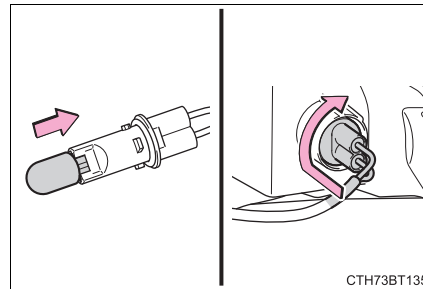
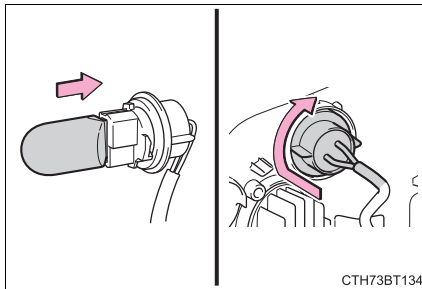

- 8** Install the light unit.

Align the tabs and push the light unit toward the front of the vehicle to install it.

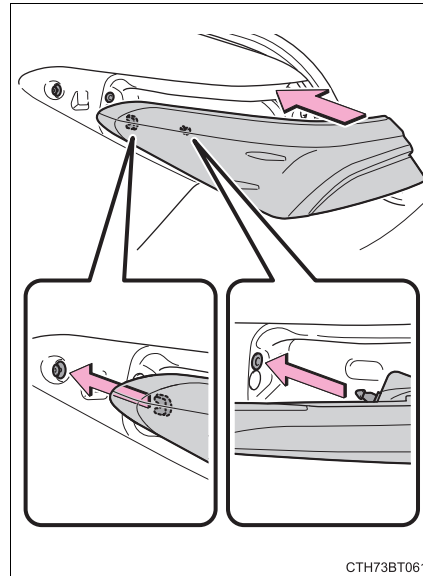

- 9** Install the 2 bolts.

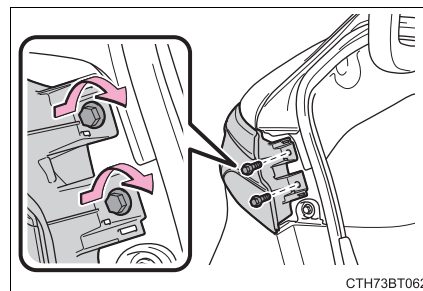

- 10 Install the cover.

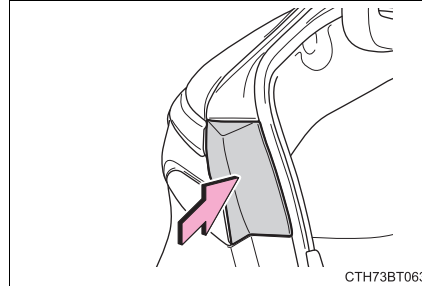

- 11 Remove the protective tape.

■ **Replacing the following bulbs**

If any of the lights listed below has burnt out, have it replaced by your Toyota dealer.

- Headlights
- Daytime running lights
- Parking lights (LED type)
- Front turn signal lights (LED type)
- Front side marker lights (LED type)
- Side turn signal lights (if equipped)
- Tail lights
- Rear side marker lights (LED type)
- Stoplights
- Rear turn signal lights (LED type)
- Back-up lights (LED type)
- High mounted stoplight
- License plate lights

■ **LED light bulbs**

The lights other than the front turn signal/parking lights (bulb type), front side marker lights (bulb type), back-up lights (bulb type), rear turn signal lights (bulb type) and rear side marker lights (bulb type) consist of a number of LEDs. If any of the LEDs burn out, take your vehicle to your Toyota dealer to have the light replaced.

■ **Condensation build-up on the inside of the lens**

Temporary condensation build-up on the inside of the headlight lens does not indicate a malfunction.

Contact your Toyota dealer for more information in the following situations:

- Large drops of water have built up on the inside of the lens.
- Water has built up inside the headlight.

 **WARNING****■ Replacing light bulbs**

- Turn off the lights. Do not attempt to replace the bulb immediately after turning off the lights.
The bulbs become very hot and may cause burns.
- Do not touch the glass portion of the light bulb with bare hands. When it is unavoidable to hold the glass portion, use and hold with a clean dry cloth to avoid getting moisture and oils on the bulb.
Also, if the bulb is scratched or dropped, it may blow out or crack.
- Fully install light bulbs and any parts used to secure them. Failure to do so may result in heat damage, fire, or water entering the headlight unit. This may damage the headlights or cause condensation to build up on the lens.

■ To prevent damage or fire

Make sure bulbs are fully seated and locked.

When trouble arises

7

7-1. Essential information

- Emergency flashers 516
- If your vehicle has
to be stopped in
an emergency 517
- If the vehicle is
submerged or water
on the road is rising 519

**7-2. Steps to take in
an emergency**

- If your vehicle needs
to be towed 520
- If you think something
is wrong 526
- Fuel pump shut off
system 527
- If a warning light turns
on or a warning
buzzer sounds 528
- If a warning message
is displayed 538
- If you have a flat tire..... 543
- If the engine will not
start..... 557
- If the electronic key does
not operate properly..... 559
- If the vehicle battery
is discharged..... 562
- If your vehicle
overheats 567
- If the vehicle becomes
stuck 570

Emergency flashers

The emergency flashers are used to warn other drivers when the vehicle has to be stopped on the road due to a breakdown, etc.

Press the switch.

All the turn signal lights will flash.
To turn them off, press the switch once again.

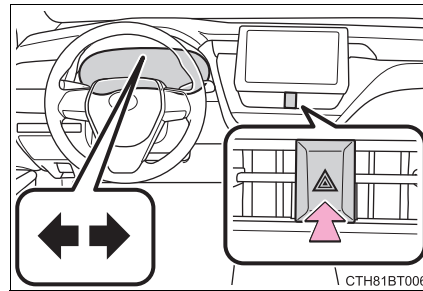

■ Emergency flashers

- If the emergency flashers are used for a long time while the engine is not operating, the battery may discharge.
- If any of the SRS airbags deploy (inflate) or in the event of a strong rear impact, the emergency flashers will turn on automatically. The emergency flashers will turn off automatically after operating for approximately 20 minutes. To manually turn the emergency flashers off, press the switch twice.
(The emergency flashers may not turn on automatically depending on the force of the impact and conditions of the collision.)

If your vehicle has to be stopped in an emergency

Only in an emergency, such as if it becomes impossible to stop the vehicle in the normal way, stop the vehicle using the following procedure:

- 1 Steadily step on the brake pedal with both feet and firmly depress it.
Do not pump the brake pedal repeatedly as this will increase the effort required to slow the vehicle.
- 2 Shift the shift lever to N.
 - ▶ If the shift lever is shifted to N
- 3 After slowing down, stop the vehicle in a safe place by the road.
- 4 Stop the engine.
 - ▶ If the shift lever cannot be shifted to N
- 3 Keep depressing the brake pedal with both feet to reduce vehicle speed as much as possible.
- 4 Vehicles without a smart key system: Stop the engine by turning the engine switch to the "ACC" position.

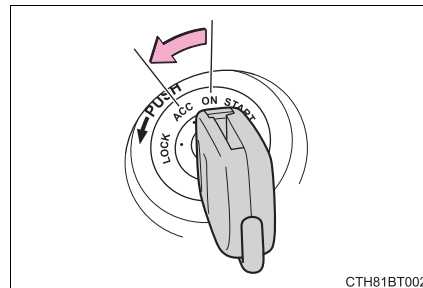

Vehicles with a smart key system: To stop the engine, press and hold the engine switch for 2 consecutive seconds or more, or press it briefly 3 times or more in succession.

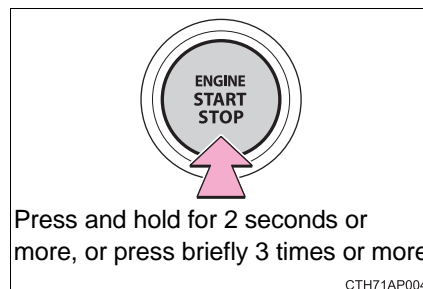

- 5 Stop the vehicle in a safe place by the road.

 WARNING

■ **If the engine has to be turned off while driving**

- Power assist for the brakes and steering wheel will be lost, making the brake pedal harder to depress and the steering wheel heavier to turn. Decelerate as much as possible before turning off the engine.
- Vehicles without a smart key system: Never attempt to remove the key, as doing so will lock the steering wheel.

If the vehicle is submerged or water on the road is rising

This vehicle is not designed to be able to drive on roads that are deeply flooded with water. Do not drive on roads where the roads may be submerged or the water may be rising. It is dangerous to remain in the vehicle, if it is anticipated that the vehicle will be flooded or set adrift. Remain calm and follow the following.

- If the door can be opened, open the door and exit the vehicle.
- If the door cannot be opened, open the window using the power window switch and ensure an escape route.
- If the window can be opened, exit the vehicle through the window.
- If the door and window cannot be opened due to the rising water, remain calm, wait until the water level inside the vehicle rises to the point that the water pressure inside of the vehicle equals the water pressure outside of the vehicle and then open the door after waiting for the rising water to enter the vehicle, and exit the vehicle.

When the outside water level exceeds half the height of the door, the door cannot be opened from the inside due to water pressure.

■ Water level exceeds the floor

When the water level exceeds the floor and time has passed, the electrical equipment will get damaged, the power windows will not operate, the engine stop, and the vehicle may not be able to get moving.

■ Using an emergency escape hammer*

Laminated glass is used in the windshield on this vehicle. Laminated glass cannot be shattered with an emergency hammer*. Tempered glass is used in the windows on this vehicle.

*: Contact your Toyota dealer or aftermarket accessory manufacturer for further information about an emergency hammer.

WARNING

■ Caution while driving

Do not drive on roads where the roads may be submerged or the water may be rising. Otherwise the vehicle may be damaged and cannot move, as well as become flooded and set adrift, which may lead to death.

If your vehicle needs to be towed

If towing is necessary, we recommend having your vehicle towed by your Toyota dealer or commercial towing service, using a wheel-lift type truck or flatbed truck.

Use a safety chain system for all towing, and abide by all state/provincial and local laws.

2WD models: If towing your vehicle with a wheel-lift type truck from the front, the vehicle's rear wheels and axles must be in good conditions. (→P. 521, 523)

If they are damaged, use a towing dolly or flatbed truck.

AWD models: If towing your vehicle with a wheel-lift type truck, use a towing dolly. (→P. 521, 523)

⚠ WARNING

Observe the following precautions.
Failure to do so may result in death or serious injury.

■ When towing the vehicle**▶ 2WD models**

Be sure to transport the vehicle with the front wheels raised or with all four wheels raised off the ground. If the vehicle is towed with the front wheels contacting the ground, the drivetrain and related parts may be damaged.

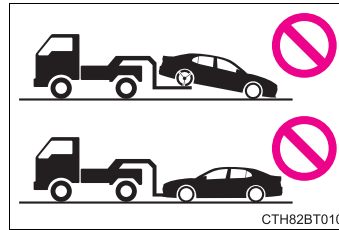
**▶ AWD models**

Be sure to transport the vehicle with all four wheels raised off the ground. If the vehicle is towed with the tires contacting the ground, the drivetrain or related parts may be damaged, the vehicle may fly off the truck.

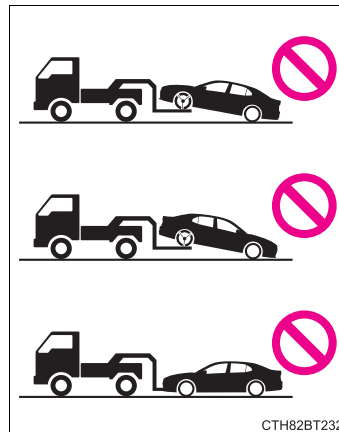
**■ While towing**

- When towing using cables or chains, avoid sudden starts, etc. which place excessive stress on the towing eyelets, cables or chains. The towing eyelets, cables or chains may become damaged, broken debris may hit people, and cause serious damage.
- Vehicles without a smart key system: Do not turn the engine switch to the "LOCK" position. There is a possibility that the steering wheel is locked and cannot be operated.

 NOTICE**■ To prevent damage to the vehicle when towing using a wheel-lift type truck**

- Vehicles without a smart key system: Do not tow the vehicle from the rear when the engine switch is in the "LOCK" position or the key is removed. The steering lock mechanism is not strong enough to hold the front wheels straight.
- When raising the vehicle, ensure adequate ground clearance for towing at the opposite end of the raised vehicle. Without adequate clearance, the vehicle could be damaged while being towed.

■ To prevent damage to the vehicle when towing with a sling-type truck

Do not tow with a sling-type truck, either from the front or rear.

■ To prevent damage to the vehicle during emergency towing

Do not secure cables or chains to the suspension components.

■ Recreational towing (behind motor home, etc.)

→P. 208

Situations when it is necessary to contact dealers before towing

The following may indicate a problem with your transmission. Contact your Toyota dealer or commercial towing service before towing.

- The engine is running but the vehicle does not move.
- The vehicle makes an abnormal sound.

Towing with a wheel-lift type truck

▶ From the front (2WD models)

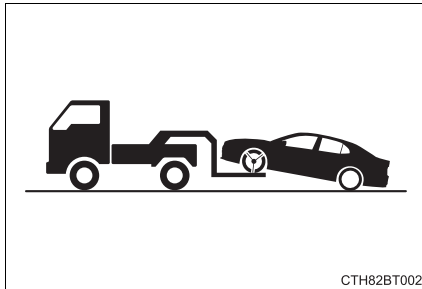

Release the parking brake.

Vehicles with electric parking brake: Turn automatic mode off.
(→P. 225)

▶ From the rear

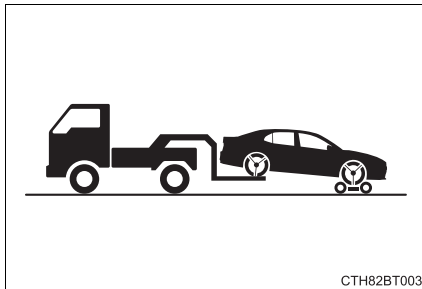

Use a towing dolly under the front wheels.

▶ From the front (AWD models)

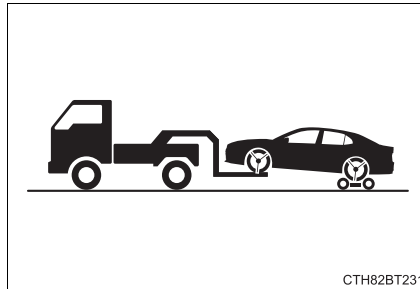

Use a towing dolly under the rear wheels.

 NOTICE

■ **Towing with a sling-type truck**

Do not tow with a sling-type truck to prevent body damage.

▶ 2WD models

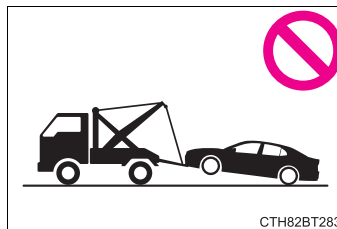

CTH82BT283

▶ AWD models

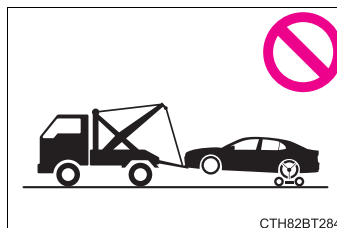

CTH82BT284

Using a flatbed truck

When using a flat-bed truck to transport the vehicle, use tire strapping belts. Refer to the owner's manual of the flat-bed truck for the tire strapping method.

▶ Vehicles without a smart key system

In order to suppress vehicle movement during transportation, set the parking brake and turn the engine switch to the "LOCK" position.

▶ Vehicles with a smart key system

In order to suppress vehicle movement during transportation, set the parking brake and turn the engine switch off.

Emergency towing

A driver must be in the vehicle to steer and operate the brakes. The vehicle's wheels, drive train, axles, steering and brakes must be in good condition.

If you think something is wrong

If you notice any of the following symptoms, your vehicle probably needs adjustment or repair. Contact your Toyota dealer as soon as possible.

Visible symptoms

- Fluid leaks under the vehicle.
(Water dripping from the air conditioning after use is normal.)
- Flat-looking tires or uneven tire wear
- Engine coolant temperature gauge needle continually points higher than normal

Audible symptoms

- Changes in exhaust sound
- Excessive tire squeal when cornering
- Strange noises related to the suspension system
- Pinging or other noises related to the engine

Operational symptoms

- Engine missing, stumbling or running roughly
- Appreciable loss of power
- Vehicle pulls heavily to one side when braking
- Vehicle pulls heavily to one side when driving on a level road
- Loss of brake effectiveness, spongy feeling, pedal almost touches the floor

Fuel pump shut off system

To minimize the risk of fuel leakage when the engine stalls or when an airbag inflates upon collision, the fuel pump shut off system stops the supply of fuel to the engine.

Follow the procedure below to restart the engine after the system is activated.

▶ Vehicles without a smart key system

- 1 Turn the engine switch to the “ACC” or “LOCK” position.
- 2 Restart the engine.

▶ Vehicles with a smart key system

- 1 Turn the engine switch off.
- 2 Restart the engine.



NOTICE

■ **Before starting the engine**







Inspect the ground under the vehicle.







If you find that fuel has leaked onto the ground, the fuel system has been damaged and is in need of repair. Do not restart the engine.



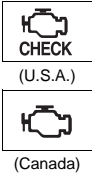

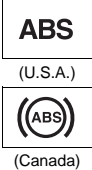
If a warning light turns on or a warning buzzer sounds

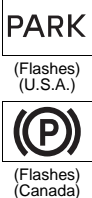



Calmly perform the following actions if any of the warning lights comes on or flashes. If a light comes on or flashes, but then goes off, this does not necessarily indicate a malfunction in the system. However, if this continues to occur, have the vehicle inspected by your Toyota dealer.

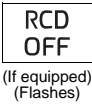

Warning light and warning buzzer list

Warning light	Warning light/Details/Actions
 (U.S.A.)  (Red) (Canada)	Brake system warning light Indicates that: <ul style="list-style-type: none"> • The brake fluid level is low; or • The brake system is malfunctioning → Immediately stop the vehicle in a safe place and contact your Toyota dealer. Continuing to drive the vehicle may be dangerous.
 (If equipped) (Yellow)	Brake system warning light Indicates a malfunction in the electric parking brake → Have the vehicle inspected by your Toyota dealer immediately.
	High coolant temperature warning light (warning buzzer)*1 Indicates that the engine coolant temperature is too high → Immediately stop the vehicle in a safe place. Handling method (→P. 567)
	Charging system warning light*1 Indicates a malfunction in the vehicle's charging system → Immediately stop the vehicle in a safe place and contact your Toyota dealer.
	Low engine oil pressure warning light (warning buzzer)*1 Indicates that the engine oil pressure is too low → Immediately stop the vehicle in a safe place and contact your Toyota dealer.

Warning light	Warning light/Details/Actions
 <p>CHECK (U.S.A.) CHECK (Canada)</p>	<p>Malfunction indicator lamp Indicates a malfunction in:</p> <ul style="list-style-type: none"> • The electronic engine control system; • The electronic throttle control system; or • The electronic automatic transmission control system <p>→ Have the vehicle inspected by your Toyota dealer immediately.</p>
	<p>SRS warning light Indicates a malfunction in:</p> <ul style="list-style-type: none"> • The SRS airbag system; • The front passenger occupant classification system; or • The seat belt pretensioner system <p>→ Have the vehicle inspected by your Toyota dealer immediately.</p>
 <p>ABS (U.S.A.) ABS (Canada)</p>	<p>ABS warning light Indicates a malfunction in:</p> <ul style="list-style-type: none"> • The ABS; or • The brake assist system <p>→ Have the vehicle inspected by your Toyota dealer immediately.</p>
	<p>Inappropriate pedal operation warning light (warning buzzer)*1 When a buzzer sounds:</p> <ul style="list-style-type: none"> • Brake Override System is malfunctioning • Drive-Start Control is malfunctioning • Drive-Start Control is operating • Parking Support Brake is operating (if equipped) <p>→ Follow the instructions displayed on the multi-information display.</p> <p>When a buzzer does not sound: Brake Override System is operating. → Release the accelerator pedal and depress the brake pedal.</p>
 <p>PARK (Flashes) (U.S.A.) (P) (Flashes) (Canada)</p>	<p>Parking brake indicator (warning buzzer)*2 It is possible that the parking brake is not fully engaged or released → Operate the parking brake once again. This light comes on when the parking brake is not released. If the light turns off after the parking brake is fully released, the system is operating normally.</p>
 <p>HOLD (If equipped) (Flashes)</p>	<p>Brake hold operated indicator Indicates a malfunction in the brake hold system → Have the vehicle inspected by your Toyota dealer immediately.</p>

Warning light	Warning light/Details/Actions
 <p>(Red/yellow)</p>	<p>Electric power steering system warning light (warning buzzer) Indicates a malfunction in the EPS (Electric Power Steering) system → Have the vehicle inspected by your Toyota dealer immediately.</p>
 <p>(Yellow)</p>	<p>LTA indicator (warning buzzer)*1 Indicates a malfunction in the LTA (Lane Tracing Assist) → Follow the instructions displayed on the multi-information display. (→P. 284)</p>
 <p>(Flashes or illuminates)</p>	<p>PCS warning light When a buzzer sounds simultaneously: Indicates a malfunction has occurred in the PCS (Pre-Collision System). → Have the vehicle inspected by your Toyota dealer immediately. When a buzzer does not sound: The PCS (Pre-Collision System) has become temporarily unavailable, corrective action may be necessary. → Follow the instructions displayed on the multi-information display. (→P. 252, 538) If the PCS (Pre-Collision System) or VSC (Vehicle Stability Control) system is disabled, the PCS warning light will illuminate. → P. 269</p>
 <p>(If equipped) (Illuminates)</p>	<p>PKSB OFF indicator When a buzzer sounds: Indicates a malfunction in the Parking Support Brake system → Have the vehicle inspected by your Toyota dealer immediately. When a buzzer does not sound: Indicates that the system is temporarily unavailable, possibly due to a sensor being dirty or covered with ice, etc. → Clear the dirt, etc.</p>
 <p>(If equipped) (Illuminates)</p>	<p>Intuitive parking assist OFF indicator*1 Indicates a malfunction in the intuitive parking assist function → Have the vehicle inspected by your Toyota dealer immediately. Indicates that the system is temporarily unavailable, possibly due to a sensor being dirty or covered with ice, etc. → Clear the dirt, etc.</p>

Warning light	Warning light/Details/Actions
	<p>RCD OFF indicator*1 When a buzzer sounds: Indicates a malfunction in the RCD (Rear Camera Detection) function → Have the vehicle inspected by your Toyota dealer immediately.</p> <p>When a buzzer does not sound: Indicates that the function temporarily cannot be used due to the camera being dirty, etc. → Clear the dirt, etc.</p>
	<p>Slip indicator Indicates a malfunction in:</p> <ul style="list-style-type: none"> • The VSC (Vehicle Stability Control) system; • The TRAC (Traction Control) system; or • The ABS <p>The light will flash when the VSC or the TRAC system is operating. → Have the vehicle inspected by your Toyota dealer immediately.</p>
	<p>Low fuel level warning light</p> <ul style="list-style-type: none"> ▶ For 2WD models <p>Indicates that remaining fuel is approximately 2.4 gal. (9.1 L, 2.0 Imp. gal.)</p> <ul style="list-style-type: none"> ▶ For AWD models <p>Indicates that remaining fuel is approximately 2.2 gal. (8.2 L, 1.8 Imp. gal.) → Refuel the vehicle.</p>
	<p>Driver's and front passenger's seat belt reminder light (warning buzzer)*3 Warns the driver and/or front passenger to fasten their seat belts → Fasten the seat belt. If the front passenger's seat is occupied, the front passenger's seat belt also needs to be fastened to make the warning light (warning buzzer) turn off.</p>
	<p>Rear passengers' seat belt reminder lights (warning buzzer)*4 Warns the rear passengers to fasten their seat belts. → Fasten the seat belt.</p>

Warning light	Warning light/Details/Actions
	<p>Master warning light A buzzer sounds and the warning light comes on and flashes to indicate that the master warning system has detected a malfunction. → P. 538</p>
	<p>Tire pressure warning light Indicates the following:</p> <ul style="list-style-type: none"> • Low tire pressure due to flat tire; • Low tire pressure due to natural causes; or • The tire pressure warning system is malfunctioning <p>→ Immediately stop the vehicle in a safe place. Handling method (→P. 534)</p>

*1: This light illuminates on the multi-information display.

*2: Parking brake engaged warning buzzer:

A buzzer will sound if the vehicle is driven at a speed of approximately 3 mph (5 km/h) or more.

*3: Driver's seat belt warning buzzer:

Vehicles without a smart key system:

The driver's seat belt warning buzzer sounds to alert the driver that his or her seat belt is not fastened. Once the engine switch is turned to the "ON" position, the buzzer sounds. If the seat belt is still unfastened, the buzzer sounds intermittently for a certain period of time after the vehicle reaches a certain speed.

Vehicles with a smart key system:

The driver's seat belt warning buzzer sounds to alert the driver that his or her seat belt is not fastened. Once the engine switch is turned to IGNITION ON mode, the buzzer sounds. If the seat belt is still unfastened, the buzzer sounds intermittently for a certain period of time after the vehicle reaches a certain speed.

Front passenger's seat belt warning buzzer:

The front passenger's seat belt warning buzzer sounds to alert the front passenger that his or her seat belt is not fastened. If the seat belt is unfastened, the buzzer sounds intermittently for a certain period of time after the vehicle reaches a certain speed.

*4: Rear passengers' seat belt warning buzzer:

The rear passengers' seat belt warning buzzer sounds to alert the rear passenger that his or her seat belt is not fastened. If the seat belt is unfastened, the buzzer sounds intermittently for a certain period of time, after the seat belt is fastened and unfastened and the vehicle reaches a certain speed.

■ SRS warning light

This warning light system monitors the airbag sensor assembly, front impact sensors, side impact sensors (front door), side impact sensors (front), side impact sensors (rear), driver's seat position sensor, driver's seat belt buckle switch, front passenger occupant classification system (ECU and sensors), "AIRBAG ON" indicator light, "AIRBAG OFF" indicator light, seat belt pretensioners, airbags, interconnecting wiring and power sources. (→P. 38)

■ Front passenger detection sensor, seat belt reminder and warning buzzer

- If luggage is placed on the front passenger seat, the front passenger detection sensor may cause the warning light to flash and the warning buzzer to sound even if a passenger is not sitting in the seat.
- If a cushion is placed on the seat, the sensor may not detect a passenger, and the warning light may not operate properly.

■ If the malfunction indicator lamp comes on while driving

First check the following:

- Is the fuel tank empty?
If it is, fill the fuel tank immediately.
- Is the fuel tank cap loose?
If it is, tighten it securely.

The light will go off after several driving trips.

If the light does not go off even after several trips, contact your Toyota dealer as soon as possible.

■ Electric power steering system warning light (warning buzzer)

When the battery charge becomes insufficient or the voltage temporarily drops, the electric power steering system warning light may come on and the warning buzzer may sound.

■ **When the tire pressure warning light comes on**

Inspect the tires to check if a tire is punctured.

If a tire is punctured: →P. 543

If none of the tires are punctured:

Turn the engine switch off then turn it to the "ON" position (vehicle without a smart key system) or IGNITION ON mode (vehicle with a smart key system). Check if the tire pressure warning light comes on or blinks.

▶ If the tire pressure warning light comes on

- 1 After the temperature of the tires has lowered sufficiently, check the inflation pressure of each tire and adjust them to the specified level.
- 2 If the warning light does not turn off even after several minutes have elapsed, check that the inflation pressure of each tire is at the specified level and perform initialization. (→P. 475)

If the warning light does not turn off several minutes after the initialization has been performed, have the vehicle inspected by your Toyota dealer immediately.

▶ If the tire pressure warning light blinks for 1 minute then stays on

There may be a malfunction in the tire pressure warning system. Have the vehicle inspected by your Toyota dealer immediately.

■ **The tire pressure warning light may come on due to natural causes**

The tire pressure warning light may come on due to natural causes such as natural air leaks and tire inflation pressure changes caused by temperature. In this case, adjusting the tire inflation pressure will turn off the warning light (after a few minutes).

■ **When a tire is replaced with a spare tire**

The compact spare tire is not equipped with a tire pressure warning valve and transmitter. If a tire goes flat, the tire pressure warning light will not turn off even though the flat tire has been replaced with the spare tire. Replace the spare tire with the repaired tire and adjust the tire inflation pressure. The tire pressure warning light will go off after a few minutes.

■ **Conditions that the tire pressure warning system may not function properly**

→P. 480

■ **Warning buzzer**

In some cases, the buzzer may not be heard because of noisy place or an audio sound.

 **WARNING****■ If both the ABS and the brake system warning lights remain on**

Stop your vehicle in a safe place immediately and contact your Toyota dealer. The vehicle will become extremely unstable during braking, and the ABS system may fail, which could cause an accident resulting in death or serious injury.

■ When the electric power steering system warning light comes on

When the light comes on yellow, the assist to the power steering is restricted. When the light comes on red, the assist to the power steering is lost and handling operations of the steering wheel become extremely heavy. When steering wheel operations are heavier than usual, grip the steering wheel firmly and operate it using more force than usual.

■ If the tire pressure warning light comes on

Be sure to observe the following precautions. Failure to do so could cause a loss of vehicle control and result in death or serious injury.

- Stop your vehicle in a safe place as soon as possible. Adjust the tire inflation pressure immediately.
- If the tire pressure warning light comes on even after tire inflation pressure adjustment, it is probable that you have a flat tire. Check the tires. If a tire is flat, change it with the spare tire and have the flat tire repaired by the nearest Toyota dealer.
- Avoid abrupt maneuvering and braking. If the vehicle tires deteriorate, you could lose control of the steering wheel or the brakes.

■ If a blowout or sudden air leakage should occur

The tire pressure warning system may not activate immediately.

 **WARNING****■ Maintenance of the tires**

Each tire, including the spare (if provided), should be checked monthly when cold and inflated to the inflation pressure recommended by the vehicle manufacturer on the vehicle placard or tire inflation pressure label (tire and load information label). (If your vehicle has tires of a different size than the size indicated on the vehicle placard or tire inflation pressure label [tire and load information label], you should determine the proper tire inflation pressure for those tires.)

As an added safety feature, your vehicle has been equipped with a tire pressure monitoring system (TPMS-tire pressure warning system) that illuminates a low tire pressure telltale (tire pressure warning light) when one or more of your tires is significantly under-inflated. Accordingly, when the low tire pressure telltale (tire pressure warning light) illuminates, you should stop and check your tires as soon as possible, and inflate them to the proper pressure. Driving on a significantly under-inflated tire causes the tire to overheat and can lead to tire failure. Under-inflation also reduces fuel efficiency and tire tread life, and may affect the vehicle's handling and stopping ability.

Please note that the TPMS (tire pressure warning system) is not a substitute for proper tire maintenance, and it is the driver's responsibility to maintain correct tire pressure, even if under-inflation has not reached the level to trigger illumination of the TPMS low tire pressure telltale (tire pressure warning light).

Your vehicle has also been equipped with a TPMS (tire pressure warning system) malfunction indicator to indicate when the system is not operating properly. The TPMS (tire pressure warning system) malfunction indicator is combined with the low tire pressure telltale (tire pressure warning light). When the system detects a malfunction, the telltale will flash for approximately one minute and then remain continuously illuminated. This sequence will continue upon subsequent vehicle start-ups as long as the malfunction exists. When the malfunction indicator is illuminated, the system may not be able to detect or signal low tire pressure as intended.

TPMS (tire pressure warning system) malfunctions may occur for a variety of reasons, including the installation of replacement or alternate tires or wheels on the vehicle that prevent the TPMS (tire pressure warning system) from functioning properly. Always check the TPMS (tire pressure warning system) malfunction telltale after replacing one or more tires or wheels on your vehicle to ensure that the replacement or alternate tires and wheels allow the TPMS (tire pressure warning system) to continue to function properly.

 NOTICE

■ **To ensure the tire pressure warning system operates properly**

Do not install tires with different specifications or makers, as the tire pressure warning system may not operate properly.

If a warning message is displayed

The multi-information display shows warnings of system malfunctions, incorrectly performed operations, and messages that indicate a need for maintenance. When a message is shown, perform the correction procedure appropriate to the message.

▶ 4.2-inch display

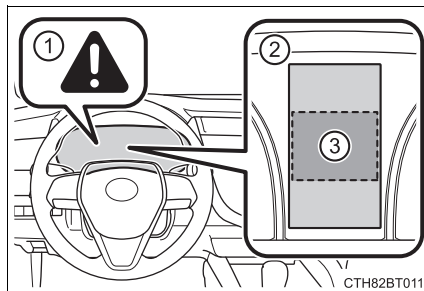

▶ 7-inch display

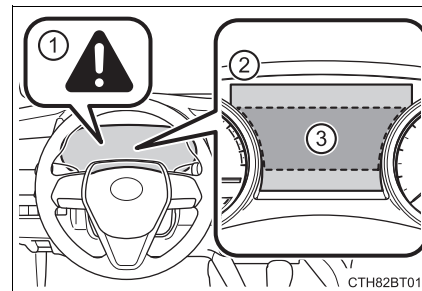

① Master warning light

The master warning light also comes on or flashes in order to indicate that a message is currently being displayed on the multi-information display.

② Multi-information display

③ Handling method

Follow the instructions of the message on the multi-information display.

If any of the warning messages are shown again after the appropriate actions have been performed, contact your Toyota dealer.

Messages and warnings

The warning lights and warning buzzers operate as follows depending on the content of the message. If a message indicates the need for inspection by a dealer, have the vehicle inspected by your Toyota dealer immediately.

	System warning light	Warning buzzer*	Warning
Comes on	—	Sounds	Indicates an important situation, such as when a system related to driving is malfunctioning or that danger may result if the correction procedure is not performed
—	Comes on or flashes	Sounds	Indicates an important situation, such as when the systems shown on the multi-information display may be malfunctioning
Flashes	—	Sounds	Indicates a situation, such as when damage to the vehicle or danger may result
Comes on	—	Does not sound	Indicates a condition, such as malfunction of electrical components, their condition, or indicates the need for maintenance
Flashes	—	Does not sound	Indicates a situation, such as when an operation has been performed incorrectly, or indicates how to perform an operation correctly

The operation of the warning lights and warning buzzers may differ from those stated. In this case, perform the correction procedure according to the displayed message.

*: A buzzer sounds the first time a message is shown on the multi-information display.

■ Warning messages

The warning messages explained below may differ from the actual messages according to operation conditions and vehicle specifications.

■ System warning lights

The master warning light does not come on or flash in the following cases. Instead, a separate system warning light will come on along with a message shown on the multi-information display.

- Malfunction in the ABS
The ABS warning light comes on. (→P. 529)
- Malfunction in the tire pressure warning system
The tire pressure warning light comes on. (→P. 532)
- Remaining fuel level is low
The low fuel level warning light comes on. (→P. 531)

■ If a message instructing to refer to the Owner's Manual is displayed

- If the following messages are shown, there may be a malfunction. Immediately stop the vehicle in a safe place and contact your Toyota dealer. Continuing to drive the vehicle may be dangerous.
 - “Low Braking Power Stop in a Safe Place See Owner's Manual”
 - “Oil Pressure Low Stop in a Safe Place See Owner's Manual”
 - “Charging System Malfunction Stop in a Safe Place See Owner's Manual”
- If the following message is shown, there may be a malfunction. Immediately have the vehicle inspected by your Toyota dealer.
 - “Smart Key System Malfunction See Owner's Manual”
- If “Engine Coolant Temp High Stop in a Safe Place See Owner's Manual” is displayed, follow the instructions accordingly. (→P. 567)

■ If “Shift to P Before Exiting Vehicle” is shown

Message is displayed when the driver's door is opened without turning the engine switch off with the shift lever in any position other than P. Shift the shift lever to P.

■ If “Auto Power Off to Conserve Battery” is displayed

This message is displayed when the power was cut off due to the automatic power off function.

The next time the engine is started, increase the engine speed slightly and maintain it at that speed for approximately 5 minutes to recharge the battery.

■ If “A New Key has been Registered Contact Your Dealer for Details” is displayed (if equipped)

This message will be displayed each time the driver's door is opened when the doors are unlocked from the outside for approximately one week after a new electronic key has been registered.

If this message is displayed but you have not had a new electronic key registered, ask your Toyota dealer to check if an unknown electronic key (other than those in your possession) has been registered.

■ If “Headlight System Malfunction Visit Your Dealer” is displayed

The following systems may be malfunctioning. Have the vehicle inspected by your Toyota dealer immediately.

- The LED headlight system
- AHB (Automatic High Beam)

■ If “Radar Cruise Control Unavailable See Owner's Manual” is shown

The dynamic radar cruise control with full-speed range or dynamic radar cruise control system is suspended temporarily or until the problem shown in the message is resolved. (causes and coping methods: →P. 252)

■ If “Radar Cruise Control Unavailable” is shown

The dynamic radar cruise control with full-speed range or dynamic radar cruise control system cannot be used temporarily. Use the system when it becomes available again.

■ If a message that indicates the malfunction of front camera is displayed

The following systems may be suspended until the problem shown in the message is resolved. (→P. 252, 528)

- PCS (Pre-Collision System)
- LTA (Lane Tracing Assist)
- AHB (Automatic High Beam)
- RSA (Road Sign Assist) (if equipped)
- Dynamic radar cruise control with full-speed range (if equipped)
- Dynamic radar cruise control (if equipped)

■ If a message that indicates the malfunction of radar sensor is displayed

The following systems may be suspended until the problem shown in the message is resolved. (→P. 252, 528)

- PCS (Pre-Collision System)
- LTA (Lane Tracing Assist)
- Dynamic radar cruise control with full-speed range (if equipped)
- Dynamic radar cruise control (if equipped)

■ **If “Maintenance Required Soon” is displayed (if equipped)**

Indicates that all maintenance according to the driven distance on the maintenance schedule* should be performed soon.

Comes on approximately 4500 miles (7200 km) after the message has been reset.

If necessary, perform maintenance. Please reset the message after the maintenance is performed. (→P. 448)

*: Refer to the separate “Scheduled Maintenance Guide” or “Owner’s Manual Supplement” for the maintenance interval applicable to your vehicle.

■ **If “Maintenance Required Visit Your Dealer” is displayed (if equipped)**

Indicates that all maintenance is required to correspond to the driven distance on the maintenance schedule*.

Comes on approximately 5000 miles (8000 km) after the message has been reset.

(The indicator will not work properly unless the message has been reset.)

Perform the necessary maintenance. Please reset the message after the maintenance is performed. (→P. 448)

*: Refer to the separate “Scheduled Maintenance Guide” or “Owner’s Manual Supplement” for the maintenance interval applicable to your vehicle.

■ **If “Engine Oil Level Low Add or Replace” is displayed**

The engine oil level may be low. Check the level of the engine oil, and add engine oil if necessary. (→P. 464) This message may be displayed if the vehicle is stopped on a slope. Move the vehicle to a level surface and check if the message disappears.

■ **Warning buzzer**

→P. 534



NOTICE

■ **If “High Power Consumption Power to Climate Temporarily Limited” is frequently shown**

There is a possible malfunction relating to the charging system or the battery may be deteriorating. Have the vehicle inspected by your Toyota dealer.

If you have a flat tire

Your vehicle is equipped with a spare tire. The flat tire can be replaced with the spare tire.

For details about tires: →P. 473

WARNING

■ If you have a flat tire

Do not continue driving with a flat tire.

Driving even a short distance with a flat tire can damage the tire and the wheel beyond repair, which could result in an accident.

Before jacking up the vehicle

- Stop the vehicle in a safe place on a hard, flat surface.
- Set the parking brake.
- Shift the shift lever to P.
- Stop the engine.
- Turn on the emergency flashers. (→P. 516)

Location of the spare tire, jack and tools

► 2WD models

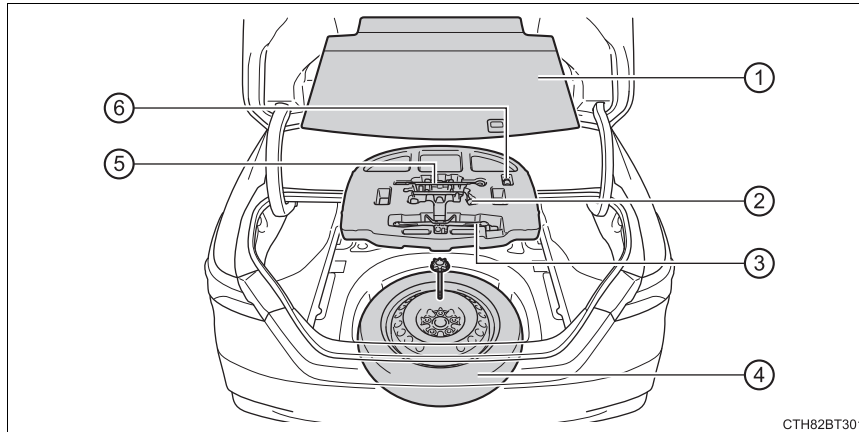

► AWD models

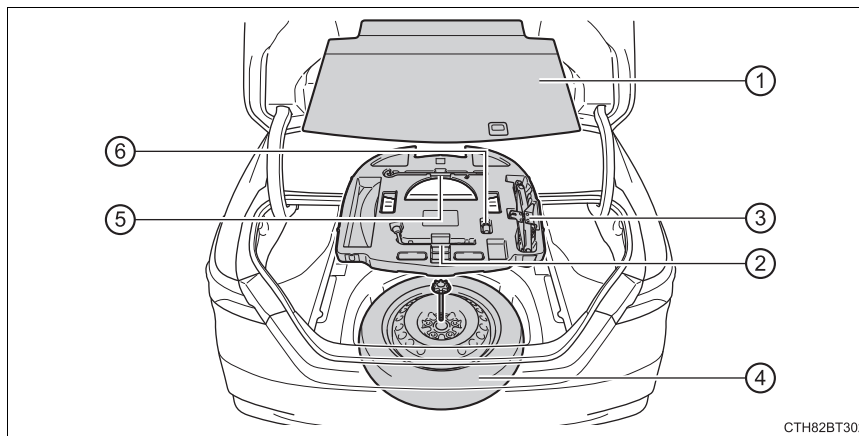

- | | |
|-----------------------|--------------------------------|
| ① Luggage floor cover | ④ Spare tire |
| ② Wheel nut wrench | ⑤ Jack handle |
| ③ Jack | ⑥ Wheel lock key (if equipped) |

⚠ WARNING**■ Using the tire jack**

Observe the following precautions.

Improper use of the tire jack may cause the vehicle to suddenly fall off the jack, leading to death or serious injury.

- Do not use the tire jack for any purpose other than replacing tires or installing and removing tire chains.
- Only use the tire jack that comes with this vehicle for replacing a flat tire.
Do not use it on other vehicles, and do not use other tire jacks for replacing tires on this vehicle.
- Put the jack properly in its jack point.
- Do not put any part of your body under the vehicle while it is supported by the jack.
- Do not start the engine or drive the vehicle while the vehicle is supported by the jack.
- Do not raise the vehicle while someone is inside.
- When raising the vehicle, do not put an object on or under the jack.
- Do not raise the vehicle to a height greater than that required to replace the tire.
- Use a jack stand if it is necessary to get under the vehicle.
- When lowering the vehicle, make sure that there is no-one near the vehicle. If there are people nearby, warn them vocally before lowering.

⚠ NOTICE**■ To prevent damage to the vehicle when using a jack**

When jacking up the rear of the vehicle, make sure not to position the jack under the bracket shown in the illustration near the rear jack point, as the vehicle body may be damaged.

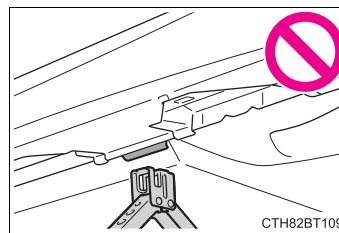

Wheel lock nut (if equipped)

When replacing tires on a vehicle with wheel lock nuts, use the following procedures to remove and install the wheel lock nuts. The wheel lock key is stored in the tray inside the luggage compartment. Always return the wheel lock key to its original position after use, so that it does not get lost. (→P. 544)

■ Removal

For ease of removal, the wheel lock nut should always be the first one loosened.

- 1 Place the wheel lock key on top of the wheel lock nut, turning until the wheel lock key and wheel lock nut patterns engage.
- 2 Place the wheel nut wrench on the wheel lock key, and while applying pressure on the wheel lock key, loosen the wheel lock nut.

■ Installation

For ease of installation, the wheel lock nut should always be the last one tightened.

- 1 By hand, install a wheel lock nut on the wheel to be installed.
- 2 Place the wheel lock key on top of the wheel lock nut, turning until the wheel lock key and wheel lock nut patterns engage.
- 3 Place the wheel nut wrench on the wheel lock key, and while applying pressure on the wheel lock key, tighten the wheel lock nut to the recommended torque.

NOTICE

■ When using a wheel lock key

Do not use an impact wrench. Using an impact wrench may cause permanent damage to wheel lock nut and wheel lock key. If in doubt about wheel lock application, contact your Toyota dealer.

Taking out the jack

- 1 Lift up the hook of the luggage floor cover on the trunk floor.

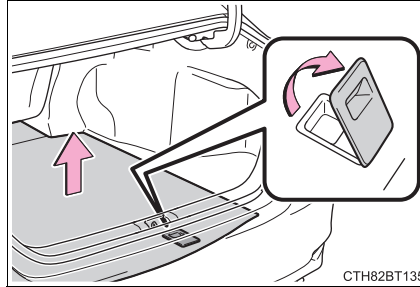

- 2 Secure the luggage floor cover using the hook provided.

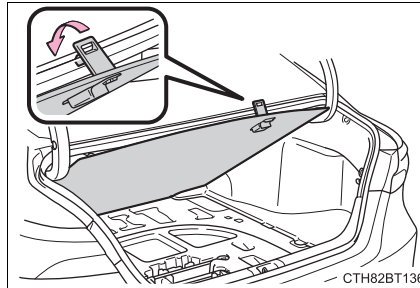

- 3 Remove the jack.

▶ 2WD models

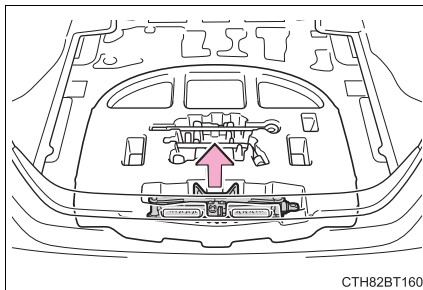

▶ AWD models

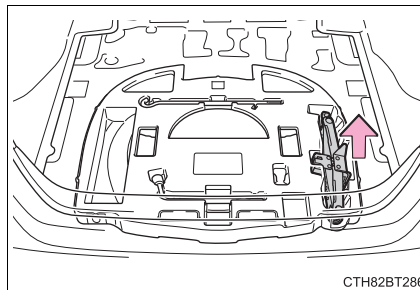

Taking out the spare tire

- 1 Lift up the hook of the luggage floor cover on the trunk floor.

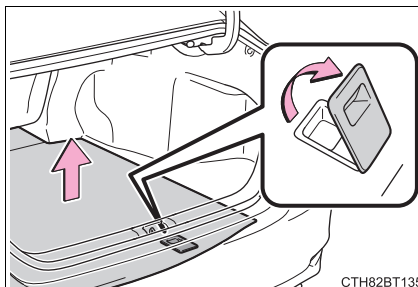

- 2 Secure the luggage floor cover using the hook provided.

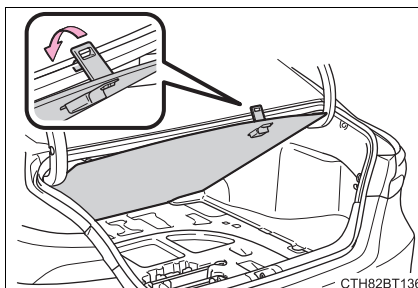

- 3 Remove the tool tray.

► 2WD models

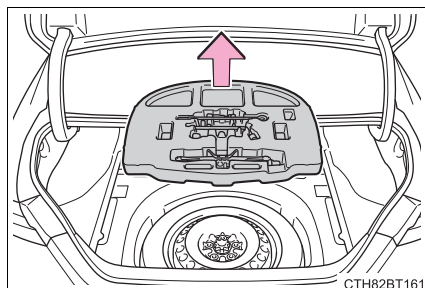

► AWD models

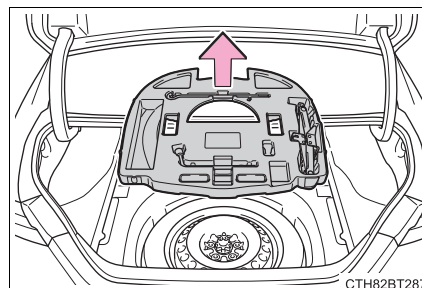

- 4 Loosen the center fastener that secures the spare tire.

When taking out or stowing the spare tire, make sure to firmly hold opposite end of the tire.

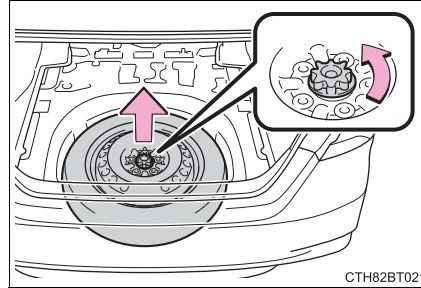

⚠ WARNING

■ When storing the spare tire

Be careful not to catch fingers or other body parts between the spare tire and the body of the vehicle.

Replacing a flat tire

- 1 Check the tires.

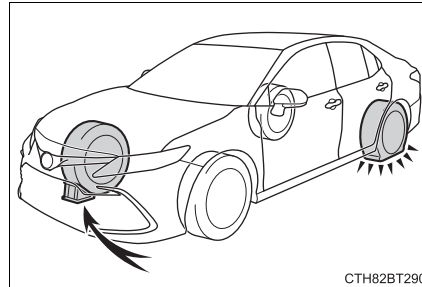

CTH82BT290

Flat tire		Wheel chock positions
Front	Left-hand side	Behind the rear right-hand side tire
	Right-hand side	Behind the rear left-hand side tire
Rear	Left-hand side	In front of the front right-hand side tire
	Right-hand side	In front of the front left-hand side tire

- 2 For vehicles with steel wheels, remove the wheel ornament using the wrench.

To protect the wheel ornament, place a rag between the wrench and the wheel ornament, as shown in the illustration.

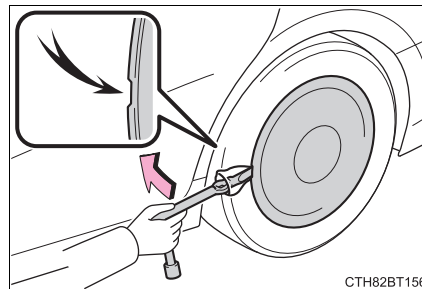

CTH82BT156

- 3 Slightly loosen the wheel nuts (one turn).

Vehicles with wheel locks: Use the wheel lock key to loosen the wheel lock.

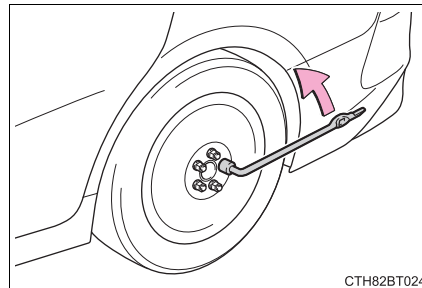

CTH82BT024

- 4 Turn the tire jack portion "A" by hand until the notch of the jack is in contact with the jack point.

To prevent damage to the vehicle when using the jack, position the jack in the correct location.
(→P. 545)

The jack point guides are located under the rocker panel. They indicate the jack point positions.

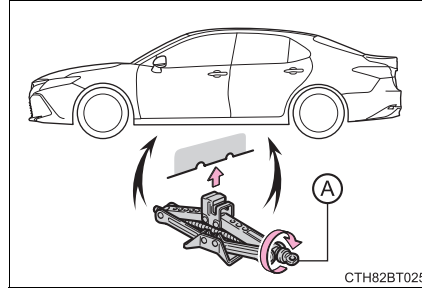

- 5 Assemble the jack handle.

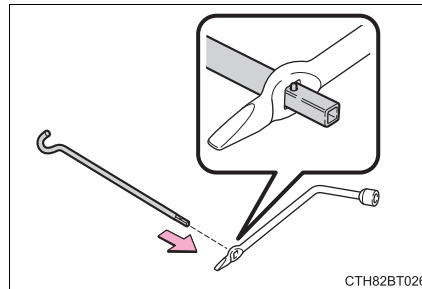

- 6 Raise the vehicle until the tire is slightly raised off the ground.

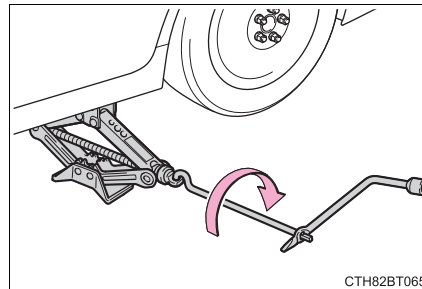

- 7 Remove all the wheel nuts and the tire.

When resting the tire on the ground, place the tire so that the wheel design faces up to avoid scratching the wheel surface.

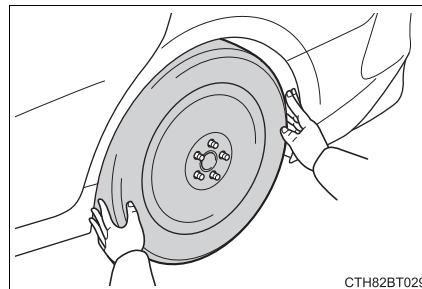

 **WARNING****■ Replacing a flat tire**

- Do not touch the disc wheels or the area around the brakes immediately after the vehicle has been driven.
After the vehicle has been driven the disc wheels and the area around the brakes will be extremely hot. Touching these areas with hands, feet or other body parts while changing a tire, etc. may result in burns.
- Failure to follow these precautions could cause the wheel nuts to loosen and the tire to fall off, resulting in death or serious injury.
 - Never use oil or grease on the wheel bolts or wheel nuts.
Oil and grease may cause the wheel nuts to be excessively tightened, leading to bolt or disc wheel damage. Remove any oil or grease that has adhered when installing the wheel nuts.
 - After replacing a tire, check the tightening torque as soon as possible.
Wheel nut torque: 76 ft•lbf (103 N•m, 10.5 kgf•m)
 - Do not attach a heavily damaged wheel ornament, as it may fly off the wheel while the vehicle is moving.
 - When installing a tire, only use wheel nuts that have been specifically designed for that wheel.
 - If there are any cracks or deformations in the bolt screws, nut threads or bolt holes of the wheel, have the vehicle inspected by your Toyota dealer.
 - When installing the wheel nuts, be sure to install them with the tapered ends facing inward.

Installing the spare tire

- 1 Remove any dirt or foreign matter from the wheel contact surface.

If foreign matter is on the wheel contact surface, the wheel nuts may loosen while the vehicle is in motion, causing the tire to come off.

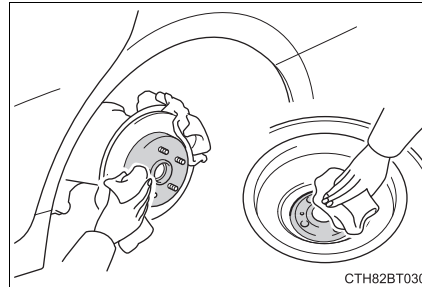

- 2 Install the tire and loosely tighten each wheel nut by hand by approximately the same amount.

When replacing a steel wheel with a steel wheel, tighten the wheel nuts until the tapered portion comes into loose contact with the disc wheel seat.

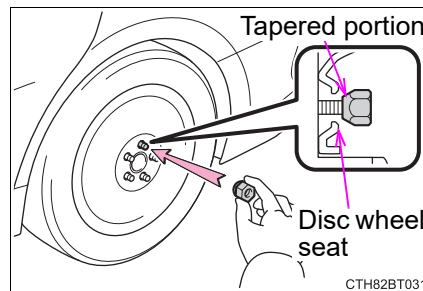

When replacing an aluminum wheel with a steel wheel, tighten the wheel nuts until the tapered portion comes into loose contact with the disc wheel seat.

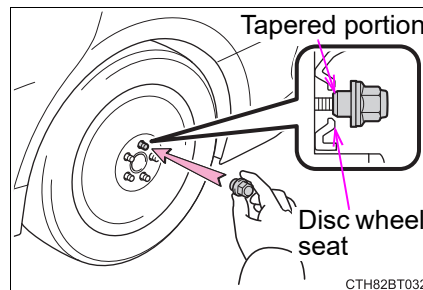

- 3 Lower the vehicle.

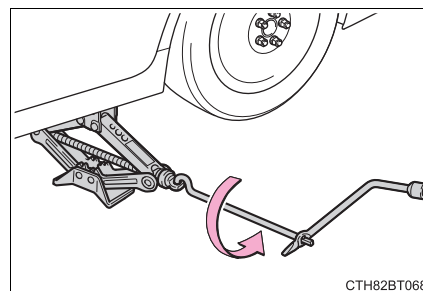

- 4 Securely tighten the wheel nuts two or three times in the order shown in the illustration using a wheel nut wrench.

Vehicles with wheel locks:
Tighten the wheel lock using the wheel lock key after tightening the other wheel nuts.

Tightening torque:
76 ft•lbf (103 N•m, 10.5 kgf•m)

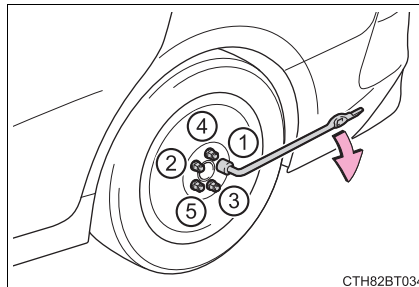

CTH82BT034

- 5 Stow the flat tire, tire jack and all tools.

■ The compact spare tire

- The compact spare tire is identified by the label "TEMPORARY USE ONLY" on the tire sidewall.
Use the compact spare tire temporarily, and only in an emergency.
- Make sure to check the tire inflation pressure of the compact spare tire. (→P. 584)

■ When using the compact spare tire

As the compact spare tire is not equipped with a tire pressure warning valve and transmitter, low inflation pressure of the spare tire will not be indicated by the tire pressure warning system. Also, if you replace the compact spare tire after the tire pressure warning light comes on, the light remains on.

■ When the compact spare tire is equipped

When driving with the compact spare tire installed, the vehicle height will be different than when driving with standard tires.

■ If you have a flat front tire on a road covered with snow or ice (vehicles with 16 or 17-inch wheels)

Install the compact spare tire on one of the rear wheels of the vehicle. Perform the following steps and fit tire chains to the front tires:

- 1 Replace a rear tire with the compact spare tire.
- 2 Replace the flat front tire with the tire removed from the rear of the vehicle.
- 3 Fit tire chains to the front tires.

⚠ WARNING**■ When using the compact spare tire**

- Remember that the compact spare tire provided is specifically designed for use with your vehicle. Do not use your compact spare tire on another vehicle.
- Do not use more than one compact spare tires simultaneously.
- Replace the compact spare tire with a standard tire as soon as possible.
- Avoid sudden acceleration, abrupt steering, sudden braking and shifting operations that cause sudden engine braking.

■ When the compact spare tire is attached

The vehicle speed may not be correctly detected, and the following systems may not operate correctly:

- | | |
|---|----------------------------------|
| • ABS & Brake assist | • Tire pressure warning system |
| • VSC | • BSM (Blind Spot Monitor)* |
| • TRAC | • Intuitive parking assist* |
| • EPS | • PKSB (Parking Support Brake)* |
| • AHB (Automatic High Beam) | • Rear view monitor system* |
| • Dynamic radar cruise control* | • Toyota parking assist monitor* |
| • Dynamic radar cruise control with full-speed range* | • Panoramic view monitor* |
| • LTA (Lane Tracing Assist) | • Navigation system* |
| • PCS (Pre-Collision System) | |

Also, not only can the following systems not be utilized fully, but they may actually negatively affect the drive-train components:

- Dynamic Torque Control AWD system*

*: If equipped

■ Speed limit when using the compact spare tire

Do not drive at speeds in excess of 50 mph (80 km/h) when a compact spare tire is installed on the vehicle.

The compact spare tire is not designed for driving at high speeds. Failure to observe this precaution may lead to an accident causing death or serious injury.

■ After using the tools and jack

Before driving, make sure all the tools and jack are securely in place in their storage location to reduce the possibility of personal injury during a collision or sudden braking.



NOTICE

■ Be careful when driving over bumps with the compact spare tire installed on the vehicle.

The vehicle becomes lower when driving with the compact spare tire compared to when driving with standard tires. Be careful when driving over uneven road surfaces.

■ Driving with tire chains and the compact spare tire

Do not fit tire chains to the compact spare tire.

Tire chains may damage the vehicle body and adversely affect driving performance.

■ When replacing the tires

When removing or fitting the wheels, tires or the tire pressure warning valve and transmitter, contact your Toyota dealer as the tire pressure warning valve and transmitter may be damaged if not handled correctly.

■ To avoid damage to the tire pressure warning valve and transmitters

When a tire is repaired with liquid sealants, the tire pressure warning valve and transmitter may not operate properly. If a liquid sealant is used, contact your Toyota dealer or other qualified service shop as soon as possible. Make sure to replace the tire pressure warning valve and transmitter when replacing the tire. (→P. 475)

If the engine will not start

If the engine will not start even though correct starting procedures are being followed (→P. 209, 211), consider each of the following points:

The engine will not start even though the starter motor operates normally.

One of the following may be the cause of the problem:

- There may not be sufficient fuel in the vehicle's tank.
Refuel the vehicle.
- The engine may be flooded.
Try to restart the engine again following correct starting procedures.
(→P. 209, 211)
- There may be a malfunction in the engine immobilizer system.
(→P. 80)

The starter motor turns over slowly, the interior lights and headlights are dim, or the horn does not sound or sounds at a low volume.

One of the following may be the cause of the problem:

- The battery may be discharged. (→P. 562)
- The battery terminal connections may be loose or corroded.

The starter motor does not turn over (vehicles with a smart key system)

The engine starting system may be malfunctioning due to an electrical problem such as electronic key battery depletion or a blown fuse. However, an interim measure is available to start the engine.
(→P. 558)

The starter motor does not turn over, the interior lights and headlights do not turn on, or the horn does not sound.

One of the following may be the cause of the problem:

- One or both of the battery terminals may be disconnected.
- The battery may be discharged. (→P. 562)

Contact your Toyota dealer if the problem cannot be repaired, or if repair procedures are unknown.

Emergency start function (vehicles with a smart key system)

When the engine does not start, the following steps can be used as an interim measure to start the engine if the engine switch is functioning normally:

- 1 Set the parking brake.
- 2 Shift the shift lever to P.
- 3 Turn the engine switch to ACCESSORY mode.
- 4 Press and hold the engine switch for about 15 seconds while depressing the brake pedal firmly.

Even if the engine can be started using the above steps, the system may be malfunctioning. Have the vehicle inspected by your Toyota dealer.

If the electronic key does not operate properly (vehicles with a smart key system)

If communication between the electronic key and vehicle is interrupted (→P. 163) or the electronic key cannot be used because the battery is depleted, the smart key system and wireless remote control cannot be used. In such cases, the doors and trunk can be opened and the engine can be started by following the procedure below.

Locking and unlocking the doors, unlocking the trunk and key linked functions

■ Doors

Using the mechanical key (→P. 142) in order to perform the following operations (driver's door only):

- ① Locks all doors
- ② Closes the windows and the moon roof*¹ or panoramic moon roof*¹ (turn and hold)*²
- ③ Unlocks the door
Turning the key rearward unlocks the driver's door. Turning the key once again unlocks the other doors.
- ④ Opens the windows and the moon roof*¹ or panoramic moon roof*¹ (turn and hold)*²

*1: If equipped

*2: This setting must be customized at your Toyota dealer.

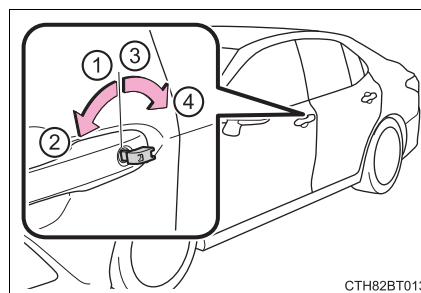

CTH82BT013

■ **Trunk**

Turn the mechanical key clockwise to open.

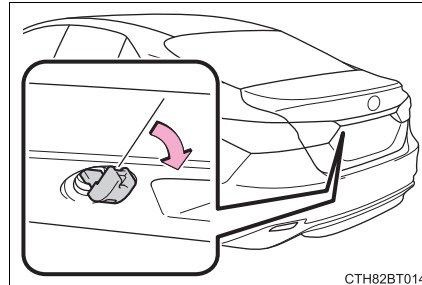

Starting the engine

1 Ensure that the shift lever is in P and firmly depress the brake pedal.

2 Touch the Toyota emblem side of the electronic key to the engine switch.

When the electronic key is detected, a buzzer sounds and the engine switch will turn to IGNITION ON mode.

When the smart key system is deactivated in customization setting, the engine switch will turn to ACCESSORY mode.

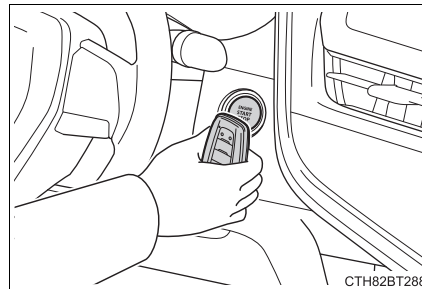

3 Firmly depress the brake pedal and check that  is displayed on the multi-information display.

4 Press the engine switch shortly and firmly.

In the event that the engine still cannot be started, contact your Toyota dealer.

■ Stopping the engine

Shift the shift lever to P and press the engine switch as you normally do when stopping the engine.

■ Replacing the key battery

As the above procedure is a temporary measure, it is recommended that the electronic key battery be replaced immediately when the battery is depleted. (→P. 494)

■ Alarm (for Canada only)

Using the mechanical key to lock the doors will not set the alarm system.

If a door is unlocked using the mechanical key when the alarm system is set, the alarm may be triggered.

■ Changing engine switch modes

Release the brake pedal and press the engine switch in step **3** above.

The engine does not start and modes will be changed each time the switch is pressed. (→P. 213)

■ When the electronic key does not work properly

● Make sure that the smart key system has not been deactivated in the customization setting. If it is off, turn the function on.
(Customizable features: →P. 606)

● Check if battery-saving mode is set. If it is set, cancel the function.
(→P. 163)

**WARNING****■ When using the mechanical key and operating the power windows or the moon roof or panoramic moon roof**

Operate the power window or the moon roof or panoramic moon roof after checking to make sure that there is no possibility of any passenger having any of their body parts caught in the window or the moon roof or panoramic moon roof. Also, do not allow children to operate the mechanical key. It is possible for children and other passengers to get caught in the power window or the moon roof or panoramic moon roof.

If the vehicle battery is discharged

The following procedures may be used to start the engine if the vehicle's battery is discharged.

You can also call your Toyota dealer or a qualified repair shop.

If you have a set of jumper (or booster) cables and a second vehicle with a 12-volt battery, you can jump start your vehicle by following the steps below.

- 1 Confirm that the electronic key (vehicles with a smart key system) or key (vehicles without a smart key system) is being carried.

When connecting the jumper (or booster) cables, depending on the situation, the alarm may activate and doors locked. (→P. 84)

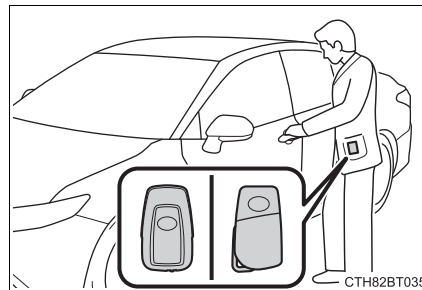

- 2 Open the hood. (→P. 457)

- 3 Vehicles with 3.5 L V6 (2GR-FKS) engine: Remove the engine cover.

Make sure to pull the engine cover straight up when removing it.

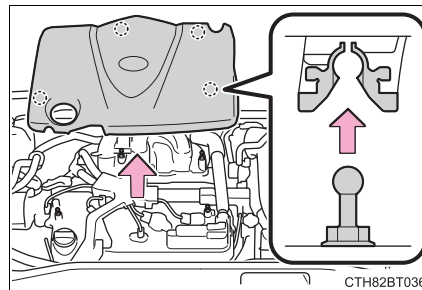

4 Connect the jumper cables according to the following procedure:

▶ 2.5 L 4-cylinder (A25A-FKS) engine

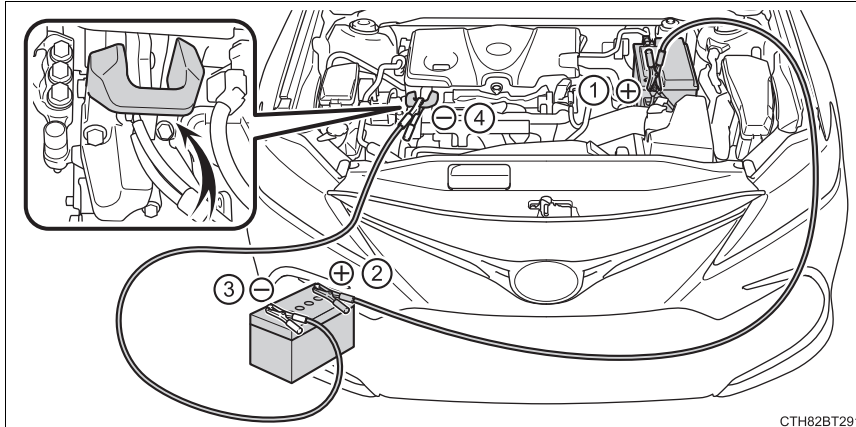

CTH82BT291

▶ 3.5 L V6 (2GR-FKS) engine

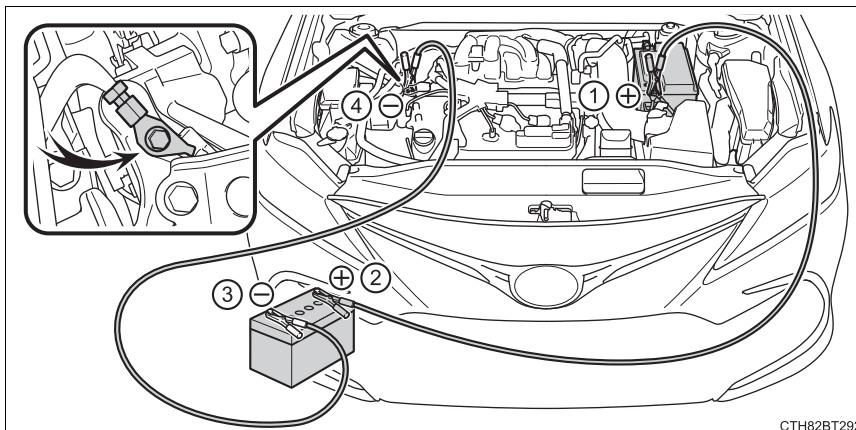

CTH82BT292

- ① Connect a positive jumper cable clamp to the positive (+) battery terminal on your vehicle.
- ② Connect the clamp on the other end of the positive cable to the positive (+) battery terminal on the second vehicle.
- ③ Connect a negative cable clamp to the negative (-) battery terminal on the second vehicle.
- ④ Connect the clamp at the other end of the negative cable to a metallic point shown in the illustration.

Use jumper cables that can reach the specified terminals and connecting point.

- 5 Start the engine of the second vehicle. Increase the engine speed slightly and maintain at that level for approximately 5 minutes to recharge the battery of your vehicle.
- 6 Vehicles with a smart key system: Open and close any of the doors of your vehicle with the engine switch off.
- 7 Vehicles without a smart key system:
Maintain the engine speed of the second vehicle and turn the engine switch to the "ON" position, then start the vehicle's engine.
Vehicles with a smart key system:
Maintain the engine speed of the second vehicle and turn the engine switch to IGNITION ON mode, then start the vehicle's engine.
- 8 Once the vehicle's engine has started, remove the jumper cables in the exact reverse order from which they were connected.
Once the engine starts, have the vehicle inspected at your Toyota dealer as soon as possible.

■ Starting the engine when the battery is discharged

The engine cannot be started by push-starting.

■ To prevent battery discharge

- Turn off the headlights and the audio system while the engine is off.
- Turn off any unnecessary electrical components when the vehicle is running at a low speed for an extended period, such as in heavy traffic.

■ When the battery is removed or discharged

- Information stored in the ECU is cleared. When the battery is depleted, have the vehicle inspected at your Toyota dealer.
- Some systems may require initialization. (→P. 614)

■ When removing the battery terminals

When the battery terminals are removed, the information stored in the ECU is cleared. Before removing the battery terminals, contact your Toyota dealer.

■ Charging the battery

The electricity stored in the battery will discharge gradually even when the vehicle is not in use, due to natural discharge and the draining effects of certain electrical appliances. If the vehicle is left for a long time, the battery may discharge, and the engine may be unable to start. (The battery recharges automatically during driving.)

■ When recharging or replacing the battery (vehicles with a smart key system)

- In some cases, it may not be possible to unlock the doors using the smart key system when the battery is discharged. Use the wireless remote control or the mechanical key to lock or unlock the doors.
- The engine may not start on the first attempt after the battery has recharged but will start normally after the second attempt. This is not a malfunction.
- The engine switch mode is memorized by the vehicle. When the battery is reconnected, the system will return to the mode it was in before the battery was discharged. Before disconnecting the battery, turn the engine switch off. If you are unsure what mode the engine switch was in before the battery discharged, be especially careful when reconnecting the battery.

■ When replacing the battery

- Use a battery that conforms to European regulations.
- Use a battery with the same case size, equivalent or greater 20 hour rate capacity (20HR), and equivalent or greater performance rating (CCA) as the battery which is being replaced.

	Case size	20 hour rate capacity (20HR)	Performance rating (CCA)
Type A	LN2	60Ah	563A
Type B	LN3	70Ah	603A

The case size, 20 hour rate capacity (20HR) and performance rating (CCA) are specified on the label attached to the battery.

- If the sizes differ, the battery cannot be properly secured.
- If the 20 hour rate capacity is low, even if the time period where the vehicle is not used is a short time, the battery may discharge and the engine may not be able to start.
- For details, consult your Toyota dealer.

WARNING

■ When removing the battery terminals

Always remove the negative (-) terminal first. If the positive (+) terminal contacts any metal in the surrounding area when the positive (+) terminal is removed, a spark may occur, leading to a fire in addition to electrical shocks and death or serious injury.

 **WARNING****■ Avoiding battery fires or explosions**

Observe the following precautions to prevent accidentally igniting the flammable gas that may be emitted from the battery:

- Make sure each jumper cable is connected to the correct terminal and that it is not unintentionally in contact with any other than the intended terminal.
- Do not allow the other end of the jumper cable connected to the “+” terminal to come into contact with any other parts or metal surfaces in the area, such as brackets or unpainted metal.
- Do not allow the + and - clamps of the jumper cables to come into contact with each other.
- Do not smoke, use matches, cigarette lighters or allow open flame near the battery.

■ Battery precautions

The battery contains poisonous and corrosive acidic electrolyte, while related parts contain lead and lead compounds. Observe the following precautions when handling the battery:

- When working with the battery, always wear safety glasses and take care not to allow any battery fluids (acid) to come into contact with skin, clothing or the vehicle body.
- Do not lean over the battery.
- In the event that battery fluid comes into contact with the skin or eyes, immediately wash the affected area with water and seek medical attention. Place a wet sponge or cloth over the affected area until medical attention can be received.
- Always wash your hands after handling the battery support, terminals, and other battery-related parts.
- Do not allow children near the battery.

 **NOTICE****■ When handling jumper cables**

When connecting the jumper cables, ensure that they do not become entangled in the cooling fan or engine drive belt.

■ When connecting jumper cables

Make sure to connect jumper cables to the specified terminals and connecting point. Failure to do so may adversely affect the electronic devices or damage to them.

If your vehicle overheats

The following may indicate that your vehicle is overheating.

- The needle of the engine coolant temperature gauge (→P. 94) enters the red zone or a loss of engine power is experienced. (For example, the vehicle speed does not increase.)
- “Engine Coolant Temp High Stop in a Safe Place See Owner’s Manual” is shown on the multi-information display.
- Steam comes out from under the hood.

Correction procedures

- 1 Stop the vehicle in a safe place and turn off the air conditioning system, and then stop the engine.
- 2 If you see steam:
Carefully lift the hood after the steam subsides.
If you do not see steam:
Carefully lift the hood.
- 3 After the engine has cooled down sufficiently, inspect the hoses and radiator core (radiator) for any leaks.

- 1 Radiator
- 2 Cooling fan

If a large amount of coolant leaks, immediately contact your Toyota dealer.

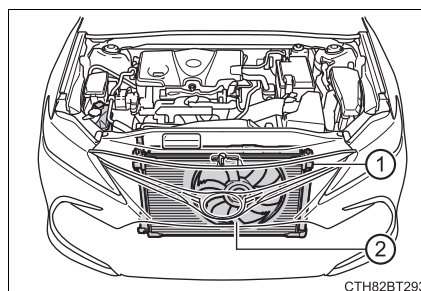

4 The coolant level is satisfactory if it is between the “F” and “L” lines on the reservoir.

- ① Reservoir
- ② “F” line
- ③ “L” line
- ④ Radiator cap

- ▶ 2.5 L 4-cylinder (A25A-FKS) engine
- ▶ 3.5 L V6 (2GR-FKS) engine

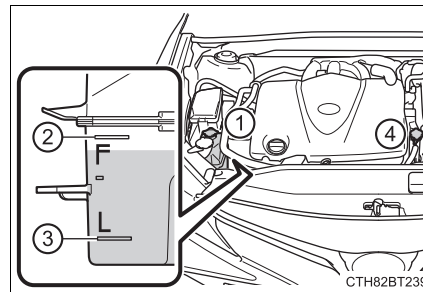
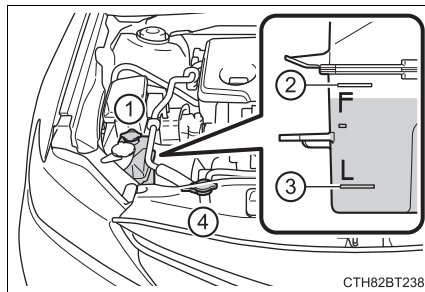

5 Add coolant if necessary.

Water can be used in an emergency if coolant is unavailable.

- ▶ 2.5 L 4-cylinder (A25A-FKS) engine
- ▶ 3.5 L V6 (2GR-FKS) engine

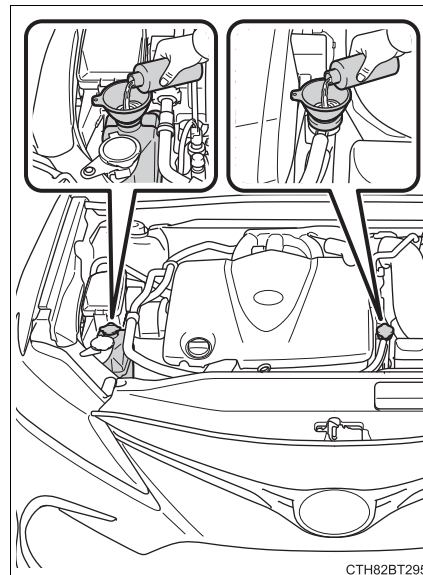
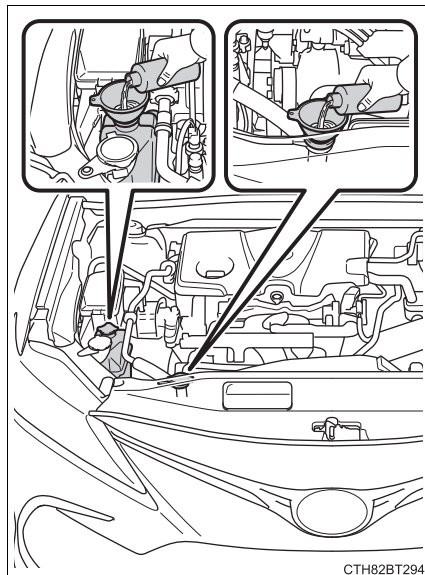

- 6 Start the engine and turn the air conditioning system on to check that the radiator cooling fan operates and to check for coolant leaks from the radiator or hoses.

The fan operates when the air conditioning system is turned on immediately after a cold start. Confirm that the fan is operating by checking the fan sound and air flow. If it is difficult to check these, turn the air conditioning system on and off repeatedly. (The fan may not operate in freezing temperatures.)

- 7 If the fan is not operating:
Stop the engine immediately and contact your Toyota dealer.
- If the fan is operating:
Have the vehicle inspected at the nearest Toyota dealer.

 **WARNING**

■ **To prevent an accident or injury when inspecting under the hood of your vehicle**

Observe the following precautions.

Failure to do so may result in serious injury such as burns.

- If steam is seen coming from under the hood, do not open the hood until the steam has subsided. The engine compartment may be very hot.
- Keep hands and clothing (especially a tie, a scarf or a muffler) away from the fan and belts. Failure to do so may cause the hands or clothing to be caught, resulting in serious injury.
- Do not loosen the radiator cap and the coolant reservoir cap while the engine and radiator are hot.
High temperature steam or coolant could spray out.

 **NOTICE**

■ **When adding engine coolant**

Wait until the engine has cooled down before adding engine coolant.

When adding coolant, do so slowly. Adding cool coolant to a hot engine too quickly can cause damage to the engine.

■ **To prevent damage to the cooling system**

Observe the following precautions:

- Avoid contaminating the coolant with foreign matter (such as sand or dust etc.).
- Do not use any coolant additives.

If the vehicle becomes stuck

Carry out the following procedures if the tires spin or the vehicle becomes stuck in mud, dirt or snow:

- 1 Stop the engine. Set the parking brake and shift the shift lever to P.
- 2 Remove the mud, snow or sand from around the front wheels.
- 3 Place wood, stones or some other material under the front wheels to help provide traction.
- 4 Restart the engine.
- 5 Shift the shift lever to D or R and release the parking brake. Then, while exercising caution, depress the accelerator pedal.

■ When it is difficult to free the vehicle

Press  to turn off TRAC.

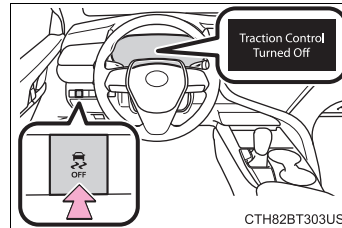

WARNING

■ When attempting to free a stuck vehicle

If you choose to push the vehicle back and forth to free it, make sure the surrounding area is clear to avoid striking other vehicles, objects or people. The vehicle may also lunge forward or lunge back suddenly as it becomes free. Use extreme caution.

■ When shifting the shift lever

Be careful not to shift the shift lever with the accelerator pedal depressed. This may lead to unexpected rapid acceleration of the vehicle that may cause an accident resulting in death or serious injury.

NOTICE

■ To avoid damaging the transmission and other components

- Avoid spinning the front wheels and depressing the accelerator pedal more than necessary.
- If the vehicle remains stuck even after these procedures are performed, the vehicle may require towing to be freed.

Vehicle specifications

8

8-1. Specifications

- Maintenance data
(fuel, oil level, etc.) 574
- Fuel information 590
- Tire information 593

8-2. Customization

- Customizable features 606

8-3. Items to initialize

- Items to initialize 614

Maintenance data (fuel, oil level, etc.)

Dimensions and weights (2WD models)

Overall length		192.1 in. (4880 mm) ^{*2} 192.7 in. (4895 mm) ^{*3} 194.6 in. (4944 mm) ^{*7}
Overall width		72.4 in. (1840 mm) ^{*2, 3} 73.1 in. (1856 mm) ^{*7}
Overall height ^{*1}		56.9 in. (1445 mm) ^{*2, 3} 56.3 in. (1430 mm) ^{*7}
Wheelbase		111.2 in. (2825 mm)
Tread ^{*1}	Front	63.0 in. (1600 mm) ^{*4} 62.6 in. (1590 mm) ^{*5} 62.2 in. (1580 mm) ^{*6}
	Rear	63.2 in. (1605 mm) ^{*4} 62.8 in. (1595 mm) ^{*5} 62.6 in. (1590 mm) ^{*6}
Vehicle capacity weight (occupants + luggage)		925 lb. (420 kg)

*1: Unladen vehicles

*2: For LE or XLE grade models

*3: For SE or XSE grade models

*4: 205/65R16 tires

*5: 215/55R17 tires and TRD models with 235/40R19 tires

*6: 235/45R18, and SE or XSE grade models with 235/40R19 tires

*7: For TRD models

Dimensions and weights (AWD models)

Overall length		192.1 in. (4880 mm) ^{*2} 192.7 in. (4895 mm) ^{*3}
Overall width		72.4 in. (1840 mm)
Overall height ^{*1}		57.1 in. (1450 mm)
Wheelbase		111.2 in. (2825 mm)
Tread ^{*1}	Front	62.6 in. (1590 mm) ^{*4} 62.2 in. (1580 mm) ^{*5}
	Rear	63.0 in. (1600 mm) ^{*4} 62.8 in. (1595 mm) ^{*5}
Vehicle capacity weight (occupants + luggage)		925 lb. (420 kg)

*1: Unladen vehicles

*2: For LE or XLE grade models

*3: For SE or XSE grade models

*4: 215/55R17 tires

*5: 235/45R18 and 235/40R19 tires

Seating capacity

Seating capacity	5 (Front 2, Rear 3)
------------------	---------------------

Vehicle identification

■ Vehicle identification number

The vehicle identification number (VIN) is the legal identifier for your vehicle. This is the primary identification number for your Toyota. It is used in registering the ownership of your vehicle.

This number is stamped on the top left of the instrument panel.

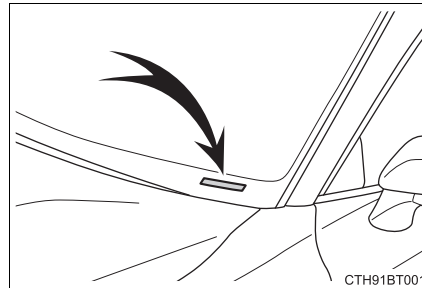

This number is also on the Certification Label.

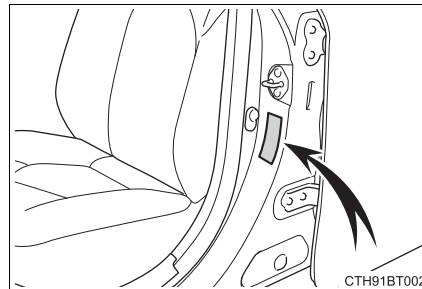

■ Engine number

The engine number is stamped on the engine block as shown.

- ▶ 2.5 L 4-cylinder (A25A-FKS) ▶ 3.5 L V6 (2GR-FKS) engine engine

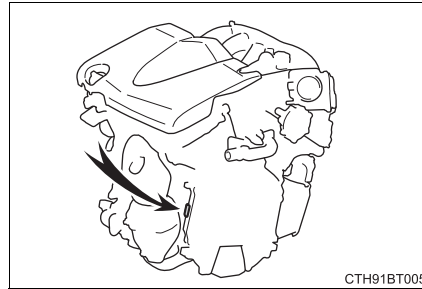
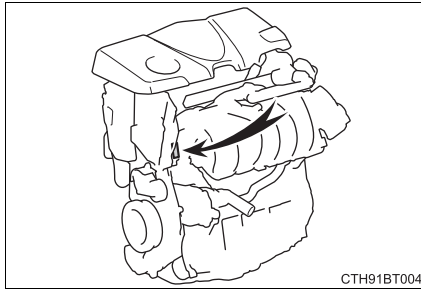

Engine

Model	A25A-FKS	2GR-FKS
Type	4-cylinder in line, 4-cycle, gasoline	6-cylinder V type, 4-cycle, gasoline
Bore and stroke	3.44 × 4.07 in. (87.5 × 103.4 mm)	3.70 × 3.27 in. (94.0 × 83.0 mm)
Displacement	151.8 cu. in. (2487 cm ³)	210.9 cu. in. (3456 cm ³)
Valve clearance	Automatic adjustment	
Drive belt tension	Automatic adjustment	

Fuel

Fuel type	Unleaded gasoline only
Octane rating	87 (Research Octane Number 91) or higher
Fuel tank capacity (Reference)	▶ For 2WD models 16.0 gal. (60.6 L, 13.3 Imp. gal.) ▶ For AWD models 14.4 gal. (54.5 L, 11.9 Imp. gal.)

Lubrication system

■ **Oil capacity (Drain and refill [Reference*])**

	With filter	Without filter
2.5 L 4-cylinder (A25A-FKS) engine	4.5 qt. (4.3 L, 3.8 Imp. qt.)	4.2 qt. (4 L, 3.5 Imp. qt.)
3.5 L V6 (2GR-FKS) engine	5.7 qt. (5.4 L, 4.8 Imp. qt.)	5.6 qt. (5.3 L, 4.7 Imp. qt.)

*: The engine oil capacity is a reference quantity to be used when changing the engine oil. When actually adding the engine oil, make sure that the oil level is between the low level mark and refill upper limit mark (→P. 464). Warm up and turn off the engine, wait about 5 minutes, and check the oil level on the dipstick.

■ **Engine oil selection**

▶ 2.5 L 4-cylinder (A25A-FKS) engine

“Toyota Genuine Motor Oil” is used in your Toyota vehicle. Use Toyota approved “Toyota Genuine Motor Oil” or equivalent to satisfy the following grade and viscosity.

Oil grade: ILSAC GF-6B multigrade engine oil

Recommended viscosity: SAE 0W-16

SAE 0W-16 is the best choice for good fuel economy and good starting in cold weather.

If SAE 0W-16 is not available, SAE 0W-20 oil may be used. However, it must be replaced with SAE 0W-16 at the next oil change.

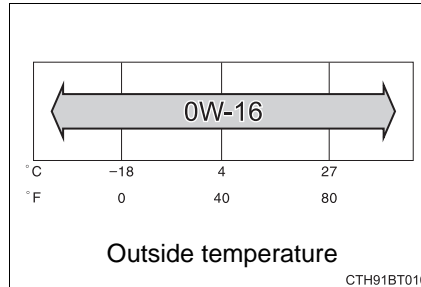

Oil viscosity (0W-16 is explained here as an example):

- The 0W in 0W-16 indicates the characteristic of the oil which allows cold startability. Oils with a lower value before the W allow for easier starting of the engine in cold weather.
- The 16 in 0W-16 indicates the viscosity characteristic of the oil when the oil is at high temperature. An oil with a higher viscosity (one with a higher value) may be better suited if the vehicle is operated at high speeds, or under extreme load conditions.

How to read oil container label:

API registered mark is added to some oil containers to help you select the oil you should use.



► 3.5 L V6 (2GR-FKS) engine

“Toyota Genuine Motor Oil” is used in your Toyota vehicle. Use Toyota approved “Toyota Genuine Motor Oil” or equivalent to satisfy the following grade and viscosity.

Oil grade: ILSAC GF-6A multigrade engine oil

Recommended viscosity: SAE 0W-20

SAE 0W-20 is the best choice for good fuel economy and good starting in cold weather.

If SAE 0W-20 is not available, SAE 5W-20 oil may be used. However, it must be replaced with SAE 0W-20 at the next oil change.

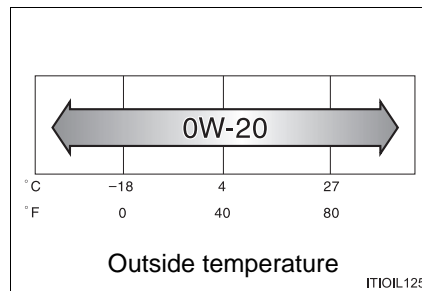

Oil viscosity (0W-20 is explained here as an example):

- The 0W in 0W-20 indicates the characteristic of the oil which allows cold startability. Oils with a lower value before the W allow for easier starting of the engine in cold weather.
- The 20 in 0W-20 indicates the viscosity characteristic of the oil when the oil is at high temperature. An oil with a higher viscosity (one with a higher value) may be better suited if the vehicle is operated at high speeds, or under extreme load conditions.

How to read oil container label:

The International Lubricant Specification Advisory Committee (ILSAC) Certification Mark is added to some oil containers to help you select the oil you should use.





Cooling system

Capacity (Reference)	<ul style="list-style-type: none"> ▶ 2.5 L 4-cylinder (A25A-FKS) engine 7.3 qt. (6.9 L, 6.1 Imp. qt.) ▶ 3.5 L V6 (2GR-FKS) engine 9.1 qt. (8.6 L, 7.6 Imp. qt.)
Coolant type	<p>Use either of the following:</p> <ul style="list-style-type: none"> • “Toyota Super Long Life Coolant” • Similar high-quality ethylene glycol-based non-silicate, non-amine, non-nitrite, and non-borate coolant with long-life hybrid organic acid technology <p>Do not use plain water alone.</p>

Ignition system

Spark plug Make	<ul style="list-style-type: none"> ▶ 2.5 L 4-cylinder (A25A-FKS) engine DENSO FC16HR-Q8 ▶ 3.5 L V6 (2GR-FKS) engine DENSO FK20HBR8
Gap	0.031 in. (0.8 mm)

 **NOTICE**

 **Iridium-tipped spark plugs**
Use only iridium-tipped spark plugs. Do not adjust spark plug gap.

Electrical system

Battery	
Specific voltage reading at 68°F (20°C):	12.3 V or higher If the voltage is lower than the standard value, charge the battery. (When checking the voltage, after turning the engine switch off, wait for 30 seconds with the high beam headlights illuminated, then turn the high beam headlights off and check the voltage.)
Charging rates	5 A max.

Automatic transaxle

Fluid capacity*	▶ 2.5 L 4-cylinder (A25A-FKS) engine 7.7 qt. (7.3 L, 6.4 Imp. qt.) ▶ 3.5 L V6 (2GR-FKS) engine 7.9 qt. (7.5 L, 6.6 Imp. qt.)
Fluid type	Toyota Genuine ATF WS

*: The fluid capacity is a reference quantity.
If replacement is necessary, contact your Toyota dealer.

 **NOTICE**
 **Transmission fluid type**

Using transmission fluid other than the above type may cause abnormal noise or vibration, or damage the transmission of your vehicle.

Transfer (AWD models)

Oil capacity	0.47 qt. (0.45 L, 0.39 Imp. qt.)
Oil type and viscosity	Toyota Genuine Differential Gear Oil LT 75W-85 GL-5 or equivalent

Your Toyota vehicle is filled with “Toyota Genuine Differential Gear Oil” at the factory.

Use Toyota approved “Toyota Genuine Differential Gear Oil” or an equivalent of matching quality to satisfy the above specification. Please contact your Toyota dealer for further details.

Rear differential (AWD models)

Oil capacity	0.52 qt. (0.50 L, 0.43 Imp. qt.)
Oil type and viscosity	Toyota Genuine Differential Gear Oil LT 75W-85 GL-5 or equivalent

Your Toyota vehicle is filled with “Toyota Genuine Differential Gear Oil” at the factory.

Use Toyota approved “Toyota Genuine Differential Gear Oil” or an equivalent of matching quality to satisfy the above specification. Please contact your Toyota dealer for further details.

Brakes

Pedal clearance ^{*1}	3.2 in. (81 mm) ^{*2} , 3.1 in. (79 mm) ^{*3}
Pedal free play	0.04 — 0.24 in. (1 — 6 mm)
Brake pad wear limit	0.04 in. (1.0 mm)
Parking brake lining wear limit (pedal type)	0.04 in. (1.0 mm)
Parking brake pedal travel (pedal type) ^{*4}	7 — 12 clicks
Fluid type	FMVSS No.116 DOT 3 or SAE J1703 FMVSS No.116 DOT 4 or SAE J1704

*1: Minimum pedal clearance when depressed with a force of 67 lbf (300 N, 31 kgf) while the engine is running.

*2: Except for TRD models

*3: For TRD models

*4: Parking brake pedal travel when depressed with a force of 67 lbf (300 N, 31 kgf).

Steering

Free play	Less than 1.2 in. (30 mm)
-----------	---------------------------

Tires and wheels (2WD models)

► Type A

Tire size	205/65R16 95H, T155/70D17 110M
Tire inflation pressure (Recommended cold tire inflation pressure)	<p>Driving under normal conditions</p> <p>Front: 35 psi (240 kPa, 2.4 kgf/cm² or bar)</p> <p>Rear: 35 psi (240 kPa, 2.4 kgf/cm² or bar)</p> <p>Spare: 60 psi (420 kPa, 4.2 kgf/cm² or bar)</p> <p>Driving at high speeds (above 100 mph [160 km/h]) (in countries where such speeds are permitted by law)</p> <p>Add 5 psi (30 kPa, 0.3 kgf/cm² or bar) to the front tires and rear tires. Never exceed the maximum cold tire inflation pressure indicated on the tire sidewall.</p>
Wheel size	16 × 6 1/2 J, 17 × 4 T (compact spare)
Wheel nut torque	76 ft•lbf (103 N•m, 10.5 kgf•m)

► Type B

Tire size	215/55R17 94V, T155/70D17 110M
Tire inflation pressure (Recommended cold tire inflation pressure)	<p>Driving under normal conditions</p> <p>Front: 35 psi (240 kPa, 2.4 kgf/cm² or bar)</p> <p>Rear: 35 psi (240 kPa, 2.4 kgf/cm² or bar)</p> <p>Spare: 60 psi (420 kPa, 4.2 kgf/cm² or bar)</p> <p>Driving at high speeds (above 100 mph [160 km/h]) (in countries where such speeds are permitted by law)</p> <p>Add 5 psi (30 kPa, 0.3 kgf/cm² or bar) to the front tires and rear tires. Never exceed the maximum cold tire inflation pressure indicated on the tire sidewall.</p>
Wheel size	17 × 7 1/2 J, 17 × 4 T (compact spare)
Wheel nut torque	76 ft•lbf (103 N•m, 10.5 kgf•m)

► Type C

Tire size	235/45R18 94V, T155/70D17 110M
Tire inflation pressure (Recommended cold tire inflation pressure)	<p>Driving under normal conditions</p> <p>Front: 35 psi (240 kPa, 2.4 kgf/cm² or bar)</p> <p>Rear: 35 psi (240 kPa, 2.4 kgf/cm² or bar)</p> <p>Spare: 60 psi (420 kPa, 4.2 kgf/cm² or bar)</p> <p>Driving at high speeds (above 100 mph [160 km/h]) (in countries where such speeds are permitted by law)</p> <p>Add 5 psi (30 kPa, 0.3 kgf/cm² or bar) to the front tires and rear tires. Never exceed the maximum cold tire inflation pressure indicated on the tire sidewall.</p>
Wheel size	18 × 8 J, 17 × 4 T (compact spare)
Wheel nut torque	76 ft•lbf (103 N•m, 10.5 kgf•m)

► Type D

Tire size	235/40R19 92V, T155/70D17 110M
Tire inflation pressure (Recommended cold tire inflation pressure)	<p>Driving under normal conditions</p> <p>Front: 35 psi (240 kPa, 2.4 kgf/cm² or bar)</p> <p>Rear: 35 psi (240 kPa, 2.4 kgf/cm² or bar)</p> <p>Spare: 60 psi (420 kPa, 4.2 kgf/cm² or bar)</p> <p>Driving at high speeds (above 100 mph [160 km/h]) (in countries where such speeds are permitted by law)</p> <p>Add 5 psi (30 kPa, 0.3 kgf/cm² or bar) to the front tires and rear tires. Never exceed the maximum cold tire inflation pressure indicated on the tire sidewall.</p>
Wheel size	19 × 8 J, 17 × 4 T (compact spare)
Wheel nut torque	76 ft•lbf (103 N•m, 10.5 kgf•m)

► Type E

Tire size	235/40R19 92V, T155/70D17 110M
Tire inflation pressure (Recommended cold tire inflation pressure)	<p>Driving under normal conditions</p> <p>Front: 35 psi (240 kPa, 2.4 kgf/cm² or bar)</p> <p>Rear: 35 psi (240 kPa, 2.4 kgf/cm² or bar)</p> <p>Spare: 60 psi (420 kPa, 4.2 kgf/cm² or bar)</p> <p>Driving at high speeds (above 100 mph [160 km/h]) (in countries where such speeds are permitted by law)</p> <p>Add 5 psi (30 kPa, 0.3 kgf/cm² or bar) to the front tires and rear tires. Never exceed the maximum cold tire inflation pressure indicated on the tire sidewall.</p>
Wheel size	19 × 8 1/2 J, 17 × 4 T (compact spare)
Wheel nut torque	76 ft•lbf (103 N•m, 10.5 kgf•m)

► Type F

Tire size	235/40R19 96Y, T155/70D17 110M
Tire inflation pressure (Recommended cold tire inflation pressure)	<p>Driving under normal conditions</p> <p>Front: 33 psi (230 kPa, 2.3 kgf/cm² or bar)</p> <p>Rear: 33 psi (230 kPa, 2.3 kgf/cm² or bar)</p> <p>Spare: 60 psi (420 kPa, 4.2 kgf/cm² or bar)</p> <p>Driving at high speeds (above 100 mph [160 km/h]) (in countries where such speeds are permitted by law)</p> <p>Add 5 psi (30 kPa, 0.3 kgf/cm² or bar) to the front tires and rear tires. Never exceed the maximum cold tire inflation pressure indicated on the tire sidewall.</p>
Wheel size	19 × 8 1/2 J, 17 × 4 T (compact spare)
Wheel nut torque	76 ft•lbf (103 N•m, 10.5 kgf•m)

Tires and wheels (AWD models)

▶ Type A

Tire size	215/55R17 94V, T155/70D17 110M
Tire inflation pressure (Recommended cold tire inflation pressure)	<p>Driving under normal conditions</p> <p>Front: 36 psi (250 kPa, 2.5 kgf/cm² or bar)</p> <p>Rear: 36 psi (250 kPa, 2.5 kgf/cm² or bar)</p> <p>Spare: 60 psi (420 kPa, 4.2 kgf/cm² or bar)</p> <p>Driving at high speeds (above 100 mph [160 km/h]) (in countries where such speeds are permitted by law)</p> <p>Add 5 psi (30 kPa, 0.3 kgf/cm² or bar) to the front tires and rear tires. Never exceed the maximum cold tire inflation pressure indicated on the tire sidewall.</p>
Wheel size	17 × 7 1/2 J, 17 × 4 T (compact spare)
Wheel nut torque	76 ft•lbf (103 N•m, 10.5 kgf•m)

▶ Type B

Tire size	235/45R18 94V, T155/70D17 110M
Tire inflation pressure (Recommended cold tire inflation pressure)	<p>Driving under normal conditions</p> <p>Front: 36 psi (250 kPa, 2.5 kgf/cm² or bar)</p> <p>Rear: 36 psi (250 kPa, 2.5 kgf/cm² or bar)</p> <p>Spare: 60 psi (420 kPa, 4.2 kgf/cm² or bar)</p> <p>Driving at high speeds (above 100 mph [160 km/h]) (in countries where such speeds are permitted by law)</p> <p>Add 5 psi (30 kPa, 0.3 kgf/cm² or bar) to the front tires and rear tires. Never exceed the maximum cold tire inflation pressure indicated on the tire sidewall.</p>
Wheel size	18 × 8 J, 17 × 4 T (compact spare)
Wheel nut torque	76 ft•lbf (103 N•m, 10.5 kgf•m)

► Type C

Tire size	235/40R19 92V, T155/70D17 110M
Tire inflation pressure (Recommended cold tire inflation pressure)	<p>Driving under normal conditions</p> <p>Front: 36 psi (250 kPa, 2.5 kgf/cm² or bar)</p> <p>Rear: 36 psi (250 kPa, 2.5 kgf/cm² or bar)</p> <p>Spare: 60 psi (420 kPa, 4.2 kgf/cm² or bar)</p> <p>Driving at high speeds (above 100 mph [160 km/h]) (in countries where such speeds are permitted by law)</p> <p>Add 5 psi (30 kPa, 0.3 kgf/cm² or bar) to the front tires and rear tires. Never exceed the maximum cold tire inflation pressure indicated on the tire sidewall.</p>
Wheel size	19 × 8 J, 17 × 4 T (compact spare)
Wheel nut torque	76 ft•lbf (103 N•m, 10.5 kgf•m)

► Type D

Tire size	235/40R19 92V, T155/70D17 110M
Tire inflation pressure (Recommended cold tire inflation pressure)	<p>Driving under normal conditions</p> <p>Front: 35 psi (240 kPa, 2.4 kgf/cm² or bar)</p> <p>Rear: 35 psi (240 kPa, 2.4 kgf/cm² or bar)</p> <p>Spare: 60 psi (420 kPa, 4.2 kgf/cm² or bar)</p> <p>Driving at high speeds (above 100 mph [160 km/h]) (in countries where such speeds are permitted by law)</p> <p>Add 5 psi (30 kPa, 0.3 kgf/cm² or bar) to the front tires and rear tires. Never exceed the maximum cold tire inflation pressure indicated on the tire sidewall.</p>
Wheel size	19 × 8 1/2 J, 17 × 4 T (compact spare)
Wheel nut torque	76 ft•lbf (103 N•m, 10.5 kgf•m)

Light bulbs*1

	Light bulbs	Bulb No.	W	Type
Exterior	Front side marker lights (bulb type)	W5W	5	A
	Front turn signal/ parking lights (bulb type)	7444NA	28/8	B
	Rear turn signal lights (bulb type)	WY21W	21	B
	Rear side maker lights (bulb type)	W5W	5	A
	Back-up lights (bulb type)	921	16	A
Interior	Rear interior light*2	—	8	C
	Door courtesy lights*2	—	5	A
	Trunk light	—	5	A

A: Wedge base bulbs (clear)

B: Wedge base bulbs (amber)

C: Double end bulbs

*1: Light bulbs not listed in this table are LED bulbs.

*2: If equipped

Fuel information

You must only use unleaded gasoline.

Select octane rating 87 (Research Octane Number 91) or higher. Use of unleaded gasoline with an octane rating lower than 87 may result in engine knocking. Persistent knocking can lead to engine damage.

At minimum, the gasoline you use should meet the specifications of ASTM D4814 in the U.S.A..

■ Gasoline quality

In very few cases, driveability problems may be caused by the brand of gasoline you are using. If driveability problems persist, try changing the brand of gasoline. If this does not correct the problem, consult your Toyota dealer.

■ Recommendation of the use of gasoline containing detergent additives

- Toyota recommends the use of gasoline that contains detergent additives to avoid the build-up of engine deposits.
- All gasoline sold in the U.S.A. contains minimum detergent additives to clean and/or keep clean intake systems, per EPA's lowest additives concentration program.
- Toyota strongly recommends the use of Top Tier Detergent Gasoline. For more information on Top Tier Detergent Gasoline and a list of marketers, please go to the official website www.toptiergas.com.

■ Recommendation of the use of low emissions gasoline

Gasolines containing oxygenates such as ethers and ethanol, as well as reformulated gasolines, are available in some cities. These fuels are typically acceptable for use, providing they meet other fuel requirements.

Toyota recommends these fuels, since the formulations allow for reduced vehicle emissions.

■ Non-recommendation of the use of blended gasoline

- Use only gasoline containing up to 15% ethanol.

DO NOT use any flex-fuel or gasoline that could contain more than 15% ethanol, including from any pump labeled E30, E50, E85 (which are only some examples of fuel containing more than 15% ethanol).

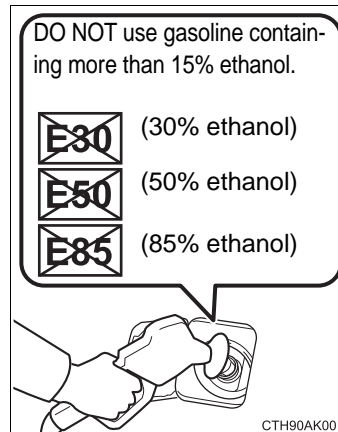

- If you use gasohol in your vehicle, be sure that it has an octane rating no lower than 87.
- Toyota does not recommend the use of gasoline containing methanol.

■ Non-recommendation of the use of gasoline containing MMT

Some gasoline contains an octane enhancing additive called MMT (Methylcyclopentadienyl Manganese Tricarbonyl).

Toyota does not recommend the use of gasoline that contains MMT. If fuel containing MMT is used, your emission control system may be adversely affected.

The malfunction indicator lamp on the instrument cluster may come on. If this happens, contact your Toyota dealer for service.

■ If your engine knocks

- Consult your Toyota dealer.
- You may occasionally notice light knocking for a short time while accelerating or driving uphill. This is normal and there is no need for concern.



NOTICE

■ Notice on fuel quality

- Do not use improper fuels. If improper fuels are used, the engine will be damaged.
- Do not use leaded gasoline.
Leaded gasoline can cause damage to your vehicle's three-way catalytic converters causing the emission control system to malfunction.
- Do not use gasohol other than the type previously stated.
Other gasohol may cause fuel system damage or vehicle performance problems.
- Using unleaded gasoline with an octane number or rating lower than the level previously stated will cause persistent heavy knocking.
At worst, this will lead to engine damage.

■ Fuel-related poor driveability

If poor driveability (poor hot starting, vaporization, engine knocking, etc.) is encountered after using a different type of fuel, discontinue the use of that type of fuel.

■ When refueling with gasohol

Take care not to spill gasohol. It can damage your vehicle's paint.

Tire information

Typical tire symbols

► Full-size tire

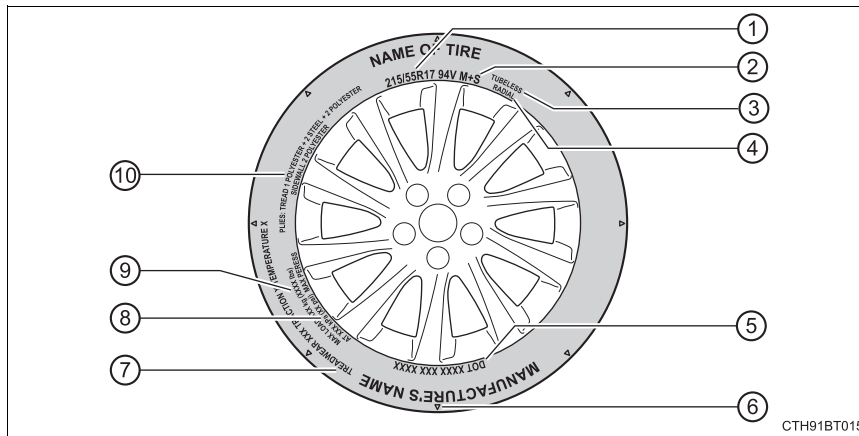

CTH91BT015

► Compact spare tire

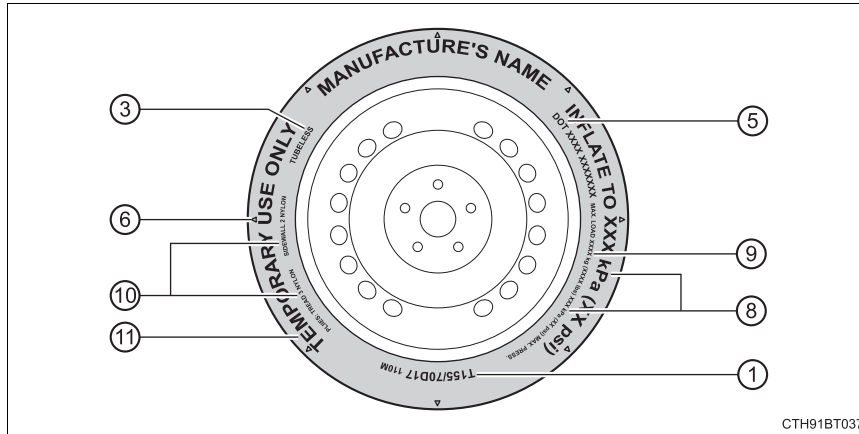

CTH91BT037

- ① Tire size (→P. 596)
- ② Summer tires or all season tires (→P. 480)

An all season tire has “M+S” on the sidewall. A tire not marked “M+S” is a summer tire.
- ③ TUBELESS or TUBE TYPE

A tubeless tire does not have a tube and air is directly put into the tire. A tube type tire has a tube inside the tire and the tube maintains the air pressure.
- ④ Radial tires or bias-ply tires

A radial tire has “RADIAL” on the sidewall. A tire not marked “RADIAL” is a bias-ply tire.
- ⑤ DOT and Tire Identification Number (TIN) (→P. 595)
- ⑥ Location of treadwear indicators (→P. 473)
- ⑦ Uniform tire quality grading

For details, see “Uniform Tire Quality Grading” that follows.
- ⑧ Maximum cold tire inflation pressure (→P. 584)

This means the pressure to which a tire may be inflated.
- ⑨ Load limit at maximum cold tire inflation pressure (→P. 479)
- ⑩ Tire ply composition and materials

Plies are layers of rubber-coated parallel cords. Cords are the strands which form the plies in a tire.
- ⑪ “TEMPORARY USE ONLY”

A compact spare tire is identified by the phrase “TEMPORARY USE ONLY” molded on its sidewall. This tire is designed for temporary emergency use only.

Typical DOT and Tire Identification Number (TIN)

► Type A

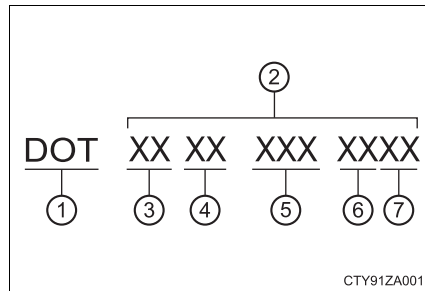

► Type B

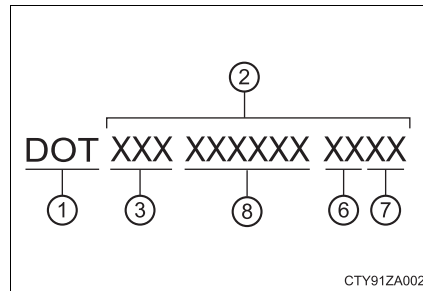

- ① DOT symbol*
- ② Tire Identification Number (TIN)
- ③ Tire manufacturer's identification mark
- ④ Tire size code
- ⑤ Manufacturer's optional tire type code (3 or 4 letters)
- ⑥ Manufacturing week
- ⑦ Manufacturing year
- ⑧ Manufacturer's code

*: The DOT symbol certifies that the tire conforms to applicable Federal Motor Vehicle Safety Standards.

Tire size

■ Typical tire size information

The illustration indicates typical tire size.

- ① Tire use
(P = Passenger car [sometimes omitted],
T = Temporary use)
- ② Section width (millimeters)
- ③ Aspect ratio
(tire height to section width)
- ④ Tire construction code (R = Radial, D = Diagonal)
- ⑤ Wheel diameter (inches)
- ⑥ Load index (2 digits or 3 digits)
- ⑦ Speed symbol (alphabet with one letter)

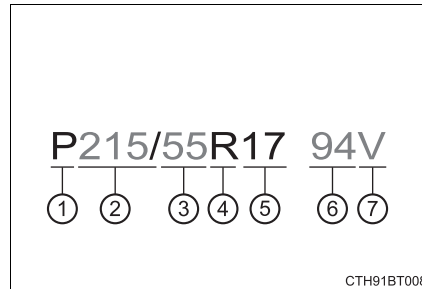

■ Tire dimensions

- ① Section width
- ② Tire height
- ③ Wheel diameter

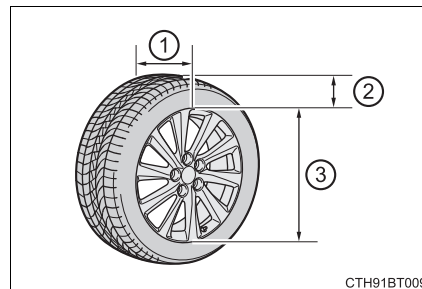

Tire section names

- ① Bead
- ② Sidewall
- ③ Shoulder
- ④ Tread
- ⑤ Belt
- ⑥ Inner liner
- ⑦ Reinforcing rubber
- ⑧ Carcass
- ⑨ Rim lines
- ⑩ Bead wires
- ⑪ Chafer

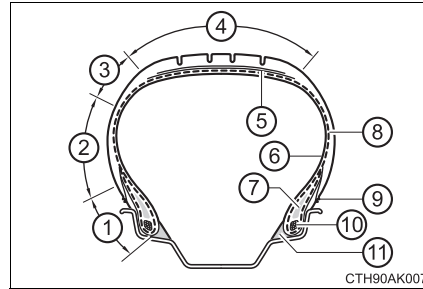

Uniform Tire Quality Grading

This information has been prepared in accordance with regulations issued by the National Highway Traffic Safety Administration of the U.S. Department of Transportation.

It provides the purchasers and/or prospective purchasers of Toyota vehicles with information on uniform tire quality grading.

Your Toyota dealer will help answer any questions you may have as you read this information.

■ DOT quality grades

All passenger vehicle tires must conform to Federal Safety Requirements in addition to these grades. Quality grades can be found where applicable on the tire sidewall between tread shoulder and maximum section width.

For example: Treadwear 200 Traction AA Temperature A

■ Treadwear

The treadwear grade is a comparative rating based on the wear rate of the tire when tested under controlled conditions on a specified government test course.

For example, a tire graded 150 would wear one and a half (1 - 1/2) times as well on the government course as a tire graded 100.

The relative performance of tires depends upon the actual conditions of their use. Performance may differ significantly from the norm due to variations in driving habits, service practices and differences in road characteristics and climate.

■ Traction AA, A, B, C

The traction grades, from highest to lowest, are AA, A, B and C, and they represent the tire's ability to stop on wet pavement as measured under controlled conditions on specified government test surfaces of asphalt and concrete.

A tire marked C may have poor traction performance.

Warning: The traction grade assigned to this tire is based on braking (straight ahead) traction tests and does not include cornering (turning) traction.

■ Temperature A, B, C

The temperature grades are A (the highest), B, and C, representing the tire's resistance to the generation of heat and its ability to dissipate heat when tested under controlled conditions on a specified indoor laboratory test wheel.

Sustained high temperature can cause the material of the tire to degenerate and reduce tire life, and excessive temperature can lead to sudden tire failure.

Grade C corresponds to a level of performance which all passenger car tires must meet under the Federal Motor Vehicle Safety Standard No. 109.

Grades B and A represent higher levels of performance on the laboratory test wheel than the minimum required by law.

Warning: The temperature grades of a tire assume that it is properly inflated and not overloaded.

Excessive speed, underinflation, or excessive loading, either separately or in combination, can cause heat buildup and possible tire failure.

Glossary of tire terminology

Tire related term	Meaning
Cold tire inflation pressure	Tire pressure when the vehicle has been parked for three hours or more, or has not been driven more than 1 mile or 1.5 km under that condition
Maximum inflation pressure	The maximum cold inflated pressure to which a tire may be inflated, shown on the sidewall of the tire
Recommended inflation pressure	Cold tire inflation pressure recommended by a manufacturer
Accessory weight	The combined weight (in excess of those standard items which may be replaced) of automatic transmission, power steering, power brakes, power windows, power seats, radio and heater, to the extent that these items are available as factory-installed equipment (whether installed or not)
Curb weight	The weight of a motor vehicle with standard equipment, including the maximum capacity of fuel, oil and coolant, and if so equipped, air conditioning and additional weight optional engine
Maximum loaded vehicle weight	The sum of: (a) Curb weight (b) Accessory weight (c) Vehicle capacity weight (d) Production options weight
Normal occupant weight	150 lb. (68 kg) times the number of occupants specified in the second column of Table 1* that follows
Occupant distribution	Distribution of occupants in a vehicle as specified in the third column of Table 1* below

Tire related term	Meaning
Production options weight	The combined weight of installed regular production options weighing over 5 lb. (2.3 kg) in excess of the standard items which they replace, not previously considered in curb weight or accessory weight, including heavy duty brakes, ride levelers, roof rack, heavy duty battery, and special trim
Rim	A metal support for a tire or a tire and tube assembly upon which the tire beads are seated
Rim diameter (Wheel diameter)	Nominal diameter of the bead seat
Rim size designation	Rim diameter and width
Rim type designation	The industry manufacturer's designation for a rim by style or code
Rim width	Nominal distance between rim flanges
Vehicle capacity weight (Total load capacity)	The rated cargo and luggage load plus 150 lb. (68 kg) times the vehicle's designated seating capacity
Vehicle maximum load on the tire	The load on an individual tire that is determined by distributing to each axle its share of the maximum loaded vehicle weight, and dividing by two
Vehicle normal load on the tire	The load on an individual tire that is determined by distributing to each axle its share of curb weight, accessory weight, and normal occupant weight (distributed in accordance with Table 1* below), and dividing by two
Weather side	The surface area of the rim not covered by the inflated tire
Bead	The part of the tire that is made of steel wires, wrapped or reinforced by ply cords and that is shaped to fit the rim
Bead separation	A breakdown of the bond between components in the bead

Tire related term	Meaning
Bias ply tire	A pneumatic tire in which the ply cords that extend to the beads are laid at alternate angles substantially less than 90 degrees to the centerline of the tread
Carcass	The tire structure, except tread and sidewall rubber which, when inflated, bears the load
Chunking	The breaking away of pieces of the tread or sidewall
Cord	The strands forming the plies in the tire
Cord separation	The parting of cords from adjacent rubber compounds
Cracking	Any parting within the tread, sidewall, or innerliner of the tire extending to cord material
CT	A pneumatic tire with an inverted flange tire and rim system in which the rim is designed with rim flanges pointed radially inward and the tire is designed to fit on the underside of the rim in a manner that encloses the rim flanges inside the air cavity of the tire
Extra load tire	A tire designed to operate at higher loads and at higher inflation pressures than the corresponding standard tire
Groove	The space between two adjacent tread ribs
Innerliner	The layer(s) forming the inside surface of a tubeless tire that contains the inflating medium within the tire
Innerliner separation	The parting of the innerliner from cord material in the carcass
Intended outboard sidewall	<p>(a) The sidewall that contains a whitewall, bears white lettering, or bears manufacturer, brand, and/or model name molding that is higher or deeper than the same molding on the other sidewall of the tire, or</p> <p>(b) The outward facing sidewall of an asymmetrical tire that has a particular side that must always face outward when mounted on a vehicle</p>

Tire related term	Meaning
Light truck (LT) tire	A tire designated by its manufacturer as primarily intended for use on lightweight trucks or multipurpose passenger vehicles
Load rating	The maximum load that a tire is rated to carry for a given inflation pressure
Maximum load rating	The load rating for a tire at the maximum permissible inflation pressure for that tire
Maximum permissible inflation pressure	The maximum cold inflation pressure to which a tire may be inflated
Measuring rim	The rim on which a tire is fitted for physical dimension requirements
Open splice	Any parting at any junction of tread, sidewall, or innerliner that extends to cord material
Outer diameter	The overall diameter of an inflated new tire
Overall width	The linear distance between the exteriors of the sidewalls of an inflated tire, including elevations due to labeling, decorations, or protective bands or ribs
Passenger car tire	A tire intended for use on passenger cars, multipurpose passenger vehicles, and trucks, that have a gross vehicle weight rating (GVWR) of 10,000 lb. or less.
Ply	A layer of rubber-coated parallel cords
Ply separation	A parting of rubber compound between adjacent plies
Pneumatic tire	A mechanical device made of rubber, chemicals, fabric and steel or other materials, that, when mounted on an automotive wheel, provides the traction and contains the gas or fluid that sustains the load
Radial ply tire	A pneumatic tire in which the ply cords that extend to the beads are laid at substantially 90 degrees to the centerline of the tread
Reinforced tire	A tire designed to operate at higher loads and at higher inflation pressures than the corresponding standard tire

Tire related term	Meaning
Section width	The linear distance between the exteriors of the sidewalls of an inflated tire, excluding elevations due to labeling, decoration, or protective bands
Sidewall	That portion of a tire between the tread and bead
Sidewall separation	The parting of the rubber compound from the cord material in the sidewall
Snow tire	A tire that attains a traction index equal to or greater than 110, compared to the ASTM E-1136 Standard Reference Test Tire, when using the snow traction test as described in ASTM F-1805-00, Standard Test Method for Single Wheel Driving Traction in a Straight Line on Snow-and Ice-Covered Surfaces, and which is marked with an Alpine Symbol () on at least one sidewall
Test rim	The rim on which a tire is fitted for testing, and may be any rim listed as appropriate for use with that tire
Tread	That portion of a tire that comes into contact with the road
Tread rib	A tread section running circumferentially around a tire
Tread separation	Pulling away of the tread from the tire carcass
Treadwear indicators (TWI)	The projections within the principal grooves designed to give a visual indication of the degrees of wear of the tread
Wheel-holding fixture	The fixture used to hold the wheel and tire assembly securely during testing

*: Table 1 — Occupant loading and distribution for vehicle normal load for various designated seating capacities

Designated seating capacity, Number of occupants	Vehicle normal load, Number of occupants	Occupant distribution in a normally loaded vehicle
2 through 4	2	2 in front
5 through 10	3	2 in front, 1 in second seat
11 through 15	5	2 in front, 1 in second seat, 1 in third seat, 1 in fourth seat
16 through 20	7	2 in front, 2 in second seat, 2 in third seat, 1 in fourth seat

Customizable features

Your vehicle includes a variety of electronic features that can be personalized to suit your preferences. The settings of these features can be changed using the multi-information display, on the audio system screen, or at your Toyota dealer.

Customizing vehicle features

When customizing vehicle features, ensure that the vehicle is parked in a safe place with the shift lever in P and the parking brake set.

■ Changing on the audio system screen

- 1 Press the "MENU" button.
- 2 Select "Setup" on the "Menu" screen.
- 3 Select "Vehicle" on the "Setup" screen.
- 4 Select "Vehicle Customization".

Various setting can be changed. Refer to the list of settings that can be changed for details.

■ Changing using the multi-information display

→P. 103, 117

Customizable features

Some function settings are changed simultaneously with other functions being customized. Contact your Toyota dealer for further details.

- ① Settings that can be changed on the audio system screen
- ② Settings that can be changed by your Toyota dealer

Definition of symbols: O = Available, — = Not available

■ Gauges, meters and multi-information display (→P. 94, 98, 111)

Function	Default setting	Customized setting	①	②
Language	English	French	O	—
		Spanish	O	—
Units*	miles (MPG US)	miles (MPG Imperial)	O	—
		km (L/100 km)	O	—
		km (km/L)	O	—
Convenience services (Suggestion function)	On	On (when the vehicle is stopped)	O	O
		Off	O	O

*: The default setting varies according to country.

■ Door lock (→P. 147, 156, 559)

Function	Default setting	Customized setting	①	②
Unlocking using a key	Driver's door unlocked in one step, all doors unlocked in two steps	All doors unlocked in one step.	—	○
Automatic door lock	Shift position linked door locking operation	Off	○	○
		Speed linked door locking operation		
Automatic door unlock	Shift position linked door unlocking operation	Off	○	○
		Driver's door linked door unlocking operation		
Locking/unlocking of the trunk when all doors are locked/unlocked*	On	Off	—	○

*: Vehicles with a smart key system

■ Smart key system* and wireless remote control (→P. 147, 156, 161)

Function	Default setting	Customized setting	①	②
Operation buzzer volume	5	Off to 7	○	○
Operation signal (Emergency flashers)	On	Off	○	○
Time elapsed before automatic door lock function is activated if door is not opened after being unlocked	60 seconds	Off	○	○
		30 seconds		
		120 seconds		
Open door warning buzzer	On	Off	—	○

*: If equipped

■ Smart key system* (→P. 147, 156, 161)

Function	Default setting	Customized setting	①	②
Smart key system	On	Off	○	—
Smart door unlocking	Driver's door	All the doors	○	○
Time elapsed before unlocking all the door when gripping and holding the driver's door handle	2 seconds	Off	—	○
Number of consecutive door lock operations	2 times	As many as desired	—	○

*: If equipped

■ Wireless remote control (→P. 140, 147, 156)

Function	Default setting	Customized setting	①	②
Wireless remote control	On	Off	—	○
Unlocking operation	Driver's door unlocked in one step, all doors unlocked in two steps	All doors unlocked in one step	○	○
Trunk unlocking operation	Press and hold (short)	One short press	—	○
		Push twice		
		Press and hold (long)		
		Off		
Panic function	On	Off	—	○
Reservation lock	On	Off	○	○

■ **Power windows, and moon roof* or panoramic moon roof***
 (→P. 179, 183, 187)

Function	Default setting	Customized setting	①	②
Key linked operation	Off	On	—	○
Wireless remote control linked operation	Off	On (open only)	—	○
Wireless remote control linked operation signal (buzzer)	On	Off	—	○

*: If equipped

■ **Moon roof* (→P. 183)**

Function	Default setting	Customized setting	①	②
Linked operation of components when key is used (open only)	Slide only	Tilt only	—	○
Linked operation of components when wireless remote control is used	Slide only	Tilt only	—	○

*: If equipped

■ **Automatic light control system (→P. 231)**

Function	Default setting	Customized setting	①	②
Light sensor sensitivity	Standard	-2 to 2	○	○
Time elapsed before headlights automatically turn off after doors are closed	30 seconds	Off	○	○
		60 seconds		
		90 seconds		

■ Lights (→P. 231)

Function	Default setting	Customized setting	①	②
Daytime running light system (except Canada)	On	Off	<input type="radio"/>	<input type="radio"/>
Windshield wiper linked headlight illumination	On	Off	—	<input type="radio"/>

■ Intuitive parking assist* (→P. 336)

Function	Default setting	Customized setting	①	②
Detection distance of the front center sensor	Far	Near	—	<input type="radio"/>
Detection distance of the rear center sensor	Far	Near	—	<input type="radio"/>

*: If equipped

■ BSM (Blind Spot Monitor)* (→P. 330)

Function	Default setting	Customized setting	①	②
Outside rear view mirror indicator brightness	Bright	Dim	—	<input type="radio"/>
Notification timing for presence of approaching vehicle (sensitivity)	Middle	Early	—	<input type="radio"/>
		Late		
		Only when vehicle detected in blind spot		

*: If equipped

■ RCTA (Rear Cross Traffic Alert)* (→P. 345)

Function	Default setting	Customized setting	①	②
RCTA buzzer volume	2	1	—	<input type="radio"/>
		3		

*: If equipped

■ **Automatic air conditioning system*** (→P. 387, 394)

Function	Default setting	Customized setting	①	②
A/C auto switch operation	Auto	Manual	○	○

*: If equipped

■ **Illumination (→P. 405)**

Function	Default setting	Customized setting	①	②
Time elapsed before lights turn off	15 seconds	Off	○	○
		7.5 seconds		
		30 seconds		
Vehicles without smart key system: Operation after the engine switch turned to the "LOCK" position Vehicles with smart key system: Operation after the engine switch turned off	On	Off	—	○
Operation when the doors are unlocked	On	Off	—	○
Operation when you approach the vehicle with the electronic key on your person* ¹	On	Off	—	○
Footwell lights* ²	On	Off	—	○
Instrument panel ornament light* ² and inside door handle lights* ²	On	Off	—	○

*¹: Vehicles with a smart key system

*²: If equipped

 WARNING**■ During customization**

As the engine needs to be running during customization, ensure that the vehicle is parked in a place with adequate ventilation. In a closed area such as a garage, exhaust gases including harmful carbon monoxide (CO) may collect and enter the vehicle. This may lead to death or a serious health hazard.

 NOTICE**■ During customization**

To prevent battery discharge, ensure that the engine is running while customizing features.

Items to initialize

The following items must be initialized for normal system operation after such cases as the battery being reconnected, or maintenance being performed on the vehicle:

Item	When to initialize	Reference
Message indicating maintenance is required (on some models)	<ul style="list-style-type: none"> • After the maintenance is performed 	P. 448
Tire pressure warning system	<ul style="list-style-type: none"> • When the tire inflation pressure is changed such as when changing traveling speed or load weight • When the tire inflation pressure is changed such as when the tire size is changed • When rotating the tires • After performing the transmitter ID code registration procedure 	P. 475

For owners

9

Reporting safety defects
for U.S. owners..... 616

Reporting safety defects
for Canadian owners 617

Seat belt instructions
for Canadian owners
(in French) 618

SRS airbag instructions
for Canadian owners
(in French) 619

Reporting safety defects for U.S. owners

If you believe that your vehicle has a defect which could cause a crash or could cause injury or death, you should immediately inform the National Highway Traffic Safety Administration (NHTSA) in addition to notifying Toyota Motor Sales, U.S.A., Inc. (Toll-free: 1-800-331-4331).

If NHTSA receives similar complaints, it may open an investigation, and if it finds that a safety defect exists in a group of vehicles, it may order a recall and remedy campaign. However, NHTSA cannot become involved in individual problems between you, your dealer, or Toyota Motor Sales, U.S.A., Inc.

To contact NHTSA, you may call the Vehicle Safety Hotline toll-free at 1-888-327-4236 (TTY: 1-800-424-9153); go to <http://www.safercar.gov>; or write to: Administrator, NHTSA, 1200 New Jersey Ave. SE., Washington, DC 20590. You can also obtain other information about motor vehicle safety from <http://www.safercar.gov>.

Reporting safety defects for Canadian owners

Canadian customers who wish to report a safety-related defect to Transport Canada, Defects Investigations and Recalls, may telephone the toll-free hotline 1-800-333-0510, mail Transport Canada - ASFAD, 330 Sparks Street, Ottawa, ON, K1A 0N5, or complete the online form at <https://www.tc.gc.ca/recalls>.

Seat belt instructions for Canadian owners (in French)

The following is a French explanation of seat belt instructions extracted from the seat belt section in this manual.

See the seat belt section for more detailed seat belt instructions in English.

Utilisation correcte des ceintures de sécurité

- Déroulez la sangle diagonale de telle sorte qu'elle passe bien sur l'épaule, sans pour autant être en contact avec le cou ou glisser de l'épaule.
- Placez la sangle abdominale le plus bas possible sur les hanches.
- Réglez la position du dossier de siège. Asseyez-vous le dos droit et caliez-vous bien dans le siège.
- Ne vrillez pas la ceinture de sécurité.

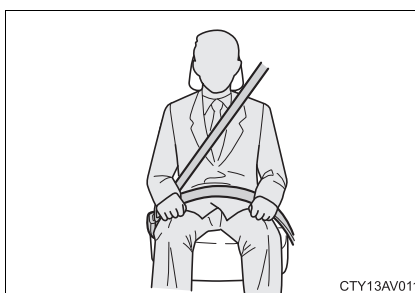

CTY13AV011

Entretien et soin

■ Ceintures de sécurité

Nettoyez avec un chiffon ou une éponge humidifiés avec de l'eau savonneuse tiède. Vérifiez régulièrement que les ceintures ne sont pas usées, effilochées ou entaillées excessivement.

▲ AVERTISSEMENT

■ Détérioration et usure des ceintures de sécurité

Inspectez le système de ceintures de sécurité régulièrement. Contrôlez l'absence de coupures, d'effilochages et de pièces desserrées. N'utilisez pas une ceinture de sécurité endommagée avant qu'elle ne soit remplacée. Une ceinture de sécurité endommagée ne permet pas de protéger un occupant de blessures graves ou mortelles.

SRS airbag instructions for Canadian owners (in French)

The following is a French explanation of SRS airbag instructions extracted from the SRS airbag section in this manual.

See the SRS airbag section for more detailed SRS airbag instructions in English.

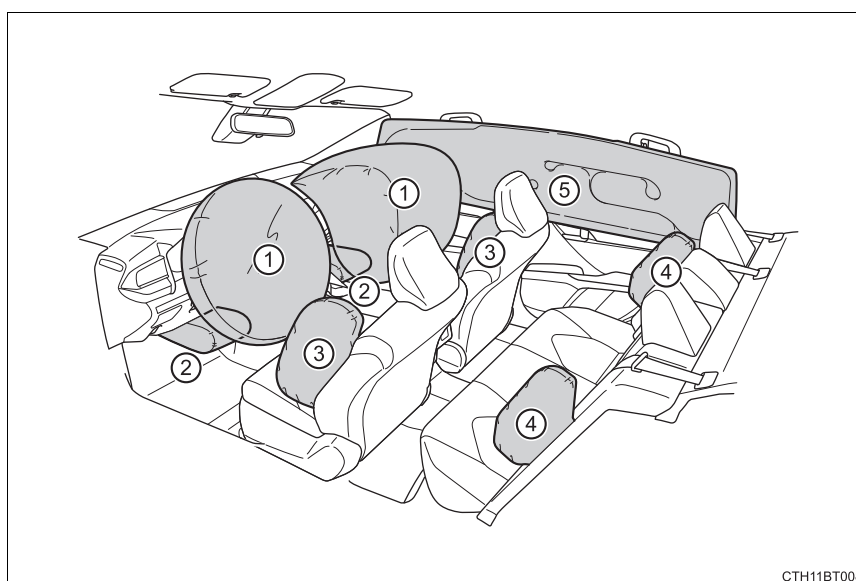

◆ Coussins gonflables frontaux SRS

- ① Coussin gonflable conducteur/coussin gonflable du passager avant SRS
Participe à la protection de la tête et du thorax du conducteur et du passager avant contre les chocs contre les éléments de l'habitacle
- ② Coussins gonflables de genoux SRS
Participent à la protection du conducteur et du passager avant

◆ Coussins gonflables latéraux et rideaux SRS

- ③ Coussins gonflables latéraux avant SRS
Participent à la protection du torse des occupants de siège avant
- ④ Coussins gonflables latéraux arrière SRS
Participent à la protection du torse des occupants des sièges latéraux arrière
- ⑤ Coussins gonflables rideaux SRS
 - Participent principalement à la protection de la tête des occupants des sièges latéraux
 - Peut contribuer à empêcher les occupants d'être éjectés du véhicule en cas de tonneau

Composants du système de coussins gonflables SRS

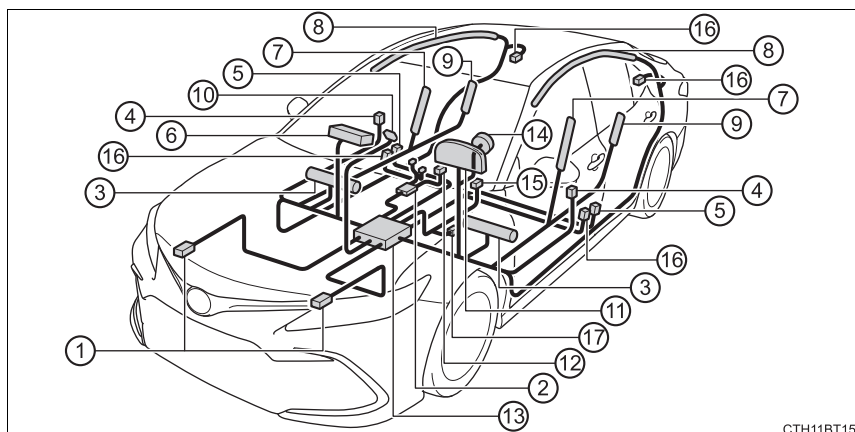

CTH11BT158

- | | |
|---|--|
| ① Capteurs d'impact avant | ⑩ Témoins indicateurs "AIRBAG ON" et "AIRBAG OFF" |
| ② Système de classification de l'occupant du siège passager avant (ECU et capteurs) | ⑪ Témoin d'avertissement SRS |
| ③ Coussins gonflables de genoux | ⑫ Contact de boucle de ceinture de sécurité du passager avant |
| ④ Capteurs d'impact latéral (portes avant) | ⑬ Ensemble de capteurs de coussins gonflables |
| ⑤ Capteurs d'impact latéral (avant) | ⑭ Coussin gonflable conducteur |
| ⑥ Coussin gonflable passager avant | ⑮ Contact de boucle de ceinture de sécurité conducteur |
| ⑦ Coussins gonflables latéraux avant | ⑯ Prétensionneurs de ceintures de sécurité et limiteurs de force |
| ⑧ Coussins gonflables rideaux | ⑰ Capteur de position du siège conducteur |
| ⑨ Coussins gonflables latéraux arrière | |

Votre véhicule est équipé de COUSSINS GONFLABLES INTELLIGENTS conçus selon les normes de sécurité américaines applicables aux véhicules à moteur (FMVSS208). L'ensemble de capteurs de coussins gonflables (ECU) régule le déploiement des coussins gonflables sur la base des informations qu'il reçoit des capteurs, etc., indiqués ci-dessus dans le schéma illustrant les composants du système. Parmi ces informations figurent la gravité du choc et l'occupation du véhicule par les passagers. Le déploiement rapide des coussins gonflables est obtenu au moyen d'une réaction chimique dans les dispositifs pyrotechniques, qui produit un gaz inoffensif permettant d'amortir le mouvement des occupants.

 AVERTISSEMENT

■ **Précautions relatives aux coussins gonflables SRS**

Respectez les précautions suivantes concernant les coussins gonflables SRS.

Le non-respect de ces précautions peut occasionner des blessures graves, voire mortelles.

- Le conducteur et tous les passagers du véhicule doivent porter correctement leur ceinture de sécurité.

Les coussins gonflables SRS sont des dispositifs supplémentaires à utiliser avec les ceintures de sécurité.

- Le coussin gonflable conducteur SRS se déploie avec une force considérable, pouvant occasionner des blessures graves, voire mortelles, si le conducteur se trouve très près du coussin gonflable. L'autorité fédérale chargée de la sécurité routière aux États-Unis (NHTSA) conseille:

La zone à risque du coussin gonflable conducteur se situant dans les premiers 2 à 3 in. (50 à 75 mm) de déploiement, vous placer à 10 in. (250 mm) de votre coussin gonflable conducteur vous garantit une marge de sécurité suffisante. Cette distance est à mesurer entre le centre du volant et le sternum. Si vous êtes assis à moins de 10 in. (250 mm), vous pouvez changer votre position de conduite de plusieurs façons:

- Reculez votre siège le plus possible, de manière à pouvoir encore atteindre confortablement les pédales.
- Inclinez légèrement le dossier du siège.
Bien que les véhicules aient une conception différente, un grand nombre de conducteurs peuvent s'asseoir à une distance de 10 in. (250 mm), même avec le siège conducteur complètement avancé, simplement en inclinant un peu le dossier de siège. Si vous avez des difficultés à voir la route après avoir incliné le dossier de votre siège, utilisez un coussin ferme et antidérapant pour vous rehausser ou remontez le siège si votre véhicule est équipé de cette fonction.
- Si votre volant est réglable, inclinez-le vers le bas. Cela a pour effet d'orienter le coussin gonflable en direction de votre poitrine plutôt que de votre tête et de votre cou.

Réglez votre siège selon les recommandations de la NHTSA ci-dessus, tout en conservant le contrôle des pédales, du volant et la vue des commandes du tableau de bord.

⚠ AVERTISSEMENT**■ Précautions relatives aux coussins gonflables SRS**

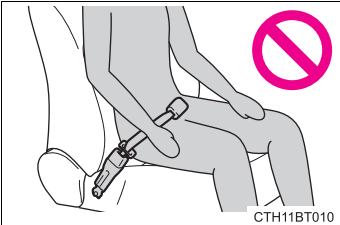
- Si vous attachez une rallonge de ceinture de sécurité aux boucles de ceinture de sécurité avant, sans l'attacher au pêne de la ceinture de sécurité, les coussins gonflables frontaux SRS déterminent que le conducteur et le passager avant ont attaché leur ceinture de sécurité, bien que la ceinture de sécurité ne soit pas attachée. Dans ce cas, les coussins gonflables frontaux SRS peuvent ne pas se déployer correctement en cas de collision, pouvant occasionner des blessures graves, voire mortelles. Veuillez à porter la ceinture de sécurité avec la rallonge de ceinture de sécurité.
- 
- Le coussin gonflable passager avant SRS se déploie également avec une force considérable, pouvant occasionner des blessures graves, voire mortelles, si le passager avant se trouve très près du coussin gonflable. Le siège du passager avant doit être éloigné le plus possible du coussin gonflable en réglant le dossier de siège de façon à ce que le passager avant soit assis bien droit dans le siège.
 - Les nourrissons et les enfants qui ne sont pas correctement assis et/ou attachés peuvent être grièvement blessés ou tués par le déploiement d'un coussin gonflable. Un nourrisson ou un enfant trop petit pour utiliser une ceinture de sécurité doit être correctement attaché au moyen d'un siège de sécurité enfant. Toyota recommande vivement d'installer tous les nourrissons et enfants sur les sièges arrière du véhicule et de prévoir pour eux des systèmes de retenue adaptés. Les sièges arrière sont plus sûrs pour les nourrissons et les enfants que le siège du passager avant.
 - N'installez jamais un siège de sécurité enfant type dos à la route sur le siège passager avant, même si le témoin indicateur "AIRBAG OFF" est allumé. En cas d'accident, la force engendrée par le déploiement rapide du coussin gonflable du passager avant peut blesser grièvement, voire tuer l'enfant si le siège de sécurité enfant type dos à la route est installé sur le siège du passager avant.

⚠ AVERTISSEMENT

■ Précautions relatives aux coussins gonflables SRS

- Ne vous asseyez pas sur le bord du siège et ne vous appuyez pas contre la planche de bord.

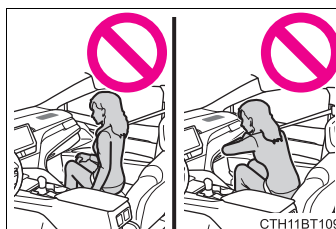

- Ne laissez pas un enfant rester debout devant le coussin gonflable passager avant SRS ou s'asseoir sur les genoux du passager avant.

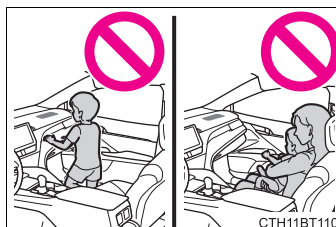

- Ne laissez pas les occupants des sièges avant voyager avec un objet sur les genoux.

- Ne vous appuyez pas contre la porte, le rail latéral de toit ou les montants avant, latéraux et arrière.

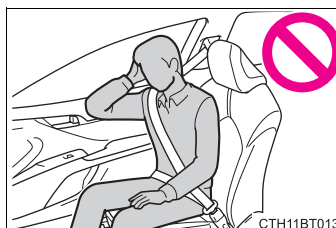

- Ne laissez personne s'agenouiller sur les sièges passagers en appui contre la porte ou sortir la tête ou les mains à l'extérieur du véhicule.

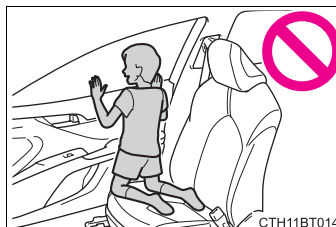

⚠ AVERTISSEMENT

■ Précautions relatives aux coussins gonflables SRS

- Ne fixez rien et ne posez rien sur des emplacements tels que la planche de bord, la garniture du volant et la partie inférieure du tableau de bord.

Ces éléments peuvent se transformer en projectiles lorsque les coussins gonflables conducteur, passager avant et genoux SRS se déploient.

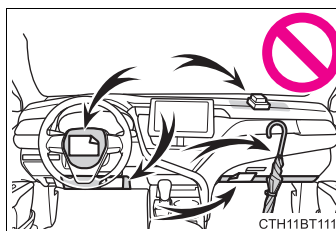

- Ne fixez rien aux portes, au pare-brise, aux vitres, aux montants avant et arrière, au rail latéral de toit et à la poignée d'assistance.

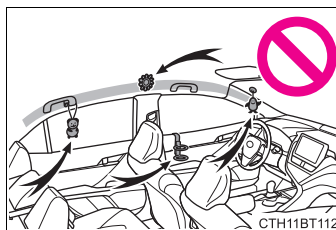

- Véhicules sans système d'accès et de démarrage mains libres: Ne fixez pas d'objets lourds, pointus ou très durs, tels que des clés et des accessoires aux clés. Ces objets risquent d'entraver le déploiement du coussin gonflable de genoux SRS ou d'être projetés vers le siège conducteur par la force de déploiement du coussin gonflable, constituant ainsi un danger potentiel.

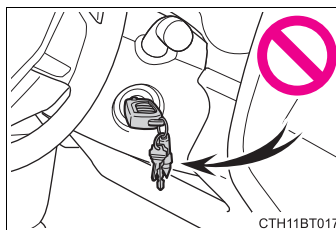

- Ne suspendez aucun cintre ou objet dur aux crochets à vêtements. Tous ces objets pourraient se transformer en projectiles et causer des blessures graves, voire mortelles en cas de déploiement des coussins gonflables rideaux SRS.

⚠ AVERTISSEMENT**■ Précautions relatives aux coussins gonflables SRS**

- Si un cache en vinyle est placé sur la zone où le coussin gonflable de genoux SRS se déploie, assurez-vous de le retirer.
- N'utilisez aucun accessoire de siège recouvrant les zones de déploiement des coussins gonflables latéraux SRS, car il risque de gêner le déploiement des coussins gonflables. De tels accessoires peuvent empêcher les coussins gonflables latéraux de fonctionner correctement, désactiver le système ou entraîner le déploiement accidentel des coussins gonflables latéraux, occasionnant des blessures graves, voire mortelles.
- Évitez de faire subir des chocs ou des pressions excessives aux parties renfermant les composants de coussins gonflables SRS ou aux portes avant.
En effet, cela pourrait entraîner un dysfonctionnement des coussins gonflables SRS.
- Ne touchez aucun composant immédiatement après le déploiement (gonflage) des coussins gonflables SRS, car ils peuvent être chauds.
- Si vous avez des difficultés à respirer après le déploiement des coussins gonflables SRS, ouvrez une porte ou une vitre pour faire entrer de l'air frais, ou bien descendez du véhicule si cela ne présente pas de danger. Essayez tout résidu dès que possible afin d'éviter d'éventuelles irritations de la peau.
- Si les parties renfermant les coussins gonflables SRS, comme les garnitures du volant et des montants avant et arrière, sont endommagées ou craquelées, faites-les remplacer par votre concessionnaire Toyota.
- Ne placez rien sur le siège du passager avant, comme un coussin par exemple. Cela a pour conséquence de répartir le poids du passager sur toute la surface du siège, ce qui empêche le capteur de détecter correctement le poids du passager. En conséquence, les coussins gonflables frontaux SRS du passager avant risquent de ne pas se déployer en cas de collision.

 AVERTISSEMENT**■ Modification et mise au rebut des composants du système de coussins gonflables SRS**

Ne mettez pas votre véhicule au rebut et ne procédez à aucune des modifications suivantes sans consulter votre concessionnaire Toyota. Les coussins gonflables SRS peuvent ne pas fonctionner correctement ou se déployer (se gonfler) accidentellement, provoquant la mort ou de graves blessures.

- Installation, dépose, démontage et réparation des coussins gonflables SRS
- Réparations, modifications, démontage ou remplacement du volant, du tableau de bord, de la planche de bord, des sièges ou de leur garnissage, des montants avant, latéraux et arrière, des rails latéraux de toit, des panneaux de porte avant, des garnitures de porte avant ou des haut-parleurs de porte avant
- Modifications du panneau de porte avant (par exemple, perçage d'un trou dans le panneau)
- Réparations ou modifications des ailes avant, du pare-chocs avant ou des flancs de l'habitacle
- Installation d'un protège-calandre (pare-buffle, pare-kangourou, etc.), de chasse-neige, de treuils ou d'un porte-bagages de toit
- Modifications du système de suspension du véhicule
- Installation d'appareils électroniques tels que les émetteurs/récepteurs radios mobiles et les lecteurs CD
- Modifications de votre véhicule pour une personne atteinte d'un handicap physique

Index	629
--------------	-----

What to do if... (Troubleshooting)	630
Alphabetical index	634

For information regarding the equipment listed below, refer to “NAVIGATION AND MULTIMEDIA SYSTEM OWNER’S MANUAL”.

- Navigation system
- Audio system
- Rear view monitor system
- Toyota parking assist monitor
- Panoramic view monitor
- Connected Services

What to do if... (Troubleshooting)

If you have a problem, check the following before contacting your Toyota dealer.

The doors cannot be locked, unlocked, opened or closed



You lose your keys

- If you lose your keys or mechanical keys, new genuine keys or mechanical keys can be made by your Toyota dealer. (→P. 144)
- If you lose your keys or electronic keys, the risk of vehicle theft increases significantly. Contact your Toyota dealer immediately. (→P. 146)



The doors cannot be locked or unlocked

- Is the key battery weak or depleted? (→P. 494)
- Vehicles with a smart key system:
Is the engine switch in IGNITION ON mode?
When locking the doors, turn the engine switch off. (→P. 213)
Vehicles with a smart key system:
Is the electronic key left inside the vehicle?
When locking the doors, make sure that you have the electronic key on your person.
- The function may not operate properly due to the condition of the radio wave. (→P. 144, 163)



The rear door cannot be opened

- Is the child-protector lock set?
The rear door cannot be opened from inside the vehicle when the lock is set. Open the rear door from outside and then unlock the child-protector lock. (→P. 152)



The trunk lid is closed with the electronic key left inside (vehicles with a smart key system)

- The function to prevent the electronic key from being left inside the trunk will operate and you can open the trunk as usual. Take the key out from the trunk. (→P. 158)

If you think something is wrong**The engine does not start
(vehicles without a smart key system)**

- Is the shift lever in P? (→P. 209)
- Is the steering wheel unlocked? (→P. 210)
- Is the battery discharged? (→P. 562)

**The engine does not start
(vehicles with a smart key system)**

- Did you press the engine switch while firmly depressing the brake pedal? (→P. 211)
- Is the shift lever in P? (→P. 214)
- Is the electronic key anywhere detectable inside the vehicle? (→P. 161)
- Is the electronic key battery weak or depleted?
In this case, the engine can be started in a temporary way. (→P. 560)
- Is the battery discharged? (→P. 562)

**The shift lever cannot be shifted from P even if you depress
the brake pedal**

- Vehicles without a smart key system:
Is the engine switch in the "ON" position?
If you cannot release the shift lever by depressing the brake pedal with the engine switch in the "ON" position. (→P. 221)
- Vehicles with a smart key system:
Is the engine switch in IGNITION ON mode?
If you cannot release the shift lever by depressing the brake pedal with the engine switch in IGNITION ON mode. (→P. 221)



The steering wheel cannot be turned after the engine is stopped (vehicles without a smart key system)

- It is locked to prevent theft of the vehicle if the key is pulled from the engine switch. (→P. 210)



The windows do not open or close by operating the power window switches

- Is the window lock switch pressed?
The power window except for the one at the driver's seat cannot be operated if the window lock switch is pressed. (→P. 179)



The engine switch is turned off automatically (vehicles with a smart key system)

- The auto power off function will be operated if the vehicle is left in ACCESSORY or IGNITION ON mode (the engine is not running) for a period of time. (→P. 214)



A warning buzzer sounds during driving

- The seat belt reminder light is flashing
Are the driver and the passenger wearing the seat belts? (→P. 531)
- The parking brake indicator is on
Is the parking brake released? (→P. 224, 225)

Depending on the situation, other types of warning buzzer may also sound. (→P. 528, 538)

**An alarm is activated and the horn sounds**

- Did anyone inside the vehicle open a door during setting the alarm?
The sensor detects it and the alarm sounds. (→P. 82)
- Vehicles without a smart key system:
To stop the alarm, turn the engine switch to the "ON" position or start the engine.
Vehicles with a smart key system:
To stop the alarm, turn the engine switch to IGNITION ON mode or start the engine.

**A warning buzzer sounds when leaving the vehicle (vehicles with a smart key system)**

- Is the message displayed on the multi-information display?
Check the message on the multi-information display. (→P. 538)

**A warning light turns on or a warning message is displayed**

- When a warning light turns on or a warning message is displayed, refer to P. 528, 538.

When a problem has occurred**If you have a flat tire**

- Stop the vehicle in a safe place and replace the flat tire with the spare tire. (→P. 543)

**The vehicle becomes stuck**

- Try the procedure for when the vehicle becomes stuck in mud, dirt, or snow. (→P. 570)

Alphabetical index

A

AAC disc*	
ABS	
(Anti-lock Brake System).....	322
Warning light.....	529
A/C	382, 387, 394
Air conditioning filter	492
Automatic air conditioning	
system.....	387, 394
Manual air conditioning	
system.....	382
Air conditioning filter	492
Air conditioning	
system.....	382, 387, 394
Air conditioning filter	492
Automatic air conditioning	
system.....	387, 394
Manual air conditioning	
system.....	382

Airbags	36
Airbag operating conditions	45
Airbag precautions for	
your child.....	39
Airbag warning light	529
Correct driving posture	28
Curtain shield airbag	
operating conditions	45
Curtain shield airbag	
precautions.....	42
Front passenger occupant	
classification system	49
General airbag precautions	39
Locations of airbags	36
Modification and disposal	
of airbags	44
Side airbag operating	
conditions	45
Side airbag precautions.....	39
Side and curtain shield	
airbags operating	
conditions	45
Side and curtain shield	
airbags precautions.....	39
SRS airbag instructions for	
Canadian owners	619
SRS airbags	36

Alarm	82
Anchor brackets	58
Antennas	
(smart key system)	161
Anti-lock Brake System	
(ABS)	322
Warning light.....	529
Approach warning	299, 315
Armrest	430
Assist grips	430
Audio *	
Audio Plus *	
Audio system *	
Automatic air	
conditioning system	387, 394
Air conditioning filter	492
Automatic High Beam	236
Automatic light control	
system	231
Automatic transmission	217
If the shift lever	
cannot be shifted from P	221
Paddle shift switches	219
S mode	218
Auxiliary boxes	413

B

Back-up lights	
Replacing light bulb	507, 512
Wattage	589
Battery	469
Battery checking	469
If the battery is discharged ...	562
Preparing and checking	
before winter	377
Replacing.....	565
Blind Spot Monitor (BSM)	330
Blind Spot Monitor	
function.....	333
Bluetooth ^{®*}	
Bottle holders	411
Brake	
Brake Hold	229
Fluid	583
Parking brake	224, 225
Warning light.....	528
Brake assist	322
Brake Hold	229
Warning light.....	529
Brake override system	195
Break-in tips	196
Brightness control	
Instrument panel light	
control	95
BSM (Blind Spot Monitor)	330
Blind Spot Monitor	
function.....	333

*: Refer to the "NAVIGATION AND MULTIMEDIA SYSTEM OWNER'S MANUAL".

C

Care

- Exterior 440
- Interior..... 444
- Seat belts..... 445
- Wheels and wheel ornaments 441

Cargo capacity..... 206

CD player*

Chains..... 378

Child-protectors..... 152

Child restraint system..... 56

- Booster seats installation..... 66
- Convertible seats installation 64
- Front passenger occupant classification system..... 49
- Infant seats definition..... 63
- Infant seats installation 58
- Installing CRS with LATCH anchors 69
- Installing CRS with seat belts..... 63
- Installing CRS with top tether strap..... 72
- LATCH anchors 69

Child safety 55

- Airbag precautions..... 39
- Battery precautions..... 470, 566
- Child restraint system 56
- How your child should wear the seat belt..... 32
- Installing child restraints 56
- Moon roof precautions..... 186
- Panoramic moon roof precautions..... 190
- Power window lock switch 179
- Power window precautions... 182
- Rear door child-protectors 152
- Removed electronic key battery precautions..... 497
- Seat belt extender precautions..... 35
- Seat belt precautions..... 34
- Seat heater precautions 402
- Trunk precautions..... 159

Cleaning 440, 444

- Exterior 440
- Interior 444
- Seat belts..... 445
- Wheels and wheel ornaments 441

Clock	98, 111
Coat hooks	431
Condenser	467
Connected Services*	
Console box	410
Consumption	
screen	134, 136
Coolant	
Capacity.....	580
Checking.....	466
Preparing and checking	
before winter.....	377
Cooling system	466
Engine overheating.....	567
Cruise control	
Dynamic radar cruise	
control.....	306
Dynamic radar cruise control	
with full-speed range	290
Cup holders	412
Curtain shield airbags	37
Customizable features	606

D

Daytime running light	
system	233
Defogger	
Outside rear view	
mirrors	383, 389, 397
Rear window	383, 389, 397
Windshield	383, 389, 397
Dimensions	574
Dinghy towing	208

Display	
Dynamic radar cruise	
control	306
Dynamic radar cruise control	
with full-speed range	290
LTA (Lane Tracing Assist)	270
Multi-information	
display	98, 111
Warning messages.....	538
Do-it-yourself maintenance	455
Door courtesy lights	
Location	405
Wattage	589
Door lock	
Doors	147
Key	149
Smart key system	147
Wireless remote control.....	148
Doors	147
Automatic door locking	
and unlocking systems.....	152
Door lock	151
Outside rear view mirrors	177
Rear door child-protector.....	152
Side doors	147
Side windows.....	179
Drive information	101
Drive-Start Control (DSC)	195
Sudden start restraint	
control	195
Driving	
Break-in tips.....	196
Correct posture.....	28
Procedures	194
Winter drive tips.....	377
DSC (Drive-Start Control)	195
Sudden start restraint	
control	195
Dynamic radar cruise	
control	306

*: Refer to the "NAVIGATION AND MULTIMEDIA SYSTEM OWNER'S MANUAL".

**Dynamic radar cruise control
with full-speed range 290**
**Dynamic Torque Control
AWD system 323**

E

Eco drive mode 375
Eco Driving Indicator 109, 126
**Eco-friendly driving
information 115**
EDR (Event data recorder) 11
**Electric Power Steering
(EPS) 323**
 Warning light 530
Electronic key 140
 Battery-saving function 163
 If the electronic key does not
operate properly 559
 Replacing the battery 494
Emergency flashers 516
Emergency, in case of
 If a warning buzzer
sounds 528
 If a warning light turns on 528
 If a warning message is
displayed 538
 If the battery is discharged 562
 If the electronic key does not
operate properly 559
 If the engine will not start 557
 If the vehicle is submerged
or water on the road is
rising 519
 If you have a flat tire 543
 If you lose your keys 144
 If you think something is
wrong 526
 If your vehicle becomes
stuck 570

If your vehicle has to be
stopped in an emergency... 517
 If your vehicle needs to be
towed 520
 If your vehicle overheats 567

Engine

ACCESSORY mode 213
 Compartment 460
 Engine switch 209, 211
 Hood 457
 How to start the
engine 209, 211
 Identification number 577
 If your vehicle has to be
stopped in an
emergency 517
 Ignition switch
(engine switch) 209, 211
 Overheating 567

Engine coolant

Capacity 580
 Checking 466
 Preparing and checking
before winter 377

Engine coolant temperature

gauge 94

Engine immobilizer system 80

Engine oil

Capacity 578
 Checking 462
 Preparing and checking
before winter 377

Engine switch 209, 211

Enhanced VSC 322

EPS

(Electric Power Steering) 323

Warning light 530

Event data recorder (EDR) 11

F

Flat tire	543
Floor mats	26
Fluid	
Automatic transaxle	581
Brake	583
Washer	472
Front interior light	406
Front passenger occupant classification system	49
Front passenger's seat belt reminder light	531
Front personal lights	407
Front seats	167
Adjustment.....	167
Cleaning.....	444
Correct driving posture	28
Head restraints	171
Seat heaters	402
Seat ventilators.....	402
Front side marker lights	
Light switch	231
Replacing light bulbs.....	504, 512
Wattage	589

Front turn signal lights

Replacing light bulbs	503, 512
Turn signal lever	223
Wattage	589

Fuel

Capacity.....	577
Fuel gauge.....	94
Fuel pump shut off system ...	527
Information.....	590
Refueling	244
Type.....	577, 590
Warning light.....	531

Fuel consumption 134**Fuel filler door** 244

Refueling	244
When the fuel filler door cannot be opened	247

Fuel pump shut off system..... 527**Fuses** 499**G****Garage door opener** 432**Gauges** 94**Glove box** 410**Grocery bag hooks**..... 415

H

Hands-free system (for cellular phone)*	
Headlights	231
Automatic High Beam	236
Light switch	231
Replacing light bulbs.....	512
Windshield wiper linked headlight illumination	235
Head restraints	171
Head-up display	128
Heated steering wheel	402
Heaters	
Automatic air conditioning system....	387, 394
Heated steering wheel	402
Manual air conditioning system	382
Outside rear view mirrors	383, 389, 397
Seat heaters	402
Seat ventilators	402
High mounted stoplight Replacing.....	512
Hill-start assist control	323
Hood	457
Hooks	
Coat hooks.....	431
Grocery bag hooks	415
Retaining hooks (floor mat)....	26
Horn	173
HUD (Head-up display)	128

I

Identification	
Engine	577
Vehicle.....	576
Ignition switch (engine switch)	209, 211
Illuminated entry system	408
Immobilizer system	80
I/M test	454
Indicators	91
Initialization	
Items to initialize	614
Inside rear view mirror	175
Instrument panel light control	95
Interior lights	406
Switch	406
Intuitive parking assist	336

J

- Jack**
 Positioning the jack..... 459
 Vehicle-equipped jack..... 544
Jack handle..... 544
Jam protection function
 Moon roof..... 184
 Panoramic moon roof 188
 Power window..... 180

K

- Keyless entry**
 Smart key system 147, 156
 Wireless remote
 control..... 148, 157
Keys..... 140
 Battery-saving function 163
 Electronic key 140
 Engine switch..... 209, 211
 If the electronic key does
 not operate properly 559
 If you lose your keys 144
 Key number plate..... 140
 Keyless entry 141
 Mechanical key 142
 Replacing the battery..... 494
 Warning buzzer..... 162
 Wireless remote control 141
Knee airbags 36

L

- Lane Tracing Assist (LTA)**..... 270
**Language (multi-
 information display)**..... 107, 124
LATCH anchors 69
Lever
 Auxiliary catch lever..... 457
 Hood lock release lever 457
 Internal trunk release lever... 158
 Shift lever..... 217
 Tilt and telescopic steering
 lock release lever 173
 Turn signal lever 223
 Wiper lever 240
License plate lights
 Light switch..... 231
 Replacing light bulbs 512
Light bulbs
 Replacing..... 502
 Wattage 589
Lights
 Automatic High Beam..... 236
 Headlight switch 231
 Illuminated entry system..... 408
 Interior lights 406
 Interior lights list..... 405
 Personal lights 407
 Replacing light bulbs 502
 Trunk light..... 158
 Turn signal lever 223
 Vanity lights 416
 Wattage 589
Load capacity 206
Lock steering column 210
LTA (Lane Tracing Assist)..... 270

*: Refer to the "NAVIGATION AND MULTIMEDIA SYSTEM OWNER'S MANUAL".

M**Maintenance**

- Do-it-yourself maintenance... 455
- General maintenance 450
- Maintenance data 574
- Maintenance requirements 447
- Resetting the message indicating maintenance is required..... 448

Malfunction indicator lamp..... 529**Manual air conditioning****system..... 382****Meter 94**

- Head-up display..... 128
- Indicators 91
- Instrument panel light control..... 95
- Meters..... 94
- Multi-information display 98, 111
- Settings..... 103, 117
- Warning lights 89
- Warning messages 538

Mirrors

- Inside rear view mirror 175
- Outside rear view mirror defoggers 383, 389, 397
- Outside rear view mirrors..... 177
- Vanity mirrors..... 416

Mobile Assistant***Moon roof..... 183**

- Door lock linked moon roof operation 184
- Jam protection function 184
- Operation..... 183

MP3 disc***Multi-information****display..... 98, 111**

- Drive information 101
- Dynamic radar cruise control 306
- Dynamic radar cruise control with full-speed range 290
- Eco-friendly driving information 115
- Language..... 107, 124
- LTA (Lane Tracing Assist) 270
- Outside temperature..... 94
- PCS (Pre-Collision System) 254
- Settings..... 103, 117
- Suggestion function 108, 125
- Warning messages..... 538

N

- Navigation system*
- Noise from under vehicle..... 8

O

- Odometer..... 94
- Oil
 - Engine oil 578
- Opener
 - Fuel filler door 246
 - Hood 457
 - Trunk..... 156
- Outside rear view mirrors 177
 - Adjusting and folding 177
 - Blind spot monitor (BSM)..... 330
 - Outside rear view mirror defoggers 383, 389, 397
- Outside temperature display 94
- Overheating..... 567

P

- Paddle shift switches 219
- Panic mode 143
- Panoramic moon roof 187
 - Jam protection function..... 188
 - Operation 187
- Panoramic view monitor*
- Parking brake..... 224, 225
 - Parking brake engaged warning buzzer/ message..... 224, 228
 - Warning light..... 529
- Parking lights..... 231
 - Light switch..... 231
 - Replacing light bulbs..... 503, 512
 - Wattage 589

Parking Support Brake

- (PKSB)..... 360
 - Indicator..... 91
 - Warning light..... 530
 - Warning messages..... 365

Parking Support Brake function (rear-crossing vehicles)..... 372

- Function..... 372

Parking Support Brake function (static objects) 368

- Function..... 368

PCS

- (Pre-Collision System)..... 254
 - Warning light..... 530

Personal lights..... 407**Phone switch *****PKSB**

- (Parking Support Brake)..... 360
 - Indicator..... 91
 - Warning light..... 530
 - Warning messages..... 365

Power outlet..... 417**Power steering**

- (Electric power steering system) 323
 - Warning light..... 530

Power windows 179

- Door lock linked window operation 181
- Jam protection function 180
- Operation..... 179
- Window lock switch 179

Pre-Collision System

- (PCS) 254
 - Warning light..... 530

Premium Audio*

*: Refer to the "NAVIGATION AND MULTIMEDIA SYSTEM OWNER'S MANUAL".

R

Radar cruise control (dynamic radar cruise control) 306

Radar cruise control (dynamic radar cruise control with full-speed range) 290

Radiator 467

Radio*

RCTA
(Rear Cross Traffic Alert) 345
 RCTA Function 347

Rear Camera Detection
Function 354

Rear Cross Traffic Alert 345
 RCTA Function 347

Rear interior light..... 406
 Wattage 589

Rear passengers' seat belt reminder light 531

Rear personal lights 407

Rear seat
 Folding down 169

Rear side marker lights
 Light switch 231
 Replacing light bulbs..... 509, 512
 Wattage 589

Rear turn signal lights

Replacing light bulbs 509, 512
 Turn signal lever 223
 Wattage 589

Rear view mirror

Inside rear view mirror 175
 Outside rear view mirrors 177

Rear view monitor system***Rear window**

defogger..... 383, 389, 397

Refueling 244

Capacity..... 577
 Fuel types 577
 Opening the fuel tank cap..... 246
 When the fuel filler door cannot be opened 247

Replacing

Electronic key battery 494
 Fuses..... 499
 Light bulbs 502
 Tires..... 543
 Wireless remote control battery 494

Reporting safety defects

for U.S. owners..... 616

Resetting the message

indicating maintenance

is required..... 448

Road Sign Assist..... 285

RSA (Road Sign Assist)..... 285

S

Safety Connect	75
Seat belt reminder light.....	531
Seat belts.....	30
Adjusting the seat belt	31
Automatic Locking	
Retractor.....	32
Child restraint system	
installation	56
Cleaning and maintaining	
the seat belt.....	445
Emergency Locking	
Retractor.....	32
How to wear your seat belt	30
How your child should wear	
the seat belt.....	32
Pregnant women, proper	
seat belt use	33
Reminder light and buzzer.....	531
Seat belt extender.....	32
Seat belt instructions for	
Canadian owners	618
Seat belt pretensioners.....	31
SRS warning light	529
Seat heaters	402
Seating capacity	206
Seat ventilators.....	402

Seats.....	167, 169
Adjustment.....	167
Adjustment precautions	168
Child seats/child restraint	
system installation.....	56
Cleaning	444
Folding down the rear	
seatbacks	169
Head restraints	171
Properly sitting in the seat	28
Seat heaters	402
Seat ventilators.....	402
Sensor	
Automatic headlight	
system.....	233
Automatic High Beam	
system.....	236
Front camera	249
Inside rear view mirror	176
Intuitive parking assist	336
LTA (Lane Tracing Assist)	270
Radar sensor	249
Service reminder	
indicators.....	88
Shift lever	217
Automatic transmission	217
If the shift lever cannot	
be shifted from P	221
S mode	218
Shift lock system.....	220
Side airbags	37
Side marker lights	231
Light switch.....	231
Replacing light	
bulbs.....	504, 509, 512
Wattage	589

*: Refer to the "NAVIGATION AND MULTIMEDIA SYSTEM OWNER'S MANUAL".

- Side mirrors** 177
 Adjusting and folding 177
 BSM (Blind Spot Monitor) 330
- Side turn signal lights**
 Replacing light bulbs..... 512
 Turn signal lever 223
- Smart key system** 161
 Antenna location 161
 Entry functions 147, 156
 Starting the engine..... 211
- Snow tires** 379
- Spare tire** 543
 Inflation pressure 584
 Storage location..... 544
- Spark plug**..... 580
- Specifications** 574
- Speedometer** 94
- Sport mode**..... 375
- Steering lock**
 Column lock release 210
- Steering wheel** 173
 Adjustment..... 173
 Audio switches*
 Heated steering wheel 402
 Meter control switches 99, 113
- Stoplights**
 Replacing light bulbs..... 512
- Storage feature** 409
- Stuck**
 If the vehicle becomes
 stuck 570
- Sunshade**
 Panoramic moon roof 187
 Roof 184
- Sun visors** 416
- Switches**
 Audio remote control
 switches*
 Automatic High Beam
 switch 236
 Brake hold switch 229
 Cruise control
 switch 290, 306
 Door lock switches..... 151
 Driving mode select
 switches 375
 Emergency flasher switch..... 516
 Engine switch 209, 211
 Fuel door opener switch 246
 Garage door opener
 switches 432
 Heated steering wheel..... 402
 Ignition switch 209, 211
 Light switch..... 231
 LTA (Lane Tracing Assist)
 switch 278
 Meter control switches.... 99, 113
 Moon roof switches..... 183
 "ODO/TRIP" switch..... 99, 113
 Outside rear view mirror
 switches 177
 Paddle shift switches 219
 Panoramic moon roof
 switches 187
 Parking brake switch 225
 Phone switch*
 Power window switches..... 179
 Rear window and outside
 rear view mirror
 defoggers
 switch 383, 389, 397

Seat heater switches 402
 "SOS" button 75
 Talk switch*
 Trunk opener switch 156
 Vehicle-to-vehicle
 distance switch 290, 306
 VSC OFF switch 324
 Window lock switch 179
 Windshield wiper and
 washer switch 240

T

Tachometer 94
Tail lights
 Light switch 231
 Replacing light bulbs 512
Talk switch*
Theft deterrent system
 Alarm 82
 Engine immobilizer system 80
Tire inflation pressure 487
 Maintenance data 584
 Warning light 532
Tire information 593
 Glossary 600
 Size 596
 Tire identification number 595
 Uniform Tire Quality
 Grading 598

Tire pressure warning system
 Initializing 475
 Installing tire pressure
 warning valve and
 transmitters 475
 Registering ID codes 477
 Warning light 532
Tires 473
 Chains 378
 Checking 473
 Glossary 600
 If you have a flat tire 543
 Inflation pressure 584
 Replacing 543
 Rotating tires 473
 Size 584
 Snow tires 379
 Spare tire 543
 Tire pressure warning
 system 474
 Uniform Tire Quality
 Grading 598
 Warning light 532
Tools 544
Top tether strap 72
Total load capacity 206
Towing
 Dinghy towing 208
 Emergency towing 520
 Trailer towing 207

*: Refer to the "NAVIGATION AND MULTIMEDIA SYSTEM OWNER'S MANUAL".

Toyota parking assist monitor*

Toyota Safety Sense 2.5+ 248

Automatic High Beam 236

Dynamic radar cruise control..... 306

Dynamic radar cruise control with full-speed range 290

LTA (Lane Tracing Assist) 270

PCS (Pre-Collision System) 254

TRAC (Traction Control) 322

Traction Control (TRAC) 322

Trailer towing 207

Transmission

Automatic transmission..... 217

Driving mode select switches..... 375

If the shift lever cannot be shifted from P 221

Paddle shift switches 219

S mode 218

Trip meters 94

Trunk..... 156

Grocery bag hooks 415

Internal trunk release lever ... 158

Smart key system 156

Trunk light 158

Trunk opener 156

Wireless remote control 157

Trunk light

Trunk light 158

Wattage 589

Turn signal lights

Replacing light bulbs..... 503, 509, 512

Turn signal lever 223

Wattage 589

U

USB charging port..... 418

USB memory*

USB port*

V

Vanity lights 416

Vanity mirrors 416

Vanity lights 416

Vehicle data recording..... 9

Vehicle identification number..... 576

Vehicle Stability Control (VSC) 322

Voice command system*

VSC (Vehicle Stability Control) 322

W

Warning buzzers

Approach warning..... 299, 315

Brake system 528

Downshifting 220

Electric power steering system..... 530

Intuitive parking assist 339

Key reminder 210

Lane departure alert function..... 275

Light reminder..... 234

Open door..... 154

Open hood..... 457

Open moon roof..... 185

Open panoramic moon roof..... 189

Open trunk..... 158

Parking brake 529

Pre-collision warning 254

RCD (Rear Camera Detection) ... 354

Seat belt reminder 531

Vehicle sway warning..... 277

Warning lights.....	89	Washing and waxing.....	440
ABS.....	529	Weight	574
Brake hold operated		Cargo capacity.....	206
indicator.....	529	Load limits	206
Brake system.....	528	Vehicle capacity weight	574
Electric power steering	530	Wheels.....	490
Intuitive parking assist OFF		Replacing.....	490
indicator.....	336	Size.....	584
LTA (Lane Tracing Assist)		Window glasses	179
indicator.....	530	Window lock switch	179
Low fuel level.....	531	Windows.....	179
Malfunction indicator lamp.....	529	Power windows.....	179
Master warning light.....	532	Rear window	
Parking brake indicator	529	defogger.....	383, 389, 397
PCS warning light	530	Washer	240
PKSB OFF indicator	530	Windshield wipers.....	240
RCD OFF indicator	354	Winter driving tips.....	377
Seat belt reminder light.....	531	Wireless charger	420
Slip indicator	531	Wireless remote control	141
SRS	529	Battery-Saving Function	163
Tire pressure.....	532	Locking/Unlocking	148, 157
Warning messages.....	538	Panic mode.....	143
Washer.....	240	Replacing the battery.....	494
Checking.....	472	WMA disc*	
Preparing and checking			
before winter.....	377		
Switch	240		

*: Refer to the "NAVIGATION AND MULTIMEDIA SYSTEM OWNER'S MANUAL".

Certifications

► Safety Connect

FCC ID: BEJTL19BNN

IC: 2703H-TL19BNN

FCC/IC WARNING:

Changes or modifications not expressly approved by the manufacture could void the user's authority to operate the equipment.

This device complies with Part 15 of the FCC Rules and Industry Canada license-exempt RSS standards. Operation is subject to the following two conditions:

- (1) this device may not cause harmful interference, and
- (2) this device must accept any interference, including interference that may cause undesired operation of the device.

This equipment complies with IC RSS-102 radiation exposure limits set forth for uncontrolled environment.

The antennas used for this transmitter must be installed to provide a separation distance of least 20cm from all persons.

FCC/IC AVERTISSEMENT:

L'utilisateur est averti que les changements ou modifications non expressément approuvés par le fabricant pourraient annuler l'autorité de l'utilisateur à utiliser l'équipement.

Ce appareil est compatible avec la Partie 15 du règlement FCC et de la Licence de l'industrie canadienne et des normes exemptes de RSS. Opération soumise aux deux conditions suivantes :

- (1) ce appareil ne doit pas causer des interférences nuisibles, et
- (2) cet appareil doit accepté toutes les interférences, y compris les interférences qui peuvent entraîner un fonctionnement indésirable de l'appareil.

Cet appareil est compatible aux limites d'exposition aux radiation IC RSS-102 définies pour un environnement non contrôlé.

Les antennes utilisées pour cet émetteur doivent être installées à une distance d'au moins 20 cm de toutes les personnes.

► Engine immobilizer system

FCC ID: MOZRI-57BTY

This device complies with part 15 of the FCC Rules. Operation is subject to the following two conditions: (1) This device may not cause harmful interference, and (2) this device must accept any interference received, including interference that may cause undesired operation.

Changes or modifications not expressly approved by the party responsible for compliance could void the user's authority to operate the equipment.

This device complies with Industry Canada's licence-exempt RSSs. Operation is subject to the following two conditions: (1) This device may not cause interference; and (2) This device must accept any interference, including interference that may cause undesired operation of the device.

Le présent appareil est conforme aux CNR d'Industrie Canada applicables aux appareils radio exempts de licence. L'exploitation est autorisée aux deux conditions suivantes : 1) l'appareil ne doit pas produire de brouillage; 2) l'utilisateur de l'appareil doit accepter tout brouillage radioélectrique subi, même si le brouillage est susceptible d'en compromettre le fonctionnement.

FCC ID: NI4TMIMB-3

This device complies with part 15 of the FCC Rules. Operation is subject to the following two conditions: (1) This device may not cause harmful interference, and (2) this device must accept any interference received, including interference that may cause undesired operation.

Changes or modifications not expressly approved by the party responsible for compliance could void the user's authority to operate the equipment.

This device complies with Industry Canada's licence-exempt RSSs. Operation is subject to the following two conditions: (1) This device may not cause interference; and (2) This device must accept any interference, including interference that may cause undesired operation of the device.

Le présent appareil est conforme aux CNR d'Industrie Canada applicables aux appareils radio exempts de licence. L'exploitation est autorisée aux deux conditions suivantes : 1) l'appareil ne doit pas produire de brouillage; 2) l'utilisateur de l'appareil doit accepter tout brouillage radioélectrique subi, même si le brouillage est susceptible d'en compromettre le fonctionnement.

► Wireless remote control (vehicles without a smart key system)

FCC ID:HYQ23ABE
FCC ID:HYQ12BFB

US

NOTE:

This device complies with part 15 of the FCC Rules. Operation is subject to the following two conditions: (1) This device may not cause harmful interference, and (2) this device must accept any interference received, including interference that may cause undesired operation.

FCC WARNING:

Changes or modifications not expressly approved by the party responsible for compliance could void the user's authority to operate the equipment.

<For 12BFB>

The FCC ID is affixed inside the equipment. You can find the ID when replacing the battery.

00

CA

NOTE:

This device contains licence-exempt transmitter(s)/receiver(s) that comply with Innovation, Science and Economic Development Canada's licence-exempt RSS(s).

Operation is subject to the following two conditions:

- (1) This device may not cause interference.
- (2) This device must accept any interference, including interference that may cause undesired operation of the device.

<For 12BFB>

The IC Certification number is affixed inside the equipment. You can find the number when replacing the battery.

02

CA

NOTE:

L'émetteur/récepteur exempt de licence contenu dans le présent appareil est conforme aux CNR d'Innovation, Sciences et Développement économique Canada applicables aux appareils radio exempts de licence.

L'exploitation est autorisée aux deux conditions suivantes :

- (1) L'appareil ne doit pas produire de brouillage;
- (2) L'appareil doit accepter tout brouillage radioélectrique subi, même si le brouillage est susceptible d'en compromettre le fonctionnement.

<Pour 12BFB>

Le numéro d'accréditation IC est apposé à l'intérieur de l'appareil. Ce numéro est visible au remplacement de la pile.

03

► Smart key system

FCC ID:HYQ23ABL
FCC ID:HYQ14FBC

US

NOTE:

This device complies with part 15 of the FCC Rules. Operation is subject to the following two conditions: (1) This device may not cause harmful interference, and (2) this device must accept any interference received, including interference that may cause undesired operation.

FCC WARNING:

Changes or modifications not expressly approved by the party responsible for compliance could void the user's authority to operate the equipment.

00

CA

NOTE:

This device contains licence-exempt transmitter(s)/receiver(s) that comply with Innovation, Science and Economic Development Canada's licence-exempt RSS(s).

Operation is subject to the following two conditions:

- (1) This device may not cause interference.
- (2) This device must accept any interference, including interference that may cause undesired operation of the device.

02

CA

NOTE:

L'émetteur/récepteur exempt de licence contenu dans le présent appareil est conforme aux CNR d'Innovation, Sciences et Développement économique Canada applicables aux appareils radio exempts de licence.

L'exploitation est autorisée aux deux conditions suivantes :

- (1) L'appareil ne doit pas produire de brouillage;
- (2) L'appareil doit accepter tout brouillage radioélectrique subi, même si le brouillage est susceptible d'en compromettre le fonctionnement.

03

FCC ID: NI4TMLF15-1 ;

This device complies with part 15 of the FCC Rules. Operation is subject to the following two conditions: (1) This device may not cause harmful interference, and (2) this device must accept any interference received, including interference that may cause undesired operation.

Changes or modifications not expressly approved by the party responsible for compliance could void the user's authority to operate the equipment.

This device complies with Industry Canada's licence-exempt RSSs. Operation is subject to the following two conditions: (1) This device may not cause interference; and (2) This device must accept any interference, including interference that may cause undesired operation of the device.

Le présent appareil est conforme aux CNR d'Industrie Canada applicables aux appareils radio exempts de licence. L'exploitation est autorisée aux deux conditions suivantes : 1) l'appareil ne doit pas produire de brouillage; 2) l'utilisateur de l'appareil doit accepter tout brouillage radioélectrique subi, même si le brouillage est susceptible d'en compromettre le fonctionnement.

► Toyota Safety Sense 2.5+

FCC ID: HYQDNMWR009

D09 US 01

NOTE:

This device complies with part 15 of the FCC Rules. Operation is subject to the following two conditions: (1) This device may not cause harmful interference, and (2) this device must accept any interference received, including interference that may cause undesired operation.

FCC WARNING:

Changes or modifications not expressly approved by the party responsible for compliance could void the user's authority to operate the equipment.

US 01

Radiofrequency radiation exposure Information:

This equipment complies with FCC radiation exposure limits set forth for an uncontrolled environment. This equipment should be installed and operated with minimum distance of 20 cm between the radiator (antenna) and your body. This transmitter must not be co-located or operating in conjunction with any other antenna or transmitter.

US 02

NOTE:

This device contains licence-exempt transmitter(s)/receiver(s) that comply with Innovation, Science and Economic Development Canada's licence-exempt RSS(s). Operation is subject to the following two conditions:

- (1) This device may not cause interference.
- (2) This device must accept any interference, including interference that may cause undesired operation of the device.

This equipment complies with ISED radiation exposure limits set forth for an uncontrolled environment and meets RSS-102 of the ISED radio frequency (RF) Exposure rules. This equipment should be installed and operated keeping the radiator at least 20 cm or more away from person's body.

CA 01

NOTE:

L'émetteur/récepteur exempt de licence contenu dans le présent appareil est conforme aux CNR d'Innovation, Sciences et Développement économique Canada applicables aux appareils radio exempts de licence. L'exploitation est autorisée aux deux conditions suivantes :

- (1) L'appareil ne doit pas produire de brouillage;
- (2) L'appareil doit accepter tout brouillage radioélectrique subi, même si le brouillage est susceptible d'en compromettre le fonctionnement.

Cet équipement est conforme aux limites d'exposition aux rayonnements énoncées pour un environnement non contrôlé et respecte les règles d'exposition aux fréquences radioélectriques (RF) CNR-102 de l'ISDE. Cet équipement doit être installé et utilisé en gardant une distance de 20 cm ou plus entre le dispositif rayonnant et le corps.

CA 02

► Blind Spot Monitor

FCC ID: HYQDNSRR004

D04 US 01

NOTE:

This device complies with part 15 of the FCC Rules. Operation is subject to the following two conditions: (1) This device may not cause harmful interference, and (2) this device must accept any interference received, including interference that may cause undesired operation.

FCC WARNING:

Changes or modifications not expressly approved by the party responsible for compliance could void the user's authority to operate the equipment.

US 01

NOTE:

This device contains licence-exempt transmitter(s)/receiver(s) that comply with Innovation, Science and Economic Development Canada's licence-exempt RSS(s). Operation is subject to the following two conditions:

- (1) This device may not cause interference.
- (2) This device must accept any interference, including interference that may cause undesired operation of the device.

This equipment complies with ISED radiation exposure limits set forth for an uncontrolled environment and meets RSS-102 of the ISED radio frequency (RF) Exposure rules. This equipment should be installed and operated keeping the radiator at least 20 cm or more away from person's body.

CA 01

NOTE:

L'émetteur/récepteur exempt de licence contenu dans le présent appareil est conforme aux CNR d'Innovation, Sciences et Développement économique Canada applicables aux appareils radio exempts de licence. L'exploitation est autorisée aux deux conditions suivantes :

- (1) L'appareil ne doit pas produire de brouillage;
- (2) L'appareil doit accepter tout brouillage radioélectrique subi, même si le brouillage est susceptible d'en compromettre le fonctionnement.

Cet équipement est conforme aux limites d'exposition aux rayonnements énoncées pour un environnement non contrôlé et respecte les règles d'exposition aux fréquences radioélectriques (RF) CNR-102 de l'ISDE. Cet équipement doit être installé et utilisé en gardant une distance de 20 cm ou plus entre le dispositif rayonnant et le corps.

CA 02

► Intuitive parking assist

Product name : Intuitive parking assist
Compliance statement : This device complies with part 18 of the FCC Rules.
Responsible Party : DENSO International America, Inc.
24777 Denso Drive, P.O. Box 5047, Southfield,
Michigan 48033-5244, U.S.A.
<https://www.denso.com/us-ca/en/about-us/company-information/diam/>

This ISM device complies with Canadian ICES-001.

Cet appareil ISM est conforme à la norme NMB-001 du Canada.

► Wireless charger

FCC ID: ACJ932AT2001

NOTE:

This device complies with part 15 and part 18 of the FCC Rules. Operation is subject to the following two conditions: (1) This device may not cause harmful interference, and (2) this device must accept any interference received, including interference that may cause undesired operation.

FCC CAUTION

Changes or modifications not expressly approved by the party responsible for compliance could void the user's authority to operate the equipment.

This equipment has been tested and found to comply with the limits for a wireless power charger, pursuant to part 18 of the FCC Rules.

This equipment generates, uses and can radiate radio frequency energy and, if not installed and used in accordance with the instructions, may cause harmful interference to radio communications.

However, there is no guarantee that interference will not occur in a particular installation.

If this equipment does cause harmful interference to radio communications, which can be determined by turning the equipment off and on, the user is encouraged to try to correct the interference by one or more of the following

measures:

- Reorient or relocate the receiving antenna.
- Increase the separation between the equipment and receiver.
- Connect the equipment into an outlet on a circuit different from that to which the receiver is connected.

This equipment complies with FCC radiation exposure limits set forth for an uncontrolled environment and meets the FCC radio frequency (RF) Exposure Guidelines. This equipment should be installed and operated keeping the radiator at least 20cm or more away from person's body.

This device contains licence-exempt transmitter(s)/receiver(s) that comply with Innovation, Science and Economic Development Canada's licence-exempt RSS(s). Operation is subject to the following two conditions:

- (1) This device may not cause interference.
- (2) This device must accept any interference, including interference that may cause undesired operation of the device.

L'émetteur/récepteur exempt de licence contenu dans le présent appareil est conforme aux CNR d'Innovation, Sciences et Développement économique Canada applicables aux appareils radio exempts de licence. L'exploitation est autorisée aux deux conditions suivantes :

- 1) L'appareil ne doit pas produire de brouillage;
- 2) L'appareil doit accepter tout brouillage radioélectrique subi, même si le brouillage est susceptible d'en compromettre le fonctionnement.

CAUTION

This equipment complies with ISED radiation exposure limits set forth for an uncontrolled environment and meets RSS-102 of the ISED radio frequency (RF) Exposure rules. This equipment should be installed and operated keeping the radiator at least 20cm or more away from person's body.

Cet équipement est conforme aux limites d'exposition aux rayonnements énoncés pour un environnement non contrôlé et respecte les règles d'exposition aux fréquences radioélectriques (RF) CNR-102 de l'ISDE. Cet équipement doit être installé et utilisé en gardant une distance de 20 cm ou plus entre le radiateur et le corps humain.

► Garage door opener

This device complies with part 15 of the FCC Rules. Operation is subject to the following two conditions: (1) This device may not cause harmful interference, and (2) this device must accept any interference received, including interference that may cause undesired operation.

changes or modifications not expressly approved by the party responsible for compliance could void the user's authority to operate the equipment.

This device complies with Industry Canada's licence-exempt RSSs. Operation is subject to the following two conditions:

- (1) This device may not cause interference; and*
- (2) This device must accept any interference, including interference that may cause undesired operation of the device.*

Le présent appareil est conforme aux CNR d'Industrie Canada applicables aux appareils radio exempts de licence. L'exploitation est autorisée aux deux conditions suivantes :

- (1) l'appareil ne doit pas produire de brouillage;*
- (2) l'utilisateur de l'appareil doit accepter tout brouillage radioélectrique subi, même si le brouillage est susceptible d'en compromettre le fonctionnement.*

► Tire pressure warning system

FCC ID: PAXPMVE000

NOTE

This device complies with part 15 of the FCC Rules. Operation is subject to the following two conditions:
 (1) This device may not cause harmful interference, and (2) this device must accept any interference received, including interference that may cause undesired operation.

FCC WARNING

Changes or modifications not expressly approved by the party responsible for compliance could void the user's authority to operate the equipment.

FCC ID: PAXPMVE100

NOTE

This device complies with part 15 of the FCC Rules. Operation is subject to the following two conditions:
(1) This device may not cause harmful interference, and (2) this device must accept any interference received, including interference that may cause undesired operation.

FCC WARNING

Changes or modifications not expressly approved by the party responsible for compliance could void the user's authority to operate the equipment.

"Perchlorate Material – special handling may apply, See www.dtsc.ca.gov/hazardouswaste/perchlorate."

NOTE

This device complies with Industry Canada licence-exempt RSS standard(s). Operation is subject to the following two conditions: (1) this device may not cause interference, and (2) this device must accept any interference, including interference that may cause undesired operation of the device.

NOTE

Le présent appareil est conforme aux CNR d'Industrie Canada applicables aux appareils radio exempts de licence. L'exploitation est autorisée aux deux conditions suivantes : (1) l'appareil ne doit pas produire de brouillage, et (2) l'utilisateur de l'appareil doit accepter tout brouillage radioélectrique subi, même si le brouillage est susceptible d'en compromettre le fonctionnement.

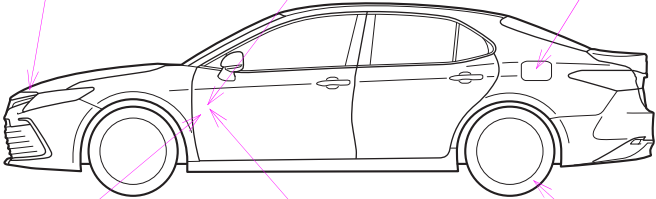
GAS STATION INFORMATION		
Auxiliary catch lever	Trunk opener	Fuel filler door
P. 457	P. 156	P. 244
		
Hood lock release lever	Fuel filler door opener	Tire inflation pressure
P. 457	P. 244	P. 584
Fuel tank capacity (Reference)	P. 577	
Fuel type	P. 577, 590	
Cold tire inflation pressure	P. 584	
Engine oil capacity (Drain and refill — reference)	P. 578	
Engine oil type	"Toyota Genuine Motor Oil" or equivalent P. 578	