

## FOREWORD

---

**Congratulations on choosing a SUBARU vehicle. This Owner's Manual has all the information necessary to keep your SUBARU in excellent condition and to properly maintain the emission control system for minimizing emission pollutants. We urge you to read this manual carefully so that you may understand your vehicle and its operation. For information not found in this Owner's Manual, such as details concerning repairs or adjustments, please contact the SUBARU dealer from whom you purchased your SUBARU or the nearest SUBARU dealer.**

**The information, specifications and illustrations found in this manual are those in effect at the time of printing. SUBARU CORPORATION reserves the right to change specifications and designs at any time without prior notice and without incurring any obligation to make the same or similar changes on vehicles previously sold. This Owner's Manual applies to all models and covers all equipment, including factory installed options. Some explanations, therefore may be for equipment not installed in your vehicle.**

**Please leave this manual in the vehicle at the time of resale. The next owner will need the information found herein.**

**SUBARU CORPORATION, TOKYO, JAPAN**

"SUBARU" and the six-star cluster design are registered trademarks of SUBARU CORPORATION.

© Copyright 2025 SUBARU CORPORATION



This manual describes the following vehicle type.

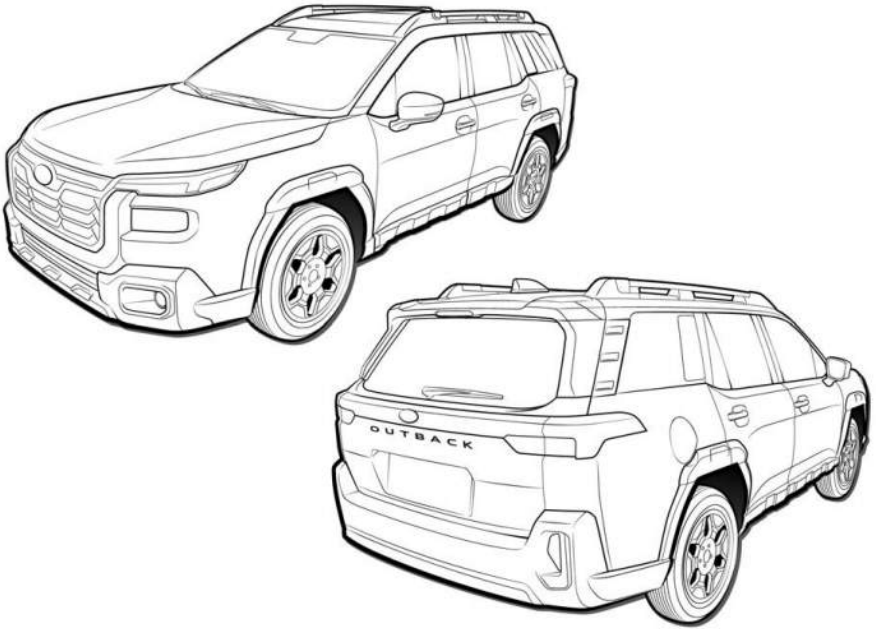





# Table of Contents

<i>Introduction</i> .....	5	
<i>Illustrated Index</i> .....	19	
<i>Seat, Seatbelt and SRS Airbags</i> .....	35	<b>1</b>
<i>Keys and Doors</i> .....	115	<b>2</b>
<i>Instruments and Controls</i> .....	153	<b>3</b>
<i>Climate Control</i> .....	253	<b>4</b>
<i>Audio</i> .....	269	<b>5</b>
<i>Interior Equipment</i> .....	273	<b>6</b>
<i>Starting and Operating</i> .....	301	<b>7</b>
<i>Driving Tips</i> .....	405	<b>8</b>
<i>In Case of Emergency</i> .....	435	<b>9</b>
<i>Appearance Care</i> .....	459	<b>10</b>
<i>Maintenance and Service</i> .....	467	<b>11</b>
<i>Specifications</i> .....	511	<b>12</b>
<i>Consumer Information and Reporting Safety Defects</i> .....	525	<b>13</b>
<i>Index</i> .....	555	<b>14</b>



## INTRODUCTION

---

<b>Warranties</b> .....	6
Warranties for U.S.A.....	6
Warranties for Canada .....	6
Warranties except for U.S.A. and Canada .....	6
<b>How to Use This Owner's Manual</b> .....	6
Using Your Owner's Manual .....	6
Safety Warnings.....	7
Safety Symbol.....	7
Abbreviation List .....	8
<b>Vehicle Symbols</b> .....	9
<b>Safety Precautions When Driving</b> .....	9
Seatbelt and SRS Airbag .....	9
Child Safety .....	10
Engine Exhaust Gas (Carbon Monoxide).....	11
Drinking and Driving .....	11
Drugs and Driving.....	11
Driving When Tired or Sleepy.....	12
Modification of Your Vehicle.....	12
Use of Cell Phones/Texting and Driving.....	12
Driving Vehicles Equipped with Navigation System.....	12
Driving with Pets .....	13
Tire Pressures .....	13
On-Road and Off-Road Driving .....	13
Attaching Accessories .....	13
Vehicle Operation.....	14
<b>General Information</b> .....	15
California Perchlorate Advisory.....	15
Noise from under the Vehicle .....	15
Vehicle Data Recording .....	15
Event Data Recorder .....	16

## WARRANTIES

---

### WARRANTIES FOR U.S.A.

SUBARU vehicles distributed by Subaru of America, Inc. and sold at retail by an authorized SUBARU dealer in the United States come with the following warranties:

- **SUBARU Limited Warranties**
- **Federal Emission Control Systems Warranties**
- **California Emissions Control Systems Warranties**

All warranty information, including applicability, details of coverage and exclusions, is in the "Warranty and Maintenance Booklet". Read these warranties carefully.

### WARRANTIES FOR CANADA

SUBARU vehicles distributed by Subaru Canada, Inc. and sold at retail by an authorized SUBARU dealer in Canada come with the following warranties:

- **SUBARU Limited Warranty**
- **Emission Control System Warranty**

All warranty information, including applicability, details of coverage and exclusions, is in the "Warranty and Service Booklet". Read these warranties carefully.

### WARRANTIES EXCEPT FOR U.S.A. AND CANADA

All warranty information, including details of coverage and exclusions, is in the "Warranty and Maintenance Booklet". Read these warranties carefully.

## HOW TO USE THIS OWNER'S MANUAL

---

### USING YOUR OWNER'S MANUAL

Before you operate your vehicle, carefully read this manual. To protect yourself and extend the service life of your vehicle, follow the instructions in this manual. Failure to observe these instructions may result in serious injury and damage to your vehicle.

Each chapter in this manual begins with a brief table of contents. This will usually allow you to tell at a glance whether or not a chapter contains the information you want.

#### Introduction

This chapter informs you general information before driving.

#### Illustrated Index

This chapter informs you about the vehicle layout with illustrations.

#### Chapter 1: Seat, Seatbelt and SRS Airbags

This chapter informs you how to use the seat and seatbelt and contains precautions for the SRS airbags.

#### Chapter 2: Keys and Doors

This chapter informs you how to operate the keys, locks and windows.

#### Chapter 3: Instruments and Controls

This chapter informs you about the operation of instrument panel indicators and how to use the instruments and other switches.

#### Chapter 4: Climate Control

This chapter informs you how to operate the climate control.

#### Chapter 5: Audio

This chapter informs you about your audio system.

**Chapter 6: Interior Equipment**

This chapter informs you how to operate interior equipment.

**Chapter 7: Starting and Operating**

This chapter informs you how to start and operate your SUBARU.

**Chapter 8: Driving Tips**

This chapter informs you how to drive your SUBARU in various conditions and explains some safety tips on driving.

**Chapter 9: In Case of Emergency**

This chapter informs you what to do if you have a problem, such as a flat tire or engine overheating.

**Chapter 10: Appearance Care**

This chapter informs you how to keep your SUBARU looking good.

**Chapter 11: Maintenance and Service**

This chapter informs you when you need to take your SUBARU to the dealer for scheduled maintenance and informs you how to keep your SUBARU running properly.

**Chapter 12: Specifications**

This chapter informs you about the dimensions and capacities of your SUBARU.

**Chapter 13: Consumer Information and Reporting Safety Defects**

This chapter informs you about Tire information, Uniform tire quality grading standards and Reporting safety defects.

**Chapter 14: Index**

This is an alphabetical listing of all that's in this manual. You can use it to quickly find something you want to read.

**For EyeSight system:**

For details about the EyeSight system, refer to the Owner's Manual supplement for the EyeSight system.

Depending on specifications, the vehicle shown in the illustrations may differ from your vehicle in terms of equipment.

**SAFETY WARNINGS**

You will find a number of WARNINGS, CAUTIONS and NOTES in this manual.

These safety warnings alert you to potential hazards that could result in injury to you or others.

Please read these safety warnings as well as all other portions of this manual carefully in order to gain a better understanding of how to use your SUBARU vehicle safely.

**WARNING**

A WARNING indicates a situation in which serious injury or death could result if the warning is ignored.

**CAUTION**

A CAUTION indicates a situation in which injury or damage to your vehicle, or both, could result if the caution is ignored.

**NOTE**

A NOTE gives information or suggestions how to make better use of your vehicle.

**SAFETY SYMBOL**

You will find a circle with a slash through it in this manual. This symbol means "Do not", "Do not do this", or "Do not let this happen", depending upon the context.

## ABBREVIATION LIST

You may find several abbreviations in this manual. The meanings of the abbreviations are shown in the following list.

Abbreviation	Meaning
ABS	Anti-lock brake system
A/C	Air conditioner
AKI	Anti knock index
ALR	Automatic locking retractor
ALR/ELR	Automatic locking retractor/ Emergency locking retractor
AVH	Auto Vehicle Hold
AWD	All-wheel drive
BSW	Blind Spot Warning
CVT	Continuously variable transmission
DRL	Daytime running light
EBD	Electronic brake force distribution
ELR	Emergency locking retractor
GAW	Gross axle weight
GAWR	Gross axle weight rating
GPS	Global positioning system
GVW	Gross vehicle weight
GVWR	Gross vehicle weight rating
LATCH	Lower anchors and tethers for children
LCA	Lane Change Assist
LED	Light emitting diode
MIL	Malfunction indicator light
MMT	Methylcyclopentadienyl manganese tricarbonyl
OBD	On-board diagnostics
RAB	Reverse Automatic Braking system
RCTW	Rear Cross Traffic Warning
RON	Research octane number
SRH	Steering Responsive Headlight









Abbreviation	Meaning
SRS	Supplemental restraint system
TIN	Tire identification number
TPMS	Tire pressure monitoring system

## VEHICLE SYMBOLS

There are some of the symbols you may see on your vehicle.

For warning and indicator lights, refer to “Table of Warning and Indicator Lights”

☞ P32.

Mark	Name
	WARNING
	CAUTION
	Read these instructions carefully
	Wear eye protection
	Battery fluid contains sulfuric acid
	Keep children away
	Keep flames away
	Prevent explosions

## SAFETY PRECAUTIONS WHEN DRIVING

### SEATBELT AND SRS AIRBAG

#### WARNING

- All persons in the vehicle must fasten their seatbelts BEFORE the vehicle starts to move. Otherwise, the possibility of serious injury becomes greater in the event of a sudden stop or accident.
- To obtain maximum protection in the event of an accident, the driver and all passengers must always wear seatbelts when in the vehicle. The SRS (Supplemental Restraint System) airbag does not replace the safety benefits of wearing a seatbelt. Used in combination with the seatbelts, the SRS airbag offers vehicle occupants the best possible protection in the event of a serious accident.

Not wearing a seatbelt increases the chance of severe injury or death in a crash even when the vehicle has the SRS airbag.

- The SRS airbags deploy with considerable speed and force. Occupants who are not seated in the proper upright position when the SRS airbag deploys could suffer very serious injuries. Because the SRS airbag needs enough space for deployment, the driver should always sit upright and well back in the seat as far from the steering wheel as practical while still maintaining full vehicle control and the front passenger should move the seat as far back as possible and sit upright and well back in the seat.

For instructions and precautions, carefully read the following sections.

- For the seatbelt system, refer to “Seatbelts” ⒸP55.
- For the SRS airbag system, refer to “SRS Airbag (Supplemental Restraint System Airbag)” ⒸP83.

## CHILD SAFETY



### WARNING

- Never hold a child on your lap or in your arms while the vehicle is moving. The passenger cannot protect the child from injury in a collision, because the child will be caught between the passenger and objects inside the vehicle.
- NEVER INSTALL A REARWARD FACING CHILD RESTRAINT SYSTEM ON THE FRONT PASSENGER'S SEAT. DOING SO RISKS SERIOUS INJURY OR DEATH TO THE CHILD BY PLACING THE CHILD'S HEAD TOO CLOSE TO THE SRS AIRBAG.
- SUBARU strongly recommends that ALL infants and children (including those in child restraint systems) sit in the REAR seat properly restrained in a child restraint system or in a seatbelt, whichever is appropriate for the child's age, height and weight. The SRS airbag deploys with considerable speed and force and can injure or even kill children, especially if they are not restrained or improperly restrained. Because children are lighter and weaker than adults, their risk of being injured from deployment is greater. According to accident statistics, children are safer when properly restrained in the rear seating positions than in the front seating positions. For instructions and precautions concerning child restraint systems, refer to “Child Restraint Systems” ⒸP67.

- Always turn the child safety locks to the “LOCK” position when children sit in the rear seat. Serious injury could result if a child accidentally opens the door and falls out. Refer to “Child Safety Locks” ⒸP139.
- Always lock the passengers' windows using the lock switch when children are riding in the vehicle. Failure to follow this procedure could result in injury to a child operating the power window. Refer to “Windows” ⒸP139.
- Never leave unattended children, adults or animals in the vehicle. They could accidentally injure themselves or others through inadvertent operation of the vehicle. Also, on hot or sunny days, temperature in a closed vehicle could quickly become high enough to cause severe or possibly fatal injuries to them.
- When leaving the vehicle, close all windows and lock all doors.
- In models with power rear gate, when it operates, the rear gate moves with remarkable force. It is possible to be injured if anyone is caught in or hit by the rear gate so be sure to obey the following cautions.
  - Check that there are no children around the rear gate before operating the power rear gate.
  - Do not allow children to operate the power rear gate.

For instructions and precautions, carefully read the following sections.

- For the seatbelt system, refer to “Seatbelts” ⒸP55.
- For the child restraint system, refer to “Child Restraint Systems” ⒸP67.
- For the SRS airbag system, refer to “SRS Airbag (Supplemental Restraint



System Airbag)” ⓄP83.

- For the power rear gate, refer to “Power Rear Gate” ⓄP142.

## ENGINE EXHAUST GAS (Carbon Monoxide)

### WARNING

- Never inhale engine exhaust gas. Engine exhaust gas contains carbon monoxide, a colorless and odorless gas which is dangerous, or even lethal, if inhaled.
- Always properly maintain the engine exhaust system to prevent engine exhaust gas from entering the vehicle.
- Never run the engine in a closed space, such as a garage, except for the brief time needed to drive the vehicle in or out of it.
- Avoid remaining in a parked vehicle for a long time while the engine is running. If that is unavoidable, then use the ventilation fan to force fresh air into the vehicle.
- Always keep the front ventilator inlet grille free from snow, leaves or other obstructions to ensure that the ventilation system always works properly.
- If at any time you suspect that exhaust fumes are entering the vehicle, have the problem checked and corrected as soon as possible. If you must drive under these conditions, drive only with all windows fully open.
- Keep the rear gate closed while driving to prevent exhaust gas from entering the vehicle.

## DRINKING AND DRIVING

### WARNING

Drinking and then driving is very dangerous. Alcohol in the bloodstream delays your reaction and impairs your perception, judgment and attentiveness. If you drive after drinking – even if you drink just a little – it will increase the risk of being involved in a serious or fatal accident, injuring or killing yourself, your passengers and others. In addition, if you are injured in the accident, alcohol may increase the severity of that injury.

Please don't drink and drive.

Drunken driving is one of the most frequent causes of accidents. Since alcohol affects all people differently, you may have consumed too much alcohol to drive safely even if the level of alcohol in your blood is below the legal limit. The safest thing you can do is never drink and drive. However if you have no choice but to drive, stop drinking and sober up completely before getting behind the wheel.

## DRUGS AND DRIVING

### WARNING

There are some drugs (over the counter and prescription) that can delay your reaction time and impair your perception, judgment and attentiveness. If you drive after taking them, it may increase your, your passengers' and other persons' risk of being involved in a serious or fatal accident.

If you are taking any drugs, check with your doctor or pharmacist or read the literature that accompanies the medication to determine if the drug you are taking can impair your driving ability. Do not drive after taking any medications that can make you drowsy or otherwise affect

your ability to safely operate a motor vehicle. If you have a medical condition that requires you to take drugs, please consult with your doctor.

Never drive if you are under the influence of any illicit mind-altering drugs. For your own health and well-being, we urge you not to take illegal drugs in the first place and to seek treatment if you are addicted to those drugs.

## DRIVING WHEN TIRED OR SLEEPY

### WARNING

When you are tired or sleepy, your reaction will be delayed and your perception, judgment and attentiveness will be impaired. If you drive when tired or sleepy, your, your passengers' and other persons' chances of being involved in a serious accident may increase.

Please do not continue to drive but instead find a safe place to rest if you are tired or sleepy. On long trips, you should make periodic rest stops to refresh yourself before continuing on your journey. When possible, you should share the driving with others.

## MODIFICATION OF YOUR VEHICLE

### WARNING

Do not remove the genuine SUBARU navigation and/or audio system. Doing so could cause the following functions to be inoperable.

- Instrument cluster display
- Rear view image and help lines

- Vehicle settings
- Clock

### CAUTION

Your vehicle should not be modified other than with genuine SUBARU parts and accessories. Other types of modifications could affect its performance, safety or durability, and may even violate governmental regulations. In addition, damage or performance problems resulting from modification may not be covered under warranties.

## USE OF CELL PHONES/TEXTING AND DRIVING

### CAUTION

Do not talk on a cell phone or text while driving; it may distract your attention from driving and lead to an accident. If you use a cell phone to talk or text, first pull off the road and park in a safe place. In some States/Provinces, it may be lawful to talk on a phone while driving, but only if the phone is hands-free.

## DRIVING VEHICLES EQUIPPED WITH NAVIGATION SYSTEM

### WARNING

Do not allow the monitor to distract your attention from driving. Also, do not operate the controls of the navigation system while driving. The loss of attention to driving could lead to an accident. If you wish to operate the controls of the navigation system, first take the vehicle off the road and stop it in a safe location.

## DRIVING WITH PETS

Unrestrained pets can interfere with your driving and distract your attention from driving. In a collision or sudden stop, unrestrained pets or cages can be thrown around inside the vehicle and hurt you or your passengers. Besides, the pets can be hurt under these situations. It is also for their own safety that pets should be properly restrained in your vehicle. Restrain a pet with a special traveling harness which can be secured to the rear seat with a seatbelt or use a pet carrier which can be secured to the rear seat by routing a seatbelt through the carrier's handle. Never restrain pets or pet carriers in the front passenger's seat. For further information, consult your veterinarian, local animal protection society or pet shop.

## TIRE PRESSURES

Check and, if necessary, adjust the pressure of each tire and the spare (if equipped) at least once a month and before any long journey.

Check the tire pressure when the tires are cold. Use a pressure gauge to adjust the tire pressures to the values shown on the tire inflation pressure label. For detailed information, refer to "Tires and Wheels" P486.

### WARNING

Driving at high speeds with excessively low tire pressures can cause the tires to deform severely and to rapidly become hot. A sharp increase in temperature could cause tread separation, and destruction of the tires. The resulting loss of vehicle control could lead to an accident.

## ON-ROAD AND OFF-ROAD DRIVING

This vehicle is classified as a utility vehicle. Utility vehicles have a significantly higher rollover rate than other types of vehicles. Your vehicle has a higher ground clearance and higher center of gravity, making it more likely to roll over than ordinary passenger cars. It also handles and maneuvers differently from other passenger cars. For this reason, please read carefully the following section and follow the instructions and precautions in order to prevent serious injury or death due to loss of control, rollover and other accidents. Refer to "On-Road and Off-Road Driving" P411.

## ATTACHING ACCESSORIES

### WARNING

- Do not attach any accessories, labels or stickers (other than properly placed inspection stickers) to the windshield. Such items may obstruct your view.
- If it is necessary to attach an accessory (such as an electronic toll collection (ETC) device or security pass) to the windshield, consult your SUBARU dealer for details on the proper location.
- Do not connect any unauthorized accessories or devices to the data link connector (OBDII port). This connector should be used only with compatible diagnostic devices for inspection and maintenance by an authorized service technician using authorized service tools. Connecting unauthorized devices, such as a driver-behavior tracking device, may adversely affect vehicle systems, including safety systems, or allow others to access information stored in your vehicle. The use of unauthorized devices may also cause unexpected mal-

functions, such as a drained battery, or may damage vehicle systems. The manufacturer's warranty will not cover any part that malfunctions, fails, or is damaged due to the use of an unauthorized device with the data link connector.

## VEHICLE OPERATION

### Before leaving vehicle unattended



#### CAUTION

Always lock your vehicle and carry your access key fob with you.

There is a risk for vehicle theft or unauthorized persons tampering with the vehicle or installing malicious electronic devices.

### Key number plate storage

#### NOTE

- *The key number is required when repairing the vehicle or making a spare access key fob. If you lose the plate with these numbers stamped on it, you will not be able to make a spare access key fob. To prevent it from being stolen, do not leave it in the vehicle and store it in a safe place. Refer to "Keyless Access with Push-Button Start System" Ⓞ P117.*
- *If you lose your key, we recommend that you delete the lost access key fob registration to prevent theft. Only a SUBARU dealer can delete key fob registration. We recommend that you consult your SUBARU dealer. Refer to "Key Replacement" Ⓞ P129.*

## Vehicle modifications



#### WARNING

- Do not install parts, make custom adjustments or perform wiring or other operations that are not suitable for the vehicle.
- Do not connect accessories to the vehicle wiring or connectors unless they are genuine SUBARU products. SUBARU's vehicle warranty does not cover any malfunctions resulting from connecting the vehicle to products other than those specified.
- It may be illegal to modify the vehicle by installing parts other than genuine SUBARU parts. Consult your SUBARU dealer about the kinds of parts (tires, wheels, mufflers, etc.) you can legally install on your vehicle.

## Device installation



#### WARNING

Connecting devices that are not intended to be used in the vehicle or in a particular connector can adversely affect the vehicle system or cause the auxiliary battery to discharge. It may also cause personal information leaks or unauthorized remote operation of vehicle features, resulting in unforeseen complications. Any complication caused by connecting a device other than one intended to be used in the vehicle is not covered by the manufacturer's warranty. SUBARU also bears no responsibility for any such complication.

- The vehicle trouble diagnosis connector should only be used to connect the vehicle data link connector (OBDII) for inspection and maintenance purposes.

- Use the USB port only for data communication with your vehicle and for device charging.

## Suspicious device handling



### WARNING

If you find an unrecognized device on your vehicle, consult your SUBARU dealer immediately.

Any problem or safety risk due to the connection of an unauthorized device is not covered by the manufacturer's warranty. SUBARU also bears no responsibility for any such cause.

## Deleting personal information from vehicle



### CAUTION

When transferring ownership of your vehicle, delete the personal information registered in the vehicle by performing a Factory Data Reset. For details about the Factory Data Reset, refer to the Owner's Manual supplement for the audio and navigation system.

Note that certain personal information inputted in the Head Unit and the phone number of any paired device will remain in vehicle data logs even after the Factory Data Reset. These data logs are strictly for quality assurance purposes and not viewable by any subsequent purchaser. To have those logs deleted permanently from the vehicle, please contact your SUBARU dealer.

## GENERAL INFORMATION

### CALIFORNIA PERCHLORATE ADVISORY

Certain vehicle components, such as airbag modules, seatbelt pretensioners and keyless entry transmitter batteries, may contain perchlorate material. Special handling may apply for service or vehicle end of life disposal. See [www.dtsc.ca.gov/hazardouswaste/perchlorate](http://www.dtsc.ca.gov/hazardouswaste/perchlorate).

### NOISE FROM UNDER THE VEHICLE

#### NOTE

*You may hear a noise from under the vehicle approximately 5 to 10 hours after the ignition switch is turned to the "OFF" position. However, this does not indicate a malfunction. This noise is caused by the operation of the fuel evaporation leakage checking system and the operation is normal. The noise will stop after approximately 15 minutes.*

### VEHICLE DATA RECORDING

The vehicle is equipped with sophisticated computers that will record certain data, such as:

- Vehicle speed
- Engine speed
- Engine control information
- Shift state information
- Driving information, etc.

### Data usage

SUBARU may use the data recorded in this computer to diagnose malfunctions, conduct research and development, and improve quality.

SUBARU will not disclose the recorded data to a third party except:

- With the consent of the vehicle owner or with the consent of the lessee if the vehicle is leased
  - In response to an official request by the police, a court of law or a government agency
  - For use by SUBARU in a lawsuit
  - For research purposes where the data is not tied to a specific vehicle or vehicle owner
- To read data recorded by an EDR, special equipment is required, and access to the vehicle or the EDR is needed. In addition to the vehicle manufacturer, other parties, such as law enforcement, that have the special equipment, can read the information if they have access to the vehicle or the EDR.

## EVENT DATA RECORDER

This vehicle is equipped with an event data recorder (EDR). The main purpose of an EDR is to record, in certain crash or near crash-like situations, such as an air bag deployment or hitting a road obstacle, data that will assist in understanding how a vehicle's systems performed. The EDR is designed to record data related to vehicle dynamics and safety systems for a short period of time, typically 30 seconds or less. The EDR in this vehicle is designed to record such data as:

- How various systems in your vehicle were operating;
- Whether or not the driver and passenger safety belts were buckled/ fastened;
- How far (if at all) the driver was depressing the accelerator and/or brake pedal; and,
- How fast the vehicle was traveling.

These data can help provide a better understanding of the circumstances in which crashes and injuries occur. NOTE: EDR data are recorded by your vehicle only if a non-trivial crash situation occurs; no data are recorded by the EDR under normal driving conditions and no personal data (e.g., name, gender, age, and crash location) are recorded. However, other parties, such as law enforcement, could combine the EDR data with the type of personally identifying data routinely acquired during a crash investigation.

---

---

---

---

---

---

---

---

---

---

---

---

---

---

---

---

---

---

---

---

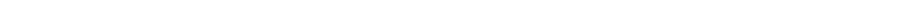
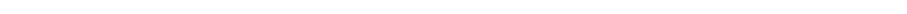
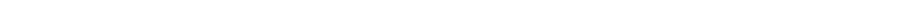
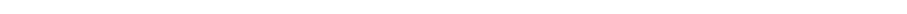
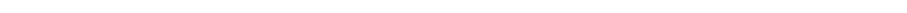
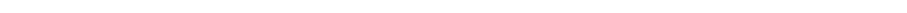
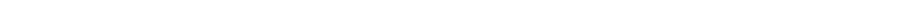



## ILLUSTRATED INDEX

---

Exterior .....	20
Interior .....	22
Cargo Area .....	25
Instrument Panel.....	26
Steering Wheel.....	27
Light Control and Wiper Control Levers/Switches .....	28
Instrument Cluster.....	29
U.S.-Spec. Models.....	29
Canada-Spec. Models.....	30
Table of Warning and Indicator Lights.....	32

## EXTERIOR

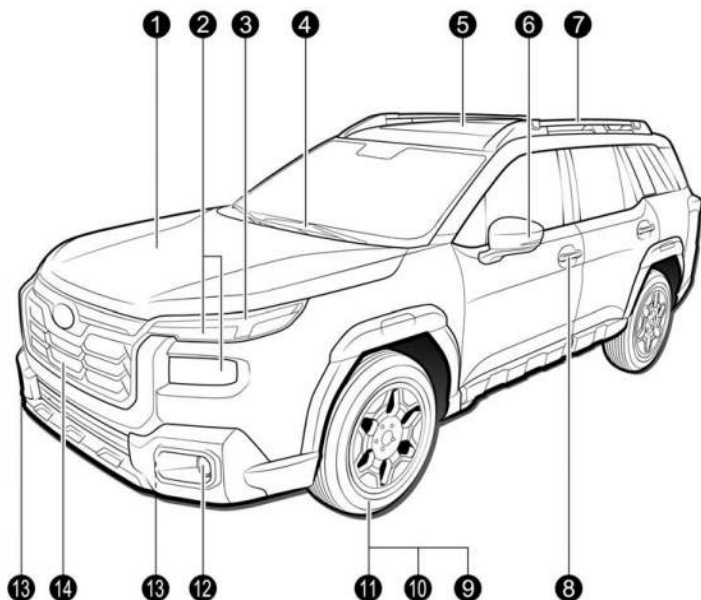

- ① Engine hood (page 473)
- ② Headlights (page 212, 504)
- ③ Turn signal lights (page 221, 504)
- ④ Windshield wipers (page 223, 496)
- ⑤ Moonroof (page 149)
- ⑥ Outside mirrors (page 245)
- ⑦ Roof rails (page 420)
- ⑧ Door locks (page 132)
- ⑨ Tire pressure (page 489)
- ⑩ Flat tires (page 439)
- ⑪ Tire chains (page 417)
- ⑫ Fog lights (page 220, 504)
- ⑬ Tie-down hooks (page 447)
- ⑭ Front camera (page 353)

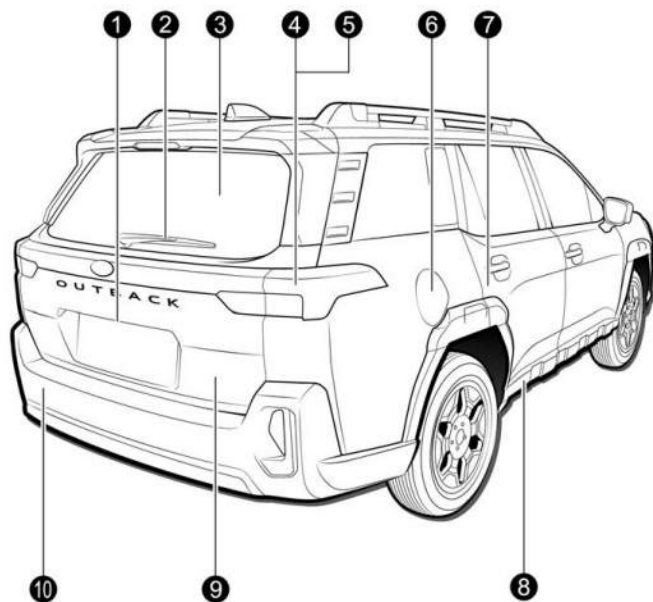

- ❶ Rear view camera (page 362)
- ❷ Rear wiper (page 225)
- ❸ Rear window defogger (page 226)
- ❹ Lights (page 212, 504)
- ❺ Turn signal lights (page 221, 504)

- ❻ Fuel filler lid and cap (page 305)
- ❼ Child safety locks (page 139)
- ❽ Tie-down holes (page 447)
- ❾ Rear gate (page 142)
- ❿ Towing hook (page 447)

## INTERIOR

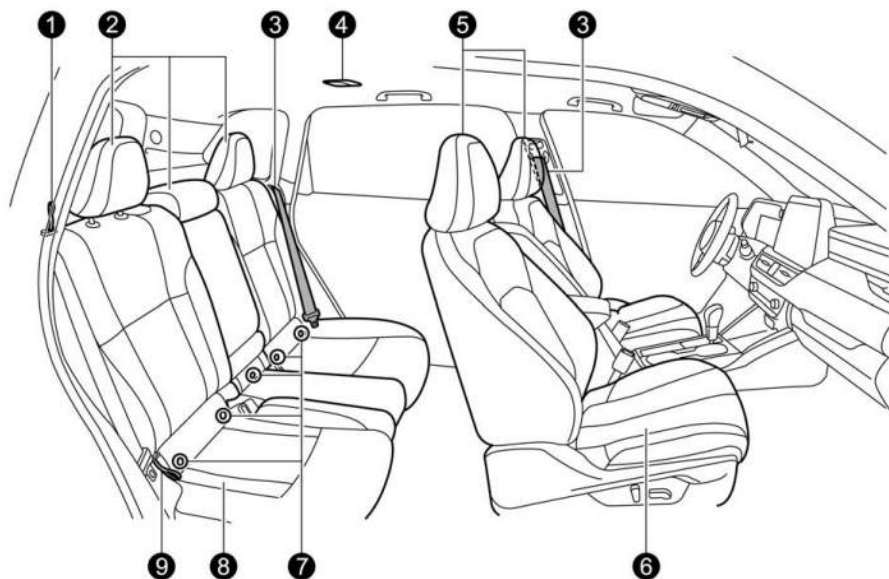

- ❶ Lock release straps (page 47)
- ❷ Head Restraint Adjustment for rear seat (page 50)
- ❸ Seatbelts (page 55)
- ❹ Dome light (page 274)
- ❺ Head Restraint Adjustment for front seat (page 45)
- ❻ Front seats (page 37)
- ❼ Lower anchors for child restraint system (page 78)
- ❽ Rear seats (page 47)
- ❾ Reclining the seatback (page 50)

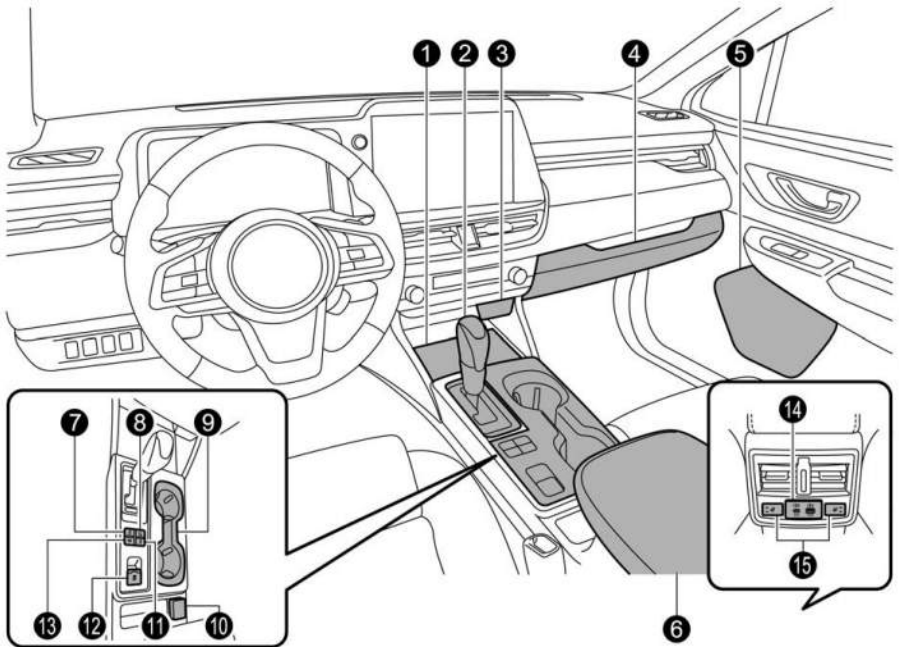

- ❶ Wireless charger (page 284)
- ❷ Select lever (page 321)
- ❸ USB power supply (page 283)
- ❹ Glove box (page 278)
- ❺ Bottle holder (page 281)
- ❻ Center console (page 279)
- ❼ Auto Start Stop OFF switch (page 348)
- ❽ View monitor switch (page 353)
- ❾ Cup holder (page 280)
- ❿ Accessory power outlets (page 282)
- ⓫ Vehicle Dynamics Control OFF switch (page 332)
- ⓬ Electronic parking brake switch (page 339)
- ⓭ Auto Vehicle Hold switch (page 343)
- ⓮ Console USB power supply (page 283)
- ⓯ Rear seat heater switches (page 54)

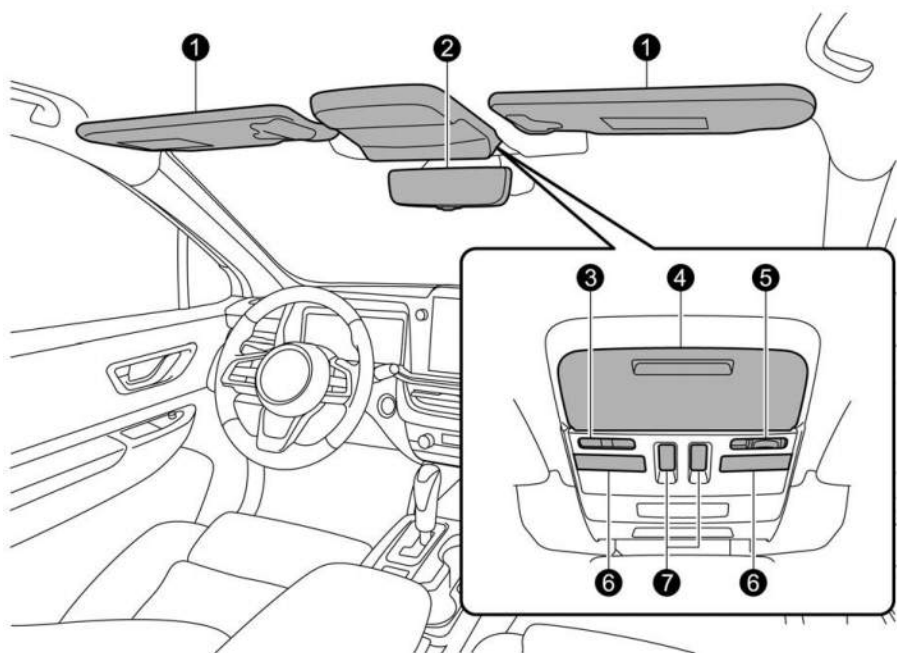

- ❶ Sun visors (page 276)
- ❷ Inside mirror (page 228)
- ❸ Buttons for MySubaru Connected Services
- ❹ Overhead console (page 278)
- ❺ Door interlock switch (page 274)
- ❻ Map light (page 274)
- ❼ Moonroof switch (page 150)

**NOTE**

*For models with MySubaru Connected Services: Refer to the Owner's Manual supplement for MySubaru Connected Services.*

## CARGO AREA

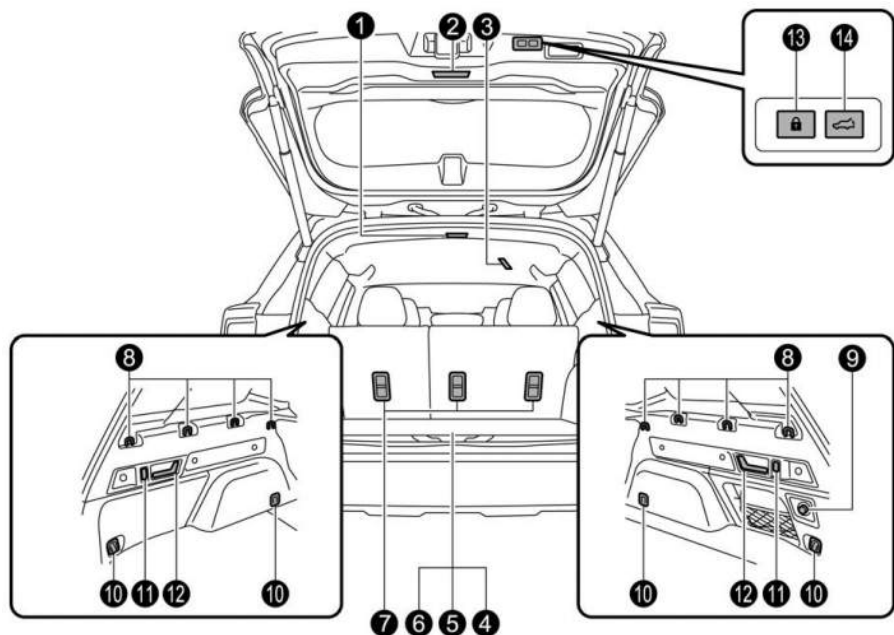

- ❶ Cargo area light (page 275)
- ❷ Rear gate light (page 275)
- ❸ Rear center seatbelt (page 60)
- ❹ Temporary spare tire (page 436)
- ❺ Maintenance tools (page 438)
- ❻ Under-floor storage compartment (page 298)
- ❼ Tether anchors (page 82)
- ❽ Multi-use cargo cover hook holders (page 294)
- ❾ Accessory power outlets (page 282)
- ❿ Cargo tie-down hooks (page 297)
- ⓫ Shopping bag hooks (page 294)
- ⓬ Release lever for rear seatback (page 47)
- ⓭ Power rear gate lock button (page 145)
- ⓮ Power rear gate button (page 145)

## INSTRUMENT PANEL

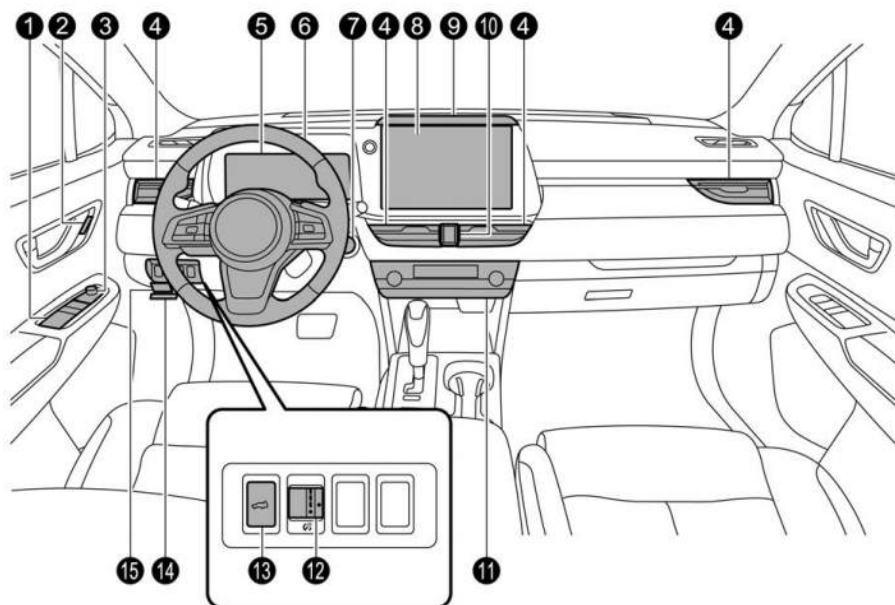

- ❶ Power window switches (page 139)
- ❷ Driver's seat memory (page 41)
- ❸ Remote control mirror switch (page 246)
- ❹ Ventilators (page 254)
- ❺ Instrument cluster (page 185)
- ❻ Tilt/Telescopic steering (page 249)
- ❼ Push-button ignition switch (page 310)
- ❽ Center information display (page 197)/ Audio\*1/Navigation system\*1
- ❾ Camera for Distraction Mitigation System (page 389)
- ❿ Hazard warning flasher switch (page 158)
- ⓫ Climate control panel (page 255)
- ⓬ Illumination brightness control dial (page 161)
- ⓭ Power rear gate button (page 144)
- ⓮ Hood release knob (page 473)
- ⓯ Fuse box (page 502)

\*1: For details about how to use the audio and navigation system (if equipped), refer to the separate navigation/audio Owner's Manual.



## STEERING WHEEL

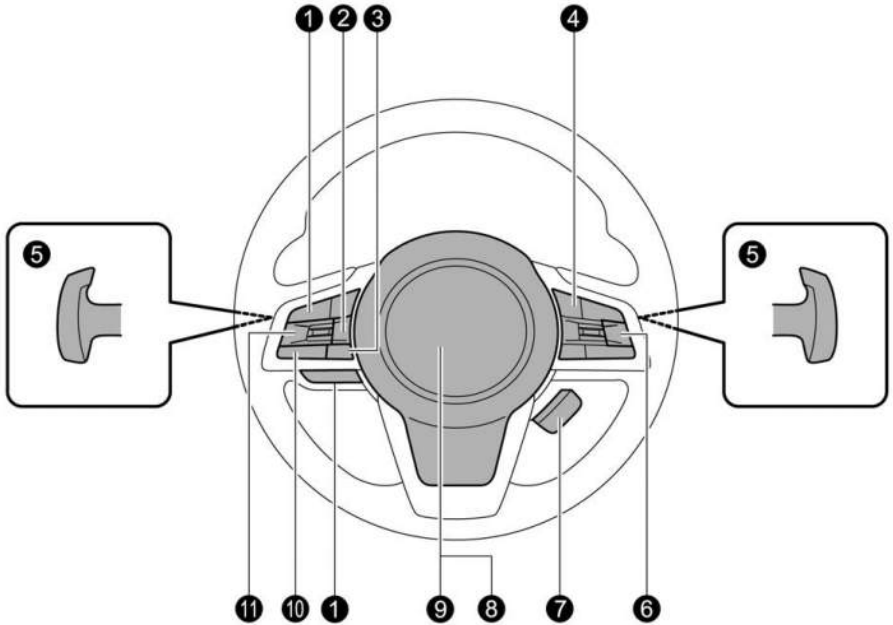

- ① Audio control switch\*1
- ② TRIP RESET switch (page 158)
- ③ Talk switch for voice assistance system\*1
- ④ Cruise control switches\*2
- ⑤ Shift paddles (page 325)
- ⑥ X-MODE switch (page 335)
- ⑦ Heated Steering Wheel switch (page 249)
- ⑧ SRS airbag (page 83)

- ⑨ Horn (page 250)
- ⑩ Hands-free phone switch\*1
- ⑪ Control switches for instrument cluster display (page 187)

\*1: For details about how to use the switches, refer to the separate navigation/audio Owner's Manual.

\*2: For details about how to use the switches, refer to the Owner's Manual supplement for the EyeSight system.

## LIGHT CONTROL AND WIPER CONTROL LEVERS/ SWITCHES

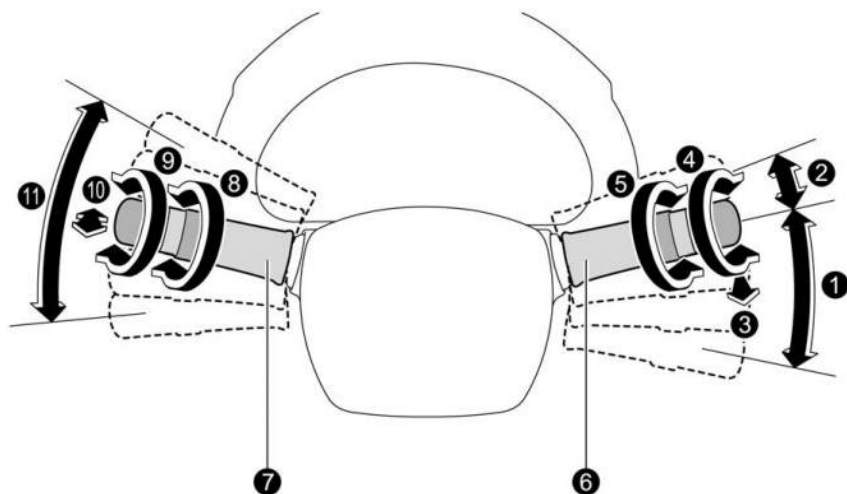

- |   |   |
|---|---|
| ① Windshield wiper (page 221)   | ⑥ Wiper control lever (page 223)                    |
| ② Mist (page 223)   | ⑦ Light control switch (page 212)                   |
| ③ Windshield washer (page 225)  | ⑧ Fog light switch (page 220)                       |
| ④ Rear window wiper and washer switch (page 225)  | ⑨ Headlight ON/OFF/AUTO (page 213)                  |
| ⑤ Wiper intermittent time control switch (page 224)/Sensor sensitivity control (page 224) | ⑩ Headlight flasher High/Low beam change (page 215) |
|   | ⑪ Turn signal lever (page 221)                      |

## INSTRUMENT CLUSTER

### U.S.-SPEC. MODELS

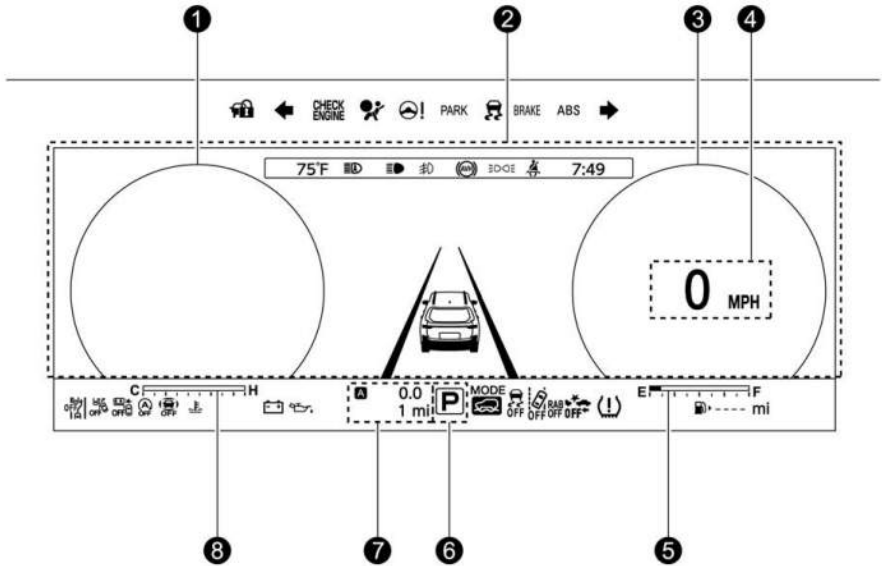

- ① Tachometer (page 158)
- ② Instrument cluster display (page 185)
- ③ Speedometer (page 158)
- ④ Digital speed screen (page 193)
- ⑤ Fuel gauge (page 159)
- ⑥ Select lever/gear position indicator (page 180)
- ⑦ Trip meter and odometer (page 158)
- ⑧ Engine coolant temperature gauge (page 160)



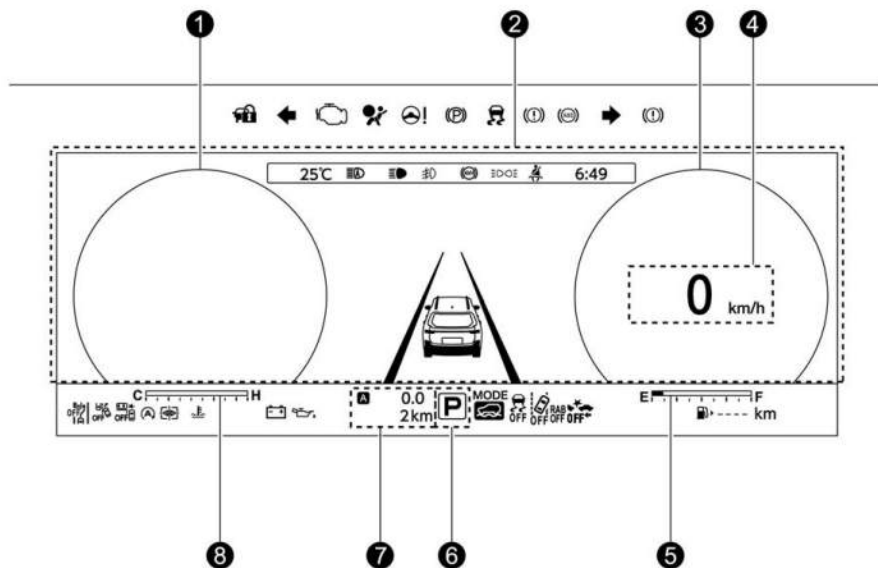

























## CANADA-SPEC. MODELS





















- 1** Tachometer (page 158)
- 2** Instrument cluster display (page 185)
- 3** Speedometer (page 158)
- 4** Digital speed screen (page 193)
- 5** Fuel gauge (page 159)
- 6** Select lever/gear position indicator (page 180)
- 7** Trip meter and odometer (page 158)
- 8** Engine coolant temperature gauge (page 160)



## TABLE OF WARNING AND INDICATOR LIGHTS

Mark	Name	Page	Mark	Name	Page
	Seatbelt warning light	163		Low fuel warning light	174
	Front passenger's seatbelt warning light	163	<b>AWD</b>	All-Wheel Drive warning light	174
	Rear seatbelt warning light	164		Power steering warning light	174
	SRS airbag system warning light	165		Auto Vehicle Hold indicator light	173
<b>ON</b> 	Front passenger's frontal airbag ON indicator light	166		Vehicle Dynamics Control warning light/Vehicle Dynamics Control operation indicator light	175
<b>OFF</b> 	Front passenger's frontal airbag OFF indicator light	166		Vehicle Dynamics Control OFF indicator light	176
<b>CHECK ENGINE</b> / 	CHECK ENGINE warning light/Malfunction indicator light	166		Access key warning indicator	176
	Coolant temperature low indicator light (blue)/Coolant temperature high warning light (red)	167		Security indicator light	180
	Charge warning light	168		Turn signal indicator lights	180
	Oil pressure warning light	168		High beam indicator light	181
	Engine low oil level warning light	168		High beam assist indicator	181
<b>AT OIL TEMP</b>	AT OIL TEMP warning light	169		LED headlight warning light	181
<b>ABS</b> / 	ABS warning light	170	<b>SRH OFF</b>	Steering Responsive Headlight OFF indicator light	181
<b>BRAKE</b> / 	Brake system warning light	171	<b>SRH</b>	Steering Responsive Headlight warning light	181
<b>PARK</b> / 	Electronic parking brake indicator light	172		Front fog light indicator light	181
	Door open indicator light	174		Headlight indicator light	181
	Engine hood open warning light	174			

Mark	Name	Page
	Low tire pressure warning light (except for Canada-spec. models)	169
	Windshield washer fluid warning light	174
	Auto Start Stop OFF indicator light	181
	Auto Start Stop indicator light (green)	182
	Auto Start Stop warning light (yellow)	181
	Auto Start Stop No Activity Detected indicator light	182
	BSW/RCTW warning indicator	183
	BSW/RCTW OFF indicator	183
	Vehicle detected in neighboring lane indicator	182
	X-MODE indicator	182
	Hill descent control indicator light	183
	Icy road surface warning indicator	183
<b>RAB</b>	RAB warning indicator	183
<b>RAB OFF</b>	RAB OFF indicator	183
	Proximity Warning Detection OFF indicator	184
	Electric damper system warning light (if equipped)	182
	Distraction Mitigation System operation indicator light (green)	184
	Distraction Mitigation System warning light (yellow)	184

Mark	Name	Page
	Distraction Mitigation System OFF indicator light	184
	Distraction Mitigation System temporary stop indicator light	184
	Front Cross Traffic Braking warning indicator (if equipped)	184
	Front Cross Traffic Braking OFF indicator (if equipped)	184

---

---

---

---

---

---

---

---

---

---

---

---

---

---

---

---

---

---

---

---



## SEAT, SEATBELT AND SRS AIRBAGS

1-1.	Front Seats .....	37
	Manual Seat (If Equipped) .....	39
	Power Seat (If Equipped).....	40
	Driver's Seat Memory Function (If Equipped).....	41
	Head Restraint Adjustment.....	45
1-2.	Rear Seats .....	47
	Folding Down the Rear Seatback.....	47
	Reclining the Seatback.....	50
	Head Restraint Adjustment.....	50
	Armrest .....	52
1-3.	Seat Heater and Front Seat Ventilation (If Equipped) .....	53
	Front Seat Heater.....	53
	Front Seat Ventilation (If Equipped) .....	54
	Rear Seat Heater (If Equipped) .....	54
1-4.	Seatbelts .....	55
	Seatbelt Safety Tips .....	55
	Emergency Locking Retractor (ELR).....	56
	Automatic Locking Retractor/Emergency Locking Retractor (ALR/ELR).....	56
	Seatbelt Warning Light and Chime .....	57
	Fastening the Seatbelt .....	57
	Seatbelt Maintenance .....	63
1-5.	Seatbelt Pretensioners .....	64
	Seatbelt with Shoulder Belt Pretensioner.....	64
	Seatbelt with Shoulder Belt and Lap Belt Pretensioners .....	65
	System Monitors .....	66
	System Servicing.....	66
	Precautions against Vehicle Modification.....	66
1-6.	Rear Seat Reminder.....	67
1-7.	Child Restraint Systems.....	67
	Safety Precautions.....	67
	Safety Tips for Installing Child Restraint Systems .....	68
	Choosing a Child Restraint System .....	70
	When Installing the Forward Facing Child Restraint System on the Front Passenger's Seat .....	70
	Installing Child Restraint Systems with ALR/ELR Seatbelt .....	72
	Installing a Booster Seat or Booster Cushion .....	76
	Installation of Child Restraint Systems by Use of Lower and Tether Anchors (LATCH).....	78
1-8.	SRS Airbag (Supplemental Restraint System Airbag).....	83
	General Precautions Regarding SRS Airbag System.....	83
	General Precautions Regarding SRS Airbag System for Accessories and Any Objects .....	85
	General Precautions Regarding SRS Airbag System and Children.....	87
	Components .....	90
	SUBARU Advanced Frontal Airbag System.....	92
	SRS Side Airbag and SRS Curtain Airbag.....	103
	SRS Airbag System Monitors .....	110

## **SEAT, SEATBELT AND SRS AIRBAGS**

---

<b>SRS Airbag System Servicing .....</b>	<b>111</b>
<b>Precautions against Vehicle Modification.....</b>	<b>112</b>
<b>How to Contact the Vehicle Manufacturer Concerning Modifications for Persons with Disabilities That May Affect the Advanced Airbag System .....</b>	<b>113</b>

## 1-1. FRONT SEATS

### WARNING

- Never adjust the seat while driving, as personal injury or loss of vehicle control may occur.
- Before adjusting the seat, ensure nothing is blocking the adjusting mechanism.
- After adjusting the seat, move it back and forth to ensure the seat is securely locked. If it is not, it may move suddenly or the seatbelt may not operate properly.
- Do not put objects under the front seats. They may interfere with front seat locking mechanism and cause an accident.
- Seatbelts provide maximum restraint when the occupant sits back and upright in the seat. To reduce the risk of sliding under the seatbelt in a collision, the front seatbacks should always be used in the upright position while the vehicle is running. If the front seatbacks are not in the upright position and a collision occurs, the risk of sliding under the lap belt and of the lap belt sliding up over the abdomen will increase, and both can result in serious injury or death.
- The SRS airbags deploy with considerable speed and force. Occupants who are not seated in the proper upright position when the SRS airbag deploys could suffer very serious injuries. Because the SRS airbag needs enough space for deployment, the driver should always sit upright and well back in the seat as far from the steering wheel as practical while still maintaining full vehicle control, and the front passenger should move the seat as far back as possible and sit upright and well

back in the seat.

### WARNING

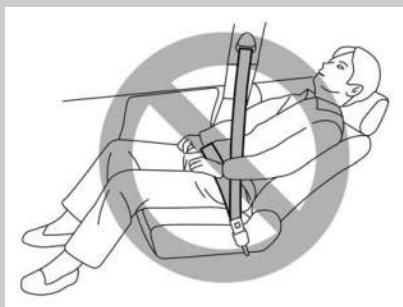

- NEVER INSTALL A REARWARD FACING CHILD RESTRAINT SYSTEM ON THE FRONT PASSENGER'S SEAT. DOING SO RISKS SERIOUS INJURY OR DEATH TO THE CHILD BY PLACING THE CHILD'S HEAD TOO CLOSE TO THE SRS AIRBAG.
- SUBARU strongly recommends that ALL infants and children (including those in child restraint systems) sit in the REAR seat properly restrained in a child restraint system or in a seatbelt, whichever is appropriate for the child's age, height and weight. The SRS airbag deploys with considerable speed and force and can injure or even kill children, especially if they are not restrained or improperly restrained. Because children are lighter and weaker than adults, their risk of being injured from deployment is greater. According to accident statistics, children are safer when properly restrained in the rear seating positions than in the front seating positions. For instructions and precautions concerning child restraint systems, refer to "Child Restraint Systems"  P67.

**WARNING**

To prevent the passenger from sliding under the seatbelt in the event of a collision, always put the seatback in the upright position while the vehicle is in motion. Also, do not place objects such as cushions between the passenger and the seatback. If you do so, the risk of sliding under the lap belt and of the lap belt sliding up over the abdomen will increase, and both can result in serious injury or death.

- SRS seat cushion airbag
- Front seat heater
- Front seat ventilation (if equipped)
- Power seat (if equipped)

**WARNING**

Do not press your feet onto the instrument panel. Doing so may prevent the occupant detection function of the SRS airbag system and SRS airbag from functioning correctly. This may result in serious injury or death in the event of an accident.

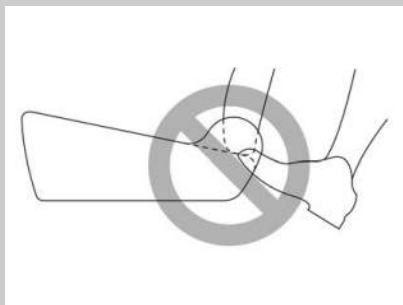
**WARNING**

Do not let rear passengers rest their feet between the front seatback and seat cushion. Doing so may interfere with the proper operation of the following systems and could result in serious injury.

- Occupant detection system
- SRS side airbag

**WARNING**

Seatbelts provide maximum restraint when the occupant sits well back and upright in the seat. Do not put cushions or any other materials between occupants and seatbacks or seat cushions. If you do so, the risk of sliding under the lap belt and of the lap

belt sliding up over the abdomen will increase, and both can result in serious internal injury or death.

**! WARNING**

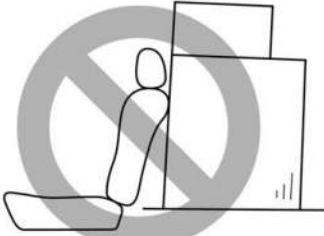

Never stack luggage or other cargo higher than the top of the seatback because it could tumble forward and injure passengers in the event of a sudden stop or accident.

## MANUAL SEAT (If Equipped)

### Forward and backward adjustment

1. Sit in the seat.
2. Pull the lever upward, slide the seat to the desired position, and then release the lever.

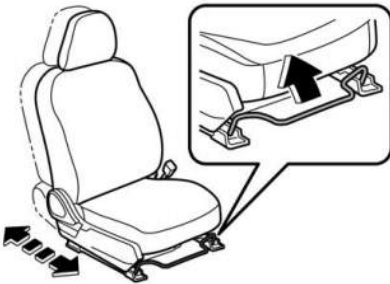

3. Try to move the seat back and forth to make sure that it is securely locked into place.

### Reclining the seatback

1. Pull up the reclining lever, adjust the seatback to the desired position, and then release the lever.

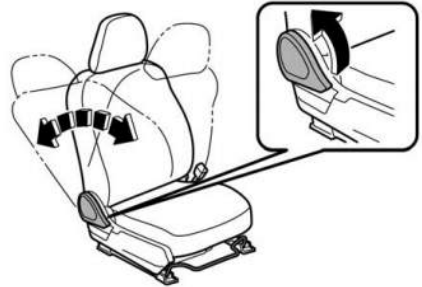

2. Make sure the seatback is securely locked into place.

The seatback placed in a reclined position can spring back upward with force when pulling up the lever. While operating the lever to return the seatback, hold the seatback lightly so that it may be raised back gradually.

## POWER SEAT (If Equipped)

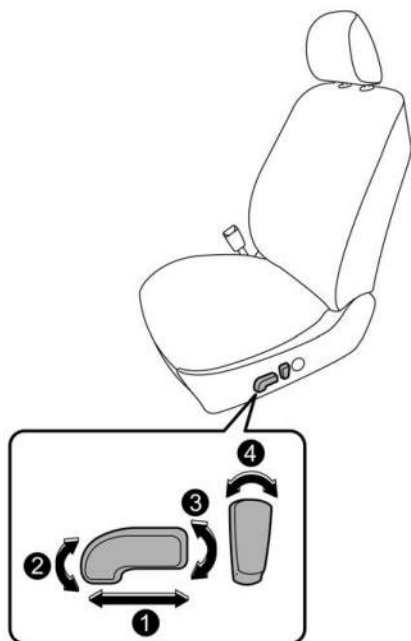

- ❶ Seat position forward/backward control switch
- ❷ Seat cushion angle control switch
- ❸ Seat height control switch
- ❹ Seatback angle (reclining) control switch

### To adjust the seat forward or backward:

Move the seat position forward/backward control switch forward or backward.

### To adjust the seat cushion angle:

Pull up or push down the front end of the seat cushion angle control switch.

### To adjust the seat height:

Pull up or push down the rear end of the seat height control switch.

### To adjust the angle of the seatback:

Move the seatback angle (reclining) control switch.

## NOTE

During forward/backward adjustment of the seat, you cannot adjust the seat cushion angle or seat cushion height.

## Lumbar support control switch (driver's seat)

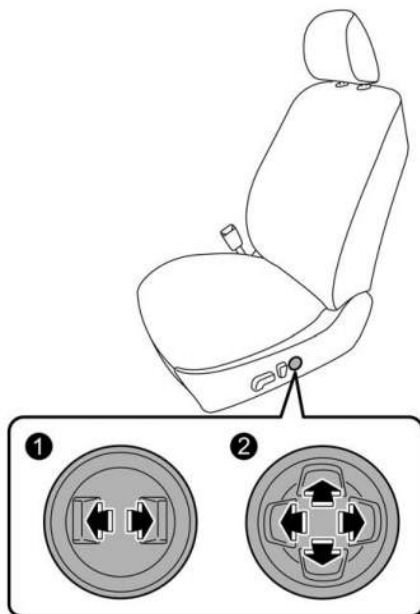

- ❶ 2-way lumbar support models
- ❷ 4-way lumbar support models

### 2-way lumbar support models:

To increase lower back support, push the front side of the switch. To decrease lower back support, push the rear side of the switch.

### 4-way lumbar support models:

To increase lower back support, push the front side of the switch. To decrease lower back support, push the rear side of the switch.

To adjust the lumbar support height, push the upper or lower side of the switch.

## Thigh extension (if equipped)

### CAUTION

When the thigh extension is pulled out to its fullest, do not put weight on the top of it. Doing so could break the part.

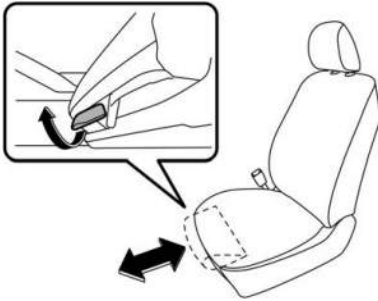

The seat front length can be adjusted.

Pull up the lever to adjust the length and release the lever to lock it.

## DRIVER'S SEAT MEMORY FUNCTION (If Equipped)

### WARNING

- To avoid loss of vehicle control or personal injury, never perform the following operations while driving.
  - Adjusting the seat
  - Retrieving the seat position
- Before adjusting the seat, make sure that cargo or the hands and feet of rear seat passengers are clear of the adjusting mechanism.
- Perform the seat position retrieval before driving. Be sure to confirm that the select lever is in the “P” position, and the parking brake is applied, when adjusting the seat position. Do not drive until the retrieval of the seat position is complete.

- When retrieving a registered seat position, make sure the hands, feet and possessions of rear seat passengers are clear of the seat adjusting mechanism.
- When any unusual conditions or malfunctions occur during the retrieval of the seat position, stop the retrieval of the seat position by performing any of the following.
  - Operate any of the power seat switches.
  - Press the “SET” button.
  - Press button “1” or “2”.
  - Operate the outside mirror control switch.

Some seat positions can be registered. Register the seat position with button “1” or “2” or each of the key fobs and retrieve the seat position.

The following seat positions can be registered.

- Forward/backward position of the seat
- Angle of the seatback
- Angle of the seat cushion
- Height of the seat
- Angle of the outside mirrors
- Angle of the outside mirrors while the vehicle is in reverse

### NOTE

*The seat position can also be retrieved with the Distraction Mitigation System user information. To do so, perform user registration in the Distraction Mitigation System settings. Refer to “Using the Distraction Mitigation System” P398.*

## Registration of memory position with button “1” or “2”

1. Adjust the seat position under the following conditions.
  - The parking brake is applied.

- The ignition switch is in the “ON” position.
  - The select lever is in the “P” position.
2. Register the adjusted positions by either of the following procedures.
    - Press the “SET” button, then press either “1” or “2” until a chirp sounds within 5 seconds.
    - While pressing and holding the “SET” button, press either “1” or “2” until a chirp sounds within 5 seconds.

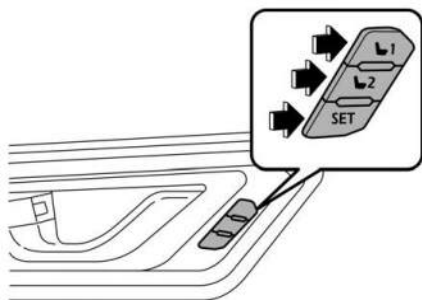

A chirp will sound once to signal that the following items were registered.

- Driver's seat position
- Both outside mirrors' angles
- Reverse tilt-down mirror angles (passenger's side only)

#### NOTE

If a new position is registered for the same button, the previously registered memory position is deleted.

### Registration of the reverse tilt-down mirror angle with button “1” or “2”



#### CAUTION

Depress the brake pedal when registering the reverse tilt-down mirror angle.

1. Move the select lever to the “R” position, then the outside mirror angle will move to the reverse tilt-down position.
2. Adjust the outside mirror angle. For details about the settings, refer to “Remote control mirror switch” P246.
3. Move the select lever to the “P” position, then the outside mirror angle will return to its original position.
4. Register the adjusted positions by either of the following procedures.
  - Press the “SET” button, then press either “1” or “2” until a chirp sounds within 5 seconds.
  - While pressing and holding the “SET” button, press either “1” or “2” until a chirp sounds within 5 seconds.

A chirp will sound once to signal that the following items were registered.

- Driver's seat position
- Both outside mirrors' angles
- Reverse tilt-down mirror angles (passenger's side only)

#### NOTE

The factory setting (default setting) for this function is set as the front passenger's side mirror. The setting of the right and left side mirror/front passenger's side mirror operation can be changed by a SUBARU dealer. Contact your SUBARU dealer for details.

### Registration of memory position with a key fob

1. Adjust the seat position under the following conditions.
  - The parking brake is applied.
  - The ignition switch is in the “OFF” position.
  - The select lever is in the “P” position.



2. Hold the access key fob and press and hold the “SET” button, then press the  button of the access key fob.

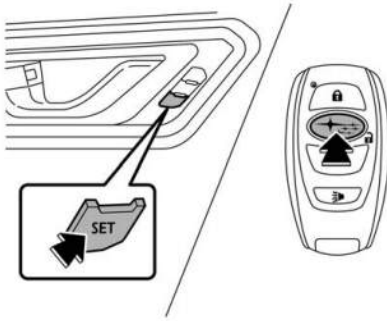

3. Move the select lever to the “P” position, then the outside mirror angle will return to its original position.
4. Turn the ignition switch to the “OFF” position.
5. Hold the access key fob and press and hold the “SET” button, then press the  button of the access key fob.

A chirp will sound once to signal that the following items were registered.

- Driver’s seat position
- Both outside mirrors’ angles
- Reverse tilt-down mirror angles (passenger’s side only)

A chirp will sound once to signal that the following items were registered.

- Driver’s seat position
- Both outside mirrors’ angles
- Reverse tilt-down mirror angles (passenger’s side only)

#### NOTE

When registering the seat position, carry the access key that you want to register with you. If you are carrying 2 or more access keys, registration may not be possible.

### Registration of the reverse tilt-down mirror angle with the key fob

#### CAUTION

Depress the brake pedal when registering the reverse tilt-down mirror angle.

1. Move the select lever to the “R” position, then the outside mirror angle will move to the reverse tilt-down position.
2. Adjust the outside mirror angle. For details about the settings, refer to “Remote control mirror switch”  P246.

#### NOTE

- The factory setting (default setting) for this function is set as the front passenger’s side mirror. The setting of the right and left side mirror/front passenger’s side mirror operation can be changed by a SUBARU dealer. Contact your SUBARU dealer for details.
- The system stores the adjusted mirror angle for approximately 45 seconds after the ignition switch is turned to the “OFF” position. Register the mirror angle while the memory function is available.

### Retrieval of memory position registered with button “1” or “2”

#### WARNING

Be sure to press the correct button to retrieve your registered seat position. If the seat position is not optimum for you, it may adversely affect your driving and may reduce the effectiveness of the seatbelt. That could result in an accident involving serious injury or death.

1. Turn the ignition switch to the “ON” position.

- Put the select lever is in the “P” position and apply the parking brake, then press button “1” or “2”.

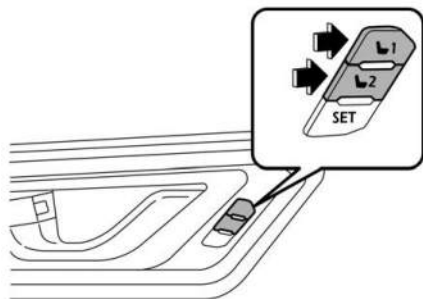

A chirp will sound and the seat and outside mirror move to the registered position.

When the select lever is moved to the “R” position, the outside mirror will move to the registered reverse tilt-down position.

#### NOTE

- If the vehicle battery is removed, the registered memory position data will not be deleted.
- When the button “1” or “2” is pressed within 45 seconds after the driver’s door is opened, the registered memory position can be retrieved even if the ignition switch is in the “OFF” position.
- If buttons “1” and “2” are pressed at the same time, execution of seat position retrieval may not be possible.
- When the retrieved position is the same as the current seat position, a chirp will sound twice.

### Retrieval of the memory position registered with access key fob

- Hold the registered access key fob.

- Unlock the driver’s door by pressing the “” button or touching the sensor behind the door handle.





- Open the driver’s door.

A chirp will sound and the seat and angle of the outside mirrors moves to the registered position.

When the select lever is moved to the “R” position, the outside mirror will move to the registered reverse tilt-down position.

#### NOTE

- A retrieved seat position might deviate as the function is used continuously over time.
- A retrieved seat position might deviate if you attempt to continue operating the registered seat in the same direction when the registered seat is already at the farthest possible point of adjustment in any direction.
- If the registered memory position cannot be retrieved after performing the previous procedures, try the following procedures.
  - Press the “SET” button on the driver’s door.
  - Press the “” button on the access key fob or the door lock button to lock the doors.
  - Perform the prior procedures again.
- If the keyless access function is disabled, the memory position cannot be retrieved by touching the sensor behind the driver’s door handle.

However, the memory position can still be retrieved by pressing the “ P126.

- If a new position is registered for the same access key fob, the previously registered memory position data will be deleted.
- If you are carrying 2 or more access keys, seat position retrieval may not be possible.
- If, while carrying an access key, 45 seconds passed after you enter the operating range of the keyless access function, it may not be possible to retrieve the registered memory position even if the door is open. For the operating range of the keyless access function, refer to “Locking and Unlocking with “Keyless Access” Entry Function”  P120.

## Clearing the registered seat position with access key fob

1. Close the driver’s door.
2. Hold the access key fob and press and hold the “SET” button, then press the “

A chirp will sound, and the registered seat position and outside mirror angle on the passenger’s side will be cleared.

### NOTE

After deleting the seat position, wait for a few moments before registering a new seat position.

## HEAD RESTRAINT ADJUSTMENT



### WARNING

- Never drive the vehicle with the head restraints removed because they are designed to reduce the

risk of serious neck injury in the event that the vehicle is struck from the rear. Also, never install the head restraints backwards. Doing so will prevent the head restraints from functioning as intended. Therefore, when the head restraints are removed, all head restraints must be reinstalled properly to protect vehicle occupants.

- All occupants, including the driver, should not operate a vehicle or sit in a vehicle’s seat until the head restraints are placed in their proper positions in order to minimize the risk of neck injury in the event of a crash.
- The front seat head restraints are designed to be installed into the front seats only. The rear seat head restraints are designed to be installed into the rear seats only. Do not attempt to install the front seat head restraints into the rear seats, or the rear seat head restraints into the front seats.

Both the driver’s seat and front passenger’s seat are equipped with head restraints. Both head restraints are adjustable in the following ways.

## Head restraint height adjustment

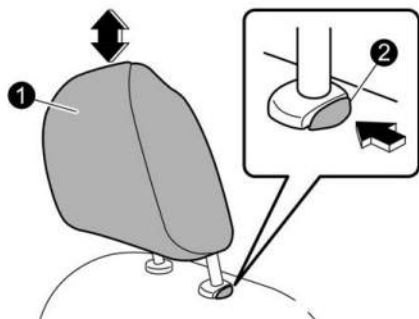

- ① Head restraint
- ② Release button

### To raise:

Pull the head restraint up.

### To lower:

Push the head restraint down while pressing the release button.

### To remove:

Pull out the head restraint while pressing the release button.

### To install:

Press and hold the release button while pushing the head restraint in until it locks in place.

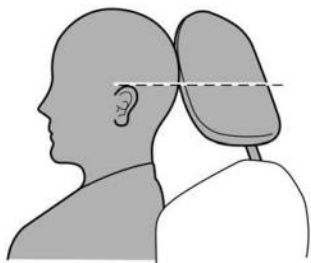

Each head restraint should be adjusted so that the center of the head restraint is closest to the top of the occupant's ears.

### NOTE

When the head restraint cannot be pulled out or installed due to insufficient clearance between the head restraint and the roof, tilt the seat and then perform the installation and removal tasks.

## 1-2. REAR SEATS

### WARNING



Seatbelts provide maximum restraint when the occupant sits back and upright in the seat. Do not place cushions or any other materials between occupants and seatbacks or seat cushions. By doing so, the risk of sliding under the lap belt and of the lap belt sliding up over the abdomen will increase, and both can result in serious internal injury or death.

### WARNING

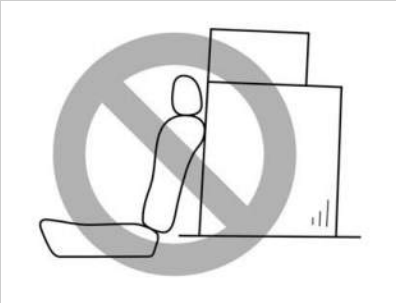

Never stack luggage or other cargo higher than the top of the seatback as it could tumble forward and injure passengers in the event of a sudden stop or accident.

## FOLDING DOWN THE REAR SEATBACK

### WARNING

- When you fold down the seatback, check that there are no passengers or objects on the rear seat. Not doing so creates a risk of injury or property damage if the seatback suddenly folds down.
- Never allow passengers to ride on the folded rear seatback or in the cargo area. Doing so may result in serious injury or death.
- Secure all objects and especially long items properly to prevent them from being thrown around inside the vehicle and causing serious injury during a sudden stop, a sudden steering maneuver or a rapid acceleration.
- When you return the seatback to its original position, shake the seatback slightly to confirm that it is securely fixed in place. If the seatback is not securely fixed in place, the seatback may suddenly fold down in the event of sudden braking, or objects may move out from the cargo area, which could cause serious injury or death.

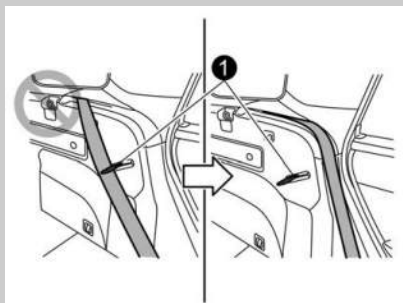
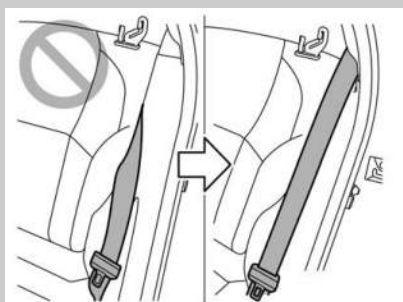
**WARNING****1** Striker

When the seatback is returned to its original position, observe the following precautions. Failure to do so may lead to serious injury or an accident because the operation efficiency of the seatbelt is inhibited.

- The seatbelt should not be caught in the seatback and it should be fully visible.
- The seatbelt should not pass behind the striker for the seatback.

**CAUTION**

- Do not hang luggage etc. on the striker. The possibility exists that the seatback may not be able to be fixed firmly in place. This could lead to unexpected accidents
- When returning the seatback to its original position, raise the seat-

back while holding it. Do not hold the seatbelt guide or strap when raising the seatback.

- Do not hang anything on the lock release strap or belt guide.
- Do not insert the lock release strap into the hole of the strap attachment part.

**Folding down the rear seatback**

1. To remove the seatbelt, insert one edge of the belt into the open gap in the belt guide, and then slide the rest of the belt out.

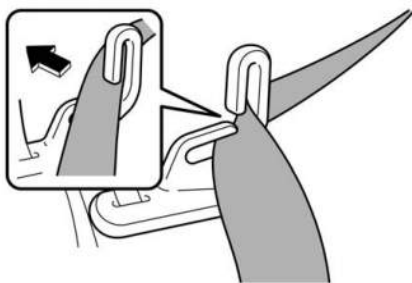

2. Lower the head restraint.

3. Unlock the seatback by pulling the strap or lever as shown in the illustration, and then fold the seatback down by supporting it with your hands.

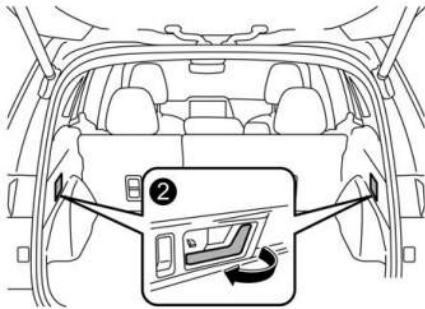
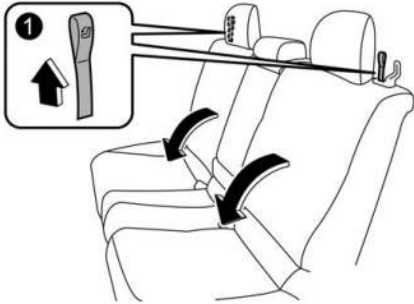

- ① Lock release strap  
② Release lever

## Return the rear seatback

### WARNING

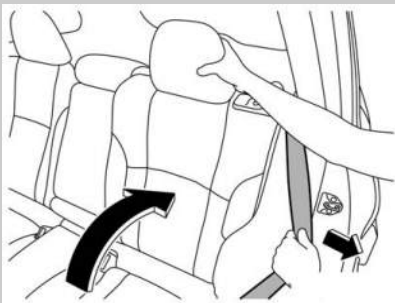

- When returning the seatback to its original position, observe the fol-

lowing precaution.

Failure to observe the precaution may damage the seatbelt, impairing its effectiveness, and possibly result in a serious injury.

- When returning the seatback to its original position, pull the seatbelt out towards the vehicle exterior so that it will not be caught between the seatback and the trim.

- To return the seatback to its original position, raise the seatback until it locks into place.
- To pass the seatbelt through the belt guide, draw out the seatbelt, insert one edge of the belt into the open gap in the belt guide, and then slide the rest of the belt in so that the entire belt fits inside the belt guide.

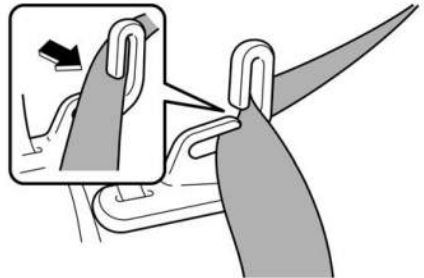

### WARNING

When you return the seatback to its original position, shake the seatback slightly to confirm that it is securely fixed in place. If the seatback is not securely fixed in place, the seatback may suddenly fold down in the event of sudden braking, or objects may move out from the cargo area, which could cause serious injury or death.

## RECLINING THE SEATBACK

**WARNING**

To prevent the passenger from sliding under the seatbelt in the event of a collision, observe the following precautions:

- Keep the seatback in the upright position while the vehicle is in motion.
- Do not place objects such as cushions between the passenger and the seatback.

Otherwise, the risk of sliding under the lap belt and of the lap belt sliding up over the abdomen will increase, and both can result in serious internal injury or death.

**CAUTION**

If your vehicle is equipped with a multi-use cargo cover, observe the following precaution.

- Be careful not to pinch your hand between the head restraint and the multi-use cargo cover when you recline the rear seat.

1. To remove the seatbelt, insert one edge of the belt into the open gap in the belt guide, and then slide the rest of the belt out.

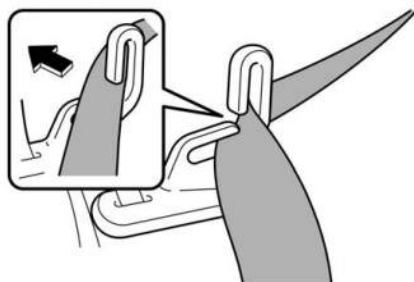

2. Pull the strap and adjust the seatback to the desired position.

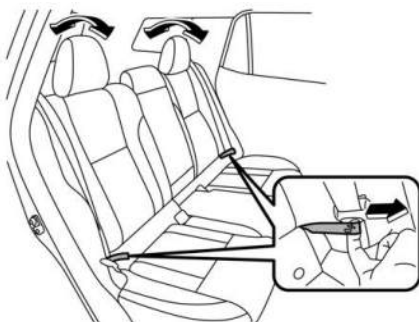

3. Release the strap and move the seatback back and forth to confirm that it is securely fixed in place.

## HEAD RESTRAINT ADJUSTMENT

Both the rear window side seats and the rear center seat are equipped with head restraints.

**WARNING**

- Never drive the vehicle with the head restraints removed because they are designed to reduce the risk of serious neck injury in the event that the vehicle is struck from the rear. Therefore, when the head restraints are removed, all head restraints must be reinstalled properly to protect vehicle occupants.



- All occupants, including the driver, should not operate a vehicle or sit in a vehicle's seat until the head restraints are placed in their proper positions in order to minimize the risk of neck injury in the event of a crash.
- The front seat head restraints are designed to be installed into the front seats only. The rear seat head restraints are designed to be installed into the rear seats only. Do not attempt to install the front seat head restraints into the rear seats, or the rear seat head restraints into the front seats.

### Rear windows side seating position

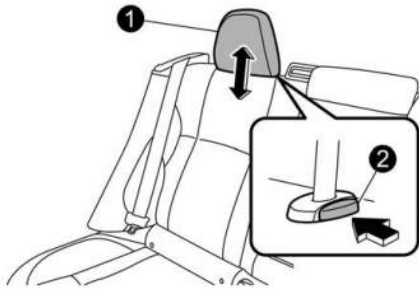

- ① Head restraint
- ② Release button

#### To raise:

Pull the head restraint up.

#### To lower:

Push the head restraint down while pressing the release button on the top of the seatback.

#### To remove:

While pressing the release button, pull out the head restraint.

#### To install:

Install the head restraint into the holes that are located on the top of the seatback until the head restraint locks.

The head restraint should be adjusted so that the center of the head restraint is closest to the top of the seat occupant's ears. When the seats are not occupied, lower the head restraints to improve rearward visibility.

#### NOTE

*When the head restraint cannot be pulled out or installed due to insufficient clearance between the head restraint and the roof, tilt the seat and then perform the installation and removal tasks.*

### Rear center seating position

#### CAUTION

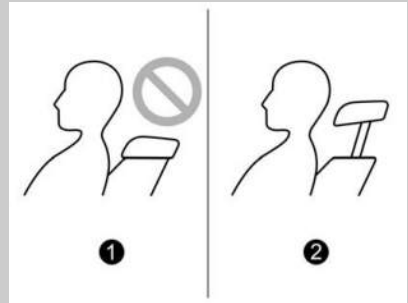

- ① Incorrect (retracted position)
- ② Correct (extended position)

The head restraint is not intended to be used in the retracted position. Before sitting on the seat, raise the head restraint to the extended position.

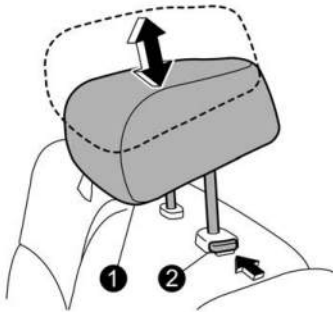

- ① Head restraint
- ② Release button

**To raise:**

Pull the head restraint up.

**To lower:**

Push the head restraint down while pressing the release button on the top of the seatback.

**To remove:**

While pressing the release button, pull out the head restraint.

**To install:**

Install the head restraint into the holes that are located on the top of the seatback until the head restraint locks. Press and hold the release button to lower the head restraint.

When the rear center seating position is occupied, raise the head restraint to the extended position. When the rear center seating position is not occupied, lower the head restraint to improve rearward visibility.

**ARMREST**

To lower the armrest, pull the armrest's top edge.

**⚠ WARNING**

- Make sure to have the rear passengers wear the seatbelts before lowering the armrest. If the rear passengers wear the seatbelts after lowering the armrest, seatbelts cannot provide maximum restraint, causing serious injuries.
- To avoid serious injury, never allow passengers to sit on the center armrest while the vehicle is in motion.

## 1-3. SEAT HEATER AND FRONT SEAT VENTILATION (If Equipped)

The seat heater and front seat ventilation operate when the ignition switch is in the "ON" position.

### CAUTION

- Do not sit on or apply weight to the front seatback when it is reclined.
- Do not kick the front seatback from the rear seat.
- When reclining the front seatback, ensure it does not make contact with the rear seat.
- Do not put hard or heavy objects or ones with protrusions on the seat, and do not stab the seat with sharp objects, such as pins or needles.
- People with delicate skin may suffer slight burns even at low temperatures if they use the seat heater for a long period of time. When using the heater, always be sure to warn the persons concerned.
- Do not put anything on the seat which insulates against heat, such as a blanket, cushion, or similar items. This may cause the seat heater to overheat.
- When the seat is warmed enough or before you leave the vehicle, be sure to turn off the seat heater.
- If water or liquid is spilled on the seat, wipe it off with a dry cloth immediately.
- Do not use the rear seat heater while the rear seatback is folded down. This may cause the seat heater to overheat.

### NOTE

When the vehicle battery power is low, the seat heater and front seat ventilation will stop. Start the engine to use the seat heater and front seat ventilation.

## FRONT SEAT HEATER

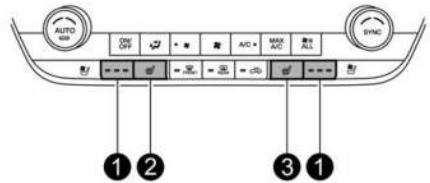

- ① Seat heater indicator (orange)
- ② Driver's seat heater button
- ③ Front passenger's seat heater button

Press the driver's/passenger's seat heater button on the climate control panel. Each time you press the button, the mode will change as follows.



### HIGH:

3 indicator lights are illuminated in orange.

### MID:

2 indicator lights are illuminated in orange.

### LOW:

1 indicator light is illuminated in orange.

### OFF:

All indicator lights turn off.

Selecting HIGH mode will cause the seat to heat up quicker.

Holding and releasing the seat heater button turns the seat heater off in any mode.

### NOTE

The front seat heater function cannot be used simultaneously with the seat ventilation.

## FRONT SEAT VENTILATION (If Equipped)

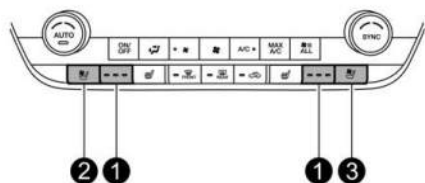

- ❶ Seat ventilation indicator (blue)
- ❷ Driver's seat ventilation button
- ❸ Front passenger's seat ventilation button

Press the driver's/passenger's seat ventilation button on the climate control panel. Each time you press the button, the mode will change as follows.

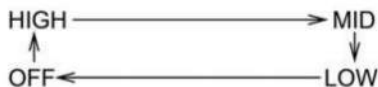

### HIGH:

3 indicator lights are illuminated in blue.

### MID:

2 indicator lights are illuminated in blue.

### LOW:

1 indicator light is illuminated in blue.

### OFF:

All indicator lights turn off.

Holding and releasing the seat ventilation button turns the seat ventilation off in any mode.

## REAR SEAT HEATER (If Equipped)



### CAUTION

Do not open and close the center console lid while operating the rear seat heater switch. There is the risk of fingers being caught in the lid.

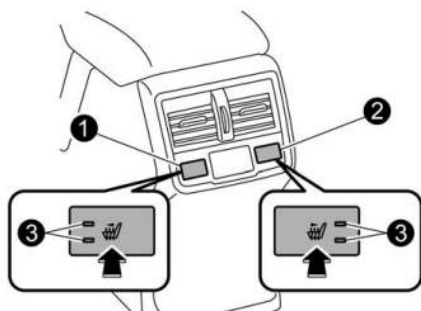

- ❶ Left side
- ❷ Right side
- ❸ Indicator lights

Press the rear seat heater switch. Each time you press the switch, the mode will change as follows.



### HIGH:

2 indicator lights are illuminated.

### LOW:

1 indicator light is illuminated.

### OFF:

All indicator lights turn off.

Selecting "HIGH" mode will cause the seat to heat up quicker.

**NOTE**

*Only the front seat heater switches retain the previous switch position even if the vehicle has restarted. The rear seat switch will reset.*

**1-4. SEATBELTS****SEATBELT SAFETY TIPS****WARNING**

- All persons in the vehicle must fasten their seatbelts **BEFORE** the vehicle starts to move. Otherwise, the possibility of serious injury becomes greater in the event of a sudden stop or accident.
- All belts should fit snugly in order to provide full restraint. Loose fitting belts are not as effective in preventing or reducing injury.
- Each seatbelt is designed to support only one person. Never use a single belt for two or more persons – even children. Otherwise, in an accident, serious injury or death could result.
- Replace all seatbelt assemblies including retractors and attaching hardware worn by occupants of a vehicle that has been in a serious accident. The entire assembly should be replaced even if damage is not obvious.
- **NEVER INSTALL A REARWARD FACING CHILD RESTRAINT SYSTEM ON THE FRONT PASSENGER'S SEAT. DOING SO RISKS SERIOUS INJURY OR DEATH TO THE CHILD BY PLACING THE CHILD'S HEAD TOO CLOSE TO THE SRS AIRBAG.**
- SUBARU strongly recommends that ALL infants and children (including those in child restraint systems) sit in the REAR seat properly restrained in a child restraint system or in a seatbelt, whichever is appropriate for the child's age, height and weight. The SRS airbag deploys with considerable speed and force and can injure or even kill children, espe-

1

cially if they are not restrained or improperly restrained. Because children are lighter and weaker than adults, their risk of being injured from deployment is greater. According to accident statistics, children are safer when properly restrained in the rear seating positions than in the front seating positions. For instructions and precautions concerning child restraint systems, refer to "Child Restraint Systems" P67.

This vehicle is equipped with a crash sensing and diagnostic module, which will record whether the seatbelt is in use by the front passenger when an SRS frontal, side or curtain airbag deploys.

### Infants or small children

Use a child restraint system that is suitable for this vehicle. Refer to "Child Restraint Systems" P67.

### Children

If a child is too big for a child restraint system, the child should sit in the rear seat and be restrained using the seatbelts. According to accident statistics, children are safer when properly restrained in the rear seating positions than in the front seating positions. Never allow a child to stand up or kneel on the seat.

If the shoulder portion of the belt crosses the face or neck, move the child closer to the belt buckle to help provide a good shoulder belt fit. Care must be taken to securely place the lap belt as low as possible on the hips and not on the child's waist. If the shoulder portion of the belt cannot be properly positioned, a child restraint system should be used. Never place the shoulder belt under the child's arm or behind the child's back.

### Expectant mothers



Expectant mothers also need to use the seatbelts. They should consult their doctor for specific recommendations. The lap belt should be worn securely and as low as possible over the hips, not over the waist.

### EMERGENCY LOCKING RETRACTOR (ELR)

The driver's seatbelt has an Emergency Locking Retractor (ELR).

The emergency locking retractor allows normal body movement but the retractor locks automatically during a sudden stop, impact or if you pull the belt very quickly out of the retractor.

### AUTOMATIC LOCKING RETRACTOR/EMERGENCY LOCKING RETRACTOR (ALR/ELR)

Each passenger's seatbelt has an Automatic Locking Retractor/Emergency Locking Retractor (ALR/ELR). The Automatic Locking Retractor/Emergency Locking Retractor normally functions as an Emergency Locking Retractor (ELR). The ALR/ELR has an additional locking mode, "Automatic Locking Retractor (ALR) mode", intended to secure a child restraint system.

The ALR mode functions as follows.

When the seatbelt is once drawn out completely and is then retracted even slightly, the retractor locks the seatbelt in that position and the seatbelt cannot be extended. As the belt is rewinding, clicks will be heard which indicate the retractor functions as an ALR. When the seatbelt is retracted fully, the ALR mode is canceled and the ELR mode is restored.

When securing a child restraint system on the rear seats by using a seatbelt, the seatbelt must be changed over to the Automatic Locking Retractor (ALR) mode. For instructions on how to install the child restraint system using a seatbelt, refer to "Installing Child Restraint Systems with ALR/ELR Seatbelt" P72.

When the child restraint system is removed, make sure that the retractor is restored to the Emergency Locking Retractor (ELR) mode by allowing the seatbelt to retract fully.

## SEATBELT WARNING LIGHT AND CHIME



Refer to "Seatbelt Warning Light and Chime" P163.

## FASTENING THE SEATBELT

### WARNING

- Never use a belt that is twisted or reversed. In an accident, this can increase the risk or severity of injury.
- Keep the lap belt as low as possible on your hips. In a collision, this spreads the force of the lap belt over stronger hip bones instead of across the weaker abdomen.
- Seatbelts provide maximum restraint when the occupant sits well back and upright in the seat. To reduce the risk of sliding under the seatbelt in a collision, the front

seatbacks should be always used in the upright position while the vehicle is running. If the front seatbacks are not used in the upright position in a collision, the risk of sliding under the lap belt and of the lap belt sliding up over the abdomen will increase, and both can result in serious internal injury or death.

- Do not put cushions or any other materials between occupants and seatbacks or seat cushions. If you do so, the risk of sliding under the lap belt and of the lap belt sliding up over the abdomen will increase, and both can result in serious internal injury or death.

### WARNING

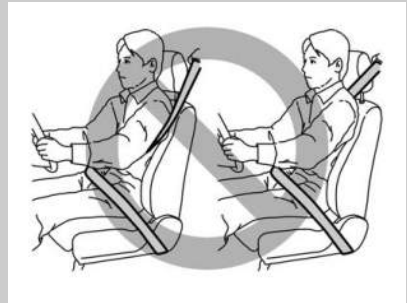

Never place the shoulder belt under the arm or behind the back. If an accident occurs, this can increase the risk or severity of injury.

### CAUTION

Metallic parts of the seatbelt can become very hot in a vehicle that has been closed up in sunny weather; they could burn an occupant. Do not touch such hot parts until they cool.

## Front seatbelts

1. Adjust the seat position.

### Driver's seat:

Adjust the seatback to the upright position. Move the seat as far from the steering wheel as practical while still maintaining full vehicle control.

### Front passenger's seat:

Adjust the seatback to the upright position. Move the seat as far back as possible.

2. Sit well back in the seat.
3. Pick up the tongue plate and pull the belt out slowly. Do not let it get twisted.
  - If the belt stops before reaching the buckle, return the belt slightly and pull it out more slowly.
  - If the belt still cannot be unlocked, let the belt retract slightly after giving it a strong pull, then pull it out slowly again.
4. Insert the tongue plate into the buckle until you hear a click.

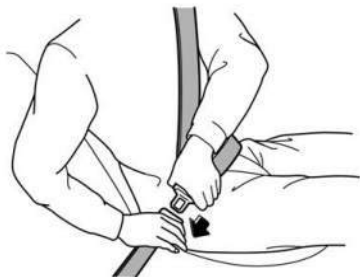

5. To tighten the lap part, pull up on the shoulder belt.

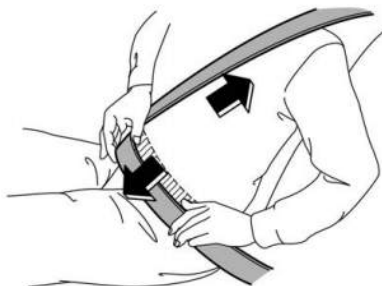

6. Place the lap belt as low as possible on the hips, not on the waist.

## Adjusting the front seat shoulder belt anchor height



The shoulder belt anchor height should be adjusted to the position best suited for the driver/front passenger. Always adjust the anchor height so that the shoulder belt passes over the middle of the shoulder without touching the neck.

### To raise:

Slide the anchor up.

### To lower:

Push and hold the upper part of the anchor and slide the anchor down.

Pull down the anchor to make sure that it is locked in place.



### WARNING

When wearing the seatbelts, make sure the shoulder portion of the webbing does not pass over your neck. If it does, adjust the seatbelt anchor to a lower position. Placing the shoulder belt over the neck may result in neck injury during sudden braking or in a collision.

### Unfastening the seatbelt

1. Push the button on the buckle.

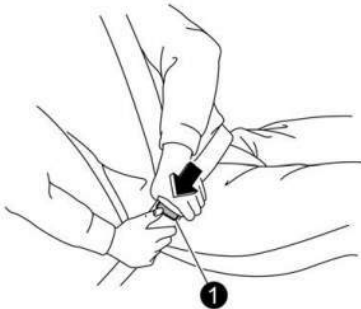

 Button

2. Retract the seatbelt slowly to prevent it from getting tangled or twisted.

Before closing the door, make sure that the belts are retracted properly to avoid catching the belt webbing in the door.

### Rear seatbelts (except rear center seatbelt)

### WARNING

Fastening your seatbelt with the shoulder belt twisted can increase the risk and severity of injuries in an accident. When attaching the shoulder belt to the belt guide, make sure that the shoulder belt is not twisted.

1. Check that the shoulder belt is fitted in the belt guide.

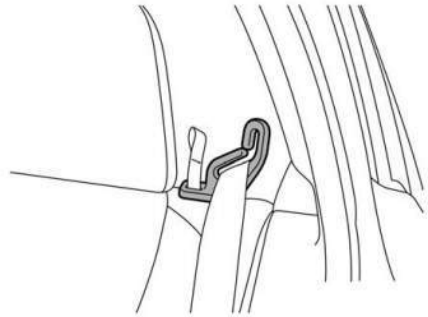

2. Sit well back in the seat.
3. Pick up the tongue plate and pull the belt out slowly. Do not let it get twisted.
  - If the belt stops before reaching the buckle, return the belt slightly and pull it out more slowly.
  - If the belt still cannot be unlocked, let the belt retract slightly after giving a strong pull on it, then pull it out slowly again.
4. Insert the tongue plate into the buckle until you hear a click.

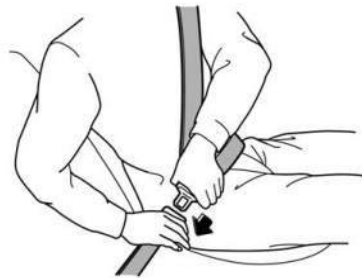

- To tighten the lap part, pull up on the shoulder belt.

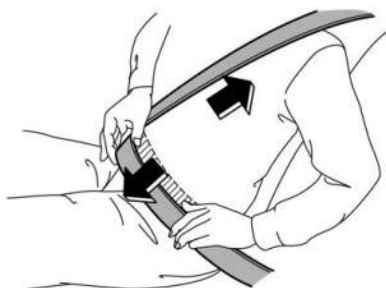

- Place the lap belt as low as possible on the hips, not on the waist.

### Unfastening the seatbelt

- Push the button on the buckle.

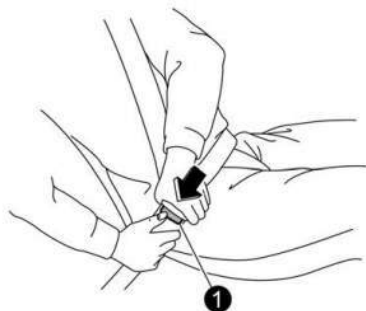

- Button

- Retract the seatbelt slowly to prevent it from getting tangled or twisted.

Before closing the door, make sure that the belts are retracted properly to avoid catching the belt webbing in the door.

### Rear center seatbelt

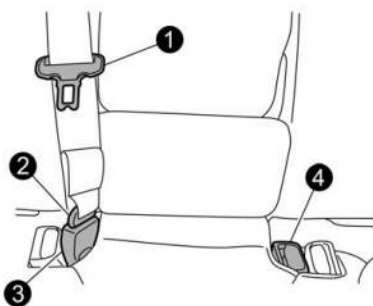

- Center seatbelt tongue plate
- Anchor tongue plate
- Anchor buckle
- Center seatbelt buckle

### ⚠ WARNING

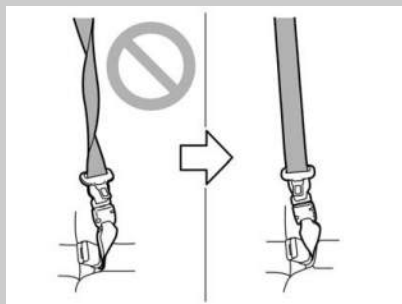

Fastening the seatbelt with the webbing twisted can increase the risk or severity of injury in an accident. When fastening the belt after it is pulled out from the retractor, especially when inserting the anchor tongue plate into the mating buckle (on right-hand side), always check that the webbing is not twisted.

**⚠ WARNING**



- Be sure to fasten both tongue plates to the respective buckles. If the seatbelt is used only as a shoulder belt (with the anchor tongue plate not fastened to the anchor buckle on the right-hand side), it cannot properly restrain the wearer in position in an accident, possibly resulting in serious injury or death.
- Before fastening the seatbelt, confirm that the seatbelt is routed through the belt guide. A seatbelt not routed through the belt guide can cause neck injuries during sudden braking or in a collision, since it may slip up on the neck.

Rear center seatbelt is stowed in the recess of the ceiling.

1. Retrieve the anchor tongue plate from the slot in the recess by pulling the anchor tongue plate, then pull out the seatbelt slowly. 1

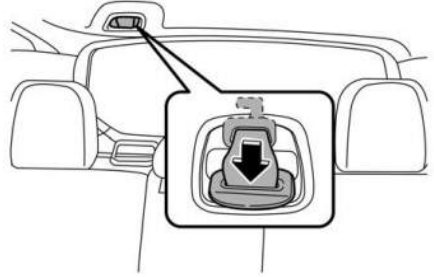

2. Pass the seatbelt through the belt guide.

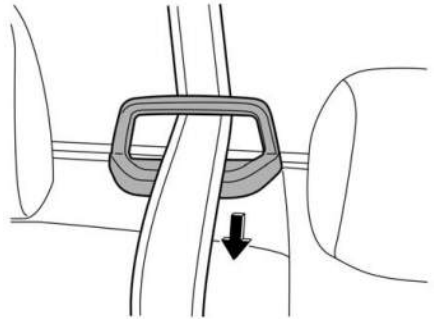

3. Make sure that the “▼” mark on the anchor tongue plate and the “▲” mark on the anchor buckle face outwards.

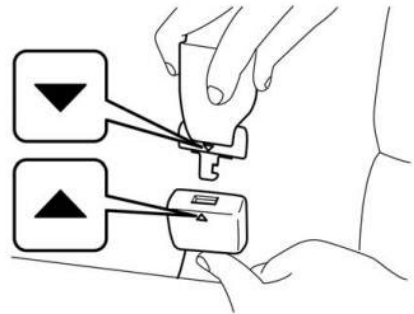

4. After confirming that the webbing is not twisted, insert the anchor tongue plate attached at the webbing end into the buckle on the right-hand side until a click sounds.

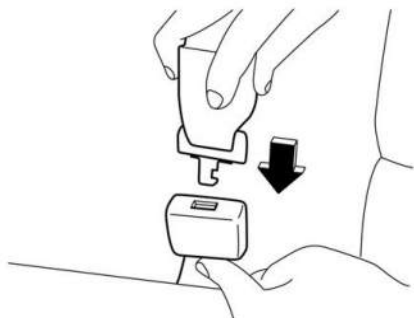

- If the belt stops before reaching the buckle, return the belt slightly and pull it out more slowly.
- If the belt still cannot be unlocked, give it a strong pull and let it retract slightly, then pull it out slowly again.

5. Insert the center seatbelt tongue plate into the center seatbelt buckle marked "CENTER" on the left-hand side until it clicks.



6. To tighten the lap part, pull up on the shoulder belt.



7. Place the lap belt as low as possible on the hips, not on the waist.

### Unfastening the seatbelt

1. Push the release button of the center seatbelt buckle (on the left-hand side) to unfasten the seatbelt.

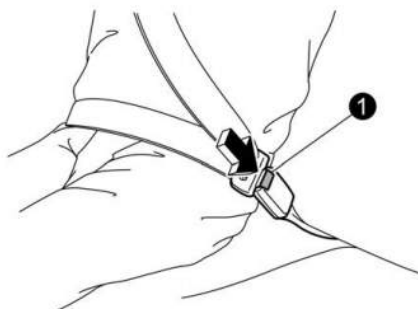

① Button

### NOTE

*When the seatback is folded down, it is necessary to disconnect the connector.*

2. Insert a tongue plate or other hard pointed object into the slot in the anchor buckle on the right-hand side and push it in. The anchor tongue plate will then disconnect from the buckle.

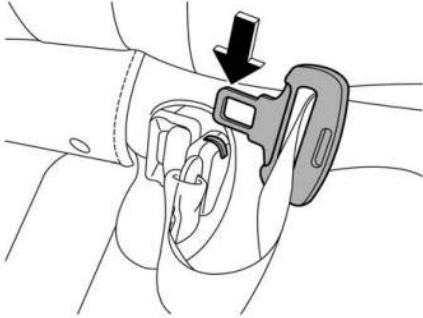

3. With the belt held by hand, allow the retractor to roll up the belt slowly. You should hold the webbing end and guide it back into the retractor while it is rolling up. Neatly store the tongue plate in the recess on the ceiling and then insert the anchor tongue plate into the slot located at the front of the recess.

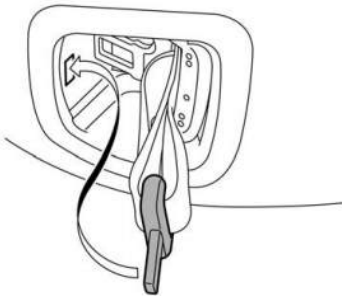
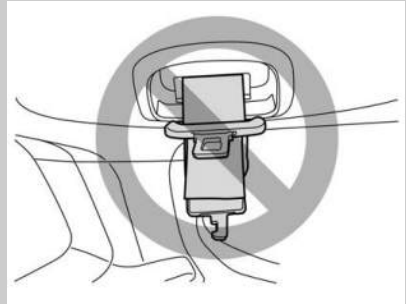
**CAUTION**

Observe the following precautions.

Otherwise, the tongue plate can hit against the trim, causing damage to the trim.

- Do not allow the retractor to roll up the seatbelt too quickly.
- Have the seatbelt fully rolled up so that the tongue plates are neatly stored.

**SEATBELT MAINTENANCE**

To clean the seatbelts, use a mild soap and lukewarm water. Never bleach or dye the belts because this could seriously affect their strength.

Inspect the seatbelts and attachments including the webbing and all hardware periodically for cracks, cuts, gashes, tears, damage, loose bolts or worn areas. Replace the seatbelts even if only minor damage is found.

**CAUTION**

- Keep the belts free of polishes, oils, chemicals and particularly battery acid.
- Never attempt to make modifications or changes that will prevent the seatbelt from operating properly.

## 1-5. SEATBELT PRETENSIONERS

The following seatbelts have a seatbelt pretensioner.

- Driver's seatbelt
- Front passenger's seatbelt
- Window-side rear passenger's seatbelts

The seatbelt pretensioners are designed to be activated in the event of an accident involving a moderate to severe frontal and side collision and rollover accident.



### WARNING

- To obtain maximum protection, the occupants should sit in an upright position with their seatbelts properly fastened. Refer to "Seatbelts" P55.
- Do not modify, remove or strike the seatbelt retractor assemblies equipped with seatbelt pretensioners or surrounding area. This could result in accidental activation of the seatbelt pretensioners or could make the system inoperative, possibly resulting in serious injury. Seatbelt pretensioners have no user-serviceable parts. For required servicing of seatbelt retractors equipped with seatbelt pretensioners, consult your SUBARU dealer.
- When discarding seatbelt retractor assemblies equipped with seatbelt pretensioners or scrapping the entire vehicle due to collision damage or for other reasons, consult your SUBARU dealer.

### NOTE

- *Seatbelt pretensioners are not designed to activate in minor impacts or in rear impacts. The pretensioner can also be activated by the following sensors.*

- Front impact sensors
- Side impact sensors
- Rollover sensor

- *Pretensioners are designed to function on a one-time-only basis. In the event that a pretensioner is activated, the seatbelt retractor assemblies equipped with seatbelt pretensioners should be replaced only by an authorized SUBARU dealer. When replacing seatbelt retractor assemblies, use only genuine SUBARU parts.*
- *If a seatbelt that has a seatbelt pretensioner does not retract or cannot be pulled out due to a malfunction or activation of the pretensioner, contact your SUBARU dealer as soon as possible.*
- *If the seatbelt retractor assembly or surrounding area has been damaged, contact your SUBARU dealer as soon as possible.*
- *When you sell your vehicle, we urge you to inform the buyer that the vehicle is equipped with seatbelt pretensioners. Also, notify the buyer of the contents in this section.*

## SEATBELT WITH SHOULDER BELT PRETENSIONER

### NOTE

*This section is applicable to the following components.*

- *Front passenger's seatbelt*
- *Rear passenger's seatbelt (window-side)*



If the sensor detects a certain predetermined amount of force during frontal or side collisions or rollover accidents, any seatbelt that has a seatbelt pretensioner is quickly drawn back in by the retractor to take up the slack so that the belt more effectively restrains the seat occupant.

The window-side rear passenger's seatbelt pretensioner includes a tension reducing device that limits the peak forces exerted by the seatbelt on the occupant in the event of a collision.

The front passenger's seatbelt pretensioner includes a tension reducing device which limits the peak forces exerted by the seatbelt on the occupant in the event of a collision.

- Adaptive force limiter

The front passenger's side adaptive force limiter will select a reducing load to suit the body size of the occupant as detected by the occupant detection sensor.

When a seatbelt pretensioner is activated, an operating noise will be heard and a small amount of smoke will be released. These occurrences are normal and not harmful. This smoke does not indicate a fire in the vehicle.

Once the seatbelt pretensioner has been activated, the seatbelt retractor remains locked. Consequently, the seatbelt cannot be pulled out and retracted and therefore must be replaced.

## SEATBELT WITH SHOULDER BELT AND LAP BELT PRETENSIONERS

### NOTE

*This section is applicable to the driver's seatbelt.*



- 1 Seatbelt retractor assembly (shoulder belt pretensioner and adaptive force limiter)
- 2 Lap belt pretensioner

If the sensor detects a certain predetermined amount of force during frontal or side collisions or rollover accidents, any seatbelt that has a seatbelt pretensioner is quickly drawn back in by the retractor to take up the slack so that the belt more effectively restrains the seat occupant.

The shoulder belt pretensioner is supplemented by a lap belt pretensioner, which is located at the base of the center pillar. The lap belt pretensioner instantaneously pulls in the belt to eliminate slack if a certain level of frontal collision force is detected. As a result, the seatbelt restrains the front seat occupant more effectively.

The driver's seatbelt pretensioner includes a tension reducing device which limits the peak forces exerted by the seatbelt on the occupant in the event of a collision.

- Adaptive force limiter

The driver's side adaptive force limiter will select a reducing load to suit the body size of the occupant as detected by the driver's seat position sensor.

When a seatbelt pretensioner is activated, an operating noise will be heard and a small amount of smoke will be released. These occurrences are normal and not harmful. This smoke does not indicate a fire in the vehicle.

Once the seatbelt pretensioner has been activated, the seatbelt pretensioner remains locked. Consequently, the seatbelt cannot be pulled out and retracted and therefore must be replaced.

## SYSTEM MONITORS

A diagnostic system continually monitors the readiness of the seatbelt pretensioner with the ignition switch in the "ON" position. The seatbelt pretensioners share the control module with the SRS airbag system. Therefore, if any malfunction occurs in a seatbelt pretensioner, the SRS airbag system warning light will illuminate. For details, refer to "SRS Airbag System Monitors"  P110.

## SYSTEM SERVICING



### WARNING

- When discarding a seatbelt retractor assembly or scrapping the entire vehicle damaged by a collision, consult your SUBARU dealer.
- Tampering with or disconnecting the system's wiring could result in accidental activation of the seatbelt pretensioner and/or SRS airbag or could make the system inoperative, which may result in serious injury. Do not use electrical test equipment on any circuit related to the seatbelt pretensioner and SRS airbag systems. For required servicing of the seatbelt pretensioner,

consult your nearest SUBARU dealer.



### CAUTION

For the locations of the sensors and control modules, refer to "Components"  P90.

If you need service or repair in those areas or near the front seatbelt retractors, have the work performed by your authorized SUBARU dealer.

### NOTE

*If the front or side part of the vehicle is damaged in an accident to the extent that the seatbelt pretensioner does not operate, contact your SUBARU dealer as soon as possible.*

## PRECAUTIONS AGAINST VEHICLE MODIFICATION

Always consult your SUBARU dealer if you want to install any accessory parts to your vehicle.



### CAUTION

Do not perform any of the following modifications. Such modifications can interfere with proper operation of the seatbelt pretensioners.

- Attachment of any equipment (bush bar, winches, snow plow, skid plate, etc.) other than genuine SUBARU accessory parts to the front end.
- Modification of the suspension system or front end structure.
- Installation of a tire of different size and construction from the tires specified on the vehicle placard attached to the driver's door pillar or specified for individual vehicle models in this Owner's Manual.



## 1-6. REAR SEAT REMINDER

This function prompts the driver to confirm the presence of passengers and cargo in the rear.

This function will be activated when the rear doors are opened and closed.

It alerts the driver by warning messages on the instrument cluster display and beeps when the ignition switch is turned from the "ON" position to the "OFF" position.



### NOTE

- *This function does not directly detect passengers and cargo in the rear seat.*
- *This function detects the opening and closing of the rear doors. In this situation, there is the possibility that the following phenomenon may occur.*
  - *It may alert the driver even if there are no passengers or cargo in the rear seat.*
  - *It may not alert the driver even if there are passengers and cargo in the rear seat.*
- *This function can be set to on or off by the "Settings". For details, refer to "Vehicle" P206.*
- *The ON/OFF setting will not be changed even if the ignition switch is turned to the "OFF" position.*
- *The ON/OFF setting will be returned to the default setting if the battery is removed.*

## 1-7. CHILD RESTRAINT SYSTEMS

### SAFETY PRECAUTIONS



Infants and children must be placed in an infant or child restraint system on the rear seat while riding in the vehicle.

You must use an infant or child restraint system that meets Federal Motor Vehicle Safety Standards or Canada Motor Vehicle Safety Standards, is compatible with your vehicle and is appropriate for the child's age and size.

All child restraint systems are designed to be secured in vehicle seats by lap belts or the lap belt portion of a lap/shoulder belt (except those described in "Installation of Child Restraint Systems by Use of Lower and Tether Anchors (LATCH)" P78).

Children could be endangered in an accident if their child restraint systems are not properly secured in the vehicle. When installing the child restraint system, carefully follow the manufacturer's instructions.

According to accident statistics, children are safer when properly restrained in the rear seating positions than in the front seating positions.

All U.S. states and Canadian provinces require that infants and small children be restrained in an approved child restraint system at all times while the vehicle is

moving.

### WARNING

- Before installing a child restraint system, be sure to confirm that the seatback is securely locked into place. Otherwise, in an accident, serious injury or death could result.
- Do not leave children in the car unattended. High interior temperatures may cause heat stroke and dehydration that result in serious injury or death.

### WARNING



Never let a passenger hold a child on their lap or in their arms while the vehicle is moving. The passenger cannot protect the child (or infant) from injury in a collision, because the child will be caught between the passenger and objects inside the vehicle. Additionally, if a passenger holds a child on their lap or in their arms in the front seat, they expose the child to another serious danger. Since the SRS airbag deploys with considerable speed and force, the child could be injured or even killed.

### WARNING

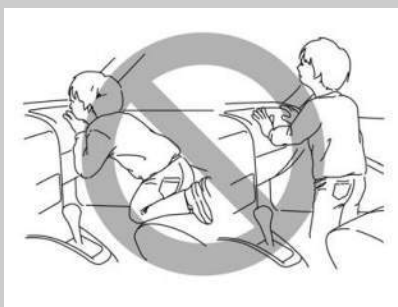

Children should be properly restrained at all times when in the vehicle. Never allow a child to stand or kneel on any seat. An unrestrained child will be thrown forward during a sudden stop or in an accident and can be injured seriously. Additionally, a child who stands or kneels on or in front of the front seat is exposed to another serious danger. Since the SRS airbag deploys with considerable speed and force, the child could be injured or even killed.

## SAFETY TIPS FOR INSTALLING CHILD RESTRAINT SYSTEMS

### WARNING

- Child restraint systems and seatbelts can become hot in a vehicle that has been closed up in sunny weather; they could burn a small child. Check the child restraint system before you place a child in it.
- Do not use a seatbelt extender. If a seatbelt extender is used when installing a child restraint system, the seatbelt will not securely hold the child restraint system. Use of a seatbelt extender could cause death or serious injury to children or other passengers in sudden braking, swerving, or accidents.

- Attach the child restraint system to the anchors properly. When using the LATCH anchors, be sure that there are no foreign objects around the anchors. Make sure the child restraint system is securely attached. Otherwise, it may cause death or serious injury to children or other passengers in sudden braking, swerving, or accidents.
- Do not leave an unsecured child restraint system in your vehicle. Unsecured child restraint systems can be thrown around inside of the vehicle in a sudden stop, turn or accident; they can strike and injure vehicle occupants as well as result in serious injuries or death to the child.
- Several types of child restraint systems may conceal the buckle of the neighboring seat. If the occupant of the neighboring seat cannot correctly fasten the seatbelt, that person must move to a different seat. If the seatbelt cannot be correctly fastened, there is the risk of serious injury or death in the event of sudden braking or a collision.
- If the child restraint system cannot be correctly installed because it contacts the driver's seat, move the child restraint system to a different seat. If it cannot be installed in a different seat (other than the driver's seat), adjust the front seat so that contact does not occur.
- Even with advanced airbags, infants and children can be seriously injured by the airbag. Seat children in the rear seat properly restrained. The SRS airbag deploys with considerable speed and force and can injure or even kill children, especially if they are not restrained or improperly restrained. Because children are lighter and weaker

than adults, their risk of being injured from deployment is greater. For that reason, be sure to secure ALL types of child restraint systems on the REAR seats. You should choose a restraint system which is appropriate for the child's age, height and weight. According to accident statistics, children are safer when properly restrained in the rear seating positions than in the front seating positions.

- Do not use lower anchors for a seat in the center seating position unless a child restraint system manufacturer's instructions permit and specify using anchors spaced as far apart as those in this vehicle.
- Do not connect two or more lower anchor attachments onto the same lower anchor.
- NEVER INSTALL A REARWARD FACING CHILD RESTRAINT SYSTEM ON THE FRONT PASSENGER'S SEAT. DOING SO RISKS SERIOUS INJURY OR DEATH TO THE CHILD BY PLACING THE CHILD'S HEAD TOO CLOSE TO THE SRS AIRBAG.
- Do not allow children to lean their heads or any other parts of their bodies against the door or the area of the seat, front and rear pillars or roof side rails. The SRS side airbags and SRS curtain airbags deploy even if children are seated in the child restraint system, and the impact could cause death or serious injury to the child.
- To secure the child restraint system, be sure to comply with all installation instructions provided by the child restraint system manufacturer. Not doing so could result in death or serious injury to children in a sudden stop or accident.
- When installing a child restraint system (except when using

LATCH), always ensure the seat belt is threaded through the belt guide to secure the child restraint system.



### CAUTION

When you install a child restraint system, follow the manufacturer's instructions supplied with it. After installing the child restraint system, check to ensure that it is held securely in position. If it is not held tight and secure, the danger of your child suffering personal injury in the event of an accident may be increased.

## CHOOSING A CHILD RESTRAINT SYSTEM



Choose a child restraint system that is appropriate for the child's age and size (weight and height) in order to provide the child with proper protection. The child restraint system should meet all applicable requirements of Federal Motor Vehicle Safety Standards for the United States or of Canada Motor Vehicle Safety Standards for Canada. It can be identified by looking for the label on the child restraint system or the manufacturer's statement of compliance in the document attached to the system. Also it is important for you to make sure that the child restraint system is compatible with the vehicle in which it will be used.

### NOTE

*Some sizes of child restraint systems may not fit the vehicle seat. Before purchasing a child restraint system, check whether it fits on the vehicle seat.*

## WHEN INSTALLING THE FORWARD FACING CHILD RESTRAINT SYSTEM ON THE FRONT PASSENGER'S SEAT



### WARNING



- NEVER INSTALL A REARWARD FACING CHILD RESTRAINT SYSTEM ON THE FRONT PASSENGER'S SEAT. DOING SO RISKS SERIOUS INJURY OR DEATH TO THE CHILD BY PLACING THE CHILD'S HEAD TOO CLOSE TO THE SRS AIRBAG.
- The front passenger's seat is not equipped with tether anchors. Therefore, when installing a child restraint system that uses tether, do not install it on the front passenger's seat.

Only forward facing child restraint systems (including booster seats) can be installed on this seat and should only be installed when it is unavoidable. When you install a forward facing child restraint system to the front passenger's seat, perform the following procedure.

1. Adjust the front passenger's seat as illustrated.



- 1 Seat position: Rearmost as possible
- 2 Seat cushion height (if equipped): Uppermost
- 3 Seatback: Upright

2. Install the child restraint system to the front passenger's seat. Refer to "Installing a forward facing child restraint system" P74.
3. Place and secure the child in the child restraint system.
4. Check that the front passenger's frontal airbag ON/OFF indicator light status meets the requirements of your child restraint system.



ON : Front passenger's frontal airbag ON indicator light

OFF : Front passenger's frontal airbag OFF indicator light

#### When front passenger's frontal airbag OFF indicator light is illuminated:

Only forward facing child restraint systems can be installed on the front passenger's seat.

#### When front passenger's frontal airbag ON indicator light is illuminated:

The child restraint systems cannot be installed on the front passenger's seat. Install the child restraint system on the rear seats. For more details, refer to "SUBARU Advanced Frontal Airbag System" P92.

5. Check that the child restraint system does not contact the head restraint. If the child restraint system does make contact with the head restraint, raise the head restraint to the extended position. If the child restraint system still makes contact, remove the head restraint. For details, refer to "Head Restraint Adjustment" P45.

## INSTALLING CHILD RESTRAINT SYSTEMS WITH ALR/ELR SEATBELT



### CAUTION

- When you install a child restraint system, follow the manufacturer's instructions supplied with it. After installing the child restraint system, check to ensure that it is held securely in position. If it is not held tight and secure, the danger of your child suffering personal injury in the event of an accident may be increased.
- When installing a child restraint system in the rear center seating position, set both seatbacks to the original position. Otherwise, the child restraint system cannot be securely restrained, which may result in death or serious injuries in the event of sudden stop, sudden steering maneuver or an accident.

## Installing a rearward facing child restraint system



### WARNING

- NEVER INSTALL A REARWARD FACING CHILD RESTRAINT SYSTEM ON THE FRONT PASSENGER'S SEAT. DOING SO RISKS SERIOUS INJURY OR DEATH TO THE CHILD BY PLACING THE CHILD'S HEAD TOO CLOSE TO THE SRS AIRBAG.
- Before installing a child restraint system, be sure to confirm that the seatback is securely locked into place. Otherwise, in an accident, serious injury or death could result.
- When installing a child restraint system in the rear seat, always ensure the seat belt is threaded through the belt guide to secure the

child restraint system.

1. Check that the shoulder belt is fitted in the belt guide. For details, refer to "Return the rear seatback" P49.

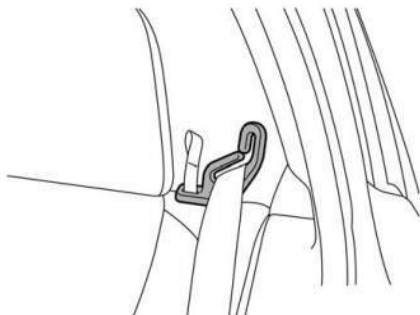

2. Place the child restraint system in the rear seating position.



### WARNING

When you intend to install a child restraint system in the rear center seating position, if the child restraint system does not fit snugly against the contours of the rear center seat cushion, install the child restraint system in the window-side seating position to be safe.

3. Run the lap and shoulder belt through or around the child restraint system following the instructions provided by its manufacturer.

4. Insert the tongue plate into the buckle until you hear a click.



5. Take up the slack in the lap belt.



6. If using the seatbelt in the ALR mode is recommended by the manufacturer's instructions supplied with the child restraint system, perform the following procedure.
- (1) Pull out the seatbelt fully from the retractor to change the retractor over from the Emergency Locking Retractor (ELR) to the Automatic Locking Retractor (ALR) mode.
  - (2) Allow the belt to rewind into the retractor. As the belt is rewinding, clicks will be heard which indicate the retractor functions as ALR.
7. Before having a child sit in the child restraint system, try to move it back and forth and right and left to check if it is firmly secured. Sometimes a child restraint system can be more firmly secured by pushing it down into the seat cushion and then tightening the

seatbelt. It should not be possible to move the child restraint system more than 1 in (2.5 cm) in any direction along the seatbelt path.

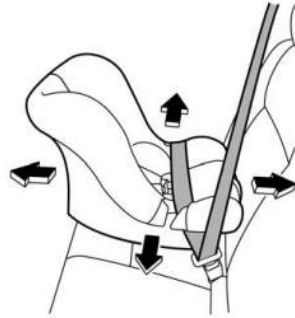

8. If the seatbelt has been set to the ALR mode in step 5, pull at the shoulder portion of the belt to confirm that it cannot be pulled out (ALR properly functioning).
9. To remove the child restraint system, press the release button on the seatbelt buckle and allow the belt to retract completely. The belt will return to the ELR mode.

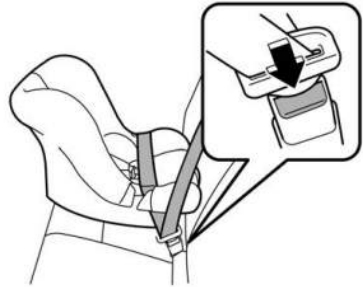



#### NOTE

*When the child restraint system is no longer in use, remove it and restore the ELR function of the retractor. That function is restored by allowing the seatbelt to retract fully.*

## Installing a forward facing child restraint system

### WARNING

- NEVER INSTALL A CHILD RESTRAINT SYSTEM ON THE FRONT PASSENGER'S SEAT IF THE FRONT PASSENGER'S FRONTAL AIRBAG ON INDICATOR LIGHT ILLUMINATES. DOING SO RISKS SERIOUS INJURY OR DEATH TO THE CHILD BY PLACING THE CHILD'S HEAD TOO CLOSE TO THE SRS AIRBAG.
- Before installing a child restraint system, be sure to confirm that the seatback is securely locked into place. Otherwise, in an accident, serious injury or death could result.
- When installing a child restraint system in the rear seat, always ensure the seat belt is threaded through the belt guide to secure the child restraint system.

1. Check that the shoulder belt is fitted in the belt guide. For details, refer to "Return the rear seatback"  P49 and "Rear center seatbelt"  P60.

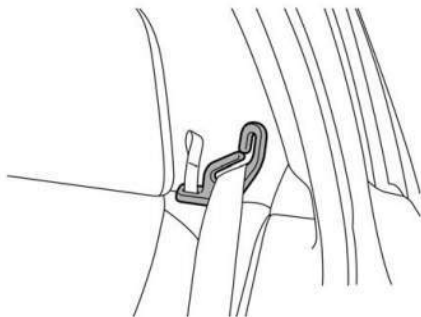

2. Place the child restraint system in the appropriate position.
3. For models with rear seat reclining mechanism, if there is a gap between the child restraint system and the

seatback, adjust the seatback angle until good contact is achieved.

4. If the child restraint system makes contact with the head restraint, raise the head restraint to the extended position. If the child restraint system still makes contact, remove the head restraint. For details, refer to "Head Restraint Adjustment"  P50.

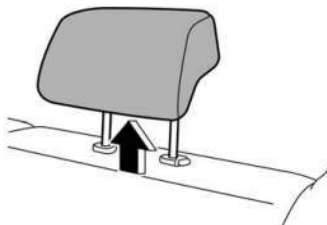

### WARNING

When you intend to install a child restraint system in the rear center seating position, if the child restraint system does not fit snugly against the contours of the rear center seat cushion, install the child restraint system in the window-side seating position to be safe.

### CAUTION

Store the removed head restraint in the cargo area. Do not place the head restraint in the passenger compartment to prevent it from being thrown around in the passenger compartment in a sudden stop or a sharp turn.

5. Run the lap and shoulder belt through the child restraint system following the instructions provided by its manufacturer.
  - When a child restraint system is installed on the rear center seating position, pass the rear center



seatbelt through the belt guide properly. For details, refer to "Rear center seatbelt" Ⓞ P60.



6. Insert the tongue plate into the buckle until you hear a click.
7. Take up the slack in the lap belt.

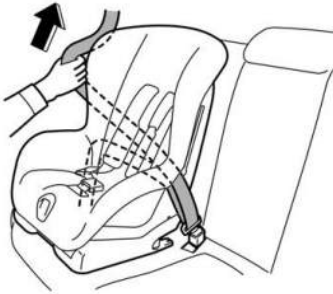

8. Pull out the seatbelt fully from the retractor to change the retractor over from the Emergency Locking Retractor (ELR) to the Automatic Locking Retractor (ALR) function. Then, allow the belt to rewind into the retractor. As the belt is rewinding, clicks will be heard which indicate the retractor functions as ALR.
9. Before having a child sit in the child restraint system, try to move it back and forth and right and left to check if it is firmly secured. Sometimes a child restraint system can be more firmly secured by pushing it down into the seat cushion and then tightening the seatbelt. It should not be possible to move the child restraint system more than 1 in (2.5 cm) in any direction

along the seatbelt path.



10. Pull at the shoulder portion of the belt to confirm that it cannot be pulled out (ALR properly functioning).
11. Attach the tether onto the tether anchor and tighten the tether firmly. For additional instructions, refer to "Tether anchors" Ⓞ P82.

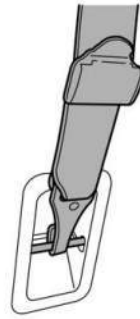

12. To remove the child restraint system, press the release button on the seat-belt buckle and allow the belt to retract completely. The belt will return to the ELR mode.



Remember that the head restraint is not intended to be used at the lowest position (retracted position). Therefore, when the rear center seat is occupied (including when a child restraint system is installed) next time, be sure to raise the head restraint to the extended position.

#### NOTE

*When the child restraint system is no longer in use, remove it and restore the ELR function of the retractor. That function is restored by allowing the seatbelt to retract fully.*

## INSTALLING A BOOSTER SEAT OR BOOSTER CUSHION

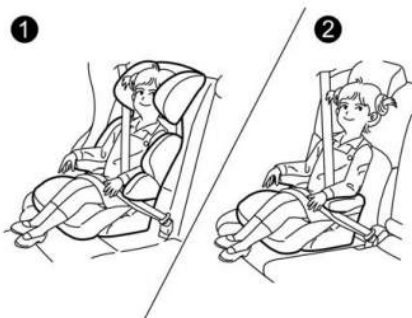

- ① Booster seat
- ② Booster cushion

### WARNING

- NEVER INSTALL A BOOSTER SEAT/CUSHION ON THE FRONT PASSENGER'S SEAT IF THE FRONT PASSENGER'S FRONTAL AIRBAG ON INDICATOR LIGHT ILLUMINATES. DOING SO RISKS SERIOUS INJURY OR DEATH TO THE CHILD BY PLACING THE CHILD'S HEAD TOO CLOSE TO THE SRS AIRBAG.
- When installing a booster seat/cushion in the rear seat, always ensure the seat belt is threaded through the belt guide to secure the booster seat/cushion.

1. Check that the shoulder belt is fitted into the belt guide. For details, refer to "Return the rear seatback" Ⓞ P49.

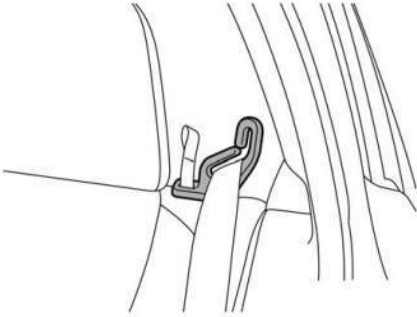

2. Adjust the head restraint as follows.

**For booster seat:**

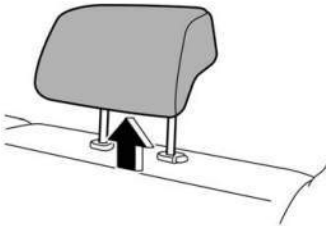

Raise the head restraint to the extended position. If the booster seat still makes contact, remove the head restraint. For details, refer to "Head Restraint Adjustment" Ⓞ P50.



**CAUTION**

Store the removed head restraint in the cargo area. Do not place the head restraint in the passenger compartment to prevent it from being thrown around in the passenger compartment in a sudden stop or a sharp turn.

**For booster cushion:**

Raise the head restraint to the extended position. Do not remove the head restraint.

3. Place the booster seat/cushion, and then sit the child on it. The child should sit well back on the booster seat/cushion.



4. For models with rear seat reclining mechanism, if there is a gap between the booster seat/cushion and the seatback, adjust the seatback angle until good contact is achieved.
5. Run the lap and shoulder belt following the instructions provided by its manufacturer. For booster seat/cushion with a belt guide, use the seatbelt through the belt guide.
6. Insert the tongue plate into the buckle until you hear a click. Take care not to twist the seatbelt.

Make sure the shoulder belt is positioned across the center of child's shoulder and that the lap belt is positioned as low as possible on the child's hips.

- To unfasten the seatbelt, press the release button on the seatbelt buckle and allow the belt to retract.



### **⚠ WARNING**

- Never use a belt that is twisted or reversed. In an accident, this can increase the risk or severity of injury to the child.
- Never place the shoulder belt under the child's arm or behind the child's back. If an accident occurs, this can increase the risk or severity of injury to the child.
- The seatbelt should fit snugly in order to provide full restraint. Loose fitting belts are not as effective in preventing or reducing injury.
- Place the lap belt as low as possible on the child's hips. A high-positioned lap belt will increase the risk of sliding under the lap belt and of the lap belt sliding up over the abdomen, and both can result in serious injury or death.
- Make sure the shoulder belt is positioned across the center of child's shoulder. Placing the shoulder belt over the neck may result in neck injury during sudden braking or in a collision.

## INSTALLATION OF CHILD RESTRAINT SYSTEMS BY USE OF LOWER AND TETHER ANCHORS (LATCH)

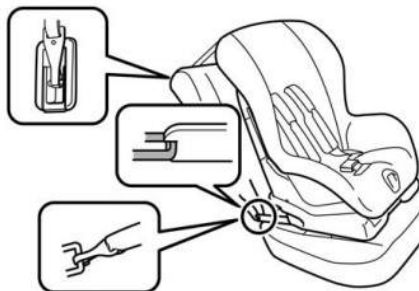

### **⚠ WARNING**

- Attach the child restraint system to the anchors properly. When using the LATCH anchors, be sure that there are no foreign objects around the anchors. Make sure the child restraint system is securely attached. Otherwise it may cause death or serious injury to children or other passengers in sudden braking, swerving, or accidents.
- When installing a child restraint system using LATCH anchors with the rear seatbelt fastened, ensure that the rear seatbelt does not become caught in the child restraint system or the lower LATCH anchors.

### NOTE

*The seatbelt warning system of the rear seats detects if any of the seats are occupied by a passenger. Installing a child restraint system in the rear seating area, using the LATCH anchors, may result in the activation of the passenger seatbelt warning light and chime. Fastening the rear seatbelt prior to installing the child restraint system will avoid activating the passenger seatbelt warning*

light and chime. For details, refer to “Rear passenger’s seats” *Ⓞ* P164.

Some types of child restraint systems can be installed on the rear seat of your vehicle without use of the seatbelts. Such child restraint systems are secured to the dedicated anchors provided on the vehicle body.

The lower and tether anchors are sometimes referred to as the LATCH system (**L**ower **A**nchors and **T**ethers for **CH**ildren).



Your vehicle is equipped with 5 lower anchors and 3 tether anchors for accommodating such child restraint systems.

## Lower anchors

### WARNING

Do not connect two or more lower anchor attachments onto the same lower anchor.

**Except for Canada-spec. models:**

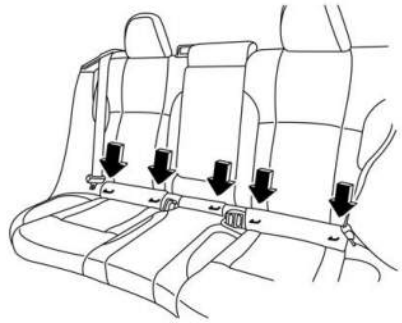

There are a total of 5 lower anchors at the rear seat. The second lower anchor from the right side is used for both the right seat and center seat. Each lower anchor is located where the seat cushion meets the seatback.

**Canada-spec. models:**

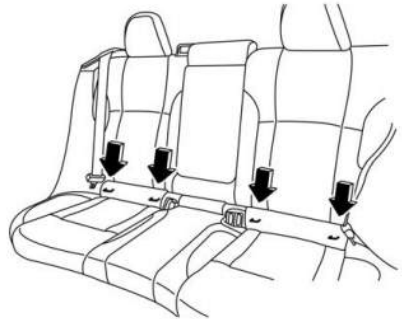

Two lower anchors are provided for installing a child restraint system in the rear seat window-side seating positions. Lower anchors for window-side seating positions may be used for a seat in the center seating position if a child restraint system manufacturer’s instructions permit this installation method and specify using anchors as far apart as those in this vehicle. Each lower anchor is located where the seat cushion meets the seatback.

## Using lower and tether anchors

**WARNING**

Before installing a child restraint system, be sure to confirm that the seatback is securely locked into place. Otherwise, in an accident, serious injury or death could result.

1. Move the seatback back and forth to confirm that it is securely locked into place. For details, refer to "Folding Down the Rear Seatback" P47.
2. You will find "Ⓜ" marks at the bottoms of the rear seatback. These marks indicate the positions of the lower anchors. Each lower anchor is located behind the cover of seatback bottom.

**Except for Canada-spec. models**

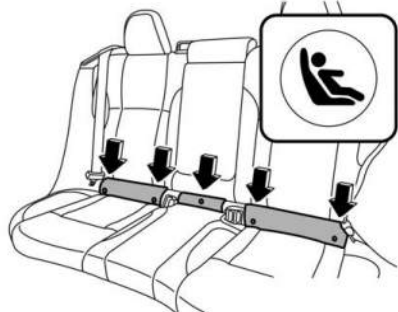

**Canada-spec. models**

**CAUTION**

When you install a child restraint system, follow the manufacturer's instructions supplied with it. After installing the child restraint system, check to ensure that it is held securely in position. If it is not held tight and secure, the danger of your child suffering personal injury in the event of an accident may be increased.

Peel off the lower anchor cover completely from the selected side of the rear seatback to expose the lower anchors to be used for installation of the child restraint system.

If it is hard to install the child restraint system because the lower anchor cover returns to the original position, press the lower anchor cover to the seat cushion until it is flat.

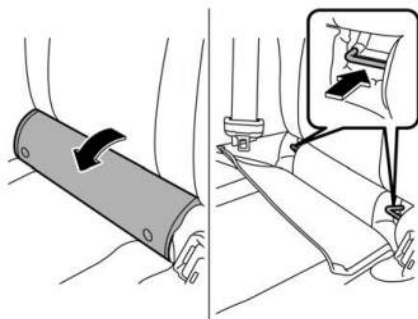

3. If the child restraint system makes contact with the head restraint of the rear seating position where the child restraint system is to be installed, raise the head restraint to the extended position. If the child restraint system still makes contact, remove the head restraint. For details, refer to "Head Restraint Adjustment" P50.

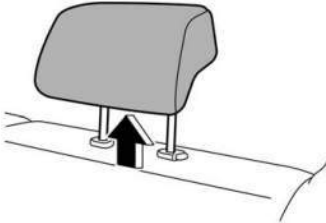
**CAUTION**

Store the removed head restraint in the cargo area. Do not place the head restraint in the passenger compartment to prevent it from being thrown around in the passenger compartment in a sudden stop or a sharp turn.

4. While following the instructions supplied by the child restraint system manufacturer, connect the lower anchor attachments onto the lower anchors located at "C" marks on the bottom of the rear seatback. When the hooks are connected, make sure the adjacent seatbelts are not caught.



5. For models with rear seat reclining mechanism, if there is a gap between the child restraint system and the seatback, adjust the seatback angle until good contact is achieved.
6. If your child restraint system is a flexible attachment type (which uses tether belts), push the child restraint system into the seat cushion and pull both left and right lower tether belts up to secure the child restraint system by taking up the slack in the belt.

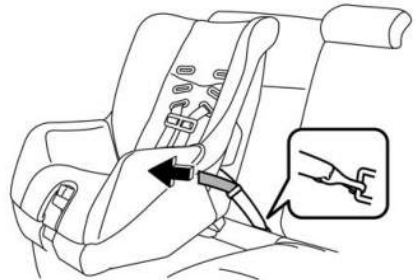

7. Attach the tether onto the tether anchor and tighten the tether firmly. For additional instructions, refer to "Tether anchors" P82.

8. Before having a child sit in the child restraint system, try to move it back and forth and right and left to check if it is firmly secured. Sometimes a child restraint system can be more firmly secured by pushing it down into the seat cushion. It should not be possible to move the child restraint system more than 1 in (2.5 cm).



9. To remove the child restraint system, follow the reverse procedures of installation.

SUBARU recommends that you check with a certified Child Passenger Safety Technician to ensure the proper installation of your child restraint system. For more information, and to locate the closest inspection location in the U.S., refer to the National Highway Traffic Safety Administration (NHTSA) website. In Canada, check with Transport Canada.

## Tether anchors

Your vehicle is equipped with three tether anchors so that a child restraint system having a tether can be installed in the rear seat. When installing a child restraint system using tether, proceed as follows, while observing the instructions by the child restraint system manufacturer.

Since a tether can provide additional stability by offering another connection between a child restraint system and the vehicle, we recommend that you use a tether whenever one is required or avail-

able.

### Tether anchor location:

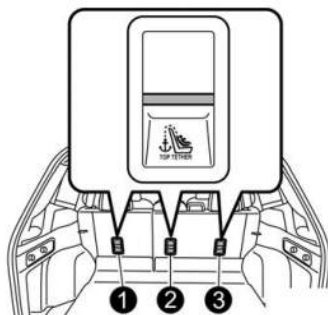

- ❶ Left seat anchor
- ❷ Center seat anchor
- ❸ Right seat anchor

Three tether anchors are installed on the back side of the rear seatback.

### To hook the tether:



### CAUTION

- Remove the head restraint when mounting a child restraint system. Otherwise, it might be possible that the tether anchor cannot be fastened tightly.
- Store the head restraint that has been removed in the cargo area. Do not place the head restraint in the passenger compartment to prevent it from being thrown around in a sudden stop or a sharp turn.



1. Attach the tether to the appropriate tether anchor.

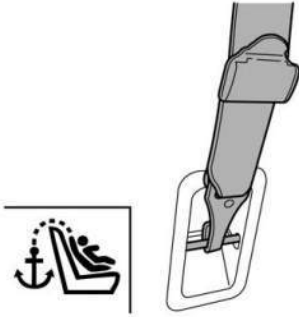

2. Tighten the tether securely.

SUBARU recommends that you check with a certified Child Passenger Safety Technician to ensure the proper installation of your child restraint system. For more information, and to locate the closest inspection location in the U.S., refer to the National Highway Traffic Safety Administration (NHTSA) website. In Canada, check with Transport Canada.

## 1-8. SRS AIRBAG (Supplemental Restraint System Airbag)

Supplemental Restraint System (SRS) name is used because the airbag system supplements the vehicle's seatbelts.

Your vehicle is equipped with a supplemental restraint system in addition to a lap/shoulder belt at each front seating position and each rear window-side seating positions.

The system also controls seatbelt pretensioners. For operation instructions and precautions concerning the seatbelt pretensioner, refer to "Seatbelt Pretensioners" P64.

## GENERAL PRECAUTIONS REGARDING SRS AIRBAG SYSTEM

### WARNING

To obtain maximum protection in the event of an accident, the driver and all passengers must always wear seatbelts when in the vehicle. The SRS airbags are designed only to be a supplement to the primary protection provided by the seatbelt. They do not eliminate the need to fasten seatbelts. Used in combination with the seatbelts, the SRS airbag offers vehicle occupants the best possible protection in the event of a serious accident.

Not wearing a seatbelt increases the chance of severe injury or death in a crash even when the vehicle has the SRS airbag.

For instructions and precautions concerning the seatbelt system, refer to "Seatbelts" P55.

**⚠ WARNING**

The SRS airbags deploy with considerable speed and force. Occupants who are not seated in the proper upright position when the SRS airbag deploys could suffer very serious injuries. Because the SRS airbag needs enough space for deployment, the driver should always sit upright and well back in the seat as far from the steering wheel as practical while still maintaining full vehicle control, and the front passenger should move the seat as far back as possible and sit upright and well back in the seat.

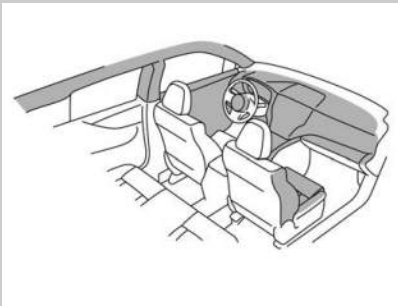
**⚠ WARNING**

- If you notice any damage or cracks where an SRS airbag is stored, have it replaced by an authorized SUBARU dealer.

- Do not strike the area around SRS airbag system component parts or subject the area to impact.

**⚠ WARNING**

- Do not sit or lean close to either front door. The SRS side airbags are stored in both front seat seat-backs next to the door, and they provide protection by deploying rapidly in the event of a side impact collision. However, the force of SRS side airbag deployment can injure an occupant if they are too close to an SRS airbag.
- Since this vehicle is equipped with SRS curtain airbags, do not sit or lean close to the front or rear door on either side. Do not put body parts out of the window. The SRS curtain airbags on both sides of the cabin are stored in the roof side (between the front pillar and a point behind the rear quarter glass), and they provide protection by deploying rapidly in the event of a side impact, rollover or an offset frontal collision. However, the force of its deployment can injure an occupant if they are too close to an SRS airbag.
- Do not sit or lean close to the SRS airbag. Because the SRS airbag deploys with considerable speed and force to protect in high speed collisions, the force of an airbag

can injure an occupant whose body is too close to SRS airbag.

It is also important to wear a seatbelt to help avoid injuries that can result when the SRS airbag contacts an occupant who is not seated in the proper upright position.

Even when properly positioned, there remains a possibility that an occupant may suffer minor injuries, such as abrasions and bruises to the face or arms, because of the SRS airbag deployment force.

### WARNING



- Keep arms away from either door or its internal trim. Vehicle occupants could be injured in the event of SRS side airbag deployment.
- Do not place any objects over or near the SRS airbag cover or between you and the SRS airbag. If the SRS airbag deploys, these objects could interfere with its proper operation and could be propelled inside the vehicle, causing injury.

### CAUTION

- When the SRS airbag deploys, some smoke will be released. This smoke could cause breathing problems for people with a history of asthma or other breathing trouble. If you or your passengers have breathing problems after SRS airbag deploys, get fresh air promptly.
- A deploying SRS airbag releases hot gas. Occupants could get burned if they come into direct contact with the hot gas.

### NOTE

- When you sell your vehicle, we urge you to inform the buyer that the vehicle is equipped with SRS airbags. Also, notify the buyer of the applicable section in this Owner's Manual.
- If the SRS airbag deploys, fuel supply will be cut off to reduce the risk of fire caused by leaking fuel. For details about restarting of the engine, refer to "If Your Vehicle Is Involved in an Accident"  P456.

## GENERAL PRECAUTIONS REGARDING SRS AIRBAG SYSTEM FOR ACCESSORIES AND ANY OBJECTS

### WARNING

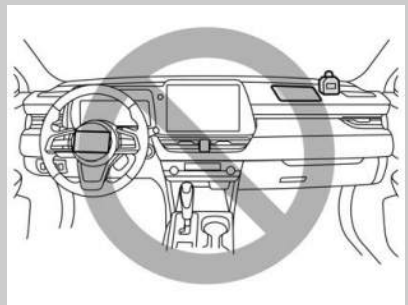

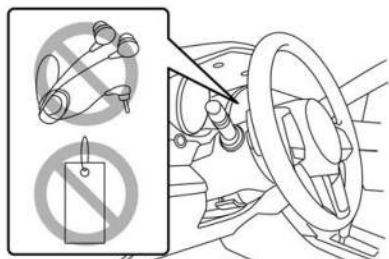

- Do not put any objects (including straps or cords) over the steering wheel pad, column cover, or dashboard.
  - These objects could be entangled with the steering wheel, preventing the SRS frontal airbag, etc. from operating properly.
  - If the SRS frontal airbag deploys, these objects could be propelled inside the vehicle, causing injury.
- Do not put any objects under the driver's side of the instrument panel. If the SRS knee airbag deploys, those objects could interfere with its proper operation and could be propelled inside the vehicle, causing injury.

**! WARNING**



Do not attach accessories to the windshield, or fit an extra-wide mirror

over the inside rear view mirror. If the SRS airbag deploys, those objects could become projectiles that could seriously injure vehicle occupants.

**! WARNING**



- Do not attach accessories to the door trim or near either SRS side airbags and do not place objects near the SRS side airbags. In the event of SRS side airbag deployment, they could be propelled dangerously toward the vehicle's occupants and cause injuries.
- Do not attach a hands-free microphone or any other accessory to a front pillar, a center pillar, a rear pillar, the windshield, a side window, an assist grip, or any other cabin surface that would be near a deploying SRS curtain airbag. A hands-free microphone or other accessory in such a location could be propelled through the cabin with great force by the curtain airbag, or it could prevent correct deployment of the curtain airbag. In either case, the result could be serious injuries.
- Never hang or place coat hangers or other hard or pointed objects near the side windows. If such items are present when the SRS curtain airbags deploy, they could be thrown through the passenger compartment and cause serious injuries. They could also prevent

proper operation of the SRS curtain airbags.

**! WARNING**

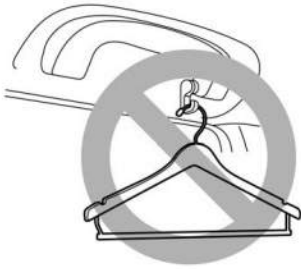

Do not hang coat hangers or other hard or pointed objects on the coat hooks. If such items were hanging on the coat hooks during deployment of the SRS curtain airbags, they could cause serious injuries by coming off the coat hooks and being thrown through the cabin or by preventing deployment of the curtain airbags.

Before hanging clothing on the coat hooks, make sure there are no sharp objects in the pockets. Hang clothing directly on the coat hooks without using hangers.

**! WARNING**



- Do not put any kind of clothes or other objects over the driver's seat and front passenger's seatback

and do not attach labels or stickers to the driver's seat and front passenger's seat surface on or near the SRS side airbag or the SRS seat cushion airbag. They could prevent proper deployment of the SRS side airbag or the SRS seat cushion airbag, reducing protection available to the occupant of the driver's seat or the front passenger's seat.

- Do not install a seat cover unless it is a genuine SUBARU seat cover exclusively designed for use with the SRS airbag. Even when using a genuine SUBARU seat cover, the SRS side airbag or the SRS seat cushion airbag may not function normally if the seat cover is not installed correctly.

## GENERAL PRECAUTIONS REGARDING SRS AIRBAG SYSTEM AND CHILDREN

**! WARNING**



SUBARU strongly recommends that ALL infants and children (including those in child restraint systems) sit in the REAR seat properly restrained in a child restraint system or in a seatbelt, whichever is appropriate for the child's age, height and weight. The SRS airbag deploys with considerable speed and force and can injure or even kill children, especially if they are

not restrained or improperly restrained. Because children are lighter and weaker than adults, their risk of being injured from deployment is greater. According to accident statistics, children are safer when properly restrained in the rear seating positions than in the front seating positions. For instructions and precautions concerning child restraint systems, refer to "Child Restraint Systems" P67.

**WARNING**



NEVER INSTALL A REARWARD FACING CHILD RESTRAINT SYSTEM ON THE FRONT PASSENGER'S SEAT, AND NEVER INSTALL A FORWARD FACING CHILD RESTRAINT SYSTEM ON THE FRONT PASSENGER'S SEAT IF THE FRONT PASSENGER'S FRONTAL AIRBAG ON INDICATOR LIGHT ILLUMINATES. DOING SO RISKS SERIOUS INJURY OR DEATH TO THE CHILD BY PLACING THE CHILD'S HEAD TOO CLOSE TO THE SRS AIRBAG.

**WARNING**

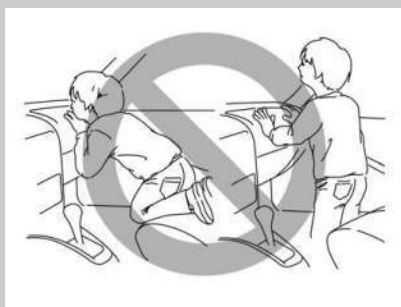

Never allow a child to stand up or kneel on the front passenger's seat. The SRS airbag deploys with considerable force and can injure or even kill the child.

**WARNING**



Never hold a child on your lap or in your arms. The SRS airbag deploys with considerable force and can injure or even kill the child.

**⚠ WARNING**

- Never allow a child to do the following.
  - Kneel on any passenger's seat facing the side window.
  - Wrap his/her arms around the front seat seatback.
  - Put his/her head, arms or other parts of the body out of the window.

In the event of an accident, the force of SRS side airbag and/or SRS curtain airbag deployment could injure the child seriously because his/her head, arms or other parts of the body are too close to the SRS side airbag and/or SRS curtain airbag.

- Since your vehicle is also equipped with a front passenger's SRS frontal airbag, children and infants should be placed on the rear seat anyway and should be properly restrained at all times.

## COMPONENTS

The SRS airbags are stowed in the following locations.

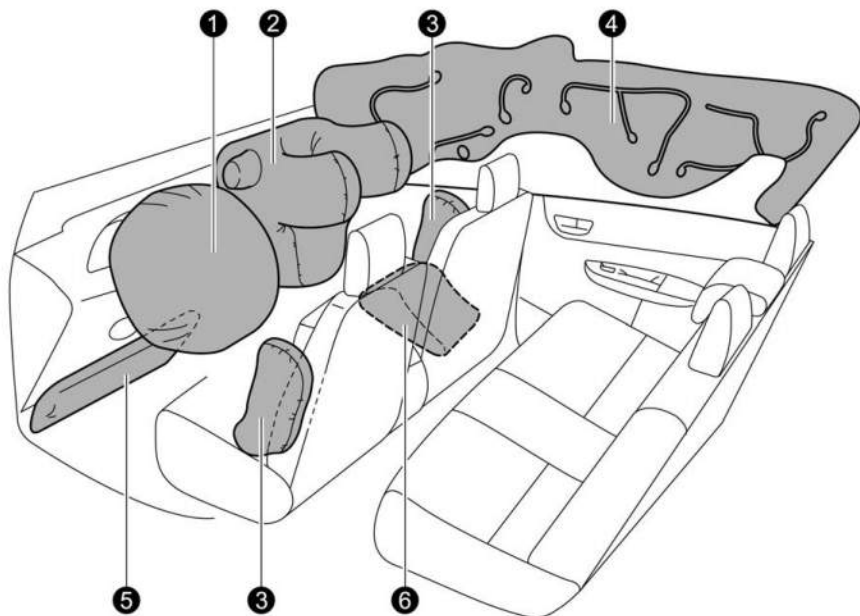

- ❶ **Driver's SRS frontal airbag:** in the center portion of the steering wheel
- ❷ **Front passenger's SRS frontal airbag:** near the top of the dashboard
- ❸ **SRS side airbag:** in the door side of each front seat seatback
- ❹ **SRS curtain airbag:** in the roof side (between the front pillar and a point over the rear seat)
- ❺ **SRS knee airbag:** under the steering column
- ❻ **SRS seat cushion airbag:** in the front passenger's seat cushion



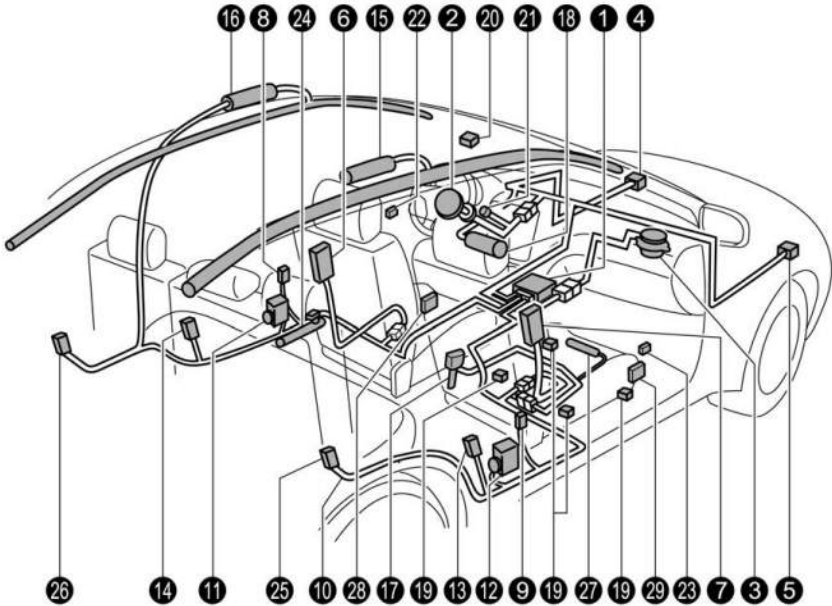

- |  |  |
|--|--|
| <ul style="list-style-type: none"> <li>① Airbag control module (including impact sensor and rollover sensor)</li> <li>② Frontal airbag module (driver's side)</li> <li>③ Frontal airbag module (front passenger's side)</li> <li>④ Front impact sensor (left-hand side)</li> <li>⑤ Front impact sensor (right-hand side)</li> <li>⑥ Side airbag module (driver's side)</li> <li>⑦ Side airbag module (front passenger's side)</li> <li>⑧ Side impact sensor (center pillar left-hand side)</li> <li>⑨ Side impact sensor (center pillar right-hand side)</li> <li>⑩ Airbag wiring</li> <li>⑪ Seatbelt pretensioner and adaptive force limiter (driver's side)</li> <li>⑫ Seatbelt pretensioner and adaptive force limiter (front passenger's side)</li> <li>⑬ Side impact sensor (rear wheel house right-hand side)</li> <li>⑭ Side impact sensor (rear wheel house left-hand side)</li> </ul> | <ul style="list-style-type: none"> <li>⑮ Curtain airbag module (right-hand side)</li> <li>⑯ Curtain airbag module (left-hand side)</li> <li>⑰ Seatbelt buckle switch (front passenger's side)</li> <li>⑱ Knee airbag module (driver's side)</li> <li>⑲ Front passenger's occupant detection sensors</li> <li>⑳ Front passenger's frontal airbag ON and OFF indicator lights</li> <li>㉑ SRS airbag system warning light</li> <li>㉒ Side impact sensor (front door left-hand side)</li> <li>㉓ Side impact sensor (front door right-hand side)</li> <li>㉔ Lap belt pretensioner (driver's side)</li> <li>㉕ Rear seatbelt pretensioner (front passenger's side)</li> <li>㉖ Rear seatbelt pretensioner (driver's side)</li> <li>㉗ Seat cushion airbag module (front passenger's side)</li> <li>㉘ Driver's seat position sensor</li> <li>㉙ Passenger's seat position sensor</li> </ul> |
|--|--|

## SUBARU ADVANCED FRONTAL AIRBAG SYSTEM

This vehicle is equipped with a SUBARU advanced frontal airbag system that complies with the new advanced frontal airbag requirements in the amended Federal Motor Vehicle Safety Standard (FMVSS) No. 208.

The SUBARU advanced frontal airbag system automatically determines the deployment force of the driver's SRS frontal airbag at the time of deployment as well as whether or not to activate the front passenger's SRS frontal airbag and, if activated, the deployment force of the SRS frontal airbag at the time of deployment.



This vehicle has warning labels on the driver's and front passenger's sun visors beginning with the phrase "EVEN WITH ADVANCED AIR BAGS" and a tag attached to the glove box lid beginning with the phrase "Even with Advanced Air Bags". Make sure that you carefully read the instructions on the warning labels and tag.

Always wear your seatbelt. The SUBARU advanced frontal airbag system is a supplemental restraint system and must be used in combination with a seatbelt. All occupants should wear a seatbelt or be seated in an appropriate child restraint system.

For the locations of the SRS airbags, refer to "Components" P90.

In a moderate to severe frontal collision, the following components deploy.

- SRS frontal airbag for driver
- SRS frontal airbag for front passenger
- SRS seat cushion airbag for front passenger
- SRS curtain airbag
- SRS knee airbag for driver

These components supplement the seatbelts by reducing the impact to the occupant's head, chest and knees.

### NOTE

*Only driver's SRS frontal airbag and front passenger's SRS frontal airbag are controlled by the SUBARU advanced frontal airbag system.*

## Driver's SRS frontal airbag

The driver's SRS frontal airbag uses a dual stage inflator. The inflator operates in different ways depending on the severity of impact.

## Front passenger's SRS frontal airbag

The front passenger's SRS frontal airbag uses a dual stage inflator. The inflator operates in different ways depending on the severity of impact.

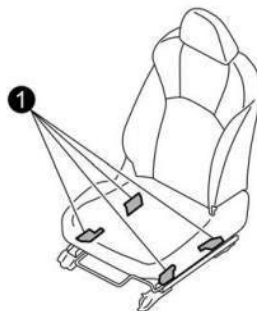

**1** Occupant detection sensors

The occupant detection sensors are installed between the seat and seat rails, and monitor the physique and posture of

the front passenger. Using this information, the occupant detection system determines whether the front passenger's SRS frontal airbag should be deployed or not.

The occupant detection system may not inflate the front passenger's SRS frontal airbag even when the driver's SRS frontal airbag deploys. This is normal. In this case, although the front passenger's SRS frontal airbag does not operate, the front passenger's seatbelt pretensioner operates with the driver's seatbelt pretensioner. For details about the seatbelt pretensioner, refer to "Seatbelt Pretensioners" P64.

### CAUTION

Observe the following precautions. Failure to do so may prevent the SUBARU advanced frontal airbag system from functioning correctly or cause the system to fail.

- Do not apply any strong impact to the front passenger's seat such as by kicking.
- Do not let rear passengers rest their feet between the front seatback and seat cushion.
- Do not remove or disassemble the front passenger's seat.
- Do not install any accessory (such as an audio amplifier) other than a genuine SUBARU accessory under the front passenger's seat.
- Do not place anything (shoes, umbrella, etc.) under the front passenger's seat.
- Do not place any objects (books, etc.) around the front passenger's seat.
- Do not use the front passenger's seat with the head restraint removed.
- Do not leave any articles on the front passenger's seat or the

seatbelt tongue and buckle engaged when you leave your vehicle.

- Do not put sharp object(s) on the seat or pierce the seat upholstery.
- Do not place a magnet near the seatbelt buckle and the seatbelt retractor.
- Do not use front seats with their backward-forward position and seatback not being locked into place securely. If any of them are not locked securely, adjust them again. For adjusting procedure, refer to "Manual Seat" P39 (models equipped with manual seats only).

### SRS airbag system warning light



If the seatbelt buckle switch and/or front passenger's occupant detection system have failed, the SRS airbag system warning light will illuminate. If the SRS airbag system warning light illuminates, immediately stop the vehicle in a safe place, and consult a SUBARU dealer.

If your vehicle has sustained impact, this may affect the proper function of the SUBARU advanced frontal airbag system. Have your vehicle inspected at your SUBARU dealer. Do not use the front passenger's seat while driving the vehicle to your SUBARU dealer.

## Passenger's frontal airbag ON and OFF indicator lights



ON : Front passenger's frontal airbag ON indicator light

OFF : Front passenger's frontal airbag OFF indicator light

Refer to "Front Passenger's Frontal Airbag ON and OFF Indicator Lights"  
P166.

## Occupant detection system

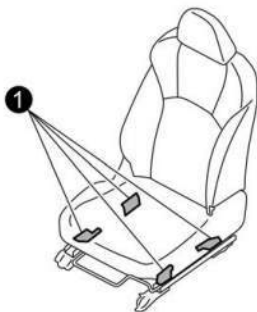

1 Occupant detection sensors

The occupant detection sensors are installed between the seat and seat rails, and monitor the physique and posture of the front passenger. Using this information, the occupant detection system determines whether the following airbags should be deployed or not.

- Front passenger's SRS frontal airbag
- Front passenger's SRS seat cushion airbag

## WARNING

Do not kick the front passenger seat or subject it to severe impact. Otherwise, the SRS airbag system warning light may illuminate to indicate a malfunction of the front passenger occupant detection system. In this case, immediately stop the vehicle in a safe place, and consult a SUBARU dealer.

If the front passenger's frontal airbag ON and OFF indicator lights do not work properly, do not allow anyone to sit on the front passenger's seat and have the occupant detection system checked by your SUBARU dealer.

Also, if luggage is placed on the front passenger's seat, this may adversely affect the ability of the system to determine deployment. This may prevent the front passenger's frontal airbag ON and OFF indicator lights from working properly. Check that the indicator lights work properly.

When the OFF indicator light turns off and the ON indicator light illuminates, the front passenger's frontal airbag may deploy during a collision. Remove luggage from the front passenger's seat.

## Conditions in which front passenger's SRS frontal airbag is not activated

The front passenger's SRS frontal airbag will not be activated when any of the following conditions are met regarding the front passenger's seat:

- The seat is empty.
- The seat is equipped with an appropriate child restraint system and an infant or a child is restrained in it. (See WARNING that follows.)
- The front passenger's occupant detection system is malfunctioning.

### WARNING

NEVER INSTALL A REARWARD FACING CHILD RESTRAINT SYSTEM ON THE FRONT PASSENGER'S SEAT EVEN IF THE FRONT PASSENGER'S SRS FRONTAL AIRBAG IS DEACTIVATED. Be sure to install it correctly in the REAR seat. Also, it is strongly recommended that any child seat or booster seat be installed in the REAR seat, and that even children who have outgrown a child restraint system be also seated in the REAR seat. This is because children sitting in the front passenger's seat may be killed or severely injured should the front passenger's SRS frontal airbag deploy. REAR seats are the safest place for children.

### CAUTION

When the front passenger's seat is occupied by an infant in an appropriate child restraint system, observe the following precautions. Failure to do so may interfere with the proper operation of the occupant detection system, activating the front passenger's SRS frontal airbag even though that seat is occupied by the infant in the child restraint system.

- Do not place any article on the seat other than the infant in the child restraint system.
- Do not place more than one infant in the child restraint system.
- Do not install any accessory such as a table or TV onto the seatback.
- Do not store a heavy load in the seatback pocket.
- Do not allow the rear seat occupant to place his/her hands or legs on the front passenger's seatback, or allow him/her to pull the seatback.

If the front passenger's frontal airbag ON indicator light illuminates and the OFF indicator light turns off even when an infant or a small child is in a child restraint system (including booster seat)



: Front passenger's frontal airbag ON indicator light

1. Turn the ignition switch to the "OFF" position.
2. Remove the child restraint system from the seat.
3. By referring to the child restraint manufacturer's recommendations as well as the child restraint system installation procedures in "Child Restraint Systems"  P67, correctly install the child restraint system.
4. Turn the ignition switch to the "ON" position and make sure that the front passenger's frontal airbag ON indicator light turns off and the OFF indicator light illuminates.

If still the ON indicator light remains illuminated while the OFF indicator light turns off, take the following actions.

- Ensure that no article is placed on the seat other than the child restraint system and the child occupant.
- For models with manual seat, ensure that the backward-forward position and seatback of front passenger's seat are locked into place securely by

moving the seat back and forth.

- Ensure that there is no article left in the seatback pocket.

If the ON indicator light still remains illuminated while the OFF indicator light turns off after taking the relevant corrective actions described above, relocate the child restraint system to the rear seat and immediately contact your SUBARU dealer for an inspection.

### NOTE

*When a child who has outgrown a child restraint system or a small adult is seated in the front passenger's seat, the SUBARU advanced frontal airbag system may or may not activate the front passenger's SRS frontal airbag depending on the occupant's seating posture. Children should always wear a seatbelt when sitting in the seat irrespective of whether the airbag is deactivated or activated. If the front passenger's SRS frontal airbag is activated (the ON indicator light remains illuminated while the OFF indicator light turns off), take the following action.*

- Ensure that no article is placed on the seat other than the occupant.

*If the ON indicator light still remains illuminated while the OFF indicator light turns off despite the fact that the actions noted above have been taken, seat the child in the rear seat and immediately contact your SUBARU dealer for an inspection. Even if the system has passed the dealer inspection, it is recommended that on subsequent trips the child always take the rear seat.*

Children who have outgrown a child restraint system should always wear the seatbelt irrespective of whether the airbag is deactivated or activated.

### Conditions in which front passenger's SRS frontal airbag is activated

The front passenger's SRS frontal airbag will be activated for deployment upon

impact when any of the following conditions are met regarding the front passenger's seat.

- When the seat is occupied by an adult.
- When certain items (e.g. jug of water) are placed on the seat.

When the front passenger's seat is occupied by an adult, observe the following precautions. Failure to do so may lessen the load on the front passenger's seat, deactivating the front passenger's SRS frontal airbag despite the fact that the seat is occupied by an adult. This may result in personal injury.

- Do not allow the rear seat occupant to lift the front passenger's seat cushion using his/her feet.
- Do not place any article under the front passenger's seat, or squeeze any article from behind and under the seat. This may lift the seat cushion.
- Do not squeeze any article between the front passenger's seat and side trim/pillar, door or center console box. This may lift the seat cushion.

### If the passenger's frontal airbag OFF indicator light illuminates and the ON indicator light turns off even when the front passenger's seat is occupied by an adult



**OFF** Front passenger's frontal airbag OFF indicator light

This can be caused by the adult incorrectly sitting in the front passenger's seat.

1. Turn the ignition switch to the "OFF" position.
2. Ask the front passenger to set the seatback to the upright position, sit up straight in the center of the seat cushion, correctly fasten the seatbelt, position his/her legs out forward, and adjust the seat to the rearmost position.
3. Turn the ignition switch to the "ON" position.

If the OFF indicator light remains illuminated while the ON indicator light remains off, take the following actions.

1. Turn the ignition switch to the "OFF" position.
2. Make sure that the front passenger does not use a blanket, extra seat cushion, seat cover, seat heater or massager, etc.
3. If wearing excessive layers of clothing, the front passenger should remove any unnecessary items before sitting in the front passenger's seat, or should sit in a rear seat.
4. Turn the ignition switch to the "ON" position and wait 6 seconds to allow the system to complete self-checking. Following the system check, both indicator lights turn off for 2 seconds. Now, the ON indicator light should illuminate while the OFF indicator light remains off.

If the OFF indicator light still remains illuminated while the ON indicator light remains off, ask the occupant to move to the rear seat and immediately contact your SUBARU dealer for an inspection.

## Operation

### Driver's side:

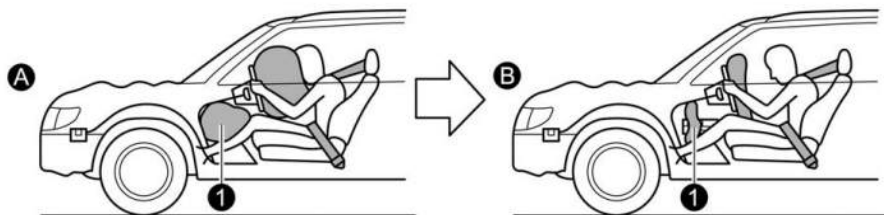

**A** SRS AIRBAGs deploy as soon as a collision occurs.

**B** After deployment, SRS AIRBAGs start to deflate immediately so that the driver's vision is not obstructed.

**1** Knee airbag

### Passenger's side:

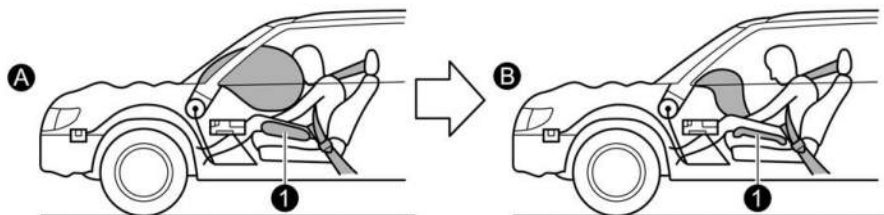

**A** SRS AIRBAGs deploy as soon as a collision occurs.

**B** After deployment, SRS AIRBAGs start to deflate immediately.

**1** Seat cushion airbag

The SRS airbags can function only when the ignition switch is in the "ON" position.

The SUBARU advanced frontal airbag system is designed to determine the activation or deactivation condition of the front passenger's SRS frontal airbag depending on the characteristic of item(s) or person on the front passenger's seat monitored by the front passenger's occupant detection sensors. For this rea-

son, only the driver's SRS frontal airbag may deploy in the event of a collision, but this does not mean failure of the system.

If the following sensors detect a predetermined amount of force during a frontal collision, the control module sends signals to the airbag module(s) (only driver's module or both driver's and front passenger's modules) instructing the module(s) to inflate the SRS frontal airbag(s).



- The front impact sensors
- The impact sensors in the airbag control module

On the driver's side, the SRS knee airbag also inflates with the SRS frontal airbag.

### After deployment

After deployment, the SRS airbag immediately starts to deflate so that the driver's vision is not obstructed and the driver's ability to maintain control of the vehicle is not impaired.

When only the SRS frontal airbag for the driver is deployed, or when the SRS frontal airbags for both the driver and front passenger are deployed, the seatbelt pretensioners for the driver and front passenger are activated at the same time.

When the SRS airbag deploys, a sudden, fairly loud inflation noise will be heard and some smoke will be released. These occurrences are a normal result of the deployment. This smoke does not indicate a fire in the vehicle.



#### CAUTION

Do not touch the SRS airbag system components around the steering wheel and dashboard with bare hands right after deployment. Doing so can cause burns because the components can be very hot as a result of deployment.

### Example of the type of accident

The driver's SRS frontal airbag and front passenger's SRS frontal airbag are designed as follows.

- To deploy in the event of an accident involving a moderate to severe frontal collision
- To function on a one-time-only basis

The driver's SRS frontal airbag and front passenger's SRS frontal airbag are not

designed as follows.

- To deploy in most lesser frontal impacts\*<sup>1</sup>
- To deploy in most side or rear impacts or in most rollover accidents\*<sup>2</sup>

\*1: Because the necessary protection can be achieved by the seatbelt alone.

\*2: Because deployment of only the driver's SRS frontal airbag or both the driver's and front passenger's SRS frontal airbags would not protect the occupant in those situations.

SRS airbag deployment depends on the level of force experienced in the passenger compartment during a collision. That level differs from one type of collision to another, and it may have no bearing on the visible damage done to the vehicle itself.

### Example of accident in which the driver's/driver's and front passenger's SRS frontal airbag(s) will most likely deploy

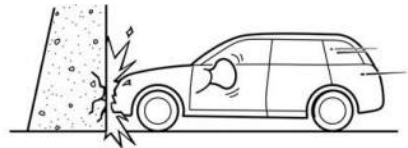

A head-on collision against a thick concrete wall at a vehicle speed of 12 to 19 mph (20 to 30 km/h) or higher activates only the driver's SRS frontal airbag or both driver's and front passenger's SRS frontal airbags. The airbag(s) will also be activated when the vehicle is exposed to a frontal impact similar in fashion and magnitude to the collision described above.

**Examples of the types of accidents in which it is possible that the driver's/driver's and front passenger's SRS frontal airbag(s) will deploy**

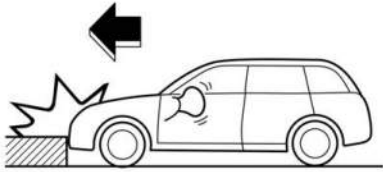
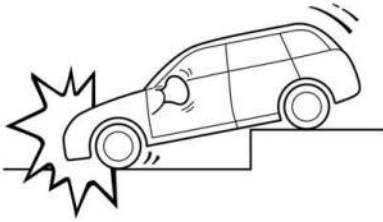

Only the driver's SRS frontal airbag or both driver's and front passenger's SRS frontal airbags may be activated when the vehicle sustains a hard impact in the undercarriage area from the road surface (such as when the vehicle plunges into a deep ditch, is severely impacted or knocked hard against an obstacle on the road such as a curb).

## Examples of the types of accidents in which deployment of the driver's/driver's and front passenger's SRS frontal airbag(s) is unlikely to occur

There are many types of collisions which might not necessarily require deployment of driver's/driver's and front passenger's SRS frontal airbag(s). In the event of accidents like those illustrated, the driver's/driver's and front passenger's SRS frontal airbag(s) may not deploy depending on the level of accident forces involved.

1

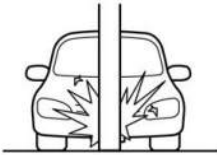

2

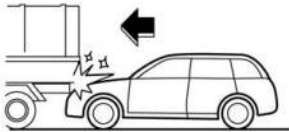

3



4

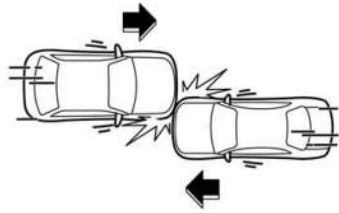

5

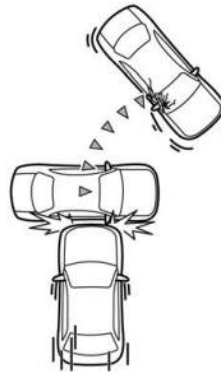

- 1 The vehicle strikes an object, such as a telephone pole or sign pole.
- 2 The vehicle slides under the load bed of a truck.
- 3 The vehicle sustains an oblique offset frontal impact.

- 4 The vehicle sustains an offset frontal collision.
- 5 The vehicle strikes an object that can move or deform, such as a parked vehicle.

## Examples of the types of accidents in which the driver's/ driver's and front passenger's SRS frontal airbag(s) are not designed to deploy in most cases

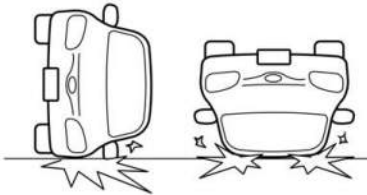
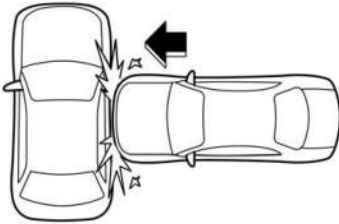

The driver's and front passenger's SRS frontal airbags are not designed to deploy in most of the following cases.

- If the vehicle is struck from the side or from behind
- If the vehicle rolls onto its side or roof
- If the vehicle is involved in a low-speed frontal collision



- 1 First impact
- 2 Second impact

In an accident where the vehicle is impacted more than once, the driver's and/or front passenger's SRS frontal airbag(s) will deploy only once.

Example: In the case of a double collision, first with another vehicle, then against a concrete wall in immediate succession, once either or both of the driver's and front passenger's SRS frontal airbags is/ are activated on the first impact, it/they will not be activated on the second impact.

## SRS seat cushion airbag operation

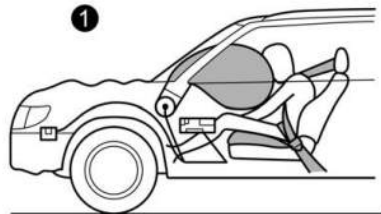

- 1 Passenger's side

### **WARNING**

The SRS seat cushion airbag is designed not to deploy when the

seatbelt for the corresponding seat is not worn. For safety reasons, all persons in the vehicle should wear their seatbelts.

The SRS seat cushion airbags are designed to deploy simultaneously when the SRS frontal airbags deploy. For details about the operating conditions, refer to “SUBARU Advanced Frontal Airbag System” P92.

The front passenger’s SRS seat cushion airbag is designed not to deploy in either of the following conditions.

- The front passenger’s seatbelt is not fastened (even when the front passenger’s frontal airbag ON indicator light illuminates while the OFF indicator light remains off).
- The front passenger’s frontal airbag ON indicator light is off while the OFF indicator light illuminates.

#### NOTE

*When the front passenger’s SRS frontal airbag is deactivated by the occupant detection system, the front passenger’s SRS seat cushion airbag is also deactivated.*

## SRS SIDE AIRBAG AND SRS CURTAIN AIRBAG



### SRS side airbag

The SRS side airbag is stored in the door side of each front seat seatback, which bears an “SRS AIRBAG” mark.

In a moderate to severe side impact collision, the SRS side airbag on the impacted side of the vehicle deploys between the occupant and the door panel and supplements the seatbelt by reducing the impact on the occupant’s chest and waist. The SRS side airbag operates only for front seat occupants.

### SRS curtain airbag

Your vehicle is equipped with a SUBARU SRS curtain airbag system that complies with the Federal Motor Vehicle Safety Standard (FMVSS) No. 226.

The SRS curtain airbag on each side of the cabin is stored in the roof side (between the front pillar and a point over the rear seat). An “SRS AIRBAG” mark is located at the top of each center pillar.

In a moderate to severe side impact collision, the SRS curtain airbag on the impacted side of the vehicle deploys between the occupant and the side window and supplements the seatbelt by reducing the impact on the occupant’s head.

In a rollover, SRS curtain airbags on both sides of the vehicle deploy between the occupant and the side window and supplement the seatbelt by reducing the impact to the occupant’s head.

In an offset frontal collision, SRS curtain airbags on both sides of the vehicle deploy between the occupant and the side window and supplement the seatbelt by reducing the impact to the occupant’s head and chest.

### Operation

The following SRS airbags is active only when the ignition switch is in the “ON” position.

- Driver’s SRS side airbag

- Front passenger's SRS side airbag
- SRS curtain airbag (right-hand side)
- SRS curtain airbag (left-hand side)

When the following sensors detect a certain amount of impact to the side of the vehicle or detect that the vehicle is leaning, airbag control units send signals to the airbag control modules to deploy the airbags.

- The side impact sensors
- The impact sensor in the airbag control module
- The rollover sensor in the airbag control module

Some of the airbags will deploy in a frontal collision. For details, refer to "SUBARU Advanced Frontal Airbag System"  P92. SRS airbags are controlled by their airbag control units and deploy as necessary to effectively protect passengers depending on the accident type. Therefore, these airbags may deploy simultaneously.

For the locations of the sensors and control modules, refer to "Components"  P90.

### After deployment

After the deployment, the SRS side airbag immediately starts to deflate.

The SRS curtain airbag remains inflated for a while following deployment then slowly deflates.

The SRS side airbag and SRS curtain airbag deploy even when no one occupies the seat on the side on which an impact is applied.

When the SRS side airbag and SRS curtain airbag deploy, a sudden, fairly loud inflation noise will be heard and some smoke will be released. These occurrences are a normal result of the deployment. This smoke does not indicate a fire in the vehicle.



### CAUTION

Do not touch the SRS side airbag system components around the front seat seatback with bare hands right after deployment. Doing so can cause burns because the components can be very hot as a result of deployment.

After deployment, do not touch any part of the SRS curtain airbag system (from the front pillar to the part of the roof side over the rear seat). Doing so can cause burns because the components can be very hot as a result of deployment.

### Example of the type of accident

The SRS side airbag and SRS curtain airbag are designed as follows:

- To deploy in the event of an accident involving a moderate to severe side impact collision
- To function on a one-time-only basis

The SRS side airbag and SRS curtain airbag are not designed to deploy in the following cases:

- In most lesser side impacts
- In most frontal or most rear impacts (because the SRS side airbag and SRS curtain airbag deployment would not protect the occupant in those situations)

The SRS curtain airbags are also designed to deploy when the vehicle is in an extremely inclined state such as during a rollover. They are not designed to deploy in most lesser inclined state.

SRS side airbag and SRS curtain airbag deployment depend on the level of force experienced in the passenger compartment during a side impact collision. That level differs from one type of collision to another, and it may have no bearing on the visible damage done to the vehicle itself.

**Example of the type of accident  
in which the SRS side airbag  
will most likely deploy**

①

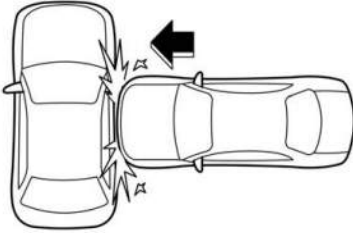

- ① A severe side impact near the front seat.

1

## Examples of the types of accidents in which the SRS curtain airbag will most likely deploy

①

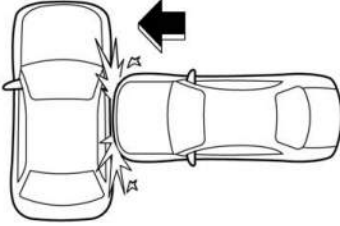

③



②

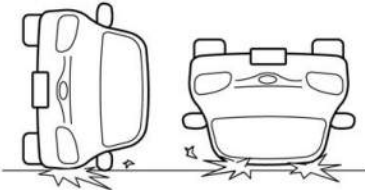

- ① The vehicle is involved in a severe side impact near the front seat or the rear seat.
- ② The vehicle rolls onto its side or the roof.
- ③ An offset frontal collision that is severe enough to deploy the front airbag.



## Examples of the types of accidents in which it is possible that the SRS side airbag and the SRS curtain airbag will deploy

It is possible that the SRS side and curtain airbags will deploy if a serious impact occurs to the underside of your vehicle. Some examples are shown in the illustration.

1

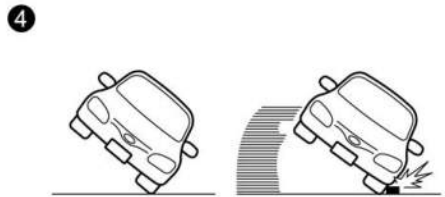
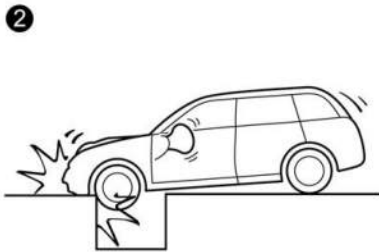
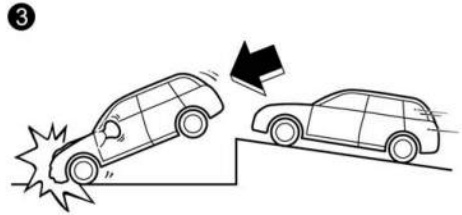
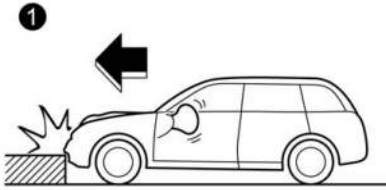

- ① Hitting a curb, edge of pavement or hard surface
- ② Falling into or jumping over a deep hole

- ③ Landing hard or vehicle falling
- ④ The angle of vehicle tip-up is marginal or the skidding vehicle's tires hit a curbstone laterally.

## Examples of the types of accidents in which the SRS side airbag is unlikely to deploy

There are many types of collisions which might not necessarily require SRS side airbag deployment. In the event of accidents like those illustrated, the SRS side airbag may not deploy depending on the level of accident forces involved.

①



③

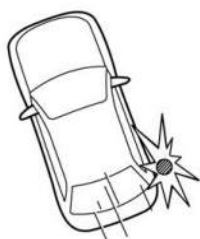

②

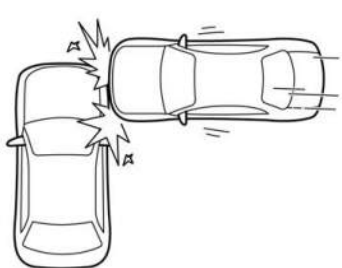

④

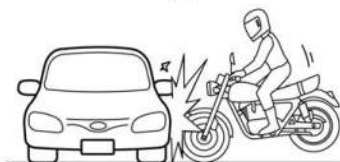

⑤

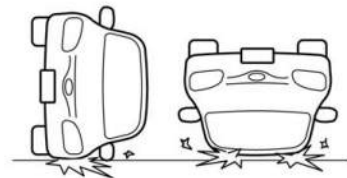

① The vehicle is involved in an oblique side-on impact.

② The vehicle is involved in a side-on impact in an area outside the vicinity of the passenger compartment.

③ The vehicle strikes a telephone pole or similar object.

④ The vehicle is involved in a side-on impact from a motorcycle.

⑤ The vehicle rolls onto its side or the roof.

## Examples of the types of accidents in which the SRS curtain airbag is unlikely to deploy

There are many types of collisions which might not necessarily require SRS curtain airbag deployment. In the event of accidents like those illustrated, the SRS curtain airbag may not deploy depending on the level of accident forces involved.

①



③



②

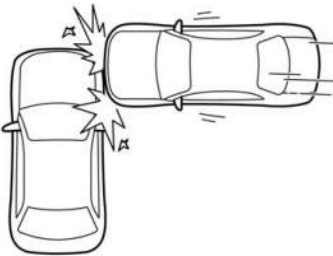

④

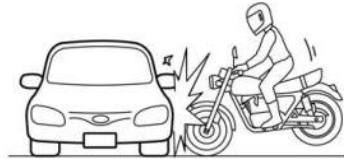

① The vehicle is involved in an oblique side-on impact.

② The vehicle is involved in a side-on impact in an area outside the vicinity of the passenger compartment.

③ The vehicle strikes a telephone pole or similar object.

④ The vehicle is involved in a side-on impact from a motorcycle.

**Examples of the types of accidents in which the SRS side airbag and SRS curtain airbag are not designed to deploy in most cases**

①

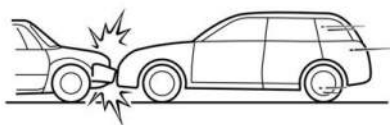

②

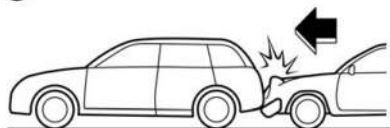

③

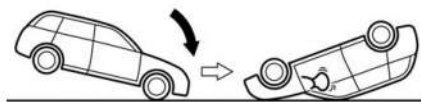

- ① The vehicle is involved in frontal collision with another vehicle (moving or stationary).
- ② The vehicle is struck from behind.
- ③ The vehicle pitches end over end.

In the event of accidents like those illustrated, the SRS side airbag and SRS curtain airbag are not designed to deploy in most cases.

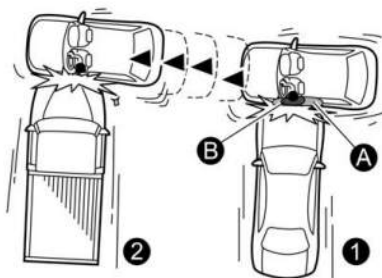

- ① First impact
- ② Second impact
- A SRS curtain airbag
- B SRS side airbag

In an accident where the vehicle is struck from the side more than once, the SRS side airbag and SRS curtain airbag deploy only once.

Example: In the case of a double side impact collision, first with one vehicle and immediately followed by another from the same direction, once the SRS side airbag and SRS curtain airbag are activated on the first impact, they will not be activated on the second.

## SRS AIRBAG SYSTEM MONITORS

A diagnostic system continually monitors the readiness of the SRS airbag system (including seatbelt pretensioners) with the ignition switch in the "ON" position.

### SRS airbag system warning light



The SRS airbag system warning light will show normal system operation by illuminating for approximately 6 seconds when the ignition switch is turned to the “ON” position.

The diagnostic system monitors the components to ensure normal operation. For information on the components the system monitors, refer to “Components” P90. Note that the diagnostic system does not monitor the SRS airbag system warning light itself.



### WARNING

If the warning light exhibits any of the following conditions, immediately stop the vehicle in a safe place, and consult a SUBARU dealer. Unless a technician checks and repairs the system as needed, the seatbelt pretensioners and/or the SRS airbag will not operate properly in the event of a collision, which may result in injury.

- Flashing or flickering of the warning light
- No illumination of the warning light when the ignition switch is first turned to the “ON” position
- Continuous illumination of the warning light
- Illumination of the warning light while driving

## SRS AIRBAG SYSTEM SERVICING



### WARNING

- When discarding an airbag module or scrapping the entire vehicle damaged by a collision, consult your SUBARU dealer.
- The SRS airbag has no user-serviceable parts. Do not use electrical test equipment on any circuit related to the SRS airbag

system. For required servicing of the SRS airbag, consult your nearest SUBARU dealer. Tampering with or disconnecting the system’s wiring could result in accidental inflation of the SRS airbag or could make the system inoperative, which may result in serious injury.



### CAUTION

If you need service or repair in areas indicated in the following list, have the work performed by an authorized SUBARU dealer. The SRS airbag control module, impact sensors and airbag modules are stored in these areas.

- Under the center of the instrument panel
- On both the right and left sides at the front of the vehicle
- Steering wheel and column and nearby areas
- Bottom of the steering column and nearby areas
- Top of the dashboard on front passenger’s side and nearby areas
- Each front seat and nearby area
- Inside each center pillar
- Inside each front door
- In each roof side (from the front pillar to a point over the rear seat)
- Between the rear seat cushion and rear wheel house on each side

**In the event that the SRS airbag is deployed, replacement of the system should be performed only by an authorized SUBARU dealer. When the components of the SRS airbag system are replaced, use only genuine SUBARU parts.**

**NOTE**

In the following cases, contact your SUBARU dealer as soon as possible.

- The front part of the vehicle was involved in an accident in which only the driver's SRS frontal airbag or both driver's and front passenger's SRS frontal airbags did not deploy.
- The pad of the steering wheel, the cover over the front passenger's SRS frontal airbag, or either roof side (from the front pillar to a point over the rear seat) is scratched, cracked, or otherwise damaged.
- The center pillar, front door, rear wheel house or rear sub frame, or an area near these parts, was involved in an accident in which the SRS side airbag and SRS curtain airbag did not deploy.
- The fabric or leather of either front seatback is cut, frayed, or otherwise damaged.
- The rear part of the vehicle was involved in an accident in which no SRS airbag was deployed.

## PRECAUTIONS AGAINST VEHICLE MODIFICATION

**WARNING**

- To avoid accidental activation of the system or rendering the system inoperative, which may result in serious injury, no modifications should be made to any components or wiring of the SRS airbag system. This includes following modifications.
  - Installation of custom steering wheels
  - Attachment of additional trim materials to the dashboard
  - Installation of custom seats
  - Replacement of seat fabric or leather

- Installation of additional fabric or leather on the front seat
- Attachment of a hands-free microphone or any other accessory to a front pillar, a center pillar, a rear pillar, the windshield, a side window, an assist grip, or any other cabin surface that would be near a deploying SRS curtain airbag.
- Installation of additional electrical/electronic equipment such as a mobile two-way radio on or near the SRS airbag system components and/or wiring is not advisable. This could interfere with proper operation of the SRS airbag system.
- Modifications on or inside the front door panels for the purpose of a speaker replacement or sound insulation
- The impact sensors, which detect the pressure of an impact, are located in the doors. Do not modify any components of the doors or door trims, such as the addition of door speakers for example. Any modifications to the doors will create a risk of the airbag system becoming inoperative or unintended airbag deployment.
- Installation of a tire of different size and construction from the tires specified on the vehicle placard attached to the driver's door pillar or specified for individual vehicle models in this Owner's Manual.

**CAUTION**

- Do not perform any of the following modifications. Such modifications can interfere with proper operation of the SRS airbag system.
- Attachment of any equipment (bush bar, winches, snow plow,

skid plate, etc.) other than genuine SUBARU accessory parts to the front end.

- Modification of the suspension system or front end structure.
- Attachment of any equipment (side steps or side sill protectors, etc.) other than genuine SUBARU accessory parts to the side body.

Always consult your SUBARU dealer if you want to install any accessory parts on your vehicle.

## HOW TO CONTACT THE VEHICLE MANUFACTURER CONCERNING MODIFICATIONS FOR PERSONS WITH DISABILITIES THAT MAY AFFECT THE ADVANCED AIRBAG SYSTEM

Changing or moving any parts of the front seats, rear seat, seatbelts, front bumper, front side frame, radiator panel, instrument panel, instrument cluster, steering wheel, steering column, tire, suspension or floor panel can affect the operation of the SUBARU advanced airbag system. If you have any questions, you may contact the following SUBARU distributors.

<Continental U.S., Alaska and the District of Columbia>

Subaru of America, Inc.

Headquarters:

Customer Advocacy Department

One Subaru Drive

P.O. Box 9103

Camden, NJ 08101-9877

Texas office:

360 North Freeport Parkway,

Coppell TX 75019

1-800-SUBARU3 (1-800-782-2783)

<Hawaii>

Subaru Hawaii

2850-A Pukoloa St.,  
Honolulu, HI 96819

877-215-0338

<Guam>

Shen's Corporation dba Prestige Automobiles

491 East Marine Corps Drive,  
Dededo, Guam 96929

671-633-2698

<Puerto Rico>

Trebol Motors

296 Marginal JF Kennedy, San Juan,  
Puerto Rico

787-793-2828

<Canada>

Subaru Canada, Inc.

Customer Care

560 Suffolk Court, Mississauga, Ontario  
L5R 4J7

1-800-894-4212

There are currently no SUBARU distributors in any other U.S. territories. If you are in such an area, please contact the SUBARU distributor or dealer from which you bought your vehicle.

---

---

---

---

---

---

---

---

---

---

---

---

---

---

---

---

---

---

---

---



## KEYS AND DOORS

2-1.	Keyless Access with Push-Button Start System .....	117
	Safety Precautions .....	117
	Locking and Unlocking with “Keyless Access” Entry Function ....	120
	Unlock Using PIN Code Access .....	122
	Power Saving Function .....	125
	Power Saving Function of Access Key Fob .....	125
	Disabling Keyless Access Function .....	126
	Selecting Audible Signal Operation .....	128
	Selecting Hazard Warning Flasher Operation .....	128
	Warning Chimes and Warning Indicator .....	128
	When Access Key Fob Does Not Operate Properly .....	128
	Replacing Battery of Access Key Fob .....	128
	Replacing Access Key Fob .....	128
2-2.	Immobilizer .....	129
	Security Indicator Light .....	129
	Key Replacement .....	129
2-3.	Remote Keyless Entry System .....	130
	Locking the Doors .....	130
	Unlocking the Doors .....	131
	Unlocking the Rear Gate .....	131
	Setting Audible Signal Operation .....	131
	Selecting Hazard Warning Flasher Operation .....	131
	Vehicle Finder Function .....	131
	Sounding a Panic Alarm .....	131
	Replacing the Battery .....	131
	Replacing Lost Access Key Fobs .....	132
2-4.	Door Locks .....	132
	Locking and Unlocking from the Outside .....	132
	Locking and Unlocking from the Inside .....	133
	Automatic Door Locking/Unlocking .....	134
	Key Lock-In Prevention Function .....	135
	Battery Drainage Reduction Function .....	135
2-5.	Alarm System .....	136
	Alarm System Operation .....	136
	Arming the System .....	137
	Disarming the System .....	137
	Alarm System Setting .....	138
	If You Have Accidentally Triggered the Alarm System .....	138
2-6.	Child Safety Locks .....	139
2-7.	Windows .....	139
	Power Window Switches .....	140
	Operating the Window .....	140
	Locking the Passengers’ Windows .....	141
	Initialization of Power Window .....	141
2-8.	Power Rear Gate .....	142
	Operating by the Power Rear Gate Button .....	144
	Operating by the Buttons on the Rear Gate .....	145
	Manual Operation .....	146

## KEYS AND DOORS

---

	Memory Function .....	146
	Reverse Function .....	147
	Rear Gate Drop Prevention Function .....	148
	Selecting Audible Signal Operation .....	148
	Initialization of Power Rear Gate .....	148
2-9.	Moonroof (If Equipped) .....	149
	Moonroof Switches .....	150
	Sunshade .....	151

## 2-1. KEYLESS ACCESS WITH PUSH-BUTTON START SYSTEM

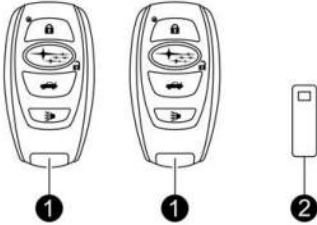

- ① Access key fobs
- ② Key number plate

The keyless access with push-button start system allows you to perform the following functions when you are carrying the access key fob.

- Locking and unlocking all the doors (including the rear gate and the fuel filler lid)
- Starting and stopping the engine. For detailed information, refer to “Starting and Stopping Engine” ⓄP310.
- Arming and disarming the alarm system. For detailed information, refer to “Alarm System” ⓄP136.

### NOTE

- *Locking and unlocking by the remote keyless entry system can also be controlled with the buttons on the access key fob. For detailed information, refer to “Remote Keyless Entry System” ⓄP130.*
- *Carefully store the key number plate supplied with the access key fob. It is necessary for vehicle repair and additional registration of access key fobs. For details, refer to “Key Replacement” ⓄP129.*

An emergency key is attached to each access key fob.

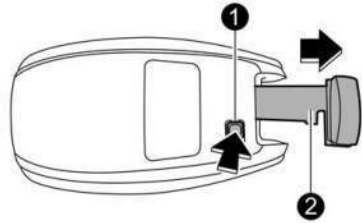

- ① Release button
- ② Emergency key

While pressing the release button of the access key fob, take out the emergency key.

The emergency key is used for the following operations.

- Locking and unlocking the driver's door
- Locking and unlocking the glove box

## SAFETY PRECAUTIONS

### WARNING

If you wear an implanted pacemaker or an implanted defibrillator, stay at least 8.7 in (22 cm) away from the transmitting antennas installed on the vehicle.

The radio waves from the transmitting antennas on the vehicle could adversely affect the operation of implanted pacemakers and implanted defibrillators.

If you wear electronic medical equipment other than an implanted pacemaker or an implanted defibrillator, before using the keyless access with push-button start system, refer to “Radio waves used for the keyless access with push-button start system” mentioned later, and contact the

electronic medical equipment manufacturer for more information. The radio waves from the transmitting antennas on the vehicle could adversely affect the operation of the electronic medical equipment.

“Radio waves used for the keyless access with push-button start system”

- The keyless access with push-button start system uses radio waves of the following frequency\* in addition to the radio waves used for the remote keyless entry system. The radio waves are periodically output from the antennas installed on the vehicle as shown in the following illustrations.

\*: Radio frequency: 134 kHz

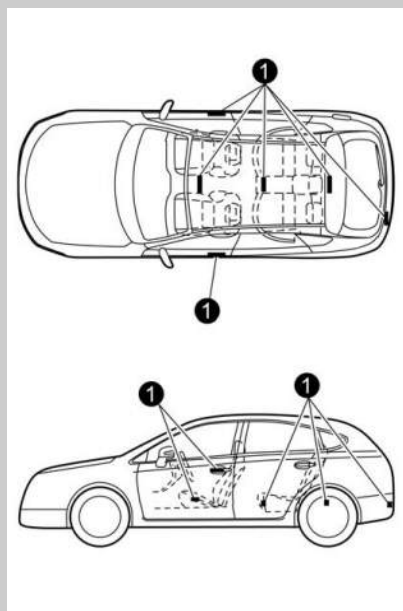

① Antennas



### CAUTION

- Never leave or store the access key fob inside the vehicle or within

6.6 ft (2 m) around the vehicle (e.g., in the garage). The access key fob may be locked inside the vehicle, or the battery may discharge rapidly. Note that the push-button ignition switch may not turn on in some cases depending on the location of the access key fob.

- The access key fob contains electronic components. Observe the following precautions to prevent malfunctions.
  - It is recommended to have the access key fob battery replaced at an authorized SUBARU dealer to avoid the risk of damage.
  - Do not get the access key fob wet. If the access key fob gets wet, wipe it off immediately and let it dry completely.
  - Do not apply strong impacts to the access key fob.
  - Never leave the access key fob in direct sunlight or anywhere that may become hot, such as on the dashboard. It may damage the battery or cause circuit malfunctions.
  - Do not wash the access key fob in an ultrasonic washer.
  - Do not leave the access key fob in humid or dusty locations. Doing so may cause malfunctions.
  - Keep the access key fob away from magnetic sources.
  - Do not leave the access key fob near a personal computer or home electrical appliance.
  - Do not leave the access key fob near a battery charger or any electrical accessories.
  - Do not apply metallic window tint or attach metallic objects to the windows.
  - Do not fit non genuine acces-

sories or parts.

- If the access key fob is dropped, the integrated emergency key inside may become loose. Be careful not to lose the emergency key.
- When traveling in an airplane, do not press the button of the access key fob. If any button of the access key fob is pressed, radio waves are emitted and may affect the operation of the airplane. In a bag, take measures to prevent the buttons from being pressed accidentally.

## NOTE

- *The operational/non-operational setting for the keyless access function can be changed. For the setting procedure, refer to “Disabling Keyless Access Function” ☞ P126.*
- *For detailed information about the operation method for the push-button ignition switch while the keyless access function is switched to the non-operational mode, refer to “If Access Key Fob Does Not Operate Properly” ☞ P451.*
- *The keyless access with push-button start system uses weak radio waves. The status of the access key fob and environmental conditions may interfere with the communication between the access key fob and the vehicle under the following conditions, and it may not be possible to lock or unlock the doors or start the engine.*
  - *When operating near a facility where strong radio waves are transmitted, such as a broadcast station and power transmission lines.*
  - *When products that transmit radio waves are used, such as an access key fob or a remote transmitter key of another vehicle.*
  - *When carrying the access key fob of your vehicle together with the access key fob of another vehicle.*
    - *When the access key fob is placed near wireless communication equipment such as a cell phone.*
    - *When the access key fob is placed near a metallic object.*
    - *When metallic accessories are attached to the access key fob.*
    - *When carrying the access key fob with an electronic appliance such as a laptop computer.*
    - *When the battery of the access key fob is discharged.*
- *The access key fob is always communicating with the vehicle and is continuously using the battery. Although the life of the battery varies depending on the operating conditions, it is approximately 1 to 2 years. If the battery becomes fully discharged, replace it with a new one.*
- *If an access key fob is lost, it is recommended that all of the remaining access key fobs be reregistered. For reregistration of an access key fob, contact a SUBARU dealer.*
- *For a spare access key fob, contact a SUBARU dealer.*
- *Up to 7 access key fobs can be registered for one vehicle.*
- *Do not leave the access key fob in the storage spaces inside the vehicle, such as the door pocket, dashboard or inside the cargo area. Vibrations may damage the key fob or turn on the switch, possibly resulting in a lockout.*
- *After the vehicle battery is discharged or replaced, initialization of the steering lock system may be required to start the engine. In this case, perform the following procedure to initialize the steering lock.*
  - (1) *Turn the push-button ignition switch to the “OFF” position. For details, refer to “Switching Power Status” ☞ P156.*
  - (2) *Open and close the driver’s door.*
  - (3) *Wait for approximately 10 seconds.*

*When the steering is locked, the initialization is completed.*

- Do not leave the access key fob in the following places.

- On the instrument panel
- On the floor
- Inside the glove box
- Inside the door trim pocket
- On the rear seat
- In the cargo area

If you do, the following situations may occur.

- The access key fob is mistakenly locked inside the vehicle.
- A false warning issues although no malfunction actually occurs.
- No warning issues even when a malfunction occurs.

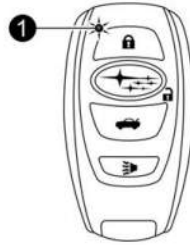

① LED indicator

When the access key fob is near either of the front doors, the LED indicator on the access key fob flashes. When the keyless access functions are disabled, the LED indicator does not flash unless a button on the access key fob is pressed.

## LOCKING AND UNLOCKING WITH “KEYLESS ACCESS” ENTRY FUNCTION

When the access key fob is carried within the operating range, all the doors (including the rear gate and the fuel filler lid) can be locked/unlocked just by touching the door handle.

### NOTE

The vehicle can also be locked/unlocked with the remote keyless entry system. For details, refer to “Remote Keyless Entry System” P130.

## Operating ranges

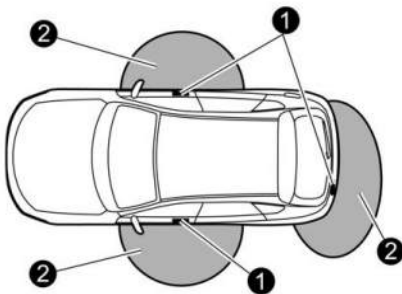

- ① Antennas
- ② Operating range

### NOTE

- If the access key fob is placed too close to the vehicle body, the keyless access functions may not operate properly. If it does not operate properly, repeat the operation from farther away.
- If the access key fob is placed near the ground or in an elevated location from the ground, even if it is in the indicated operating range, the keyless access function may not operate properly.
- When the access key fob is within the operating range, it is possible for anyone, even someone who is not carrying the access key fob, to operate the keyless access function. Note that the keyless access function can be operated only by the door handle, door lock sensor or rear gate opener button in the operating range in which the access key fob is detected.
- It is not possible to lock the doors, the rear gate and the fuel filler lid using the keyless access function when the access key fob is inside the vehicle. However, depending on the status of the access key fob and the environmental conditions, the access key fob

may be locked inside the vehicle. Before locking the vehicle, make sure that you have the access key fob.

- When the battery of the access key fob is discharged, or when operating it in a location with strong radio waves or noise (e.g., near a radio tower, power plant, broadcast station or an area where wireless equipment is used), or while talking on a cell phone, the operating ranges may be reduced, or the keyless access function may not operate. In such a case, perform the procedure described in "Locking and Unlocking" ☞ P451.
- The doors may lock or unlock when the car is being washed or exposed to a significant amount of water that touches the door handle while the key fob is still in the operating range.

## How to lock and unlock

It is possible to perform the following operations when you are carrying the access key fob.

- Lock and unlock the doors and the fuel filler lid.
- Lock and unlock the rear gate.

### NOTE

- It is not possible to lock the doors, the rear gate and the fuel filler lid using the keyless access function when the push-button ignition switch is in the "ACC" or "ON" position. Refer to "Switching Power Status" ☞ P156.
- If the door handle is gripped with a gloved hand, the door lock may not be released.
- If the door lock sensor is touched four times or more repeatedly, the system will ignore the sensor operation.
- When performing the locking procedure too quickly, locking may not complete. After performing the locking procedure, it is recommended to pull the rear door handle to confirm that the doors have been locked.

- If any of the doors (including the rear gate) is not fully closed, the following will occur to alert you.
  - An electronic chirp sounds five times.
  - The hazard warning flashers flash five times.
- If any of the doors or the rear gate is open, the doors, the rear gate and the fuel filler lid cannot be locked.
- Within 3 seconds after locking the doors and the rear gate using the keyless access function, it is not possible to unlock the doors and/or the rear gate using the keyless access function.
- When locking, be sure to carry the access key fob to prevent locking the access key fob in the vehicle.
- The setting of the hazard warning flasher operation can be changed by operating the center information display. For details, refer to "Vehicle" ☞ P206. Also, the setting of the hazard warning flasher operation can be changed by your SUBARU dealer. Contact your SUBARU dealer for details.

## Locking the vehicle

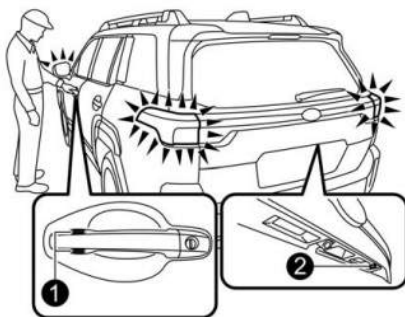

- ① Door lock sensor
- ② Rear lock button

To lock all the doors, carry the access key fob with you and perform one of the following operations:

- Touch the door lock sensor.

- Press the rear lock button.

An electronic chirp will sound once and the hazard warning flashers will flash once.

### NOTE

*After touching the door lock sensor to lock all of the doors (including the rear gate), if you touch the door lock sensor once more to attempt the lock operation without first unlocking the doors, nothing will happen, even if the door lock sensor is touched. In this case, perform the unlocking operation once first. You can then touch the door lock sensor to lock the doors.*

## Unlocking the vehicle

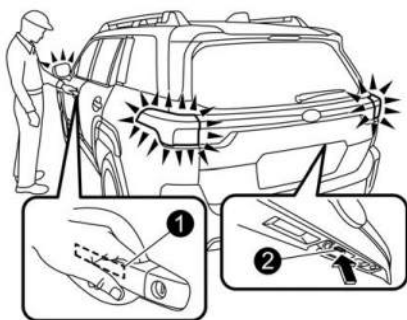

- 1 Front door handle sensor
- 2 Rear gate opener button

To unlock the door, carry the access key fob with you and perform one of the following operations:

- Grip the door handle.
- Press the rear gate opener button.

An electronic chirp will sound twice and the hazard warning flashers will flash twice.

## Door unlock selection function

When you use the keyless access function to unlock the vehicle, gripping the driver's door handle or the front passenger's handle will cause trigger different unlock operations as described below.

### When the driver's door handle is gripped:

The driver's door and the fuel filler lid will unlock.

### When the front passenger's door handle is gripped:

All the doors (including the rear gate) and the fuel filler lid will unlock.

The settings can be changed with the following methods.

- The setting can be changed by operating the center information display. For details, refer to "Vehicle" P206.
- The setting can be changed by a SUBARU dealer.

## UNLOCK USING PIN CODE ACCESS

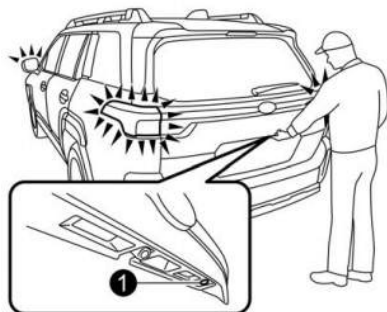

- 1 Rear lock button



While all the doors (including the rear gate and the fuel filler lid) are locked, you can unlock them without a key by pressing the rear lock button.

### NOTE





*PIN Code Access will be helpful if the key is accidentally left in the vehicle. It is recommended that a 5-digit security code (PIN code) is registered.*



## Registration for a PIN code

Steps	Operation	Time from the previous step
1	Turn off the ignition switch.	—
2	Close all the doors (including the rear gate).	—
3	Press and hold the  button on the access key fob, then press and hold the rear lock button until a chirp sounds intermittently.	—
4	Press the  button on the access key fob.	Within 30 seconds
5	Input the PIN code using the rear lock button within 30 seconds after the chirp sound of step 4. For example, to register “32468” as the PIN code, perform the following procedure.	Within 30 seconds
	(1) Press the button three times.	
	(2) After a chirp sounds once, press the button twice.	
	(3) After a chirp sounds once, press the button four times.	
	(4) After a chirp sounds once, press the button six times.	
(5) After a chirp sounds once, press the button eight times.		
6	Perform step 5 again within approximately 30 seconds after the chirp starts sounding intermittently.	—
7	All doors will be unlocked and locked. Then the PIN code will be registered.	—

### NOTE

- Press the  button within 30 seconds of step 6 to end the preparation mode and move on to the registration stage. Unless the  button is pressed within 30 seconds after step 6, the PIN code registration will be canceled.
- Press the rear lock button ten times to enter “0”.
- Change the PIN code frequently to protect your vehicle from theft.
- If you have lent your vehicle to another person, confirm that the PIN code has not been changed or deleted. If the PIN code has been changed or deleted, reregister a new PIN code.
- If you make an error during the registration procedure, press the  or  button on the access key fob. Then start over from step 1.
- To protect your vehicle from theft, you cannot register “00000” to “99999” or “12345” as a PIN code.
- Do not register your vehicle license plate number or simple numbers such as “11122” or “12121” as a PIN code. Doing so will increase the risk of vehicle theft.
- When you try to register “22222”, the registered PIN code will be deleted. You cannot unlock the doors by PIN Code Access until a new code is registered.
- After registering a new PIN code, make sure that you can unlock the doors using the PIN code.
- The PIN code cannot be deleted while the keyless access function is disabled by operating the access key fob.

- *Reregister the PIN code in the following case.*
  - *When you forget the PIN code*
  - *When you want to change the PIN code*

## Unlocking

Perform steps (1) to (5) of step 5 described in "Registration for a PIN code".

### NOTE

- You cannot unlock by PIN Code Access in the following cases.
  - When the access key fob is within the operating ranges
  - When the ignition switch is in the "ACC" or "ON" position
- If you make an operation error during the unlocking procedure, start over with the unlocking procedure after waiting for 5 seconds or longer.
- To protect your vehicle from theft, a buzzer will sound if incorrect PIN codes are entered five times continuously. If this occurs, you cannot unlock the doors by PIN Code Access for 5 minutes.

## POWER SAVING FUNCTION

To protect the access key fob battery and the vehicle battery, the keyless access function will be disabled as follows.

- When the keyless access function and the remote keyless entry system have not been used:
  - (1) 5 days after the push-button ignition switch has been turned off, communication between the antennas and the access key fob will be stopped.
  - (2) 9 days after step (1), the sensors (both lock sensor and unlock sensor) on the front passenger's door will be disabled.
- When the access key fob has been left in the operating range for 10 minutes or longer while all doors are locked, the keyless access function will be disabled.

## Recovery from power saving mode

When one of the following operations is performed, the keyless access function will be recovered.

- Unlock by gripping the door handle (only when the sensors on the front passenger's door are not disabled) or pressing rear gate opener button on the rear gate.
- Lock or unlock by the remote keyless entry system.
- Open a door and then close it.
- Turn the push-button ignition switch to the "ON" position.

## POWER SAVING FUNCTION OF ACCESS KEY FOB

This function stops the access key fob from receiving signals and helps minimize the battery consumption of the access key fob.

1. Press the "2" button twice while holding the "1" button.
2. Confirm that the LED indicator blinks 4 times to notify that the setting is complete.

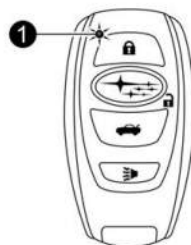

1 LED indicator

When the access key fob is in the power save mode, the keyless access function and push-button start system will not be available. To cancel the power save mode, press one of the buttons on the

access key fob.

## DISABLING KEYLESS ACCESS FUNCTION

When the vehicle is not going to be used for a long time, or when you choose not to use the keyless access function, the keyless access function can be disabled.

### WARNING

If you have an implanted pacemaker or an implanted defibrillator, perform the procedure “By operating the driver’s door” [P127](#) to disable the keyless access function. If you perform the procedure “By operating the access key fob” [P126](#), the operation of an implanted pacemaker or implanted defibrillator may be affected by the radio waves from the transmitting antennas installed on the vehicle.

### NOTE

- *If the access key is kept in or comes near the vehicle, the system becomes active and both the vehicle and access key batteries’ energy will be consumed. If this occurs frequently or continuously, both the vehicle and access key batteries can become fully drained.*
- *The locking and unlocking function by the remote keyless entry system is not disabled.*
- *To start the engine while the functions are disabled, perform the procedure described in “Starting Engine” [P452](#).*



## By operating the access key fob

To disable the keyless access function by operating the access key fob, register a PIN code for PIN Code Access. For details about registering a PIN code, refer to “Unlock Using PIN Code Access” [P122](#).

1. Open the driver’s door.

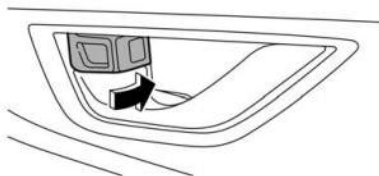
2. Rotate the lock lever forward.



3. Press and hold the “” button and “” button on the access key fob simultaneously for more than 5 seconds.



A chirp sound will be heard, and the function will be disabled.

## By operating the driver's door

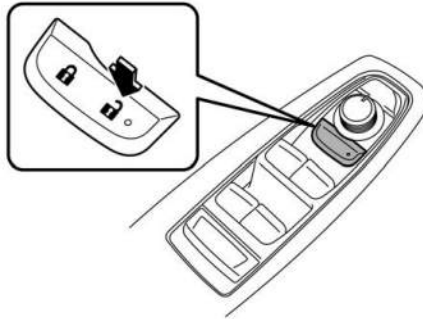

2

To disable the keyless access function by operating the driver's door, perform the following procedures.

Steps	Operation	Time	Status
1	Sit in the driver's seat, and close the door.	—	Close
2	Push "L" on the power door locking switch.	—	Close
3	Open the driver's door.	Within 5 sec.	Close→Open
4	Push "L" on the power door locking switch twice.	Within 5 sec.	Open
5	Close and open the driver's door twice.	Within 10 sec.	Open→Close→Open→Close→Open
6	Push "L" on the power door locking switch twice while the door is open.	Within 10 sec.	Open
7	Close and open the driver's door once.	Within 10 sec.	Open→Close→Open
8	Close the door.	Within 5 sec.	Open→Close

A chirp will sound and the functions will be disabled.

### NOTE

*In steps 4 and 6, press the power door locking switch firmly. If the switch is not pressed firmly, the functions may not be disabled.*

## Enabling functions

When the procedure to disable the functions is performed again, a chirp sound will be heard, and the functions are enabled.

### NOTE

- *The keyless access function will be enabled only if you perform the procedure in the same manner you disabled the function (for example, when disabling by operating the driver's door, the function will not be enabled even if you operate the access key fob).*
- *Press the push-button ignition switch if you do not know the procedure in which the keyless access function was disabled.*
  - *When disabling by operating the driver's door: A chirp will not be heard.*
  - *When disabling by operating the access key fob: A chirp will be heard.*

## SELECTING AUDIBLE SIGNAL OPERATION

Using an electronic chirp, the system will give you an audible signal when the doors are locked or unlocked. If desired, you can turn the audible signal off by operating the center information display. For details, refer to "Vehicle" ⒻP206.

Furthermore, the volume setting of the audible signal can also be changed by a SUBARU dealer. Consult your SUBARU dealer for details.

## SELECTING HAZARD WARNING FLASHER OPERATION

Using the hazard warning flasher, the system will give you a visible signal when the doors are locked or unlocked. If desired, you can turn the hazard warning flashers off by operating the center information display. For details, refer to "Vehicle" ⒻP206. The setting can also be

changed by a SUBARU dealer. Consult your SUBARU dealer for details.

## WARNING CHIMES AND WARNING INDICATOR

The keyless access with push-button start system is equipped with a warning chime and the access key warning indicator in order to minimize improper operations and help protect your vehicle from theft.

For details, refer to "Warning Chimes and Warning Indicator of the Keyless Access with Push-Button Start System" ⒻP176.

## WHEN ACCESS KEY FOB DOES NOT OPERATE PROPERLY

Refer to "If Access Key Fob Does Not Operate Properly" ⒻP451.

## REPLACING BATTERY OF ACCESS KEY FOB

Refer to "Replacing Battery of Access Key Fob" ⒻP507.

## REPLACING ACCESS KEY FOB

Access key fobs can be replaced at SUBARU dealers. For more details, contact a SUBARU dealer.

## 2-2. IMMOBILIZER

The immobilizer system is designed to prevent an unauthorized person from starting the engine. Only keys registered with your vehicle's immobilizer system can be used to operate your vehicle. If engine start is attempted with an unregistered access key fob or key, the engine will not start. Even if the engine does start, it will stop after a few seconds. This system, however, is not a 100% anti-theft guarantee.



### CAUTION

- Do not place the key under direct sunlight or anywhere it may become hot.
- Do not get the key wet. If the key gets wet, wipe it dry with a cloth immediately.
- Do not modify or remove the system. If modified or removed, the proper operation of the system cannot be guaranteed.

### NOTE

- To protect your vehicle from theft, please pay close attention to the following security precautions:
  - Never leave your vehicle unattended with its keys inside.
  - Before leaving your vehicle, close all windows and the moonroof, and lock all the doors (including the rear gate and the fuel filler lid).
  - Do not leave spare keys or any record of your key number in the vehicle.
- The vehicle has a maintenance-free type immobilizer system.

## SECURITY INDICATOR LIGHT

Refer to "Security Indicator Light" P180.

## KEY REPLACEMENT

Your key number plate will be required if you ever need a replacement key made. Any new key must be registered for use with your vehicle's immobilizer system before it can be used. The maximum number of keys that can be registered for use with one vehicle is seven.

One key that has already been registered is required in order to register a new key.

### NOTE

*If you lose a key, the lost key's ID code still remains in the memory of the vehicle's immobilizer system. For security reasons, the lost key's ID code should be erased from the memory. To erase the lost key's ID code, all keys that will be used are required.*

*For details about new key registration and erasing the lost key's ID code, contact your SUBARU dealer.*

## 2-3. REMOTE KEYLESS ENTRY SYSTEM



### CAUTION

- Do not expose the access key fob to severe shocks, such as those experienced as a result of dropping or throwing.
- Do not take the access key fob apart except when replacing the battery.
- Do not get the access key fob wet. If it gets wet, wipe it dry with a cloth immediately.
- When you carry the access key fob on an airplane, do not press the button of the access key fob while in the airplane. When any button of the access key fob is pressed, radio waves are sent and may affect the operation of the airplane. When you carry the access key fob in a bag on an airplane, take measures to prevent the buttons of the access key fob from being pressed.

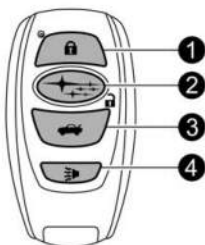

- ① Lock/arm button
- ② Unlock/disarm button
- ③ Rear gate unlock button
- ④ PANIC button

The remote keyless entry system has the following functions.

- Locking and unlocking all the doors (including the rear gate and the fuel filler lid)
- Unlock the rear gate
- Sounding a panic alarm
- Arming and disarming. For details, refer to “Alarm System” ☞ P136.

The operable distance of the remote keyless entry system is approximately 30 feet (10 meters). However, this distance will vary depending on environmental conditions. The system's operable distance will be shorter in areas near a facility or electronic equipment emitting strong radio waves such as a power plant, broadcast station, TV tower, or remote controller of home electronic appliances.

### NOTE

- *The remote keyless entry system will not be activated when the push-button ignition switch is in any position other than the “OFF” position.*
  - *The hazard warning flashers will flash once or twice when the access key fob button is pressed in the following cases.*
    - When locking the doors
    - When unlocking the doors
    - When unlocking the rear gate
- If desired, you can turn the hazard warning flashers off by operating the center information display. For details, refer to “Vehicle” ☞ P206.*

## LOCKING THE DOORS

Press the “” button to lock all the doors (including the rear gate and the fuel filler lid). An electronic chirp will sound once and the hazard warning flashers will flash once.

If any of the doors (including the fuel filler lid) is not fully closed, the following will occur to alert you that the doors are not properly closed.





- An electronic chirp sounds five times.
- The hazard warning flashers flash five times.

When you close the door, it will automatically lock and then the following will occur.

- An electronic chirp sounds once.
- The hazard warning flashers flash once.

## UNLOCKING THE DOORS

Press the “” button to unlock the driver’s door and fuel filler lid. An electronic chirp will sound twice and the hazard warning flashers will flash twice. To unlock all the doors and the rear gate, briefly press the “” button again within 5 seconds.

### NOTE

*If the interval between the first and second presses of the “” button for unlocking all the doors is extremely short, the system may not respond.*

## UNLOCKING THE REAR GATE

Press the “” button to unlock the rear gate. An electronic chirp will sound twice and the hazard warning flashers will flash twice.

This operation setting can be changed by a SUBARU dealer. Consult your SUBARU dealer for details.

## SETTING AUDIBLE SIGNAL OPERATION

Using an electronic chirp, the system will give you an audible signal when the doors lock and unlock.

If desired, you can turn the audible signal off by operating the center information display.

For details, refer to “Vehicle” .

Furthermore, the volume setting of the audible signal can also be changed by a SUBARU dealer. Consult your SUBARU

dealer for details.

## SELECTING HAZARD WARNING FLASHER OPERATION

Using the hazard warning flasher, the system will give you a visible signal when the doors are locked or unlocked. If desired, you can turn the hazard warning flashers off by operating the center information display. For details, refer to “Vehicle” .

The setting can also be changed by a SUBARU dealer. Consult your SUBARU dealer for details.

## VEHICLE FINDER FUNCTION

Use this function to find your vehicle parked among many vehicles in a large parking lot. Provided you are within 30 feet (10 meters) of the vehicle, pressing the “” button three times in a 5-second period will cause your vehicle’s horn to sound once and its hazard warning flashers to flash three times.

### NOTE

*If the interval between presses is too short when you press the “” button three times, the system may not respond to the signals from the access key fob.*

## SOUNDING A PANIC ALARM

To activate the alarm, press the PANIC button once.

The horn will sound and the hazard warning flashers will flash.

To deactivate the panic alarm, press any button on the access key fob. If a button on the access key fob is not pressed, the alarm will be deactivated after approximately 30 seconds.

## REPLACING THE BATTERY

Refer to “Replacing Battery” .

## REPLACING LOST ACCESS KEY FOBS

If you lose a transmitter or want to purchase additional transmitters (up to seven can be programmed), you should re-program all your access key fobs for security reasons. For details, contact your SUBARU dealer and have the access key fobs programmed into the remote keyless entry system.

## 2-4. DOOR LOCKS

### LOCKING AND UNLOCKING FROM THE OUTSIDE

#### NOTE

*If you unlock the driver's door with a key (including an emergency key) and open the door while the alarm system is armed, the alarm system is triggered and the vehicle's horn sounds. In this case, perform any of the following operations:*

- *Press any button on the access key fob (except when the access key fob battery is discharged).*
- *Turn the push-button ignition switch to the "ACC" position.*
- *Carry the access key fob and perform either of the following procedures.*
  - *Grip the front door handle.*
  - *Press the rear gate opener button.*

*For details about the alarm system, refer to "Alarm System" P136.*

### How to lock and unlock the vehicle using the key

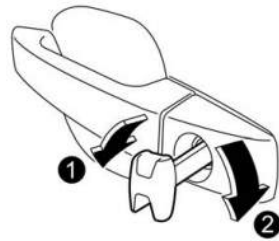

- ① Lock
- ② Unlock

In this case, only the driver's side door is locked or unlocked.

#### NOTE

*Models with "keyless access with push-button start system":*

*The emergency key is directional. If the key cannot be inserted, change the direction that the grooved side is facing and insert it again.*

## How to lock the vehicle without using the key

To lock the door from outside without the key, the following methods are available.

### Locking using lock lever

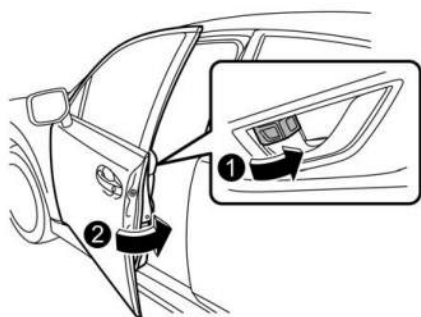

- ① Move the lock lever to the lock position.
- ② Close the door.

In this way, only the door that was operated will be locked.

### Locking using power door locking switch

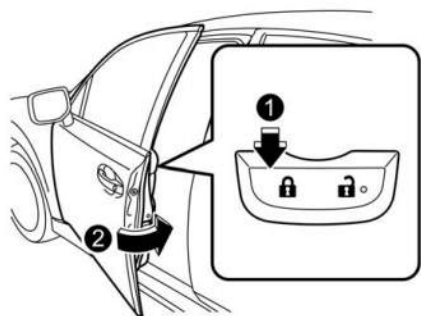

- ① Press the side of the power door locking switch.\*
- ② Close the door.

\*: For details about the power door locking switch, refer to “How to use the power door locking switches” P134.

In this case, all the closed doors, the fuel filler lid and the rear gate are locked at the same time.

### NOTE

*Make sure that you do not leave the key inside the vehicle before locking the doors from the outside without the key.*

## LOCKING AND UNLOCKING FROM THE INSIDE

To lock the door from inside the vehicle, use the lock lever or power door locking switch.

### How to use the lock lever

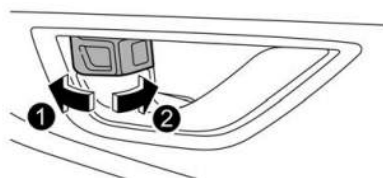

- ① Unlock
- ② Lock

The red mark on the lock lever appears when the door is unlocked.

Pull the inside door handle to open an unlocked door.

Always make sure that all the doors and the rear gate are closed before starting to drive.

### WARNING

- Keep all doors locked when you drive, especially when small children are in your vehicle.

Along with the proper use of seatbelts and child restraint systems, locking the doors reduces the chance of being thrown out of the vehicle in an accident.

It also helps prevent passengers from falling out by preventing a door from being accidentally opened, and intruders from unexpectedly opening doors and entering your vehicle.

- Do not pull the front door handle from inside while driving. The door could open even if it is locked.



### CAUTION

Do not pull the front inside door handle while operating the door lock. There is a risk that it will not be possible to open or lock the front doors.

## How to use the power door locking switches

All the doors (including the rear gate and the fuel filler lid) can be locked and unlocked by pressing either side of the power door locking switches located on the driver's side and the front passenger's side doors.

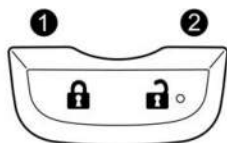

- ① Lock
- ② Unlock

### NOTE

*Make sure that you do not leave the key inside the vehicle before locking the doors from the outside using the power door locking switches.*

## AUTOMATIC DOOR LOCKING/UNLOCKING

All the doors (including the fuel filler lid) are automatically locked or unlocked under the following conditions.

### For automatic door locking:

- When the vehicle speed reaches 12 mph (20 km/h) or higher (factory default setting).
- When the select lever is shifted into a position other than the “P” position.

### For automatic door unlocking:

- When the driver's door is open (factory default setting).
- When the ignition switch is turned to OFF.
- When the select lever is shifted into the “P” position.

### NOTE

- *The automatic door lock and unlock setting can be changed using the center information display. Refer to “Vehicle” P206.*
- *When locking the door by the power door locking switches, automatic door locking will not operate.*
- *When unlocking the door by the power door locking switches, automatic door unlocking will not operate.*
- *If the system detects a strong enough impact to deploy the airbags, all doors may be automatically unlocked. For further details, refer to “Automatic Door Locking/Unlocking Operation When Involved in an Accident” P456.*
- *When getting out of the vehicle from a rear door, make sure to unlock all the doors by pushing the unlock side of*

*the power door locking switch. If a rear door is unlocked from the inside door lever then the door is opened and closed, the Key lock-in prevention function will be triggered. All doors will be unlocked, the Key lock-in prevention warning indicator “” will appear and the warning chime will also sound.*

## KEY LOCK-IN PREVENTION FUNCTION

All the doors will not lock when the power door locking switch is pushed with the driver's door open while the ignition switch is in the “ACC” or “ON” position.

### NOTE

- *When leaving the vehicle, make sure you are holding the key before locking the doors.*
- *When getting out of the vehicle from a rear door, make sure to unlock all the doors by pushing the unlock side of the power door locking switch.*
- *When getting out of the vehicle from a rear door, make sure to unlock all the doors by pushing the unlock side of the power door locking switch. If a rear door is unlocked from the inside door lever then the door is opened and closed, the Key lock-in prevention function will be triggered. All doors will be unlocked, the Key lock-in prevention warning indicator “” will appear and the warning chime will also sound.*
- *The factory setting (default setting) for this function is set as “operational”. This function's operational/non-operational setting can be changed by a SUBARU dealer. Contact a SUBARU dealer for details.*

## Non-operation of key lock-in prevention function

When the system is set so that it does not operate, the doors are locked by the following operation.

- If the lock lever is turned to the front (“LOCK”) position with the driver's door open and the driver's door is then closed with the lock lever in that position, the driver's door is locked.
- If the emergency key is used to lock the driver's door from the outside of the vehicle, the door is locked.

## BATTERY DRAINAGE REDUCTION FUNCTION

Under various conditions, lights inside the vehicle will automatically turn off to reduce the risk of discharging the battery.

### Battery drainage reduction function for various conditions

This function will enter standby mode when the ignition switch is turned to the “OFF” position.

If the following actions are not performed within 10 minutes, while the function is in standby mode, any room lights that are on will automatically turn off.

Turning off lights	<ul style="list-style-type: none"> <li>– Map light</li> <li>– Dome light</li> <li>– Ignition switch light</li> <li>– Cargo area light</li> <li>– Rear gate light*1</li> <li>– Vanity mirror light</li> <li>– Door step lights</li> </ul>
Actions	<ul style="list-style-type: none"> <li>– Turn the ignition switch to the “ACC” or “ON” position.</li> <li>– Open or close the doors, including the rear gate.</li> <li>– Push the unlock button on the access key fob.</li> <li>– Hold the front door handle and unlock it while holding the access key fob.</li> <li>– Come close to the vehicle that the front door was locked while holding the access key fob (if OFF delay timer setting for period of time is not off).</li> <li>– Push the panic button on the access key fob.</li> </ul>

\*1: If equipped

Perform the action in the above table to illuminate the lights again when the battery drainage reduction function is active.

**NOTE**

- *The battery drainage reduction function cannot be turned off.*
- *If the battery drainage reduction function is in operation when a door is open, the target room light will not be illuminated.*
- *To protect the battery from battery drainage, make sure that all doors, including the rear gate, are completely closed when leaving the vehicle.*
- *When the door is opened while the ignition switch is in the "OFF" position, the door open indicator light will illuminate. The door open indicator light will turn off after 2 minutes.*

**2-5. ALARM SYSTEM**

The alarm system helps to protect your vehicle and valuables from theft. The horn sounds and the hazard warning flashers flash if someone attempts to break into your vehicle.

The system can be armed or disarmed with the keyless access function or access key fob.

The system will not be activated when the push-button ignition switch is in the "ACC" or "ON" position.

Your vehicle's alarm system has been set for activation at the time of shipment from the factory. You can set the system for deactivation yourself or have it done by your SUBARU dealer.

**ALARM SYSTEM OPERATION**

When the alarm system is armed, it is triggered by the opening any of the doors, the rear gate or engine hood.

The alarm system will activate the following alarms when triggered.

- The vehicle's horn will sound for 30 seconds.
- The hazard warning flashers will flash for 30 seconds.

If any of the doors, the rear gate or engine hood remains open after the 30-second period, the horn will continue to sound for a maximum of 3 minutes. If the door, rear gate or engine hood is closed while the horn is sounding, the horn will stop sounding with a delay of up to 30 seconds.

**NOTE**

*The alarm system can be set to trigger the illumination of the following interior lights.*

- *Map lights (illuminates only when the door interlock switch is in the "DOOR" position)*
- *Dome light (illuminates only when the dome light switch is in the "DOOR" position)*

The notifications regarding the map lights and dome light are deactivated as the factory setting. A SUBARU dealer can activate the system. Contact your SUBARU dealer for details.

## ARMING THE SYSTEM

The alarm system becomes armed when the following operation is performed.

1. Close all windows and the moonroof (if equipped) and turn the ignition switch to the "OFF" position.
2. Carry the key and get out of the vehicle.
3. Make sure that the engine hood is locked.
4. Lock the doors using any of the following methods.
  - Locking using the remote keyless entry system. For details, refer to "Remote Keyless Entry System" ☞P130.
  - Locking using the keyless access function. For details, refer to "Locking the vehicle" ☞P121.
  - Locking using the power door locking switch. For details, refer to "Locking using power door locking switch" ☞P133.
5. Approximately 30 seconds later, the system will enter surveillance state.

When the system is in surveillance state, the security indicator light will then flash slowly (twice approximately every 2 seconds), indicating that the system has been armed for surveillance.

### NOTE

- The system can be armed even if the windows and/or moonroof are open. Always make sure that they are fully closed before arming the system.
- The 30-second standby time can be eliminated if you prefer. Have it performed by your SUBARU dealer.
- If any of the following actions is done during the standby period, the system will not switch to the surveillance state.
  - Doors (including the rear gate) are unlocked using the access key fob.
  - Doors (including the rear gate) are unlocked using the keyless access function.
  - Any door (including the engine hood) is opened.
  - Push-button ignition switch is turned to the "ACC" position.

### NOTE



- All doors, the rear gate and fuel filler lid will lock, an electronic chirp will sound once, the hazard warning flashers will flash once, and the security indicator light will start flashing rapidly.

## DISARMING THE SYSTEM

Perform either of the following procedures.

- Briefly press unlock/disarm button (for less than 2 seconds) on the access key fob.
- Carry the access key fob and perform either of the following procedures.
  - Grip the front door handle.
  - Press the rear lock button.

- Unlock using the PIN Code Access.

The flashing of the security indicator light will then change slowly (once approximately every 3 seconds from twice approximately every 2 seconds), indicating that the alarm system has been disarmed.

## Emergency disarming

If you cannot disarm the system using the access key fob (i.e., the transmitter is lost, broken or the transmitter battery is too weak), you can disarm the system without using the access key fob.

The system can be disarmed if you turn the ignition switch from the “OFF” position to the “ON” position with a registered key/access key fob.

### NOTE

*If the access key fob battery is discharged, perform the procedure described in “Switching Power Status” P452. In such a case, replace the battery immediately. Refer to “Replacing Battery of Access Key Fob” P507.*

## ALARM SYSTEM SETTING

To change the setting of your vehicle's alarm system for activation or deactivation, do the following.

1. Disarm the alarm system. Refer to “Disarming the System” P137.
2. Sit in the driver's seat and shut all doors, the rear gate and engine hood.
3. Turn the ignition switch to the “ON” position.
4. Hold down “” of the driver's power door locking switch, open the driver's door within the following 1 second, and wait 10 seconds without releasing the switch. The setting will then be changed as follows.

Setting status	Instrument cluster display	Horn
Activate	AL ON	Once
Deactivate	AL OFF	Twice

### NOTE

*You may have the above setting change done by your SUBARU dealer.*

## IF YOU HAVE ACCIDENTALLY TRIGGERED THE ALARM SYSTEM

### To stop the alarm

Do any of the following operations:

- Press any button on the access key fob.
- Turn the push-button ignition switch to the “ACC” position.

### NOTE

*Only registered keys will stop the alarm. If the immobilizer transponder is not registered, the alarm will not stop.*



## 2-6. CHILD SAFETY LOCKS

### WARNING

Always turn the child safety locks to the “LOCK” position when children sit on the rear seat. Serious injury could result if a child accidentally opens the door and falls out.

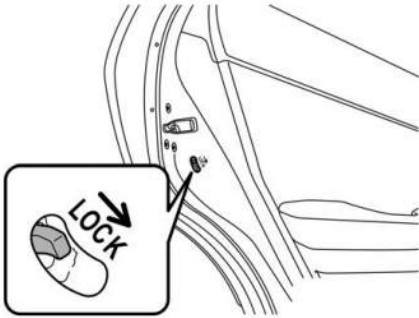

Each rear door has a child safety lock. When the child safety lock lever is in the “LOCK” position, the door cannot be opened from inside. The door can only be opened from the outside.

## 2-7. WINDOWS

### WARNING

To avoid serious personal injury caused by entrapment, always conform to the following instructions without exception.

- When operating the power windows, be extremely careful to prevent anyone’s body parts or any other objects from being caught in the window.
- Always lock the passengers’ windows using the lock switch when children are riding in the vehicle.
- Always carry the key when you leave the vehicle for safety reasons and never allow an unattended child to remain in the vehicle. Failure to follow this procedure could result in injury to a child operating the power window.

### NOTE

- *If the power window system detects resistance, an impact or abnormality, the window operation may be automatically stopped to prevent further jamming, entrapment or malfunction.*
  - *The closing window slides down slightly and stops.*
  - *The opening window stops sliding down.*
- *The power window system may detect resistance, an impact or an abnormality in the following cases.*
  - *A substantial sized object is caught between the window and the window frame.*
  - *A foreign object is caught between the window and the window frame.*
  - *The vehicle drives over a deep pothole.*
- *The window cannot be closed for a few seconds after the window is automatically stopped by the system.*

## POWER WINDOW SWITCHES

You can raise and lower the vehicle windows by operating the power window switch.

The switch illuminates when activated.

**Driver's side power window switches:**

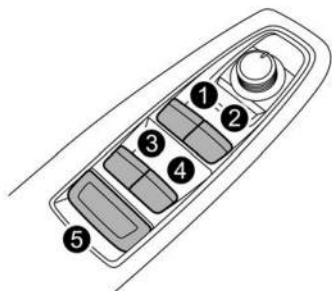

- ❶ For front left window
- ❷ For front right window
- ❸ For rear left window
- ❹ For rear right window
- ❺ Lock switch

All door windows can be controlled by the power window switch cluster on the driver side door.

**Passenger's side power window switch:**

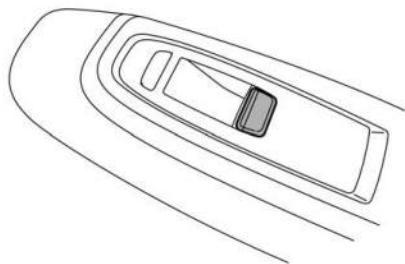

Each passenger's window can be controlled by the power window switch located on the door.

## OPERATING THE WINDOW

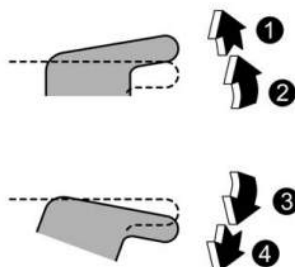

- ❶ Automatically close\*
- ❷ Close
- ❸ Open
- ❹ Automatically open\*

\*: To stop the window halfway, operate the switch to the opposite side.

### NOTE

Avoid the following.

- Continuously operating a switch in the same direction after the window is fully closed or fully opened.
- Continuously operating three or more switches all at once in the same direction after the windows are fully closed or fully opened.

Either of the operations described above may cause the power window breaker to operate making it impossible to open or close the window. Be sure to initialize the power windows. Refer to "Initialization of Power Window"  $\text{\textcircled{P}} P141$ .

### Anti-entrapment function

While closing the window automatically, if the window senses a substantial enough object trapped between the window and the window frame, it automatically moves down slightly and stops.

If a foreign object is caught while window is opening automatically, the window will stop.

### CAUTION

- Never attempt to test the power window operation using body parts.
- If an object is caught just before the window fully closes, the system may not operate properly.

### NOTE

- *If a window detects an impact similar to that caused by trapping an object (for example, when the vehicle encounters a deep pothole), the anti-entrapment function may operate.*
- *You cannot close the window for a few seconds after the anti-entrapment function operates.*

### Off delay function

The windows can be operated for approximately 40 seconds even after the ignition switch is turned to the "ACC" or "OFF" position. If a front door is opened within 40 seconds, the off delay function is canceled.

### LOCKING THE PASSENGERS' WINDOWS

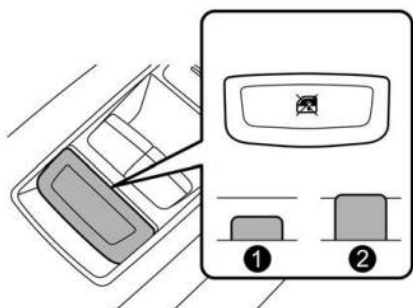

- ① Lock
- ② Unlock

When the lock switch is in the lock position, the rear passenger's window switches on the driver side door and the

passengers' window switches cannot be operated.

When the indicator on the window switches does not illuminate, the window switch cannot be operated.

### INITIALIZATION OF POWER WINDOW

If the one-touch auto up and down function or off delay function does not operate properly, operate each window according to the following procedure in order to initialize the power window system.

1. Close the door.
2. Turn the ignition switch to the "ON" position.
3. Open the window completely and then press and hold down the power window switch for approximately 1 second.
4. Close the window completely and then pull and hold the power window switch for approximately 1 second.

## 2-8. POWER REAR GATE

### WARNING

- When operating the power rear gate, observe the following precautions. Ignoring the precautions may result in an injury (e.g., anyone's body is hit against the rear gate or is caught in the rear gate, etc.)
  - Make sure there are no people around the rear gate.
  - Never let anyone get close to the rear gate.
- When closing the rear gate, be extremely careful to prevent anyone's fingers, arms, neck, head or other objects from being caught in the rear gate. Otherwise, serious personal injury may be caused by entrapment.
- After opening the rear gate on a slope by using the power rear gate feature, the rear gate may close. Make sure that the rear gate has stopped completely after opening it.
- When leaving the vehicle, always carry the key for safety and never allow an unattended child to remain in the vehicle. Failure to follow this procedure could result in injury to a child operating the power rear gate.
- The driver should be aware of and pay careful attention to his/her responsibilities.
- Use the power rear gate only when the area around the rear gate is clearly visible and when you have checked that there is no danger of people being caught in the gate.
- To prevent dangerous exhaust gas from entering the vehicle, always keep the rear gate closed while the engine is running.

- Do not attempt to shut the rear gate while holding the recessed grip. Also do not close the rear gate by pulling the grip from inside the cargo space. There is a danger of your hand being caught and injured.

### CAUTION

- When closing the rear gate after opening it, make sure to use the power rear gate. If you close the rear gate manually with extra force, the power rear gate may be damaged.
- Do not install any accessories other than genuine SUBARU parts on the rear gate. If the weight of rear gate increases excessively, the rear gate stay cannot support the rear gate sufficiently when opening the rear gate. Also, the power rear gate may not function properly or may malfunction.
- When loading and unloading cargo, be careful not to come in contact with the hot engine exhaust gas or the exhaust pipe, because they could burn you.
- Be careful not to hit your head or face on the rear gate when opening or closing the rear gate and when loading or unloading cargo.

You can open and close the power rear gate in the following ways.

- Power rear gate button  
For details, refer to "Operating by the Power Rear Gate Button" ☞P144.
- Rear gate opener button  
For details, refer to "Operating by the Buttons on the Rear Gate" ☞P145.
- Manual operation  
For details, refer to "Manual Operation" ☞P146.

The power rear gate operates only when all of the following conditions are satisfied.

- The vehicle is stopped completely.
- The outside temperature is within a range from  $-22^{\circ}\text{F}$  to  $140^{\circ}\text{F}$  (from  $-30^{\circ}\text{C}$  to  $60^{\circ}\text{C}$ ).
- The ignition switch is in the “OFF” or “ACC” position. Or, the ignition switch is in the “ON” position and the select lever is in the “P” position.

We recommend using the power rear gate function in most circumstances instead of manual operation.

#### NOTE

- *If the rear gate cannot be opened due to a discharged vehicle battery, a malfunction in the door locking/unlocking system or other causes, you can unlock it by manually operating the rear gate lock release lever. For the procedure, refer to “If the Rear Gate Cannot Be Opened” P453.*
- *Avoid keeping the rear gate open for more than a few hours. Doing so may drain the vehicle battery.*
- *The rear gate may not move smoothly when the battery power becomes low.*
- *Do not press the power rear gate button repeatedly while the power rear gate is operating. Otherwise, the system may ignore the button operation in order to avoid being damaged.*
- *If the vehicle starts to move while the power rear gate is operating, the system sounds a buzzer and closes the rear gate automatically. At this time, if the system detects jamming, it will deactivate the power rear gate and the rear gate will not be closed. If this occurs, close the rear gate manually. For details, refer to “Manual Operation” P146.*
- *If you try to open the rear gate using the power rear gate function immediately after closing the rear gate using the power rear gate function, an electronic chirp will sound and the rear*

*gate will not open. Wait for a while before trying to open the rear gate via the power rear gate function.*

- *If either of the operating conditions has not been satisfied while operating the power rear gate, an electronic chirp will sound and the power rear gate will be deactivated. In this case, the rear gate may stop opening or closing suddenly.*

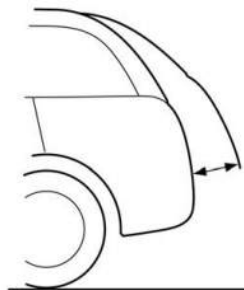

- *The rear gate cannot be paused when it is in the approximately 2 in (5 cm) range from the fully closed position. The system will ignore any button operation and the rear gate will continue to open.*
- *The rear gate will remain unlocked even after closing it. Always lock the rear gate when leaving the vehicle.*
- *If you cannot open/close the rear gate by performing the operation described here, a short electronic chirp will sound three times (beep, beep, beep). In this case, perform the initialization of the power rear gate. Refer to “Initialization of Power Rear Gate” P148.*
- *Before using the power rear gate, remove any accumulated snow from the rear gate.*

## OPERATING BY THE POWER REAR GATE BUTTON

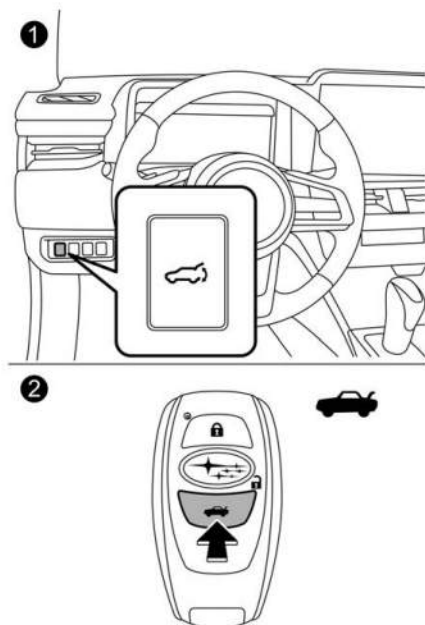

- ① Power rear gate button on the instrument panel
- ② Power rear gate button on the access key fob

### Opening the rear gate:

Press and hold the power rear gate button when the rear gate is closed.

An electronic chirp and the hazard warning flashers will operate as follows:

- When operating the power rear gate button on the instrument panel: sounds and flashes twice.
- When operating the power rear gate button on the access key fob: sounds and flashes four times.

The rear gate will open automatically.

### NOTE

- If you cannot open the rear gate by operating the power rear gate button on the instrument panel, then it may be locked by using the keyless access function or the remote keyless entry system. Unlock the doors using the keyless access function or the remote keyless entry system before pressing the power rear gate button again.
- The factory setting (default setting) of the operation for the “” button on the access key fob is pressing and holding. This setting can be changed to non-operation or pressing twice at SUBARU dealers. For more details, contact a SUBARU dealer.

### Pausing the rear gate while it is opening:

Briefly press the power rear gate button while the rear gate is being opened.

An electronic chirp will sound twice and the hazard warning flashers will flash twice.

### NOTE

If you press the power rear gate button again, the rear gate will close.

### Closing the rear gate:

Press and hold the power rear gate button.

An electronic chirp will sound twice and the hazard warning flashers will flash twice.

### NOTE

If you briefly press the power rear gate button again, the rear gate will open.

## OPERATING BY THE BUTTONS ON THE REAR GATE

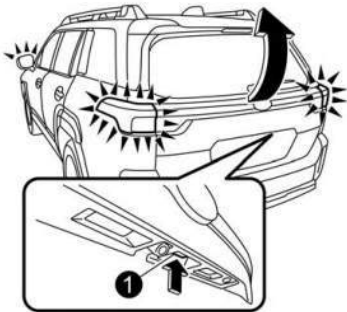

① Rear gate opener button

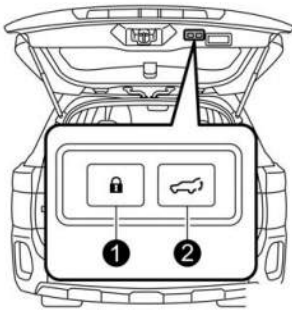

- ① Power rear gate lock button  
② Power rear gate button

### Opening the rear gate:

When the rear gate is locked	Briefly press the rear gate opener button while carrying the access key.
When the rear gate is unlocked	Briefly press the rear gate opener button.

After you operate the rear gate, an electronic chirp will sound twice and the hazard warning flashers will flash twice. The rear gate will open automatically.

### Pausing the rear gate while it is opening:

Briefly press either of the following buttons while the rear gate is being opened.

- Rear gate opener button

- Power rear gate button
- Power rear gate lock button

### NOTE

If you press the power rear gate button again, the rear gate will close.

### Closing the rear gate:

Briefly press either of the following buttons.

- Rear gate opener button
- Power rear gate button

An electronic chirp will sound twice and the hazard warning flashers will flash twice.

### NOTE

If you press the power rear gate button again, the rear gate will open.

### Locking the doors using the power rear gate lock button:

1. Carry the access key fob.
2. Press the power rear gate lock button.

All doors, the rear gate and the fuel filler lid are locked, and the rear gate will be closed. Also, the hazard warning flashers will flash once, and an electronic chirp will sound once.

### NOTE

- When you push the power rear gate lock button for more than 2 seconds, all the doors will lock, but the auto closing function of the rear gate will be canceled.
- If you push the power rear gate lock button while the access key is inside the vehicle, an electronic chirp sounds and the rear gate does not operate.
- When the ignition switch is placed in the "ON" or "ACC" position, the rear gate does not operate when you push the power rear gate lock button.
- If any of the doors is not fully closed, the electronic chirp sounds five times to alert you that the doors are not properly closed.

## MANUAL OPERATION

### Opening the rear gate:

Lift the rear gate up to the midway position. The rear gate will automatically open from the midway position to the fully open position.

### Closing the rear gate:



Pull down the rear gate when the rear gate is opened. The rear gate will close automatically.

This function is disabled as the factory default setting. To use the function, it must be enabled. Consult your SUBARU dealer to have this function set to enabled or disabled. When opening and closing the rear gate with this function disabled, make sure to use the power rear gate by operating the button.

The rear gate can be lowered easily if you pull down on the inside handle as shown in the illustration.



### CAUTION

- Never attempt to close the rear gate by grabbing or pressing on the outer metal surface or damage may result.
- Always use the inside handle to avoid damaging the exterior surface of the gate.

### NOTE

- If the rear gate is moved slowly, it may not operate automatically open or close.
- When leaving the vehicle, make sure that all doors and the rear gate are completely locked.

## MEMORY FUNCTION

The preferred rear gate height can be registered.

### Registration of the rear gate height:

1. Open the rear gate and stop it at the preferable height.
2. Press and hold the power rear gate button to register the height.



① Power rear gate button

An electronic chirp sounds for confirmation.

The rear gate will stop at the registered position when the memory function is on.

### NOTE

- Register the rear gate height to turn on the “Power Rear Gate Height Memory” automatically. Refer to “Vehicle” P206.
- To change the registered height, perform the registering procedure again.
- It is possible to register the height from approximately 2 in (5 cm) or more from the completely closed position.



**Deactivation of the memory function:**

Deactivate the memory function to open the rear gate fully. Perform either of the following operation to deactivate the memory function.

- Deactivate the “Power Rear Gate Height Memory” function on the center information display (CID). Refer to “Vehicle” P206.
- Register the position of the rear gate at the fully open position.

**Utilizing the memorized rear gate height:**

To open the rear gate and stop it at the registered height, perform the following procedure.

1. Check that “Power Rear Gate Height Memory” is on. Refer to “Vehicle” P206.
2. Press and hold any of the power rear gate buttons or briefly press the rear gate opener button.

**NOTE**

*The rear gate will open to the position that is stored in the memory function even if the rear gate is opened by the reverse function.*

**REVERSE FUNCTION****⚠ WARNING**

- Do not let parts of your body get caught when operating the reverse function. If the reverse function does not operate for some reason, this may lead to serious injury or accidents.
- The reverse function may not operate if foreign objects are caught in the rear gate just before it closes completely. Be careful not to catch your fingers and other body parts.
- The reverse function may not operate depending on the object

shape and the manner in which it was caught. Be careful not to catch your fingers and other body parts.

**⚠ CAUTION**

- If the reverse function is operated 3 times consecutively, automatic opening and closing of the power rear gate function will be canceled and the rear gate will stop opening or closing suddenly. However, the rear gate may open or close depending on the rear gate height when automatic operation is ceased. Be careful that the rear gate does not hit anyone’s head or face, etc. and that fingers and baggage, etc. are not caught in it.
- Take care not to damage the touch sensors. Otherwise, the reverse function may cease to operate.

If, while opening or closing using power rear gate, the rear gate catches persons or baggage or hits an obstacle, an electronic chirp will sound 3 times and the rear gate will operate as follows.

**When opening the rear gate:**

The rear gate will automatically close.

**When closing the rear gate:**

The rear gate will automatically open.

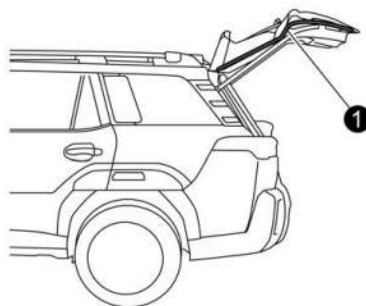

① Touch sensor

Touch sensors are attached on the left and right edges of the rear gate. If the touch sensors detect fingers, baggage, etc. while closing by the power rear gate function, an electronic chirp will sound 3 times and the rear gate will open automatically.

#### NOTE

*When the rear gate is opened using the reverse function, it will be opened fully or to the height registered in the memory function.*

### REAR GATE DROP PREVENTION FUNCTION

If, while fully opened via the power rear gate function, the rear gate is lowered, the rear gate drop prevention function will apply braking to the rear gate so that it prevents a rapid closure of the rear gate.

#### NOTE

*If you close the rear gate manually just after the rear gate is fully opened using the power rear gate function, the rear gate drop prevention function will detect a rapid closure of the rear gate and apply braking to the rear gate. In this case, this is not a malfunction.*

### SELECTING AUDIBLE SIGNAL OPERATION

Using an electronic chirp, the power rear gate will give you an audible signal before starting its operation. If desired, the audible signal can be turned off by a SUBARU dealer. Consult your SUBARU dealer for details.

You can also turn the audible signal off by operating the center information display. For details, refer to "Vehicle" P206.

The ON/OFF setting of the audible signal also works as the audible signal settings for the "remote keyless entry system" and the "keyless access with push-button start system". However, for the electronic

chirp such as that caused by "Reverse Function" P147, it cannot be set as non-operational.

### INITIALIZATION OF POWER REAR GATE

If the power rear gate detects some abnormality while operating, an electronic chirp will sound and the power rear gate operation will be automatically stopped in either opening or closing position. In this case, the system needs to be initialized in the following order to restart the function properly.

#### If the power rear gate is closed

1. Keep pressing the rear gate opener button until it is unlocked (for approximately 5 seconds) and lift up the rear gate.

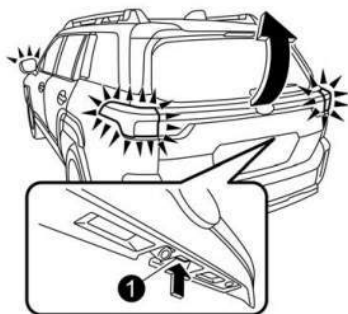

1. Rear gate opener button
2. Pull down the rear gate until it starts to close automatically. The system will be initialized once the gate is fully closed.
3. Operate the power rear gate and check that the function operates properly.

#### If the power rear gate is opened

1. Pull down the rear gate until it starts to close automatically. The system will be initialized once the gate is fully closed.  
If the rear gate will not close comple-

tely, keep pressing the rear gate opener button for approximately 5 seconds and pull down the rear gate.

2. Operate the power rear gate and check that the function operates properly.



### CAUTION

If the power rear gate function does not operate properly, have your vehicle checked by a SUBARU dealer.

## 2-9. MOONROOF (If Equipped)

The moonroof has both tilting and sliding functions.



### WARNING

Never let anyone's hands, arms, head or any objects protrude from the moonroof. A person could be seriously injured if any of the following conditions occur.

- The vehicle stops suddenly.
- The vehicle turns sharply.
- The vehicle is involved in an accident.
- Body parts protruding from the vehicle are struck by outside objects.

To avoid serious personal injury caused by entrapment, always conform to the following instructions without exception.

- Before closing the moonroof, make sure that no one's hands, arms, head or other objects will be accidentally caught in the moonroof.
- Always carry the key when you leave the vehicle for safety reasons and never allow an unattended child to remain in the vehicle. Failure to follow this procedure could result in injury to a child operating the moonroof.
- Never try to check the anti-entrapment function by deliberately placing part of your body in the moonroof.

**CAUTION**

- Do not sit on the edge of the open moonroof.
- Do not operate the moonroof if falling snow or extremely cold conditions have caused it to freeze shut.
- The anti-entrapment function does not operate when the moonroof is being tilted down. Be sure to confirm that it is safe to tilt the moonroof down before doing so.
- If the moonroof does not close, have the system checked by a SUBARU dealer.

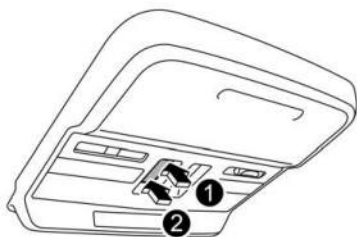
**MOONROOF SWITCHES****Tilting moonroof**

- ① Up
- ② Down

To raise the moonroof, press and hold the switch in the up side and release. To lower the moonroof, press and hold the switch in the down side.

**NOTE**

*Release the switch after the moonroof has been raised or has been lowered completely. Pressing the switch continuously may cause damage to the moonroof.*

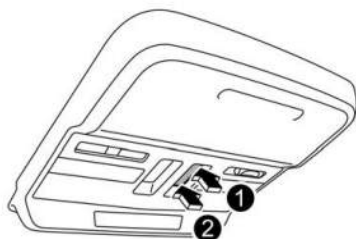
**Sliding moonroof**

- ① Open
- ② Close

**Opening the moonroof:**

To open the moonroof using the automatic function, press and hold the open side of the switch and then release it.

To stop the moonroof at a selected mid-way position while opening it, momentarily press the open or close side of the switch.

The sunshade will also be opened together with the moonroof.

The moonroof will stop at a position approximately 3.8 in (9.7 cm) away from the fully opened position.

Press the open side of the switch again to open the moonroof completely.

**Closing the moonroof:**

To close the moonroof using the automatic function, press and hold the close side of the switch and then release it.

To stop the moonroof at a selected mid-way position while closing it, momentarily press the open or close side of the switch.

**NOTE**

- *After washing the vehicle or after it rains, wipe away water on the roof prior to opening the moonroof to prevent drops of water from falling into the passenger compartment.*

- *Driving with the moonroof fully open can cause an annoying sound to be generated at high speeds. If this occurs, use the moonroof at the initial stop position of 3.8 in (9.7 cm) away from the fully opened position.*
- *For the sake of safety, it is recommended that you avoid driving with the moonroof fully opened.*

## Anti-entrapment function

When the moonroof senses a substantial enough object trapped between its glass and the vehicle's roof during closure, it automatically opens fully. The anti-entrapment function may also be activated by a strong shock on the moonroof even when there is nothing trapped.



### CAUTION

Never attempt to test this function using fingers, hands or other parts of your body.

## SUNSHADE

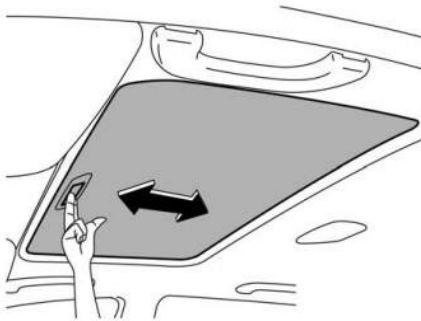

The sunshade can be slid forward or backward by hand while the moonroof is closed.

If the moonroof is opened, the sunshade also moves back.

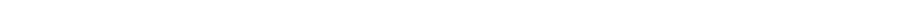
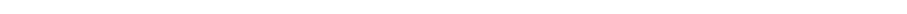

## INSTRUMENTS AND CONTROLS

3-1.	Push-Button Ignition Switch .....	156
	Safety Precautions .....	156
	Operating Range for Push-Button Start System .....	156
	Switching Power Status .....	156
	When Access Key Fob Does Not Operate Properly .....	157
3-2.	Hazard Warning Flasher .....	158
3-3.	Meters and Gauges .....	158
	Speedometer .....	158
	Tachometer .....	158
	Odometer .....	158
	Double Trip Meter .....	159
	Fuel Gauge and Driving Range on Remaining Fuel .....	159
	Engine Coolant Temperature Gauge .....	160
	Instrument Cluster Settings .....	160
3-4.	Illumination Brightness Control .....	161
	Auto Dimmer Cancel Function .....	161
3-5.	Warning and Indicator Lights .....	162
	Seatbelt Warning Light and Chime .....	163
	SRS Airbag System Warning Light .....	165
	Front Passenger's Frontal Airbag ON and OFF Indicator Lights ...	166
	CHECK ENGINE Warning Light/Malfunction Indicator Light .....	166
	Coolant Temperature Low Indicator Light (Blue)/Coolant Temperature High Warning Light (Red) .....	167
	Charge Warning Light .....	168
	Oil Pressure Warning Light .....	168
	Engine Low Oil Level Warning Light .....	168
	AT OIL TEMP Warning Light .....	169
	Low Tire Pressure Warning Light (Except for Canada-Spec. Models) .....	169
	ABS Warning Light .....	170
	Brake System Warning Light .....	171
	Electronic Parking Brake Indicator Light .....	172
	Auto Vehicle Hold Indicator Light .....	173
	Low Fuel Warning Light .....	174
	Door Open Indicator Light .....	174
	Engine Hood Open Warning Light .....	174
	Windshield Washer Fluid Warning Light .....	174
	All-Wheel Drive Warning Light .....	174
	Power Steering Warning Light .....	174
	Vehicle Dynamics Control Warning Light/Vehicle Dynamics Control Operation Indicator Light .....	175
	Vehicle Dynamics Control OFF Indicator Light .....	176
	Warning Chimes and Warning Indicator of the Keyless Access with Push-Button Start System .....	176
	Security Indicator Light .....	180
	Select Lever/Gear Position Indicator .....	180
	Turn Signal Indicator Lights .....	180
	High Beam Indicator Light .....	181
	High Beam Assist Indicator .....	181

## INSTRUMENTS AND CONTROLS

---

	LED Headlight Warning Light .....	181
	Steering Responsive Headlight OFF Indicator Light .....	181
	Steering Responsive Headlight Warning Light .....	181
	Headlight Indicator Light .....	181
	Front Fog Light Indicator Light .....	181
	Auto Start Stop Warning Light (Yellow) .....	181
	Auto Start Stop OFF Indicator Light .....	181
	Auto Start Stop Indicator Light (Green) .....	182
	Auto Start Stop No Activity Detected Indicator Light .....	182
	Electric Damper System Warning Light (If Equipped) .....	182
	X-MODE Indicator .....	182
	Vehicle Detected in Neighboring Lane Indicator .....	182
	Hill Descent Control Indicator Light .....	183
	BSW/RCTW Warning Indicator .....	183
	BSW/RCTW OFF Indicator .....	183
	Icy Road Surface Warning Indicator .....	183
	RAB Warning Indicator .....	183
	RAB OFF Indicator .....	183
	Proximity Warning Detection OFF Indicator .....	184
	Distraction Mitigation System Operation Indicator Light (Green) .....	184
	Distraction Mitigation System Warning Light (Yellow) .....	184
	Distraction Mitigation System OFF Indicator Light .....	184
	Distraction Mitigation System Temporary Stop Indicator Light .....	184
	Front Cross Traffic Braking Warning Indicator (If Equipped) .....	184
	Front Cross Traffic Braking OFF Indicator (If Equipped) .....	184
3-6.	Instrument Cluster Display .....	185
	Basic Operation .....	187
	Instrument Cluster Display Mode .....	188
	Welcome Screen (Opening Animation) and Good-Bye Screen (Ending Animation) .....	189
	Warning Screen .....	189
	Meter Information Screen .....	189
	Telltale Screen .....	190
	Basic Screens .....	191
	Digital Speed Screen .....	193
3-7.	Center Information Display (CID) Features .....	194
	Welcome Screen and Good-Bye Screen .....	194
	Touch Screen Operations .....	195
3-8.	Center Information Display .....	197
	HOME Icon .....	198
	Outside Temperature and Clock .....	198
	Information Bar .....	198
	Status Bar .....	198
	Driver Profile Icon .....	198
	How to Change the Screen Settings .....	199
	Shortcut Icons .....	199
	Setting .....	200



## INSTRUMENTS AND CONTROLS

3-9.	Clock .....	210
	Setting the Clock Manually.....	210
	Setting the Clock Automatically.....	210
	Setting 12-Hour Display/24-Hour Display .....	211
3-10.	Valet Mode .....	211
	Activation of Valet Mode .....	211
	Deactivation of Valet Mode.....	212
	Change the Passcode .....	212
3-11.	Light Control Switch.....	212
	Headlights .....	213
	High/Low Beam Change (Dimmer).....	215
	Headlight Flasher.....	215
	High Beam Assist Function.....	215
	Daytime Running Light System .....	218
3-12.	Steering Responsive Headlight (SRH) .....	219
3-13.	Front Fog Light Switch.....	220
3-14.	Turn Signal Lever.....	221
	One-Touch Lane Changer.....	221
3-15.	Wiper and Washer.....	221
	Windshield Wiper and Washer Switches .....	223
	Rear Window Wiper and Washer Switch .....	225
3-16.	Defogger and Deicer.....	226
3-17.	Mirrors .....	228
	Inside Mirror (without Auto-Dimming Function) (If Equipped).....	228
	Auto-Dimming Mirror/Compass (If Equipped).....	228
	Auto-Dimming Mirror/Compass with HomeLink® (If Equipped).....	229
	Smart Rearview Mirror/Compass with HomeLink® (If Equipped)....	235
	Outside Mirrors.....	245
3-18.	Tilt/Telescopic Steering Wheel.....	249
3-19.	Heated Steering Wheel System (If Equipped).....	249
3-20.	Horn .....	250

### 3-1. PUSH-BUTTON IGNITION SWITCH

#### SAFETY PRECAUTIONS

Refer to “Safety Precautions” ☞ P117.

#### OPERATING RANGE FOR PUSH-BUTTON START SYSTEM

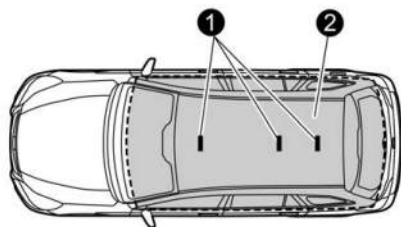

- ① Antennas
- ② Operating range

#### NOTE

- If the access key fob is not detected within the operating range of the antennas inside the vehicle, the push-button ignition switch and the engine start cannot be operated.
- Even when the access key fob is outside the vehicle, if it is placed too close to the glass, it may be possible to switch the power or to start the engine.
- Do not leave the access key fob in the following places. It may become impossible to operate the push-button ignition switch and the engine start.
  - On the instrument panel
  - On the floor
  - Inside the glove box
  - Inside the door trim pocket
  - On the rear seat
  - At the corner of the cargo area

- When operating the push-button ignition switch or starting the engine, if the access key fob battery is discharged, perform the procedure described in “If Access Key Fob Does Not Operate Properly” ☞ P451. In such a case, replace the battery immediately. Refer to “Replacing Battery of Access Key Fob” ☞ P507.

#### SWITCHING POWER STATUS

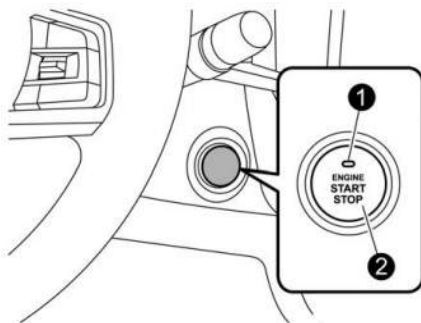

- ① Operation indicator
- ② Push-button ignition switch

The power status is switched every time the push-button ignition switch is pressed.

1. Carry the access key fob, and sit in the driver's seat.
2. Make sure the select lever is in the “P” position.
3. Press the push-button ignition switch without depressing the brake pedal. Every time the button is pressed, the power is switched in the sequence of “OFF”, “ACC”, “ON” and “OFF”. When the engine is stopped and the push-button ignition switch is in “ACC” or “ON”, the operation indicator on the push-button ignition switch illuminates in orange.

Power status	Indicator color	Operation
OFF	Turned off	Power is turned off.
ACC	Orange	The following systems can be used: audio and accessory power outlet.
ON	Orange (while engine is stopped)	All electrical systems can be used.
	Turned off (while engine is running)	



### CAUTION

- To prevent the vehicle battery from discharging, do not leave the push-button ignition switch in the “ON” or “ACC” position for a long time.
- To avoid a malfunction, observe the following precautions.
  - Do not spill drinks or other liquids on the push-button ignition switch.
  - Do not touch the push-button ignition switch with a hand that is soiled with oil or other contaminants.
- If the push-button ignition switch does not operate smoothly, stop the operation. Contact a SUBARU dealer immediately.
- If the operation indicator on the push-button ignition switch does not illuminate even when the instrument panel illumination is turned on, have the vehicle inspected at a SUBARU dealer.
- If the vehicle was left in the hot sun for a long time, the surface of the push-button ignition switch may get hot. Be careful not to burn yourself.

### NOTE

- When operating the push-button ignition switch, firmly press it all the way.
- If the push-button ignition switch is pressed quickly, the power may not turn on or off.
- If the indicator light on the push-button ignition switch flashes in green when the push-button ignition switch is pressed, steering is locked. When this occurs, press the push-button ignition switch while turning the steering wheel left and right.

3

### Battery drainage reduction function

If you leave the push-button ignition switch in the “ON” position (when the engine is not running), a series of messages will be displayed on the instrument cluster in the following order, and then the push-button ignition switch will be automatically set to “OFF”.

- After approximately 5 minutes, the message “Turn Power OFF or Turn Car ON to Charge Battery” will be displayed.
- After approximately 15 minutes, the battery charge drops and the message “Some Functions Disabled Reduced Battery Level” will be displayed.
- When the select lever is in the “P” position and the ignition switch remains in the “ON” position for approximately 30 minutes, the system automatically turns the push button ignition switch to the “OFF” position.

### WHEN ACCESS KEY FOB DOES NOT OPERATE PROPERLY

Refer to “If Access Key Fob Does Not Operate Properly” ☞ P451.

### 3-2. HAZARD WARNING FLASHER

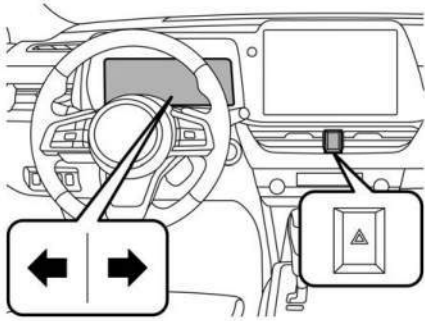

The hazard warning flasher is used to warn other drivers when you have to park your vehicle under emergency conditions. The hazard warning flasher works with the ignition switch in any position.

To turn on the hazard warning flasher, press the hazard warning flasher switch on the instrument panel. All the turn signal lights and the turn signal indicator lights will flash. To turn off the flasher, press the switch again.

#### NOTE

*When the hazard warning flasher is on, the turn signals do not work.*

### 3-3. METERS AND GAUGES

#### NOTE

*Liquid crystal displays are used in some of the meters and gauges in the instrument cluster. You will find their indications hard to see if you wear polarized glasses.*

#### SPEEDOMETER

The speedometer shows the vehicle speed.

#### TACHOMETER

The tachometer shows the engine speed in thousands of revolutions per minute.



#### CAUTION

Do not operate the engine with the pointer of the tachometer in the red zone. In this range, fuel injection will be cut by the engine control module to protect the engine from overrevving. The engine will resume running normally after the engine speed is reduced below the red zone.

#### ODOMETER

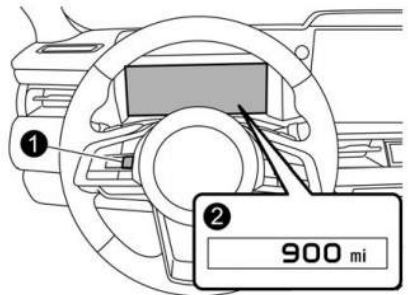

① TRIP RESET switch

② Odometer

This meter displays the odometer when the ignition switch is in the "ON" position.

The odometer shows the total distance that the vehicle has been driven.

**NOTE**

If you press the TRIP RESET switch when the ignition switch is in the "OFF" or "ACC" position, the odometer/trip meter will light up. The indicators will turn off when the TRIP RESET switch is not operated for approximately 10 seconds.

**DOUBLE TRIP METER**

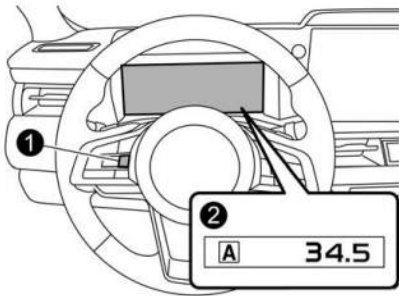

- ① TRIP RESET switch
- ② Trip meter

This meter displays the two trip meters when the ignition switch is in the "ON" position.

The trip meter shows the distance that the vehicle has been driven since you last set it to zero.

The display can be switched as shown in the following sequence by pressing the TRIP RESET switch.



To reset the trip meter, select either the A trip or B trip meter, then press and hold the TRIP RESET switch.

**CAUTION**

To ensure safety, do not attempt to change the function of the indicator during driving, as an accident could result.

**NOTE**

- If the connection between the instrument cluster and battery is broken for any reason such as vehicle maintenance or fuse replacement, the data recorded on the trip meter will be lost.
- If you press the TRIP RESET switch when the ignition switch is in the "OFF" or "ACC" position, the odometer/trip meter will light up. It is possible to switch between the A trip meter and B trip meter indications while the odometer/trip meter is lit up. In addition, it is possible to reset the trip meter by pressing and holding the TRIP RESET switch. The indicators will turn off when the TRIP RESET switch is not operated for approximately 10 seconds.

**FUEL GAUGE AND DRIVING RANGE ON REMAINING FUEL**

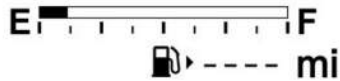

The fuel gauge shows the approximate amount of fuel remaining in the tank.

The gauge may move slightly due to fuel level movement in the tank (e.g., during braking, turning or acceleration).

**NOTE**

- You will see the “▶” sign in the fuel gauge. This indicates that the fuel filler lid is located on the right side of the vehicle.
- If you press the TRIP RESET switch while the ignition switch is in the “OFF” or “ACC” position, the fuel gauge will light up and indicate the amount of fuel remaining in the tank. The gauge will turn off when the TRIP RESET switch is not operated for approximately 10 seconds.
- The driving range on the remaining fuel is only a guide. The indicated value may differ from the actual driving range on the remaining fuel, so you must immediately fill the tank when the low fuel warning light illuminates.
- If you refuel the vehicle with approximately 2.6 US gal (10 liters, 2.2 Imp gal) or less of fuel, the values indicated on the fuel gauge and driving range on the remaining fuel may not update. As a guideline, refueling the vehicle with approximately 2.6 US gal (10 liters, 2.2 Imp gal) or more of fuel will update the indicated values.

The coolant temperature will vary in accordance with the outside temperature and driving conditions.

We recommend that you drive moderately until the pointer of the temperature gauge reaches near the middle of the range. Engine operation is optimum with the engine coolant at this temperature range and high revving operation when the engine is not warmed up enough should be avoided.

 **CAUTION**

If the pointer exceeds the normal operating range, safely stop the vehicle as soon as possible.

Refer to “Engine Overheating”  
☞P446.

**INSTRUMENT CLUSTER SETTINGS**

Instrument cluster settings can be set on the center information display. For details, refer to “Displays” ☞P204.

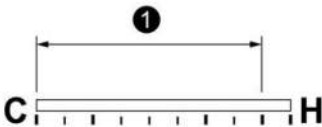
**ENGINE COOLANT TEMPERATURE GAUGE**

- 1** Normal operating range

The temperature gauge shows engine coolant temperature when the ignition switch is in the “ON” position.

**3-4. ILLUMINATION BRIGHTNESS CONTROL**

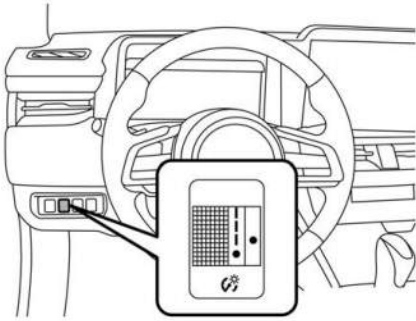

The illumination brightness of the instrument cluster, center information display and climate control panel dims under the following conditions.

- The light switch is in the “ ” or “ ” position when the ambient light is dark.
- The light switch is in the “AUTO” position and the headlights illuminate automatically.

You can adjust the illumination brightness for better visibility.

To brighten, turn the control dial upward.  
To darken, turn the control dial downward.

**NOTE**

- When the control dial is turned fully upward, the illumination brightness becomes the maximum and the automatic dimming function does not work at all.
- The brightness setting is not canceled even when the ignition switch is turned to the “OFF” position.
- The operation method of illumination brightness will differ depending whether or not “Brightness Dial Control” in the center information display is on. Refer to the operation method indicated the following table.

“Brightness Dial Control” is on.

Operational item	Instrument cluster and climate control panel	Center information display
Control dial	Available	Available
“Brightness Adjustment” <sup>*1</sup> on the center information display	Not available	Not available

“Brightness Dial Control” is off.

Operational item	Instrument cluster and climate control panel	Center information display
Control dial	Available	Not available
“Brightness Adjustment” on the center information display	Not available	Available

\*1: When “Brightness Dial Control” is on, “Brightness Adjustment” on the center information display is not available. For details about “Brightness Dial Control” on/off settings, refer to “Brightness/Contrast” P199.

**AUTO DIMMER CANCEL FUNCTION**

When the ambient light is bright, the illumination brightness is set to the maximum regardless of the position of the control dial. In this case, you cannot adjust the illumination brightness by using the control dial. When the ambient light is dark, you can dim the illumination brightness as described above.

The operational/non-operational setting and sensitivity of the auto dimmer cancel function can be changed by your SUBARU dealer. Contact your SUBARU dealer for details.

### 3-5. WARNING AND INDICATOR LIGHTS

Several of the warning and indicator lights illuminate momentarily and then go out when the ignition switch is initially turned to the "ON" position. This permits checking the operation of the bulbs.

Apply the parking brake and turn the ignition switch to the "ON" position. For the system check, the following lights illuminate and turn off after several seconds or after the engine has started:

: Rear seatbelt warning light

: SRS airbag system warning light

ON : Front passenger's frontal airbag ON indicator light

: Front passenger's frontal airbag OFF indicator light

 / : CHECK ENGINE warning light/  
Malfunction indicator light

: Charge warning light

: Oil pressure warning light

ABS / : ABS warning light

: Vehicle Dynamics Control warning light/  
Vehicle Dynamics Control operation indicator light

: Vehicle Dynamics Control OFF indicator light

BRAKE / : Brake system warning light

PARK / : Electronic parking brake indicator light

: Power steering warning light

: Low tire pressure warning light (except for Canada-spec. models)

: Auto Start Stop warning light (yellow)



If any lights fail to illuminate, it indicates a burned-out bulb or a malfunction of the corresponding system.

Consult your authorized SUBARU dealer for repair.

## SEATBELT WARNING LIGHT AND CHIME



Your vehicle is equipped with a seatbelt warning device at the driver's and passenger's seat, as required by current safety standards.

### Driver's and front passenger's seats

With the ignition switch turned to the "ON" position, this device reminds the driver and front passenger to fasten their seatbelts by illuminating the warning lights in the locations indicated in the following illustration and sounding a chime.

Driver's warning light



Front passenger's warning light



### NOTE

- If the driver's and/or front passenger's seatbelt(s) are/is not fastened while driving, the seatbelt warning system operates as follows according to the vehicle speed.
  - The warning light will illuminate when the vehicle speed is approximately 4 mph (6 km/h) or less.
  - The warning light will blink, and the warning chime will make a beep sound when the vehicle speed is between approximately 4 mph (6 km/h) and 13 mph (20 km/h). The warning chime will stop when the vehicle stops.
  - The warning light will blink, and the warning chime will sound loudly when 15 seconds have elapsed when the vehicle speed is between approximately 4 mph (6 km/h) and 13 mph (20 km/h).
  - The warning light will blink, and the warning chime will sound loudly when the vehicle speed is approximately more than 13 mph (20 km/h).
- The warning light will turn off and the warning chime will stop when the seatbelt is fastened.

If there is no passenger on the front passenger's seat, the seatbelt warning system for the front passenger's seat will be deactivated. The front passenger's seatbelt warning system monitors whether or not there is a passenger on the front passenger's seat.



### CAUTION

Observe the following precautions. Failure to do so may prevent the device from functioning correctly or cause the device to fail.

- Do not install any accessory such as a table or TV onto the seatback.
- Do not store a heavy load in the seatback pocket.

- Do not allow the rear seat occupant to place his/her hands or legs on the front passenger's seatback, or allow him/her to pull the seatback.
- Do not use front seats with their backward-forward position and seatback not being locked into place securely. If any of them are not locked securely, adjust them again. For adjusting procedure, refer to "Front Seats" P37.

If the seatbelt warning system for the front passenger's seat does not function correctly (e.g., it is activated even when the front passenger's seat is empty or it is deactivated even when the front passenger has not fastened his/her seatbelt), take the following actions.

- Ensure that no article is placed on the seat other than a child restraint system and its child occupant, although we strongly recommend that all children sit in the rear seat properly restrained.
- Ensure that there is no article left in the seatback pocket.
- Ensure that the backward-forward position and seatback of front passenger's seat are locked into place securely by moving the seat back and forth.

If still the seatbelt warning system for front passenger's seat does not function correctly after taking relevant corrective actions described above, immediately contact your SUBARU dealer for an inspection.

## Rear passenger's seats

### Rear seatbelt warning light

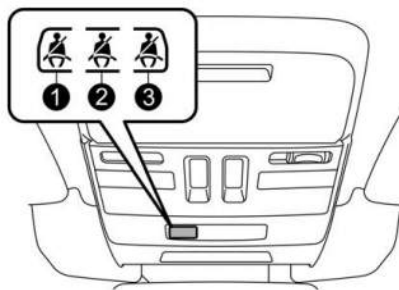

- ❶ Rear left seat
- ❷ Rear center seat
- ❸ Rear right seat

With the ignition switch turned to the "ON" position, the seatbelt warning light and chime reminds the rear passenger to fasten their seatbelt by illuminating the warning lights in the locations indicated in the above illustration and sounding a chime.

### WARNING

- The driver must check that all the passengers have fastened their seatbelts properly since the seatbelt warning system may not detect passengers under the following circumstances.
  - When cushions or child restraint systems, etc., are used.
  - When a child or small adult is sitting in the seat.
- Observe the following precautions
  - Do not apply any strong impact to the rear seat.
  - Do not fold the seatback forward when objects are on the seat.
  - Do not spill liquid on the rear seat. If liquid is spilled, wipe it off immediately.

- Do not remove or disassemble the rear seat.

**NOTE**

- The seatbelt warning system of the rear seat detects if the seat is occupied by a passenger. Heavy cargo or large pets on the rear seat may result in the activation of the passenger seatbelt warning light and chime. Fastening the rear seatbelt prior to loading cargo or large pets will avoid activating the passenger seatbelt warning light and chime.
- When folding the rear seat, ensure that the seat is empty prior to folding. Items caught between the seat bottom and seatback, when folded, may damage the seat surface or activate the passenger seatbelt warning light and chime.

If passengers in the rear seats do not fasten their seatbelts when the ignition switch is turned to the “ON” position, the seatbelt warning lights will illuminate or blink to indicate that their seatbelts are not fastened.

**NOTE**

- If the rear passenger’s seatbelt(s) are/ is still not fastened while driving, the seatbelt warning system operates as follows according to the vehicle speed.
  - The warning light will illuminate when the vehicle speed is approximately 4 mph (6 km/h) or less.
  - When the vehicle speed is approximately between 4 mph (6 km/h) and 13 mph (20 km/h), the seatbelt warning lights will blink and a warning chime will sound. The chime will make a beep sound for 15 seconds, and it then will become louder and continue for 35 seconds. The warning light will blink for 50 seconds, then it will illuminate steadily and the chime will stop.

- The warning light will blink, and the beep will sound loudly for 35 seconds when the vehicle speed is approximately more than 13 mph (20 km/h). After 35 seconds, the blinking warning light will illuminate steadily and the chime will stop. The warning lights will continue to illuminate until their seatbelts are fastened.
- The warning light will turn off and the warning chime will stop when the seatbelt is fastened.

**SRS AIRBAG SYSTEM WARNING LIGHT****WARNING**

If the warning light exhibits any of the following conditions, immediately stop the vehicle in a safe place, and consult a SUBARU dealer. Unless a technician checks and repairs the system as needed, the seatbelt pretensioners and/or the SRS airbag will not operate properly in the event of a collision, which may result in injury.

- Flashing or flickering of the warning light
- No illumination of the warning light when the ignition switch is first turned to the “ON” position
- Continuous illumination of the warning light
- Illumination of the warning light while driving

For details about the components monitored by the warning light, refer to “SRS Airbag System Monitors” Ⓞ P110.

## FRONT PASSENGER'S FRONTAL AIRBAG ON AND OFF INDICATOR LIGHTS

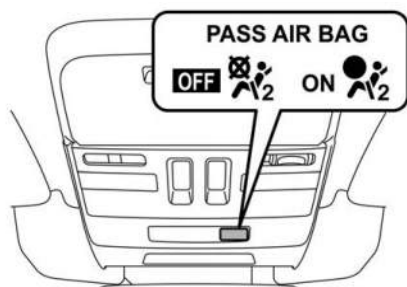

 Front passenger's frontal airbag ON indicator light

 Front passenger's frontal airbag OFF indicator light

For details about the operating conditions of SRS seat cushion airbag, refer to "SUBARU Advanced Frontal Airbag System" P92.

The front passenger's frontal airbag ON and OFF indicator lights show you the status of the front passenger's SRS frontal airbag.

The indicator lights are located as shown in the illustration.

When the ignition switch is turned to the "ON" position, both the ON and OFF indicator lights illuminate for 6 seconds during which time the system is checked. Following the system check, both indicator lights turn off for 2 seconds. After that, one of the indicator lights illuminates depending on the status of the front passenger's SRS frontal airbag determined by the SUBARU advanced frontal airbag system monitoring.

If the front passenger's SRS frontal airbag is activated, the passenger's frontal airbag ON indicator light will illuminate while the OFF indicator light will remain off.

If the front passenger's SRS frontal airbag is deactivated, the passenger's frontal airbag ON indicator light will remain off while the OFF indicator light will illuminate.

With the ignition switch turned to the "ON" position, if both the ON and OFF indicator lights remain illuminated or off simultaneously even after the system check period, the system is malfunctioning. Contact your SUBARU dealer immediately for an inspection.

## CHECK ENGINE WARNING LIGHT/MALFUNCTION INDICATOR LIGHT



### CAUTION

If the CHECK ENGINE warning light/malfunction indicator light illuminates while you are driving, have your vehicle checked/repaired by your SUBARU dealer as soon as possible. Continued vehicle operation without having the emission control system checked and repaired as necessary could cause serious damage, which may not be covered by your vehicle's warranty.

If this light illuminates steadily or blinks while the engine is running, it may indicate that there is at least one problem or potential problem somewhere in the emission control system.

### If the light illuminates constantly

If the light illuminates constantly while driving or does not turn off after the engine starts, an emission control system malfunction has been detected.

You should have your vehicle checked by an authorized SUBARU dealer immediately.

#### NOTE

*This light also illuminates when the fuel filler cap is not tightened until it clicks.*

If you have recently refueled your vehicle, the cause of the CHECK ENGINE warning light/malfunction indicator light coming on could be a loose or missing fuel filler cap. Remove the cap and retighten it until it clicks. Make sure nothing is interfering with the sealing of the cap. Tightening the cap will not make the CHECK ENGINE warning light/malfunction indicator light turn off immediately. It may take several driving trips. If the light does not turn off, take your vehicle to your authorized SUBARU dealer immediately.

#### If the light is blinking

If the light is blinking while driving, an engine misfire condition has been detected which may damage the emission control system.

To prevent serious damage to the emission control system, you should conform to the following instructions.

- Reduce vehicle speed.
- Avoid hard acceleration.
- Avoid steep uphill grades.
- Reduce the amount of cargo, if possible.
- Stop towing a trailer as soon as possible.

The CHECK ENGINE warning light/malfunction indicator light may stop blinking and illuminate steadily after several driving trips. You should have your vehicle checked by an authorized SUBARU dealer immediately.

## COOLANT TEMPERATURE LOW INDICATOR LIGHT (Blue)/COOLANT TEMPERATURE HIGH WARNING LIGHT (Red)



### CAUTION

- After turning the ignition switch to the “ON” position, if this indicator light/warning light behaves in any of the following ways, the electrical system may be malfunctioning. Contact your SUBARU dealer immediately for an inspection.
  - It remains blinking in RED.
  - It remains illuminated in RED for more than 2 seconds.
  - It remains blinking in RED and BLUE alternately.
- While driving, if this indicator light/warning light behaves in any of the following ways, take the specified appropriate measure listed below.
  - Blinking or illuminated in RED: Safely stop the vehicle as soon as possible, and refer to the emergency steps to take in the case of engine overheating. After that, have the system checked by your nearest SUBARU dealer. Refer to “Engine Overheating” P446.
  - Blinking in RED and BLUE alternately: The electrical system may be malfunctioning. Contact your SUBARU dealer for an inspection.

This coolant temperature low indicator light/coolant temperature high warning light has the following three functions.

- Illumination in **BLUE** indicates insufficient warming up of the engine.

- Blinking in **RED** indicates that the engine is close to overheating.
- Illumination in **RED** indicates overheating condition of the engine.

If the engine coolant temperature increases over the specified range, the indicator light/warning light blinks in **RED**. At this time, the engine is close to overheating.

If the engine coolant temperature increases further, the indicator light/warning light illuminates in **RED** continuously. At this time, the engine may be overheating.

When the indicator light/warning light blinks in **RED** or illuminates in **RED**, safely stop the vehicle as soon as possible, and refer to the emergency steps to take in the case of engine overheating. Refer to “Engine Overheating” ⒸP446. After that, have the system checked by your nearest SUBARU dealer.

Also, if the indicator light/warning light often blinks in **RED**, the electrical system may be malfunctioning. Contact your SUBARU dealer for an inspection.

#### NOTE

*If the engine is restarted after a certain driving condition, this indicator light/warning light may illuminate in RED. However, this is not a malfunction if the indicator light/warning light turns off after a short time.*

### CHARGE WARNING LIGHT



If this light illuminates when the engine is running, it may indicate that the charging system is not working properly.

If the light illuminates while driving or does not turn off after the engine starts, stop the engine at the first safe opportunity and check the drive belt. If the drive belt is loose, broken or if the drive belt is in

good condition but the light remains illuminated, contact your nearest SUBARU dealer immediately.

### OIL PRESSURE WARNING LIGHT



#### CAUTION

Do not operate the engine with the oil pressure warning light on. This may cause serious engine damage.

If this light illuminates when the engine is running, it may indicate that the engine oil pressure is low and the lubricating system is not working properly.

If the light illuminates while driving or does not turn off after the engine starts, stop the engine at the first safe opportunity and contact your nearest SUBARU dealer immediately.

### ENGINE LOW OIL LEVEL WARNING LIGHT



This light appears when the engine oil level decreases to the lower limit.

If the warning light appears, check the engine oil level on a level surface. When the engine oil level is not within the normal range, refill with engine oil. Refer to “Engine Oil” ⒸP476. After adding or changing the engine oil, warm up the engine and stop it on a level surface, then start the engine after a lapse of 1 minute or more. Confirm that the warning light has turned off after the engine has started. If the warning light does not turn off after refilling the engine oil, or the light appears even though the engine oil level is within the normal range, have the vehicle checked by a SUBARU dealer.

#### NOTE

- *The oil level will be detected by the system just after turning the ignition switch to the “OFF” position. If the oil level is below the lower limit when the*

*ignition switch is turned to the "ON" position, the engine low oil level warning light will turn on.*

- *When the vehicle is parked on a steep slope, the engine low oil level warning light may not illuminate even if the oil level is below the lower limit to avoid erroneous lighting.*

## AT OIL TEMP WARNING LIGHT

If this light illuminates when the engine is running, it may indicate that the transmission fluid temperature is too hot.

If the light illuminates while driving, immediately stop the vehicle in a safe place and let the engine idle until the warning light turns off.

## Transmission control system warning

If the AT OIL TEMP warning light flashes after the engine has started, it may indicate that the transmission control system is not working properly. Contact your nearest SUBARU dealer for service immediately.

## LOW TIRE PRESSURE WARNING LIGHT (Except for Canada-Spec. Models)

When the ignition switch is turned to the "ON" position, the low tire pressure warning light will illuminate for a few seconds to check that the tire pressure monitoring system (TPMS) is functioning properly. If there is no problem and all tires are properly inflated, the light will go out.

Each tire, including the spare (if provided), should be checked monthly when cold and inflated to the inflation pressure recommended by the vehicle manufacturer on the vehicle placard or tire inflation pressure label. (If your vehicle has tires of a different size than the size indicated on the vehicle placard or tire inflation pres-

sure label, you should determine the proper tire inflation pressure for those tires.)

As an added safety feature, your vehicle has been equipped with a tire pressure monitoring system (TPMS) that illuminates a low tire pressure telltale when one or more of your tires is significantly under-inflated. Accordingly, when the low tire pressure telltale illuminates, you should stop and check your tires as soon as possible, and inflate them to the proper pressure. Driving on a significantly under-inflated tire causes the tire to overheat and can lead to tire failure. Under-inflation also reduces fuel efficiency and tire tread life, and may affect the vehicle's handling and stopping ability.

Please note that the TPMS is not a substitute for proper tire maintenance, and it is the driver's responsibility to maintain correct tire pressure, even if under-inflation has not reached the level to trigger illumination of the TPMS low tire pressure telltale.

Your vehicle has also been equipped with a TPMS malfunction indicator to indicate when the system is not operating properly. The TPMS malfunction indicator is combined with the low tire pressure telltale. When the system detects a malfunction, the telltale will flash for approximately one minute and then remain continuously illuminated. This sequence will continue upon subsequent vehicle start-ups as long as the malfunction exists. When the malfunction indicator is illuminated, the system may not be able to detect or signal low tire pressure as intended. TPMS malfunctions may occur for a variety of reasons, including the installation of replacement or alternate tires or wheels on the vehicle that prevent the TPMS from functioning properly. Always check the TPMS malfunction telltale after replacing one or more tires or wheels on your vehicle to ensure that the replacement or alternate tires and wheels allow the TPMS to continue to function properly.

Should the warning light illuminate steadily after blinking for approximately one minute, have the system inspected by your nearest SUBARU dealer as soon as possible.



### WARNING

If this light does not illuminate briefly after the ignition switch is turned on or the light illuminates steadily after blinking for approximately one minute, you should have your Tire Pressure Monitoring System checked at a SUBARU dealer as soon as possible.

If this light illuminates while driving, never brake suddenly. Instead, perform the following procedure. Otherwise an accident involving serious vehicle damage and serious personal injury could occur.

- 1) Keep driving straight ahead while gradually reducing speed.
- 2) Slowly pull off the road to a safe place.
- 3) Check the pressure for all four tires and adjust the pressure to the COLD tire pressure shown on the tire inflation pressure label on the door pillar on the driver's side.

If this light still illuminates while driving after adjusting the tire pressure, a tire may have significant damage and a fast leak that causes the tire to lose air rapidly. If you have a flat tire, refer to "Flat Tires" P439.

When a replacement tire is mounted or a wheel rim is replaced without the original pressure sensor/transmitter being transferred, the Low tire pressure warning light will illuminate steadily after blinking for approximately one minute. This indicates the TPMS is unable to monitor all four road wheels. Contact your SUBARU dealer as soon as possible for tire and sensor replacement and/or system resetting. If the light illuminates steadily after blinking for approximately one minute,

promptly contact a SUBARU dealer to have the system inspected.



### CAUTION

The tire pressure monitoring system is NOT a substitute for manually checking tire pressure. The tire pressure should be checked periodically (at least monthly) using a tire gauge. After any change to tire pressure(s), the tire pressure monitoring system will not re-check tire inflation pressures until the vehicle is first driven more than 25 mph (40 km/h). After adjusting the tire pressures, increase the vehicle speed to at least 25 mph (40 km/h) to start the TPMS re-checking of the tire inflation pressures. If the tire pressures are now above the severe low pressure threshold, the low tire pressure warning light should turn off a few minutes later. Therefore, be sure to install the specified size for the front and rear tires.

## ABS WARNING LIGHT ABS /



### CAUTION

- If any of the following conditions occur, we recommend that you have the ABS repaired at the first available opportunity by your SUBARU dealer.
  - The warning light does not illuminate when the ignition switch is turned to the "ON" position.
  - The warning light illuminates when the ignition switch is turned to the "ON" position, but it does not turn off even after starting the vehicle.
  - The warning light illuminates during driving.
- When the warning light is on (and brake system warning light is off),



the ABS function shuts down; however, the conventional brake system continues to operate normally.

The ABS warning light illuminates together with the brake system warning light if the EBD system malfunctions. For further details of the EBD system malfunction warning, refer to “Brake System Warning Light” P171.

### NOTE

*If the warning light behavior is as described in the following conditions, the ABS may be considered normal.*

- *The warning light illuminates right after the engine is started but turns off immediately, remaining off.*
- *The warning light remains illuminated after the engine has been started, but it turns off while driving.*
- *The warning light illuminates during driving, but it turns off immediately and remains off.*

When driving with an insufficient battery voltage such as when the engine is jump started, the ABS warning light may illuminate. This is due to the low battery voltage and does not indicate a malfunction. When the battery becomes fully charged, the light will turn off.

## BRAKE SYSTEM WARNING LIGHT

BRAKE / (!)



### WARNING

- Driving with the brake system warning light on is dangerous. This indicates your brake system may not be working properly. If the light remains illuminated, have the brakes inspected by a SUBARU dealer immediately.
- If at all in doubt about whether the brakes are operating properly, do not drive the vehicle. Have your vehicle towed to the nearest

SUBARU dealer for repair.

- If the brake system warning light illuminates, the electronic parking brake system may be malfunctioning. Immediately stop your vehicle in a safe location, use tire stops under the tires to prevent the vehicle from moving and contact your SUBARU dealer. For details, refer to “Electronic Parking Brake” P339.

3

### NOTE

- *Even if the brake system warning light illuminates, if the warning light behavior is as described in the following examples, the electronic parking brake system is not malfunctioning.*
  - *The warning light turns off when the electronic parking brake is applied or released.*
  - *The warning light turns off when the ignition switch is turned to the “ON” position again.*
- *The brake system warning light may illuminate immediately after the engine is started. However, it is not malfunctioning if the warning light turns off after the electronic parking brake is released.*
- *The brake system warning light may illuminate after the electronic parking brake is frequently applied and released. However, the electronic parking brake system is not malfunctioning if the light turns off after a short period of time.*
- *When the engine is started while the electronic parking brake is applied/ released, the system may judge an abnormal situation and the warning light may illuminate. If the warning light illuminates, turn the ignition switch once to the “OFF” position and then restart the engine. Then, apply/release the electronic parking brake. If the warning light turns off, the system will be restored.*

This light has the following functions.

### Brake fluid level warning

This light illuminates when the brake fluid level has dropped to near the “MIN” level of the brake fluid reservoir with the ignition switch in the “ON” position and with the parking brake fully released.

If the brake system warning light should illuminate while driving (with the parking brake fully released and with the ignition switch positioned in “ON”), it could be an indication of leaking of brake fluid or worn brake pads. If this occurs, immediately stop the vehicle at the nearest safe place and check the brake fluid level. If the fluid level is below the “MIN” mark in the reservoir, do not drive the vehicle. Have the vehicle towed to the nearest SUBARU dealer for repair.

### Electronic Brake Force Distribution (EBD) system warning

If the warning light remains on even though the parking brake is released, the brake fluid level may be low or there could be a problem with the EBD system. Park the vehicle in a safe place immediately and contact a SUBARU dealer.

### Electronic brake booster warning

The brake system warning light illuminates when the electronic brake booster is malfunctioning. In addition, the warning messages “Brake System” and “Check Owner’s Manual” are displayed alternately on the instrument cluster display. If the warning light illuminates, promptly park in a safe location as soon as possible and contact your SUBARU dealer.

### Electronic parking brake system warning

The brake system warning light illuminates when the electronic parking brake system is malfunctioning. If the warning light illuminates, promptly park in a safe

location as soon as possible and contact your SUBARU dealer.

The brake system warning light remains illuminated when the parking brake cannot be released even if the electronic parking brake switch is pushed. For details, refer to “Electronic Parking Brake” P339.

### Frequent operation warning:

The brake system warning light illuminates and a chirp sound will be heard if the electronic parking brake switch is operated too frequently. In this case, the operation of the electronic parking brake switch is restricted to protect the electronic parking brake system.

### ELECTRONIC PARKING BRAKE INDICATOR LIGHT

#### Parking brake indicator

The light illuminates with the parking brake applied while the ignition switch is in the “ACC” or “ON” position. It turns off when the parking brake is fully released.

### Electronic parking brake system warning

#### WARNING

- When you release the electronic parking brake while the engine is running, the electronic parking brake indicator light will turn off. However, if the light still illuminates, stop the vehicle in a safe location immediately and have the system inspected by a SUBARU dealer.
- If at all in doubt about whether the brakes are operating properly, do not drive the vehicle. Have your vehicle towed to the nearest SUBARU dealer for repair.
- If the electronic parking brake indicator light flashes, the electro-

nic parking brake system may be malfunctioning. Immediately stop your vehicle in a safe location, use tire stops under the tires to prevent the vehicle from moving and contact your SUBARU dealer. For details, refer to “Electronic Parking Brake” ⒶP339.

## NOTE

- *When the ignition switch is turned to the “OFF” position with the electronic parking brake applied, the electronic parking brake indicator light remains illuminated for approximately 30 seconds and then turns off.*
- *When the electronic parking brake switch is pulled to apply the electronic parking brake while the ignition switch is in the “OFF” position, the electronic parking brake indicator light illuminates, remains illuminated for approximately 30 seconds and then turns off.*
- *Even if the electronic parking brake indicator light flashes, if the warning light behavior is as described in the following examples, the electronic parking brake system is not malfunctioning.*
  - *The indicator light turns off when the electronic parking brake is released.*
- *The electronic parking brake indicator light may flash immediately after the engine is started. However, it is not malfunctioning if the indicator light turns off after the electronic parking brake is released.*
- *The electronic parking brake indicator light may flash after the electronic parking brake is frequently applied and released. However, the electronic parking brake system is not malfunctioning if the light turns off after a short period of time.*

The electronic parking brake indicator light flashes when the electronic parking brake system is malfunctioning. If the

indicator light flashes, promptly park in a safe location as soon as possible and contact your SUBARU dealer.

The electronic parking brake indicator light remains illuminated when the parking brake cannot be released even if the electronic parking brake switch is pushed. For details, refer to “Electronic Parking Brake” ⒶP339.

## Parking brake apply inhibit warning:

The electronic parking brake indicator light flashes for 10 seconds and a chirp sound will be heard if the electronic parking brake switch is operated when the parking brake cannot be applied.

## Frequent operation warning:

The electronic parking brake indicator light flashes for 10 seconds and a chirp sound will be heard if the electronic parking brake switch is operated too frequently. In this case, the operation of the electronic parking brake switch is restricted to protect the electronic parking brake system.

## NOTE

*Wait until the indicator light turns off.*

## AUTO VEHICLE HOLD INDICATOR LIGHT



### CAUTION

If the Auto Vehicle Hold indicator light does not illuminate even when the Auto Vehicle Hold switch is pressed to activate the Auto Vehicle Hold function, the electronic parking brake system may be malfunctioning.

This indicator illuminates when the Auto Vehicle Hold is activated. This indicator blinks while the vehicle is stopped by the Auto Vehicle Hold function. For details, refer to “Auto Vehicle Hold Function” ⒶP343.

## LOW FUEL WARNING LIGHT



The low fuel warning light illuminates when the tank is nearly empty approximately 2.6 US gal (10 liters, 2.2 Imp gal). It only operates when the ignition switch is in the "ON" position.



### CAUTION

Promptly put fuel in the tank whenever the low fuel warning light illuminates. Engine misfires as a result of an empty tank could cause damage to the engine.

## DOOR OPEN INDICATOR LIGHT



When any of the doors or the rear gate is not fully closed, the door open indicator light appears. This function is effective even if the ignition switch is in the "OFF" or "ACC" position.

The open door is indicated by the corresponding part of the door open indicator light.

Always make sure this indicator does not appear before you start to drive.

### NOTE

*When the ignition switch is in the "OFF" position and the door open indicator light is illuminated, it will automatically turn off after two minutes to protect the battery.*

## ENGINE HOOD OPEN WARNING LIGHT



The warning light illuminates if the engine hood is not fully closed. This function is effective even if the ignition switch is in the "OFF" or "ACC" position.

Always make sure this light is not illuminated before you start to drive.

## WINDSHIELD WASHER FLUID WARNING LIGHT



This light appears when the fluid level in the washer fluid tank decreases to the lower limit (approximately 0.6 US qt (0.6 liters, 0.5 Imp qt)).

## ALL-WHEEL DRIVE WARNING LIGHT

AWD



### WARNING

Continued driving with the AWD warning light flashing can lead to powertrain damage. If the AWD warning light flashes, promptly park in a safe location and then check whether all four tires are the same diameter and whether any of the tires has a puncture or has lost air pressure for some other reason.

### NOTE

*If the temporary spare tire is used, the AWD warning light may flash. Use of the temporary spare tire should therefore be restricted to the minimum time necessary. Replace the temporary spare tire with a conventional tire as soon as possible.*

This light flashes if the vehicle is driven with tires of different diameters fitted on its wheels or with the air pressure excessively low in any of its tires.

## POWER STEERING WARNING LIGHT



While the engine is running, this warning light illuminates when a malfunction has been detected in the electric power steering system.



### CAUTION

When the power steering warning light is illuminated, there may be more resistance when the steering wheel is operated. Drive carefully to the near-

est SUBARU dealer and have the vehicle inspected immediately.

### NOTE

*If the steering wheel is operated in the following ways, the power steering control system may temporarily limit the power assist in order to prevent the system components, such as the control computer and drive motor, from overheating.*

- *The steering wheel is operated frequently and turned sharply while the vehicle is maneuvered at extremely low speeds, such as while frequently turning the steering wheel during parallel parking.*
- *The steering wheel remains in the fully turned position for a long period of time.*

*At this time, there will be more resistance when steering. However, this is not a malfunction. Normal steering force will be restored after the steering wheel is not operated for a while and the power steering control system has an opportunity to cool down. However, if the power steering is operated in a non-standard way which causes power assist limitation to occur too frequently, that may result in a malfunction of the power steering control system.*

## VEHICLE DYNAMICS CONTROL WARNING LIGHT/VEHICLE DYNAMICS CONTROL OPERATION INDICATOR LIGHT



### Vehicle Dynamics Control warning light



#### CAUTION

The Vehicle Dynamics Control system provides its ABS control through the electrical circuit of the ABS. Accordingly, if the ABS is inoperative, the

Vehicle Dynamics Control system becomes unable to provide ABS control. As a result, the Vehicle Dynamics Control system becomes inoperative, causing the warning light to illuminate. Although both the Vehicle Dynamics Control and ABS are inoperative in this case, the ordinary functions of the brake system are still available. You will be safe while driving in this condition, but drive carefully and have your vehicle checked at a SUBARU dealer as soon as possible.

### NOTE

- *If the electrical circuit of the Vehicle Dynamics Control system itself malfunctions, the warning light only illuminates. At this time, the ABS (Anti-lock Brake System) remains fully operational.*
- *The warning light illuminates when the electronic control system of the ABS/ Vehicle Dynamics Control system malfunctions.*
- *The Vehicle Dynamics Control warning light, ABS warning light, and brake system warning light illuminate simultaneously if the EBD system malfunctions. For further details of the EBD system malfunction warning, refer to "Electronic Brake Force Distribution (EBD) system warning" P172.*

The Vehicle Dynamics Control system is probably inoperative under any of the following conditions. Have your vehicle checked at a SUBARU dealer immediately.

- The warning light does not illuminate when the ignition switch is turned to the "ON" position.
- The warning light illuminates while the vehicle is running.

### NOTE

*If the warning light behavior is as described in the following examples, the Vehicle Dynamics Control system may be considered normal.*

- The warning light illuminates right after the engine is started but turns off immediately and remains off.
- The warning light illuminates after the engine has started and turns off while the vehicle is subsequently being driven.
- The warning light illuminates during driving, but turns off immediately and remains off.

### Vehicle Dynamics Control operation indicator light

The indicator light flashes during activation of the skid suppression function and during activation of the traction control function.

#### NOTE

- The light may remain illuminated for a short period of time after the engine has been started, especially in cold weather. This does not indicate the existence of a problem. The light should turn off as soon as the engine has warmed up.
- The indicator light illuminates when the engine has developed a problem and the CHECK ENGINE warning light/malfunction indicator light is on.

The Vehicle Dynamics Control system is probably malfunctioning under the following condition. Have your vehicle checked at a SUBARU dealer as soon as possible.

- The light does not turn off even after the lapse of several minutes (the engine has warmed up) after the engine has started.

### VEHICLE DYNAMICS CONTROL OFF INDICATOR LIGHT



The light illuminates when the Vehicle Dynamics Control OFF switch is pressed to deactivate the Vehicle Dynamics Control system. Refer to "To Turn On/Off the Vehicle Dynamics Control System"

☞ P333.

The Vehicle Dynamics Control system is probably malfunctioning under any of the following conditions. Have your vehicle checked at a SUBARU dealer immediately.

- The light does not illuminate while the system check.
- The light does not turn off even after a period of approximately 2 seconds after the ignition switch has been turned to the "ON" position.

### WARNING CHIMES AND WARNING INDICATOR OF THE KEYLESS ACCESS WITH PUSH-BUTTON START SYSTEM



The keyless access with push-button start system is equipped with a warning chime and the access key warning indicator in order to minimize improper operations and help protect your vehicle from theft.

When the warning chime sounds and/or the warning indicator appears, take the appropriate action.

You cannot turn the warning chimes off. However, the volume setting of the outside warning chime can be changed by a SUBARU dealer. Consult your SUBARU dealer for details.

**WARNING**

Never drive the vehicle if the indicator on the push-button ignition switch is flashing in green when starting the engine. This indicates the status that the steering wheel is not released and could result in an accident involving serious injury or death.

**CAUTION**

- When starting the engine again after the operation indicator on the push-button ignition switch flashes in green, if the operation indicator is still flashing in green, there could be a steering lock malfunction. Contact your SUBARU dealer as soon as possible.
- When the operation indicator on the push-button ignition switch flashes in orange, contact a SUBARU dealer immediately.

**NOTE**

- *Even when the access key fob is within the operating ranges inside the vehicle, the access key warning for engine start may be provided depending on the status of the access key fob and the environmental conditions.*
- *When the access key fob is taken out of the vehicle through an open window, the access key takeout warning or passenger access key takeout warning will not be provided.*

**List of warnings****CAUTION**

When any of the following warnings occurs even if the access key warning indicator does not appear, take the appropriate action.

Inside warning chime	Outside warning chime	Operation indicator on push-button ignition switch	Status	Action
Ding, ding ... (intermittent)	—	—	The driver's door is opened while the push-button ignition switch is "ACC" position and the select lever is in the "P" position.	Switch the push-button ignition switch to "OFF", or close the driver's door. When exiting the vehicle, be sure to switch the push-button ignition switch to "OFF".
			The push-button ignition switch is switched to "OFF" while the driver's door is open.	Close the driver's door.
Ding	Short beep (2 seconds)	—	<b>Lockout warning:</b> The doors are locked by following methods when an access key fob is left in the car. <ul style="list-style-type: none"> <li>• The door is closed when the lock lever of the door is in the lock position.</li> <li>• The door is closed when the power door locking switch is in the lock position.</li> </ul>	Take out the access key fob from the vehicle, and lock the doors. The doors cannot be locked while the access key fob is inside the vehicle. A chirp sound will be heard, and all doors will be unlocked.
—	Short beep (2 seconds)	—	<b>Access key lock-in warning:</b> The door lock sensor is touched while the push-button ignition switch is "OFF" and the access key fob is inside the vehicle.	Take out the access key fob from the vehicle, and lock the doors. If the access key fob is inside the vehicle, the doors cannot be locked.
—	Beep, beep, beep, beep (5 times)	—	<b>Door ajar warning:</b> The door lock sensor is touched while the ignition switch is in the "OFF" position and one of the doors including the rear gate is opened.	Close the doors securely and lock them. If one of the doors including the rear gate is opened, the doors cannot be locked.
Ding	Long beep (60 seconds max.)	—	<b>Power warning:</b> The door lock sensor is touched while you are carrying the access key fob, the push-button ignition switch is in a position other than "OFF" and the select lever is in the "P" position.	Return the access key fob inside the vehicle, or switch the push-button ignition switch to "OFF". If the push-button ignition switch is not switched to "OFF", the doors cannot be locked.
Ding, ding ... (7 seconds)	—	—	<b>Access key warning:</b> The vehicle is driven while the access key fob is not inside the vehicle.	Carry the access key fob, and drive the vehicle.
Ding	—	—	<b>Access key warning for engine start:</b> The push-button ignition switch is pressed while the access key fob is not inside the vehicle.	Carry the access key fob, and press the push-button ignition switch.
Ding	Beep, beep, beep (3 times)	—	<b>Access key takeout warning:</b> The driver exits the vehicle with the access key fob and closes the driver's door while the push-button ignition switch is in a position other than "OFF" and the select lever is in a position other than the "P" position.	Switch the push-button ignition switch to "OFF", and get out of the vehicle.



Inside warning chime	Outside warning chime	Operation indicator on push-button ignition switch	Status	Action
Ding	Beep, beep, beep (3 times)	—	<b>Passenger access key take-out warning:</b> A fellow passenger exits the vehicle with the access key fob and closes a door other than the driver's door while the push-button ignition switch is in a position other than "OFF".	Return the access key fob to inside the vehicle, or switch the push-button ignition switch to "OFF".
Long beep (continuous)	Long beep (continuous)	—	<b>Access key takeout without "P" position warning:</b> The driver exits the vehicle with the access key fob and closes the driver's door while the push-button ignition switch is in a position other than "OFF" and the select lever is in a position other than the "P" position.	Shift the select lever to the "P" position, switch the push-button ignition switch to "OFF" and exit the vehicle.
Long beep (continuous)	—	—	<b>Select lever position warning:</b> <ul style="list-style-type: none"> <li>Case 1: The engine is turned off by pressing the push-button ignition switch while the select lever is in a position other than the "P" position.</li> <li>Case 2: The driver's door is opened while the push-button ignition switch is in a position other than "OFF" and the select lever is in a position other than the "P" position.</li> </ul>	<ul style="list-style-type: none"> <li>Case 1: Start the engine, shift the select lever to the "P" position, switch the push-button ignition switch to "OFF" and exit the vehicle.</li> <li>Case 2: Shift the select lever to the "P" position, switch the push-button ignition switch to "OFF" and exit the vehicle.</li> </ul>
Ding	—	—	The battery of the access key fob is low.	Replace the battery of the access key fob. For details, refer to "Replacing Battery" P507.
Ding	—	Flashes in green (15 seconds max)	<b>Steering lock warning:</b> The engine start procedure is performed, but the steering is still locked.	While turning the steering wheel right and left lightly, depress the brake pedal and press the push-button ignition switch.
Ding	—	Flashes in orange	<b>System malfunction warning:</b> A malfunction is detected in the power system or steering lock.	Contact a SUBARU dealer immediately and have the vehicle inspected.

## SECURITY INDICATOR LIGHT



This indicator light shows the status of the alarm system. It also indicates operation of the immobilizer system.

### Alarm system

It blinks to show the driver the operational status of the alarm system. For detailed information, refer to “Alarm System” [P136](#).

### Immobilizer system

The security indicator light starts blinking in the following conditions.

- Immediately after the push-button ignition switch is turned to the “OFF” position.
- Immediately after the driver’s door is opened or closed when all of the following conditions are met.
  - The push-button ignition switch is in the “ON” or “ACC” position.
  - The engine is not running.

In the event that an unauthorized key is used (for example, the key is unregistered or the ID code does not match), the power is not switched to “ON” and the security indicator light continues blinking.

### NOTE

- *The security indicator light remains off in the following conditions. It means that the matching of the ID code is completed and the immobilizer system is deactivated, and it does not indicate a malfunction.*
  - While the engine is running
  - The push-button ignition switch has been turned to the “ON” or “ACC” position and the driver’s door has not been opened or closed
- *Even if a malfunction occurs, such as the security indicator light flashes irregularly, it will not affect the functionality of the immobilizer system.*

## SELECT LEVER/GEAR POSITION INDICATOR

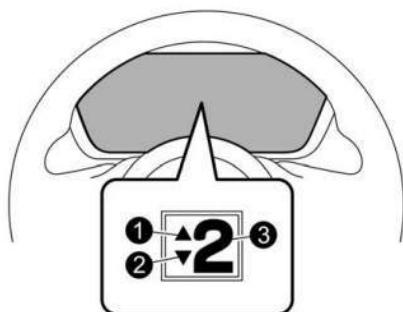

- 1 Upshift indicator
- 2 Downshift indicator
- 3 Select lever/gear position indicator

The select lever position is displayed on the indicator.

When the manual mode is selected, the gear position indicator, which shows the current gear selection, and the available up shift/downshift indicator light up. Refer to “Selection of Manual Mode” [P325](#).

## TURN SIGNAL INDICATOR LIGHTS



These lights show the operation of the turn signal or lane change signal.

If the indicator lights do not blink or blink rapidly, the turn signal bulb may be burned out. Replace the bulb as soon as possible. Refer to “Replacing Bulbs” [P504](#).

## HIGH BEAM INDICATOR LIGHT

This light shows that the headlights are in the high beam mode.

This indicator light also illuminates when operating the headlight flasher.

## HIGH BEAM ASSIST INDICATOR

This indicator appears when the high beam assist function is activated. For details about the high beam assist function, refer to “High Beam Assist Function” [P215](#).

## LED HEADLIGHT WARNING LIGHT

This light illuminates if the LED headlights malfunction. Have your vehicle inspected at a SUBARU dealer as soon as possible.

## STEERING RESPONSIVE HEADLIGHT OFF INDICATOR LIGHT



This light illuminates when the Steering Responsive Headlight function is off. For details about the on/off setting, refer to “Vehicle” [P206](#).

## STEERING RESPONSIVE HEADLIGHT WARNING LIGHT

The light illuminates when a malfunction occurs in the Steering Responsive Headlight. Refer to “Steering Responsive Headlight (SRH)” [P219](#).

## HEADLIGHT INDICATOR LIGHT

This indicator light illuminates under the following conditions.

- The light switch is turned to the “” or “” position.

- The light switch is in the “AUTO” position and the headlights illuminate automatically.

## FRONT FOG LIGHT INDICATOR LIGHT

This indicator light illuminates while the front fog lights are illuminated.

## AUTO START STOP WARNING LIGHT (Yellow)

### CAUTION

If the Auto Start Stop warning light is illuminated in yellow, there may be a malfunction in the Auto Start Stop system. When starting the engine again after the Auto Start Stop warning light illuminates, if it is still illuminating, we recommend that you have your vehicle inspected at a SUBARU dealer as soon as possible.

The Auto Start Stop warning light will illuminate in yellow if you open the engine hood when the engine has been temporarily stopped by the Auto Start Stop system.

In this case, to ensure safety, the engine will not be automatically restarted, even if you release the brake pedal. Use normal operation to restart the engine.

## AUTO START STOP OFF INDICATOR LIGHT

This light will illuminate when the Auto Start Stop OFF switch is pressed to prevent the Auto Start Stop system from operating. It will turn off when the Auto Start Stop OFF switch is pressed once more to enable operation of the Auto Start Stop system. For details about the setting, refer to “To turn on/off the Auto Start Stop system” [P351](#).

**CAUTION**

If the Auto Start Stop OFF indicator light does not illuminate when the Auto Start Stop OFF switch is pressed, we recommend that you contact a SUBARU dealer for an inspection as soon as possible.

**AUTO START STOP INDICATOR LIGHT (Green)**

This indicator light illuminates when the engine has been temporarily stopped by the Auto Start Stop system. It will turn off when the engine is restarted.

**AUTO START STOP NO ACTIVITY DETECTED INDICATOR LIGHT**

When a vehicle is stopped, the indicator light illuminates when the operating condition of the Auto Start Stop system is not met. The light will turn off when the vehicle starts driving. Refer to “Non-operational conditions” P349.

**ELECTRIC DAMPER SYSTEM WARNING LIGHT (If Equipped)**

This light illuminates if the Electric Damper System malfunctions.

**WARNING**

When the Electric Damper System warning light illuminates, have the vehicle inspected at an authorized SUBARU dealer.

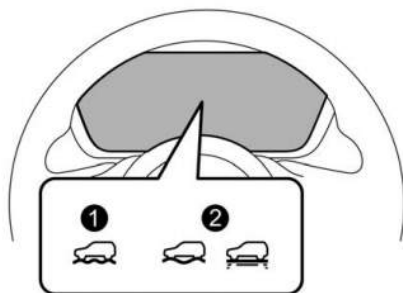
**X-MODE INDICATOR**

- ❶ Models with 1 mode
- ❷ Models with 2 modes (DEEP SNOW/MUD, SNOW/DIRT)

This indicator appears while X-MODE is activated. It will disappear when X-MODE is deactivated. Refer to “To Activate/Deactivate X-MODE” P336.

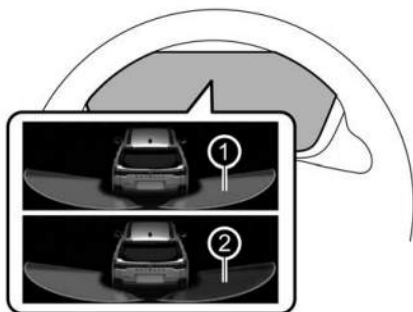
**VEHICLE DETECTED IN NEIGHBORING LANE INDICATOR**

- ❶ When a vehicle is detected (white area with yellow outline is indicated)
- ❷ When the turn signal lever is being operated while a vehicle is detected (yellow area is indicated)

When BSW/RCTW detects a vehicle approaching from behind in the neighboring lane, the system displays a vehicle detected in neighboring lane indicator on the screen. For details, refer to “BSW/

RCTW" ⓄP367.

## HILL DESCENT CONTROL INDICATOR LIGHT



This indicator appears while the hill descent control function is in standby. It will flash while the hill descent control function is operating. It will disappear when the hill descent control function is not available. Refer to "Hill Descent Control Function" ⓄP337.

## BSW/RCTW WARNING INDICATOR



This warning indicator appears on the instrument cluster display when the BSW (Blind Spot Warning) or RCTW (Rear Cross Traffic Warning) is malfunctioning for any reason. For further details, refer to "BSW/RCTW Warning Indicator" ⓄP373. If this indicator remains displayed, have your vehicle inspected by your SUBARU dealer as soon as possible.

## BSW/RCTW OFF INDICATOR



This indicator appears on the instrument cluster display when "Blind Spot Warning (BSW)/Rear Cross Traffic Warning (RCTW)" is touched to deactivate BSW (Blind Spot Warning) and RCTW (Rear Cross Traffic Warning), or when the BSW/RCTW is suspended temporarily. For details, refer to "BSW/RCTW OFF Indicator" ⓄP373.

## ICY ROAD SURFACE WARNING INDICATOR



When the outside temperature is approximately 37°F (3°C) or less, the icy road surface warning indicator will illuminate to inform the driver that the road surface may be frozen.

## NOTE

- The outside temperature indicator shows the temperature in the area around the sensor. However, the temperature may not be indicated correctly or the update may be delayed in the following conditions.
  - While parking or driving at low speeds
  - When the outside temperature changes suddenly (example: when going in and out of an underground parking area or when passing through a tunnel)
  - When starting the engine after being parked for a certain period of time
- The icy road surface warning indicator should be treated only as a guide. Be sure to check the condition of the road surface before driving.
- Once the icy road surface warning indicator appears, it will not disappear unless the outside temperature has increased to approximately 41°F (5°C) or higher.

## RAB WARNING INDICATOR

# RAB

This indicator illuminates if the Reverse Automatic Braking (RAB) system malfunctions. Refer to "Reverse Automatic Braking (RAB) System" ⓄP375.

## RAB OFF INDICATOR

# RAB OFF

This indicator illuminates when the Reverse Automatic Braking (RAB) system is turned OFF, or when the Reverse Automatic Braking (RAB) system is suspended temporarily. Refer to "Reverse Automatic Braking (RAB) System" ⓄP375.

## PROXIMITY WARNING DETECTION OFF INDI- CATOR



This indicator illuminates when the Proximity Warning Detection is turned OFF. For the setting procedure, refer to “Reverse Automatic Braking (RAB) System ON/OFF Setting” [P386](#).

## DISTRACTION MITIGA- TION SYSTEM OPERA- TION INDICATOR LIGHT (Green)



This indicator illuminates when the Distraction Mitigation System is activated. Refer to “Distraction Mitigation System operation indicator light (green)” [P398](#).

## DISTRACTION MITIGA- TION SYSTEM WARNING LIGHT (Yellow)



This warning light illuminates if the Distraction Mitigation System malfunctions. We recommend that you have your vehicle inspected at a SUBARU dealer as soon as possible. Refer to “Distraction Mitigation System warning light (yellow)” [P398](#).

## DISTRACTION MITIGA- TION SYSTEM OFF INDI- CATOR LIGHT



This indicator illuminates when “Distraction Mitigation System” is touched to deactivate the Distraction Mitigation System. Refer to “Distraction Mitigation System OFF indicator light” [P398](#).

## DISTRACTION MITIGA- TION SYSTEM TEMPOR- ARY STOP INDICATOR LIGHT



This indicator illuminates when the Distraction Mitigation System is temporarily stopped. Refer to “Distraction Mitigation System temporary stop indicator light” [P398](#).

### NOTE

*The Distraction Mitigation System stops temporarily when the temperature of the Distraction Mitigation System unit is high.*

## FRONT CROSS TRAFFIC BRAKING WARNING IN- DICATOR (If Equipped)



The Front Cross Traffic Braking warning indicator illuminates if there is a malfunction in the Front Cross Traffic Information and Front Cross Traffic Braking. We recommend that you have your vehicle inspected at a SUBARU dealer as soon as possible. Refer to “Front Cross Traffic Information” [P360](#).

## FRONT CROSS TRAFFIC BRAKING OFF INDICA- TOR (If Equipped)



This indicator illuminates when you touch “Brake and Warning” on the screen to deactivate the Front Cross Traffic Information and Front Cross Traffic Braking. Refer to “EyeSight/Driving Assistance” [P202](#).

## 3-6. INSTRUMENT CLUSTER DISPLAY

---

### **WARNING**

Always pay adequate attention to safe driving when operating the instrument cluster display while the vehicle is in motion. When operation of the instrument cluster display interferes with your ability to concentrate on driving, stop the vehicle before performing operations on the screen. Also, do not concentrate on the display while driving. Doing so may cause you to look away from the road and could result in an accident.

Various information will be shown on the instrument cluster display. Also, a warning message will appear on the display if a malfunction is detected. In addition, several settings for the displayed content can be performed.

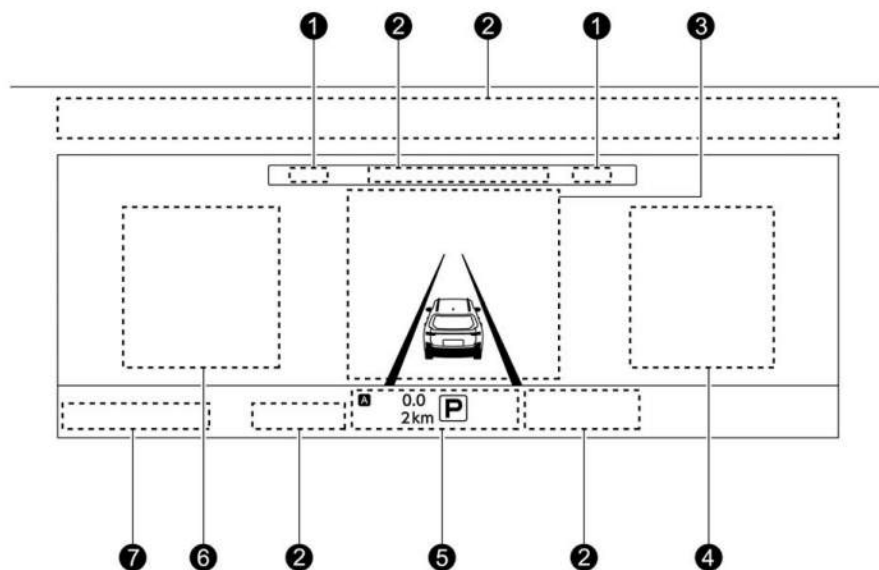

❶ Meter information screen (Refer to “Meter Information Screen” ☞P189.)

❷ Warning and indicator (Refer to “Warning and Indicator Lights” ☞P162.)

❸ Warning screen (Refer to “Warning Screen” ☞P189.)  
EyeSight screen\*

❹ Digital speed screen (Refer to “Digital Speed Screen” ☞P193.)

❺ Double trip meter (Refer to “Double Trip Meter” ☞P159.)  
Odometer screen (Refer to “Odometer” ☞P158.)

X-MODE indicator (Refer to “X-MODE” ☞P335.)

Select lever/gear position indicator (Refer to “Select Lever/Gear Position Indicator” ☞P180.)

❻ Basic screen (Refer to “Basic Screens” ☞P191.)

Warning screen (Refer to “Warning Screen” ☞P189.)

❼ Telltale screen (Refer to “Telltale Screen” ☞P190.)

\*: For details, refer to the separate EyeSight Owner’s Manual.



## BASIC OPERATION

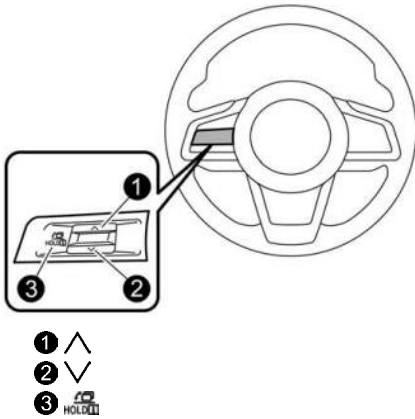

By operating ^ or v of the control switches, the screens can be changed.

If there are some useful messages, such as vehicle information, warning information, etc., they will interrupt the current screen, and appear on the display accompanied by a beep. If such a screen is displayed, take proper action according to the message shown on the screen.

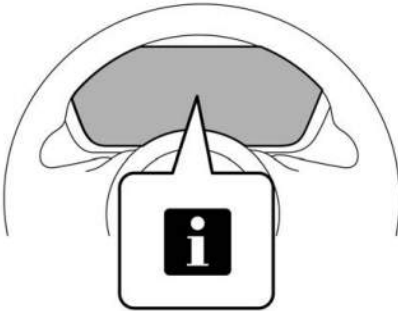

The warning screen will return to the original screen after a few seconds. While the information reminder is shown on the display, it may be possible to display the warning screen again. To recall the message marked with on the display, press and hold the switch on the steering wheel.

## INSTRUMENT CLUSTER DISPLAY MODE

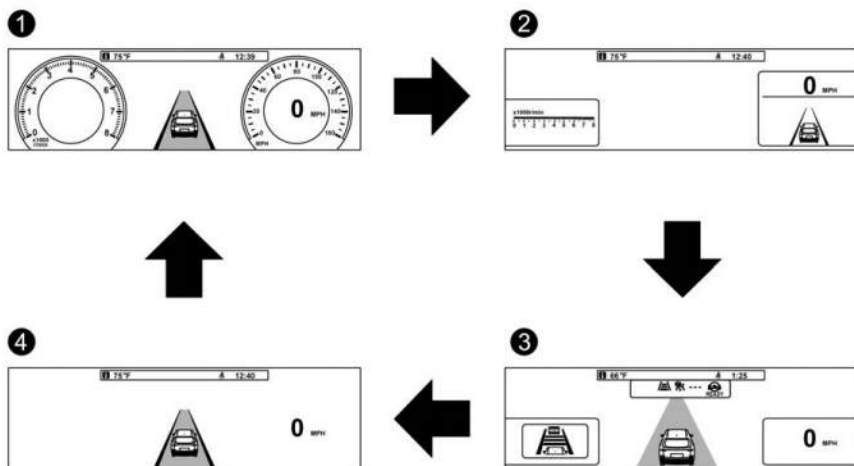
**1** Classic mode

In classic mode, the analogue tachometer and speedometer display respectively.

**2** Map mode\*1

In map mode, the tachometer and speedometer are displayed together with the genuine SUBARU navigation system.

**3** EyeSight mode\*2

The EyeSight mode screen displays the vehicle operating status and surroundings.

**4** Calm mode

In calm mode, only the minimum necessary information is displayed.

EyeSight system.

There are four different screen modes to choose from. To change the screen mode, press the “ HOLD” switch or operate the Center Information Display settings. Refer to “Displays” P204.

**NOTE**

- When a warning screen or a turn-by-turn display is displayed, the screen mode cannot be switched.
- Depending on the mode, the display location of such things as the instruments, basic screen, and EyeSight screen will change.

\*1: For details about the audio and navigation system, refer to the Owner’s Manual supplement for the audio and navigation system.

\*2: For details about the EyeSight system, refer to the Owner’s Manual supplement for the

## WELCOME SCREEN (Opening Animation) AND GOOD-BYE SCREEN (Ending Animation)

Welcome screen and Good-bye screen are motion graphics displayed on the instrument cluster display and center information display upon entering and exiting the vehicle.

When the driver's door is opened and closed after unlocking the door, the welcome screen (opening animation) will appear on the instrument cluster display for approximately 20 seconds.

When the ignition switch is turned to the "OFF" position, the instrument cluster display gradually turns off by showing good-bye screen (ending animation).

### NOTE

- *The welcome screen and the good-bye screen may differ in the actual words and appearance.*
- *The basic screen will be shown when the ignition switch is turned to the "ON" position while the welcome screen is displayed.*
- *Once the welcome screen appears, it takes a certain period of time to display it again.*
- *If the ignition switch is operated after unlocking the driver's door, the welcome screen will not appear even when the driver's door is opened and closed.*
- *The welcome screen will disappear when you lock the driver's door by using the remote keyless entry system or the keyless access function while the welcome screen is displayed.*
- *The welcome screen including the audio/navigation unit can be set to on or off.*

## WARNING SCREEN

Example of warning

SRS  
Airbag System



If there is a warning message or a maintenance notification, it will appear on the instrument cluster display. Take the appropriate actions based on the messages indicated.

## METER INFORMATION SCREEN

This screen informs the driver of various information.

The meter information screen can be changed. For details, refer to "Displays" P204.

### Clock and temperature



This screen displays the clock and outside temperature.

## NOTE

- The clock can be displayed in either 12-hour display or 24-hour display. For details, refer to “Setting 12-Hour Display/24-Hour Display” [P211](#).
- The outside temperature indicator shows the temperature in the area around the sensor. However, the temperature may not be indicated correctly or the update may be delayed in the following conditions.
  - While parking or driving at low speeds
  - When the outside temperature changes suddenly (example: when going in and out of an underground parking area or when passing through a tunnel)
  - When starting the engine after being parked for a certain period of time
- You can set the temperature units to be displayed in Fahrenheit (°F) or Celsius (°C). For details, refer to “Displays” [P204](#).

## Compass (if equipped)

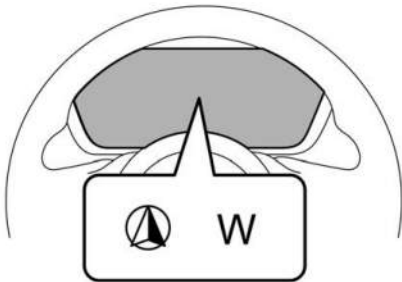

The direction of the vehicle is displayed.

## TELLTALE SCREEN

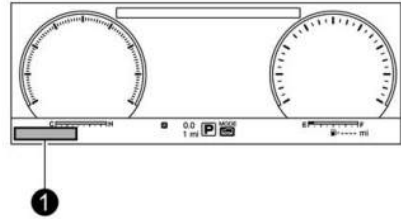















1 Telltale screen

When the corresponding situation occurs, the following telltales will be displayed on the telltale screen.

## NOTE

- When there is warning information to display, it will be displayed in five warning indicators, starting on the left in ascending order of severity.
- If there are 6 or more warning messages to display, the indicators will be displayed in sequential order.

Mark	Name	Page
	Door open indicator light	174
	Engine hood open warning light	174
	LED headlight warning light	181
<b>SRH OFF</b>	Steering Responsive Headlight OFF indicator light	181
<b>SRH</b>	Steering Responsive Headlight warning light	181
	Engine low oil level warning light	168
<b>AT OIL TEMP</b>	AT OIL TEMP warning light	169
<b>AWD</b>	All-Wheel Drive warning light	174

Mark	Name	Page
<b>RAB</b>	RAB warning indicator	183
	Proximity Warning Detection OFF indicator	184
	BSW/RCTW warning indicator	183
	BSW/RCTW OFF indicator	183
	Hill descent control indicator light	183
	Auto Start Stop warning light (yellow)	181
	Auto Start Stop indicator light (green)	182
	Auto Start Stop OFF indicator light	181
	Auto Start Stop No Activity Detected indicator light	182
	Windshield washer fluid warning light	174
	Distraction Mitigation System operation indicator light (green)	184
	Distraction Mitigation System warning light (yellow)	184
	Distraction Mitigation System OFF indicator light	184
	Distraction Mitigation System temporary stop indicator light	184
	Icy road surface warning light	183
	Electric damper system warning light (if equipped)	182
	Front Cross Traffic Braking warning indicator (if equipped)	184
	Front Cross Traffic Braking OFF indicator (if equipped)	184

**BASIC SCREENS**

By operating the  $\wedge$  or  $\vee$  switch on the steering wheel, you can change the screen that is always displayed.

**ECO gauge:**

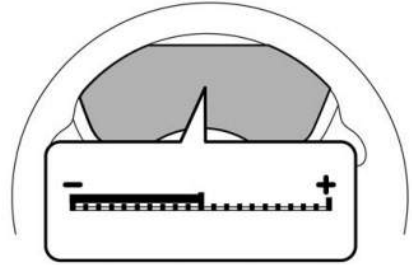

The ECO gauge shows the difference between the average rate of fuel consumption since the trip meter was last reset and the current rate of fuel consumption.

The ECO gauge indicates the current fuel efficiency as shown in the following chart.

Displayed unit	Needle position	
	“+” side	“-” side
MPG	Better	Poorer
l/100km	Poorer	Better

**NOTE**

- The ECO gauge shows only an approximate indication.
- After resetting the trip meter, the average rate of fuel consumption is not shown until driving for approximately 10 seconds. Until that time, the ECO gauge does not operate.

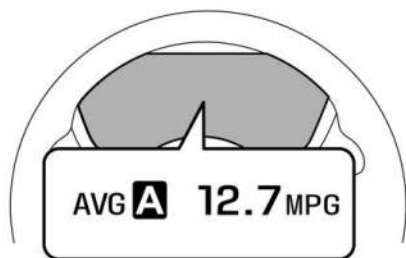
**Average fuel consumption screen:**

AVG: Average fuel consumption

This screen displays the average rate of fuel consumption since the trip meter was last reset.

**NOTE**

*The driving range on the remaining fuel is only a guide. The indicated value may differ from the actual driving range on the remaining fuel, so you must immediately fill the tank when the low fuel warning light illuminates.*

**Current fuel consumption screen:**

: Current fuel consumption

**NOTE**

*The driving range on the remaining fuel is only a guide. The indicated value may differ from the actual driving range on the remaining fuel, so you must immediately fill the tank when the low fuel warning light illuminates.*

**Driving information screen:**

: Journey time

: Journey distance

This screen displays the journey time (the time that has elapsed since the ignition switch was turned to the "ON" position) and journey distance (the distance that has been driven since the ignition switch was turned to the "ON" position).

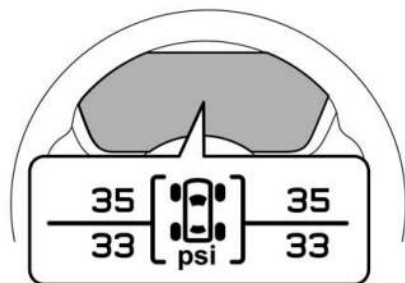
**TPMS screen (except for Canada-spec. models):**

This screen displays each tire pressure.

When a tire is deflated, the deflated tire and the tire pressure will be displayed on the screen in yellow.

**NOTE**

- The tire pressure values are displayed several minutes after driving.
- You can set the tire pressure units. For details about setting the units, refer to "Displays" P204.

- Once the tire pressure monitoring system detects the low tire pressure, the tire pressure values will display in yellow until the system detects the normal tire pressure.
- Immediately adjust the tire pressure when the warning light illuminates. When the tire pressure monitoring system detects the adjusted tire pressure, the warning light will turn off and the tire pressure values will turn to white.
- For information about the specified value of the air pressure, refer to "Tires"  P517.

#### Navigation screen (if equipped):



When the route guidance is set in the navigation system, this item shows the navigation route information. For details about the navigation system, refer to the separate navigation/audio Owner's Manual.

#### Audio screen:

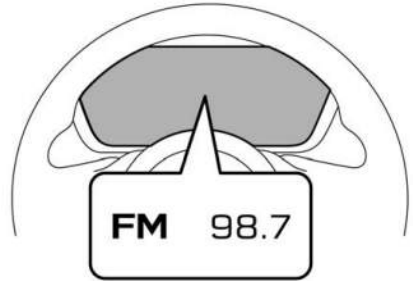

The audio screen shows the status of audio information. For details about the audio system, refer to the separate navigation/audio Owner's Manual.

#### DIGITAL SPEED SCREEN

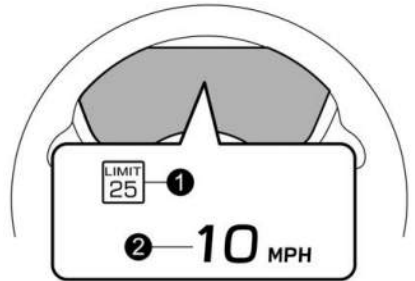

- ❶ Speed limit indicator
- ❷ Vehicle speed

This screen displays the current vehicle speed.

## 3-7. CENTER INFORMATION DISPLAY (CID) FEATURES



### WARNING

Always pay attention to safe driving when operating the center information display while the vehicle is in motion. When operation of the center information display is disturbing your awareness and ability to concentrate on driving, stop the vehicle in a safe place before performing operations on the display. Also, do not concentrate on the display while driving. Doing so could result in an accident.

All information is displayed on the center information display, including vehicle settings, vehicle status, navigation system (if equipped) operation and audio operation.

Items	Page
Maintenance information	209
Rear view camera	362
Surround View Monitor*	353
Navigation system*	Refer to the separate navigation/audio Owner's Manual.
Audio/telephone	Refer to the separate navigation/audio Owner's Manual.
EyeSight	Refer to the Owner's Manual supplement for the EyeSight system.

\*: If equipped

The center information display can also be used to set and initialize the center information display itself.

### NOTE

- *When the vehicle is in motion, certain functions and selections may not be available.*

- *The language and units for both the center information display and the instrument cluster display can be changed. For details, refer to "Displays" Ⓞ P204.*
- *The images displayed in this Owner's Manual are sample images. The actual image may vary depending on the region and vehicle specifications.*

## WELCOME SCREEN AND GOOD-BYE SCREEN

Welcome screen and Good-bye screen are motion graphics displayed on the instrument cluster display and center information display upon entering and exiting the vehicle.

### Welcome screen

When the driver's door is opened and closed, the welcome screen will appear for a short time.

### NOTE

- *The welcome screen will disappear when the ignition switch is turned to the "ON" position while the welcome screen is shown.*
- *For a certain period of time after the welcome screen has once appeared, it may not appear again even when the driver's door is opened and closed. This does not indicate a malfunction.*

### Good-bye screen

The good-bye screen will be displayed under the following conditions.

- The driver's door is opened after the ignition switch is put in the "OFF" position.
- 1 minute have passed after the ignition switch is put in the "OFF" position with the driver's door closed.
- 1 minute have passed when the hands-free phone is used after the ignition switch is put in the "OFF" position.



- The battery voltage is low when the ignition switch is put in the “OFF” position.

### TOUCH SCREEN OPERATIONS

The center information display has a touch screen. Operations are performed by touching the touch screen directly.

#### Touch

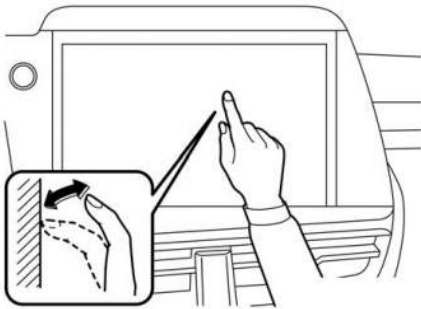

Quickly touch and release once.

#### Drag

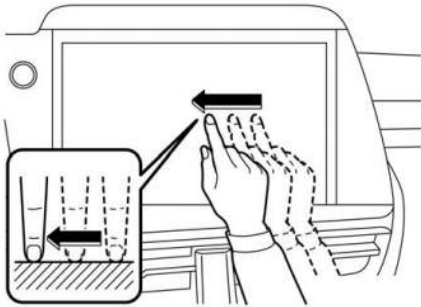

Touch the screen and move the screen to the desired position.

#### Swipe



Quickly move the screen by swiping with your finger.

#### NOTE

*Swipe operations may not be performed smoothly in high altitudes.*

#### ON/OFF setting



- ① ON
- ② OFF

Touch  to turn the function OFF or ON.

## Item selecting

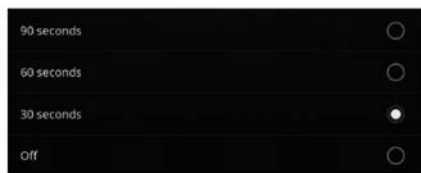

Touch the preferred setting.

### 3-8. CENTER INFORMATION DISPLAY

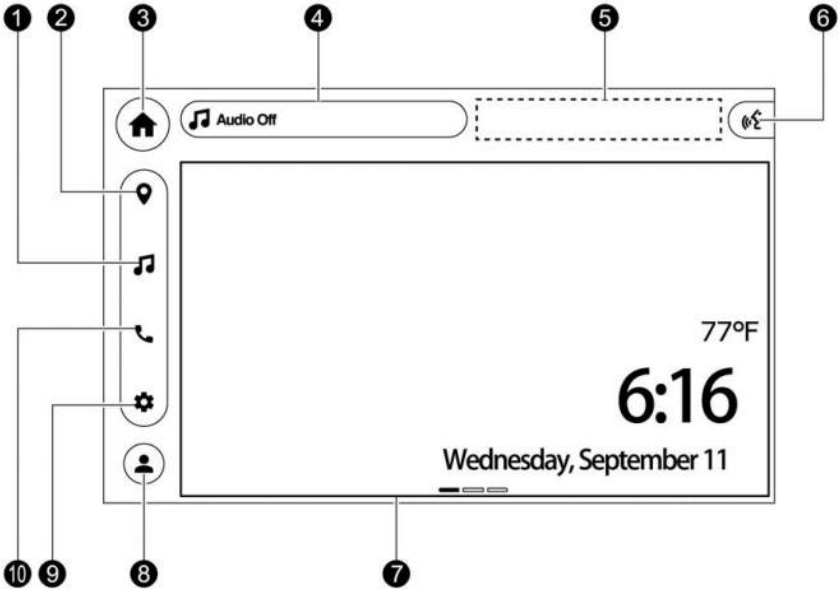

- 1 Audio icon (Refer to the separate navigation/audio Owner's Manual.)
- 2 Navigation icon\*1 (Refer to the separate navigation/audio Owner's Manual.)
- 3 HOME icon (Refer to "HOME Icon" P198.)
- 4 Information bar (Refer to "Information Bar" P198.)
- 5 Status bar (Refer to "Status Bar" P198 and the separate navigation/audio Owner's Manual.)
- 6 Voice assistance icon (Refer to the separate navigation/audio Owner's Manual.)

- 7 Main screen (Refer to "Shortcut Icons" P199.)
- 8 Driver profile icon (Refer to "Driver Profile Icon" P198.)
- 9 Setting icon (Refer to "Setting" P200.)
- 10 Phone icon (Refer to the separate navigation/audio Owner's Manual.)

\*1: if equipped

While the ignition switch is in the "ACC" or "ON" position, the touch panel will activate.

## HOME ICON

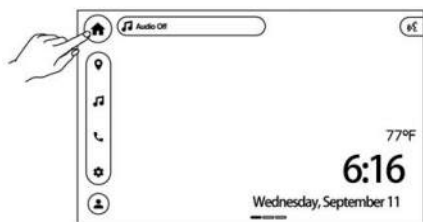

To display the main screen, touch  (HOME).

Swipe right/left on the main screen to change the widget screen, apps screen, and calm screen. For details, refer to the separate navigation/audio Owner's Manual.

## OUTSIDE TEMPERATURE AND CLOCK

The outside temperature and clock are displayed on the main screen or status bar.

### NOTE

- *The outside temperature indicator shows the temperature in the area around the sensor. However, the temperature may not be indicated correctly or the update may be delayed in the following conditions.*
  - While parking or driving at low speeds
  - When the outside temperature changes suddenly (example: when going in and out of an underground parking area or when passing through a tunnel)
  - When starting the engine after being parked for a certain period of time
- You can set the temperature units to be displayed in Fahrenheit (°F) or Celsius (°C). For details, refer to "Displays" [P204](#).

- Touch the clock on the screen to display the clock setting screen. Refer to "Clock" [P210](#).

## INFORMATION BAR

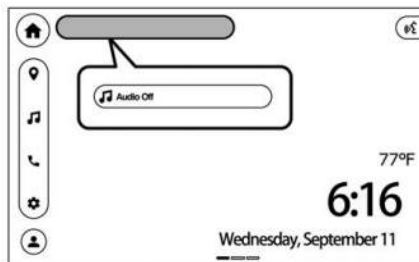



Information such as active features is shown on the information bar. For some functions, touching the display shows the operation menu.

## STATUS BAR

The outside temperature, clock and status icon are displayed on the status bar. For details, refer to "Outside Temperature and Clock" [P198](#) and the separate navigation/audio Owner's Manual.

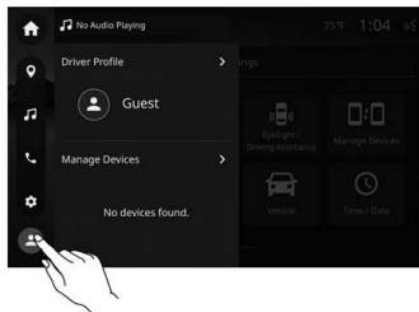
## DRIVER PROFILE ICON



Touch  to confirm the driver profile and manage devices.

## Driver profile

Touch the driver profile screen to register user. For details, refer to “Distraction Mitigation System” [P389](#).

## Manage devices

Touch the manage devices screen to pair your vehicle’s system with a device that uses Apple CarPlay or a similar application. For details, refer to the separate navigation/audio Owner’s Manual.

## HOW TO CHANGE THE SCREEN SETTINGS

Set and adjust the brightness and contrast of the center information display.

### Brightness/Contrast

1. Touch  (Settings).
2. → “Displays”
3. → “Brightness/Contrast”

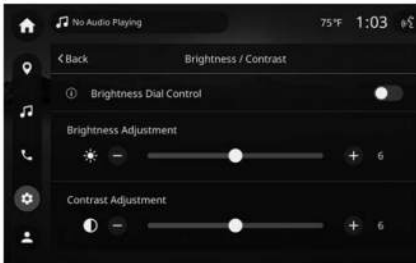

4. Adjust the brightness and contrast by dragging  or touching +/-.

### NOTE

“Brightness Adjustment” can only be adjusted when “Brightness Dial Control” is off. Refer to “Displays” [P204](#).

## SHORTCUT ICONS



This Owner’s Manual includes explanations of the vehicle settings.

To access the shortcut icons, touch  (HOME) and then swipe to select the apps screen.

For details about the following menu, refer to the separate navigation/audio Owner’s Manual.

- Apple CarPlay
- Phone
- Add Shortcut

For details about the following menu, refer to the Owner’s Manual supplement for MySubaru Connected Services.

- MySubaru

### Valet mode icon

For details, refer to “Valet Mode” [P211](#).

## Display Off icon

### Activation of the display off mode:

Touch “Display Off”.



### Deactivation of the display off mode:

Press and hold the volume knob to turn the screen back on.

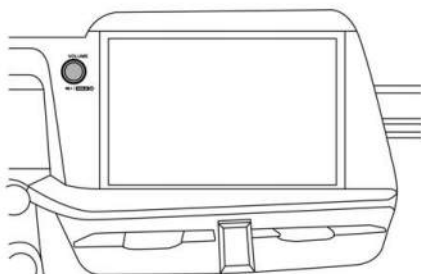

## SETTING

This Owner's Manual includes explanations of the vehicle settings.

To access the settings menu, touch  (Settings).





For details about the following menu, refer to the separate navigation/audio Owner's Manual.

- Manage Devices
- Phone
- Voice Assistance
- Network Connection
- Software

## Sound

Configure the sound settings of the audio/navigation system and the warning alerts.

1. Touch  (Settings).
2. → “Sound” 
3. Select the preferred menu.

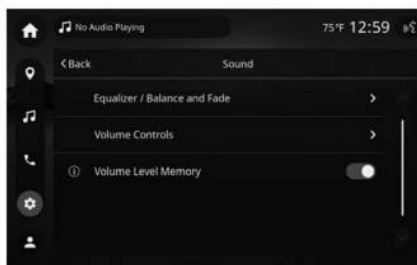

The setting adjustments to the following items can be manually changed to meet your personal requirements.

Item			Available settings	Page reference for the vehicle system operation
1st menu	2nd menu	3rd menu		
Equalizer/Balance and Fade	Equalizer	—	Setting and adjustment of the equalizer	*1
	Balance and Fade	—	Setting and adjustment of the Balance and Fade	*1
Volume Controls	Navigation Guidance Volume*3	—	Setting and adjustment of the navigation guidance volume	*1
	System Notification Volume*3	—	Setting and adjustment of the system notification volume	*1
	Touchscreen Beep	—	ON/OFF	*1
	Touchscreen Beep Volume	—	Setting and adjustment of the beep sound volume	*1
	Safety Warning Volume	—	High/Mid/Low	372, 386 and *2
	Ringtone Volume	—	Setting and adjustment of the ringtone volume	*1
	Caller Voice Volume	—	Setting and adjustment of the caller voice volume	*1
	In-Call Voice Volume	—	Setting and adjustment of the in-call voice volume	*1
	Voice Assistance Volume	—	Setting and adjustment of the voice assistance volume	*1
Harmonizer*3	—	—	Select to enable/disable the function.	*1
Speed Volume Control*3	—	—	High/Mid/Low/Off	*1
Volume Level Memory	—	—	ON/OFF	*1

\*1: For details about the audio and navigation system, refer to the Owner's Manual supplement for the audio and navigation system.

\*2: For details about the EyeSight system, refer to the Owner's Manual supplement for the EyeSight system.



\*3: if equipped

## Profiles

Register, edit and switch driver profiles.  
For details, refer to “Using the Distraction Mitigation System” P398.

## EyeSight/Driving Assistance

Perform the EyeSight system setting and driving assistance function setting.

1. Touch  (Settings).
2. → “EyeSight/Driving Assistance” 
3. Select the preferred menu.

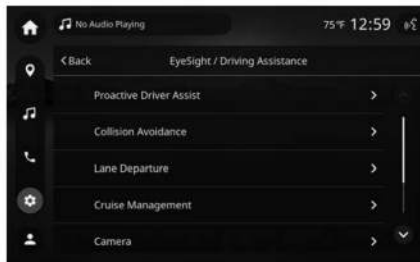



The setting adjustments to the following items can be manually changed to meet your personal requirements.



Item			Available settings	Page reference for the vehicle system operation
1st menu	2nd menu	3rd menu		
Proactive Driver Assist	Acceleration Override Assist	—	ON/OFF	*1
Collision Avoidance	Pre-Collision Braking	Brake and Warning	ON/OFF	*1
		Warning Timing	Far/Normal/Near	*1
	Proximity Warning Detection	Warning	ON/OFF	*1
	Blind Spot Warning (BSW)/Rear Cross Traffic Warning (RCTW)	—	ON/OFF	374
Lane Departure	Emergency Lane Keeping Assist	—	ON/OFF	*1
	Lane Departure Prevention	—	ON/OFF	*1
	Lane Departure Warning	—	ON/OFF	*1
	Warning Timing	—	Normal/Delayed	*1
Cruise Management	Cruise Control	Driving Mode	Eco/Comfort/Standard/Dynamic	*1
		Forward Vehicle Alert	ON/OFF	*1
		Pre-curve Speed Control*2	ON/OFF	*1
Camera	Steering Angle Guides	—	ON/OFF	365 and 356
	Camera Off Delay	—	ON/OFF	363 and 354
Other Safety/Assistance Controls	Forward Vehicle Movement	—	ON/OFF	*1
	EyeSight Assist Monitor	—	ON/OFF	*1
	Rest Suggestions*2	—	ON/OFF	*1
Left/Right Driving	—	—	Right Side/Left Side	*1

\*1: For details about the EyeSight system, refer to the Owner's Manual supplement for the EyeSight system.

\*2: if equipped

## Displays

Configure the center information display setting and instrument cluster setting.

1. Touch  (Settings).
2. → “Displays” 
3. Select the preferred menu.

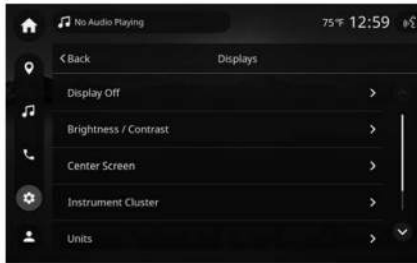

The setting adjustments to the following items can be manually changed to meet your personal requirements.



Item			Available settings	Page reference for the vehicle system operation
1st menu	2nd menu	3rd menu		
Display Off	—	—	Turn the screen off.	200
Brightness/Contrast	Brightness Dial Control	—	ON/OFF	161 and 199
	Brightness Adjustment	—	Set and adjust the brightness of the display.	
	Contrast Adjustment	—	Set and adjust the contrast of the display.	
Center Screen	Home Screen Settings	—	Edit the shortcut icon on the home screen.	*1
Instrument Cluster	Header options	—	Outside Temperature/Clock, Compass/Clock*2, None	189
	Display Mode	—	Classic/Map*2/ EyeSight/Calm	188
	Route Guidance Alerts	—	ON/OFF	*1
Units	Measurement	—	mi, mph, Gallons/ km, km/h, Liters	158 and 185
	Temperature	—	°C/°F	198
	Tire Pressure*2	—	PSI/kPa	191
Language	—	—	English/Français/ Español	185 and 194

\*1: For details about the audio and navigation system, refer to the Owner's Manual supplement for the audio and navigation system.

\*2: if equipped

## Vehicle

Configure the vehicle setting.

1. Touch  (Settings).
2. → “Vehicle” 
3. Select the preferred menu.

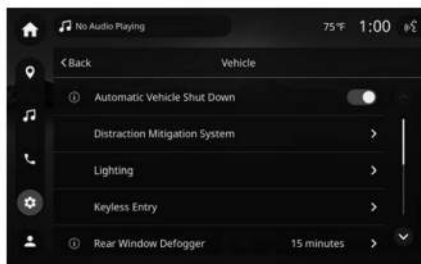

The setting adjustments to the following items can be manually changed to meet your personal requirements.

Item			Available settings	Page reference for the vehicle system operation
1st menu	2nd menu	3rd menu		
Automatic Vehicle Shut Down	—	—	ON/OFF	312
Distraction Mitigation System	Distraction Mitigation System	—	ON/OFF	389
	User Recognition	—	ON/OFF	
	Auto Retract Driver Seat* <sup>1</sup>	—	ON/OFF	
	Seat and Mirror Position* <sup>1</sup>	—	Reregister the driver's position.	
Lighting	Interior Light Timing	—	30 seconds/20 seconds/10 seconds/Off	276
	Welcome Lighting	Approach Duration	90 seconds/60 seconds/30 seconds/Off	214
		Departure Duration	90 seconds/60 seconds/30 seconds/Off	
	Auto Headlights	Daylight Sensitivity	High/Medium/Low/Minimal	213
		Wiper Sync	ON/OFF	213
		Steering Responsive Headlights (SRH)	—	ON/OFF
Keyless Entry	Alert Sound	—	ON/OFF	128 and 131
	Hazard Flashers	—	ON/OFF	128 and 131
	Door Unlock	—	Driver Door Only/All	122
	Rear Gate/Trunk Unlock	—	Rear Gate/Trunk Only, All	122
Rear Window Defogger	—	—	Continuous/15 minutes	226
One-Touch Lane Change	—	—	ON/OFF	221
Auto Door Locks	Lock Behavior	—	Shift from Park/Vehicle Speed/Off	134
	Unlock Behavior	—	Driver Door Open/Ignition Off/Shift into Park/Off	
Rear Seat Reminder	—	—	ON/OFF	67

Item			Available settings	Page reference for the vehicle system operation
1st menu	2nd menu	3rd menu		
Side Mirrors*1	Automatic Folding*1	—	ON/OFF	247
	Reverse Tilt*1	—	ON/OFF	246
Power Rear Gate Height Memory	—	—	ON/OFF	146

\*1: if equipped

## Time/date

Set and adjust the time and date. For details, refer to “Clock” P210.

## Maintenance

You can set maintenance reminders.

1. Touch (Settings).
2. → “Maintenance” .
3. Select the preferred menu.

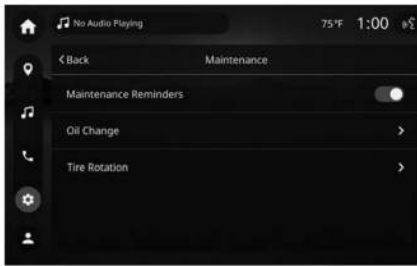

### Maintenance Reminders ON/OFF setting:

Touch the changing menu and select OFF or ON .

When “Maintenance Reminders” is illuminated, the maintenance items can be set.

### Setting the Next Service Date for a maintenance reminder:

1. Touch “Oil Change” or “Tire Rotation” on the 2nd menu in the “Maintenance”.
2. → “Next Service Date”

3. → or



4. → “Set”

### Setting the Interval Distance for the maintenance reminder:

1. Touch “Oil Change” or “Tire Rotation” on the 2nd menu in the “Maintenance”.
2. → “Interval Distance”
3. → Enter the interval distance.

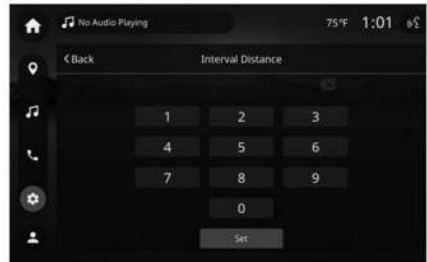

4. → “Set”

### NOTE

Touch “Reset” to reset each setting.



## Valet mode

For details, refer to “Valet Mode” P211.

## 3-9. CLOCK

For models with a genuine SUBARU navigation and/or audio system, the clock can be adjusted using either auto mode or manual mode.

### SETTING THE CLOCK MANUALLY

1. Turn the ignition switch to the "ON" position.
2. Touch  (Settings).
3. →  "Time/Date"



4. Models with navigation system:  
→ Select "Set Automatically" to OFF

Models with MySubaru Connected Services without navigation system:

→ Select "Set Automatically" to OFF



Models without MySubaru Connected Services or navigation system:

→ Select "Sync with Phone" to OFF





5. →  or 

6. → "Apply"

### NOTE

The clock setting screen can also be displayed by touching the clock on the status bar.

### SETTING THE CLOCK AUTOMATICALLY

1. Turn the ignition switch to the "ON" position.
2. Touch  (Settings).
3. →  "Time/Date"
4. Models with navigation system:  
→ Select "Set Automatically" to ON



Models with MySubaru Connected Services without navigation system:

→ Select "Set Automatically" to ON



Models without MySubaru Connected Services or navigation system:

→ Select "Sync with Phone" to ON

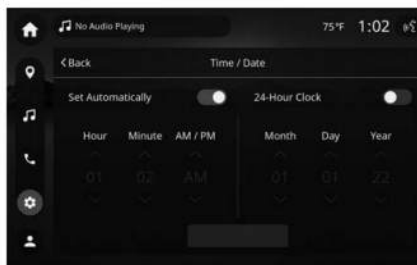

### Models with navigation system:

The clock will be set automatically where a GPS signal is available.

### Models with MySubaru Connected Services without navigation system:

The clock will be set automatically where a DCM (Data Communication Module in vehicle cellular connection) signal is



available.

### Models without MySubaru Connected Services or navigation system:





The clock will be set and adjusted automatically when a smartphone is connected via Bluetooth®.

Register the smartphone to the audio system. For details, refer to the separate navigation/audio Owner's Manual.

#### NOTE

*Depending on the model of smartphone, the settings of the connected smartphone may need to be changed. (ex: For iOS or other models, notification settings may need to be activated.) For details, check the instructions on connecting smartphones.*

### SETTING 12-HOUR DISPLAY/ 24-HOUR DISPLAY

1. Turn the ignition switch to the "ON" position.
2. Touch  (Settings).
3. →  "Time/Date"
4. → Select "24-Hour Clock" to 24-hour display  or 12-hour display .

## 3-10. VALET MODE

When leaving your vehicle with a valet service, such as at a hotel or restaurant, you can set the valet mode, which disables the navigation, audio, and vehicle setting functions.

### ACTIVATION OF VALET MODE

1. Touch "Valet Mode".



2. → "Activate Valet Mode"
3. Enter the passcode.



4. Touch "Activate".

When the valet mode is activated, "Valet Mode Active" is indicated on the information bar.

## DEACTIVATION OF VALET MODE

1. Touch the information bar.



2. Enter the passcode.
3. Touch “Deactivate”.
4. → “Continue”

## CHANGE THE PASSCODE

1. Touch “Valet Mode”.
2. → “Change Passcode”
3. Enter the current passcode.
4. Touch “Change”.
5. Enter the new passcode.
6. Touch “Set”.

### NOTE

*If you enter the passcode incorrectly three times in a row when setting or canceling valet mode, a message prompting you to contact a SUBARU dealer will be displayed, but it is still possible to enter the passcode even after the fourth attempt.*

*If you have forgotten your passcode, consult your SUBARU dealer.*

## 3-11. LIGHT CONTROL SWITCH



### CAUTION

- Use of any lights for a long period of time while the engine is not running can cause the battery to discharge.
- Before leaving the vehicle, make sure that the light control switch is turned to the off position. If the vehicle is left unattended for a long time with the light control switch set to a position other than the off position, even though the lights will turn off after 10 minutes, the battery may be discharged.

The light control switch operates when the push-button ignition switch is in the “ACC” or “ON” position.

Regardless of the position of the light control switch, the illuminated lights are turned off when the push-button ignition switch is turned off.

### NOTE

*The light control switch can be operated (except auto on/off headlights) even when the push-button ignition switch is turned to the “OFF” position.*

*If the driver’s door is opened while the headlights are illuminated under such conditions, a chirp sound will inform the driver that the lights are illuminated.*

## HEADLIGHTS

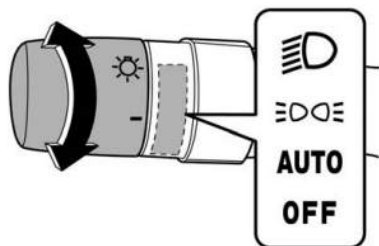

To turn on the headlights, turn the knob on the end of the light control switch.

### “OFF” position (except for Canada-spec. models):

The headlights are all off.

Only when the following conditions are fulfilled, instrument panel illumination, headlights, parking lights, front side marker lights, rear side marker lights, tail lights and license plate lights are automatically on or off depending on the level of the ambient light.

- The engine is running.
- The parking brake is fully released.
- The select lever is in a position other than the “P” position.

### “OFF” position (Canada-spec. models):

The headlights are all off.\*1\*2

\*1: When the light switch is switched to the “OFF” position while the vehicle is stopped, the lights turn off. Then the light switch will automatically return to the “AUTO” position.

\*2: The headlights will automatically change to the AUTO mode when the following conditions are met:

- The engine is running.
- The parking brake is fully released.
- The select lever is in a position other than the “P” position.

### “AUTO” position:

When the ignition switch is in the “ON” position, the instrument panel illumination, headlights, parking lights, front side marker lights, rear side marker lights, tail lights and license plate lights are **automatically on or off** depending on the level of the ambient light.

### NOTE

- If the light control switch is in the “AUTO” position and the headlights do not turn on when it becomes dark outside, turn the light switch to the “ON” position. If this happens, have your vehicle inspected by your SUBARU dealer as soon as possible.
- The light sensitivity of the auto on/off headlights can be changed by operating the center information display. For details, refer to “Vehicle” P206. Also, the setting can be changed by a SUBARU dealer. Consult your SUBARU dealer for details.

### “” position:

Instrument panel illumination, parking lights, front side marker lights, rear side marker lights, tail lights and license plate lights are on.

### “” position:

Instrument panel illumination, headlights, parking lights, front side marker lights, rear side marker lights, tail lights and license plate lights are on.

## Auto-on/off wiper-linked headlights

While the light control switch is in the “AUTO” position, the headlights will automatically turn on when the windshield wipers operate several times. The headlights will automatically turn off approximately 1 minute after the wiper stops.

The ON/OFF setting of this function can be changed by operating the center information display. Refer to “Vehicle”  P206.

Also, the setting can be changed by a SUBARU dealer. Consult your SUBARU dealer for details.

## Welcome lighting function

The welcome lighting function turns on the low beam headlight for smooth approaching to or exiting from the vehicle at night or in a dark place.

The function is activated while all of the following conditions are met.

- The light control switch is in the “AUTO” position.
- It is dark enough to turn on the auto on/off headlights.

### NOTE

*If the engine is turned off after turning off the light switch, the welcome lighting function may not operate (for Canada models).*

### When approaching:

While the welcome lighting function is activated, the low beam headlights will automatically illuminate when unlocking the doors by using the remote keyless entry system.

The low beam headlights will remain illuminated for 30 seconds\*<sup>1</sup> and then turn off. However, if any of the following operations is done, the low beam headlights will turn off.

- The doors are locked.
- The light control switch is turned to a position other than “AUTO”.

### When exiting:

While the welcome lighting function is activated, the low beam headlights will remain illuminated even when either of the following operation is done.

- The push-button ignition switch is turned to the “OFF” position.

The low beam headlights will turn off under any of the following conditions.

- 3 minutes have passed since the low beam headlights were illuminated by the welcome lighting function.
- 30 seconds have passed since the door is opened and closed.\*<sup>1</sup>
- The light control switch is turned to a position other than “AUTO”.
- The locking procedure is performed twice. When performing the unlocking procedure after performing the locking procedure, perform the locking procedure twice again.

\*<sup>1</sup>: The setting for the period of time in which the low beam headlights remain on by the welcome lighting function can be changed by a SUBARU dealer. Contact your SUBARU dealer for details. Also, you can change the setting by operating the center information display. For details, refer to “Vehicle”  P206.

## Battery drainage reduction function

When the headlights are illuminated and the push-button ignition switch is in the “OFF” position, the battery drainage reduction function will be active.

When the battery drainage reduction function is active, the following system operations help reduce the risk of battery discharge.

- The headlights turn off automatically after 10 minutes.
- When you open or close the door or operate the light control switch, the headlights will turn off automatically 10 minutes later.

### NOTE

- *When you leave the vehicle, put the light control switch in the “OFF” position to prevent battery discharge.*
- *When you open or close the door or operate the light control switch after the headlights turn off automatically,*

*the headlights will turn on again.*

## Sensor for the auto on/off headlights

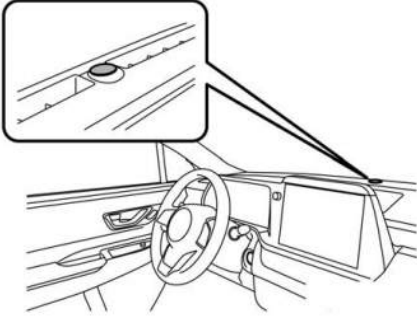



The location of the sensor is shown in the illustration.

### CAUTION

If any object is placed on or near the sensor, the sensor may not detect the level of the ambient light correctly and the auto on/off headlights may not operate properly.

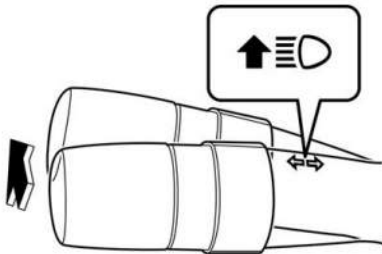
## HIGH/LOW BEAM CHANGE (Dimmer)





While the light control switch is in the  or "AUTO" position in a dark place, the headlights will turn on.

Pushing the lever forward and releasing it will activate the high beam. Pulling the

lever rearward and releasing it will switch the headlights to low beam.

When the light control switch is in the "AUTO" position, pushing the lever forward turns the High Beam Assist is on.

Refer to "High Beam Assist Function"  P215.

When the headlights are on high beam, the high beam indicator light  on the instrument cluster also illuminates.

## HEADLIGHT FLASHER

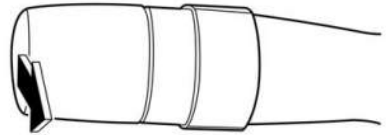

### CAUTION

Do not hold the lever in the flashing position for more than just a few seconds.

To flash the headlights, pull the lever toward you and then release it. The high beam will stay on for as long as you hold the lever. The headlight flasher works even though the lighting switch is in the off position.

When the headlights are on high beam, the high beam indicator light  on the instrument cluster also illuminates.

## HIGH BEAM ASSIST FUNCTION

The high beam assist function automatically changes the headlight from high beam to low beam (or vice versa).

When all of the following conditions are met, the headlight will change to high beam.

- When the vehicle speed increases to or above 20 mph (32 km/h).
- There is no preceding or oncoming vehicle.
- The forward area of the vehicle is dark.
- The road does not have a sharp curve.

When any of the following conditions are met, the headlight will change to low beam.

- When the vehicle speed decreases to or below 10 mph (16 km/h).
- When the forward area of the vehicle is bright.
- When there is a preceding or oncoming vehicle.
- When the EyeSight system is malfunctioning or is temporarily stopped.

#### NOTE

- *Do not overestimate the capacity of the high beam assist function. The driver always has the responsibility to understand the surrounding situation, to drive safely, and to change the headlight mode manually if necessary.*
- *The high beam assist function utilizes the stereo camera installed at the position of the front map lights.*
- *For details on how to handle the stereo camera, refer to the Owner's Manual supplement for the EyeSight system.*
- *The factory setting (default setting) for this function is set as "operational". This setting can be changed to OFF (non-operation) at SUBARU dealers. For more details, contact a SUBARU dealer.*

### How to use the high beam assist function

The high beam assist function will be activated when all the following conditions are met.

- The light control switch is in the "AUTO" position and the low beam headlights are on automatically.
- The turn signal lever is pushed forward.



When the high beam assist function is activated, the high beam assist indicator on the instrument cluster will illuminate.



#### NOTE

*If the high beam assist function is malfunctioning or is temporarily stopped, the headlight will be fixed at low beam.*

### How to temporarily lower the sensitivity of the high beam assist function

The sensitivity of the high beam assist function can be lowered by using the following operations.

1. After turning the ignition switch to the "ON" position, set the light control switch to the "AUTO" position and push the signal lever forward (high beam position).
2. After the high beam assist indicator on the instrument cluster illuminates, turn the ignition switch to the "OFF" position.

3. Turn the ignition switch to the “ON” position and within approximately 15 seconds, press the “ / ” (following distance setting) switch more than 10 times consecutively.

*tail lights and license plate lights will turn on.*

## Tips for the high beam assist system

- The high beam assist function recognizes the condition surrounding the vehicle based on the brightness of illumination ahead of your vehicle, etc. Therefore, the headlight mode may switch in some situations that do not match to the driver’s sense.
- A bicycle or cargo cycle may not be detected.
- Under the following situations, the brightness of ambient illumination may not be detected correctly and the high beam assist function may not work properly. As a result, the glare of the high beam may disturb the oncoming vehicle or vehicle ahead. Also, the low beam mode may continue although there are no oncoming vehicles and vehicles ahead. In the such cases, change the headlight mode manually.
  - In bad weather (fog, snow, sand storm, heavy rain, etc.).
  - When the windshield glass is dirty or fogged.
  - When the windshield is cracked or damaged.
  - If there are lights similar to the headlights or the tail lights in the surrounding area.
  - When an oncoming vehicle or vehicle ahead is driven without its headlights and tail lights on.
  - If the headlights of an oncoming vehicle or the tail lights of a vehicle ahead are dirty or discolored, or if the light beams are not aimed correctly.
  - When a rapid change of brightness continues while driving.
  - When driving on a road with many ups and downs or uneven surfaces.

When the sensitivity of the high beam assist function is lowered, the high beam assist indicator “A” on the instrument cluster display will flash.

### NOTE

- *The sensitivity of the high beam assist function cannot be lowered in the following conditions.*
  - *Cruise control indicator is illuminated.*
  - *The EyeSight warning indicator (yellow) is illuminated.*
- *The sensitivity of the high beam assist function returns to normal level the next time the ignition switch is turned to the “OFF” position and the engine is restarted.*

## How to change the headlight mode manually

### Change to the low beam:

- Set the light control switch to “”.
- Pull the lever while the high beam is turning on and release it.

### Change to the high beam:

Push the lever forward and release it.

At this time, the high beam assist function will turn off, the high beam assist indicator will turn off and the high beam indicator light will turn on.

### NOTE

- *After manually changing the headlight mode to the high beam, if you turn on the high beam assist function, push the lever forward and release it.*
- *When manually changing the headlight mode to the high beam, if you turn the light control switch to the “DQ” position, the parking lights, front side marker lights, rear side marker lights,*

- When driving on a road with many curves.
  - When there are some objects that reflect light strongly, such as a road sign or a mirror in vehicle ahead.
  - When the rear part of the vehicle ahead, such as a container, reflects light strongly.
  - When the headlights of your vehicle are damaged or dirty.
  - When your vehicle is tilted, such as in case the vehicle has a flat tire or is being towed.
  - When the stereo camera is deformed or the stereo camera lenses are dirty.
  - Immediately after the engine has started.
- In the following conditions, the headlight mode will not be automatically changed from the high beam to the low beam.
    - When your vehicle passes an oncoming vehicle suddenly in a blind curve.
    - When another vehicle passes in front of your vehicle.
    - When an oncoming vehicle or vehicle ahead comes in and out of view because of continuous curves, median strips, roadside trees, etc.
  - If the stereo camera detects the light of the front fog lights of an oncoming vehicle, the headlight mode may change from the high beam to the low beam automatically.
  - The headlight mode may change from the high beam to the low beam, or the low beam mode may continue, when affected by a street light, traffic signal, illumination of an advertisement board, or a reflective object such as a road sign and signboard.
  - The timing of the change of headlight mode may differ due to the following factors.
    - Color or brightness of the headlights of an oncoming vehicle or the tail lights of a vehicle ahead.
    - The headlights of the oncoming vehicle or the tail lights of the vehicle ahead are covered with mud, snow, etc.
    - Movement and direction of an oncoming vehicle or a vehicle ahead.
    - When the headlights of an oncoming vehicle or the tail lights of a vehicle ahead illuminate on only one side.
    - When the oncoming vehicle or vehicle ahead is a motorcycle.
    - Conditions of a road (slope, curve, road surface, etc.).
    - Number of passengers and weight of loaded cargo.
    - Limitation of the detection ability of the stereo camera.

## DAYTIME RUNNING LIGHT SYSTEM



### WARNING

When the daytime running lights are illuminated, the tail lights do not illuminate. When it becomes dark outside, turn the light switch to the  position to illuminate the headlights and tail lights. This will improve visibility and allow other drivers to see your vehicle more easily.

The daytime running lights will automatically illuminate when the following conditions are fulfilled.

- The engine is running.
- The parking brake is fully released.
- The light control switch is in “AUTO”, “” or “OFF”.
- The select lever is in a position other than the “P” position.



**NOTE**

When the light switch is in the “**DOGS**” position, the instrument panel illumination, front side marker lights, tail lights and license plate lights are also illuminated.

### 3-12. STEERING RESPONSIVE HEADLIGHT (SRH)

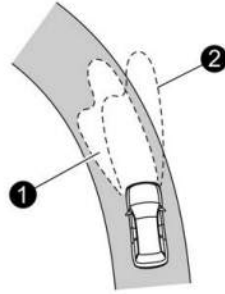

- ❶ The target area of illumination when SRH is activated
- ❷ The target area of illumination when SRH is not activated

SRH is a function that automatically moves the headlight beam to the left or right in accordance with the steering angle and vehicle speed. This function helps to improve the visibility at night by illuminating the road ahead at corners and intersections.

You can turn the SRH function on or off. The settings can be changed by using the center information display. Refer to “Vehicle” P206.

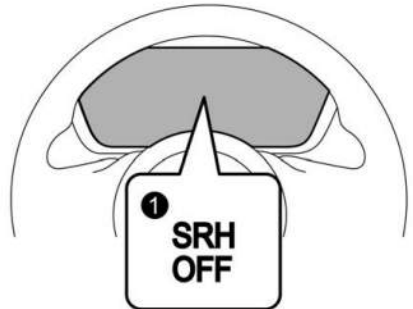

- ❶ Steering Responsive Headlight OFF indicator light

The Steering Responsive Headlight OFF indicator light on the instrument cluster display turns off when SRH is turned on.

The Steering Responsive Headlight OFF indicator light on the instrument cluster display illuminates when SRH is turned off.

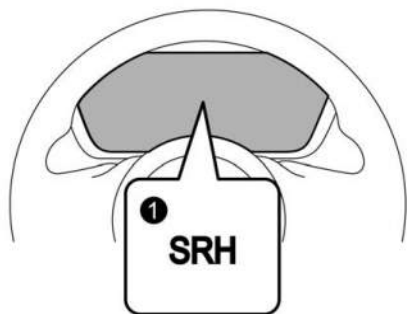

- ① Steering Responsive Headlight warning light

If SRH is malfunctioning, the Steering Responsive Headlight warning light on the instrument cluster display illuminates and a message appears on the warning screen when the ignition switch is in the "ON" position. It indicates that SRH has been deactivated. Contact a SUBARU dealer for an inspection.

#### NOTE

- The SRH function operative/non-operative status is kept when the engine is turned off, even if the engine is restarted.
- When you turn the ignition switch to the "ON" position, the Steering Responsive Headlight OFF indicator light will illuminate and turn off after several seconds.
- SRH only activates when the vehicle is traveling forward at the speed of approximately 5 mph (8 km/h) or more.

### 3-13. FRONT FOG LIGHT SWITCH

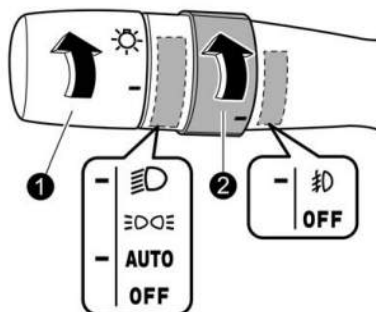

- ① Headlight switch  
② Fog light switch

#### To turn on the front fog lights:

Turn the fog light switch to the "☁" position while the headlights are in either of the following conditions.

- The headlight switch is in the "☁" position with the low beam mode selected.
- The headlight switch is in the "AUTO" position and the low beam headlights turn on automatically.

#### To turn off the front fog lights:

Turn the fog light switch back down to the "OFF" position.



The front fog light indicator light located on the instrument cluster will illuminate when the front fog lights are on.

### 3-14. TURN SIGNAL LEVER

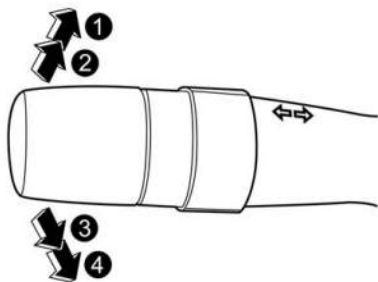

- ① Right turn
- ② Lane change right signal
- ③ Lane change left signal
- ④ Left turn

If the lever does not return after cornering, return the lever to the neutral position by hand.

To signal a lane change, push the turn signal lever up or down slightly and hold it during the lane change. The lever will return automatically to the neutral position when you release it.

### ONE-TOUCH LANE CHANGER

To flash the turn signal and turn signal indicator light three times, push the turn signal lever up or down slightly and immediately release it.

#### NOTE

*The operational/non-operational setting of the one-touch lane changer can be changed by a SUBARU dealer. Contact the nearest SUBARU dealer for details. The setting can also be changed by operating the center information display. Refer to "Vehicle" P206.*

### 3-15. WIPER AND WASHER

#### ⚠ WARNING

In freezing weather, do not use the windshield washer until the windshield is sufficiently warmed by the defroster. Otherwise the washer fluid can freeze on the windshield, blocking your view.

#### ⚠ CAUTION

- Do not operate the washer continuously for more than 10 seconds, or when the washer fluid tank is empty. This may cause overheating of the washer motor. Check the washer fluid level frequently, such as at fuel stops.
- Do not operate the wipers when the windshield is dry. This may scratch the glass, damage the blade rubbers and might cause the wiper motor to fail. Before operating the wiper on a dry windshield, always use the windshield washer.
- In freezing weather, be sure that the blade rubbers are not frozen to the windshield or rear window before switching on the wipers. Attempting to operate the wiper with the blade rubbers frozen to the window glass could cause not only the blade rubbers to be damaged but also might cause the wiper motor to fail. If the blade rubbers are frozen to the window glass, be sure to operate the defroster, windshield wiper deicer or rear window defogger before turning on the wiper.
- If the wipers stop during operation because of ice or some other obstruction on the window, this might cause the wiper motor to fail even if the wiper switch is turned off. If this occurs, promptly stop the vehicle in a safe location, turn the

ignition switch to the “OFF” position and clean the window glass to allow proper wiper operation.

- Use clean water if windshield washer fluid is unavailable. In areas where water freezes in winter, use SUBARU Windshield Washer Fluid or the equivalent. Refer to “Windshield Washer Fluid” ☞ P495.

Also, when driving the vehicle when there are freezing temperatures, use non-freezing type wiper blades.

- Do not clean the wiper blades with gasoline or a solvent, such as paint thinner or benzine. This will cause deterioration of the wiper blades.
- When the wiper switch is in the “AUTO” position, do not touch the windshield near the rain sensor and do not place a wet cloth on the windshield near the rain sensor. Doing so may result in unexpected wiper operation and cause injury.
- When washing the vehicle, make sure that the wiper is turned off. Otherwise, the wipers may operate unexpectedly and cause injury.
- When having your vehicle washed in an automatic car wash, make sure that the wiper is turned off. Otherwise, the wipers may be damaged because they may operate unexpectedly and car wash brushes could become tangled around them.

## NOTE

- *The windshield wiper motor is protected against overloads by a circuit breaker. If the motor operates continuously under an unusually heavy load, the circuit breaker may trip to stop the motor temporarily. If this happens, park your vehicle in a safe location, turn off the wiper switch, and*

*wait for approximately 10 minutes. The circuit breaker will reset itself, and the wipers will again operate normally.*

- *Clean your blade rubbers and window glass periodically with a washer solution to prevent streaking, and to remove accumulations of road salt or road film. Operate the windshield washer for at least 1 second so that washer solution will be sprinkled all over the windshield or rear window.*
- *Grease, wax, insects, or other material on the windshield or the wiper blade results in jerky wiper operation and streaking on the glass. If you cannot remove the streaks after operating the windshield washer or if the wiper operation is jerky, clean the outer surface of the windshield and rear window using a sponge or soft cloth with a neutral detergent or mild-abrasive cleaner. Do not, however, use detergent to clean the blade rubbers. Use only a sponge or soft cloth (and no neutral detergent or mild-abrasive cleaner) when you clean the blade rubbers. If you wipe the rubber of the blade strongly, the black coating component will peel off, which will cause the wiper to judder. Also, after wiping it off, check that the rubber has not come loose. After cleaning the window glass and wiper blade rubbers, be sure to rinse them with clean water. Rinse the window until the water does not form beads on the glass. This indicates that the glass is clean.*
- *If you cannot eliminate the streaking even after following this procedure, replace the wiper blades (or blade rubbers) with new ones. For replacement instructions, refer to “Replacement of Wiper Blades” ☞ P496.*
- *When the wiper switch is turned to the “AUTO” position while the ignition switch is in the “ON” position, the wipers will operate once. This indicates that the wiper switch is in the “AUTO” position.*

- When the wiper switch is in the “AUTO” position, the following situations may occur.
  - The wipers may operate if the rain sensor or the windshield is vibrated or objects such as insects, dirt, mud, etc. are covering them. Turn off the wiper unless it is raining or snowing.
  - The wipers do not operate if the rain sensor does not detect rain or snow. If necessary, push the wiper control lever down to the low speed position or high speed position.
  - The wipers may not operate properly if the rain sensor does not detect the amount of raindrops because a water-repellent coating, dirt, or ice is on the upper half of the windshield.
  - The rain sensor may be malfunctioning if the wiper intermittent operation does not vary depending on the amount of rainfall. If necessary, turn the wiper switch to any position except the “AUTO” position. We recommend that you contact your SUBARU dealer and have the system inspected as soon as possible.
  - The wipers stop operation if the ambient temperature decreases to 5°F (-15°C) or lower. The wipers resume operation when the ambient temperature increases to 14°F (-10°C) or higher. If you need to operate the wipers under 5°F (-15°C), push the wiper control lever down to the low speed position or high speed position.
  - The wipers may not operate if the temperature around the rain sensor is more than 176°F (80°C) because the system cannot detect the amount of raindrops under these temperatures.

## WINDSHIELD WIPER AND WASHER SWITCHES

The wiper operates only when the ignition switch is in the “ON” position.

### Windshield wipers

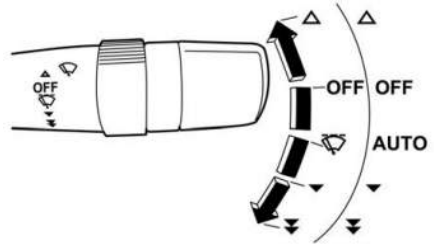

- △ : Mist (for a single wipe)
- OFF : Off
- WIPER/AUTO : Intermittent/Automatic operation
- ▼ : Low speed
- ▼▼ : High speed

To turn the wipers on, push the wiper control lever down.

To turn the wipers off, return the lever to the “OFF” position.

For a single wipe of the wipers, push the lever up. The wipers operate until you release the lever.

### NOTE

- The automatic adjusting mode of the wiper timing can be changed from the rain-sensing mode to the vehicle speed interlocking mode. The setting can be changed by a SUBARU dealer. For more details, contact a SUBARU dealer.
- While the intermittent wiper is in operation, if the vehicle is started, the wiper will operate once.
- If the wiper switch is in the “AUTO” position and the wipers do not operate when it rains, or the wiper switch is in

the “Low speed” position and the wipers do not operate, turn the wiper switch to the “High speed” position. In this case, contact your SUBARU dealer.

### Wiper intermittent time control (models without automatic rain sensing windshield wipers)

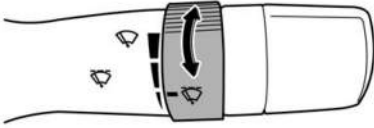

When the wiper switch is in the “” position, turn the dial to adjust the operating interval of the wiper. The operating interval can be adjusted in several steps from the shortest interval to the longest.

### Automatic operation (models with automatic rain sensing windshield wipers)

With the wiper switch in the “AUTO” position, the wipers operate automatically when the rain sensor detects falling rain. The wiper timing is automatically adjusted depending on the amount of rain.

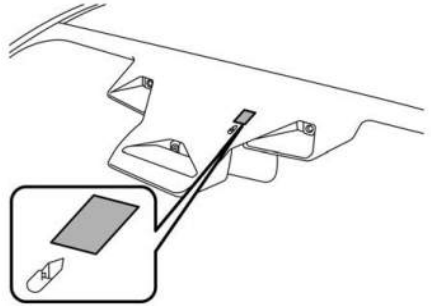

The rain sensor is on the windshield glass.

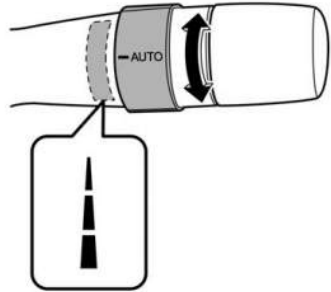

Turn the dial to adjust the sensitivity of the rain sensor for wiper control. Turn the dial downward to increase the sensitivity. Turn the dial upward to decrease the sensitivity.

#### NOTE

When the wiper control lever is in the “AUTO” position, if you turn the dial downward, the wipers will operate once to inform you that the sensor sensitivity has been increased.

## Windshield washer

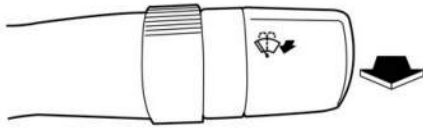

To wash the windshield, pull the wiper control lever toward you. The washer fluid sprays until you release the lever. The wipers operate while you pull the lever.

### NOTE

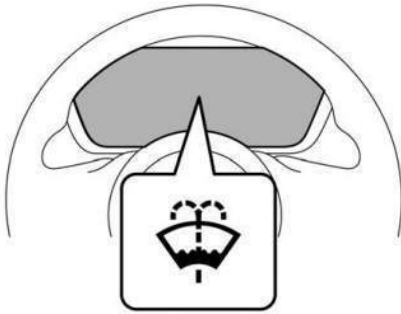

The windshield washer fluid warning light appears when the washer fluid level in the tank has dropped to the lower limit. If the warning light appears, refill the tank with fluid. For the tank refilling method, refer to "Windshield Washer Fluid" Ⓞ P495.

## REAR WINDOW WIPER AND WASHER SWITCH

The wiper operates only when the ignition switch is in the "ON" position.

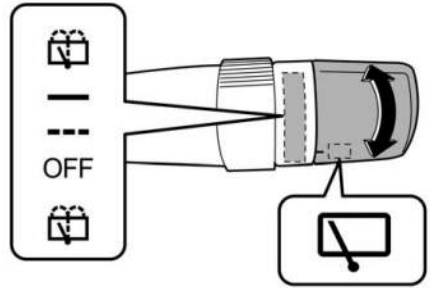

: Washer (accompanied by wiper operation)

: Continuous

: Intermittent

OFF: Off

: Washer (accompanied by wiper operation)

## Rear wiper

To turn the rear wiper on, turn the knob switch upward.

To turn the wiper off, return the knob switch to the "OFF" position.

With the switch turned to the "----" position, the rear wiper will operate intermittently at intervals corresponding to the vehicle speed. In this position, when you move the select lever to the "R" position, the rear wiper will switch to continuous operation. When you move the select lever from the "R" (reverse) position to another position, the rear wiper will return to intermittent operation.

### Reverse gear interlocked rear wiper:

Even if the rear wiper switch is in the "OFF" position, if the front windshield wiper is operating continuously, the rear wiper will operate intermittently when you move the select lever to the "R" (reverse) position.

The factory setting (default setting) of the reverse gear interlocked rear wiper is as follows.

- Except for Canada and Mexico: Non-operation

- For Canada and Mexico: Operation  
This setting can be changed by a SUBARU dealer. Consult your SUBARU dealer for details.

**CAUTION**

Do not attach anything that disturbs the rear wiper operation on the rear gate. Doing so may damage the rear wiper when it operates.

**Washer**

To wash the rear window while the rear wiper is operating, turn the knob switch upward to the “” position. The washer fluid sprays until you release the knob.

To wash the rear window when the rear wiper is not in use, turn the knob switch downward to the “” position. The washer fluid sprays and the wiper operates until you release the knob.

The rear view camera washer also operates while the rear window washer is operating.

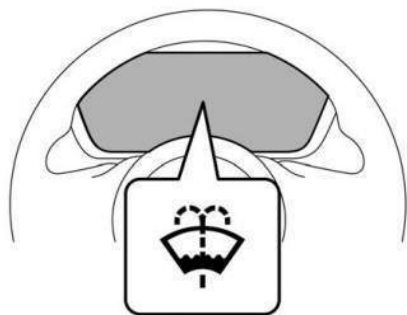
**NOTE**

The windshield washer fluid warning light appears when the washer fluid level in the tank has dropped to the lower limit. If the warning light appears, refill the tank with fluid. For the tank refilling method, refer to “Windshield Washer Fluid”  P495.

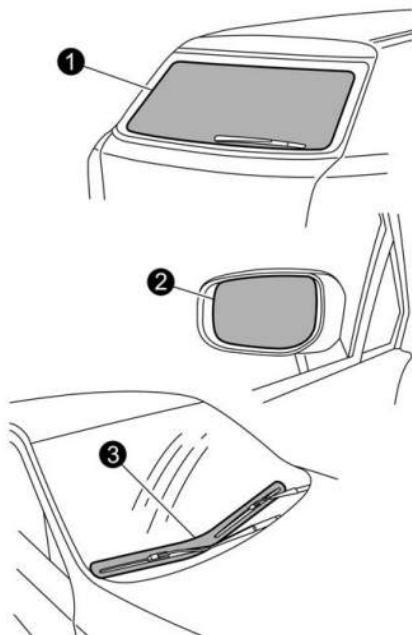
**3-16. DEFOGGER AND DEICER**

- 1 Rear window defogger and rear wiper deicer
- 2 Outside mirror defogger
- 3 Windshield wiper deicer

The defogger and deicer system is activated only when the ignition switch is in the “ON” position.

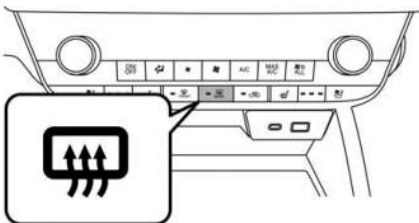



To activate the defogger and deicer system, press the defogger button. The rear window defogger, outside mirror defogger and windshield wiper deicer are activated simultaneously. The indicator light on the defogger button illuminates while the defogger and deicer system is activated.

To turn them off, press the defogger button again. They also turn off when the ignition switch is turned to the "ACC" or "OFF" position.

The defogger and deicer system will automatically shut off after approximately 15 minutes. If the rear window and outside mirrors have been cleared and the windshield wiper blade rubbers have been deiced completely before that time, press the defogger button to turn them off. If defrosting, defogging or deicing is not complete, you have to press the defogger button to turn them on again.

It is possible to set the defogger and deicer system for the continuous operation mode by operating the center information display. For details, refer to "Vehicle" P206.



### CAUTION

- To prevent the battery from being discharged, do not operate the defogger and deicer system continuously for any longer than necessary.
- Do not use sharp instruments or window cleaner containing abrasives to clean the inner surface of the rear window. They may damage the conductors printed on the window.

### NOTE

- Turn on the defogger and deicer system if the wipers are frozen to the windshield.
- If the windshield is covered with snow,

remove the snow so that the windshield wiper deicer works effectively.

- While the defogger and deicer system is in the continuous operation mode:
  - If the vehicle speed remains at 9 mph (15 km/h) or lower for 15 minutes, the windshield wiper deicer system automatically stops operating. However, the rear window defogger system and outside mirror defogger system maintain continuous operation in this condition.
  - If the vehicle battery voltage drops below the permissible level, continuous operation of the defogger system and deicer system is canceled and the system stops operating.
- When the vehicle battery power is low, the defogger will stop. Start the engine to use the defogger.

## 3-17. MIRRORS

Always check that the inside and outside mirrors are properly adjusted before you start driving.

### INSIDE MIRROR (without Auto-Dimming Function) (If Equipped)

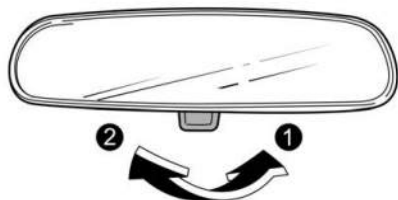

- ① Normal position
- ② Anti-glare position

Push the tab on the mirror for normal use. To reduce glare from the headlights of the vehicle behind you, pull the tab to the anti-glare position.

### AUTO-DIMMING MIRROR/COMPASS (If Equipped)

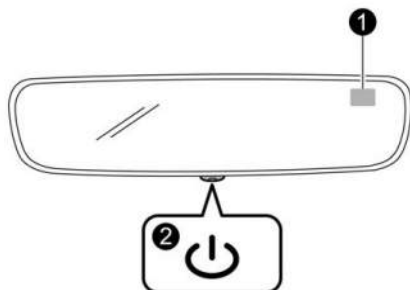

- ① Compass
- ② Switch

During nighttime driving, the auto-dimming feature senses distracting glare from vehicle headlights behind you and automatically dims to eliminate the glare and preserve your vision.

### To Operate the Auto-Dimming Feature



Press the “” switch to turn the auto-dimming feature on/off. The auto-dimming feature is enabled when the switch’s green LED indicator is on. The auto-dimming feature will default to on with each ignition cycle.

### To Operate the Compass Feature

1. To turn the compass feature on/off, press and hold the “” switch for more than 3 seconds or until the display turns on/off. The compass feature will default to on with each ignition cycle.
2. If the display reads “C”, slowly drive the vehicle in circles until compass is calibrated.
3. To adjust for compass zone variance:

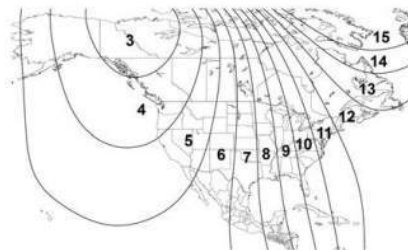
#### Compass calibration zones



- (1) Find your current location and zone number on the map.
- (2) Press and hold the “” switch for more than 6 seconds or until a zone number appears in the display.
- (3) Once the zone number appears in the display, toggle the “” switch

again until your current location zone number appears. After you stop pressing the switch, your new zone number will be saved. Within a few seconds, the display will show a compass direction.

- If the vehicle's magnetics have changed or if the compass appears inaccurate, recalibrate the compass. Press and hold the "⏻" switch for more than 9 seconds or until a "C" appears in the display. Once a "C" appears in the display, slowly drive the vehicle in circles until compass is calibrated.

## AUTO-DIMMING MIRROR/ COMPASS WITH HOMELINK® (If Equipped)

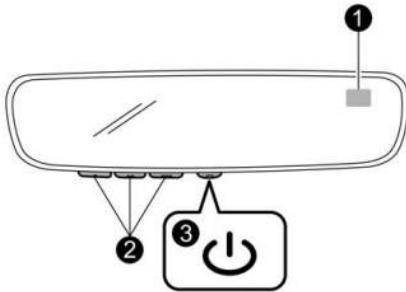

- ① Compass
- ② HomeLink® buttons
- ③ Switch

During nighttime driving, the auto-dimming feature senses distracting glare from vehicle headlights behind you and automatically dims to eliminate the glare and help preserve your vision.

## To Operate the Auto-Dimming Feature

Press the "⏻" switch to turn the auto-dimming feature on/off. The auto-dimming feature is enabled when the switch's green LED indicator is on. The auto-dimming feature will default to on with

each ignition cycle.

## To Operate the Compass Feature (if equipped)

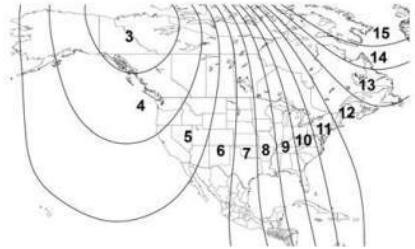

- To turn the compass feature on/off, press and hold the "⏻" switch for more than 3 seconds or until the display turns on/off. The compass feature will default to on with each ignition cycle.
- If the display reads "C", slowly drive the vehicle in circles until compass is calibrated.
- To adjust for compass zone variance:  
**Compass calibration zones (U.S.)**

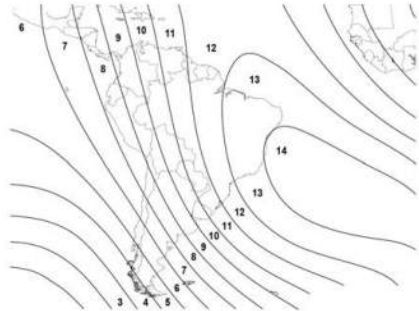

## Compass calibration zones (South America)



- Find your current location and zone number on the map.
- Press and hold the "⏻" switch for more than 6 seconds or until a zone number appears in the display.

- (3) Once the zone number appears in the display, toggle the “” switch again until your current location zone number appears. After you stop pressing the switch, your new zone number will be saved. Within a few seconds, the display will show a compass direction.
4. If the vehicle’s magnetics have changed or if the compass appears inaccurate, recalibrate the compass. Press and hold the “” switch for more than 9 seconds or until a “C” appears in the display. Once a “C” appears in the display, slowly drive the vehicle in circles until compass is calibrated.

## HomeLink® Wireless Control System

The HomeLink® Wireless Control System provides a convenient way to replace up to three hand-held radio frequency remotes used to activate devices such as gate operators, garage door openers, entry door locks, security systems, even home lighting. The below steps are generic programming instructions; for Genie and Sommer garage door openers please go directly to the HomeLink® website. Additional information and programming videos can be found at [www.HomeLink.com](http://www.HomeLink.com) and [www.youtube.com/HomeLinkGentex](http://www.youtube.com/HomeLinkGentex).



### CAUTION

- Before programming HomeLink® to a garage door opener or gate operator, make sure that people and objects are out of the way of the device to prevent potential harm or damage.
- When programming a garage door opener, it is advised to park outside of the garage.
- Do not use HomeLink® with any garage door opener that lacks safety stop and reverse features as

required by U.S. federal safety standards (this includes any garage door opener model manufactured before April 1, 1982). A garage door that cannot detect an object signaling the door to stop and reverse does not meet current U.S. federal safety standards.

- It is also recommended that a new battery be placed in the hand-held remote (garage door opener remote) of the device for quicker and more accurate training.
- Turn the ignition switch to the “ON” or “ACC” position before programming and/or operating HomeLink®.
- Keep the hand-held remote (garage door opener remote) of the device you are programming for use in other vehicles as well as for future HomeLink® programming.
- For security reasons, when transferring ownership of your vehicle, it is recommended to delete the programmed HomeLink® buttons. Refer to “Erasing HomeLink® buttons”  P233.

## Programming a New HomeLink® button

1. Press and release the HomeLink® button that you would like to program. The HomeLink® indicator light will flash orange slowly (if not, refer to “Erasing HomeLink® buttons”  P233).

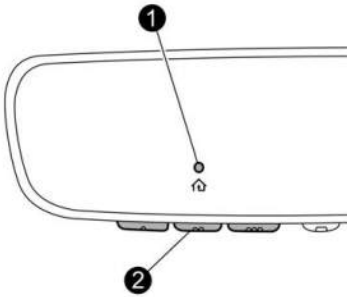

- ① Indicator Light
- ② HomeLink® buttons

2. Position the hand-held remote (garage door opener remote) 1 to 3 inches (2 to 8 cm) away from the HomeLink® button that you would like to program.

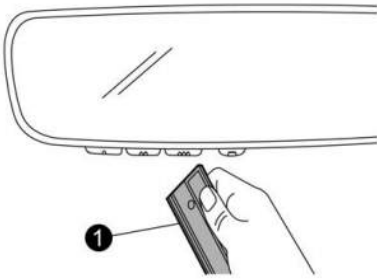

- ① Garage door opener remote

#### NOTE

*Some hand-held remotes (garage door opener remotes) may actually train better at a distance of 6 to 12 inches (15 to 30 cm). Keep this in mind if you have difficulty with the programming process.*

3. While the HomeLink® indicator light is flashing orange, press and hold the hand-held remote button. Continue pressing the hand-held remote button until the HomeLink® indicator light changes from orange to green. You may now release the hand-held remote button.

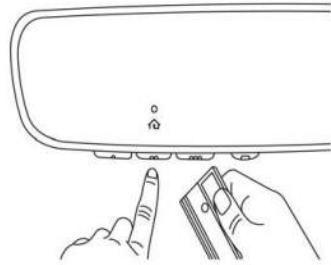

#### NOTE

*Some devices may require you to replace this “Programming a New HomeLink® button” step 3 with procedures noted in the “Gate Operator / Canadian Programming” section. Refer to “Gate Operator/ Canadian Programming” P233.*

4. Press the HomeLink® button that you would like to program and observe the indicator light.

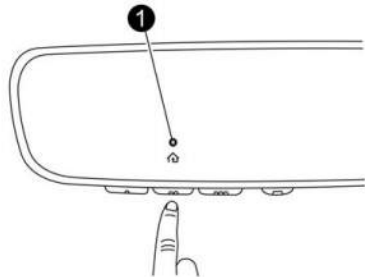

- ① Indicator Light
  - If the indicator light remains constant green, your device should operate when the HomeLink® button is pressed. At this point, if your device operates, programming is complete.
  - If the indicator light rapidly flashes green, firmly press, hold for two seconds and release the HomeLink® button up to three times to complete the programming process. At this point if your device operates, programming is com-

plete. If the device does not operate, continue with the next step of the programming instructions.

- At the garage door opener motor, (security gate motor, etc.) locate the "Learn", "Smart", or "Program" button. This can usually be found where the hanging antenna wire is attached to the motor-head unit (see the device's manual to identify this button). The name and color of the button may vary by manufacturer.

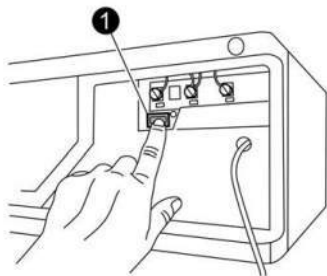

1 "Learn" button

#### NOTE

A ladder and/or second person may simplify the following steps.

- Firmly press and release the "Learn", "Smart", or "Program" button. You now have 30 seconds in which to complete step 7.

- Return to the vehicle and firmly press, hold for 2 seconds and release the HomeLink® button up to three times. At this point programming is complete and your device should operate when the HomeLink® button is pressed and released.

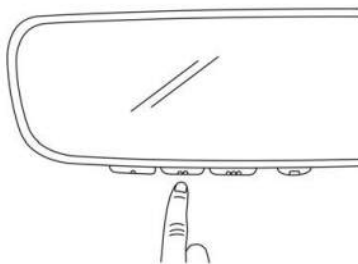

- If status indicator arrows appear next to the indicator light, please refer to "Garage Door Two-Way Communication" P233.

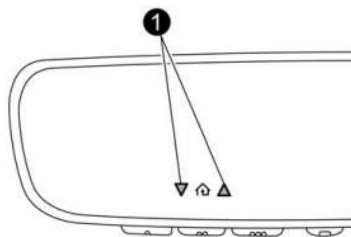

1 Status Indicators

In the event that there are still programming difficulties or questions, additional HomeLink® information and programming videos can be found at [www.HomeLink.com](http://www.HomeLink.com) and [www.youtube.com/HomeLinkGentex](http://www.youtube.com/HomeLinkGentex). For Genie and Sommer garage door openers please go directly to the HomeLink® website.

## Gate Operator/Canadian Programming

Canadian radio-frequency laws require transmitter remote signals to “time-out” (or quit) after several seconds of transmission, which may not be long enough for HomeLink® to pick up the signal during programming. Similar to this Canadian law, some U.S. gate operators are designed to “time-out” in the same manner. The indicator LED on the hand-held remote will go off when the device times out, indicating that it has finished transmitting.

If you live in Canada or you are having difficulties programming a gate operator or garage door opener by using the programming procedures, replace “Programming a New HomeLink® button” step 3 with the following:

While the HomeLink® indicator light is flashing orange, press and release (“cycle”) your device’s hand-held remote every two seconds until the HomeLink® indicator light changes from orange to green. You may now release the hand-held remote button.

### NOTE

*If programming a garage door opener or gate operator, it is advised to unplug the device during the “cycling” process to prevent possible overheating.*

Proceed with “Programming a New HomeLink® button” step 4 to complete.

## Using HomeLink®

To operate, simply press and release the programmed HomeLink® button. Activation will now occur for the trained device (i.e. garage door opener, gate operator, security system, entry door lock, home/office lighting, etc.). For convenience, the hand-held remote of the device may also be used at any time.

## Erasing HomeLink® buttons

To erase programming from the three buttons (individual buttons cannot be erased but can be “reprogrammed” as outlined below), follow the step noted:

Press and hold the two outer HomeLink® buttons for at least 10 seconds. The LED indicator will change from continuously lit to rapidly flashing. Release both buttons. Do not hold for longer than 20 seconds. HomeLink® is now ready to be programmed at any time beginning with “Programming a New HomeLink® button” - step 1.

## Reprogramming a Single HomeLink® button

To program a previously trained button, follow these steps:

1. Press and hold the desired HomeLink® button. DO NOT release the button.
2. The indicator light will begin to slowly flash orange after 20 seconds. The HomeLink® button can be released at this point. Proceed with “Programming a New HomeLink® button” - step 3.
3. If you do not complete the programming of a new device to the button, it will revert to the previously stored programming.

## Garage Door Two-Way Communication

HomeLink® has the capability of communicating with your garage door opener. HomeLink® can receive and display “closing” or “opening” status messages from compatible garage door opener systems. At any time, HomeLink® can also recall and display the last recorded status communicated by the garage door opener to indicate your garage door being “closed” or “opened”.

HomeLink® has the capability of receiving this communication from the garage door opener at a range up to 820 feet (250 m).

Range may be reduced by obstacles such as houses or trees. You may have to slow your vehicle speed to successfully receive the garage door opener communication.

## Programming Two-Way Communication

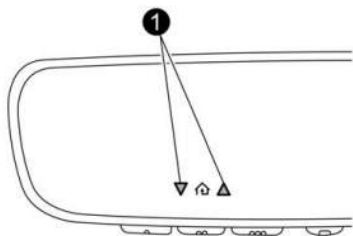

### 1 Status Indicators

Within 5 seconds after programming a new HomeLink® button, both of HomeLink's garage door status indicators will flash rapidly green indicating that the garage door two-way communication has been enabled. If your garage door status indicators flashed, two-way communication programming is complete.

If the garage door status indicators do not flash, additional HomeLink® information and programming videos can be found online at [www.HomeLink.com](http://www.HomeLink.com) and [www.youtube.com/HomeLinkGentex](http://www.youtube.com/HomeLinkGentex).

## Using Two-Way Communication

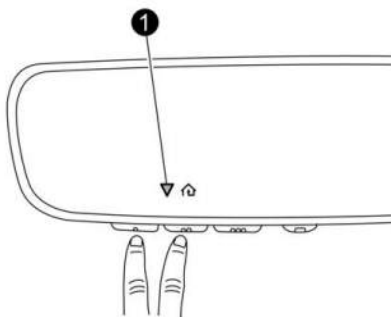

### 1 Status Indicator

Recall and display (at any time) the last recorded garage door status message communicated to HomeLink® by simultaneously pressing HomeLink® buttons 1 and 2 for 2 seconds. HomeLink® will display the last recorded status for 3 seconds.

If two-way communication programming is successful, HomeLink® will display the status of your garage door opener with arrow indicators (see below).

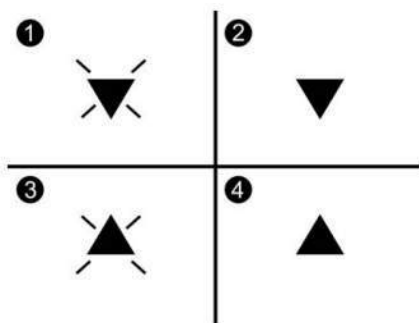

- 1 Garage Door Opener CLOSING (Blinking Orange)
- 2 Garage Door Opener CLOSED (Solid Green)
- 3 Garage Door Opener OPENING (Blinking Orange)
- 4 Garage Door Opener OPENED (Solid Green)



## SMART REARVIEW MIRROR/ COMPASS WITH HOMELINK® (If Equipped)

### Safety precautions

#### WARNING

- Never rely exclusively on the Smart Rearview Mirror. The Smart Rearview Mirror has blind spots that must be checked prior to operating the vehicle. Please exercise caution when using this system.
- Do not disassemble or modify the main unit, camera or wiring of the Smart Rearview Mirror. If there is a strange odor or smoke, stop using it immediately and we recommend that you consult a SUBARU dealer.
- Never operate the Smart Rearview Mirror while driving. Doing so could result in an accident that causes serious injury or death.

#### CAUTION

- Do not put the main unit, camera or wiring of the Smart Rearview Mirror close to fire. Doing so could result in a malfunction and fire.
- When the Smart Rearview Mirror malfunctions, change to the mirror mode immediately and we recommend that you consult a SUBARU dealer.
- Staring at Smart Rearview Mirror for extended period of time may result in car sickness.
- The display could become hard to see because of lights (e.g. sunlight or the headlights of approaching vehicles) from outside of the vehicle. In this case, change to the mirror mode if necessary.

#### NOTE

When the moonroof is opened (if equipped):

If the sunlight is too bright to see the display of the Smart Rearview Mirror, close the moonroof (sunshade), or select the mirror mode.

### Smart Rearview Mirror switches

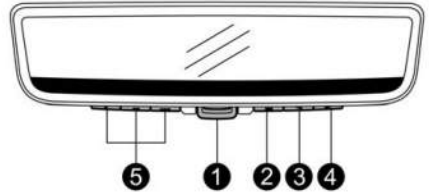

- ① Mode lever
- ② Left button
- ③ Center button
- ④ Right button
- ⑤ HomeLink buttons

### How to use the Smart Rearview Mirror

#### CAUTION

Adjust the rearview mirror before driving.

- 1) Change the Smart Rearview Mirror to the mirror mode.
- 2) Sit with the correct posture in the driver's seat and adjust the mirror position to see behind.
- 3) Change the Smart Rearview Mirror to the display mode.

If you start driving without adjusting the mirror, light may reflect on the mirror while selecting the display mode and it may make it hard to see the screen.

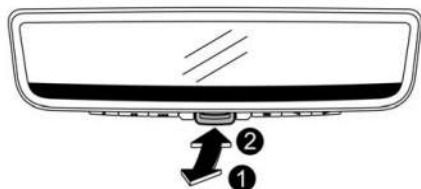
**To change the mode:**

- ❶ To select the display mode, first adjust the rearview mirror, then pull the mode lever towards you.
- ❷ To select the mirror mode, push the mode lever away from you.

Select the display mode to show the image from the camera that is installed on the rear gate.

Select the mirror mode to use as a normal mirror. If the mirror mode is selected, the image from the camera is not shown on the mirror.

**NOTE**

- It is not possible to use the Smart Rearview Mirror in the display mode when the ignition switch is in the "OFF" or "ACC" position.
- When using the display mode, parts of the vehicle interior may reflect light on the display. Adjust the angle of the Smart Rearview Mirror to avoid unwanted reflection.

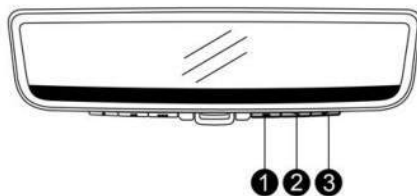
**To adjust the display:**

- ❶ Left button
- ❷ Center button
- ❸ Right button

Press any of the left, center or right buttons to display the main menu.

**NOTE**

- The main menu cannot be displayed on the display while the select lever is in a position other than the "P" position.
- If you do not press the adjustment buttons that are at the bottom of the Smart Rearview Mirror for 5 seconds, the adjustment menu will disappear.

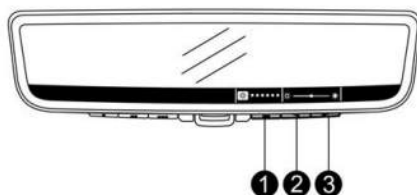
**Brightness adjustment:**

- ❶ Setting button: Press the setting button to set the brightness.
- ❷ Press this button to decrease the brightness.
- ❸ Press this button to increase the brightness.

After pressing the setting button, the mode will change to the up/down adjustment mode.

#### Up/down adjustment:

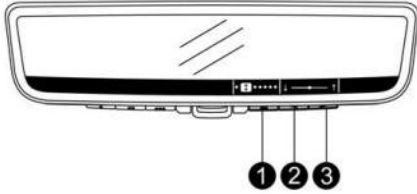

- ❶ Setting button: Press the setting button to set the angle.
- ❷ Press this button to lower the angle.
- ❸ Press this button to raise the angle.

After pressing the setting button, the mode will change to the left/right adjustment mode.

#### Left/right adjustment:

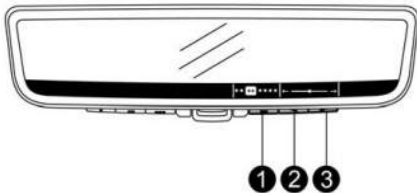

- ❶ Setting button: Press the setting button to set the angle.
- ❷ Press this button to turn the angle left.
- ❸ Press this button to turn the angle right.

After pressing the setting button, the mode will change to the rotation adjustment mode.

#### Rotation adjustment:

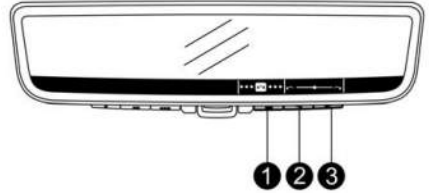

- ❶ Setting button: Press the setting button to set the angle.
- ❷ Press this button to turn the angle counterclockwise.
- ❸ Press this button to turn the angle clockwise.

After you press the setting button, the mode will return to the brightness adjustment mode.

#### Dimming setting:

The Smart Rearview Mirror has a dimming mirror mode. When the mirror mode is selected with the ignition switch in the "ON" position, auto dimming will activate. This mode decreases glare automatically depending on the brightness level from behind.

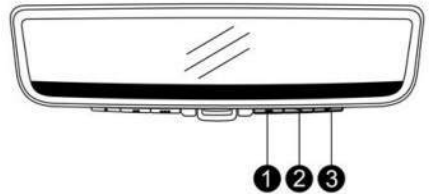

- ❶ Left button
- ❷ Center button
- ❸ Right button

When selecting the mirror mode, press any of the buttons to display the auto

dimming menu. Press the center or right buttons to turn the dimming mirror mode ON/OFF.

#### Dimming mirror mode ON indicator

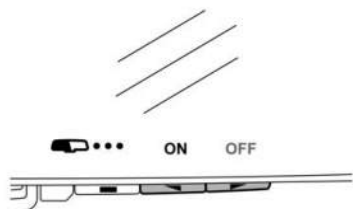

#### Dimming mirror mode OFF indicator

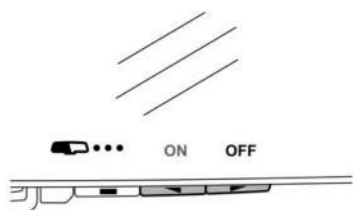

When turning the dimming mirror mode ON/OFF, the dimming mirror mode ON/OFF indicator will illuminate for 5 seconds.

#### NOTE

- When the ignition switch is turned to the "OFF" position, auto dimming will not activate.
- When the display mode is selected, auto dimming will not activate.

## When the display mode malfunctions



When there is a vehicle communication error, the warning indicators will appear as shown in the illustration.

When the warning indicators appear, operate the mode lever to select the mirror mode. In such a case, we recommend that you consult your SUBARU dealer for repair.

If the mode does not change to the mirror mode even when operating the mode lever, the mode lever may have malfunctioned. In such a case, press and hold one of the left, center, or right buttons for 10 seconds. Then the mode will change to the mirror mode.



When there is a camera calibration error, the warning indicators will appear as shown in the illustration.

When the warning indicators appear, operate the mode lever to select the mirror mode. In such a case, we recom-

mend that you consult your SUBARU dealer for repair.

## Maintenance

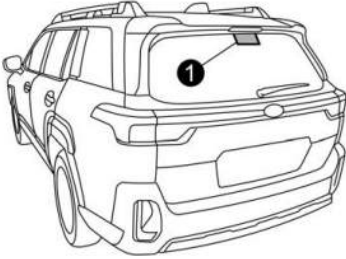

### 1 Camera

- Make sure to clean the Smart Rearview Mirror and the area around the camera regularly. If these parts are not clean, the screen cannot be seen clearly.
- Wipe off the Smart Rearview Mirror and the area around the camera by using a dry soft cloth. If the foreign matter cannot be removed, first wipe the area off using a wet soft cloth, and then wipe using a dry cloth.
- Do not use alcohol, benzine or thinner for cleaning. Doing so could result in discoloration, deterioration, or malfunction.
- Make sure to clean the rear camera lens regularly. When you clean the rear camera lens, first soak a soft cloth with diluted mild detergent to wipe it off, and wipe using a dry cloth.
- When installing a roof box or a similar accessory, do not block the area in front of the camera lens to avoid interfering with the camera image on the mirror.
- When the Smart Rearview Mirror's visibility is poor because there is dirt or other foreign material adhering to the camera, switch to the original rearview mirror.

## Tips

- Do not use the display mode for a long time while the engine is not running. Doing so could result in the battery discharge.
- Do not install radio antennas around the Smart Rearview Mirror. Radio waves may disturb the Smart Rearview Mirror screen.
- Observe the following instructions. Not doing so could result in malfunction or the main mirror unit falling off.
  - Do not push the button too strongly or move the lever too forcibly.
  - Do not turn the main mirror unit more than 90 degrees.
  - Do not impact the main mirror unit.
  - Do not impact the camera or antenna.
- If the screen is hard to see because of light, select the mirror mode.
- If LED lights or scattered reflections are caught in the camera, the screen may flicker. However, this is not a malfunction.
- If something moves rapidly near the camera, the display may not be able to catch the item. However, this is not a malfunction.
- If the display mode is used, the view of the rear will be different from the normal use of the inner mirror or the mirror mode. Do not rely solely on the Smart Rearview Mirror; check the rear visually if necessary. Pay attention to traffic conditions for safe driving.
- Adjust the brightness of the screen appropriately. If the screen is too bright, the driver's eyes may get tired while driving.
- The Smart Rearview Mirror sometimes becomes hot. However, this is not a malfunction.
- In the following cases, the color may not be clear. However, this is not a malfunction.

- The shown items are a very far distance away.
- The environmental conditions are very dark.

## To operate the compass feature

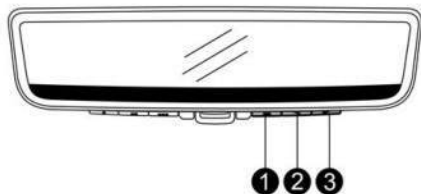

- ① Left button
- ② Center button
- ③ Right button

Press any of the left, center or right buttons to display the main menu. Select compass mode using the left button.

### NOTE

*The main menu cannot be displayed on the display while the select lever is in a position other than the "P" position.*

## To turn the compass feature on/off:

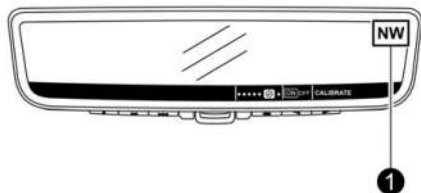

- ① Compass

Select "ON" or "OFF" using the center button.

## Compass calibration:

If the compass appears inaccurate, recalibrate the compass.



1. Select "CALIBRATE" using the right button.
2. To start the compass calibration, press the center button.
3. Select "Continue" using the center button.

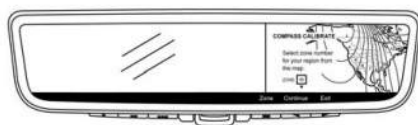

4. Select your current location in the display using the left button.
5. Select "Continue" using the center button.
6. Once "C" appears in the display, slowly drive the vehicle in circles until compass is calibrated.

## HomeLink® Wireless Control System

The HomeLink® Wireless Control System provides a convenient way to replace up to three hand-held radio-frequency remotes used to activate devices such as

gate operators, garage door openers, entry door locks, security systems, and even home lighting. The below steps are generic programming instructions; for Genie and Sommer garage door openers, please go directly to the HomeLink website. Additional information and programming videos can be found at [www.HomeLink.com/Subaru](http://www.HomeLink.com/Subaru) and [www.youtube.com/HomeLinkGentex](http://www.youtube.com/HomeLinkGentex).

sale of the vehicle, the programmed HomeLink buttons be erased for security purposes. Refer to "Erasing HomeLink buttons".

**CAUTION**

- Before programming HomeLink to a garage door opener or gate operator, make sure that people and objects are out of the way of the device to prevent potential harm or damage.
- When programming a garage door opener, it is advised to park outside of the garage.
- Do not use HomeLink with any garage door opener that lacks safety stop and reverse features, as required by U.S. federal safety standards (this includes any garage door opener model manufactured before April 1, 1982). A garage door that cannot detect an object signaling the door to stop and reverse does not meet current U.S. federal safety standards.
- It is also recommended that a new battery be placed in the hand-held remote (garage door opener remote) of the device for quicker and more accurate training.
- Some vehicles may require the ignition switch to be turned to the "ON" or "ACC" position for programming and/or operation of HomeLink.
- Keep the hand-held remote (garage door opener remote) of the device you are programming for use in other vehicles as well as for future HomeLink programming. It is also suggested that upon the

**HomeLink set up:**

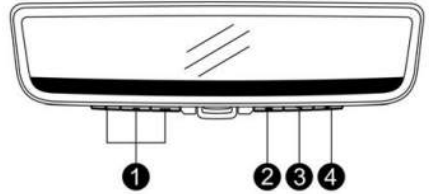

- ① HomeLink buttons
- ② Left button
- ③ Center button
- ④ Right button

Press any of the left, center or right buttons to display the main menu. Select HomeLink menu using the left button or press any of the HomeLink buttons.

**NOTE**

*The main menu cannot be displayed on the display while the select lever is in a position other than the "P" position.*

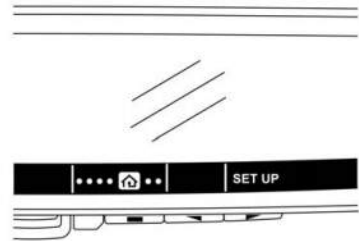

1. Select "SET UP" using the right button.
2. Select "Continue" using the HomeLink left button.

3. Press any of the HomeLink buttons.
4. Be sure to read the displayed instructions. Select "Continue" using the HomeLink left button.
5. Position the hand-held remote (garage door opener remote) 2 in (5 cm) away from the mirror.

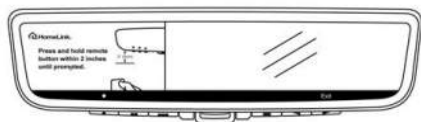
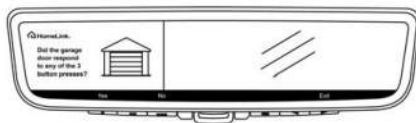

1 Garage door opener remote

6. While the HomeLink programming instructions are displayed, press and hold the hand-held remote button.

#### NOTE

*Some hand-held remotes (garage door opener remotes) may actually train better at a distance of 6 to 12 in (15 to 30 cm). Keep this in mind if you have difficulty with the programming process.*

7. Be sure your garage door is not moving, then press OK.
8. Firmly press the HomeLink left button 3 times. At this point, your device should operate when the HomeLink button is pressed and released.

9. "Program Success":  
If the programmed HomeLink button works, select "Yes" and programming is completed.  
If the programmed HomeLink button does not work, select "No" and proceed to step 10.

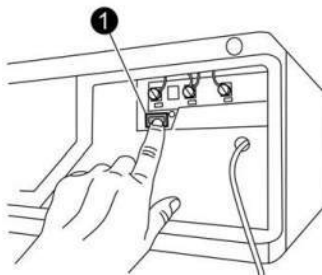

1 "Learn" button

10. At the garage door opener motor, (security gate motor, etc.) locate the "Learn", "Smart", or "Program" button. This can usually be found where the



hanging antenna wire is attached to the motor-head unit (see the device's manual to identify this button). The name and color of the button may vary by manufacturer.

### NOTE

*A ladder and/or second person may simplify the following steps.*

11. Firmly press and release the "Learn", "Smart", or "Program" button. You now have 30 seconds in which to complete step 12.
12. Return to the vehicle and press the HomeLink left button.
13. Firmly press the HomeLink left button 3 times.  
At this point, your device should operate when the HomeLink button is pressed and released.
14. "Program Success":  
If the programmed HomeLink button works, select "Yes" and programming is completed.

In the event that there are still programming difficulties or questions, additional HomeLink information and programming videos can be found at [www.HomeLink.com/Subaru](http://www.HomeLink.com/Subaru) and [www.youtube.com/HomeLinkGentex](http://www.youtube.com/HomeLinkGentex). For Genie and Sommer garage door openers, please go directly to the HomeLink website.

### Gate Operator/Canadian Programming:

Canadian radio-frequency laws require transmitter remote signals to "time-out" (or quit) after several seconds of transmission, which may not be long enough for HomeLink to pick up the signal during programming. Similar to this Canadian law, some U.S. gate operators are designed to "time-out" in the same manner. The indicator LED on the hand-held remote will go off when the device times out, indicating that it has finished transmitting.

If you live in Canada or you are having difficulties programming a gate operator or garage door opener by using the programming procedures, replace "Programming a New HomeLink Button" step 3 with the following:

While the HomeLink indicator light is flashing orange, press and release ("cycle") your device's hand-held remote every two seconds until the HomeLink indicator light changes from orange to green. You may now release the hand-held remote button.

### NOTE

*If programming a garage door opener or gate operator, it is advised to unplug the device during the "cycling" process to prevent possible overheating.*

Proceed with "Programming a New HomeLink Button" step 4 to complete.

### Using HomeLink:

To operate, simply press and release the programmed HomeLink button. Activation will now occur for the trained device (i.e. garage door opener, gate operator, security system, entry door lock, home/office lighting, etc.). For convenience, the hand-held remote of the device may also be used at any time.

### Erasing HomeLink Buttons:

1. Press any of the left, center or right buttons to select the main menu.  
Select HomeLink menu using the left button.
2. Select "SET UP" using the right button.
3. Select "Continue" using the HomeLink left button.
4. Select the "Trash can icon" using the HomeLink left button.

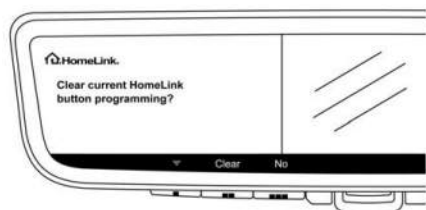

5. To erase the program for the HomeLink button, select "Clear" using the HomeLink center button.

HomeLink is now ready to be programmed at any time beginning with "Programming a new HomeLink button" - step 1.

### Reprogramming a Single HomeLink Button:

To program a previously programmed HomeLink button, refer to "HomeLink set up".

### Garage Door Two-Way Communication:

HomeLink has the capability of communicating with your garage door opener. HomeLink can receive and display "closing" or "opening" status messages from compatible garage door opener systems. At any time, HomeLink can also recall and display the last recorded status communicated by the garage door opener to indicate your garage door being "closed" or "opened".

HomeLink has the capability of receiving this communication from the garage door opener at a range up to 820 feet (250 m). Range may be reduced by obstacles such as houses or trees. You may have to slow your vehicle speed to successfully receive the garage door opener communication.

### Programming Two-Way Communication:

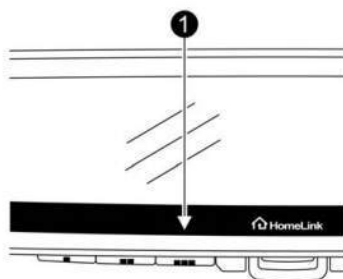

#### 1 Status Indicators

Within five seconds after programming a new HomeLink button, both of HomeLink's garage door status indicators will flash rapidly green indicating that the garage door two-way communication has been enabled. If your garage door status indicators flashed, two-way communication programming is complete.

If the garage door status indicators do not flash, additional HomeLink information and programming videos can be found online at [www.HomeLink.com/Subaru](http://www.HomeLink.com/Subaru) and [www.youtube.com/HomeLinkGentex](http://www.youtube.com/HomeLinkGentex).

### Using Two-Way Communication:

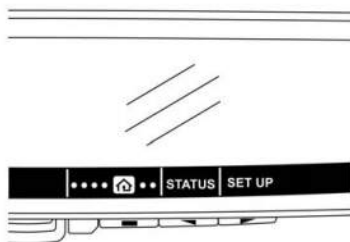

Press any of the left, center or right buttons to display the main menu. Select HomeLink menu using the left button. Select "STATUS" using the center button.

**NOTE**

The main menu cannot be displayed on the display while the select lever is in a position other than the “P” position.

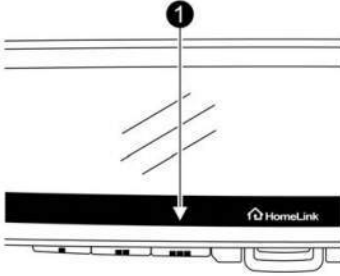
**1** Status Indicators

Recall and display (at any time) the last recorded garage door status message communicated to HomeLink. HomeLink will display the last recorded status for 5 seconds.

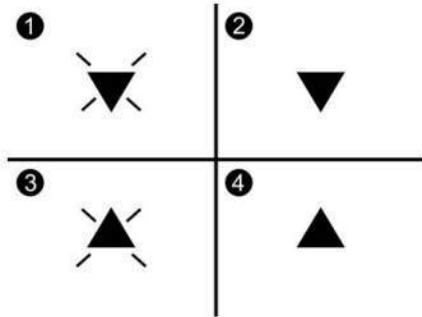

- 1** Garage Door Opener CLOSING (Blinking Orange)
- 2** Garage Door Opener CLOSED (Solid Green)
- 3** Garage Door Opener OPENING (Blinking Orange)
- 4** Garage Door Opener OPENED (Solid Green)

If two-way communication programming is successful, HomeLink will display the status of your garage door opener with arrow indicators.

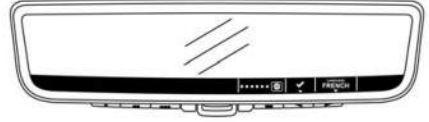
**Language**

Changes the language displayed in the Smart Rearview Mirror.

1. Press any of the left, center or right buttons to display the main menu. Select “LANGUAGE” using the left button.
2. Select the language using the right button and press the center button.

**NOTE**

The main menu cannot be displayed on the display while the select lever is in a position other than the “P” position.

**OUTSIDE MIRRORS****Convex mirror (passenger side)****WARNING**

Objects look smaller in a convex mirror and farther away than when viewed in a flat mirror. Do not use the convex mirror to judge the distance of vehicles behind you when changing lanes. Use the inside mirror (or glance backwards) to determine the actual size and distance of objects that you view in convex mirror.

**CAUTION**

Make sure to adjust the mirrors before driving.

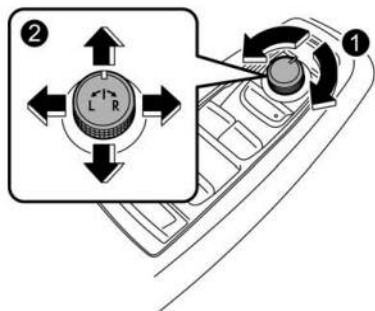
**Remote control mirror switch**

- 1 Select side to adjust
- 2 Direction control

The remote control mirrors operate when the ignition switch is in the “ON” or “ACC” position.

1. Turn the control switch to the side that you want to adjust. “L” is for the left mirror, “R” is for the right mirror.
2. Move the control switch in the direction you want to move the mirror.
3. Return the control switch to the neutral position to prevent unintentional operation.

**NOTE**

The mirrors can also be adjusted manually.

For models with memory function:

- The outside mirror can be adjusted for approximately 45 seconds after the following conditions are met.
  - The ignition switch is turned to the “OFF” position.
  - The door is unlocked using the access key fob.
- The outside mirror angle can be registered with button “1”, “2” or each of the key fobs. For details, refer to

“Driver’s Seat Memory Function” [☞ P41](#).

- The outside mirror angle can also be retrieved with the Distraction Mitigation System user information. To do so, perform user registration in the Distraction Mitigation System settings. Refer to “Using the Distraction Mitigation System” [☞ P398](#).

**Reverse tilt-down feature (if equipped)**

When backing the vehicle up, the right and/or left outside mirrors will turn downward automatically to provide better rear visibility.

1. Push the ignition switch to the ON position.
2. Move the select lever to the R (Reverse) position.
3. The outside mirror angle moves downward.

The outside mirror angle will return to its original position when the following condition are met.

- Approximately 9 seconds after the select lever is moved to any position other than R (Reverse).
- The ignition switch is turned to the “OFF” position.
- The vehicle is running.

**NOTE**

- The reverse tilt-down mirror angle can be registered with button “1”, “2” or each of the key fobs. For details, refer to “Driver’s Seat Memory Function” [☞ P41](#).
- The reverse tilt-down mirror angle can also be retrieved with the Distraction Mitigation System user information. To do so, perform user registration in the Distraction Mitigation System settings. Refer to “Using the Distraction Mitigation System” [☞ P398](#).
- The operational/non-operational setting can be changed by operating

the center information display. Refer to “Vehicle”  $\text{\textcircled{P}}206$ .

- The factory setting (default setting) for this function is set as the front passenger’s side mirror. The setting of driver’s side mirror operation can be changed by a SUBARU dealer. Contact your SUBARU dealer for details.



### CAUTION

Depress the brake pedal during the reverse tilt-down mirror angle adjustment.

To adjust the reverse tilt-down mirror angle, adjust the outside mirror using the remote control mirror switch while the reverse tilt-down operates. For details about how to adjust the outside mirror angle, refer to “Remote control mirror switch”  $\text{\textcircled{P}}246$ .

### Memory function:

The angle of the reverse tilt-down mirror can be registered. Register the position with button “1”, “2” or each of the access key fobs and retrieve the position.

For details about registration or retrieval of a position, refer to “Driver’s Seat Memory Function”  $\text{\textcircled{P}}41$ .

### NOTE

*If the seat is moved forward or backward 1.18 in (30 mm) or more, the reverse tilt-down will move to the factory default position or the last position hold.*

### Hold last position function:

The angle of the reverse tilt-down mirror can be set to the latest adjusted angle.

The hold last position function operates when the following condition are met.

- The memory function is not used.
- The seat is moved forward or backward 1.18 in (30 mm) or more.

### NOTE

- The factory setting (default setting) for this function is set as “non-operational”. This setting can be changed to “operational” at SUBARU dealers. For more details, contact a SUBARU dealer.
- If the hold last position function setting is “non-operation”, the reverse tilt-down will move to the factory default position.

### Power folding mirror switch (if equipped)

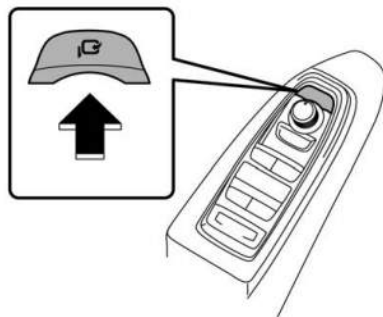

The power folding mirror switch operates when the ignition switch is in the “ON” or “ACC” position.

To fold the outside mirrors, press the power folding mirror switch. To unfold the mirrors, press the switch again.

### NOTE

- If the outside mirrors have been operated (folded or unfolded) manually, when you turn the ignition switch from the “OFF” position to the “ACC” or “ON” position, the outside mirrors may be adjusted automatically depending on the status of the power folding mirror switch.
- If the outside mirrors have been manually folded slightly forward of the regularly unfolded position, when you turn the ignition switch from the “OFF” position to the “ACC” or “ON” position, the outside mirrors may automatically

*fold further forward depending on the status of the power folding mirror switch. When this happens, press the power folding mirror switch. By doing so, the outside mirrors which have been folded to the furthest forward position will extend to the regularly unfolded position and then fold rearward in the usual way. In order to unfold the outside mirrors, press the switch again.*

- *When you fold the outside mirrors manually, the mirrors may not unfold when the switch is pressed, even though the motor operating sound is heard. When this happens, operate the power folding mirror switch again.*
- *When you unfold the outside mirrors manually, the mirrors may become wobbly. Be sure to unfold the mirrors by operating the switch. If the outside mirrors are still wobbly, fold the mirrors again and then unfold them by operating the switch again.*
- *When the temperature is low, the outside mirrors may stop during operation. Push the switch again. When the outside mirrors do not work by operating the switch, move the outside mirrors several times manually. This makes it possible to operate them by switch operation.*
- *When you operate the power folding mirror switch continuously, it may not work. This is not a malfunction. Operate after waiting for a short period of time.*
- *The outside mirrors can be operated (folded or unfolded) manually for approximately 45 seconds after the following conditions are met.*
  - *The ignition switch is turned to the “OFF” position.*
  - *The door is unlocked using the access key fob.*

### **Power folding door mirror with the automatic function (if equipped):**

The mirrors automatically fold when the power folding mirror switch is in the mirror unfolding position, the ignition switch is turned OFF, and the doors are locked.

The mirrors automatically unfold when the power folding mirror switch is in the mirror unfolding position and the doors are unlocked.

### **NOTE**

- *The power folding door mirror with the automatic function does not operate automatically when the power folding mirror switch is in the mirror folding position.*
- *The automatic setting of the power folding door mirrors can be changed by operating the center information display. For details, refer to “Vehicle” P206. Also, the setting can be changed by your SUBARU dealer. Contact your SUBARU dealer for details.*

### 3-18. TILT/TELESCOPIC STEERING WHEEL

#### WARNING

- Do not adjust the steering wheel tilt/telescopic position while driving. This may cause loss of vehicle control and result in personal injury.
- If the lever cannot be raised to the fixed position, adjust the steering wheel again. It is dangerous to drive without locking the steering wheel. This may cause loss of vehicle control and result in personal injury.

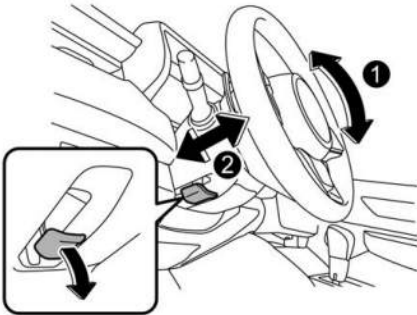

- 1** Tilt adjustment
- 2** Telescopic adjustment

- Adjust the seat position. Refer to "Front Seats" P37.
- Pull the tilt/telescopic lock lever down.
- Move the steering wheel to the desired level.
- Pull the lever up to lock the steering wheel in place.
- Make sure that the steering wheel is securely locked by moving it up and down, and forward and backward.

### 3-19. HEATED STEERING WHEEL SYSTEM (If Equipped)

The Heated Steering Wheel system warms the steering wheel at a constant temperature.

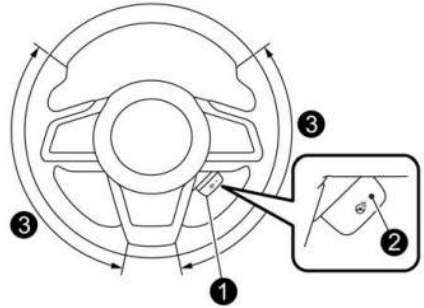

- 1** Heated Steering Wheel switch
- 2** Indicator light
- 3** Heated area

To turn on the Heated Steering Wheel system, pull the Heated Steering Wheel switch when the ignition switch is in the "ON" or "ACC" position. Then the steering wheel will be warmed and the indicator light on the switch will illuminate. To turn off the Heated Steering Wheel system, pull the switch again. Then the indicator light will turn off.

#### CAUTION

- Use the Heated Steering Wheel system with the engine running. Otherwise, the battery voltage may drop below the permissible level and it may not be possible to start the engine.
- There is a possibility that people with delicate skin may suffer slight burns even at low temperatures if they use the Heated Steering Wheel for a long period of time. When using the Heated Steering Wheel, always be sure to warn the persons concerned.

- Do not cover the Heated Steering Wheel with an object such as a steering wheel cover. Doing so may cause the Heated Steering Wheel to overheat.
- Do not spill liquid on the steering wheel. If liquid is spilled, wipe it off immediately and dry it before using the Heated Steering Wheel system.

#### NOTE

- *If the surface temperature of the steering wheel is approximately above 104°F (40°C) when the switch is turned on, the system will not heat the steering wheel. Then, the indicator light will continue to illuminate.*
- *The Heated Steering Wheel system will automatically turn off approximately 30 minutes after the system has been turned on.*
- *The temperature of the Heated Steering Wheel system cannot be adjusted.*

### 3-20. HORN

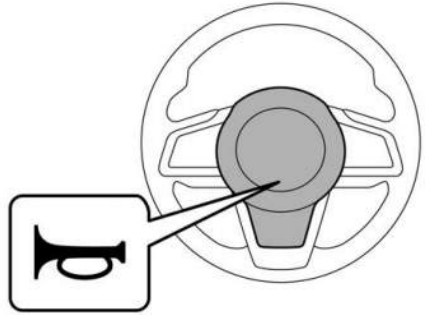

To sound the horn, push the horn pad.



---

---

---

---

---

---

---

---

---

---

---

---

---

---

---

---

---

---

---

---

---

---

---

---

---

---

---

---

---

---

---

---

---

---

---

---

---

---

---

---

## CLIMATE CONTROL

---

<b>4-1.</b>	<b>Ventilator Control.....</b>	<b>254</b>
	Center Ventilators .....	254
	Side Ventilators .....	254
	Rear Ventilators .....	254
<b>4-2.</b>	<b>Climate Control Panel.....</b>	<b>255</b>
<b>4-3.</b>	<b>Automatic Climate Control Operation .....</b>	<b>257</b>
	Sensors .....	258
<b>4-4.</b>	<b>Manual Climate Control .....</b>	<b>259</b>
	Airflow Mode Selection .....	259
	Dynamic Ventilation .....	260
	Temperature Control .....	261
	Fan Speed Control .....	262
	Air Conditioner Control .....	262
	Air Inlet Selection .....	262
	To Turn Off the Climate Control System.....	262
<b>4-5.</b>	<b>Defrosting .....</b>	<b>263</b>
<b>4-6.</b>	<b>Operating Tips for Heater and Air Conditioner .....</b>	<b>264</b>
	Cleaning Ventilator Grille.....	264
	Efficient Cooling after Parking in Direct Sunlight .....	264
	Lubrication Oil Circulation in the Refrigerant Circuit.....	264
	Checking Air Conditioning System before Summer Season .....	264
	Cooling and Dehumidifying in High Humidity and Low Temperature Weather Condition .....	264
	Air Conditioner Compressor Shut-Off When Engine Is Heavily Loaded .....	264
	Refrigerant for Your Climate Control System .....	265
<b>4-7.</b>	<b>Air Filtration System.....</b>	<b>265</b>
	Replacing the Cabin Air Filter.....	265

## 4-1. VENTILATOR CONTROL

### CENTER VENTILATORS

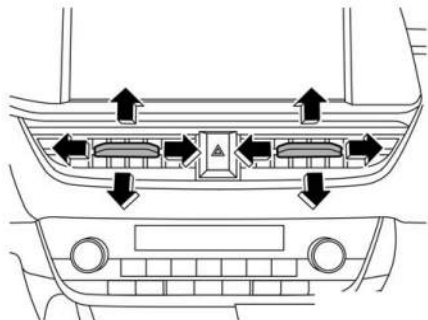

To adjust the airflow direction, move the tab. To close the ventilator, move the tab towards the center of the vehicle.

### SIDE VENTILATORS

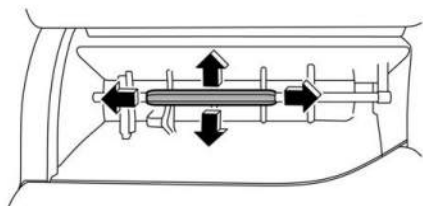

To adjust the airflow direction, move the tab. To close the ventilator, move the tab towards the outside of the vehicle.

### REAR VENTILATORS

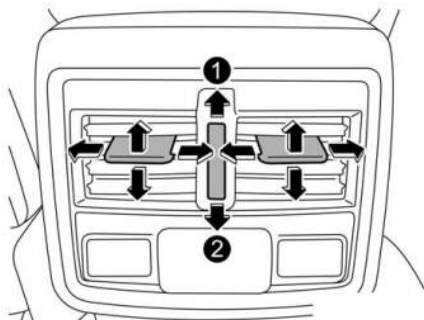

- ① Open
- ② Close

To adjust the flow direction, move the tab.

## 4-2. CLIMATE CONTROL PANEL



### WARNING

- The cooling function operates only when the engine is running.
- Do not leave children or adults who would normally require the support of others alone in your vehicle. Pets should not be left alone either. On hot, sunny days, temperatures in a closed vehicle could quickly become high enough to cause severe or possibly fatal injuries to people or animals.

4

### NOTE

*When the vehicle battery power is low, the climate control system will stop. Start the engine to use the climate control system.*

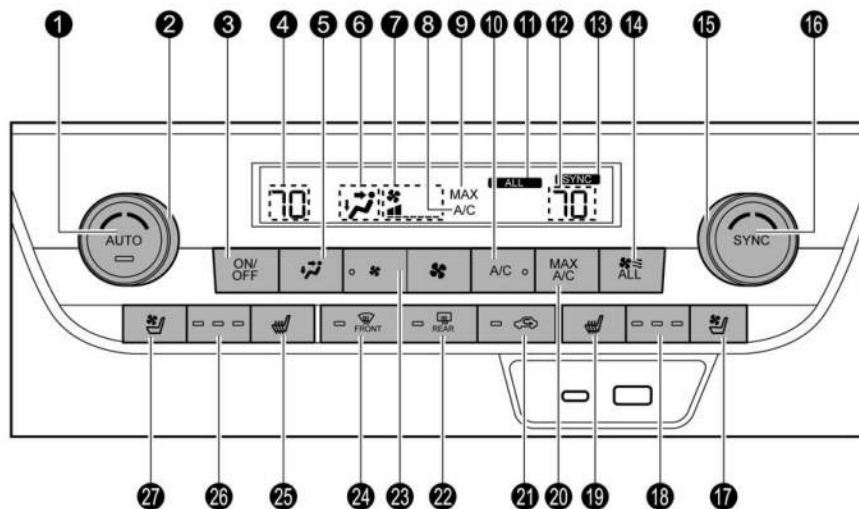

- 1 AUTO button (Refer to "Automatic Climate Control Operation" P257.)
- 2 Driver's side temperature control dial (Refer to "Temperature Control" P261.)
- 3 ON/OFF button (Refer to "Automatic Climate Control Operation" P257.)
- 4 Driver's side set temperature indicator (Refer to "Temperature Control" P261.)
- 5 Airflow mode selection button (Refer to "Airflow Mode Selection" P259.)
- 6 Airflow mode indicator (Refer to "Airflow Mode Selection" P259.)
- 7 Fan speed indicator (Refer to "Fan Speed Control" P262.)
- 8 Air conditioner ON indicator (Refer to "Air Conditioner Control" P262.)
- 9 MAX A/C indicator (Refer to "MAX A/C mode" P261.)
- 10 Air conditioner button (Refer to "Air Conditioner Control" P262.)
- 11 Dynamic Ventilation indicator (Refer to "Dynamic Ventilation" P260.)
- 12 Passenger's side set temperature indicator (Refer to "Temperature Control" P261.)
- 13 SYNC indicator (Refer to "SYNC mode" P261.)
- 14 Dynamic Ventilation button (Refer to "Dynamic Ventilation" P260.)
- 15 Passenger's side temperature control dial (Refer to "Temperature Control" P261.)
- 16 SYNC button (Refer to "SYNC mode" P261.)
- 17 Front passenger's seat ventilation button\*1 (Refer to "Front Seat Ventilation" P54.)
- 18 Front passenger's seat heater and seat ventilation\*1 indicator (Refer to "Seat Heater and Front Seat Ventilation" P53.)
- 19 Front passenger's seat heater button (Refer to "Front Seat Heater" P53.)
- 20 MAX A/C button (Refer to "MAX A/C mode" P261.)
- 21 Air inlet selection button (Refer to "Air Inlet Selection" P262.)

- 22 Defogger button (Refer to “Defogger and Deicer” ⓄP226.)
- 23 Fan speed control button (Refer to “Fan Speed Control” ⓄP262.)
- 24 Defroster button (Refer to “Defrosting” ⓄP263.)
- 25 Driver’s seat heater button (Refer to “Front Seat Heater” ⓄP53.)
- 26 Driver’s seat heater and seat ventilation\*1 indicator (Refer to “Seat Heater and Front Seat Ventilation” ⓄP53.)
- 27 Driver’s seat ventilation button\*1 (Refer to “Front Seat Ventilation” ⓄP54.)

\*1: if equipped

### 4-3. AUTOMATIC CLIMATE CONTROL OPERATION

When the auto mode is selected, the following functions are automatically controlled.

- Airflow mode
- Air inlet selection
- Air conditioner operation
- Fan speed

To activate this mode, perform the following.

1. Press the AUTO button. The indicator light on the AUTO button illuminates.
2. Set the preferred temperature using the temperature control dial.

#### NOTE

- Operate the automatic climate control system when the engine is running.
- Even when cooling is not necessary, the air conditioner will automatically turn on if the temperature is set much lower than the current outlet air temperature. Even in this case, the air conditioner ON indicator on the climate control panel illuminates.
- The air conditioner may not operate in the following cases:
  - When the cabin temperature is low
  - When the ambient temperature decreases close to 32°F (0°C)
- The controllable temperature range may vary depending on the regional specifications of the vehicle.
- When the indicator light on the AUTO button is illuminated, if you operate the fan speed control or the airflow mode, press the defroster button, or turn on MAX A/C mode, the indicator light on the AUTO button will turn off. You can then manually control the system as desired using the climate control panel. To change the system back to auto mode, press the AUTO mode button.

To turn off the climate control system, press the ON/OFF button.

At this time, the air inlet selection mode will differ depending on the auto mode and manual mode.

- When the air inlet selection is set to auto mode: Outside air circulation
- When the air inlet selection is set to manual mode: No change

When the ignition switch is changed to the "OFF" or "ACC" position from "ON", the air inlet mode will automatically change to the outside air mode regardless of whether it is the auto mode or manual mode.

The automatic climate control system employs several sensors. These sensors are delicate. If they are treated incorrectly and become damaged, the system may not be able to control the interior temperature correctly. To avoid damaging the sensors, observe the following precautions:

- Do not subject the sensors to impact.
- Keep water away from the sensors.
- Do not cover the sensors.

## SENSORS

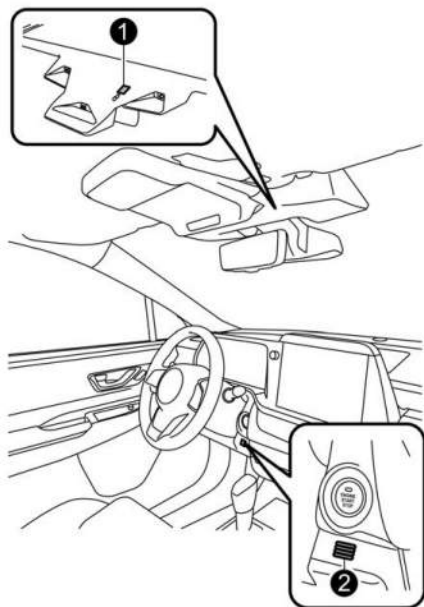

- ① Rain\*/solar radiation and humidity sensor
- ② Interior air temperature sensor

\*: If a rain sensor is equipped.



## 4-4. MANUAL CLIMATE CONTROL

### AIRFLOW MODE SELECTION

Select the airflow mode using the airflow mode selection button.

Airflow modes are as follows.

#### Ventilation:

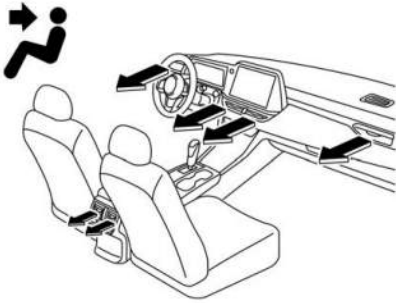

Instrument panel outlets

#### Ventilation 2:

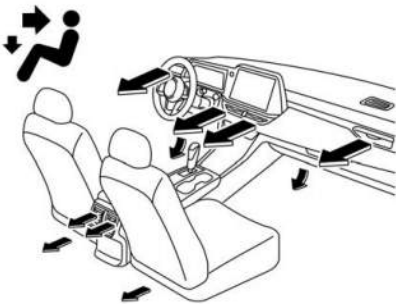

Instrument panel outlets and foot outlets

#### Bi-level:

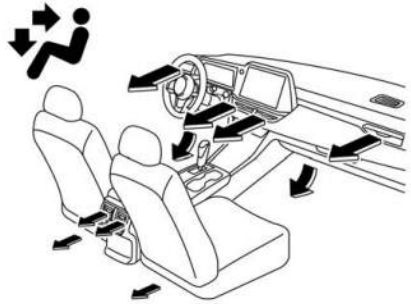

Instrument panel outlets and the foot outlets

#### Heat:

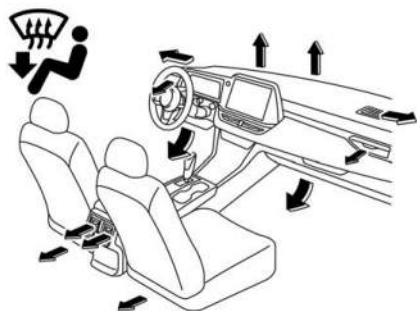

Foot outlets, both side outlets of the instrument panel and some through windshield defroster outlets (A small amount of air flows to the windshield and both side windows to prevent fogging.)

**Heat-def:**

Windshield defroster outlets, foot outlets and both side outlets of the instrument panel

**DYNAMIC VENTILATION**

Dynamic Ventilation is a system that uses sensors and other technology to judge that someone is sitting in the front passenger seat or rear seat and prioritizes the climate control for these seats when they are occupied.

When the push-button ignition switch is turned to the "ON" position, the climate control system automatically selects the Dynamic Ventilation mode according to where the vehicle occupants are sitting.

**"DRIVER" mode (driver's seat is only occupied):**

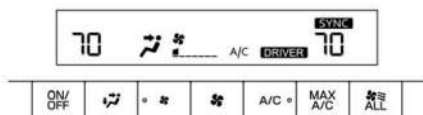

When the climate control system judges that the driver is the only vehicle occupant, "DRIVER" is illuminated on the climate control panel and the system

directs the airflow only to the driver. To cancel the airflow "DRIVER" mode, press the "ALL" button, and "ALL" will be illuminated on the climate control panel instead of "DRIVER", and airflow will be directed to all the seats.

**"FRONT" mode (driver's seat and front passenger's seat are occupied):**

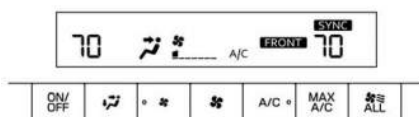

When the climate control system judges that the driver's and passenger's seats are occupied, "FRONT" is illuminated on the climate control panel and the system directs the airflow to the driver and front passenger. To cancel the airflow "FRONT" mode, press the "ALL" button, and "ALL" will be illuminated on the climate control panel instead of "FRONT", and airflow will be directed to all the seats.

**"ALL" mode (rear seats are occupied by passengers):**

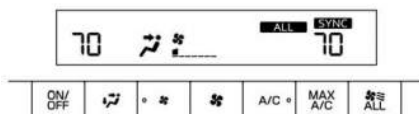

When the climate control system judges that there are passengers occupying the rear seats, "ALL" is illuminated on the climate control panel and the system

directs the airflow to all vehicle occupants. To cancel the airflow "ALL" mode, press the "ALL" button, and "DRIVER" or "FRONT" will be illuminated on the climate control panel depending on which passenger's seats are occupied, and airflow will be directed to the seats depending on the airflow mode.

#### NOTE

- Depending on the settings of the climate control system or other factors affecting the temperature inside the vehicle, the operation of the Dynamic Ventilation mode for occupants may differ from the operation indicated on the climate control panel.
- The climate control system judges that the front passenger's seat is occupied by detecting such things as the fastening of the seatbelt, opening or closing of the door, and operation of the passenger's side temperature setting controls.
- If "FRONT" is illuminated on the climate control panel when the front passenger's door is opened and then closed and the climate control system subsequently judges that the front passenger's seat is not occupied, the climate control panel will illuminate "DRIVER" when the vehicle speed reaches approximately 13 mph (20 km/h).
- The climate control system judges that there are passengers occupying the rear seats according to the opening and closing of the rear doors. However, pressing "ALL" button will turn off the function that judges whether the rear doors are open or closed. To turn the function on again, turn the ignition switch to the "OFF" position for approximately one hour.
- The system may not be able to judge the presence of passengers accurately, in which case this function may not operate properly.

## TEMPERATURE CONTROL

Turn the temperature control dial to set the preferred interior temperature.

### MAX A/C mode

For quicker cooling, press the MAX A/C button.

Press the MAX A/C button to turn on the MAX A/C mode. The MAX A/C indicator will illuminate on the climate control panel. Press the MAX A/C button again to turn off the MAX A/C mode and return to the previous setting. The MAX A/C indicator will not illuminate on the climate control panel. When the MAX A/C mode is off, the MAX A/C indicator will no longer be illuminated.

When the MAX A/C mode is on, the following settings will be changed automatically.

- The air conditioner will turn on.
- The temperature will be set on the lowest.
- The fan speed will be set on the maximum speed.
- The air inlet will be set to the recirculation mode.
- The airflow mode setting will be set to the ventilation mode.

#### NOTE

MAX A/C mode will be canceled if the Distraction Mitigation System completes user recognition again while MAX A/C mode is in use.

### SYNC mode

When the SYNC mode is turned on, both the driver's and passenger's side temperatures are synchronized using the driver's side temperature control dial.

Press the SYNC button to turn on the SYNC mode. The SYNC indicator will illuminate on the climate control panel.

Press the SYNC button again or turn the passenger's side temperature control dial to cancel the SYNC mode. The SYNC

indicator will not illuminate on the climate control panel. When the SYNC mode is off, the SYNC indicator will no longer be illuminated. In this case, temperature control on the driver's side and passenger's side will be separated. The temperature will be controlled individually using the driver's and passenger's temperature control dials.

## FAN SPEED CONTROL

Select the preferred fan speed by pressing the fan speed control buttons.

### NOTE

*When the vehicle battery power is low, the fan will stop. Start the engine to use the climate control.*

## AIR CONDITIONER CONTROL

The air conditioner operates only when the engine is running.

Press the air conditioner button while the fan is in operation to turn on the air conditioner. When the air conditioner is on, the air conditioner ON indicator illuminates.

To turn off the air conditioner, press the button again.

### NOTE

*For efficient defogging or dehumidifying in cold weather, turn on the air conditioner. However, if the ambient temperature decreases to approximately 32°F (0°C), the air conditioner and dehumidification system may not work properly.*

## AIR INLET SELECTION

Select the air inlet by pressing the air inlet selection button.

### Recirculation mode:

When the indicator light on the air inlet selection button illuminates, interior air is recirculated inside the vehicle. Press the air inlet selection button to the ON position in the following cases.

- When driving on a dusty road
- When you want cooling performance to increase (for example, in particularly hot weather)

### Outside air circulation mode:

When the indicator light on the air inlet selection button does not illuminate, outside air is drawn into the passenger compartment. Press the air inlet selection button to the OFF position in the following cases.

- When the road is no longer dusty
- When the interior has cooled to a comfortable temperature



### WARNING

Continued operation in the recirculation mode may fog up the windows. Switch to the outside air circulation mode as soon as the outside dusty condition clears.

### NOTE

*When outside air circulation is selected, the system may automatically adjust the air inlet setting depending on such factors as the temperature setting, the temperature inside the vehicle, or conditions outside the vehicle.*

## TO TURN OFF THE CLIMATE CONTROL SYSTEM

To turn off the climate control system, press the ON/OFF button.

## 4-5. DEFROSTING

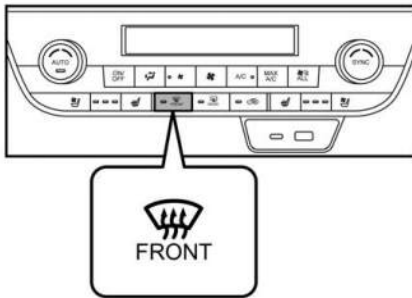
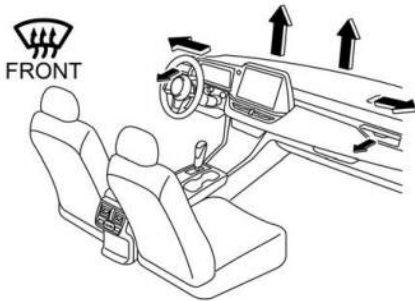

- After defrosting the windshield by pressing the defroster button “

To defrost or dehumidify the windshield and front door windows, perform the following procedures.

- To select the “

### NOTE

- When the “4

## 4-6. OPERATING TIPS FOR HEATER AND AIR CONDITIONER

### CLEANING VENTILATOR GRILLE

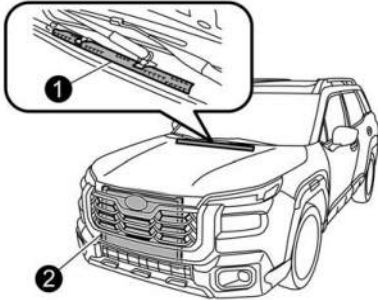

- ① Front ventilator inlet grille
- ② Condenser

Always keep the front ventilator inlet grille free of snow, leaves, or other obstructions to ensure efficient heating and defrosting. Since the condenser is located in front of the radiator, this area should be kept clean because cooling performance is impaired by any accumulation of insects and leaves on the condenser.

### EFFICIENT COOLING AFTER PARKING IN DIRECT SUNLIGHT

After parking in direct sunlight, drive with the windows open for a few minutes to allow outside air to circulate into the heated interior. This results in quicker cooling by the air conditioner. Keep the windows closed during the operation of the air conditioner for maximum cooling efficiency.

### LUBRICATION OIL CIRCULATION IN THE REFRIGERANT CIRCUIT

Operate the air conditioner compressor at a low engine speed (at idle or low driving speeds) a few minutes each month during the off-season to circulate its oil.

### CHECKING AIR CONDITIONING SYSTEM BEFORE SUMMER SEASON

Check the air conditioner unit for refrigerant leaks, hose conditions, and proper operation each spring. Have the air conditioning system checked by your SUBARU dealer.

### COOLING AND DEHUMIDIFYING IN HIGH HUMIDITY AND LOW TEMPERATURE WEATHER CONDITION

Under certain weather conditions (high relative humidity, low temperatures, etc.) a small amount of water vapor emission from the air outlets may be noticed. This condition is normal and does not indicate any problem with the air conditioning system.

### AIR CONDITIONER COMPRESSOR SHUT-OFF WHEN ENGINE IS HEAVILY LOADED

To improve acceleration and gas mileage, the air conditioner compressor is designed to temporarily shut off during air conditioner operation whenever the accelerator is fully depressed such as during rapid acceleration or when driving on a steep upgrade.

## REFRIGERANT FOR YOUR CLIMATE CONTROL SYSTEM

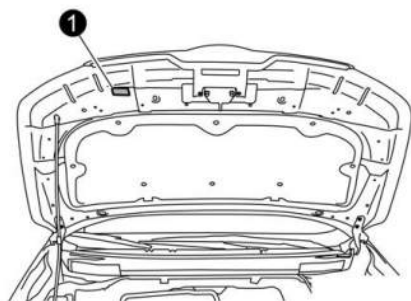

① Air conditioner label

Your air conditioner uses ozone friendly refrigerant R-1234yf (HFO-1234yf).

Before adding, changing or checking the refrigerant, check the air conditioner label in the location shown in the illustration to confirm which type of refrigerant is used in your vehicle.

Consult your SUBARU dealer for service.

Repairs needed as a result of using the wrong refrigerant are not covered under warranty.

## 4-7. AIR FILTRATION SYSTEM

Your vehicle's air conditioning system is equipped with an air filtration system. Replace the cabin air filter according to the replacement schedule found in the "Warranty and Maintenance Booklet". This schedule should be followed to maintain the filter's dust collection ability. Under extremely dusty conditions, the filter should be replaced more frequently. Have your filter checked or replaced by your SUBARU dealer. For replacement, use only a genuine SUBARU air filter kit.



### CAUTION

Contact your SUBARU dealer if the following occurs, even if it is not yet time to change the filter.

- Reduction of the airflow through the vents.
- Windshield gets easily fogged or misted.

### NOTE

*The filter can influence the air conditioning, heating and defroster performance if not properly maintained.*

## REPLACING THE CABIN AIR FILTER

1. Open the glove box.

- Remove the damper shaft from the glove box.

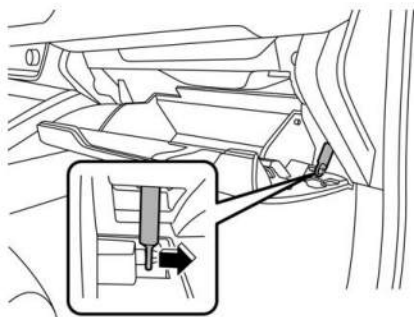

- Push both sides of the glove box inward to unlock the stoppers and then pull down the glove box as far as it will go.

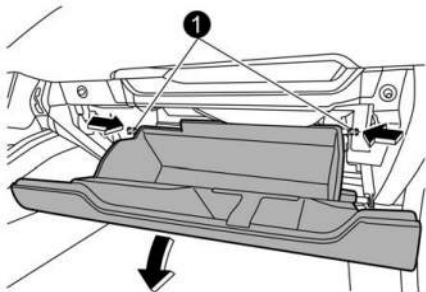

1 Stoppers

- Pull out the glove box horizontally and remove the hinge portion. When doing this, be careful not to damage the hinge.

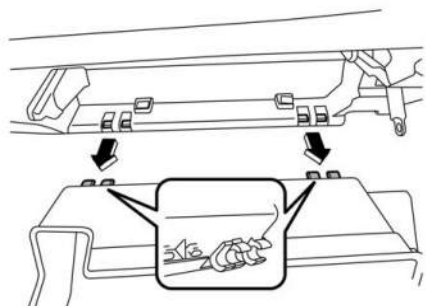

- Pinch both tabs and remove the filter cover.

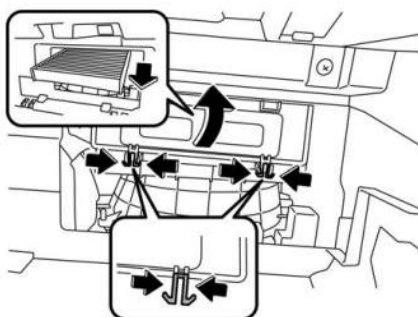

- Gently tilt down the end of the filter and slowly pull it out 0.4 in (1 cm). Slowly pull out the rest of the filter.
- Replace the cabin air filter with a new one and then reinstall the cover.



### CAUTION

The arrow mark on the filter must point UP.

- Reinstall the glove box, and connect the damper shaft.
- Close the glove box.

### NOTE

When removing the cabin air filter, do not allow any adhering foreign material to fall into the housing.



---

---

---

---

---

---

---

---

---

---

---

---

---

---

---

---

---

---

---

---

---

---

---

---

---

---

---

---

---

---

---

---

---

---

---

---

---

---

---

---

## AUDIO

---

5-1.	Antenna .....	270
	Roof Antenna.....	270
5-2.	Audio Set.....	270

## 5-1. ANTENNA

---

### ROOF ANTENNA

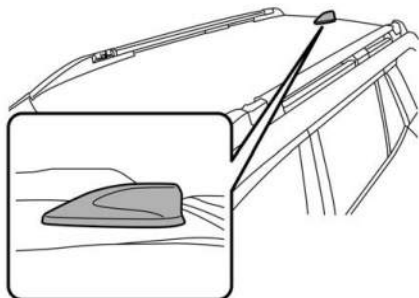

The satellite radio antenna is installed in the center of the roof at the rear.

## 5-2. AUDIO SET

---

If your vehicle is equipped with a genuine SUBARU navigation system or audio system, refer to the separate navigation/audio Owner's Manual for details.

---

---

---

---

---

---

---

---

---

---

---

---

---

---

---

---

---

---

---

---

---

---

---

---

---

---

---

---

---

---

---

---

---

---

---

---

---

---

---

---

## INTERIOR EQUIPMENT

6-1.	Interior Light.....	274
	Map Lights.....	274
	Dome Light.....	274
	Cargo Area Light .....	275
	Rear Gate Light (If Equipped) .....	275
	OFF Delay Timer .....	276
6-2.	Sun Visors .....	276
	Sun Visor Extension Plate.....	276
	Vanity Mirror with Light.....	277
6-3.	Overhead Console .....	278
6-4.	Storage Compartment .....	278
	Glove Box.....	278
	Center Tray.....	279
	Center Console.....	279
	Center Console Tray .....	279
	Front Passenger's Tray .....	280
6-5.	Cup Holder .....	280
	Front Passenger's Cup Holder .....	280
	Rear Passenger's Cup Holder .....	281
6-6.	Bottle Holders .....	281
6-7.	Accessory Power Outlets.....	282
6-8.	USB Power Supply .....	283
	How to Use the USB Power Supply .....	283
6-9.	Wireless Charger (If Equipped).....	284
	How to Use the Wireless Charger.....	285
	Mobile Device Holder .....	289
6-10.	Ashtray (Dealer Option).....	290
6-11.	Assist Grip.....	291
6-12.	Coat Hook.....	292
6-13.	Floor Mat .....	293
6-14.	Shopping Bag Hook.....	294
6-15.	Multi-Use Cargo Cover .....	294
	Using the Multi-Use Cargo Cover .....	294
6-16.	Cargo Tie-Down Hooks .....	297
6-17.	Adjustable Storage Net .....	298
6-18.	Under-Floor Storage Compartment.....	298

## 6-1. INTERIOR LIGHT



### CAUTION

When leaving your vehicle, make sure the lights are turned off to avoid battery discharge.

## MAP LIGHTS

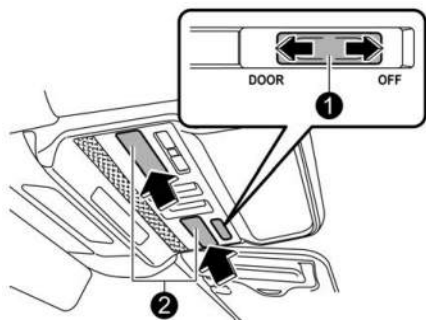

- ① Door interlock switch
- ② Lens

To turn on the map light, press the lens.

To turn it off, press the lens again.



### CAUTION

Do not keep watching the light source because they use LEDs. Doing so could damage your eyes.

The door interlock switch has the following positions.

### OFF:

The map lights do not illuminate in conjunction with a door opening. However, the lights can be turned on manually by pressing the map light lens.

### DOOR:

The map light illuminates in the following cases.

- Any of the doors (other than the rear gate) is opened.

- The doors are unlocked using the keyless access function. Refer to "Locking and Unlocking with "Keyless Access" Entry Function" [P120](#).
- The doors are unlocked using the remote keyless entry system. Refer to "Remote Keyless Entry System" [P130](#).
- The ignition switch is turned from the "ACC" position to the "OFF" position.

After all the doors (other than the rear gate) are closed, the map lights gradually turn off. For details, refer to "OFF Delay Timer" [P276](#).

## DOME LIGHT

### Dome light switches

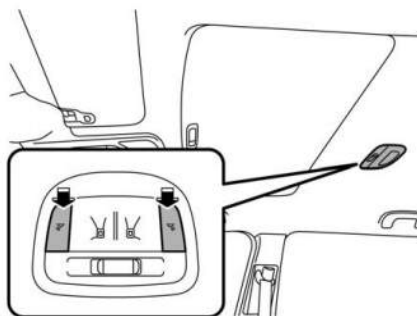

To turn on the dome light, press the switch.

To turn it off, press the switch again.



### CAUTION

Do not keep watching the light source because they use LEDs. Doing so could damage your eyes.



**Door interlock switch**

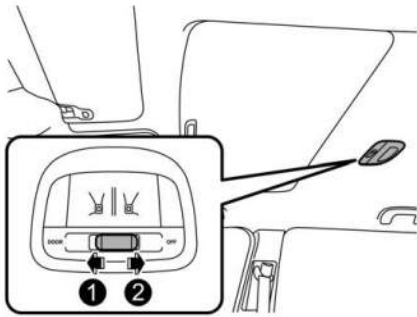

- 1 DOOR
- 2 OFF

The door interlock switch has the following positions.

**OFF:** The dome lights do not illuminate automatically in conjunction with a door opening. However, the lights can be turned on manually by pressing the switch.

**DOOR:** The dome lights illuminate automatically when any of the doors (including the rear gate) is opened even while the dome light is off. Several seconds after all the doors (including the rear gate) are closed, the dome lights gradually turn off. For details, refer to “OFF Delay Timer” P276.

**CARGO AREA LIGHT**

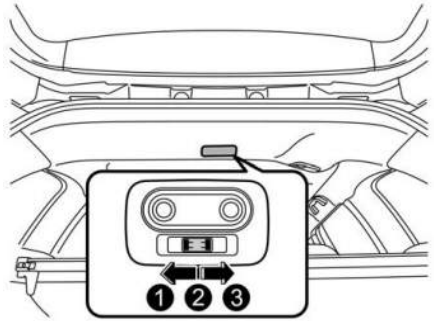

- 1 OFF
- 2 DOOR
- 3 ON

**OFF:**

The light remains off.

**DOOR:**

The light illuminates when the rear gate is opened. The light remains illuminated and gradually turns off after the rear gate is closed.

**ON:**

The light remains on continuously.

**REAR GATE LIGHT (If Equipped)**

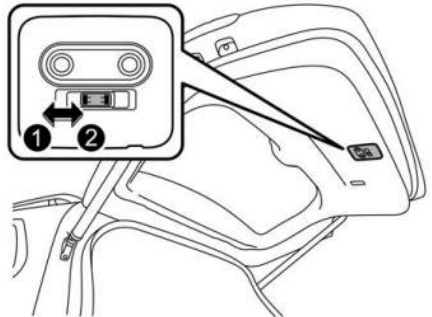

- 1 OFF
- 2 DOOR

**OFF:**

The light remains off.

**DOOR:**

The rear gate light will illuminate when the rear gate is opened.

**OFF DELAY TIMER**

This function will automatically illuminate the following lights for a certain period of time.

- Dome light
- Map lights
- Cargo area light
- Rear gate light (If equipped)

When the door interlock switch is set to the "DOOR" position, the light will turn on and off depending on the locking and unlocking of the doors, the opening and closing of the doors, as well as the position of the ignition switch.

**NOTE**

*The setting for the period of time in which the lights remain on (OFF delay timer) can be changed by operating the center information display. For details, refer to "Vehicle" P206.*

*Also, the setting of the lights remain on (OFF delay timer) can be changed by your SUBARU dealer. Contact your SUBARU dealer for details.*

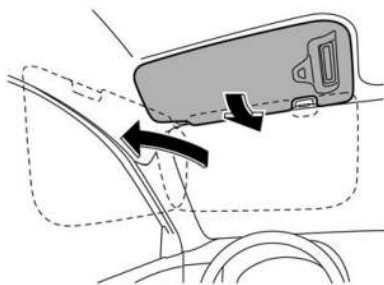
**6-2. SUN VISORS**

To block out glare, swing down the visors.

To use the sun visor at a side window, swing it down and move it sideways.

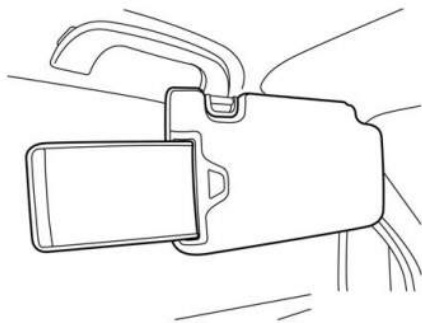
**SUN VISOR EXTENSION PLATE**

With the sun visor positioned over the side window, you can use the sun visor extension plate to prevent glare through the gap between the sun visor and center pillar. To use the extension plate, pull it toward the rear of the vehicle. When you have finished using it, stow it by pushing it toward the front of the vehicle.

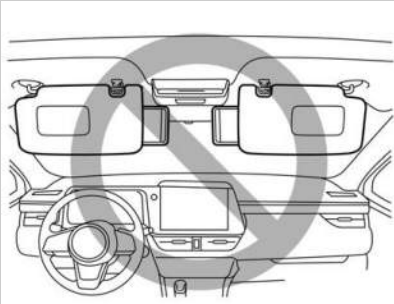
**CAUTION**

Do not pull out the extension plate with the sun visor positioned over the windshield. The extension plate would obstruct your view of the inside mirror.

**NOTE**

*Use of the vanity mirror light for a long period of time while the engine is not running can cause battery discharge.*

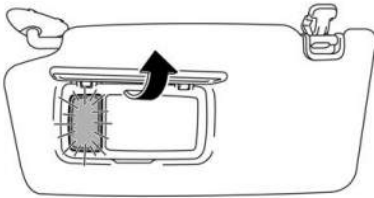
**VANITY MIRROR WITH LIGHT**

To use the vanity mirror, swing down the sun visor and open the vanity mirror cover.

The lights beside the vanity mirror illuminate when the mirror cover is opened.

**CAUTION**

Keep the vanity mirror cover closed while the car is being driven to avoid being blinded by glare.

### 6-3. OVERHEAD CONSOLE

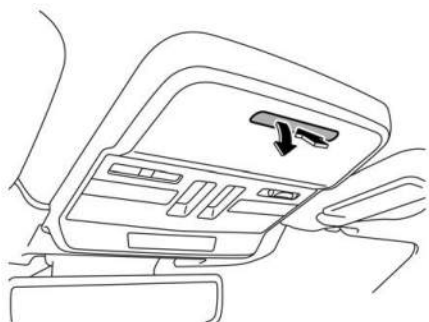

To open the console, push on the lid lightly and it will automatically open.



#### CAUTION

- Before driving, ensure that the overhead console is closed.
- When your vehicle is parked in the sun or on a warm day, the inside of the overhead console heats up. Avoid storing plastic or other heat-vulnerable or flammable articles such as a lighter in the overhead console.

### 6-4. STORAGE COMPARTMENT



#### CAUTION

- Always keep the storage compartment closed while driving to reduce the risk of injury in the event of sudden stops or an accident.
- Do not store the following items in the storage compartment. Otherwise, it may cause a fire or accident.
  - Spray cans, containers with flammable or corrosive liquids or any other dangerous items.
  - Plastic or other heat-vulnerable or flammable articles such as a lighter.

### GLOVE BOX

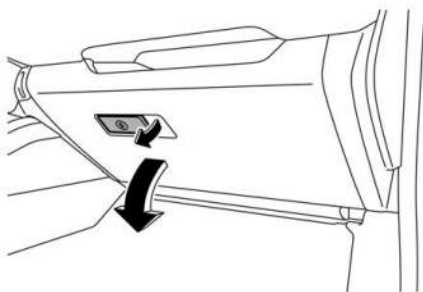

To open the glove box, pull the handle. To close it, push the lid firmly upward.

To lock the glove box, insert the emergency key and turn it clockwise. To unlock the glove box, insert the emergency key and turn it counterclockwise.

An emergency key is attached to the access key fob.

**NOTE**

- When the instrument panel illumination is on, the light that illuminates the glove box is on. Refer to “Headlights” Ⓞ P213.
- The emergency key is directional. If the key cannot be inserted, change the direction that the grooved side is facing and insert it again.

**CENTER TRAY**

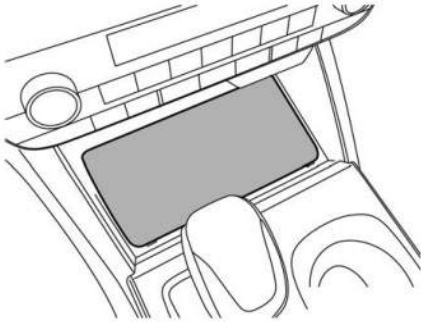

The center tray is located below the center of the instrument panel.

**⚠ WARNING**

For models with the wireless charger: When the wireless charger is turned on, do not place coins, keys, clips, or other metal objects on the center tray. For details, refer to “Wireless Charger” Ⓞ P284.

**⚠ CAUTION**

Do not use the center tray to hold objects that could roll out of the tray. You may get injured if objects are thrown out of the tray while the vehicle is in motion.

**NOTE**

When the instrument panel illumination is on, the light that illuminates the center tray is on. Refer to “Headlights” Ⓞ P213.

**CENTER CONSOLE**

The center console box provides a storage space.

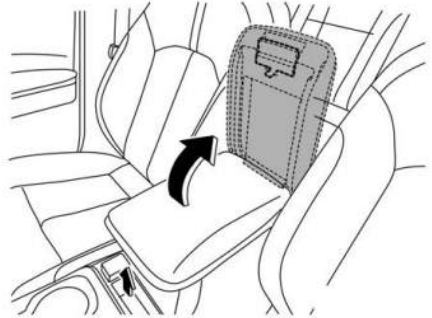

To open the lid, pull up the lock release lever.

**CENTER CONSOLE TRAY**

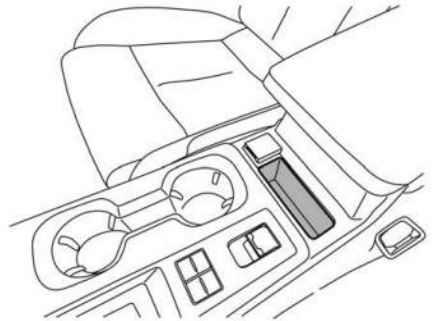

The center console tray is located on the front side of the center console.

## FRONT PASSENGER'S TRAY

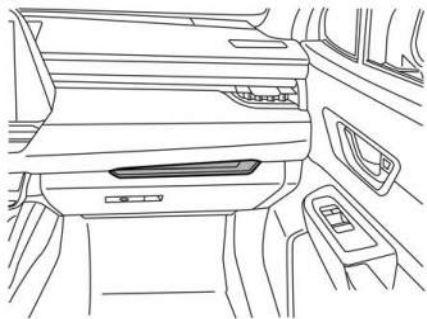

The front passenger's tray is located on the upper side of the glove box.



### CAUTION

Do not store the following items in the front passenger's tray. Otherwise, it may cause a injury or accident.

- Items with pointed tips, such as a screwdriver
- Objects weighing over 8.8 oz (250 g)
- Items extending from the front passenger's tray

## 6-5. CUP HOLDER



### CAUTION

Take care to avoid spills. Beverages, if hot, might burn you and/or your passengers. Spilled beverages may also damage upholstery, carpets or audio equipment.

## FRONT PASSENGER'S CUP HOLDER

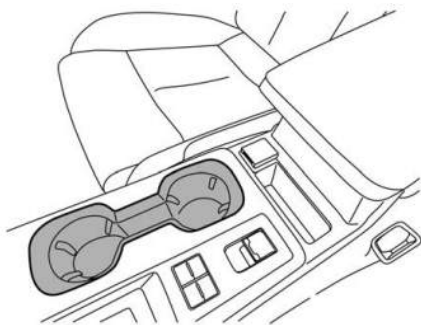

The dual cup holder is built into the center console.



### CAUTION

- Do not pick up a cup from the cup holder or put a cup in the holder while you are driving, as this may distract you and lead to an accident.
- Take care not to spill a beverage on the select lever or any switch(es) in the adjacent area. If the beverage is spilled, it may cause a malfunction of the select lever and/or switch(es).

## REAR PASSENGER'S CUP HOLDER



A dual cup holder is built into the armrest.

### CAUTION

When a cup containing a beverage is in the cup holder, do not fold down or recline any seat. Otherwise, the beverage could spill while driving and, if the beverage is hot, it could burn you and/or your passengers.

## 6-6. BOTTLE HOLDERS

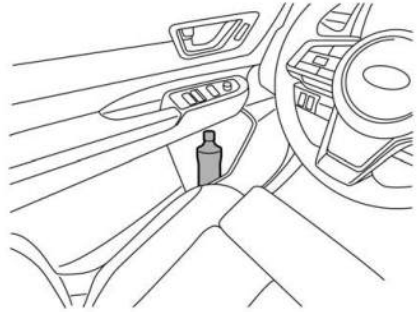

The bottle holder equipped on each door trim can be used to hold beverage bottles and other items.

### CAUTION

- Do not pick up a bottle from the bottle holder or put a bottle in the holder while you are driving, as this may distract you and lead to an accident.
- When placing a beverage in a bottle holder, make sure it is capped. Otherwise, the beverage could spill when opening/closing the door or while driving and, if the beverage is hot, it could burn you and/or your passengers.

## 6-7. ACCESSORY POWER OUTLETS

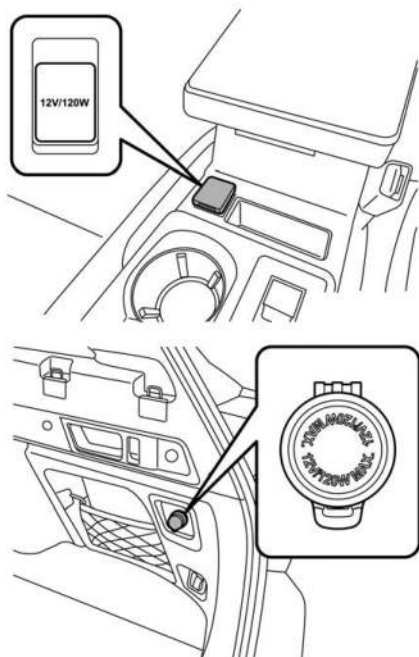

An accessory power outlet is provided as shown in the illustration.

You can use an in-vehicle electrical appliance by connecting it to an outlet.

Electrical power (12 V DC) from the battery is available at any of the outlets when the ignition switch is in either the “ACC” or “ON” position.

The maximum power rating of an appliance that can be connected is **120 W**.

the cap on the accessory power outlet when it is not in use.

- Use only electrical appliances which are designed for 12 V DC.
- The maximum power rating of an appliance that can be connected is 120 W. Do not use an appliance which exceeds the indicated wattage for each outlet.
- When using appliances connected to two or more outlets simultaneously, the total power consumed by them must not exceed 120 W. Overloading the accessory power outlet can cause a short circuit. Do not use double adapters or more than one electrical appliance.
- If the plug on your electric appliance is either too loose or too tight for the accessory power outlet, this can result in a poor contact or cause the plug to get stuck. Only use plugs that fit properly.
- Use of an electric appliance in the accessory power outlet for a long period of time while the engine is not running can cause battery discharge.
- Before driving your vehicle, make sure that the plug and the cord on your electrical appliance will not interfere with your shifting gears and operating the accelerator and brake pedals. If they do, do not use the electrical appliance while driving.



### CAUTION

- Do not attempt to use a cigarette lighter in the accessory power outlet.
- Do not place any foreign objects, especially metal ones such as coins or aluminum foil, into the accessory power outlet. That could cause a short circuit. Always put



**6-8. USB POWER SUPPLY**

**⚠ CAUTION**

- The specification of a USB port that can be used is the Type-A and Type-C. If a different specification of device is connected, power supply or charging may not be possible, or the device may malfunction.
- There is a risk that a connected device may malfunction or data may be damaged. The connection of a device shall be performed at your responsibility.
- To avoid an electric shock or a malfunction, observe the following precautions.
  - Do not connect a USB hub.
  - Do not insert any metal or other foreign object into the USB port.
  - Do not spill water or other liquid on the USB port.
- Be careful not to pull the connected cable. Doing so could break the USB port and the connected device.
- If a device is connected for a long time when the engine is not running, doing so may cause the risk of a discharged battery. Even when the engine is running, we recommend that you do not connect a device for an unnecessarily long time.
- Do not connect a malfunctioning device. Doing so may cause the risk of smoke and fire.

*connecting a device, be sure to read the instruction manual of the device and check whether or not this specification of the output is supported by the device. If a device that requires power exceeding the maximum rating is connected, power supply or charging may not be possible. Even if charging could be completed, the time required for charging may be longer than when the genuine charger for that device is used.*

- Depending on the device, charging may be possible only when a special cable is used. In this case, be sure to connect the device using the special cable.
- When a device that communicates with a PC is connected, power supply or charging may not be possible.
- When connect a device for charging, disconnect the device promptly after charging is completed.

**HOW TO USE THE USB POWER SUPPLY**

**Front seat USB port:**

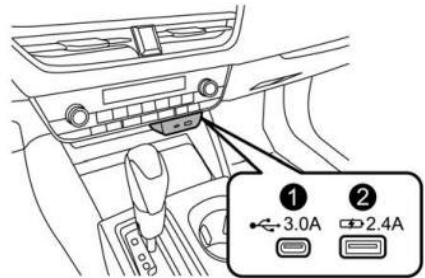

- ① USB Type-C: DC 5 V/3.0 A
- ② USB Type-A: DC 5 V/2.4 A

**NOTE**

- The rated voltage of each USB port is 5 V. For details about the maximum rated power, refer to “How to Use the USB Power Supply” P283. Before

## Console USB port:

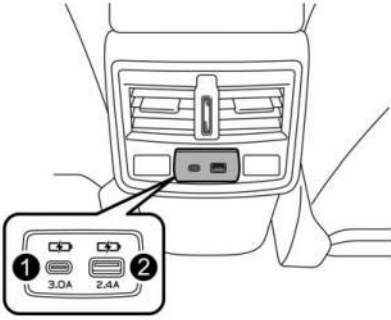

- ① USB Type-C: DC 5 V/3.0 A
- ② USB Type-A: DC 5 V/2.4 A

Before using the USB port to use or charge an electronic device, turn the ignition switch to the “ACC” or “ON” position. The combined maximum output of the two USB ports is 5.4 A.

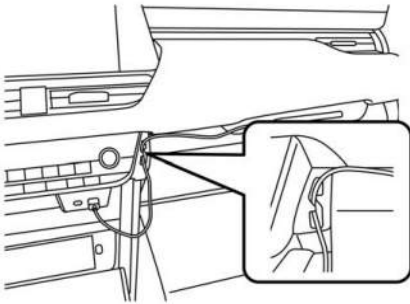
**NOTE**

Use a cable clip when connecting a mobile device placed on the front passenger's tray to the front seat USB port.

## 6-9. WIRELESS CHARGER (If Equipped)

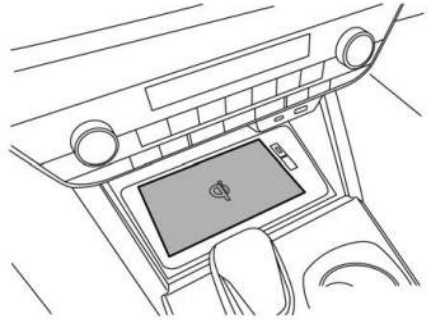

To charge a cell phone, smartphone or a similar mobile device compatible with the Qi wireless charging standard, place the device in the charging area located below the center information display.

The “Qi” logo is a trademark of the Wireless Power Consortium.

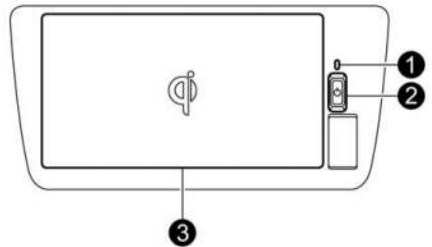

- ① Indicator light
- ② Power switch
- ③ Charging area

**NOTE**

Mobile devices and wireless chargers contain coils for charging. These coils allow the wireless charging system to charge a mobile device with a high level of charging efficiency. When your device is in the charging area, the wireless charger detects it and aligns an integrated moving coil with the coil in your device for charging. If vehicle vibration causes the

two coils to become misaligned while the vehicle is in motion, the moving coil of the wireless charger automatically repositions itself and resumes charging.

However, if the mobile device moves out of the charging area, charging will automatically stop.

## HOW TO USE THE WIRELESS CHARGER

1. The wireless charger operate when the ignition switch is in the “ON” or “ACC” position.
2. Press the power switch once to turn on the wireless charger. When the wireless charger is ON, the indicator light illuminates in green.

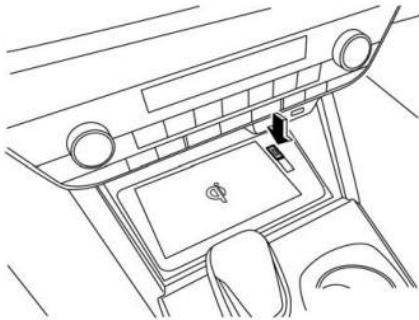

3. Place the mobile device so that the screen or keypad is facing up (the charging surface is facing downward). The center of the device must also be aligned with the center of the charging area. The indicator light illuminates in orange during charging.

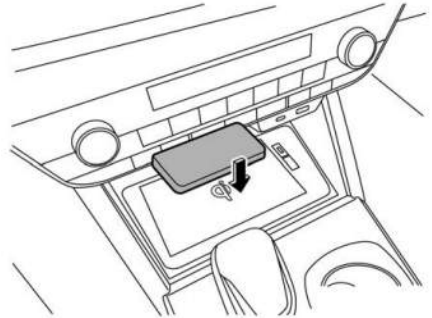

4. The indicator light illuminates in green when charging is complete.

6

### NOTE

- If the indicator light does not illuminate in orange and device charging does not occur, move the device to the center of the charging area. Depending on the mobile device, the charging coil may not be in the center of the device. In such cases, place the mobile device so that its charging coil is in the center of the charging area.
- The power status of the wireless charger is stored even when the ignition switch is turned to the “OFF” position.

### How to use the quick charge

The following types of mobile devices support quick charging as opposed to normal charging (5 W).

- Mobile devices compliant with WPC\* Ver. 1.2.4 and compatible with fast chargers can be charged up to 10 W.
- iPhone 8 (or later) with an iOS version compliant with WPC\* Ver. 1.2.4 and compatible with 7.5 W charging.

\* WPC: Wireless Power Consortium

1. Press the power switch three times to change to the quick-charging mode while your mobile device is charging in normal mode. The indicator light will change from orange to alternating green and orange when the wireless

charger switches to the quick-charging mode.

- When charging is complete, the indicator light will turn green, and the quick charging mode will end. To restart quick-charging, switch to the quick-charging mode again.

## To turn off the wireless charger

Press the power switch once. When the wireless charger is OFF, the wireless charger indicator light turns off.

### NOTE

*When using the center tray as a storage compartment, ensure that the indicator light is off. Refer to "Center Tray" P279.*

## Indicator light patterns

Indicator light	Interpretation
Off	The wireless charger is turned off
Green (illuminated)	Standby (ready for charging)*1
	Charging is complete*2
Orange (illuminated)	A mobile device is in the charging area (a mobile device is being detected)
	Charging
Green and orange illuminate alternately	Quick charging is in progress

\*1: No power is output for charging when the wireless charger is in standby mode. Even if metal objects are placed on the charging tray in this state, they will not overheat.

\*2: For some mobile devices, the indicator light remains orange even after charging is complete.

List of warnings

Indicator light	Possible causes	Solution
Flashes orange once per second	A communication error occurred between the wireless charger and the access key fob.	If the engine is running, stop the engine and restart it. If the ignition switch is in "ACC", start the engine once.
Repeatedly flashes orange three times	Metallic foreign object detected. A foreign object is detected between the mobile device and the charging area.	Remove any foreign objects between the mobile device and the charging area.
	The wireless charger detected insufficient charging performance because the charging coils of the mobile device and wireless charging coils are far apart.	Remove the mobile device from the charging area, check that the activation indicator light is illuminating in green again, and place the device in the center of the charging area. If there is a case or cover on your mobile device, be sure to remove it.
Repeatedly flashes orange four times	The temperature inside the wireless charger has increased.	Remove the mobile device from the charging area temporarily to stop charging. When the temperature of the mobile device cools down, start charging the device again.

**WARNING**

- Do not apply hair spray or insecticide to the wireless charger or wipe it using flammable substances such as oils, alcohol, benzine, or paint thinner. Doing so may cause a vehicle fire.
- For safety reasons, drivers must not operate a charging mobile device while driving.
- Do not charge small devices such as cordless headphones or light-weight cell phones while driving. Due to their light weight, these devices may be thrown from the charging tray resulting in an accident.
- The wireless power receiver can affect some implanted or other electrical medical devices. If you use a cardiac pacemaker, ventricular pacing pulse generator, cardioverter-defibrillator, or a similar device, consult with your physician before using the wireless charger.

**CAUTION**

- Before charging your device, make sure that there is no metal between the charging area and the mobile device. Metal objects may generate heat and cause burns when placed in the charging area.
- Do not apply strong force or impact to the charging area.
- Do not affix aluminum stickers to or place other metal objects in the charging area. Also, do not charge a mobile device that has aluminum stickers or other metal objects attached to it that may come in contact with the charging area. Metal objects may generate heat and cause burns when placed in the charging area.

- Do not disassemble, modify, or remove the wireless charger.
- Do not place magnetized objects in or near the charging area.
- During charging, do not cover your device with a cloth, etc.
- Do not charge your device in dusty conditions.
- Make sure that no foreign objects or liquids are placed or spilled in the wireless charger.
- Do not place the access key fob near the wireless charger.
- When your device is charging, keep any magnetic cards such as credit cards and precision devices such as watches away from the charging area. They may be damaged.
- Do not leave objects in the trays unattended for a long period of time. The paint on the trays may deteriorate depending on the type of device case or accessory.
- When the OS version of a mobile device is updated, the charging specifications may change significantly. Also, if the OS versions compatible with WPC change, the quick charging function may become unavailable. For details, check the website of your mobile device manufacturer.
- To prevent discharging the vehicle battery, do not use the wireless charger for long periods of time when the engine is stopped.

**NOTE**

- *This function is not available for devices larger than the charger tray.*
- *The wireless charger and mobile device will emit heat during charging, but this is not a malfunction.*
- *When your mobile device emits heat*

during charging, the mobile device's protective function may cancel charging.

- The fan may activate when the temperature rises, but this is not a malfunction.
- Qi standard wireless charger can be used on compatible devices. However, not all Qi standard devices and compatibility are guaranteed.
- If you hear noise on the AM radio while your device is charging, you may be able to reduce the noise by changing the charging frequency. To change the charging frequency, press and hold the power switch to turn on the system. After a certain amount of time, the indicator light will flash orange twice to indicate when the frequency changes.
- If the access key fob cannot be detected in the cabin, the battery cannot be charged. In addition, charging may be temporarily suspended when the remote keyless entry system is in operation, such as when opening and closing doors.
- In the following cases, the wireless charger will not operate normally:
  - You are in an area near a facility where electronic equipment is emitting strong radio waves, such as a power plant, broadcast station, or TV tower, or an electronic remote controller is being used nearby.
  - The ambient temperature around the charging tray is high due to hot weather.
- If charging stops after a certain period of time, and the wireless charger does not operate normally, it may be due to any of the following reasons:
  - The mobile device is protruding from the charging area.
  - The mobile device is equipped with a large protruding camera.
  - A thick object such as a case, cover, or accessory is between the charging surface of the portable

- device and the charging area.
- Two or more mobile devices are placed on the charging tray at the same time.

## MOBILE DEVICE HOLDER

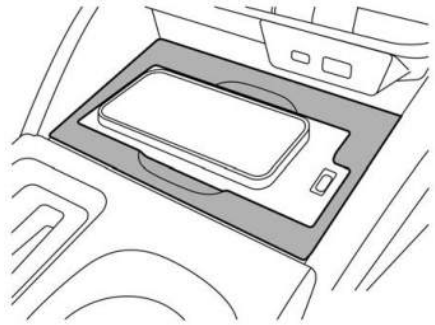

6

The mobile device holder is an accessory designed to securely hold smartphones and other devices placed on the wireless charger.

Attach the mobile device holder to the wireless charger by following these steps.

1. Install the mobile device holder on the wireless charger so that the wider side of the holder faces toward the front of the vehicle.
2. Lift the front part of the mobile device holder slightly and insert the tabs into the notches of the wireless charger.

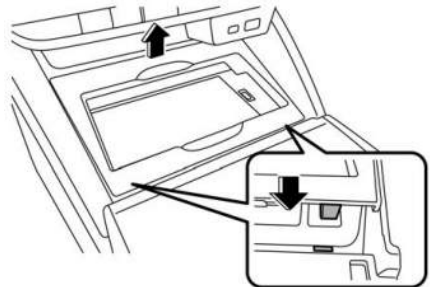

3. Place the mobile device holder onto the wireless charger.  
To remove the mobile device holder, perform the installation steps in reverse order.

**CAUTION**

To prevent damage to the mobile device holder, pay attention to the following precautions when handling it.

- Do not try to force the tabs of the mobile device holder into the notches of the wireless charger.
- When installing or removing the mobile device holder, be careful not to hit any of the surrounding components.

## 6-10. ASHTRAY (Dealer Option)

**CAUTION**

- Do not use ashtrays as waste receptacles or leave a lighted cigarette in an ashtray. This could cause a fire.
- Always extinguish matches and cigarettes before putting them into the ashtray, and then close the ashtray securely. If you keep the ashtray open, the fire of the cigarette may spread to another cigarette butt and start a fire.
- Do not put flammable material in the ashtray.
- Do not leave a lot of cigarette butts in the ashtray.

**NOTE**

*Particles of ash and tobacco will accumulate around the hinges of the ashtray's inner lid. Clean them off using a toothbrush or a similar narrow-ended implement.*

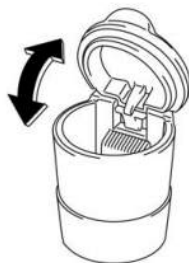

The portable ashtray can be installed in each cup holder or bottle holder. For the locations of the cup holders, refer to "Cup Holder" ☞P280. For the locations of the bottle holders, refer to "Bottle Holders" ☞P281.



When using the ashtray, open the lid of the ashtray. Fully close the lid after using the ashtray to help reduce residual smoke.

## 6-11. ASSIST GRIP

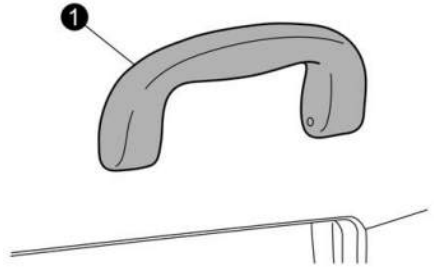

1 Assist grip

The assist grip is to be held to support the body of the passengers when they are in the seat and the vehicle is moving.

### WARNING

Do not hold the assist grip when getting up from the seat. Holding and pulling the assist grip in the wrong way could break the grip and possibly cause injury.

### CAUTION

Do not attach heavy objects to the assist grip. Doing so could break it and damage the object.

## 6-12. COAT HOOK

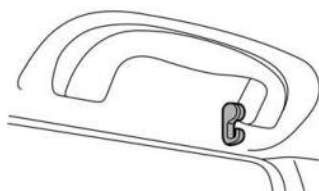

The coat hook is attached to each rear passenger's assist grip.

### **WARNING**

Obey the following instructions.

- Do not hang coat hangers or other hard or pointed objects on the coat hooks. Hang clothing directly on the coat hooks without using hangers.
- Before hanging clothing on the coat hooks, make sure there are no pointed objects in the pockets.

If these instructions are ignored, the following may occur in sudden stops or in a collision.

- Serious injuries by the items thrown through the cabin.
- Incorrect SRS curtain airbag deployment.

### **CAUTION**

Never hang anything on the coat hook that might obstruct the driver's view or that could cause injury in sudden stops or in a collision. And do not hang items on the coat hook that weigh 11 lbs (5 kg) or more.

**6-13. FLOOR MAT**

**⚠ CAUTION**



If the floor mat slips forward and interferes with the movement of the pedals during driving, it could cause an accident. Observe the following precautions to prevent the floor mat from slipping forward.

- Be sure to use a genuine SUBARU floor mat designed with grommets in the correct locations.
- Make sure that the driver's floor mat is placed back in its proper location and is correctly secured on its retaining pins.
- Do not use more than one floor mat.

2. Turn the upper knob of each retaining hook (clip) to secure the floor mats in place.

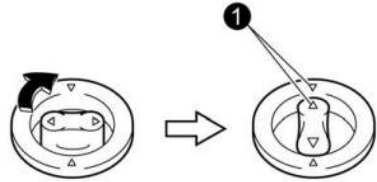

- 1 Align the triangle marks (△) when installing the floor mats.

1. Insert the retaining hooks (clips) into the floor mat eyelets.

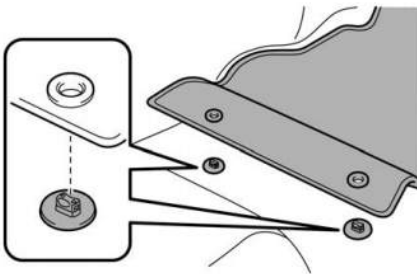

## 6-14. SHOPPING BAG HOOK



### CAUTION

Do not hang items on the shopping bag hook that weigh 6 lbs (3 kg) or more.

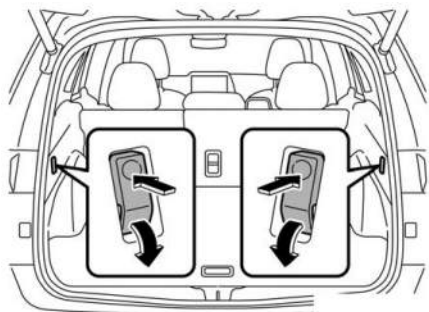

A shopping bag hook is attached to each side of the cargo area.

## 6-15. MULTI-USE CARGO COVER

Adjusting the installation position and direction of the hooks on the cover and of the hook holders on the vehicle will allow you to change how you use the multi-use cargo cover.

### NOTE

*If the multi-use cargo cover gets dirty, wipe it off using a wet cloth.*

## USING THE MULTI-USE CARGO COVER

Multi-use cargo cover

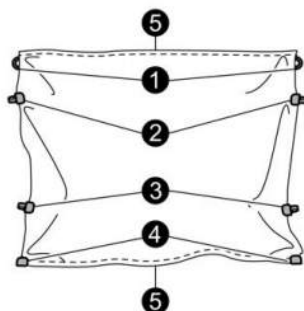

- ① Rubber hook
- ② Hook
- ③ Hook
- ④ Magnet
- ⑤ Zipper

Cover installation positions

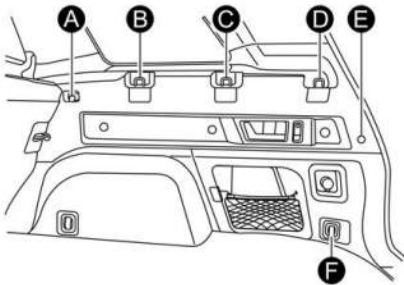

- A** Hook holder
- B** Hook holder
- C** Hook holder
- D** Hook holder
- E** Magnet
- F** Cargo hook

**Multi-use cargo cover**

The multi-use cargo cover is provided to cover the cargo area and protect its contents from direct sunlight.

1. Hang the rubber hook **1** of the cover from the hook holder **A**.
2. Hang the hook **2** of the cover from the hook holder **B**.
3. Hang the hook **3** of the cover from the hook holder **D**.
4. Attach the magnet **4** of the cover to the vehicle side magnet **E**.

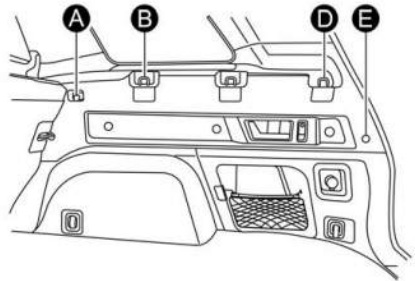
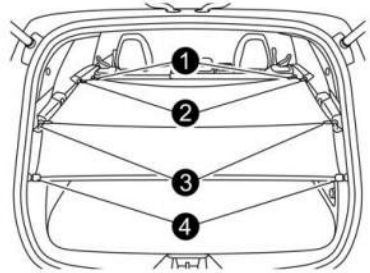

## Usage as partition

The multi-use cargo cover can be used as a partition to prevent the cargo loaded in the cargo area from collapsing.

1. Hang the hook **2** of the cover from the hook holder **D**.
2. Hang the hook **3** of the cover from the cargo hook **F**.

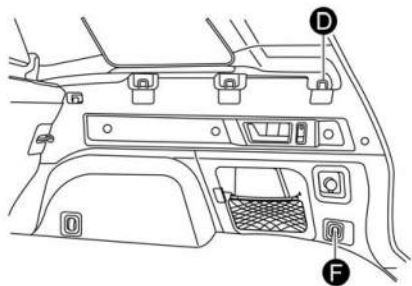
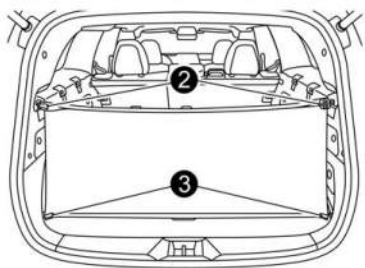

### CAUTION

When using the multi-use cargo cover as a partition, do not apply a load of more than 13 lbs (6 kg).

## Usage as hammock

The multi-use cargo cover can be used as a hammock to load luggage in the following cases.

- When the cargo area is dirty, but you need to put some items in the cargo area.
- To make luggage storage from the back seat easier.

### Installation on front hooks:

1. Hang the hook **2** of the cover from the hook holder **B**.
2. Hang the hook **3** of the cover from the hook holder **C**.

### Installation on rear hooks:

1. Hang the hook **2** of the cover from the hook holder **C**.
2. Hang the hook **3** of the cover from the hook holder **D**.

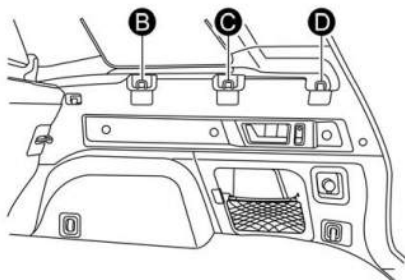
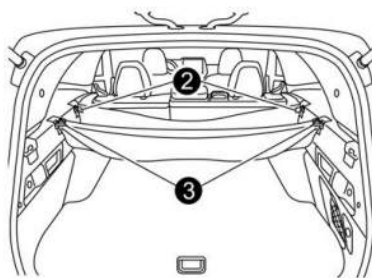

**CAUTION**

- Before driving the vehicle with items stored in the multi-use cargo cover, close the zipper. If not, the luggage may fly out and could cause an accident or injury.
- Do not place a load of more than 2.76 lbs (1.25 kg) on the multi-use cargo cover.

**Usage as step cover**

When working in the cargo area or loading cargo into the cargo area, you can use the multi-use cargo cover as step cover to prevent damaging or soiling the cargo area or rear bumper.

1. Close the zipper.
2. Hang the hook **2** of the cover from the cargo hook **F**.

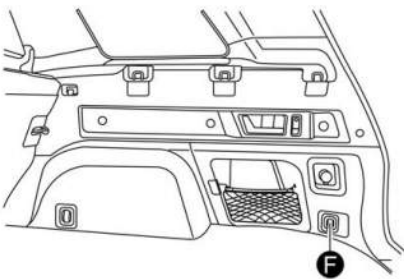
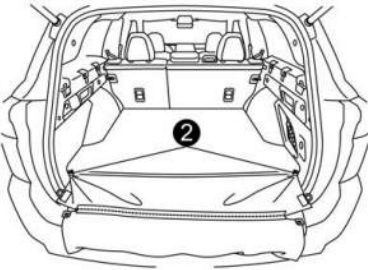

**6-16. CARGO TIE-DOWN HOOKS**

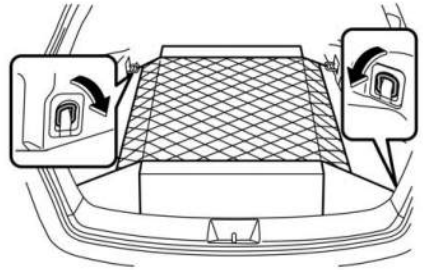

6

The cargo area is equipped with four tie-down hooks so that cargo can be secured with a cargo net or ropes.

When using the tie-down hooks, turn them down out of the storing recesses.

**CAUTION**

The cargo tie-down hooks are designed only for securing light cargo. Never try to secure cargo that exceeds the capacity of the hooks. The maximum load capacity is 44 lbs (20 kg) per hook.

## 6-17. ADJUSTABLE STORAGE NET

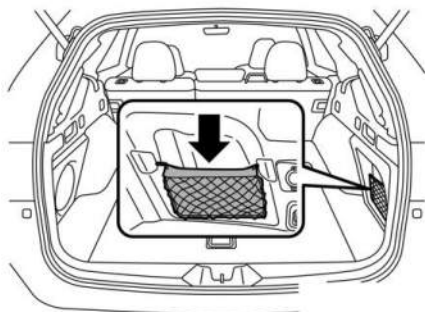

There is an adjustable storage net in the cargo area. Push the net downward to expand the cargo area.

## 6-18. UNDER-FLOOR STORAGE COMPARTMENT

For Outback models

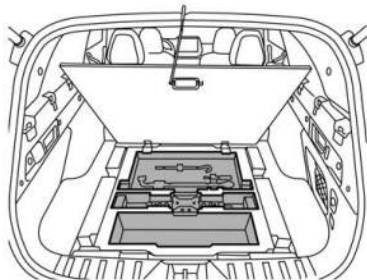

For Subaru Outback Wilderness models

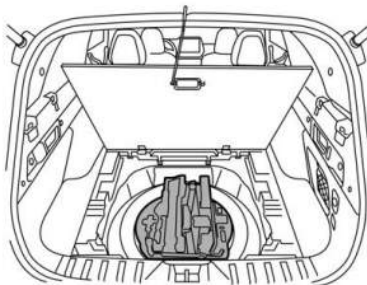

The under-floor storage compartment is located under the floor of the cargo area and can be used to store small items. To open the lid, pull the handle up.

Hang the hook provided on the underside of the lid on the rear edge of the roof to keep the lid open.



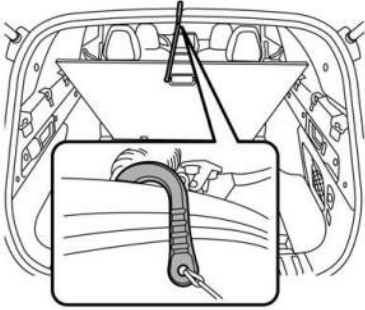

If it is difficult to hang the cargo floor lid from the hook, use a dry cloth to wipe off any material adhering to the opening of the rear gate where you would like to attach the hook.

#### NOTE

*When storing a flat tire, put the subfloor storage in the cargo area.*



#### CAUTION

- Always keep the lid of the under-floor storage compartment closed while driving to reduce the risk of injury in the event of sudden stop or an accident.
- Do not store spray cans, containers with flammable or corrosive liquids or any other dangerous items in the under-floor storage compartment.
- Before closing the under-floor storage compartment lid, ensure that the hook is returned to its original position. If the hook gets caught in the rear gate, it may become damaged.

---

---

---

---

---

---

---

---

---

---

---

---

---

---

---

---

---

---

---

---

## STARTING AND OPERATING

7-1.	Fuel .....	304
	Fuel Requirements .....	304
	Fuel Filler Lid and Cap .....	305
7-2.	State Emission Testing (U.S. Only) .....	308
7-3.	Preparing to Drive .....	309
7-4.	Starting and Stopping Engine .....	310
	General Precautions When Starting/Stopping Engine .....	310
	Safety Precautions for “Keyless Access with Push-Button Start System” .....	310
	Operating Range for Push-Button Start System .....	310
	Starting Engine .....	310
	Automatic Vehicle Shut Down Function .....	312
	Stopping Engine .....	312
	When Access Key Fob Does Not Operate Properly .....	313
	Steering Lock .....	313
7-5.	Remote Engine Start System (Dealer Option) .....	314
	Remote Engine Starter Transceiver (Fob) .....	315
	Alternate Operation Method for Models with “Keyless Access with Push-Button Start System” .....	318
	Entering the Vehicle While It Is Running via Remote Start .....	318
	Entering the Vehicle Following Remote Engine Start Shutdown ...	319
	Heating or Cooling the Interior of the Vehicle .....	319
	Remote Transmitter Program (Remote Engine Starter Transceiver) .....	319
	System Maintenance .....	319
7-6.	Continuously Variable Transmission .....	321
	Continuously Variable Transmission Features .....	321
	Select Lever .....	322
	Shift Lock Function .....	323
	Selection of Manual Mode .....	325
	Driving Tips .....	326
7-7.	Power Steering .....	327
7-8.	Braking .....	328
	Braking Tips .....	328
	Brake System .....	328
	Disc Brake Pad Wear Warning Indicators .....	329
7-9.	ABS (Anti-Lock Brake System) .....	330
	ABS Self-Check .....	330
	ABS Warning Light .....	330
7-10.	Electronic Brake Force Distribution (EBD) System .....	331
	EBD System Malfunctions .....	331
7-11.	Vehicle Dynamics Control System .....	332
	Vehicle Dynamics Control System Monitor .....	333
	To Turn On/Off the Vehicle Dynamics Control System .....	333
7-12.	X-MODE .....	335
	To Activate/Deactivate X-MODE .....	336
	Hill Descent Control Function .....	337

## STARTING AND OPERATING

---

7-13.	Tire Pressure Monitoring System (TPMS) (Except for Canada-Spec. Models).....	338
	TPMS Screen.....	339
7-14.	Parking Your Vehicle.....	339
	Electronic Parking Brake.....	339
	Parking Tips.....	342
	Auto Vehicle Hold Function.....	343
	Emergency Brake.....	346
7-15.	Hill Start Assist System.....	346
7-16.	Auto Start Stop System.....	348
	System Operation.....	348
	Displaying the Auto Start Stop System Status.....	352
	System Warning.....	352
7-17.	Surround View Monitor (If Equipped).....	353
	How to Change the Display of Surround View Monitor.....	353
	How to Cancel Surround View Monitor.....	356
	How to View the Camera Images.....	356
	Range of Surround View Monitor.....	359
	Using the Camera.....	359
	Front Cross Traffic Information (If Equipped).....	360
	Rear Cross Traffic Warning (RCTW).....	362
	How to Get the Source Code that Uses Open Source Software....	362
7-18.	Rear View Camera (If Equipped).....	362
	How to Use the Rear View Camera.....	363
	Viewing Range on the Screen.....	364
	Help Lines.....	365
7-19.	BSW/RCTW.....	367
	System Features.....	367
	Operating Conditions.....	369
	BSW/RCTW Approach Indicator Light/Warning Buzzer.....	370
	BSW/RCTW OFF Indicator.....	373
	BSW/RCTW Warning Indicator.....	373
	To Turn On/Off the BSW/RCTW.....	374
	Handling of Rear Radar Sensors.....	374
7-20.	Reverse Automatic Braking (RAB) System.....	375
	Reverse Automatic Braking (RAB) System Overview.....	377
	Operating Conditions.....	378
	Proximity Warning Detection Function.....	381
	Automatic Braking Function Operation.....	384
	Canceling the Reverse Automatic Braking (RAB) System Operation.....	386
	Reverse Automatic Braking (RAB) System ON/OFF Setting.....	386
	RAB Warning Indicator.....	387
	Handling of the Sonar Sensors.....	387
	How to Get the Source Code That Uses Open Source Software ...	388
7-21.	Distraction Mitigation System.....	389
	User Recognition Function.....	394
	Inattentive/Drowsy Driving Warning.....	396

## STARTING AND OPERATING

---

Distraction Mitigation System Indicator/Warning .....	398
Using the Distraction Mitigation System .....	398
Distraction Mitigation System ON/OFF Settings .....	402
How to Get the Source Code That Uses Open Source Software ...	403

## 7-1. FUEL



### CAUTION

- Use of a fuel which is low in quality or use of an inappropriate fuel additive may cause damage to the engine and/or fuel system.
- Some gas stations, particularly those in high altitude areas, offer fuels posted as regular octane gasoline with an octane rating below 87 AKI (90 RON). Use of those fuels are not recommended.

## FUEL REQUIREMENTS

The engine is designed to operate using **unleaded gasoline** with an octane rating of **87 AKI (90 RON) or higher**.

### NOTE

*When using the 2.4 L turbo engine model to tow a trailer, SUBARU recommends using unleaded gasoline with an octane rating of 91 AKI (95 RON) or higher to reduce the risk of engine overheat.*

## Fuel octane rating

Using a gasoline with a lower octane rating can cause persistent and heavy knocking, which can damage the engine. Do not be concerned if your vehicle sometimes knocks lightly when you drive up a hill or when you accelerate. Contact your SUBARU dealer if you use a fuel with the specified octane rating and your vehicle knocks heavily or persistently.

### RON:

This octane rating is the Research Octane Number.

### AKI:

This octane rating is the average of the Research Octane and Motor Octane numbers and is commonly referred to as the Anti Knock Index (AKI).

## Unleaded gasoline

The neck of the fuel filler pipe is designed to accept only an unleaded gasoline filler nozzle. Under no circumstances should leaded gasoline be used because it will damage the emission control system and may impair driveability and fuel economy.

## Reformulated gasoline

SUBARU supports the use of reformulated gasoline when available. Reformulated gasoline has been blended to burn more cleanly and reduce vehicle emissions.

## MMT

Some gasoline contains an octane-enhancing additive called MMT (Methylcyclopentadienyl Manganese Tricarbonyl). If you use such fuels, your emission control system performance may deteriorate and the CHECK ENGINE warning light/malfunction indicator light may turn on. If this happens, return to your authorized SUBARU Dealer for service. If it is determined that the condition is caused by the type of fuel used, repairs may not be covered by your warranty.

## Gasoline for cleaner air

Your use of gasoline with detergent additives will help prevent deposits from forming in your engine and fuel system. This helps keep your engine in tune and your emission control system working properly, and is a way of doing your part for cleaner air. If you continuously use a high quality fuel with the proper detergent and other additives, you should never need to add any fuel system cleaning agents to your fuel tank.

Many gasolines are now blended with materials called oxygenates. Use of these fuels can also help keep the air cleaner. Oxygenated blend fuels, such as ethanol (ethyl or grain alcohol) may be used in your vehicle, but should contain no more than 15% ethanol for the proper

operation of your SUBARU.

Do not use any gasoline that contains more than 15% ethanol, including from any pump labeled E30, E50 or E85 (which are only some examples of fuel containing more than 15% ethanol).

In addition, some gasoline suppliers are now producing reformulated gasolines, which are designed to reduce vehicle emissions. SUBARU approves the use of reformulated gasoline.

If you are not sure what the fuel contains, you should ask your service station operators if their gasolines contain detergents and oxygenates and if they have been reformulated to reduce vehicle emissions.

As additional guidance, only use fuels suited for your vehicle as explained in the following.

- Fuel should be unleaded and have an octane rating no lower than that specified in this manual.
- Methanol (methyl or wood alcohol) is sometimes mixed with unleaded gasoline. Methanol can be used in your vehicle **ONLY** if it does not exceed 5% of the fuel mixture **AND** if it is accompanied by sufficient quantities of the proper cosolvents and corrosion inhibitors required to prevent damage to the fuel system. Do not use fuel containing methanol **EXCEPT** under these conditions.
- If undesirable driveability problems are experienced and you suspect they may be fuel related, try a different brand of gasoline before seeking service at your SUBARU dealer.
- Fuel system damage or driveability problems which result from the use of improper fuel are not covered under the SUBARU Limited Warranty.

## TOP TIER™ fuel



SUBARU recommends the use of TOP TIER™ approved gasoline. For more information on TOP TIER™ approved gasoline and a list of marketers, refer to the official website: [www.toptiergas.com](http://www.toptiergas.com)

## FUEL FILLER LID AND CAP

### Locations of the fuel filler lid

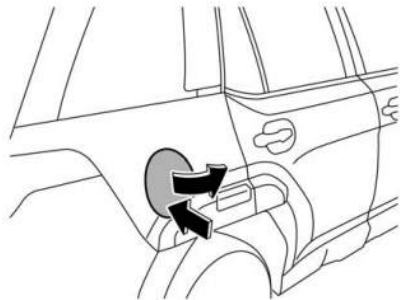

The fuel filler lid is located at the rear right side of the vehicle.

### Refueling

Only one person should be involved in refueling. Do not allow others to approach the area of the vehicle near the fuel filler pipe while refueling is in progress.

Be sure to observe any other precautions that are posted at the service station.

1. Before refueling, stop the vehicle, then turn off the ignition switch to turn off all the electrical components. At this

time, the fuel filler lid also unlocks.

### NOTE

When you lock the door, the fuel filler lid also locks. To unlock the fuel filler lid, perform one of the operations below.

- Press the “” button on the key fob.
  - Press the unlock side of the power door locking switch.
2. Push the rear side of the fuel filler lid.
  3. The fuel filler lid opens automatically. Open it further by hand.

### WARNING

Before opening the fuel filler cap, first touch the vehicle body or a metal portion of the fuel pump or similar object to discharge any static electricity that may be present on your body. If your body is carrying an electrostatic charge, there is a possibility that an electric spark could ignite the fuel, which could burn you. To avoid acquiring a new static electric charge, do not get back into the vehicle while refueling is in progress.

4. Remove the fuel filler cap by turning it slowly counterclockwise.

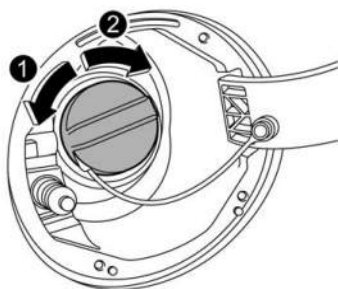

- ① Open
- ② Close

### WARNING

- Gasoline vapor is highly flammable. Before refueling, always

turn the ignition switch to the “OFF” position first and then close all vehicle doors and windows. Make sure that there are no lighted cigarettes, open flames or electrical sparks in the adjacent area. Only handle fuel outdoors. Quickly wipe up any spilled fuel.

- When opening the cap, grasp it firmly and turn it slowly to the left. Do not remove the cap quickly. Fuel may be under pressure and spray out of the fuel filler neck, especially in hot weather. If you hear a hissing sound while you are removing the cap, wait for the sound to stop and then slowly open the cap to prevent fuel from spraying out and creating a fire hazard.

5. Set the fuel filler cap on the cap holder inside the fuel filler lid.

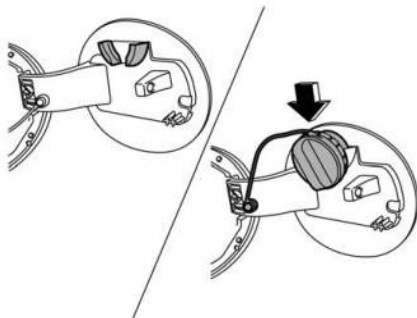

### WARNING

- When refueling, insert the fuel nozzle securely into the fuel filler pipe. If the nozzle is lifted or not fully inserted, its automatic stopping mechanism may not function, causing fuel to overflow the tank and creating a fire hazard.
- Stop refueling when the automatic stop mechanism on the fuel nozzle activates. If you continue to add fuel, temperature changes or other conditions may cause fuel to over-



flow from the tank and create a fire hazard.

6. Stop filling the tank after the fuel filler pump automatically stops. Do not add any more fuel.
7. Put the cap back on and turn it clockwise until you hear a clicking noise. Be certain not to catch the tether under the cap while tightening.



### CAUTION

Make sure that the cap is tightened until it clicks to prevent fuel spillage in the event of an accident.



8. Close the fuel filler lid completely.



### CAUTION

Do not let fuel spill on the exterior surfaces of the vehicle. Because fuel may damage the paint, be sure to wipe off any spilled fuel quickly. Paint damage caused by spilled fuel is not covered under the SUBARU Limited Warranty.

### NOTE

- You will see the “” sign in the fuel gauge. This indicates that the fuel filler lid is located on the right side of the vehicle.
- If the fuel filler cap is not tightened until it clicks or if the tether is caught under the cap, the CHECK ENGINE warning light/malfunction indicator light may illuminate. Refer to “CHECK ENGINE Warning Light/Malfunction Indicator Light”  P166.
- To lock the fuel filler lid, perform one of the operations below. However if these operations are performed when the fuel filler lid is open, the fuel filler lid will not lock when it is subsequently closed.
  - Press the “” button on the key fob.

- Press the lock side of the power door locking switch.

- When the doors are locked or unlocked using the automatic door lock system, the fuel filler lid will be locked or unlocked at the same time.



### CAUTION

- Never add any cleaning agents to the fuel tank. The addition of a cleaning agent may cause damage to the fuel system.
- After refueling, turn the cap to the right until it clicks to ensure that it is fully tightened. If the cap is not securely tightened, fuel may leak out while the vehicle is being driven or fuel spillage could occur in the event of an accident, creating a fire hazard.
- Do not let fuel spill on the exterior surfaces of the vehicle. Because fuel may damage the paint, be sure to wipe off any spilled fuel quickly. Paint damage caused by spilled fuel is not covered under the SUBARU Limited Warranty.
- Always use a genuine SUBARU fuel filler cap. If you use the wrong cap, it may not fit or have proper venting and your fuel tank and emission control system may be damaged. It could also lead to fuel spillage and a fire.
- Immediately put fuel in the tank whenever the low fuel warning light illuminates. Engine misfires as a result of an empty tank could cause damage to the engine. Continuing to operate your vehicle at an extremely low fuel level may result in a reduction of engine performance.

## 7-2. STATE EMISSION TESTING (U.S. Only)



### WARNING

Only use a four-wheel dynamometer when testing an All-Wheel Drive (AWD) model.

Testing of an AWD model must NEVER be performed on a single two-wheel dynamometer. Attempting to do so will result in uncontrolled vehicle movement and may cause an accident or injuries to persons nearby.



### CAUTION

- At state inspection time, remember to tell your inspection or service station in advance not to place your SUBARU AWD vehicle on a two-wheel dynamometer. Otherwise, serious transmission damage will result.
- Resultant vehicle damage due to improper testing is not covered under the SUBARU Limited Warranty and is the responsibility of the state inspection program or its contractors or licensees.

California and a number of federal states have Inspection/Maintenance programs to inspect your vehicle's emission control system. If your vehicle does not pass this test, some states may deny renewal of your vehicle's registration.

Your vehicle is equipped with a computer that monitors the performance of the engine's emission control system. Certified emission inspectors will inspect the On-Board Diagnostic (OBDII) system as part of the state emission inspection process. The OBDII system is designed to detect engine and transmission problems that might cause the vehicle emissions to exceed allowable limits.

OBDII inspections apply to all 1996 model year and newer passenger cars and trucks. Over 30 states plus the District of Columbia have implemented emission inspection of the OBDII system.

- The inspection of the OBDII system consists of a visual operational check of the "**CHECK ENGINE**" warning light/malfunction indicator light (MIL) and an examination of the OBDII system with an electronic scan tool.
- A vehicle passes the OBDII system inspection if proper operation of the "**CHECK ENGINE**" warning light is observed, there are no stored diagnostic trouble codes, and the OBDII readiness monitors are all complete.
- A vehicle fails the OBDII inspection if the "**CHECK ENGINE**" warning light is not properly operating (light is illuminated or is not working due to faulty LED (Light Emitting Diode)) or there is one or more diagnostic trouble codes stored in the vehicle's computer.
- A state emission inspection may reject (not pass or fail) a vehicle if the number of OBDII system readiness monitors "**NOT READY**" is greater than one. If the vehicle's battery has been recently replaced or disconnected, the OBDII system inspection may indicate that the vehicle is not ready for the emission test. Under this condition, the vehicle driver should be instructed to drive his/her vehicle for a few days to reset the readiness monitors and return for an emission re-inspection.
- Owners of rejected or failing vehicles should contact their SUBARU Dealer for service.

Some states still use dynamometers in their emission inspection program. A dynamometer is a treadmill or roller-like testing device that allows your vehicle's wheels to turn while the vehicle remains in one place. Prior to your vehicle being put on a dynamometer, tell your emission inspector not to place your SUBARU

AWD vehicle on a two-wheel dynamometer. **Otherwise, serious transmission damage will result.**

The U.S. Environmental Protection Agency (EPA) and states using two-wheel dynamometers in their emission testing program have EXEMPTED SUBARU AWD vehicles from the portion of the testing program that involves a two-wheel dynamometer. There are some states that use four-wheel dynamometers in their testing program. When properly used, this equipment should not damage a SUBARU AWD vehicle.

Under no circumstances should the rear wheels be jacked off the ground, nor should the driveshaft be disconnected in an attempt to bypass AWD for state emission testing. An AWD vehicle must be tested using an AWD dynamometer with all 4 wheels driven and loaded.

## 7-3. PREPARING TO DRIVE

You should perform the following checks and adjustments every day before you start driving.

1. Check that all windows, mirrors, and lights are clean and unobstructed.
2. Check the appearance and condition of the tires. Also check tires for proper inflation.
3. Look under the vehicle for any sign of leaks.
4. Check that no small animals enter the engine compartment.
5. Check that the hood and rear gate are fully closed.
6. Check the adjustment of the seat.
7. Check the adjustment of the inside and outside mirrors.
8. Fasten your seatbelt. Check that your passengers have fastened their seatbelts.
9. Check the operation of the warning and indicator lights when the ignition switch is turned to the "ON" position.
10. Check the gauges, indicator and warning lights after starting the engine.



### CAUTION

Trapping small animals in the cooling fan and drive belt may result in a malfunction. Check that no small animal enters the engine compartment and under the vehicle before starting the engine.

### NOTE

- *Engine oil, engine coolant, brake fluid, washer fluid and other fluid levels should be checked daily, weekly or at fuel stops.*
- *When towing a trailer, refer to "Trailer Hitch (Dealer Option)" P424.*

## 7-4. STARTING AND STOPPING ENGINE

### GENERAL PRECAUTIONS WHEN STARTING/STOPPING ENGINE

#### WARNING

- Never start the engine from outside the vehicle (except when using the remote engine start system). It may result in an accident.
- Do not leave the engine running in locations with poor ventilation, such as a garage and indoors. The exhaust gas may enter the vehicle or indoors, and it may result in carbon monoxide poisoning.
- Do not start the engine near dry foliage, paper, or other flammable substances. The exhaust pipe and exhaust emissions can create a fire hazard at high temperatures.

#### CAUTION

- If the engine is stopped during driving, the catalyst may overheat and burn.
- When starting the engine, be sure to sit in the driver's seat (except when using the remote engine start system).

#### NOTE

- *Avoid racing and rapid acceleration immediately after the engine has started.*
- *After the engine starts, the engine speed will be kept high.*
- *On rare occasions, it may be difficult to start the engine depending on the fuel used and the driving condition (repeated short trips when the engine is not warmed up sufficiently). In such a*

*case, it is recommended to switch to a different brand of fuel.*

- *On rare occasions, transient knocking may be heard from the engine when the accelerator is operated rapidly such as a rapid start-up and a rapid acceleration. This is not a malfunction.*
- *The engine starts more easily when the headlights, air conditioner and rear window defogger are turned off.*

### SAFETY PRECAUTIONS FOR “KEYLESS ACCESS WITH PUSH-BUTTON START SYSTEM”

Refer to “Safety Precautions”  P117.

### OPERATING RANGE FOR PUSH-BUTTON START SYSTEM

Refer to “Operating Range for Push-Button Start System”  P156.

### STARTING ENGINE

#### WARNING

- There are some general precautions when starting the engine. Carefully read the precautions described in “General Precautions When Starting/Stopping Engine”  P310.
- If the indicator on the push-button ignition switch flashes in green after the engine has started, never drive the vehicle. The steering is still locked, and it may result in an accident.

#### CAUTION

- When the operation indicator on the push-button ignition switch is flashing in orange, there may be a malfunction with the vehicle. Con-

tact a SUBARU dealer immediately.

- If the indicator on the push-button ignition switch is flashing in green after the engine has started, it means that the steering is still locked. While moving the steering wheel right and left, depress the brake pedal, and press the push-button ignition switch.
- Do not continue pressing the push-button ignition switch for more than 10 seconds. Doing so could cause a malfunction. If the engine does not start, stop pressing the push-button ignition switch. Instead, press the push-button ignition switch without depressing the brake pedal to switch the power status to "OFF". Wait 10 seconds, and then press the push-button ignition switch to start the engine.

#### NOTE

- *When pressing the push-button ignition switch while depressing the brake pedal:*
  - The engine starter operates for a maximum of 10 seconds and after starting the engine, the engine starter stops automatically.
  - The engine can be started regardless of the power status.
- *If the engine does not start, check the security indicator light. Then press the push-button ignition switch without depressing the brake pedal to switch the power to "OFF".*
  - If the light had illuminated, try to start the engine again.
  - If the light had been off, press the push-button ignition switch while depressing the brake pedal more forcefully.
- *The engine start procedures may not function depending on the radio wave conditions around the vehicle. In such a case, refer to "Starting Engine"*  
 ☞ P452.

- *If the vehicle battery is discharged, the steering cannot be unlocked. Charge the battery.*
- *It may be difficult to start the engine when the battery has been disconnected and reconnected (for maintenance or other purposes). This difficulty is caused by the electronically controlled throttle's self-diagnosis function. To overcome it, keep the ignition switch in the "ON" position for approximately 10 seconds before starting the engine.*
- *After the engine starts, the engine speed will be kept high.*
- *Do not shift the select lever while the engine starter is cranking.*

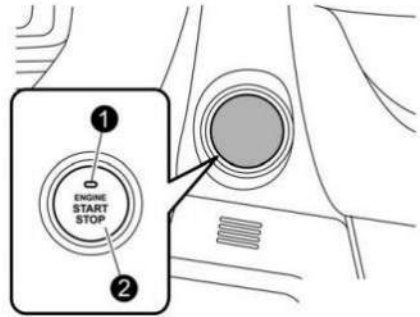

- ① Operation indicator
- ② Push-button ignition switch

When the push-button ignition switch is pressed while depressing the brake pedal, the engine will start. The starting procedure for the engine is as follows.

1. Carry the access key fob, and sit in the driver's seat.
2. Make sure the parking brake is applied.
3. Make sure the select lever is in the "P" position. The engine can also start when the select lever is in the "N" position, however, for safety reasons, start in the "P" position.
4. Depress the brake pedal until the operation indicator on the push-button ignition switch turns green. When starting with the select lever in the "N"

position, the indicator does not turn green.

- While depressing the brake pedal, press the push-button ignition switch.

### NOTE

While pressing the select lever button in, the indicator on the push-button ignition switch will not turn green even when the select lever is in the “P” position.



## AUTOMATIC VEHICLE SHUT DOWN FUNCTION

### WARNING

- The cooling function operates only when the engine is running.
- Do not leave children or adults who would normally require the support of others alone in your vehicle. Pets should not be left alone either. On hot, sunny days, temperatures in a closed vehicle could quickly become high enough to cause severe or possibly fatal injuries to people or animals.

This vehicle has a function to automatically stop the engine if it is left in the following state for about 30 minutes while the engine is running.

- The select lever is in the “P” position.
- The vehicle is stopped.

If the engine stops automatically, the ignition switch turns to the “OFF” position.

### How to reset the timer of the Automatic Vehicle Shut Down function

If you want to continue running the engine, you can reset the timer of the Automatic Vehicle Shut Down function by doing any of the following operations.

- Touch “Delay” according to the message displayed in the center information display before the engine is automatically stopped.
- Depress the brake pedal.
- Shift the select lever into a position other than the “P” position.

If you reset the Automatic Vehicle Shut Down function, it will reactivate after approximately 30 minutes have passed.

### How to deactivate the Automatic Vehicle Shut Down function

The Automatic Vehicle Shut Down function can be temporarily disabled using the center information display settings. For details, refer to “Vehicle”  P206.

If you disable the Automatic Vehicle Shut Down function, it will not work and the engine will continue to run.

The Automatic Vehicle Shut Down function will be enabled the next time you turn the ignition switch to the “OFF” position and restart the engine.

## STOPPING ENGINE

- Stop the vehicle completely.
- Move the select lever to the “P” position.
- Press the push-button ignition switch. The engine will stop, and the power will be switched off.

### WARNING

- Do not touch the push-button ignition switch during driving.

When the push-button ignition switch is operated as follows, the engine will stop.

- The switch is pressed and held for 3 seconds or longer.
- The switch is pressed briefly 3 times or more in succession.

The electric power steering system will not operate either. A greater force will be required to steer, and it may result in an accident.

- If the engine stops during driving, do not operate the push-button ignition switch or open any of the doors until the vehicle is stopped in a safe location. It is dangerous because the steering lock may be activated. Stop the vehicle in a safe place, and contact a SUBARU dealer immediately.

### CAUTION

- Do not stop the engine while the select lever is in a position other than the “P” position.
- If the engine is stopped while the select lever is in a position other than the “P” position, the power will be in “ACC”. If the vehicle is left in this condition, the battery may be discharged.

### NOTE

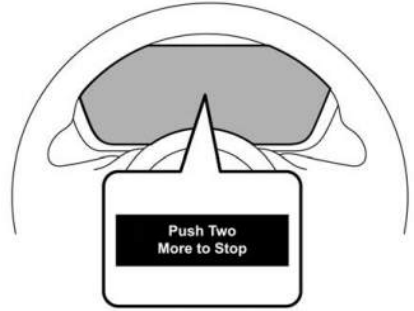

- If you press the push-button ignition switch while driving, the emergency engine stop interrupt screen alerts the driver by messages on the instrument cluster display and beeps.
- Although you can stop the engine by operating the push-button ignition switch, do not stop the engine during driving except in an emergency.

### WHEN ACCESS KEY FOB DOES NOT OPERATE PROPERLY

Refer to “If Access Key Fob Does Not Operate Properly” ¶P451.

### STEERING LOCK

After stopping the engine and any door is opened, the steering wheel will be locked due to the steering lock function.

When the engine is restarted, the steering lock will be automatically released.

## When the steering lock cannot be released

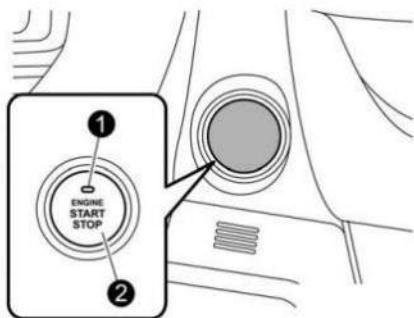

- ① Operation indicator
- ② Push-button ignition switch

When you cannot restart the engine due to the steering lock, check the status of operation indicator and perform the following steps.

### Operation indicator flashing in green:

1. Check that the select lever is set in the "P" position.
2. Depress the brake pedal and keep it.
3. Press the push-button ignition switch while turning the steering wheel left and right.

### Operation indicator flashing in orange:

There may be a malfunction in the steering lock function. Immediately contact your nearest SUBARU dealer.

## 7-5. REMOTE ENGINE START SYSTEM (Dealer Option)

### WARNING

- There are some general precautions when starting the engine. Carefully read the precautions described in "General Precautions When Starting/Stopping Engine" P310.
- Do not remote start a vehicle in an enclosed environment (e.g. closed garage). Prolonged operation of a motor vehicle in an enclosed environment can cause a harmful build-up of carbon monoxide. Carbon monoxide is harmful to your health. Exposure to high levels of carbon monoxide can cause headaches, dizziness or in extreme cases unconsciousness and/or death.

The remote engine start system allows you to start the engine from outside the vehicle. In addition, the remote engine start system can activate the heater or air conditioner, providing you with a comfortable cabin upon entry. For more details, refer to the Owner's Manual supplement for the remote engine start system.

### NOTE

- *The length of time for which it is acceptable to allow the engine to remain idling may be bound by local laws and regulations. Check the local rules when using the remote engine start system.*
- *When taking your vehicle in for service, it is recommended that you inform the service personnel that your vehicle is equipped with a remote engine start system.*



## REMOTE ENGINE STARTER TRANSCEIVER (Fob)



1 Fob button

### Starting the engine

#### NOTE

*All vehicle doors and the engine hood must be closed prior to activating the remote engine start system. Any open entry point will prevent starting or cause the engine to stop.*

The remote engine start system is activated by pressing the fob button on your remote engine starter transceiver (fob) twice within 3 seconds. If the fob is within operating range of the system and the start request is received, the following will occur.

- The fob flashes and beeps once.
- The horn sounds once.
- The side marker lights, tail lights, and parking lights flash once.

The system will check certain safety preconditions before starting, and if all conditions are met, the engine will start within 5 seconds. After the engine starts, the following will occur.

- The fob flashes and beeps twice.
- The horn sounds once.
- The side marker lights, tail lights, and parking lights flash once.

While the engine is idling via the remote engine start system, the following will occur.

- The side marker lights, tail lights, and parking lights remain illuminated.
- The fob button flashes once every 3 seconds.
- The power windows are disabled.

If the engine turns over but does not start (or starts and stalls) the remote engine start system will power off and then attempt to start the engine 3 additional times. The system will not attempt to restart the engine if it determines a vehicle malfunction is preventing starting. If the engine does not start after 3 additional attempts, the remote engine start request will be aborted.

### Stopping the engine

Press and hold the fob button for at least 2 seconds to stop the engine. The fob will flash and beep three times, indicating the engine has stopped. If the stop request is not received (for example, if the user is too far away from the vehicle), the fob will continue to flash once every 3 seconds. The system will automatically stop the engine after 15 minutes.

### Remote start safety features

For safety and security reasons, the remote engine start system will prevent starting (or stop the engine if running) and sound the horn twice if any of the following conditions is detected. In addition, the fob will flash and beep 3 times.

- The total run-time has exceeded 20 minutes.
- The brake pedal is depressed.
- The push-button ignition switch is in a position other than "OFF".
- The engine hood is open.
- The engine idle speed exceeds 3,500 rpm.
- The security alarm is triggered.

- The select lever is not in the “P” position.

If the system detects any door open during operation, it will prevent starting or stop the engine, and sound the horn and flash side marker lights, tail lights, and parking lights 6 times.

In addition to the items above, if the vehicle's engine management system determines there is a safety risk due to a vehicle-related problem, the vehicle will power down and the horn will sound 3 times.

#### **NOTE**

- *If the alarm system is armed at the time of remote engine starter activation (the security indicator light on the instrument cluster is flashing), the alarm system will remain armed throughout the remote start run cycle.*
- *If the alarm system is disarmed at the time of remote engine starter activation (the security indicator light on the instrument cluster is not flashing), the alarm system will remain disarmed throughout the remote start run cycle.*

### **Remote start operation - fob confirmation**

Your remote engine starter fob is a bidirectional transceiver that can confirm system operation with several different visual and audible indications. The fob's LED-backlit button and internal piezo buzzer will indicate the status of the system using the following the flash and beep sequences, provided the fob is within operational range of the system.

Precondition	Fob Indication		Meaning
	Flash	Beep	
Fob start button is being pressed	Continuous while button is held down	—	The fob is transmitting an RF signal
User attempts to start engine by pressing fob button twice within 3 sec	1 flash	1 beep	Engine start request received
	2 flashes	2 beeps	Engine started successfully
	1 flash every 3 sec	—	Engine idling
	3 flashes	3 beeps	Vehicle is in range but engine not started
Engine idling by remote engine start operation	1 flash every 3 sec	—	Engine idling
	3 flashes	3 beeps	Engine stopped by system time-out or for safety reasons (see sections above)
User attempts to stop engine by pressing and holding fob button for at least 2 sec	3 flashes	3 beeps	Engine stopped by user request
	1 flash every 3 sec	—	Stop request not received. Engine still idling.

## ALTERNATE OPERATION METHOD FOR MODELS WITH “KEYLESS ACCESS WITH PUSH-BUTTON START SYS- TEM”

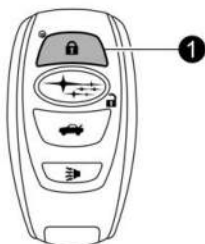

① Lock button

An access key fob can be used as the remote engine start transmitter. Operate the lock button to start or stop the engine as follows.

### Before starting the engine

Before using the remote engine start system to start the engine, confirm the following conditions.

- The select lever is in the “P” position.
- All doors are closed.
- The engine hood is closed.
- The push-button ignition switch is in the “OFF” position.

### Starting the engine

To start the engine with remote engine start system, briefly press the lock button twice within 2 seconds, then press and hold the lock button for 3 seconds.

1. Press the lock button briefly. The hazard warning flashers then flash once and the buzzer chirps once.
2. Within 2 seconds, press the lock button briefly again. The hazard warning flashers then flash once again, and the buzzer chirps once

again.

3. After step 2, immediately press and hold the lock button. The hazard warning flashers then flash three times, and the horn will honk once.
4. Approximately 3 seconds after step 3, release the lock button. The engine will then start successfully.

### Stopping the engine

Press and hold the lock button to stop the engine with remote engine start system.

### Remote start safety features

For detailed information, refer to “Remote start safety features” [P315](#).

## ENTERING THE VEHICLE WHILE IT IS RUNNING VIA RE- MOTE START

1. Unlock the vehicle doors using the keyless access function and remote keyless entry system.

### NOTE

*If the vehicle’s doors are unlocked manually using the key, the vehicle’s alarm system will trigger (if the alarm system is armed prior to activating the remote engine start system) and the engine will turn off. Perform either of the following procedures to disarm the alarm system. Refer to “Alarm System” [P136](#).*

- Turn the push-button ignition switch to the “ACC” or “ON” position.
  - Press any button on the access key fob.
2. Enter the vehicle. The engine will remain running provided the access key fob is present and detected by the vehicle.
  3. Press the push-button ignition switch once while depressing the brake pedal before driving your vehicle. The remote engine starter transceiver (fob) will flash and beep 3 times to indicate that the remote start system has been

shut down.

## ENTERING THE VEHICLE FOLLOWING REMOTE ENGINE START SHUTDOWN

An alarm trigger may occur if the vehicle is opened by the remote keyless entry transmitter within a few seconds immediately following remote engine start shutdown.

## HEATING OR COOLING THE INTERIOR OF THE VEHICLE

After the system starts the engine, the heater or air conditioning will activate and heat or cool the interior to a factory default temperature setting, with automatic selected for all other settings.

## REMOTE TRANSMITTER PROGRAM (Remote Engine Starter Transceiver)

New transmitters can be programmed to the remote engine start system in the event that a transmitter is lost, stolen, damaged or additional transmitters are desired (the system will accept up to eight transmitters). New remote engine start transmitters can be programmed according to the following procedure.

1. Open the driver's door (the driver's door must remain open throughout the entire process).
2. Depress and hold the brake pedal.
3. Turn the ignition switch to "ON" then "OFF", back to "ON" then "OFF", back to "ON" then "OFF", then back to "ON" again and leave the ignition "ON" throughout the programming process.
4. The system will flash the side marker lights, tail lights and parking lights and honk the horn three times, indicating that the system has entered the transmitter learn mode.
5. Press and release the "Q" button on the transmitter that you want to program.
6. The system will flash the side marker lights, tail lights and parking lights and honk the horn one time, indicating that the system has learned the transmitter. Upon successful programming, the remote start confirmation transmitter button will flash one time.
7. Repeat step 5 for any additional transmitters (the system will accept up to eight transmitters).
8. The system will exit the transmitter learn mode if the key is turned to the "OFF" position, the door is closed or after 2 minutes.

## SYSTEM MAINTENANCE

### NOTE

*For remote engine starter transceiver:*

*In the event that the vehicle's battery is replaced, discharged or disconnected, it will be necessary to start the vehicle a minimum of one time using the key prior to activating the remote engine start system. This is required to allow the vehicle electronic systems to resynchronize.*

## Changing the battery



### CAUTION

- Do not let dust, oil or water get on or in the remote engine start transmitter when replacing the battery.
- Be careful not to damage the printed circuit board in the remote engine start transmitter when replacing the battery.
- Be careful not to allow children to touch the battery and any removed parts; children could swallow them.
- There is a danger of explosion if an incorrect replacement battery is

used. Replace only with the same or equivalent type of battery.

- Battery should not be exposed to excessive heat such as sunshine, fire or the like.

### For models with “keyless access with push-button start system”:

Perform the procedure described in “Replacing Battery of Access Key Fob” P507.

### For remote engine starter transceiver:

The 3-volt lithium battery (model CR-2450) supplied in your remote engine start transmitter should last approximately one year, depending on usage. When the battery begins to weaken, you will notice a decrease in range (distance from the vehicle that your remote control operates). Follow the instructions below to change the remote engine start transmitter battery.

1. Remove the small phillips screw located on the back side lower left corner of the transmitter.



2. Carefully pry the remote engine start transmitter halves apart using a small flat-head screwdriver.

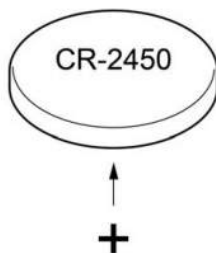
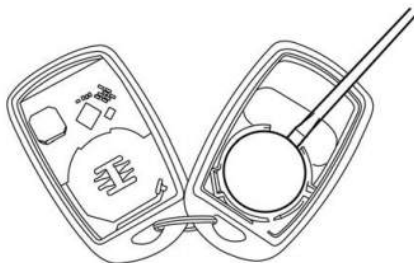

3. Remove the circuit board from the bottom half of the case and remove the battery and replace with new one. Be sure to observe the (+) sign on the old battery before removing it to ensure that the new battery is inserted properly (battery “+” should be pointed away from the transmitter circuit board on battery).
4. Carefully snap the case halves back together, reinstall the phillips screw and test the remote engine start system.

## 7-6. CONTINUOUSLY VARIABLE TRANSMISSION

### WARNING

Do not shift from the “P” or “N” position into the “D” or “R” position while depressing the accelerator pedal. This may cause the vehicle to lurch forward or backward.

### CAUTION

- Observe the following precautions. Failure to observe these precautions could cause damage to the transmission.
  - Shift into the “P” or “R” position only after the vehicle has completely stopped.
  - Do not shift from the “D” position into the “R” position or vice versa until the vehicle has completely stopped.
- Do not race the engine for more than 5 seconds in any position except the “N” or “P” position when the brake is applied or when chocks are used in the wheels. This may cause the transmission fluid to overheat.
- Never move the vehicle rearward by inertia with the select lever set in a forward driving position or move the vehicle forward by inertia with the select lever set in the “R” position. Doing so may result in an unexpected accident or malfunction.

- When parking the vehicle, first securely apply the parking brake and then place the select lever in the “P” position. Do not park for a long time with the select lever in any other position as doing so could result in a dead battery.

## CONTINUOUSLY VARIABLE TRANSMISSION FEATURES

The continuously variable transmission is electronically controlled and provides an infinite number of forward speeds and 1 reverse speed.

### NOTE

- *When the engine coolant temperature is still low, the transmission will shift at higher engine speeds than when the coolant temperature is sufficiently high in order to shorten the warm-up time and improve driveability. The gearshift timing will automatically shift to the normal timing after the engine has warmed up.*
- *Immediately after transmission fluid is replaced, you may feel that the transmission operation is somewhat unusual. This results from invalidation of data which the on-board computer has collected and stored in memory to allow the transmission to shift at the most appropriate times for the current condition of your vehicle. Optimized shifting will be restored as the vehicle continues to be driven for a while.*
- *When driving under continuous heavy load conditions such as climbing a long, steep hill, the engine speed, vehicle speed and air conditioning system cooling performance may automatically be reduced. This is not a malfunction. This phenomenon results from the engine control function maintaining the cooling performance of the vehicle. The engine and vehicle speed will return to a normal speed*

when the engine is able to maintain the optimum cooling performance after the heavy load decreases. Driving under a heavy load must be performed with extreme care.

- The continuously variable transmission is a chain type system that provides superior transmission efficiency for maximum fuel economy. At times, depending on varying driving conditions, a chain operating noise may be heard that is characteristic of this type of system.
- Place the shift boot to the original position after it is lifted. If the select lever is operated with the shift boot in the rolled up position, the shift boot may have tension and it may disturb the select lever operation.

## SELECT LEVER

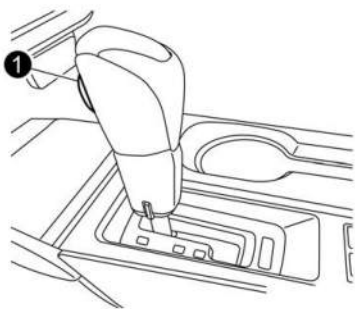

- 1 Select lever button

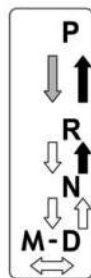

- ➡ : With the brake pedal depressed, shift while pressing the select lever button in
- ➡ : Shift while pressing the select lever button in
- ➡ : Shift without pressing the select lever button

The select lever has four positions, "P", "R", "N", "D" and also has an "M" gate.

### NOTE

- For some models, to protect the engine while the select lever is in the "P" or "N" position, the engine is controlled so that the engine speed may not become too high even if the accelerator pedal is depressed hard.
- When you change the select lever position, make sure to move the select lever firmly to the selected position.

## P (Park)

This position is for parking the vehicle and starting the engine. In this position, the transmission is mechanically locked to prevent the vehicle from rolling freely.

When you park the vehicle, first apply the parking brake, then shift into the "P" position. Do not hold the vehicle with only the mechanical friction of the transmission.

To shift the select lever from the "P" to any other position, you should depress the brake pedal fully then move the select lever. This prevents the vehicle from lurching when it is started.



## R (Reverse)

This position is for backing the vehicle. To shift from the “N” to “R” position, stop the vehicle completely then move the lever to the “R” position while pressing the select lever button in.

When the ignition switch has been turned to the “ACC” position, the movement of the select lever from the “N” to “R” position is only possible by depressing the brake pedal. For details, refer to “Shift Lock Function” ☞ P323.

## N (Neutral)

This position is for restarting a stalled engine. In this position, the transmission is neutral, meaning that the wheels and transmission are not locked. Therefore, the vehicle will roll freely, even on the slightest incline unless the parking brake or foot brake is applied.

Avoid coasting with the transmission in neutral. Engine braking has no effect in this condition.



### WARNING

Do not drive the vehicle with the select lever in the “N” (neutral) position. Engine braking has no effect in this condition and the risk of an accident is consequently increased.

## D (Drive)

This position is for normal driving. The transmission shifts automatically and continuously into a suitable gear according to the vehicle speed and the acceleration you require. Also, while driving up and down a hill, the transmission assists and controls the driving performance and engine braking while corresponding to the road grade.

When more acceleration is required in “D” position, depress the accelerator pedal fully to the floor and hold that position.

The transmission will automatically downshift. In this case, the transmission will operate like a conventional automatic transmission. When you release the pedal, the transmission will return to the original gear position.

If one of the shift paddles behind the steering wheel is operated while driving in the “D” position, the transmission will temporarily switch to the manual mode. In this mode, you can shift to any gear position using the shift paddles. For details about the manual mode, refer to “Selection of Manual Mode” ☞ P325. Once the vehicle speed stabilizes, the transmission will switch from the manual mode back to the “D” position for normal driving.

### While climbing a grade:

When driving up a hill, undesired upshift is prevented from taking place when the accelerator is released. This minimizes the chance of subsequent downshifting to a lower gear when accelerating again. This prevents repeated upshifting and downshifting resulting in a smoother operation of the vehicle.

### NOTE

*The transmission may downshift, depending on the way the accelerator pedal is depressed to accelerate the vehicle again.*

## SHIFT LOCK FUNCTION

The shift lock function helps prevent the improper operation of the select lever.

- The select lever cannot be operated unless the ignition switch is turned to the “ON” position and the brake pedal is depressed.
- The select lever cannot be moved from the “P” position to any other position before the brake pedal is depressed. Depress the brake pedal first, and then operate the select lever.
- Only the “P” position allows you to turn the push-button ignition switch to the

“OFF” position.

- If the ignition switch is turned to the “ACC” position while the select lever is in the “N” position, the select lever may not be moved to the “P” position without depressing the brake pedal and pressing the select lever button.

### Shift lock release

If the select lever cannot be operated, turn the ignition switch back to the “ON” position, then move the select lever to the “P” position with the select lever button pressed and the brake pedal depressed.

If the select lever does not move after performing the above procedure, check and confirm the following and release the shift lock accordingly.

- **When the select lever cannot be shifted from “P” to “N”:**

Refer to “Shift lock release using the shift lock release portion” P324.

- **When the select lever cannot be shifted from “N” to “R” or “P”:**

Place the ignition switch in the “ACC” position, then move the select lever to the “P” position with the brake pedal depressed.

If the select lever still does not move, refer to “Shift lock release using the shift lock release portion” P324.

If the shift lock cannot be released without using the shift lock release button in the above cases, there may be a malfunction in the shift lock system or the vehicle control system.

Contact a SUBARU dealer for an inspection as soon as possible.

### Shift lock release using the shift lock release portion

Perform the following procedure to release the shift lock.

1. Apply the parking brake and stop the engine.

2. Cover the tip of a flat-head screwdriver with vinyl tape or cloth so that it will not scratch. Insert a flat-blade screwdriver into the two slits and then lift upward.

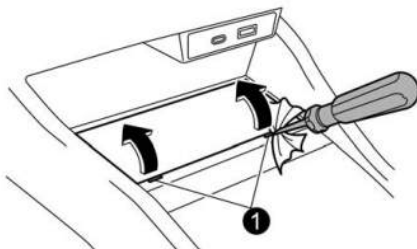

① Slit

3. Remove the center tray or wireless charger (if equipped).

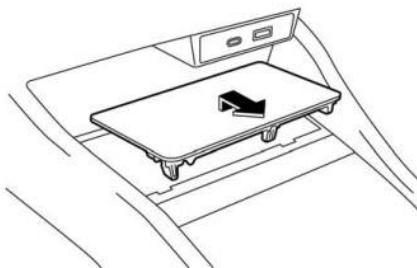

4. While depressing the brake pedal, press the shift lock release portion, and then move the select lever.

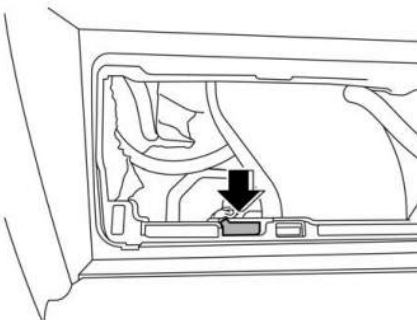

If the select lever does not move after performing the above procedure, the shift lock system may be malfunctioning. Contact a SUBARU dealer for an inspection as soon as possible.

## SELECTION OF MANUAL MODE

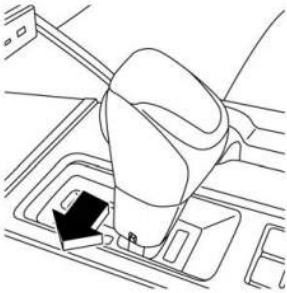

With the vehicle either moving or stationary, move the select lever from the “D” position to the “M” position to select the manual mode.

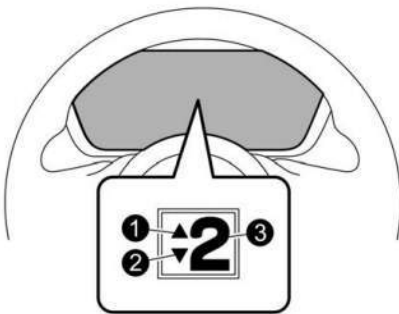

- ① Upshift indicator
- ② Downshift indicator
- ③ Gear position indicator

When the manual mode is selected, the gear position indicator and upshift indicator and/or downshift indicator on the instrument cluster illuminate. The gear position indicator shows the currently selected gear in the 1st-to-8th gear range. The upshift and downshift indicators show when a gearshift is possible.

When the upshift indicator “▲” is on, upshifting is possible. When the downshift indicator “▼” is on, downshifting is possible. When both indicators are on, upshifting and downshifting are both possible. When the vehicle stops (for example, at traffic signals), the downshift indicator turns off.

Gearshifts can be performed using the shift paddle behind the steering wheel.

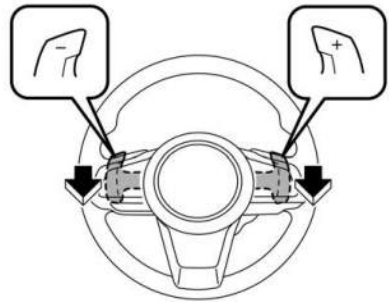

To upshift to the next higher gear position, pull the shift paddle that has “+” indicated on it. To downshift to the next lower gear position, pull the shift paddle that has “-” indicated on it.

To deselect the manual mode, return the select lever to the “D” position from the “M” position. While driving with the select lever in the “D” position, if you change gears by operating the shift paddle, the gear position indicator illuminates and shows the current gear condition.



### CAUTION

Do not place or hang anything on the shift paddles. Doing so may result in accidental gear shifting.

### NOTE

Please read the following points carefully and bear them in mind when using the manual mode.

- If you attempt to shift down when the engine speed is too high, i.e., when a

*downshift would push the tachometer needle beyond the red zone, beeps will be emitted to warn you that the downshift is not possible.*

- *If you attempt to shift up when the vehicle speed is too low, the transmission will not respond.*
- *You can perform a skip-shift (for example, from 4th to 2nd) by operating the shift paddle twice in rapid succession.*
- *The transmission automatically selects 1st gear when the vehicle stops moving.*
- *If the temperature of the transmission fluid becomes too high, the AT OIL TEMP warning light will illuminate. Immediately stop the vehicle in a safe place and let the engine idle until the warning light turns off.*

#### NOTE

*If the accelerator and brake pedals are depressed at the same time, driving torque may be restrained. This is not a malfunction.*

## DRIVING TIPS

- On a road surface where there is a risk of wheelspin (for example, a snow- or gravel-covered road), you can pull away from a standstill safely and easily by first selecting the 2nd gear of the manual mode.
- Always apply the foot or parking brake when the vehicle is stopped in the “D” or “R” position.
- Make sure to apply the parking brake when parking your vehicle. Do not hold the vehicle with only the transmission.
- Do not keep the vehicle in a stationary position on an uphill grade by using the “D” position. Use the brake instead.
- The engine may, on rare occasions, knock when the vehicle rapidly accelerates or rapidly pulls away from a standstill. This phenomenon does not indicate a malfunction.

## 7-7. POWER STEERING

The vehicle is equipped with an electric power steering system.



When the ignition switch is turned to the “ON” position, the power steering warning light on the instrument cluster illuminates to inform the driver that the warning system is functioning properly. Then, if the engine started, the warning light turns off to inform the driver that the steering power assist is operational.



### CAUTION

When the power steering warning light is illuminated, there may be more resistance when the steering wheel is operated. Drive carefully to the nearest SUBARU dealer and have the vehicle inspected immediately.

### NOTE

*If the steering wheel is operated in the following ways, the power steering control system may temporarily limit the power assist in order to prevent the system components, such as the control computer and drive motor, from overheating.*

- *The steering wheel is operated frequently and turned sharply while the vehicle is maneuvered at extremely low speeds, such as while frequently turning the steering wheel during parallel parking.*

- *The steering wheel remains in the fully turned position for a long period of time.*

*At this time, there will be more resistance when steering. However, this is not a malfunction. Normal steering force will be restored after the steering wheel is not operated for a while and the power steering control system has an opportunity to cool down. However, if the power steering is operated in a non-standard way which causes power assist limitation to occur too frequently, this may result in a malfunction of the power steering control system.*

## 7-8. BRAKING

### BRAKING TIPS



#### WARNING

Never rest your foot on the brake pedal while driving. This can cause dangerous overheating of the brakes and needless wear on the brake pads.

### When the brakes get wet

When driving in rain or after washing the vehicle, the brakes may get wet. As a result, brake stopping distance will be longer. To dry the brakes, drive the vehicle at a safe speed while lightly depressing the brake pedal to heat up the brakes.

### Use of engine braking

Remember to make use of engine braking in addition to foot braking. When descending a grade, if only the foot brake is used, the brakes may start working improperly because of brake fluid overheating, caused by overheated brake pads. To help prevent this, shift into a lower gear to get stronger engine braking.

### Braking when a tire is punctured

Do not depress the brake pedal suddenly when a tire is punctured. This could cause a loss of control of the vehicle. Keep driving straight ahead while gradually reducing speed. Then slowly pull off the road to a safe place.

## BRAKE SYSTEM

### Two separate circuits

Your vehicle has a dual circuit brake system. Each circuit works diagonally across the vehicle. If one circuit of the brake system should fail, the other half of the system still works. If one circuit fails, the brake pedal will go down much closer

to the floor than usual and you will need to press it down much harder. And a much longer distance will be needed to stop the vehicle.

### Electronic brake booster

The vehicle is equipped with an electronic brake booster to provide additional braking force. Do not turn off the ignition switch while driving because that will turn off the brake booster, resulting in poor braking power.

The brakes will continue to work even when the brake booster completely stops functioning. If this happens, you will have to depress the pedal much harder than during normal braking, and the braking distance will increase.

#### NOTE

*When the following operations are performed, an operating sound from the electronic brake boost control module may be heard. This is not a malfunction.*

- *The brake pedal was operated.*
- *The driver's door was opened.*
- *The EyeSight function was activated.*
- *Several minutes have passed after the engine stopped.*

### Supplemental booster function when pressure fails:

If there is a malfunction in the brake system, the power for the braking will be stored by controlling the hydraulic pressure of the Vehicle Dynamics Control system.

When the brake pedal is depressed while the supplemental booster function is operating, an operation sound and brake pedal vibration may be generated.

### Brake assist system



#### WARNING

Do not be overconfident about the brake assist. It is not a system that brings more braking ability to the vehicle beyond its braking capability.

Always use the utmost care when driving regarding vehicle speed and safe distance.

 **CAUTION**

When you need to brake suddenly, continue depressing the brake pedal strongly to bring the effect of the brake assist.

Brake assist is a driver assistance system. It assists the brake power when the driver cannot depress the brake pedal strongly and the brake power is insufficient.

Brake assist generates the brake power according to the speed at which the driver depresses the brake pedal.

**NOTE**

*When you depress the brake pedal strongly or suddenly, the following phenomena occur. However, even though these occur, they do not indicate any malfunctions, and the brake assist system is operating properly.*

- *You might feel that the brake pedal is applied by lighter force and generates a greater braking force.*
- *You might hear the sound of ABS operating from the engine compartment.*

## DISC BRAKE PAD WEAR WARNING INDICATORS

 **WARNING**

It is dangerous to drive the vehicle when the wear limits of the brake pads and/or those of the brake discs are exceeded. Doing so could result in an accident.

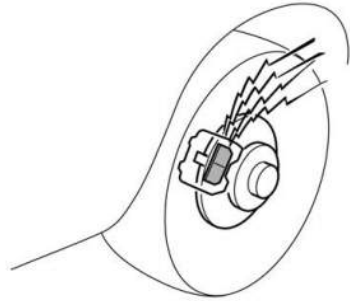

The disc brake pad wear warning indicators on the disc brakes give a warning noise when the brake pads are worn.

If you hear a squealing or scraping noise, have the brake pads checked and replaced by your SUBARU dealer as soon as possible. Brake disc damage may result if the pads are not replaced when needed.

## 7-9. ABS (Anti-Lock Brake System)



### WARNING

Always use the utmost care in driving – overconfidence because you are driving with an ABS equipped vehicle could easily lead to a serious accident.



### CAUTION

- The ABS does not always decrease stopping distance. You should always maintain a safe following distance from other vehicles.
- When driving on badly surfaced roads, gravel roads, icy road, or over newly fallen snow, stopping distances may be longer for a vehicle with the ABS than one without. When driving under these conditions, therefore, reduce your speed and leave ample distance from other vehicles.
- When you feel the ABS operating, you should maintain constant brake pedal pressure. Do not pump the brake pedal since doing so may defeat the operation of the ABS.

The ABS prevents the lock-up of wheels which may occur during sudden braking or braking on slippery road surfaces. This helps prevent the loss of steering control and directional stability caused by wheel lock-up.

When the ABS is operating, you may hear a chattering noise or feel a slight vibration in the brake pedal. This is normal when the ABS operates.

The ABS will not operate when the vehicle speed is below approximately 6 mph (10 km/h).

## ABS SELF-CHECK

You may feel a slight shock in the brake pedal and hear the operating noise of the ABS from the engine compartment just after the vehicle is started. This is caused by an automatic functional test of the ABS being carried out and does not indicate any abnormal condition.

## ABS WARNING LIGHT

Refer to “ABS Warning Light” ⒸP170.



## 7-10. ELECTRONIC BRAKE FORCE DISTRIBUTION (EBD) SYSTEM

The EBD system maximizes the effectiveness of the brakes by allowing the rear brakes to supply a greater proportion of the braking force. It functions by adjusting the distribution of braking force to the rear wheels in accordance with the vehicle's loading condition and speed.

The EBD system is an integral part of the ABS and uses some of the ABS components to perform its function of optimizing the distribution of braking force. If any of the ABS components used by the EBD function fails, the EBD system also stops working.

When the EBD system is operating, you may hear a chattering noise or feel a slight vibration in the brake pedal. This is normal and does not indicate a malfunction.

If all of the warning lights remain on even though the parking brake is released, the brake fluid level may be low or there could be a problem with the EBD system. Park the vehicle in a safe place immediately and contact a SUBARU dealer.

### WARNING

- Driving with the brake system warning light on is dangerous. This indicates your brake system may not be working properly. If the light remains on, have the brakes inspected by a SUBARU dealer immediately.
- If at all in doubt about whether the brakes are operating properly, do not drive the vehicle. Have your vehicle towed to the nearest SUBARU dealer for repair.

7

## EBD SYSTEM MALFUNCTIONS

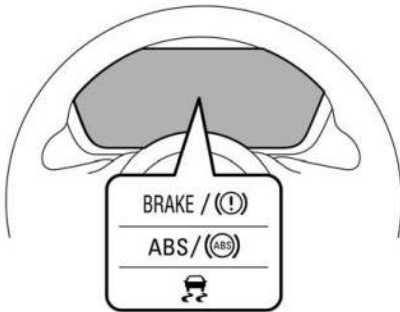

If a malfunction occurs in the EBD system, the system stops working and the following warning lights illuminate simultaneously.

- Brake system warning light
- ABS warning light
- Vehicle Dynamics Control warning light

## 7-11. VEHICLE DYNAMICS CONTROL SYSTEM



### WARNING

Always use the utmost care in driving – overconfidence because you are driving with a Vehicle Dynamics Control system equipped vehicle could easily lead to a serious accident.



### CAUTION

- Even if your vehicle is equipped with Vehicle Dynamics Control system, winter tires should be used when driving on snow-covered or icy roads; in addition, vehicle speed should be reduced considerably. Simply having a Vehicle Dynamics Control system does not guarantee that the vehicle will be able to avoid accidents in any situation.
- Activation of the Vehicle Dynamics Control system is an indication that the road being traveled on has a slippery surface; since having Vehicle Dynamics Control is no guarantee that full vehicle control will be maintained at all times and under all conditions, its activation should be seen as a sign that the speed of the vehicle should be reduced considerably.
- Whenever suspension components, steering components, or an axle are removed from a vehicle equipped with the Vehicle Dynamics Control system, have an inspection of that system performed by an authorized SUBARU dealer.
- The following precautions should be observed in order to ensure that the Vehicle Dynamics Control system is operating properly.
  - All four wheels should be fitted

with tires of the same size, type, and brand. Furthermore, the amount of wear should be the same for all four tires.

- Keep the tire pressure at the proper level as shown on the tire inflation pressure label attached to the driver's side door pillar.
- When replacing a flat tire, use only the specified temporary spare tire. However, even with the specified temporary spare tire, the effectiveness of the Vehicle Dynamics Control system will be reduced.
- If non-matching tires are used, the Vehicle Dynamics Control system may not operate correctly.

In the event of wheelspin and/or skidding on a slippery road surface and/or during cornering and/or an evasive maneuver, the Vehicle Dynamics Control system adjusts the engine's output and the wheels' respective braking forces to help maintain traction and directional control.

#### ● Traction Control Function

The traction control function is designed to prevent spinning of the driving wheels on slippery road surfaces, thereby helping to maintain traction and directional control. Activation of this function is indicated by flashing of the Vehicle Dynamics Control operation indicator light.

#### ● Skid Suppression Function

The skid suppression function is designed to help maintain directional stability by suppressing the wheels' tendency to slide sideways during steering operations. Activation of this function is indicated by flashing of the Vehicle Dynamics Control operation indicator light.

**NOTE**

- The Vehicle Dynamics Control system may be considered normal when the following conditions occur.
  - Slight twitching of the brake pedal is felt.
  - The vehicle or steering wheel shakes to a small degree.
  - An operating noise from the engine compartment is heard briefly when starting the engine and when driving off after starting the engine.
  - The brake pedal seems to jolt when driving off after starting the engine.
- In the following circumstances, the vehicle may be less stable than it feels to the driver. The Vehicle Dynamics Control system may therefore operate. Such operation does not indicate a system malfunction.
  - On gravel-covered or rutted roads
  - On unfinished roads
  - When the vehicle is towing a trailer
  - When the vehicle is fitted with snow tires or winter tires
- Activation of the Vehicle Dynamics Control system will cause operation of the steering wheel to feel slightly different compared to that for normal conditions.
- It is always important to reduce speed when approaching a corner, even if the vehicle is equipped with Vehicle Dynamics Control.
- Always turn off the engine before replacing a tire as failure to do so may render the Vehicle Dynamics Control system unable to operate correctly.

**VEHICLE DYNAMICS CONTROL SYSTEM MONITOR**

Refer to “Vehicle Dynamics Control Warning Light/Vehicle Dynamics Control Operation Indicator Light” ⓄP175 and “Vehicle Dynamics Control OFF Indicator Light” ⓄP176.

**TO TURN ON/OFF THE VEHICLE DYNAMICS CONTROL SYSTEM**

Press the Vehicle Dynamics Control OFF switch to deactivate the Vehicle Dynamics Control system.

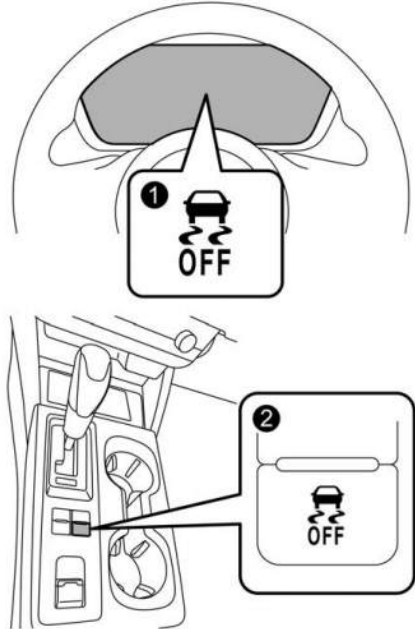

- ❶ Vehicle Dynamics Control OFF indicator light
- ❷ Vehicle Dynamics Control OFF switch

Creating an adequate driving wheel slip by deactivating the Vehicle Dynamics Control system temporarily may help to escape from the following situations. Turn the Vehicle Dynamics Control system off when necessary.

- A standing start on a steeply sloping road with a snowy, gravel-covered, or otherwise slippery surface
- Extrication of the vehicle when its wheels are stuck in mud or deep snow

When turning off the Vehicle Dynamics Control system during engine operation, the Vehicle Dynamics Control OFF in-

indicator light on the instrument cluster illuminates. The Vehicle Dynamics Control system will be deactivated. When the switch is pressed again to reactivate the Vehicle Dynamics Control system, the Vehicle Dynamics Control OFF indicator light turns off.

You should not deactivate the Vehicle Dynamics Control system except under the above-mentioned situations.



### CAUTION

The Vehicle Dynamics Control system helps prevent unstable vehicle motion such as skidding using control of the brakes and engine power. Do not turn off the Vehicle Dynamics Control system unless it is absolutely necessary. If you must turn off the Vehicle Dynamics Control system, drive very carefully based on the road surface condition.

### NOTE

- *Even when the Vehicle Dynamics Control system is deactivated, components of the brake control system may still activate. When the brake control system is activated, the Vehicle Dynamics Control operation indicator light flashes.*
- *When the switch has been pressed to deactivate the Vehicle Dynamics Control system, the Vehicle Dynamics Control system automatically reactivates itself the next time the ignition switch is turned to the "OFF" position and the engine is restarted.*
- *If the switch is pressed and held for 30 seconds or longer, the indicator light turns off, the Vehicle Dynamics Control system is activated, and the system ignores any further pressing of the switch. To make the switch usable again, turn the ignition switch to the "OFF" position and restart the engine.*
- *When the switch has been pressed to deactivate the Vehicle Dynamics Control system, the vehicle's running performance is comparable with that of a vehicle that does not have a Vehicle Dynamics Control system. Do not deactivate the Vehicle Dynamics Control system except when absolutely necessary.*

## 7-12. X-MODE

### WARNING

- Always use the utmost care in driving – overconfidence because you are driving a vehicle with X-MODE could easily lead to a serious accident.
- Always use the utmost care in driving – overconfidence because you are driving a vehicle with hill descent control function could easily lead to a serious accident. Be especially careful, and depress the brake pedal if necessary when driving on extremely steep downhill, frozen, muddy or sandy roads. Failure to control the vehicle's speed may cause a loss of control and result in a serious accident.

### CAUTION

- Even if your vehicle is equipped with X-MODE, winter tires should be used when driving on snow-covered or icy roads; in addition, vehicle speed should be reduced considerably. Simply having X-MODE does not guarantee that the vehicle will be able to avoid accidents in any situation.
- Activate X-MODE when you encounter a very slippery surface at low speed. However, having X-MODE is no guarantee that full vehicle control will be maintained at all times and under all conditions. When activating X-MODE, the speed of the vehicle should be reduced considerably.
- Whenever suspension components, steering components, or an axle are removed from a vehicle, have the system inspected by an authorized SUBARU dealer.

- Observe the following precautions in order to ensure that X-MODE is operating properly:
  - All four wheels should be fitted with tires of the same size, type, and brand. Furthermore, the amount of wear should be the same for all four tires.
  - Keep the tire pressure at the proper level as shown on the label attached to the vehicle's door pillar.
  - Use only the special temporary spare tire to replace a flat tire. With a normal temporary spare tire, the effectiveness of X-MODE is reduced and this should be taken into account when driving the vehicle in such a condition.
- If the hill descent control function has operated continuously for a long time, the temperature of the brake disc may increase and the hill descent control function may be temporarily disabled. In this case, the hill descent control indicator light will disappear. When the hill descent control indicator light disappears, the hill descent control function is disabled.

X-MODE is the integrated control system of the engine, AWD and Vehicle Dynamics Control system, etc. for driving with bad road conditions. Using X-MODE, you can drive more comfortably even in slippery road conditions including uphill and downhill.

X-MODE has the following functions.

#### **Hill descent control function:**

Using the hill descent control function, you can keep the vehicle at a consistent speed driving downhill. If the vehicle speed is likely to increase, the brake control system will be activated to adjust the vehicle speed.

**Driving ability control:**

This mode increases the hill-climbing ability and driving ability as well as enabling smooth application of torque for easier control of the steering wheel.

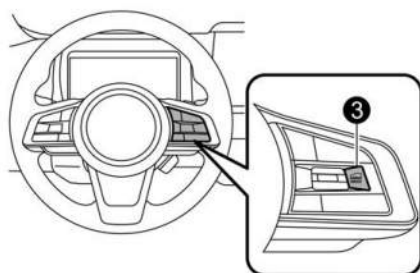
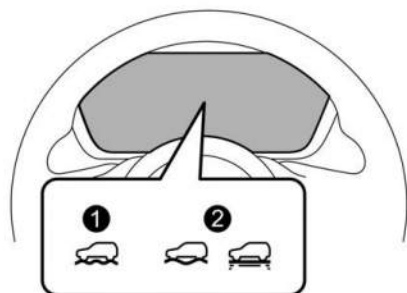
**TO ACTIVATE/DEACTIVATE X-MODE**

- ❶ Models with 1 mode
- ❷ Models with 2 modes (DEEP SNOW/MUD, SNOW/DIRT)
- ❸ X-MODE switch

**Models with 1 mode:**

To activate or deactivate X-MODE, press the X-MODE switch on the steering wheel.

**Models with 2 modes (DEEP SNOW/MUD, SNOW/DIRT):**

Each time the X-MODE switch on the steering wheel is pressed, the mode changes in the order of SNOW/DIRT, DEEP SNOW/MUD and off.

**NOTE**

- Even if you try to activate X-MODE when the vehicle speed is 12 mph (20 km/h) or more, X-MODE will not be activated. At this time, a buzzer will sound twice.
  - If the vehicle speed reaches 25 mph (40 km/h) or more while X-MODE is activated, a buzzer will sound once and X-MODE will be deactivated. X-MODE will automatically reactivate when the vehicle speed drops below 22 mph (35 km/h).
    - When you use the cruise control after X-MODE is automatically deactivated, X-MODE will not be automatically reactivated when the vehicle speed drops below 22 mph (35 km/h).
  - While the engine is running, if any of the following conditions is met, X-MODE will be deactivated. In this case, it is not possible to activate X-MODE.
    - The CHECK ENGINE warning light/Malfunction indicator light illuminates.
    - The AT OIL TEMP warning light flashes.
    - The ABS warning light illuminates.
    - The Vehicle Dynamics Control warning light illuminates.
  - The Auto Start Stop system will be stopped while X-MODE is activated.
  - If there is a possibility that the engine could overheat because of a temperature increase of the engine coolant, it is not possible to activate X-MODE. Even while X-MODE is activated, X-MODE will be deactivated when the engine coolant temperature increases.
- Models with 2 modes:**
- SNOW/DIRT is suitable for driving on a snow-covered road where the points of contact between the tires and road surface are visible, or for driving on an unpaved road.
  - DEEP SNOW/MUD is suitable for driving on a road covered with deep

*snow where the points of contact between the tires and road surface are not visible, or for driving on a muddy road.*

*pedal is depressed during hill descent control function operation.*

## HILL DESCENT CONTROL FUNCTION

The hill descent control function will be in standby mode when X-MODE is activated and the vehicle speed is less than approximately 12 mph (20 km/h).

The function will operate when the vehicle speed is less than approximately 12 mph (20 km/h) and the accelerator ratio is less than approximately 10%.

The function will turn off when the vehicle speed is more than approximately 12 mph (20 km/h) and the accelerator pedal is depressed.



### CAUTION

The braking power of the hill descent control function may not be sufficient when strong braking power is needed (e.g., when towing a trailer).

## Hill descent control indicator light



This indicator appears while the hill descent control function is in the standby mode. It flashes while the function is operating. It will disappear when the function is in the disabled mode. When this function is changed from operational to non-operational, it will disappear when the vehicle speed reaches more than approximately 18 mph (30 km/h).

## NOTE

- *Even while the hill descent control function is operating, you can vary the vehicle speed using the brake pedal or accelerator pedal.*
- *During braking by the hill descent control function, the stop lights will illuminate.*
- *The hill descent control function is operable regardless of the gradient of the road.*
- *The hill descent control function may be considered normal when the following conditions occur.*
  - *An operating sound is heard briefly from the engine compartment while the hill descent control function is operating.*
  - *The sensation of depressing the brake pedal is different, (harder than usual etc.) when the brake*

## 7-13. TIRE PRESSURE MONITORING SYSTEM (TPMS) (Except for Canada-Spec. Models)

The tire pressure monitoring system provides the driver with a warning message by sending a signal from a sensor that is installed in each wheel when tire pressure is severely low.

The tire pressure monitoring system will activate only when the vehicle is driven at speeds above 25 mph (40 km/h). Also, this system may not react immediately to a sudden drop in tire pressure (for example, a blow-out caused by running over a sharp object).

### WARNING

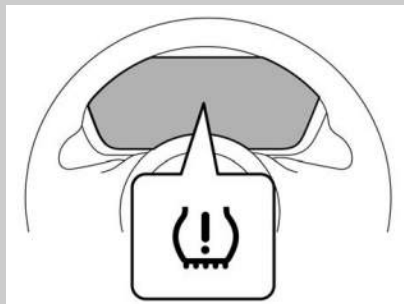

- If the low tire pressure warning light illuminates while driving, never brake suddenly. Instead, perform the following procedure. Otherwise an accident involving serious vehicle damage and serious personal injury could occur.
  - (1) Keep driving straight ahead while gradually reducing speed.
  - (2) Slowly pull off the road to a safe place.
  - (3) Check the pressure for all four tires and adjust the pressure to the COLD tire pressure shown on the tire inflation pressure label on the door pillar on the

driver's side.

Even when the vehicle is driven a very short distance, the tires get warm and their pressures increase accordingly. Be sure to let the tires cool thoroughly before adjusting their pressures to the standard values shown on the tire inflation pressure label. Refer to "Tires and Wheels" ⒸP486. The tire pressure monitoring system does not function when the vehicle is stationary. After adjusting the tire pressures, increase the vehicle speed to at least 25 mph (40 km/h) to start the TPMS rechecking of the tire inflation pressures. If the tire pressures are now above the severe low pressure threshold, the low tire pressure warning light should turn off a few minutes later.

If this light still illuminates while driving after adjusting the tire pressure, a tire may have significant damage and a fast leak that causes the tire to lose air rapidly. If you have a flat tire, refer to "Flat Tires" ⒸP439.

- When a replacement tire is mounted or a wheel rim is replaced without the original pressure sensor/transmitter being transferred, the low tire pressure warning light will illuminate steadily after blinking for approximately one minute. This indicates the TPMS is unable to monitor all four road wheels. Contact your SUBARU dealer as soon as possible for tire and sensor replacement and/or system resetting.



**CAUTION**

Do not place metal film or any metal parts under the driver's seat. This may cause poor reception of the signals from the tire pressure sensors, and the tire pressure monitoring system will not function properly.

## TPMS SCREEN

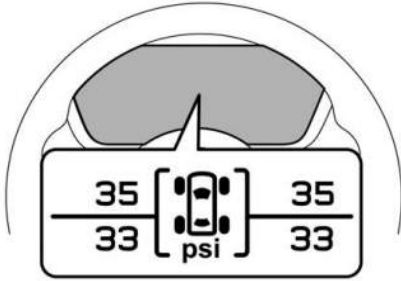

This screen displays each tire pressure. Refer to “Basic Screens” P191.

## 7-14. PARKING YOUR VEHICLE

**WARNING**

- Never leave unattended children or pets in the vehicle. They could accidentally injure themselves or others through inadvertent operation of the vehicle. Also, on hot or sunny days, the temperature in a closed vehicle could quickly become high enough to cause severe or possibly fatal injuries to them.
- Do not park the vehicle over flammable materials such as dry grass, waste paper or rags, as they may burn easily if they come near hot engine or exhaust system parts.
- Be sure to stop the engine if you take a nap in the vehicle. If engine exhaust gas enters the passenger compartment, occupants in the vehicle could die from carbon monoxide (CO) contained in the exhaust gas.

## ELECTRONIC PARKING BRAKE

Your vehicle is equipped with an electronic parking brake. You can apply/release the parking brake by operating the electronic parking brake switch.

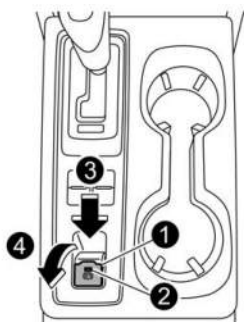

- ① Electronic parking brake switch
- ② Indicator light
- ③ Release the electronic parking brake
- ④ Apply the electronic parking brake

### To apply:

Depress the brake pedal and pull up the electronic parking brake switch.

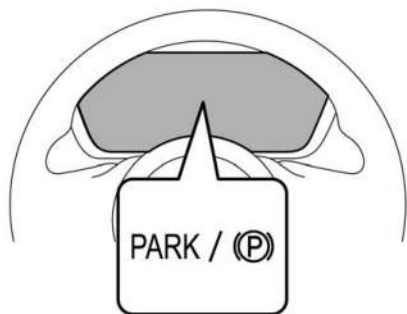

When the parking brake is applied, the following indicator lights illuminate.

- The electronic parking brake indicator light on the instrument cluster (for details, refer to “Electronic Parking Brake Indicator Light” ⓄP172.)
- The indicator light on the electronic parking brake switch

### To release:

Press the electronic parking brake switch firmly while the ignition switch is in the “ON” position and the brake pedal is depressed.

## ⚠ WARNING

- Before exiting the vehicle, make sure that you turn off the engine. Otherwise, the parking brake may be released and an accident may occur.
- If the brake system warning light turns on, the electronic parking brake system may be malfunctioning. Immediately stop your vehicle in a safe location, use tire stops under the tires to prevent the vehicle from moving and contact your SUBARU dealer.
- If the electronic parking brake is operated under the following conditions, the electronic parking brake indicator light may flash.
  - The brake is overheated.
  - The vehicle is on a steep slope.
 In such cases, the vehicle may start to move which may lead to an accident. Always use the tire stops.

## ⚠ CAUTION

- When the electronic parking brake cannot be applied due to a malfunction, contact your SUBARU dealer immediately for an inspection. If you have to park your vehicle in such conditions, perform the following procedure.
  - Stop your vehicle in a flat location.
  - Shift the select lever in the “P” position. When the select lever cannot be shifted into the “P” position, you must release shift lock. Refer to “Shift Lock Function” ⓄP323.
  - Use tire stops under the tires to prevent the vehicle from moving.

- Never drive with the parking brake applied. Doing so will cause unnecessary brake pad wear. Before driving off, always make sure that the parking brake has been released and the brake system warning light has turned off.
- The braking power of the parking brake may not be sufficient when stronger braking power is needed (e.g., when parking on a steep slope while towing a trailer).

- When the electronic parking brake has not been used for a long period of time, the electronic parking brake may operate automatically after the ignition switch is turned to the "OFF" position. This occurs due to checking the proper operation of the electronic parking brake and does not indicate a malfunction.
- If the electronic parking brake switch is malfunctioning and the electronic parking brake cannot be released, refer to the instructions described in "Automatic release function by accelerator pedal" (P342).

## NOTE

- The parking brake will not be released under the following conditions even if the electronic parking brake switch is pressed.
  - The ignition switch is in the "ACC" or "OFF" position.
  - The brake pedal is not depressed.
- The electronic parking brake system uses motors to apply the parking brake. Therefore, operating sounds from the motors will be heard when applying or releasing the parking brake. Make sure that the motor sounds are heard when applying or releasing the parking brake.
- When the electronic parking brake system has a malfunction or the electronic parking brake operation is prohibited temporarily, if the electronic parking brake switch is operated, a chirp sound is heard and the electronic parking brake indicator light flashes.
- When you cannot release the parking brake due to, for example, a system malfunction, contact your SUBARU dealer and have your SUBARU dealer release the parking brake.
- If the operation of the electronic parking brake switch is stopped midway or performed extremely slowly, the system may detect an error and turn on the brake system warning light. However, this does not indicate a malfunction if the warning light turns off after operating the switch.
- After activating the electronic parking brake, you may hear a short sound several minutes after the electronic parking brake indicator light and the indicator light on the electronic parking brake switch illuminate as the system confirms proper engagement. This sound is different from the apply and release sound. This can occur:
  - If the brakes are extremely hot.
  - If the car is parked on a steep incline.
  - If the electronic parking brake is applied after the ignition switch is turned OFF.

This is a normal operating sound under any of these conditions.
- The Auto Start Stop system is deactivated while the electronic parking brake is applied.
- If you operate the electronic parking brake switch while the Auto Start Stop system is activated, the Auto Start Stop system will be deactivated. The electronic parking brake will activate after the engine is restarted. After the electronic parking brake indicator light is illuminated, release your foot from the brake pedal.
- When starting the engine or restarting the engine using the Auto Start Stop system, if you operate the electronic parking brake switch, the electronic parking brake indicator light may flash

temporarily. However, this is not a malfunction if the light turns off after the electronic parking brake is deactivated.

### Automatic release function by accelerator pedal

The electronic parking brake system has an automatic release function. The parking brake will be automatically released by depressing the accelerator pedal. However, the automatic release function does not operate under the following conditions.

- Any door (other than the rear gate) is open.
- The driver's seatbelt is not fastened.

If the parking brake is automatically released, the electronic parking brake indicator light and the indicator light on the electronic parking brake switch turn off.

#### NOTE

*Even if you have applied the parking brake, the parking brake will be automatically released when the accelerator pedal is depressed.*

### Electronic parking brake system warning



#### CAUTION

If the brake system warning light turns on, the electronic parking brake system may be malfunctioning. Immediately stop your vehicle in the nearest safe location and contact your SUBARU dealer.

If a malfunction occurs in the electronic parking brake system, the brake system warning light turns on. Refer to "Electronic parking brake system warning"

☞ P172.

### PARKING TIPS

When parking your vehicle, always perform the following items.

- Apply the parking brake.
- Place the select lever in the "P" (Park) position.

Never rely on the transmission alone to hold the vehicle.

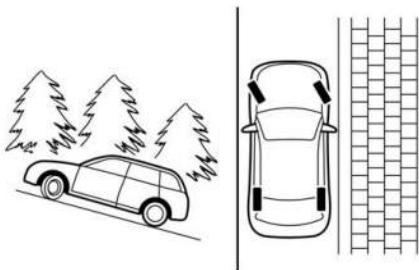

When parking on a hill, always turn the steering wheel as described here. When the vehicle is headed up the hill, the front wheels should be turned away from the curb.

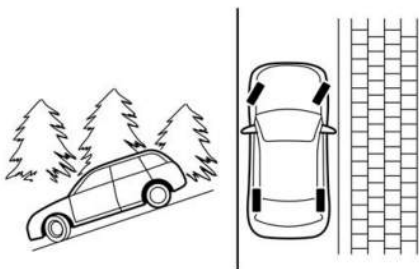

When facing downhill, the front wheels should be turned into the curb.

**CAUTION**

If your vehicle has a bumper under guard (optional), pay attention to blocks and other obstructions on the ground when parking. The underspoiler could be damaged by contact with them.

Otherwise, the vehicle may move unexpectedly, causing serious injury or accidents.

- When washing your vehicle in an automatic car wash
- When being towed

**AUTO VEHICLE HOLD FUNCTION**

The Auto Vehicle Hold function will automatically keep the vehicle stopped even after releasing the brake pedal when the vehicle is at a complete stop, such as at traffic signals.

**CAUTION**

- When stopping on a steep slope with the Auto Vehicle Hold function turned on, the electronic parking brake may be automatically applied. Then the electronic parking brake indicator light will flash. In such a case, depress and hold the brake pedal while stopping. Otherwise, the vehicle may move.
- When being towed, turn off the Auto Vehicle Hold function.

**WARNING**

- Do not use the Auto Vehicle Hold function on a steep hill or slippery road. The vehicle may move even when using the Auto Vehicle Hold function, causing serious injury or accidents.
- Do not use the Auto Vehicle Hold function to park the vehicle. The vehicle may move unexpectedly, causing serious injury or accidents. Make sure to shift the select lever to the “P” position and apply the electronic parking brake in the following cases.
  - When you are going to park your vehicle.
  - When passengers are getting in or out of the vehicle.
  - When you are loading or unloading.
- When using the Auto Vehicle Hold function, do not release the brake pedal before the Auto Vehicle Hold indicator illuminates. The vehicle may move unexpectedly, causing serious injury or accidents.
- Deactivate the Auto Vehicle Hold function in the following cases.

**NOTE**

*We recommend turning on the Auto Vehicle Hold function when stopping on an incline. If the Auto Vehicle Hold function is turned off, the vehicle may roll backward when driving off.*

## To turn on/off the Auto Vehicle Hold function

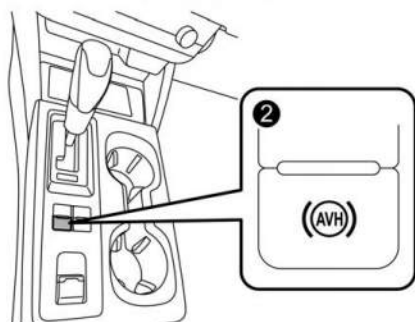
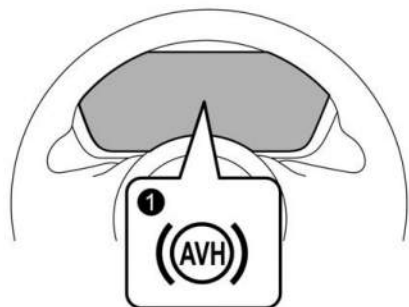

- ① Auto Vehicle Hold indicator light
- ② Auto Vehicle Hold switch

### To turn on:

Press the Auto Vehicle Hold switch when the Auto Vehicle Hold indicator light is OFF. Then the Auto Vehicle Hold indicator light will illuminate.

### To turn off:

Press the Auto Vehicle Hold switch when the Auto Vehicle Hold indicator light illuminates. Then the Auto Vehicle Hold indicator light will turn off.

### NOTE

- When the electronic parking brake system has a malfunction while the Auto Vehicle Hold function is turned on, a chirp will sound, the Auto Vehicle Hold indicator light will turn off and the brake system warning light will turn on.

- Every time when starting the engine, the Auto Vehicle Hold function will be set to "OFF".
- If the Auto Vehicle Hold switch is pressed and held for more than 30 seconds, the Auto Vehicle Hold indicator light will turn off, and the system will ignore any further pressing of the switch. To activate the function again, restart the engine.
- When the Auto Vehicle Hold function is deactivated while the Auto Vehicle Hold function has a malfunction, if you press the Auto Vehicle Hold switch, a chirp will sound.

## To operate the Auto Vehicle Hold function

Stop the vehicle by depressing the brake pedal when all of the following conditions are met. Then the Auto Vehicle Hold function will operate.

- Driver's door is closed.
- The driver's seatbelt is fastened.
- The select lever is in a position other than the "P" position.



While the vehicle is kept stopped by the Auto Vehicle Hold function, the Auto Vehicle Hold indicator light will flash.

## To release the Auto Vehicle Hold function

Perform any of the following operations to release the Auto Vehicle Hold function.

- Depress the accelerator pedal.

- Depress the brake pedal again.
- Apply the electronic parking brake.
- Shift the select lever to the “P” position with the brake pedal pressed.
- Press the Auto Vehicle Hold switch with the brake pedal pressed (The Auto Vehicle Hold function turns off).

When the Auto Vehicle Hold function is released, the Auto Vehicle Hold indicator light will change from flashing to illuminated.

Under any of the following conditions, the Auto Vehicle Hold function will be automatically released and the electronic parking brake will be automatically applied.

- The Auto Vehicle Hold function has been in operation for 10 minutes.
- The driver’s seatbelt is unfastened.
- The ignition switch is turned to the “OFF” position.
- The vehicle is stopped on a steep slope.
- The Auto Vehicle Hold function is malfunctioning.

In such cases, the Auto Vehicle Hold indicator light will turn off and the electronic parking brake indicator light will illuminate.

## Tips

- When the electronic parking brake is automatically applied with the vehicle kept stopped by the Auto Vehicle Hold function, release the electronic parking brake by either of the following operations before starting off. Then make sure that the electronic parking brake indicator light is off.
  - Depress the accelerator pedal with the driver’s seatbelt fastened and with the doors closed.
  - Press the electronic parking brake switch with the brake pedal depressed.

- Under certain conditions, including a malfunction of the Auto Vehicle Hold, a warning buzzer will sound and a warning message will appear on the instrument cluster display. All warning messages should be strictly observed.
- On a steep slope, the vehicle cannot be kept stopped by the Auto Vehicle Hold function. In such a case, depress and hold the brake pedal.
- When stopping on a steep slope with the Auto Vehicle Hold function activated, the electronic parking brake may be automatically applied after stopping, then the electronic parking brake indicator light may flash. In such a case, depress and hold the brake pedal while stopped. Otherwise, the vehicle may move. When getting out of the vehicle, stop the vehicle on a flat surface, then apply the electronic parking brake.
- If the Auto Vehicle Hold indicator light does not illuminate even after pressing the Auto Vehicle Hold switch with the operating conditions met, the function may have a malfunction. Contact your SUBARU dealer for an inspection.
- You may hear a sound while the Auto Vehicle Hold function is keeping your vehicle stopped. This is normal, and does not represent a malfunction.
- When you depress the brake pedal to release the Auto Vehicle Hold function, an operation sound or vibration may be generated, or the brake pedal may return slowly. This is not a malfunction.
- While the vehicle is kept stopped by the Auto Vehicle Hold function, the brake pedal may feel stiff. However, this is not a malfunction.
- When using the Auto Vehicle Hold function, depress the brake pedal firmly. Otherwise, the Auto Vehicle Hold may not operate.

- When the Auto Vehicle Hold switch is pressed and held for more than 30 seconds, the Auto Vehicle Hold indicator light will turn off and further operation of the switch will be ignored. To make the switch usable again, turn the ignition switch to the "OFF" position and then turn it to the "ON" position.

## EMERGENCY BRAKE

If the foot brake has a malfunction, you can stop the vehicle by pulling the electronic parking brake switch continuously.

While applying the emergency brake, the electronic parking brake indicator light and the indicator light on the electronic parking brake switch illuminate and a chirp sounds.



### CAUTION

Use the emergency brake only in case of an emergency. If the emergency brake is excessively used, the brake parts will wear down faster or the brake may not work sufficiently due to brake overheating.

## NOTE

- While using the emergency brake, the electronic parking brake indicator light and the indicator light on the electronic parking brake switch illuminate and a chirp sounds.
- While using the emergency brake, a sound may be heard from the engine compartment. This is the operating sound of the brake that is activated by the Vehicle Dynamics Control system, and does not indicate a malfunction.

## 7-15. HILL START ASSIST SYSTEM

The Hill start assist system temporarily holds the vehicle so that it does not roll downhill even if the brake pedal is released when starting on a slope. This makes it easier to start on a slope.

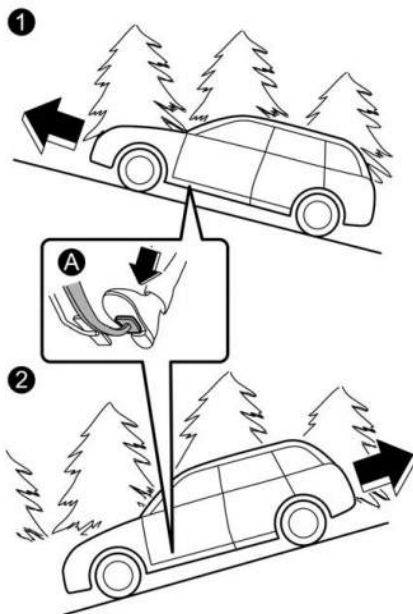

- Starting forward facing uphill
  - Starting backward facing downhill
- A Brake pedal

The Hill start assist system operates when the vehicle has stopped with the brake pedal depressed.

Braking power is maintained temporarily (for approximately 2 seconds) by the Hill start assist system after the brake pedal is released. The driver is therefore able to start the vehicle in the same way as on a level grade, just using the accelerator pedal.



If the braking power of the Hill start assist system is insufficient after the brake pedal is released, apply more braking power by depressing the brake pedal again.

 **CAUTION**

- The Hill start assist system is a device only for helping the driver to START the vehicle on an uphill grade. To prevent accidents when the vehicle is parked on a slope, be sure to firmly set the parking brake. When setting the parking brake, make sure that the vehicle remains stationary when the brake pedal is released.
- Do not turn the ignition switch to the "OFF" position while the Hill start assist system is operating. The Hill start assist system will deactivate, causing an accident.

The Hill start assist system may not operate on slight grades. Also, the Hill start assist system does not operate in the following cases.

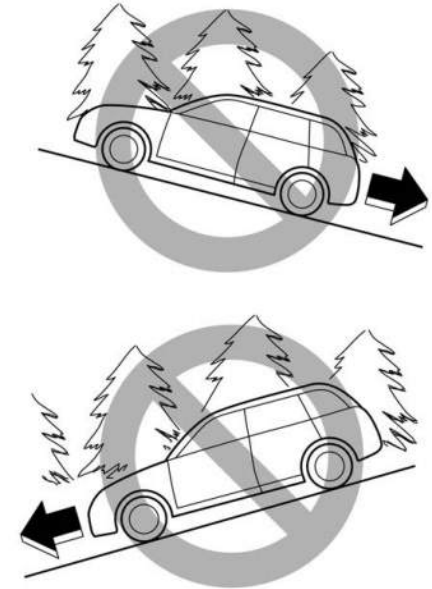

- When starting backward facing uphill
- When starting forward facing downhill
- While the parking brake is applied
- While the ignition switch is in the "ACC" or "OFF" position
- While the Vehicle Dynamics Control warning light is illuminated. Refer to "Vehicle Dynamics Control Warning Light/Vehicle Dynamics Control Operation Indicator Light" [P175](#).
- While the Auto Start Stop warning light is illuminated. Refer to "Auto Start Stop Warning Light (Yellow)" [P181](#).

 **CAUTION**

The braking power of the Hill start assist system may not be sufficient when strong braking power is needed (e.g., when towing a trailer).

**NOTE**

- *A slight jolt may be felt when the vehicle begins to move forward after being reversed.*
- *When using the Hill start assist system, a braking effect may be felt even after the brake pedal has been released.*
- *The Hill start assist system will deactivate when the Auto Vehicle Hold function is activated.*

**7-16. AUTO START STOP SYSTEM**

The Auto Start Stop system is designed to automatically stop and restart the engine when the vehicle is stationary for a short period of time (while waiting for a traffic light or in a traffic jam) after the engine has warmed up. The system operates in order to reduce fuel consumption, exhaust emissions and undesired idling noise.

**SYSTEM OPERATION****WARNING**

Turn off the Auto Start Stop system before towing the vehicle.

**CAUTION**

The Auto Start Stop system is designed to automatically stop and restart the engine for a short period of time during idling. Do not use the system when parking the vehicle normally.

So that it can be used safely and comfortably, in addition to driver operations, the Auto Start Stop system is designed to constantly monitor the vehicle conditions as well as the environment inside and outside the vehicle, in order to control stopping and restarting of the engine.

After the vehicle has been completely stopped by depressing the brake pedal with the select lever in the “D” position, the engine will be automatically stopped.

If you release the brake pedal with the select lever kept in the “D” position, the engine will be automatically restarted.

However, when the Auto Vehicle Hold indicator light illuminates, the engine will not restart.

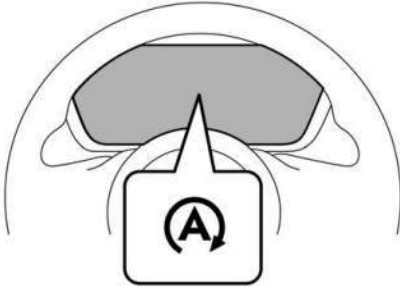
**Auto Start Stop indicator light (green)**

If the engine is temporarily stopped by the system, the Auto Start Stop indicator light on the instrument cluster will illuminate in green. This indicator light will turn off when the system restarts the engine.

**NOTE**

- After starting the engine, if the vehicle is left idling without being driven, the Auto Start Stop system will not operate.
- Your vehicle is equipped with a special high-performance battery. When replacing the vehicle battery, be sure to replace it with a genuine SUBARU battery (or equivalent) designed specifically for use in a vehicle equipped with the Auto Start Stop system. For details, consult your SUBARU dealer.

**Operational conditions**

The engine can be automatically stopped by the Auto Start Stop system when all of the following conditions are met.

- The engine is sufficiently warmed up.
- The engine hood is closed.
- The driver's door is closed.
- The driver's seatbelt is fastened.
- The CHECK ENGINE warning light/malfunction indicator light is off.\*1
- The airflow mode selection is set to a mode other than "OFF" mode.

- The rear window defogger is not in use.
- X-MODE has been turned off.

After the vehicle is stopped, the engine will be automatically stopped when the following conditions are met.

- The steering wheel is in the straight ahead position.
- The steering wheel is not being operated.

\*1: Even if the CHECK ENGINE warning light/malfunction indicator light is illuminated, the Auto Start Stop system may operate when the system recovers from the malfunction.

**NOTE**

- After the vehicle is stopped, the engine may not automatically stop under the following conditions.
  - The vehicle is stopped on a road with a steep slope.
  - The vehicle is stopped by hard braking.
- After the vehicle is stopped, the engine may not automatically stop if the brake pedal is not fully depressed. Make sure to depress the brake pedal firmly when stopping the vehicle.
- In the following cases, it may take some time for the Auto Start Stop system to operate.
  - When the battery is discharged because the vehicle has not been used for a long period of time, etc.
  - The coolant temperature is low.
  - When the battery terminals have been reconnected after replacing the battery, etc.

**Non-operational conditions**

In any of the following cases, the Auto Start Stop system will not operate.

- When the Auto Start Stop warning light/Auto Start Stop OFF indicator light is illuminating.

- When the CHECK ENGINE warning light/malfunction indicator light is illuminating.\*1
- The electronic parking brake is applied.
- When the engine hood is opened.
- When the CVT fluid is not sufficiently warmed up.
- When the temperature of the CVT fluid is abnormally high.
- When the vehicle battery is not in good condition.
- When using the climate control system, the temperature difference between the setting temperature and the temperature inside the vehicle is significant.
- When using the climate control system, the amount of air flow is significant.

\*1: Even if the CHECK ENGINE warning light/malfunction indicator light is illuminated, the Auto Start Stop system may operate when the system recovers from the malfunction.

### NOTE

The Auto Start Stop system may not operate in the following cases:

- The CHECK ENGINE warning light/malfunction indicator light or other warning lights on the instrument cluster are illuminated or flashing.
- You are driving the vehicle in a high-elevation area.

### Engine restart operational conditions

In any one of the following cases, the engine will be automatically restarted even if the brake pedal is kept depressed.

- When slightly releasing the brake pedal on road with a steep slope and the vehicle begins rolling.
- When further depressing the brake pedal.

- When depressing the accelerator pedal.
- When you move the select lever to the "R" position.
- When turning the steering wheel.
- When operating the electronic parking brake switch.
- When activating X-MODE.
- When the airflow mode selection set to "⌘" mode.
- When the climate control system can no longer maintain the set temperature.
- When unbuckling the driver's seatbelt.
- When opening the driver's door.
- When activating the rear window defogger.
- When the Auto Vehicle Hold function is released, refer to "Auto Vehicle Hold Function" ⓄP343.

### Engine restart non-operational conditions



#### WARNING

Do not open the engine hood when the Auto Start Stop system is in operation. It may cause the vehicle to move while on a slope, the steering wheel operation may become heavy, or the brakes may not work well, which can create dangerous conditions.

To ensure safety, the engine will not be automatically restarted if the engine hood is opened when the Auto Start Stop system is in operation, even if the brake pedal is released. In this case, check the surrounding area and restart the engine by normal operation.

Also, when the Auto Vehicle Hold operation indicator light is illuminated, the engine will not restart.

**NOTE**

- When the Auto Start Stop system is in operation, the brake pedal may feel stiff. However, this is not a malfunction.
- When the battery is discharged, the engine will be automatically restarted even if you keep the brake pedal depressed.
- In the following cases, the length of time that the engine is temporarily stopped by the Auto Start Stop system may be shorter.
  - When the climate control system is in operation.
  - When the outside temperature is high, or when it is low (because the climate control system can no longer maintain the set temperature).
  - When consumption of electricity by electrical components is high.
- When the engine is automatically restarted by the Auto Start Stop system, the power provided via the accessory power outlet will be reduced. Depending on the connected appliance, the power of the appliance may temporarily turn off.

malfunction in the Auto Start Stop system. When starting the engine again after the Auto Start Stop warning light illuminates, if it is still illuminating, we recommend that you have your vehicle inspected at a SUBARU dealer as soon as possible.

The Auto Start Stop warning light will illuminate in yellow if you open the engine hood when the engine has been temporarily stopped by the Auto Start Stop system.

In this case, to ensure safety, the engine will not be automatically restarted, even if you release the brake pedal. Use normal operation to restart the engine.

7

**To turn on/off the Auto Start Stop system**

**Auto Start Stop warning light (yellow)**

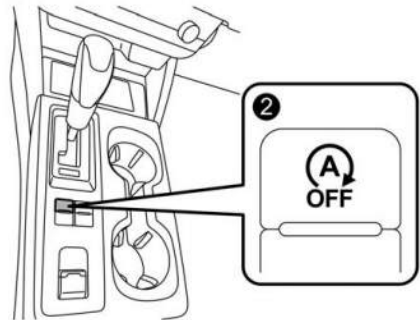
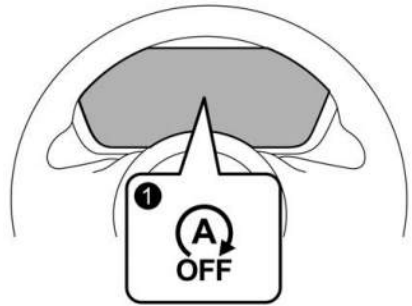
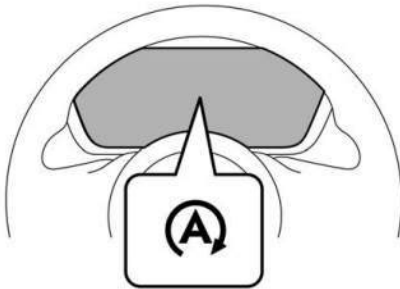

**⚠ CAUTION**  
If the Auto Start Stop warning light is illuminated in yellow, there may be a

- ① Auto Start Stop OFF indicator light
- ② Auto Start Stop OFF switch

If the Auto Start Stop OFF switch is pressed, operation of the Auto Start Stop system will be disabled. The Auto Start Stop OFF indicator light on the instrument cluster display will illuminate. If the switch is pressed once more, the Auto Start Stop system will turn on again. The Auto Start Stop OFF indicator light will then turn off.

While the engine is temporarily stopped by the system, if the Auto Start Stop system turns off, the engine will be restarted even if you do not release the brake pedal.

#### NOTE

- *If the engine is restarted when the Auto Start Stop system is not operational and the ignition switch has been turned to the "OFF" position, the Auto Start Stop system will turn on again.*
- *Be sure to turn the ignition switch to the "OFF" position when leaving the vehicle. Failure to do so could result in the battery discharging.*

### Auto Start Stop No Activity Detected indicator light

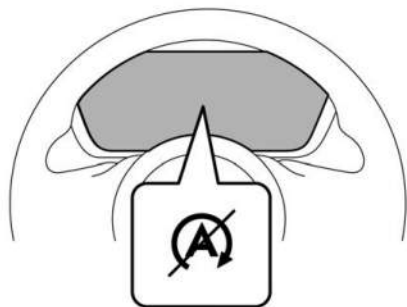

If the operational conditions are not met when the vehicle is stopped, the engine will not stop and the Auto Start Stop No Activity Detected indicator light will illuminate. It will turn off when the vehicle begins to drive.

### DISPLAYING THE AUTO START STOP SYSTEM STATUS

Approximate indications of the time that the engine has been stopped by the Auto Start Stop system and/or the amount of fuel saved can be displayed on the instrument cluster display. For details, refer to "Basic Screens"  P191.

### SYSTEM WARNING

So that it can be used safely and comfortably, the Auto Start Stop system is designed to constantly monitor the vehicle conditions as well as the environment inside and outside the vehicle in addition to driver operations, and to provide various warnings to the driver via the warning light and/or indicator light illuminating and a buzzer sounding. For details about the warning light and indicator light, refer to "Auto Start Stop Warning Light (Yellow)"  P181.

#### Warning buzzer

The buzzer will sound when the engine hood is opened while the engine is stopped by the Auto Start Stop system.

When this occurs, the buzzer will stop sounding when the following operations are performed.

- The engine is restarted by normal operation. (Refer to "Preparing to Drive"  P309.)
- The ignition switch is turned to the "OFF" position.

#### Display of warning messages

If a warning message is displayed on the instrument cluster display while driving, a malfunction may have occurred in the Auto Start Stop system. In this case, the Auto Start Stop warning light will illuminate. Have your vehicle inspected at a SUBARU dealer as soon as possible.

## 7-17. SURROUND VIEW MONITOR (If Equipped)

Surround View Monitor is a feature that displays camera images on the center information display to allow the driver to check the blind spots of the vehicle. You can use it to check the area in the front of the vehicle, when starting the vehicle or while driving, and the area to the rear of the vehicle, when backing up. You can also use it to check your surroundings when parking the vehicle.

### WARNING

- Never rely on only the Surround View Monitor when driving the vehicle. The image on the monitor screen may appear different from the vehicle's actual surroundings. If you drive the vehicle by viewing only the monitor image, a collision or an accident may occur. When driving the vehicle, always remain alert and check the surrounding traffic directly and by using the mirrors.
- Do not use the Surround View Monitor in the following situations.
  - You are driving on a dirt road or a road covered in snow.
  - The camera malfunctions (e.g. the lens or bracket is broken).
  - The outside mirrors are retracted.
  - The front door is not fully closed.
- If the outside temperature is low, the monitor screen may become dark or the image may become dim. In particular, the image of a moving object may appear distorted or disappear from the screen. Always remain alert and check the surrounding traffic directly when driving.

### NOTE

If any of the following malfunctions occur in the Surround View Monitor system, refer to “Malfunctions of the Center Information Display”  P454.

- The screen becomes blue or black.
- The screen does not switch to the image of the Surround View Monitor.
- The camera status indicator is not displayed on the screen.

## HOW TO CHANGE THE DISPLAY OF SURROUND VIEW MONITOR

When the ignition switch is in the “ON” position, you can operate the select lever and the view monitor switch to display the image on the Surround View Monitor.

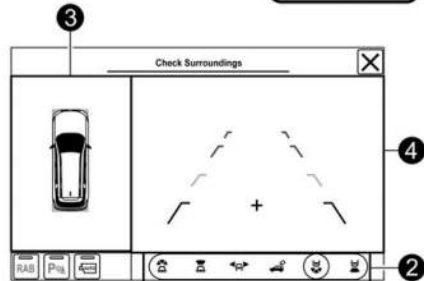
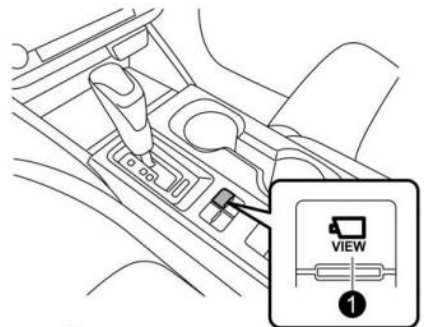

- ① View monitor switch
- ② View icon
- ③ Top view screen
- ④ View screen

The top view screen of the Surround View Monitor is always displayed when it is active. The view screen can be changed to Side/Front/Rear/3D by pressing the view monitor switch or the view icon.

### When the select lever is in the “P” position

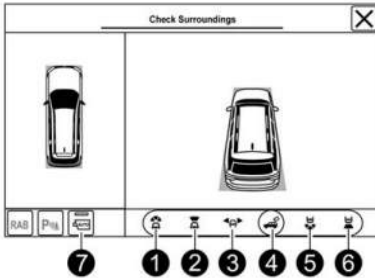

- ① Front wide view icon
- ② Front view icon
- ③ Side view icon
- ④ 3D view icon
- ⑤ Rear wide view icon
- ⑥ Rear view icon
- ⑦ AUTO mode icon

When the view monitor switch is pressed while the select lever is in the “P” position, the surround view monitor is displayed. Pressing the view monitor switch or touching the view icon while the image of the camera is displayed will switch the screen view.

#### NOTE

*Touch the AUTO mode icon to turn on the AUTO mode. The AUTO mode indicator will illuminate. In AUTO mode, the Surround View Monitor automatically turns on when the vehicle speed decreases to 9 mph (15 km/h) or less and displays the previously shown view screen. To turn off AUTO mode, touch the AUTO mode icon again. The AUTO mode indicator will turn off.*

### When the select lever is in the “R” position

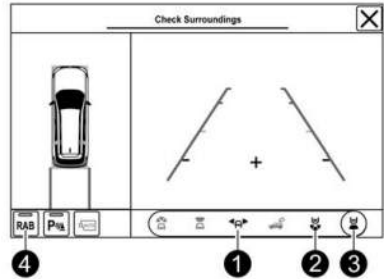

- ① Side view icon
- ② Rear wide view icon
- ③ Rear view icon
- ④ Reverse Automatic Braking (RAB) system ON/OFF icon

When the select lever is moved to “R”, the image in the rearward direction is displayed. Pressing the view monitor switch or touching the view icon while the image of the rear camera is displayed will switch the screen view.



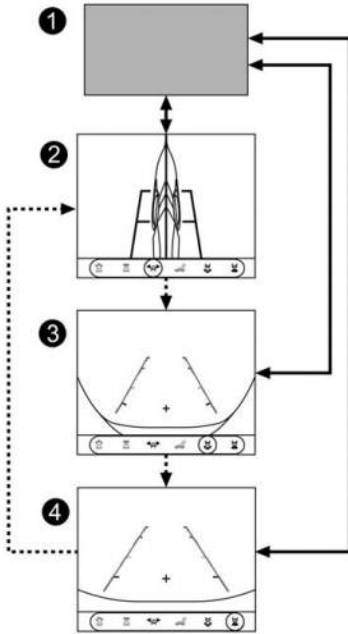

- ① Original screen
- ② Side view screen
- ③ Rear wide view screen
- ④ Rear view screen

—>: Shift the select lever

----->: Press the view monitor switch

**NOTE**

- If you turn off the Surround View Monitor or use it to operate another function, the next time the image is displayed, the previously displayed screen will be shown. However, if the side view screen is displayed when you turn off the Surround View Monitor, the next time the monitor image is displayed, the rear view screen or the rear wide view screen will be shown.
- When “Camera Off Delay” is on, the rear-view image will be displayed on the center information display for a certain period after the select lever is shifted from the “R” position to another position (other than the “P” position). To turn the function on and off, refer to

“EyeSight/Driving Assistance”  
P202.

**When the select lever is in the “N” or “D” position**

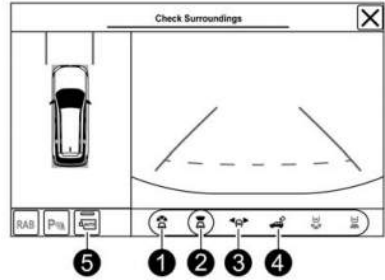

- ① Front wide view icon
- ② Front view icon
- ③ Side view icon
- ④ 3D view icon
- ⑤ AUTO mode icon

When the view monitor switch is pressed while the select lever is in the “N” or “D” position, the surround view monitor is displayed.

Pressing the view monitor switch or touching the view icon while the image of the camera is displayed will switch the screen view.

**NOTE**

- If you turn off the Surround View Monitor or use it to operate another function, the next time the image is displayed, the previously displayed screen will be shown.
- Touch the AUTO mode icon to turn on the AUTO mode. The AUTO mode indicator will illuminate. In AUTO mode, the Surround View Monitor automatically turns on when the vehicle speed decreases to 9 mph (15 km/h) or less and displays the previously shown view screen. To turn off AUTO mode, touch the AUTO mode icon again. The AUTO mode indicator

will turn off.

## HOW TO CANCEL SURROUND VIEW MONITOR

There are several ways to cancel Surround View Monitor.

### Manual cancellation

The Surround View Monitor will be canceled by either of the following operations.

- Press the view monitor switch until the original screen is displayed (when the select lever is other than the “R” position).
- Move the select lever to a position other than the “R” position (when the select lever is in the “R” position).
- Touch .

### Automatic cancellation

If any of the following conditions are met, the Surround View Monitor is canceled automatically.

- When the select lever is other than in the “R” position
  - About 3 minutes have elapsed since you pressed the view monitor switch to access the Surround View Monitor.
- When the select lever is not in the “R” or “P” position
  - The vehicle accelerates to 13 mph (20 km/h) or more.
  - You depress the brake pedal and pull up the electronic parking brake switch to apply the parking brake.
- When the select lever is in the “D” or “R” position
  - The select lever is shifted to the “P” position.

## HOW TO VIEW THE CAMERA IMAGES

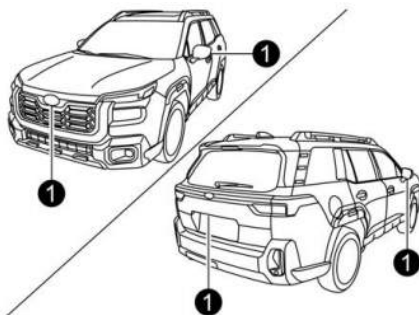

1 Cameras

The camera image displays guiding lines that provide information on the distance and direction of travel of your vehicle, as well as information on any vehicles you are approaching.



### CAUTION

- When you drive the vehicle, do not rely only on the guiding lines. Make sure that you check your surroundings directly.
- The position and other information provided by the guiding lines may differ from the actual distance of objects from the vehicle if it is tilting at an angle relative to the road surface due to the number of passengers or the distribution of cargo on board the vehicle.

### NOTE

- *Top view and rear view only: The display of the predicted course line linked to the steering angle can be turned on/off by operating “Steering Angle Guides” in the center information display. To turn the function on and off, refer to “EyeSight/Driving Assistance” P202.*
- *The camera image may be hard to see in the following situations. This is not a*

malfunction.

- Vehicle surroundings are dark (such as at night).
  - Ambient temperature outside the vehicle is high or low.
  - There is water or humidity on the lens (such as in rainy weather).
  - There is foreign material (such as mud) on or near the camera.
  - Sunlight or a headlight beam shines directly toward the camera lens.
- Under an artificial light such as a fluorescent lamp, sodium-vapor lamp or mercury lamp, the lighted portion may appear to flicker (flicker phenomenon).
  - When the display is cold, the image may leave traces or become darker than usual, causing a difficulty in viewing the screen. When driving your vehicle, make sure that you check your surroundings directly for traffic.
  - The following conditions may affect the appearance of the screen, but any resulting image distortion on the screen does not indicate a malfunction.
    - When humidity is high on a rainy day, the camera lens becomes foggy.
    - When driving at night, the light from a vehicle or building located ahead shines in the direction of the camera.
    - When the vehicle is in a dark place or when driving at night, the camera image may be adjusted to make image noise less visible. Therefore, the image may look like a monochromatic image or the image colors may differ from the actual colors. The image sharpness in the center and in the four corners of the screen may differ. This is not a malfunction.
  - The image of the surround view monitor may appear to be slightly different from the actual color of the objects.

### 3D view

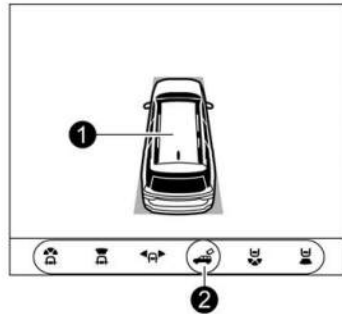

- ① Vehicle icon
- ② 3D view icon

The 3D view displays the area around the vehicle.

### Top view

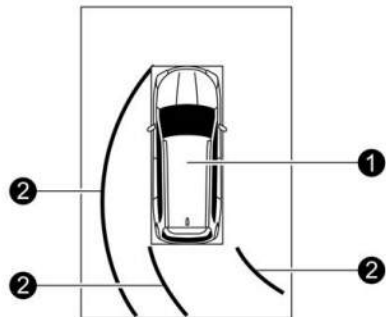

- ① Vehicle icon
- ② Predicted course line\*

\*: When the select lever is in the "R" position.

The top view displays an image of the vehicle's surroundings from above the vehicle. This view is useful for checking the vehicle's surroundings when you are driving.

## Front view/front wide view

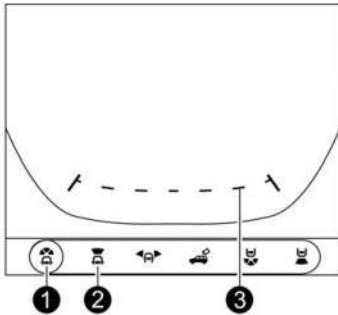

- ① Front wide view icon
- ② Front view icon
- ③ Guiding lines

The guiding lines that indicate the width and the front end of your vehicle are displayed on the monitor.

## Side view

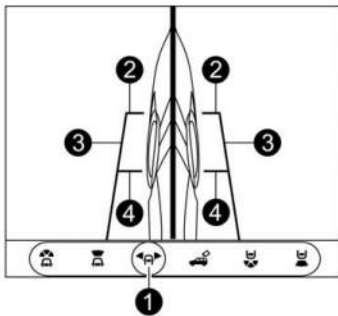

- ① Side view icon
- ② Front-of-vehicle guiding line
- ③ Side-of-vehicle guiding line
- ④ Center-of-front-tire guiding line

The guiding lines that indicate the width and the front end of the vehicle are displayed on the monitor.

## Rear view/rear wide view

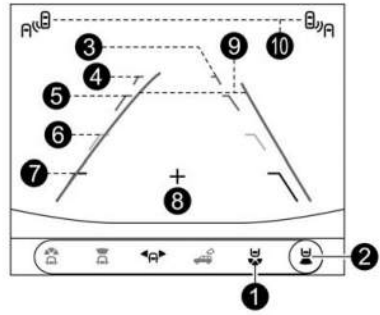

- ① Rear wide view icon
- ② Rear view icon
- ③ Vehicle width line (oblique vertical line)
- ④ Approx. 10 ft (3 m) from the bumper (green horizontal line)
- ⑤ Approx. 6 ft (2 m) from the bumper (green horizontal line)
- ⑥ Approx. 3 ft (1 m) from the bumper (yellow horizontal line)
- ⑦ Approx. 1.5 ft (0.5 m) from the bumper (red horizontal line)
- ⑧ Vehicle centerline
- ⑨ Dynamic guidelines
- ⑩ Approaching vehicle icon (Rear Cross Traffic Warning (RCTW))

The help lines are a guide to help you judge distances based on the screen image.

## RANGE OF SURROUND VIEW MONITOR

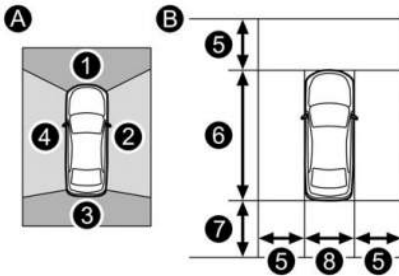

- A** Camera to be used
- B** Range of displayed image
- 1** Front camera
- 2** Side camera (right-hand side)
- 3** Rear camera
- 4** Side camera (left-hand side)
- 5** Approx. 6 ft (2 m) from the vehicle
- 6** Vehicle overall length
- 7** Approx. 8 ft (2.5 m) from the vehicle
- 8** Vehicle overall width

### **! WARNING**

The range that can be viewed with the camera is limited. Always make sure that you check your surroundings directly when the vehicle is in motion and proceed slowly. If you do not, it may cause an accident or injury.

### NOTE

- The range of the displayed image may differ depending on the status of your vehicle or of the road surface.
- Because the Surround View Monitor system uses a specially designed lens, the sense of distance in the displayed image is different from the actual distance.

## USING THE CAMERA

### **! CAUTION**

Obey the following instructions to prevent a system malfunction.

- Do not apply any strong impact to the camera such as by hitting it with an object. Striking the camera can change the mounting angle.
- The camera unit is a waterproof structure. Do not attempt to remove, disassemble or modify the unit.
- Do not vigorously rub the camera lens or polish it using a hard brush or abrasive compounds. The lens may be scratched, which can affect the camera image.
- The camera lens is made of glass or plastic. Do not allow any organic solvent, body wax, oil film remover or glass coating agent to become attached on the lens surface. If any becomes attached, remove it immediately.
- Do not expose the camera lens to any sudden temperature change such as spraying hot water on it in cold weather.
- Do not apply the water jet of a high pressure washer to the camera or the surrounding area when cleaning the vehicle. The force of the water pressure can dislodge the camera. Also, water may enter inside the camera and cause a malfunction.
- If the camera is exposed to any impact, it can lead to a malfunction. Have the camera inspected by your SUBARU dealer as soon as possible.
- Do not use a steam cleaner under any circumstances. Some types of steam cleaners inject hot steam.

- The camera surface may be damaged by a flying stone.

### NOTE

If the camera lens is covered in dirt, the system will not be able to produce a sharp image. If there is foreign material on the camera, such as water drops, snow or mud, clean it with water and wipe away any moisture with a soft cloth. If the camera is heavily soiled, wash it using a neutral detergent.

## FRONT CROSS TRAFFIC INFORMATION (If Equipped)

While the Surround View Monitor is being displayed, the presence of vehicles approaching from the left and right is indicated by icons. If the select lever is set to the "D" position or the "M" position and the system detects an approaching vehicle while the vehicle is stopped, the icon will illuminate.

If the system detects an approaching vehicle (including motorcycle) while the vehicle is traveling at a speed of approximately 13 mph (20 km/h) or less, the icon will flash and alert the driver using a warning message, an alarm sound, and the EyeSight Assist Monitor display.

For details about the EyeSight Assist Monitor, refer to the Owner's Manual supplement for the EyeSight system.

### NOTE

When the AUTO mode icon is activated on the Surround View Monitor and the system detects a vehicle, only the approaching vehicle icon will blink.

e.g., when the front view screen is displayed

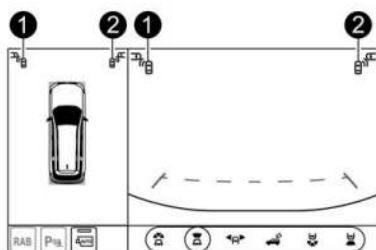

- ① When there is a vehicle approaching from the left
- ② When there is a vehicle approaching from the right



### WARNING

- The driver is responsible for driving safely. Before you start driving, check the vehicle surroundings with the brake depressed.
- Depending on the vehicle condition or the surrounding environment, the radar sensors ability to detect objects may become unstable.
- The system is not activated when the speed of an approaching vehicle is less than 3 mph (5 km/h) or more than 37 mph (60 km/h).

## To turn On/Off the Front Cross Traffic Information

To turn the Front Cross Traffic Information on and off, operating “Brake and Warning” in the center information display. Refer to “EyeSight/Driving Assistance” P202.

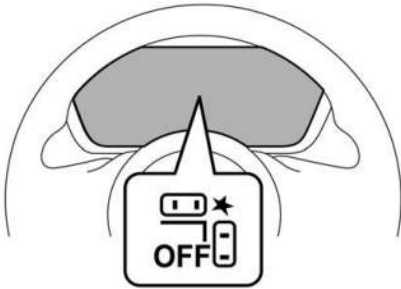

When the Front Cross Traffic Information function is turned OFF, the Front Cross Traffic Braking OFF indicator on the instrument cluster display will illuminate.

## Handling of front radar sensors

### Front radar sensors



There are two radar sensors mounted inside the front bumper, one on each side of the vehicle.

### Areas of the vehicle that cannot be repaired

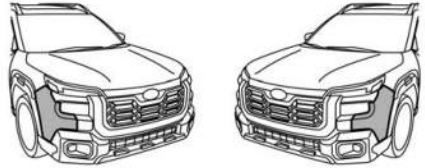

### CAUTION

To ensure correct operation of the Front Cross Traffic Information, obey the following precautions.

- Always keep the bumper surface near the radar sensors clean.
- Do not affix any stickers or other items on the bumper surface near the radar sensors. We recommend that you consult your SUBARU dealer for details.
- Do not modify the bumper near the radar sensors.
- Do not paint the bumper near the radar sensors.
- Do not expose the bumper near the radar sensors to strong impacts. If a sensor becomes misaligned, a system malfunction may occur that affects the functions that detect vehicles in the detection areas. If any strong impact is applied to the bumper, contact your SUBARU dealer for an inspection.
- Do not disassemble the radar sensors.

**NOTE**

If the radar sensors require repair or replacement, or the bumper area around the radar sensors requires repair, paint-work or replacement, contact your SUBARU dealer for assistance.

**REAR CROSS TRAFFIC WARNING (RCTW)**

When the rear view is displayed, the icon flashes when the Rear Cross Traffic Warning (RCTW) detects a vehicle approaching on the left or right from behind the vehicle. For details about Rear Cross Traffic Warning (RCTW), refer to “Rear Cross Traffic Warning (RCTW)” P368.

e.g., when the rear view screen is displayed

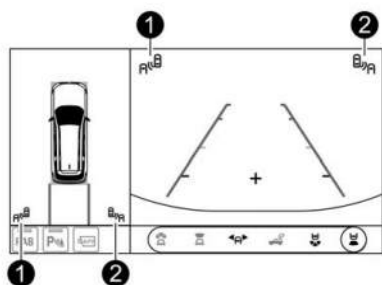

- 1 When there is a vehicle approaching from the left
- 2 When there is a vehicle approaching from the right

**HOW TO GET THE SOURCE CODE THAT USES OPEN SOURCE SOFTWARE**

Free Open-Source Software Information: This product uses Free Open-Source Software (FOSS).

The license information and/or the source code of such FOSS can be found at the following URL:

<http://car.panasonic.jp/oss/n02yrf1e>

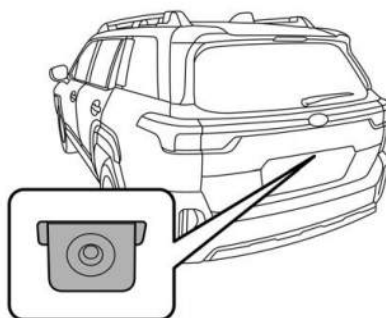
**7-18. REAR VIEW CAMERA (If Equipped)**

A rear view camera is attached to the rear gate. When the ignition switch is in the “ON” position and the select lever is set to “R”, the rear view camera automatically displays the rear view image behind the vehicle on the center information display.

**! WARNING**

- Since the rear view camera uses a wide-angle lens, the image on the monitor is different from the actual view in terms of distance.
- Since the range of the image on the monitor is limited, always check the rear view and the surrounding area with your eyes and mirrors, and move backward at a slow speed. Moving backward only by checking the rear view image from the camera could cause an accident.
- Do not disassemble or modify the camera, switch or wiring. If smoke comes out or you smell a strange odor, stop using the rear view camera immediately. Contact your SUBARU dealer for an inspection. Continued use may result in accident, fire or electric shock.



 **CAUTION**

- When washing your vehicle with a high-pressure washer, do not allow water to touch the camera directly. Entry of water in the camera lens may result in condensation, malfunction, fire or electric shock.
- Since the camera is a precision device, do not subject it to strong impacts. Otherwise, malfunction, fire or electric shock may occur.
- If mud or snow sticks to or is frozen on the camera, you must be very careful when removing it. Otherwise, damage to the camera may cause a fire or electric shock. Pour water or lukewarm water over the camera to remove mud and ice, and wipe it with a soft, dry cloth.
- Do not put a flame close to the camera or wiring. Otherwise, damage or fire may occur.
- When replacing the fuse, be sure to use a fuse with the specified rating. Use of a fuse with a different rating may result in a malfunction.
- If you use the rear view camera for a long time while the engine is not operated, the battery may become completely discharged.

**NOTE**

- *Do not wipe the camera with alcohol, benzine or paint thinner. Otherwise, discoloration may occur. To remove contamination, wipe the camera with a cloth moistened with a diluted neutral detergent. Then wipe it with a soft, dry cloth.*
- *When waxing the vehicle, be careful not to apply the wax to the camera. If it comes in contact with the camera, moisten a clean cloth with a diluted neutral detergent to remove the wax.*
- *The camera lens has a hard coating to help prevent scratches. However,*

*when washing the vehicle or cleaning the camera lens, be careful not to scratch the camera lens. Do not use a washing brush directly on the camera lens. The image quality of the rear view camera may deteriorate.*

- *Strong light shined on the camera lens may develop vertical lines around the light source. This is not a malfunction.*
- *Under the fluorescent light, the display may flicker. However, this is not a malfunction.*
- *The image of the rear view camera may be slightly different from the actual color of the objects.*
- *If any of the following malfunctions occur in the rear view camera system, refer to “Malfunctions of the Center Information Display” P454.*
  - *The screen becomes blue or black.*
  - *The screen does not switch to the image of the rear view camera.*
  - *The camera status indicator is not displayed on the screen.*

**HOW TO USE THE REAR VIEW CAMERA**

When the select lever is set to “R”, the rear view camera automatically displays the rear view image from the vehicle. When the lever is set to other positions, the image before setting to “R” is displayed.

1. Set the ignition switch to “ON”.
2. Set the select lever to “R”.

**NOTE**

- *The image of the rear view camera is horizontally reversed as is the case with the vehicle inside mirror or the outside mirror.*
- *When “Camera Off Delay” is on, the rear view image will be displayed on the center information display for a certain period of time after the select lever is shifted to a position other than the “P” position from “R”. To turn the function on and off, refer to “EyeSight/*

Driving Assistance” P202.

- It may be difficult to see the image of the rear view camera in the following cases. This is not a malfunction of the camera.
  - The vehicle is in a dark place (at night, in a tunnel, etc.).
  - The vehicle is in an extremely hot or cold place.
  - An object (such as raindrops, snow, dirt, etc.) that disturbs the view of the rear view camera sticks to the lens of the camera.
  - Strong light is shining directly on the camera lens (occasionally, there are vertical lines on the screen).

## VIEWING RANGE ON THE SCREEN



### CAUTION

The range that can be viewed with the rear view camera is limited. Always be sure to check with your eyes when moving backward and proceed slowly. Otherwise, it may cause an accident or injury.

Range of view

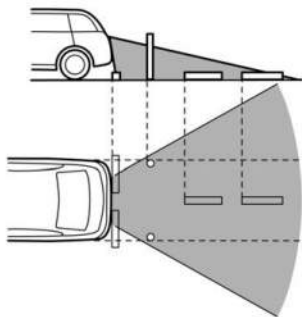
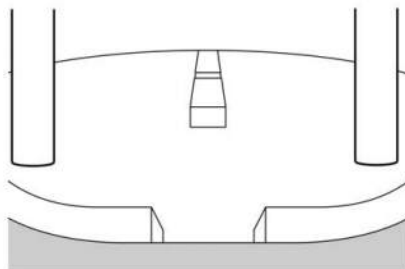

Image from camera



The area from the rear end of the bumper can be viewed. Areas at both ends of the bumper and areas just under the bumper cannot be viewed.

Also, the image from the rear view camera looks shorter than the actual distance.

Range of view

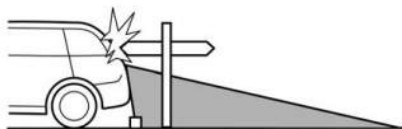
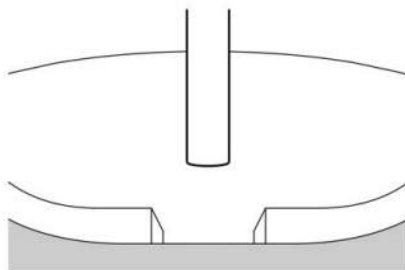

Image from camera



The area above the camera cannot be viewed. If there is an object that has a

wide projection on its upper part such as a sign pole behind the vehicle, the projection cannot be seen on the screen.

## HELP LINES

The help lines are a guide to help you realize the actual distance from the screen image.

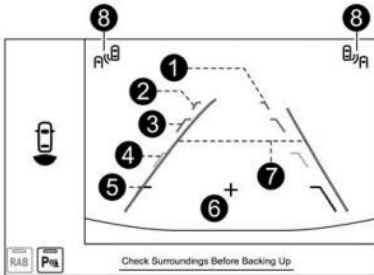

- ❶ Vehicle width line (oblique vertical line)
- ❷ Approx. 10 ft (3 m) from the bumper (green horizontal line)
- ❸ Approx. 6 ft (2 m) from the bumper (green horizontal line)
- ❹ Approx. 3 ft (1 m) from the bumper (yellow horizontal line)
- ❺ Approx. 1.5 ft (0.5 m) from the bumper (red horizontal line)
- ❻ Vehicle centerline
- ❼ Dynamic guidelines
- ❽ Approaching vehicle icon (Rear Cross Traffic Warning (RCTW)) (if equipped)

When the select lever is set to “R”, the monitor screen displays the help lines together with the rear view image.

### NOTE

*If you shift to the “R” range within several seconds after turning on the ignition switch, the warning message may not be displayed. Wait for several seconds after turning on the ignition switch before shifting to the “R” range. Then, the warning message will be displayed.*

### CAUTION

- When moving backward, always check the back with your eyes without relying on the help lines. Otherwise, it may cause an accident or injury.
- The actual position may be different from the indication of the help lines.
- Differences may occur due to the number of passengers or the loaded cargo.
- When the vehicle is on a slope or inclined against the road, the indication is different from the actual position.

### NOTE

*When “Steering Angle Guides” is off, the dynamic guidelines will disappear on the center information display. To turn the dynamic guidelines on and off, refer to “EyeSight/Driving Assistance” P202.*

### Difference between screen image and actual road

The distance markers show the distance for a level road when the vehicle is not loaded. It may be different from the actual distance depending on the loading conditions or road conditions.

When there is an upward slope at the back:

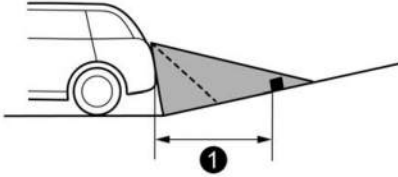

① 3 ft (1 m)

The distance on the screen looks farther than the actual distance.

When there is a downward slope at the back:

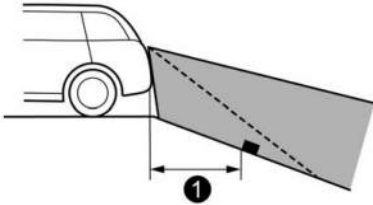

① 3 ft (1 m)

The distance on the screen looks nearer than the actual distance.

#### NOTE

When cargo is loaded, the rear view distance on the screen looks farther than the actual distance as in an upward slope.

Feature of distance marker

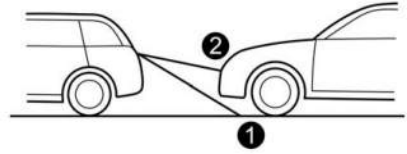

① 3 ft (1 m) line

② 10 ft (3 m) line

The distance marker shows the distance on the road. If there is a car or another object close behind, distance cannot be correctly displayed.

## 7-19. BSW/RCTW

The BSW/RCTW consists of rear corner radar sensors with Blind Spot Warning and Rear Cross Traffic Warning.

These functions of BSW/RCTW are the systems that detect objects and vehicles to the rear and draw attention to the driver when changing a lane or when driving in reverse.

### WARNING

The driver is responsible for driving safely. Always be sure to check the surroundings with your eyes when changing lanes or reversing the vehicle.

The system is designed to assist the driver in changing lanes or reversing safely by monitoring the rear and side areas of the vehicle. However, you cannot rely on this system alone in assuring the safety during a lane change or reversing. Overconfidence in this system could result in an accident and lead to serious injury or death. Since the system operation has various limitations, the flashing or illumination of the BSW/RCTW approach indicator light may be delayed, or the warning buzzer may be delayed or inoperative, even if there is a vehicle traveling in a neighboring lane or approaching your vehicle from either side.

The driver is responsible for paying attention to the rear and side areas of the vehicle.

### CAUTION

In the following cases, turn off the BSW/RCTW system. The system may not operate properly due to blocked radar waves.

- When towing a load
- When a bicycle carrier or other item is fitted to the rear of the vehicle

- When using a chassis dynamometer or free roller device, etc.
- When running the engine and making the wheels rotate while lifting up the vehicle

## SYSTEM FEATURES

BSW/RCTW consists of the following functions.

- To detect a vehicle in a blind spot on a neighboring lane or a vehicle approaching at high speed while driving the vehicle (Blind Spot Warning)
- To detect a vehicle approaching from the right or left while reversing the vehicle (Rear Cross Traffic Warning)

The system uses rear radar sensors for the following features.

### NOTE

The BSW/RCTW radar sensor is approved under the radio wave related laws of each country. For details, refer to "Certification for the BSW/RCTW" *P550*.

## Blind Spot Warning (BSW)

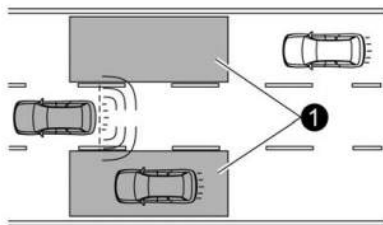

### Operating range

The system notifies the driver of the presence of vehicles in its blind spot.

- If the system detects a vehicle in its blind spot, it warns the driver by illuminating the BSW/RCTW ap-

proach indicator light(s) on the outside mirror(s).

- If the driver operates the turn signal lever in the direction where the BSW/RCTW approach indicator light is illuminating, the system warns the driver of dangers by flashing the BSW/RCTW approach indicator light on the outside mirror(s).

### Lane Change Assist (LCA):

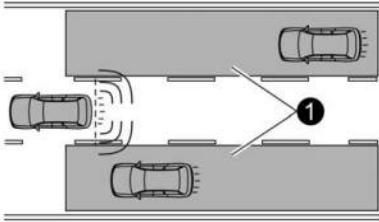

#### ① Operating range

The system notifies the driver of vehicles approaching at a high speed in the neighboring lanes.

- If the system detects a vehicle approaching at a high speed in the neighboring lanes, it warns the driver of dangers by illuminating the BSW/RCTW approach indicator light(s) on the outside mirror(s).
- If the driver operates the turn signal lever in the direction where the BSW/RCTW approach indicator light is illuminating, the system warns the driver of dangers by flashing the BSW/RCTW approach indicator light on the outside mirror(s).

### Rear Cross Traffic Warning (RCTW)

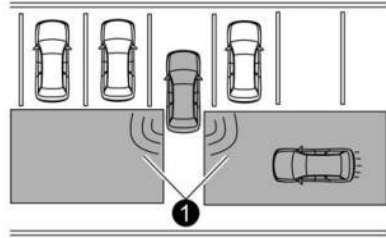

#### ① Operating range

The system notifies the driver of another vehicle approaching from either side when driving in reverse. This feature helps the driver check the rear and side areas of the vehicle when moving backward.

If the system detects a vehicle approaching from either side while moving backward, it warns the driver of dangers in the following way.

- The BSW/RCTW approach indicator light(s) on the outside mirror(s) flashes.
- A warning buzzer sounds.
- An icon appears on the center information display.

### Limitations of the detectability of RCTW:

Since the detectability of RCTW is limited, the RCTW may not operate properly in angled parking.

Example 1

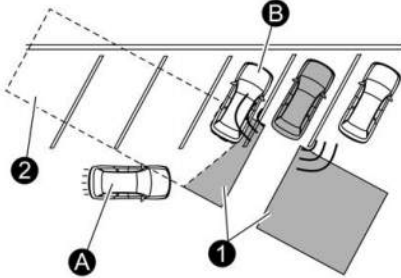

- ① The detection range of the rear radar sensors
- ② Area out of detection range of the rear radar sensors
- Ⓐ Vehicle that may not be detected
- Ⓑ Parked vehicle

### WARNING

An approaching vehicle Ⓐ may not be detected because the detection range is limited by the parked vehicle Ⓑ. Always be sure to check the surroundings with your eyes when reversing the vehicle.

Example 2

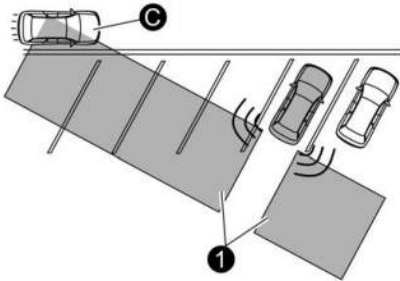

- ① The detection range of the rear radar sensors
- Ⓒ Vehicle that may be detected

### NOTE

The system may detect that a vehicle Ⓒ is passing in front of your vehicle. Always be sure to check the surroundings with your eyes when reversing the vehicle.

### OPERATING CONDITIONS

The BSW/RCTW will operate when all of the following conditions are met.

- The ignition switch is in the “ON” position.
- The BSW/RCTW warning indicator and BSW/RCTW OFF indicator are turned off.
- The vehicle is driven at speeds above 7 mph (12 km/h) (except when reversing).
- The select lever is in the “R” position (RCTW only).

The BSW/RCTW will not operate in the following situations.

- The BSW/RCTW OFF indicator appears.
- The vehicle speed is below 6 mph (10 km/h) even when the BSW/RCTW OFF indicator does not appear (except when reversing).

### NOTE

- In the following cases, the BSW/RCTW will stop operating and the BSW/RCTW warning indicator will appear.
  - When a malfunction occurs in the system, including the BSW/RCTW approach indicator light
- If the BSW/RCTW warning indicator appears, exercise proper caution. For details, refer to “BSW/RCTW Warning Indicator”  P373.
- In the following cases, the BSW/RCTW will temporarily stop operating (or may stop operating) and the BSW/RCTW OFF indicator will appear.
  - When the radar sensor becomes significantly misaligned (If the orientation of the radar sensor is

– CONTINUED –

shifted for any reason, readjustment is required. Have the sensor adjusted at a SUBARU dealer.)

- When a large amount of snow or ice sticks to the rear bumper surface around the rear radar sensors
  - When the vehicle is driven on a snow-covered road or in an environment in which there are no objects around (such as in a desert) for a prolonged period of time
  - When the temperature around the rear radar sensors increases excessively due to long driving on uphill grades in the summer, etc.
  - When the temperature around the rear radar sensors becomes extremely low
  - When the vehicle battery voltage lowers
  - When the vehicle voltage exceeds the battery voltage rating
- The BSW/RCTW will resume operation once these conditions are corrected, and the BSW/RCTW OFF indicator will disappear. However, if the BSW/RCTW OFF indicator appears for a prolonged period of time, have the system inspected at a SUBARU dealer as soon as possible.
- The detectability of the rear radar sensors is restricted. The BSW/RCTW detection may be impaired and the system may not operate properly under the following conditions.
    - When the rear bumper around the rear radar sensors is distorted
    - When ice, snow or mud adheres to the rear bumper surface around the rear radar sensors
    - When stickers, etc. are affixed on the areas of the rear radar sensors on the rear bumper
    - During adverse weather conditions such as rain, snow or fog
    - When driving on wet roads such as snow-covered roads and through puddles
  - The rear radar sensors may not detect or may have difficulty detecting the following vehicles and objects.

- Small motorcycles, bicycles, pedestrians, stationary objects on the road or road side, etc.
- Vehicles with body shapes that the radar may not reflect (vehicles with lower body height such as a trailer with no cargo and sports cars)
- Vehicles that are not approaching your vehicle even though they are in the detection area (either on a neighboring lane to the rear or beside your vehicle when reversing) (The system determines the presence of approaching vehicles based on data detected by the rear radar sensors.)
- Vehicles traveling at significantly different speeds
- Vehicles driving in parallel at almost the same speed as your vehicle for a prolonged time
- Oncoming vehicles
- Vehicles in a lane beyond the neighboring lane
- Vehicles traveling at a significantly lower speed that you are trying to overtake
- On a road with extremely narrow lanes, the system may detect vehicles driving in a lane next to the neighboring lane.

## BSW/RCTW APPROACH INDICATOR LIGHT/WARNING BUZZER

While the BSW/RCTW is active, the following item(s) will operate to alert the driver:

- The BSW/RCTW approach indicator light (when there are vehicles in the neighboring lanes).
- The BSW/RCTW approach indicator light and warning buzzer (when a vehicle is approaching from the left or right side while your vehicle is reversing)



## BSW/RCTW approach indicator light

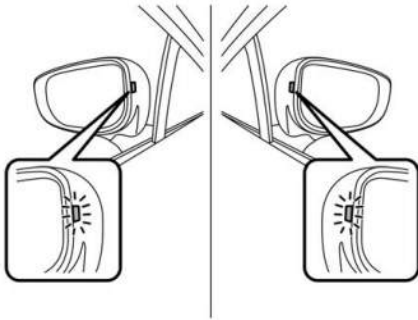

It is mounted on each side of the outside mirrors.

The indicator light will illuminate when a vehicle approaching from behind is detected.

The indicator light will flash to warn the driver of dangers under the following conditions.

- While the indicator light is illuminating, if the turn signal lever is operated toward the side in which this light turned on
- When reversing the vehicle while the system detects a vehicle approaching from either side

## Vehicle detected in neighboring lane indicator

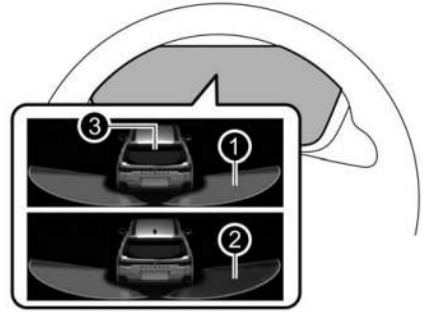

- 1 When a vehicle is detected (white area with yellow outline is indicated)
- 2 When the turn signal lever is being operated while a vehicle is detected (yellow area is indicated)
- 3 Your vehicle indicator\*1

When your vehicle indicator\*1 is displayed, the instrument cluster also shows the vehicle detection status of the neighboring lane.

\*1: For details regarding your vehicle indicator, refer to the Owner's Manual supplement for the EyeSight system.

### NOTE

When your vehicle indicator is turned off or your vehicle is reversing, the instrument cluster will not display the vehicle detected in neighboring lane indicator.

### BSW/RCTW approach indicator light dimming function:

When the headlights are turned on, the brightness of the BSW/RCTW approach indicator light will be reduced.

### NOTE

- You may have difficulty seeing the BSW/RCTW approach indicator light under the following conditions.
  - When sunlight shines directly on it
  - When the headlight beams from a vehicle traveling behind shines directly on it
- While the illumination brightness control dial is in the fully upward position,

even if the headlights are turned on, the brightness of the BSW/RCTW approach indicator light will not be reduced. For details about the illumination brightness control dial, refer to “Illumination Brightness Control” [P161](#).

## BSW/RCTW approach warning buzzer (only when reversing)

A warning buzzer sounds along with flashing of the BSW/RCTW approach indicator light to warn the driver of dangers.

The setting of the warning buzzer volume can be changed by operating the center information display. For details, refer to “Sound” [P200](#).

## Safety tips regarding the BSW/RCTW approach indicator light/warning buzzer

- In the following cases, operation of the BSW/RCTW approach indicator light and the warning buzzer may be delayed or the system may fail to issue these warnings.
  - When a vehicle moves to the neighboring lane from a lane next to the neighboring lane
  - When driving on a steep incline or on repeated sharp uphill and downhill grades
  - When going beyond a pass
  - When both your vehicle and a vehicle driving on a neighboring lane are driving on the far side of each lane.
  - When several narrowly-spaced vehicles are approaching in a row
  - In low radius bends (tight bends or when making turns at an intersection)
  - When there is a difference in height between your lane and the neighboring lane

- Immediately after the BSW/RCTW is activated by touching “Blind Spot Warning (BSW)/Rear Cross Traffic Warning (RCTW)”
  - Immediately after the select lever is shifted to the “R” position
  - When extremely heavy cargo is loaded in the cargo area
- During reversing, operation of the BSW/RCTW approach indicator light and the warning buzzer may be delayed or the system may fail to issue these warnings under the following conditions.
    - When backing out of an angled parking space
    - When a large-sized vehicle is parked next to your vehicle (That vehicle prevents the propagation of radar waves.)
    - When reversing on sloped roads
    - When reversing at a high speed

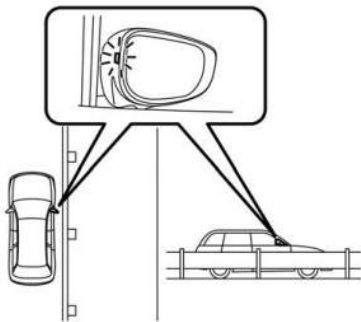

- The BSW/RCTW approach indicator light may illuminate when driving close to solid objects on the road or road side (such as guardrails, tunnels and sidewalls).
- When turning at an intersection in urban areas, or a multilane intersection, the BSW/RCTW approach indicator light may flash.
- If a building or a wall exists in the reversing direction, the BSW/RCTW approach indicator light may flash and the warning buzzer may sound.

- In the following cases, the system may detect a vehicle driving two lanes away from your vehicle.
  - When your vehicle drives on the near side of its lane from the corresponding vehicle
  - When the vehicle driving two lanes away drives on the near side of its lane from your vehicle

## BSW/RCTW OFF INDICATOR

### System temporary stops

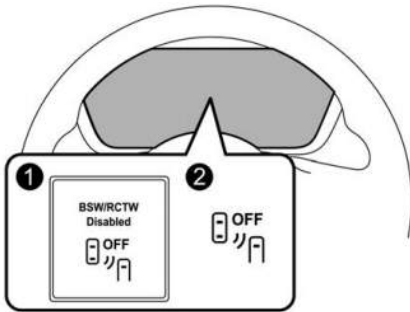

- ❶ BSW/RCTW temporary stop message
- ❷ BSW/RCTW OFF indicator

This display appears when the system is used at extremely high or low temperatures or when abnormal voltage exists. Once these conditions are corrected, the system will recover from the temporary stop condition and the indicator will disappear.

If the indicator remains displayed for a prolonged time, have the system inspected at a SUBARU dealer.

### System temporary stops due to reduced radar sensitivity

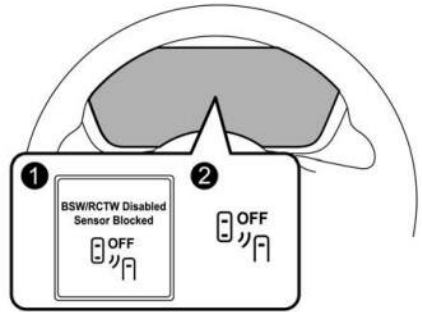

- ❶ BSW/RCTW temporary stop message due to reduced radar sensitivity
- ❷ BSW/RCTW OFF indicator

This display appears when the detectability of the rear radar sensors is reduced. Once the condition is corrected, the system will recover from the temporary stop condition and the indicator will disappear.

If the indicator remains displayed for a prolonged time, have the system inspected at a SUBARU dealer.

## BSW/RCTW WARNING INDICATOR

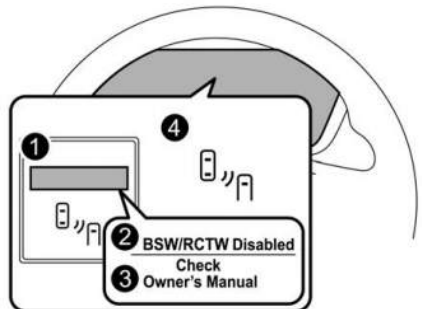

- ❶ BSW/RCTW malfunction message
- ❷ At first, this message will appear
- ❸ Then this message will appear
- ❹ BSW/RCTW warning indicator

This display appears when a malfunction occurs in the system. Contact a SUBARU dealer and have the system inspected.

## TO TURN ON/OFF THE BSW/RCTW

To turn the BSW/RCTW system on and off, operate the center information display. Refer to “EyeSight/Driving Assistance” P202.

### BSW/RCTW OFF indicator

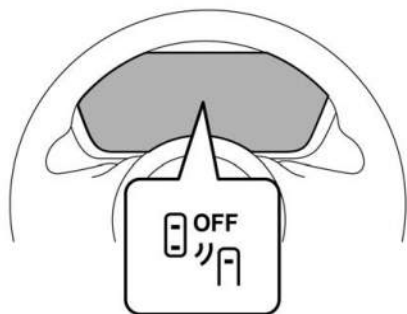

When the BSW/RCTW system is turned OFF, the BSW/RCTW OFF indicator on the instrument cluster display will illuminate.

### NOTE

- If the ignition switch is turned to the “OFF” position, the last known status of the system is maintained. For example, if the ignition switch is turned to the “OFF” position with the BSW/RCTW deactivated, the BSW/RCTW remains deactivated the next time the ignition switch is turned to the “ON” position.
- When the BSW/RCTW system is turned off, some EyeSight system functions will turn off. Refer to the Owner’s Manual supplement for EyeSight system.

## HANDLING OF REAR RADAR SENSORS

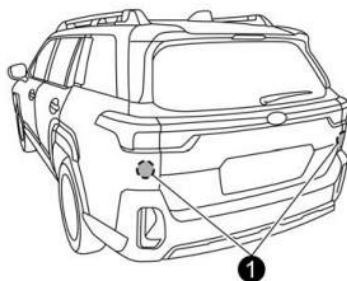

1 Rear radar sensors

The rear radar sensors, one on each side of the vehicle, are mounted inside the rear bumper.

### CAUTION

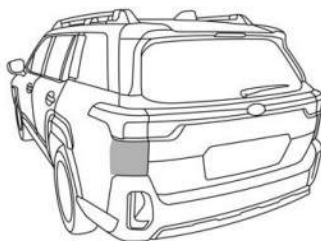

To ensure correct operation of the BSW/RCTW, observe the following precautions.

- Always keep the bumper surface near the rear radar sensors clean.
- Do not affix any stickers or other items on the bumper surface near the rear radar sensors. For details, consult your SUBARU dealer.
- Do not modify the bumper near the rear radar sensors.
- Do not paint the bumper near the rear radar sensors.

- Do not expose the bumper near the rear radar sensors to strong impacts. If a sensor becomes misaligned, a system malfunction may occur, including the inability to detect vehicles entering the detection areas. If any strong shock is applied to the bumper, be sure to contact your SUBARU dealer for inspection.
- Do not disassemble the rear radar sensors.

**NOTE**

*If the rear radar sensors require repair or replacement, or the bumper area around the rear radar sensors requires repair, paintwork or replacement, contact your SUBARU dealer for assistance.*

## 7-20. REVERSE AUTOMATIC BRAKING (RAB) SYSTEM

Reverse Automatic Braking (RAB) is a system designed to help avoid collisions or reduce collision damage when reversing the vehicle. If a wall or an obstacle is detected in the reversing direction, the system will notify the driver with a warning sound and may activate the vehicle's brakes automatically.

**WARNING**

- Reverse Automatic Braking (RAB) is not a system intended to replace the driver's responsibility to check their surroundings for vehicles or obstacles to avoid a collision.
- The driver is responsible for driving safely. Before reversing, be sure to first depress the brake pedal and visually check the surroundings.
- There are some cases in which the vehicle cannot avoid collision, because the system operation has limitations. The warning sound or automatic braking may be delayed or may not operate at all even when an obstacle is present.
- Make sure to set the Automatic Braking function to OFF when the vehicle is on the free roller or on the chassis dynamometer. Otherwise, the vehicle may move and it may cause an accident.
- The system is not designed to detect people (including children), animals or other moving objects.
- Depending on the vehicle condition or the surrounding environment, the sonar sensor's ability to detect objects may become unstable.
- When an attachment part (trailer hitch, bicycle carrier, bumper guard) is installed on the rear of the vehicle, turn off the Reverse Automatic Braking (RAB). If this func-

tion is on when an attachment or a similar part is installed, it may result in a system malfunction that causes an accident resulting in serious damage, injury or death.

#### NOTE

*The Reverse Automatic Braking (RAB) system records and stores the following data when automatic braking operates. It does not record conversations, personal information or other audio data.*

- *Distance from the object*
- *Vehicle speed*
- *Accelerator pedal operation status*
- *Brake pedal operation status*
- *Select lever position*
- *Outside temperature*
- *The sensitivity setting of the sonar sensors*

*SUBARU and third parties contracted by SUBARU may acquire and use the recorded data for the purpose of vehicle research and development. SUBARU and third parties contracted by SUBARU will not disclose or provide the acquired data to any other third party except under the following conditions.*

- *The vehicle owner has given his/her consent.*
- *The disclosure/provision is based on a court order or other legally enforceable request.*
- *Data that has been modified so that the user and vehicle cannot be identified is provided to a research institution for statistical processing or similar purposes.*

## REVERSE AUTOMATIC BRAKING (RAB) SYSTEM OVERVIEW

The Reverse Automatic Braking (RAB) system will operate the following 2 functions using 4 sonar sensors.

- **Proximity Warning Detection function**

The Reverse Automatic Braking (RAB) system detects objects rearward and warns the driver by warning message on the center information display and warning beeps.

- **Automatic Braking function**

The Automatic Braking function detects objects rearward and if there is a high risk of a collision, the system decelerates the vehicle and controls the braking to reduce damage.

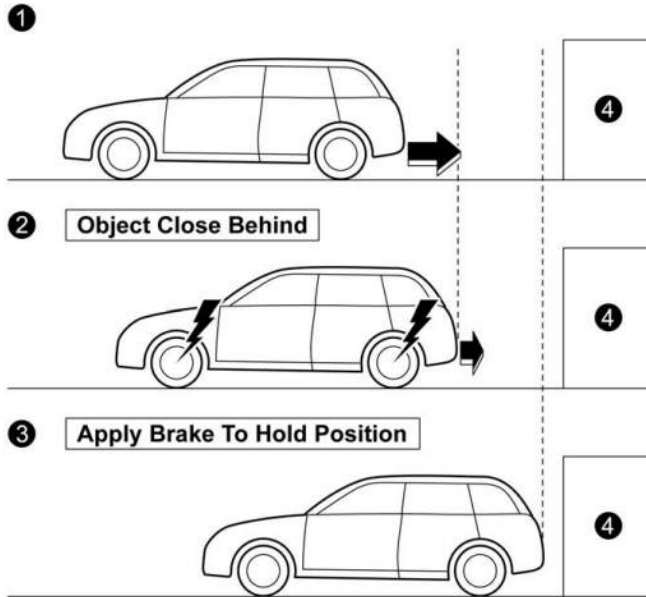

① When reversing

② When either strong automatic braking or torque control is applied to prevent collision (in this case, short warning beeps or continuous warning beeps will sound)

③ When the vehicle is stopped by the system (in this case, the continuous beep will remain sounding)

④ Object (e.g., a wall)

## Detecting range

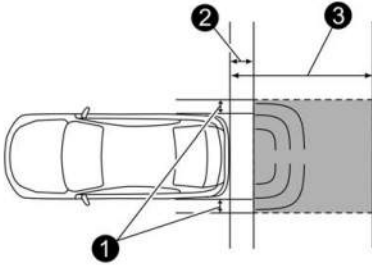

- ❶ Detecting range (width): Approximately 6 in (15 cm) outside of the vehicle width
- ❷ Range that the system cannot detect: Approximately 12 in (30 cm) behind the rear of the vehicle
- ❸ Detecting range (length): Approximately 5 ft (1.5 m) from the rear of the vehicle

### WARNING

If your vehicle is trapped on a railroad crossing and you are trying to escape by reversing through the crossing gate, the system may recognize the crossing gate as an obstacle and brake may activate. In this case, remain calm and either continue to depress the accelerator pedal or cancel the system. To cancel the system, refer to “Canceling the Reverse Automatic Braking (RAB) System Operation”  P386.

## OPERATING CONDITIONS

The Reverse Automatic Braking (RAB) system will operate when all of the following conditions are met.

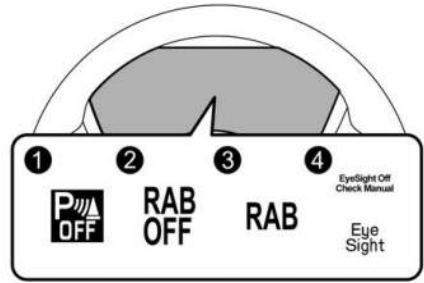

- ❶ Proximity Warning Detection OFF indicator
  - ❷ RAB OFF indicator
  - ❸ RAB warning indicator
  - ❹ EyeSight warning indicator
- The ignition switch is in the “ON” position.
  - The EyeSight warning indicator is off.
  - The RAB warning indicator is off.
  - The RAB OFF indicator is off.
  - The select lever is in the “R” position.
  - Proximity Warning Detection OFF indicator is off.

### Proximity Warning Detection function:

- Proximity Warning Detection is set to “ON”.
- The vehicle speed is from 0 to 9 mph (0 to 15 km/h).

### Automatic Braking function:

- Automatic Braking is set to “ON”.
- The vehicle speed is from 1 to 9 mph (1.5 to 15 km/h).

### NOTE

- In the following cases, the Reverse Automatic Braking (RAB) system will not operate. Promptly contact a SUBARU dealer to have the system inspected.
  - The EyeSight warning indicator is illuminated.
  - The RAB warning indicator is illuminated.



- In the following cases, the Reverse Automatic Braking (RAB) system cannot be operated.
  - The  (EyeSight Temporary Stop indicator: White) is illuminated, and the messages corresponding to the EyeSight temporary stop are displayed on the instrument cluster display. For details, refer to the Owner's Manual supplement for the EyeSight system.
  - The RAB OFF indicator is illuminated.
- In the following cases, the functions may not be able to properly work. Promptly contact a SUBARU dealer to have the system inspected.
  - A sticker, paint, or a chemical is applied to the sonar sensors or the rear bumper.
  - The rear bumper is modified.
  - The rear bumper has been removed and attached.
  - The ground clearance is changed due to the vehicle's loading condition or modification.
  - There is damage to the sonar sensors or the rear bumper.
  - The rear bumper is exposed to strong impact, or the rear bumper is deformed.
- On a steep hill, the system's automatic braking ability will be reduced.
- The system is designed to avoid collisions by automatic hard braking when the vehicle's reversing speed is less than approximately 3 mph (5 km/h). However, the system does not guarantee that the vehicle will be able to avoid collisions in any situation.
- If the vehicle is reversed at an extremely slow speed, the driver's operation may be prioritized. In this case, automatic braking will not operate.
- In the following situations, the system may not be able to detect an object correctly:
  - When the vehicle is approaching diagonally to an object
  - When the steering wheel is turned greatly
- The system may not be able to detect and apply the brake with the following objects.
  - Sharp or thin objects such as poles, fences and ropes which may not reflect the sound wave emitted from the sonar sensor.
  - Objects that are too close to the rear bumper when the select lever is set to the "R" position.
  - Objects with a surface which may not reflect the sound wave emitted from the sonar sensor such as a chain link fence or bicycle.
- Objects the system is not designed to detect and apply brake.
  - Pedestrians.
  - Moving objects including moving vehicles.
  - Objects which absorbs sound waves such as cloth or snow.
  - Objects whose surface has a diagonal angle.
  - Objects that are low to the ground such as parking blocks.
  - Objects that are high above the ground such as objects hanging from above.
  - Objects that are out of range of the center of the vehicle in the horizontal direction.
  - Objects that are not perpendicular to the ground.
  - The surface of the object is uneven or wavy.
- When reversing the vehicle, the functions may not be able to work properly or may cause a system malfunction if the following conditions exist.
 

High frequency sound from other sources are nearby:

  - Horn sound from another vehicle.
  - Engine sound from other vehicles.
  - Sound of an air brake.
  - Vehicle detection equipment or a sonar from another vehicle.
  - A sound wave with a frequency similar to the vehicle's system is transmitted near by.
  - A vehicle equipped with the same system is reversing toward your reversing direction.

*Weather conditions:*

- Extremely high or extremely low temperatures in which the area near the sonar sensor becomes too hot or too cold to operate.
- The sonar sensors or the rear bumper near the sonar sensors are exposed to heavy rain or a significant amount of water.
- Fog, snow or sandstorm, etc.
- Air is moving rapidly such as when a strong wind is blowing.

*Parts attached to the rear bumper near the sonar sensors:*

- Commercial electronic parts (fog light, fender pole, radio antenna) are attached.
- Parts that emit high frequency sound, such as a horn or speaker, are attached.

*Vehicle conditions:*

- Ice, snow or mud is adhered to the sonar sensors or the rear bumper near the sonar sensors.
- The vehicle is significantly inclined.
- The ground clearance is significantly reduced due to the vehicle's loading condition, etc.
- When the sonar sensor is misaligned due to a collision or an accident.

*Surrounding environment:*

- A cloth banner, flag, hanging branch or railroad crossing bars are present in the reversing direction.
- When reversing on a gravel or grassy area.
- When reversing in an area where objects or walls are adjacent to the vehicle such as narrow tunnels, narrow bridges, narrow roads or narrow garages.
- Wheel track or hole is present in the ground of the reversing direction.
- When reversing over a drainage cover (grating cover).

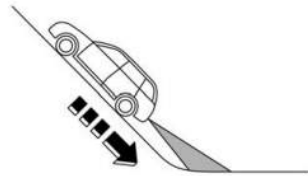
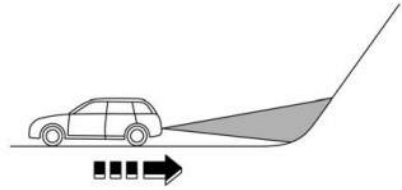

- The path of the reversing direction is inclined such as on a steep uphill.
- When reversing downhill.

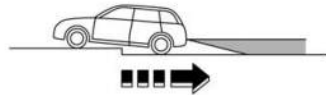

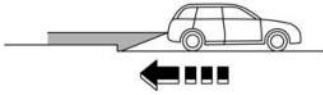

proximity, closest proximity.

#### NOTE

*It may take time to display the wall and sound warning beeps after the object was recognized by the Proximity Warning Detection function.*

- *A curb or step is present in the reversing direction.*
- *Reversing in a garage with a low ceiling or a tunnel.*
- *There is a patch of snow rearward.*
- *There is a puddle of water.*
- *There is an obstacle that is next to an object.*
- *Going back along a wall.*
- *The area where the road starts touching dirt and snow*
- *When reversing on an uneven road.*
- *In circumstances such as the following, it may not be possible to avoid a collision even when the system operates normally.*
  - *Roads are slippery.*
  - *The tire air pressure is not correct.*
  - *The tires have become worn.*
  - *Tire chains are installed.*
  - *Tires which are not the designated size are installed.*
  - *Emergency repairs were performed using a puncture repair kit.*
  - *The suspension was modified.*
  - *Vehicle driving is unstable due to accident or malfunction.*
  - *The brake warning light is illuminated.*

## PROXIMITY WARNING DETECTION FUNCTION

When the Reverse Automatic Braking (RAB) system is in operation, audible warning beeps will sound to warn the driver of a potential collision in 4 levels: long proximity, medium proximity, short

## Guideline of detecting range

Alert level	Range of detected object*	Distance indicator	Alarm pattern
Long proximity alert (object detected)	24 to 43 in (60 to 110 cm)	Green	Short beeps
Medium proximity alert (approaching the object)	18 to 24 in (45 to 60 cm)	Yellow	Fast beeps
Short proximity alert (approaching closer to the object)	12 to 18 in (30 to 45 cm)	Orange	Rapid short beeps
Closest proximity alert (too close to the object)	12 in (30 cm) or less	Red	Continuous beep

\*: Range of detection may vary depending on the environmental condition.

**Obstacle detected and alert level**

When an object is detected in the reversing direction, the range of detected object will be shown on the center information display and instrument cluster display.

A warning alarm will sound and, depending on the speed, either torque control to generate engine braking or automatic braking will be applied.

**Instrument cluster display**

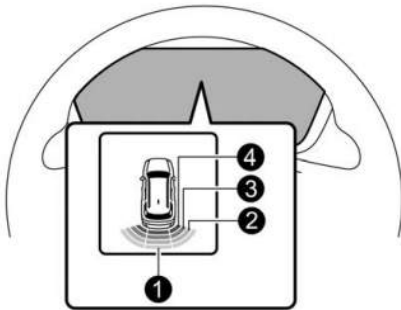

- 1 Long proximity alert (green)
- 2 Medium proximity alert (yellow)
- 3 Short proximity alert (orange)
- 4 Closest proximity alert (red)

The alert levels are indicated on the center information display as shown in the following.

**Center information display (models with Surround View Monitor)**

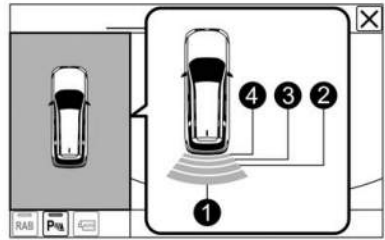

- 1 Long proximity alert (green)
- 2 Medium proximity alert (yellow)
- 3 Short proximity alert (orange)
- 4 Closest proximity alert (red)

**Long proximity alert (object detected)**

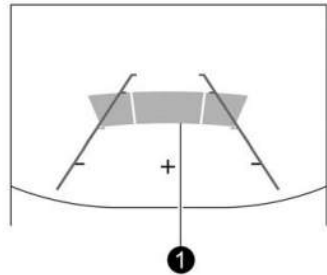

- 1 Green: 24 to 43 in (60 to 110 cm) or more

Medium proximity alert (approaching the object)

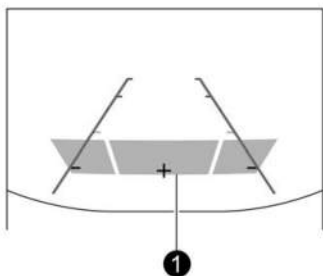

① Yellow: 18 to 24 in (45 to 60 cm)

Short proximity alert (approaching the object closer)

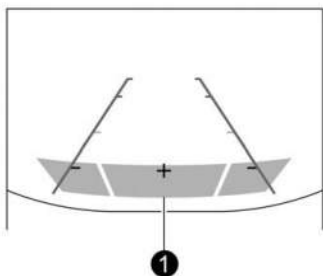

① Orange: 12 to 18 in (30 to 45 cm)

Closest proximity alert (too close to the object)

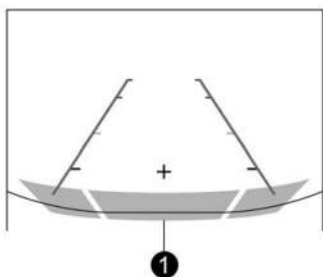

① Red: 12 in (30 cm) or less

## AUTOMATIC BRAKING FUNCTION OPERATION

### Object close behind warning

Automatic braking warning

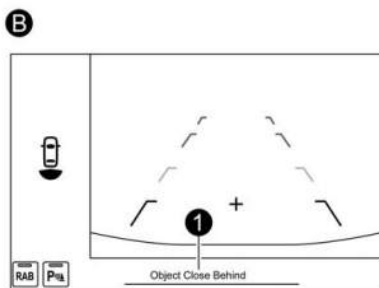
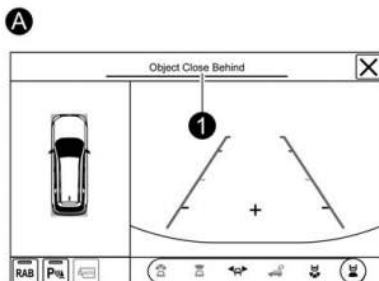

**A** Surround View Monitor

**B** Rear view camera

① Warning message

If the system determine the risk of collision with the object. Short warning beeps or continuous warning beeps will sound and either strong automatic braking or torque control will be applied to prevent collision.

At this time, a warning message is also displayed on the instrument cluster display.

## Depress brake pedal warning

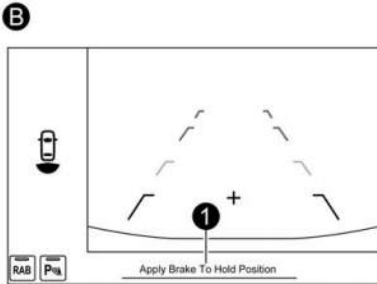
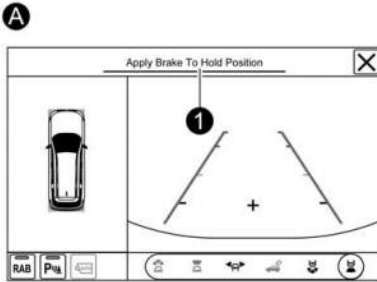

- A Surround View Monitor
- B Rear view camera
- 1 Warning message

Make sure to depress the brake pedal once the vehicle has been stopped by automatic braking. Until the brake pedal is depressed, a message will be displayed on the center information display and the continuous beep will remain sounding.

At this time, a warning message is also displayed on the instrument cluster display.

**NOTE**

The Proximity Warning Detection function and Automatic Braking function are different in operation conditions. Therefore, there are cases in which only one of these functions will activate.

**WARNING**

Depress the brake pedal immediately after the system stops the vehicle by automatic braking. Depending on the conditions of the road surface and tires, the vehicle may not remain stopped, possibly leading to an accident.

**After the vehicle is stopped by the system**

After the brake pedal is depressed, the RAB OFF indicator will illuminate and the system will temporarily stop operating. The RAB OFF indicator will turn off when the select lever is shifted to a position other than the "R" position.

The system will operate again the next time the select lever is shifted to the "R" position.

**NOTE**

- In the following cases, after the vehicle has been stopped by the Reverse Automatic Braking (RAB) system, brake control is released and the electronic parking brake operates. For details about releasing the parking brake, refer to "Electronic Parking Brake" P339.
  - When 2 minutes pass after the vehicle is stopped
  - When any door is opened
- The Reverse Automatic Braking (RAB) system may stop operating

temporarily in the following cases and the RAB OFF indicator will illuminate.

- Ice, snow or mud is adhered to the sonar sensors or the rear bumper near the sonar sensors.
- Objects are too close to the rear bumper when the select lever is set to the "R" position.
- The system detects sounds of a similar frequency to the RAB sonar.
- The Vehicle Dynamics Control OFF mode is selected.
- The electric power steering system is in the overheating prevention status because the steering wheel has been operated while the vehicle is at a standstill or driving at an extremely slow speed.

## CANCELING THE REVERSE AUTOMATIC BRAKING (RAB) SYSTEM OPERATION

The Reverse Automatic Braking (RAB) system can be temporarily canceled by any of the following operations.

- While the vehicle is stopped by the operation of automatic braking, the brake pedal is depressed.
- While the vehicle is stopped by the operation of automatic braking, the accelerator pedal is depressed.
- The accelerator pedal is depressed continuously (In this case, limited acceleration will be canceled and the vehicle will continue reversing.)
- The select lever is shifted to a position other than the "R" position.

### NOTE

The system will be canceled if the object is no longer detected.

## REVERSE AUTOMATIC BRAKING (RAB) SYSTEM ON/OFF SETTING

While the select lever is shifted to the "R" position, the below functions of the Reverse Automatic Braking (RAB) system can be set by operating the center information display.

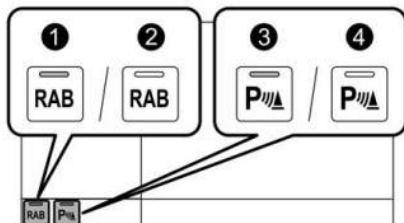

- ① ON setting key of Automatic Braking function
- ② OFF setting key of Automatic Braking function
- ③ ON setting key of the Proximity Warning Detection function
- ④ OFF setting key of the Proximity Warning Detection function

When the ON setting key is shown, the corresponding setting is ON.

Touch the ON setting key to turn the setting OFF.

When the OFF setting is shown, the corresponding setting is OFF.

Touch the OFF setting key to turn the setting ON.

When the Automatic Braking function or the Proximity Warning Detection function is turned OFF, the following indicator(s) will illuminate.



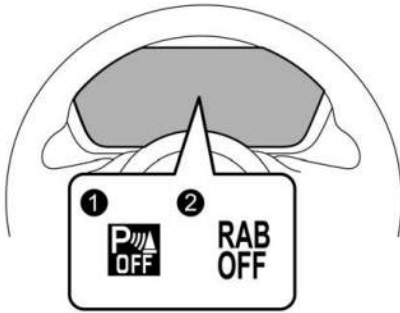

- ① Proximity Warning Detection OFF indicator
- ② RAB OFF indicator

The RAB OFF indicator or the Proximity Warning Detection OFF indicator will turn off when the corresponding function is turned ON.

#### NOTE

- When the settings cannot be changed, the ON/OFF setting key will be grayed out.
- The ON/OFF setting key may be grayed out if the Reverse Automatic Braking (RAB) system malfunctions, etc. In this case, turn the ignition switch to the “OFF” position and then turn it to the “ON” position again. If the setting cannot be changed even after turning the ignition switch to the “ON” position again, consult your SUBARU dealer.
- As soon as you turn off the ignition switch, the Reverse Automatic Braking (RAB) ON/OFF setting is stored in the system. Therefore, when you turn the ignition switch from the “OFF” state to the “ON” position, the Reverse Automatic Braking (RAB) setting will revert to the state that was set before the ignition switch was turned off.
- When you turn the ignition switch off, the Proximity Warning Detection ON/OFF settings will always reset, and the system will not store the settings of the function. Therefore, every time you turn the ignition switch to the “ON”

position, the Proximity Warning Detection will turn on automatically.

Also, the following settings can be changed by operating the center information display.

- Warning volume
- Proximity Warning Detection

For details, refer to “Sound” ⓄP200 and “EyeSight/Driving Assistance” ⓄP202.

## RAB WARNING INDICATOR

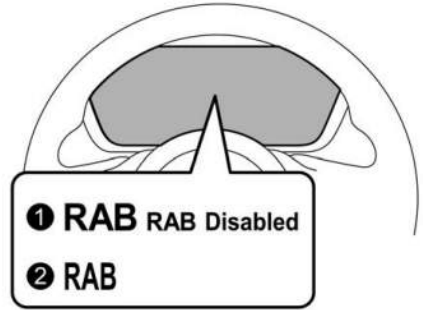

- ① RAB malfunction message
- ② RAB warning indicator

If the Reverse Automatic Braking (RAB) system malfunctions, the above indicator illuminates on the instrument cluster. Contact the nearest SUBARU dealer for details.

## HANDLING OF THE SONAR SENSORS

The 4 sonar sensors are located in the rear bumper. To ensure the proper operation of the Reverse Automatic Braking (RAB) system, observe the following precautions.

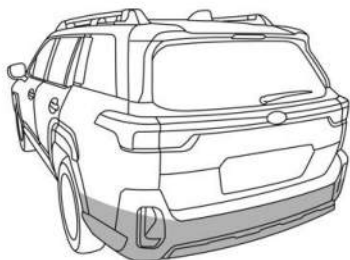

## HOW TO GET THE SOURCE CODE THAT USES OPEN SOURCE SOFTWARE

### Free Open-Source Software Information

This product uses Free Open-Source Software (FOSS).

The license information and/or the source code of such FOSS can be found at the following URL:

<http://car.panasonic.jp/oss/o04d6c00>

- Do not affix any stickers or other items on the sonar sensor or the rear bumper surface.
- Always keep the sonar sensor and the rear bumper surface clean.
- Do not modify rear bumper.
- Do not paint the rear bumper surface.
- Do not apply high pressure water to the sonar sensors with a high pressure car-washing machine.
- Do not apply strong impacts to the rear bumper surface. If a sensor becomes misaligned, a system malfunction may occur, including inability to detect objects in the reversing direction. If any strong impact is applied to the rear bumper, contact a SUBARU dealer to have the system inspected.
- Do not disassemble the sonar sensors.

### NOTE

*If the sonar sensors require repair or replacement, or if the area of the rear bumper near the sonar sensors requires repair, paintwork or replacement, contact your SUBARU dealer for assistance.*

## 7-21. DISTRACTION MITIGATION SYSTEM

Distraction Mitigation System is introduced as Driver Monitoring System in some countries.

The Distraction Mitigation System monitors possible cases when the driver is not paying attention to the forward direction, and also recognizes individual users.

This system warns the driver of inattentive/drowsy driving, and can support safe and comfortable driving by automatically retrieving the following settings.

- Driver's position (models with driver's seat memory function)
- Climate control setting
- Meter setting
- Center information display setting
- Language settings
- Audio and navigation personalization

When a user is registered, various settings are automatically retrieved when the user enters the vehicle.

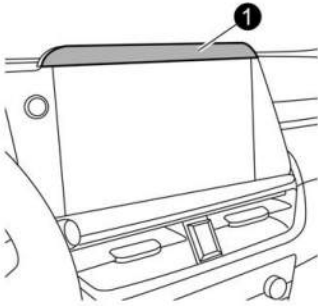

① Camera

### CAUTION

- Always use the utmost care in driving
  - Overconfidence because you are driving a vehicle with the Distraction Mitigation System could easily lead to a serious

accident.

- This system cannot detect if the driver is feeling drowsy or is concentrating on safe driving.
- It cannot judge if the driver is awake or asleep, if their driving abilities have diminished, or if they are concentrating on safe driving.
- In some circumstances, the system may not be able to correctly detect the driver state.

### NOTE

- *The user recognition camera does not save images, audio, or video.*
- *The Distraction Mitigation System may not operate correctly when sunlight is shining into the vehicle in the following ways.*
  - *Sunlight is shining directly (or through glass) onto the user recognition camera.*
  - *There are shadows on the driver's face caused by sunlight (or any light with a strong infrared component).*
  - *There are large momentary fluctuations in the strength of the sunlight (or any light with a strong infrared component) shining on the face.*
- *Correct detection may not be possible when a device that includes an infrared light source (such as a commercially available Distraction Mitigation System) is installed in the vehicle interior.*
- *The Distraction Mitigation System may not operate correctly at the following times when the driver is wearing glasses or sunglasses.*
  - *The sunglasses do not allow the easy passage of infrared light.*
  - *The surrounding scenery is reflected strongly in the lenses of the glasses or sunglasses.*
  - *The eyes are hidden by the frame of the glasses and the user recog-*

- inition camera cannot detect the eyes.
- The light from an infrared light source (LED) is reflected in the lenses of the glasses or sunglasses.
  - The driver is wearing an eyepatch.
  - The driver is wearing a hat set deeply over the eyes.
- Depending on the type of mask, correct detection of inattentive/drowsy driving may not be possible.
  - Correct user recognition is not possible if the eyes, nose, or mouth is covered with a mask, muffler, sunglasses, or other item.
  - The Distraction Mitigation System may not operate correctly when the eyebrows, eyes, nose, or mouth is hidden due to item that is between the face and the system.
  - If a thick cover is attached to the steering wheel, then depending on the position set for the tilt/telescopic steering wheel, the cover may block the system's view of the face, and the system and the Distraction Mitigation System may not operate correctly.
  - Do not attach any stickers to the user recognition camera or the infrared light source (LED). If the user recognition camera or infrared light source (LED) is covered by an obstruction, it will not be possible to correctly monitor the driver.
  - If an accessory is hung from the inside mirror, correct detection may not be possible.
  - Do not touch the user recognition camera or the infrared light source (LED) directly with your fingers. If there is dirt or a fingerprint on these parts, it will not be possible to correctly monitor the driver. If there is dirt or a fingerprint on these parts, either wipe them with a soft dry cloth, or wipe gently with a damp cloth after first firmly wringing the water out.
  - If the surface of the user recognition camera or the infrared light source (LED) becomes scratched, correct detection may not be possible. Be careful that hard objects do not contact these parts.
  - If there is condensation on the user recognition camera or the infrared light source (LED), correct detection may not be possible. If there is condensation on these parts, wipe it away with a soft dry cloth.
  - When registering a user for user recognition, avoid closing your eyes as much as possible.
  - If the user recognition success rate is low, it is possible that the user is not correctly registered. Delete the registered data and perform registration again.
  - If a user frequently drives both with glasses and contact lenses, it is recommended that registration be performed both when wearing glasses and when wearing contact lenses.
  - User recognition starts immediately after entering the vehicle, however if the user looks downward or at the driver side mirror for a long time, the user may not be recognized.
  - When one person among twins or another pair of persons with similar facial features is registered, the other person may be incorrectly recognized as the registered user when entering the vehicle.
  - If the person in the passenger's seat leans into the driver's seat, or in other cases when there are two or more faces near the driver's seat, the system may not operate correctly.
  - There are cases when the system concludes that the user's eyes are closed when the user is looking downward during driving, such as when checking instruments or the navigation screen. In such cases, the drowsy driving warning buzzer may sound or the system may otherwise not operate correctly.



- *If the eyes are narrowed when laughing or when there is a dazzling outside light, the system may judge that the eyes are closed and the drowsy driving warning buzzer may sound or the system may otherwise not operate correctly.*
- *The drowsy driving or asleep warning states are recognized from the length of time and percentage of time that the eyes are closed. The drowsy driving warning buzzer will not sound simply when the driver feels sleepy or yawns.*
- *Even when the driver does not feel sleepy, if his or her eyes are closed or if he or she blinks frequently, the drowsy driving warning buzzer may sound.*
- *The inattentive driving warning buzzer may sound if the driver leans forward or puts his or her head out of the window while driving.*
- *The inattentive driving warning buzzer will not sound when the vehicle is stopped or traveling at slow speed even if the driver is not looking ahead.*
- *The Distraction Mitigation System collects and stores data regarding drivers' facial features. Facial recognition data is stored locally and does not leave the vehicle. It is not transmitted to or stored by SUBARU or anyone else. The Distraction Mitigation System may be disabled and any stored driver data may be deleted by following the instructions below. If the Distraction Mitigation System is disabled, it will be unable to provide any of its safety or convenience functions.*

The functions which are available vary depending on the Distraction Mitigation System setting and the user recognition function setting.

## Available functions

			Distraction Mitigation System*1	
			ON	OFF
User recognition function*2	ON	Inattentive/drowsy driving warning	Available	Not available
		User recognition function	Available	Not available
	OFF	Inattentive/drowsy driving warning	Available	Not available
		User recognition function	Not available	Not available

## Available function items

			Distraction Mitigation System*1		
			ON	OFF	
			Driver Profiles items*3		
User recognition function*2	ON	Add		Available	Available*4
		Edit	Edit user registration	Available	Not available*5
			 (Delete user)	Available	Not available*5
		Change User		Available	Not available
	OFF	Add		Available*4	Available*4
		Edit	Edit user registration	Not available	Not available*5
			 (Delete user)	Available	Not available*5
		Change User		Not available	Not available

Available function items

		Distraction Mitigation System items*3	Distraction Mitigation System*1	
			ON	OFF
User recognition function*2	ON	Auto Retract Driver Seat*6	Available	Available
		Seat and Mirror Position*6	Available	Not available
	OFF	Auto Retract Driver Seat*6	Not available	Not available
		Seat and Mirror Position*6	Not available	Not available

\*1: The system can be turned ON/OFF with the center information display. Refer to “Vehicle” P206.

\*2: The function can be turned ON/OFF in the center information display customization settings. Refer to “Vehicle” P206.

\*3: For details, refer to “Using the Distraction Mitigation System” P398.

\*4: Touch “Add” to enable the system, which will activate the Distraction Mitigation System.

\*5: If the Distraction Mitigation System is off, “Edit” will be unavailable.

\*6: Models with driver’s seat memory function

The functions which are available vary depending on whether or not the user is registered.

Available functions

	The user is registered.	The user is not registered.
User recognition function	Available	Not available

## USER RECOGNITION FUNCTION



### WARNING

Perform registration, retrieving, or delete of the seat position and outside mirror angle before beginning driving. There is the risk of an accident if registration, retrieving, or delete is performed while driving.

When a user is registered, it is possible to retrieve the following settings.

### Driver position personalization (models with driver's seat memory function)

#### Seat position and outside mirror angle:

Retrieves the registered seat position and outside mirror angle.

#### Reverse tilt angle:

Retrieves the registered reverse tilt-down outside mirror angle.

### Meter personalization

#### Instrument cluster display basic screen:

Displays the screen which the user had selected at the time when he/she last exited the vehicle.

### Center information display personalization

#### Center information display basic screen:

Displays the screen which the user had selected at the time when he/she last exited the vehicle.

## Climate control personalization

### Climate control settings:

Retrieves the preferred setting temperature, airflow mode selection, and other settings which the user had selected at the time when he/she last exited the vehicle.

### NOTE

*When a recognized user exits the vehicle while the MAX A/C mode is on and the push engine switch is turned off, the system stores the setting configured before MAX A/C mode was turned on.*

### Distraction Mitigation System ON/OFF status

Retrieves the Distraction Mitigation System ON/OFF status which the user had selected at the time when he/she last exited the vehicle.

### Language settings

The language displayed on the center information display and instrument cluster display is determined by the user-registered settings.

### Audio and navigation personalization

Retrieves the preferred audio and navigation settings that were in effect when the user last exited the vehicle. For details about how to set the audio and navigation system, refer to the separate navigation/audio Owner's Manual.



## Changing the personalization settings

Item		Remarks
Driver's position personalization (models with driver's seat memory function)	Seat position/outside mirror angle	Change the setting by using the center information display customization function. Refer to "Vehicle" P206.
	Reverse tilt-down outside mirror angle	
Meter personalization*	Instrument cluster display basic screen	When the customization screen linked with the synchronized user function is selected and the setting is changed, it is automatically stored.
Center information display personalization*	Center information display basic screen	
Climate control personalization*	Climate control settings	
Language settings*	Language settings of center information display and instrument cluster display	
Audio and navigation personalization*	Audio and navigation system settings	
Distraction Mitigation System ON/OFF status		

\*: When the Distraction Mitigation System is OFF, the Distraction Mitigation System continues to store the conditions from immediately before the Distraction Mitigation System was turned OFF even if the screen was selected and the setting was changed.

## INATTENTIVE/DROWSY DRIVING WARNING

While driving, the Distraction Mitigation System monitors possible cases of driver inattention or drowsiness and warns the driver.

When the inattentive/drowsy driving warning activates, the buzzer sounds and an interrupt display appears.

### NOTE

- *The inattentive/drowsy driving warning operates regardless of the status of the user recognition function.*
- *The inattentive driving warning does not activate when the turn signal is operating or when the select lever is in the "R" position.*
- *When the pre-collision brake system OFF indicator is illuminated on the instrument cluster display, the inattentive driving warning activates at the same timing as usual even when a vehicle ahead or obstacle is detected. For details about the EyeSight system, refer to the Owner's Manual supplement for the EyeSight system.*

When the EyeSight system has detected a vehicle ahead or obstacle in the forward direction, the inattentive driving warning may activate at earlier timing than usual.

Refer to the Owner's Manual supplement for the EyeSight system.

### NOTE

*When Adaptive Cruise Control and the Lane Centering function are active, warning screens other than the inattentive driving warning are displayed on the instrument cluster display. For details, refer to the Owner's Manual supplement for the EyeSight system.*

## Inattentive driving warning





# Keep Eyes on Road

When the system monitors that the driver may be inattentive, it warns the driver.

When the inattentive driving warning activates, the buzzer sounds and an interrupt display appears on the instrument cluster display.

**Drowsy driving warning**

Possible drowsiness is detected from face features, and a warning is given to the driver. When the drowsy driving warning activates, the buzzer sounds and an interrupt display appears.

	Instrument cluster display	Center information display	Warning chime
Drowsy driving	Stay Alert! 	Stay Alert! 	Beep, beep... (Continues until the driver's eyes open.)
Very drowsy			Beep, beep, beep, beep, beep (5 times)
Slightly drowsy	Take a Break! 	*1	Beep
Not drowsy	—	—	—

7

\*1: The navigation system (if equipped) has a periodic rest notification function. For details, refer to the separate navigation/audio Owner's Manual.

**NOTE**

*When Adaptive Cruise Control and the Lane Centering function are active, warning screens other than the drowsy driving warning are displayed on the instrument cluster display. For details, refer to the Owner's Manual supplement for the EyeSight system.*

## DISTRACTION MITIGATION SYSTEM INDICATOR/WARNING

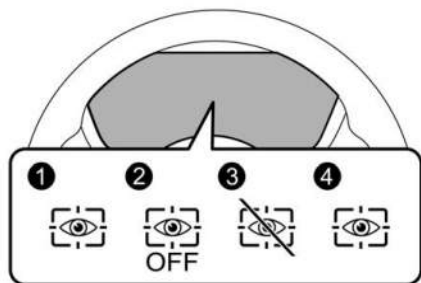

- ① Distraction Mitigation System operation indicator light (green)
- ② Distraction Mitigation System OFF indicator light
- ③ Distraction Mitigation System temporary stop indicator light
- ④ Distraction Mitigation System warning light (yellow)

The Distraction Mitigation System indicator/warning indicates the status of the Distraction Mitigation System on the instrument cluster display.

### NOTE

When the Distraction Mitigation System OFF indicator, Distraction Mitigation System temporary stop indicator, or Distraction Mitigation System warning is illuminated, the Distraction Mitigation System function cannot be used. In addition, the following items cannot be selected.

- Add
- Change User
- Edit
- Seat and Mirror Position (models with driver's seat memory function)

### Distraction Mitigation System operation indicator light (green)

This indicator illuminates when the Distraction Mitigation System is operating.

### Distraction Mitigation System OFF indicator light

This indicator illuminates when the Distraction Mitigation System is turned off. Only the Distraction Mitigation System will remain activate even if the system is turned off.

### Distraction Mitigation System temporary stop indicator light

This indicator illuminates when the Distraction Mitigation System is temporarily stopped.

### NOTE

The Distraction Mitigation System stops temporarily in the following circumstances.

- When the temperature of the main unit of the Distraction Mitigation System is high or low.
- When the Distraction Mitigation System cannot monitor the driver's face.
- When the camera and the infrared light source (LED) are covered and the Distraction Mitigation System cannot monitor the driver correctly.



### Distraction Mitigation System warning light (yellow)

This warning illuminates when there is a problem with the Distraction Mitigation System. Contact a SUBARU dealer to have the system inspected.

## USING THE DISTRACTION MITIGATION SYSTEM

You can register users using the Center Information Display. Once you are registered in the system, you can use the user recognition function.

## Register User

1. To access “Driver Profiles”, follow either of the procedures below.
  - Touch  (Settings).  
→ Touch “Profiles”  to access “Driver Profiles”.
  - Touch  (Driver Profile).  
→ Touch “Driver Profile” to access “Driver Profiles”.
2. → “Add”
3. Select the row you want to register.
4. Select the language.
5. → “Next”
6. Enter the name.

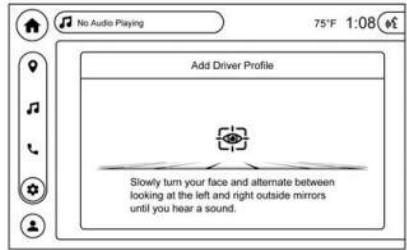

When the screen changes, the registration of the facial scan is completed.

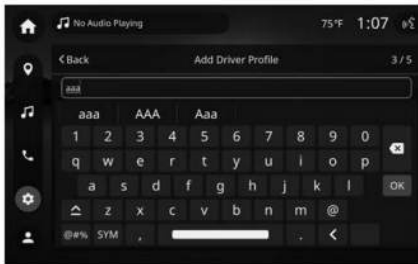

7. → “OK”
8. → 
9. Select the preferred icon.
10. → “Next”

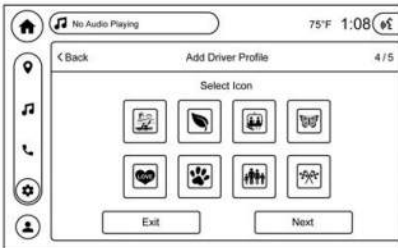

11. Touch “Next” and then the registration of the facial scan will start. While seated in the driver’s seat, face forward and wait for a few moments.

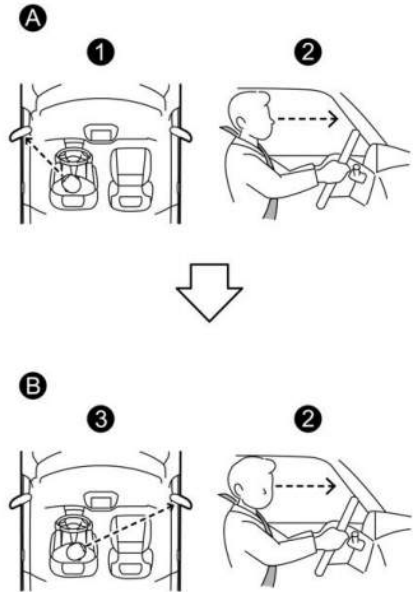

- A** Left side direction
- B** Right side direction
- 1** Slowly turn your face toward the left outside mirror.
- 2** Do not lower your chin.
- 3** Slowly turn your face toward the right outside mirror.





**NOTE**

- If user registration cannot be performed, slowly turn your face toward the left and right door mirrors as shown in the illustration.
- There are some cases where user registration cannot be completed properly. In those cases, refer to “Distraction Mitigation System” P389.
- If “There was a problem with Facial Registration. Please try again.” appears, repeat the procedure from step 11.

**Editing User Registration**

You can edit the user information registered in the “Driver Profile”, including name, language, icon, seat position (models with driver’s seat memory function), and side mirror position (models with driver’s seat memory function).

You can only edit the information of the current user.

1. To access “Driver Profiles”, follow either of the procedures below.
  - Touch  (Settings).  
→ Touch “Profiles”  to access “Driver Profiles”.
  - Touch  (Driver Profile).  
→ Touch “Driver Profile” to access “Driver Profiles”.
2. → “Edit”
3. Select a current user from the list.
4. Select the language.
5. → “Next”
6. Enter the name.
7. → 
8. Select the preferred icon.
9. → “Next”
10. Adjust the driver’s seat and outside mirrors to the desired position.\*
11. → “Next”\*





\*: If the driver’s seat memory function is equipped.

**Deleting User**

Users can be registered in the Distraction Mitigation System, and registered users can be deleted.

**NOTE**

User information can also be deleted by resetting the center information display to the factory default settings. When the settings are reset to the factory default settings, all user information is deleted. The settings cannot be reset to the factory default settings when the Distraction Mitigation System is OFF.

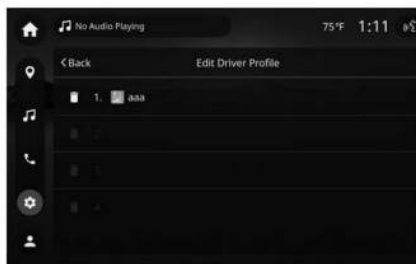

1. To access “Driver Profiles”, follow either of the procedures below.
  - Touch  (Settings).  
→ Touch “Profiles”  to access “Driver Profiles”.
  - Touch  (Driver Profile).  
→ Touch “Driver Profile” to access “Driver Profiles”.
2. → “Edit”
3. Touch  of the desired user from the list.



4. → “Delete”

**Change User**

To set another registered user as the driver, perform the following procedure.

1. To access “Driver Profiles”, follow either of the procedures below.
  - Touch  (Settings).  
→ Touch “Profiles”  to access “Driver Profiles”.

- Touch  (Driver Profile).  
→ Touch “Driver Profile” to access “Driver Profiles”.
- 2. → “Change User”
- 3. → “Next”

2. Sit in the driver’s seat and face forward for a few moments.
3. When user recognition is completed, the Hello screen appears on the instrument cluster display.

The facial scan will start.

## User recognition

When a user is registered with the user recognition function, the Distraction Mitigation System performs the following.

1. When the door is opened or closed and the push-button ignition switch is OFF, the user recognition screen appears and the Distraction Mitigation System starts user recognition.



The user recognition screen may not appear when the door is opened in some cases, such as when only a short time has passed after the push-button ignition switch was turned OFF. In such cases, user recognition starts when the door is closed however the user recognition screen does not appear.



At this time, climate control settings, instrument cluster display basic screen, center information display basic screen, and customization settings all change based on the user information.

### NOTE

- If the language setting is different when user recognition is performed, a message will be displayed to change the language setting.
- While user recognition is in progress, executing other operations on the center information display may result in the user’s configured settings being applied improperly.
- When a center information display operation switch is pressed, the user recognition screen is canceled, however user recognition continues.
- If user recognition fails, perform re-cognition again following the instructions, refer to “Change User” [P400](#).
- User recognition is not performed while driving.
- When the select lever is not in the “P” position, the seat position will not change even when user recognition is completed (models with driver’s seat memory function).
- If the seat position or outside mirror

– CONTINUED –

angle are in motion at the time when user recognition is completed, then it is not possible to retrieve the seat position, outside mirror angle, or reverse tilt-down outside mirror angle (models with driver's seat memory function).

- If any of the following operations is performed while retrieving of the seat position or outside mirror angle, retrieving of the seat position and outside mirror angle is canceled (models with driver's seat memory function).
  - The power seat adjustment switch was operated.
  - The outside mirror adjustment switch was operated.
  - The "SET" button was pressed.
  - The "1" or "2" button was pressed.
  - The select lever was moved to a position other than "P" position.
- User recognition may not be possible when there is dirt or fingerprints on the user recognition camera. To clean, either wipe using a soft cloth or else wipe gently using a moistened cloth that has been thoroughly wrung out.

## DISTRACTION MITIGATION SYSTEM ON/OFF SETTINGS

### NOTE

- When the Distraction Mitigation System is turned OFF after user recognition was completed, the user recognition function stores the Distraction Mitigation System ON/OFF state.
- Even when the Distraction Mitigation System is set to OFF, the Distraction Mitigation System automatically turns ON once the driver's door is opened and closed while the vehicle is stopped. When the driver gets in the vehicle, a message will appear on the instrument cluster display.
- After the Distraction Mitigation System was turned OFF, if the Distraction Mitigation System is turned ON while the driver's door is open, user recognition may not occur correctly.

## To turn on/off the Distraction Mitigation System

To turn the Distraction Mitigation System on and off, operate the center information display. Refer to "Vehicle" ⒻP206. When the Distraction Mitigation System is turned OFF, the Distraction Mitigation System OFF indicator on the instrument cluster display will illuminate.

### NOTE

Even when the Distraction Mitigation System is turned off, the user recognition does not switch on or off automatically.

## User recognition settings

The Distraction Mitigation System User recognition function can be turned ON/OFF. For the setting procedure, refer to "Vehicle" ⒻP206.

### NOTE

- The user recognition function setting cannot be changed for each individual user.
- The default setting for the user recognition function is ON.
- When the user recognition function is turned OFF, the following items cannot be selected.
  - Change User
  - Seat and Mirror Position (models with driver's seat memory function)

## Automatically retract seat on entry (models with driver's seat memory function)

The automatically retract seat on entry which automatically slides back the driver's seat when the driver's door is unlocked and opened.

This function can be turned ON/OFF. For the setting procedure, refer to "Vehicle" ⒻP206.



**CAUTION**

Sit in the seat after the power seat movement backward has been completed. Not doing so could result in injury.

**NOTE**

- *If the seat position is not registered in the access key fob memory, the automatically retract seat on entry function can be used.*
- *Even when the automatically retract seat on entry setting is ON, the automatically retract seat on entry function automatically turns OFF when the user recognition function is OFF.*
- *Automatically retract seat on entry cannot be selected when the Distraction Mitigation System temporary stop indicator or Distraction Mitigation System warning is illuminated.*
- *This function will operate if the seat is in front of the center of the seat sliding mechanism.*

**HOW TO GET THE SOURCE CODE THAT USES OPEN SOURCE SOFTWARE**

Free Open-Source Software Information

This product uses Free Open-Source Software (FOSS).

The license information and/or the source code of such FOSS can be found at the following URL:

[http://www.embedded-carmultimedia.jp/RTOS/License/oss/DMS\\_0103/](http://www.embedded-carmultimedia.jp/RTOS/License/oss/DMS_0103/)

---

---

---

---

---

---

---

---

---

---

---

---

---

---

---

---

---

---

---

---

## DRIVING TIPS

---

8-1.	New Vehicle Break-In Driving – the First 1,000 miles (1,600 km) .....	406
8-2.	Fuel Economy Hints .....	406
8-3.	Engine Exhaust Gas (Carbon Monoxide).....	407
8-4.	Catalytic Converter .....	407
8-5.	Periodic Inspections .....	408
8-6.	Driving in Foreign Countries .....	409
8-7.	Frequent Driving Prevents Vehicle Battery from Discharging .....	409
8-8.	Driving Tips for AWD Vehicles.....	410
8-9.	On-Road and Off-Road Driving.....	411
	Before Driving.....	412
	During Driving .....	412
	After Driving .....	413
8-10.	Winter Driving .....	414
	Operation during Cold Weather .....	414
	Driving on Snowy and Icy Roads.....	415
	Corrosion Protection.....	416
	Snow Tires .....	417
	Tire Chains .....	417
	Rocking the Vehicle .....	418
8-11.	Loading Your Vehicle.....	418
	Vehicle Capacity Weight.....	419
	GVWR and GAWR (Gross Vehicle Weight Rating and Gross Axle Weight Rating) .....	419
	Roof Rail .....	420
	Roof Tent.....	422
8-12.	Trailer Hitch (Dealer Option) .....	424
	Connecting a SUBARU Genuine Trailer Hitch .....	425
	If Not Towing a Trailer .....	426
8-13.	Trailer Towing.....	426
	Warranties and Maintenance .....	426
	Maximum Load Limits .....	427
	Trailer Hitches (Dealer Option) .....	429
	When You Do Not Tow a Trailer .....	429
	Connecting a Trailer.....	430
	Trailer Towing Tips.....	431

## **8-1. NEW VEHICLE BREAK- IN DRIVING – THE FIRST 1,000 MILES (1,600 km)**

The performance and long life of your vehicle are dependent on how you handle and care for your vehicle while it is new. Follow these instructions during the first 1,000 miles (1,600 km):

- Do not race the engine. And do not allow engine speed to exceed 4,000 rpm except in an emergency.
- Do not drive at one constant engine or vehicle speed for a long time, either fast or slow.
- Avoid starting suddenly and rapid acceleration, except in an emergency.
- Avoid hard braking, except in an emergency.

The same break-in procedures should be applied to a newly installed or overhauled engine or when brake pads are replaced with new ones.

## **8-2. FUEL ECONOMY HINTS**

The following suggestions will help to save your fuel.

- Select the proper gear position for the speed and road conditions.
- Avoid sudden acceleration or deceleration. Always accelerate gently until you reach the desired speed. Then try to maintain that speed for as long as possible.
- Do not pump the accelerator and avoid racing the engine.
- Avoid unnecessary engine idling.
- Keep the engine properly tuned.
- Keep the tires inflated to the correct pressure shown on the tire inflation pressure label, which is located under the door latch on the driver's side. Low pressure will increase tire wear and fuel consumption.
- Use the air conditioner only when necessary.
- Keep the front and rear wheels in proper alignment.
- Avoid carrying unnecessary luggage or cargo.
- The indication of the ECO gauge shows a reference for saving fuel. For details, refer to "Basic Screens"  P191.

### 8-3. ENGINE EXHAUST GAS (Carbon Monoxide)

#### WARNING

- Never inhale engine exhaust gas. Engine exhaust gas contains carbon monoxide, a colorless and odorless gas which is dangerous, or even lethal, if inhaled.
- Always properly maintain the engine exhaust system to prevent engine exhaust gas from entering the vehicle.
- Never run the engine in a closed space, such as a garage, except for the brief time needed to drive the vehicle in or out of it.
- Avoid remaining in a parked vehicle for a long time while the engine is running. If that is unavoidable, then use the ventilation fan to force fresh air into the vehicle.
- Always keep the front ventilator inlet grille free from snow, leaves or other obstructions to ensure that the ventilation system always works properly.
- If at any time you suspect that exhaust fumes are entering the vehicle, have the problem checked and corrected as soon as possible. If you must drive under these conditions, drive only with all windows fully open.
- Keep the rear gate closed while driving to prevent exhaust gas from entering the vehicle.

#### NOTE

*Due to the expansion and contraction of the metals used in the manufacture of the exhaust system, you may hear a crackling sound coming from the exhaust system for a short time after the engine has been shut off. This sound is normal.*

### 8-4. CATALYTIC CONVERTER

#### WARNING

- Avoid fire hazards. Do not drive or park the vehicle anywhere near flammable materials (e.g. grass, paper, rags or leaves), because the catalytic converter operates at very high temperatures.
- Keep everyone and flammable materials away from the exhaust pipe while the engine is running. The exhaust gas is very hot.

2.5 L non-turbo models

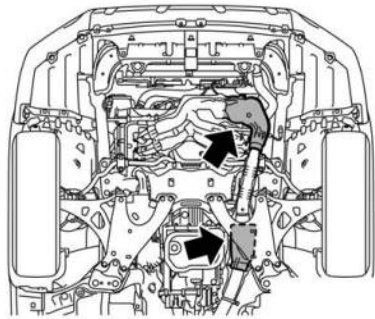

2.4 L turbo models

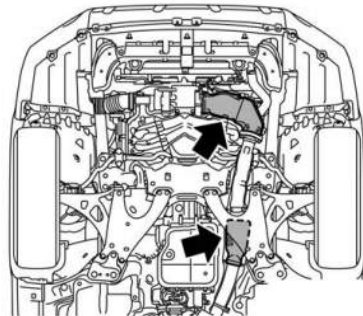

The catalytic converter is installed in the exhaust system. It serves as catalyst to reduce HC, CO and NO<sub>x</sub> in exhaust gases, thus providing cleaner exhaust.

To avoid damage to the catalytic converter:

- Use only unleaded gasoline. Even a small amount of leaded gasoline will damage the catalytic converter.
- Never start the engine by pushing or pulling the vehicle.
- Avoid racing the engine.
- Never turn off the ignition switch while the vehicle is moving.
- Keep your engine tuned-up. If you feel the engine running rough (misfiring, backfiring or incomplete combustion), have your vehicle checked and repaired by an authorized SUBARU dealer.
- Do not apply undercoating or rust prevention treatment to the exhaust system.
- Do not drive with an extremely low fuel level.

## **8-5. PERIODIC INSPECTIONS**

---

To keep your vehicle in the best condition at all times, always have the recommended maintenance services listed in the maintenance schedule in the "Warranty and Maintenance Booklet" performed at the specified time or mileage intervals.

## 8-6. DRIVING IN FOREIGN COUNTRIES

---

When planning to use your vehicle in another country:

- Confirm the availability of the correct fuel. Refer to “Fuel Requirements” ☞ P304.
- Comply with all regulations and requirements of each country.

## 8-7. FREQUENT DRIVING PREVENTS VEHICLE BATTERY FROM DISCHARGING

---

Vehicle batteries are a consumable item. If the battery charge is not maintained regularly, the battery will deteriorate and may require replacement sooner than expected. The battery is charged by running the engine. It is recommended to drive the car for a longer time occasionally to prevent the vehicle battery from becoming drained, especially if it is regularly driven only a short time daily (e.g. only 10 minutes) or if it is parked for 10 days or more. It may be possible to recover the state of charge and maintain the battery performance by driving for a longer time (e.g. more than 30 minutes). If you cannot drive enough, we recommend to charge the battery as needed. If no action is taken, the battery will become discharged. This is a normal characteristic of any battery.

## 8-8. DRIVING TIPS FOR AWD VEHICLES

### WARNING

- Always maintain a safe driving speed according to the road and weather conditions in order to avoid having an accident on a sharp turn, during sudden braking or under other similar conditions.
- Always use the utmost care in driving – overconfidence because you are driving an All-Wheel Drive vehicle could easily lead to a serious accident.
- When replacing or installing tire(s), all four tires must be the same for the following items.
  - (a) Size
  - (b) Speed symbol
  - (c) Load index
  - (d) Circumference
  - (e) Construction
  - (f) Manufacturer
  - (g) Brand (tread pattern)
  - (h) Degrees of wear

For items (a) to (c), you must obey the specification that is printed on the tire inflation pressure label. The tire inflation pressure label is located on the driver's door pillar.

If all four tires are not the same in items (a) to (h), serious mechanical damage could be caused to the drivetrain of the car, and affect the followings.

- Ride
- Handling
- Braking
- Speedometer/Odometer calibration

- Clearance between the body and the tires

It also may be dangerous and lead to loss of vehicle control, and it can lead to an accident.

### CAUTION

If you use a temporary spare tire to replace a flat tire, be sure to use the original temporary spare tire stored in the vehicle. Using other sizes may result in severe mechanical damage to the drive train of your vehicle.

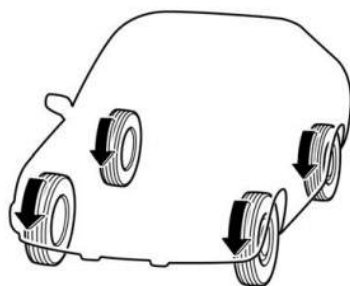

All-Wheel Drive distributes the engine power to all four wheels. AWD vehicles provide better traction when driving on slippery, wet or snow-covered roads and when moving out of mud, dirt and sand. By shifting power between the front and rear wheels, SUBARU AWD can also provide added traction during acceleration, and added engine braking force during deceleration.

Therefore, your SUBARU AWD vehicle may handle differently than an ordinary two wheel drive vehicle and it contains some features unique to AWD. For safety purposes as well as to avoid damaging the AWD system, you should keep the following tips in mind:

- An AWD vehicle is better able to climb steeper roads under snowy or slippery conditions than a two wheel drive vehicle. There is little difference in



handling, however, during extremely sharp turns or sudden braking. Therefore, when driving down a slope or turning corners, be sure to reduce your speed and maintain an ample distance from other vehicles.

- Always check the cold tire pressure before starting to drive. The recommended tire pressure is provided on the tire inflation pressure label, which is located on the door pillar on the driver's side.
- Frequent driving of an AWD vehicle under hard-driving conditions such as steep hills or dusty roads will necessitate more frequent replacement of the following items than that specified in the "Warranty and Maintenance Booklet".
  - Engine oil
  - Brake fluid
  - Rear differential gear oil
  - Continuously variable transmission fluid
  - Front differential gear oil
- There are some precautions that you must observe when towing your vehicle. For detailed information, refer to "Towing" Ⓕ P447.

## 8-9. ON-ROAD AND OFF-ROAD DRIVING

### WARNING

- Always maintain a safe driving speed according to the road and weather conditions in order to avoid having an accident on a sharp turn, during sudden braking or under other similar conditions.
- Always use the utmost care in driving – overconfidence because you are driving an All-Wheel Drive vehicle could easily lead to a serious accident.
- In a rollover crash, an unbelted person is significantly more likely to die than a person wearing a seatbelt. The driver and all passengers should fasten their seatbelts before starting to drive in order to minimize the chance of serious injury or death.
- Do not make sharp turns or quick maneuvers unless absolutely unavoidable. Such actions are dangerous, as you may lose control, possibly resulting in a rollover which could cause death or serious injury.
- Whenever strong crosswinds are present, slow down sufficiently to maintain control of your vehicle. Remember that your vehicle, with its higher profile and center of gravity, is more likely to be affected by crosswinds than ordinary passenger cars.
- Never attempt to drive through pools and puddles, or roads flooded with water. Water entering the engine air intake or the exhaust pipe or water splashing onto electrical parts may damage your vehicle and may cause it to stall. In this case, contact your SUBARU dealer immediately. Regardless of

its depth, it can wash away the ground from under your tires, resulting in possible loss of traction and even vehicle rollover.



### CAUTION

- Frequent driving of an AWD model under hard-driving conditions such as rough roads or off roads will necessitate more frequent replacement of the following items than that specified in the maintenance schedule described in the “Warranty and Maintenance Booklet”.
  - Engine oil
  - Brake fluid

Remember that damage done to your SUBARU while operating it off-road and not using common sense precautions such as those listed here is not eligible for warranty coverage.

- After driving on gravel roads or rough roads, check the undercarriage of the vehicle body for any damage, deformation, or paint removal. If you notice any irregularities, contact a SUBARU dealer for an inspection as soon as possible.

Your vehicle is classified as a utility vehicle. Utility vehicles feature a higher ground clearance which enables them to be used for wide applications including off-road driving. However, please keep in mind that your vehicle is neither a conventional off-road vehicle nor an all-terrain vehicle. A higher center of gravity in relation to the tread width as compared with ordinary passenger cars makes vehicles of this type more likely to roll over. In reality, utility vehicles have a significantly higher rollover rate than other types of vehicles. The high ground clearance of this vehicle is a real advantage, giving you a better view of the road

and allowing you to anticipate problems earlier. However, remember that your utility vehicle is not designed for high-speed cornering comparable to ordinary passenger cars and that your vehicle could roll over if you make a sharp turn at high speed.

If you take your SUBARU off-road, certain common sense precautions such as those in the following list should be taken.

## BEFORE DRIVING

- Make certain that you and all of your passengers are wearing seatbelts.
- Carry some emergency equipment, such as a towing rope or chain, a shovel, wheel blocks, first aid kit and cell phone or citizens band radio.
- Secure all cargo carried inside the vehicle and make certain that it is not piled higher than the seatbacks. During sudden stops or jolts, unsecured cargo could be thrown around in the vehicle and cause injury. Do not pile heavy loads on the roof. Those loads raise the vehicle’s center of gravity and make it more prone to tip over.
- Never equip your vehicle with tires larger than those specified in this manual.

## DURING DRIVING

### General precautions:

- Drive carefully. Do not take unnecessary risks by driving in dangerous areas or over rough terrain.
- Slow down and employ extra caution at all times. When driving off-road, you will not have the benefit of marked traffic lanes, banked curves, traffic signs and the like.
- Do not drive across steep slopes. Instead, drive either straight up or straight down the slopes. A vehicle can much more easily tip over sideways than it can end over end. Avoid driving straight up or down slopes that

are too steep.

- Avoid sharp turning maneuvers, especially at higher speeds.
- Do not grip the inside or spokes of the steering wheel. A bad bump could jerk the wheel and injure your hands. Instead, drive with your fingers and thumbs on the outside of the rim.
- Do not drive or park over or near flammable materials such as dry grass or fallen leaves, as they may burn easily. The exhaust system is very hot while the engine is running and right after the engine stops. This could create a fire hazard.

### Precautions when driving under especially dangerous situations:

- If you must rock the vehicle to free it from sand or mud, depress the accelerator pedal slightly and move the select lever back and forth between “1”/“D” and “R” repeatedly. Do not race the engine. For the best possible traction, avoid spinning the wheels when trying to free the vehicle.
- When the road surface is extremely slippery, you can obtain better traction by starting the vehicle with the transmission in 2nd than 1st. Refer to “Selection of Manual Mode” P325.

## AFTER DRIVING

- Always check your brakes for effectiveness immediately after driving in sand, mud or water. Do this by driving slowly and stepping on the brake pedal. Repeat that process several times to dry out the brake discs and brake pads.
- After driving through tall grass, mud, rocks, sand, rivers, etc., check that there is no grass, bush, paper, rags, stones, sand, etc. adhering to or trapped on the underbody. Clear off any such matter from the underbody. If the vehicle is used with these materials trapped or adhering to the underbody, a mechanical breakdown or fire

could occur.

- Wash the vehicle’s underbody after off-road driving. Suspension components are particularly prone to dirt buildup, so they need to be washed thoroughly.

## 8-10. WINTER DRIVING

### OPERATION DURING COLD WEATHER

Carry some emergency equipment, such as a window scraper, a bag of sand, flares, a small shovel and jumper cables.

Check the battery and cables. Cold temperatures reduce battery capacity. The battery must be in good condition to provide enough power for cold winter starts.

It normally takes longer to start the engine in very cold weather conditions. Use an engine oil of a proper grade and viscosity for cold weather. Using heavy summer oil will make it harder to start the engine.

Keep the door locks from freezing by squirting them with deicer or glycerin.

Forcing a frozen door open may damage or separate the rubber weather strips around the door. If the door is frozen, use hot water to melt the ice, and afterwards thoroughly wipe the water away.

Use a windshield washer fluid that contains an antifreeze solution. Do not use engine antifreeze or other substitutes because they may damage the paint of the vehicle.

If you fill the washer fluid tank with a fluid with a different concentration from the one used previously, purge the old fluid from the piping between the washer fluid tank and washer nozzles by operating the washer for a certain period of time. Otherwise, if the concentration of the fluid remaining in the piping is too low for the outside temperature, it may freeze and block the nozzles.



#### CAUTION

- Adjust the washer fluid concentration appropriately for the outside temperature. If the concentration is

inappropriate, sprayed washer fluid may freeze on the windshield and obstruct your view, and the fluid may freeze in the washer fluid tank.

- Be careful foreign matter does not contaminate the washer fluid when filling the tank. Contamination could cause malfunctions, such as clogging the pump.
- State or local regulations on volatile organic compounds may restrict the use of methanol, a common windshield washer anti-freeze additive. Washer fluids containing non-methanol anti-freeze agents should be used only if they provide cold weather protection without damaging your vehicle's paint, wiper blades or washer system.

### Before driving your vehicle

Before entering the vehicle, remove any snow or ice from your shoes because that could make the pedals slippery and driving dangerous.

While warming up the vehicle before driving, check that the accelerator pedal, brake pedal, and all other controls operate smoothly.

Clear away ice and snow that has accumulated under the fenders to avoid making steering difficult. During severe winter driving, stop when and where it is safe to do so and check under the fenders periodically.

### Parking in cold weather



#### WARNING

Snow can trap dangerous exhaust gases under your vehicle. Keep snow clear of the exhaust pipe and from around your vehicle if you park the vehicle in snow with the engine run-

ning.



### CAUTION

- Do not use the parking brake when parking for long periods in cold weather since it could freeze in that position.
- When the vehicle is parked in snow or when it snows, raise the wiper blades off the glass to prevent damage to them.
- Under either of the following conditions, icing may develop on the brake system, which could cause poor braking action.
  - When the vehicle has been left parked after use on roads heavily covered with snow
  - When the vehicle has been left parked during a snowstorm

Check for snow or ice buildup on the suspension, disc brakes and brake hoses underneath the vehicle. If there is caked snow or ice, remove it, being careful not to damage the disc brakes and brake hoses and ABS harness.

When parking for long periods in cold weather, you should observe the following tips.

1. Place the select lever in the “P” position.
2. Use tire stops under the tires to prevent the vehicle from moving.

## Refueling in cold weather

To help prevent moisture from forming in the fuel system and the risk of its freezing, use of an antifreeze additive in the fuel tank is recommended during cold weather.

Use only additives that are specifically designed for this purpose. When an antifreeze additive is used, its effect lasts longer if the tank is refilled whenever the fuel level reaches half empty.

If your SUBARU is not going to be used for an extended period, it is best to have the fuel tank filled to capacity.

## Opening rear gate (models with power rear gate)



### CAUTION

Before operating the power rear gate, check that there is no frost or snow between the power rear gate and the vehicle body. If you notice frost or snow etc. on the power rear gate, remove it. If you forcibly operate the power rear gate with frost or snow, it may cause a malfunction.

8

## DRIVING ON SNOWY AND ICY ROADS



### WARNING

Do not use the cruise control on slippery roads such as snowy or icy roads. This may cause loss of vehicle control.



### CAUTION



Avoid prolonged continuous driving in snowstorms. Snow will enter the engine's intake system and may hinder the airflow, which could result in engine shutdown or even breakdown.

To prevent skidding and slipping, avoid sudden braking, abrupt acceleration, high-speed driving, and sharp turning when driving on snowy or icy roads.

Always maintain ample distance between your vehicle and the vehicle ahead of you to avoid the need for sudden braking.

To supplement the foot brake, use the engine brake effectively to control the vehicle speed. (Shift into a lower gear when necessary.)





Avoid shifting down abruptly. Such behavior can cause the wheels to lock, possibly leading to loss of vehicle control.

An anti-lock brake system (ABS) enhances your vehicle's braking performance on snowy and icy roads. For information about braking on slippery surfaces, refer to "ABS (Anti-Lock Brake System)"  P330 and "Vehicle Dynamics Control System"  P332.

## Wiper operation when snowing

Before driving in cold weather, make sure the wiper blade rubbers are not frozen to the windshield or rear window.

If the wiper blade rubbers are frozen to the windshield or rear window, perform the following procedure.

- To thaw the windshield wiper blade rubbers, use the defroster with the airflow selection in  and the temperature set for maximum warmth until the wiper blade rubbers are completely thawed. Refer to "Climate Control"  P253.
- If your vehicle is equipped with a wiper deicer, use it. It is helpful to thaw the windshield wiper blade rubbers. Refer to "Defogger and Deicer"  P226.
- To thaw the rear wiper blade rubbers, use the rear window defogger. Refer to "Defogger and Deicer"  P226.

When driving in snow, if frozen snow starts to stick on the surface of the windshield despite wiper operation, use the defroster with the airflow selection in  and the temperature set for maximum warmth. After the windshield gets warmed enough to melt the frozen snow on it, wash it away using the windshield

washer. Refer to "Windshield washer"  P225.

Snow stuck on the wiper arm prevents the wiper from working effectively. If snow is stuck on the wiper arm, pull off the road to a safe place, then remove it. If you stop the vehicle at road side, use the hazard warning flasher to alert other drivers. Refer to "Hazard Warning Flasher"  P158.

We recommend use of non-freezing type wiper blades (winter blades) during the seasons you could have snow and freezing temperatures. Blades of this type give superior wiping performance in snowy conditions. Be sure to use blades that are suitable for your vehicle.



### CAUTION

During high-speed driving, non-freezing type wiper blades may not perform as well as standard wiper blades. If this happens, reduce the vehicle speed.

### NOTE

*When the season requiring non-freezing type wiper blades is over, replace them with standard wiper blades.*

## Lighting operation when snowing

Check that the headlights are clean before driving. If snow, frost or ice are attached to the headlights, remove it.

If the headlights are not clean, they will not light the front normally. Also if the indicators and brake lamps are not clean, the vehicle will not be able to inform its status to other drivers and it may result in an accident.

## CORROSION PROTECTION

Refer to "Corrosion Protection"  P463.

## SNOW TIRES

### WARNING

- When replacing or installing winter tire(s), all four tires must be the same for the following items.
  - (a) Size
  - (b) Speed symbol
  - (c) Load index
  - (d) Circumference
  - (e) Construction
  - (f) Manufacturer
  - (g) Brand (tread pattern)
  - (h) Degrees of wear

For items (a) to (c), you must obey the specification that is printed on the tire inflation pressure label. The tire inflation pressure label is located on the driver's door pillar.

If all four tires are not the same in items (a) to (h), serious mechanical damage could be caused to the drivetrain of the car, and affect the followings.

- Ride
- Handling
- Braking
- Speedometer/Odometer calibration
- Clearance between the body and the tires

It also may be dangerous and lead to loss of vehicle control, and it can lead to an accident.

- Do not use a combination of radial, belted bias or bias tires since it may cause dangerous handling characteristics and lead to an accident.

Your vehicle is equipped with "all season tires" which are designed to provide an adequate measure of traction, handling

and braking performance in year-round driving. In winter, it may be possible to enhance performance through use of tires designed specifically for winter driving conditions.

If you choose to install winter tires on your vehicle, be sure to use the correct tire size and type. You must install four winter tires that are of the same size, construction, brand and load range and you should never mix radial, belted bias or bias tires since this may result in dangerous handling characteristics. When you choose a tire, make sure that there is enough clearance between the tire and vehicle body.

### CAUTION

Do not use 225/55R19 winter or snow tires on models with 19-inch wheels. Doing so may result in damage caused by contact between the tire and the vehicle body. For winter or snow tires, SUBARU recommends using 225/60R18 tires in combination with 18-inch genuine SUBARU wheels.

Remember to drive with care at all times regardless of the type of tires on your vehicle.

## TIRE CHAINS

### CAUTION

Tire chains cannot be used on your vehicle because of the lack of clearance between the tires and vehicle body.

### NOTE

*When tire chains cannot be used, use of another type of traction device (such as spring chains) may be acceptable if use on your vehicle is recommended by the device manufacturer, taking into account tire size and road conditions. Follow the device manufacturer's instructions,*

*especially regarding maximum vehicle speed.*

*To help avoid damage to your vehicle, drive slowly, readjust or remove the device if it is contacting your vehicle, and do not spin your wheels. Damage caused to your vehicle by use of a traction device is not covered under warranty.*

*Make certain that any traction device you use is an SAE class S device, and use it on the front wheels only. Always use the utmost care when driving with a traction device. Overconfidence because you are using a traction device could easily lead to a serious accident.*

## ROCKING THE VEHICLE

If you must rock the vehicle to free it from snow, sand, or mud, depress the accelerator pedal slightly and move the select lever back and forth between “D” and “R” repeatedly. Do not race the engine. For the best possible traction, avoid spinning the wheels when trying to free the vehicle.

When the road surface is extremely slippery, you can obtain better traction by starting the vehicle with the transmission in 2nd than 1st.

For information on holding the transmission in 2nd position, refer to “Selection of Manual Mode” P325.

## 8-11. LOADING YOUR VEHICLE

### WARNING

Never allow passengers to ride on a folded rear seatback, in the cargo area. Doing so may result in serious injury.

### WARNING

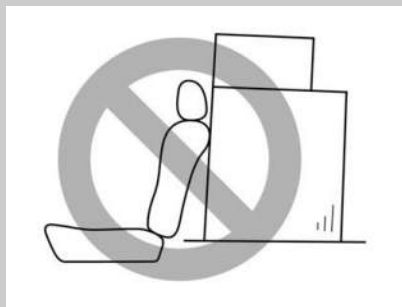

- Never stack luggage or other cargo higher than the top of the seatback because it could tumble forward and injure passengers in the event of a sudden stop or accident. Keep luggage or cargo low, as close to the floor as possible.
- When you carry something inside the vehicle, secure it whenever you can to prevent it from being thrown around inside the vehicle during sudden stops, sharp turns or in an accident.
- Do not pile heavy loads on the roof. These loads raise the vehicle's center of gravity and make it more prone to tip over.
- Secure long items properly to prevent them from shooting forward and causing serious injury during a sudden stop.
- Never exceed the maximum load limit. If you do, some parts on your vehicle can break, or it can change



the way your vehicle handles. This could result in loss of control and cause personal injury. Also, overloading can shorten the life of your vehicle.

- Do not place anything on the extended cargo area cover. Such items could tumble forward in the event of a sudden stop or a collision. This could cause serious injury.

### CAUTION

Do not carry spray cans, containers with flammable or corrosive liquids or any other dangerous items inside the vehicle.

### NOTE

For better fuel economy, do not carry unneeded cargo.

## VEHICLE CAPACITY WEIGHT

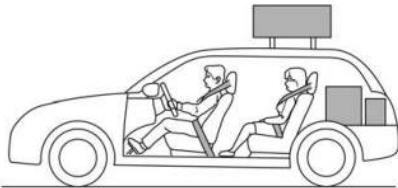

The load capacity of your vehicle is determined by weight, not by available cargo space.

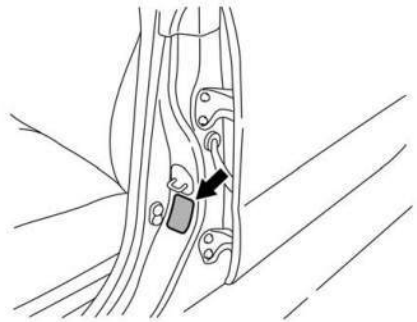

The maximum load you can carry in your vehicle is shown on the tire inflation pressure label attached to the driver's side door pillar. It includes the total weight of the driver and all passengers and their belongings, any optional equipment such as a trailer hitch, roof rack or bike carrier, etc., and the tongue load of a trailer.

## GVWR AND GAWR (Gross Vehicle Weight Rating and Gross Axle Weight Rating)

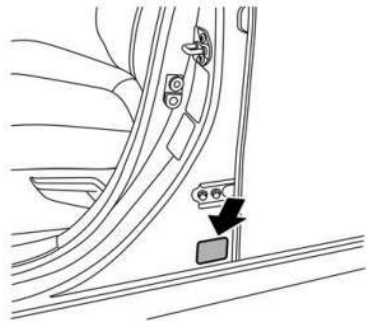

The certification label attached to the driver's side door pillar shows GVWR (Gross Vehicle Weight Rating) and GAWR (Gross Axle Weight Rating).

The GVW (Gross Vehicle Weight) must never exceed the GVWR. GVW is the combined total of weight of the vehicle, fuel, driver, all passengers, luggage, any optional equipment and trailer tongue load. Therefore, the GVW changes depending on the situation.

In addition, the total weight applied to each axle (GAW) must never exceed the GAWR. The front and rear GAWs can be adjusted by relocating luggage inside the vehicle.

Even if the total weight of your luggage is lower than the vehicle capacity weight, either front or rear GAW may exceed the GAWR, depending on the distribution of the luggage.

When possible, the load should be evenly distributed throughout the vehicle.

If you carry heavy loads in the vehicle, you should confirm that GVW and front and rear GAWs are within the GVWR and GAWR by putting your vehicle on a vehicle scale, found at a commercial weighing station.

Do not use replacement tires with a lower load range than the originals because they may lower the GVWR and GAWR limitations. Replacement tires with a higher load range than the originals do not increase the GVWR and GAWR limitations.

## ROOF RAIL

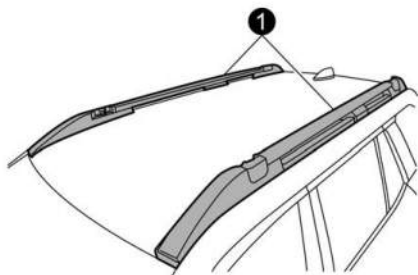

1 Roof rails

Cargo can be carried on the roof after securing the roof crossbars to the roof rails and installing the appropriate carrying attachments. When installing the roof crossbars and the carrying attachments, follow the manufacturer's instructions. The roof rail system is designed to carry

loads (cargo, roof crossbars and carrying attachments) of no more than **220 lbs (100 kg)**. Be sure not to exceed your vehicle's GVWR and GAWR.

### CAUTION

- When using the carrying attachments, make sure that the total carrying load of the cargo, roof crossbars and carrying attachments does not exceed 220 lbs (100 kg). Overloading may cause damage to the vehicle. Read the manufacturer's instructions and pay attention to not exceed the load limit of the parts.
- For cargo carrying purposes, the roof rails must be used together with the roof crossbars and any appropriate carrying attachment that may be needed. The roof rails must never be used alone to carry cargo. Otherwise, damage to the roof or paint, or a dangerous road hazard due to loss of cargo could result.

### NOTE

*Remember that the vehicle's center of gravity is altered with the weight of the load on the roof, thus affecting driving characteristics.*

*Drive carefully. Avoid rapid starts, hard cornering and abrupt stops. Crosswind effects will be increased.*

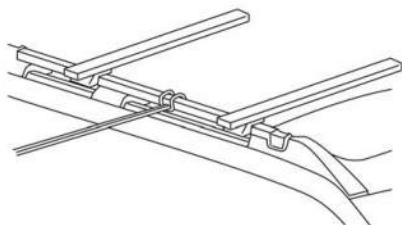

When placing a load laterally on the vehicle, such as by tying a rope directly to the roof rails, ensure you follow these guidelines. Incorrect usage of the roof rails can warp or damage both the vehicle body and the roof rails.

- Mount the crossbars in two places near the roof rail pillars (mount only crossbars approved by SUBARU). For detailed installation instructions, refer to the manual that comes with the crossbars.
- When fastening ropes or other items to the roof rails, ensure the rope is secured in the middle between the two installed crossbars.
- The maximum weight capacity for ropes or other items secured directly to the roof rail is 220 lbf (100 kgf).
- Do not attempt to secure items such as a tarp to the roof rail by using a rope with a hook or stay at the end.
- Ensure that you park on a level surface before attaching a rope to a roof rail to support a load such as a tarp.
- Avoid applying a lateral load directly to the roof rails when the crossbars are carrying more than 220 lbs (100 kg).
- Ensure that the rope does not damage the doors or any other part of the vehicle body.

## Rope hooks (attached to the roof rails)

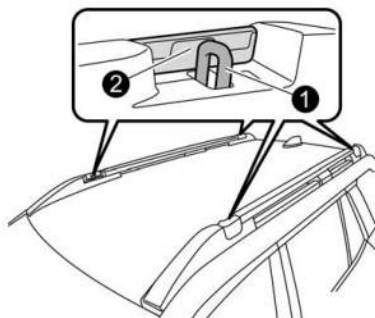

- ① Rope hooks
- ② Covers



### CAUTION

- When you use the rope hooks, always secure the rope at all four hook points.
- The cover cannot be removed.
- Do not tighten the rope excessively. Otherwise, it may lead to damage to the vehicle body or cargo.
- Check that the rope is not loose before driving the vehicle.
- When you use the rope hooks, never exceed the maximum load limit.

## ROOF TENT



Roof tents may be used under certain conditions at your own risk.

**WARNING**

Adding weight to the vehicle's roof can adversely affect handling, braking, and rollover resistance. The vehicle must never be driven with a total roof rail load in excess of 220 lbs (100 kg).

**CAUTION**

- The roof rail load limit for stationary vehicles (800 lbs (363 kg)) applies only when the vehicle is parked and the load is evenly distributed left/right and front/rear and the roof crossbars and roof tent are tightly secured to the vehicle. If these conditions are not met, the load limit will be lower.
- The maximum load limit of the roof crossbars must be obtained from the manufacturer or retailer of the roof rack. When driving the vehicle, the maximum roof rail load is 220 lbs (100 kg) or the crossbar load limit (whichever is lower).

## When driving the vehicle

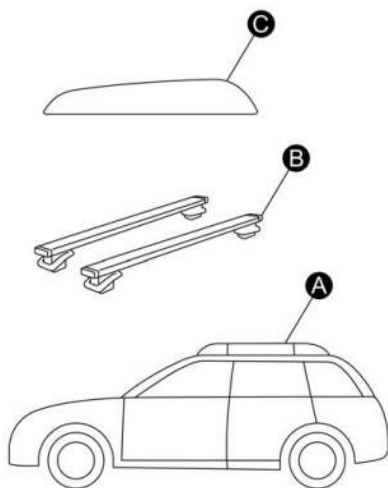

- Ⓐ Roof rails
- Ⓑ Roof crossbars
- Ⓒ Roof tent
- Ⓑ + Ⓒ < 220 lbs (100 kg)

The total load on the roof rails during driving must not exceed the value specified here.

## When the vehicle is parked on level ground

within the roof rail load limit of 220 lbs (100 kg). Refer to the user manual that accompanied the roof tent for important safety information and instructions on the proper installation and use of the tent.

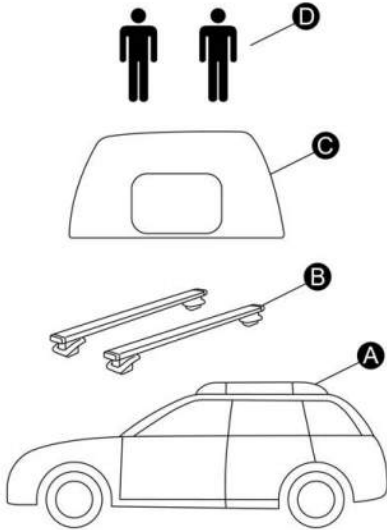

- A** Roof rails
- B** Roof crossbars
- C** Roof tent
- D** Occupants in the roof tent

The total weight on the roof rails – including the roof crossbars, roof tent, and all occupants and contents in the roof tent – must not exceed either the vehicle’s roof rail load limit (800 lbs (363 kg)), evenly distributed, or the load limit of the roof crossbars, whichever is lower.

### Load limit of the roof rails **A**.

$$\mathbf{B + C + D < (800\ lbs\ (363\ kg))}$$

Exceeding this load limit could cause damage to the vehicle or racking system. The vehicle must never be driven with occupants in the roof tent. Before the vehicle is driven, occupants and cargo must be removed from the roof tent and the roof rail load must be restored to

## 8-12. TRAILER HITCH (Dealer Option)

### WARNING

- Never exceed the maximum weight specified for the trailer hitch. Exceeding the maximum weight could cause an accident resulting in serious personal injuries. Permissible trailer weight changes depending on the situation. For possible recommendations and limitations, refer to “Trailer Towing”  P426.
- Trailer brakes are required when the tow load exceeds 1,000 lbs (453 kg).
- Be sure your trailer has safety chains and that each chain will hold the trailer’s maximum gross weight. Towing trailers without safety chains could create a traffic safety hazard if the trailer separates from the hitch due to coupling damage or hitch ball damage.
- Be sure to check the hitch pin and safety pin for positive locking placement before towing a trailer. If the ball mount separates from the receiver the trailer could become loose and create a traffic safety hazard.
- Although towing regulations for trailer or caravan vehicles vary by state/region, all regulations agree that specifications such as the maximum gross trailer weight must not exceed the lesser of the following:
  - Maximum gross trailer weight
  - Maximum gross tongue weight
  - GVWR
  - GAWR
- Failure to comply with the procedures set forth will not only compromise your safety, but will also

negate your insurance coverage and/or may violate the state road and traffic acts and regulations.

- It is recommended to only use the Genuine SUBARU Ball Mount developed for use with this trailer hitch available at your SUBARU dealership. Use the hitch only as a weight carrying hitch. Do not use with any type of weight distributing hitch.
- The standard bumper beam must be installed after you remove the trailer hitch. Consult a SUBARU dealer for purchase of a standard bumper beam if you do not have the original.
- Safety performance is decreased and there is increased risk of injury to passengers in the case of an accident if the SUBARU genuine trailer hitch or a standard bumper beam is not installed. One of them must always be installed on the vehicle.
- If a trailer hitch is installed, it is not possible to install the rear towing hook.

When any of the tires are punctured, you can seal the tire temporarily. However, do not tow a trailer when a sealed tire is used. We recommend that you consult the nearest SUBARU dealer for details.

The maximum gross trailer weight and maximum gross tongue weight are indicated in the following table.

	Maximum gross trailer weight	Maximum gross tongue weight
2.4 L turbo models	3,500 lbs (1,588 kg)	350 lbs (159 kg)
2.5 L non-turbo models	2,700 lbs (1,224 kg)	270 lbs (122 kg)

When towing a trailer, refer to “Trailer Towing”  P426.

## CONNECTING A SUBARU GENUINE TRAILER HITCH

1. Remove the receiver cover from the hitch receiver tube. Then insert the ball mount into the hitch receiver tube.
2. Insert the hitch pin into the hole located on the hitch receiver tube so that the pin passes through the ball mount.

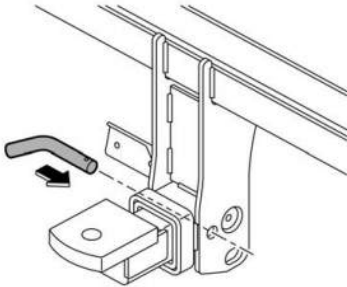

3. Insert the safety pin through the provided hole on the hitch pin securely.

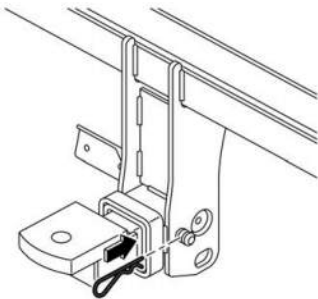

4. Check the ball mount assembly by pulling on it to make sure it does not come off the hitch receiver.

5. Use only a hitch ball that is appropriate for the ball mount and your trailer. The hitch ball must be securely installed on the ball mount.

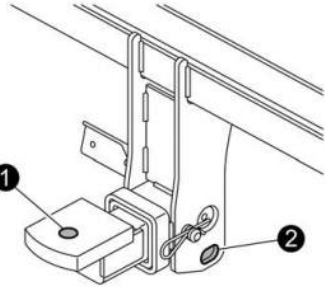

- ❶ Hitch ball installation point
- ❷ Hooks for safety chains

6. Connect your trailer to the hitch ball.
7. Connect the trailer and the hitch with safety chains that will hold the trailer's maximum gross weight. In case the trailer hitch connector or hitch ball should break or become disconnected, the trailer could get loose and create a traffic safety hazard. For safety, always connect the towing vehicle and trailer with trailer safety chains.

Two chains should be used in total, one to the right side and the other to the left side trailer tongue. Pass the chains crossing each other under the trailer tongue to prevent the trailer from dropping onto the ground in case the trailer tongue should disconnect from the hitch ball. Allow sufficient slack in the chains taking tight turn situations into account; however, be careful not to let them drag on the ground.

### WARNING

- For safety, always connect the towing vehicle and trailer with safety chains.
- Do not connect safety chains to any part of the vehicle other than

the safety chain hooks.

- Be sure to check the hitch pin and safety pin for positive locking placement before towing a trailer. If the ball mount comes off the hitch receiver, the trailer could get loose and create a traffic safety hazard.
8. Connect the hitch wire harness's black four-pin wire connector to the towing trailer's wire harness.

#### Hitch harness connector

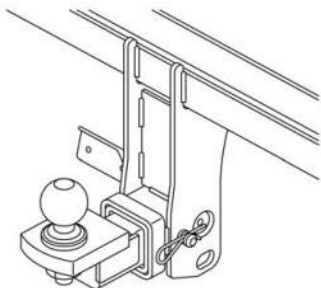

9. Confirm proper function of the hitch wire harness by individually activating the brake, stop and turn signal lights on the trailer.

#### NOTE

- A genuine SUBARU hitch is available from your SUBARU dealer.
- Always disconnect the trailer wire harness before launching or retrieving a watercraft.

#### IF NOT TOWING A TRAILER

- Remove the ball mount from the hitch receiver tube.
- Place the dust cap over the four-pin connector of the hitch electrical wire harness to protect against possible damage.
- Occasionally lubricate terminals of the four-pin connector using terminal grease.

## 8-13. TRAILER TOWING

Your vehicle is designed and intended to be used primarily as a passenger-carrying vehicle. Towing a trailer puts additional loads on your vehicle's engine, drivetrain, brakes, tires and suspension and has an adverse effect on fuel economy.

If you do decide to tow a trailer, your safety and satisfaction depend upon proper use of correct equipment and cautious operation of your vehicle.

Seek the advice of your SUBARU dealer to assist you in purchasing a hitch and other necessary towing equipment appropriate for your vehicle. Do not use towing equipment other than genuine SUBARU towing equipment. In addition, be sure to follow the instructions for proper installation and use provided by the trailer or caravan's manufacturer.

SUBARU assumes no responsibility for injuries or vehicle damage that result from trailer towing equipment, or from any errors or omissions in the instructions accompanying such equipment or for your failure to follow the proper instructions. Regularly check that the hitch mounting bolts and nuts are tightened securely.

#### WARRANTIES AND MAINTENANCE

SUBARU warranties do not apply to vehicle damage or malfunction caused by trailer towing. If you use your vehicle to tow a trailer, more frequent maintenance will be required due to the additional load. (Refer to "Maintenance schedule under severe driving conditions" in the "Warranty and Maintenance Booklet".)



Under no circumstances should a trailer be towed with a new vehicle or a vehicle with any new powertrain component (engine, transmission, differential, wheel bearings, etc.) for the first 1,000 miles (1,600 km) of driving.

**MAXIMUM LOAD LIMITS**

**⚠ WARNING**

Never exceed the maximum load limits explained in the following. Exceeding the maximum load limits could cause personal injury and/or vehicle damage.

**⚠ CAUTION**

- Adequate size trailer brakes are required when the trailer and its cargo exceed 1,000 lbs (453 kg) total weight.
- Before towing a trailer, check the trailer total weight, GVW, GAWs and tongue load. Make sure the load and its distribution in your vehicle and trailer are acceptable.

**Total trailer weight**

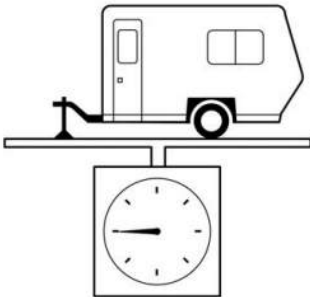

The total trailer weight (trailer weight plus its cargo load) must never exceed the maximum total trailer weight in the following table.

**2.4 L turbo models**

Conditions	Maximum total trailer weight	Maximum tongue weight
When towing a trailer without brakes.	1,000 lbs (453 kg)	100 lbs (45 kg)
When towing a trailer with brakes.	3,500 lbs (1,588 kg)	350 lbs (159 kg)

**2.5 L non-turbo models**

Conditions	Maximum total trailer weight	Maximum tongue weight
When towing a trailer without brakes.	1,000 lbs (453 kg)	100 lbs (45 kg)
When towing a trailer with brakes.	2,700 lbs (1,224 kg)	270 lbs (122 kg)

**Gross Vehicle Weight (GVW) and Gross Vehicle Weight Rating (GVWR)**

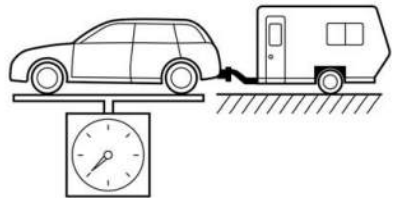

The Gross Vehicle Weight (GVW) must never exceed the Gross Vehicle Weight Rating (GVWR).

Gross Vehicle Weight (GVW) is the combined total of the weight of the vehicle, driver, passengers, luggage, trailer hitch, trailer tongue load and any other optional equipment installed on your vehicle. Therefore, the GVW changes depending on the situation.

Determine the GVW each time before going on a trip by putting your vehicle and trailer on a vehicle scale.

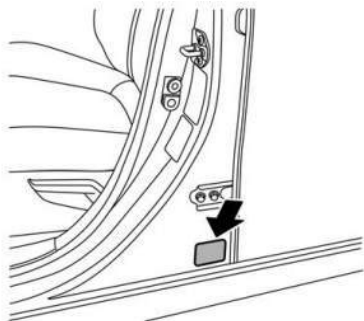

GVWR of your vehicle that is given by SUBARU is shown on the certification label located at the bottom of driver's side door pillar of your vehicle.

### Gross Axle Weight (GAW) and Gross Axle Weight Rating (GAWR)

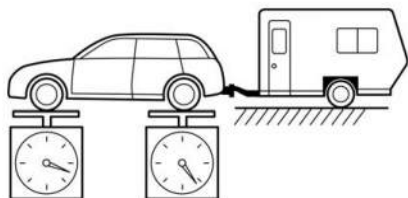

The total weight applied to each axle (GAW) must never exceed the Gross Axle Weight Rating (GAWR). The front and rear GAWs can be adjusted by relocating passengers and luggage inside the vehicle. The front and rear GAWR of your vehicle that is given by SUBARU are also shown on the certification label located at the bottom of driver's side door pillar.

To check both GVWR and GAWR and to confirm that the total weight and weight distribution are within safe driving limits,

you should have your vehicle and trailer weighed at a commercial weighing station.

Be sure that all cargo is firmly secured to prevent a change in weight distribution while driving.

### Tongue load

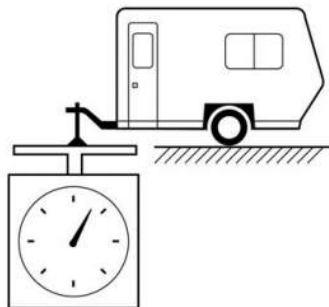

Ensure that the trailer tongue load is from 8% to 11% of the total trailer weight and does not exceed the maximum value. For details about the trailer tongue load, refer to "Trailer hitch" "Trailer Hitch (Dealer Option)" P424.

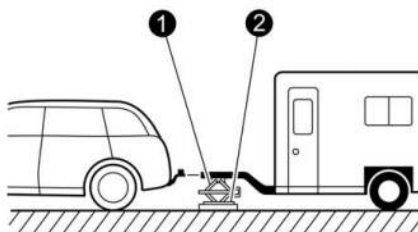

- 1 Jack
- 2 Bathroom scale

The tongue load can be weighed with a bathroom scale as shown in the illustration above. When weighing the tongue load, be sure to position the towing coupler at the height at which it would be during actual towing, using a jack as shown.

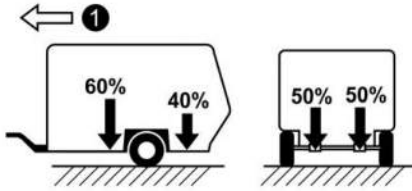

### 1 Front

The tongue load can be adjusted by proper distribution of the load in the trailer. Never load the trailer with more weight in the back than in the front; approximately 60 percent of the trailer load should be in the front and approximately 40 percent in the rear. Also, distribute the load as evenly as possible on both the left and right sides.

Be sure that all cargo is firmly secured to prevent a change in weight distribution while driving.

### WARNING

If the trailer is loaded with more weight in the back of trailer's axle than in the front, the load is taken off the rear axle of the towing vehicle. This may cause the rear wheels to skid, especially during braking or when vehicle speed is reduced during cornering, resulting in over-steer, spin out and/or jack-knifing.

## TRAILER HITCHES (Dealer Option)

### WARNING

Never drill the frame or under-body of your vehicle to install a commercial trailer hitch. If you do, dangerous exhaust gas, water or mud may enter the passenger compartment through

the drilled hole. Exhaust gas contains carbon monoxide, a colorless and odorless gas which is dangerous, or even lethal, if inhaled. Also, drilling the frame or under-body of your vehicle could cause deterioration of strength of your vehicle and cause corrosion around the drilled hole.

### CAUTION

- Do not modify the vehicle exhaust system, brake system, or other systems when installing a hitch or other trailer towing equipment.
- Do not use axle-mounted hitches as they can cause damage to the axle housing, wheel bearings, wheels or tires.

Do not use a trailer hitch other than a genuine SUBARU trailer hitch. A genuine SUBARU trailer hitch is available from your SUBARU dealer.

## WHEN YOU DO NOT TOW A TRAILER

### CAUTION

- The housing should be kept dirt and corrosion-free at the points of contact. The surfaces only require cleaning with a cloth. Grease or other lubricants should never be used.
- If the ball is not installed, the plastic insert and/or bumper cover should then be installed for protection and to prevent it from getting dirty.

When the ball is not used, place the ball cap and store securely.

## CONNECTING A TRAILER

### Trailer brakes

#### WARNING

- Adequate size trailer brakes are required when the trailer and its cargo exceed 1,000 lbs (453 kg) total weight.
- Do not directly connect your trailer's hydraulic brake system to the hydraulic brake system in your vehicle. Direct connection would cause the vehicle's brake performance to deteriorate and could lead to an accident.

If your trailer's total weight (trailer weight plus its cargo weight) exceeds 1,000 lbs (453 kg), the trailer is required to be equipped with its own brake system.

Electric brakes or surge brakes are recommended, and must be installed properly. Check that your trailer's brakes conform with Federal, state/province and/or other applicable regulations. Your SUBARU's brake system is not designed to be tapped into the trailer's hydraulic brake system. Please ask your SUBARU dealer and professional trailer supplier for more information about the trailer's brake system.

### Trailer safety chains

#### WARNING

Always use safety chains between your vehicle and the trailer. Towing trailer without safety chains could create a traffic safety hazard if the trailer separates from the hitch due to coupling damage or hitch ball damage.

In case the trailer hitch connector or hitch ball should break or become disconnected, the trailer could get loose and

create a traffic safety hazard.

For safety, always connect the towing vehicle and trailer with trailer safety chains. Two chains should be used in total, one to the right side and the other to the left side trailer tongue. Pass the chains crossing each other under the trailer tongue to prevent the trailer from dropping onto the ground in the event the trailer tongue should disconnect from the hitch ball. Allow sufficient slack in the chains taking tight turn situations into account; however, be careful not to let them drag on the ground.

### Outside mirrors

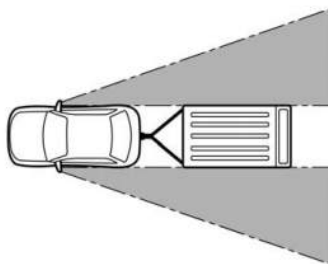

After hitching a trailer to your vehicle, check that the standard outside mirrors provide a good rearward field of view without significant blind spots. If significant blind spots occur with the vehicle's standard outside mirrors, use towing mirrors that conform with Federal, state/province and/or other applicable regulations.

### Trailer lights

#### CAUTION

Direct splicing or other improper connection of trailer lights may damage your vehicle's electrical system and cause a malfunction of your vehicle's lighting system.

Connection of trailer lights to your vehicle's electrical system requires modifications to the vehicle's lighting circuit to increase its capacity and accommodate wiring changes. To ensure the trailer lights are connected properly, please consult your SUBARU dealer. Check for proper operation of the turn signals and the brake lights each time you connect a trailer to your vehicle.

## Tires



### WARNING

Never tow a trailer when the temporary spare tire is used. The temporary spare tire is not designed to sustain the towing load. Use of the temporary spare tire when towing can result in failure of the spare tire and/or less stability of the vehicle.

Make sure that all the tires on your vehicle are properly inflated. Refer to "Tires"  P517.

Trailer tire condition, size, load rating and proper inflation pressure should be in accordance with the trailer manufacturer's specifications. Also check federal, state, province and/or other applicable regulations.

In the event your vehicle gets a flat tire when towing a trailer, ask a commercial road service representative or professional to repair the flat tire.

If you carry a regular size spare tire in your vehicle or trailer as a precaution against getting a flat tire, be sure that the spare tire is firmly secured.

## TRAILER TOWING TIPS



### CAUTION

- For models equipped with the BSW (Blind Spot Warning) and RCTW (Rear Cross Traffic Warning) driv-

ing support systems, when towing a trailer, touch "Blind Spot Warning (BSW)/Rear Cross Traffic Warning (RCTW)" to deactivate the system. The system may not operate properly due to the blocked radar waves. For details about how to turn on/off the BSW/RCTW, refer to "EyeSight/Driving Assistance"  P202.

- For models equipped with the Reverse Automatic Braking (RAB) system, consult your SUBARU dealer for additional information about towing a trailer.
- Never exceed 45 mph (72 km/h) when towing a trailer in hilly country on hot days.
- When towing a trailer, steering, stability, stopping distance and braking performance will be different when compared to normal operation. For safety's sake, you should employ extra caution when towing a trailer and you should never drive at excessive speeds. You should also keep the following tips in mind:
  - The braking power of the parking brake may not be sufficient when stronger braking power is needed (e.g., when parking on a steep slope while towing a trailer).

## Before starting out on a trip

- Check the towing regulations for trailer or caravan vehicles that vary by state/region. Failure to comply with the procedures set forth will not only compromise your safety, but will also negate your insurance coverage and/or may violate the state road and traffic acts and regulations.
- Check that the vehicle and vehicle-to-hitch mounting are in good condition. If any problems are apparent, do not tow the trailer.

- Check that the vehicle rests horizontally with the trailer attached. If the vehicle is tipped sharply up at the front and down at the rear, check the total trailer weight, GVW, GAWs and tongue load again, then confirm that the load and its distribution are acceptable.
- Check that the tire rating and pressures are correct.
- Check that the vehicle and trailer are connected properly. Confirm that:
  - The trailer tongue is connected properly to the hitch ball.
  - The trailer lights connector is connected properly and trailer's brake lights illuminate when the vehicle's brake pedal is pressed, and that the trailer's turn signal lights flash when the vehicle's turn signal lever is operated.
  - The safety chains are connected properly.
  - All cargo in the trailer is secured safely in position.
  - The outside mirrors provide a good rearward field of view without a significant blind spot.
- Sufficient time should be taken to learn the "feel" of the vehicle/trailer combination before starting out on a trip. In an area free of traffic, practice turning, stopping and backing up.

### Driving with a trailer

- You should allow for considerably more stopping distance when towing a trailer. Avoid sudden braking because it may result in skidding or jackknifing and loss of control.
- Avoid uneven steering, sharp turns and rapid lane changes.
- Slow down before turning. Make a larger than normal turning radius because the trailer wheels will be closer than the vehicle wheels to the inside of the turn. In a tight turn, the trailer could hit your vehicle.

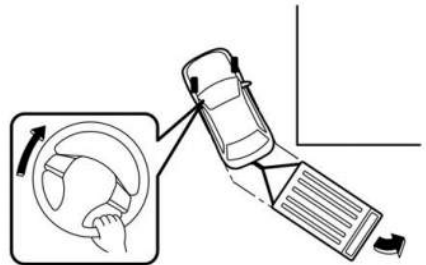
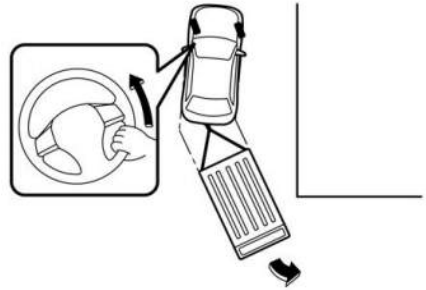

To reverse around a corner, perform the following procedure.

1. Reverse slowly and steer in the opposite direction to the way you want to turn.
2. Once the trailer begins to swing around, straighten the steering wheel.

3. Turn the wheel in the opposite direction.
  4. Steer the vehicle around to be in line with the trailer, then straighten the steering again.
- If the ABS warning light illuminates while the vehicle is in motion, stop towing the trailer and have repairs performed immediately by your nearest SUBARU dealer.

### Driving on grades

- Before going down a steep hill, slow down and shift into lower gear (if necessary, use 1st gear) in order to utilize the engine braking effect and prevent overheating of your vehicle's brakes. Do not make sudden downshifts.
- When driving uphill in hot weather, the air conditioner may turn off automatically to protect the engine from overheating.
- When driving uphill in hot weather, because the engine and transmission are relatively prone to overheating, pay attention to the following items.
  - Engine coolant temperature gauge
  - Coolant temperature high warning light
  - AT OIL TEMP warning light
- If any of the following conditions occur, immediately turn off the air conditioner and stop the vehicle in the nearest safe location. Refer to "If You Park Your Vehicle in an Emergency" ☞P436 and "Engine Overheating" ☞P446.
  - Engine coolant temperature gauge needle approaches the OVERHEAT zone. Refer to "Engine Coolant Temperature Gauge" ☞P160.
  - Coolant temperature high warning light illuminates. Refer to "Coolant Temperature Low Indicator Light (Blue)/Coolant Temperature High

Warning Light (Red)" ☞P167.

- AT OIL TEMP warning light illuminates. Refer to "AT OIL TEMP Warning Light" ☞P169.
- Do not use the accelerator pedal to stay stationary on an uphill slope instead of using the parking brake or foot brake. That may cause the transmission fluid to overheat.

### Parking on a grade

Always block the wheels under both vehicle and trailer when parking. Apply the parking brake firmly. You should not park on a hill or slope. If parking on a hill or slope cannot be avoided, you should take the following steps:

1. Apply the brakes and hold the pedal down.
2. Have someone place wheel blocks under both the vehicle and trailer wheels.
3. When the wheel blocks are in place, release the regular brakes slowly until the blocks absorb the load.
4. Apply the regular brakes and then apply the parking brake; slowly release the regular brakes.
5. Shift into the "P" position and shut off the engine.

---

---

---

---

---

---

---

---

---

---

---

---

---

---

---

---

---

---

---

---



## IN CASE OF EMERGENCY

---

9-1.	If You Park Your Vehicle in an Emergency .....	436
9-2.	Temporary Spare Tire .....	436
9-3.	Maintenance Tools .....	438
	Tool Locations .....	438
9-4.	Flat Tires .....	439
	Changing a Flat Tire.....	439
	Tire Pressure Monitoring System (TPMS) (Except for Canada-Spec. Models).....	442
	TPMS Screen (Except for Canada-Spec. Models) .....	443
9-5.	Jump Starting .....	443
	How to Jump Start .....	445
9-6.	Engine Overheating .....	446
	If Steam Is Coming from the Engine Compartment .....	446
	If No Steam Is Coming from the Engine Compartment .....	446
9-7.	Towing .....	447
	Towing Hook and Tie-Down Hooks/Holes.....	447
	Using a Flat-Bed Truck.....	449
	Towing with All Wheels on the Ground.....	450
9-8.	If the Electronic Parking Brake Cannot Be Released .....	451
9-9.	If Access Key Fob Does Not Operate Properly .....	451
	Locking and Unlocking .....	451
	Switching Power Status .....	452
	Starting Engine .....	452
9-10.	If the Rear Gate Cannot Be Opened.....	453
9-11.	Malfunctions of the Center Information Display .....	454
9-12.	If the Moonroof (If Equipped) Does Not Close .....	454
9-13.	If the Fuel Filler Lid Cannot Be Opened .....	455
9-14.	If Your Vehicle Is Involved in an Accident.....	456
	To Restart the Engine When Involved in an Accident.....	456
	Automatic Door Locking/Unlocking Operation When Involved in an Accident.....	456

## 9-1. IF YOU PARK YOUR VEHICLE IN AN EMERGENCY

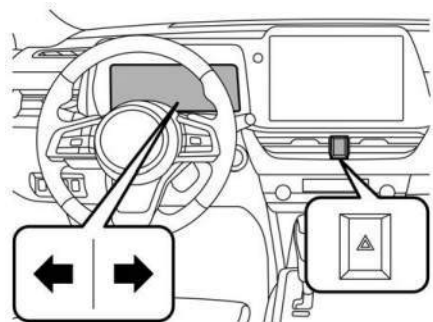

The hazard warning flasher should be used in day or night to warn other drivers when you have to park your vehicle under emergency conditions.

Avoid stopping on the road. It is best to safely pull off the road if a problem occurs.

The hazard warning flasher can be activated regardless of the ignition switch position.

Turn on the hazard warning by pressing the hazard warning flasher switch. Turn it off by pressing the switch again.

When the hazard warning flashers are flashing, the corresponding turn signal indicator light will also flash.

### NOTE

*When the hazard warning flasher is on, the turn signals do not work.*

## 9-2. TEMPORARY SPARE TIRE

### ⚠ WARNING

- Never tow a trailer when the temporary spare tire is used. The temporary spare tire is not designed to sustain the towing load. Use of the temporary spare tire when towing can result in failure of the spare tire and/or less stability of the vehicle and may lead to an accident.
- Except for Canada-spec. models, when a spare tire is mounted or a wheel rim is replaced without the original pressure sensor/transmitter being transferred, the low tire pressure warning light will illuminate steadily after blinking for approximately one minute. This indicates the tire pressure monitoring system (TPMS) is unable to monitor all four road wheels. Contact your SUBARU dealer as soon as possible for tire and sensor replacement and/or system resetting.

### ⚠ CAUTION

- Never use any temporary spare tire other than the original. Using other sizes may result in severe mechanical damage to the drive train of your vehicle.
- Always conform to the following instructions when using the temporary spare tire. Otherwise, a seriously dangerous situation may occur.

The temporary spare tire is stored under the under-floor storage compartment.

The temporary spare tire is smaller and lighter than a conventional tire and is

designed for emergency use only. Remove the temporary spare tire and re-install the conventional tire as soon as possible because the spare tire is designed only for temporary use.

Check the inflation pressure of the temporary spare tire periodically to keep the tire ready for use. For the correct pressure, refer to "Temporary Spare Tires" P517.

When using the temporary spare tire, note the following.

- Drive with caution when the temporary spare tire is installed. Avoid hard acceleration and braking, or fast cornering, as control of the vehicle may be lost.
- Do not exceed 50 mph (80 km/h).
- Do not put a tire chain on the temporary spare tire. Because of the smaller tire size, a tire chain will not fit properly.
- Do not use two or more temporary spare tires at the same time.
- Do not drive over obstacles. This tire has a smaller diameter, so road clearance is reduced.

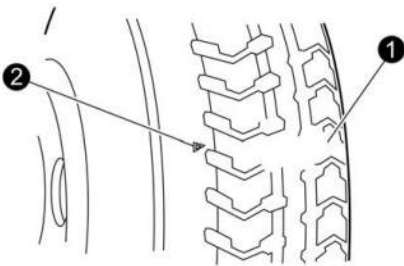

- ① Tread wear indicator bar
- ② Indicator location mark

- When the wear indicator appears on the tread, replace the tire.
- The temporary spare tire must be used only on a rear wheel. If a front wheel tire gets punctured, replace the

wheel with a rear wheel and install the temporary spare tire in place of the removed rear wheel.

## 9-3. MAINTENANCE TOOLS

Your vehicle is equipped with the following maintenance tools.

- Jack
- Jack handle
- Screwdriver
- Towing hook (eye bolt)
- Wheel nut wrench

### TOOL LOCATIONS

For Outback models

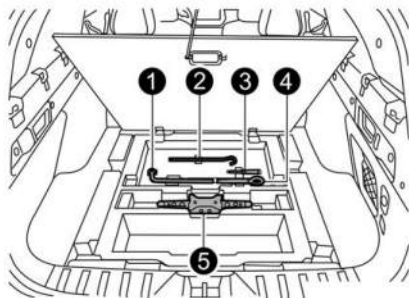

- ① Wheel nut wrench
- ② Jack handle
- ③ Screwdriver
- ④ Towing hook (eye bolt)
- ⑤ Jack

For Subaru Outback Wilderness models

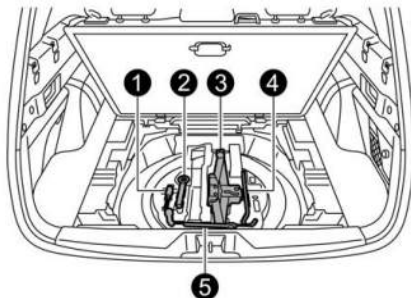

- ① Screwdriver
- ② Towing hook (eye bolt)
- ③ Jack
- ④ Jack handle
- ⑤ Wheel nut wrench

The maintenance tools are stored under the under-floor storage compartment. For the method to use the jack, refer to "Flat Tires" P439.

## 9-4. FLAT TIRES

If you have a flat tire while driving, never brake suddenly; keep driving straight ahead while gradually reducing speed. Then slowly pull off the road to a safe place.

### CHANGING A FLAT TIRE

#### WARNING

- Use only the jack and the jack handle provided with your vehicle. The jack supplied with the vehicle is designed only for changing a tire. Never put any part of your body under the vehicle while the vehicle is being supported by the jack. Doing so could result in serious injury or death.
- Do not jack up the vehicle on an incline or a loose road surface. The jack can come out of the jacking point or sink into the ground and this can result in serious injury or death.
- Before jacking up the vehicle, be sure that there are no occupants or cargo on board.
- Do not jack up the vehicle with an object on or underneath the jack. The jack can be unstable and this can result in a severe accident.
- Always turn off the engine before raising the flat tire off the ground using the jack. Never swing or push the vehicle supported with the jack. The jack can come out of the jacking point due to a jolt and this can result in serious injury or death.
- All passengers must exit the vehicle before you raise it with the jack. Raising the vehicle with someone inside of it could result in serious injury or death.

- Do not start the vehicle while it is supported by the jack. Doing so could result in serious injury or death.

#### CAUTION

Do not hit and bend the disc rotor backing plate when removing and installing the tire. A bent backing plate may scrape against the disc rotor and cause noise while the vehicle is in motion.

#### NOTE

Contact a SUBARU dealer when jacking up the vehicle using a garage jack.

1. Park on a hard, level surface, whenever possible, then stop the engine.
2. Apply the parking brake and place the select lever in the "P" position.
3. Turn on the hazard warning flasher and unload all occupants and luggage from the vehicle.
4. Put wheel blocks at the front and rear of the tire diagonally opposite the flat tire.

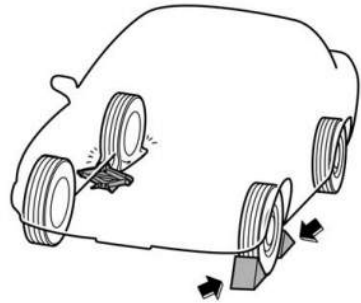

5. Take out the jack, jack handle and wheel nut wrench.

The tools and the spare tire are stored under the floor of the cargo area. Refer to "Maintenance Tools" P438.

## NOTE

- Make sure that the jack is well lubricated before using it.
  - To take out the tools and spare tire, remove the multi-use cargo cover to open the under-floor storage compartment. Refer to "Maintenance Tools" P438.
6. Take out the under-floor storage compartment and turn the attaching bolt counterclockwise, then take the spare tire out.

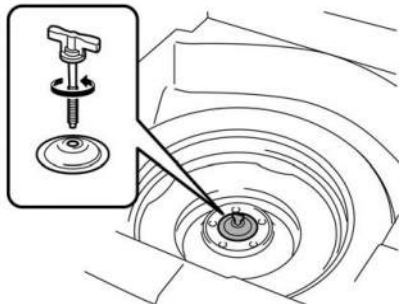

## NOTE

Carefully read "Temporary Spare Tire" P436 and strictly follow the instructions.

7. Loosen the wheel nuts using the wheel nut wrench but do not remove the nuts.



8. Place the jack under the side sill at the front or rear jack-up point closest to the flat tire.

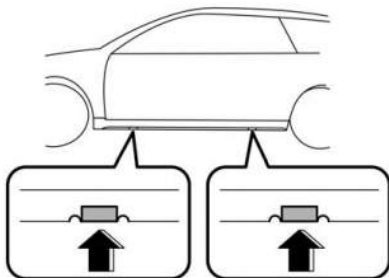

9. Turn the jackscrew by hand until the jack head engages firmly into the jack-up point.

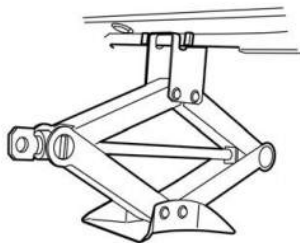

10. Insert the jack handle into the hole of the wheel nut wrench.



11. Insert the jack handle into the jack-screw, and turn the handle until the tire clears the ground. Do not raise the vehicle higher than necessary.

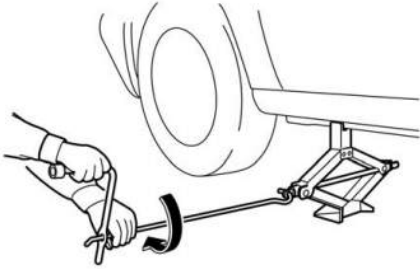

12. Remove the wheel nuts and the flat tire.  
 13. Before putting the spare tire on, clean the mounting surface of the wheel and hub with a cloth.

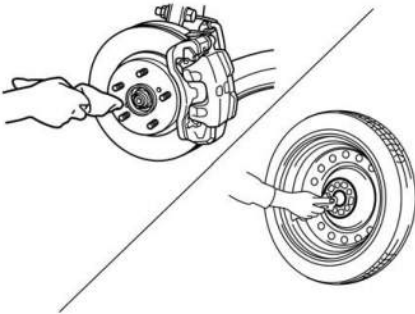

14. Put on the spare tire. Replace the wheel nuts. Tighten them by hand.

**⚠ WARNING**  
 Do not use oil or grease on the wheel studs or nuts when the spare tire is installed. This could cause the nuts to become loose and lead to an accident.

15. Turn the jack handle counterclockwise to lower the vehicle.

16. Use the wheel nut wrench to securely tighten the wheel nuts to the specified torque, following the tightening order in the illustration.

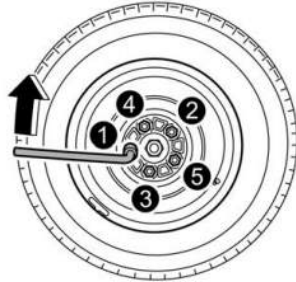

**NOTE**  
 For the wheel nut tightening torque, refer to "Tires" Ⓞ P517. Never use your foot on the wheel nut wrench or a pipe extension on the wrench because you may exceed the specified torque. Have the wheel nut torque checked at the nearest automotive service facility.

17. Store the flat tire in the spare tire compartment. Install with the support holder facing upward and secure the flat tire by firmly tightening the attaching bolt.

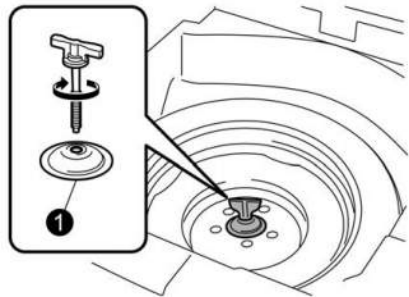

① Support holder

**NOTE**  
 If you cannot fix the flat tire firmly, try turning the support holder upside down.

18. Store the jack, jack handle and wheel nut wrench in their storage locations.



### WARNING

Never place a tire or tire changing tools in the passenger compartment after changing wheels. In a sudden stop or collision, loose equipment could strike occupants and cause injury. Store the tire and all tools in the proper place.

## TIRE PRESSURE MONITORING SYSTEM (TPMS) (Except for Canada-Spec. Models)

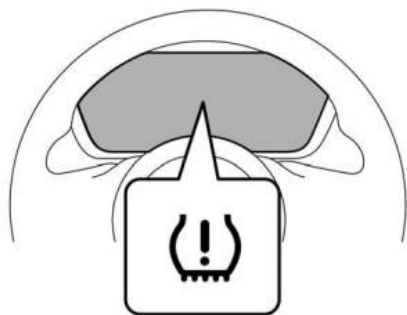

The tire pressure monitoring system provides the driver with the warning message indicated by sending a signal from a sensor that is installed in each wheel when tire pressure is severely low.

The tire pressure monitoring system will activate only when the vehicle is driven. Also, this system may not react immediately to a sudden drop in tire pressure (for example, a blow-out caused by running over a sharp object).



### WARNING

- If the low tire pressure warning light illuminates while driving, never brake suddenly. Instead, perform the following procedure. Otherwise an accident involving serious ve-

hicle damage and serious personal injury could occur.

- (1) Keep driving straight ahead while gradually reducing speed.
- (2) Slowly pull off the road to a safe place.
- (3) Check the pressure for all four tires and adjust the pressure to the COLD tire pressure shown on the tire inflation pressure label on the door pillar on the driver's side.

If this light still illuminates while driving after adjusting the tire pressure, a tire may have significant damage and a fast leak that causes the tire to lose air rapidly. If you have a flat tire, refer to "Flat Tires" P439.

- When a replacement tire is mounted or a wheel rim is replaced without the original pressure sensor/transmitter being transferred, the low tire pressure warning light will illuminate steadily after blinking for approximately one minute. This indicates the TPMS is unable to monitor all four road wheels. Contact your SUBARU dealer as soon as possible for tire and sensor replacement and/or system resetting.



## TPMS SCREEN (Except for Canada-Spec. Models)

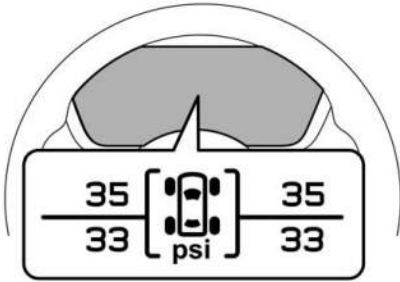

This screen displays each tire pressure. Refer to “Basic Screens” P191.

## 9-5. JUMP STARTING

### WARNING

- Battery fluid is SULFURIC ACID. Do not let it come in contact with the eyes, skin, clothing or the vehicle.

If battery fluid gets on you, thoroughly flush the exposed area with water immediately. Get medical help if the fluid has entered your eyes.

If battery fluid is accidentally swallowed, immediately drink a large amount of milk or water, and obtain immediate medical help.

Keep everyone including children away from the battery.

- The gas generated by a battery explodes if a flame or spark is brought near it. Do not smoke or light a match while jump starting.
- Never attempt jump starting if the discharged battery is frozen. It could cause the battery to burst or explode.
- Whenever working on or around a battery, always wear suitable eye protectors, and remove metal objects such as rings, bands or other metal jewelry.
- Be sure the jumper cables and clamps on them do not have loose or missing insulation.
- Do not jump start unless cables in suitable condition are available.
- A running engine can be dangerous. Keep your fingers, hands, clothing, hair and tools away from the cooling fan, drive belt and any other moving engine parts. Removing rings, watches and ties is advisable.

- Jump starting is dangerous if it is done incorrectly. If you are unsure about the proper procedure for jump starting, consult a competent mechanic.

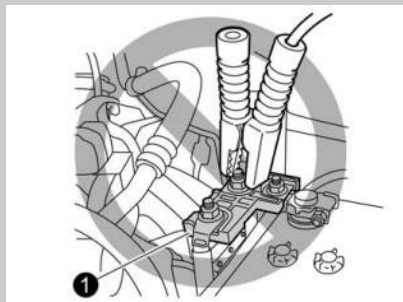

❶ Fuse

- Never connect the jumper cables to a fuse near the terminal of the vehicle battery. Doing so may ignite gases generated by the battery and result in an explosion, which could damage the electronic devices and the engine.

When your vehicle does not start due to a run down (discharged) battery, the vehicle may be jump started by connecting your battery to another battery (called the booster battery) with jumper cables.

## HOW TO JUMP START

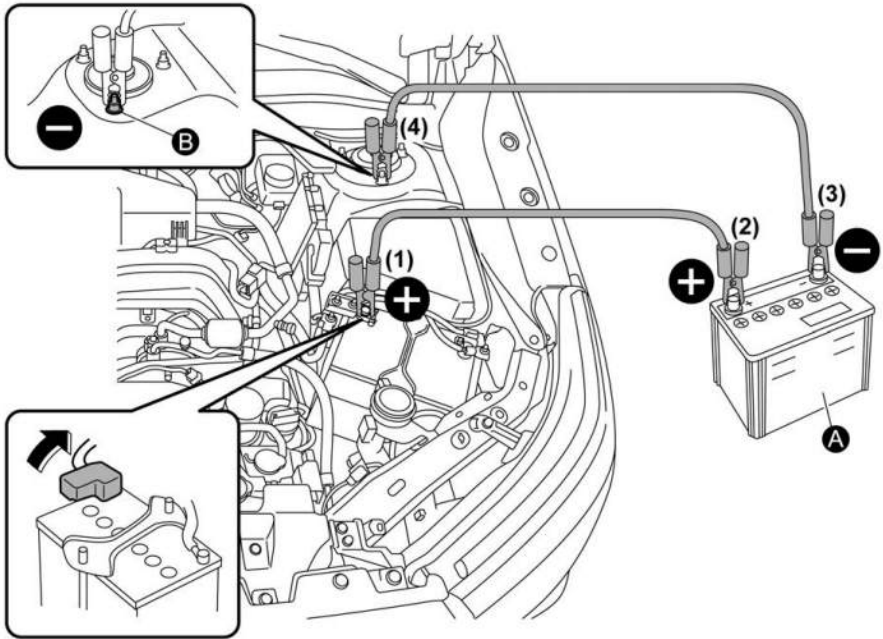

- A** Booster battery  
**B** Strut mounting nut

1. Make sure the booster battery is 12 volts and the negative terminal is grounded.
2. If the booster battery is in another vehicle, do not let the two vehicles touch.
3. Turn off all unnecessary lights and accessories.
4. Connect the jumper cables exactly in the sequence illustrated.
  - (1) Connect one jumper cable to the positive (+) terminal of the discharged battery.
  - (2) Connect the other end of the jumper cable to the positive (+) terminal of the booster battery.
  - (3) Connect one end of the other cable to the negative (-) terminal of the booster battery.
  - (4) Connect the other end of the cable to the strut mounting nut. Make sure that the cables are not near any moving parts and that the cable clamps are not in contact with any other metal.
5. Start the engine of the vehicle with the booster battery and run it at moderate speed. Then start the engine of the vehicle that has the discharged battery.
6. When finished, carefully disconnect the cables in exactly the reverse order.

## 9-6. ENGINE OVERHEATING



### WARNING

Never remove the radiator cap until the engine has been shut off and has fully cooled down. When the engine is hot, the coolant is under pressure. Removing the cap while the engine is still hot could release a spray of boiling hot coolant, which could burn you very seriously.



### CAUTION

If the engine overheats, the engine speed or the vehicle speed may be reduced. Stop the vehicle in a safe place immediately.

perature Low Indicator Light (Blue)/ Coolant Temperature High Warning Light (Red)" ⓄP167.

- After the engine has fully cooled down, check the coolant level in the reserve tank.  
If the coolant level is below the "LOW" mark, add coolant up to the "FULL" mark.
- If there is no coolant in the reserve tank, add coolant to the reserve tank. Then remove the radiator cap and fill the radiator with coolant.

If you remove the radiator cap from a hot radiator, first wrap a thick cloth around the radiator cap, then turn the cap counter-clockwise slowly without pressing down until it stops. Release the pressure from the radiator. After the pressure has been fully released, remove the cap by pressing down and turning it.

## IF STEAM IS COMING FROM THE ENGINE COMPARTMENT

Turn off the engine and get everyone away from the vehicle until it cools down.

## IF NO STEAM IS COMING FROM THE ENGINE COMPARTMENT

### NOTE

For details about how to check the coolant level or how to add coolant, refer to "Engine Coolant" ⓄP479.

- Keep the engine running at idling speed.
- Open the hood to ventilate the engine compartment. Refer to "Engine Hood" ⓄP473.
- Confirm that the cooling fan is turning. If the fan is not turning, immediately turn off the engine and contact your authorized dealer for repair.
- After the coolant temperature high warning light that has blinked or illuminated in RED turns off, turn off the engine. For details about the warning light, refer to "Coolant Tem-

## 9-7. TOWING

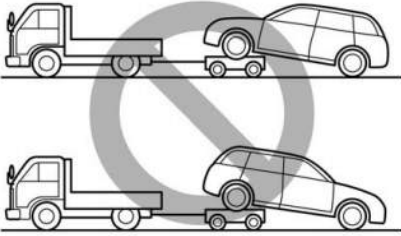

### WARNING

Never tow AWD models with the front wheels raised off the ground while the rear wheels are on the ground, or with the rear wheels raised off the ground while the front wheels are on the ground. This will cause the vehicle to spin away due to the operation or deterioration of the center differential.

If towing is necessary, SUBARU recommends it be done by your SUBARU dealer or a commercial towing service.

### TOWING HOOK AND TIE-DOWN HOOKS/HOLES

The towing hooks should be used only in an emergency.

**SUBARU recommends towing be done by your SUBARU dealer or a commercial towing service.**

### CAUTION

- Use only the specified towing hook and tie-down hooks/holes. Never use suspension parts or other parts of the body for towing or tie-down purposes.

- Never use the tie-down hole closest to the muffler under the vehicle for towing purposes.

### Front towing hooks

The front towing hooks are located on the bottom of the body on the front left and right side of the vehicle.

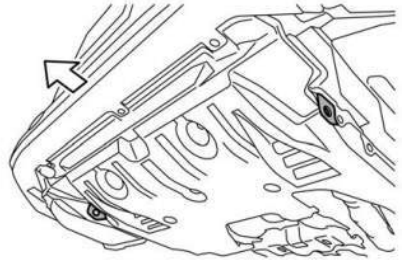

### Rear towing hook

1. Take out the screwdriver, towing hook, wheel nut wrench and jack handle from the under-floor storage compartment.
2. Cover the tip of a flat-head screwdriver with vinyl tape or cloth so that it will not scratch the bumper. Insert the flat-head screwdriver into the cutout of the cover and pry open the cover.

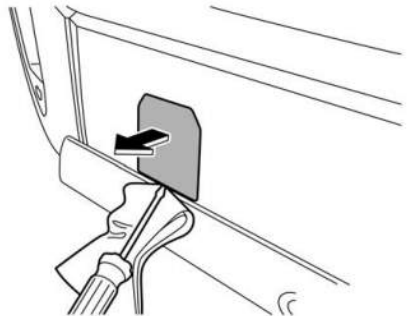

- Screw the towing hook into the threaded hole until its thread can no longer be seen.

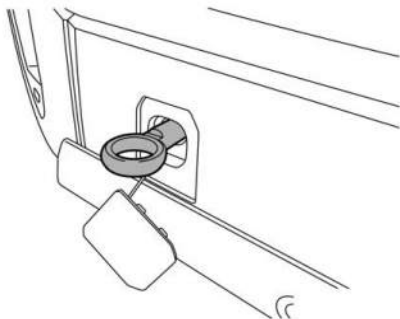

- Tighten the towing hook securely using the jack handle and wheel nut wrench.

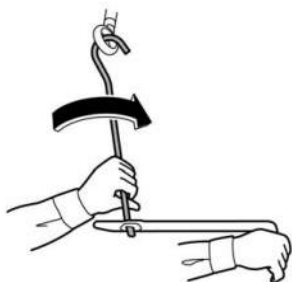

After towing, remove the towing hook from the vehicle and stow it in the under-floor storage compartment.

Fit the towing hook cover on the bumper.

### WARNING

- Do not use the towing hook for purposes other than towing your vehicle.

- Be sure to remove the towing hook after towing. Leaving the towing hook mounted on the vehicle could interfere with proper operation of the fuel pump shut off function when the vehicle is struck from behind.



### CAUTION

- To prevent deformation to the bumper and the towing hook, do not apply an excessive load to the towing hook.
- For models equipped with the BSW/RCTW system, when towing another vehicle, touch “Blind Spot Warning (BSW)/Rear Cross Traffic Warning (RCTW)” to deactivate the system. The system may not operate properly due to the blocked radar waves. For details about how to turn on/off the Blind Spot Warning (BSW)/Rear Cross Traffic Warning (RCTW), refer to “EyeSight/Driving Assistance”  P202.

## Front tie-down hooks

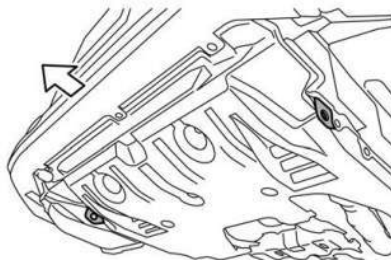

The front tie-down hooks are located between each of the front tires and the front bumper.

## Rear tie-down holes

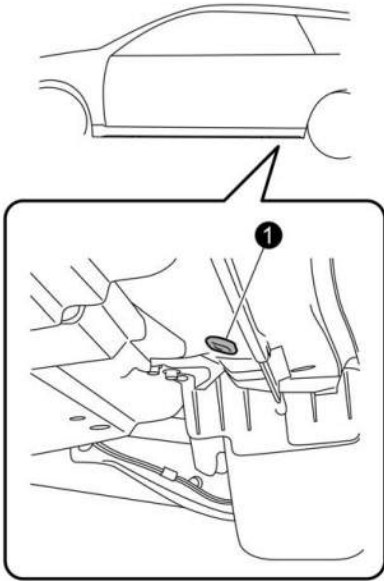

① Rear tie-down hole

The rear tie-down holes are located near each of the jack-up reinforcements.

There is a plug in each rear tie-down hole. To use the rear tie-down holes, remove the plugs. After using the rear tie-down holes, return the plugs to their original places.

### WARNING

Use the rear tie-down holes only for downward anchoring. If they are used to anchor the vehicle in any other direction, cables may slip out of the holes, possibly causing a dangerous situation.

## USING A FLAT-BED TRUCK

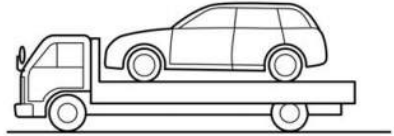

This is the best way to transport your vehicle. Use the following procedures to ensure safe transportation.

1. Shift the select lever into the "P" position.
2. Apply the parking brake firmly.
3. Secure the vehicle onto the carrier properly with safety chains. Each safety chain should be equally tightened and care must be taken not to pull the chains so tightly that the suspension bottoms out.

### CAUTION

Transport by flat-bed truck may cause the headlights to become misaligned. In such a case, have the headlight alignment checked by a SUBARU dealer after transporting the vehicle by flat-bed truck.

## TOWING WITH ALL WHEELS ON THE GROUND

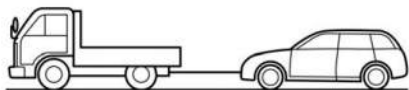

### WARNING

- Never turn the ignition switch to the “OFF” position while the vehicle is being towed because the steering wheel and the direction of the wheels will be locked.
- Remember that the brake booster and power steering do not function when the engine is not running. Because the engine is turned off, it will take greater effort to operate the brake pedal and steering wheel.

### CAUTION

- If transmission failure occurs, transport your vehicle on a flat-bed truck.
- Sometime damaged vehicles cannot be towed because of their damaged condition. In that case, use a flat-bed truck for transportation.
- The traveling speed must be limited to less than 20 mph (32 km/h) and the traveling distance to less than 31 miles (50 km). For greater speeds and distances, transport your vehicle on a flat-bed truck.

- Use a flat-bed truck if there are long distance downgrades or steep slopes. However, do not apply the brake pedal for a long time because the engine braking will not work while towing. Doing so could overheat the brake.
- Drive carefully and do not make an impact on the towing rope by suddenly starting.
- Use a specific towing rope for towing. If wire ropes and metal chains are needed to be used for towing, wrap the contact portion of the bumper with cloth to protect it from damage.

1. Release the parking brake and put the transmission in neutral.
2. The ignition switch should be in the “ON” position while the vehicle is being towed.
3. Take up slack in the towline slowly to prevent damage to the vehicle.



## 9-8. IF THE ELECTRONIC PARKING BRAKE CANNOT BE RELEASED

Contact your SUBARU dealer and have your SUBARU dealer release the electronic parking brake.

## 9-9. IF ACCESS KEY FOB DOES NOT OPERATE PROPERLY



### CAUTION

Keep metallic objects, magnetic sources and signal transmitters away from the area between the access key fob and the push-button ignition switch. They may interfere with the communication between the access key fob and the push-button ignition switch.

The following functions may be inoperable because of strong radio signals in the surrounding area or a low battery condition of the access key fob.

- Locking/unlocking all the doors including rear gate
- Switching the power status
- Starting the engine

In such cases, perform the following procedure. When the battery of the access key fob is discharged, replace it with a new one. Refer to “Replacing Battery of Access Key Fob”  $\text{\textcircled{P}}507$ .

## LOCKING AND UNLOCKING

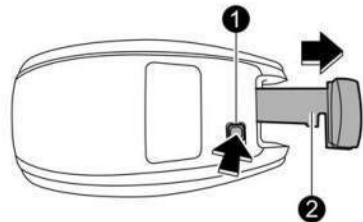

- ① Release button
- ② Emergency key

While pressing the release button of the access key fob, take out the emergency

key.

Lock or unlock the driver's door with the emergency key in the procedure described in "Locking and Unlocking from the Outside" P132.

#### NOTE

*After locking or unlocking, be sure to attach the emergency key back to the access key fob.*

### SWITCHING POWER STATUS

1. Apply the parking brake.
2. Place the select lever in the "P" position.
3. Depress the brake pedal.
4. Hold the access key fob with the buttons facing you, and touch the push-button ignition switch with it.

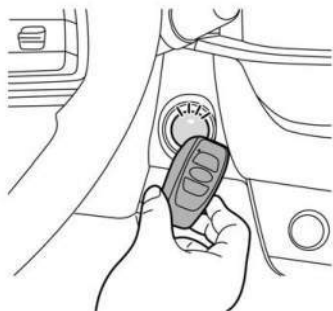

When the communication between the access key fob and the vehicle is completed, a chime (ding) will sound. At the same time, the status of the push-button ignition switch changes to either of the following.

- When the keyless access with push-button start system is deactivated: "ACC"
- Under other conditions: "ON"

5. When the keyless access with push-button start system is deactivated, press the push-button ignition switch with the brake pedal released. The status of the push-button ignition switch then changes to "ON".

#### NOTE

*If the power does not switch even though the above procedure was followed precisely, contact your SUBARU dealer.*

### STARTING ENGINE

1. Apply the parking brake.
2. Place the select lever in the "P" position.
3. Depress the brake pedal.
4. Hold the access key fob with the buttons facing you, and touch the push-button ignition switch with it.

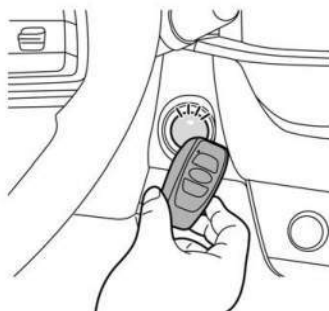

When the communication between the access key fob and the vehicle is completed, a chime (ding) will sound. At the same time, the push-button ignition switch turns to the "ACC" or "ON" position.

5. After the push-button ignition switch turns to the "ACC" or "ON" position, while depressing the brake pedal, press the push-button ignition switch.

#### NOTE

*If the engine does not start even though the above procedure was followed precisely, contact your SUBARU dealer.*

## 9-10. IF THE REAR GATE CANNOT BE OPENED

In the event that you cannot open the rear gate by pressing the rear gate opener button, you can open it from inside the cargo area.

1. Cover the tip of a flat-head screwdriver with vinyl tape or cloth so that it will not scratch. Remove the access cover at the bottom-center of the rear gate trim using flat-head screwdriver.

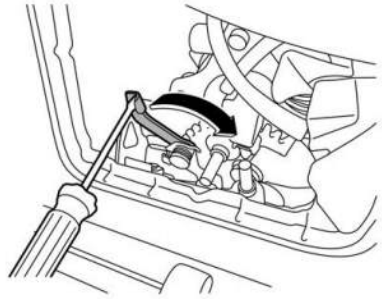
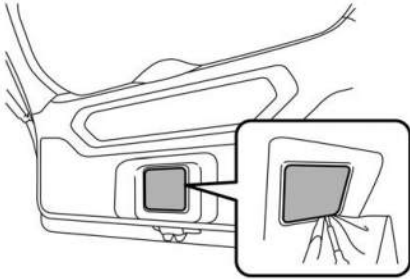

### CAUTION

Never operate the rear gate lock release lever with your fingers because doing so may cause an injury. Always use a flat-head screwdriver or a similar tool.

2. Turn the rear gate lock release lever to the right position using a flat-head screwdriver or a similar tool. Then the rear gate will open.

### **9-11. MALFUNCTIONS OF THE CENTER INFORMATION DISPLAY**

---

If the screen becomes blue or black, temporary errors or malfunctions may occur in the center information display.

If they are only temporary errors, the following procedure may help to eliminate them.

1. Park the vehicle in a safe place.
2. Turn the ignition switch once to the "OFF" position.
3. Open and close the door.
4. Wait for the good-bye screen to appear on the center information display, and then for it to disappear.
5. Start the engine.
6. If the center information display is not recovered by restarting it, contact your SUBARU dealer.

### **9-12. IF THE MOONROOF (If Equipped) DOES NOT CLOSE**

---

If the moonroof does not close, have the system checked by a SUBARU dealer.

### 9-13. IF THE FUEL FILLER LID CANNOT BE OPENED

If the fuel filler lid cannot be opened due to a malfunction or a dead battery, it can be opened from the cargo area.

1. Cover the tip of a flat-head screwdriver with vinyl tape or cloth so that it will not scratch. Remove the access cover at the right-side of the cargo area trim using a flat-head screwdriver.

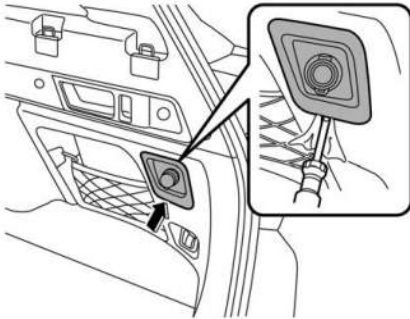

2. Remove the clip from the trim.

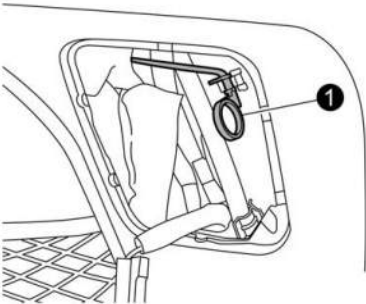

① Clip

3. Pull the clip to unlock the fuel filler lid.

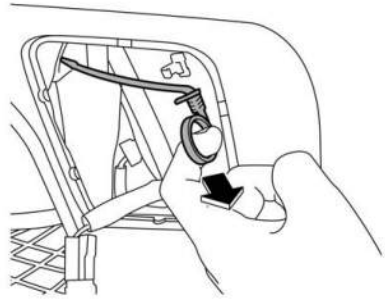

## 9-14. IF YOUR VEHICLE IS INVOLVED IN AN ACCIDENT

### TO RESTART THE ENGINE WHEN INVOLVED IN AN ACCIDENT



#### CAUTION

If your vehicle is involved in an accident, be sure to inspect the ground under the vehicle before restarting the engine. If you find that fuel has leaked on the ground, do not try to restart the engine. The fuel system has been damaged and is in need of repair. Immediately contact the nearest automotive service facility. Consult your SUBARU dealer.

Your vehicle has a fuel pump shut off system. When the vehicle sustains an impact in an accident, etc., the fuel pump shut off system stops supplying the fuel in order to minimize fuel leakage. However, depending on the impact conditions at the time of collision, the fuel pump shut-off system may not operate.

Perform the following procedures to restart the engine after the system is activated.

1. Turn the push-button ignition switch to the "ACC" or "OFF" position.
2. Restart the engine.

### AUTOMATIC DOOR LOCKING/ UNLOCKING OPERATION WHEN INVOLVED IN AN ACCIDENT

When the automatic door locking/unlocking function is ON, all the doors will be locked automatically while driving. For further details, refer to "Automatic Door Locking/Unlocking" P134.

When the vehicle sustains a strong impact which may trigger the airbags to

deploy, the door locks may be unlocked automatically to enable emergency escape. Generally, an impact sustained from a rear end collision does not trigger the airbags to deploy. However if the impact is strong enough to deploy the airbags, it can also trigger the unlocking function.

Under such circumstance, the automatic door locking/unlocking function will be suspended and the doors will remain unlocked.

Confirm the safety of the surroundings first and carry out the following to retrieve the automatic door locking/unlocking function.

1. Turn the push-button ignition switch to the "OFF" position.
2. Turn the push-button ignition switch to the "ON" position.

#### NOTE

*Depending on the severity of the impact, the emergency unlocking may not function.*



#### CAUTION

If the following occur, there may be a malfunction in the system.

Have the system inspected by a SUBARU dealer.

- The doors unlock automatically while driving.
- With all doors shut, the doors unlock when pressing the lock side of the power door locking switch.
- The automatic door locking/unlocking function does not operate.

---

---

---

---

---

---

---

---

---

---

---

---

---

---

---

---

---

---

---

---

---

---

---

---

---

---

---

---

---

---

---

---

---

---

---

---

---

---

---

---



## APPEARANCE CARE

---

<b>10-1. Exterior Care .....</b>	<b>460</b>
Washing .....	460
Waxing and Polishing .....	461
Cleaning Alloy Wheels .....	462
Cleaning Tire (Vehicle with White Letter Tires).....	462
<b>10-2. Corrosion Protection .....</b>	<b>463</b>
Most Common Causes of Corrosion.....	463
To Help Prevent Corrosion .....	463
<b>10-3. Cleaning the Interior .....</b>	<b>464</b>
Seat Fabric Material .....	464
Leather Seat Materials.....	464
Synthetic Leather Upholstery .....	464
Instrument Panel, Console Panel, Switches, Instrument Cluster, and Other Plastic Surface.....	465
Center Information Display.....	465

## 10-1. EXTERIOR CARE

### WASHING



#### CAUTION

- When using detergent to wash your vehicle, use plenty of water and thoroughly rinse away the detergent so that none remains on the brake calipers. If the brakes (brake calipers) are wet, the braking distance will be longer. To dry the brakes (brake calipers), drive the vehicle at a safe speed while lightly pressing the brake pedal to warm up the brakes (brake calipers).
- Do not wash the engine compartment and areas adjacent to it. If water enters the engine air intake or electrical parts, it will cause engine trouble or a malfunction of the power steering.
- When washing inner fenders, underbody, bumpers and protruding objects such as exhaust pipes and exhaust finishers, be careful to prevent injuries from contacting sharp ends.
- Do not use any organic solvents when washing the surface of the bulb assembly cover. However, if a detergent with organic solvents is used to wash the cover surface, completely rinse off the detergent with water. Otherwise, the cover surface may be damaged.
- If the climate control system is operating when you wash the vehicle, do not set the air inlet selection of the climate control to outside air circulation mode. There is a risk that water may enter the vehicle through the air inlets.

#### NOTE

*When having your vehicle washed in an automatic car wash, make sure beforehand that the car wash is of suitable type.*

The best way to preserve your vehicle's beauty is frequent washing. Wash the vehicle at least once a month to avoid contamination by road grime.

Wash dirt off with a wet sponge and plenty of lukewarm or cold water. Do not wash the vehicle with hot water and in direct sunlight.

Salt, chemicals, insects, tar, soot, tree sap, and bird droppings should be washed off by using a light detergent, as required. If you use a light detergent, make certain that it is a neutral detergent. Do not use strong soap or chemical detergents. All cleaning agents should be promptly flushed from the surface and not allowed to dry there. Rinse the vehicle thoroughly with plenty of lukewarm water. Wipe the remaining water off with a chamois or soft cloth. Wear rubber gloves and use a hand brush when washing down underbody, inner fenders and suspension to effectively remove mud and dirt off.

#### Washing the underbody

Chemicals, salts and gravel used for deicing road surfaces are extremely corrosive, accelerating the corrosion of underbody components, such as the exhaust system, fuel and brake lines, brake cables, floor pan and fenders, and suspension.

Thoroughly flush the underbody and inside of the fenders with lukewarm or cold water at frequent intervals to reduce the harmful effects of such agents.

Mud and sand adhering to the underbody components may accelerate their corrosion.

After driving off-road or on muddy or sandy roads, wash the mud and sand off the underbody.

Carefully flush the suspension and axle parts, as they are particularly prone to mud and sand buildup. Do not use a sharp-edged tool to remove caked mud.

 **CAUTION**

- Be careful not to damage brake hoses, sensor harnesses, and other parts when washing suspension components.
- When cleaning the lower part of the car body, keep a sufficient distance between the car wash nozzle and the car body, and do not wash the same area continuously. Doing so may damage components of the engine, electrical system, rubber trim, or other parts.

**Using a pressure washer**

- Keep a good distance of 12 in (30 cm) or more between the washer nozzle and the vehicle.
- Do not wash the same area continuously.
- If you are unable to remove a stain easily using the pressure washer, wash the area by hand. Note that some pressure washers may spray hot or high pressure water that will damage the vehicle body paint, damage or deform moldings or other resin parts, or cause water to leak into the vehicle.

**WAXING AND POLISHING**

Always wash and dry the vehicle before waxing and polishing.

Use a good quality polish and wax and apply them according to the manufacturer’s instructions. Wax or polish when the painted surface is cool.

Be sure to polish and wax the chrome trim, as well as the painted surfaces. Loss of wax on a painted surface leads to loss of the original luster and also quickens the

deterioration of the surface. It is recommended that a coat of wax be applied at least once a month, or whenever the surface no longer repels water.

If the appearance of the paint has diminished to the point where the luster or tone cannot be restored, lightly polish the surface with a fine-grained compound. Never polish just the affected area, but include the surrounding area as well. Always polish in only one direction. A No. 2000 grain compound is recommended. Never use a coarse-grained compound. Coarser grained compounds have a smaller grain-size number and could damage the paint. After polishing with a compound, coat with wax to restore the original luster. Frequent polishing with a compound or an incorrect polishing technique will result in removing the paint layer and exposing the undercoat. When in doubt, it is always best to contact your SUBARU dealer or an auto paint specialist.

10

 **CAUTION**

Do not use any agents with organic solvents on the surface of the bulb assembly cover. However, if a polish or wax with organic solvents is applied to the cover surface, completely wipe off the polish or wax. Otherwise, the cover surface may be damaged.

**NOTE**

*Be careful not to block the windshield washer nozzles with wax when waxing the vehicle.*

For Subaru Outback Wilderness models, if wax gets onto the hood decal when you are waxing your vehicle, this could enhance the reflective appearance of the hood decal and impair the antireflective function.

## CLEANING ALLOY WHEELS

### Vehicles without matte painted wheels

- Promptly wipe the alloy wheels clean of any kind of grime or agent. If dirt is left on too long, it may be difficult to clean off.
- Do not use soap containing grit to clean the wheels. Be sure to use a neutral cleaning agent, and later rinse thoroughly with water. Do not clean the wheels with a stiff brush or expose them to a high-speed washing device.
- Clean the vehicle (including the alloy wheels) with water as soon as possible when it has been splashed with sea water, exposed to sea breezes, or driven on roads treated with salt or other agents.

### Vehicles with matte painted wheels



#### CAUTION

Be sure to observe the following precautions as matte painted wheels can be damaged.

- Do not scrub or polish the wheels using a brush or dry cloth.
- Do not use any wheel coatings or abrasive detergents.

As matte painted wheels require different cleaning methods than conventional alloy wheels, be sure to observe the following. For details, consult your SUBARU dealer.

- Remove dirt using water. If the wheels are excessively dirty, use a sponge or soft cloth dampened with a diluted neutral detergent to remove the dirt.

## CLEANING TIRE (Vehicle with White Letter Tires)

It is recommended to clean the white letter part on the side of the tire frequently because it easily gets dirty. When cleaning, use a neutral detergent and wash with a sponge.

## 10-2. CORROSION PROTECTION

Your SUBARU has been designed and built to resist corrosion. Special materials and protective finishes have been used on most parts of the vehicle to help maintain fine appearance, strength, and reliable operation.

### MOST COMMON CAUSES OF CORROSION

The most common causes of corrosion are:

- The accumulation of moisture retaining dirt and debris in body panel sections, cavities, and other areas.
- Damage to paint and other protective coatings caused by gravel and stone chips or minor accidents.

Corrosion is accelerated on the vehicle when:

- It is exposed to road salt or dust control chemicals, or used in coastal areas where there is more salt in the air, or in areas where there is considerable industrial pollution.
- It is driven in areas of high humidity, especially when temperatures range just above freezing.
- Dampness in certain parts of the vehicle remains for a long time, even though other parts of the vehicle may be dry.
- High temperatures will cause corrosion to parts of the vehicle which cannot dry quickly due to lack of proper ventilation.

### TO HELP PREVENT CORROSION

Wash the vehicle regularly to prevent corrosion of the body and suspension components. Also, wash the vehicle promptly after driving on any of the following surfaces.

- Roads that have been salted to prevent them from freezing in winter
- Mud, sand, or gravel
- Coastal roads

After the winter has ended, it is recommended that the underbody be given a very thorough washing.

Before the beginning of winter, check the condition of underbody components, such as the exhaust system, fuel and brake lines, brake cables, suspension, steering system, floor pan, and fenders. If any of them are found to be rusted, they should be given an appropriate rust prevention treatment (except for the exhaust system) or should be replaced. Contact your SUBARU dealer to perform this kind of maintenance and treatment if you need assistance.

Repair chips and scratches in the paint as soon as you find them.

Check the interior of the vehicle for water and dirt accumulation under the floor mats because that could cause corrosion. Occasionally check under the mats to make sure the area is dry.

Keep your garage dry. Do not park your vehicle in a damp, poorly ventilated garage. In such a garage, corrosion can be caused by dampness. If you wash the vehicle in the garage or put the vehicle into the garage when wet or covered with snow, that can cause dampness.

If your vehicle is operated in cold weather and/or in areas where road salts and other corrosive materials are used, the door hinges and locks, rear gate lock, and hood latch should be inspected and lubricated periodically.

### 10-3. CLEANING THE INTERIOR

Use a soft, damp cloth to clean the climate control panel, audio equipment, instrument panel, center console, instrument cluster panel, and switches. (Do not use organic solvents.)

#### SEAT FABRIC MATERIAL

Remove loose dirt, dust or debris with a vacuum cleaner. If the dirt is caked on the fabric or hard to remove with a vacuum cleaner, use a soft brush then vacuum it.

Wipe the fabric surface with a tightly wrung cloth and dry the seat fabric thoroughly. If the fabric is still dirty, wipe using a solution of mild soap and lukewarm water then dry thoroughly.

If the stain does not come out, try a commercially available fabric cleaner. Use the cleaner on a hidden place and make sure it does not affect the fabric adversely. Use the cleaner according to its instructions.



#### CAUTION

When cleaning the seat, do not use benzine, paint thinner, or any similar materials. Doing so could damage the surface and cause the color to deteriorate.

#### LEATHER SEAT MATERIALS

The leather used by SUBARU is a high quality natural product which will retain its distinctive appearance and feel for many years with proper care.

Allowing dust or road dirt to build up on the surface can cause leather to become brittle and wear prematurely. To maintain its resiliency, leather should be cleaned monthly or whenever it becomes soiled. Some types of clothing textiles may transfer color to the leather.

Before cleaning leather upholstery, vacuum it to remove dust. Use a soft and lint-free cloth dampened with lukewarm water and mild soap, taking care not to soak the leather or allow water to penetrate the stitched seams. Use a gentle circular motion while cleaning the leather - do not rub or apply extreme pressure. Wipe the leather again with another clean, slightly damp cloth to remove soap residue and dry with a soft cloth.

Minor surface blemishes or difficult dirt spots may be treated with a commercial leather spray.



#### CAUTION

Never use alcohol, cleaning solvents, leather oils, varnishes or polishes on your leather as it will dry out the leather finish.

If your SUBARU is to be parked for a long time in bright sunlight, it is recommended that the seats and headrests be covered, or the windows shaded, to prevent fading or shrinkage.

You will discover that each leather seat section will develop soft folds or wrinkles, which is characteristic of genuine leather.

#### SYNTHETIC LEATHER UPHOLSTERY

The synthetic leather material used on the SUBARU may be cleaned using mild soap or detergent and water, after first vacuuming or brushing away loose dirt. Allow the soap to soak in for a few minutes and wipe off with a clean, damp cloth. Commercial foam-type cleaners suitable for synthetic leather materials may be used when necessary. Much like genuine leather, some types of fabric used in clothing may transfer color to synthetic leather. If you do not clean transferred color from synthetic leather for an extended period of time, it may be difficult to remove the color, so be sure to clean any such stains from synthetic

leather promptly.

**CAUTION**

Strong cleaning agents such as solvents, paint thinners, window cleaner or gasoline must never be used on leather or synthetic interior materials. Doing so could damage the surface and cause the color to deteriorate.

**INSTRUMENT PANEL, CONSOLE PANEL, SWITCHES, INSTRUMENT CLUSTER, AND OTHER PLASTIC SURFACE**

Use a soft, damp cloth to clean the instrument panel, center console, instrument cluster panel, and switches.

**CAUTION**

- Do not use organic solvents such as paint thinners or gasoline, or strong cleaning agents that contain those solvents. Doing so could damage the surface and cause the color to deteriorate.
- Do not use chemical solvents that contain silicone on the vehicle audio system, electrical components of the air-conditioner or any switches. If silicone adheres to these parts, it may cause damage to electrical components.

**CAUTION**

- Do not spray neutral detergent directly onto the display(s). Doing so could damage the monitor's components.
- Do not wipe the display(s) with a hard cloth. Doing so could scratch the monitor.
- Do not use cleaning fluid that contains thinner, gasoline, or any other volatile substance. Such cleaning fluid could erase the lettering on the switches on the display(s).

**CENTER INFORMATION DISPLAY**

To clean the center information display, wipe it with a silicone cloth or with a soft cloth. If the display(s) is/are extremely dirty, clean it with a soft cloth moistened with neutral detergent then carefully wipe off any remaining detergent.

---

---

---

---

---

---

---

---

---

---

---

---

---

---

---

---

---

---

---

---



## MAINTENANCE AND SERVICE

11-1.	Maintenance Schedule .....	469
11-2.	Maintenance Precautions .....	469
	Before Checking or Servicing in the Engine Compartment .....	470
	When Checking or Servicing in the Engine Compartment .....	471
	When Checking or Servicing in the Engine Compartment While the Engine Is Running .....	471
11-3.	Maintenance Tips .....	472
	When Replacing Parts .....	472
	Removing and Reinstalling Clips .....	472
11-4.	Engine Hood .....	473
11-5.	Engine Compartment Overview .....	475
11-6.	Engine Oil .....	476
	Engine Oil Consumption .....	476
	Checking the Oil Level .....	476
	Changing the Oil and Oil Filter .....	477
	Recommended Grade and Viscosity .....	477
	Synthetic Oil .....	478
11-7.	Cooling System .....	478
	Cooling Fan, Hose and Connections .....	479
	Engine Coolant .....	479
11-8.	Air Cleaner Element .....	480
	Replacing the Air Cleaner Element .....	480
11-9.	Spark Plugs .....	482
	Recommended Spark Plugs .....	482
11-10.	Drive Belt .....	482
11-11.	Continuously Variable Transmission Fluid .....	483
11-12.	Front Differential Gear Oil and Rear Differential Gear Oil .....	483
	Recommended Grade and Viscosity .....	483
11-13.	Brake Fluid .....	484
	Checking the Fluid Level .....	484
	Recommended Brake Fluid .....	484
11-14.	Brake Pedal .....	485
11-15.	Replacement of Brake Pad .....	485
	Breaking-In of New Brake Pads .....	485
11-16.	Tires and Wheels .....	486
	Types of Tires .....	486
	Tire Pressure Monitoring System (TPMS) (Except for Canada-Spec. Models) .....	487
	Tire Inspection .....	488
	Tire Pressures and Wear .....	489
	Wheel Balance .....	490
	Wear Indicators .....	491
	Rotational Direction of Tires .....	491
	Tire Rotation .....	492
	Tire Replacement .....	493
	Wheel Replacement .....	493
11-17.	Alloy Wheels .....	494

## MAINTENANCE AND SERVICE

---

11-18. Windshield Washer Fluid .....	495
11-19. Replacement of Wiper Blades.....	496
Windshield Wiper Blade Assembly .....	497
Window Wiper Blade Rubber.....	498
Rear Window Wiper Blade Rubber.....	499
11-20. Battery .....	500
11-21. Fuses .....	502
11-22. Installation of Accessories.....	503
11-23. Replacing Bulbs.....	504
Headlights .....	504
Rear Combination Lights.....	504
Other Bulbs .....	505
Adjusting Headlight Aim .....	506
11-24. Replacing Battery .....	507
Replacing Battery of Access Key Fob.....	507

## 11-1. MAINTENANCE SCHEDULE

### U.S. models

The scheduled maintenance items required to be serviced at regular intervals are shown in the "Warranty and Maintenance Booklet". For details, read the separate "Warranty and Maintenance Booklet".

### Canada models

The scheduled maintenance items required to be serviced at regular intervals are shown in the "Warranty and Service Booklet". For details, read the separate "Warranty and Service Booklet".

### Except for U.S. and Canada models

Some items of your vehicle are required to be serviced at scheduled intervals. For details about your maintenance schedule, read the separate "Warranty and Maintenance Booklet".

## 11-2. MAINTENANCE PRECAUTIONS

When maintenance and service are required, it is recommended that all work be done by an authorized SUBARU dealer.

If you perform maintenance and service by yourself, you should familiarize yourself with the information provided in this section on general maintenance and service for your SUBARU.

Incorrect or incomplete service could cause improper or unsafe vehicle operation. Any problems caused by improper maintenance and service performed by you are not eligible for warranty coverage.

### WARNING

- Testing of an All-Wheel Drive vehicle must NEVER be performed on a single two-wheel dynamometer or similar apparatus. Attempting to do so will result in transmission damage and in uncontrolled vehicle movement and may cause an accident or injuries to persons nearby.
- Always select a safe area when performing maintenance on your vehicle.
- Always be very careful to avoid injury when working on the vehicle. Remember that some of the materials in the vehicle may be hazardous if improperly used or handled, for example, battery acid.
- Your vehicle should only be serviced by persons fully competent to do so. Serious personal injury may result to persons not experienced in servicing vehicles.
- Always use the proper tools and make certain that they are well maintained.

- Never get under the vehicle supported only by a jack. Always use safety stands to support the vehicle.
- Never keep the engine running in a poorly ventilated area, such as a garage or other closed areas.
- Do not smoke or allow open flames around the fuel or battery. This will cause a fire.
- Because the fuel system is under pressure, replacement of the fuel filter should be performed only by your SUBARU dealer.
- Wear adequate eye protection to guard against getting oil or fluids in your eyes. If something does get in your eyes, thoroughly wash them out with clean water.
- Do not tamper with the wiring of the SRS airbag system or seatbelt pretensioner system, or attempt to take its connectors apart, as that may activate the system or it can render it inoperative. NEVER use a circuit tester for these wiring. If your SRS airbag or seatbelt pretensioner needs service, consult your nearest SUBARU dealer.
- Check the inside of the engine compartment to see if there are any cloths and tools left. If they are left inside, they may be a cause of malfunction and fire.

### NOTE

*SUBARU does not endorse the use of non-SUBARU approved flushing systems and strongly advises against performing these services on a SUBARU vehicle. Non-SUBARU approved flushing systems use chemicals and/or solvents which have not been tested or approved by SUBARU. SUBARU warranties do not cover any part of the vehicle which is damaged by adding or applying chemicals and/or solvents other than those*

*approved or recommended by SUBARU.*

## BEFORE CHECKING OR SERVICING IN THE ENGINE COMPARTMENT



### WARNING

- Always stop the engine and apply the parking brake to prevent the vehicle from moving.
- Always let the engine cool down. Engine parts become very hot when the engine is running and remain hot for some time after the engine is stopped.
- Do not spill engine oil, engine coolant, brake fluid or any other fluid on hot engine components. This may cause a fire.
- When the ignition switch is in the "ON" position, the cooling fan may operate suddenly even when the engine is stopped. If your body or clothes come into contact with a rotating fan, that could result in serious injury. To avoid risk of injury, always turn the push-button ignition switch to the "OFF" position and confirm that the operation indicator on the switch is turned off. Then take the access key fob out from the vehicle.
- Before performing any servicing on a vehicle equipped with a remote engine start system temporarily place that system in the service mode to prevent it from unexpectedly starting the engine.

## WHEN CHECKING OR SERVICING IN THE ENGINE COMPARTMENT

**CAUTION**

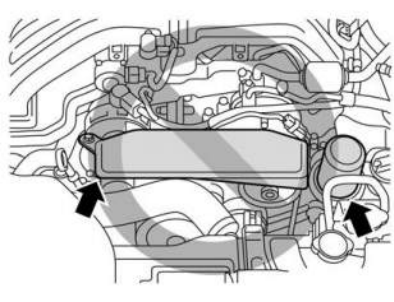

- Do not contact the cover while checking the components in the engine compartment. Doing so may cause your hand to slip off the cover and result in an unexpected injury.
- Do not touch the oil filter until the engine has cooled down completely. Doing so may result in a burn or other injury. Note that the oil filter becomes very hot when the engine is running and remains hot for some time after the engine has stopped.

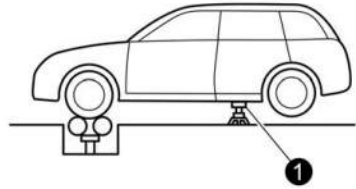

**1 Safety stand**

For any maintenance and inspection performed on AWD models which requires a running engine and wheels turning, jack up all four wheels or use free rollers to prevent the vehicle from moving. Never race the engine or brake suddenly.

## WHEN CHECKING OR SERVICING IN THE ENGINE COMPARTMENT WHILE THE ENGINE IS RUNNING

**WARNING**

A running engine can be dangerous. Keep your fingers, hands, clothing, hair and tools away from the cooling fan, drive belt and any other moving engine parts. Removing rings, watches and ties is advisable.

## 11-3. MAINTENANCE TIPS

### WHEN REPLACING PARTS

For information about replacement parts for maintenance, contact any authorized SUBARU dealer or repairer, or another duly qualified and equipped professional.

### REMOVING AND REINSTALLING CLIPS

Some clips and fender linings must be removed before replacing the air cleaner element or specific bulbs.

#### Removing clips

There are several types of clips used for your vehicle.

##### Type A:

1. Turn the clips counterclockwise using a flat-head screwdriver until the center portion of the clip is raised.

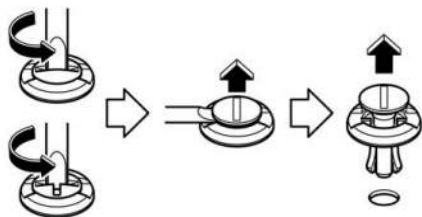

2. Remove the clips with a flat-head screwdriver using leverage.

##### Type B:

1. Pull out the center portion of the clip using a flat-head screwdriver as shown in the illustration.

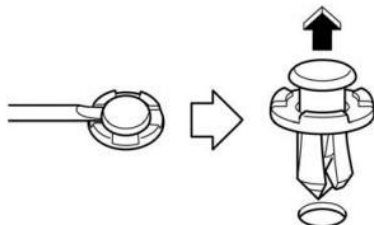

2. Pull the protruded center portion to remove the entire body of the clip.

##### Type C:

1. Turn the clip counterclockwise using a Phillips screwdriver until the center portion of the clip is raised.

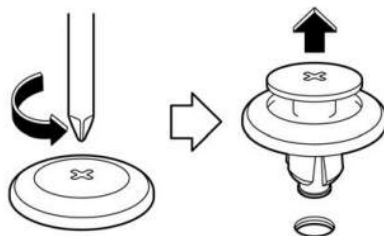

2. Remove the entire clip by pulling it up.

Reinstalling clips

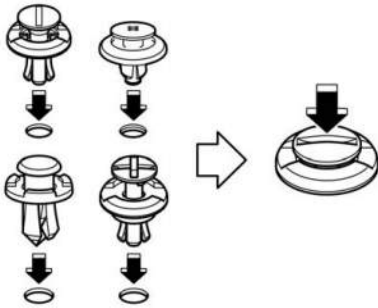

Insert the clip without the center portion first and then push the center portion of the clip into the hole.

11-4. ENGINE HOOD

**CAUTION**

- Be extremely careful not to catch fingers or other objects when closing the engine hood.
- Do not push the hood forcibly to close it. It could deform the metal.
- Be extremely careful opening the engine hood when the wind is strong. The engine hood could close suddenly, possibly causing injuries from slamming.
- Do not install accessories other than genuine SUBARU parts to the engine hood. If the engine hood becomes too heavy, the stay may not be able to support holding it open.
- Check that the end of the hood prop is inserted into the slot. If it is not inserted properly, the hood may drop and cause injury.

11

**NOTE**

*If the base of the hood prop is jammed, put the hood prop back in position without applying excessive force.*

**Opening the engine hood:**

1. If the wiper blades are lifted off the windshield, return them to their original position.

2. Pull the hood release knob under the instrument panel.

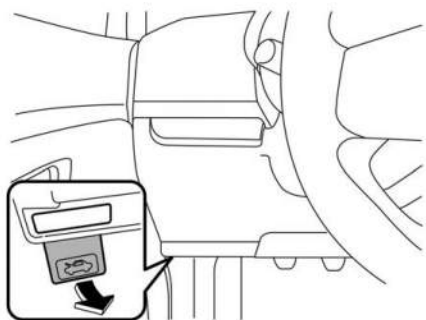

3. Release the secondary hood release by moving the lever between the front grille and the hood toward the left.

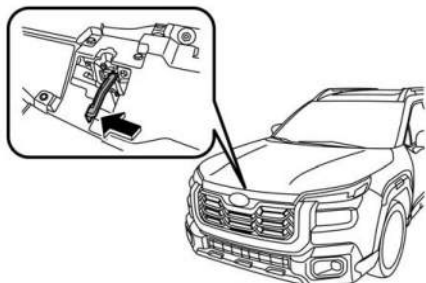

4. Lift up the hood, release the hood prop from its retainer and put the end of the hood prop into the slot in the hood. Hold the grip for handling the hood prop.

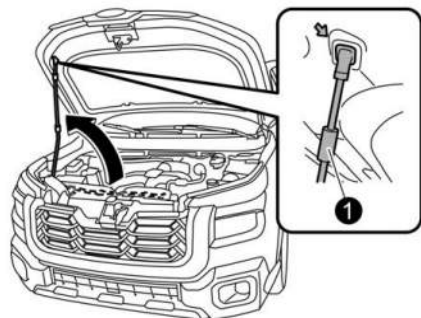

① Grip

### Closing the engine hood:

1. Lift the hood slightly and remove the hood prop from the slot in the hood and return the prop to its retainer.
2. Lower the hood to a height of approximately 7.8 to 11.8 in (20 to 30 cm) above its closed position and then let it drop.
3. After closing the hood, be sure the hood is securely locked.

If this does not close the hood, release it from a slightly higher position.

### WARNING

Always check that the hood is properly locked before you start driving. If it is not, it might fly open while the vehicle is moving and block your view, which may cause an accident and serious bodily injury.



11-5. ENGINE COMPARTMENT OVERVIEW

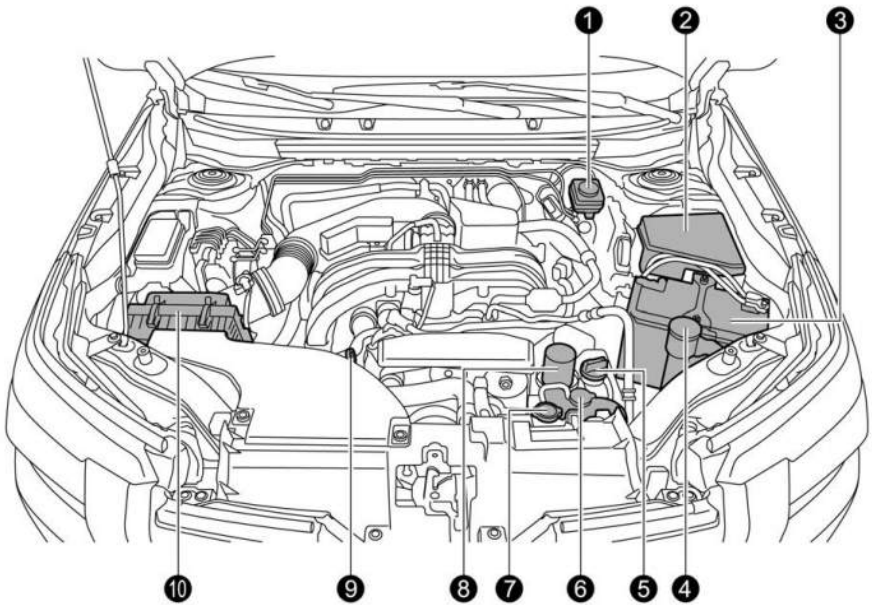

- ① Brake fluid reservoir (page 484)
- ② Main fuse box (page 502)
- ③ Battery (page 500)
- ④ Washer fluid tank (page 495)
- ⑤ Engine oil filler cap (page 476)

- ⑥ Engine coolant reservoir (page 479)
- ⑦ Radiator cap (page 479)
- ⑧ Engine oil filter (page 477)
- ⑨ Engine oil level gauge (page 476)
- ⑩ Air cleaner case (page 480)

## 11-6. ENGINE OIL



### CAUTION

- If the level gauge is not pulled out easily, twist the level gauge right and left, then pull it out. Otherwise, you may be injured accidentally straining yourself.
- Use only engine oil with the recommended grade and viscosity.
- Be careful not to spill engine oil when adding it. If oil touches the exhaust pipe, it may cause a bad smell, smoke, and/or a fire. If engine oil gets on the exhaust pipe, be sure to wipe it off.

## ENGINE OIL CONSUMPTION

Some engine oil will be consumed while driving. The rate of consumption can be affected by such factors as transmission type, driving style, terrain and temperature. Under the following conditions, oil consumption can be increased and thus require refilling between maintenance intervals:

- When the engine is new and within the break-in period
- When the engine oil is of lower quality
- When the incorrect oil viscosity is used
- When engine braking is employed (repeatedly)
- When the engine is operated at high engine speeds (for extended periods of time)
- When the engine is operated under heavy loads (for extended periods of time)
- When towing a trailer
- When the engine idles for extended periods of time
- When the vehicle is operated in stop and go and/or heavy traffic situations

- When the vehicle is used under severe thermal conditions
- When the vehicle accelerates and decelerates frequently

Under these or similar conditions, you should check your oil at least every 2nd fuel fill-up and change your engine oil more frequently. Different drivers in the same car may experience different results. If your oil consumption rate is greater than expected, contact your authorized SUBARU dealer who may perform a test under controlled conditions.

## CHECKING THE OIL LEVEL

1. Park the vehicle on a level surface and stop the engine. If you check the oil level just after stopping the engine, wait for at least 5 minutes for the oil to drain back into the oil pan before checking the level.



### CAUTION

If the level gauge is not pulled out easily, twist the level gauge right and left, then pull it out. Otherwise, you may be injured accidentally straining yourself.

2. Pull out the level gauge, wipe it clean, and insert it again.

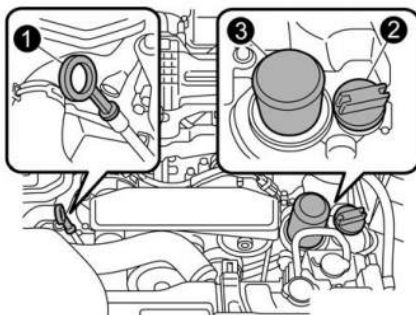

- ① Oil level gauge
- ② Oil filler cap
- ③ Oil filter

3. Be sure the level gauge is correctly inserted until it stops.
4. Pull out the oil level gauge again.

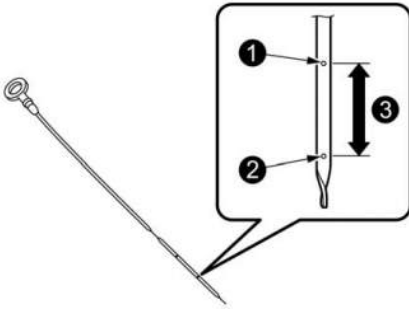

- ① Full level
- ② Low level
- ③ Approximately 1.1 US qt (1.0 liters, 0.9 Imp qt) from low level to full level

5. Check the oil levels on both sides of the level gauge. The engine oil level must be judged by the lowest of the two levels. If the oil level is below the low level mark, add oil so that the full level is reached.

**CAUTION**

- Be careful not to touch the engine oil filter when removing the oil filler cap. Doing so may result in a burn, a pinched finger, or may cause some other injury.
- Use only engine oil with the recommended grade and viscosity.
- Be careful not to spill engine oil when adding it. If oil touches the exhaust pipe, it may cause a bad smell, smoke, and/or a fire. If engine oil gets on the exhaust pipe, be sure to wipe it off.

To add engine oil, remove the engine oil filler cap and slowly pour engine oil through the filler neck. After pouring oil into the engine, you must use the level gauge to confirm that the oil level is

correct.

**NOTE**

- To prevent overfilling the engine oil, do not add any additional oil above the full level when the engine is cold.
- After adding or changing the engine oil, warm up the engine and stop it on a level surface, then start the engine after a lapse of 1 minute or more. Confirm that the warning light has turned off after the engine has started. Refer to “Engine Low Oil Level Warning Light” P168.

**CHANGING THE OIL AND OIL FILTER**

Change the oil and oil filter according to the maintenance schedule in the “Warranty and Maintenance Booklet”.

The engine oil and oil filter must be changed more frequently than listed in the maintenance schedule when driving on dusty roads, when short trips are frequently made, or when driving in extremely cold weather.

**NOTE**

- Changing the engine oil and oil filter should be performed by a well-trained expert. Contact your SUBARU dealer for changing the engine oil and oil filter. Fully trained mechanics are on standby at a SUBARU dealer to utilize the special tools, spare parts and recommended oil for this work, and also, used oils are properly disposed of.
- If performing oil replacement yourself, observe the local regulations and dispose of waste oil properly.

**RECOMMENDED GRADE AND VISCOSITY**

**CAUTION**

Use only engine oil with the recommended grade and viscosity.

Refer to “Engine Oil” ☞P513.

### NOTE

*Engine oil viscosity (thickness) affects fuel economy. Oils of lower viscosity provide better fuel economy. However, in hot weather, oil of higher viscosity is required to properly lubricate the engine.*

### SYNTHETIC OIL

You should use synthetic engine oil that meets the same requirements given for conventional engine oil. When using synthetic oil, you must use oil of the same classification, viscosity and grade shown in this Owner’s Manual. Refer to “Engine Oil” ☞P513. Also, you must follow the oil and filter changing intervals shown in the “Warranty and Maintenance Booklet”.

### NOTE

*Synthetic oil of the grade and viscosity noted in chapter 12 is the recommended engine oil for optimum engine performance. Conventional oil may be used if synthetic oil is unavailable.*

## 11-7. COOLING SYSTEM



### WARNING

- Never remove the radiator cap until the engine has been shut off and has cooled down completely. Since the coolant is under pressure, you may suffer serious burns from a spray of boiling hot coolant when the cap is removed.
- Be careful of the rotating cooling fan when the engine hood is open. When the engine temperature is high, the cooling fan in the engine compartment may operate when the ignition switch is in the “ON” position, even if the engine is stopped. Touching the cooling fan while it is rotating may result in injury.



### CAUTION

- Vehicles are filled at the factory with SUBARU SUPER COOLANT that does not require the first change for 11 years/137,500 miles (11 years/220,000 km). Do not mix this coolant with any other brand or type of coolant during this period. Mixing with a different coolant will reduce the life of the coolant. When necessary to top up the coolant for any reason, use only SUBARU SUPER COOLANT.  
If SUBARU SUPER COOLANT is diluted with another brand or type, the maintenance interval is shortened to that of the mixing coolant.
- Do not splash the engine coolant over painted parts. The alcohol contained in the engine coolant may damage the paint surface.

## COOLING FAN, HOSE AND CONNECTIONS

Your vehicle employs an electric cooling fan which is thermostatically controlled to operate when the engine coolant reaches a specific temperature.

If the radiator cooling fan does not operate even when the coolant temperature high warning light blinks or illuminates in RED, the cooling fan circuit may be defective. Refer to "Coolant Temperature Low Indicator Light (Blue)/Coolant Temperature High Warning Light (Red)" ⓄP167.

Check the fuse and replace it if necessary. Refer to "Fuses" ⓄP502. If the fuse is not blown, have the cooling system checked by your SUBARU dealer.

If the frequent addition of coolant is necessary between vehicle service visits, it is recommended that you have your vehicle inspected by an authorized SUBARU dealer to check for leaks, damage, or looseness.

## ENGINE COOLANT

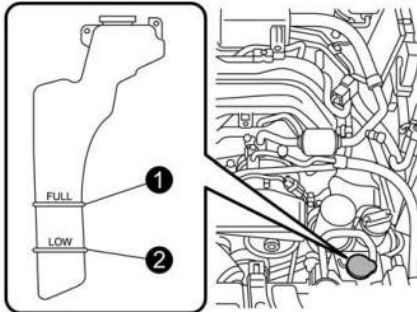

- ① "FULL" level mark
- ② "LOW" level mark

Check the coolant level, such as at fuel stops.

## Checking the coolant level

1. Check the coolant level on the outside of the reservoir while the engine is cool.
2. If the level is close to or lower than the "LOW" level mark, add coolant up to the "FULL" level mark. If the reserve tank is empty, remove the radiator cap and refill coolant up to just below the filler neck as shown in the following illustration.
3. After refilling the reserve tank and the radiator, check the radiator cap for debris and the gasket rubber for damage.

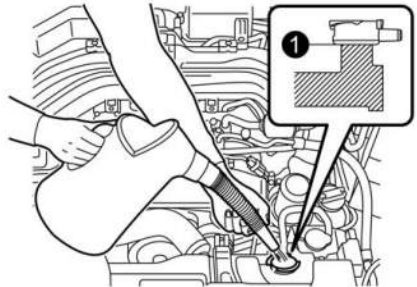

11

- ① Fill up to this level.

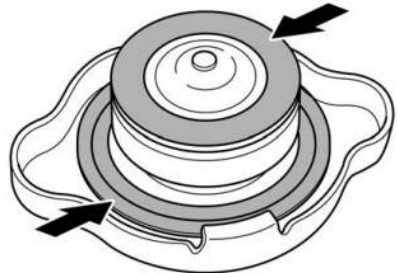

### ⚠ CAUTION

- Be careful not to spill engine coolant when adding it. If coolant touches the exhaust pipe, it may cause a bad smell, smoke, and/or a fire. If engine coolant gets on the

exhaust pipe, be sure to wipe it off.

- Do not splash the engine coolant over painted parts. The alcohol contained in the engine coolant may damage the paint surface.

4. Reinstall the cap and check that the rubber gaskets inside the radiator cap are in the proper position.

## Changing the coolant

It may be difficult to change the coolant. Have the coolant changed by your SUBARU dealer if necessary.

The coolant should be changed according to the maintenance schedule in the "Warranty and Maintenance Booklet".

## 11-8. AIR CLEANER ELEMENT



### WARNING

Do not operate the engine with the air cleaner element removed. The air cleaner element not only filters intake air but also stops flames if the engine backfires. If the air cleaner element is not installed when the engine backfires, you could be burned.



### CAUTION

When replacing the air cleaner element, use a genuine SUBARU air cleaner element. If it is not used, there is the possibility of causing a negative effect to the engine.

The air cleaner element functions as a filter screen. When the air cleaner element is perforated or removed, engine wear will be excessive and engine life shortened.

The air cleaner element is a dry type. It is unnecessary to clean or wash the air cleaner element.

## REPLACING THE AIR CLEANER ELEMENT

Replace the air cleaner element according to the maintenance schedule in the "Warranty and Maintenance Booklet". Under extremely dusty conditions, replace it more frequently. It is recommended that you always use genuine SUBARU parts.

1. Unsnap the two clips holding the air cleaner case (rear).

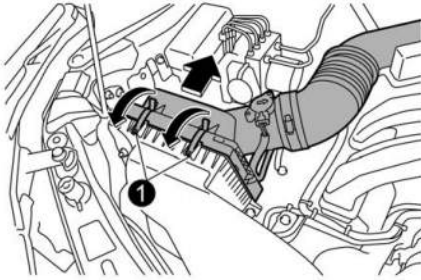

1 Clips

2. Open the air cleaner case and pull the cover rearward while lifting it up.
3. Remove the air cleaner element.



4. Clean the inside of the air cleaner case (both front and rear) with a damp cloth and install a new air cleaner element.
5. To install the air cleaner case (rear), insert the projections on the air cleaner case (rear) into the slits on the air cleaner case (front).

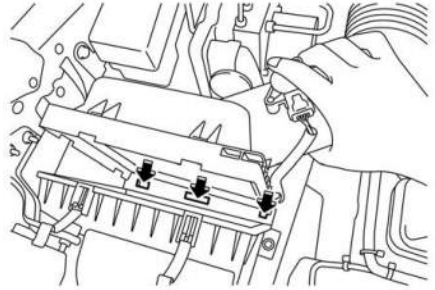

6. Install in the reverse order of removal.

**NOTE**

*Install the air cleaner element so that the surface with "UPR" printed on it faces upward.*

## 11-9. SPARK PLUGS

---

It may be difficult to replace the spark plugs. It is recommended that you have the spark plugs replaced by your SUBARU dealer.

The spark plugs should be replaced according to the maintenance schedule in the "Warranty and Maintenance Booklet".

## RECOMMENDED SPARK PLUGS

Refer to "Electrical System" ☞ P517.

## 11-10. DRIVE BELT

---

It is unnecessary to check the deflection of the drive belt periodically because your engine is equipped with an automatic belt tension adjuster. However, replacement of the drive belt should be done according to the maintenance schedule in the "Warranty and Maintenance Booklet". Consult your SUBARU dealer for replacement.

If the drive belt is loose, cracked or worn, contact your SUBARU dealer.



## 11-11. CONTINUOUSLY VARIABLE TRANSMISSION FLUID

---

There is no fluid level gauge. It is unnecessary to check the continuously variable transmission fluid level. However, if necessary, consult your SUBARU dealer for inspection.

## 11-12. FRONT DIFFERENTIAL GEAR OIL AND REAR DIFFERENTIAL GEAR OIL

---

It is not necessary to check the gear oil level. Check that there are no cracks, damage or leakage. However, the oil inspection should be performed according to the maintenance schedule in the "Warranty and Maintenance Booklet". Consult your SUBARU dealer for details.

## RECOMMENDED GRADE AND VISCOSITY

Each oil manufacturer has its own base oils and additives. Never use different brands together. For details, refer to "Front Differential and Rear Differential Gear Oil" Ⓓ P516.



### CAUTION

Using a differential gear oil other than the specified oil may cause a decline in vehicle performance.

## 11-13. BRAKE FLUID

### CHECKING THE FLUID LEVEL

#### WARNING

- Never let brake fluid contact your eyes because brake fluid can be harmful to your eyes. If brake fluid gets in your eyes, immediately flush them thoroughly with clean water. For safety, when performing this work, wearing eye protection is advisable.
- Brake fluid absorbs moisture from the air. Any absorbed moisture can cause a dangerous loss of braking performance.
- If the vehicle requires frequent refilling, there may be a leak. If you suspect a problem, have the vehicle checked at your SUBARU dealer.

#### CAUTION

- When adding brake fluid, be careful not to allow any dirt into the reservoir.
- Never splash the brake fluid over painted surfaces or rubber parts. Alcohol contained in the brake fluid may damage them.
- Be careful not to spill brake fluid when adding it. If brake fluid touches the exhaust pipe, it may cause a bad smell, smoke, and/or a fire. If brake fluid gets on the exhaust pipe, be sure to wipe it off.

Visually check the brake fluid level of the reservoir monthly on the even surface.

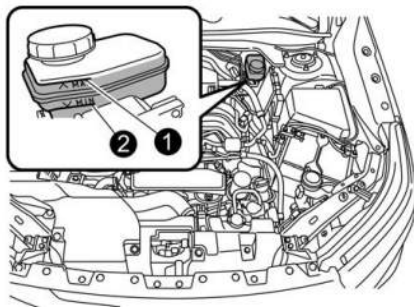

- ① "MAX" level line
- ② "MIN" level line

Be sure to check the brake fluid level from the outside of the reservoir. If the fluid level is below "MIN", top up brake fluid to "MAX". Use only brake fluid from a sealed container.

### RECOMMENDED BRAKE FLUID

Refer to "Fluids" P516.

#### CAUTION

Never use different brands of brake fluid together. Also, avoid mixing DOT 3 and DOT 4 brake fluids even if they are the same brand.

## 11-14. BRAKE PEDAL

Check the brake pedal free play and reserve distance according to the maintenance schedule in the “Warranty and Maintenance Booklet”.

## 11-15. REPLACEMENT OF BRAKE PAD

### CAUTION

- If you continue to drive despite the scraping noise from the audible brake pad wear indicator, it will result in the need for costly brake rotor repair or replacement.
- It is recommended that you disconnect the vehicle battery before replacing the brake pad. However, it is dangerous to disconnect the vehicle battery. Have your SUBARU dealer replace the brake pad.

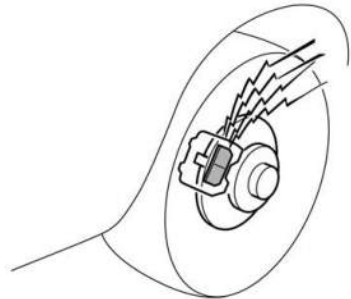

11

The disc brakes have audible wear indicators on the brake pads. If the brake pads wear close to their service limit, the wear indicator makes a very audible scraping noise when the brake pedal is applied.

If you hear this scraping noise each time you apply the brake pedal, have the brake pads serviced by your SUBARU dealer as soon as possible.

## BREAKING-IN OF NEW BRAKE PADS

When replacing the brake pad, use only genuine SUBARU parts. After replacement, the new parts must be broken in.

Contact your SUBARU dealer for details.

### **Brake pad**

While maintaining a speed of 30 to 40 mph (50 to 65 km/h), step on the brake pedal lightly. Repeat this five or more times.

## **11-16. TIRES AND WHEELS**

---

### **TYPES OF TIRES**

You should be familiar with type of tires present on your vehicle.

The factory-installed tires on your new vehicle are all season tires.

#### **All season tires**

All season tires are designed to provide an adequate measure of traction, handling and braking performance in year-round driving including snowy and icy road conditions. However, all season tires do not offer as much traction performance as winter (snow) tires in heavy or loose snow or on icy roads.

All season tires are identified by "ALL SEASON" and/or "M+S" (Mud & Snow) on the tire sidewall.

#### **Summer tires**

Summer tires are high-speed capability tires best suited for highway driving under dry conditions.

Summer tires are inadequate for driving on slippery roads such as on snow-covered or icy roads.

If you drive your vehicle on snow-covered or icy roads, we strongly recommend the use of winter (snow) tires.

When installing winter tires, be sure to replace all four tires.

#### **Winter (snow) tires**

Winter tires are best suited for driving on snow-covered and icy roads. However, winter tires do not perform as well as summer tires and all season tires on roads other than snow-covered and icy roads.

## TIRE PRESSURE MONITORING SYSTEM (TPMS) (Except for Canada-Spec. Models)

The tire pressure monitoring system provides the driver with a warning message by sending a signal from a sensor that is installed in each wheel when tire pressure is severely low. The tire pressure monitoring system will activate only when the vehicle is driven. Also, this system may not react immediately to a sudden drop in tire pressure (for example, a blow-out caused by running over a sharp object).

If you adjust the tire pressures in a warm garage and will then drive the vehicle in cold outside air, the resulting drop in tire pressures may cause the low tire pressure warning light to illuminate. To avoid this problem when adjusting the tire pressures in a warm garage, inflate the tires to pressures higher than those shown on the tire inflation pressure label. Specifically, inflate them by an extra 1 psi (6.9 kPa, 0.07 kgf/cm<sup>2</sup>) for every difference of 10°F (5.6°C) between the temperature in the garage and the temperature outside. By way of example, the following table shows the required tire pressures that correspond to various outside temperatures when the temperature in the garage is 60°F (15.6°C).

### Example:

Tire size: 225/65R17 102T, 225/60R18 100H, 225/55R19 99H

Standard tire pressures:

Front: 35 psi (240 kPa, 2.4 kgf/cm<sup>2</sup>)

Rear: 33 psi (230 kPa, 2.3 kgf/cm<sup>2</sup>)

Garage temperature: 60°F (15.6°C)

Outside temperature	Adjusted pressure [psi (kPa, kgf/cm <sup>2</sup> )]	
	Front	Rear
30°F (-1°C)	38 (260, 2.7)	36 (250, 2.5)
10°F (-12°C)	40 (275, 2.8)	38 (265, 2.75)
-10°F (-23°C)	42 (290, 3.0)	41 (280, 2.9)

If the low tire pressure warning light illuminates when you drive the vehicle in cold outside air after adjusting the tire pressures in a warm garage, re-adjust the tire pressures using the method described above. Then, increase the vehicle speed to at least 25 mph (40 km/h) and check to see that the low tire pressure warning light goes off a few minutes later. If the low tire pressure warning light does not go off, the tire pressure monitoring system may not be functioning normally. In this event, go to a SUBARU dealer to have the system inspected as soon as possible.

While the vehicle is driven, friction between tires and the road surface causes the tires to warm up. After illumination of the low tire pressure warning light, any increase in the tire pressures caused by an increase in the outside air temperature or by an increase in the temperature in the tires can cause the low tire pressure warning light to go off.

It may not be possible to install TPMS valves on certain wheels that are on the market. Therefore, if you change the wheels (for example, a switch to snow tires), use wheels that have the same part number as the standard-equipment wheels. Without four operational TPMS valve/sensors on the wheels, the TPMS will not fully function and the warning light in the instrument panel will illuminate steadily after blinking for approximately one minute.

### WARNING

If the low tire pressure warning light does not illuminate briefly after the ignition switch is turned on or the light illuminates steadily after blinking for approximately one minute, you should have your Tire Pressure Monitoring System checked at a SUBARU dealer as soon as possible.

If this light illuminates while driving, never brake suddenly. Instead, per-

form the following procedure. Otherwise an accident involving serious vehicle damage and serious personal injury could occur.

- 1) Keep driving straight ahead while gradually reducing speed.
- 2) Slowly pull off the road to a safe place.
- 3) Check the pressure for all four tires and adjust the pressure to the COLD tire pressure shown on the tire inflation pressure label on the door pillar on the driver's side.

If this light still illuminates while driving after adjusting the tire pressure, a tire may have significant damage and a fast leak that causes the tire to lose air rapidly. If you have a flat tire, refer to "Flat Tires" ⒼP439.

When a replacement tire is mounted or a wheel rim is replaced without the original pressure sensor/transmitter being transferred, the low tire pressure warning light will illuminate steadily after blinking for approximately one minute. This indicates the TPMS is unable to monitor all four road wheels. Contact your SUBARU dealer as soon as possible for tire and sensor replacement and/or system resetting. If the light illuminates steadily after blinking for approximately one minute, promptly contact a SUBARU dealer to have the system inspected.

### TPMS valve self-registration

When the wheels are replaced (such as when installing snow tires) or when a new TPMS valve is mounted on a new installed wheel, you will need to perform TPMS valve self-registration. Refer to the following procedure to perform TPMS valve self-registration.

1. Install the wheels with TPMS valves on the vehicle.

2. Adjust the tire pressure to the specified value. For information about the specified value of the tire pressure, refer to "Tires" ⒼP517.
3. Drive at speeds above 25 mph (40 km/h) for at least 4 miles (6 km) or until the low tire pressure warning light turns off.

### NOTE

- *When installing TPMS valves, use only genuine SUBARU parts.*
- *Registration of TPMS valves can also be done at a SUBARU dealer. Consult your SUBARU dealer.*

### TIRE INSPECTION

Check on a daily basis that the tires are free from serious damage, nails, and stones. At the same time, check the tires for abnormal wear.

Contact your SUBARU dealer immediately if you find any problem.

### NOTE

- *When the wheels and tires strike curbs or are subjected to harsh treatment as when the vehicle is driven on a rough surface, they can suffer damage that cannot be seen with the naked eye. This type of damage does not become evident until time has passed. Try not to drive over curbs, potholes or on other rough surfaces. If doing so is unavoidable, keep the vehicle's speed down to a walking pace or less, and approach the curbs as squarely as possible. Also, make sure the tires are not pressed against the curb when you park the vehicle.*

- *If you feel unusual vibration while driving or find it difficult to steer the vehicle in a straight line, one of the tires and/or wheels may be damaged. Drive slowly to the nearest authorized SUBARU dealer and have the vehicle inspected.*

**TIRE PRESSURES AND WEAR**

Maintaining the correct tire pressures helps to maximize the tires' service lives and is essential for good running performance. Check and, if necessary, adjust the pressure of each tire and the spare (if equipped) at least once a month and before any long journey.

**Tire inflation pressure label**

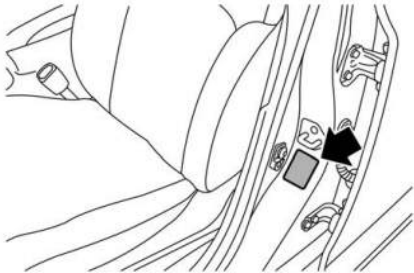

Check the tire pressures when the tires are cold. Use a pressure gauge to adjust the tire pressures to the values shown on the tire inflation pressure label. The tire inflation pressure label is located on the door pillar on the driver's side.

Driving even a short distance warms up the tires and increases the tire pressures. Also, the tire pressures are affected by the out-

side temperature. It is best to check tire pressure outdoors before driving the vehicle.

When a tire becomes warm, the air inside it expands, causing the tire pressure to increase. Be careful not to mistakenly release air from a warm tire to reduce its pressure.

**NOTE**

- *The air pressure in a tire increases by approximately 4.3 psi (30 kPa, 0.3 kgf/cm<sup>2</sup>) when the tire becomes warm.*
- *The tires are considered cold when the vehicle has been parked for at least 3 hours or has been driven less than 1 mile (1.6 km).*



**WARNING**

Do not let air out of warm tires to adjust pressure. Doing so will result in low tire pressure.

Incorrect tire pressures detract from controllability and ride comfort, and they cause the tires to wear abnormally.

- Correctly inflated tires (tread worn evenly)

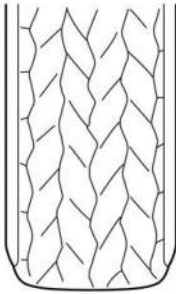

Roadholding is good, and steering is responsive. Rolling resistance is low, so fuel consumption is also lower.

- Under inflated tires (tread worn at shoulders)

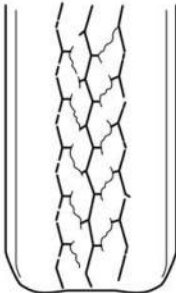

Rolling resistance is high, so fuel consumption is also higher.

- Over inflated tires (tread worn in center)

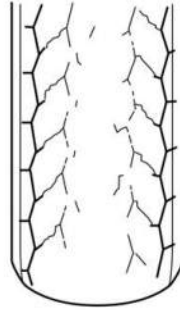

Ride comfort is poor. Also, the tire magnifies the effects of road surface bumps and dips, possibly resulting in vehicle damage.

#### **WARNING**

Driving at high speeds with excessively low tire pressures can cause the tires to deform severely and to rapidly become hot. A sharp increase in temperature could cause tread separation, and destruction of the tires. The resulting loss of vehicle control could lead to an accident.

## **WHEEL BALANCE**

Each wheel was correctly balanced when your vehicle was new, but the wheels will become unbalanced as the tires become worn during use. Wheel imbalance causes the steering wheel to vibrate slightly at certain vehicle speeds and detracts from the vehicle's straight-line stability. It can also cause steering and sus-



pension system problems and abnormal tire wear. If you suspect that the wheels are not correctly balanced, have them checked and adjusted by your SUBARU dealer. Also have them adjusted after tire repairs and after tire rotation.

**CAUTION**

Loss of correct wheel alignment causes the tires to wear on one side and reduces the vehicle's running stability. Contact your SUBARU dealer if you notice abnormal tire wear.

**NOTE**

The suspension system is designed to hold each wheel at a certain alignment (relative to the other wheels and to the road) for optimum straight-line stability and cornering performance.

**WEAR INDICATORS**

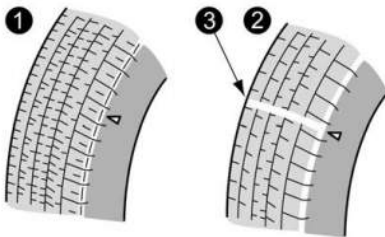

- ① New tread
- ② Worn tread
- ③ Tread wear indicator

Each tire incorporates a tread wear indicator, which becomes visible when the depth of the tread

grooves decreases to 0.063 in (1.6 mm). A tire must be replaced when the tread wear indicator appears as a solid band across the tread.

**WARNING**

When a tire's tread wear indicator becomes visible, the tire is worn beyond the acceptable limit and must be replaced immediately. With a tire in this condition, driving at high speeds in wet weather can cause the vehicle to hydroplane. The resulting loss of vehicle control can lead to an accident.

**NOTE**

For safety, inspect the tire tread regularly and replace the tires before their tread wear indicators become visible.

**ROTATIONAL DIRECTION OF TIRES**

Example of rotational direction marked on the sidewall:

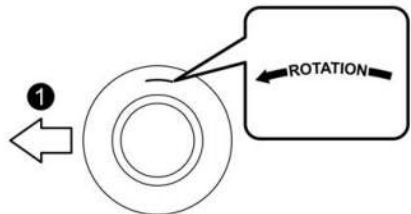

- ① Front

If the tires have specific rotational direction, refer to the arrow marked

on the side wall.

The arrow should be pointing forward direction when the wheels are fitted.

## TIRE ROTATION

Vehicles equipped with 4 non-unidirectional tires:

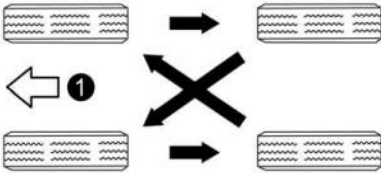

① Front

Vehicles equipped with unidirectional tires:

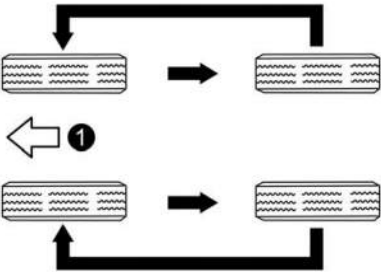

① Front

Models with a spare tire of the same wheel type as the installed tires:

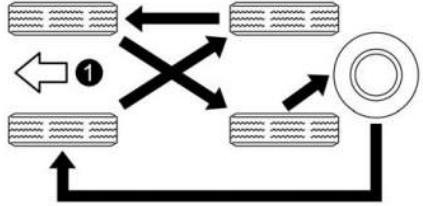

① Front

### NOTE

*In prior to carrying out a tire rotation, check the side wall of the tires and confirm the following.*

- All 5 tires are the same in brand and tread pattern.
- The rotational directions and sizes match.

Tire wear varies from wheel to wheel. Move the tires to the positions shown in the illustration each time they are rotated. For the tire rotation schedule, refer to the "Warranty and Maintenance Booklet".

Replace any damaged or unevenly worn tire at the time of rotation. After tire rotation, adjust the tire pressures and make sure the wheel nuts are correctly tightened.

After driving approximately 600 miles (1,000 km), check the wheel nuts again and retighten any nut that has become loose.

## TIRE REPLACEMENT

The wheels and tires are important and integral parts of your vehicle's design; they cannot be changed arbitrarily. The tires fitted as standard equipment are optimally matched to the characteristics of the vehicle and were selected to give the best possible combination of running performance, ride comfort, and service life. It is essential for every tire to have a size and construction matching those shown on the tire inflation pressure label. For more details about tire inflation pressure, refer to "Tires" P517.

Using tires of a non-specified size detracts from controllability, ride comfort, braking performance, speedometer accuracy and odometer accuracy. It also creates incorrect body-to-tire clearances and inappropriately changes the vehicle's ground clearance.

All four tires must be the same in terms of manufacturer, brand (tread pattern), construction, and size. You are advised to replace the tires with new ones that are identical to those fitted as standard equipment.

For safe vehicle operation, SUBARU recommends replacing all four tires at the same time.

### WARNING

- When replacing or installing tire(s), all four tires must be the same for the following items.
  - (a) Size
  - (b) Speed symbol
  - (c) Load index
  - (d) Circumference
  - (e) Construction
  - (f) Manufacturer
  - (g) Brand (tread pattern)
  - (h) Degrees of wear

For items (a) to (c), you must obey the specification that is printed on the tire inflation pressure label. The tire inflation pressure label is located on the driver's door pillar.

If all four tires are not the same in items (a) to (h), serious mechanical damage could be caused to the drivetrain of the car, and affect the followings.

- Ride
- Handling
- Braking
- Speedometer/Odometer calibration
- Clearance between the body and the tires

It also may be dangerous and lead to loss of vehicle control, and it can lead to an accident.

- Use only radial tires. Do not use radial tires together with belted bias tires and/or bias-ply tires. Doing so can dangerously reduce controllability, resulting in an accident.

11

## WHEEL REPLACEMENT

When replacing wheels due, for example, to damage, make sure the replacement wheels match the specifications of the wheels that are fitted as standard equipment. Replacement wheels are available from SUBARU dealers.

### WARNING

Use only those wheels that are specified for your vehicle. Wheels not meeting specifications could interfere with brake caliper operation and may cause the tires to rub against the wheel well housing during turns. The resulting loss of vehicle control could lead to an accident.

**NOTE**

*When any of the wheels are removed and replaced for tire rotation or to change a flat tire, always check the tightness of the wheel nuts after driving approximately 600 miles (1,000 km). If any nut is loose, tighten it to the specified torque.*

**11-17. ALLOY WHEELS**

---

Alloy wheels can be scratched and damaged easily. Handle them carefully to maintain their appearance, performance, and safety.

- When any of the wheels is removed and replaced for tire rotation or to change a flat, always check the tightness of the wheel nuts after driving approximately 600 miles (1,000 km). If any nut is loose, tighten it to the specified torque.
- Never apply oil to the threaded parts, wheel nuts, or tapered surface of the wheel.
- Never let the wheel rub against sharp protrusions or curbs.
- When wheel nuts, balance weights, or the center cap is replaced, be sure to replace them with genuine SUBARU parts designed for alloy wheels.
- When stacking and storing removed tires, place shock-absorbing material between the tires to protect the wheels from becoming scratched.

## 11-18. WINDSHIELD WASHER FLUID

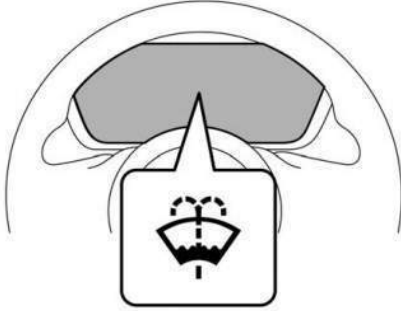

When there is only a small amount of washer fluid remaining, the windshield washer fluid warning light will appear. When this occurs, refill the washer fluid as follows.

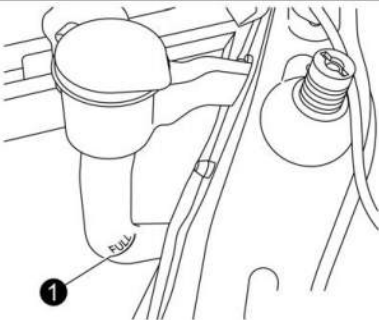
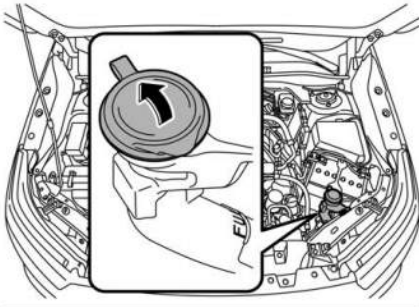

① "FULL" mark

Remove the washer tank filler cap, then add fluid until it reaches the "FULL" mark on the tank.

Use windshield washer fluid. If windshield washer fluid is unavailable use clean water.

In areas where water freezes in winter, use an anti-freeze type windshield washer fluid.

 **CAUTION**

Never use engine coolant as washer fluid because it could cause paint damage.

If you fill the washer fluid tank with a fluid with a different concentration from the one used previously, purge the old fluid from the piping between the washer fluid tank and washer nozzles by operating the washer for a certain period of time. Otherwise, if the concentration of the fluid remaining in the piping is too low for the outside temperature, it may freeze and block the nozzles.

11

 **CAUTION**

- Adjust the washer fluid concentration appropriately for the outside temperature. If the concentration is inappropriate, sprayed washer fluid may freeze on the windshield and obstruct your view, and the fluid may freeze in the washer fluid tank.
- Be careful foreign matter does not contaminate the washer fluid when filling the tank. Contamination could cause malfunctions, such as clogging the pump.
- State or local regulations on volatile organic compounds may restrict the use of methanol, a common windshield washer anti-freeze additive. Washer fluids containing non-methanol anti-freeze agents should be used only

if they provide cold weather protection without damaging your vehicle's paint, wiper blades or washer system.

## 11-19. REPLACEMENT OF WIPER BLADES

Grease, wax, insects, or other material on the windshield or the wiper blade results in jerky wiper operation and streaking on the glass. If you cannot remove the streaks after operating the windshield washer or if the wiper operation is jerky, clean the outer surface of the windshield and rear window using a sponge or soft cloth with a neutral detergent or mild-abrasive cleaner. Do not, however, use detergent to clean the blade rubbers. Use only a sponge or soft cloth (and no neutral detergent or mild abrasive cleaner) when you clean the blade rubbers. If you wipe the rubber of the blade strongly, the black coating component will peel off, which will cause the wiper to judder. Also, after wiping it off, check that the rubber has not come loose. After cleaning the window glass and wiper blade rubbers, be sure to rinse them with clean water. Rinse the window until the water does not form beads on the glass. This indicates that the glass is clean.



### CAUTION

- Do not clean the wiper blades with gasoline or a solvent, such as paint thinner or benzine. This will cause deterioration of the wiper blades.
- When you wish to raise the passenger-side wiper arm, first raise the driver-side wiper arm. Otherwise, the passenger-side wiper assembly and driver-side wiper assembly will touch each other, possibly resulting in scratches.
- Return the passenger-side wiper arm to its original position before returning the driver-side wiper arm to its original position. Otherwise, the passenger-side wiper assembly and driver-side wiper assembly will touch each other, possibly resulting in scratches.
- When returning the raised wipers

to the original positions, return the wipers slowly on the windshield by hand. Returning the wipers from the detached positions by the spring operation might change the shape of the wiper arm or scratch the windshield.

- While removing the wiper blades from the wiper arms, do not return the wiper arms to the original positions. Otherwise, the windshield surface may be scratched.

If you cannot eliminate the streaking even after following this method, replace the wiper blades using the following procedures.

### WINDSHIELD WIPER BLADE ASSEMBLY

**NOTE**

*Do not lower the wiper arm while the wiper blade assembly is removed.*

1. Raise the wiper arm off the windshield. First raise the driver's side wiper arm and then raise the front passenger's side wiper arm.

 **CAUTION**

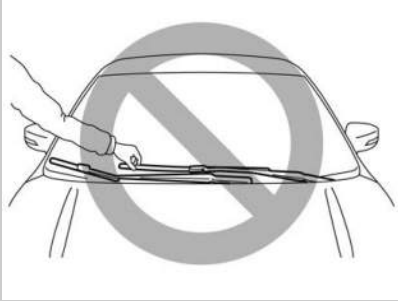

Hold the wiper arm when replacing the wiper blade. Holding the wiper blade, may result in blade deformation.

2. Hold the wiper blade connection by hand, open the lock cover to release the lock.

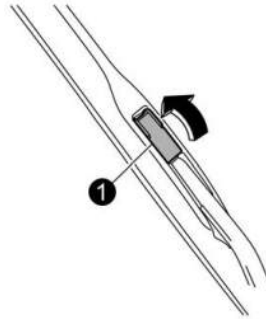

① Lock cover

3. Remove the wiper blade assembly by holding its pivot area and pushing it in the direction shown by the arrow.

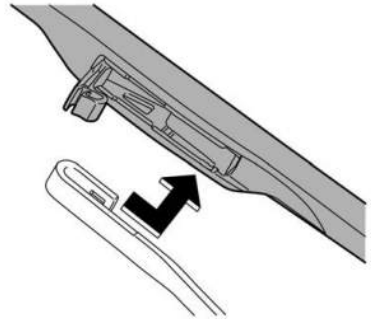

- When installing the wiper blade assembly, align it with the wiper arm connection part and then slide it in the opposite direction of removal to install. After installing the wiper blade assembly, close the lock cover and check that the connection part is locked completely.

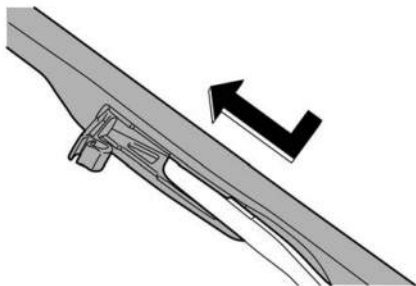

- Hold the wiper arm by hand and slowly lower it in position.

## WINDOW WIPER BLADE RUBBER

- Grasp the locked end of the blade rubber assembly and pull it firmly until the stoppers on the rubber are free of the support.

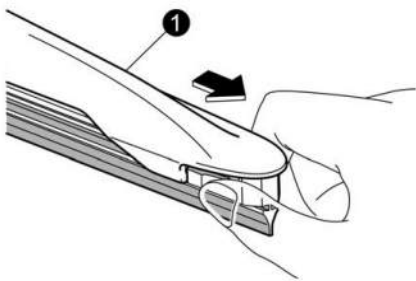

① Support

- If the new blade rubber is not provided with two metal spines, remove the metal spines from the old blade rubber and install them in the new blade rubber.

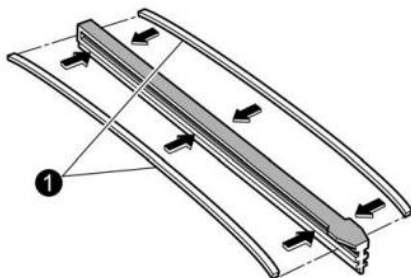

① Metal spines

- Align the claws of the support with the grooves in the rubber and slide the blade rubber assembly into the support until it locks.

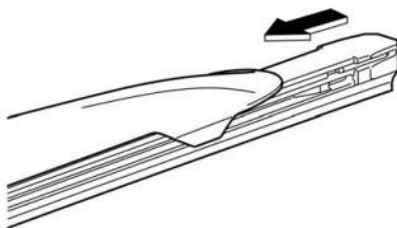



4. Be sure to position the claws at the end of the support between the stoppers on the rubber as shown. If the rubber is not retained properly, the wiper blade may scratch the windshield.

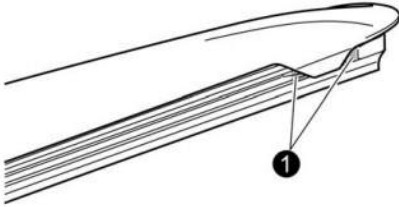

1 Stopper

## REAR WINDOW WIPER BLADE RUBBER

1. Pull out the end of the blade rubber assembly to unlock it from the plastic support.

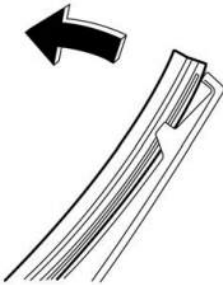

2. Pull the blade rubber assembly out of the plastic support.

3. If the new blade rubber is not provided with two metal spines, remove the metal spines from the old blade rubber and install them in the new blade rubber.

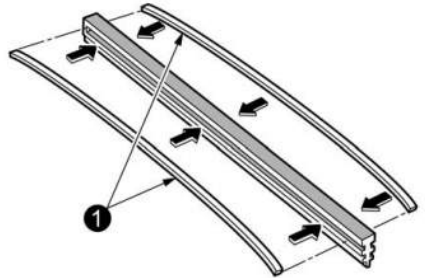

1 Metal spines

4. Align the claws of the plastic support with the grooves in the blade rubber assembly, then slide the blade rubber assembly into place.

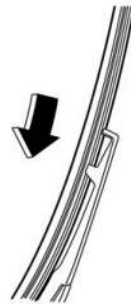

Securely retain both ends of the rubber with the stoppers on the plastic sup-

port ends. If the rubber is not retained properly, the wiper may scratch the rear window glass.

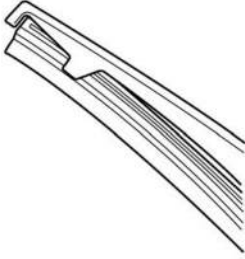

5. Install the wiper blade assembly to the wiper arm. Make sure that it locks in place.
6. Hold the wiper arm by hand and slowly lower it in position.

## 11-20. BATTERY

### WARNING

- Before beginning work on or near any battery, be sure to extinguish all cigarettes, matches, and lighters. Never expose a battery to an open flame or electric sparks. Batteries give off a gas which is highly flammable and explosive.
- For safety, in case an explosion does occur, wear eye protection or shield your eyes when working near any battery. Never lean over a battery.
- Do not let battery fluid contact eyes, skin, fabrics, or paint because battery fluid is a corrosive acid. If battery fluid gets on your skin or in your eyes, immediately flush the area with water thoroughly. Seek medical help immediately if acid has entered the eyes.

If battery fluid is accidentally swallowed, immediately drink a large amount of milk or water, and seek medical attention immediately.

- To lessen the risk of sparks, remove rings, metal watchbands, and other metal jewelry. Never allow metal tools to contact the positive battery terminal and anything connected to it WHILE you are at the same time in contact with any other metallic portion of the vehicle because a short circuit will result.
- Keep everyone including children away from the battery.
- Charge the battery in a well-ventilated area.
- Battery posts, terminals, and related accessories contain lead and lead compounds, chemicals known to the State of California to cause cancer and reproductive

harm. Batteries also contain other chemicals known to the State of California to cause cancer. Wash hands after handling.

LN3 Battery

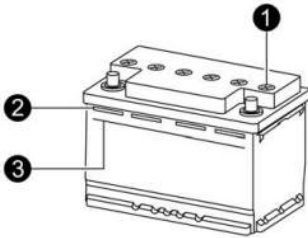

- ① Cap
- ② Upper level
- ③ Lower level

**NOTE**

To avoid battery drain, do not use electric power (e.g., lights, wipers, climate control, seat heaters, etc.) for longer than necessary when the engine is off. If using the radio, room lights or other electrical equipment with the engine off, even if the ignition switch is in the "ACC" position, the battery will drain.

It is unnecessary to periodically check the battery fluid level or periodically refill with distilled water.

However, if the battery fluid level is below the lower level, remove the cap. Fill to the upper level with distilled water. Refer to "Electrical System" P517.

**For MySubaru Connected Services without navigation system:**

When the vehicle battery is discharged or replaced, certain internal settings can be restored only by pairing the vehicle to a smartphone via Bluetooth, or by visiting a SUBARU dealer. Until those internal settings are restored, certain convenience features, including the "Service Appointment Scheduler," may be unavailable.

**CAUTION**

Never use more than 10 amperes when charging the battery because it will shorten battery life.

## 11-21. FUSES



### CAUTION

Never replace a fuse with one having a higher rating or with material other than a fuse because serious damage or a fire could result.

### NOTE

*Fuse rating and used circuit are described on behind each fuse box cover.*

The fuses are designed to melt during an overload to prevent damage to the wiring harness and electrical equipment. The fuses are located in two fuse boxes.

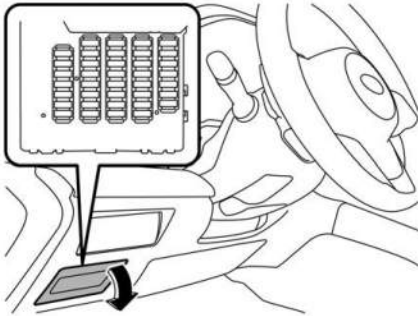

One is located under the instrument panel behind the fuse box cover on the driver's seat side. To remove the cover, pull it out.

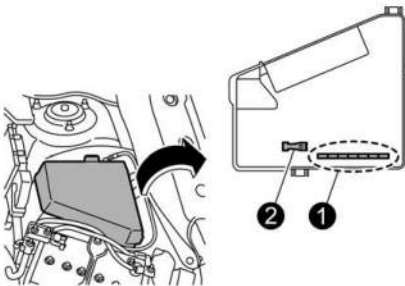

- ① Spare fuses
- ② Fuse puller

The other one (main fuse box) is housed in the engine compartment. Also, the spare fuses and fuse puller are stored in the fuse box cover.

Pinch the upper part of the fuse puller when removing it from the main fuse box.

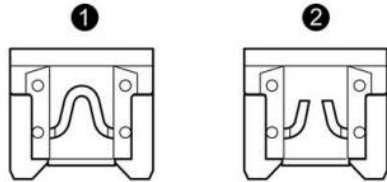

- ① Good
- ② Blown

If any lights, accessories or other electrical controls do not operate, inspect the corresponding fuse. If a fuse has blown, replace it.

1. Turn the ignition switch to the "OFF" position and turn off all electrical accessories.
2. Remove the fuse box cover.
3. Determine which fuse may be blown. Look at the back side of each fuse box cover.
4. Pull out the fuse with the fuse puller.

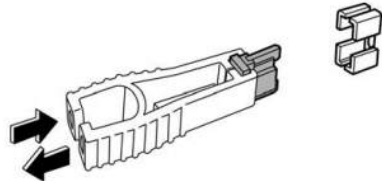

5. Inspect the fuse. If it has blown, replace it with a spare fuse of the same rating.

6. If the same fuse blows again, this indicates that its system has a problem. Contact your SUBARU dealer for repairs.

## **11-22. INSTALLATION OF ACCESSORIES**

---

Always consult your SUBARU dealer before installing fog lights or any other electrical equipment in your vehicle. Such accessories may cause the electronic system to malfunction if they are incorrectly installed or if they are not suited for the vehicle. We recommend that you install only genuine SUBARU accessories on your vehicle.

## 11-23. REPLACING BULBS



### WARNING

Bulbs may become very hot while illuminated. Before replacing bulbs, turn off the lights and wait until the bulbs cool down. Otherwise, there is the risk of sustaining a burn injury.



### CAUTION

Replace any bulb only with a new bulb of the specified wattage. Using a bulb of different wattage could result in a fire. For the specified wattage of each bulb, refer to "Bulb Chart" P518. For replacement, contact your SUBARU dealer.

Do not touch the glass portion of the light bulb with bare hands. When holding the glass portion is unavoidable, hold it with a clean dry cloth to avoid getting moisture and grease on the bulb. If there are any fingerprints or grease on the bulb surface, wipe them away with a soft cloth moistened with alcohol. Also, if the bulb is scratched or dropped, it may blow out or crack.

## HEADLIGHTS



The LED headlight warning light illuminates if the LED headlights malfunction.

We recommend that you have your vehicle inspected at a SUBARU dealer as soon as possible.

## REAR COMBINATION LIGHTS

1. Use a screwdriver to remove the secured clips of the covers.

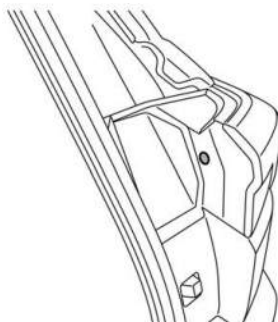

2. Slide the side cover upward and remove it.

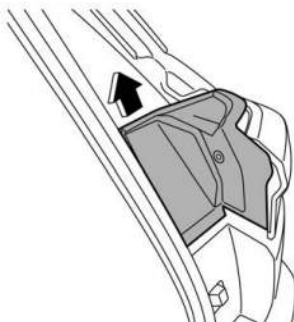

3. Remove the upper and lower screws.

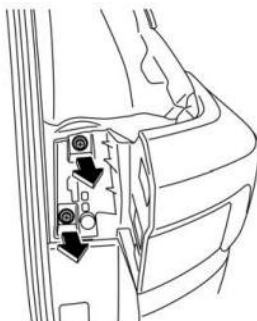

4. Slide the rear combination light assembly rearward to remove it from the vehicle.

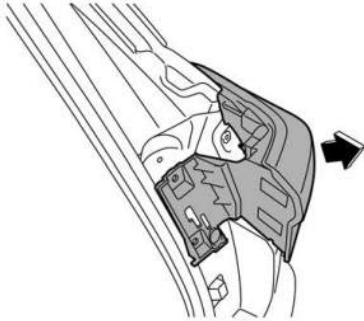

5. Disconnect the electrical connector.

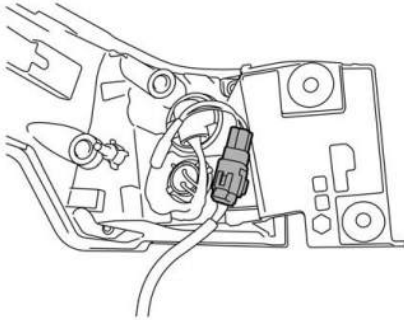

6. Remove the bulb holder from the rear combination light assembly by turning it counterclockwise.

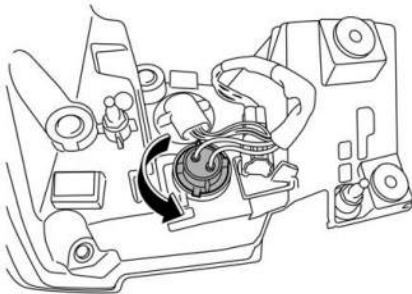

7. Pull the bulb out of the bulb holder and replace it with a new one.

8. Set the bulb holder into the rear combination light assembly and turn it clockwise until it locks.
9. Reconnect the electrical connector.
10. Reinstall the rear combination light assembly by sliding the two-pronged part of the combination light assembly securely to each holder of the vehicle side.

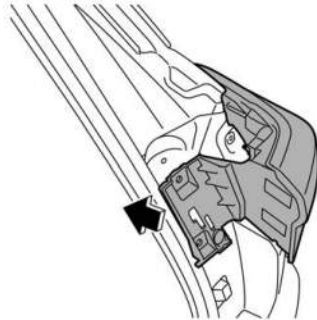

11. Tighten the upper and lower screws.
12. Reinstall the side cover.

### OTHER BULBS

It may be difficult to replace the bulbs. We recommend that you have the bulbs replaced by your SUBARU dealer if necessary.

## ADJUSTING HEADLIGHT AIM

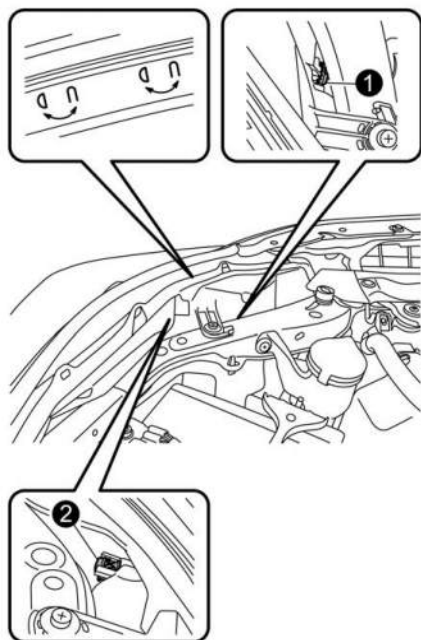

- ① Adjustment screw A
- ② Adjustment screw B

### Before checking the headlight aiming

1. Make sure the vehicle has a full tank of gasoline and the area around the headlight is not deformed.
2. Park the vehicle on level ground.
3. Sit in the driver's seat.
4. Bounce the vehicle several times.

### Headlight aim adjustment

1. Turn the screw A clockwise or counterclockwise to adjust it. Remember the direction of the rotation and number of rotations.

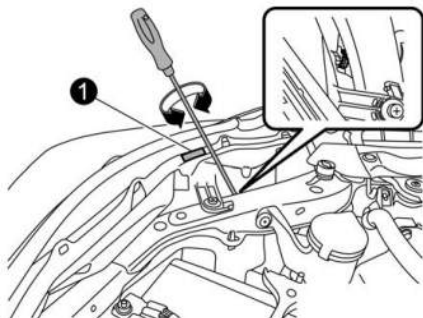

- ① Adjustment direction mark

2. Turn screw B the same number of turns and in the same direction as step 1.

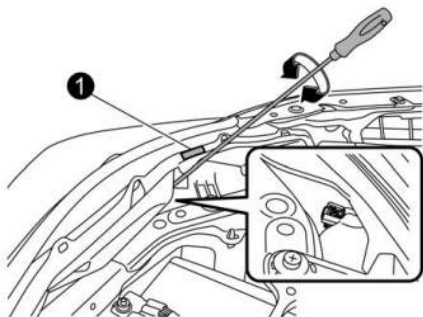

- ① Adjustment direction mark

### NOTE

- If the headlight aim cannot be adjusted, contact your SUBARU dealer.
- To inspect of the headlight aim position, consult a SUBARU dealer.



## 11-24. REPLACING BATTERY

The access key fob battery may be discharged under the following conditions.

- The operation of the keyless access function is unstable.
- The operating distance of the remote keyless entry system is unstable.
- The transmitter does not operate properly when used within the standard distance.

Replace the battery with a new one.

### CAUTION

- Do not let dust, oil or water get on or in the access key fob when replacing battery.
- Be careful not to damage the printed circuit board in the access key fob when replacing the battery.
- Be careful not to allow children to touch the battery and any removed parts; children could swallow them.
- There is a danger of an explosion if the battery is incorrectly replaced. Replace only with the same or equivalent type of the battery.
- Batteries shall not be exposed to excessive heat such as bright sunlight, fire or the like.

### NOTE

- *Replace only with the same or equivalent type of battery recommended by the manufacturer.*
- *Dispose of used batteries according to the local laws.*
- *Mount the battery in the correct orientation to prevent fluid leakage. Be careful not to bend the terminals. It may result in a malfunction.*

- *It is recommended that the battery should be replaced by a SUBARU dealer.*
- *Use a new battery.*
- *After replacing the battery, confirm that the access key fob functions properly.*
- *To clear the access key fob battery warning message after replacing the battery, carry the key fob into the vehicle. Then, without depressing the brake pedal, turn the ignition switch to the "ON" position and then to the "OFF" position.*
  - *If the access key fob battery warning message does not disappear even after you replace the battery, it is possible that another access key fob, other than the one you are holding, is nearby and the warning message is responding to that access key fob. Replace the battery of the second access key fob as well and follow the same procedure.*
  - *Do not perform the warning message clearing procedure while holding two or more access key fobs.*

11

## REPLACING BATTERY OF ACCESS KEY FOB

Button battery: CR2032 or equivalent

### CAUTION

- When removing or fitting the access key fob cover, make sure that the plastic part does not come off or become misaligned.
- Before replacing the battery, remove any static electricity.

1. Take out the emergency key.

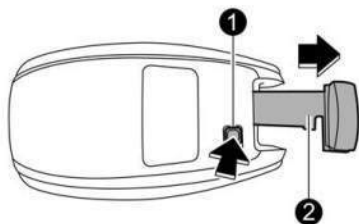

1 Release button

2 Emergency key

2. Wrap a flat-head screwdriver with vinyl tape or a cloth, and insert it in the gap to remove the cover.

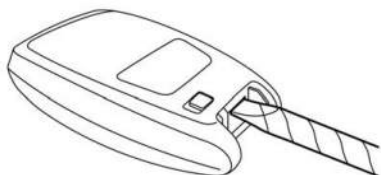

4. Insert a new battery with its positive (+) side facing upward as shown in the figure.

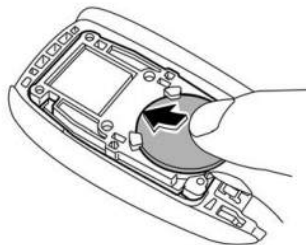

5. Attach the cover to the access key fob by fitting the projections and recesses together.

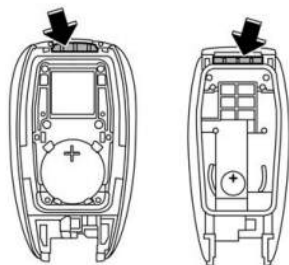

3. Take out the battery using a flat-head screwdriver with vinyl tape or a cloth.

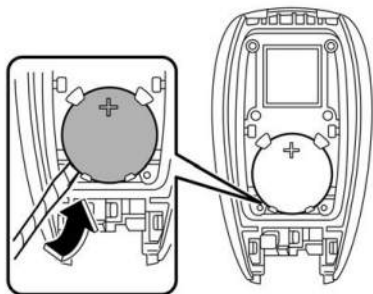

---

---

---

---

---

---

---

---

---

---

---

---

---

---

---

---

---

---

---

---

---

---

---

---

---

---

---

---

---

---

---

---

---

---

---

---

---

---

---

---

## SPECIFICATIONS

---

<b>12-1. Specifications</b> .....	<b>512</b>
Dimensions.....	512
Engine.....	512
Fuel.....	512
Engine Oil.....	513
Front Differential and Rear Differential Gear Oil.....	516
Fluids.....	516
Engine Coolant.....	516
Electrical System.....	517
Tires.....	517
Temporary Spare Tires.....	517
Brake Disc.....	517
<b>12-2. Bulb Chart</b> .....	<b>518</b>
Safety Precautions.....	518
Bulb Chart.....	519
<b>12-3. Vehicle Identification</b> .....	<b>521</b>
<b>12-4. Function Settings</b> .....	<b>522</b>
Function Settings and Adjustments on the Center Information Display.....	522
Individual Settings and Adjustments Excluding Center Information Display.....	522
Function Settings and Adjustments Performed by a Dealer.....	522

## 12-1. SPECIFICATIONS

These specifications are subject to change without notice.

### DIMENSIONS

		in (mm)	
Item		Outback	Subaru Outback Wilderness
Overall length		191.7 (4,870)	191.7 (4,870)
Overall width		74.0 (1,880)	74.0 (1,880)
Overall height		67.5 (1,715)	68.3 (1,735)
Wheel base		108.1 (2,745)	108.1 (2,745)
Tread	Front	62.4 (1,585)	62.0 (1,575)
	Rear	63.4 (1,610)	63.0 (1,600)
Ground clearance*		8.66 (220)	9.45 (240)

\*: Measured with vehicle empty

### ENGINE

Engine model	FB25 (2.5 L, DOHC, non-turbo)	FA24 (2.4 L, DOHC, turbo)
Engine type	Horizontally opposed, liquid cooled 4 cylinder, 4-stroke direct injection gasoline engine	Horizontally opposed, liquid cooled 4 cylinder, 4-stroke direct injection gasoline engine
Displacement cu-in (cc)	152 (2,498)	146 (2,387)
Bore × Stroke in (mm)	3.70 × 3.54 (94.0 × 90.0)	3.70 × 3.39 (94.0 × 86.0)
Compression ratio	12.0	10.6
Firing order	1 – 3 – 2 – 4	1 – 3 – 2 – 4

### FUEL

Fuel requirement	Unleaded gasoline with 87 AKI (90 RON) or higher
Fuel tank capacity	18.0 US gal (68 liters, 15.0 Imp gal)

For more details, refer to "Fuel" ☞P304.

## ENGINE OIL

For the checking, adding and replacing procedure or other details, refer to “Engine Oil” P476.

### NOTE

*Have the procedure for changing the engine oil and oil filter performed by a properly-trained expert. It is recommended that you have this service performed by your SUBARU dealer.*

## Approved engine oil

Always use the SUBARU approved engine oil. For further details, please contact your SUBARU dealer.

If the approved engine oil is unavailable, use the alternative engine oil described on the next page.



## Alternative engine oil

If the SUBARU approved oil is unavailable, the following alternative oil can be used.

### NOTE

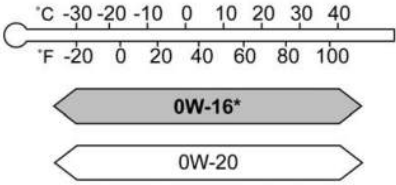

- *Each quantity indicated here is only a guideline. The necessary quantity for replacement may differ slightly depending on the temperature and other factors.*
- *In choosing an oil, you want the proper quality and viscosity, as well as one that will enhance fuel economy. Oils of lower viscosity provide better fuel economy. However, in hot weather, oil of higher viscosity is required to properly lubricate the engine. The following table lists the recommended viscosities and applicable temperatures.*
- *When adding oil, you may use different brands together as long as they are the same ILSAC and API classification and SAE viscosity as those recommended by SUBARU.*

## 2.5 L non-turbo models:

Oil grade	 <p>ILSAC (International Lubricant Specification Advisory Committee) GF-6B, which can be identified with the ILSAC certification mark (Shield mark)</p>	 <p>ILSAC (International Lubricant Specification Advisory Committee) GF-6A, which can be identified with the ILSAC certification mark (Starburst mark)</p>	 <p>API (American Petroleum Institute) classification SP with the words "RE-SOURCE CONSERVING"</p>
SAE viscosity No. and applicable temperature	<p>0W-16 synthetic oil is the required oil for optimum engine performance and protection. Conventional oil may be used if synthetic oil is unavailable.</p>  <p>*: If 0W-16 synthetic oil is not available, 0W-20 conventional oil may be used if replenishment is needed but should be changed to 0W-16 synthetic oil at the next oil change.</p>		
Engine oil capacity	<ul style="list-style-type: none"> <li>● Adding the oil from L to F level: 1.1 US qt (1.0 liters, 0.9 Imp qt)</li> <li>● Changing the oil and oil filter: 4.7 US qt (4.4 liters, 3.9 Imp qt)</li> <li>● Changing the oil: 4.4 US qt (4.2 liters, 3.7 Imp qt)</li> </ul>		

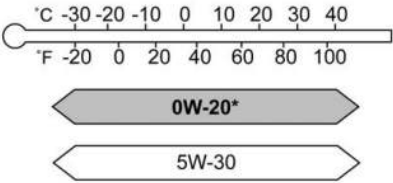

2.4 L turbo models:

<p>Oil grade</p>	 <p>ILSAC (International Lubricant Specification Advisory Committee) GF-6A, which can be identified with the ILSAC certification mark (Starburst mark)</p>	 <p>API (American Petroleum Institute) classification SP with the words "RESOURCE CONSERVING"</p>
<p>SAE viscosity No. and applicable temperature</p>	<p>0W-20 synthetic oil is the required oil for optimum engine performance and protection. Conventional oil may be used if synthetic oil is unavailable.</p>  <p>*: If 0W-20 synthetic oil is not available, 5W-30 conventional oil may be used if you need to add oil. However, you should change to 0W-20 synthetic oil at the next oil change.</p>	
<p>Engine oil capacity</p>	<ul style="list-style-type: none"> <li>● Adding the oil from L to F level: 1.1 US qt (1.0 liters, 0.9 Imp qt)</li> <li>● Changing the oil and oil filter: 4.8 US qt (4.5 liters, 4.0 Imp qt)</li> <li>● Changing the oil: 4.5 US qt (4.3 liters, 3.8 Imp qt)</li> </ul>	

## FRONT DIFFERENTIAL AND REAR DIFFERENTIAL GEAR OIL

Oil	Front differential gear oil	Rear differential gear oil
Oil grade	<ul style="list-style-type: none"> <li>● SUBARU Extra MT*3</li> <li>● API classification GL-5 (75W-90)*4</li> </ul>	API classification GL-5 (75W-90)
Oil capacity*1	2.5 L non-turbo models: 1.4 US qt (1.3 liters, 1.1 Imp qt) 2.4 L turbo models: 1.3 US qt (1.2 liters, 1.1 Imp qt)	0.8 US qt (0.8 liters, 0.7 Imp qt)
Remarks*2	"Front Differential Gear Oil and Rear Differential Gear Oil" ☞P483	

\*1: The indicated oil quantity is only a guideline. The necessary quantity for replacement may differ slightly depending on the temperature and other factors. Check the oil level after refilling the gearbox with oil.

\*2: For more details about maintenance and service, refer to the indicated section.

\*3: The vehicle is filled at the factory with this oil.

\*4: You may use this type of differential gear oil. However, using this type of oil will detract from fuel efficiency.

## FLUIDS

Fluid	Continuously variable transmission fluid	Brake fluid
Fluid type*1	Consult your SUBARU dealer.	FMVSS No. 116, DOT 3 or DOT 4 brake fluid
Fluid capacity*2	2.5 L non-turbo models for Outback: 12.4 US qt (11.7 liters, 10.3 Imp qt) 2.4 L turbo models for Outback/Subaru Outback Wilderness: 12.6 US qt (11.9 liters, 10.5 Imp qt)	—
Remarks*3	"Continuously Variable Transmission Fluid" ☞P483	"Brake Fluid" ☞P484

\*1: Use one of the indicated types of fluid.

\*2: The indicated fluid quantity is only a guideline. The necessary quantity for replacement may differ slightly depending on the temperature and other factors.

\*3: For more details about maintenance and service, refer to the indicated section.

## ENGINE COOLANT

Coolant capacity	2.5 L non-turbo models: 8.7 US qt (8.2 liters, 7.2 Imp qt) 2.4 L turbo models: 9.2 US qt (8.7 liters, 7.7 Imp qt)
Coolant type	SUBARU SUPER COOLANT

The indicated coolant quantity is only a guideline. The necessary quantity for replacement may differ slightly depending on the temperature and other factors. For more details about maintenance and service, refer to "Cooling System" ☞P478.

**ELECTRICAL SYSTEM**

Battery type	LN3
Alternator	2.5 L non-turbo models: 12 V-150 A 2.4 L turbo models: 12 V-190 A
Spark plugs	2.5 L non-turbo models: DILKAR7Q8 (NGK) 2.4 L turbo models: SILKFR8A6 (NGK)

**TIRES**

Tire size	225/65R17 102T	225/60R18 100H	225/55R19 99H
Wheel size	17 × 7 J	18 × 7 J	19 × 7 J
Pressure	Front	35 psi (240 kPa, 2.4 kgf/cm <sup>2</sup> )	
	Rear	33 psi (230 kPa, 2.3 kgf/cm <sup>2</sup> )	
Wheel nut tightening torque	89 lbf-ft (120 N·m, 12 kgf·m)*1		

\*1: This torque is equivalent to applying approximately 88 to 110 lbf (40 to 50 kgf) at the end of the wheel nut wrench. If you have tightened the wheel nuts by yourself, have the tightening torque checked at the nearest automotive service facility as soon as possible. For the wheel nut tightening procedure, refer to “Changing a Flat Tire” P439.

**TEMPORARY SPARE TIRES**

Temporary spare tire size	T155/80 D17
Temporary spare tire inflation pressure (recommended cold tire inflation pressure)	60 psi (420 kPa, 4.2 kgf/cm <sup>2</sup> )

**BRAKE DISC**

If you need information on the usage limit value of brake discs and the method for measuring them, consult your SUBARU dealer.

## 12-2. BULB CHART

---

### SAFETY PRECAUTIONS



#### **WARNING**

Bulbs may become very hot while illuminated. Before replacing bulbs, turn off the lights and wait until the bulbs cool down. Otherwise, there is a risk of sustaining a burn injury.



#### **CAUTION**

Replace any bulb only with a new bulb of the specified wattage. Using a bulb of different wattage could result in a fire.

BULB CHART

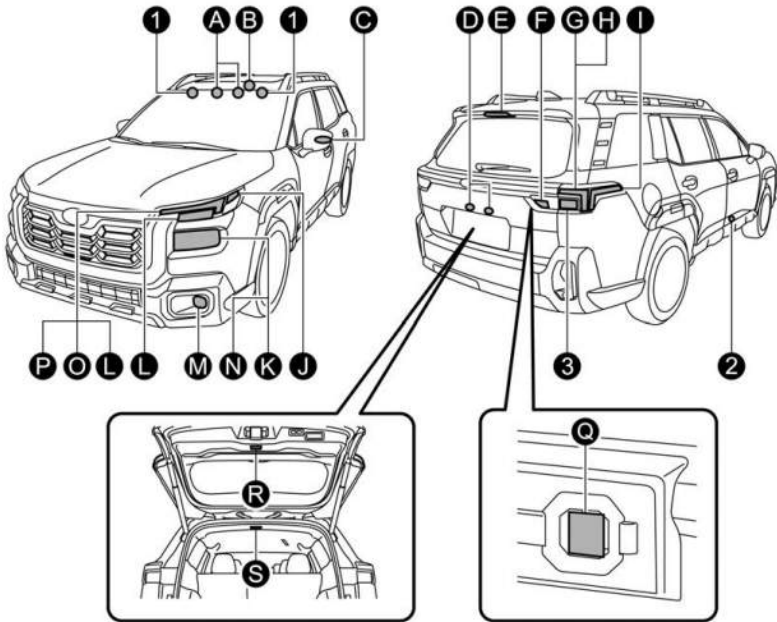

**NOTE**

Light sources indicated by a number are light bulbs, and light sources indicated by a letter are LEDs. For LED replacement, consult your SUBARU dealer.

	<b>Wattage</b>	<b>Bulb No.</b>
① Vanity mirror lights	12 V-2 W	—
② Door step lights	12 V-5 W	W5W
③ Rear turn signal lights	12 V-21 W	WY21W
Ⓐ Map lights	—	—
Ⓑ Dome light	—	—
Ⓒ Side turn signal lights	—	—
Ⓓ License plate lights	—	—
Ⓔ High-mounted stop light	—	—
Ⓕ Backup light (Outback)	—	—
Ⓖ Tail lights	—	—
Ⓗ Stop lights	—	—
Ⓘ Rear side marker lights	—	—
Ⓙ Front side marker light	—	—
Ⓚ Low and high beam headlights	—	—
Ⓛ Front turn signal lights	—	—
Ⓜ Front fog lights	—	—
Ⓝ Daytime running light	—	—
Ⓞ Front position lights	—	—
Ⓟ Accessory lamp	—	—
Ⓠ Backup light (Subaru Outback Wilderness)	—	—
Ⓡ Rear gate light (if equipped)	—	—
Ⓢ Cargo area light	—	—

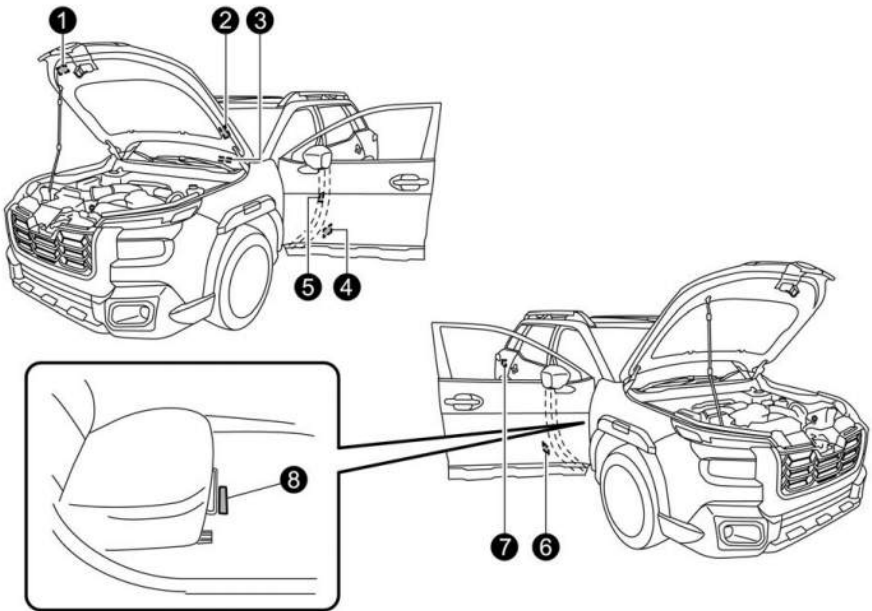
**12-3. VEHICLE IDENTIFICATION**

- ① Air conditioner label
- ② Emission control label
- ③ Vehicle identification number
- ④ Certification label
- ⑤ Tire inflation pressure label (vehicle placard)

- ⑥ Model number label
- ⑦ Fuel label
- ⑧ Vehicle identification number (under the floor carpet of the right-hand front seat)

## 12-4. FUNCTION SETTINGS

### FUNCTION SETTINGS AND ADJUSTMENTS ON THE CENTER INFORMATION DISPLAY

Setting adjustments can be manually changed within the center information display to meet your personal requirements. Refer to “Center Information Display (CID) Features” P194.

### INDIVIDUAL SETTINGS AND ADJUSTMENTS EXCLUDING CENTER INFORMATION DISPLAY

For setting adjustments to the following items, refer to the appropriate page for details.

Item	Function	Available settings	Factory default setting	Page
Alarm system	Alarm system	Operation/Non-operation	Operation	138
Remote keyless entry system	Audible signal	Operation/Non-operation	Operation	131

### FUNCTION SETTINGS AND ADJUSTMENTS PERFORMED BY A DEALER

Item	Function	Available settings	Factory default setting
Alarm system	Monitoring start delay time (after closing doors)	0 seconds/30 seconds	30 seconds
	Map lights/Dome light/Cargo area light illumination	ON/OFF	OFF
Keyless access with push-button	Audible signal volume*1	Level 1 to 7	Level 6
Remote keyless entry system	Audible signal volume*1	Level 1 to 7	Level 6
Key lock-in prevention	Key lock-in prevention	Operation/Non-operation	Operation
Auto dimmer cancel	Sensitivity of the operation of the auto dimmer cancel	OFF/Min/Low/Mid/Hi/Max	Mid
High beam assist function	High beam assist function	Operation/Non-operation	Operation
Reverse gear interlocked rear wiper	Reverse gear interlocked rear wiper operation	Operation/Non-operation	Except for Canada and Mexico: Non-operation For Canada and Mexico: Operation
Automatic rain sensing windshield*2	Automatic adjusting mode of wiper timing	Rain-sensing mode/vehicle speed interlocking mode	Rain-sensing mode wiper
Power rear gate open and close function	Power rear gate opening and closing by access key fob	Non-operation/Pressing twice/Pressing and holding	Pressing and holding



Item	Function	Available settings	Factory default setting
Power rear gate open and close function	Manual operation	Operation/Non-operation	Non-operation

\*1: The audible signal volume cannot be set under level 5 for the warning chime.

\*2: If equipped

---

---

---

---

---

---

---

---

---

---

---

---

---

---

---

---

---

---

---

---

## CONSUMER INFORMATION AND REPORTING SAFETY DEFECTS

13-1.	For U.S.A. ....	526
13-2.	Tire Information.....	526
	Tire Labeling.....	526
	Recommended Tire Inflation Pressure .....	529
	Glossary of Tire Terminology .....	530
	Tire Care – Maintenance and Safety Practices .....	535
	Vehicle Load Limit – How to Determine .....	535
	Determining Compatibility of Tire and Vehicle Load Capacities ....	538
	Adverse Safety Consequences of Overloading on Handling and Stopping and on Tires.....	538
	Steps for Determining Correct Load Limit.....	539
13-3.	Uniform Tire Quality Grading Standards .....	540
	TREADWEAR.....	540
	TRACTION AA, A, B, C.....	540
	TEMPERATURE A, B, C.....	540
13-4.	Reporting Safety Defects (USA) .....	541
13-5.	How to Contact Transport Canada in Order to Report a Safety Concern Relating to the Vehicle (Canada).....	542
13-6.	Certifications of Radio Frequency Devices .....	542
	Certification for Keyless Access with Push-Button Start System and Immobilizer System.....	542
	Certification for the Auto-Dimming Mirror/Compass with HomeLink® (If Equipped) .....	544
	Certification for the Smart Rearview Mirror/Compass with HomeLink® (If Equipped) .....	546
	Certification for the Wireless Charger.....	548
	Certification for Remote Engine Starter .....	550
	Certification for Tire Pressure Monitoring System.....	550
	Certification for the BSW/RCTW .....	550
	Certification for the Front Cross Traffic Information/Front Cross Traffic Braking .....	551
	Certification for MySubaru Connected Services .....	553

### 13-1. FOR U.S.A.

---

The following information has been compiled according to Code of Federal Regulations "Title 49, Part 575".

### 13-2. TIRE INFORMATION

---

#### TIRE LABELING

Many markings (e.g. Tire size, Tire Identification Number or TIN) are placed on the sidewall of a tire by tire manufacturers. These marking can provide you with useful information on the tire.

#### Tire size

Your vehicle comes equipped with P-Metric tire size. It is important to understand the sizing system in selecting the proper tire for your vehicles. Here is a brief review of the tire sizing system with a breakdown of its individual elements.

#### P Metric

With the P-Metric system, Section Width is measured in millimeters. To convert millimeters into inches, divide by 25.4. The Aspect Ratio (Section Height divided by Section Width) helps provide more dimensional information about the tire size.

Example:

**P 205 / 60 R 16**  
(1) (2) (3) (4) (5)

- (1) P = Certain tire type used on light duty vehicles such as passenger cars
- (2) Section Width in millimeters
- (3) Aspect Ratio (= section height ÷ section width).
- (4) R = Radial Construction

(5) Rim diameter in inches

For example, “V” means 149 mph (240 km/h)

**Load and Speed Rating Descriptions**

The load and speed rating descriptions will appear following the size designation.

They provide two important facts about the tire. First, the number designation is its load index. Second, the letter designation indicates the tire’s speed rating.

**Example:**

**P 205 / 60 R 16 91 V**  
 Size designation (6) (7)

(6) Load Index: A numerical code which specifies the maximum load a tire can carry at the speed indicated by its speed symbol, at maximum inflation pressure.

For example, “91” means 1,356 lbs (615 kg), “90” means 1,323 lbs (600 kg), “89” means 1,279 lbs (580 kg)

**! WARNING**

Load indices apply only to the tire, not to the vehicle. Putting a load rated tire on any vehicle does not mean the vehicle can be loaded up to the tire’s rated load.

(7) Speed Rating: An alphabetical system describing a tire’s capability to travel at established and predetermined speeds.

**! WARNING**

- Speed ratings apply only to the tire, not to the vehicle. Putting a speed rated tire on any vehicle does not mean the vehicle can be operated at the tire’s rated speed.
- The speed rating is void if the tires are worn out, damaged, repaired, retreaded, or otherwise altered from their original condition. If tires are repaired, retreaded, or otherwise altered, they may not be suitable for original equipment tire designed loads and speeds.

**Tire Identification Number (TIN)**

Tire Identification Number (TIN) is marked on the intended outboard sidewall. Here is a brief review of the TIN with a breakdown of its individual elements.

**Type A****DOT XX XX XXX XXXX**

- | (1) | (2)   | (3) | (4) | (5) |
|-----|---|-----|-----|-----|
| (1) | DOT symbol*                                 |     |     |     |
| (2) | Manufacturer's Identification Mark          |     |     |     |
| (3) | Tire Size Code                              |     |     |     |
| (4) | Tire Type Code (Optional, within 4 letters) |     |     |     |
| (5) | Date of Manufacture                         |     |     |     |

The first two figures identify the week, starting with "01" to represent the first full week of the calendar year; the second two figures represent the year. For example, 0101 means the 1st week of 2001.

\*: The DOT symbol certifies that the tire conforms to applicable Federal Motor Vehicle Safety Standards.

**Type B****DOT XXX XXXXXX XXXX**

- | (1) | (2)                 | (3) | (4) |
|-----|---------------------|-----|-----|
| (1) | DOT symbol*         |     |     |
| (2) | Plant Code          |     |     |
| (3) | Manufacturer's Code |     |     |
| (4) | Date of Manufacture |     |     |

The first two figures identify the week, starting with "01" to represent the first full week of the calendar year; the second two figures represent the year. For example, 0101 means the 1st week of 2001.

\*: The DOT symbol certifies that the tire conforms to applicable Fed-

eral Motor Vehicle Safety Standards.

**Other markings**

The following markings are also placed on the sidewall.

**Maximum permissible inflation pressure**

The maximum cold inflation pressure to which this tire may be inflated. For example, "350 kPa (51 PSI) MAX. PRESS"

**Maximum load rating**

The load rating at the maximum permissible weight load for this tire. For example, "MAX. LOAD 615 kg (1,356 LBS) @ 350 kPa (51 PSI) MAX. PRESS."

**WARNING**

Maximum load rating applies only to the tire, not to the vehicle. Putting a load rated tire on any vehicle does not mean the vehicle can be loaded up to the tire's rated load.

**Construction type**

Applicable construction of this tire. For example, "TUBELESS STEEL BELTED RADIAL"

**Construction**

The generic name of each cord material used in the plies (both sidewall and tread area) of this tire.

For example, "PLIES: TREAD 2 STEEL + 2 POLYESTER + 1 NYLON SIDEWALL 2 POLYE-

STER”

**Uniform Tire Quality Grading (UTQG)**

For details, refer to “Uniform Tire Quality Grading Standards” P540.

**RECOMMENDED TIRE INFLATION PRESSURE**

**Recommended cold tire inflation pressure**

For the recommended cold tire inflation pressure for your vehicle’s tires, refer to “Tires” P517.

**Vehicle placard**

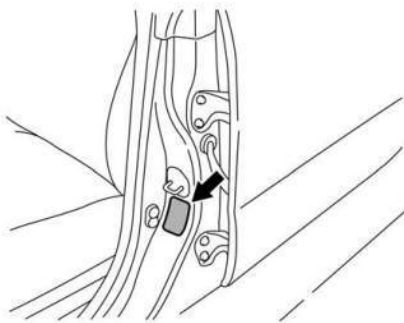

The vehicle placard is affixed to the driver’s side B-pillar.

**Example:**

TIRE AND LOADING INFORMATION RENSEIGNEMENTS SUR LES PNEUS ET LE CHARGEMENT			
SEATING CAPACITY / TOTAL X1		FRONT X1	
NOMBRE DE PLACES		AVANT X1	
		ARRIÈRE X	
The combined weight of occupants and cargo should never exceed XXXXkg or XXXlbs. Le poids total des occupants et du chargement ne doit jamais dépasser XXXXkg ou XXXlbs.			
TIRE / PNEU	SIZE / DIMENSIONS	COLD TIRE PRESSURE / PRESSION DES PNEUS À FROID	SEE OWNER'S MANUAL FOR ADDITIONAL INFORMATION VOIR LE MANUEL DE L'USAGER POUR PLUS DE RENSEIGNEMENTS
FRONT / AVANT	PXXXXRXXX	XXXXKPA, XXPSI	
REAR / ARRIÈRE	PXXXXRXXX	XXXXKPA, XXPSI	
SPARE / DE SECOURS	TXXXXDXX	XXXXKPA, XXPSI	

The vehicle placard shows original tire size, recommended cold tire inflation pressure on each tire at maximum loaded vehicle weight, seating capacity and loading information.

**Adverse safety consequences of under-inflation**

Driving at high speeds with excessively low tire pressures can cause the tires to flex severely and to rapidly become hot. A sharp increase in temperature could cause tread separation, and failure of the tire(s). Possible resulting loss of vehicle control could lead to an accident.

**Measuring and adjusting air pressure to achieve proper inflation**

Check and, if necessary, adjust the pressure of each tire (including the spare) at least once a month and before any long journey. Check the tire pressures when the tires are cold. Use a pressure gauge to adjust the tire pressures to the specific values. Driving even a short distance warms up the tires and increases the tire pressures. Also, the tire pressures are affected by the outside temperature. It is best to check tire pressure outdoors before driving the vehicle. When a tire becomes warm, the air inside it expands, causing the tire pressure to increase. Be careful not to mistakenly release air from a warm tire to reduce its pressure.

## GLOSSARY OF TIRE TERMINOLOGY

- **Accessory weight**

The combined weight (in excess of those standard items which may be replaced) of automatic transmission, power steering, power brakes, power windows, power seats, radio, and heater, to the extent that these items are available as factory-installed equipment (whether installed or not).

- **Bead**

The part of the tire that is made of steel wires, wrapped or reinforced by ply cords and that is shaped to fit the rim.

- **Bead separation**

A breakdown of the bond between components in the bead.

- **Bias ply tire**

A pneumatic tire in which the ply cords that extend to the beads are laid at alternate angles substantially less than 90 degrees to the centerline of the tread.

- **Carcass**

The tire structure, except tread and sidewall rubber which, when inflated, bears the load.

- **Chunking**

The breaking away of pieces of the tread or sidewall.

- **Cold tire pressure**

The pressure in a tire that has been driven less than 1 mile or has been standing for three hours or more.

- **Cord**

The strands forming the plies in the

tire.

- **Cord separation**

The parting of cords from adjacent rubber compounds.

- **Cracking**

Any parting within the tread, sidewall, or inner liner of the tire extending to cord material.

- **Curb weight**

The weight of a motor vehicle with standard equipment including the maximum capacity of fuel, oil and coolant, and if so equipped, air conditioning and additional weight optional engine.

- **Extra load tire**

A tire designed to operate at higher loads and higher inflation pressure than the corresponding standard tire.

- **Groove**

The space between two adjacent tread ribs.

- **Innerliner**

The layer(s) forming the inside surface of a tubeless tire that contains the inflating medium within the tire.

- **Innerliner separation**

The parting of the innerliner from cord material in the carcass.

- **Intended outboard sidewall**

- (1) The sidewall that contains a whitewall, bears white lettering or bears manufacturer, brand, and/or model name molding that is higher or deeper than the same molding on the other sidewall of the tire, or



(2) The outward facing sidewall of an asymmetrical tire that has a particular side that must always face outward when mounting on a vehicle.

● **Light truck (LT) tire**

A tire designated by its manufacturer as primarily intended for use on lightweight trucks or multipurpose passenger vehicles.

● **Load rating**

The maximum load that a tire is rated to carry for a given inflation pressure.

● **Maximum inflation pressure**

The maximum cold inflation pressure to which a tire may be inflated.

● **Maximum load rating**

The load rating for a tire at the maximum permissible inflation pressure for that tire.

● **Maximum loaded vehicle weight**

The sum of:

- (a) Curb weight
- (b) Accessory weight
- (c) Vehicle capacity weight
- (d) Production options weight

● **Maximum permissible inflation pressure**

The maximum cold inflation pressure to which a tire may be inflated.

● **Measuring rim**

The rim on which a tire is fitted for physical dimension requirements.

● **Normal occupant weight**

150 lbs (68 kg) times the number of occupants specified in the second column of Table 1 that is appended to the end of this section.

● **Occupant distribution**

Distribution of occupants in a vehicle as specified in the third column of Table 1 that is appended to the end of this section.

● **Open splice**

Any parting at any junction of tread, sidewall, or innerliner that extends to cord material.

● **Outer diameter**

The overall diameter of an inflated new tire.

● **Overall width**

The linear distance between the exteriors of the sidewalls of an inflated tire, including elevations due to labeling, decorations, or protective bands or ribs.

● **Passenger car tire**

A tire intended for use on passenger cars, multipurpose passenger vehicles, and trucks, that have a gross vehicle weight rating (GVWR) of 10,000 lbs (4,535 kg) or less.

● **Ply**

A layer of rubber-coated parallel cords.

● **Ply separation**

A parting of rubber compound between adjacent plies.

● **Pneumatic tire**

A mechanical device made of rubber, chemicals, fabric and steel or other materials, that, when mounted on an automotive wheel, provides the traction and contains the gas or fluid that sustains the load.

- **Production options weight**

The combined weight of those installed regular production options weighing over 5.1 lbs (2.3 kg) in excess of those standard items which they replace, not previously considered in curb weight or accessory weight, including heavy duty brakes, ride levelers, roof rack, heavy duty battery, and special trim.

- **Radial ply tire**

A pneumatic tire in which the ply cords that extend to the beads are laid at substantially 90 degrees to the centerline of the tread.

- **Recommended inflation pressure**

The cold inflation pressure recommended by a vehicle manufacturer.

- **Reinforced tire**

A tire designed to operate at higher loads and at higher inflation pressures than the corresponding standard tire.

- **Rim**

A metal support for a tire or a tire and tube assembly upon which the tire beads are seated.

- **Rim diameter**

Nominal diameter of the bead seat.

- **Rim size designation**

Rim diameter and width.

- **Rim type designation**

The industry of manufacturer's designation for a rim by style or code.

- **Rim width**

Nominal distance between rim

flanges.

- **Section width**

The linear distance between the exteriors of the sidewalls of an inflated tire, excluding elevations due to labeling, decoration, or protective bands.

- **Sidewall**

That portion of a tire between the tread and bead.

- **Sidewall separation**

The parting of the rubber compound from the cord material in the sidewall.

- **Snow tire**

A tire that attains a traction index equal to or greater than 110, compared to the ASTM E1136-93 Standard Reference Test Tire, when using the snow traction test as described in ASTM F-1805-00, Standard Test Method for Single Wheel Driving Traction in a Straight Line on Snow-and Ice-Covered Surfaces, and that is marked with an Alpine Symbol "A" on at least one sidewall.

- **Test rim**

The rim on which a tire is fitted for testing, and it may be any rim listed as appropriate for use with that tire.

- **Tread**

That portion of a tire that comes into contact with the road.

- **Tread rib**

A tread section running circumferentially around a tire.

- **Tread separation**

Pulling away of the tread from the tire carcass.

- **Treadwear indicators (TWI)**

The projections within the principal grooves designed to give a visual indication of the degrees of wear of the tread.

- **Vehicle capacity weight**

The rated cargo and luggage load plus 150 lbs (68 kg) times the vehicle's designated seating capacity.

- **Vehicle maximum load on the tire**

Load on an individual tire that is determined by distributing to each axle its share of the maximum loaded vehicle weight and dividing by two.

- **Vehicle normal load on the tire**

Load on an individual tire that is determined by distributing to each axle its share of the curb weight, accessory weight, and normal occupant weight (distributed in accordance with Table 1 that is appended to the end of this section) and dividing by 2.

- **Wheel-holding fixture**

The fixture used to hold the wheel and tire assembly securely during testing.

**534 CONSUMER INFORMATION AND REPORTING SAFETY DEFECTS**

Table 1 — Occupant loading and distribution for vehicle normal load for various designated seating capacities

Designated seating capacity, number of occupants	Vehicle normal load, number of occupants	Occupant distribution in a normally loaded vehicle
2 through 4	2	2 in front.
5 through 10	3	2 in front, 1 in second seat.
11 through 15	5	2 in front, 1 in second seat, 1 in third seat, 1 in fourth seat.
16 through 22	7	2 in front, 2 in second seat, 2 in third seat, 1 in fourth seat.

**TIRE CARE – MAINTENANCE AND SAFETY PRACTICES**

- Check on a daily basis that the tires are free from serious damage, nails, and stones. At the same time, check the tires for abnormal wear.
- Inspect the tire tread regularly and replace the tires before their tread wear indicators become visible. When a tire’s tread wear indicator becomes visible, the tire is worn beyond the acceptable limit and must be replaced immediately. With a tire in this condition, driving at even low speeds in wet weather can cause the vehicle to hydroplane. Possible resulting loss of vehicle control can lead to an accident.
- To maximize the life of each tire and ensure that the tires wear uniformly, it is best to rotate the tires every 6,000 miles (10,000 km). For details about tire rotation, refer to “Tire Rotation” P492. Replace any damaged or unevenly worn tire at the time of rotation. After tire rotation, adjust the tire pressures and make sure the wheel nuts are correctly tightened. For information about the tightening torque and tightening sequence for the wheel nuts, refer to “Flat Tires” P439.

**VEHICLE LOAD LIMIT – HOW TO DETERMINE**

The load capacity of your vehicle is determined by weight, not by available cargo space. The load limit of your vehicle is shown on the vehicle placard attached to the driver’s side B-pillar. Locate the statement “The combined weight of occupants and cargo should never exceed XXX kg or XXX lbs” on your vehicle’s placard.

The vehicle placard also shows seating capacity of your vehicle.

The total load capacity includes the total weight of driver and all passengers and their belongings, any cargo, any optional equipment such as a trailer hitch, roof rack or bike carrier, etc., and the tongue load of a trailer. Therefore cargo capacity can be calculated by the following method.

Cargo capacity = Load limit – (total weight of occupants + total weight of optional equipment + tongue load of a trailer (if applicable))

**Calculating total and load capacities varying seating configurations**

Calculate the available load capacity as shown in the following examples:

**Example 1A**



Vehicle capacity weight of the vehicle is 800 lbs (363 kg), which is indicated on the vehicle placard with the statement “The combined weight of occupants and cargo should never exceed 363 kg or 800 lbs”.

For example, if the vehicle has one occupant weighing 154 lbs (70 kg) plus cargo weighing 551 lbs (250 kg).

1. Calculate the total weight.

**Total weight**

$$= \frac{154 \text{ lbs (70 kg)}}{\text{(Occupant)}} + \frac{551 \text{ lbs (250 kg)}}{\text{(Cargo)}}$$

$$= \mathbf{705 \text{ lbs (320 kg)}}$$

2. Calculate the available load capacity by subtracting the total weight from the vehicle capacity weight of 800 lbs (363 kg).

**Available Load Capacity**

$$= \frac{800 \text{ lbs (363 kg)}}{\text{(Vehicle capacity weight)}} - \frac{705 \text{ lbs (320 kg)}}{\text{(Total weight)}}$$

$$= \mathbf{95 \text{ lbs (43 kg)}}$$

3. The result of step 2 shows that a further 95 lbs (43 kg) of cargo can be carried.

**Example 1B**



For example, if a person weighing 176 lbs (80 kg) now enters the same vehicle (bringing the number of occupants to two), the calculations are as follows:

1. Calculate the total weight.

**Total weight**

$$= \frac{154 \text{ lbs (70 kg)}}{\text{(Occupant)}} + \frac{176 \text{ lbs (80 kg)}}{\text{(Occupant)}}$$

$$+ \frac{551 \text{ lbs (250 kg)}}{\text{(Cargo)}}$$

$$= \mathbf{881 \text{ lbs (400 kg)}}$$

2. Calculate the available load capacity.

**Available Load Capacity**

$$= \frac{800 \text{ lbs (363 kg)}}{\text{(Vehicle capacity weight)}} - \frac{881 \text{ lbs (400 kg)}}{\text{(Total weight)}}$$

$$= \mathbf{-81 \text{ lbs (-37 kg)}}$$

3. The total weight now exceeds the capacity weight by 81 lbs (37 kg), so the cargo weight must be reduced by 81 lbs (37

kg) or more.

**Example 2A**

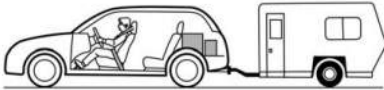

Vehicle capacity weight of the vehicle is 800 lbs (363 kg), which is indicated on the vehicle placard with the statement “The combined weight of occupants and cargo should never exceed 363 kg or 800 lbs”.

For example, the vehicle has one occupant weighing 165 lbs (75 kg) plus cargo weighing 265 lbs (120 kg). In addition, the vehicle is fitted with a trailer hitch weighing 22 lbs (10 kg), to which is attached a trailer weighing 1,764 lbs (800 kg). 10% of the trailer weight is applied to the trailer tongue (i.e. Tongue load = 176 lbs (80 kg)).

1. Calculate the total weight.

**Total weight**

$$\begin{aligned}
 &= \frac{165 \text{ lbs (75 kg)}}{\text{(Occupant)}} + \frac{265 \text{ lbs (120 kg)}}{\text{(Cargo)}} \\
 &+ \frac{22 \text{ lbs (10 kg)}}{\text{(Trailer hitch)}} + \frac{176 \text{ lbs (80 kg)}}{\text{(Tongue load)}} \\
 &= \mathbf{628 \text{ lbs (285 kg)}}
 \end{aligned}$$

2. Calculate the available load capacity.

**Available Load Capacity**

$$\begin{aligned}
 &= \frac{800 \text{ lbs (363 kg)}}{\text{(Vehicle capacity weight)}} - \frac{628 \text{ lbs (285 kg)}}{\text{(Total weight)}} \\
 &= \mathbf{172 \text{ lbs (78 kg)}}
 \end{aligned}$$

3. The result of step 2 shows that a further 172 lbs (78 kg) of cargo can be carried.

**Example 2B**



For example, if a person weighing 143 lbs (65 kg) and a child weighing 40 lbs (18 kg) now enter the same vehicle (bringing the number of occupants to three), and a child restraint system weighing 11 lbs (5 kg) is installed in the vehicle for the child to use, the calculations are as follows:

1. Calculate the total weight.

**Total weight**

$$= \frac{165 \text{ lbs (75 kg)} + 143 \text{ lbs (65 kg)}}{\text{(Occupant)}}$$

$$+ \frac{40 \text{ lbs (18 kg)}}{\text{(Occupant)}}$$

$$+ \frac{11 \text{ lbs (5 kg)}}{\text{(Child restraint)}} + \frac{265 \text{ lbs (120 kg)}}{\text{(Cargo)}}$$

$$+ \frac{22 \text{ lbs (10 kg)}}{\text{(Trailer hitch)}} + \frac{176 \text{ lbs (80 kg)}}{\text{(Tongue load)}}$$

$$= \mathbf{822 \text{ lbs (373 kg)}}$$

2. Calculate the available load capacity.

**Available Load Capacity**

$$= \frac{800 \text{ lbs (363 kg)}}{\text{(Vehicle capacity weight)}} - \frac{822 \text{ lbs (373 kg)}}{\text{(Total weight)}}$$

$$= \mathbf{-22 \text{ lbs (-10 kg)}}$$

3. The total weight now exceeds the capacity weight by 22 lbs (10 kg), so the cargo weight must be reduced by 22 lbs (10 kg) or more.

## DETERMINING COMPATIBILITY OF TIRE AND VEHICLE LOAD CAPACITIES

The sum of four tires' maximum load ratings must exceed the maximum loaded vehicle weight ("GVWR"). In addition, sum of the maximum load ratings of two front tires and of two rear tires must exceed each axle's maximum loaded capacity ("GAWR"). Original equipment tires are designed to fulfill those conditions.

The maximum loaded vehicle weight is referred to Gross Vehicle Weight Rating (GVWR). And each axle's maximum loaded capacity is referred to Gross Axle Weight Rating (GAWR). The GVWR and each axle's GAWR are shown on the vehicle certification label affixed to the driver's door.

The GVWR and front and rear GAWRs are determined by not only the maximum load rating of tires but also loaded capacities of the vehicle's suspension, axles and other parts of the body.

Therefore, this means that the vehicle cannot necessarily be loaded up to the tire's maximum load rating on the tire sidewall.

## ADVERSE SAFETY CONSEQUENCES OF OVERLOADING ON HANDLING AND STOPPING AND ON TIRES

Overloading could affect vehicle handling, stopping distance, vehicle and tire as shown in the following. This could lead to an accident and possibly result in severe personal injury.

- Vehicle stability will deteriorate.
- Heavy and/or high-mounted loads could increase the risk of rollover.
- Stopping distance will increase.
- Brakes could overheat and fail.
- Suspension, bearings, axles and other parts of the body could break or experience accelerated wear that will shorten vehicle life.



- Tires could fail.
- Tread separation could occur.
- Tire could separate from its rim.

load capacity of your vehicle.

## **STEPS FOR DETERMINING CORRECT LOAD LIMIT**

1. Locate the statement “The combined weight of occupants and cargo should never exceed XXX kg or XXX lbs.” on your vehicle’s placard.
2. Determine the combined weight of the driver and passengers that will be riding in your vehicle.
3. Subtract the combined weight of the driver and passengers from XXX kg or XXX lbs.
4. The resulting figure equals the available amount of cargo and luggage load capacity. For example, if the “XXX” amount equals 1,400 lbs (635 kg) and there will be five 150 lbs (68 kg) passengers in your vehicle, the amount of available cargo and luggage load capacity is 650 lbs (1,400 – 750 (5 × 150) = 650 lbs).
5. Determine the combined weight of luggage and cargo being loaded on the vehicle. That weight may not safely exceed the available cargo and luggage load capacity calculated in Step 4.
6. If your vehicle will be towing a trailer, load from your trailer will be transferred to your vehicle. Consult this manual to determine how this reduces the available cargo and luggage

### **13-3. UNIFORM TIRE QUALITY GRADING STANDARDS**

This information indicates the relative performance of passenger car tires in the area of treadwear, traction, and temperature resistance. This is to aid the consumer in making an informed choice in the purchase of tires.

Quality grades can be found where applicable on the tire sidewall between tread shoulder and maximum section width. For example:

#### **TREADWEAR 200 TRACTION AA TEMPERATURE A**

The quality grades apply to new pneumatic tires for use on passenger cars. However, they do not apply to deep tread, winter type snow tires, space-saver or temporary use spare tires, tires with nominal rim diameters of 12 inches or less, or to some limited production tires.

All passenger car tires must conform to Federal Safety Requirements in addition to these grades.

#### **TREADWEAR**

The treadwear grade is a comparative rating based on the wear rate of the tire when tested under controlled conditions on a specified government test course.

For example, a tire graded 150 would wear one and one-half (1-1/2) times as well on the government course as a tire graded 100. The relative performance of tires

depends upon the actual conditions of their use, however, and may depart significantly from the norm due to variations in driving habits, service practices and differences in road characteristics and climate.

#### **TRACTION AA, A, B, C**

The traction grades, from highest to lowest, are AA, A, B and C. Those grades represent the tire's ability to stop on wet pavement as measured under controlled conditions on specified government test surfaces of asphalt and concrete. A tire marked C may have poor traction performance.



#### **WARNING**

The traction grade assigned to this tire is based on straight-ahead braking traction tests, and does not include acceleration, cornering, hydroplaning, or peak traction characteristics.

#### **TEMPERATURE A, B, C**

The temperature grades are A (the highest), B, and C, representing the tire's resistance to the generation of heat and its ability to dissipate heat when tested under controlled conditions on a specified indoor laboratory test wheel. Sustained high temperature can cause the material of the tire to degenerate and reduce tire life, and excessive temperature can lead to sudden tire failure. The grade C corresponds to a level of

performance which all passenger car tires must meet under the Federal Motor Vehicle Safety Standard No. 109. Grades B and A represent higher levels of performance on the laboratory test wheel than the minimum required by law.

 **WARNING**

The temperature grade for this tire is established for a tire that is properly inflated and not overloaded. Excessive speed, underinflation, or excessive loading, either separately or in combination, can cause heat buildup and possible tire failure.

### **13-4. REPORTING SAFETY DEFECTS (USA)**

If you believe that your vehicle has a defect which could cause a crash or could cause injury or death, you should immediately inform the National Highway Traffic Safety Administration (NHTSA) in addition to notifying Subaru of America, Inc.

If NHTSA receives similar complaints, it may open an investigation, and if it finds that a safety defect exists in a group of vehicles, it may order a recall and remedy campaign. However, NHTSA cannot become involved in individual problems between you, your dealer, or Subaru of America, Inc. To contact NHTSA, you may call the Vehicle Safety Hotline toll-free at 1-888-327-4236 (TTY: 1-800-424-9153); go to <http://www.safercar.gov>; or write to: Administrator, NHTSA, 1200 New Jersey Avenue, SE, West Building, Washington, DC 20590. You can also obtain other information about motor vehicle safety from <http://www.safercar.gov>.

### 13-5. HOW TO CONTACT TRANSPORT CANADA IN ORDER TO REPORT A SAFETY CONCERN RELATING TO THE VEHICLE (Canada)

---

Transport Canada - ASFAD  
330 Sparks Street  
Ottawa, ON K1A 0N5

Telephone: 819-994-3328  
(Ottawa-Gatineau area or internationally)  
Toll free: 1-800-333-0510 (in Canada)

Online:  
<http://www.tc.gc.ca/recalls>

Transports Canada - ASFAD  
330, rue Sparks  
Ottawa (Ontario) K1A 0N5

Téléphone: 819-994-3328  
(dans la région de Ottawa-Gatineau et à l'extérieur du pays)  
Sans frais: 1-800-333-0510 (au Canada)

Internet:  
<http://www.tc.gc.ca/rappels>

### 13-6. CERTIFICATIONS OF RADIO FREQUENCY DEVICES

---

#### CERTIFICATION FOR KEYLESS ACCESS WITH PUSH-BUTTON START SYSTEM AND IMMOBILIZER SYSTEM

- **U.S.-spec. models**

FCC ID: HYQ14AKE

FCC ID: Y8PSU23S-1

FCC ID: Y8PSSPIMB02



#### CAUTION

##### FCC WARNING

Changes or modifications not expressly approved by the party responsible for compliance could void the user's authority to operate the equipment.

This device complies with part 15 of the FCC Rules. Operation is subject to the following two conditions: (1) This device may not cause harmful interference, and (2) this device must accept any interference received, including interference that may cause undesired operation.

● **Canada-spec. models**

– **Type 1**

**NOTE**

*This device complies with Industry Canada's licence-exempt RSSs. Operation is subject to the following two conditions: (1) This device may not cause interference; and (2) This device must accept any interference, including interference that may cause undesired operation of the device.*

**REMARQUE**

*Le présent appareil est conforme aux CNR d'Industrie Canada applicables aux appareils radio exempts de licence.*

*L'exploitation est autorisée aux deux conditions suivantes: (1) l'appareil ne doit pas produire de brouillage; (2) l'utilisateur de l'appareil doit accepter tout brouillage radioélectrique subi, même si le brouillage est susceptible d'en compromettre le fonctionnement.*

– **Type 2**

**NOTE**

*This device contains licence-exempt transmitter(s)/receiver(s) that comply with Innovation, Science and Economic Development Canada's licence-exempt RSS(s). Operation is subject to the following two conditions:*

- (1) This device may not cause interference.*
- (2) This device must accept any interference, including interference that may cause undesired operation of the device.*

**REMARQUE**

*L'émetteur/récepteur exempt de licence contenu dans le présent appareil est conforme aux CNR d'Innovation, Sciences et Développement économique Canada applicables aux appareils radio exempts de licence. L'exploitation est autorisée aux deux conditions suivantes:*

- (1) L'appareil ne doit pas produire de brouillage;*
- (2) L'appareil doit accepter tout brouillage radioélectrique subi, même si le brouillage est susceptible d'en compromettre le fonctionnement.*

● **Mexico-spec. models**

Este equipo opera a título secundario, consecuentemente, debe aceptar interferencias perjudiciales incluyendo equipos de la misma clase y puede no causar interferencias a sistemas operando a título primario.

IFT SUDE1424-05676  
14AKE  
DENSO

**CERTIFICATION FOR THE  
AUTO-DIMMING MIRROR/  
COMPASS WITH HOMELINK® (If  
Equipped)**

In the event that there are still programming difficulties or questions, additional HomeLink® information and programming videos can be found at [www.HomeLink.com](http://www.HomeLink.com), [www.youtube.com/HomeLinkGen-tex](http://www.youtube.com/HomeLinkGen-tex), or by calling the toll-free HomeLink-hotline at 1-800-355-3515.

- **U.S.-spec. models**



**CAUTION**

**FCC WARNING**

Changes or modifications not expressly approved by the party responsible for compliance could void the user's authority to operate the equipment.

This device complies with FCC rules part 15 and Innovation, Science, and Economic Development Canada RSS-210. Operation is subject to the following two conditions: (1) This device may not cause harmful interference, and (2) This device must accept any interference that may be received including interference that may cause undesired operation.

**WARNING:** The transmitter has been tested and complies with FCC and ISED rules.

Changes or modifications not expressly approved by the party responsible for compliance could void the user's authority to operate the device.

This equipment complies with FCC and ISED radiation exposure limits set forth for an uncontrolled environment. End Users must follow the specific operating instructions for satisfying RF exposure compliance. This transmitter must be at least 20 cm from the user and must not be co-located or operating in conjunction with any other antenna or transmitter.

● **Canada-spec. models**

This device complies with FCC rules part 15 and Innovation, Science, and Economic Development Canada RSS-210. Operation is subject to the following two conditions: (1) This device may not cause harmful interference, and (2) This device must accept any interference that may be received including interference that may cause undesired operation.

**WARNING:** The transmitter has been tested and complies with FCC and ISED rules.

Changes or modifications not expressly approved by the party responsible for compliance could void the user's authority to operate the device.

This equipment complies with FCC and ISED radiation exposure limits set forth for an uncontrolled environment. End Users must follow the specific operating instructions for satisfying RF exposure compliance. This transmitter must be at least 20 cm from the user and must not be co-located or operating in conjunction with any other antenna or transmitter.

Cet appareil est conforme aux règlements de la FCC, section 15, et au CNR-210 d'Innovation, Sciences et Développement économique Canada. Le fonctionnement est assujéti aux deux conditions suivantes : (1) cet appareil ne doit pas causer d'interférences nuisibles et (2) cet appareil doit accepter toute interférence reçue, y compris celle qui pourrait entraîner un dysfonctionnement. **MISE EN GARDE :** L'émetteur a subi des tests et est conforme aux règlements de la FCC et d'ISDE. Les changements ou modifications non approuvés explicitement par la partie responsable de la conformité pourraient rendre caduque l'autorisation de l'utilisateur de se servir du dispositif.

Cet appareil est conforme aux limites d'exposition aux radiations de la FCC et d'ISDE établies pour un environnement non contrôlé. Les utilisateurs finaux doivent respecter les instructions d'utilisation spécifiques pour satisfaire aux exigences de conformité aux expositions de RF. L'émetteur doit se trouver à 20 cm au minimum de l'utilisateur et ne doit pas être situé au même endroit que tout autre émetteur ou antenne ni fonctionner avec un autre émetteur ou antenne.

HomeLink® and the HomeLink® house are registered trademarks of Gentex Corporation.

 **WARNING**

- When programming the HomeLink® Wireless Control System, you may be operating a garage door opener or other device. Make sure that people and objects are out of the way of the garage door or other device to prevent potential harm or damage.

- Do not use the HomeLink® Wireless Control System with a garage door opener that lacks the safety stop and reverse feature as required by applicable safety standards. A garage door opener which cannot detect an object, signaling the door to stop and reverse, does not meet these safety standards. Using a garage door opener without these features increases risk of serious injury or death. For more information, consult the HomeLink® website at [www.homelink.com](http://www.homelink.com) or call 1-800-355-3515.

### **CERTIFICATION FOR THE SMART REARVIEW MIRROR/COMPASS WITH HOMELINK® (If Equipped)**

#### **Certification:**

In the event that there are still programming difficulties or questions, additional HomeLink information and programming videos can be found at [www.HomeLink.com/Subaru](http://www.HomeLink.com/Subaru), [www.youtube.com/HomeLinkGen-tex](http://www.youtube.com/HomeLinkGen-tex), or by calling the toll-free HomeLink-hotline at 1-800-355-3515.

- **U.S.-spec. models**



#### **CAUTION**

##### **FCC WARNING**

Changes or modifications not expressly approved by the party responsible for compliance could void the user's authority to operate the equipment.

This device complies with FCC rules part 15 and Innovation, Science, and Economic Development Canada RSS-210. Operation is subject to the following two conditions: (1) This device may not cause harmful interference, and (2) This device must accept any interference that may be received including interference that may cause undesired operation.

**WARNING:** The transmitter has been tested and complies with FCC and ISED rules.

Changes or modifications not expressly approved by the party responsible for compliance could void the user's authority to operate the device.

This equipment complies with FCC and ISED radiation exposure limits set forth for an uncontrolled environment. End Users must follow the specific operating instructions for satisfying RF exposure compliance. This transmitter must be at least 20 cm from the user and must not be co-located or operating in conjunction with any other antenna or transmitter.



- **Canada-spec. models**

This device complies with FCC rules part 15 and Innovation, Science, and Economic Development Canada RSS-210. Operation is subject to the following two conditions: (1) This device may not cause harmful interference, and (2) This device must accept any interference that may be received including interference that may cause undesired operation.

**WARNING:** The transmitter has been tested and complies with FCC and ISED rules.

Changes or modifications not expressly approved by the party responsible for compliance could void the user's authority to operate the device.

This equipment complies with FCC and ISED radiation exposure limits set forth for an uncontrolled environment. End Users must follow the specific operating instructions for satisfying RF exposure compliance. This transmitter must be at least 20 cm from the user and must not be co-located or operating in conjunction with any other antenna or transmitter.

Cet appareil est conforme aux règlements de la FCC, section 15, et au CNR-210 d'Innovation, Sciences et Développement économique Canada. Le fonctionnement est assujéti aux deux conditions suivantes : (1) cet appareil ne doit pas causer d'interférences nuisibles et (2) cet appareil doit accepter toute interférence reçue, y compris celle qui pourrait entraîner un dysfonctionnement. **MISE EN GARDE :** L'émetteur a subi des tests et est conforme aux règlements de la FCC et d'ISDE. Les changements ou modifications non approuvés explicitement par la partie responsable de la conformité pourraient rendre caduque l'autorisation de l'utilisateur de se servir du dispositif.

Cet appareil est conforme aux limites d'exposition aux radiations de la FCC et d'ISDE établies pour un environnement non contrôlé. Les utilisateurs finaux doivent respecter les instructions d'utilisation spécifiques pour satisfaire aux exigences de conformité aux expositions de RF. L'émetteur doit se trouver à 20 cm au minimum de l'utilisateur et ne doit pas être situé au même endroit que tout autre émetteur ou antenne ni fonctionner avec un autre émetteur ou antenne.

HomeLink® and the HomeLink® house are registered trademarks of Gentex Corporation.

 **WARNING**

- When programming the HomeLink® Wireless Control System, you may be operating a garage door opener or other device. Make sure that people and objects are out of the way of the garage door or other device to prevent potential harm or damage.
- Do not use the HomeLink® Wireless Control System with a garage door opener that lacks the safety stop and reverse feature as required by applicable safety standards. A garage door opener which cannot detect an object, signaling the door to stop and reverse, does not meet these safety standards. Using a garage door opener without these features increases risk of serious injury or death. For more information, consult the HomeLink® website at [www.HomeLink.com/Subaru](http://www.HomeLink.com/Subaru) or call 1-800-355-3515.

**CERTIFICATION FOR THE WIRELESS CHARGER**

**The U.S. and other FCC compliant countries:**

FCC ID: ACJ932AF2201

 **CAUTION****FCC CAUTION**

Changes or modifications not expressly approved by the party responsible for compliance could void the user's authority to operate the equipment.

This equipment has been tested and found to comply with the limits for a wireless power charger, pursuant to part 18 of the FCC Rules.

This equipment generates, uses and can radiate radio frequency energy and, if not installed and used in accordance with the instructions, may cause harmful interference to radio communications.

However, there is no guarantee that interference will not occur in a particular installation.

If this equipment does cause harmful interference to radio communications, which can be determined by turning the equipment off and on, the user is encouraged to try to correct the interference by one or more of the following measures:

- Reorient or relocate the receiving antenna.

- Increase the separation between the equipment and receiver.
- Connect the equipment into an outlet on a circuit different from that to which the receiver is connected.

This equipment complies with FCC radiation exposure limits set forth for an uncontrolled environment and meets the FCC radio frequency (RF) Exposure Guidelines. This equipment should be installed and operated keeping the radiator at least 20 cm or more away from person's body.

**NOTE**

*This device complies with part 15 and part 18 of the FCC Rules. Operation is subject to the following two conditions: (1) This device may not cause harmful interference, and (2) this device must accept any interference received, including interference that may cause undesired operation.*

**Canada-spec. models:**

This device contains licence-exempt transmitter(s)/receiver(s) that comply with Innovation, Science and Economic Development Canada's licence-exempt RSS(s). Operation is subject to the following two conditions:

- (1) This device may not cause interference.
- (2) This device must accept any interference, including interference that may cause undesired operation of the device.

L'émetteur/récepteur exempt de licence contenu dans le présent appareil est conforme aux CNR d'Innovation, Sciences et Développement économique Canada applicables aux appareils radio exempts de licence. L'exploitation est autorisée aux deux conditions suivantes :

- 1) L'appareil ne doit pas produire de brouillage;
- 2) L'appareil doit accepter tout brouillage radioélectrique subi, même si le brouillage est susceptible d'en compromettre le fonctionnement.

 **CAUTION**

This equipment complies with ISED radiation exposure limits set forth for an uncontrolled environment and meets RSS-102 of the ISED radio frequency (RF) Exposure rules. This equipment should be installed and operated keeping the radiator at least 20 cm or more away from person's body.

Cet équipement est conforme aux limites d'exposition aux rayonnements énoncées pour un environnement non contrôlé et respecte les règles d'exposition aux fréquences radioélectriques (RF) CNR-102 de l'ISDE. Cet équipement doit être installé et utilisé en gardant une distance de 20 cm ou plus entre le radiateur et le corps humain.

## CERTIFICATION FOR REMOTE ENGINE STARTER

### U.S.-spec. models



#### CAUTION

##### FCC WARNING

Changes or modifications not expressly approved by the party responsible for compliance could void the user's authority to operate the equipment.

This device complies with part 15 of the FCC Rules. Operation is subject to the following two conditions: (1) This device may not cause harmful interference, and (2) this device must accept any interference received, including interference that may cause undesired operation.

### Canada-spec. models

#### NOTE

*This device complies with Industry Canada's licence-exempt RSSs. Operation is subject to the following two conditions: (1) This device may not cause interference; and (2) This device must accept any interference, including interference that may cause undesired operation of the device.*

#### REMARQUE

*Le présent appareil est conforme aux CNR d'Industrie Canada applicables aux appareils radio exempts de licence. L'exploitation est autorisée aux deux conditions suivantes: (1) l'appareil ne doit pas produire de brouillage; (2) l'utilisateur de l'appareil doit accepter tout brouillage radioélectrique subi, même si le brouillage est susceptible d'en compromettre le fonctionnement.*

## CERTIFICATION FOR TIRE PRESSURE MONITORING SYSTEM



#### CAUTION

##### FCC WARNING

Changes or modifications not expressly approved by the party responsible for compliance could void the user's authority to operate the equipment.

This device complies with part 15 of the FCC Rules. Operation is subject to the following two conditions: (1) This device may not cause harmful interference, and (2) this device must accept any interference received, including interference that may cause undesired operation.

## CERTIFICATION FOR THE BSW/RCTW

### The U.S. and other FCC compliant countries:

FCC ID: OAYSRR3A



#### CAUTION

##### FCC WARNING

Changes or modifications not expressly approved by the party responsible for compliance could void the user's authority to operate the equipment.

This device complies with part 15 of the FCC Rules. Operation is subject to the following two conditions: (1) This device may not cause harmful interference, and (2) this device must accept any interference received, including interference that may cause undesired operation.

**Canada-spec. models:**

This device contains licence-exempt transmitter(s)/receiver(s) that comply with Innovation, Science and Economic Development Canada's licence-exempt RSS(s). Operation is subject to the following two conditions:

1. This device may not cause interference.
2. This device must accept any interference, including interference that may cause undesired operation of the device.

Radiofrequency radiation exposure information:

This equipment complies with radiation exposure limits set forth for an uncontrolled environment. This equipment should be installed and operated with minimum distance of 20 cm between the radiator and your body.

L'émetteur/récepteur exempt de licence contenu dans le présent appareil est conforme aux CNR d'Innovation, Sciences et Développement économique Canada applicables aux appareils radio exempts de licence. L'exploitation est autorisée aux deux conditions suivantes:

1. L'appareil ne doit pas produire de brouillage;
2. L'appareil doit accepter tout brouillage radioélectrique subi, même si le brouillage est susceptible d'en compromettre le fonctionnement.

Informations sur l'exposition aux rayonnements radiofréquences:

Cet équipement est conforme aux limites d'exposition aux rayonnements définies pour un environnement non contrôlé. Cet équipement doit être installé et utilisé avec un minimum de 20 cm de distance entre la source de rayonnement et votre corps.

**Mexico-spec. models:**

Certificado de homologacion:  
RLVCOSR15-0442

Continental SRR3-A

Este equipo opera a titulo secundario, consecuentemente, debe aceptar interferencias perjudiciales incluyendo equipos de la misma clase y puede no causar interferencias a sistemas operando a titulo primario.

**CERTIFICATION FOR THE FRONT CROSS TRAFFIC INFORMATION/FRONT CROSS TRAFFIC BRAKING**

• **U.S.-spec. models**



**CAUTION**

**FCC WARNING**

Changes or modifications not expressly approved by the party responsible for compliance could void the user's authority to operate the equipment.

This device complies with part 15 of the FCC Rules. Operation is subject to the following two conditions: (1) This device may not cause harmful interference, and (2) this device must accept any interference received, including interference that may cause undesired operation.

### ● Canada-spec. models

This device contains licence-exempt transmitter(s)/receiver(s) that comply with Innovation, Science and Economic Development Canada's licence-exempt RSS(s). Operation is subject to the following two conditions:

- (1) This device may not cause interference.
- (2) This device must accept any interference, including interference that may cause undesired operation of the device.

L'émetteur/récepteur exempt de licence contenu dans le présent appareil est conforme aux CNR d'Innovation, Sciences et Développement économique Canada applicables aux appareils radio exempts de licence. L'exploitation est autorisée aux deux conditions suivantes :

- 1) L'appareil ne doit pas produire de brouillage;
- 2) L'appareil doit accepter tout brouillage radioélectrique subi, même si le brouillage est susceptible d'en compromettre le fonctionnement.

### ● Mexico-spec. models

La operación de este equipo está sujeta a las siguientes dos condiciones: (1) es posible que este equipo o dispositivo no cause interferencia perjudicial y (2) este equipo o dispositivo debe aceptar cualquier interferencia, incluyendo la que pueda causar su operación no deseada.

**CERTIFICATION FOR MySubaru Connected Services**

• **U.S.-spec. models**

This device complies with Part 15 of the FCC Rules. Operation is subject to the following two conditions: (1) This device may not cause harmful interference, and (2) this device must accept any interference received, including interference that may cause undesired operation.

This equipment has been tested and found to comply with the limits for a Class B digital device, pursuant to Part 15 of the FCC Rules.

These limits are designed to provide reasonable protection against harmful interference in a residential installation. This equipment generates, uses and can radiate radio frequency energy and, if not installed and used in accordance with the instructions, may cause harmful interference to radio communications. However, there is no guarantee that interference will not occur in a particular installation.

If this equipment does cause harmful interference to radio or television reception, which can be determined by turning the equipment off and on, the user is encouraged to try to correct the interference by one of the following measures:

- Reorient or relocate the receiving antenna.
- Increase the separation between the equipment and receiver.
- Connect the equipment into an outlet on a circuit different from that to which the receiver is connected.
- Consult the dealer or an experienced radio/TV technician for help.

**Part § 15.21**

Users must be advised that changes or modifications not expressly approved by the party responsible for compliance could void the user's authority to operate the equipment

**FCC Caution:**

- Any changes or modifications not expressly approved by the party responsible for compliance could void the user's authority to operate this equipment.
- This transmitter must not be co-located or operating in conjunction with any other antenna or transmitter.

**Radiation Exposure Statement:**

This device meets the government's requirements for exposure to radio waves.

This device is designed and manufactured not to exceed the emission limits for exposure to radio frequency (RF) energy set by the Federal Communications Commission of the U.S. Government.

The exposure standard for wireless device employs a unit of measurement known as the Specific Absorption Rate, or SAR. The SAR limit set by the FCC is 1.6W/kg. \*Tests for SAR are conducted using standard operating positions accepted by the FCC with the device transmitting at its highest certified power level in all tested frequency bands.

### ● Canada-spec. models

This device contains license-exempt transmitter(s)/receiver(s) that comply with Innovation, Science and Economic Development Canada's license-exempt RSS(s). Operation is subject to the following two conditions: (1) This device may not cause interference. (2) This device must accept any interference, including interference that may cause undesired operation of the device.

L'émetteur/récepteur exempt de licence contenu dans le présent appareil est conforme aux CNR d'Innovation, Sciences et Développement économique Canada applicables aux appareils radio exempts de licence. L'exploitation est autorisée aux deux conditions suivantes : (1) L'appareil ne doit pas produire de brouillage; (2) L'appareil doit accepter tout brouillage radioélectrique subi, même si le brouillage est susceptible d'en compromettre le fonctionnement.

This device and its antenna(s) must not be co-located or operating in conjunction with any other antenna or transmitter, except in accordance with FCC/ISED multi-transmitter product procedures.

Cet appareil et son antenne ne doivent pas être situés ou fonctionner en conjonction avec une autre antenne ou un autre émetteur, sauf conformément aux procédures de produits multi-émetteurs FCC/ISED.

### **Radiation Exposure Statement:**

This equipment complies with IC radiation exposure limits set forth for an uncontrolled environment. This equipment should be installed and operated with minimum distance 20cm between the radiator & your body. Additional testing and certification for SAR will be required if the distance limitation cannot be met.

### **Déclaration d'exposition aux radiations:**

Cet équipement est conforme aux limites d'exposition aux rayonnements IC établies pour un environnement non contrôlé.

Cet équipement doit être installé et utilisé avec un minimum de 20 cm de distance entre la source de rayonnement et votre corps. Des tests et une certification supplémentaires pour le SAR seront requis si la limitation de distance ne peut pas être respectée.





There is an illustrated index in this Owner's Manual. If you have difficulty finding your target items in the index, try to use the illustrated index.

Illustrated index .....	19
<b>A</b>	
Abbreviation .....	8
ABS (Anti-lock Brake System) .....	330
Warning light .....	170
Access key fob .....	117
Warning indicator .....	176
Accessories .....	503
Accessory power outlet .....	282
Adjustable storage net .....	298
Air cleaner element .....	480
Air conditioner	
Automatic climate control .....	257
Manual climate control .....	259
Air filtration system .....	265
Airflow mode .....	259
Alarm system .....	136
All-Wheel Drive warning light .....	174
Alloy wheel .....	494
Cleaning .....	462
Antenna	
Roof antenna .....	270
Anti-lock Brake System (ABS) .....	330
Arming the system .....	137
Armrest .....	52
Ashtray .....	290
Assist grip .....	291
AT OIL TEMP warning light .....	169
Audio	
Antenna .....	270
Set .....	270
Auto dimmer cancel function .....	161
Auto Start Stop system .....	348
Indicator light .....	182
No Activity Detected indicator light .....	182
OFF indicator light .....	181
Warning light .....	181
Auto Vehicle Hold function	
ON indicator light .....	173
Auto-dimming mirror/compass .....	229
Automatic Locking Retractor/Emergency Locking Retractor (ALR/ELR) .....	56
<b>B</b>	
Battery .....	500
Jump starting .....	443

Replacement (access key fob) .....	507
Replacement (remote engine start transmitter) .....	319
Replacement (remote keyless entry system) .....	131
Vehicle battery .....	500
Booster cushion .....	76
Booster seat .....	76
Bottle holder .....	281
Brake	
Assist .....	328
Disc .....	517
Disc brake pad wear warning indicators .....	329
Fluid .....	484, 516
Pad .....	486
Parking .....	339
Pedal .....	485
System .....	328
Tips .....	328
Brake system .....	328
Warning light .....	171
Braking .....	328
Tips .....	328
Breaking-in of new brake pads .....	485
BSW/RCTW .....	367
Approach indicator light/warning buzzer .....	370
OFF indicator .....	183, 373
Warning indicator .....	183, 373
Warning volume .....	372
Bulb	
Chart .....	518
Replacing .....	504
<b>C</b>	
Camera	
Front view camera .....	353
Rear view camera .....	362
Smart Rearview Mirror camera .....	239
Cargo area	
Light .....	275
Multi-use cargo cover .....	294
Tie-down hooks .....	297
Catalytic converter .....	407
Center console .....	279
Center console tray .....	279
Center information display (CID) .....	194
11.6-inch display models .....	197
Center tray .....	279
Changing	
Coolant .....	480
Flat tire .....	439

Oil and oil filter .....	477
Charge warning light .....	168
CHECK ENGINE warning light/Malfunction indicator light .....	166
Checking	
Coolant level .....	479
Fluid level (brake fluid) .....	484
Fluid level (washer fluid) .....	495
Oil level (engine oil) .....	476
Child restraint systems .....	67
Installation of a booster cushion .....	76
Installation of a booster seat .....	76
Installation with ALR/ELR seatbelt .....	72
Lower and top tether anchors .....	78
Child safety .....	10
Locks .....	139
Chime	
Light .....	212
Seatbelt .....	163
Cleaning	
Alloy wheels .....	462
Center information display .....	465
Interior .....	464
Ventilation grille .....	264
Climate control system .....	255
Automatic .....	257
Manual .....	259
Clock .....	210
Coat hook .....	292
Compass .....	228, 229
Continuously variable transmission (CVT) .....	321
Fluid .....	483, 516
Oil temperature warning light (AT OIL TEMP) .....	169
Coolant .....	479, 516
Changing .....	480
Temperature gauge .....	160
Temperature high warning light .....	167
Temperature low indicator light .....	167
Cooling system .....	478
Corrosion protection .....	463
Cup holder .....	280
Front passenger's .....	280
Rear passenger's .....	281
<b>D</b>	
Daytime running light system .....	218
Defogger .....	226
Defrosting .....	263
Deicer .....	226
Differential gear oil .....	483, 516

Dimensions .....	512
Disarming the alarm system .....	137
Disc brake pad wear warning indicators .....	329
Distraction Mitigation System .....	389
OFF indicator light .....	184
Operation indicator light .....	184
Temporary stop indicator light .....	184
Warning light .....	184
Dome light .....	274
Door	
Locks .....	132
Open indicator light .....	174
Double trip meter .....	159
Drainage reduction functions .....	157
Drive belts .....	482
DriverFocus .....	389
Driving	
All-Wheel Drive warning light .....	174
AWD models .....	410
Drinking .....	11
Drugs .....	11
Foreign countries .....	409
Off road .....	411
Pets .....	13
Snowy and icy roads .....	415
Tips .....	326, 406, 410
Tired or sleepy .....	12
Winter .....	414
<b>E</b>	
Electrical system .....	517
Electronic Brake Force Distribution (EBD) system .....	331
Warning .....	172
Electronic parking brake .....	339
Automatic release function by accelerator pedal .....	342
Indicator light .....	172
Warning .....	172, 342
Emergency Locking Retractor (ELR) .....	56
Engine .....	512
Compartment overview .....	475
Coolant .....	479, 516
Exhaust gas (carbon monoxide) .....	11, 407
Hood .....	473
Hood open warning light .....	174
Low oil level warning light .....	168
Oil .....	476, 513
Overheating .....	446
Starting & stopping .....	310
Event data recorder .....	16

Exterior care .....	460
<b>F</b>	
Flat tires .....	439
Floor mat .....	293
Fluid	
Brake .....	484
Continuously variable transmission (CVT) .....	483
Fluid level .....	516
Fog light .....	220
Indicator light .....	181
Switch .....	220
Folding mirror switch .....	247
Front	
Differential gear oil .....	483, 516
Passenger's frontal airbag ON and OFF indicators .....	166
Seatbelt pretensioners .....	64
Front seat heater .....	53
Front seats .....	37
Forward and backward adjustment .....	39
Head restraint adjustment .....	45
Manual seat .....	39
Power seat .....	40
Reclining .....	39
Fuel .....	304
Consumption indicator .....	191
Economy hints .....	406
Filler lid and cap .....	305
Gauge .....	159
Requirements .....	304, 512
Function settings .....	522
Fuses .....	502
<b>G</b>	
GAWR (Gross Axle Weight Rating) .....	419
Glove box .....	278
GVWR (Gross Vehicle Weight Rating) .....	419
<b>H</b>	
Hazard warning flasher .....	158, 436
Head restraint adjustment	
Front seat .....	45
Rear seat .....	50
Headlight	
Aim adjustment .....	506
Bulb replacement .....	504
Bulb wattage .....	518
Control switch .....	212

Flasher .....	215
Indicator light .....	181
OFF delay function .....	214
Warning light .....	181, 504
Welcome lighting function .....	214
High beam assist	
Function .....	215
Indicator light .....	181
High/low beam change (dimmer) .....	215
Hill descent control .....	337
Indicator light .....	183
HomeLink® .....	229, 235
Hook	
Cargo tie-down .....	297
Coat .....	292
Shopping bag .....	294
Towing and tie-down .....	447
Horn .....	250
Hose and connections .....	479

**I**

Icy road surface warning indicator .....	183
Illumination brightness control .....	161
Immobilizer .....	129
Indicator light (security indicator light) .....	180
Indicator light	
Auto Start Stop .....	182
Auto Start Stop No Activity Detected .....	182
Auto Start Stop OFF .....	181
Auto Vehicle Hold ON .....	173
BSW/RCTW OFF .....	183, 373
BSW/RCTW warning .....	183, 373
Coolant temperature low .....	167
Distraction Mitigation System OFF .....	184
Distraction Mitigation System operation .....	184
Distraction Mitigation System temporary stop .....	184, 398
Door open .....	174
Electronic parking brake .....	172
Front Cross Traffic Braking OFF .....	184
Front fog light .....	181
Front passenger's frontal airbag ON and OFF indicators .....	166
Headlight .....	181
High beam .....	181
High beam assist .....	215
Hill descent control .....	183
Immobilizer .....	180
Malfunction .....	166
Proximity Warning Detection OFF .....	184
RAB OFF .....	183

Security .....	180
Select lever/Gear position .....	180
Steering Responsive Headlight OFF .....	181
Turn signal .....	180
Vehicle detected in neighboring lane .....	182
Vehicle Dynamics Control OFF .....	176
Vehicle Dynamics Control operation .....	176
X-MODE .....	182
Inside mirror .....	228, 229, 235
Instrument cluster display .....	185
Interior lights .....	274
<b>J</b>	
Jack-up point .....	439
Jump starting .....	443
<b>K</b>	
Key	
Replacement .....	129
Keyless access entry function .....	120
Keyless access with push-button start system .....	117
Disabling keyless access functions .....	126
Locking and unlocking doors .....	120
Warning chimes and warning indicator .....	176
When access key fob does not operate properly .....	451
Keyless entry system .....	130
<b>L</b>	
Lap belt pretensioner .....	65
Leather seat materials .....	464
Light	
Backup .....	519
Cargo area .....	275, 519
Control switch .....	212
Daytime running .....	218, 519
Dome .....	274
Front fog .....	220, 519
Front turn .....	519
Map .....	274, 519
Rear combination .....	504
Rear gate .....	275, 519
Stop .....	519
Tail .....	519
Turn signal .....	221, 504, 519
Vanity mirror .....	277, 519
Loading your vehicle .....	418
Low tire pressure warning light .....	169
Lower and top tether anchor .....	78



<b>M</b>	
Maintenance	
Precautions .....	469
Schedule .....	469
Seatbelt .....	63
Tips .....	472
Tools .....	438
Malfunction indicator light (CHECK ENGINE warning light) .....	166
Manual	
Mode (continuously variable transmission) .....	325
Seat .....	39
Map light .....	274
Maximum load limits .....	427
Meters and gauges .....	158
Mirror defogger .....	226
Mirrors .....	228
Moonroof .....	149, 454
Multi-use cargo cover .....	294
<b>N</b>	
New vehicle break-in driving .....	406
<b>O</b>	
Odometer .....	158
Off road driving .....	411
Oil filter .....	477
Oil level	
Differential gear .....	483
Engine .....	476
Warning light .....	168
Oil pressure warning light .....	168
On-road and off-road driving .....	13
Outside	
Mirror defogger .....	226
Mirrors .....	245
Overhead console .....	278
Overheating engine .....	446
<b>P</b>	
Parking	
Brake .....	339
Tips .....	342
Passenger seatbelt reminder .....	163
Periodic inspections .....	408
Petrol fuel .....	304
PIN Code Access .....	122
Power	
Outlets .....	282

Outside mirrors.....	245
Rear gate.....	142
Rear gate button.....	144
Seat.....	40
Steering.....	327
Steering warning light.....	174
Precautions against vehicle modification.....	66, 112
Preparing to drive.....	309
Push-button	
Ignition switch.....	156
Starting and stopping engine.....	310
<b>R</b>	
RAB (Reverse Automatic Braking)	
OFF indicator.....	183
ON/OFF setting.....	386
Warning indicator.....	183, 387
RCTW.....	368
Rear	
Combination lights.....	504
Differential gear oil.....	483, 516
Gate.....	453
Gate light.....	275
Turn signal light.....	504
Rear seat.....	47
Armrest.....	52
Folding down.....	47
Head restraint adjustment.....	50
Heater.....	54
Reclining.....	50
Rear Seat Reminder.....	67
Rear view camera.....	362
Rear window	
Defogger.....	226
Wiper and washer switch.....	225
Wiper blade rubber.....	499
Recommended	
Brake fluid.....	516
Continuously variable transmission fluid.....	516
Differential gear oil.....	516
Engine oil.....	513
Spark plugs.....	517
Refueling.....	305
Remote engine start system.....	314
Remote keyless entry system.....	130
Replacement	
Brake pad and lining.....	485
Wiper blades.....	496

Replacing	
Access key fob battery .....	507
Air cleaner element .....	480
Battery (remote keyless entry system) .....	131
Battery of access key fob .....	507
Lost transmitters (remote keyless entry system) .....	132
Replacing bulbs .....	504
Headlight .....	504
Rear combination light .....	504
Rear turn signal light .....	504
Reverse Automatic Braking system .....	375
Rocking the vehicle .....	418
Roof rails .....	420
Roof tent .....	422

**S**

Safety	
Precautions when driving .....	9
Symbol .....	7
Warnings .....	7
Seat	
Fabric .....	464
Front .....	37
Front seat ventilation .....	54
Heater .....	53
Manual seat .....	39
Power .....	40
Rear .....	47
Seatbelt .....	9, 55
Fastening .....	57
Maintenance .....	63
Pretensioners .....	64
Safety tips .....	55
Warning light and chime .....	163
Security	
Alarm system .....	136
Immobilizer .....	129
Indicator light .....	180
Select lever	
Position indicator .....	180
Shift lock function .....	323
Shopping bag hook .....	294
Shoulder pretensioners .....	64
Smart Rearview Mirror .....	235
Snow tires .....	417, 486
Snowy and icy roads .....	415
Sounding a panic alarm .....	131
Spark plugs .....	482, 517
Specifications .....	512

Speedometer.....	158
SRS	
Curtain airbag .....	103
Frontal airbag.....	92
Side airbag .....	103
SRS airbag (Supplemental Restraint System airbag) .....	9, 83
SRS airbag system	
Monitors .....	110
Servicing .....	111
Warning light.....	165
Starting & stopping engine.....	310
State emission testing (U.S. only).....	308
Steering lock.....	313
Steering Responsive Headlight.....	219
OFF indicator light .....	181
Warning light.....	181
Steering wheel	
Heated Steering Wheel system .....	249
Lock.....	313
Power.....	327
Tilt/telescopic .....	249
Warning light.....	174
Stop light.....	504, 519
Storage compartment.....	278
Sun visors.....	276
Sunshade .....	151
Supplemental Restraint System airbag (SRS) .....	83
Synthetic leather upholstery .....	464
<b>T</b>	
Tachometer.....	158
Temperature gauge.....	160
Temperature warning light	
AT OIL TEMP .....	169
Coolant.....	167
Temporary spare tire .....	436
Tether (child restraint system) .....	78
Tie-down hooks .....	447
Tilt/telescopic steering wheel.....	249
Tire	
Chains.....	417
Information.....	526
Inspection .....	488
Pressures and wear .....	489
Replacement.....	493
Rotation.....	492
Size and pressure.....	517
Types .....	486

Tire pressure monitoring system (TPMS).....	338, 442, 487
Screen .....	339
Warning light.....	169
Tires and wheels .....	486
Tools .....	438
Top tether anchors.....	78
Towing.....	447
All wheels on the ground .....	450
Flat-bed truck.....	449
Hooks.....	447
Weight.....	427
Trailer	
Connecting .....	425
Hitch .....	424, 429
Towing.....	426
Towing tips.....	431
Trip meter.....	159
Turn signal	
Indicator lights .....	180
Lever.....	221

**U**

Under-floor storage compartment.....	298
USB power supply .....	283

**V**

Vanity mirror.....	277
Vehicle	
Capacity weight.....	419
Identification.....	521
Symbols .....	9
Vehicle Dynamics Control	
OFF indicator light .....	176
Operation indicator light.....	176
System.....	332
Warning light .....	175
Ventilator .....	254

**W**

Warning and indicator lights .....	162
Warning chimes	
Keyless access with push-button start system.....	176
Seatbelt.....	163
Warning indicator	
Icy road surface.....	183
RAB .....	183, 387
Warning light	
ABS .....	170

Access key .....	176
All-Wheel Drive.....	174
AT OIL TEMP .....	169
Auto Start Stop.....	181
Brake system .....	171
Charge .....	168
CHECK ENGINE .....	166
Coolant temperature high .....	167
Distraction Mitigation System .....	184
Engine hood open .....	174
Engine low oil level .....	168
Icy road surface.....	183
Keyless access with push-button start system.....	176
LED headlight .....	181
Low fuel.....	174
Low tire pressure.....	169
Oil pressure .....	168
Power steering .....	174
Seatbelt.....	163
SRS airbag system .....	165
Vehicle Dynamics Control .....	175
Windshield washer fluid .....	174
Warranties .....	6
Warranties and maintenance.....	426
Washing .....	460
Waxing and polishing .....	461
Wear indicators .....	491
Welcome lighting function .....	214
Wheel	
Alloy.....	494
Balance .....	490
Nut tightening torque.....	517
Replacement.....	493
Windows.....	139
Windshield	
Washer fluid.....	495
Wiper and washer switches .....	223
Wiper blades.....	497
Wiper deicer.....	226
Winter	
Driving.....	414
Tires.....	417, 486
Wiper and washer.....	221
Wiper deicer.....	226
<b>X</b>	
X-MODE.....	335
Indicator light.....	182



---

---

---

---

---

---

---

---

---

---

---

---

---

---

---

---

---

---

---

---



---

---

---

---

---

---

---

---

---

---

---

---

---

---

---

---

---

---

---

---

---

---

---

---

---

---

---

---

---

---

---

---

---

---

---

---

---

---

---

---

---

---

---

---

---

---

---

---

---

---

---

---

---

---

---

---

---

---

---

---

# GAS STATION REFERENCE

---

## FUEL

Use only **unleaded gasoline** with an octane rating of **87 AKI (90 RON) or higher**.

## FUEL OCTANE RATING

### AKI

This octane rating is the average of the Research Octane and Motor Octane numbers and is commonly referred to as the Anti Knock Index (AKI).

### RON

This octane rating is the Research Octane Number.

## LIMIT OF ETHANOL CONTENT

No more than 15%

## FUEL TANK CAPACITY

18.0 US gal (68 liters, 15.0 Imp gal)

## ENGINE OIL

Use only the following oils.

### 2.5 L non-turbo models:

- ILSAC (International Lubricant Specification Advisory Committee) GF-6B, which can be identified with the ILSAC certification mark (Shield mark)
- or ILSAC (International Lubricant Specification Advisory Committee) GF-6A, which can be identified with the ILSAC certification mark (Starburst mark)
- or API (American Petroleum Institute) classification SP with the words "RESOURCE CONSERVING"

### 2.4 L turbo models:

- ILSAC (International Lubricant Specification Advisory Committee) GF-6A, which can be identified with the ILSAC certification mark (Starburst mark)
- or API (American Petroleum Institute) classification SP with the words "RESOURCE CONSERVING"

For the complete viscosity requirements, refer to "Engine Oil" [P513](#).

## ENGINE OIL CAPACITY

2.5 L non-turbo models: 4.7 US qt (4.4 liters, 3.9 Imp qt)

2.4 L turbo models: 4.8 US qt (4.5 liters, 4.0 Imp qt)

The indicated oil quantity is only a guideline and is estimated based on a case when the engine oil is changed with an oil filter. Check the oil level using an oil level gauge after refilling the engine with oil. For more details about maintenance and service, refer to "Engine Oil" [P476](#).

## COLD TIRE PRESSURE

Refer to "Tires" [P517](#).