



***Levante***

Owner's manual





**WARNING:**

Operating, servicing and maintaining a passenger vehicle or off-highway motor vehicle can expose you to chemicals including engine exhaust, carbon monoxide, phthalates, and lead, which are known to the State of California to cause cancer and birth defects or other reproductive harm. To minimize exposure, avoid breathing exhaust, do not idle the engine except as necessary, service your vehicle in a well-ventilated area and wear gloves or wash your hands frequently when servicing your vehicle. For more information go to: <http://www.P65Warnings.ca.gov/passenger-vehicle>"[www.P65Warnings.ca.gov/passenger-vehicle](http://www.P65Warnings.ca.gov/passenger-vehicle).



Dear Customer,

thank you for choosing a Maserati.

This vehicle represents the result of Maserati's great experience in the design and production of sports, touring and racing vehicles.

The purpose of this manual and of the other documents in the two on-board documentation kits is to provide you with an understanding of the equipment, systems and controls of the vehicle and to explain how they work.

The description of all the on-board safety systems and devices and the car's technical data are given in the main guide.

Before driving your vehicle for the first time, we suggest reading this manual carefully in order to quickly acquaint with commands and functions of your vehicle.

In a dedicated section of this manual you will also find instructions for basic maintenance procedures, in order to ensure steady levels of performance, quality and safe driving.

In addition, keep in mind that proper maintenance is an essential factor to help preserve the value of the vehicle over time and protect the environment.

For "Scheduled Maintenance" or any other operation, contact your **Authorized Maserati Dealer**: you can trust our trained technical staff, who is constantly updated and provided with the required equipment in order to ensure that all service operations are performed properly and reliably.

All the documents contained in on-board documentation kits are integral part of the vehicle and should always be kept on board.

All documentation is also available at <https://ownerdocumentation.maserati.com>.



<b>Introduction</b>	<b>1</b>
<b>Understanding the Vehicle</b>	<b>2</b>
<b>Before Starting</b>	<b>3</b>
<b>Dashboard Instruments and Controls</b>	<b>4</b>
<b>Starting and Driving</b>	<b>5</b>
<b>Driver Assistance Systems</b>	<b>6</b>
<b>In an Emergency</b>	<b>7</b>
<b>Maintenance and Care</b>	<b>8</b>
<b>Index</b>	<b>9</b>





## 1 - Introduction

On-board Documentation Kits .....	6
Updating .....	6
Owner's Information Online .....	7
Consulting the Manual .....	7
Abbreviations .....	8



## On-board Documentation Kits

---

On board there are various documents to provide the User with all the necessary information regarding the manufacturer's warranty, assistance requests and to know all the devices supplied with the car and their functions, in order to be able to operate the vehicle using all of its potential.

These documents are contained in two kits, one placed in the dashboard glove box and the other inside the luggage compartment.

The kit inside the dashboard glove box contains the Warranty Card and Owner's Main Guide.

The kit inside the luggage compartment, in addition to this Owner's Manual, also contains the Maserati Intelligent Assistant (MIA) information booklet and Regulatory Information.

Depending on the equipment chosen, the market, etc., the kits may contain other additional documents.

### **NOTE:**

**After reviewing the manual, always put the document in its case to avoid losing it.**

All specifications and illustrations contained in these documents refer to the manual publishing date.

Updated versions of the on-board documentation and the "Regulatory Information" are always available and can be consulted by accessing the website <https://ownerdocumentation.maserati.com>.

In case of loss, excluding the Warranty Card, it is possible to purchase a copy of these documents by requesting it from your **Authorized Maserati Dealer**.

## Updating

---

Constant improvements are being performed to maintain this vehicle's high level of quality. Therefore, there may be differences between this manual and your vehicle.

Maserati reserves the right to carry out design and functional changes and to provide updates or improvements.

This manual illustrates and describes all versions of the current vehicle model. Therefore, some of the equipment and accessories in this publication may not appear on your vehicle; please only consider the information related to your vehicle.

All specifications and illustrations contained in this manual are as of the Manual publishing date.

### **NOTE:**

**The updated version of the on-board documentation can be consulted by accessing the website <https://ownerdocumentation.maserati.com>.**





## Owner's Information Online

All of the on-board documents can also be consulted online in PDF format by accessing the website <https://ownerdocumentation.maserati.com>. The website is available for most markets.

The online documents may be more up to date than those supplied with the car. By accessing the website [www.maserati.com](http://www.maserati.com) it is possible to watch videos and find other useful information regarding your Maserati and all available services.

## Consulting the Manual

This manual illustrates maintenance and use information related to 3.8 V8 and 3.0 V6 motorization models. If not otherwise specified, the information is valid for all models.

For an easy identification of the topics, this Manual is divided into sections and chapters: each chapter can have more paragraphs.

### Meaning of Warning and Note Symbols

Within the text, important warnings and notes are also easily identifiable through icons.



#### **WARNING!**

**Describe operating procedures that could result in a collision, bodily injury and/or death.**



#### **ENVIRONMENTAL!**

**This note indicates the correct behavior when using the vehicle to protect the environment.**



#### **CAUTION!**

**Describe procedures that could result in damage to your vehicle.**

#### **NOTE:**

**Additional information regarding the subject and/or the operation described.**



In addition to these, this symbol in the text indicates a reference to the Owner's Main Guide.

### Optional Equipment and Versions/Markets Validity



In addition to the standard equipment, this manual also describes optional parts and accessories which are identified in the title and /or text by this symbol alongside in brackets.



Optional equipment and also some functions or systems are not available in all vehicle versions and may only be available in certain markets. In these cases, the equipment or the function/system will be identified in the title and/or text by this symbol alongside in brackets.

### Other General Indications

- In the images the vehicle is represented in the base version. On other versions, some part or equipment may differ from those shown in the images.



## Introduction

- “Left” and “right” in this manual, always refer to the driving direction.
- All indications and images in this manual refer to a vehicle with left-hand drive. On right-hand drive vehicles, some controls are ordered differently than shown in the illustrations.
- If not otherwise specified, the instrument cluster shown in the images is the version with the speedometer in MPH of the 3.0 V6 motorization model – however the indications given are also valid for the version in km/h and for all the other motorization models.

## Abbreviations

---

Some descriptions and terms with particular meanings are found in this manual in abbreviated form.

<b>A/C</b>	Air-Conditioning system.	<b>DRL</b>	Daytime Running Lights.
<b>ABA</b>	Advanced Brake Assist.	<b>EBD</b>	Electronic Brake-force Distribution.
<b>ABS</b>	Anti-Lock Braking System.	<b>ECU</b>	Electronic Control Unit.
<b>ABSA</b>	Active Blind Spot Assist.	<b>EDR</b>	Event Data Recorder.
<b>ACC</b>	Adaptive Cruise Control.	<b>EPB</b>	Electric Parking Brake.
<b>ADA</b>	Active Driving Assist.	<b>EPS</b>	Electric Power Steering.
<b>ADAS</b>	Advanced Driver Assistance Systems.	<b>ESC</b>	Electronic Stability Control.
<b>AEB</b>	Autonomous Emergency Braking	<b>ETC</b>	Electronic Throttle Control.
<b>AFS</b>	Advanced Frontlighting System.	<b>FCW</b>	Forward Collision Warning.
<b>ALR</b>	Automatic Locking Retractor.	<b>HBA</b>	Hydraulic Brake Assistance.
<b>AQS</b>	Air Quality Sensor.	<b>HDC</b>	Hill Descent Control.
<b>ATC</b>	Automatic Temperature Control.	<b>HSA</b>	Hill Start Assist.
<b>AWD</b>	All-Wheel Drive.	<b>I.C.E.</b>	Increased Control and Efficiency.
<b>BAS</b>	Brake Assist System.	<b>LATCH</b>	Lower Anchors and Tether for CHildren.
<b>BSA</b>	Blind Spot Assist.	<b>LDW</b>	Lane Departure Warning (Lane-Sense).
<b>BTO</b>	Brake Throttle Override.	<b>LKA</b>	Lane Keeping Assist.
<b>CAN</b>	Controller Area Network.	<b>MIL</b>	Malfunction Indicator Light.
<b>CC</b>	Cruise Control.	<b>MIA</b>	Maserati Intelligent Assistant.
<b>CRS</b>	Child Restraint Systems.	<b>OBD</b>	On-Board Diagnostics.
		<b>ORC</b>	Occupant Restraint Controller.
		<b>ORS</b>	Occupants Restraint Systems.
		<b>PEB</b>	Pedestrian Emergency Braking.
		<b>RAB</b>	Ready Alert Braking.



<b>RCP</b>	Rear Cross Path.
<b>RKE</b>	Remote Keyless Entry.
<b>ROM</b>	Roll-Over Mitigation.
<b>SAB</b>	Side Air Bag.
<b>SABIC</b>	Supplemental Side Air Bag Inflatable Curtains.
<b>SBR</b>	Seat Belt Reminder.
<b>SRS</b>	Supplemental Restraint Sys- tem.
<b>TCS</b>	Traction Control System.
<b>TFT</b>	Thin Film Transistor.
<b>TPMS</b>	Tire Pressure Monitoring Sys- tem.
<b>TSA</b>	Traffic Sign Assist.
<b>TSM</b>	Trailer Sway Mitigation.
<b>VIN</b>	Vehicle Identification Number.





## 2 - Understanding the Vehicle

Main Controls Overview .....	12
Front Power Seats .....	14
Memorize the Driver's Seat Position .....	17
Rear Seats .....	19
Steering Wheel Adjustment .....	21
Adjustable Pedals (OPT) .....	23
Rearview Mirrors .....	23
External Lighting .....	26
Interior Lighting .....	32
Internal Equipment .....	35
Audio System .....	41
Cargo Area .....	43
Front to Back Roof Rails (FR) .....	50
HomeLink® (HL) .....	51
Air Conditioning Distribution .....	55



# Main Controls Overview

## On Dashboard

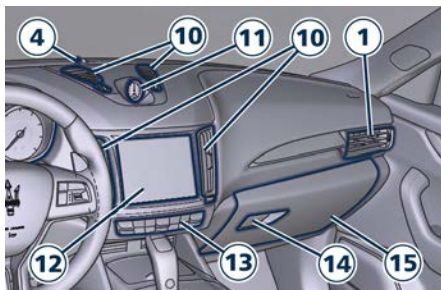
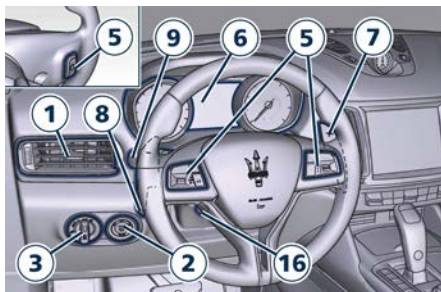

- 1 Adjustable side air outlets (page 57)
- 2 Engine **START/STOP** button (page 60) and (page 154)
- 3 Light switch (page 127)
- 4 Vehicle security alarm light (  : chapter "Vehicle Security Alarm" in section "Safety")
- 5 Steering wheel controls (page 123)
- 6 Instrument cluster (page 86)

- 7 Right shift paddle + (page 167)
- 8 Left shift paddle - (page 167)
- 9 Multifunction lever (windshield wipers, headlight washer and headlight selection, turn signals) (page 132)
- 10 Adjustable central air outlets (page 57)
- 11 Analogue clock (page 137)
- 12 MIA display (page 109)
- 13 Climate controls (page 141)
- 14 Dashboard glove box handle (page 137)
- 15 Dashboard storage compartment with two USB ports for charging of connected source (page 35)
- 16 Steering wheel adjustment control (page 21)

## On Central Console

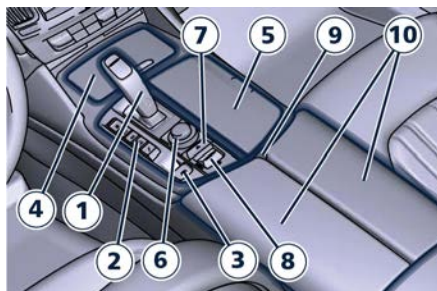

Central Console Front Part

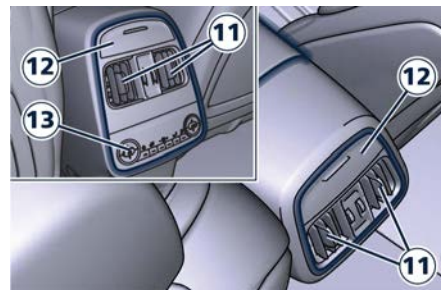

Central Console Rear Part

- 1 Automatic transmission shift lever (page 161)
- 2 Drive mode switches (page 171)
- 3 Electric Parking Brake lever (page 191)
- 4 Cover for compartment with AUX, USB and SD memory card port (page 37)
- 5 Cover for cup holder and cigarette lighter/power socket compartment (page 36)
- 6 Rotary selectors and buttons for the multimedia navigation (page 109)
- 7 Hazard lights switch (page 259)
- 8 Drive height selector (page 183)
- 9 Unlock button for central console compartment with cup holder and power outlet (page 36)
- 10 Central console covers with armrest function (page 36)
- 11 Adjustable air outlets (page 57)



- 12 Cover for power outlet and USB slots compartment (page 36)
- 13 Four-zone climate controls for rear passengers (DPT) (page 148)

### On Front Dome Console

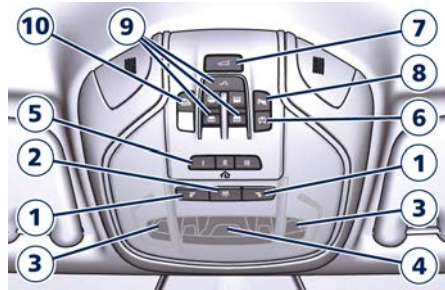

- 1 Reading lights control button (page 32)
- 2 Central light control button (page 32)
- 3 Reading lights (page 32)
- 4 Central light (page 32)
- 5 HomeLink controls (📶) (page 51)
- 6 Button to switch off passenger compartment lights (page 33)
- 7 Button to open fully/partially the power liftgate (page 79)
- 8 Button to enable/disable front sensors of the Park Assist system (page 214)
- 9 Sunroof controls (📶) (page 76)

- 10 Button to activate the SOS call (DPT) (page 261)

### On Front Doors

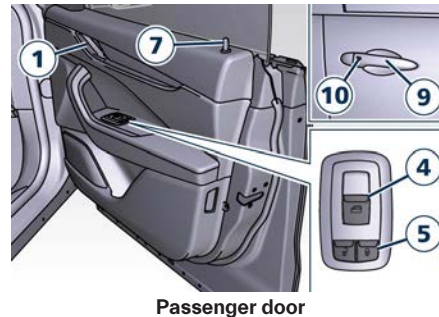
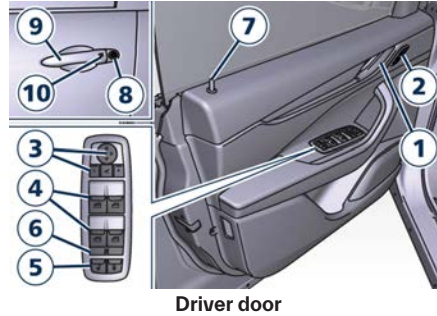

- 1 Internal door handle (📶: chapter “Doors Security Locking” of section “Safety”)
- 2 Driver’s seat, steering wheel, adjustable pedals and rear mirrors memory switch (page 17)

- 3 External rear view mirrors switches (page 23)
- 4 Power window switches (page 71)
- 5 Power door lock/unlock switches (📶: chapter “Doors Security Locking” of section “Safety”)
- 6 Rear windows and sunshade lockout button (page 73)
- 7 Internal door lock/unlock knob (📶: chapter “Doors Security Locking” of section “Safety”)
- 8 Door outboard opening lock (page 60)
- 9 External door handle (page 70)
- 10 Door lock button with “Passive Entry” function (page 68)



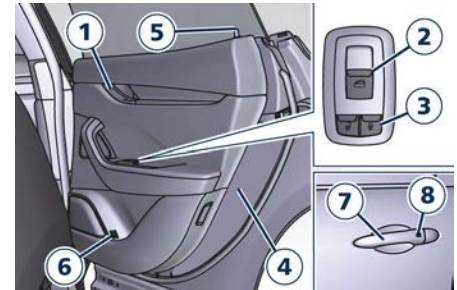

### On Rear Doors



- 1 Internal rear door handle (📶: chapter “Doors Security Locking” of section “Safety”)
- 2 Power window and sunshade (DPT) switch (page 73)



## Understanding the Vehicle

- 3 Power doors lock/unlock buttons (  : chapter “Doors Security Locking” of section “Safety”)
- 4 “Child protection” door lock system (  : chapter “Doors Security Locking” of section “Safety”)
- 5 Internal door lock/unlock knob (  : chapter “Doors Security Locking” of section “Safety”)
- 6 Heated switch for right rear seat (  ). The heated switch for the left rear seat is on the left rear door (page 20)
- 7 External door handle (page 68)
- 8 Door lock button with “Passive Entry” function (page 68)

## Front Power Seats

Seats, head restraints and seat belts are part of the Occupant Restraint System (ORS) of the vehicle. For further information,  : chapter “Occupant Restraint System (ORS)” and “Head Restraints” in section “Safety”.



### WARNING!

**Be sure everyone in your vehicle is in a seat and using a seat belt properly.**

Depending on the different markets and versions, the front seats may have different controls for adjustment and optional functions. The configurations shown below may differ from the ones in your vehicle.

### Front Power Seat Controls

The power seats switches are located on the outboard side of the seat cushion. Use the front switch **1** to move the seat up or down, forward or rearward or to recline the seat cushion. Use the switch **2** to recline the seatback. Use the rear switch **3** to adjust the lumbar support.

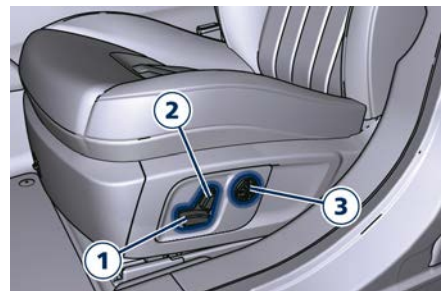

### Seat Forward/Rearward Adjustment

The seat can be adjusted both forward and rearward.

Push the seat switch **1** forward or rearward, the seat will move in the direction of the switch.

Release the switch **1** when the desired position is reached.

### Seat Up/Down Adjustment

The height of the seat can be adjusted up- or downward.





Grip switch **1** from the back side and push it down or up.  
Release the switch **1** when the desired position is reached.

**CAUTION!**

If the seat's movement does not work, make sure that the corresponding fuse is not tripped (see chapter "If a Fuse Blows" in section "In an Emergency").

**Seat Tilt Control (Up/Down)**

The angle of the seat cushion can be adjusted in four directions.  
Pull upward or push the front of the switch **1**, to move the front cushion seat in the direction of the switch.  
Release the switch **1** when the desired position is reached.

**Seat Back Tilt Control**

The angle of the seatback can be adjusted forward or rearward.  
Push the seatback switch **2** forward or rearward, the upper seatback will move in the direction of the switch.  
Release the switch **2** when the desired position is reached.

**Power Lumbar**

Push the switch **3** forward or rearward to increase or decrease the lumbar support.  
Push the switch **3** upward or downward to raise or lower the lumbar support.

**WARNING!**

- **Never adjust the seat while driving. You could lose control of the vehicle. Moving the seat could distract you or make you press a pedal unintentionally.**
- **Seats should be adjusted before fastening the seat belts and while the vehicle is parked.**
- **Do not ride with the seatback reclined so that the shoulder belt is no longer resting against your chest. In a collision you could slide under the seat belt, which could result in serious injury or death.**

**CAUTION!**

Do not place any object under a power seat or obstruct its movement as it may cause damage to the seat controls. Seat movement may become limited if there is an obstruction in the way.

**Front Heated Seats**

The front seats can be equipped with heaters in both seat cushions and seatbacks.  
The front seats heating is operated by the MIA system.

The seat comfort icons are in the upper status bar in any MIA screen configuration.

Touch the heated/vented seat icon near the temperature value to open the pop up that will allow you to activate and set the function on the driver's seat and/or on the passenger seat.



To activate and set the heating/ventilation functions of the front seats and the heating of the steering wheel (if available), in addition to what is indicated, it is possible to access the "Seats and Wheel" submenu of the "Comfort" page in which there are the seats and wheel icon.



### WARNING!

- **Persons with low skin sensitivity because of advanced age, chronic illness, diabetes, spinal cord injury, medication, alcohol use, exhaustion or other physical conditions must be careful when using the seat heater. It may cause irritation even at low temperatures, especially if used for long periods of time.**
- **Do not place anything on the seat that insulates against heat, such as a blanket or cushion. This may cause the seat heater to overheat.**

### Front Seats Heat Function

#### NOTE:

The engine must be running for the heated seats to operate.

If the function is not active (state "OFF"), the dynamic parts of the icon are grey:

to activate the function operate in the following mode:

- Starting from the state "OFF", within 15 seconds touch the driver or passenger seat soft-key once to select HI-level heating displayed by the seat icon with 2 arrows and 2 red lines.
- Within 15 seconds, touch the driver or passenger seat soft-key a second time to select LO-level heating displayed by the seat icon with 1 arrow and 1 red line.
- Within 15 seconds, touch the same soft-key a third time to shut off the seat heating.

#### NOTE:

Once a heat setting is selected, heat will be felt within 2 to 5 minutes.

When the HI-level setting is selected, the heater will provide a boosted heat level during the first 4 minutes of operation. Then, the heat output will drop to the normal HI-level.

If the HI-level setting is selected, the system will automatically switch to LO-level after a maximum of 60 minutes of continuous operation.

At that time, the display will indicate the change from HI to LO.

The LO-level setting will turn in "OFF" state automatically after a maximum of approximately 45 minutes.

### Front Ventilated Seats (🌀)

To enhance occupants comfort by high external temperatures, both the driver and passenger seats, on request, can be ventilated.

Small fans are located in the seat cushion and seatback, they draw air from the seat surface through fine perforations in the seat cover to help keep the driver and front passenger cooler when the temperature is high.

The ventilated seats are operated with the MIA system.

The seat comfort icons are in the upper status bar in any MIA screen configuration or are accessible in the "Seats and Wheel" submenu of the "Comfort" page as indicated for heated seats.

Touch the heated/vented seat icon near the temperature value to open the pop up that will allow you to activate and set the function on the driver's seat and/or on the passenger seat.



### Front Ventilated Seats Function

#### NOTE:

The engine must be running for the ventilated seats to operate.

If the function is not active (state "OFF"), the dynamic parts of the icon are grey: to activate the function operate in the following mode:

- Starting from the state "OFF", within 15 seconds touch the driver or passenger seat soft-key once to select HI-level ventilation displayed by the seat icon with the fan and two blue lines.
- Within 15 seconds, touch the driver or passenger seat soft-key a second time to select LO-level ventilation displayed by the seat icon with the fan and 1 blue line.
- Within 15 seconds, touch the same soft-key a third time to shut off the seat ventilation.

## Memorize the Driver's Seat Position

This function allows the driver to store up to two different memory profiles for easy recall through a memory switch. Each memory profile contains desired position settings for the driver seat, external side mirrors, adjustable pedals (OPT), power tilt and telescopic steering column and a set of programmed radio stations.

Your key fob can also be set to recall the same positions by pressing the  button.

#### NOTE:

- Only one key fob can be linked to each of the memory positions.
- "Passive Entry" door handles cannot be linked to the memory function. Use either the memory recall switch or the key fob (if linked to the memory function) to recall memory positions 1 or 2.

The memory seat switch is located on the driver's door trim panel. The switch consists of three buttons:

- The "S" (SET) button, which is used to activate the memory save function.
- The "1" and "2" buttons which are used to recall either of two programmed memory profiles.

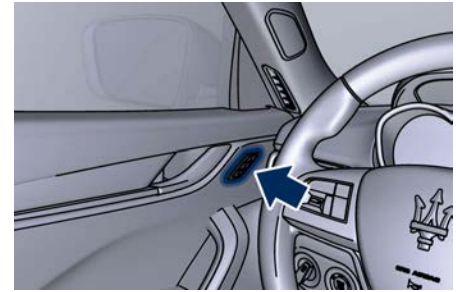

### Memory Profiles Setting

#### NOTE:

Saving a new memory profile will erase an existing profile from memory.

To create a new memory profile, perform the following:

- Cycle the ignition device to the **ACC** or **RUN** position.
- Adjust all memory profile settings to desired preferences (i.e., seat, side mirrors, adjustable pedals (OPT), power tilt and telescopic steering column, and radio station presets).
- Press and release the "S" button on the memory switch.
- Within 5 seconds, press and release the memory button "1" or "2".
- Check on the instrument cluster for the positive response of the actions "Memory 1 (or 2) profile set".

After these steps, the profile set will be memorized in the selected position.



### NOTE:

Memory profiles can be set without the vehicle in P (Park), but the vehicle must be in P (Park) to recall a memory profile.

### Pairing Remote Keyless Entry Transmitter to Seats Memory



Your key fob can be programmed to recall one of two programmed memory profiles by pressing the  button on the key fob.

### NOTE:

This function can be enabled or disabled using the MIA system, refer to “Functions of Setting Menu on MIA” in section “Dashboard Instruments and Controls” for further information.

To program your key fobs, perform the following actions:

- Cycle the ignition device to the **RUN** position.
- Move the seat and/or the other adjustable devices in the position that you wish to memorize, or recall a previously memorized profile, pressing the corresponding memory button “1” or “2”.
- Cycle the ignition device to the **OFF** position.
- Press and release the “S” button.
- Within 5 seconds, press and release the memory button “1” or “2”.

- Press and release the  button on key fob.
- Within 3 seconds, press and release the  button on the key fob.

To check if the system has memorized the correct profile, you can move the seat and press the  button: the seat will move to the memorized position.

### NOTE:

Your key fobs can be unlinked to your memory settings by pressing the “S” button followed by the  button on the key fob.

### Memory Position Recall

### NOTE:

The vehicle must be in P (Park) to recall memory positions. If a recall is attempted when the vehicle is not in P (Park), a message will display in the instrument cluster.

To recall the memory settings for driver, press memory button number “1” or “2” on the driver's door trim panel or the  button on the key fob linked to memory position “1” or “2” with ignition device in the **RUN** position.

A recall can be canceled by pressing any of the buttons (“S”, “1”, or “2”) during a recall. When a recall is canceled, the driver seat, external side mirrors, adjustable pedals () , and power tilt

and telescopic steering column stop moving.

A delay of at least one second will occur before selecting a new recall.

### Easy Entry/Exit Driver Seat

This function provides automatic driver seat positioning to enhance driver mobility when entering and exiting the vehicle.

The distance the driver seat moves depends on where you have the driver seat positioned when you place the ignition device to the **OFF** position.

- When you cycle the ignition device to the **OFF** position the driver seat:
  - will move about 2.36 in (60 mm) rearward if the driver seat position is greater than or equal to ca. 5.51 in (140 mm) forward of the rear stop;
  - will move to a position of ca. 3.15 in (80 mm) rearward of the rear stop if the driver seat position is between 5.51 in (140 mm) and 3.15 in (80 mm) forward of the rear stop.
- The seat will return to its previously set position when you place the ignition device into the **ACC** or **RUN** position.
- The easy entry/exit function is disabled when the driver seat position is less than 3.15 in (80 mm) forward of the rear stop. In this position, there would be no benefit to the driver by moving the seat for easy exit or easy entry.

Each stored memory setting will have an associated easy entry/exit position.

**NOTE:**

The "Easy Entry/Exit" function can be enabled or disabled using the MIA system, refer to "Functions of Settings Menu on MIA" in section "Dashboard Instruments and Controls" for further information.

## Rear Seats

Rear seats can fit three passengers. Seats, head restraints and seat belts are parts of the occupant restraint system of the vehicle.

For further information, : chapter "Occupants Restraint Systems (ORS)" and "Head Restraints" in section "Safety".



**WARNING!**

**Be sure everyone in your vehicle is in a seat and using a seat belt properly.**

### Rear Seat Folding Seatback

The 60/40 split-folding seatback of the rear seat provides for a recliner function with three available fixed positions that can be set using the lever on seat external side. The LH lever tilts the long part (60), while the RH lever tilts the shorter one (40).

The less tilted position (90°) is the one most suitable when a child seat must be installed; the other positions tilt the seatback toward the liftgate up to 23°. To tilt the seatback, lift the lever from its rest position **0** to position **1** while pushing the seatback to the back until reaching the required position. When releasing the lever, the fixed positions

will be acknowledged by lever control cable clicking in place to lock. Ensure that seatback is fastened to the position by trying to move it back and forth. Lever control cable locks also when fully folding the seatback down on the seat.

To move the seatback in another position, lift the lever to position **1** and hold it up until bringing seatback to the new fixed position, which is acknowledged by the cable locking in place when releasing the lever.

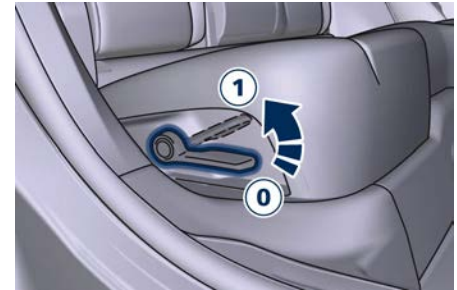

**WARNING!**

- **Ensure the seatback is always locked in one of the fixed positions before fastening the rear seat belts. An unlocked seatback cannot ensure the necessary stability for passengers and/or for child seats. An unlocked**



## Understanding the Vehicle

2

**seatback could cause severe injuries in case of accident.**

- **When fastening a child seat on external rear seats, ensure that the corresponding seatback is in the full upright position.**
- **Always check that the head restraint of the rear seats that must be occupied by a passenger is correctly adjusted (  : chapter “Head Restraints” in section “Safety”. ).**

### NOTE:

Rear seat backrest can be fully folded to increase luggage space. See “Cargo Area” in this section for further details.

### Rear Armrest

The rear armrest is mobile and can be folded up into the seatback.

- To lower it, pull the stripe as indicated.



- To close it, pull it upwards then push it back into its seat.

On the front part of the armrest there are two cupholders (see “Internal Equipment” in this section).



### CAUTION!

The armrest is not designed to support the weight of an adult or a child: please use it only to store beverages or small objects.

### NOTE:

Seatback panel behind armrest features an opening allowing you to carry long objects or ski bags with no need to fold the seatback. See “Cargo Area” in this section for further details.

### Rear Side Heated Seats

The side rear seats can be equipped with heaters both in seat cushion and seatback.

Rear seats heating can be adjusted by operating control devices on the trim panel of each rear door.



### WARNING!

- **Persons with low skin sensitivity because of advanced age, chronic illness, diabetes, spinal cord injury, medication, alcohol use, exhaustion or other physical conditions must be careful when using the seat heater.**

**It may cause irritation even at low temperatures, especially if used for long periods of time.**

- **Do not place anything on the seat that insulates against heat, such as a blanket or cushion. This may cause the seat heater to overheat. Sitting in a seat that has been overheated could cause irritation due to the increased surface temperature of the seat.**

The switch on the trim panel with the resistance icon activates the heating on the corresponding seat.

- Push the switch once to select the highest heating level. The two upper LEDs on the switch will illuminate.
- Push the same switch a second time to select the lowest level. Only one LED will illuminate.
- Push the same switch a third time to shut the heating elements off. The LED will turn off.



**NOTE:**

- Once a heat setting is selected, heat will be felt within two to five minutes.
- The engine must be running for the heated seats to operate.

By selecting the HI-level setting, the heater will provide a boosted heat level during the first four minutes of operation. Then, the heat output will drop to the normal HI-level.

By setting the HI-level, the system will automatically switch to LO-level after a maximum of 60 minutes of continuous operation. The LO-level setting will turn off automatically after a maximum of approximately 45 minutes.

## Steering Wheel Adjustment

This function allows you to tilt the steering column upward or downward or to lengthen or shorten it in order to adjust the steering wheel to an optimized position.

### Power Adjustment

The power tilt/telescoping steering column/wheel switch is located on the lower left side of the steering column. To adjust the tilt of the steering column/wheel, move the switch up or down as desired.



To lengthen or shorten the steering column/wheel, pull the switch toward you or push the switch away from you as desired.

**NOTE:**

You can use your key fob or the memory buttons on the driver's door trim panel

to return the tilt/telescopic steering column/wheel to programmed positions. See “Memorize the Driver's Seat Position” in this section.

**WARNING!**

**Do not adjust the steering column/wheel while driving. Adjusting the steering column/wheel while driving could cause the driver to lose control of the vehicle. Be sure the steering column/wheel is adjusted before driving your vehicle. Failure to follow this warning may result in serious injury or death.**

### Heated Steering Wheel

The steering wheel may contain a heating element inside the rim that helps warm driver's hands by cold weather. The heated steering wheel has only one temperature setting. Once turned on, this function will operate for approximately 58 to 70 minutes before automatically shutting off.

The heated steering wheel can shut off early or may not turn on when the steering wheel is already warm. The heated steering wheel can be turned on and off using the MIA system.



## Understanding the Vehicle

The heated steering wheel icon is in the upper status bar in any MIA screen configuration.

Touch the steering wheel icon near the temperature value of driver's side to open the pop up that will allow you to activate the heating function.



To activate the heating function, in addition to what is indicated, it is possible to access the "Seats and Wheel" submenu of the "Comfort" page in which there is the wheel icon.



### NOTE:

The engine must be running for the heated steering wheel to operate.

If the function is not active (state "OFF"), the dynamic parts of the icon are grey: to activate the function operate in the following mode:

- Within 15 seconds, touch the heated steering wheel soft-key to turn on the function displayed by the steering wheel icon with the arrows and red line.
- Within 15 seconds, touch the heated steering wheel soft-key a second time to shut off the function: the dynamic parts of the icon turns grey.



### WARNING!

- **Persons with low skin sensitivity because of advanced age, chronic illness, diabetes, spinal cord injury, medication, alcohol use, exhaustion or other physical conditions must be careful when using the seat heater. It may cause irritation even at low temperatures, especially if used for long periods of time.**
- **Do not place anything on the steering wheel that insulates against heat, such as a blanket or steering wheel covers of any type and material. This may**

**cause the steering wheel heater to overheat.**





## Adjustable Pedals (OPT)

The adjustable pedals system is designed to allow greater range of pedals positions enabling driver comfort with regard to the steering wheel tilt and the seat position.

This function allows the brake and accelerator pedals to move toward or away from the driver's feet.

The switch is located on the front side of the driver's seat cushion shield.



Press the switch downward to move the pedals forward (toward the front of the vehicle).

Lift the switch upward to move the pedals rearward (toward the driver).



### WARNING!

**Do not adjust the pedals position while the vehicle is moving. You could lose control and have an accident. Always adjust the pedals position while the vehicle is parked.**

The following messages will be displayed if the driver is attempting to adjust the pedals when the system is locked out:

- “Adjustable Pedals Unavailable While Reversing”;
- or “Adjustable Pedals Unavailable While Cruise Engaged”.

### NOTE:

For vehicles equipped with driver memory seat, use your key fob or the memory buttons on the driver's door trim panel to return the adjustable pedals to programmed positions. See “Memorize the Driver's Seat Position” in this section for further information.



### WARNING!

**Do not place any object under the adjustable pedals or obstruct their movements as it may cause damage to the pedal controls. Pedal movement may become limited if there is an obstruction in the adjustable pedals.**

## Rearview Mirrors

### External Mirrors

External mirrors can be adjusted electrically and are equipped with anti-mist resistors operated by the air conditioning system (see “Air Conditioning Controls” in section “Dashboard Instruments and Controls”). The mirrors can be closed electrically and will yield in both directions in case of a collision.

The external mirrors are electrochromic, which means, they automatically operate an anti-glare function by gradually shading as the light hitting the mirrors increases.

The external rear-view electrochromic mirrors work in conjunction with the internal rear-view electrochromic mirror.

### NOTE:

- The mirrors can be adjusted electrically only with the ignition device in **ACC** and **RUN** position.
- When the vehicle is started, the indicator light shown in the picture will momentarily illuminate in both outside rear-view mirrors to let the driver know that the Blind Spot Assist (BSA) system (BSA) is operational. For more details see chapter “Blind Spot Assist - BSA” or

(Continued)



(Continued)

"Active Blind Spot Assist - ABSA" in section "Driver Assistance Systems".



The external of the rear-view mirror support is equipped with LEDs, lighting up when the turn signals and vehicle entry/exit lights are activated.

When the surround view camera system is installed, at the external bottom side of the rear-view mirror is the side view camera (refer to "Surround View Camera System" in section "Driver Assistance Systems").

### Mirrors Positioning

The power mirror controls are located on the driver's door trim panel. The power mirror controls consist of mirror select buttons and a four-way mirror control switch.

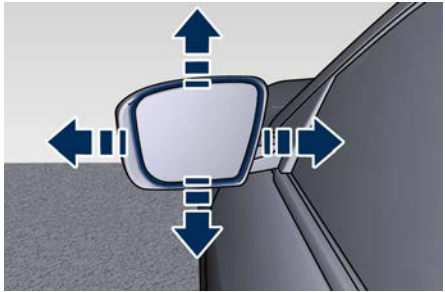
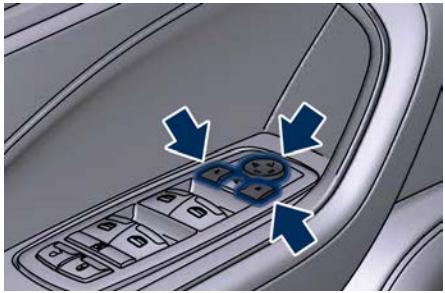

To adjust a rearview mirror, press either the L (left) or R (right) button to select the mirror that you want to adjust. The spin button will illuminate indicating the rearview mirror is activated and can be adjusted.

Press the mirror control switch corresponding to the arrow indicating the direction of the desired movement. For optimal vision orientate the outside(s) mirror(s) in order to frame the adjacent lane and get a partial overlap

with the visible image on the inside rearview mirror.

Power mirror preselected positions can be reset by operating the Memory Driver Seat device (if equipped). Check "Memorize the Driver's Seat Position" in this section for further information.

**WARNING!**

**Vehicles and other objects seen in the external side convex mirror will look smaller and farther away than they really are. Use the inside mirror to judge the size or distance of a vehicle seen in the external side convex mirror.**

### Tilt Side Mirrors In Reverse

This function provides automatic external rearview mirrors positioning, allowing the driver to view the ground area behind the front doors.

The external mirrors will move slightly downward from the current position when the shift lever is shifted into reverse. The external mirrors will then return to the original position when the lever is shifted out of the reverse position. Each memory set of the driver's seat (see "Memorize the Driver's Seat Position" chapter in this section) corresponds to a mirror tilt position in reverse.

**NOTE:**

The mirrors tilt in reverse can be turned on and off using the MIA system, refer to “Functions of Settings Menu on MIA” in section “Dashboard Instruments and Controls”.

**Folding Mirrors**

By selecting this function on MIA the rear-view mirrors automatically fold when the vehicle is locked by the key fob and when the power liftgate is closed and locked by pressing the  button on the outer ledge of the left trunk compartment lining. When the vehicle and the liftgate will be unlocked and the ignition device is set on **ACC** or **RUN** position, the rear-view mirrors will automatically open in the position they had before the lock.

The switch for the power folding mirrors is located between the power mirror switches.

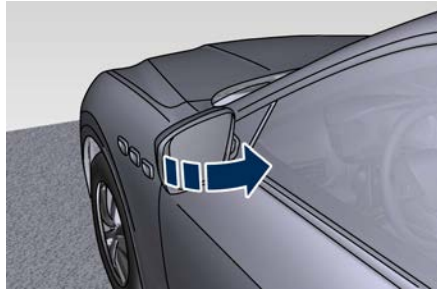
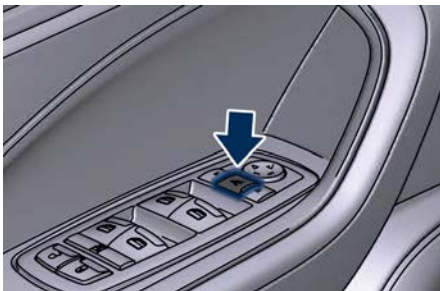

Press the switch once and the mirrors will fold in; press the switch a second time to reset the mirrors to the standard position.

There is a way to make external mirrors automatically fold/unfold.

- If the function is available, it needs to be activated by MIA (refer to “Functions of Settings Menu on MIA” in section “Dashboard Instruments and Controls”).
- If the mirrors are automatically folded after the last lock action, then they will automatically unfold when the ignition device is set on **ACC** or **RUN** position.
- If the mirrors were manually folded by the switch on the driver's door panel, before a lock action, they will need to be manually unfolded to reactivate the automatic function.

**CAUTION!**

Never retract or open the mirrors manually: it could damage the power mechanism.

**Internal Rearview Mirror**

The position of internal rearview mirror can be manually adjusted, and is endowed with an accident prevention release system operating in the event of a collision.

Internal rearview mirror is electrochromic: this glare function is automatically deactivated in reverse to ensure maximum visibility of obstacles.

**CAUTION!**

To avoid damage to the mirror during cleaning, never spray any cleaning solution directly onto the mirror. Apply the solution onto a clean cloth and wipe the mirror clean.

**“Mirror Dimmer” Function**

The auto-dimming function can be disabled or re-enabled by pressing the on/off button on the mirror base.

Disabling this function will increase the reflectance of the internal mirror, increasing visibility at night.



## External Lighting

### External Lights Equipment

The vehicle is equipped with lighting systems and functions that depend on the type of equipment and the target market. Some of these are completely automatic, other can be switched on and off via the light switch and the multifunction lever on the dashboard, or via "Controls" and "Settings" menu of "Vehicle" page on MIA.

This chapter only describes systems that may or may not be installed because of the various options available.

For switching the external lights on and off via the light switch and the multifunction lever behind the steering wheel, refer to the chapter "Light Controls" in section "Dashboard Instruments and Controls".

### External Lights Cluster

The lights of the front clusters are arranged as follows:

#### Bi-Xenon Version

- 1 Bi-Xenon low-beam/high-beam bulb (25W-No AFS).
- 2 Position and DRL light LED.
- 3 Turn signal LED.
- 4 Side-marker light LED.
- 5 Side reflex-reflector.
- 6 Front fog light LED.

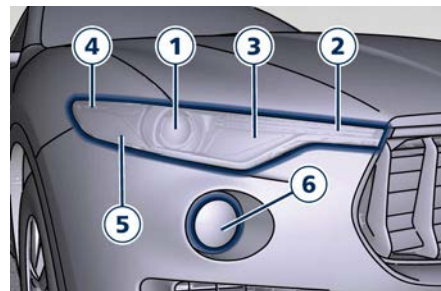

Bi-Xenon Version

#### Full-LED Version (L)

- 1 Low-beam light LED.
- 2 Position, DRL and direction indicator light LED.
- 3 Matrix high-beam light LED.
- 4 Side-marker LED.
- 5 Side reflex-reflector.
- 6 Bending light LED.
- 7 Front fog LED light.

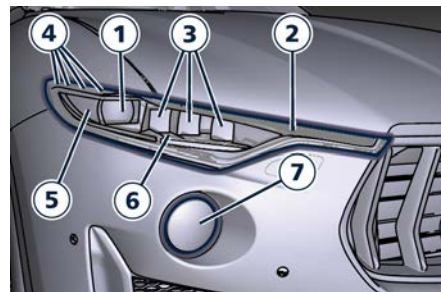

Full-LED Version



The lights of the rear clusters are arranged as follows:

- 1 Position light guide LED.
- 2 Stop and direction indicator light LED.
- 3 Side reflex-reflector.
- 4 Reverse light LED.
- 5 Rear fog light LED.

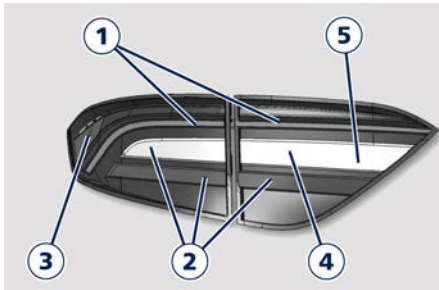

### Integrated External Rearview Mirror Lights

LED turn signals are integrated on the support of the external rear-view mirrors.

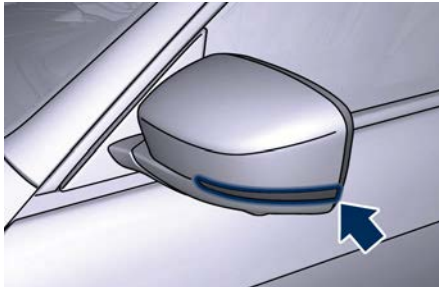

The LED turn signal indicators flash simultaneously with the corresponding turn signal lights in the front and rear of the vehicle. Turning on the hazard warning flashers will also activate these LEDs.

On the vehicles with "Surround View Camera System", the external mirrors are equipped also with approach and courtesy LEDs (OPT), lighting up when the vehicle entry/exit lights are activated. For further information, see chapter "Illuminated Entry/Exit" in section "Before Starting".

### SmartBeam™ System

The SmartBeam™ system provides increased forward lighting for a more comfortable and secure driving experience without resulting in glare to other vehicles in certain traffic situations. The SmartBeam™ system uses a forward facing digital camera, located on the windshield behind the internal rear-view mirror, and an electronic headlights controller in order to dynamically adapt the front light distribution according to the traffic scenario.

The digital camera works like a human eye, it is able to see which is the traffic context while the headlight electronic controller works like a human brain, using information from the camera to command a headlight reaction that gives

to the driver the "best" light distribution (best is always in reference to the specific traffic environment). The camera gives information to the electronic headlight controller about environmental brightness, traffic participants vehicle and obstacles lights, distances and velocities. Using a proper combination of all these data the smart beam system is able to dynamically modify the light shape produced by the dipped beam and by the full beam as well, to make the driver visibility as much comfortable as possible in every condition without glaring other traffic participants.

### System Limitations

There are some cases in which the SmartBeam™ system may not function properly temporarily, and cause glaring for other vehicles especially with "Auto Dim High Beams" function activated on MIA "Settings" page (see "Functions of Settings Menu on MIA" in section "Dashboard Instruments and Controls"). These cases could be related to:

- Vehicles headlight and/or rear light (one or both of them) not visible in the field of view of the camera.
- Heavy rainy weather.
- Heavy foggy weather.
- Snowing weather.
- Windshield dirt or impurities in camera lens zone.



## Understanding the Vehicle

• Camera lens obstruction or logging. In all these cases, it will be the driver's responsibility to avoid this glaring by acting manually on the system, switching off the high beam by means of steering wheel multifunction lever.

### Bi-Xenon Headlight (without AFS)

The gas-discharge (xenon) headlights operate with an electric arc saturated with Xenon gas under pressure, instead of the incandescent filament.

The light produced is assuredly higher compared to traditional light bulbs, in terms of quality (brighter light) as well as of the span and positioning of the illuminated area.



#### **WARNING!**

**If xenon headlamp replacement is necessary, contact the Authorized Maserati Dealer only: DANGER - RISK OF ELECTRICAL SHOCK.**

### Adaptive "Full-LED" Headlight

These headlights combines the "Full-LED" technology to the AFS (Advanced Frontlighting System) adaptive functions, using a forward-facing camera located on the windshield behind the internal rear-view mirror.

### "Full-LED" Technology

This technology allows having headlights with a simpler construction and a more compact size compared to those equipped with traditional or Xenon light bulbs.

Other advantages are:

- a clearer light beam, with a cool white tone that allows a better perception of the contrasts thus making the night vision more efficient and less tiring;
- a longer duration equivalent at least to that of the vehicle;
- a reduced current consumption.

These functions positively affect some vehicle management economy aspects by eliminating/reducing the light bulb replacements and the fuel consumption. The picture shows the increased brightness of the low beam of standard halogen headlights (A) compared to those Full-LED (B) in the "motorway beam" mode.

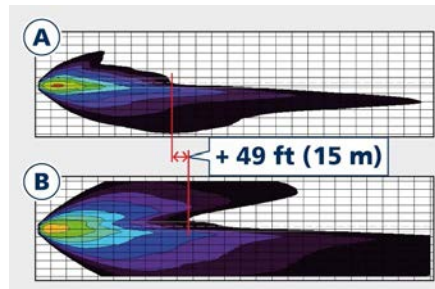

### AFS Functions

The system is able to process signals of onboard systems and subsequently start up five strategic steps in the following situations:

- "motorway beam";
- "country beam";
- "town beam";
- "adverse weather beam";
- "tourist beam" (for example in countries with circulation on the opposite side). In this case this function must be activated via the menu of MIA (refer to "Functions of Settings Menu on MIA" in section "Dashboard Instruments and Controls").

The advantages offered by the AFS system are perceived especially in case of bad weather, fog and/or insufficient road indications providing broader illumination of the side zones, which are normally left in the dark, and for motorway driving.

This surely increases driving safety as it offers less eye stress and increased orientation for the driver and better detection of other persons on the road sides (pedestrians, bicycle riders and motorcycle drivers). Furthermore, the headlamps are suitable to prevent glare, providing optimal lighting when driving the car in a country with circulation on the opposite side.



The tables show the light values (lux) and the light flux (lumen) of AFS headlights.

**NOTE:**

The values reported in the tables may change depending on the destination market of the car.

	Lighting (at 27 yd/25 m)
Low beam	55 lux
Low beam (low speed)	43 lux
Low beam (high speed)	58 lux
Low beam (wet road)	42 lux
High beam	150 lux

	Light flux
Low beam	765 lm
Low beam (low speed)	600 lm
Low beam (high speed)	800 lm
Low beam (wet road)	790 lm
High beam	1440 lm

The system assures better visibility of the road surface when driving in a

curve, steering, or in the event of road deviations, optimizing vertical light distribution according to the current drive path.

The increased lateral illumination is gained through a fixed bending light or a cornering light (depending on the market) elaborating information about the steering angle, the vehicle speed and the turn indicator.

The improved vertical illumination, in case of fast acceleration and/or fast deceleration, will assure the deeper illuminated distance from the vehicle, through a dynamical adaptation of headlight vertical attitude.

**NOTE:**

- Each time the adaptive headlight system is turned on, the headlights adjustment will perform a self-adjustment cycle.
- All AFS functions are available only if the vehicle is moving forward.
- “Adaptive Front Light” function can be turned on or off using the MIA system, refer to “Functions of Settings Menu on MIA” in section “Dashboard Instrument and Controls” for further information.

**AFS System Failure**

In the event of AFS system unavailable, the related warning light and message will light up on the TFT display. Take your vehicle to the nearest Center of the

**Authorized Maserati Dealer** as soon as possible to check the system.



**Automatic High Beam**

The Automatic High Beam headlight control system provides increased forward lighting at night by automating high beam control through the use of the forward-facing digital camera located behind the rear-view mirror, which is the same one used for example by the Lane Keeping Assist - LKA system on vehicles with ADAS systems.

This camera detects the environmental luminosity, the headlamps of oncoming vehicles and the tail lamps of proceeding vehicles in the front area. In these cases, the system automatically switches from high beams to low beams until the approaching vehicle is out of view.

Furthermore, the digital camera is able to detect the urban areas and the inhabited



## Understanding the Vehicle

centers and to turn off the high beams when driving near of one of them.

The properly working for this system (if all the other conditions are met) is ensured between 21.7 MPH (35 km/h) and 155 MPH (250 km/h).

### Activation Mode

To activate Automatic High Beam function:

- Shift the multifunction lever onward .
- Put the light switch in "AUTO" position.
- Touch the "Vehicle" soft-key on the main category bar of the MIA display and open the "Settings" menu.
- Choose the "Auto Dim High Beams" function in the "Lights" submenu and insert the check mark in the box to turn on the function.
- To turn off the function delete the check mark in the box.

After these steps, the green indicator on the upper right side of the TFT display comes on.



### NOTE:

- The function is enabled only if the brightness sensor detects the right lighting conditions and them switch to low beam on.
- Broken, muddy, or obstructed headlights and taillights of vehicles in the field of view will cause headlights to remain on longer (closer to the vehicle). Also, dirt, film, and other obstructions on the windshield or camera lens will cause the system to function improperly.

### High Beam with "Glare Free" Function (not allowed on the US market)

The "Glare Free" function associated with "Full-LED" headlamps assists the driver during traveling on an off-city road with not sufficient environmental illumination allowing the high beam

use also with other traffic participants without glaring disturbance.

The no glaring effect is obtained through matrixes of LED that are dynamically switched on and off in order to create a shadow zone in correspondence of each other traffic participants lights (motor vehicles and bicycles, as well), according to the information about other vehicles' lights coming from the forward-facing digital camera located on the windshield, behind the internal rear-view mirror.

The no glaring system is a multi-shadow system, since it's able to create up to four light tunnels simultaneously, each tunnel zone is as large as the obstacle that should not be glared.

The figure represents an example of the car that is travelling in the following scenarios:



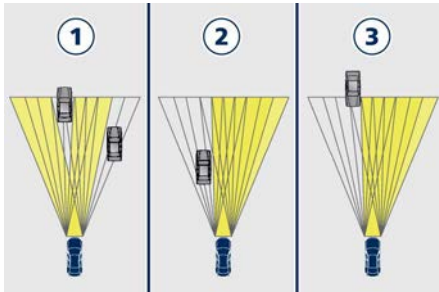

- 1 two vehicles ahead in the same direction;
- 2 another vehicle that is overtaking;
- 3 another vehicle proceeding in the opposite direction.

The system is able to detect and react to an oncoming vehicle starting from a distance of about 400 yd (400 m), in a couple of seconds. Instead, in case of the preceding vehicles, the system is able to detect and react in few seconds starting from a distance of about 100 yd (100 m).

### Activation Mode

The digital camera is the same used for the automatic high beam, and like automatic high beam also for "Glare Free" function it needs to be activated by MIA "Settings" menu of "Vehicle" page, insert the check mark on the box of the "Auto Dim High Beams" function

(see chapter "Functions of Settings Menu on MIA" in section "Dashboard Instruments and Controls").

The "Glare Free" function will be engaged after the following actions:

- Engine run.
- Function enabled by MIA.
- Low beam on.
- Interior light switch in position "Auto".
- Multifunction lever in "High beam" activated position.

The "Glare Free" function will work if:

- The vehicle speed is equal or greater than 21.7 MPH (35 km/h) in the engagement phase of the function.
  - Environmental brightness is not sufficient for a safe and comfortable drive.
  - Traffic scenario out of urban context.
- Once the system will be active, there will be two indicators on the instrument cluster, showed in the same time: one blue and one green.

The green indicator indicates that the "Auto Dim High Beams" function is activated on MIA; the blue indicator indicates that all or only some high beam LEDs are physically on in that moment. When instead there is the needing to switch off the whole high beam module to obtain the no glaring effect, on the instrument cluster there will be just one indicator on: the green one.

When the scenario allows the partial or full use of high beam with no glaring disturbance, the blue indicator will appear again.

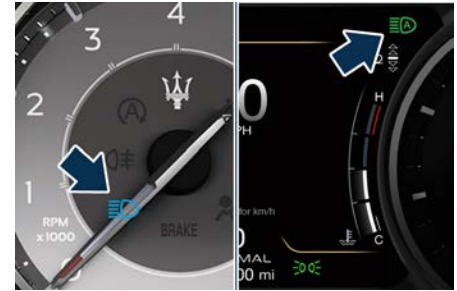

### NOTE:

- Some unpredictable conditions, such as dirt, dust, film or any other obstruction on camera lens zone events could affect "Glare Free" function making it working improperly.
- Heavy rainy and foggy weather could affect system performance, leaving the full beam switched on for longer time than the nominal working condition. This could cause a glaring disturbance for other vehicles, to avoid this the driver has to switch off the high beam manually.
- In phase of disengagement of the function, the minimum operating speed is 15.5 MPH (25 km/h).

(Continued)



## Understanding the Vehicle

2

### (Continued)

- “Glare Free” function proper operation is guaranteed if vehicle speed is less than, or at least equal to 155 MPH (250 km/h).

### Automatic High Beams/Glare Free High Beams Failure

In the event of a failure on high beam system (Automatic or Glare Free equipped, as well), the related amber warning light will light up on the TFT display.

Take your vehicle to the nearest Center of the **Authorized Maserati Dealer** as soon as possible avoiding to use this system.

## Interior Lighting

The interior and external approach lights turn on and off when entering/exiting the vehicle (see “Illuminated Entry/Exit” in section “Before Starting” for further information).

### Dome Lights

The dome lights integrated into the front dome console, include a central and two reading lights.

The central light automatically turns on when one of the doors is opened and turns off when the door is closed (timed switching off). The light may be switched on manually by pressing the central button.

The reading lights are controlled by the respective side buttons.



If they are turned on by pressing the button, both central and reading lights will stay on for about 10 minutes after turning the engine off, and will then turn off gradually.

When the exterior lights are switched on, the two night LEDs fitted on the side of the power buttons on the overhead console will light up to facilitate the use of the transmission lever and the central console.



If one or more doors are opened, the front and rear dome lights will turn on for 27 seconds. If the door is closed before this time, the lights will dim and subsequently switch off after about 3 seconds.

### NOTE:

The dome lights will also turn on by pressing the  or  button for centralized doors unlock and lock on the key fob. See “Illuminated Entry/Exit” section “Before Starting” for further information.

In the event of a collision causing automatic interruption of fuel supply, the dome lights switch on automatically and remain lit for approx. 15 minutes. Apart the lights on the front dome console, there is a light with relevant on/off switch located next to the passenger handholds for the external rear seats. These lights will operate only



when the ignition device is in the **ACC** or **RUN** position.



### Button to Switch off Passenger Compartment Lights

In addition to specific switches to turn on and off the front and rear side dome lights as previously described, on the front console there is a button that allows to turn off and on all these lights.



## Interior Lights

To protect the battery, the interior lights will turn off automatically 10 minutes after the ignition device has been shifted to **OFF**. This occurs if the interior lights were turned on manually or by opening a door. The glove box light, on the dashboard, shares the same characteristics excepting the trunk and liftgate lights. When the ignition device is out of **OFF**, the light switch can be in any position, and the system is in “NIGHT” mode (detected by the RLS solar sensor) the brightness of controls, instruments and ambient lights, can be adjusted by means of the buttons on steering wheel right-hand side, enter “Vehicle settings” menu and select “Interior Lighting” sub-menu.

Press and release the multifunction switch  $\gt$  to visualize the available parameters:

- “Backlighting” (example shown in figure).
- “Ambient Lighting”.



Use arrow  $\wedge$  or  $\vee$  to scroll the list of parameters that can be adjusted and confirm selection by pressing and releasing multifunction switch  $\gt$ : available options will be shown on the display. A check mark will remain next to the previously-selected item until a new selection is made.



Press and release the multifunction switch  $\gt$  to select the option. A selection notice pops up for 2 seconds



## Understanding the Vehicle

and then the display reverts to the last modified parameter.

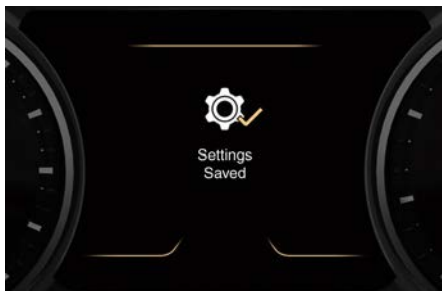

The dimmable lights are the following:

- instrument cluster dials and display;
- dome light (front/rear);
- LED in correspondence of the internal door handle;
- doors and steering wheel backlight controls LED;
- front footrest light;
- front seats night lighting.



### Cargo Lights

To illuminate the cargo area there are two lights on liftgate and two more inside the trunk compartment. These lights turn on when liftgate is opened and turn off when it is closed.

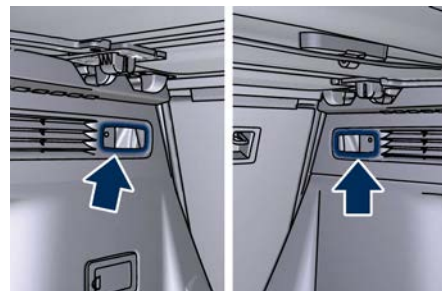
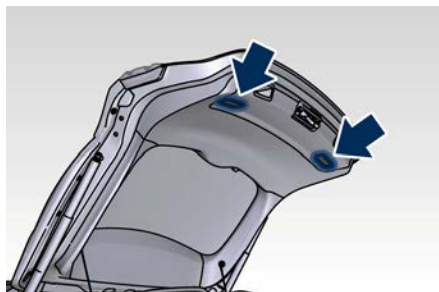

If liftgate is left open for a long time, lights will turn off after 30 minutes to save battery charge.

## Internal Equipment



### WARNING!

Cellular phones, music players, and other handheld electronic devices should be stowed while driving. Use of these devices while driving could cause an accident due to distraction.

### Electric Power Outlets

The vehicle is equipped with four 12 Volt (13 Amp) electric power outlets, two available for the front seat passengers, one for rear seat passengers and one fitted in the trunk compartment.

In vehicles equipped with “Smoking Kit” the electric power outlet inside the cupholder is replaced with a cigarette lighter.

All power outlets are supplied only when the engine is started or the ignition device set to **ACC** or **RUN**.

Power outlets are protected by a fuse. Insert a cigar lighter or accessory plug into the power outlets to ensure proper operation. Otherwise, check the matching fuse integrity, see “If a Fuse Blows” in section “In an Emergency” for further information.



### CAUTION!

- Do not plug in accessories that exceed the maximum power of 160 Watts (13 Amps) at 12 Volts.
- Power outlets are designed for accessory plugs only. Do not insert any other object in the power outlets as this will damage the outlet and blow the fuse. Damages caused by improper use of the power outlet are not covered by the New Vehicle Limited Warranty.



### WARNING!

To avoid serious injury or death:

- Only devices designed for use in this type of outlet should be inserted into any 12 Volt outlet.
- Replacing the fuses that protect power outlets with others of higher amperage, there is the risk of fire.
- Do not touch with wet hands.
- Close the lids when the plug is not used and while driving the vehicle.
- If this outlet is mishandled, it may cause an electric shock and failure.

### Power Outlet for Cigarette Lighter inside the Cupholder Compartment

To access the power outlet inside the cupholder beside the shift lever,

press the cover as indicated to open it completely.

### NOTE:

This outlet is specifically dedicated to power the cigarette lighter. It is not recommended to use it as an outlet to charge devices: use the other power outlets for this function.



### CAUTION!

High power consumption items plugged into this outlet for long periods may discharge the battery and/or prevent the engine from starting.





## Understanding the Vehicle

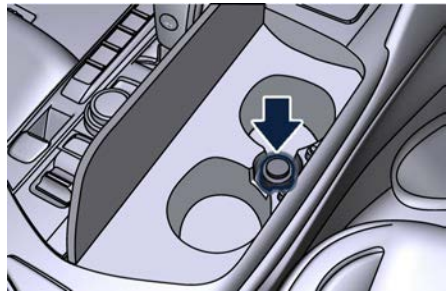

### Power Outlets inside the Central Console

To access the power outlet located inside the glove box of the central console you need to open the half-lids as indicated in the following paragraph.

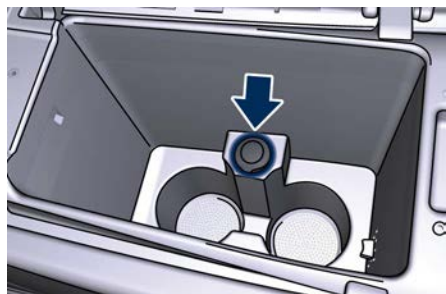

### Rear Power Outlets

A 12 V power outlet in the compartment at the rear end of the central console, is available upon request for rear seat passengers.

To access the power outlet, push the lid as indicated: it will open completely.



### Power Outlet inside the Trunk

The power outlet is positioned on the right side of the trunk compartment.



### Cupholders

The vehicle is equipped with several cupholders.



### CAUTION!

- Use light and shatterproof containers.
- Do not forcefully push unsuitable containers into the cupholders to prevent damage to the containers.
- Do not store hot drinks.

### Cupholders for Front Passengers

The front cupholders are located beside the transmission lever and within the central console.

To access the cupholder, push the cover as shown in the picture and it will open completely.

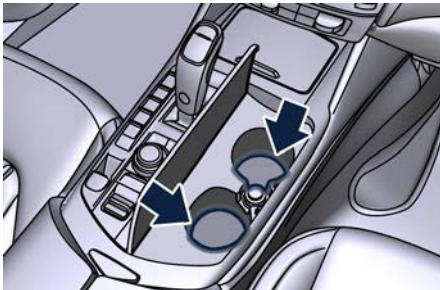

By pressing the indicated button on the central console, the half-lids will rise completely enabling access to the inner compartment where the two cupholders are located.

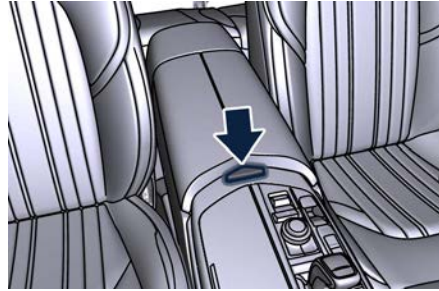

The storage and passenger compartment share the same air conditioning even though you may exclude the air conditioning of the cupholder compartment by moving the indicated button.



To close one or both of the half-lids, push them down to the locking position.

#### Cupholders for Rear Passengers

Two cupholders are available in the front side of the rear seats central armrest.

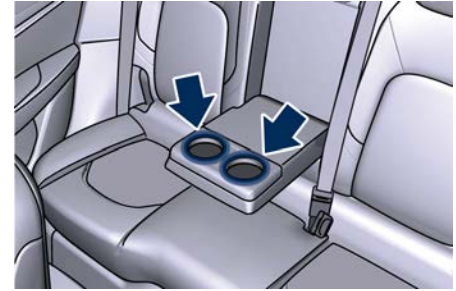

#### AUX, USB and SD Memory Card Ports

The ports are located inside the compartment at the front end of the central console. To access the inputs, push the lid as indicated: it will open completely.

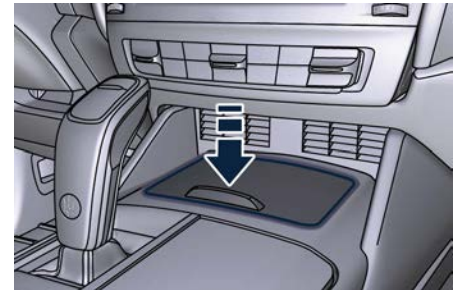

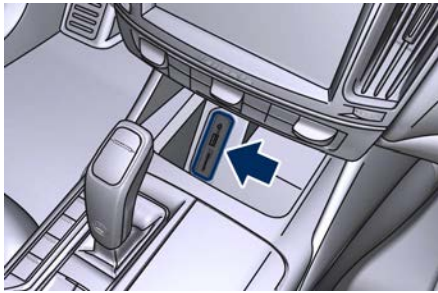



The AUX auxiliary port features:

- typical port impedance between AUX-IN and AUX\_REF: 13 Kohm;
- max. applicable voltage: 0.75 Vrms at 1 kHz;
- port compatible only with 3.5 mm jack connectors (not included).

Any player with these characteristics and analogue audio output (headset output type) can be served by the MIA system. The system can recognize the connection to a player outlet autonomously, by enabling access to the audio functions connected to this source.

This USB port  can be used for data exchange (refer to the "Maserati Intelligent Assistant (MIA)" guide for further details).

Two other USB ports for charging of connected source (CHARGE ONLY label) are present inside the glove box compartment of the dashboard .

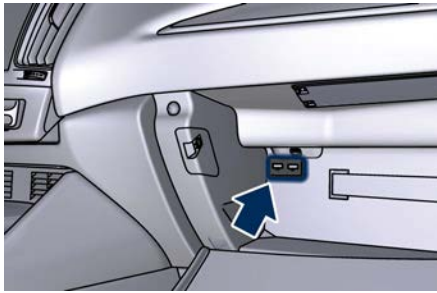

In the compartment of the central console there is also a SD memory card port. Once inserted into the slot, to extract it, press lightly on the card. For rear seat passengers, there are two USB ports inside the compartment located on the rear end of the central console, above the air vents. To access the USB ports open the outside cover.



This USB ports allow charging (CHARGE ONLY label) the connected source.

Following conditions can create USB inputs damage or malfunction:

- Usage of non-original lightning cables.
- Usage of defective rechargeable devices (smartphone, tablet, mass storage devices or other generic USB devices).
- ONLY insert media (eg., USB or SD card), into your vehicle if it came from a trusted source.
- Usage of damaged or defective cables.

### iPod® Connection

An iPod® can be connected to the system via USB and AUX ports by means of a special cable (optional).

The MIA will then control the following functions: play, pause, fast forward, rewind, next track, previous track, random or repeat mode, selection and navigation of playlist/genre/singer/album/Podcast.



**CAUTION!**  
Do not leave your USB device, iPod® or an external audio source in the vehicle for extended periods of time: extreme temperatures and humidity can occur in the vehicle.



## Sun Visors

Sun visors can be folded to the front and to the side of the vehicle. To move the sun visor laterally, lower and release it from its catch as indicated.

In this condition, the sun visor can be extended by sliding the sun visor end backward.

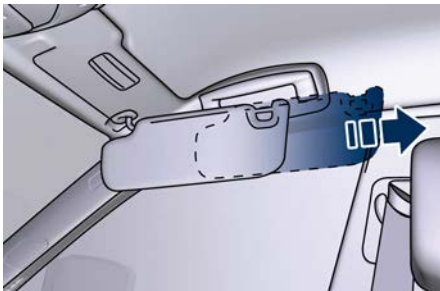
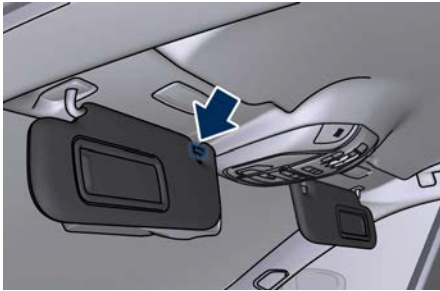

By lowering the sun visor you can access the courtesy mirror and, by sliding the mirror protective cover, the light on the

dome will automatically light up (with the ignition device on **ACC** or **RUN**).

### NOTE:

The light on the dome turns on only when the sun visor is in non-extended position and pushed towards the end-stop of the sliding rod support.

Before raising the sun visor, close the mirror cover: the light will turn off. A business card holder is fitted inside each sun visor.

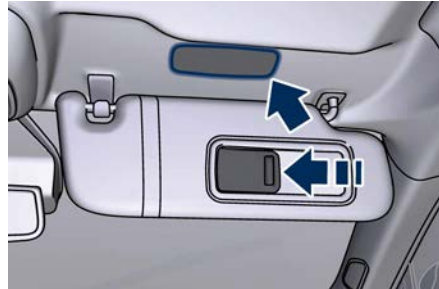

## Smoking Kit (OPT)

The kit includes a lighter and a removable ashtray with cover.

The Smoking kit for front seats passengers is located inside the box beside the transmission shift lever and can be accessed by pressing the cover as indicated.

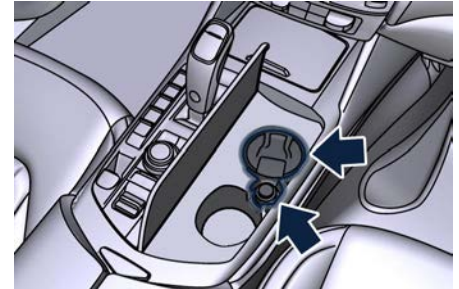

The rear seat passengers can use the removable ashtray by inserting it into the rear doors pocket, while the lighter can be inserted into the power outlet at the end of the central console.

Press the central button to activate the cigarette lighter. After about 20 seconds the button returns automatically to the initial position and stops the heating: from this time the cigarette lighter is ready for use.



## Understanding the Vehicle

2



### CAUTION!

After use, always make sure that the cigarette lighter is switched off.



### WARNING!

- The cigarette lighter reaches high temperatures. Handle it carefully and do not allow children to use it so as to avoid risk of fire and injury!
- The cigarette lighter may not be used as a power outlet.

### Handholds and Cloth Hooks

Handholds are fitted above the passenger doors. Once grabbed, they will lower until the block position. When released, a return spring will bring them back to the original position.



Behind the rear handholds there is a light with relevant on/off switch (refer

to chapter “Light Controls” in section “Dashboard Instruments and Controls”). Cloth hooks are present on rear handholds and on pillars between doors.



On the side walls of the trunk compartment there is a shopping hook that can withstand a maximum load of 22 lb (10 kg).

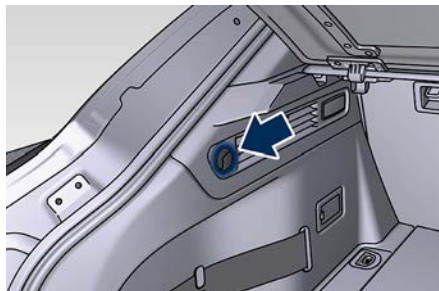

### Mesh Pockets

Front seats are fitted with mesh pockets, on the rear of the seatbacks, and accessible by rear passengers.



### CAUTION!

Do not put heavy or sharp objects in the mesh pockets.

### iPad Holder (Genuine Accessories)

The **Authorized Maserati Dealer** can provide you with all information about the “Maserati iPad Holder” to be fixed to the slide rods of the front head restraints, available in the “Genuine Accessories” range.

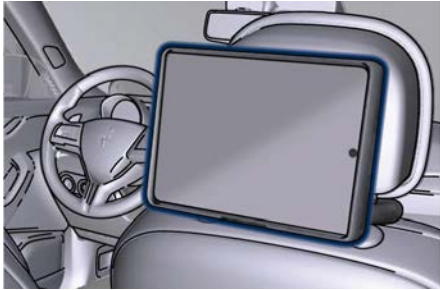

### Wi-Fi Hotspot

The user can activate a Wi-fi Hotspot in the car which allows them to connect up to 8 mobile devices.

To take advantage of this service, the user needs to subscribe directly with the Maserati Mobile Network Operator Partner. This can be done through the user web portal, directing him/her to a dedicated page on the partner's website. In order to use the Wi-Fi please select the field at the soft-key of the "Apps" screen.



For further information about this service, see the "Maserati Intelligent Assistant (MIA)" guide.

## Audio System

The vehicle is equipped with an audio system that offers superior sound quality, higher sound pressure levels and reduced energy consumption.

The system maximizes the amplifier and speaker technology delivering substantially higher components and system efficiency.

### Basic System

The basic sound system features 8 speakers and can develop a sound output of 80 W.

The basic system includes:

- Four 6.5 in (165 mm) diameter Woofers, one on each door.
- Four 1 in (25 mm) diameter Tweeters, one at the base of the windshield side pillars and one on each rear door.



## Understanding the Vehicle



Basic System

- each side wall of the trunk, above the cover level.
- Four 1 in (25 mm) diameter Tweeters: one at the base of the windshield side pillars and one on each rear door.
  - One bass box in the trunk, under the front part of the floor.
  - 12-channel amplifier positioned in the wall of the trunk left side.

### High Premium System

The vehicle can be equipped with a “High Premium” audio system including 17 speakers and 1280 W of sound power, available upon request.

The “High Premium” system includes:

- Four 6.5 in (165 mm) Woofers: one on each door.
- Five 4 in (100 mm) Midranges: one on center dashboard, one on each front door and one on each side wall of the trunk, above the cover level.
- Seven 1 in (25 mm) Tweeters: one on center dashboard, one at the base of the windshield side pillars, one on each rear door and one on each side wall of the trunk, above the cover level.
- One bass box in the trunk, under the front part of the floor.
- 16-channel amplifier positioned in the wall of the trunk left side.



Premium System

### Premium System

The vehicle can be equipped with a “Premium” sound system which features 14 speakers and can develop a sound output of 900 W.

This system includes:

- Four 6.3 in (160 mm) diameter Woofers: one on each door.
- Five 3.1 in (80 mm) diameter Midrange: one on the top of the dashboard, one on each front door panel and one on

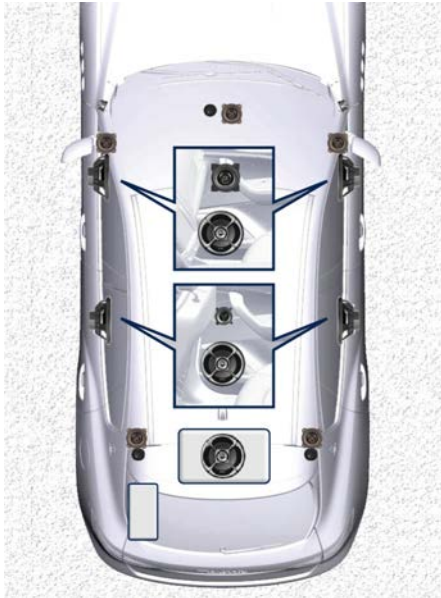

High Premium System

## Cargo Area



### WARNING!

To help protect against personal injury, passengers must not be seated in the rear cargo area. The rear cargo space is intended for load carrying purposes only, not for passengers, who should sit in seats and use seat belts.

## Vehicle Load Carrying Capacity

The load carrying capacity of your vehicle is shown on the vehicle loading information label positioned on the driver's side door pillar.



The information indicated on the label concerns passengers and luggage loading operations.

Do not exceed the specified Gross Vehicle Weight Rating (GVWR) or the Gross Axle Weight Rating (GAWR), both front and rear.

The GVWR is the total allowable weight of your vehicle. This includes driver, passengers, and cargo.

The total load must be limited so that you do not exceed the GVWR indicated on the label.



### WARNING!

- Improper weight distribution can have an adverse effect on the way the vehicle steers, handles and the way the brakes operate.
- Never drive with the liftgate open. Exhaust gases can enter the passenger compartment.
- Do not arrange any luggage on cargo area cover. In said position luggage could not only impair driver's view but also, in case of collision or unexpected stop, it could cause injury to all occupants.

The trunk is the most suitable place to load bulky and heavy objects onboard the vehicle. The maximum allowable load on the floor of the trunk is 440 lb (200 kg).

To load your vehicle properly, store heavier items below and be sure you distribute their weight as evenly as possible.



## Understanding the Vehicle

Stow all loose items securely before start driving as they could move during the trip.

To separate trunk from passenger compartment, the vehicle is equipped with a rigid horizontal panel, fitted behind the rear seat backrest. When vehicle is at a standstill, cargo area cover can withstand a maximum static load of 260 lb (120 kg).

Apart from cargo area cover, the vehicle can be also equipped with a vertical rolling Cargo Net, to be used to separate the cargo area from the passenger area.

The **Authorized Maserati Dealer** can provide you with any information about the items dedicated to the usage of the trunk (luggage compartment mat, net, foldable box,...), available in the "Genuine Accessories" range.

### Luggage Fasteners and Retainers

Vehicle can be equipped with fixed and mobile anchorages on trunk floor allowing to fasten and retain any luggage in a convenient and safe manner. Using a special and approved net with hooks available in the "Genuine Accessories" range, also large and heavy objects can be fastened to trunk floor. Eyelets to secure the luggage net are provided on the four corners of trunk floor.

For retaining luggage placed in compartments on the trunk side walls there are special elastic bands.

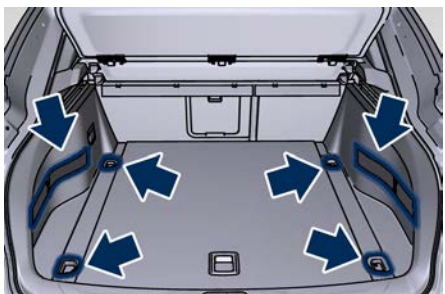

Longitudinal rails on trunk floor provide safe anchorage for luggage of different size, thanks to the special hooks with locking button. To position the hook, slide it along the rails until reaching the required position, holding down the central button.

Release the button and slightly move the hook to secure its position in the notches of the guide.

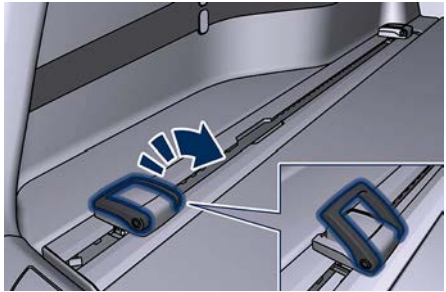

By using the Railing Fastening Bar, available in the "Genuine Accessories" range, fastened by means of sliding blocks along the floor rails, you can fasten heavy luggage in the innermost area of the trunk.

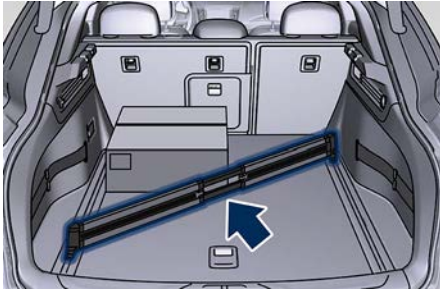
**CAUTION!**

To avoid luggage inadvertent movement, in case of sudden braking or collision, always check correct fastening of the retainers onto floor rails before anchoring any luggage.

**NOTE:**

The Authorized Maserati Dealer can provide you with information about the available “Genuine Accessories” for the trunk compartment.

### Loading with Rear Seatbacks Folded Down

The 60/40 split-folding seatback of the rear seat provides cargo-carrying versatility.

The seatback folded down provides a continuous nearly-flat extension of the load floor able to accommodate bulky luggage, large-sized equipment and

objects that may not fit with the normal dimensions of the trunk.

**NOTE:**

Both seat backs can be folded down independently.

**WARNING!**

To prevent the other luggage in the trunk from getting into the passenger compartment and creating a potential danger for the passengers, keep trunk cover installed when folding down one of the two seatbacks.

When the seatbacks are unfolded to the upright position, make sure they are latched in one of the fixed positions (see “Rear Seats” in this section).

**WARNING!**

- Make sure that the seatback is securely locked into position. If the seatback is not securely locked into position, the seat will not provide the proper stability for child seats and/or rear passengers. An improperly latched seat could cause serious injury.
- The cargo area in the rear of the vehicle with the rear seatbacks in the folded down position should not be used as a play area by children when

the vehicle is in motion. They could be seriously injured in a collision. Children should be seated and use proper restraint systems.

### Ski and Snowboard Bag Compartment

To stow and safely fasten a ski and snowboard bag, with no need to fold down the seatback, use the opening available at the back of the longer seatback (60), at the level of the armrest between the rear seats.

To reach this compartment and properly arrange the bag, proceed as follows.

- From inside the passenger compartment, lower the armrest between the rear seats.
- From the trunk compartment, open the flap at the back of the long seatback.



- Insert the bag end without anchor hook into seatback opening.



## Understanding the Vehicle

- Fasten the hook to one of the eyelets available on trunk floor.
- From the passenger compartment, route bag strap under armrest and fasten it.

2

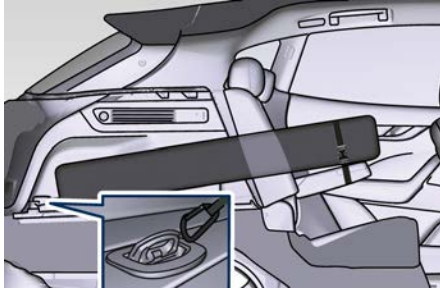

If you follow these instructions, the bag will be securely fastened to vehicle structure and will thus remain in place also in case of collision or unexpected braking.

The Maserati approved Ski and Snowboard Bag available in the "Genuine Accessories" range, can be fastened also by folding down the seatback.

### Accessories Compartment

In order to hold any accessories to be kept on the vehicle, the car is equipped with a storage box with carrying handles, at the rear end of the trunk compartment.

To reach this box, lift or remove the trunk floor panel.

#### NOTE:

The **Authorized Maserati Dealer** can provide you with information about the available "Genuine Accessories" for the trunk compartment.

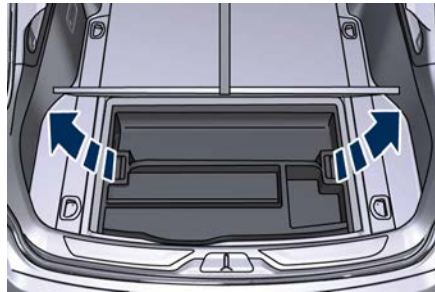

### Trunk Compartment Cover

Trunk compartment cover is made of two parts, the most outward one lifts when liftgate is opened.

The cover can be removed to obtain a larger cargo area, as follows:

- slide the top end of side linkages out of the shafts on rear pillars;

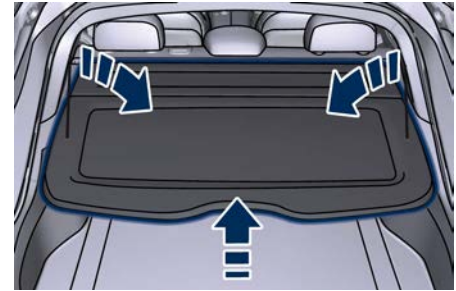

- lift the cover rear end and slide it towards the liftgate: this will result in sliding the four lower ends of the cover inner part out of their guides on trunk panel;

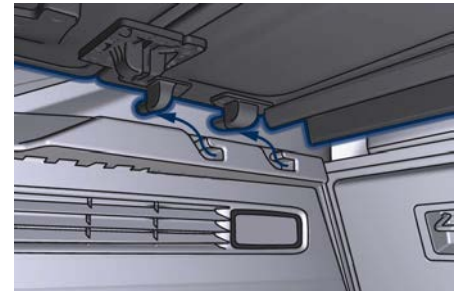

- remove trunk cover from the vehicle. The two parts of trunk cover can be folded one onto the other for a more compact unit.



**WARNING!**

Driving with no trunk cover could be dangerous. Any unfastened luggage or objects could move into the passenger compartment in case of sudden stop or collision and seriously injure the occupants. To prevent this, always refit the trunk cover or use the Cargo Net as described in the following paragraph "Installing the Cargo Net for Cargo Area".



When refitting the trunk cover, perform the same operations in reverse order.

**WARNING!**

After refitting the trunk cover, make sure that the lower ends of the inner part have properly engaged in their guides. If cover is not properly positioned and fastened, in case of unexpected stop or collision it could move and seriously injure the passengers in the rear seats.

**Cargo Area Extension**

The following procedure is aimed at obtaining the maximum possible extension of the cargo area, and it can be only a partial extension if you carry out only a few of the listed operations.

- Remove the trunk cover as indicated under "Trunk Compartment Cover" in this chapter.
- Completely lower the side head restraints of rear seats (  : chapter "Head Restraints" in section "Safety").
- On the long part (60) of the backrest place the central head restraint in the position of use indicated on the label applied on the fixed side windows (  : chapter "Head Restraints" in section "Safety").
- Completely fold down the rear seatback by lifting the lever to position 1 and hold it up.

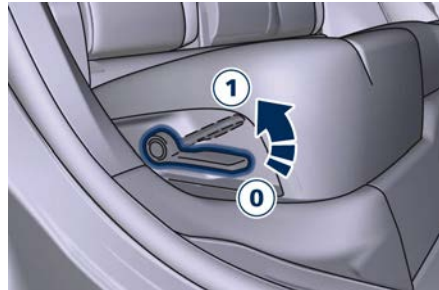

- Release the lever when seatback is against the seat: the control cable will click into place and lock.
- In this position, push down on the seatback of the long part (60): the control cable will click into place and lock.

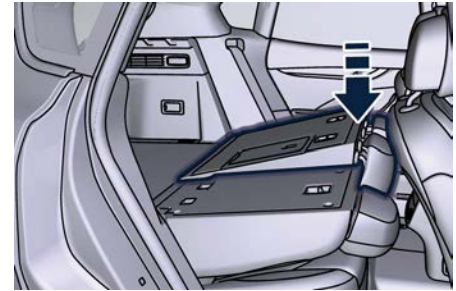

Now that seatbacks are folded down, trunk floor and the back panels of seatbacks will form a larger flat floor.

**CAUTION!**

Seatback rear panel is not suitable to support heavy loads and metal objects with protruding elements that might scratch its surface. If necessary, protect the seatback rear panel surface using rigid panels.

**Installing the Cargo Net (OPT) for Cargo Area**

The Cargo Net can be installed to two positions depending on the current extension of the cargo area. When only the trunk cover is removed (see previous paragraph), while backrests are still vertical, the Cargo Net must be installed immediately behind them (position A).



## Understanding the Vehicle

2

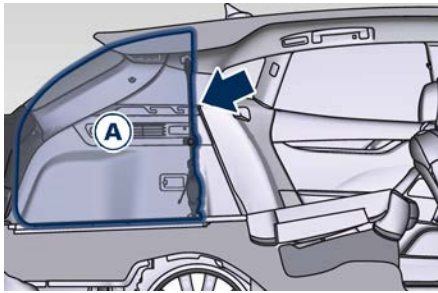

While, in case also backrests were folded down, the Cargo Net must be installed in a more forward position behind the front seats (position **B**).

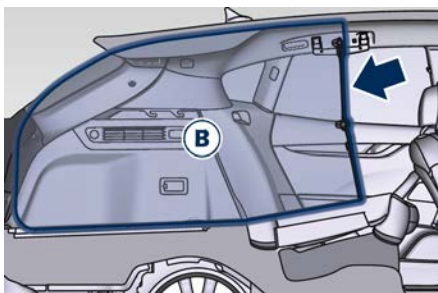

### **WARNING!**

- Before installing the Cargo Net in the more forward position make sure that the backrests are locked in the lowest position.
- The Cargo Net must be properly installed following the instructions in this paragraph.
- The Cargo Net will not properly hold objects in case of sudden vehicle braking or collision depending on cargo weight.
- Heavy loads not sufficiently fastened could exceed net capacity and hit the vehicle occupants, with the ensuing risk of injury.
- Before leaving for a trip, fasten all objects that might move to trunk floor, using the devices provided by Maserati for this purpose.
- When using the Cargo Net, do not load any heavy object on top of the other objects which are laid on the trunk floor (see example in the figures).

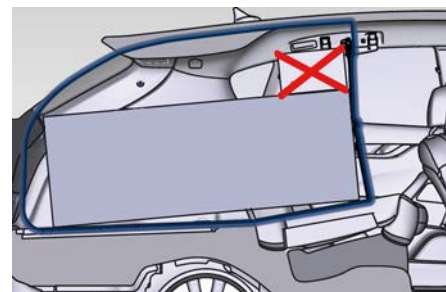
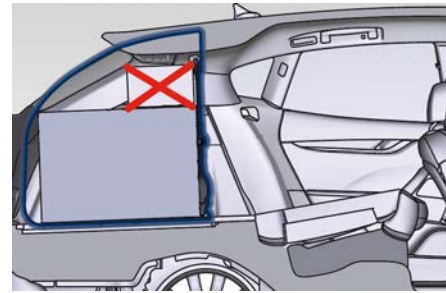

The Cargo Net is housed in the accessories compartment under the trunk floor.

The Cargo Net is supplied folded, inside a bag that is part of the net itself.

To install it, open the bag zip, unfold the two parts until hearing the jointing elements clicking in place.

To close it, press the button indicated in the figure, at the two jointing elements.

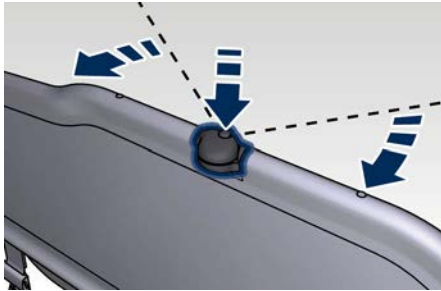

To install the Cargo Net in position **A**, proceed as follows.

- Turn downwards the upper part of the protection cover on roof brackets.



- Insert the net top ends in the slot on roof brackets (position **A**).
- Pull net down to ensure it is properly engaged (position **B**).

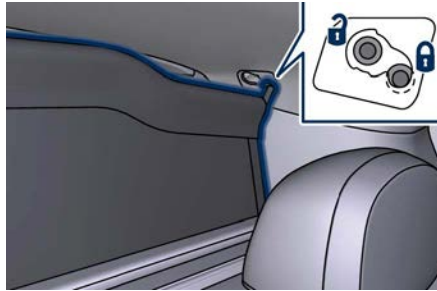

- Fully unfold Cargo Net down and engage the ends of side tethers, with hook, in the fixed or mobile retainers available on trunk floor.
- Pull down the free ends of the tethers to tension the Cargo Net: once released, the tether will remain in taut position **B**. To disengage and release tether from retainer position **B**, lift the tether free end as indicated in the figure.



- Freeing the net lower part from the Cargo Net structure.

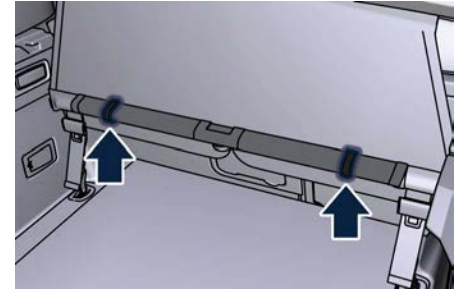

- Attach the lower side ends of the Cargo Net to the tethers, using the Velcro appendices indicated in the figure.

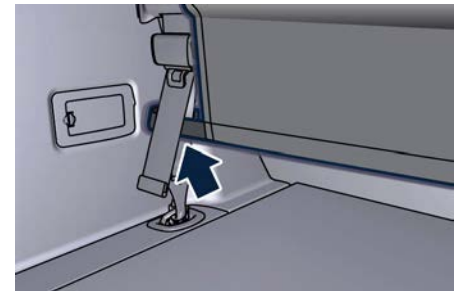

Should it be necessary to position the Cargo Net in position **B** - more forward, i.e., behind the front seats - use the top retainers next to external rear passenger handholds.

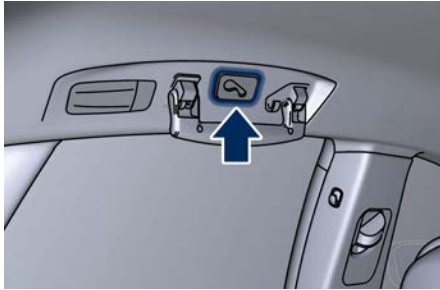

- Lower the handhold and engage the net top ends in the slot on roof, as already described for the rear retainers.

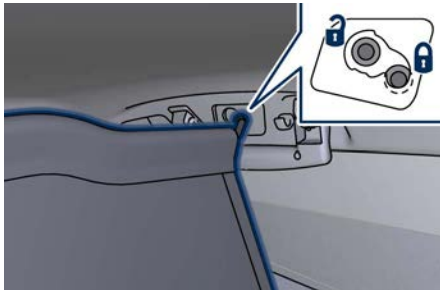

- Fasten the lower tethers of Cargo Net to external retainers, also used to fasten the top safety belt for children seat, available on rear seat backrests (  : chapter “Child Restraint Systems (CRS)” in section “Safety”).
- Attach the Velcro appendices indicated in the figure, as described for the rear retainers.

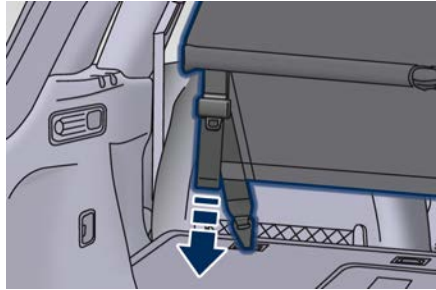

When Cargo Net is no longer necessary, release the net lower part from the fastening tethers, rewind it on itself and fasten it to the Cargo Net structure. Remove the Cargo Net from its fastening points, fold it and close the bag zip. Store bag under trunk floor, then restore vehicle original conditions by repositioning all moved or removed parts.

## Front to Back Roof Rails ( )

The front to back roof rails that can be installed to this vehicle have been designed to carry luggage or equipment suitable for transport outside of the vehicle.



Weight of luggage/equipment carried on the rails must not exceed 176 lb (80 kg) and must be evenly distributed. This weight must be added to the load carried inside of the vehicle as well as the passengers' weight, and total must not exceed the the total allowable weight- GVWR (  : chapter “Weights” in section “Technical Specifications”). When arranging load on rails, make sure that it will not interfere with power liftgate and sunroof opening (if equipped).

Securely fasten load to rails using the suitable retainers that can hold the



original anchorage points throughout the trip.

When installing to rails any bicycle, surfboard or other types of carriers requiring cross bars, please comply with the equipment manufacturer's instructions to ensure proper installation.

The **Authorized Maserati Dealer** can provide you with any information about the Maserati approved Carrying Items, available in the "Genuine Accessories" range.



### WARNING!

- During the trip, it is recommended to periodically check that all luggage or equipment carried on the roof rails remained properly fastened. Parts or items that may have shifted or become unfastened during travel could damage the vehicle or become detached from the roof, resulting in potential danger to you or vehicles around yours.
- When driving with a bulky load on roof rails, take additional precautions and drive at lower speed, keeping a wider safety distance from vehicles ahead. Indeed, a bulky and/or heavy load carried on the roof will affect driving behavior and steering response since it shifts the vehicle center of gravity to

**a higher position compared to normal conditions.**

### NOTE:

All objects/equipment carried on the roof and protruding beyond the windshield, e.g. surfboard, must be fastened to both sides of the vehicle. Any wind blow might suddenly increase load lift possibly resulting in breakage and loss of part of the carried equipment.

## HomeLink®

HomeLink® replaces up to three hand-held transmitters operating the automatic devices that open garage doors and gates, enable/disable the lighting or security systems. The HomeLink® unit is powered by your vehicle's 12 Volt battery. The HomeLink® buttons that are located in the overhead console designate the three different HomeLink® channels.

The HomeLink® indicator light is located in front of the buttons.



### NOTE:

HomeLink® is disabled when the vehicle security alarm is active (  : chapter "Vehicle Security Alarm" in section "Safety").



### WARNING!

- Your motorized door or gate will open and close while you are programming the universal transceiver. Do not program the transceiver if people, pets or other objects are in the path of the door or gate. Only use this transceiver with a garage door opener that has a “stop and reverse” function as required by Federal safety standards. This includes most garage door opener models manufactured after 1982. Do not use a garage door opener without these safety functions. Call toll-free 1-800-355-3515 or, on the Internet at [www.HomeLink.com](http://www.HomeLink.com) for safety information or assistance.
- Vehicle exhaust contains carbon monoxide, a dangerous gas. Do not run your vehicle in the garage while programming the transceiver. Exhaust gas can cause serious injury or death.

### Before You Start Programming HomeLink®

Be sure that your vehicle is parked outside of the garage before you begin programming.

For more efficient programming and accurate transmission of the radio-frequency signal it is recommended that a new battery be placed in the hand-held

transmitter of the device that is being programmed to the HomeLink® system. Before starting programming it is necessary to erase the standard codes memorized on the HomeLink® device during the production phase. To erase such codes:

- place the ignition device in the **RUN** position without starting the engine;
- press and hold the two outside HomeLink® buttons (I and III) until the indicator light starts flashing (after approximately 20 seconds);
- release the buttons.

#### NOTE:

- Erasing the standard codes should only be performed when programming HomeLink® for the first time. Do not perform this operation to program additional buttons.
- If you have any problems, or require assistance, please call toll-free 1-800-355-3515 or, on the Internet at [www.HomeLink.com](http://www.HomeLink.com) for information or assistance.



### System with Devices Provided with Rolling Codes

#### Programming the Hand-held Transmitters Manufactured after 1995

These devices can be identified by the “LEARN” or “TRAIN” setting button located where the hanging antenna is attached to the garage door/gate opener. It is NOT the button that is normally used to open and close the door.

The name and color of the button may vary by manufacturer.

- Place the ignition device to the **RUN** position without starting the engine.
- Place the hand-held transmitter 1 to 3 inches (5 - 30 cm) away from the HomeLink® button you wish to program.
- Simultaneously press the HomeLink® button you want to program and the hand-held transmitter button.



- Release immediately the Homelink® button you want to program.
- Continue holding the hand-held transmitter button until the indicator light starts flashing quickly; then release the button.

The quick flashing light indicates that the channel with the new frequency has been acquired and programmed correctly by the HomeLink® system.

#### **NOTE:**

The distance necessary between the portable hand-held transmitter and the HomeLink® in the vehicle depends on the system you wish to program. Probably it will be necessary to try several times. Upon every attempt, keep the setting position for at least 15 seconds before trying again.

#### **Synchronizing the Rolling Codes**

At the end of the previously-described programming, if the HomeLink® has been programmed for a rolling code system, it will be necessary to synchronize it to ensure its correct operation.

- Locate the “LEARN” or “TRAINING” setting button of the opening motor. Firmly press it and then release it. On some garage door openers/devices there may be a light that blinks when the garage door opener/device is in the LEARN/TRAIN mode.

#### **NOTE:**

You have 30 seconds to initiate the next step after the setting button has been pressed.

- Return to the vehicle and press the programmed HomeLink® button for two seconds and then release it.
- Repeat this operation a second time.

If the garage door opening device activates, the programming/synchronization phase is complete.

#### **NOTE:**

If the garage door opening device does not activate, press the button a third time for two seconds and then release it to complete the programming/synchronization phase.

- To program the remaining two HomeLink® buttons, repeat the same step for each remaining button. **DO NOT erase the channels.**

#### **Reprogramming a Single HomeLink® Button**

To reprogram a channel that has been previously trained, follow these steps:

- Place the ignition device to the **RUN** position without starting the engine.
- Press and hold the desired HomeLink® button.
- **Without releasing the button** proceed with “Programming the hand-held

transmitters” from second step and follow all remaining steps.

### **System with Devices Without Rolling Code**

#### **Programming the Hand-held Transmitters Manufactured before 1995**

- Turn the ignition device to the **RUN** position without starting the engine.
- Place the hand-held transmitter 1 to 3 inches (5 to 30 cm) away from the HomeLink® button you wish to program.
- Simultaneously press and hold both buttons until the indicator light starts flashing quickly; then release both buttons.

The quick flashing light indicates that the channel with the new frequency has been acquired and programmed correctly by the HomeLink® system.

#### **NOTE:**

The distance necessary between the portable hand-held transmitter and the HomeLink® in the vehicle depends on the system you wish to program. Probably it will be necessary to try several times. Upon every attempt, keep the setting position for at least 15 seconds before trying again.

- Press and hold the programmed HomeLink® button.

If the garage door opener/device activates, programming is complete. To



## Understanding the Vehicle

program the remaining two HomeLink® buttons, repeat each step for the same remaining button. **Do not erase the channels.**

### Reprogramming a Single HomeLink® Button

To reprogram a channel that has been previously trained, follow these steps:

- Place the ignition device to the **RUN** position without starting the engine.
- Press and hold the desired HomeLink® button.
- **Without releasing the button** proceed with “Programming the hand-held transmitters” from second step and follow all remaining steps.

### Using HomeLink®

To operate, press and release the programmed HomeLink® button.

Activation will now occur for the programmed device (i.e., garage door opener, gate operator, security system, entry door lock, home/office lighting, etc.). The hand-held transmitter of the device may also be used at any time.

### Security

It is advisable to erase all channels before you sell or turn in your vehicle.

To erase the channels press and hold the two outside HomeLink® buttons (I and III) until the indicator light starts flashing (after approximately 20 seconds).

The HomeLink® Universal Transceiver is disabled when the vehicle security alarm is active (  : chapter “Vehicle Security Alarm” in section “Safety”).

### Troubleshooting Tips

If you are having trouble while programming HomeLink®, here are some of the most common solutions:

- Replace the battery in the original hand-held transmitter.
- Press the LEARN button on the garage door opener to complete the training for a rolling code.
- Did you unplug the device for programming and forgot to plug it back in?

If you have any problems, or require assistance, please call toll-free 1-800-355-3515 or, on the Internet at [www.HomeLink.com](http://www.HomeLink.com) for information or assistance.

#### NOTE:

**You can consult the list of compatible devices with the HomeLink®, and their level of compatibility, on the website [www.HomeLink.com](http://www.HomeLink.com).**

### Radio Frequency Device - Regulatory Information

The “Regulatory Information” for all the radio frequency and radar devices can be consulted by accessing the

“Services” section on the website [www.maserati.com](http://www.maserati.com).





## Air Conditioning Distribution

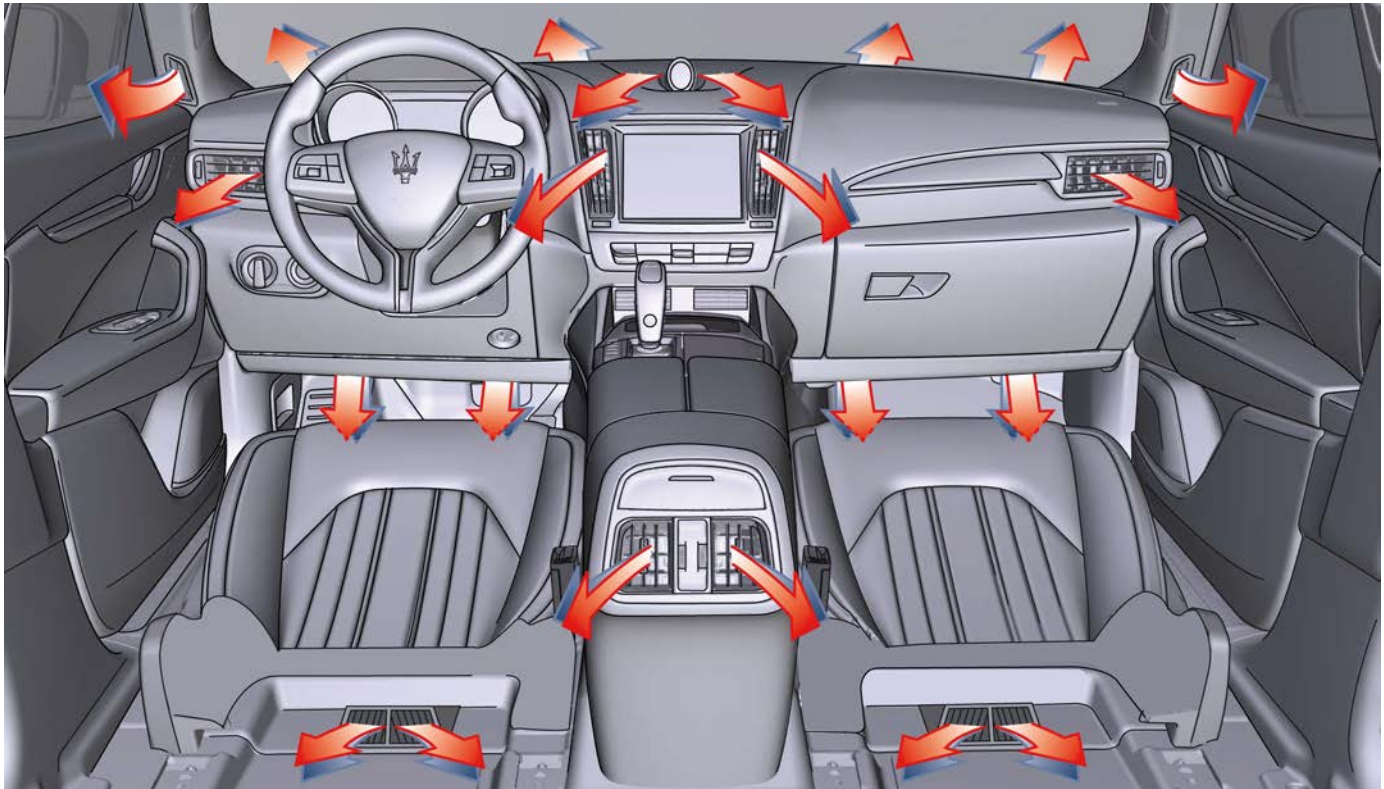

A/C Dual-zone

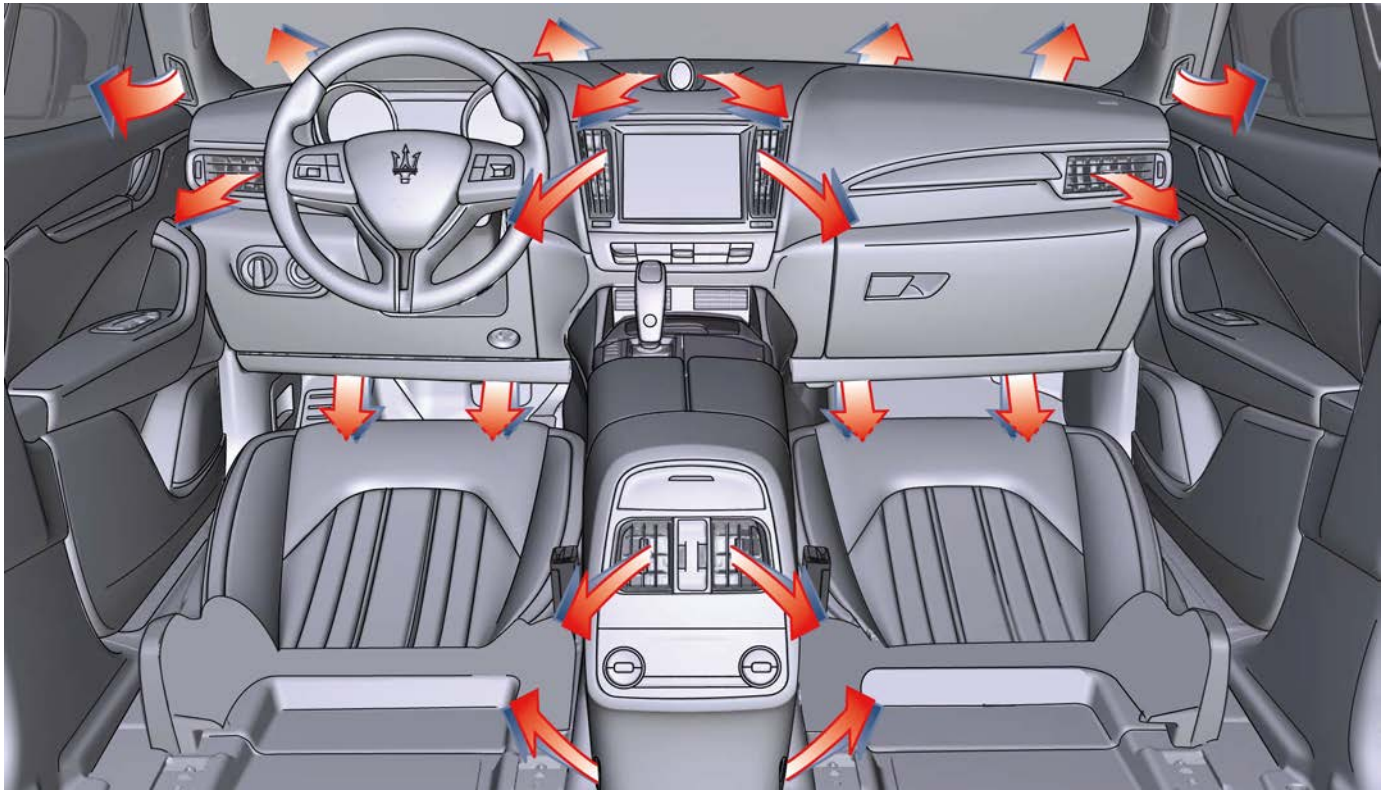

A/C Four-zone

Adjustable and fixed air vents allow passengers to achieve the optimal comfort conditions.

### Fixed Air Vents

- The fixed vents, positioned on the upper part of the dashboard, beneath the windshield and on the windshield side pillars are meant to guarantee the defogging and defrosting of the windshield and the side windows.

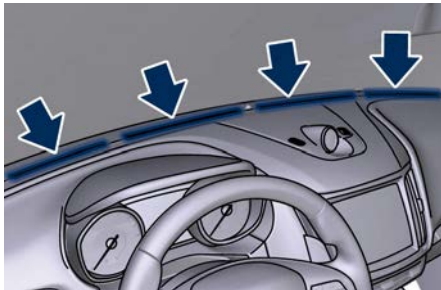

- The fixed vents under the dashboard are aimed at ventilating the lower part of the front passenger compartment.



- The ventilation of the lower part of the rear passengers compartment is made by means of fixed vents positioned as follows:
  - under the front seats, for the dual-zone A/C system;
  - on each side of the rear end of the central console, for the vehicles equipped with the four-zone A/C system.

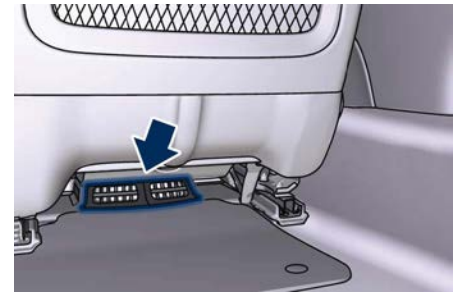

A/C Dual-zone

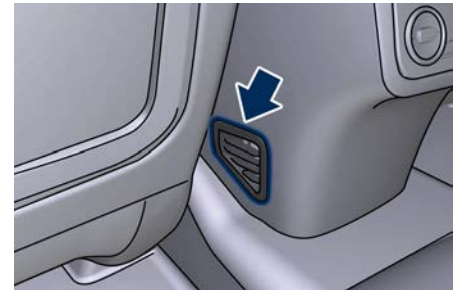

A/C Four-zone

### Adjustable Air Vents

The adjustable vents are located at the center of the dashboard, on both sides of the MIA display and on the upper surface, and at the side ends of the dashboard. They have the purpose of ventilating the upper part of the passenger compartment. There are also adjustable vents placed at the rear end of the central console. The rotor 1 ,



## Understanding the Vehicle

located near each vent, allows to control the quantity of the air flow from fully closed to fully open, and vice versa. Excluding the adjustable vents on the upper surface of the dashboard, the grill of these vents can be oriented by operating on the central handle **2**.

2

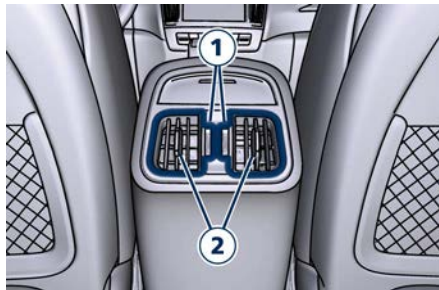
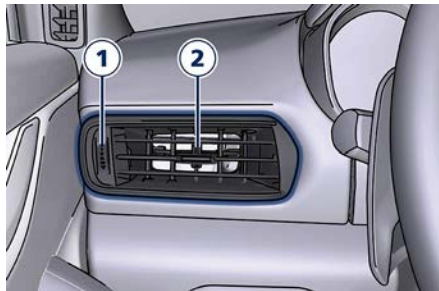
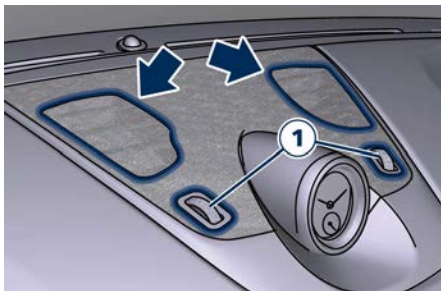
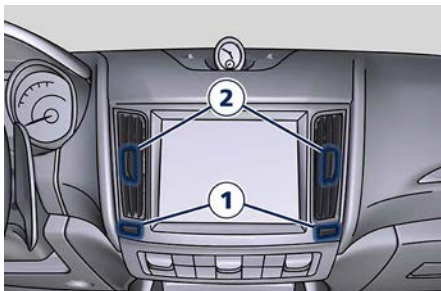

### NOTE:

In order not to obstruct the air conditioning inlet, the defrosting or the defogging function of the glass surfaces, avoid covering vents with clothing or other items.



### 3 - Before Starting

Keys .....	60
Illuminated Entry/Exit .....	62
Unlock the Vehicle with Key fob .....	65
Requiring and Setting Additional Key fobs .....	66
Passive Entry System .....	68
Power Windows .....	71
Power Sunshades on Rear Door Windows (OPT) .....	73
Power Sunroof with Sunshade (PS) .....	76
Power Liftgate Operation .....	79
Hood Operation .....	83



## Before Starting

### Keys

The vehicle is equipped with a Remote Keyless Entry (RKE) transmitter and a Keyless Ignition Node (KIN), to enter, start and protect the vehicle.



### Keyless Ignition Device

The KIN allows the driver to operate the ignition device with the push of a button, as long as the RKE transmitter is inside the vehicle.



The ignition device has three operating setups indicated on the outer ring. Pressing and releasing the middle button, you can switch from one setup to the next without starting the engine, the switched on indication will turn amber. The engine will start by pushing the center button **START/STOP** with the brake pedal pressed and the device set in any of the three operating setups. In case the ignition device does not change by pushing a button, the RKE transmitter, also called the "key fob", may have a low or discharged battery. If this occurs it is necessary to replace the battery in order to operate the ignition device (see "Requiring and Setting Additional Key fobs" in this section). It is still possible to operate the ignition device using the key fob with discharged battery by pressing the nose side (side opposite of the emergency key) of the key fob on the **START/STOP** button.



### Ignition Device Positions

The ignition device has three operating modes and is activated by pressing the central button only.

- Press and release the central button, to switch from one mode to the next without starting the engine: the active mode indication will light up on the outer ring.
  - Push the central **START/STOP** button with brake pedal pressed and ignition device in any of the three operating modes, to start the engine (  : chapter "Normal Starting of the Engine" in section "Starting and Driving").
- OFF:** is the initial mode that enables centralized door locking from inside the vehicle, provided that all doors are closed.
- ACC:** mode puts power to accessories.

**CAUTION!**

Do not leave the ignition device on the **ACC** position for a long time before a long period of inactivity to avoid further discharging of the battery.

**RUN**: mode enables all devices and controls of the vehicle. mode enables all devices and controls of the vehicle. After 30 minutes of inactivity with the ignition device in the **RUN** or **ACC** position, the transmission lever in P (Park) position and the engine off, the system turns **OFF** automatically in order to preserve battery life.

**Key fob**

The vehicle is provided with two programmed key fobs. In addition to the RKE transmitter the key fob contains an emergency key. The emergency key allows you to open the vehicle by inserting into the lock of

the opening handle on the driver's door, in case the battery of the vehicle or the key fob go dead.

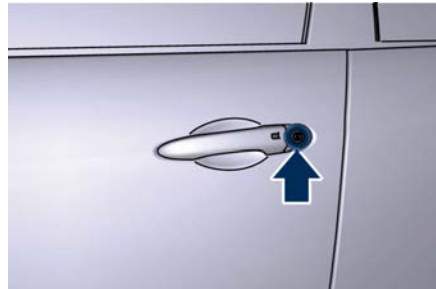

You can keep the emergency key with you when using valet parking. To remove the emergency key:

- hold the mechanical latch on the back of the key fob sideways;
- simultaneously remove the emergency key by sliding laterally towards the end of the key fob.

**NOTE:**

You can insert either side of the emergency key into the lock cylinder.

**Shift Ignition Device to OFF Alert**

Opening the driver's door to exit the vehicle when the ignition device is set in **ACC** or **RUN** (engine not running), a beep will remind you to cycle the ignition to **OFF**.

In addition to the acoustic signal a dedicated message is displayed on the instrument cluster.

If the ignition device is left in the **ACC** or **RUN** position, when vehicle is locked the system will turn off the instrument cluster and automatically set ignition device to **OFF**.

With the MIA system, the power window switches, radio, power sunroof (☀️), and power outlets will remain active for up to 10 minutes after the ignition device is cycled to the **OFF** position. Opening either front door will cancel this function, it is possible to set the timing of this function.

**NOTE:**

Refer to “Functions of Settings Menu on MIA” in section “Dashboard Instruments and Controls” for further information.



## Before Starting



### WARNING!

- When leaving the vehicle, always remove the key fob and lock your vehicle.
- Do not allow children to be in a vehicle unattended or with access to an unlocked vehicle. A child or others could be seriously or fatally injured. Children should be warned not to touch the parking brake trigger, brake pedal or the shift lever.
- Do not leave the key fob in or near the vehicle, and do not leave the ignition device in the ACC or RUN mode. A child could operate power windows, other controls, or move the vehicle.
- Do not leave children or animals inside parked vehicles in hot weather. Interior heat build-up may cause serious injury or death.
- An unlocked car is an invitation to thieves. Always remove the key fob from vehicle, cycle the ignition device to OFF and lock all doors when leaving the vehicle unattended.





### WARNING!

- Do not ingest battery, chemical burn hazard. This product contains a coin/button cell battery. There is a potential chemical burn hazard. Do not ingest the battery. If the coin/button is swallowed, it can cause severe internal burns in just 2 hours and can lead to death.
- Keep new and used batteries away from children. If the battery compartment does not close securely, stop using the product and keep it away from children. If you think batteries might have been swallowed or placed inside any part of the body, seek immediate medical attention.

## Illuminated Entry/Exit

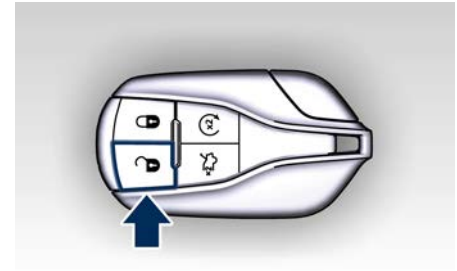
Lights will turn on and off when you enter/exit the vehicle and operate the buttons on the key fob and/or on the “Passive Entry” system as follows:





- If the unlock command is enabled by pressing the specific  button on the key fob or by the “Passive Entry” system, the “illuminated entry” mode will activate. Courtesy & dimmable internal lighting, night front seats



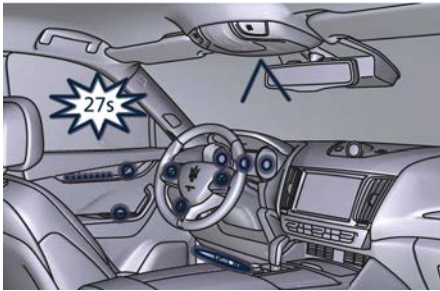

lighting, and approach lighting will stay on for 27 seconds.



- If the lock command of the car is enabled by pressing the specific  button on the key fob or by the “Passive Entry” system, when the key fob is out of range, all the lights will turn off within 3 seconds, if they were previously on.

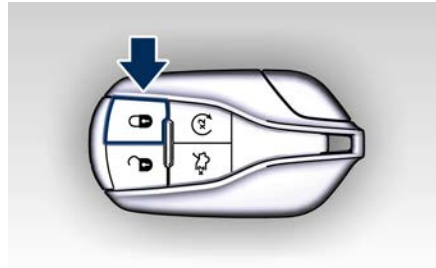

- After activating the power liftgate opening command in the possible modes (see “Power Liftgate Operation” in this section), the inner trunk and liftgate lights will turn on and will stay

on for 10 minutes before turning off. The lights will immediately turn off if you lock the power liftgate before 10 minutes.

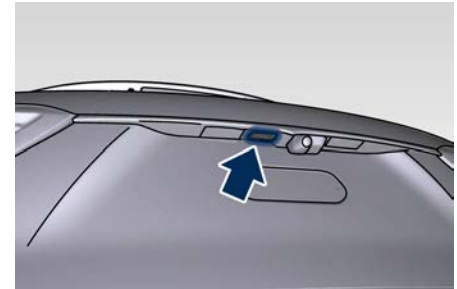
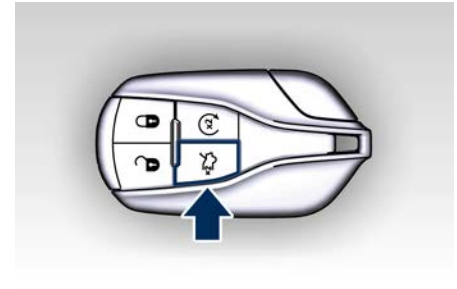



## Before Starting

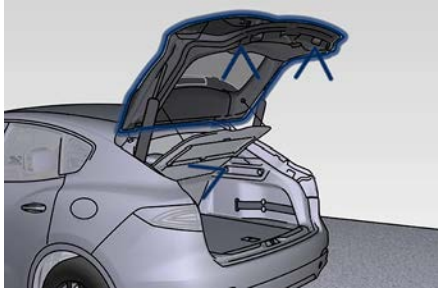

- On the vehicles equipped with this function, if the **PANIC** button is pressed on the key fob, the headlights, position lights and the courtesy & dimmable lights will turn on. For further information,  : chapter "Vehicle Security Alarm" in section "Safety".

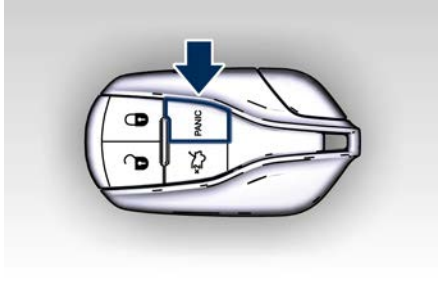

### Vehicle Lighting with Open/Closed Doors

- If one or more doors are open, the central light, front/rear domelights (main and spot light), the instrument

cluster, the MIA display, the night front seats lighting and the ignition device backlight will turn on and will light up for 27 seconds.

- If the doors are closed, all lights will turn off (within 3 seconds) with the exception of the console display and the ignition device backlight, which will turn off after 27 seconds.



### Courtesy Light with Logo

If equipped, a courtesy light with the Maserati logo can be provided

on the bottom of the front doors. The illuminated logo will remain on until the door is closed.

### NOTE:

The **Authorized Maserati Dealer** can provide you with any information about the Maserati approved "Courtesy Light with Logo", available in the "Genuine Accessories" range.

### Use of Light Switch for Vehicle Lighting

Vehicle lighting can be operated from the key fob, the "Passive Entry" system and from the light switch on the left side of the dashboard.

Refer to "Light Controls" in section "Dashboard Instruments and Controls" where it is indicated which external lights turn on according to light switch position.



United States Market

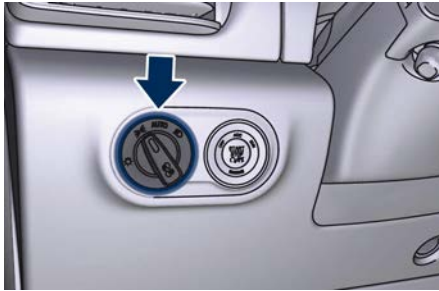

Canadian Market

## Ambient Lights and Backlight Adjustment

The ambient light and the backlight of the controls and instruments does not depend on the position of the light switch but on the detection of the ambient brightness made by the RLS solar sensor.

In “DAY” mode the backlighting of the instruments will be at 100% intensity while the backlighting of the switches will be at minimum. In “NIGHT” mode backlighting will be set through the buttons on steering wheel right-hand side. The ambient lighting are adjustable in the same condition which is possible to adjust the backlighting. Enter “Vehicle Setting” menu and choose “Backlighting” or “Ambient Lighting” of the “Interior Lighting” sub-menu.

## Unlock the Vehicle with Key fob

The Remote Keyless Entry (RKE) system allows you to unlock the doors and the fuel filler door, open the power liftgate and turn the approach and courtesy lights on from a distance up to approximately 33 ft (10 m). The key fob does not need to be pointed at the vehicle to activate the system. See “Illuminated Entry/Exit” in this section for further information.



### NOTE:

**Driving at speeds of 5 MPH (8 km/h) and above disables the system from responding to all key fobs buttons.**

## Unlock the Doors, Fuel Filler Door and Liftgate

Press and release the unlock button  on the key fob once to unlock the driver's door or twice within five seconds to

unlock all doors, the fuel filler door and the power liftgate. The turn signal lights will flash for the unlock signal recognition. The illuminated entry/exit system will also turn on. See “Passive Entry System” in this section for further information.

## Unlock Driver Door/All Doors with Key fob 1st Press

This function allows you to program the system to unlock either the driver's door or all doors, the fuel filler door and the power liftgate, by the first press of the unlock button  on the key fob. To change the current setting, see “Functions of Settings Menu on MIA” in section “Dashboard Instruments and Controls”.

## Lock/Unlock Doors Flash Lights

This function will cause the flash of the turn signal lights when the doors are locked or unlocked with the key fob. This function can be turned on or turned off. To change the current setting, see “Functions of Settings Menu on MIA” in section “Dashboard Instruments and Controls”.

## Turn Headlights On with Key fob

This function activates the headlights for up to 90 seconds when the doors are unlocked with the key fob. The duration can be set as desired. To change the



## Before Starting

current setting, see “Functions of Settings Menu on MIA” in section “Dashboard Instruments and Controls”.

### Sound Horn when Locking the Doors with Key fob

With this function activated the horn will sound when the doors are locked with the key fob. This function can be enabled or disabled. To change the current setting, see “Functions of Settings Menu on MIA” in section “Dashboard Instruments and Controls”.

### Unlatch the Liftgate

Press the button  on the key fob two times within five seconds to unlock and fully open the power liftgate. See chapters “Passive Entry System” and “Power Liftgate Operation” in this section for further information.

## Requiring and Setting Additional Key fobs

Provide your **Authorized Maserati Dealer** the following when ordering additional key fob:

- all key fobs in your possession;
- a personal ID;
- the identification and registration documents proving ownership of the vehicle.

Setting new key fobs or re-setting the original ones can only be performed at an **Authorized Maserati Dealer**.

### NOTE:

Codes of any key fob that are not present when the new setting procedure is done will be deleted from the memory to prevent lost or stolen key fobs transmitters being used to disarm the electronic alarm system.

### Key fob Battery Replacement

### NOTE:

A low charge level of the key fob battery will be indicated on the instrument cluster display.

The recommended replacement battery type is: CR2032. To replace the battery proceed as follows:

- Remove the emergency key as indicated in “Keys” chapter of the current section.

- Loosen the lateral screw that connects the two side covers with a torx T6 screwdriver.



- Separate the two lateral covers from the key fob case.





- Separate both parts of the key fob case.



- Remove the card with PCB (Printed Circuit Board).



- Remove the battery from its seat and replace with a new recommended type of battery.

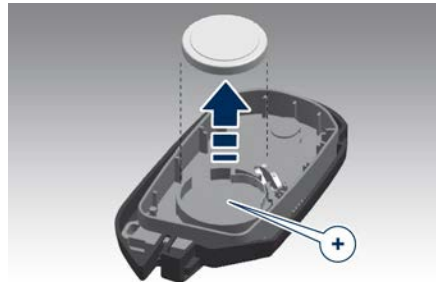

### ENVIRONMENTAL!

Batteries contain dangerous materials that could harm the environment. Please dispose of them according to local regulations or at an Authorized Maserati Dealer.

### NOTE:

Avoid touching the new battery with your fingers. Skin oils may cause battery deterioration. If you touch a battery, clean with alcohol.

- Match the + sign on the battery to the + sign on the inside of the battery clip, located on the back cover.
- Replace the printed circuit board by using the indicated pin for the sealing of the two covers.
- Assemble the key fob case and reassemble the two lateral covers: a click will indicate successful sealing.
- Combine the disassembled parts with clamping screw and reassemble the emergency key.

### Radio Frequency RKE Transmitter - Regulatory Information

The "Regulatory Information" for all the radio frequency and radar devices can be accessed by accessing the "Services" section on the website [www.maserati.com](http://www.maserati.com).



## Passive Entry System

The “Passive Entry” system is an enhancement to the vehicle’s Remote Keyless Entry (RKE) system. This function allows you to lock and unlock the vehicle’s door(s) without having to press the key fob lock or unlock buttons.

**NOTE:**

- “Passive Entry” may be programmed to on/off; see “Functions of Settings Menu on MIA” in section “Dashboard Instruments and Controls” for further information.
- If wearing gloves, or if it has been raining on the “Passive Entry” door handle, the unlock sensitivity can be affected, resulting in a slower response time.
- Access to the vehicle using “Passive Entry” system may not work properly in case of interference caused by external sources such as metal objects, mobile phones, overhead power lines, antennas, etc. In these cases, use the buttons of the key fob to open and close the vehicle or the emergency key, inserting it into the driver side door lock.
- The “Passive Entry” system does not lock and unlock the doors directly and immediately but with a slight delay (about 2 seconds).

### Unlock Door from the Driver Side

With a valid key fob within 3.3 ft (1 m) of the driver’s door handle, grip the driver’s door outside handle to unlock the door automatically. The interior door panel lock knob will rise when the door is unlocked.



**NOTE:**

If “1<sup>st</sup> Press of Key Fob Unlocks” is programmed on all doors will unlock when you grip the front driver’s door

handle. To select between “Driver Door” and “All Doors”, see “Functions of Settings Menu on MIA” in section “Dashboard Instruments and Controls”.

### Unlock Door from the Passenger Side

With a valid key fob within 3.3 ft (1 m) of the passenger door handle, grip the front passenger outside door handle to unlock all four doors automatically. The interior door panel lock knob will rise when the door is unlocked.

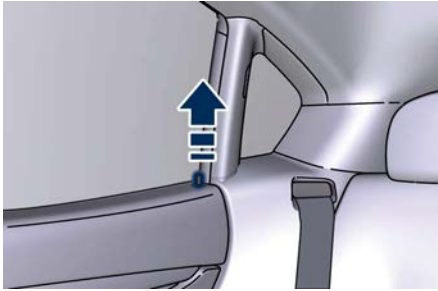

**NOTE:**

All doors will unlock when you grip the front passenger door handle regardless of the driver's door unlock preference setting ("Driver Door" or "All Doors").

### Preventing Inadvertent Locking of the Key fob Inside the Vehicle

To minimize the possibility of unintentionally locking a key fob inside your vehicle, the "Passive Entry" system is equipped with an automatic door unlock function which will function if the ignition device is in the **OFF** position. If one of the vehicle doors is open and the door panel switch  is used to lock the vehicle, once all open doors have been closed, the system checks the inside and outside of the vehicle for any valid key fobs.

If one of the vehicle's key fobs is detected inside the vehicle, and no other valid key fobs are detected outside

the vehicle, the "Passive Entry" system automatically unlocks all vehicle doors and chirps the horn fourteen times (on the fifteenth attempt ALL doors will lock and the key fob will be locked in the vehicle). This will happen even when pressing the lower  button on the outer edge of the left trunk compartment lining to close and lock the power liftgate.

**NOTE:**

The vehicle automatically unlocks the doors under any of the following conditions:

- the doors are manually locked using the door lock knob positioned on the door panel;
- there is a valid key fob inside the vehicle;
- there is not a valid key fob outside the vehicle.

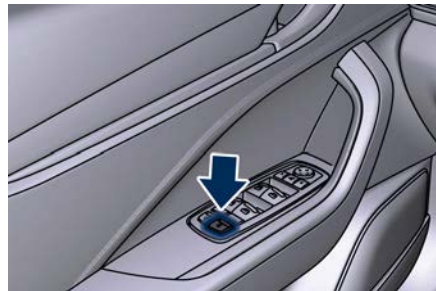
**NOTE:**

The vehicle will not automatically unlock the doors under any of the following conditions:

- the doors are locked using the key fob;
- the doors are locked using the "Passive Entry" button on the door handles;
- there is a valid key fob outside the vehicle and within 3.3 ft (1 m) of either "Passive Entry" door handle;
- fifteen attempts are made to lock the doors using the door panel switch and/or the lower  button (on the outer edge of the left trunk compartment) and then close the doors.





## Before Starting

3



If the key fob is inside the passenger compartment and one of the doors locked only to the first detent of lock pawl (hence it is not fully closed), when the vehicle lock function with alarm system for trunk lid and doors is being activated by means of RH button  at the bottom of the trunk lid, said function will be activated all the same.

In this condition, any attempt to duly close the door that is partially open will cancel vehicle lock and alarm system arming thus leaving vehicle unlocked.

### Release the Liftgate and Enter the Trunk

With the key fob within 3.3 ft (1 m) of the power liftgate, press the button located between the license plate lights, the power liftgate will automatically open until it has reached its maximum height; if the same button is not pressed again to stop it (for more information, see

chapter “Power Liftgate Operation” in this section).

If the vehicle had already been unlocked through key fob or “Passive Entry”, the presence of the key fob is not required; simply use the button located between the license plate lights to unlock the manual liftgate or to open the power liftgate/Hand-free automatically.



### Manual Door Lock from Outside

With one of the vehicle’s key fobs within 3.3 ft (1 m) of the driver or passenger front door handles, press the external door handle button to lock all four doors.

#### NOTE:

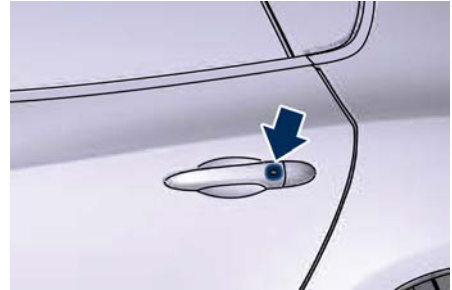
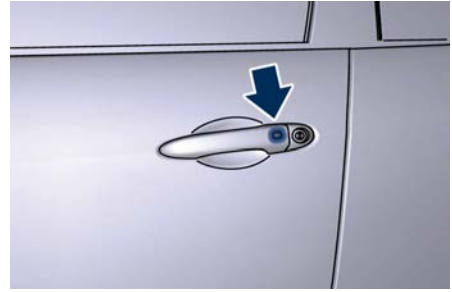
- After pressing the outside door handle button, you must wait two seconds before you can lock or unlock the doors using this door handle. By pulling the external door handle, you can check if the car remains locked, without “Passive Entry” system reacting and unlocking the doors.
- The “Passive Entry” system will not operate if the key fob battery is dead.
- If power liftgate/Hands free has been left open, it will stay open when you press the button on door external handle, and the locking function will only occur after the closing of the power liftgate.



The vehicle doors can also be locked by using the key fob lock button  or the lock button  located on the vehicle’s inner door panel.



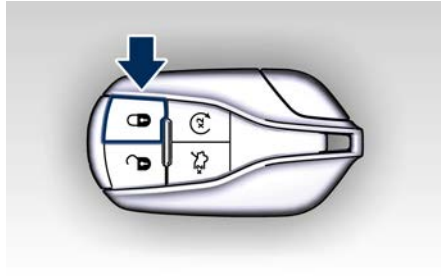

### Radio Frequency RKE Transmitter - Regulatory Information

The "Regulatory Information" for all the radio frequency and radar devices can be consulted by accessing the "Services" section on the website [www.maserati.com](http://www.maserati.com).

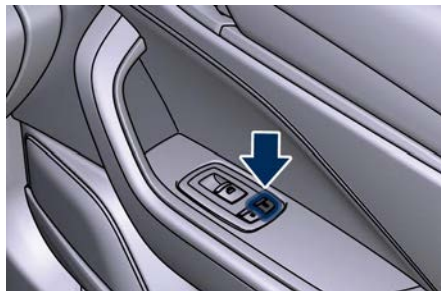
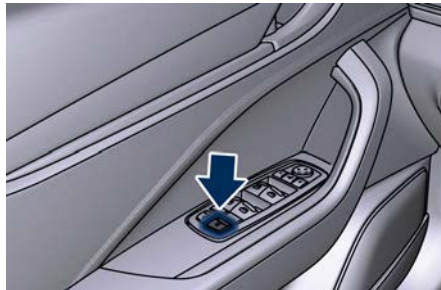

### Power Windows

The window controls on the driver's door panel govern all the door windows.

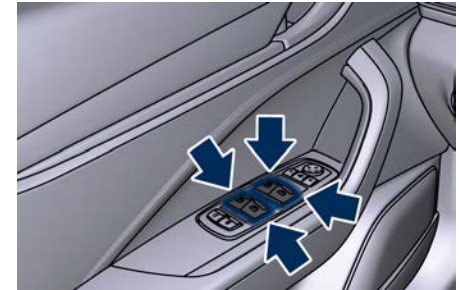

There are single window controls on each passenger door trim panel, which operate the corresponding window. The window controls will operate only when the ignition device is in the **ACC** or **RUN** position.

(Continued)



## Before Starting

### NOTE:

- The power window switches will remain active for up to 10 minutes after the ignition device is turned to the OFF position. Opening either front door will cancel this function. The time lapse can be set. See “Functions of Settings Menu on MIA” in section “Dashboard Instruments and Controls” for further information.
- Frequent activations of the power windows could result in a temporary lock out of the motors. In this case, wait a moment before a new activation.



### WARNING!

Improper use of the power windows and the sunroof (if equipped) can however be dangerous, even with the anti-pinch prevention system. Before and during activation of the power window, always check that the passengers are not exposed to the risk of injury both by the moving window and by personal objects that could be dragged or hit by it. Do not leave unattended children in a vehicle with a key fob inside. When getting out of the vehicle, always remove the key fob to prevent the windows being

**accidentally activated, posing a risk to passengers remaining onboard.**

### Auto-Down Function

The driver door power window switch and some model passenger door power window switches have an auto-down function.

Press the window switch to the second detent, release, and the window will go completely down automatically.

To open the window part way, press the window switch to the first detent and release it when you want the window to stop.

To stop the window from going all the way down during the auto-down operation, pull up on the switch briefly.

### Auto-Up Function with Anti-Pinch Protection

Lift the window switch to the second detent, release, and the window will go all the way up automatically.

To stop the window from going all the way up during the auto-up operation, push down on the switch briefly.

To close the window part way, lift the window switch to the first detent and release it when you want the window to stop.

### NOTE:

- If the window runs into any obstacle during auto-closure, it will reverse direction and then go back down. Remove the obstacle and use the window switch again to close the window.
- Any impact due to rough road conditions may trigger the auto reverse function unexpectedly during auto-closure. If this happens, pull the switch lightly to the first detent and hold to close the window manually.
- Frequent activations of the anti-pinch function could disable the auto-down and auto-up function of the windows. In order to re-activate this function proceed with a reset cycle as described in the next paragraph.



### WARNING!

**There is no anti-pinch protection when the window is almost closed. Be sure to clear all objects from the area before closing the window.**

### Reset Auto-Up/Down

Should the auto-up/down function stop working, the window probably needs to be reset.



To reset auto-up/down, pull the window switch up to close the window



completely and push the window switch down to open the window completely.

### Open the Windows with Key fob and Ignition Off

When the ignition device is in **OFF** position, windows can be opened by pressing the  button on the key fob.

- Press the  button and release it;
- Press a second time the  button and keep it pressed until complete opening of the windows, if they were closed.

### Rear Window and Sunshade Lockout Button

The window lockout button on the driver's door trim panel allows to disable the window and sunshade control on the rear doors by pressing the window lockout button (setting it in the down position).



To enable the controls previously described, press the window lockout

button again (setting it in the up position).

### Wind Buffeting

Wind buffeting can be described as the perception of pressure or a helicopter-type sound. Your vehicle may exhibit wind buffeting with the windows down, or the sunroof (if equipped) in open or partially open positions. This is a normal occurrence and can be minimized. If the buffeting occurs with the rear windows open, open the front and rear windows together to minimize the buffeting. If the buffeting occurs with the sunroof open, then adjust the sunroof opening to minimize the buffeting.

## Power Sunshades on Rear Door Windows

### NOTE:

- On vehicles provided with power sunshades on the rear windows, the window switches also operate the sunshades.
- The rear windows lock button operates the rear power sunshades as well.
- The window and sunshades controls will operate only if the ignition device is in **ACC** or **RUN** position.

Operation of the rear windows and related sunshades is done by pressing or pulling the window switch and depends on the position of the windows prior to the command operation.

As described for the opening and closing functions of the power windows (see chapter “Power Windows” in this section), the windows switch has two functioning modes: press and release the switch to the first detent to partially move the window; press and release the switch to the second detent to move the window all the way up or down.



### Before Starting

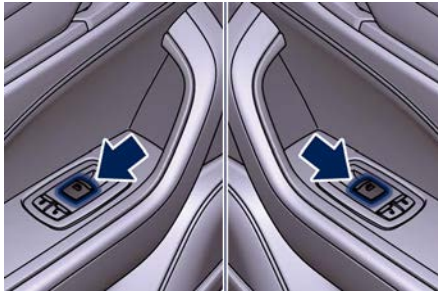
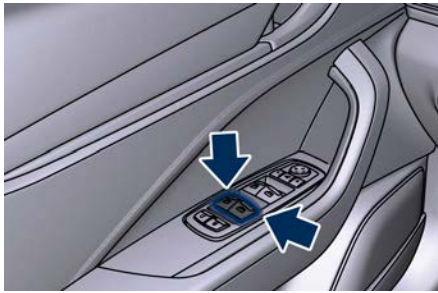

### Operations



### WARNING!

Rear seat passengers must be careful when operating the sunshades, since there is the risk of being pinched between the top of the sunshade and the head lining, during raising, and between the top edge of the sunshade and the door panel, during lowering.



### CAUTION!

Before activating the sunshade, make sure that no objects can interfere with its travel.

The following images and the subsequent text show the possible starting positions (“A”, “B”, “C” and “UP”, “DOWN”) and function of the window and the sunshade, to be independently activated by pressing or lifting the control switch  to the first (1) or second (2) detent.

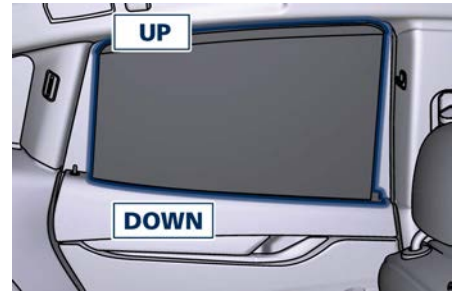

A. Sunshade fully unrolled (“UP” position) and Window closed (“UP” position)

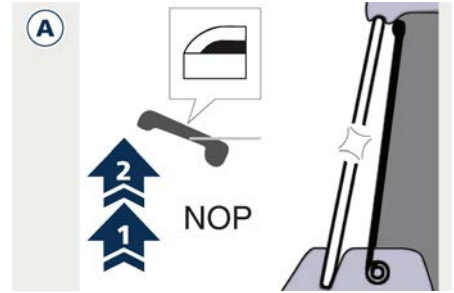
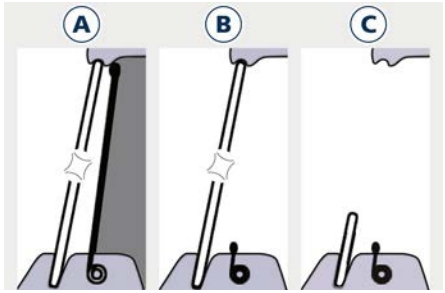

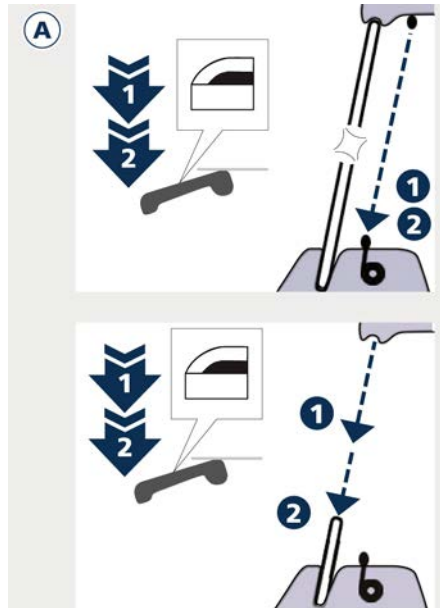

• Pulling the control up to **1** or **2** detent: no action (“**NOP**”).

- 1.1 Pressing the control to **1** detent: the sunshade rolls down completely and the window stays closed.

- 1.2 Pressing the control again to **1** detent: the window opens partially until the control is released and the sunshade stays down (pressing the control to **2** detent: the window opens completely).
- 2.1 Pressing the control to **2** detent: the sunshade rolls down completely while the window stays closed.
- 2.2 Pressing the control again to **2** detent: the window opens completely.

**B. Sunshade fully rolled down (“DOWN” position) and Window closed (“UP” position)**

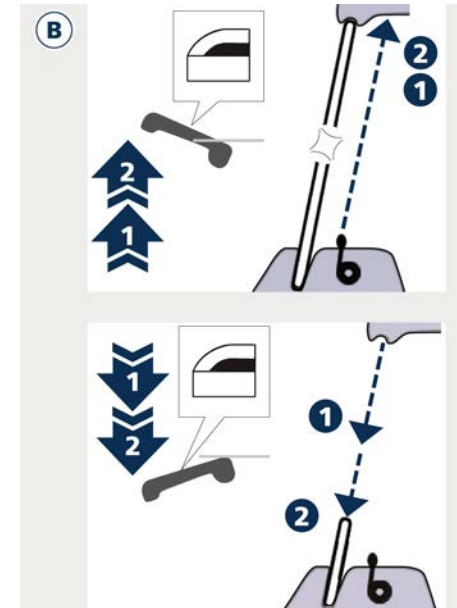

- Pulling the control up to **1** or **2** detent: the sunshade unrolls completely and the window stays closed.
- Pressing the control to **1** or **2** detent: the window opens partially or completely and the sunshade remains rolled.



## Before Starting

C. Sunshade fully rolled down (“DOWN” position) and Window completely open (“DOWN” position)

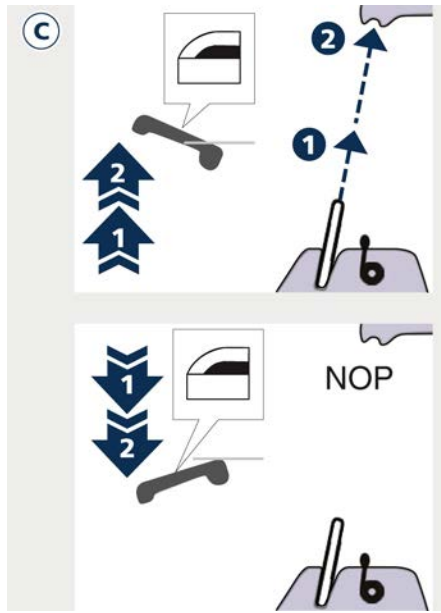

- Pulling the control to 1 or 2 detent: the window closes partially or completely and the sunshade remains rolled.
- Pressing the control to 1 or 2 detent: no action (“NOP”).

### Teaching Cycle

After battery disconnection, the following teaching cycle is required to store the limit positions the sunshades.

Use the controls on the rear doors to move the sunshades.

- With glass closed, lift rear sunshade control on driver side for a few seconds. It is not necessary that the sunshade reaches its upper limit.
- Reverse the sunshade movement by pressing the control downwards. Once the lower limit is reached, press and hold the control for at least 10 seconds. This action allows setting the control unit in initialization status.
- Release the movement command.
- Within maximum 15 seconds:
  - Press once the control downwards (first or second detent). In this way the control unit stores the lower limit position. During this operation a slight click of the sunshade motor that switches to mechanical lock condition can be heard.
  - Lift the control and hold it up until the sunshade completes its upstroke and reaches the car body pillar, fully home. Once the upper limit stop is reached, the sunshade will move downwards for approx. 0.08-0.12 in (2-3 mm) and the control unit will store this height as the upper limit. Now the teaching of the driver side rear sunshade is complete.
- Repeat the same operations for the passenger side rear sunshade to complete the teaching procedure.

## Power Sunroof with Sunshade

The sunroof and the sunshade are power-controlled and can only be operated with the ignition device in RUN position.

The sunroof is made of two glass panels: the front one can be moved whereas the rear one is fixed. The right switch controls the sunroof movement, whereas the left one controls the sunshade.

Lifting of the sunroof front panel for venting is controlled by the button, behind the two switches.

By opening the sunroof a front flap rises automatically in order to deviate the air flow.

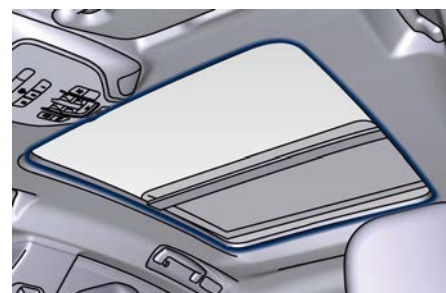

**WARNING!**

- **Improper use of the sunroof can be dangerous, even if it features a finger-trap prevention system. Before and during the sunroof operation, always make sure that passengers are not exposed to the risk of injuries caused by the moving sunroof or by personal objects dragged or hit by the moving sunroof.**
- **Never leave children in a vehicle with the key fob in the passenger compartment.**
- **In a collision, there is a greater risk of being thrown from the vehicle if the sunroof is open. Always fasten your seat belt properly and make sure all passengers are properly secured too.**
- **Do not allow small children to operate the sunroof. Never insert fingers, other**

**body parts, or any object through the roof opening.**

**CAUTION!**

- **In the event of rain, always close the sunroof to prevent water infiltrations from staining the fabric/leather upholstery.**
- **Do not open the sunroof if there is ice on it: risk of damage.**
- **Do not open the sunroof in case of presence of any object (bicycle, surfboard or other type of carriers fixed to cross bars) that might interfere with sunroof.**

**Slide Opening Sunroof**

Press backward and release the right switch: the front panel will open completely.

From the completely open position, press onward and release the right switch: the front panel will close completely.

The automatic movement can be interrupted in any position by pressing backward and onward the right switch again.

**Venting Sunroof**

Press and release the rear button; the sunroof front panel will open to the vent position. Where this function is available,

this type of opening can be activated regardless of the sunroof position. During this opening operation, any movement of the button will stop the movement of the sunroof.

By pressing the rear button when the sunroof is completely closed, the latter will open to the venting position.

**Sunshade**

Press backward and release the left switch: the sunshade will move to the vehicle rear side until completely open. From this position, press onward and release the left switch to move the sunshade to the vehicle front side until completely closed.

During the opening and closing operations, work on backward and onward the left switch to interrupt the sunshade movement in any position.

**Pinch Protect Function**

This function will detect an obstruction in the roof opening during the automatic closure or a constant obstruction of the sunroof front panel. If an obstruction is detected by the safety system during the closing movement, the sunroof front panel will automatically retract. If this occurs, remove the obstruction then press onwards and release the right switch to reactivate the sunroof automatic closure.



## Before Starting

### NOTE:

- If three consecutive attempts to close the sunroof result in pinch protect reversals, the fourth attempt will be manual, with pinch protect function disabled.
- Pinch protection is disabled while pressing the switch/es.

### Initialization Procedure

In case of a fault in the automatic opening/closing movements or in case of battery removal, it is necessary to initialize the automatic operation of the sunroof.



Proceed as follows:

- bring the sunroof in the completely closed position;
- push the ignition device to **OFF** position and keep this condition for 10 seconds;
- push the ignition device to **RUN** position;
- press the right switch onwards and keep it pressed for at least 10 seconds after which you should hear the sunroof electric motor mechanic stop;
- within 5 seconds, press the right switch onwards again and keep it pressed: the sunroof performs an automatic complete opening and closing cycle. Should this not happen, repeat the procedure from the beginning;
- press the right switch onwards and keep it pressed until the sunroof is

completely closed: the initialization procedure is then completed.

### Opening the Power Sunroof with Key fob and Ignition Off

When the ignition device is in **OFF** position, if the sunroof is closed, it can be open together with the windows by pressing the  button on the key fob (refer to “Power Windows” in this section).

- Press and release the  button.
- Press a second time the  button and keep it pressed until the sunroof is completely closed.

To open completely the sunroof from the outside, press in the same way the  button on the key fob.

### Wind Buffeting

Wind buffeting can be described as the perception of pressure or a helicopter-type sound. Your vehicle may exhibit wind buffeting with the windows down, or the sunroof in certain open or partially open positions. This is a normal occurrence and can be minimized. If the buffeting occurs with the rear windows open, then open the front and rear windows together to minimize the buffeting. If the buffeting occurs with the sunroof open, then adjust the sunroof opening to minimize the buffeting.

### Ignition Off Operation

The power sunroof controls will remain active for up to approximately ten minutes after the ignition device is in **OFF** position. Opening either front door will cancel this function. The ignition system timing can be set using the MIA system (see “Functions of Settings Menu on MIA” in section “Dashboard Instruments and Controls”).

### Sunroof Maintenance

Use only a nonabrasive cleaner and a soft cloth to clean the glass panel.





## Power Liftgate Operation

Automatic opening and closing movement of the power liftgate is driven by electric actuators and a motorised latch ensuring lid locking upon closing. Power liftgate can be opened from outside pressing twice within five seconds the button  on the key fob or from inside pressing the button on front dome console.

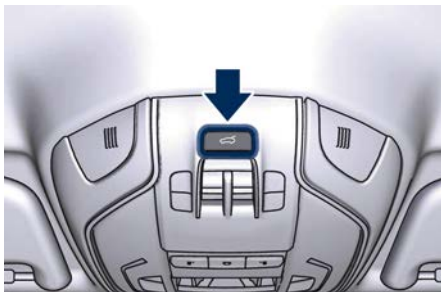
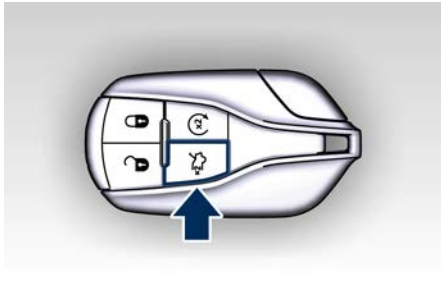

### NOTE:

The shift lever must be in P (Park) before the button on front dome console can operate.

The  button on key fob and button on front dome console not only allow user to completely open the power liftgate, but also to stop it at any intermediate position by pressing the button again whenever you wish to stop and resume the opening process.

When the button  on the key fob is pressed twice within five seconds, the direction indicators flash twice to indicate the opening or closing of the power liftgate, if the light flashing function at closing is activated on MIA (for more information, see the chapter "Functions of Settings Menu on MIA" in section "Dashboard Instruments and Controls").

With the ignition device in **RUN** position, the red symbol  and the image of the car with the liftgate open will be displayed on the instrument cluster. Once the liftgate is closed, both symbol and image will disappear from the display.



With the ignition device in the **OFF** position, only the liftgate open symbol will display until closure. See "Passive Entry System" in this section for more information on liftgate operation with the "Passive Entry" function.

In addition to these commands, it is possible open and close the power liftgate, or stop its movement, by simply moving your foot under the rear bumper, if the vehicle is so equipped with the kick sensor option. In this latter case, the liftgate will be opened and closed only if the "Passive Entry" system acknowledges the presence of the key fob within 3.3 ft (1 m) of the liftgate. Power liftgate uses the button in between the license plate lights, indicated in figure, to activate the opening once the car has been unlocked by the key fob or by the "Passive Entry" function.



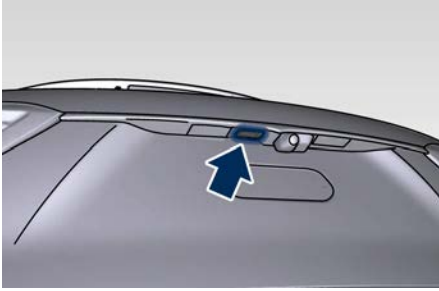

## Before Starting



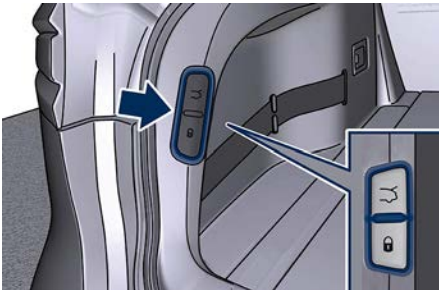

3

By pressing this button when the power liftgate is closed, you can open it completely, or by pressing the button again stop the opening process, or by pressing the button again invert the movement and close it completely. When the power liftgate is open, to move it there are two buttons positioned on the outer edge of the left boot compartment lining as indicated in figure.





When the liftgate is completely open if you press and release the upper button , the power liftgate will be completely closed unless it is stopped;

- if instead the power liftgate is in an intermediate position and you press and release the upper button  during the closing or opening stroke, it will be stopped;
- if instead the power liftgate is stopped in an intermediate position and you press and release the upper button , it will reverse its previous movement and it will be completely opened or closed unless it is stopped again.

In any case, when you press the upper button , the doors will not be locked and the alarm system will not be armed.

When the liftgate is completely open if you press and release the lower button , the power liftgate will be completely closed unless it is stopped;

- if instead the power liftgate is in an intermediate position and you press and release the lower button  during the closing or opening stroke, it will be stopped;
- if instead the power liftgate is stopped in an intermediate position and you press and release the lower button , it will reverse its previous movement and it will be completely opened or closed unless it is stopped again.

In any case, when you press the lower button , the doors will not be locked and the alarm system will not be armed immediately, but only when the liftgate will have reached the totally closed position as effect of every movement commands received from every other available inputs.

### NOTE:

- The order of the functions shown does not represent the sequence in which they can be performed.
- The buttons of the power liftgate do not work if a gear is engaged or if the vehicle speed is higher than 0 MPH or km/h.
- The power liftgate does not work with temperatures lower than  $-22^{\circ}\text{F}$  ( $-30^{\circ}\text{C}$ ) or higher than  $150^{\circ}\text{F}$  ( $65^{\circ}\text{C}$ ).
- If the opening buttons or the handles are operated while the power liftgate is closing, the stroke of liftgate stops. Pressing another time the same command it reverses movement and fully open.
- If the opening buttons or the handles are operated while the power liftgate is opening, the motor of the liftgate is disabled to allow manual operation.
- If the power liftgate finds several obstacles during the same operating



- cycle, it will stop automatically and must be opened or closed manually.
- If the power liftgate is closing and a gear is engaged, the liftgate will continue closing. In this condition, it is possible that, during the closing stroke, it may find an obstacle and stop.





### WARNING!

If, for any reason, the liftgate must remain open while driving, close all the windows and activate the fan of the air conditioning control at the maximum speed to force the air out of the vehicle to avoid exhaust emission intrusion. Do not activate recirculation.

### Set the Position of Maximum Power Liftgate Opening

The maximum opening position of the liftgate can be modified using the previously described buttons on the outer left edge of the trunk compartment.

1. Activate the liftgate and stop it in the new maximum opening position to be set, by pressing the upper  button.
2. Press the upper  or lower  buttons and keep it pressed for 3 seconds.

3. Release the button (pressed in the previous point). Upon the following opening controls, the liftgate will stop in the stored position.

If you want to reset the maximum possible opening position of the liftgate, proceed as described below starting from the previously set opening position.

1. Manually push the liftgate to the maximum possible opening position.
2. Repeat the previously performed steps 2 and 3.

### Power Liftgate Automatic Safe Movement

Power liftgate safe opening and closing is ensured by a protection system able to stop its movement when an obstacle is detected along the path: when opening or closing, it stops automatically and then slightly moves back. Along the upper outer edges, the vehicle can be equipped with anti-pinch protection sensors. These sensors stop the automatic closing stroke and partly open the power liftgate when a pressure is carried out, also slight, within their range shown in the figure.

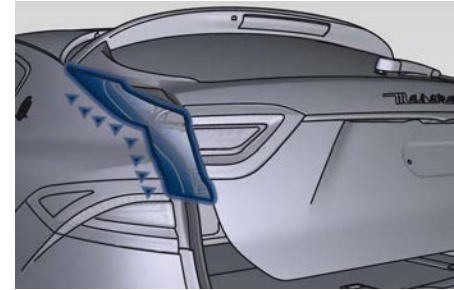

After the closing command, when power liftgate starts closing, all the indicators will blink to warn anyone within range. Apart from activating indicators blinking when power liftgate is operated, it is also possible to activate a sound warning by selecting the relevant function within MIA user settings (see “Functions of Settings Menu on MIA” in section “Dashboard Instruments and Controls”).

When power liftgate edge reaches the car body, the motor locking the latch is activated automatically.

If necessary, the power liftgate can also be opened or closed manually using the handles indicated in the picture. This operation could be required when the liftgate remains open for a long period of time.



## Before Starting

3

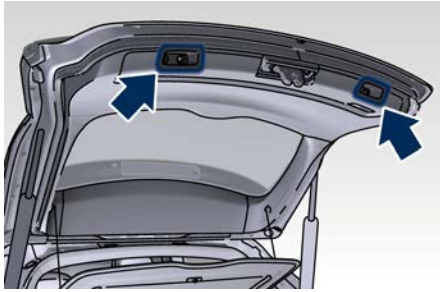

### NOTE:

Frequent activations of the anti-pinch protection function may disable the automatic movement of the power liftgate. To reactivate this function, perform a reset cycle by carrying out a complete opening/closing sequence, after manually closing the power liftgate.



### WARNING!

- **Activate power liftgate only when vehicle is at a standstill to not obstruct rear visibility.**
- **Always pay utmost attention when opening and closing the tailgate. If for any reason the protection system might fail to respond, it could cause injury to anyone within the operating area.**

- **After the closing command, always make sure that power liftgate is completely closed.**



### CAUTION!

- Under extreme weather conditions, liftgate seal could freeze and compromise power liftgate automatic opening and closing.
- Before opening power liftgate, make sure that no objects or snow are set on liftgate or might jam or prevent its opening.

### Hands Free Power Liftgate Release and Closing

"Hands Free" mode is controlled by the "Passive Entry" system (see chapter "Passive Entry System" in this section), which automatically releases and closes the power liftgate when you place your foot in the area under the rear bumper. The system will only operate if the system acknowledges the presence of the key fob within 3.3 ft (1 m) of the power liftgate.

The range of the sensors that detect your foot movement extends along and underneath the central portion of the rear bumper.

To activate the power liftgate, stand behind the vehicle, near the liftgate, and move your foot under the bumper as if to

kick something. Do not place your foot too close to the bumper or touch the underbody.



### WARNING!

- **Pay careful attention to the exhaust tailpipes as they can reach high temperatures and, in case of contact, they can cause severe burns.**
- **When it is not necessary to open the power liftgate with the "Hands Free" mode, make sure the key fob is outside the range of use (3.3 ft/1 m). Otherwise, the power liftgate can be opened accidentally by an unintentional movement of the foot.**



In order for the sensors to detect your foot movement, move your foot towards the vehicle rather than sideways and immediately pull it back: from this moment, the power liftgate will activate within two seconds.



If closed, with the foot movement the power liftgate will:

- unlock and completely open;
- after another kick, will stop;
- after another kick, will reverse its movement and completely close unless stopped again.

If open, with the foot movement the power liftgate will:

- completely close but not lock;
- another kick before the completed closing can stop the movement;
- if the movement was stopped another kick operation will invert a complete opening.

#### NOTE:

- If your foot movement fails to activate the power liftgate movement, wiggling your foot under the bumper will not help. Repeat the whole kick movement.
- In particular situations, external factors affecting the sensor area may trigger the Hands free power liftgate release function. For example, when washing the vehicle, a water jet aimed at the sensor area may trigger the Hands free power liftgate release function. Keep the key fob away from the sensing range of the sensors (10 ft/3 m) or disable the Hands Free function from the MIA menu (see “Functions of Settings Menu on MIA” in section “Dashboard Instruments and

Controls”). A key fob located in the front seat passenger area is considered out of range of the Hands Free liftgate release sensor.

- If somebody or something knocks against the power liftgate while it is moving, the safety system might stop lid opening or closing movement.

### Power Liftgate Emergency Release

If the power release control fails to operate by either the key fob or by pressing the button on the dome console, the vehicle battery could be low or disconnected.

If the doors are still locked, use the emergency mechanical key inserted in the driver’s door lock to enter the vehicle and open the hood. In this condition, it is possible to temporarily power the system by using the battery remote poles located inside the engine compartment (see “Auxiliary Jump-Start Procedure” in section “In an Emergency”).

Then it is possible to normally unlock and open the power liftgate by using the key fob or the button on the dome console.

Have the vehicle serviced by an **Authorized Maserati Dealer**.

## Hood Operation

### Opening

Two latches must be released to open the hood.

- From inside the vehicle, pull the hood release lever located under the left lower side of the dashboard.



- Move to the outside and stand in front of the vehicle front grille.



- Slightly lift the hood and push the safety catch as indicated by the arrow.



## Before Starting

The safety catch is located in the center of the hood.

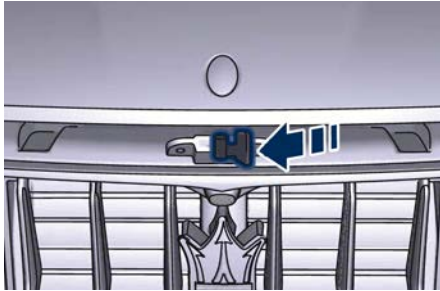

- Lift the hood completely: this operation is facilitated by two gas struts keeping the hood in the fully open position.

With the ignition device in **RUN** position, the red symbol  will display on the instrument cluster with the message indicating that the hood is open.

### Closing

Lower the hood, and then gently drop it. This should secure the inclusion of both latches.



#### CAUTION!

To prevent possible damage, do not slam the hood to close it.



#### WARNING!

**Be sure the hood is fully latched before driving your vehicle. If the lid is not fully latched, it could open when the vehicle is in motion and block your vision. Failure to follow this warning could result in serious injury or death.**



#### WARNING!

**Gear shifting is always active and may be performed even when one or more doors, the hood or the liftgate are open. Therefore, in these conditions, take great care to avoid moving the transmission shift lever and so accidentally engage gears.**



## 4 - Dashboard Instruments and Controls

Instrument Cluster Overview .....	86
TFT Display Areas .....	87
TFT Display Pop up Messages .....	88
TFT Display Setting and Menu Overview .....	89
TFT Display: Menu and Submenu Content .....	93
Warning and Indicator Lights .....	98
Maserati Intelligent Assistant Operation .....	109
Functions of Controls Menu on MIA .....	112
Functions of Settings Menu on MIA .....	113
Controls on Steering Wheel .....	123
Light Controls .....	127
Wipers and Washers Controls .....	134
Analog Clock .....	137
Glove Box Compartment .....	137
Air Conditioning Controls .....	141



# Instrument Cluster Overview

The instrument cluster is divided into three main areas.

**A** - Analogue speedometer. It indicates the vehicle speed and displays in its interior some of the main warning lights (see "Warning and Indicator Lights" in this section).

**B** - Analogue tachometer. It indicates the engine revolutions and displays in its interior some of the main warning lights (see "Warning and Indicator Lights" in this section).

**C** - TFT display. In this area are displayed all the other warning and indicator lights (see "Warning and Indicator Lights" in this section), information, signs and text and/or icon messages.

### NOTE

The image shows the instrument cluster before starting the engine.

U.S. Federal Regulations requires that upon transfer of vehicle ownership, the seller certify to the purchaser the correct mileage that the vehicle has been driven.



V8 Engines (in example TROFEO version)



V6 Engines

If your odometer needs to be repaired or serviced, the repair technician should leave the odometer reading the same as it was before the repair or service. This repair should be performed by an **Authorized Maserati Dealer**.

The odometer setting should be maintained following the repair or service.

Keep a record of the odometer mileage before any repair or service to ensure that the odometer is properly reset.





## TFT Display Areas

When operating, the TFT Display is divided into sectors including menus and sub-menus, running data, warning/indicator lights and messages represented in the example of picture.



The presence of some areas depends on the type of equipment and the target market.

The different sectors of the display layout are rendered in the following picture.

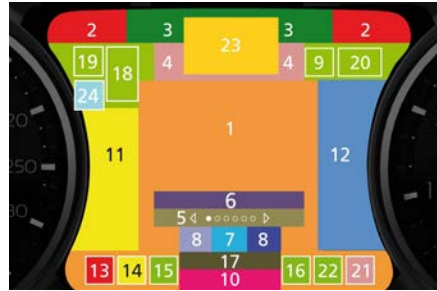

- 1 Main area.
- 2 Selectable information (data, time, outside temperature, compass, etc.). When setting the “Auto Dim High Beams” function (if equipped), in the right portion of this area is displayed the respective green indicator.
- 3 Main menu number and titles with scroll arrows (the number and the main menu title is always visible while scrolling the menu, and for the next five seconds).
- 4 Submenu titles.
- 5 Position within the submenus and scroll arrows (example: 1 of 5). There can be maximum 9 displayable submenu positions. When the number of submenu points exceeds 9, the points are replaced by a numerical value within the scroll arrows.
- 6 Menu Instruction (hideable).
- 7 Shift lever positions (P, R, N, D, M, 1, 2, 3...).
- 8 Gear shift indicator light and paddles (if equipped).
- 9 Hard or soft suspension and Launch Control (TROFEO version only) indicator light.
- 10 Complete odometer (total distance covered by the vehicle).
- 11 Fuel gauge.
- 12 Engine temperature gauge.
- 13 Reconfigurable quadrant for red telltales
- 14 Reconfigurable quadrant for amber telltales.
- 15 Front fog indicator light.
- 16 Low beam headlights/position lights.
- 17 OFF ROAD, I.C.E., NORMAL, SPORT, and CORSA (TROFEO version only) modes indicator light.
- 18 Combined telltale of ACC, LKA and ADA status. They are displayed in the cluster when one (or more) of these systems is enabled and a different menu from “Drive Assist” is displayed in the main area.
- 19 CC, ACC and HDC status function.
- 20 Ride height indicator.
- 21 Electric Parking Brake failure warning light.
- 22 Speed Warning indicator (dynamic text).



- 23 Traffic Sign Assist icons: conditioned and unconditioned speed limit and/or supplementary signs (time restriction, etc.). See "Traffic Sign Assist - TSA" in section "Driver Assistance Systems" for further details.
- 24 BSA and ABSA status.

## TFT Display Pop up Messages

The main area of the TFT display is the one dedicated to "pop up" messages. These pop up messages fall into several categories:

The display background may change according to the type of pop up message displayed.



- No color: normal conditions.
- Yellow color: low-critical warning.
- Red color: high-critical warning.

### Five-Second Stored Messages

When the appropriate conditions occur, this type of message appears on the main display area for five seconds and then returns to the previous screen. Most of the messages of this type are then stored (as long as the condition that activated them remains active) and can be reviewed from the "Stored

Messages" main menu item. Example of this message type is the one shown in the picture.



### Unstored Messages

This message type is displayed until the condition that activated the message is cleared (see example in picture).



### Unstored Messages with Ignition Device in RUN

This message type is displayed until the ignition device is in **RUN** position. An

example of this message type is the one shown in picture.



### Five-Second Unstored Messages

When appropriate conditions occur, this type of message appears on the main display area for five seconds then returns to the previous screen.

### Navigation Messages

When the navigation menu is enabled on the MIA, information pop-ups will be displayed while changing direction or approaching a turning point until the navigation system requires its displaying, or until a command is given via the buttons on the steering wheel. On highway, the first pop up will be displayed at 2 miles (3.2 km) from the turn, on roadway, at 1 mile (1.6 km). While approaching the turn, further pop ups will be displayed starting at 437 yd (400 m) from the turning point and the countdown to 0 miles/meters.



While getting closer to a turn, the sections referred to the distance already traveled will switch off while the ones referred to the distance yet to be traveled will remain on.

#### NOTE:

- Popup boxes might take up the space normally used to display main menu items and relevant submenus.
- The distance indicated under the road name is expressed in the unit of measure set by the user.

## TFT Display Setting and Menu Overview

### Setting Controls

Operate the controls on the right side of the steering wheel to scroll, modify and program the main and submenu.

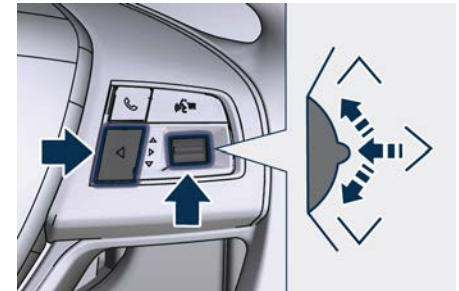

Press and release the multifunction switch in the  $\wedge$  and  $\vee$  arrow directions, corresponding to the same symbols on the TFT display, to scroll upwards and downwards the main menu titles.

The screen area in sector 1 (main Area) will be updated and the selected title will be shown in sector 3 (main menu number and title).

Press and release the multifunction switch  $\triangleright$ , corresponding to the same symbol and the indication "SELECT" on the TFT display, to enter the information screens or a submenu. Keep the switch



> depressed for 2 seconds to restore the selected/visualized functions. The selected sub-menu title selected will be displayed in sector 4 (submenu titles).

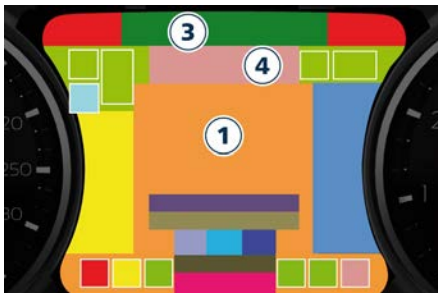

Within a submenu, press and release the multifunction switch in the ^ and v arrow directions to scroll the menu. Press the < button, corresponding to the same symbol and the indication "EXIT" on the TFT display, to return to the main menu from an item of interest or from an information screen. When the driver selects a main menu page and the Traffic Sign Assist (TSA) function on "Vehicle" page of MIA is set off (see "Functions of Settings Menu on MIA" in this section), main menu title, its number and the scroll arrows will disappear after two seconds. When driver selects a main menu, if the TSA function is set on and a sign and/or

a speed limit icon is displayed in sector 23, only the main menu number and the scroll arrows remain displayed in the sector 3, left side.



## Menu Overview

### 1. MAIN MENU

- View speed in MPH or km/h

### 2. VEHICLE INFO

- Drive Mode
- Tire Pressure
- Gauges: Transmission Temperature, Oil Temperature and Oil Pressure
- Battery Voltage
- Maintenance

### 3. DRIVER ASSIST

- Shows a specific feedback referred only to ACC, LKA and ADA drive assist systems (for each of these systems, see section " Driver Assistance Systems")

### 4. TRIP & FUEL ECONOMY

- Trip A: Distance, Average (fuel economy), Average (speed), Elapsed time
- Trip B: Distance, Average (fuel economy), Average (speed), Elapsed time
- Fuel Economy: Current fuel economy bar graph, Range, Average (fuel economy)

### 5. START&STOP

- Messages relating to the Start&Stop function

### 6. STORED MESSAGES

### 7. VEHICLE SETTINGS

- Speed Warning: enables, disables or sets the speed limit represented in the dynamic icon on the TFT display
- Auto apply Off/On of the Electric Parking Brake
- Passenger Air bag enable/disable
- Interior Lighting
  - Backlighting
  - Ambient Lighting
- Screen Setup
  - Upper Left
  - Upper Right
  - Main Menu: Line 1
  - Main Menu: Line 2
  - Main Menu: Line 3
  - MPH km/h Display On/Off
  - Main Menu Navigation
  - Audio: Radio, Media and Projection Mode

- Key-On Display
- Key-Off Display
- Defaults

## How to Set TFT Display

To set the TFT display it is necessary to select the "Screen Setup" submenu from the "Vehicle Settings" menu, proceeding as follows.

After having entered the "Vehicle Settings" menu, press and release the multifunction switch in the  $\wedge$  or  $\vee$  arrow directions until this menu item is displayed.

Press and release the multifunction switch  $\gt$  to access the available items for this submenu.

If the vehicle exceeds 5 MPH (8 km/h), this function is unavailable and the main screen shows possible options in grey (not activable).

Operate this function with the vehicle stopped and transmission in P (Park) position.

In order to enter a function, press the multifunction switch  $\gt$ .

The following directory shows the items available in this submenu:

### Upper Left

- None
- Compass
- Outside Temperature (default: Upper Right)
- Date

- Time
- Time/Date (default: Upper Left)
- Range to Empty
- Average MPG (or L/100km or km/L)
- Current MPG (or L/100km or km/L)
- Trip A Distance
- Trip B Distance

### Upper Right (example in picture)

- None
- Compass
- Outside Temperature (default: Upper Right)
- Date
- Time
- Time/Date (default: Upper Left)
- Range to Empty
- Average MPG (or L/100km or km/L)
- Current MPG (or L/100km or km/L)
- Trip A Distance
- Trip B Distance



### Main Menu: Line 1 (only displays in Main Menu)

- None (default status)
- Compass

- Outside Temp.
- Date
- Time
- Time/Date
- Range to Empty
- Average MPG (or L/100km or km/L)
- Current MPG (or L/100km or km/L)
- Trip A Distance
- Trip B Distance
- Audio

### Main Menu: Line 2 (only displays in Main Menu)

- Same configurable options as Line 1

### Main Menu: Line 3 (only displays in Main Menu)

- Same configurable options as Line 1

### MPH km/h Display (instruction line)

- On
- Off

### Main Menu Navigation

- On
- Off

### Audio

- Radio frequency
- Media: USB and Bluetooth® (text label only)
- Projection Mode: Apple CarPlay™ and Android Auto™ (text label only)

### Key-Off Display

- On
- Off

### Key-Off Display

- On: Trip summary



## Dashboard Instruments and Controls

- Off: screen with Maserati logo and trident

### Defaults

- Restore
- Cancel

Scroll with the switch in the  $\wedge$  or  $\vee$  arrow directions to view the selectable items (in the example “Time” is selected). A check mark will remain next to the previously-selected item until a new selection is made.



Press and release the multifunction switch  $>$  to select an item. The notification of setting saved appears as a popup for 2 seconds, then the display will show the last-modified item.



Press and release the  $<$  button to return to the “Screen Setup” submenu. “Screen Setup” submenu parameters set by the user as the ones to be displayed are also indicated in the top part of the MIA (see example in the figures).



As for the instruction line “MPH km/h Display”, you can either select to display it in sector 6 or not (“Off” option). In the latter case, the function of changing units remains in any case active.

If the “Main Menu Navigation” is set to “On”, navigation information will be displayed in the main area of the display only if a destination has been set on the navigator of the MIA. If function is set to “Off”, the navigation information will not be displayed (🚗).

“Key-On Display” and “Key-Off Display” items allow user to set display during vehicle key-on and off.

“Key-On Display” is normally set to “On”. When entering the vehicle, after the welcome screen, the display will show the information concerning engine starting sequence. While if it is set to “Off” (example shown in figure), the display will show the information displayed before last vehicle key-off.



When engine is started and ignition device is pressed to stop it, it is possible to set “Key-Off Display”, “On” or “Off” to obtain the following display settings:

- “On”: “Trip summary” screen (Trip B is reset after each key-on/key-off cycle);
- “Off”: screen with Maserati logo and trident.

The “Defaults” item of “Screen Setup” submenu allows restoring Maserati factory settings.

## TFT Display: Menu and Submenu Content

### 1. MAIN MENU

Press and release the multifunction switch in the  $\wedge$  or  $\vee$  arrow directions until this menu item is displayed. Pressing and releasing the multifunction switch  $\>$  will toggle the unit of measure between MPH or km/h.



Further to speed, the main area can indicate three lines that can be set to the same options and in the top right or top left area. When these three lines are present and turn-by-turn navigation is on, main menu area will automatically show navigation information. For further details, please refer to “Maserati Intelligent Assistant (MIA)” guide. Press and release the  $\leftarrow$  button to return to the main menu.

### 2. VEHICLE INFO

Press and release the multifunction switch in the  $\wedge$  or  $\vee$  arrow directions until this menu item is displayed.

Press and release the switch  $\>$  to access the submenus.

Press and release the multifunction switch in the  $\wedge$  or  $\vee$  arrow directions to scroll through the following information displays pressing and releasing the multifunction switch  $\>$  to display the selected information.

#### Drive mode

Press and release the multifunction switch in the  $\wedge$  or  $\vee$  arrow directions until this menu item is displayed. The screen graphically shows the Drive Mode: OFF ROAD, I.C.E., NORMAL, SPORT, CORSA (TROFEO version only) and  $\text{🔧}$  (Suspension) set by the user through the relevant controls.

The display main area will show vehicle image with parameters and color-coded components affected by the selected drive mode.

The image will show the following parameters:

- current ground clearance indicated in front of vehicle and on a specific indicator on top right corner;



# Dashboard Instruments and Controls

4

- torque distribution percentage indicated under the arrow in front of the wheels;
- selected drive mode (in the example shown: SPORT).

For any color-coded components, color depends on settings of:

- ESC: identified by wheel color.
- PowerTrain: identified by engine + transmission unit color.
- Suspension  : identified by the color of the four shock absorbers.



For every drive mode, function (ESC, PowerTrain and Suspension) and color of the components shown are matched as follows:

Drive Mode	ESC	PT	
OFF ROAD			
I.C.E.			
NORMAL			
SPORT			S
CORSA (*)			
(*) TROFEO version only.			

### NOTE:

To set drive parameters according to own needs and path, refer to chapter "Drive Mode" and "Off-road Drive" in section "Starting and Driving".

Press and release the < button to return to the main menu.

### Tire Pressure

Indicates the pressure of each single tire (see example below). For further information,  : chapter "Tire Pressure Monitoring System (TPMS)" in section "Safety".



### Gauges

This screen shows the following parameters in bar graph form.

- **Oil Pressure**

Displays the current motor oil pressure level.

- **Oil Temperature**

Displays the current engine oil temperature level. The gauge fill and telltale (if applicable) are highlighted in red to emphasize that the parameter is at a critical level.

### NOTE:

This strategy is also applicable in the "Transmission Temperature" and "Oil Pressure" information screen.

- **Transmission Temperature**

Displays the current transmission temperature level.





### Battery Voltage

Displays the current voltage of the 12V battery.



### Maintenance

(service)

Displays mileage and days remaining to next scheduled maintenance service.



Press and release the > button to return to the main menu.

### 3. DRIVER ASSIST

Press and release the multifunction switch in the ^ or v arrow directions until this menu item is displayed.

The screen graphically shows current status of driver assist systems: the figure shows an example with ACC engaged and HAS set.



### NOTE:

To set these systems, see chapters “Adaptive Cruise Control - ACC”, “Active Driving Assist - ADA” and “Lane Keeping Assist - LKA” in section “Driver Assistance Systems”.

Press and release the < button to return to the main menu.

### 4. TRIP & FUEL ECONOMY

Press and release the multifunction switch in the ^ or v arrow directions until this menu item is displayed.

For each of the “Trip A” and “Trip B” sub-menus the screen will display the following:

- **“Distance”** traveled in miles or km. Shows the total covered distance since the last reset.
- **“Average”** consumption in MPG (US), MPG (UK) or L/100km. Shows the average fuel consumption since the last reset.
- **“Average”** speed in MPH or km/h. Shows the average speed since the last reset.
- **“Elapsed Time”**. Shows the total time of travel since the last reset in “hours:minutes: seconds.” Elapsed Time will increment when the ignition device is in the **RUN** or **START** position.



## Dashboard Instruments and Controls

4

Press the multifunction switch > for 1 second and release to reset "Trip A" or "Trip B".  
"Trip B" is reset after each key on/key off cycle.



The "Fuel Economy" screen will display the following:

### Current Fuel Economy in MPG (US), MPG (UK) or L/100km

Shows the current fuel economy. During AutoStop stage performed by the Start&Stop system (see "Normal Starting of the Engine" in section "Starting and Driving"), a dash will be displayed instead of the value.

### Range in miles or km

Shows the range since the last fuel average reset.  
When the fuel economy is reset, the display will read "Reset" or show dashes for two seconds.

Then, the history information will be erased, and the averaging will continue from the last fuel average reading before the reset.

### Fuel Economy Average in MPG (US), MPG (UK) or L/100km

Shows the average fuel economy since the last reset.  
Press the multifunction switch > for 1 second and release it to reset the fuel economy average.

When the fuel economy is reset, the display will read "Reset" or show dashes for two seconds.

Then, the history information will be erased, and the averaging will continue from the last fuel average reading before the reset.



Press and release the < button to return to the main menu.

## 5. START & STOP

Press and release the multifunction switch in the ^ or v arrow directions until this menu item is displayed.  
With the ignition device in RUN position, the screen will display the status of the function (see example in picture). To change the status of the function, please see chapter "Automatic Start&Stop System" of section "Starting and Driving".



## 6. STORED MESSAGES

Press and release the multifunction switch in the ^ or v arrow directions until this menu item is displayed.  
The system will either display the number of the stored messages (if any available) or "No Stored Messages" if there are no stored messages.  
Press and release the multifunction switch in the ^ or v arrow directions to scroll the stored messages.



When the number of messages exceeds 9, the submenu points will be replaced by a numerical value indicating the message number. Press and release the multifunction switch  $\triangleright$  to view the selected message (see example in the picture).



Press and release the  $\triangleleft$  button to return to the main menu.

## 7. VEHICLE SETTINGS

With ignition device in **RUN** position and vehicle stopped, press and release the multifunction switch in the  $\wedge$  or  $\vee$  arrow directions until this menu item is displayed.

Press and release the multifunction switch  $\triangleright$  to access the submenus.

Scroll with the multifunction switch in the  $\wedge$  or  $\vee$  arrow directions to view the selectable items:

- Speed Warning: in order to set this function see example below.

- Electric Parking Brake: in order to modify the status of electric parking brake, see chapter “Parking Brake” in section “Starting and Driving”.
- Interior Lighting: to adjust interior lighting brightness or/and ambient lighting see chapter “Interior Lighting” in section “Understanding the Vehicle”.
- Screen Setup: see chapter “TFT Display Setting and Menu Overview” in this section.

### Example to modify the “Speed Warning” status

#### NOTE:

- Minimum set speed: 20 MPH (30 km/h).
- Maximum set speed: 175 MPH (280 km/h).

When the vehicle is in motion (above 5 MPH – 8 km/h) this function is available and displayed in the list of “Vehicle Settings” menu.

Scroll with the multifunction switch in the  $\wedge$  or  $\vee$  arrow directions to view the selectable items.

Press and release the multifunction switch  $\triangleright$  to select “Speed Warning”.

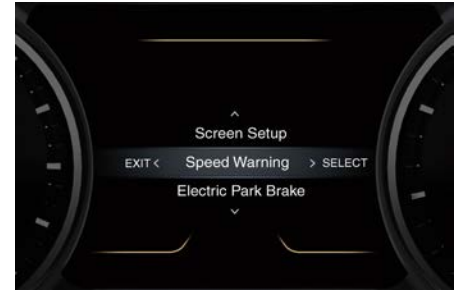

Press and release the multifunction switch  $\triangleright$  once again to view the related options: “Off” is the default status.

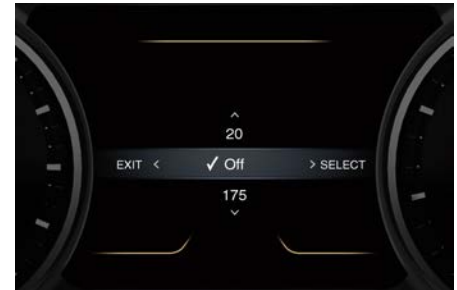

Scroll with the multifunction switch in the  $\wedge$  or  $\vee$  arrow directions to view the selectable options.

Speed values are in loop, keeping the multifunction switch pressed in the  $\wedge$  or  $\vee$  arrow directions will increase scroll speed.



## Dashboard Instruments and Controls

Press and release the multifunction switch  to select the option. A check mark will remain next to the previously-selected item until a new selection is made.



A setting saved notification appears as a popup for 2 seconds and a white telltale indicating the set speed limit will appear on display.

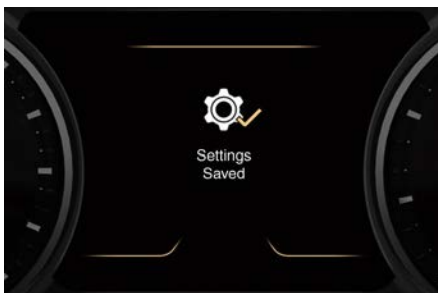

Then the display will show the last modified item.

When the set speed is exceeded, the driver is alerted by an acoustic signal and the telltale indicating the speed limit becomes amber. A pop-up message indicating that the limit has been exceeded will appear on display.



The pop-up message and the telltale will be displayed for 5 seconds then system will return to the previous screen.

## Warning and Indicator Lights

### Warning and Indicator Lights on Speedometer

The following telltales are displayed on the speedometer, and related messages are visible for 5 seconds on the central sector of the display, unless otherwise indicated.



### Malfunction Indicator Light (MIL)

 The Malfunction Indicator Light (MIL) is part of an onboard diagnostic system that monitors engine and automatic transmission control systems.

Under normal conditions, this indicator light should switch on when the ignition device is in **RUN** position and switch off soon after the engine is started (the MIL does not shut off immediately).

This is a sign of the indicator light working properly. If the indicator remains illuminated or switches on while driving, there is a failure in the fuel supply/ignition and emission control systems.

The failure could cause high exhaust emissions, loss of performance, poor vehicle handling and high consumption levels.

Should this occur, proceed with caution to your **Authorized Maserati Dealer** without heavy throttle application or driving at high speeds. Obey all applicable local traffic regulations. The indicator light will go out if the problem is no longer present. The error will be registered by the system in any case.



### CAUTION!

- When the ignition device is in the **RUN** position and if the indicator light does not switch on or if it switches on while driving, contact an **Authorized Maserati Dealer** as soon as possible.
- Prolonged driving with the MIL on could cause damage to the engine control system. It also could affect fuel economy and drivability. If the MIL is flashing, severe catalytic converter damage and power loss may occur.

Immediate service is required. In addition, the On-Board Diagnostics (OBDII) system incorporates a diagnostic connector that can be interfaced using diagnostic equipment. This makes it possible to read the error codes stored in the control unit, together with a set of specific parameters for the engine operation diagnostic cycle, for compliance with CARB & EPA OBDII regulations.

### Left Turn Signal Indicator Light



This indicator lights up when the left turn signals or the hazard flashers are turned on.

The indicator light will flash at the same frequency of the turn signals and is controlled by the multifunction lever behind the steering wheel. If the vehicle electronics sense that the vehicle drives for more than 1 mile (1.6 km) with either turn signal on, a continuous sound will alert the driver to turn the signal off.

If the indicator flashes at a fast rate, check for a defective exterior light LED.

### Tire Pressure Monitoring Light



This warning light is connected to the Tire Pressure Monitoring System (TPMS).

Under normal conditions, the warning light should illuminate when the ignition

device is in **RUN** and should go off once the engine is started.

If the warning light remains lit or illuminates while driving, the pressure of one or more tires is too low and a message will be displayed.

The TPMS malfunction warning light is connected to the low tire pressure monitoring light.

When the system detects a malfunction, the monitoring light and the related message will flash for approximately one minute and then remain lit.

This sequence will continue upon subsequent vehicle startups as long as the malfunction lasts.

When the malfunction warning lights up, the system may not be able to detect or signal low tire pressure correctly.

For further information,  : chapter “Tire Pressure Monitoring System (TPMS)” in section “Safety”.

### Anti-Lock Braking System (ABS) Malfunction Warning Light



This warning light, and its related message, indicate possible malfunctions of the Anti-Lock Brake System (ABS).

The warning light will turn on when the ignition device is in **RUN** position and may stay on for 4 seconds. If the ABS light remains lit or turns on while driving, the Anti-Lock portion of the brake



## Dashboard Instruments and Controls

system is not functioning and requires service. However, the conventional brake system will continue to operate normally if the **BRAKE** (US market) or  (CDN market) warning light is switched off.

If the ABS light turns on while driving, or if it does not switch on when the ignition device is in **RUN** position, please visit an **Authorized Maserati Dealer** as soon as possible to restore the Anti-Lock brake function.

### 4 Electronic Stability Control (ESC) Activation/Malfunction Indicator Light

 The ESC activation/malfunction indicator light on the instrument cluster will display when the ignition device is in **RUN** position. It should switch off by starting the engine.

If the light stays on with the engine running, there is a malfunction in the ESC system.

If the light still stays on after several ignition cycles, and the vehicle has been driven for several miles at more than 30 MPH (48 km/h) speed, visit an **Authorized Maserati Dealer** as soon as possible to have the problem diagnosed and serviced.

#### NOTE:

Each time the ignition device is in **RUN**:

- The ESC OFF indicator light  and the ESC activation/malfunction indicator light illuminates temporarily.
- When the ESC is functioning, the system will make buzzing or clicking sounds. This is normal. The sounds will stop once ESC becomes inactive and the road conditions that caused the ESC activation no longer persist.

### Electronic Stability Control (ESC) OFF Indicator Light



This indicator notifies that the Electronic Stability Control (ESC) is disabled (OFF); the linked message will be displayed.

### Warning and Indicator Light on Tachometer

The following telltales are displayed on the tachometer and related messages are visible for 5 seconds on the central sector of the display, unless otherwise indicated.



US Market



CDN Market

### Start&Stop Active Indicator Light



This indicator light indicates that the engine has been switched off automatically by the Start&Stop system.

When the engine starts again, this indicator light will switch off. If this indicator light during an automatic engine shutdown (AutoStop) phase starts flashing, it will be necessary to restart the engine normally with the



ignition device while holding down the brake pedal.

See chapter “Automatic Start&Stop System” in section “Starting and Driving” for further information.

### Rear Fog Light Indicator



This indicator lights up when the rear fog lights are switched on.

### High Beam Indicator



This indicator lights up when the high beams are switched on or when blinking.

### Brake Indicator Light



This warning light monitors various brake functions, including brake fluid level, brake pads wear (on US market only) and parking brake engagement. If the brake warning light illuminates the parking brake may be engaged, the brake

US



CDN

pads have reached wear limit (on US market only), the brake fluid level may be low or a problem with the anti-lock brake system (ABS) reservoir may have occurred.

In all the above situations, a related message will be displayed.

If the warning light still illuminates when the parking brake has been disengaged, and the fluid level is at the full mark on

the master cylinder reservoir, there could be a brake hydraulic system malfunction or a problem with the brake booster detected by the ABS/ESC system. If this occurs, the light will remain lit until the problem has been solved.

If the problem concerns the brake booster, the ABS master cylinder will run when engaging the brake and a brake pedal pulsation may be felt during each stop of the vehicle.

Inefficiency of one of the dual brake system cycles is indicated by the brake warning light, which will turn on when the brake fluid level in the master cylinder has dropped below a certain level.

The warning light will remain lit until the problem has been solved. If the brake warning light flashes for 10 seconds with the electric parking brake warning light and the related message on, an EPB system failure has occurred. If a brake failure occurs, visit an **Authorized Maserati Dealer** as soon as possible in order to check up the brake system. In the event of an Electronic Brake Force Distribution (EBD) failure, both the brake warning light and the ABS light illuminate. Immediate repair of the ABS system is required.

Functioning of the brake warning light can be checked by turning the ignition device from **OFF** to **RUN** position. The warning light should illuminate for approximately 2 seconds. The warning light should switch off unless the parking brake is engaged or a brake fault is detected. If the warning light does not illuminate, have the light system repaired by an **Authorized Maserati Dealer**.

The warning light will also switch on when the parking brake is engaged with the ignition device in **RUN** position. This warning light only indicates the brake is engaged but not the clamping force of the parking brake to the wheels.



### **WARNING!**

**Driving a vehicle with the red brake light on can be very dangerous and is not recommended. Part of the brake system may have failed, resulting in increased braking distances and the risk of an accident. Have the vehicle checked as soon as possible at an Authorized Maserati Dealer.**

### Air Bag Warning Light



This warning light will illuminate for a few seconds for a bulb check when the ignition device is in **RUN**.



If the warning light does not illuminate while starting the engine, stays lit, or switches on while driving, have the system checked at an **Authorized Maserati Dealer** as soon as possible. In the latter case, the message will remain displayed: to hide it, press the button  on the steering wheel right side.



For further information,  : chapter “Supplemental Restraint System (SRS) – Air bags” in section “Safety”.



### **WARNING!**

**If the warning light remains ON or if it does not illuminate or illuminates while driving, contact your Authorized Maserati Dealer as soon as possible.**

### **Right Turn Signal Indicator Light**



This indicator lights up when the right turn signals or the hazard flashers are switched on.

The indicator light will flash at the same frequency of the turn signals and is controlled by the multifunction lever behind the steering wheel. If the vehicle electronics sense that the vehicle drives for more than 1 mile (1.6 km) with either turn signal on, a continuous sound will alert the driver to turn the signal off. If the indicator flashes at a fast rate, check for a defective exterior light LED.

### **Seat Belt Reminder Indicator Light**



When the ignition device is in **RUN**, the seat belt reminder indicator light will light up for a few seconds as a bulb check. During the bulb check, you will hear an acoustic signal if one or both front seat belts are unbuckled.

After the bulb check or while driving, if a seat belt is unbuckled, together with the acoustic signal the seat belt reminder light will light up and a message will indicate which belt is not fastened.



### **WARNING!**

**Maserati urges you to use the seat belts correctly fastened and adjusted at all times. Correct use of the seat belts can help reduce the risk of serious injury in the event of an accident. Do not pass seat belts over sharp edges: they could tear. Do not pin anything to the seat belts. This could reduce their initial strength and cause them to tear in the event of a crash.**

For further information,  : chapter “Occupants Restraint Systems” in section “Safety”.

### **Warning and Indicator Lights on TFT Display**

The relevant messages will be indicated within the main area for 5 seconds, unless otherwise specified. Fault messages will be stored under “Stored Messages”.

### **Charging System Warning Light**



This warning light shows the status of the electrical charging system. If the warning light stays on or comes on while driving, turn off some of the vehicle's non-essential electrical devices or increase engine speed (if at idle). If the charging system warning light remains on, it means that the vehicle is experiencing a problem





with the charging system. **IMMEDIATELY** contact an **Authorized Maserati Dealer** to have the vehicle serviced. If jump starting is required, refer to “Auxiliary Jump Start Procedure” in section “In an Emergency”.

### Transmission Temperature Warning Light



This warning light and the related message indicate that the transmission fluid temperature is rising. If this warning light turns on, safely pull over and stop the vehicle. Then, shift the transmission into P (Park) and run the engine at idle until the temperature drops and the light switches off. If the problem persists, contact an **Authorized Maserati Dealer**.



### CAUTION!

Continuous driving with the transmission temperature warning light illuminated will eventually cause severe transmission damage or failure.

### Engine Temperature Warning Light



This warning light notifies when the engine is overheated. If the temperature reaches critical levels and the gauge displayed in sector 12, on the left side of the tachometer, turns red, this warning light under the

engine temperature gauge indicator will illuminate in red color combined with the related message on display. When the temperature is reaching the set threshold an acoustic signal will be heard. If the warning light switches on while driving, safely pull over and stop the vehicle. If the A/C system is on, turn it off. Also, shift the transmission into N (Neutral) and idle the vehicle. If the temperature does not return to normal, immediately turn the engine off and contact an **Authorized Maserati Dealer**. Check “Engine Overheating” in section “In an Emergency” for more information.

### Low Oil Pressure Warning Light



Under normal conditions, the warning light illuminates when the ignition device is turned to **RUN** and goes off as soon as the engine is started. If the warning light stays or turns on while driving, the engine oil pressure is too low. The warning light is combined with a displayed message and an acoustic signal that will last 4 minutes. In this case, turn the engine off immediately and carry out the necessary checks. Do not operate the vehicle until the problem has been corrected. This warning light does not indicate the oil level. The engine oil level must be

checked with the dipstick located under the hood (see “Maintenance Procedures” in section “Maintenance and Care”). If the problem persists, contact an **Authorized Maserati Dealer**.

### Engine Oil Temperature Warning Light



This warning light indicates that the engine oil is overheated. The warning light is combined with the related displayed message. In this case, drive carefully until the temperature drops back to normal level and the warning light turns off. If the problem persists, contact an **Authorized Maserati Dealer**.

### Low Engine Oil Level Warning Light



This warning light and the related displayed message, indicate a low engine oil level. The engine oil level must be checked with the dipstick fitted under the hood (see “Maintenance Procedures” in section “Maintenance and Care”).

### Electric Power Steering Failure Warning Light



This warning light, and the related message, illuminate when the electric power steering is not operating and needs service. If the warning light is on, steering assistance may be not available. After battery disconnection event, the warning light may be on. In this case,



## Dashboard Instruments and Controls

start the engine and perform a steering wheel stroke end to end.

If the problem persists, contact an **Authorized Maserati Dealer**.

### Catalyst Over Temperature Warning Light



This warning light, and the related message, light up if the engine runs irregularly with consequent high temperature in the exhaust system.



#### CAUTION!

- If the warning light is accompanied by the message “Catalyst Temp Getting Hot Reduce Speed”: the temperature of the catalytic converters is too high. The driver must slow down immediately until the warning light turns off.
- If the message “Catalyst Temp Hot Stop Safely Wait To Cool” appears after decelerating: the temperature in the catalytic converters has reached a dangerous level and the catalytic converters could be damaged. Drive slowly to the nearest Authorized Maserati Dealer.

### Door Ajar Indicator Light



This indicator illuminates when one or more doors are ajar. The indicator light will show which door is ajar. When one or more doors

are open, a related message will be displayed if the vehicle is running at a speed of 5 MPH (8 km/h) or faster.

### Liftgate and Hood Ajar Indicators Lights



These light indicators will illuminate to indicate that the liftgate and/or the hood are ajar.



When the liftgate or the hood is open, a related message will be displayed besides the indicator light if the vehicle is running at a speed of 5 MPH (8 km/h) or faster.

### Traffic Sign Assist (TSA) Indicator Lights (OPT)



Speed limit unconditioned signs (in example: 80 MPH), limiting condition acknowledged (in



example: snow) and conditioned speed limit signs are displayed when the TSA function is active.

For further information, see "Traffic Sign Assist - TSA" in section "Driver Assistance Systems".

### Electronic Throttle Control (ETC) Indicator



This indicator light indicates a failure of the Electronic Throttle Control (ETC) system. If the indicator turns on while driving (a torque decrease is possible), have the system checked by an **Authorized Maserati Dealer**.

When detecting a failure, the light indicator will illuminate while the engine is running.

If the indicator remains lit with the engine running, you can still drive your vehicle. However, contact an **Authorized Maserati Dealer** as soon as possible.

If the indicator is flashing while the engine is running, immediate service is required. You may experience reduced performance, an elevated/rough idle or engine stall and your vehicle may require towing.

### Low Fuel Indicator Light



When the fuel level reaches approximately 4.2 Gallons (16 liters) this indicator light

under the fuel gauge indicator will turn on, and remain on until fuel is added together with the related message. In this condition the color indicating the quantity of fuel in the tank, inside the indicator light on display, will go from white to amber.

Refer to “Refueling” in section “Starting and Driving” for fuel filling.

### Windshield and Headlights Washer Low Fluid Indicator Light



This indicator light will illuminate for 5 seconds to indicate a low level of the windshield



and headlights washer fluid. A related message will be displayed. See “Maintenance Procedures” in section “Maintenance and Care” for fluid filling.

### Headlight Aiming System Failure Warning Light



This warning light and the related message indicate a failure of the automatic headlight aiming system (horizontal leveling, electromechanical swiveling) or of the Advanced Frontlighting System (AFS). Please contact an **Authorized Maserati Dealer** to check the system.

### Advanced Frontlighting System (AFS) Failure Warning Light



**Warning Light** This warning light and the related message light up to report a failure of the AFS system. Contact an **Authorized Maserati Dealer** as soon as possible.

### Automatic High Beam Failure Warning Light



This warning light and the related message illuminate to report a failure of the automatic high beam headlights. Contact an **Authorized Maserati Dealer** as soon as possible.

### Suspensions Failure Warning Light



This warning light and the related message turn on while driving if there is a failure of the suspension system. Please contact an **Authorized Maserati Dealer** to check the system.

### Ice Hazard Indicator Light



When the external temperature falls below 38°F (3°C), the temperature value blinks for a few seconds, the indicator light turns on, a message is displayed and an acoustic signal is triggered to warn the driver of the risk of icy roadbed.

Under such conditions, we recommend using the I.C.E. drive mode (see “Automatic Transmission” in section “Starting and Driving”) drive carefully and slow down as the grip of the tires may be significantly reduced. The indicator light flashes for 5 seconds and switches off when the temperature reaches 43°F (6°C) or higher.

### Brake Pads Wear Warning Light (CDN market only)



This warning light and the related message indicate that the brake pads have reached their wear limit. Please contact the **Authorized Maserati Dealer** to have them replaced.

### Fuel Filler Cap (Gas cap) Open Warning Light



After refueling the car performs a check of the fuel filler cap and this warning light comes on if it is not correctly closed, after approximately 10 minutes also depending on driving conditions. See “Refueling” in section “Starting and Driving” for more details. Do not drive with this warning light on. Check that the fuel filler cap is tightened correctly. If the warning light still lights on, please contact an **Authorized Maserati Dealer** as soon as possible.

### Electric Parking Brake Failure Warning Light



This warning light and related message illuminate when there is an EPB system failure. The failure could also completely or partially block the vehicle because the parking brake could remain on even after it has been automatically or manually disengaged though its controls. If it is still possible to use the vehicle (parking brake not engaged) drive to the nearest **Authorized Maserati Dealer** and remember to performing each operation/command that the electric parking brake is not functioning.



### Start&Stop Disable Indicator Light



This indicator light illuminates when Start&Stop system is not available in the conditions described in "Start&Stop Not Active" of the "Automatic Start&Stop System" chapter, or the system is turned off through the controls on the right side of the steering wheel or the relevant soft-key on MIA. See chapter "Automatic Start&Stop System" of section "Starting and Driving" for further information.

### Start&Stop Failure Warning Light



This warning light illuminates when there is a failure in the Start&Stop system. Switch the engine on or off using the normal procedure with the ignition device **START/STOP** and have the vehicle checked at an **Authorized Maserati Dealer**.

### Scheduled Maintenance (Service) Indicator



This indicator light illuminates and a message flashes on the display for approximately 5 seconds after an acoustic signal to indicate that the next scheduled maintenance is due or is already overdue.

Unless reset, the message will continue to display each time you cycle the ignition device to the **RUN** position.

To turn off the message temporarily, press and release the < button on the steering wheel. To reset the service indicator system, please visit an **Authorized Maserati Dealer**.

### ADAS Status Indicators Lights (If equipped)



When you are not viewing the "Drive Assist" page, the indicators lights at the top left-hand side of the display indicate status of individual ADAS system or the combination of them (see examples).



For further details, refer to "Adaptive Cruise Control - ACC", "Lane Keeping Assist - LKA" and "Active Driving Assist - ADA" in section "Driver Assistance Systems".

### Forward Collision Warning (FCW) Off



This warning light informs the driver that FCW is disabled. If this light occurs together with other specific messages, take your vehicle to an **Authorized Maserati Dealer** for service.

This warning light will light even when the activation of another driver assistance function or drive mode (such as "ESC OFF") disables the FCW.

### Forward Collision Warning (FCW) and Pedestrian Emergency Braking (PEB) Fault



This warning light informs that FCW and/or PEB is in fault state and the autonomous braking may not be available. If this occurred together with other specific messages, could mean that a system fault requiring servicing at an **Authorized Maserati Dealer**.

It is nevertheless possible to drive the vehicle without using this function (for further details, refer to "Forward Collision Warning - FCW" in section "Driver Assistance Systems").

### Trailer Connection Fault Warning Light (NOT for TROFEO version)



The warning light and the relevant message are displayed to indicate a fault or failure of the connection between vehicle and trailer. In these cases please contact an **Authorized Maserati Dealer** as soon as possible, and avoid using the vehicle with a trailer.

### AWD Failure Warning Light



This warning light turns on to indicate a fault of the AWD system otherwise a fault or overheating due to excessive wheel spin. Contact an **Authorized Maserati Dealer**

as soon as possible, and avoid using the vehicle in heavy duty conditions.

### Passive Speed Limit Set



This indicator light indicates the passive speed limit set via the controls on the RH side of the steering wheel (for further details, refer to "TFT Display Setting and Menu Overview" in this section).

### Passive Speed Limit Exceeded



This indicator light informs the driver that the speed limit that was set has been exceeded.

### Suspension Setting Indicator Light



This indicator light displays which suspensions setting (soft "S" or hard "H") is on. For further details, refer to "Drive Mode" in section "Starting and Driving".

### Drive Mode Indicator Light



Drive mode set by the driver through the controls on central console is displayed above the transmission lever indicator (example in picture: NORMAL). For further details, refer to "Drive Mode" in section "Starting and Driving".

### Ride Height Indicator Light



Ride height set through the control on central console is always displayed in the specific area on the RH side of the TFT display.

From the "Normal" level (shown in picture) ride height can be lowered at "Aero 1" or "Aero 2" levels when using vehicle on the road. When using the vehicle off road, ride height can be set to a higher position thanks to "Off Road 1" or "Off Road 2" levels. For further details, refer to "Drive Mode" and "Off-road Drive" in section "Starting and Driving".



The lowest position "Entry/Exit" shown in picture is used for entering and exiting the vehicle.

### Cruise Control (CC) Ready or Canceled



This white indicator light will illuminate when the CC is ready to be set (with 3 dashes below) and, once it sets, when it is temporarily canceled (set speed in white below). For further information, check "Cruise Control" in section "Driver Assistance Systems".

### Cruise Control (CC) Set



This green indicator light will illuminate with the set speed when the CC is set and in driver override. For further information, check "Cruise Control" in section "Driver Assistance Systems".

### Blind Spot Assist (BSA) or Active Blind Spot Assist (ABSA) Ready and Active



This white indicator light indicates that the BSA is in stand-by (ready); the some indicator light in green color indicates that the system is active.



### Active Blind Spot Assist (ABSA) Intervention



This amber indicator light indicates the intervention of the system on the steering to avoid a potentially dangerous lane change. For further information, see "Active Blind Spot Assistance - ABSA" in section "Driving Assistance systems".

### Lane Keeping Assist (LKA) Fault



This warning light on indicates that the LKA system is in fault. If the warning light and the relevant message do not go off after a few manoeuvres and eventually an ignition cycle, contact an **Authorized Maserati Dealer**.

### Adaptive Cruise Control (ACC) Ready or Canceled



This white indicator light indicates that the ACC is ready to be set (with 3 dashes below) and, once it sets, when it is temporarily canceled (set speed in white below).



## Dashboard Instruments and Controls

For further details, refer to “Adaptive Cruise Control - ACC” in section “Driver Assistance Systems”.

### Adaptive Cruise Control (ACC) Set



This green warning light with below the set speed turns on when the ACC is set (for further details, refer to “Adaptive Cruise Control - ACC” in section “Driver Assistance Systems”) and vehicle will keep set speed.

### Adaptive Cruise Control (ACC) Fault



This warning light turns on when ACC is not operating or needs servicing, For further details, refer to “Adaptive Cruise Control - ACC” in section “Driver Assistance Systems”.

### Blind Spot Assist (BSA) and Active Blind Spot Assist (ABSA) Failure



This warning light and related message light on to report a failure of the BSA system.

As consequence, on vehicles equipped with ABSA also this latter will be not working or malfunctioning. Contact an **Authorized Maserati Dealer** as soon as possible avoiding to use this system.

### Active Driving Assist (ADA) Fail



This warning light will turn on to indicate a failure of the ADA system.

Contact the **Authorized Maserati Dealer** as soon as possible avoiding using this system.

### Hill Descent Control (HDC) Ready



This white indicator light turns on to indicate that HDC is ready to be set and, once it sets, to turn it off temporarily. For further details, refer to “Hill Descent Control - HDC” in section “Driver Assistance Systems”.

### Hill Descent Control (HDC) Set



This green indicator light with below the set speed turns on when the HDC is set. For further details, refer to “Hill Descent Control - HDC” in section “Driver Assistance Systems”.

### Low Beams On Indicator Light



This indicator light will illuminate when the low beams headlights are turned on.

For further details, see “External Lighting” in section “Understanding the Vehicle”.

### Headlight On Indicator Light



This indicator will illuminate when the position lights or headlights are turned on.

For further details, see “External Lighting” in section “Understanding the Vehicle”.

### Front Fog lights On Indicator Light



This indicator light turns on when the fog lights are on. For further details, see “External Lighting” in section “Understanding the Vehicle”.

### Automatic High Beam On Indicator



This indicator light turns on when the “Auto Dim High Beams” function is set on MIA (see “Functions of Settings Menu on MIA” in this section).

### Gear Shift Indicator Light



This indicator lights up to indicate gear shift change in order to optimize fuel consumption.



See “Drive Mode” in section “Starting and Driving” for further information.

### Performance "Launch Control" Indicator Light (TROFEO version only)



This indicator lights up when the car is launched in the "Launch Control" performance start procedure.

See chapter “Launch Control Mode” in section “Starting and Driving” for the activation procedure.

## Maserati Intelligent Assistant Operation

### General Notes

The vehicle is equipped with the infotainment Maserati Intelligent Assistant (MIA) system, an advanced user interface which combines innovative and exclusive technical functions integrating entertainment, user settings, air conditioning, navigation, communication and information functions within a single system. The MIA system features an audio system which is acoustically optimized for this specific vehicle. Only the MIA functions related to driving and on-board comfort that the user can set are described in this manual; all other entertainment and communication functions are described in a specific guide called "Maserati Intelligent Assistant (MIA)". This guide also includes all warnings and precautions, which are essential for a safe use of the MIA system. Maserati advises you to read this guide carefully and thoroughly.

### Manual Controls and Devices

The MIA display is positioned in the central part of the dashboard and the manual controls and devices for multimedia navigation and to connect

external sources are positioned on the central console.

This manual controls are a further interface for the driver and nearby passenger, that adds to the MIA display soft-keys. Using the manual controls, the MIA display will work as a graphic display of the inputs from the controls.

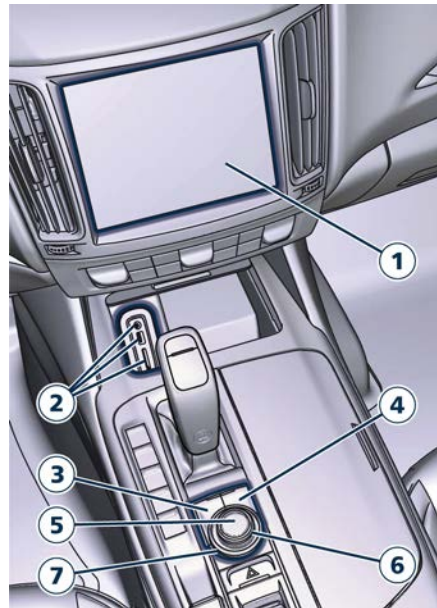

#### 1 MIA touch display

The touch screen soft-keys allows to access to all available functions.

When you touch an active area of the screen a visual feedback of active area's is linked to the touch event. It is valid for all active areas with or without long touch functionality. This feedback associated to the touching state highlight the icon or text label and apply an additional graphic shape. This strategy is valid for all the active areas of the display (soft-keys, main category bar, etc...) except the lists, the status bar and the draggable areas.

To select a list item touch and release the screen or press the "BROWSE-ENTER" button in the central console.

#### 2 Ports for SD card, AUX and USB

For further details, refer to "Internal Equipment" in section "Understanding the Vehicle".

#### 3 "BROWSE/ENTER" button

In Radio/Media screen, after selecting a function using the tune/scroll knob or soft-keys on MIA display, press this button to see the detail of the items/options of the selected function. When in "Phone" page, open phonebook browse.

#### 4 "MUTE" button

Press this button to mute the volume of the active sources.

#### 5 "ON/OFF" button

Press this button to turn the MIA system on or off.



## 6 "VOLUME" control

Independently from currently shown MIA screen, turn this knob clockwise to increase the volume, counter-clockwise to decrease it.

When the volume control is adjusted through the "VOLUME" knob or the steering wheel control, a volume alert pop up will appear at the top of MIA screen. Volume alert shows the icon of the active source, the volume level bar with numerical value and the - and + soft-keys. Touch this soft-keys or press anywhere or drag the scrubber bar to decrease/increase the volume of the source highlighted.

Touching the drop down arrow on the right side of the volume alert to view and possibly change the volume level of the other sources (Media, Phone, Navigation and Voice Recognition).



The volume control pop up can be closed 5 seconds time out after last

touch, touching anywhere outside of the pop up or touch the "X" soft-key on the upper right side.

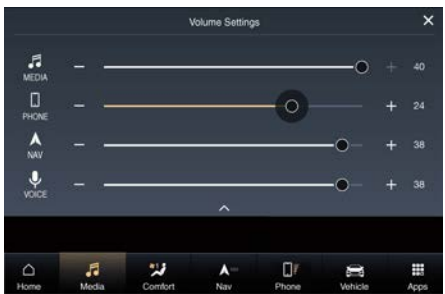

## 7 "TUNE-SCROLL" control

When navigating a list, turn this knob clockwise to move the cursor downwards, or counter-clockwise to move it upwards. In any main screen, turn this knob to tune a Radio stations up or down and to skip the previous or next track of Media source.

### NOTE:

For more information on the other functions, see "Maserati Intelligent Assistant (MIA)" guide included in the onboard documentation.

## Main Status Bar on MIA Display

Main status bar is set up by Maserati: some of soft-keys that make up the bar can be customised according to personal requirements, as explained in

"Customising Main Status and Category Bar" in this chapter.

The composition of the main status bar is briefly indicated below. For further information, refer to the "Maserati Intelligent Assistant (MIA)" guide included in the on board documentation.



- 1 Driver temperature and seat and steering wheel comfort functions (if equipped).
- 2 Status alert box.
- 3 Clock.
- 4 Geolocation.
- 5 Profiles (customisable).
- 6 Start&Stop (customisable).
- 7 Passenger temperature and seat comfort function (if equipped).

### NOTE:

The images may represent a main status bar other than the one on your MIA.





## Main Category Bar on MIA Display

The soft-keys located on the lower part of the MIA display represent the default main categories, which are briefly indicated below. The figure shows the main menu bar of a car equipped with navigator.



Main category bar is set up by Maserati: it can be customized according to personal requirements, as explained in "Customizing the Main Status and Category Bar" in this chapter. To view the label of the soft-keys in the main category bar it is necessary to activate the "Show Main Category Labels" function in the "Display" submenu of the "Settings" screen of the "Vehicle" page.

### NOTE:

The images may represent a main category bar other than the one on your MIA.

For further information on the "Home", "Media", "Nav", "Phone" and "Apps", refer to the "Maserati Intelligent Assistant (MIA)" guide included in the onboard documentation.

Touch one of these soft-keys to access the list of functions that the user can set.

- 1 **"Home"** soft-key  
Touch this soft-key to enter the home page from which you can choose among all the available widgets the one to display the desired function.
- 2 **"Media"** soft-key  
Touch this soft-key to access media sources such as: Radio, USB device, AUX, Bluetooth and SD card as long as the requested media is present.
- 3 **"Comfort"** soft-key  
Touch this soft-key to access the air conditioning settings and the other comfort controls available: Heated Seats, Heated Steering Wheel and Ventilated Seats. See "Air Conditioning Controls" in this section for further details.
- 4 **"Nav"** soft-key (if equipped)

- 5 **"Phone"** soft-key  
Touch this soft-key to access the MIA Phone function that can be set or monitored via MIA.
- 6 **"Vehicle"** soft-key  
Touch this soft-key to access the "Controls" and "Settings" menu from which to choose which the customer programmable functions of some driver assistance system (ADAS) to set up. Functions can be selected and adjusted or turned on/off by touching the related soft-key (see "Functions of Controls Menu on MIA" in this section).
- 7 **"Apps"** soft-key  
Touch this soft-key to have access to the Apps page from which you can choose which app you want to display between "Favorites", "Recent", "Categories" and "All".

### Switch OFF Touchscreen Backlight

If the screen backlight becomes annoying when driving, it is possible to switch it off pressing  ON/OFF button described in the "Manual Controls and Devices" of this chapter.

The MIA touch screen can be turned off by touching the "Screen Off" soft-key in the "Controls" menu of the "Vehicle" page.



### Touchscreen Display Warnings



#### CAUTION!

- Do NOT attach any object to the touchscreen, doing so can result in damage to the touchscreen.
- Do not press the screen with any hard or sharp objects (pen, USB stick, jewelry, etc.) which could scratch the touchscreen surface.
- Do not spray any liquid or caustic chemicals directly on the screen. Use a clean and dry micro fiber lens cleaning cloth in order to clean the touchscreen.
- If necessary, use a lint-free cloth dampened with a cleaning solution, such as isopropyl alcohol, or an isopropyl alcohol and water solution ratio of 50:50. Be sure to follow the solvent manufacturer's precautions and directions.

### Customizing the Main Status and Category Bar

The soft-keys for the main functions of the MIA system, indicated at the bottom of the MIA display, and some of those on the main status bar can be easily customized to suit user's requirements, as follows:

- drag and drop the soft-key to move it inside the bar;

- touch the "Apps" soft-key to open applications/settings screen or access the screen with the function symbol to be inserted in the bar;
- drag and drop the icon corresponding to the selected function until it overlaps the one to be replaced on the top of the bottom bar.

Once it is set in the category bar, the new connection will be immediately operational.

## Functions of Controls Menu on MIA

The MIA system uses a combination of keys able to access and change the customer programmable functions present in the "Controls" or "Settings" menu of the "Vehicle" screen page.

A shortcut to set the customer programmable functions is available in the "Apps" screen page.

Once you enter the "Controls" screen, using the touch soft-keys or turn the "TUNE-SCROLL" knob to scroll and change settings of the customer programmable functions.

Touch the function soft-key or press the "BROWSE-ENTER" button to confirm the selection.

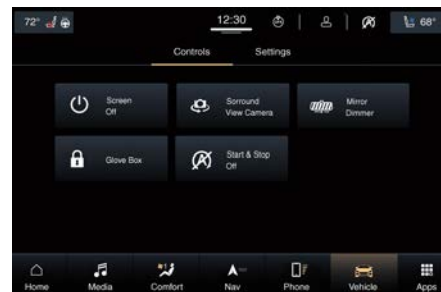

Some functions can be set only on or off touching the corresponding soft-key



## Functions of Settings Menu on MIA

---

The MIA system uses a combination of keys able to access and change the customer programmable functions present in the "Controls" or "Settings" menu of the "Vehicle" screen page.

A shortcut to set the customer programmable functions is available in the "Apps" screen page.

Once you enter the "Settings" screen, using the touch soft-keys or turn the "TUNE-SCROLL" knob to scroll and change settings of the customer programmable functions.

### NOTE:

- All settings must be edited with ignition device set to **RUN** position.
- Some of the customer programmable functions are optional or for a specific model/version and may not be available on your vehicle.
- Only one touch screen area/soft-key may be selected at a time.

### Modes for Setting a Function

To enter the desired function, touch the corresponding soft-key on the lateral list (the picture shown is "Display").

which will be highlighted with the yellow outline (example: "Start&Stop Off").

Other functions can have one or more instruction/setting pages that are accessed by touching the corresponding soft-key (example: "Glove Box").

### NOTE:

- All settings must be edited with ignition device set to **RUN** position.
- Some of the customer programmable functions are optional or for a specific model/version and may not be available on your vehicle.
- Only one touch screen area/soft-key may be selected at a time.

### Screen Off

This function allows you to switch off the MIA screen backlight if it becomes annoying when driving.

### Surround View Camera

Activating this function the system uses four cameras to monitor the area around the vehicle when transmission lever is shifted to P (Park), N (Neutral) or D (Drive) position.

When activation occurs by touching the "Surround View Camera" soft-key in the "Controls" screen or moving the shift lever in R (Reverse) position, the initial view will be the default view (associated with current gear state).

See "Surround View Camera System" in section "Driver Assistance Systems" for further details.

### Mirror Dimmer

The auto-dimming function can be disabled or re-enabled by touching this soft-key. See "Rear-View Mirrors" in section "Understanding the Vehicle" for further details.

### Glove Box

This function allows you to enter a 4-digit PIN code to lock and unlock the glove box in the passenger side of the dashboard.

See "Glove Box Compartment" in this section for further details.

### Start&Stop Off

This function allows you to disable the Start&Stop when frequent stops and restarts of the engine may become annoying.

See "Automatic Start&Stop System" in section "Starting and Driving" for further details.



To scroll through the functions of the list, move the cursor up or down, or touch the arrow  $\nabla$  or  $\blacktriangle$  until the function to be set is displayed. Touching the  $\blacktriangle$  or  $\nabla$  soft keys and the cursor on the right side of the screen will allow you to scroll up or down through the available setting options. In this screen one or more boxes may indicate status or possible variants of the function. A check mark in a box indicates the active status of the function.

When in a setting line with many options:

- touching on the option currently not selected (no check mark in option) move the selector and change the option accordingly;
- touching on the option already selected (with selection) do not perform action (maintain the option selection).

When in a setting line with one option only:

- if on/off setting (example: "Touchscreen Beep") touching on the option select/deselect the option (check mark appear/disappear). The same behavior is performed touching on the entire row area;
- if one-of-many option setting (example: "English" under "Language" function) touching on the option do not perform action (maintain the check mark). Also in this case, the same behavior is performed touching on the entire row area.

When in a function with +/- soft-key:

- if touch on the +/- soft-key, increase or decrease the value. Touching outside the +/- soft-key do not perform action;
  - when the maximum value +/- is reached, +/- the soft-key turn gray.
- Once the procedure is completed, touch the  $\blacktriangleleft$  back arrow to return to the previous menu or touch the upper right "X" soft-key, to close the settings screen.

In this mode the MIA system allows you to access the following programmable functions: Display, Safety & Driving Assistant, Clock & Date, Phone/Bluetooth, Voice, Navigation, Camera, Mirrors & Wipers, Lights, Doors & Locks, Seats & Comfort, Key Off Options, Suspension, Audio, Notifications, Sirius XM Setup,

Geolocation, Software Updates, System Information and Reset.

## Display

Touch this soft-key to set the following modes.

### • Language

When in this display, you can select one language for all display descriptions, including the trip functions and the navigation system.

The available languages are specific to the target markets.

### • Display Mode

When in this display, you can select "Auto" or "Manual" mode.

### • Display Brightness with Headlights On

When "Display Mode" function is in "Manual" mode, you can select the brightness with the headlights on (night condition). Adjust the brightness from level 0 to 10 with the "+" and "-" setting soft-keys or by selecting any point on the scale between the "+" and "-" soft-keys.

### • Display Brightness with Headlights Off

When "Display Mode" is in "Manual" mode, you can select the brightness with the headlights off (day condition). Adjust the brightness as previously explained for "Headlights On" setting.

### • Units

After pressing the “Units” and then “Custom” soft-key on the touchscreen you may select between “US” units and “Metric” of measure. Each unit of measure can be independently displayed in the TFT Display and in the navigation system. The following selectable units of measure are listed below:

- **Speed** unit:  
select from: “MPH” or “km/h”.
- **Distance** unit:  
select from: “mi” or “km”.
- **Fuel Consumption** unit:  
select from: “MPG (US)”, “MPG (UK)”, “L/100km” or “km/L”.
- **Pressure** unit:  
select from: “psi”, “kPa” or “bar”.
- **Temperature** unit:  
select from: “°F” or “°C”.
- **Power** unit:  
select from: “kW”, “HP (US)” or “HP (UK)”.
- **Torque** unit:  
select from: “lb-ft” or “Nm”.

#### • Touchscreen Beep

When in this display, you can turn on or shut off the sound activated by pressure of a touchscreen soft-key.

#### • Show Main Category Bar Labels

By selecting this function, the system shows the labels on the soft-keys of the main category bar.

#### • Navigation Turn-by-Turn Displayed in Cluster

By selecting this function, the next turn direction will appear on the instrument cluster along a programmed route until the desired destination is reached (see picture).

#### • Phone Pop-ups Displayed in Cluster

When this mode is selected a pop up message will appear in case of incoming call. Information associated to call in progress are available by entering to the “Audio” menu using the buttons on the steering wheel RH side.



#### Safety & Driving Assistant

Touch this soft-key to set the following modes.

#### • Forward Collision Warning / Pedestrian Emergency Braking

The FCW function primary use the front radar and the forward looking camera for sensing vehicle and pedestrian (if

the car is equipped with Pedestrian Emergency Braking - PEB function) ahead, provide warnings to the driver and may perform brakings and brake jerks (if set).

FCW is always active: it is possible to set the warnings, the sensitivity and the aid of the active braking.

FCW warnings can be set in "Off", "Only Warning" and "Warning + Active Braking".

FCW sensitivity can be set to “Near”, to “Med (Medium)” or to “Far”.

The default status of FCW sensitivity is the “Med” setting.

FCW with active braking can be set to “On” or “Off”.

See "Forward Collision Warning - FCW" in section "Driver Assistance Systems" for more details.

#### • Traffic Sign Assist

Activating this function the forward-facing digital camera, with the aid of maps on the navigation system, is able to detect traffic signs with a restriction (e.g. in snow conditions) and speed limits. Those are displayed by the TSA system on the instrument cluster display together with a possible alert when the vehicle exceeds the speed limit.



See “Traffic Sign Assist - TSA” in section “Driver Assistance Systems” for further details.

### • Lane Keeping Assist

Activating this function the LKA system will attempt to keep the vehicle in lane and can apply direct input to electric power steering system to change direction of vehicle.

Driver warnings are “Visual & Haptic” (default mode).

System response can be set to “Early”, “Medium” (default mode) and “Late”.

System reaction force can be set to “Low”, “Medium” (default mode) and “High”.

See “Lane Keeping Assist - LKA” in section “Driver Assistance Systems” for more details.

### • Blind Spot Alert

Activating this function the system will try to prevent collision between host vehicle and potential blind spot collision hazard.

This function can be set in “Off”, “Lights” or “Lights + Chime”.

See “Blind Spot Assist - BSA” in section “Driver Assistance Systems” for more details.

### • Active Blind Spot Assist

Activating this function the system will try to prevent collision between host vehicle and potential blind spot

collision hazard. System applies direct input to electric power steering system to change direction of vehicle to avoid collision.

Driver warnings can be only “Visual”, “Visual & Acoustic” (default mode) or “Visual & Haptic”.

System response can be set to “Early”, “Medium” (default mode) and “Late”.

System reaction force can be set to “Low”, “Medium” (default mode) and “High”.

See “Active Blind Spot Assist - ABSA” in section “Driver Assistance Systems” for more details.

### • Park Assist

The park assist system will scan for objects behind and in front of the vehicle when the transmission shift lever is in R (Reverse) and the vehicle speed is less than 7.5 MPH (12 km/h).

The system can be enabled with “Sound Only”, “Sound+Display”, or turned “Off”. See “Park Assist” in section “Driver Assistance Systems” for further information.

### • ParkSense Front Sensors Active in Drive

If this function is active, when driver takes shift lever from P (Park) or N (Neutral) to D (Drive), front parking sensors are activated. If this function is not active, when driver takes shift

lever from P (Park) or N (Neutral) to D (Drive), front parking sensors are NOT activated.

### • Front ParkAssist Volume

When this function is selected, the chime volume of front park assist sensors can be set to “Low”, “Medium” or “High” level. “Medium” is the default setting.

The system will retain its last known configuration state through ignition cycles.

### • Rear ParkAssist Volume

When this function is selected, the chime volume of rear park assist sensors can be set to “Low”, “Medium” or “High” level.

“Medium” is the default setting.

The system will retain its last known configuration state through ignition cycles.

## Clock & Date

Time is always visible on the dashboard analog clock (see “Analog Clock” in this section) and in digital format on the instrument cluster and on the MIA display.



With this function it is possible to view and set the following modes.

- **Sync with GPS Time**

Time is normally automatically synchronized with the radio signal. It is also possible to set automatic synchronization mode using GPS signal instead.

- **Set Time Hours**

With “Sync with GPS Time” function unchecked and this mode selected, you can set the hours manually from 1 to 24.

To select, touch the “+” or “-” soft-keys to adjust the hours.

- **Set Time Minutes**

With “Sync with GPS Time” function unchecked and this mode selected, you can set the minutes manually from 0 to 59. To select, touch the “+” or “-” soft-keys as done for the hours.

- **Time Format**

When in this mode, you can select the time format display. To change the current setting, touch and release the “12 Hrs” or “24 Hrs” soft-key.

- **Show Time In Status Bar**

This function will allow you to turn on or shut off the digital clock in the upper status bar.

- **Set Date (in Cluster)**

When in this mode, you can set the date manually in the upper status bar of the MIA and on the instrument cluster display. Touch the “+” or “-” soft-keys to adjust day, month and year.

## Phone/Bluetooth

Touch this soft-key to select the function related to the connect phones.

- **Device Manager**

By selecting this function, when touch the "Phone" soft-key in the main category bar the system open the "Device Manager" page to manage the connected devices.

- **Do Not Disturb All**

By selecting this function will block incoming texts, calls or both.

- **Enable Two Active Phones**

By selecting this function the MIA system enable two phones connected via Bluetooth.

**NOTE:**

On the Maserati website, at [www.maserati.com](http://www.maserati.com), or through an **Authorized Maserati Dealer** you may consult the list of telephones that are compatible with the MIA, and their level of compatibility.

- **Phone Pop-ups Displayed in Cluster**

When this mode is selected a pop-up message will appear in case of incoming call. Information associated to call in progress are available by entering to the “Audio” menu using the buttons on the steering wheel RH side.

## Voice

After touching this soft-key the following modes to give voice commands will be available.

- **Voice Options**

It is possible choose between "Female" or "Male" voice commands.

- **Wake Up Word**

With the microphones in the listening mode, this function allows you to select the wake up word from the available options.



### • **Voice Barge-in**

By selecting this function it is possible to respond to a voice response before the statement is completed.

### • **Show Command List**

When this function is selected, it is possible to select suggested options during a voice control session.

## Navigation

Touch this soft-key to set the following modes.

- **Show**
- **Map View**
- **Routing**
- **Sound & Alerts**
- **Other**

## Camera

Touch this soft-key to set the following modes.

### • **Surround View Camera Delay**

By selecting this function the image of surround camera is displayed on MIA screen.

### • **Surround View Camera Guidelines**

By selecting this function on the screen of the surround camera are displayed guidelines.

### • **ParkView Backup Camera Delay**

By selecting this function, when the shift lever is moved out of R (Reverse), the rear view image will be displayed for up to 10 seconds after shifting

unless the forward vehicle speed exceeds 8 MPH (12 km/h).

### • **ParkView Backup Camera Active Guidelines**

By selecting this function on the screen of the parkview backup camera are displayed active guidelines.

## Mirrors & Wipers

Touch this soft-key to set the following modes.

### • **Tilt Side Mirrors In Reverse**

By selecting this function the outside side-view mirrors will tilt downward when the ignition device is in **RUN** position and the transmission shift lever is in R (Reverse) position. The mirrors will move back to their previous position when the transmission is shifted out of R (Reverse).

### • **Auto Folding Side Mirrors**

By selecting this function the rear-view mirrors automatically fold when the vehicle is locked by the key fob and when the power trunk lid (if equipped) is closed and locked by pressing the  button on the outer ledge of the left boot compartment lining. When the vehicle and the liftgate will be unlocked, the rear-view mirrors will automatically open in the position they had before the lock.

If the mirrors were manually folded by the switch on the driver's door panel,

before a lock action, they will need to be manually unfold to reactivate the automatic behave.

### • **Rain Sensing Auto Wipers**

By selecting this function, the system will automatically activate the windshield wipers if the rain sensor senses moisture on the windshield.

### • **Headlights with Wipers**

By selecting this function, while the headlight lever is in "AUTO" position, the headlight will turn on approximately 10 seconds after the wipers are activated. The headlight will also turn off when the wipers deactivate if they were activated in the current mode.

## Lights

Press the "Lights" soft-key to set the following modes.

### • **Headlight Off Delay**

By selecting this function, the driver can choose to have the headlight off or lit for 30, 60, or 90 seconds when the engine is shut off. To change the current headlight off delay status, touch and release the "0", "30", "60" or "90" soft-key to select the desired time range.

### • **Adaptive Front Lights**

By selecting this function, the driver can set the light sensor by choosing between "on" or "off".





- **Headlight Illumination on Approach**

By selecting this function, the driver can choose to have the headlight off or lit for 30, 60, or 90 seconds when the doors are unlocked with the key fob.

- **Headlights with Wipers**

By selecting this function, while the headlight lever is in “AUTO” position, the headlight will turn on approximately 10 seconds after the wipers are activated. The headlight will also turn off when the wipers deactivate if they were activated in the current mode.

- **Auto Dim High Beams**

By selecting this function, the high beam headlight will deactivate automatically under certain conditions. See “External Lighting” in section “Understanding the Vehicle” for further information.

- **Daytime Running Lights (DRL)** (for vehicles of US market only)

By selecting and check-mark this function, the DRL lights will turn on whenever the engine running.

- **Headlight Dip** (right/left-hand drive)

By selecting this function, the headlights will change their light distribution when a left-hand-drive vehicle enter a Country with right-hand-drive system and vice versa.

- **Flash Lights with Lock**

By selecting this function, the headlights will flash when the doors are locked or unlocked with the key fob or when using the “Passive Entry” function.

## Doors & Locks

Touch this soft-key to set the following modes.

- **Auto Door Locks**

When this function is selected, all doors will automatically lock when the vehicle is in motion.

- **Auto Unlock on Exit**

By selecting this function, all doors will unlock when the vehicle is stopped, the transmission is in P (Park) or N (Neutral) position and the driver’s door is open.

- **Flash Lights with Lock**

By selecting this function, the headlights will flash when the doors are locked or unlocked with the key fob or when using the “Passive Entry” function.

- **Sound Horn with Lock**

When this function is selected, the horn will sound when the doors are locked with the key fob. You can choose from the following options: “Off” (no sound), “1<sup>st</sup> Press” (sound on the first press of the button) and “2<sup>nd</sup> Press” (sound on the second press of the button).

- **Sound Horn with Remote Start**

When this function is selected, the horn will sound when you use the key fob to start the engine. See “Remote Start System” in section “Starting and Driving” for further details.

- **1st Press of Key Fob Unlock**

By selecting this function you may set up only the driver’s door or all doors mode will unlock on the first press of the key fob button. When “Driver Door” is selected, you must press the key fob button twice to unlock also the passenger’s doors.

When unlocking “All Doors” by first press selection mode, all doors will unlock on the first press of the key fob button.

- **Passive Entry**

This function allows you to lock and unlock the vehicle door(s) without having to push the key fob or buttons. By selecting this function, “Passive Entry” may be set to “On” or “Off”.

The default status is “On”. With “Passive Entry” deactivated, also the “Pre-Short Drop” function is disabled (for further information, refer to “Bodywork Maintenance and Care” in section “Maintenance and Care”).

- **Personal Settings Linked to Key Fob**

This selected mode enables to combine the key fob to personal driver’s



position settings. These settings will be implemented when pressing the button on the key fob with ignition device in **RUN** position.

### • **Hands Free Power Liftgate**

To prevent the accidental opening of the power liftgate with Hand free function with the movement of the foot, it is possible to disable this function. This operation is recommended when you have to wash the car (for further information, refer to “Power Liftgate Operation” in section “Before Starting”).

### **Seat & Comfort (If equipped)**

Press this soft-key to set the following modes.

#### • **Easy Exit Seats**

When this function is selected, the driver's seat will automatically move rearward once the engine is shut off for easy exit of the vehicle.

#### • **Auto-on Driver Heated/Vented Seat & Steering Wheel**

This function allows to activate the comfort of the driving seat when starting the engine.

If equipped, the driver's heated/vented seat and/or heated steering wheel will automatically activate by temperatures below 40°F (4°C). When temperatures are above 80°F (26°C) the driver vented seat will turn on.

If the vehicle is equipped with the remote start system, you can choose from the following options: “Off”, “Remote Start” (activation of this function when you use the key fob to start the engine) and “All Starts” (activation of this function when you start the engine in all modes).

### **Key Off Options**

This function allows you to set some functions after turning off the engine.

#### • **Easy Exit Seats**

When this function is selected, the driver's seat will automatically move rearward once the engine is shut off for easy exit of the vehicle.

#### • **Key Off Power Delay** (power duration after engine shutdown)

By selecting this function, the power window switches, radio, MIA Phone System, power sunroof (if equipped), and power outlets will remain active for up to 10 minutes after turning off the engine.

Opening of one front doors will cancel this function.

The switch-off delay can be cancelled (0 seconds) you can choose from 45 seconds, 5 minutes or 10 minutes.

#### • **Headlight Off Delay**

By selecting this function the headlight will stay lit for up to 90 seconds after turning off the engine.

The switch-off delay can be cancelled (0 seconds) or reduced to 60 or 30 seconds.

#### • **Auto Entry/Exit Suspension**

Select this mode to automatically lower vehicle to minimum ground clearance when driver takes transmission to P (Park) to help entry into and exit from the vehicle and unloading of cargo from the trunk compartment.

### **Suspension**

This function allows displaying and setting the following modes of the pneumatic suspension system.

#### • **Auto Entry/Exit Suspension**

Select this mode to automatically lower vehicle to minimum ground clearance when driver takes transmission to P (Park) to help entry into and exit from the vehicle and unloading of cargo from the trunk compartment.

#### • **Display Suspension Messages**

Select this mode to choose whether to display all suspension related messages (option "All") or only suspension warning messages (option "Warning only").

#### • **Tire Jack Mode** (Stationary Auto Leveling)



Select this mode to disable the pneumatic suspension to avoid automatic levelling, when vehicle must be lifted for changing a wheel or tire.

#### • Transport To Mode

Select this mode to lower the pneumatic suspension to minimum ride height and disable system operation to help vehicle loading and transport, for instance on the platform of a tow truck.

#### • Wheel Alignment Mode

Select this mode to prevent automatic pneumatic suspension alignment when servicing suspension and/or steering parts.

### Audio

This function enables to view and set the available audio modes depending on the type of audio system supplied on the car.

#### • Audio Settings

Touch this function to open the subscreen with all the audio settings items.

The following settings refer to the “High Premium” audio system.

#### • Balance/Fade

Use this screen to adjust the balance and fade settings. Touch and drag the speaker icon, use the arrows to adjust, or tap the “C” icon to readjust to the center.

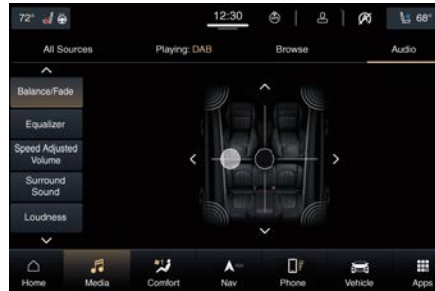

#### • Equalizer

Use this screen is used to adjust the “Bass”, “Mid” and “Treb” settings. Adjust the settings with the “+” and “-” setting soft-keys or scroll and touch the slider in any point on the scale between the “+” and “-” soft-keys.

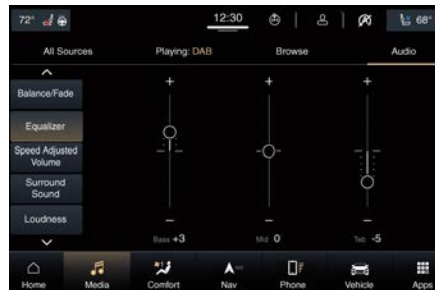

#### • Speed Adjusted Volume

This function increases or decreases volume combined to vehicle speed. To change the speed adjusted volume touch the “Off”, “1”, “2” or “3” soft-key.

#### • Surround Sound

This function provides simulated surround sound mode. Available settings: “On” and “Off”.

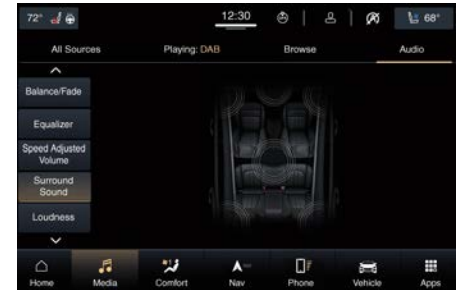

#### • AUX Volume Offset

This function tunes audio level for portable devices connected to the AUX port trough the “-” and “+” soft-keys.

#### • Auto Play

When a portable device is connected via USB port to MIA system, it plays automatically the songs if this function is set to “On”.

#### • Clari-Fi

This function improves the audio quality by enhancing digitally compressed source files such as MP3 and AAC files and certain music tracks played by radio stations. In case of high-definition source files, Clari-Fi shall apply no enhancement. Clari-Fi intervention is completely automatic.



### Notification

Touch this soft-key to set the following modes.

- **App Drawer Favoriting Popups**

By selecting this function is possible turns on and off popup for "App Favorited".

- **App Drawer Unfavoriting Popups**

By selecting this function is possible turns on and off popup for "App Unfavorited".

- **New Text Message Popups**

By selecting this function is possible turns on and off receiving/storing a popup for new text messages of any connected phone.

- **Missed Calls Message**

By selecting this function is possible turns on and off receiving/storing a popup for missed calls of any connected phone.

- **Navigation Popups**

By selecting this function is possible turns on and off receiving/storing predictive Navigation popups and any other Navigation popups that can be turned off.

- **Drive Mode Transition Popups**

### SiriusXM Setup

After pressing the "SiriusXM Setup" soft-key the following settings will be available.

- **Tune Start**

"Tune Start" begins playing the current song from the beginning when you tune to a music channel, so you can enjoy the complete song. "Tune Start" works in the background, so you will not even realize it's on, except that you will miss the experience of joining your favorite song with only a few seconds left to play.

- **Channel Skip**

SiriusXM can be programmed to designate a group of channels that are the most desirable to listen to or to exclude undesirable channels while scanning. To make your selection, touch the Channel Skip soft-key, select the channels you would like to skip followed by pressing the arrow < soft-key.

- **Subscription Information**

SiriusXM Satellite Radio requires a user-paid subscription to access these stations.

It will be necessary to access the information on the Subscription Information Screen in order to subscribe. Touch the Subscription Info soft-key to access your receiver ID number. Write down the SiriusXM ID numbers for your radio. To activate SiriusXM service, either call the number listed on the

screen or visit SiriusXM online at [www.siriusxm.com/subscriptions](http://www.siriusxm.com/subscriptions) or call the number listed.

### Geolocation

Touch this soft-key to set the following modes.

- **Geolocation**

By selecting this function is possible disables or re-enables the GPS tracking in the vehicle.

### Software Updates

Touch this soft-key to set the following modes.

- **Software Downloads over Wi-Fi**

By selecting this function you can download the MIA software via Wi-Fi.

### System Information

Touch this soft-key to set the following modes.

- **Version Information**

By selecting this function you can access the data page relating to the software version installed on MIA.

- **License Information**

### Restore Settings

Touch this soft-key to set the functions which allow you to reset data, Apps and password used by MIA system.

- **Restart Radio**

- **Reset App Drawer to Default Order**



By selecting this function a popup will appear asking user to confirm App Drawer resetting. Select "Yes" to restore, or "Cancel" and "X" to close the popup without reset the App Drawer.

- **Restore Setting to Default**

When this function is selected, it will reset the "Clock", "Audio", and "Radio" settings to their default settings. Run this function and a pop up will appear asking user to confirm default settings resetting. Select "Yes" to restore, or "Cancel" and "X" to exit. Once the settings are restored, a pop up appears confirming that settings have been reset to default and then the MIA will restart.

- **Clear Personal Data**

When this function is selected, it will remove personal data concerning settings and/or options that have been modified compared to factory settings and will also remove from system memory Bluetooth devices, Apps and presets.

To remove personal information, select this function and a pop up will appear asking confirmation to delete all personal data. Select "Yes" to clear, or "Cancel" and "X" to exit. Once the data have been cleared, a pop up appears confirming that personal data have

been cleared and then the MIA will restart.

- **Reset Wi-Fi Password for Projection**

By selecting this function a popup will appear with the request to confirm the intention to change the Wi-Fi password. Select "Yes" and then "OK" to reset the password, or "Cancel" and "X" to close the popup without reset the Wi-Fi password.

- **Factory Reset**

Selecting this function a popup will appear with the request to confirm the intention to reset the MIA to the factory defaults. The "Yes" choice will cause the MIA to restart and the backup camera, the radio, SOS Call and several driving assistance functions will not available. This could take several minutes. Select "Cancel" or "X" to close the popup without resetting the factory defaults.

## Controls on Steering Wheel

### ADAS Controls

The controls on the left side of the steering wheel are dedicated to ADAS systems and their presence and layout depend on the car's options.

The "Standard Configuration", in addition to the multifunction switch **1**, includes the controls of the Hill Descent Control (HDC) **2** and Cruise Control (CC) **3** systems.

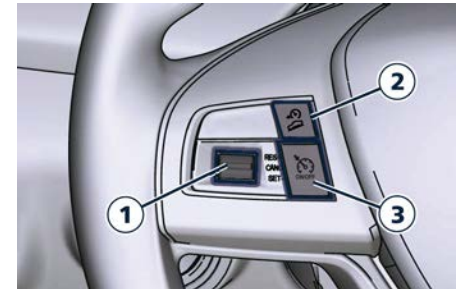

Standard Configuration

The "Optional Configuration", in addition to the multifunction switch **1** and HDC button **2**, includes the ON/OFF Adaptive Cruise Control (ACC) button **4**, the button **5** to set the ACC time gap to the sensed vehicle ahead and can include the Active Driving Assist (ADA) ON/OFF button **6**. The two ACC controls also allow the switching on and off of the CC.

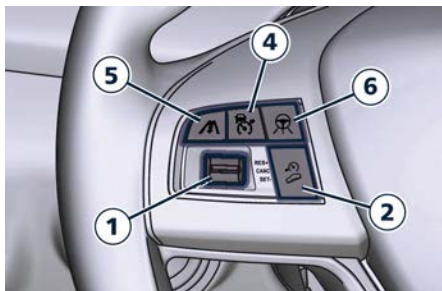

Optional Configuration

For all information on the use of these commands, see the chapters on the individual ADAS systems in the section "Driver Assistance Systems".

## Phone and Voice Controls

The controls on the right side of the steering wheel activate/deactivate the phone mode (📞) and the Voice Recognition (🗣️) functions.

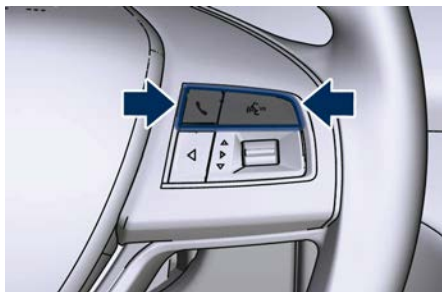

These functions are only available when one or more Bluetooth® compatible mobile phones are paired with the MIA system connection.

To pair a phone and to learn all available functions refer to the "Maserati Intelligent Assistant (MIA)" guide.

### NOTE:

On the Maserati website, at [www.maserati.com](http://www.maserati.com), or through an **Authorized Maserati Dealer** you may consult the list of telephones that are compatible with the MIA, and their level of compatibility.

The voice command communication system is fully integrated with the vehicle's audio system.

The volume can be adjusted from the "VOLUME" upper knob on the central console (see "Maserati Intelligent Assistant Operation" in this section) or from the steering wheel audio controls described in this chapter.

The system will automatically mute the radio when using the phone mode.

When activating the phone mode using voice commands with speakerphone, you should talk quietly in a normal conversational tone by keeping the driving position and turning to the microphone of the voice command system located inside of the internal rear-view mirror.

The ability of the system voice control to recognize the user's voice commands can be invalidated when speaking too quickly or too loudly.



### WARNING!

**Any voice-controlled system should be used only in safe driving conditions following all applicable regulations. Full attention should be kept on driving.**

### Phone Mode Button

By using the phone button 📞 on the steering wheel it is possible to: activate the phone mode, start a call, show recent incoming and outgoing calls, show contacts list, etc.



Touching the active call soft-key on the main category bar, the "Phone" page will open (see example in picture).





When pressing the phone button  an audible sound will invite you to impart a command.

Information on incoming call is indicated in a pop-up on instrument cluster display main area if this function is checkmarked on MIA (see “Functions of Settings Menu on MIA” in this section). Said information will stay displayed until a control is executed (e.g.: answer, reject, etc.) for the incoming call.

The screen will only display the phone number or name of caller (if available) as long as this complies with system specifications in terms of font and number of characters.

Call details can be displayed at any time through “Audio” submenu item, then “Phone: call details” using the buttons on steering wheel RH side. On display, said details shall temporarily replace the ones on media source in use.

### Voice Recognition Button

The short pressure of the VR  button on the steering wheel allows you to give voice commands dedicated to all the native functions of the MIA (radio, media, navigator, climate, etc.). Excluded are all functions that interact with the Apps: “Apple CarPlay” and “Android Auto” or those of the voice assistants: Siri, Google Voice, etc..., supported on the mobile paired via Bluetooth® to the MIA. A long pressure of the VR  button, in addition to the native ones of the MIA, allows to give voice commands dedicated to the above mentioned Apps and voice assistants.

#### NOTE:



**The pressure difference of the VR  button (short or long) is effective only when the mobile is paired via Bluetooth® to the MIA.**

On the markets where it is available, once voice recognition is activated via the VR  button on the steering wheel, a “teleprompter” screen is displayed on the MIA with a list of commands specific to each active function key shown on the vertical menu bar in the left side of the screen.

The teleprompter screen shall always open at the “Suggested” menu (see example in picture). Selecting a different

menu will bring up commands within that menu.

The key words to activate the dialog are white, the variable ones gray between the symbols “< >” and the alternative ones after the slash “/”.

Touching voice help  soft-key the help response will be reproduced. It will have the same function as saying help. If the dialogue is paused, at the end of the help  prompt the teleprompter will return to the listening status.

Touching setting  soft-key the voice session will be canceled and will open the voice settings page.

At the top center of the teleprompter screen is displayed an animation representing the listening, processing and speaking state. While in the listening state, the animation will react to the microphone input: when in speaking state, will react to the prompt.

Touch the “Cancel” soft-key to end the voice dialog and close the teleprompter screen.

Touching one of the soft-key on the main category bar, the session is cancelled and displays the selected category screen.

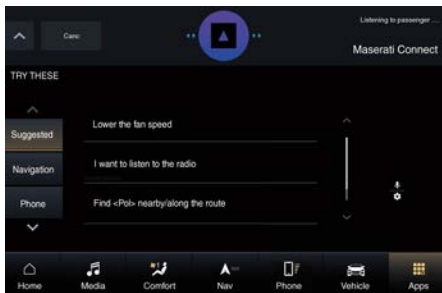

When pressing the VR  button an acoustic signal will invite to give a voice command.

**NOTE:**

For further details refer to the "Maserati Intelligent Assistant (MIA) guide".

**Siri Smart Personal Assistant**

When a compatible iPhone® or iPad® that supports Siri voice recognition is paired to the vehicle via Bluetooth®, a long press of the VR  button activates the Siri Smart Personal Assistant.

Siri requires mobile internet access and its functionality might change depending on the geographical area. Through simple voice commands, without taking your eyes off the road, it may be possible to send messages, make phone calls, create notes and reminders, etc.

## Audio System Controls

The vehicle is equipped with audio controls which allow the driver to operate the audio system. These controls can be used to adjust audio volume, change radio station or mode. These audio controls are rocker-type switches with a button in the center and are located on the rear side of the steering wheel, right behind the front switches.



Press any button to display information on the radio station or track being listened to inside a pop-up for 2 seconds on instrument cluster.

The right-hand control manages the volume.

By pressing the top of the rocker switch you can increase the volume and by pressing the bottom of the rocker switch you can lower it. Press the center button to mute the volume.

The left-hand control functions depend on the current source. To change source, press the center button.

When in "Radio" mode, pressing the top of the switch will "Seek" up for the previous listenable station and pressing the bottom of the switch will "Seek" down for the previous listenable station. When an external source is connected to MIA, a light press on the top of the switch will play the next track on the device connected.

Press the bottom of the switch once to go to the beginning of the current track, or to the beginning of the previous track if it is within one second after the current track begins to play.

If you press the switch up or down twice, it plays the second track; three times, it will play the third one, etc.





## Light Controls

### Light Switch

The headlight switch located on the left side of the dashboard can be used to turn on and off the position/DRL lights, headlights, side marker, license plate lights and front and rear fog lights.

The light switch on vehicles of United States (US) market can take the following positions:

- 0 All lights off;
- ☰☑ Position/DRL lights, side marker and license plate light;

- AUTO** Automatic headlights;
- ☰☑☑ Manual headlights.

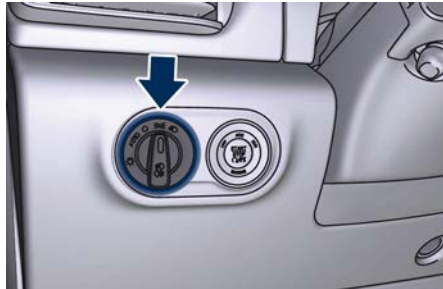

US Market

The light switch on vehicles of Canadian (CDN) market can take the following positions:

- ☰☑☑ Position/DRL lights, side marker and license plate light;

- AUTO** Automatic headlights;
- ☰☑☑☑ Manual headlights.



CDN Market

The light switch can also be pressed to turn the front (☰☑) and rear (☰☑☑) fog lights on and off.

By turning the light switch in ☰☑☑ or ☰☑☑☑ position: the instrument cluster will display the related telltale.



When the engine is not started and the lights are switched on automatically by

the twilight sensor or manually via the light switch, after about 30 minutes the lighting system turns off the lights that would otherwise remain lit and could discharge the battery.

The following tables show the on/off condition of external lights, according to the ignition device position, to the engine status, to the twilight sensor mode and to the light switch position.





Table Valid for United States Market Only

Ignition Device Position	Engine Status	Twilight Sensor Mode	Lights Switch Position			
			AUTO	0		
OFF	–	–	All lights off.	All lights off.	Position lights (1), side marker and license plate lights on (3).	Low beams, position (1), side marker and license plate lights on.
ACC	Off	–	All lights off.	All lights off.	Position lights (1), side marker and license plate lights on (2).	Low beams, position (1), side marker and license plate lights on (2).
RUN	Off	–	All lights off.	All lights off.	Position lights (1), side marker and license plate lights on (2).	Low beams, position (1), side marker and license plate lights on (2).
RUN	On	DAY	DRL (1) on (if enable by MIA).	DRL (1) on (if enable by MIA).	DRL (1), rear position lights, side marker and license plate lights on.	Low beams, position (1), side marker and license plate lights on.
RUN	On	NIGHT	Low beams, position (1), side marker and license plate lights on.	DRL (1) on (if enable by MIA).	DRL (1), rear position lights, side marker and license plate lights on.	Low beams, position (1), side marker and license plate lights on.

(1) The lighting system uses the same LED for DRL and front position lights with two different levels of intensity: high for DRL and low for position lights.  
(2) The lights are powered up for 30 minutes to preserve the charge of the battery.  
(3) To preserve the charge of the battery, do not leave these lights on for a long time.



Table Valid for Canadian Market Only

Ignition Device Position	Engine Status	Twilight Sensor Mode	Light Switch Position		
				AUTO	
<b>OFF</b>	–	–	Position lights (1), side marker and license plate lights on (3).	All lights off.	Low beams, position (1), side marker and license plate lights on.
<b>ACC</b>	Off	–	Position lights (1), side marker and license plate lights on (2).	All lights off.	Low beams, position (1), side marker and license plate lights on (2).
<b>RUN</b>	Off	–	Position lights (1), side marker and license plate lights on (2).	All lights off.	Low beams, position (1), side marker and license plate lights on (2).
<b>RUN</b>	On	DAY	DRL (1) on.	DRL (1) on.	Low beams, position (1), side marker and license plate lights on.
<b>RUN</b>	On	NIGHT	Low beams, position (1), side marker and license plate lights on.	Low beams, position (1), side marker and license plate lights on.	Low beams, position (1), side marker and license plate lights on.

(1) The lighting system uses the same LED for DRL and front position lights with two different levels of intensity: high for DRL and low for position lights.

(2) The lights are powered up for 30 minutes to preserve the charge of the battery.

(3) To preserve the charge of the battery, do not leave these lights on for a long time.



### Position Lights and Daytime Running Lights (DRL)

The lighting system uses the same high or low intensity headlamps LED, respectively, for the DRL lights and front position lights.

With the light switch turned in , the position lights will turn on when the ignition device is in any position and the engine is stopped or when the engine is running and the twilight sensor is in "NIGHT" mode.

The position lights are always on when the light switch is set in the  position.

DRL lights will turn on when the twilight sensor is in "DAY" mode, the engine is running and the light switch is in  or "AUTO" position.

#### NOTE:

If the headlights or position/DRL lights are on after the ignition device is placed in OFF position, a buzzer will alert the driver while opening the driver's door to exit the car.

If a turn signal is activated, the DRL LED on the same side of the vehicle will turn off for the duration of the turn signal activation. Once the turn signal is deactivated, the DRL LED will light up again.

#### NOTE:

On Canadian vehicles DRL are always on. On United States vehicles the DRL lights can be turned on and off using the MIA system, see "Functions of Settings Menu on MIA" in section "Dashboard Instruments and Controls" for further information.

### Automatic Headlights

This system automatically turns the headlights on or off according to ambient light intensity detected by the twilight sensor positioned on the inner surface of the windshield, over the rear view mirror. To turn the system on, rotate the lights switch clockwise to "AUTO" position.

When the automatic system is activated, the headlight time delay function is activated as well. This means the headlights will stay on for up to 90 seconds after you place the ignition device into OFF position.

To turn the automatic system off, move the lights switch out of "AUTO" position.

#### NOTE:

The engine must be running and the twilight sensor in "NIGHT" mode before the headlights turn on in automatic mode.

The responsibility for turning on the lights, depending on the daylight and regulations in force in the country of

use, always lies with the driver. The automatic system for switching on and off the external lights is to be considered as an aid for the driver. If necessary, switch the lights including the rear fog lights on and off manually.

### Headlights On with Wipers

When this function is active, the headlights will turn on approximately 10 seconds after activation of the wipers, if the lights switch is placed in the "AUTO" position. The headlights will additionally turn off by deactivation of the wipers if previously activated with this function.

#### NOTE:

The headlights with wipers function may be turned on and off using the MIA system, refer to "Functions of Settings Menu on MIA" in section "Dashboard Instruments and Controls".

### Headlights Time Delay

This safety function provides headlight illumination for up to 90 seconds (programmable) when leaving your vehicle in an unlit area. To activate automatically the delay function with the light switch in "AUTO" position, place the ignition device in the OFF or ACC position while the headlights are still on. The delay interval begins when the lights switch is turned off (position "0"), on the vehicles of United States market, and/or



when the ignition device is placed in the **OFF** or **ACC** position on vehicles of Canadian market. If you turn the headlights or position lights on, or place the ignition device in **RUN**, the system will cancel the delay.

If you turn the headlights off ("0" position) before the ignition, they will turn off in the normal mode.

To activate manually the delay function the headlights must be on before place the ignition device in the **OFF** or **ACC** position and the light switch in "AUTO" position.

#### NOTE:

- To activate this function the lights must be turned off ("0" position), on vehicles of united States market only, and/or the light switch must be turned in "AUTO" position within 45 seconds of placing the ignition device in the **OFF** or **ACC** position.
- Once the delay function is active, any additional shifting of the light switch will cancel the function.
- The headlight delay time is programmable using the MIA system, see "Functions of Settings Menu on MIA" in section "Dashboard Instruments and Controls".
- If the low beam bulbs/LEDs are active due to "Headlights with Wipers", then

the headlamps delay function will not be activated when the ignition device is set in **OFF** position.



#### Manual Headlights

Turning the light switch in position  turns on the low beam together with the position lights, the side markers and the license plate lights regardless of the ignition device state and the "DAY" or "NIGHT" mode detected by the twilight sensor (see table in "Light Switch" paragraph of this chapter).

The related telltale  will display on the instrument cluster.

#### Fog Lights

##### NOTE:

The front fog lights can only be switched on if the position lights (the picture shows that of United States market) are switched on . It is possible to turn on the rear fog lights only if the low beam lights () or the front fog lights () are on.

The front and rear fog lights switch is built into the light switch.

The front and rear fog lights turn on and off in the following order:

- press the lights switch once to turn on the front fog lights;

- press the lights switch a second time to turn on the rear fog lights (front fog lights will stay on);
- from this condition, press the lights switch again to turn off the rear fog lights (front fog lights will stay on);
- press the lights switch again to turn off the front fog lights.

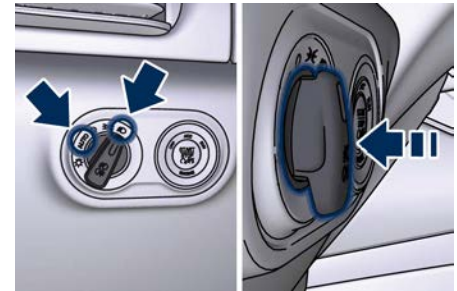

Turning the lights switch off (position "0") will also deactivate the front and rear fog lights on vehicles of United States market.

The green indicator light  in the instrument cluster display illuminates when the front fog lights are turned on.



The amber indicator light  inside the tachometer of the instrument cluster illuminates when the rear fog lights are turned on.



**NOTE:**  
After a key-off/key-on cycle, the front fog lights will activate automatically when turning on the position lights (  ). The rear fog lights will only turn on by operating as previously described.

## Multifunction Lever

The multifunction lever is fitted on the left side of the steering column. The multifunction lever controls the operation of the turn signals, headlight beam selection and overtaking lights. This lever also controls the operation of wipers and washers acting on the windshield and on the liftgate (for this content see the chapter “Wipers and Washers Control” of this section).

## Turn Signals

Move the multifunction lever all the way up or down until the stop triggers.

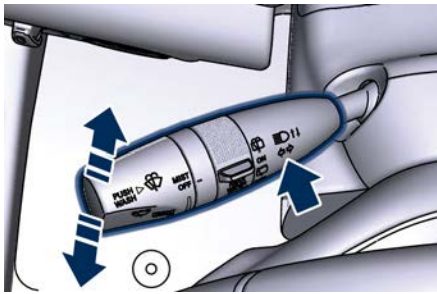

The left or right arrow on the speedometer and tachometer instrument cluster illuminates to show proper operation of the front and rear turn signal lights.



To activate lane change function, tap the lever up or down once, without moving beyond the detent. The turn signals (right or left) will flash three times then automatically turn off.

This function is useful when overtaking or changing lanes.

## NOTE:

- If either light remains on and does not flash, or flashes at a fast rate, check for a defective outside light. If an



indicator on the instrument cluster fails while moving the lever, then the turn indicator is probably defective.

- The message that a turn signal is on will appear in the instrument cluster and a continuous chime will sound if the vehicle is driven more than 1 mile (1.6 km) with either turn signal on.

### High Beams and Flashing

To switch on the high beams with the light switch in  or "AUTO" position, shift the multifunction lever onward.

The blue telltale  will illuminate on the tachometer.



By pulling the lever backward (toward the steering wheel) you switch off the high beams and switch on the low beams.

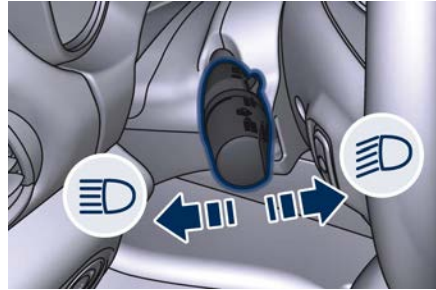

You can signal another vehicle with your headlights by lightly pulling the multifunction lever toward you. This will turn on the high beams headlights until the lever is released.

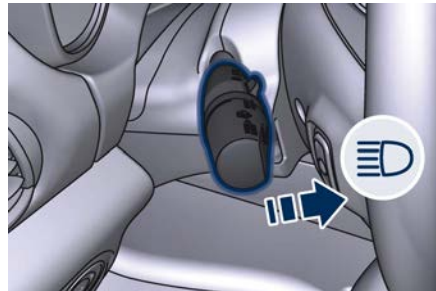

Flashing occurs also with lights off (lights switch in position "0") if the ignition device is **RUN** position.

### NOTE:

The high beams can only be switched on manually by pushing the multifunction lever forward.

If the high beams are activated, they will turn on automatically every time the low beams are switched on either manually or automatically. We recommend therefore that you switch them off when they are no longer necessary and every time the twilight sensor deactivates the external lights.



# Wipers and Washers Controls

The multifunction lever operates the wipers and washers acting on the windshield and on the window of the liftgate when the ignition device is placed in **RUN** or **ACC** position. The multifunction lever is located on the left side of the steering column.

The windshield washer and headlight washer (if equipped) share the same fluid reservoir, and a low fluid level is indicated by the same indicator light  and by the message on the instrument cluster.



To refill the fluid, see “Maintenance Procedures” in section “Maintenance and Care”.



### CAUTION!

- Turn the washer acting on the windshield and on the window of the liftgate wipers off when driving through an automatic car wash. The windshield wipers may be damaged if the wiper control is left in any position other than “OFF”.
- In cold weather, always turn off the wiper switch and allow the wipers to return to the park position before turning off the engine. If the wiper switch is left on and the wipers freeze to the windshield and/or to the window of the liftgate, the wiper motor may be damaged when the vehicle is restarted.
- Always remove any buildup of snow that prevents the wiper blades from returning to the off position. If the wiper control is turned off and the blades cannot return to the off position, the wiper motor may be damaged.

### Windshield Wipers

- Rotate the end of the multifunction lever to one of the four settings to activate the automatic intermittent setting (see “Rain Sensing Windshield Wipers” paragraph in this chapter).
- For low speed wiper operation (stable position "LO"): rotate the end of the multifunction control lever forward to

the first trigger after the intermittent setting.

- Rotate to the second trigger after the intermittent setting for high-speed (stable position HI) wiper operation.
- Rotate the end of the lever backward to the “MIST” position to activate a single wipe cycle. The wipers will continue to operate until you release the multifunction lever.
- To turn the wipers off rotate the lever to “OFF”.

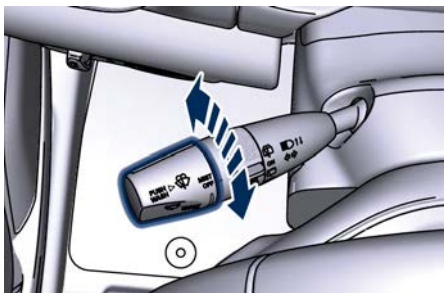

### Rain Sensing Windshield Wipers

This function detects moisture on the windshield through an internal rearview mirror integrated sensor, which automatically activates the relative wipers.

Rotate forward the end of the multifunction lever to one of four settings to adjust the detection system. First wiper delay position is the least sensitive, and fourth wiper delay





position is the most sensitive. Third position should be used for normal rain conditions.

The rain sense wipers will automatically change between an intermittent wipe, slow wipe and a fast wipe depending on the amount of detected moisture sensed by a particular area of the windshield.

Place the wiper switch in the “OFF” position when you do not want to use the automatic intermittent system.

The rain sensing function can be turned on and off using the MIA system, see “Functions of Settings Menu on MIA” in section “Dashboard Instruments and Controls” for further information.



### CAUTION!

- The rain sensing function may not function properly by ice or dried salt water on the windshield.
- Use on the windshield of RainX® or products containing wax or silicone may reduce rain sensor performance.

The rain sensing system has protective functions for the wiper blades and arms. It will not operate under the following conditions:

- **Low Temperature Wipe Inhibit:** the rain sensing function will not operate when the ignition device is in **RUN** position, the vehicle is stationary and

the outside temperature is below 32°F (0°C). To resume, set the automatic function on the multifunction lever, start the engine and drive or wait until the outside temperature rises above freezing.

- **Wipe Inhibit with Transmission in Neutral Position:** the rain sensing function will not operate when the ignition device is placed in the **RUN** position, the transmission shift lever is in the N (Neutral) position and the vehicle speed is less than 5 MPH (8 km/h). To resume, set the multifunction lever to the automatic function or move the shift lever out of N (Neutral).

## Headlights On with Windshield Wipers

When activating this function, the headlights will light up approximately 10 seconds after the wipers acting on the windshield are turned on if the light switch is placed in “AUTO” position. In addition, the headlights switch off when the wipers are turned off (position “OFF”) if they were previously turned by using this function.

Powering on Headlights with wipers can be activated and deactivated with the MIA system, see “Functions of Settings Menu on MIA” in section “Dashboard Instruments and Controls” for further information.

## Wiper Blade Maintenance

When the wiper arms acting on the windshield are in the rest position it is not possible to check or replace the blades (Service position) as they are folded under the hood. To service the blades (see paragraph “Wiper Maintenance and Blades Replacement” in chapter “Maintenance Procedures” of section “Maintenance and Care”) it is necessary to shift the multifunction lever to “OFF” and the ignition device to **OFF** position.

Shift the control lever within 15 seconds to the “MIST” position (forward rotation of the end of the multifunction control lever) and release. The blades are brought in a position enabling to open the wiper arms and change the blades.

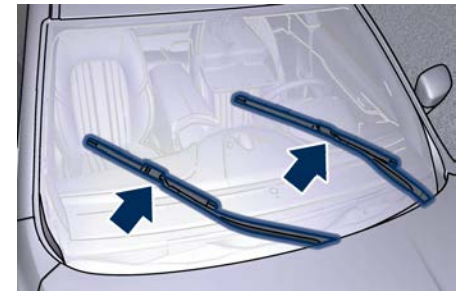

It is possible to use the “MIST” position for a maximum of 3 times within two minutes, corresponding to different three



blades positions on the windshield. When completed, bring the ignition device in **RUN**: the arms will reposition. If necessary move the multifunction lever to other required operating positions. To change the wiper blade on rear window of liftgate, simply lift the wiper arm to detach it from window (see paragraph “Wiper Maintenance and Blades Replacement” in chapter “Maintenance Procedures” of section “Maintenance and Care”).



### **WARNING!**

**Operate or service the windshield wiper blades without deactivating the wipers (“OFF” position), leaving the ignition device in RUN can be dangerous for the operator since the rain sensor may suddenly activate the wipers. Always use “Service” position for any intervention on the windshield wiper blades.**

## Windshield Washers and Headlight Washers

To use the washer on the windshield, push the end of the multifunction lever inward (toward the steering column) and hold it as long as washer spray is desired.

If you activate the washer while the windshield wiper control is in the

automatic intermittent range, the wipers will operate for two wipe cycles after releasing the lever and then resume the previously-selected intermittent interval. If you activate the washer while the windshield wiper is turned off (“OFF” position) the wipers will operate for three wipe cycles and then turn off.

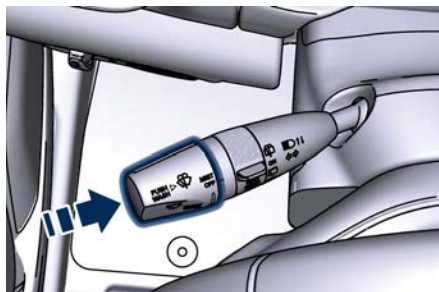

### **WARNING!**

- **Do not start the windshield washer during the cold months until the windshield has warmed up. If it has not warmed up, the liquid could freeze on the glass and block your view.**
- **Sudden loss of visibility through the windshield could lead to a collision. You might not see other vehicles or other obstacles. To avoid sudden icing of the windshield during freezing weather, warm the windshield with**

**the defroster before and during windshield washer use.**

### **Headlight Washers (if provided)**

The multifunction lever also operates the headlight washers when the ignition device is in **RUN** position and the headlights are turned on.

The headlight washers will spray a timed high-pressure spray of washer fluid onto each headlight lens every 11 windshield wipers cycles.

### **Heated Windshield Washer Nozzles**

To avoid fluid freezing inside at low external temperatures, a fluid supply nozzles can be heated by internal resistors.

## Rear Window Wiper/Washer

Use the switch on multifunction lever as follows to turn on the rear window wiper and/or washer:

- From the “OFF” position, turn control forward to the first detent to activate wiper intermittently;
- Turn control forward to the second detent to activate wiper continuous action;
- A further rotation forward (unstable position) will trigger the rear window washer until control is released. After control release, the rear window wiper will resume continuous operation;



- From the “OFF” position, turn control backward (unstable position) to trigger rear window washer until control is released: the rear window wiper will perform several cycles. Once released, control will go back to “OFF” position.

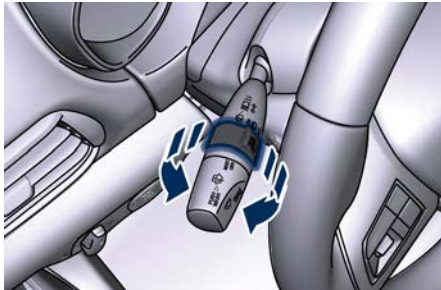

As a precaution, rear window washer pump stops if control is held in active position for over 20 seconds. When control is released, pump will resume normal operation.

If rear window wiper is still on, the wiper arm will automatically go back to rest position when the ignition device is turned **OFF**.

## Analog Clock

To adjust the analog clock located on the center of the dashboard between the air outlets, use the MIA system (see “Functions of Settings Menu on MIA” in this section).



The time can be displayed also on the MIA upper status bar and on the instrument cluster display (see “Functions of Settings Menu on MIA” in this section).

Clock lighting works in the same way as instrument and controls backlighting (refer to “Interior Lighting” in section “Understanding the Vehicle”).

## Glove Box Compartment

There is a glove box compartment on the passenger side of the dashboard to store small items or documents.



**WARNING!**  
Do not operate the vehicle with a lid glove box compartment in the open position. It could injure the occupants during a brake or in an accident.



**CAUTION!**  
Do not place objects weighing over 22 lb (10 kg) in the glove box compartment.

To open the glove box, pull the handle as shown in the picture.

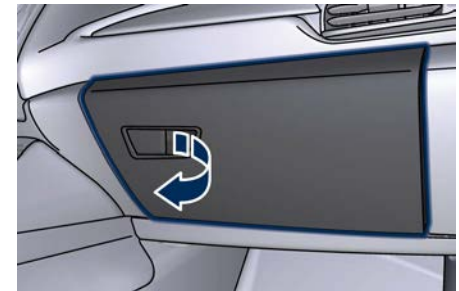

In the compartment there is a location to hold one of the two on-board documentation kits.



## Dashboard Instruments and Controls

Inside the door there are compartments for storing glasses and small items.

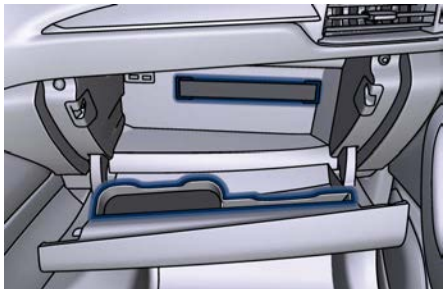

The compartment is illuminated by a courtesy light when open (the light will automatically switch off when the compartment is closed).

Under the courtesy light there are two USB ports for charging the connected source (see “Internal Equipment” in section “Understanding the Vehicle” for further details).

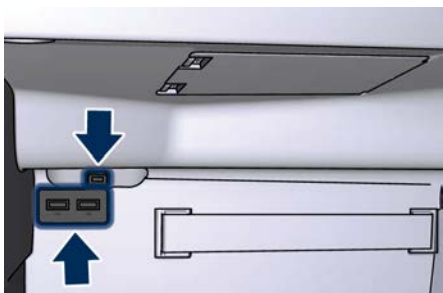

### Privacy Lock Functions

The glove box compartment is equipped with an opening/closing electric actuator that can be locked and unlocked via the MIA, by entering a 4-digit PIN code. These functions are useful for example when you have to leave the vehicle to another driver (for example, valet parking).

"Glove Box" function allow you to only lock the glove box and is available in the "Controls" menu of the "Vehicle" page and in the "Apps" page.

"Valet Mode" function is only available in the "Profiles" page and, in addition to lock the glove box, allows you to lock all the driver profiles for listening and guidance. It is important to memorize and take note of the PIN since if it is lost, you must contact the **Authorized Maserati Dealer** that will reset this function.

#### NOTE:

- “Glove Box Mode” and “Valet Mode” can not be activated at the same time.
- “Glove Box Mode” and “Valet Mode” lock functions must be activated when the glove box is already closed. If you activated one of these lock functions when the glove box is opened, the glove box will not close properly and will not lock

### Glove Box Activation Procedure

- Open “Controls” screen and touch “Privacy Lock” soft-key.

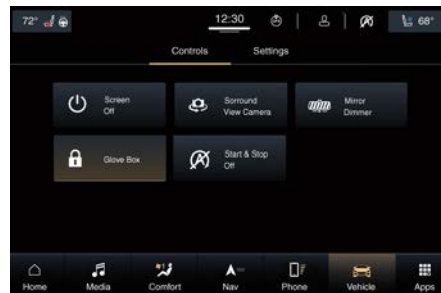

- Touch "Yes" soft-key in the function described screen to activate the function.

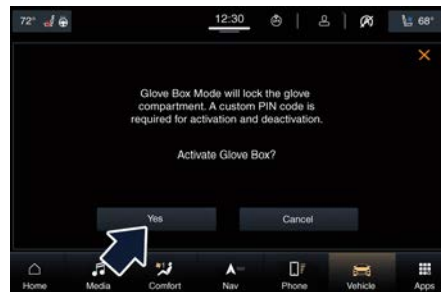

- Using the keypad, enter the four digits of the PIN and touch “OK”. The system prompts you re-enter the PIN code to confirm it.



#### NOTE:

- To activate and deactivate the function, the user has 10 attempts to type a 4 digit PIN before system cancels the deactivation. The user can try again in 30 minutes.
- If you do not enter all PIN digits, a prompt will indicate that you should do so.
- In case of an incoming call while entering the PIN, the MIA system will temporarily stop the release function. As soon as the call is over, the keypad screen will be displayed again so that you can enter the PIN.
- When the next page shown in figure appears, touch "OK".

Glove box is now locked and the MIA will go back to "Controls" page. In this condition, the system operation is reduced and only "Climate", "Controls" and "Settings" functions are active.

#### Glove Box Deactivation Procedure

To unlock the glove box which has been locked with PIN code, touch "Vehicle" category soft-key and open the "Controls" menu.

- Touch the "Glove Box" soft-key to enter this page.
- Unlock glove box by entered the lock code as previously specified.
- Touch "OK" to deactivate the function.

#### Glove Box Manual Unlock

If battery is dead, it is necessary to manually work the actuator on the LH side of the glove box to unlock the glove box that has been locked using the PIN code.

- Proceed carefully and start with the central part, indicated by the arrows in the figure, and remove the dashboard molding beneath and on the sides of the climate control panel. This molding is fastened by means of 10 pins (indicated in the figure) press-fitted onto clips present in dashboard structure.

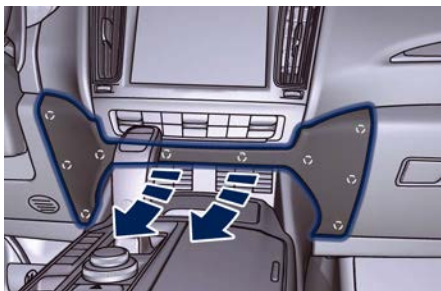

- After removing the molding, take the screwdriver from the tool kit under trunk mat (see "Tool kit" in section "In an Emergency").
- Insert screwdriver tip inside the hole on LH side of glove box structure: push until home against actuator pin.
- Push down screwdriver tip to release actuator pin and manually unlock the glove box. The actuator will remain in this condition until battery feed is restored.

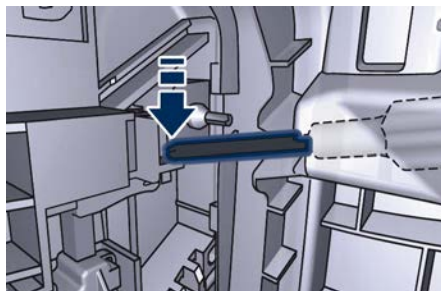

### Inner Section

- Reinstall the molding ensuring that pins match with the clips of dashboard structure.
- Press on the molding, always starting from the central part until all 10 pins are engaged in their clips and "click" in place.

After releasing the glove box by means of this procedure, do not lock glove box using the PIN code and contact an **Authorized Maserati Dealer** to have unlock function via PIN code checked.

### Valet Mode Activation Procedure

- Open "Profiles" screen and touch "Valet mode" soft-key.

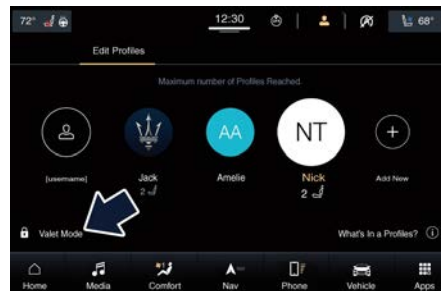

- Touch "Yes" soft-key in the function described screen to activate the function.



- Using the keypad, enter the four digits of the PIN and touch "GO".



### To Exit Valet Mode Function

To exit Valet Mode function touch the "Exit Valet Mode" soft-key in the "Welcome" pop up at key on. Deactivate the function by entering the lock PIN code as previously specified.

#### NOTE:

Valet Mode function cannot be deactivated while the vehicle is in motion.

## Air Conditioning Controls

The vehicle is equipped with an automatic dual-zone air conditioning system that allows to adjust separately the temperature and the airflow distribution in the left and in the right zone of the passenger compartment, according to the requests of the driver and the front passenger.

A humidity sensor, positioned on the inner surface of the windshield, over the rear view mirror, allows the A/C system to prevent/eliminate fogging of the windshield and side windows. The best efficacy in preventing fogging is obtained by selecting the "AUTO" function, described later.

A dual zone solar sensor helps to achieve the best comfort in presence of solar radiation.

Upon request, the vehicle can be equipped with an additional automatic dual-zone air conditioning system installed in the central console, between the front seats.

The additional dual-zone module, can be operated by the rear passengers (see "Four-zone Climate Control" in this chapter), by means of the control panel at the end of central console, but also by the front passengers entering the "Comfort" category on MIA display.

#### NOTE:

- To activate and deactivate the function, the user have 10 attempts to type a 4 digit PIN before system cancels the deactivation. The user can try again in 30 minutes.
- If you do not enter all PIN digits, a prompt will indicate that you should do so.
- In case of incoming call while entering the PIN, the MIA system will temporarily stop the release function. As soon as the call is over, the keypad screen will be displayed again so that you can enter the PIN.

"Valet Mode" activated will be indicated in the main status bar with a  lock symbol combined with the Profile icon. In this condition if user touch the Profile icon in the main status bar a popup will indicate that the function is not available in Valet Mode.



## Dual Zone Climate Controls

This system can be operated by using the controls of the climate control panel on the dashboard, or the soft-keys on the MIA display when "Climate" mode is selected.

To monitor the comfort parameters on board, you can also access the widget page from the "Home" screen and choose the "Climate" widget (see example in picture).



To navigate the MIA screen, it is possible use the "TUNE-SCROLL" lower rotary knob on the central console to scroll through the soft-key of each function: the cursor will appear in grey outline on the first available function. Press "BROWSE/ENTER" button to enter the selected function and to adjust it through the "BROWSE/ENTER" knob.

The front seats and steering wheel comfort setting soft-keys may be

present in the upper status bar if the car is equipped with these devices. When these are active, the related icon is colored red or blue: when they are not active, it is grey (see "Front Seats" and/or "Steering Wheel Adjustment" in section "Understanding the Vehicle" for further details).



Front seats and steering wheel comfort setting soft-keys are present even when the A/C is off.

When the MIA system is in any category other than "Comfort" ("Home", "Media", "Phone", etc.) the driver and passenger temperature is always visible on the upper status bar together with the front seats and steering wheel comfort functions (if equipped).

### Description of Controls

All described functions can be set and modified using the controls on the

climate control panel or the soft-keys on the MIA display.

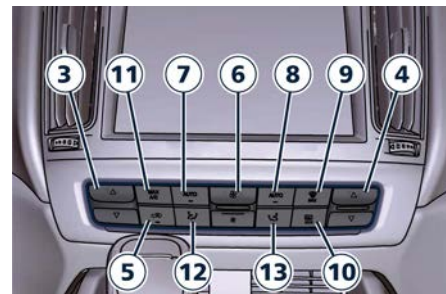

Press any of controls on the climate control panel to display "Comfort" screen.

To adjust driver and passenger side temperature and blower speed, climate control panel features rocker switches that can be pushed up to increase temperature/speed, or down to decrease them.



When MIA is in any category other than “Comfort”, pressing an air distribution or blower hard control on the climate control panel a small pop up will appear for 3 seconds above the “Comfort” icon on the main category bar (see example in picture).



### 1. Climate control on/off

Once you enter the screen “Climate”, touch the soft-key indicated in picture to switch the climate control on/off.



The “OFF” soft-key will appear in place of “ON” when the A/C is on. If the A/C system has been turned off, temperature values in the upper status bar will be obscured in all MIA modes.

#### NOTE:

For vehicles equipped with Remote Start, the Air Conditioning System will not function during Remote Start operation if the climate control is left in “OFF”.

### 2. A/C

Touch the “A/C” soft-key to change the current air conditioning setting; the soft-key illuminates when the A/C is on. Operating this function will cause the automatic function to switch into manual mode and the “AUTO” LED on the buttons and MIA soft-key will turn off.

### 3. Driver temperature control

Provides the driver with independent temperature control. Touch the blue √ soft-key for cooler temperature.

Touch the red ^ soft-key for warmer temperature. The driver's temperature setting will be displayed on the upper status bar, left side.

The temperature can also be adjusted by touching and sliding the bar towards soft-key ^, to increase temperature, or towards soft-key √ to decrease it.

During this phase, the corresponding temperature will be displayed on the upper status bar.

It is possible to adjust the temperature on the driver and passenger side even when you are outside the “Comfort” screen by simply touching the temperature indication on the upper status bar. A pop up will appear below with the bar and √/^ arrows to change the temperature and the “SYNC” soft-key to synchronise the driver's side temperature with which of the passenger side (see example in picture).



You can also increase or decrease the temperature using the rocker switch on the climate control panel.

#### NOTE:

In “SYNC” mode, this control will also automatically and simultaneously adjust the passenger temperature.

### 4. Passenger temperature control



Provides the passenger with independent temperature control.

Touch the  $\checkmark$  soft-key for cooler temperature. Touch the  $\wedge$  soft-key for warmer temperature. The passenger's temperature setting will be displayed on the upper status bar.

The temperature can also be adjusted by touching and sliding the bar towards soft-key  $\wedge$ , to increase temperature, or towards soft-key  $\checkmark$  to decrease it.

During this phase, the corresponding temperature will be displayed on the upper status bar as for the driver's side. You can increase or decrease the temperature using the rocker switch on the climate control panel.

### NOTE:

Pressing the 4 button/soft-key while in "SYNC" mode will automatically exit "SYNC" and it is possible to adjust the temperature on the passenger side.

### 5. Recirculation

Press to change the current setting, the LED indicator on the button and the relevant soft-key illuminates to indicate which recirculation function is activated. For further details, see paragraph "Dual zone Climate Control Functions" in this chapter.

### 6. Blower control

Blower control is used to adjust the amount of air forced through the climate system. Eight levels of blower speed can be selected. Adjusting the blower will cause automatic mode to switch to manual.

On the climate control panel, push the rocker switch up to increase fan speed. Push the rocker switch down to decrease fan speed. Pushing down the rocker switch when set blower is at the first speed, causes the A/C system shutdown (OFF condition).

On the MIA display, touch the number corresponding to the blower speed you want to set.

When the MIA is displayed in any category other than "Climate", the blower speed is indicated by the number in the "Comfort" soft key of the main category bar.

### 7-8. AUTO

This function automatically controls the interior temperature by adjusting the air flow rate and the air distribution respectively on the driver and on the passenger zone. Press "AUTO" to switch the ATC between manual and automatic mode. The LED on the button and the "AUTO" soft-key illuminates when the automatic function is activated. See "Automatic Temperature Control (ATC)" in this chapter for more information.

### 9. MAX defrosting/demisting

Press the  button or the MIA soft-key to switch the airflow setting to the windshield and the front side windows to get quick defrosting/ defogging. The LED on the button and the MIA soft-key illuminates when this function is activated. Operating this function will cause the ATC to switch into manual mode: so the "AUTO" LED on the button and the MIA soft-key will turn off. With engine off, the blower will run at minimum speed (level 1) and can be increased manually: with engine on, the blower speed will gradually increase to the higher speed (level 8). MAX defrosting/demisting shall also involve REAR defrosting/demisting function. If this function is turned off the climate system will return to the previous setting, switching on the A/C ("A/C" LED on the button and the MIA soft-key illuminated).

### 10. REAR defrosting/demisting

Press the  button or the MIA soft-key to turn on the rear window defroster and the heated outside mirrors. The LED on the button and the MIA soft-key will illuminate when the rear window defroster and the heated external mirrors are on. The rear window defroster and the heated external mirrors automatically turn off after 10 minutes.

For any subsequent request after the first one (in the current ignition cycle), the system activates the function for 5 minutes. The timing described above is automatically reset and the defrost/demisting function is deactivated at each key-off.



### CAUTION!

Failure to observe the following cautions may cause damage to the rear windows defroster:

- Use care when washing the inside of the rear window. Do not use abrasive window cleaners on the interior surface of the window. Use a soft cloth and a mild washing solution, wiping parallel to the heating elements. Labels can be peeled off after soaking with warm water.
- Do not use scrapers, sharp instruments, or abrasive window cleaners on the interior surface of the window.
- Keep all objects inside the vehicle at a safe distance from the window.

### 11. MAX A/C

By pressing the "MAX A/C" button of the MIA soft-key, the system automatically switches to get the maximum cold air flow in both zones.

### 12-13 Air flow distribution modes

The airflow distribution mode, respectively on the driver and on the passenger zone, can be adjusted so air comes from the dashboard vents, vents under the dashboard in direction of the floor, demist/defrost vents and vents under the front seats and adjustable vents at the rear end of the central console for the rear passengers only. The climate control panel features a single button for each zone: press it several times to select and set the required airflow distribution mode.

The airflow mode combinations will cycle in this order: "Dashboard" → "Bi-Level" → "Floor" → "Mix" → "Defrost" → "Hi-Level" → "Tri-Level". When MIA are out of the "Comfort" page, each time the button is pressed, a pop up will appear with the airflow mode activated.

When in the "Comfort" category, the MIA displays the relevant soft-keys to set these modes individually for each zone.

The arrow on the symbol soft-key in white indicates active status, in grey indicates inactive status.

Available settings are as follows:

- **"Dashboard" mode**

Air for each zone flows from four adjustable vents of the dashboard and two positioned at the rear end of the central console. Each of these vents can be singly adjusted. The air grids

or vanes of the vents can be moved to adjust air flow direction. A setting wheel, placed near each vent, allows to regulate or close the airflow.

- **"Bi-Level" mode**

Air for each zone flows from the dashboard and central console adjustable vents and from the fixed floor vents described in "Floor" mode. A small portion of the airflow is directed through the defrost/demist vents to prevent windows fogging.

#### NOTE:

Bi-Level mode is designed to let cooler air come in the dashboard and rear part of the central console vents and warmer air from the floor vents.

- **"Floor" mode**

Air for each zone flows from the fixed front vents, located under the dashboard, and under the front seats for the rear passengers. A small portion of the airflow is directed through the defrost/demist vents to prevent windows fogging.

- **"Mix" mode**

Air for each zone flows from the defrost/demist vent, the fixed vent under the dashboard and which from floor vent described in "Floor" mode.



This mode is recommended for cold climates, to improve comfort and prevent windows fogging.

• **“Defrost” mode**

Air for each zone flows from the dashboard defrost/demist vents to prevent windows fogging.

• **“Hi-Level” mode**

Air for each zone flows from the dashboard defrost/demist vents, from the dashboard and central console adjustable vents and from the fixed floor vents described in "Floor" mode.

• **“Tri-Level” mode**

Air for each zone flows from all the adjustable/fixed and defrost/demist vents.

**14. “SYNC” mode**

Touch the “SYNC” soft-key on the MIA to switch the Sync function on/off. The “SYNC” soft-key illuminates when this function is selected. This function is used to synchronise the passenger temperature setting with the driver temperature setting.

It is possible to activate this function even when MIA is in any category other than "Comfort" through the pop up window that opens when you touch the driver's temperature soft-key on the upper status bar.

Changing the passenger temperature setting while in “SYNC” will automatically exit this function.

### Dual Zone Climate Control Functions

#### Air Conditioning (A/C)

The “A/C” soft-key allows to manually activate or deactivate the air conditioning system. When the air conditioning system is turned on, cool dehumidified air will flow through the vents into the cabin. For improved fuel economy, touch the “A/C” soft-key to turn off the air conditioning and manually adjust the blower and airflow mode settings.

When the A/C and automatic functions are switched off it is not possible to have air at a lower temperature than the outside.

#### Recirculation and Air Quality Sensor (AQS)

When outside air contains smoke, odours, or high humidity, or if rapid cooling is desired, you may wish to recirculate interior air by pressing the recirculation control button or the relevant soft-key to activate the two different functionalities.

The recirculation function, that allows to open/close the A/C air inlet by operating the button on the climate control

panel or the MIA soft-key, is integrated with the Air Quality Sensor.

This sensor, positioned upstream of the A/C filter, in front of the air intake of the A/C system, detects the presence of polluting substances and submits an electric signal to the A/C control unit, that closes the intake of the external air by activating the air recirculation.

The button or the MIA soft-key can therefore enable three operating modes, switchable in sequence: "Auto", "Manual" and "Open".

Starting from the outside air condition ("Open" mode) with LED on the button off and MIA soft-key not highlighted, in which the external air is aspirated by the A/C system and treated to be introduced into the passenger compartment, subsequent actuations of the button or the MIA soft-key change the state as follows.

- First press - "Auto" mode : the A/C system activates the automatic recirculation control by using the signal transmitted from the AQS. The symbol "A" on the button lights up and the MIA soft-key with the symbol "A" in white lights up.
- Second press - "Manual" mode: the A/C system activates the recirculation, the LED on the button light up and the MIA soft-key with the



symbol "A" in white lights up. The A/C system will stay this way up to a new actuation, or until the increased humidity could lead to windshield fogging: in this case the recirculation automatically switches to external air.

- Third press - "Open" mode: the A/C system switches back to external air (default operating mode).

The next press of the button or the MIA soft-key restarts the operating cycle just described.

**NOTE:**

To avoid the risk of fogging, the AQS is disabled when the external temperature falls below 35 °F (2 °C) or rises above 79 °F (26 °C).

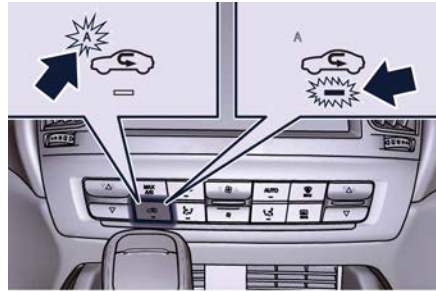

**NOTE:**

In cold weather, use of recirculation mode may lead to window fogging. Select the MIX mode and increase the blower speed to prevent fogging.

**MAX A/C**

Activating this function, the system switches to exit automatic mode and enter A/C and recirculation functions. The minimum temperature (LO) in both zones, the maximum blower speed and

the "Dashboard" air distribution mode are also selected.

The blower speed can be adjusted and the air distribution can be modified without exiting "MAX A/C". To exit "MAX A/C" touch the relevant MIA soft-key or exit A/C or recirculation functions.

Selecting , "AUTO", or "OFF", will also exit "MAX A/C".

**Automatic Temperature Control (ATC)**

**Automatic operation**

The system activates automatic mode in the following ways:

- Press the "AUTO" soft-key of driver and/or passenger zone on the climate control panel or the relevant soft-key button on the MIA screen. The text "Auto" and the fan in white will appear inside the space usually occupied by the blower speeds.





- Set the desired temperature adjusting the driver and/or passenger temperature control buttons or soft-keys. The system automatically work to maintain the best comfort level inside the passengers compartment.
- When the system is set up for your comfort level, it is not necessary to change the settings anymore, simply allow the system to function automatically.

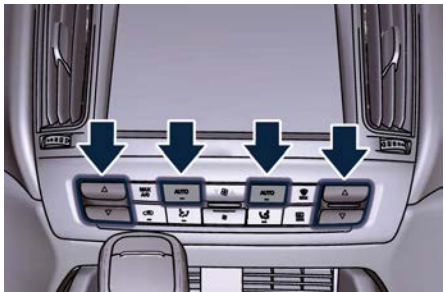

- To provide you with maximum comfort in the automatic mode, during cold start-ups the blower speed will remain low until the engine warms up.
- AUTO mode can be deactivated by operating any airflow or blower controls and by pressing "AUTO", "A/C", "MAX AC", "MAX" or "OFF" button or the associated MIA soft-key.

### Manual operation

The system allows manual selection of blower speed, air distribution mode, A/C status and recirculation control. The blower fan speed can be set to any fixed speed by using the blower control. In this case the blower will operate at a fixed speed until a different speed is selected. This allows the front occupants to control the volume of air circulated in the vehicle exiting the automatic mode. The user can also choose the direction of the airflow by selecting one of the available mode settings. A/C operation, recirculation control and SYNC mode can also be manually selected.

### Four-Zone Climate Controls (OPT)

Air conditioning controls that allow rear passengers to adjust the temperature in the left and right rear part of the passenger compartment are located at the rear end of the central console underneath the adjustable air outlets.

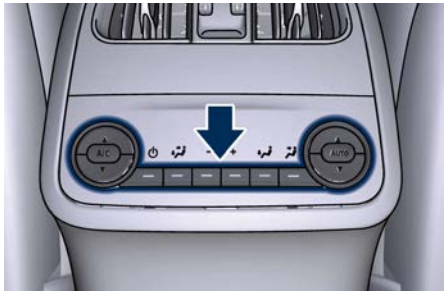

### Description of Controls

The following functions can be operated/adjusted by using the rear climate control panel.

#### 1. Rear climate control on/off

Press the button to switch the rear climate control on/off. The LED on the button turns on when the rear A/C is on.

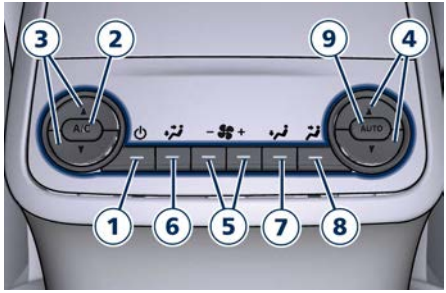

#### 2. A/C

Press to change the current air conditioning (A/C) setting, the "A/C" symbol on the button illuminates when



the A/C is on. This will cause the automatic operation to switch into manual mode and the "AUTO" indicator will turn off.

### 3. Left side temperature control

Provides the rear passengers with independent temperature control.

Push the ▼ button for cooler temperature settings or the ▲ button for warmer temperature. The set temperature value will be displayed in the area above the buttons.

### 4. Right side temperature control

Provides the rear seats passengers with independent temperature control.

Push the ▼ button for cooler temperature settings or the ▲ button for warmer temperature. The set temperature value will be displayed in the area above the buttons.

### 5. Blower control

Blower control is used to regulate the airflow of the rear climate system.

There are seven blower speeds available. Adjusting the blower will cause the automatic mode to switch to manual.

Press the "+" button to increase blower speed.

Press the "-" button for lower speed.

### Airflow distribution modes

The airflow distribution can be adjusted to let air come in from the adjustable and fixed central console vents and floor vents. The set mode is recognisable through the lighting of the soft-key or the LED on the button of the climate control panel.

### 6. "Bi-Level" mode

Air comes from the adjustable vents on the rear central console and from the fixed ones on the lateral sides of the central console directed to the floor.

#### NOTE:

**The Bi-Level mode is designed to provide comfort by sending cooler air out of the central console vents and warmer air from the floor vents.**

### 7. "Floor" mode

Air comes from the fixed floor vents under the front seats and on the lateral sides of the central console.

### 8. "Torso" mode

Air comes from the adjustable vents on the central console. Each of these vents can be singly adjusted. The air grids of the vents can be moved up/down and right/left to adjust the airflow direction. A setting wheel, placed near each vent, allows to regulate the airflow or to close the vent.

### 9. AUTO

This function automatically controls the interior temperature by adjusting the air flow rate and the air distribution.

- Press the "AUTO" button: the automatic rear climate control switches from manual to automatic mode and vice-versa. The "AUTO" symbol on the button illuminates when this function is activated.
- Adjust then the temperature you wish to maintain by regulating the left and/or right side temperature control buttons. Once the desired temperature is set, the system will achieve and automatically maintain that comfort level.
- When the system is set up for your comfort level, it is not necessary to change the settings anymore: simply allow the system to function automatically.

To provide you with maximum comfort in the automatic mode, during cold start-ups the blower speed will remain low until the engine warms up.

### Four-Zone Climate Control by the Driver

When the car is equipped with the additional dual-zone module in the "Comfort" screen are present 3 soft-keys to set the "Front" climate, the "Seats and Wheel" functions (if equipped) and the "Rear" climate. To set the rear climate zones touch "Rear" soft-key or select it



## Dashboard Instruments and Controls

with the manual controls on the central console.



4

Once you have entered the rear climate screen, by touching the following soft-keys, the driver is able to:

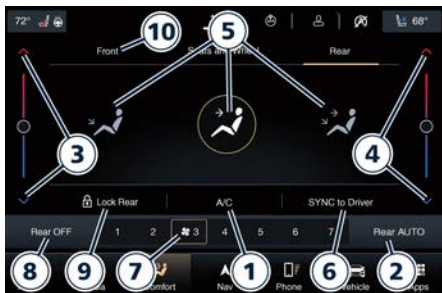

- 1 The A/C compressor will turn on.
- 2 The system switch the ATC between manual and automatic mode by controlling the interior temperature (controls 3, 4) by adjusting the air flow rate and the air distribution (controls 5) of the rear passengers.
- 3 Adjust the temperature in the left rear zone similar to the way indicated for the front zones.
- 4 Adjust the temperature in the right rear zone similar to the way indicated for the front zones.
- 5 Set the airflow distribution in “Torso”, “Bi-Level” or “Floor” mode.
- 6 Synchronise the two rear passenger temperature setting. If the driver adjust the temperature while SYNC mode is on, this will affect the rear passenger temperature. If the front or rear passengers adjust the temperature setting the system

automatically break the function and turn it off.

- 7 Set the blower speed through seven speed levels.
- 8 Turn off the rear climate option.
- 9 Block the settings of the rear climate.
- 10 Return to the front climate control screen.
- 11 Re-activate the rear climate setting.

### Operating Tips

- Continuous use of the air recirculation in winter, in rainy weather or humid climate is not recommended because it may cause window fogging.
- Interior fogging on the windshield can be quickly removed by fast defrosting/defogging. The “Mix” mode can be used to maintain a clear windshield and provide sufficient heating. If side window fogging becomes a problem increase blower speed.

### NOTE:

- Recirculation mode without A/C should not be used for long periods of time, as fogging may occur.
- If inside the passenger compartment there are conditions of high temperature and humidity, when the A/C compressor is switched on (A/C soft-key illuminated on MIA display





or LED on climate control panel A/C button ON) there may be some cold steam at ventilation port outlet: this situation is normal and does not indicate air conditioning system malfunction.

- **Automatic Temperature Controls (ATC) will automatically adjust the climate control settings to reduce or eliminate window fogging on the front windshield.**
- Make sure the external air intake grille, located directly in front of the windshield, is free of obstructions such as leaves or other objects. Leaves collected in the air intake may reduce airflow, and if they enter the plenum, they could plug the water drains. In winter make sure the air intake is clear of ice, slush, and snow.
- The temperature can be displayed in US or Metric units by selecting the “Units” customer programmable function. See “Functions of Settings Menu on MIA” in this section.
- Any time you store your vehicle or keep it stationary (i.e., during vacation) for two weeks or more, run the air conditioning system at idle for about five minutes in the fresh air by high blower setting. This will ensure adequate system lubrication and

minimize the possibility of compressor damage when the system is started again.

### **A/C Filter**

The climate control system filters outside air containing dust, pollen and some odors. Strong odors cannot be totally removed by A/C filter at the entrance of the air climate system. See “Maintenance Procedures” in section “Maintenance and Care” for filter replacement instructions.





## 5 - Starting and Driving

Normal Starting of the Engine .....	154
Remote Start System (🔑) .....	156
Automatic Start&Stop System .....	158
Automatic Transmission .....	161
All-Wheel Drive .....	170
Drive Mode .....	171
Setting Ride Height .....	183
Launch Control Mode (TROFEO version only) .....	187
Off-Road Drive .....	188
Parking Brake .....	191
Parking .....	195
Using the Brakes .....	197
Use of the Engine .....	198
Refueling .....	199
Driving Conditions .....	201
Trailer Towing (🚲) .....	204



# Normal Starting of the Engine



### WARNING!

It is dangerous to run the engine in an enclosed area. The engine consumes oxygen and discharges carbon dioxide, carbon monoxide and other toxic gases in the atmosphere.

When doors are opened, the instrument cluster displays the Maserati Logo in the center and the complete odometer plus the open doors indicator  in the lower part of the cluster.



Before starting the engine, close the doors, adjust your seat, the inside and outside mirrors, fasten your seat belt and instruct all other occupants to buckle their seat belts.

The shift lever must be in P (Park) or N (Neutral) position before you can

start the engine. Apply the brakes before shifting into any driving gear (see “Automatic Transmission” in this section).



### CAUTION!

- Before starting the engine, switch off the electrical devices with a high power consumption (air-conditioning and heating system, heated rear window, headlights, etc.).
- Do not start the engine if the fuel level in the tank is low.

The keyless ignition allows the driver to operate the ignition device by pushing the center button, as long as the key fob is within the passenger compartment (check “Keys” in section “Before Starting” for further information).

By pressing the brake pedal and pushing the **START/STOP** button the engine starts. Instrument cluster displays the initial sequence with indicator light and analog instruments test routine and switch-on of the engine temperature indicators and fuel level. This happens if option “Key-On Display” was set in “Screen Setup” submenu for display switch-on (see chapter “TFT Display Setting and Menu Overview” in section “Dashboard Instruments and Controls”).



The current display subsequently sets up with the latest screenshot.

If the engine fails to start, the starter will disengage automatically after 10 seconds. If you wish to stop the cranking of the engine prior to starting it, press the button again.

### NOTE:

Normal starting of either a cold or a warm engine is obtained without pumping or pressing the accelerator pedal.

If the driver only pushes the **START/STOP** button but does not press the brake pedal, the ignition device cycles to the **ACC** position (see “Keys” in section “Before Starting”) and the instrument cluster displays the latest screenshot.

At the second press of the **START/STOP** button, the ignition device switches to **RUN** position (see “Keys” in section



“Before Starting”) and the instrument cluster displays the latest screenshot. At the third press of the **START/STOP** button the ignition device returns to **OFF** position and the display powers down. At the fourth press of the **START/STOP** button the screen will display the message that invites you to press the brake pedal and push the **START/STOP** button to start the engine.

#### NOTE:

If the ignition device is left in the **ACC** or **RUN** (engine not running) position and the transmission is in P (Park), the system will automatically time out after 30 minutes of inactivity and the ignition device will switch to the **OFF** position.

After starting the engine, the idle speed is controlled automatically and will decrease as the engine warms up.

### Engine Start Failure



#### WARNING!

- Do not attempt to push or tow your vehicle to get it started. Vehicles equipped with an automatic transmission cannot be started this way.
- If the vehicle battery is dead, booster cables may be used to obtain a start from a booster battery or the battery in

another vehicle. This type of start can be dangerous if done improperly. See “Auxiliary Jump Start Procedure” in section “In an Emergency” for further information.

### Starting and Driving with a Cold Engine

Start-off slowly, avoiding sudden acceleration and rev the engine up at low medium speeds. Highperformance driving should be avoided until the engine temperature reaches 149-158°F (65-70°C).

### Engine Turn-Off

- With the shift lever in P (Park), D (Drive) or R (Reverse) positions (see “Automatic Transmission” in this section) and vehicle standstill, press and release the **START/STOP** button to switch off the engine. A burst on the accelerator pedal before turning off the engine has no purpose and increases fuel consumption.
- If the shift lever is in N (Neutral) and the **START/STOP** button is pressed once, the instrument cluster will display a “Vehicle Not in Park” message and the engine will remain running.



#### WARNING!

Never leave a vehicle out of the P (Park) position; it could move and cause injuries to people nearby.

#### NOTE:

If the ignition device is left in the **ACC** or **RUN** (engine not running) position and the transmission is in P (Park), the system will automatically time out after 30 minutes of inactivity and the ignition device will switch to **OFF** position.

### Engine Turn Off when in Automatic Start&Stop

When the engine has been turned off by the Start&Stop system, press and release the **START/STOP** button. The ignition device will return to the **OFF** position and the vehicle is off.

### “Panic Stop” Strategy

In panic conditions, if driver stops engine in any non-standard manner while driving at a speed over 5 MPH (8 km/h), the “Panic Stop” strategy can manage the situation by checking gear change condition upon engine cutting, driver’s action on brakes, road condition (flat or slope) so as to set gear change to the most suitable condition.



### Remote Start System

On the vehicles that are equipped with this system, the key fob enables to start the engine conveniently from outside the vehicle while still maintaining security.

The system has a range of approximately 300 ft (91 m). Obstructions between the vehicle and the key fob may reduce this range.

#### NOTE:

**Changes or modifications not expressly approved by the party responsible for compliance could void the user's authority to operate the equipment.**

If your key fob fails to operate from a normal distance, check for these conditions:

- A weak battery in the key fob. The expected life of the battery is a minimum of three years.
- Closeness to a radio transmitter such as a radio station tower, airport transmitter, and some mobile or CB radio.
- Obstructions between the vehicle and the Key Fob.

#### How to use Remote Start

All of the following conditions must be met before the engine will remote start:

- System not disabled from previous remote start event.
- Vehicle theft alarm not active.

- Vehicle Panic mode not active.
  - Doors closed.
  - Hood closed.
  - Power liftgate closed.
  - Hazard lights switched off.
  - Brake pedal not pressed.
  - Battery at an acceptable charge level.
  - The shift lever is in P (Park) position.
  - The vehicle transmission is in automatic mode.
  - The remote start has not been activated yet two consecutive times.
- If EPB (Electric Parking Brake) is not selected, at key-off in some conditions the remote start system may not allow engine to start. We suggest to set "Auto Apply On" function through the switch on the right-side of the steering wheel (refer to "Parking Brake" in this section).



#### WARNING!

- **Do not start or run an engine in a closed garage or confined area. Exhaust gas contains Carbon Monoxide (CO) which is odorless and colorless**
- **Keep key fobs away from children. Operation of the Remote Start System, windows, door locks or other controls could cause serious injury or death.**

### Engine Remote Start Abort Message on Instrument Cluster

The following messages will display on the instrument cluster if the vehicle fails to remote start or exits remote start prematurely:

- "Remote Start Canceled Door Open".
- "Remote Start Canceled Liftgate Open".
- "Remote Start Canceled Fuel Low".
- "Remote Start Canceled Time Expired".
- "Remote Start Disabled Start Vehicle to Reset".

The message on the instrument cluster stays active as long as the ignition device is in **RUN** position.

#### To enter Remote Start Mode

##### NOTE:

On some versions, the remote start button  on the key fob is replaced by the **PANIC** button.

Press and release the button  on the key fob twice within five seconds. The vehicle doors will lock, position lights will flash and the horn will ring twice (if the "Sound Horn with Remote Start" function of the "Doors & Locks" submenu is activate using the MIA System, refer to "Functions of Settings Menu on MIA" in section "Dashboard Instruments and Controls"). Then, the engine will start and

the vehicle will remain in the “Remote Start” mode for a 15-minute cycle.



**NOTE:**

- In case of an engine fault or low fuel level, the vehicle will start and then shut down in 10 seconds.
- The position lights will turn on and remain lighted up during “Remote Start” mode.
- For security reasons, power window and power sunroof operation (if equipped) are disabled when the vehicle is in the “Remote Start” mode.
- The engine can be started two consecutive times (two 15-minute cycles) with the key fob. However, the ignition device must be cycled to the **RUN** position before you can repeat the start sequence for a third cycle.

### To exit Remote Start Mode without Driving the Vehicle

Press and release the button (x2) one time or allow the engine to run for the entire 15-minute cycle.

**NOTE:**

To avoid unintentional shutdowns, the system will disable the one time press of the button (x2) for two seconds after receiving a valid “Remote Start” request.

### To exit Remote Start Mode and Drive the Vehicle

Before the end of the 15-minute cycle, press and release the button  on the key fob to unlock the doors and disarm the vehicle security alarm. Then, prior to the end of the 15-minute cycle, press and release the **START/STOP** button.

**NOTE:**

The message “Remote Start Active Push Start Button” will display in the instrument cluster until you push the **START/STOP** button.

### Driver's Seat Comfort with Remote Start

The driver's heated and ventilated seat and the heated steering wheel (if equipped) can be programmed to come on during a remote start. Refer to “With Vehicle Start” function of the “Seats & Comfort” submenu in the “Settings” page

(see chapter “Functions of Settings Menu on MIA” of section “Dashboard Instruments and Controls” for further information).

### Radio Frequency RKE Transmitter - Regulatory Information

The “Regulatory Information” for all the radio frequency and radar devices can be consulted by accessing the “Services” section on the website [www.maserati.com](http://www.maserati.com).



## Automatic Start&Stop System

The Maserati Start&Stop system allows the engine to automatically switch off when the vehicle stops and to restart when the driver intends to drive. This function helps reduce fuel consumption. During the "Stop (AutoStop)" phase the ignition is still on and all security functions are available.

In order for the Start&Stop to activate, the vehicle must be stationary and the brake pedal adequately pressed.

### NOTE:

**If the brake pedal is not sufficiently pressed the Start&Stop may not function even if the vehicle is stopped.**

When the Start&Stop switches off the engine, the related light  illuminates on the instrument cluster.

As soon as the brake pedal is released, the engine turns on.

While the vehicle is stopped, the transmission can be placed in P (Park) pressing the "P" button on the shift lever. In this case it is possible to release the brake pedal and the vehicle will remain in "AutoStop" with engine off. Pressing the brake pedal and shifting transmission into D (Drive) or R (Reverse)

will deactivate the "AutoStop" condition and restart the engine.



### Start&Stop Deactivated

Start&Stop function is deactivated under the following conditions:

- When SPORT or CORSA drive mode is activated.
- When  (ESC OFF) drive mode is activated.
- When ride height is set to "Off Road 1" or "Off Road 2".
- If it has been disabled through the main menu item "Start & Stop" via the controls on the right side of the steering wheel (see chapter "TFT Display: Menu and Submenu Content" in section "Dashboard Instruments and Controls") or via the MIA by pressing the "S&S Off" soft-key on the main bar or through the "Start&Stop Off" soft-key in the "Controls" page (see "Functions of Controls Menu on

MIA" Screen" in section "Dashboard Instruments and Controls").

### Start&Stop Not Active

For keeping driving safety, interior comfort and a correct functioning of engine and vehicle, the Start&Stop function does not activate under the following conditions:

- When the driver's seat belt is unbuckled (see example in picture).



- When the driver door is open.
- When the fuel level is too low.
- When the vehicle is stopped on a very steep road.
- When the vehicle is stopped with steered wheels (over 135° of steering wheel angle for each part).
- When the vehicle is maneuvering: shift lever in R (Reverse).
- When the temperature conditions inside the vehicle do not correspond to the air conditioning setting.





- When the front and rear “defroster” function is activated.
- When the engine coolant and the engine oil temperature are not on proper functioning level.
- When the external temperature is too cold.
- When the battery charge is below safety value.
- When the previous stop had just happened (few seconds) and the minimum speed has not yet been achieved.
- Shortly after R (Reverse) has been set or when driving under a certain speed level.
- When the hood is open.
- The sensors managing the Start&Stop have been damaged.
- Start&Stop system faults are present.
- When Adaptive Cruise Control (ACC) and/or Highway Assist (HAS) system are engaged.

### Automatic Restarting of the Engine

The engine may automatically restart, before the brake pedal has been released, when one of the following conditions occurs:

- The SPORT drive mode or  (ESC OFF) drive mode is being activated.
- If the Start&Stop function has been disabled via MIA by pressing the

- “S&S Off” soft-key on the main bar or through the “Start&Stop Off” soft-key in the “Controls” page (see “Functions of Controls Menu on MIA” in the section “Dashboard Instruments and Controls”).
- If shift lever is moved to R (Reverse).
- If the steering wheel is moved to steer the wheels.
- When the temperature conditions inside the vehicle do not correspond to the air conditioning setting.
- When changing the temperature setting on the air conditioning.
- When the defroster function is being activated.
- When the battery charge is below safety value.
- When the accelerator pedal is being pressed (together with the brake pedal).
- If a long time has passed since the last automatic stop of the engine.

### Occupants Safety Function

To enhance occupants safety, the Start&Stop system monitors if the driver is present and does not allow automatic restarting of the engine if one of the following maneuvers is being performed while in “AutoStop” condition:

- The driver unbuckles his/her seat belt and releases the brake pedal.
- The driver opens the door and releases the brake pedal.

- The driver unbuckles the seat belt and opens the door.
- The driver opens the hood.

All the above-mentioned conditions deactivate the Start&Stop function (the “AutoStart” is deactivated and the engine remains off) and the transmission shift automatically in P (Park).

The  telltale will flash to indicate the Start&Stop function disabling. To restart the engine it is necessary to press the brake pedal and push the **START/STOP** button.

Move the shift lever to D (Drive) to drive away.



### **WARNING!**

**Even when the vehicle is stopped within the “Stop (AutoStop)” phase, the vehicle driver is responsible for the vehicle, the vehicle’s occupants and the vehicle’s surrounding area. Never leave the vehicle unattended with the engine running; doing so poses a risk of danger. It is a good practice to always ensure to set the parking brake and place the transmission gear selector lever into the P (Park) position, thereby ensuring the vehicle will not move, when performing any vehicle checks, maintenance and/or service procedures on the vehicle.**



## Start&Stop Function Disabling

Start&Stop enabled is the default status. Under certain driving conditions, when frequent stops and restarts of the engine may become annoying, it is possible to turn off the Start&Stop function in different ways.

When the Start&Stop function is turned off in the all following ways, in addition to the related message the amber indicator  on the TFT display indicated in the picture will turn on.



- Use the controls located on the right side of the steering wheel (see instructions in chapter “TFT Display Setting and Menu Overview” in section “Dashboard Instruments and Controls”) and hold the multifunction switch  to change the status of the function.
- It is possible to disable the Start&Stop via the MIA in the following ways.

### NOTE:

The highlighted and yellow soft-key indicates the disabled status of Start&Stop system and vice versa.

- Touch the "  " soft-key on the main status bar to disable the function: the icon becomes yellow.
- Or:
- Entering the "Vehicle" page and touch the "Controls" soft-key.
  - Touch the "Start&Stop Off" soft-key to disable the function.
  - Touch a second time the same soft-key to re-enable the function.

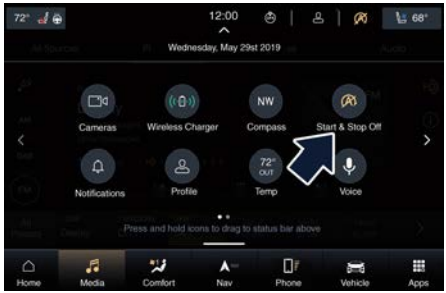

If the driving conditions allow it, the user can re-enable the Start&Stop function at any time using one of previous ways.

### NOTE:

After user intervention, the Start&Stop system will automatically update the status of the function in all contexts where it can be modified.

## Start&Stop System Failure

When the  indicator light and the related message illuminate on the TFT display (see chapter “Warning and Indicator Lights” in section “Dashboard Instruments and Controls”) there is a malfunction in the Start&Stop system and the engine cannot be switched off and restarted automatically. To switch off or restart the engine it is necessary to push the **START/STOP**. Have the vehicle checked at an **Authorized Maserati Dealer**.



The "Start & Stop" soft-key is also present on the shortcuts page (shown in picture) and in the "Apps" page.



## Automatic Transmission

The vehicle is equipped with an electronically controlled 8-speed automatic transmission, which automatically changes gear according to the vehicle's instantaneous usage parameters (vehicle speed, road gradient and accelerator pedal position).

It is possible to change gear manually thanks to the "M +/-" (Manual) position for the shift lever.

The electronic shift lever replaces the conventional mechanical lever and has no mechanical connection to the transmission. The transmission is operated by electrical actuators on the hydraulic system and all commands to the control system are transmitted by the CAN network. The lever itself represents a mere user interface. Gear positions are simulated by solenoids inside the lever body, which are computer-controlled and enable or disable certain positions of the lever. The solenoids inside the shift lever prevent the movement of the lever towards invalid positions.

The electronically-controlled transmission provides a precise shift schedule. The transmission electronics are self-calibrating, therefore the

gearshift behavior could become perfect as expected after few hundreds of km.



### CAUTION!

In order to properly use the automatic transmission, it is essential that you read through the whole chapter, so that you can understand right from the start what the correct and granted operations are. Damage to the transmission may occur if the following precautions are not observed:

- Shift into P (Park) only after the vehicle has come to a complete stop: this is the default position of the lever. After engaged P (Park) it is possible set the ignition device to **OFF**.
- Shift into or out of R (Reverse) only after the vehicle has come to a complete stop and the engine is at idle speed.
- Do not shift between P (Park), R (Reverse), N (Neutral) or D (Drive) when the engine is above idle speed
- To effect any change from vehicle stop to R (Reverse), D (Drive), 1<sup>st</sup> or 2<sup>nd</sup> gear, it is necessary to keep the brake pedal fully depressed.



### WARNING!

- It is dangerous to move the shift lever out of P (Park) or N (Neutral) if the engine speed is higher than idle speed. Only shift into gear when the engine is idling normally and when your foot is firmly pressing on the brake pedal.
- As with all vehicles, you should never exit a vehicle while the engine is running. Before exiting a vehicle, always apply the electronic parking brake, shift the transmission into P (Park), and turn the engine off.
- When leaving the vehicle, always remove the key fob and lock your vehicle.
- Do not leave the key fob in or near the vehicle.

This vehicle is equipped with a function which requires the transmission to be placed in P (Park) before the engine can be turned off. This prevents the driver from inadvertently leaving the vehicle without having placed the transmission in P (Park). This system also locks the transmission in P (Park) whenever the ignition device is in the **OFF** position.

### Automatic Transmission Lever

Automatic transmission is operated by a shift lever with unlock button, located on



## Starting and Driving

the central console, which can have the following operating positions:

- P (Park): button control;
- R (Reverse);
- N (Neutral);
- D (Drive) automatic forward speed;
- M +/- (Manual): “+” shifting to higher gear or “-” shifting to lower gear in manual mode (see “Drive Mode” in this section).



Transmission status is visible on the lever and on the lower part of the Instrument cluster display.



### Shift Lever Movements

Shift lever has two main positions with a single step selection (backward/forward): two unstable position (2) and (3) and two stable position (1) and (4).



- Automatic lane (“R”, “N”, “D”) as main central position.
- Manual lane (“M +/-”) on left position: move forward for “-” and backward for “+”.
- “P” is a button on the top of the lever.

### Shift Lever Backlit

- White backlit for “P”, “R”, “N”, “D” and “M +/-”: brighter when selected and dimmer when not selected.
- When P (Park) mode is selected, the letter “P” becomes brighter and “P♦” appears brighter near “N”.

Backlit on the shift lever depends on the status of the ignition device.

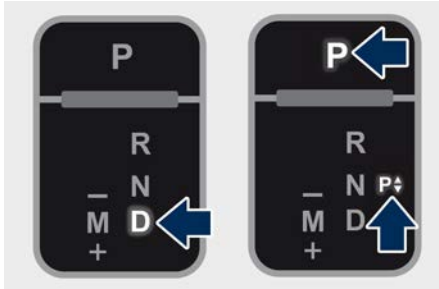

### To Engage a Mode (briefly)

To select one of the operating modes, move the lever as previously indicated and press the brake pedal at the same time.

To engage “P” mode, driver must press the “P” button.

In order to engage “R”, “N” or “D” mode, driver have to move the shift lever by pressing the unlock button. If the unlock button is not pressed, the instrument cluster shows the pop up message shows in picture.



The lever functions like a joystick, so releasing it after giving the command, it automatically returns to the two stable positions (vertical in line with “R”, “N” and “D” or in line with “-” and “+” when in “M +/-” mode).

- To engage the N (Neutral) mode from R (Reverse) or D (Drive) mode, the driver has to move the shift lever and press the brake pedal only.
- Normally, to engage R (Reverse) mode, press the brake pedal and the unlock button together.
- Normally, to pass from R (Reverse) mode directly to D (Drive) mode and vice versa, in addition to pressing the brake pedal, it is necessary to press the unlock button.
- The P (Park) mode can be automatically enabled by pressing the “P” button: if the shift lever was in “M +/-” position, will go to central stable position automatically.

- If using the shift lever in M +/- (Manual) mode, you can activate it by moving the lever from D (Drive) to the left and then forward towards the “-” symbol or back towards the “+” symbol and the gear is shifted.
- To exit P (Park) mode, or to pass from N (Neutral) to D (Drive) or R (Reverse) position when the car is stopped or is moving at a low speed, the brake pedal must also be pressed.



### CAUTION!

- **DO NOT accelerate while shifting from P (Park) or N (Neutral) to another mode to not damage the transmission.**
- **After selecting a transmission mode, wait a few seconds before accelerating. This precaution is particularly important with a cold engine.**

### Transmission Status on the Instrument Cluster Display

By pressing the unlock button on the lever, the gear change positions field is displayed: if you release the button without moving the lever, the field disappears after 2 seconds. By operating instead the lever, the new range will be indicated in the field and in the lower part of the display.



## Automatic Transmission Range P (Park)

Use this position to park the vehicle. The transmission can be shifted from “P” position only with the brake pedal and the unlock button pressed: then move the shift lever. To move the shift lever from “P” position to any other position, the engine must be switched on. The engine can be regularly started in P (Park) range. Never attempt to use P (Park) while the vehicle is in motion. When parking on a level surface, you may press the “P” button first, and then apply the electronic parking brake by pulling the trigger upwards.

If the vehicle is in D (Drive) status, in M +/- (Manual) or temporarily in manual drive mode, the gear position is indicated beside the lever status (“D” or “M”), on the lower part of the display.

## Service Shift Lever

In the event of a shift lever malfunction, a message on the instrument cluster will invite to stop the car safety and turn off the engine.

In this way the system moves the transmission in P (Park) position.



The Instrument cluster will display the related indicator light **BRAKE** (United States market) or  (Canadian market) and the message for 5 seconds.



United States Market



Canadian Market

When parking on a hill, apply the parking brake before pressing the “P” button. For enhanced security, turn the front wheels toward the kerb on a downhill and away from the kerb on an uphill grade.



#### WARNING!

- **Never use the P (Park) mode as a substitute for the electric parking brake. Always apply the parking brake fully when parked to prevent vehicle movement and possible injury or damage.**
- **Make sure the transmission is in P (Park) before leaving the vehicle.**



#### CAUTION!

**DO NOT** race the engine when shifting from P (Park) or N (Neutral) into another gear range, as this can damage the drivetrain.

The following indicators should be used to ensure that you have engaged the shift lever into the “P” position:

- when shifting into P (Park), push the “P” button on the shift lever.
- with the brake pedal released, verify that “P” position is illuminated on the shift lever and in the instrument cluster display.

#### R (Reverse)

This range is used to move the vehicle backward.

Switching to R (Reverse) starting from N (Neutral) is only possible if the vehicle is moving backwards.

We recommend to shift into R (Reverse) only after the vehicle has come to a complete stop.

- Vehicle stationary: switching between R (Reverse) and D (Drive), passing from N (Neutral). In addition to the action of the shift lever this requires applying the brake pedal and the unlock button being pressed.
- Vehicle moving: the driver can switch from R (Reverse) to N (Neutral) acting



## Starting and Driving

on the shift lever without pressing the unlock button and the brake pedal.

### N (Neutral)

- Vehicle stationary and engine started: switching from N (Neutral) to P (Park) requires “P” button pressed only. Switching from N (Neutral) to R (Reverse) and/or D (Drive) requires brake pedal and unlock button pressed and the action on the shift lever.
- Vehicle moving: switching from N (Neutral) to R (Reverse) and/or D (Drive) requires pressing the unlock button and the action on the shift lever. Switching to R (Reverse) starting from N (Neutral) is only possible if the vehicle is moving backwards, while switching to D (Drive) starting from N (Neutral) is only possible if the vehicle is moving forwards.

Set the parking brake and shift the transmission into P (Park) mode if you must leave the vehicle.



### WARNING!

**Do not switch to N (Neutral) and/or never turn off the ignition to coast downhill. These are unsafe practices that limit driver's response to changing traffic or road conditions.**



### CAUTION!

**Towing the vehicle, coasting, or driving for any other reason with the transmission in N (Neutral) can result in transmission damage. Refer to “Towing a Disabled Vehicle” in section “Emergency” for further information.**

### D (Drive)

This range should be used for most city and highway driving. It provides the smoothest upshifts and downshifts and the best fuel economy. The transmission automatically shifts up and down through all gears. The D (Drive) mode provides optimum driving characteristics under all normal operating conditions of the vehicle.

- Vehicle stationary: to switch from D (Drive) to R (Reverse) requires brake pedal and unlock button pressed and the action on the shift lever: to reach N (Neutral) starting from D (Drive) is possible by only acting on the shift lever.
- To enable special operations while the car is moving at a low speed, such as getting out of marsh or snow, it is possible to run quickly from D (Drive) to R (Reverse), and vice versa, by pressing the unlock button and acting on the shift lever passing from N (Neutral).

- Vehicle moving: switching to N (Neutral) from D (Drive) it is not necessary to press brake pedal.
- From D (Drive) selected mode it is always possible to switch to M +/- (Manual) mode, by move the shift lever to the left (see following paragraph); to return to “D” position, move the shift lever to the right. It is possible to shift from D (Drive) mode to M +/- (Manual) mode regardless of car speed.
- When in D (Drive) mode, using the paddles behind the steering wheel (if equipped), will cause the system to enter a temporary function and enable the manual shift mode. This range is indicated with the symbols “+/-” above and below “D” letter on the gear range field of the display. The system will then switch back to automatic mode according to time elapsed in “temporary” mode and driving conditions.

At extremely cold temperatures (-23°F / -30°C or below), transmission may be affected by the low temperature of the engine and transmission. Normal operation will resume once the transmission temperature has risen to a normal level.

### M +/- (Manual)

This mode is obtained by moving the shift lever to the left in “M +/-” position.





In this mode, the transmission interacts with the driver in order to allow manual shift and ensure increased control of the vehicle. The current mode allows the transmission system to optimize the engine brake action, remove undesired shifting into higher and lower gears and improve the overall performance of the vehicle.

This mode allows you to move the shift lever step by step forward “-” or backward “+” without pressing the unlock button. The current transmission gear is displayed on the instrument cluster beside “M”.



Manual mode can be activated at any time, with no need to release the brake pedal.

In M +/- (Manual) mode, the transmission will shift up or down (+/-) if manually selected by the driver by using the shift

lever, or shift paddles on the steering wheel (if foreseen).

The transmission remains in the engaged gear until the driver shifts into another higher or lower gear, except in the following cases.

- Lack of accelerator pedal activity will cause the transmission to revert to automatic operation. The transmission will also upshift automatically once maximum engine speed is reached.
- If in SPORT mode, the transmission will remain in the selected gear even when maximum engine speed is reached. The transmission will upshift only if enabled by the driver. Manual upshift or downshift will be maintained as long as SPORT mode is selected, even by full stroke pedal press.
- If in “M +/-” or in SPORT mode, the transmission will automatically downshift as the vehicle slows to halt (to prevent engine lugging) and the current gear will display on the instrument cluster. Shifting the shift lever backward “+” or moving the right shift paddle “+” towards the steering wheel when stationary, will cause the vehicle to start in second gear. If the vehicle speed is too low, the system will ignore further upshifts. Avoid using speed control when the M +/- (Manual) mode is engaged.

When the car stops in M +/- (Manual) mode, the transmission automatically moves the shift lever and inserts P (Park). If you enter the I.C.E. drive mode when the gearshift is in “M +/-” position, the system activates the automatic return of the shift lever in D (Drive) mode.

### Shift Paddles (if equipped)

The driver can change gears with the shift paddles behind the steering wheel when in D (Drive) and M +/- (Manual) mode.

Using the shift paddles, the corresponding icon will display on the instrument cluster beside the “M” indication and current shifted gear.

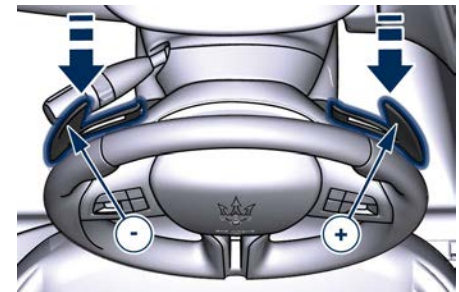



Pull the right shift paddle “+” towards the steering wheel and release it to enter the higher gear; do the same operation with the left shift paddle “-” to enter the lower gear.

- When in D (Drive) mode, by pressing “-” paddle the transmission shifts to “D1 - D2” temporary mode (or the “Launch Control” on the TROFEO version).
- Pull simultaneously both paddles to deactivate the D (Drive) temporary mode (or the “Launch Control” on the TROFEO version).

### Gear Shift Indicator (GSI)

In order to improve fuel economy, we recommend that you shift gears when the GSI system prompts you to do so. This will help reduce fuel consumption without significantly affecting vehicle performance.

When in “M +/-” (Manual) mode, GSI indicates when a gear shift is needed in two different ways, depending on

whether you use the paddles or the transmission lever to change gear.

- When using the paddles, GSI indicates when a gear shift is needed by coloring the correspondent paddle in white: up (right side) or down (left side) and displaying “SHIFT” reinforced by an up/down arrow according to the side.



- When using the transmission lever to shift, GSI indicates when a gear shift is needed by displaying just “SHIFT” on the corresponding side reinforced by an up/down arrow according to the side.



When the new gear is engaged, the GSI turns off. If the shift runs late or is not performed at all, the indicator remains lit for a few seconds then turns off. As soon as new conditions requiring further gear change occur, the indicator light will illuminate again.

### NOTE:

The GSI system will only work when the transmission is set in M +/- (Manual) mode.

### Transmission Malfunction and Overheating Conditions

#### Transmission Emergency Control

Transmission function is electronically monitored to detect abnormal conditions. If a condition that could result in transmission damage is detected, “Transmission Limp Home Mode” will be activated. In this situation, the transmission may operate only in certain gears, or may not shift at all.



In some situations, the transmission system may not re-engage if the engine is turned off and restarted.

A message in the instrument cluster will inform the driver about the more serious transmission conditions, and indicate what actions may be necessary.

### Transmission Oil Overtemperature

If the transmission oil temperature exceeds the operating limit, the red warning light  illuminates on the instrument cluster.



In this case, slow down until temperature returns to normal level (the light will turn off).

If this is not sufficient, we recommend to stop the vehicle, shift the lever to position P (Park) or N (Neutral) and keep the engine idle until the temperature red warning light  turns off and the message disappears from the display. Resume driving without demanding high

engine performance. If the red warning light  and the related message turns on again, it is advisable to stop the vehicle, turn off the engine and wait for the engine/transmission assembly to fully cool down.

If the instrument cluster message indicates that the transmission may not re-engage after engine shutdown, perform the following procedure preferably at an **Authorized Maserati Dealer**.

In the event of a momentary problem, the transmission can be reset to regain all forward gears by performing the following steps.

- Stop the vehicle.
  - Shift the transmission into P (Park), if possible.
  - Turn the engine off.
  - Wait approximately 30 seconds.
  - Restart the engine.
  - Shift the transmission into D (Drive) and then into the desired gear range.
- If the problem is no longer detected, the transmission will return to normal operation.

### NOTE:

Even if the transmission can be reset, we recommend that you visit an **Authorized Maserati Dealer** at your earliest possible convenience, which has diagnostic

equipment to determine if the problem could recur.

### Transmission Manual Release of P (Park) Position

See chapter “Transmission Manual Release of P (Park) Position” in section “In an Emergency”.



### All-Wheel Drive

The active on-demand All-Wheel Drive (AWD) system provides available optimum traction for a wide variety of road and off-road surface and driving conditions. The system minimizes wheel slip by automatically redirecting torque to the front and rear wheels as necessary.

To maximize fuel economy, the AWD system automatically disengages torque distribution on front axle when road and environmental conditions are such that wheel slip is unlikely to occur. When specific road and environmental conditions require increased levels of road traction, the AWD system automatically distributes the torque between front and rear axle in order to grant the best driving experience. Torque distribution is displayed on the TFT in the “Drive Mode” main menu. Refer to “TFT Display: Menu and Submenu Content” in section “Dashboard Instruments and Controls” for further information.



**WARNING!**  
There may be a slight delay for AWD engagement after a wheel slip condition occurs.



#### NOTE:

If the AWD system service warning light and message appears after engine start up, or during driving, it means that the AWD system is not functioning properly or is in recovery mode due to overheating caused by the excessive wheel spin. In this condition the vehicle can continue driving but only rear wheel drive is working. If the warning light and message are often activated, it is recommended to have the vehicle serviced at an **Authorized Maserati Dealer**.



## Drive Mode

### Controls Preview

Drive modes and ride heights to use with the vehicle on and off road can be set using the buttons and vehicle height selector on central console.



#### CAUTION!

"NORMAL" is the default drive mode, optimized for the best balance between performance, fuel consumption and emissions in the standard conditions use of the car.

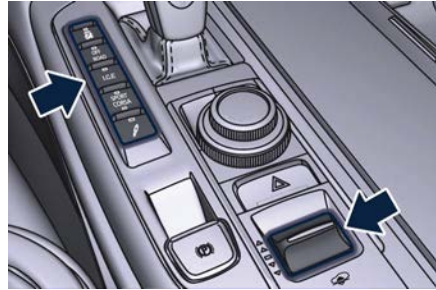
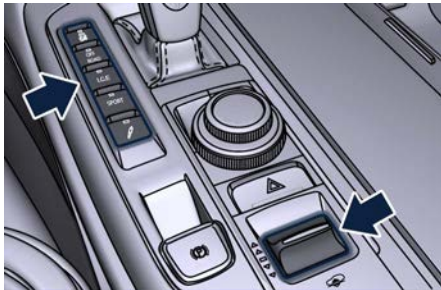

TROFEO Version only

Buttons on the central console have following functions:

- (ESC OFF): to exclude/reactivate the ESC system.
- OFF ROAD: to activate/deactivate the specific driving mode for off road conditions (uphill/downhill, cobblestone, mud, grass and sand). In this mode, the vehicle has a specific ESC/ASR calibration and shock absorbers skyhook damping curve. Activating this drive mode, will also change the EPS setting. When in "OFF ROAD" drive mode, hard suspension can not be set through the button on the central console.
- I.C.E: to activate/deactivate the drive mode to ensure increased control on slippery surfaces as well as higher energy efficiency (see "Monitoring Setting on Display" in this chapter).

- SPORT (NOT for TROFEO version): to activate/deactivate a sportier drive mode. In this mode, the vehicle has a faster throttle response and ESC sport calibration (not recommended on wet/slippery surfaces). Activating this drive mode, will also change the EPS setting.
- SPORT and CORSA (TROFEO version only): to activate/deactivate the sportier and the race drive mode. When in "SPORT" drive mode, the vehicle has a faster throttle response and ESC sport calibration (not recommended on wet/slippery surfaces). Activating this drive mode, will also change the EPS setting. When in "CORSA" drive mode, in addition to what indicated for the sports mode, the transmission use a specific gear shift pattern and the traction is shifted more on the rear wheels with increased oversteering behavior. Traction control with dedicated calibration to maximize traction vs stability and "Launch Control" start mode.
- (Suspension): to switch between the two suspension setting modes: soft (LED light off and "S" in the telltale on the TFT display) and hard (LED light on and "H" in the telltale on the TFT display).

By selecting one of these drive modes, the yellow or white LED on the button





## Starting and Driving

illuminates and, for some of these, the vehicle configuration obtained is graphically displayed on instrument cluster. The same screen is also obtained when selecting the “Drive mode” menu using the buttons on steering wheel.

### Setting the Drive Mode

Drive modes can be set using the buttons on central console.



Keys (buttons) only have two statuses: OFF and ON. The OFF status (button released) is the standard function mode. The ON status is activated by pressing the button, the dedicated LED will illuminate. It is necessary to press the  (ESC OFF) button for at least 3 seconds. At each key-on the car starts always in NORMAL drive mode (all the LEDs are OFF) and driver can select different drive mode according to following table.

Button	ON – Button pressed (LED ON)
	Electronic Stability Control ESC partially deactivated.
<b>OFF ROAD</b>	OFF ROAD drive mode ON.
<b>I.C.E.</b>	Increased Control and Efficiency mode ON (*).

Button	ON – Button pressed (LED ON)
<b>SPORT</b>	Sportier drive mode (SPORT) ON.
<b>SPORT CORSA</b> (TRO-FEO version only)	<ul style="list-style-type: none"> <li>• Button pressed the first time (upper LED ON): sportier drive mode (SPORT) ON.</li> <li>• Button pressed the second time (upper and lower LED ON): race drive mode (CORSA) ON, ESC partially deactivated (ON) and hard/stiff suspension setting (“S”).</li> <li>• When button is pressed third time, it returns to OFF-button release.</li> </ul>
	Soft/Hard suspension setting.
(*) I.C.E. (Increased Control and Efficiency) operates on engine supply in order to reduce fuel consumption, exhausts, noisiness (efficiency) by dampening vehicle reactions (control). The current mode is also useful for low-grip surfaces.	









The tables below summarize the adjustment of transmission and engine parameters according to set drive mode/s.  (ESC OFF) is the only mode

that does not depend on the activation or deactivation of the other modes. The tables show the two configurations with:

-  (ESC OFF) button NOT pressed;
-  (ESC OFF) button pressed.



 (ESC OFF) Button NOT pressed (NOT for TROFEO Version)

<div style="display: flex; flex-direction: column; align-items: center;"> <div style="display: flex; align-items: center; margin-bottom: 5px;"> <div style="width: 15px; height: 15px; background-color: black; margin-right: 5px;"></div> <span>Button pressed: LED ON</span> </div> <div style="display: flex; align-items: center;"> <div style="width: 15px; height: 15px; border: 1px solid black; margin-right: 5px;"></div> <span>Button not pressed: LED OFF</span> </div> </div>	<div style="display: flex; flex-direction: column; align-items: center;"> <div style="display: flex; align-items: center; margin-bottom: 5px;"> <div style="width: 15px; height: 15px; border: 1px solid black; margin-right: 5px;"></div>  </div> <div style="display: flex; align-items: center; margin-bottom: 5px;"> <div style="width: 15px; height: 15px; border: 1px solid black; margin-right: 5px;"></div> <span>OFF ROAD</span> </div> <div style="display: flex; align-items: center; margin-bottom: 5px;"> <div style="width: 15px; height: 15px; border: 1px solid black; margin-right: 5px;"></div> <span>I.C.E.</span> </div> <div style="display: flex; align-items: center; margin-bottom: 5px;"> <div style="width: 15px; height: 15px; border: 1px solid black; margin-right: 5px;"></div> <span>SPORT</span> </div> <div style="display: flex; align-items: center;"> <div style="width: 15px; height: 15px; border: 1px solid black; margin-right: 5px;"></div>  </div> </div>	<div style="display: flex; flex-direction: column; align-items: center;"> <div style="display: flex; align-items: center; margin-bottom: 5px;"> <div style="width: 15px; height: 15px; background-color: black; margin-right: 5px;"></div>  </div> <div style="display: flex; align-items: center; margin-bottom: 5px;"> <div style="width: 15px; height: 15px; background-color: black; margin-right: 5px;"></div> <span>OFF ROAD</span> </div> <div style="display: flex; align-items: center; margin-bottom: 5px;"> <div style="width: 15px; height: 15px; border: 1px solid black; margin-right: 5px;"></div> <span>I.C.E.</span> </div> <div style="display: flex; align-items: center; margin-bottom: 5px;"> <div style="width: 15px; height: 15px; border: 1px solid black; margin-right: 5px;"></div> <span>SPORT</span> </div> <div style="display: flex; align-items: center;"> <div style="width: 15px; height: 15px; border: 1px solid black; margin-right: 5px;"></div>  </div> </div>	<div style="display: flex; flex-direction: column; align-items: center;"> <div style="display: flex; align-items: center; margin-bottom: 5px;"> <div style="width: 15px; height: 15px; border: 1px solid black; margin-right: 5px;"></div>  </div> <div style="display: flex; align-items: center; margin-bottom: 5px;"> <div style="width: 15px; height: 15px; border: 1px solid black; margin-right: 5px;"></div> <span>OFF ROAD</span> </div> <div style="display: flex; align-items: center; margin-bottom: 5px;"> <div style="width: 15px; height: 15px; background-color: black; margin-right: 5px;"></div> <span>I.C.E.</span> </div> <div style="display: flex; align-items: center; margin-bottom: 5px;"> <div style="width: 15px; height: 15px; border: 1px solid black; margin-right: 5px;"></div> <span>SPORT</span> </div> <div style="display: flex; align-items: center;"> <div style="width: 15px; height: 15px; border: 1px solid black; margin-right: 5px;"></div>  </div> </div>	<div style="display: flex; flex-direction: column; align-items: center;"> <div style="display: flex; align-items: center; margin-bottom: 5px;"> <div style="width: 15px; height: 15px; border: 1px solid black; margin-right: 5px;"></div>  </div> <div style="display: flex; align-items: center; margin-bottom: 5px;"> <div style="width: 15px; height: 15px; border: 1px solid black; margin-right: 5px;"></div> <span>OFF ROAD</span> </div> <div style="display: flex; align-items: center; margin-bottom: 5px;"> <div style="width: 15px; height: 15px; border: 1px solid black; margin-right: 5px;"></div> <span>I.C.E.</span> </div> <div style="display: flex; align-items: center; margin-bottom: 5px;"> <div style="width: 15px; height: 15px; background-color: black; margin-right: 5px;"></div> <span>SPORT</span> </div> <div style="display: flex; align-items: center;"> <div style="width: 15px; height: 15px; border: 1px solid black; margin-right: 5px;"></div>  </div> </div>	<div style="display: flex; flex-direction: column; align-items: center;"> <div style="display: flex; align-items: center; margin-bottom: 5px;"> <div style="width: 15px; height: 15px; border: 1px solid black; margin-right: 5px;"></div>  </div> <div style="display: flex; align-items: center; margin-bottom: 5px;"> <div style="width: 15px; height: 15px; border: 1px solid black; margin-right: 5px;"></div> <span>OFF ROAD</span> </div> <div style="display: flex; align-items: center; margin-bottom: 5px;"> <div style="width: 15px; height: 15px; border: 1px solid black; margin-right: 5px;"></div> <span>I.C.E.</span> </div> <div style="display: flex; align-items: center; margin-bottom: 5px;"> <div style="width: 15px; height: 15px; border: 1px solid black; margin-right: 5px;"></div> <span>SPORT</span> </div> <div style="display: flex; align-items: center;"> <div style="width: 15px; height: 15px; background-color: black; margin-right: 5px;"></div>  </div> </div>
<b>Setup</b>	NORMAL + Auto + Soft suspensions	OFF ROAD + Auto + Off Road suspensions	I.C.E. + Auto + Soft suspensions	SPORT + Auto + Soft suspensions	NORMAL + Auto + Hard suspensions
Stability control	Active	Active with specific tuning	Active	Active-Sport (*)	Active-Sport (*)
Electric Power Steering (EPS)	Normal	Off Road	Normal	Sport	Sport
Suspensions setup	Normal	Off Road	Normal	Normal	Hard
Engine control	Normal	Normal	Comfort	Performance	Performance
Engine boost	Normal boost	Overboost	Low boost	Overboost	Overboost
Exhaust sound	Low (Rev. Threshold)	Normal	Close to 5000 rpm	Always High	Always High
Gear shifting point	Normal	Off Road	Comfort	Performance	Performance
Kick down	Yes	Yes	Yes - Soft	Yes - Strong	Yes - Strong
Upshift rev. limiter	Yes	Yes	Yes	Yes (No, when in M+/-)	Yes (No, when in M+/-)
Automatic down-shift	Normal	Anti - Stall	Normal	Performance (Anti - Stall, when in M+/-)	Performance (Anti - Stall, when in M+/-)



# Starting and Driving

<input checked="" type="checkbox"/> Button pressed: LED ON <input type="checkbox"/> Button not pressed: LED OFF	<input type="checkbox"/> OFF ROAD <input type="checkbox"/> I.C.E. <input type="checkbox"/> SPORT <input type="checkbox"/>	<input checked="" type="checkbox"/> OFF ROAD <input type="checkbox"/> I.C.E. <input type="checkbox"/> SPORT <input type="checkbox"/>	<input type="checkbox"/> OFF ROAD <input checked="" type="checkbox"/> I.C.E. <input type="checkbox"/> SPORT <input type="checkbox"/>	<input type="checkbox"/> OFF ROAD <input type="checkbox"/> I.C.E. <input checked="" type="checkbox"/> SPORT <input type="checkbox"/>	<input type="checkbox"/> OFF ROAD <input type="checkbox"/> I.C.E. <input type="checkbox"/> SPORT <input checked="" type="checkbox"/>
Shifting timing	Normal	Quick - Normal	Comfort	Sport (Quick - Sport, when in M+/-)	Sport (Quick - Sport, when in M+/-)

(\* In low- and medium-grip conditions (e.g., rain, snow, ice, sand, etc.) it is advisable not to activate SPORT mode, even with the ESC system active (button (ESC OFF) not pressed).

## (ESC OFF) Button pressed (NOT for TROFEO version)

<input checked="" type="checkbox"/> Button pressed: LED ON <input type="checkbox"/> Button not pressed: LED OFF	<input checked="" type="checkbox"/> OFF ROAD <input type="checkbox"/> I.C.E. <input type="checkbox"/> SPORT <input type="checkbox"/>	<input checked="" type="checkbox"/> OFF ROAD <input type="checkbox"/> I.C.E. <input type="checkbox"/> SPORT <input type="checkbox"/>	<input checked="" type="checkbox"/> OFF ROAD <input checked="" type="checkbox"/> I.C.E. <input type="checkbox"/> SPORT <input type="checkbox"/>	<input checked="" type="checkbox"/> OFF ROAD <input type="checkbox"/> I.C.E. <input checked="" type="checkbox"/> SPORT <input type="checkbox"/>	<input checked="" type="checkbox"/> OFF ROAD <input type="checkbox"/> I.C.E. <input type="checkbox"/> SPORT <input checked="" type="checkbox"/>
Setup	NORMAL + Auto + Soft suspensions	OFF ROAD + Auto + Off Road suspensions	I.C.E. + Auto + Soft suspensions	SPORT + Auto + Soft suspensions	NORMAL + Auto + Hard suspensions
Stability control	OFF	OFF	OFF	OFF	OFF
Electric Power Steering (EPS)	Normal	Off Road	Normal	Sport	Sport
Suspensions setup	Normal	Off Road	Normal	Normal	Hard
Engine control	Normal	Normal	Comfort	Performance	Performance
Engine boost	Normal boost	Overboost	Low boost	Overboost	Overboost
Exhaust sound	Low (Rev. Threshold)	Normal	Close to 5000 rpm	Always High	Always High





Button pressed: LED ON Button not pressed: LED OFF	OFF ROAD I.C.E. SPORT 	OFF ROAD I.C.E. SPORT 	OFF ROAD I.C.E. SPORT 	OFF ROAD I.C.E. SPORT 	OFF ROAD I.C.E. SPORT 
Gear shifting point	Normal	Off Road	Comfort	Performance	Performance
Kick down	Yes	Yes	Yes - Soft	Yes - Strong	Yes - Strong
Upshift rev. limiter	Yes	Yes	Yes	Yes (No, when in M+/-)	Yes (No, when in M+/-)
Automatic down-shift	Normal	Normal (Anti - Stall, when in M+/-)	Normal	Performance (Anti - Stall, when in M+/-)	Performance (Anti - Stall, when in M+/-)
Shifting timing	Normal	Normal	Comfort	Sport (Quick - Sport, when in M+/-)	Sport (Quick - Sport, when in M+/-)

**WARNING!**













On TROFEO version, when CORSA drive mode is activated, the (ESC OFF) indicator light on the instrument cluster is on because the intervention of the Electronic Stability Control (ESC) system is lower than the other modes, but still present to allow a sportier drive.

You can always press (ESC OFF) button to fully deactivate ESC system. Due to high power output of the engine can be potentially dangerous to drive the car on wet or slippery roads with ESC off and CORSA drive mode set.



## Starting and Driving

### (ESC OFF) Button NOT pressed (TROFEO Version only)

<div style="display: flex; flex-direction: column; align-items: center;"> <div style="background-color: black; width: 20px; height: 10px; margin-bottom: 5px;"></div> <b>Button pressed: LED ON</b> <div style="width: 20px; height: 10px; margin-bottom: 5px; border: 1px solid black;"></div> <b>Button not pressed: LED OFF</b> </div>	<div style="display: flex; flex-direction: column; align-items: center;"> <div style="width: 20px; height: 10px; border: 1px solid black; margin-bottom: 5px;"></div> <b>OFF ROAD</b> <div style="width: 20px; height: 10px; border: 1px solid black; margin-bottom: 5px;"></div> <b>I.C.E.</b> <div style="width: 20px; height: 10px; border: 1px solid black; margin-bottom: 5px;"></div> <b>SPORT</b> <div style="width: 20px; height: 10px; border: 1px solid black; margin-bottom: 5px;"></div> <b>CORSA</b> <div style="width: 20px; height: 10px; border: 1px solid black; margin-bottom: 5px;"></div> </div>	<div style="display: flex; flex-direction: column; align-items: center;"> <div style="width: 20px; height: 10px; border: 1px solid black; margin-bottom: 5px;"></div> <div style="background-color: black; width: 20px; height: 10px; margin-bottom: 5px;"></div> <b>OFF ROAD</b> <div style="width: 20px; height: 10px; border: 1px solid black; margin-bottom: 5px;"></div> <b>I.C.E.</b> <div style="width: 20px; height: 10px; border: 1px solid black; margin-bottom: 5px;"></div> <b>SPORT</b> <div style="width: 20px; height: 10px; border: 1px solid black; margin-bottom: 5px;"></div> <b>CORSA</b> <div style="width: 20px; height: 10px; border: 1px solid black; margin-bottom: 5px;"></div> </div>	<div style="display: flex; flex-direction: column; align-items: center;"> <div style="width: 20px; height: 10px; border: 1px solid black; margin-bottom: 5px;"></div> <div style="width: 20px; height: 10px; border: 1px solid black; margin-bottom: 5px;"></div> <b>OFF ROAD</b> <div style="background-color: black; width: 20px; height: 10px; margin-bottom: 5px;"></div> <b>I.C.E.</b> <div style="width: 20px; height: 10px; border: 1px solid black; margin-bottom: 5px;"></div> <b>SPORT</b> <div style="width: 20px; height: 10px; border: 1px solid black; margin-bottom: 5px;"></div> <b>CORSA</b> <div style="width: 20px; height: 10px; border: 1px solid black; margin-bottom: 5px;"></div> </div>	<div style="display: flex; flex-direction: column; align-items: center;"> <div style="width: 20px; height: 10px; border: 1px solid black; margin-bottom: 5px;"></div> <div style="width: 20px; height: 10px; border: 1px solid black; margin-bottom: 5px;"></div> <b>OFF ROAD</b> <div style="width: 20px; height: 10px; border: 1px solid black; margin-bottom: 5px;"></div> <b>I.C.E.</b> <div style="background-color: black; width: 20px; height: 10px; margin-bottom: 5px;"></div> <b>SPORT</b> <div style="width: 20px; height: 10px; border: 1px solid black; margin-bottom: 5px;"></div> <b>CORSA</b> <div style="width: 20px; height: 10px; border: 1px solid black; margin-bottom: 5px;"></div> </div>	<div style="display: flex; flex-direction: column; align-items: center;"> <div style="width: 20px; height: 10px; border: 1px solid black; margin-bottom: 5px;"></div> <div style="width: 20px; height: 10px; border: 1px solid black; margin-bottom: 5px;"></div> <b>OFF ROAD</b> <div style="width: 20px; height: 10px; border: 1px solid black; margin-bottom: 5px;"></div> <b>I.C.E.</b> <div style="width: 20px; height: 10px; border: 1px solid black; margin-bottom: 5px;"></div> <b>SPORT</b> <div style="background-color: black; width: 20px; height: 10px; margin-bottom: 5px;"></div> <b>CORSA</b> <div style="width: 20px; height: 10px; border: 1px solid black; margin-bottom: 5px;"></div> </div>	<div style="display: flex; flex-direction: column; align-items: center;"> <div style="width: 20px; height: 10px; border: 1px solid black; margin-bottom: 5px;"></div> <div style="width: 20px; height: 10px; border: 1px solid black; margin-bottom: 5px;"></div> <b>OFF ROAD</b> <div style="width: 20px; height: 10px; border: 1px solid black; margin-bottom: 5px;"></div> <b>I.C.E.</b> <div style="width: 20px; height: 10px; border: 1px solid black; margin-bottom: 5px;"></div> <b>SPORT</b> <div style="width: 20px; height: 10px; border: 1px solid black; margin-bottom: 5px;"></div> <b>CORSA</b> <div style="background-color: black; width: 20px; height: 10px; margin-bottom: 5px;"></div> <div style="width: 20px; height: 10px; border: 1px solid black; margin-bottom: 5px;"></div> </div>
Setup	NORMAL + Auto + Soft suspensions	OFF ROAD + Auto + Off Road suspensions	I.C.E. + Auto + Soft suspensions	SPORT + Auto + Soft suspensions	CORSA + Manual + Corsa suspensions	NORMAL + Auto + Corsa suspensions
Stability control	Active	Active with specific tuning	Active	Active-Sport (*)	Active-Corsa (*)	Active-Sport (*)
Electric Power Steering (EPS)	Normal	Off Road	Normal	Sport	Corsa	Sport
Suspensions setup	Normal	Off Road	Normal	Normal	Hard	Hard
Engine control	Normal	Normal	Comfort	Performance	Performance	Performance
Engine boost	Normal boost	Overboost	Low boost	Overboost	Overboost	Overboost
Exhaust sound	Low (Rev. Threshold)	Normal	Close to 5000 rpm	Always High	Always High	Always High
Gear shifting point	Normal	Off Road	Comfort	Performance	Performance	Performance
Kick down	Yes	Yes	Yes - Soft	Yes - Strong	Not	Yes - Strong
Upshift rev. limiter	Yes	Yes	Yes	Yes (No, when in M+/-)	Not	Yes (No, when in M+/-)
Automatic downshift	Normal	Anti - Stall	Normal	Performance (Anti - Stall, when in M+/-)	Anti - Stall	Performance (Anti - Stall, when in M+/-)



<input checked="" type="checkbox"/> Button pressed: LED ON <input type="checkbox"/> Button not pressed: LED OFF	<input type="checkbox"/> OFF ROAD <input type="checkbox"/> I.C.E. <input type="checkbox"/> SPORT <input type="checkbox"/> CORSA <input type="checkbox"/>	<input type="checkbox"/> OFF ROAD <input checked="" type="checkbox"/> OFF ROAD <input type="checkbox"/> I.C.E. <input type="checkbox"/> SPORT <input type="checkbox"/> CORSA <input type="checkbox"/>	<input type="checkbox"/> OFF ROAD <input type="checkbox"/> OFF ROAD <input checked="" type="checkbox"/> I.C.E. <input type="checkbox"/> SPORT <input type="checkbox"/> CORSA <input type="checkbox"/>	<input type="checkbox"/> OFF ROAD <input type="checkbox"/> OFF ROAD <input type="checkbox"/> I.C.E. <input checked="" type="checkbox"/> SPORT <input type="checkbox"/> CORSA <input type="checkbox"/>	<input type="checkbox"/> OFF ROAD <input type="checkbox"/> OFF ROAD <input type="checkbox"/> I.C.E. <input type="checkbox"/> SPORT <input checked="" type="checkbox"/> CORSA <input checked="" type="checkbox"/>	<input type="checkbox"/> OFF ROAD <input type="checkbox"/> OFF ROAD <input type="checkbox"/> I.C.E. <input type="checkbox"/> SPORT <input type="checkbox"/> CORSA <input checked="" type="checkbox"/>
Shifting timing	Normal	Quick - Normal	Comfort	Sport (Quick - Sport, when in M+/-)	Quick - Corsa	Sport (Quick - Sport, when in M+/-)

(\*) In low- and medium-grip conditions (e.g., rain, snow, ice, sand, etc.) it is advisable not to activate SPORT or CORSA mode, even with the ESC system active (button (ESC OFF) not pressed).

(ESC OFF) Button pressed (TROFEO version only)

<input checked="" type="checkbox"/> Button pressed: LED ON <input type="checkbox"/> Button pressed: LED OFF	<input checked="" type="checkbox"/> OFF ROAD <input type="checkbox"/> I.C.E. <input type="checkbox"/> SPORT <input type="checkbox"/> CORSA <input type="checkbox"/>	<input checked="" type="checkbox"/> OFF ROAD <input type="checkbox"/> I.C.E. <input type="checkbox"/> SPORT <input type="checkbox"/> CORSA <input type="checkbox"/>	<input checked="" type="checkbox"/> OFF ROAD <input type="checkbox"/> OFF ROAD <input checked="" type="checkbox"/> I.C.E. <input type="checkbox"/> SPORT <input type="checkbox"/> CORSA <input type="checkbox"/>	<input checked="" type="checkbox"/> OFF ROAD <input type="checkbox"/> OFF ROAD <input type="checkbox"/> I.C.E. <input checked="" type="checkbox"/> SPORT <input type="checkbox"/> CORSA <input type="checkbox"/>	<input checked="" type="checkbox"/> OFF ROAD <input type="checkbox"/> I.C.E. <input type="checkbox"/> SPORT <input checked="" type="checkbox"/> CORSA <input checked="" type="checkbox"/>	<input checked="" type="checkbox"/> OFF ROAD <input type="checkbox"/> I.C.E. <input type="checkbox"/> SPORT <input type="checkbox"/> CORSA <input checked="" type="checkbox"/>
Setup	NORMAL + Auto + Soft suspensions	OFF ROAD + Auto + Off Road suspensions	I.C.E. + Auto + Soft suspensions	SPORT + Auto + Soft suspensions	CORSA + Manual + Corsa suspensions	NORMAL + Auto + Corsa suspensions
Stability control	OFF	OFF	OFF	OFF	OFF	Active-Sport
Electric Power Steering (EPS)	Normal	Off Road	Normal	Sport	Corsa	Sport
Suspensions setup	Normal	Off Road	Normal	Normal	Hard	Hard
Engine control	Normal	Normal	Comfort	Performance	Performance	Performance



## Starting and Driving

<div style="display: flex; flex-direction: column; align-items: center;"> <div style="display: flex; align-items: center; margin-bottom: 5px;"> <div style="width: 15px; height: 15px; background-color: black; margin-right: 5px;"></div> <div>Button pressed: LED ON</div> </div> <div style="display: flex; align-items: center;"> <div style="width: 15px; height: 15px; border: 1px solid black; margin-right: 5px;"></div> <div>Button pressed: LED OFF</div> </div> </div>	<div style="display: flex; flex-direction: column; align-items: center;"> <div style="display: flex; align-items: center; margin-bottom: 5px;"> <div style="width: 15px; height: 15px; background-color: black; margin-right: 5px;"></div> <div style="font-size: 10px; margin-right: 5px;"></div> <div>OFF ROAD</div> </div> <div style="display: flex; align-items: center; margin-bottom: 5px;"> <div style="width: 15px; height: 15px; border: 1px solid black; margin-right: 5px;"></div> <div>I.C.E.</div> </div> <div style="display: flex; align-items: center; margin-bottom: 5px;"> <div style="width: 15px; height: 15px; border: 1px solid black; margin-right: 5px;"></div> <div>SPORT</div> </div> <div style="display: flex; align-items: center; margin-bottom: 5px;"> <div style="width: 15px; height: 15px; border: 1px solid black; margin-right: 5px;"></div> <div>CORSA</div> </div> <div style="display: flex; align-items: center;"> <div style="width: 15px; height: 15px; border: 1px solid black; margin-right: 5px;"></div> <div style="font-size: 10px;"></div> </div> </div>	<div style="display: flex; flex-direction: column; align-items: center;"> <div style="display: flex; align-items: center; margin-bottom: 5px;"> <div style="width: 15px; height: 15px; background-color: black; margin-right: 5px;"></div> <div style="font-size: 10px; margin-right: 5px;"></div> <div>OFF ROAD</div> </div> <div style="display: flex; align-items: center; margin-bottom: 5px;"> <div style="width: 15px; height: 15px; border: 1px solid black; margin-right: 5px;"></div> <div>I.C.E.</div> </div> <div style="display: flex; align-items: center; margin-bottom: 5px;"> <div style="width: 15px; height: 15px; border: 1px solid black; margin-right: 5px;"></div> <div>SPORT</div> </div> <div style="display: flex; align-items: center; margin-bottom: 5px;"> <div style="width: 15px; height: 15px; border: 1px solid black; margin-right: 5px;"></div> <div>CORSA</div> </div> <div style="display: flex; align-items: center;"> <div style="width: 15px; height: 15px; border: 1px solid black; margin-right: 5px;"></div> <div style="font-size: 10px;"></div> </div> </div>	<div style="display: flex; flex-direction: column; align-items: center;"> <div style="display: flex; align-items: center; margin-bottom: 5px;"> <div style="width: 15px; height: 15px; background-color: black; margin-right: 5px;"></div> <div style="font-size: 10px; margin-right: 5px;"></div> <div>OFF ROAD</div> </div> <div style="display: flex; align-items: center; margin-bottom: 5px;"> <div style="width: 15px; height: 15px; border: 1px solid black; margin-right: 5px;"></div> <div>I.C.E.</div> </div> <div style="display: flex; align-items: center; margin-bottom: 5px;"> <div style="width: 15px; height: 15px; border: 1px solid black; margin-right: 5px;"></div> <div>SPORT</div> </div> <div style="display: flex; align-items: center; margin-bottom: 5px;"> <div style="width: 15px; height: 15px; border: 1px solid black; margin-right: 5px;"></div> <div>CORSA</div> </div> <div style="display: flex; align-items: center;"> <div style="width: 15px; height: 15px; border: 1px solid black; margin-right: 5px;"></div> <div style="font-size: 10px;"></div> </div> </div>	<div style="display: flex; flex-direction: column; align-items: center;"> <div style="display: flex; align-items: center; margin-bottom: 5px;"> <div style="width: 15px; height: 15px; background-color: black; margin-right: 5px;"></div> <div style="font-size: 10px; margin-right: 5px;"></div> <div>OFF ROAD</div> </div> <div style="display: flex; align-items: center; margin-bottom: 5px;"> <div style="width: 15px; height: 15px; border: 1px solid black; margin-right: 5px;"></div> <div>I.C.E.</div> </div> <div style="display: flex; align-items: center; margin-bottom: 5px;"> <div style="width: 15px; height: 15px; background-color: black; margin-right: 5px;"></div> <div>SPORT</div> </div> <div style="display: flex; align-items: center; margin-bottom: 5px;"> <div style="width: 15px; height: 15px; border: 1px solid black; margin-right: 5px;"></div> <div>CORSA</div> </div> <div style="display: flex; align-items: center;"> <div style="width: 15px; height: 15px; border: 1px solid black; margin-right: 5px;"></div> <div style="font-size: 10px;"></div> </div> </div>	<div style="display: flex; flex-direction: column; align-items: center;"> <div style="display: flex; align-items: center; margin-bottom: 5px;"> <div style="width: 15px; height: 15px; background-color: black; margin-right: 5px;"></div> <div style="font-size: 10px; margin-right: 5px;"></div> <div>OFF ROAD</div> </div> <div style="display: flex; align-items: center; margin-bottom: 5px;"> <div style="width: 15px; height: 15px; border: 1px solid black; margin-right: 5px;"></div> <div>I.C.E.</div> </div> <div style="display: flex; align-items: center; margin-bottom: 5px;"> <div style="width: 15px; height: 15px; border: 1px solid black; margin-right: 5px;"></div> <div>SPORT</div> </div> <div style="display: flex; align-items: center; margin-bottom: 5px;"> <div style="width: 15px; height: 15px; background-color: black; margin-right: 5px;"></div> <div>CORSA</div> </div> <div style="display: flex; align-items: center;"> <div style="width: 15px; height: 15px; border: 1px solid black; margin-right: 5px;"></div> <div style="font-size: 10px;"></div> </div> </div>	<div style="display: flex; flex-direction: column; align-items: center;"> <div style="display: flex; align-items: center; margin-bottom: 5px;"> <div style="width: 15px; height: 15px; background-color: black; margin-right: 5px;"></div> <div style="font-size: 10px; margin-right: 5px;"></div> <div>OFF ROAD</div> </div> <div style="display: flex; align-items: center; margin-bottom: 5px;"> <div style="width: 15px; height: 15px; border: 1px solid black; margin-right: 5px;"></div> <div>I.C.E.</div> </div> <div style="display: flex; align-items: center; margin-bottom: 5px;"> <div style="width: 15px; height: 15px; border: 1px solid black; margin-right: 5px;"></div> <div>SPORT</div> </div> <div style="display: flex; align-items: center; margin-bottom: 5px;"> <div style="width: 15px; height: 15px; border: 1px solid black; margin-right: 5px;"></div> <div>CORSA</div> </div> <div style="display: flex; align-items: center;"> <div style="width: 15px; height: 15px; background-color: black; margin-right: 5px;"></div> <div style="font-size: 10px;"></div> </div> </div>
Engine boost	Normal boost	Overboost	Low boost	Overboost	Overboost	Overboost
Exhaust sound	Low (Rev. Threshold)	Normal	Close to 5000 rpm	Always High	Always High	Always High
Gear shifting point	Normal	Off Road	Comfort	Performance	Performance	Performance
Kick down	Yes	Yes	Yes - Soft	Yes - Strong	Not	Yes - Strong
Upshift rev. limiter	Yes	Yes	Yes	Yes (No, when in M+/-)	Not	Yes (No, when in M+/-)
Automatic downshift	Normal	Normal (Anti - Stall, when in M+/-)	Normal	Performance (Anti - Stall, when in M+/-)	Anti - Stall	Performance (Anti - Stall, when in M+/-)
Shifting timing	Normal	Normal	Comfort	Sport (Quick - Sport, when in M+/-)	Quick - Corsa	Sport (Quick - Sport, when in M+/-)

**NOTE:**

A different drive mode can be set even with engine running and vehicle in motion.

To activate a drive mode, press briefly the corresponding button. The LED beside the button will light up and set drive mode screen will be displayed (example in the figure: NORMAL) for 5 seconds.



### Activate/Deactivate (ESC OFF) Drive Mode

To activate  (ESC OFF) drive mode press the corresponding button for at least 3 seconds: the yellow LED on the button will turn on.

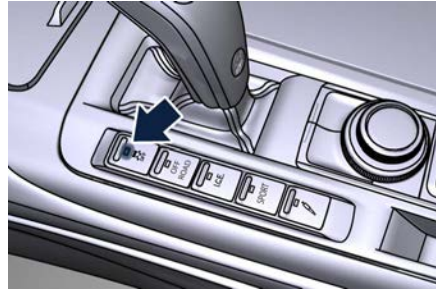

To deactivate the drive mode, press the same button again: the LED will turn off and the display will show the message indicating that  (ESC OFF) drive mode is off and ESC system is active.

### Activate/Deactivate OFF ROAD, I.C.E. and SPORT Drive Mode

To activate one of these drive mode, press the corresponding button once: the white LED on the button will turn on (example in picture: SPORT mode).



To disable the drive mode activated, press the same button again: the LED will turn off.

Excluding TROFEO version, if you deactivate the SPORT mode by briefly pressing the related button when is activate (LED lit) it also deactivates the  (Suspension) mode if it was activate (LED lit).

### Activate/Deactivate SPORT and CORSA Drive Mode (TROFEO Version only)

To activate SPORT drive mode, press the corresponding button once: the upper white LED on the button will turn on.

CORSA drive mode can be active by pressing again the same button for more than a second (about 1.2 seconds): also the lower LED on the button will turn on.



To return in SPORT drive mode, press the SPORT/CORSA button again.

When in "CORSA" drive mode, "OFF ROAD" and  (Suspension) hard (S) drive mode can not be set and you can run the "Launch Control" start procedure (see "Launch Control Mode" in this section).



To disable the SPORT mode without activating the CORSA mode, press the same button once again: the two LED will turn off.

### Activate/Deactivate Hard Suspension Drive Mode

Briefly press “  ” (Suspension) button on the central console to activate the hard suspension setting recognizable by the green color of the 4 shock absorbers, when in NORMAL, I.C.E. or SPORT drive mode. When exiting the drive mode screen, the setting is always visible through the icon  with "S" (Soft) or "H" (Hard) beside on the upper right side of the TFT display (area 9).

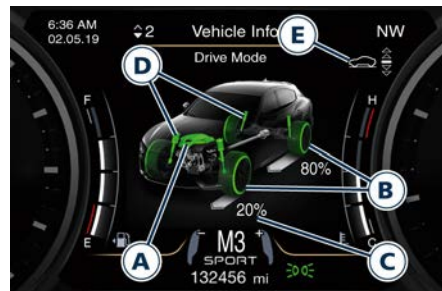









**SPORT**

### Monitoring Settings on Display









By gaining access to “Drive mode” submenu of “VEHICLE INFO” menu through the buttons on steering wheel right-hand side, it is possible to monitor the settings for driving on and off road. The list and figure show vehicle parameters referred to each drive mode. Each drive mode and its parameters are identified by a different color (example in the figure: SPORT).

- A** Powertrain.
- B** Drive Mode/ESC.
- C** Torque distribution.
- D** Suspension stiffness.
- E** Ride height.

The table below specifies the default, ride height and relevant commands that can be set, for each drive mode.

Drive Mode	Default Condition		Possible Ride Height / Command
	ESC	Off Road	<ul style="list-style-type: none"> <li>• Off Road 1 / Via dedicated drive height selector according to current speed.</li> <li>• Off Road 2 / Via dedicated drive height selector according to current speed.</li> </ul>
		Off Road	
		Off Road 1	
	ESC	I.C.E.	<ul style="list-style-type: none"> <li>• Normal / Via dedicated drive height selector according to current speed.</li> <li>• Aero 1 / Via dedicated drive height selector according to current speed.</li> <li>• Aero 2 / Only speed dependent.</li> <li>• Entry/Exit / Via dedicated drive height selector according to current speed.</li> </ul>
		Normal	
		Normal	
	ESC	Normal	<ul style="list-style-type: none"> <li>• Normal / Via dedicated drive height selector according to current speed.</li> <li>• Aero 1 / Via dedicated drive height selector according to current speed.</li> <li>• Aero 2 / Only speed dependent.</li> <li>• Entry/Exit / Via dedicated drive height selector according to current speed.</li> </ul>
		Normal	
		Normal	



Drive Mode	Default Condition		Possible Ride Height / Command
	ESC	Sport	<ul style="list-style-type: none"> <li>• Normal / Via dedicated drive height selector according to current speed.</li> <li>• Aero 1 / Via dedicated drive height selector according to current speed.</li> <li>• Aero 2 / Only speed dependent.</li> <li>• Entry/Exit / Via dedicated drive height selector according to current speed.</li> </ul>
		Normal	
		Normal	
	ESC	Corsa	<ul style="list-style-type: none"> <li>• Other ride heights can not be set when in "CORSA" mode.</li> <li>• Entry/Exit / Via dedicated drive height selector according to current speed.</li> </ul>
		Corsa	
		Aero 2	
	ESC	Sport	<ul style="list-style-type: none"> <li>• Normal / Via dedicated drive height selector according to current speed.</li> <li>• Aero 1 / Via dedicated drive height selector according to current speed.</li> <li>• Aero 2 / Only speed dependent.</li> <li>• Entry/Exit / Via dedicated drive height selector according to current speed.</li> </ul>
		Sport	
		Aero 1	





	Aero 2
	Entry/Exit



During transition from one position to another, the instrument cluster display will show a pop-up indicator (above the coolant temperature indicator) which reproduces the ride height symbols. On this indicator, the LED for the new position, set by means of the selector on central console, will flash while the LEDs of intermediate positions will turn on when set position is reached. The new position will be displayed on the dedicated area at top right of the display and the indicator will turn off after approximately 2 seconds.

### Automatic Selection of “NORMAL” Drive Mode upon Ignition (Predominant Mode)

If “Off Road” drive mode was set before switching off the vehicle, “NORMAL” drive mode will be set automatically upon re-ignition. Over 3 MPH (5 km/h), vehicle height if was set to “Off Road 1” or “Off Road 2” will lower to “Normal” ride height if no other inputs from the user.

### I.C.E. Mode excluding ESC

To release the vehicle in low grip conditions (e.g.: heaps of snow, mud, sand, etc), it is possible to shift the transmission in the specific driving mode as required for these situations, by pressing the I.C.E. button and to exclude completely the yaw and spinning control system, by pressing the button for at last three seconds (ESC OFF).

## Setting Ride Height

The pneumatic suspension system ensures vehicle continuous automatic leveling and allows setting ground clearance by simply moving the ride height selector.

The selector can be moved forward (▲) and backward (▼) by one position at a time in order to set six different heights. Every position is identified by the switch-on of the corresponding LED at the left side of the selector and in the dedicated area at top right of the display.

The table below shows the possible selector positions and the relevant symbols.

	Off Road 2
	Off Road 1
	Normal
	Aero 1

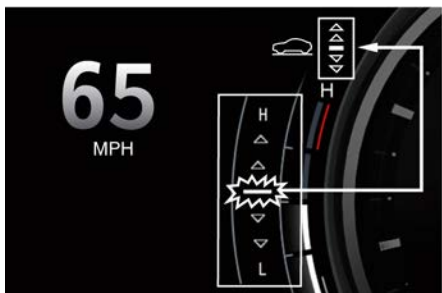

The system requires that the engine be running for all changes. When lowering the vehicle, all of the doors, including the liftgate, must be closed.

If a door is opened at any time while the vehicle is lowering, the change will not be completed until the open door/s is/are closed.

The pneumatic suspension system of this vehicle uses a lifting and lowering pattern preventing the headlights from incorrectly shining into oncoming traffic. When raising the vehicle, the rear of the vehicle will move up first and then the front.

When lowering the vehicle, the front will move down first and then the rear.

After the engine is turned off, it may be noticed that the pneumatic suspension system operates briefly, this is normal. The system is correcting the position of the vehicle with little suspension

movements to ensure a proper appearance.

### Display Messages

After shifting selector to change position, a pop-up message will indicate for 5 seconds when set position has been reached (after pneumatic suspension system intervention that might last up to 30 seconds).

This type of message will be displayed only if the option to view all pneumatic suspension system messages and not only the warnings was set. For further details, refer to “Functions of Settings Menu on MIA” in section “Dashboard Instruments and Controls”.



Set ride height and drive mode can be monitored on instrument cluster display via “Drive mode” menu, using buttons on the right-hand side of the steering wheel (see chapter “TFT Display: Menu

and Submenu Content” in section “Dashboard Instruments and Controls”). The change from one position to another can occur only if the following requirements are met.

- Lifting: engine running, speed lower than preset limit, etc.
  - Lowering: engine running, speed lower than preset limit, doors closed, etc.
- Ride height change can be temporarily suspended or disabled under the following conditions, as indicated in the pop-up messages on instrument cluster display.
- High speed: decrease speed to set new height.
  - Pneumatic suspension system overheat: wait for the system to cool down before changing height.
  - Door(s) and/or liftgate open: close door(s) and liftgate to lower the vehicle.
  - Pneumatic suspension system temporarily disabled or in fault: wait a few minutes and repeat the operation or contact an **Authorized Maserati Dealer**.
  - Low battery: start the engine to recharge battery and change ride height.
  - Entry/Exit position not available: check the cause preventing this control.



## Using the Ride Height Positions and speed Thresholds

The different ride heights that can be set with the selector allow user to drive the vehicle on and off road, using the available drive modes and functions.

### NOTE:

The indications below explain as a general rule which selector position has to be used in certain situations and which are the speed thresholds at which it is possible to set the available ride height and when system automatically switches to a different height. In any case, the driver must always assess and set the ride height and drive mode most suitable to the conditions of the current driving path on a case by case basis.

- **Normal:** normal ground clearance. This is the standard height position of the pneumatic suspension and is meant for normal road conditions. In this ride height position driver can set the "NORMAL" and "I.C.E. drive modes. After the engine is switched off, the drive mode is set to "NORMAL". If "OFF ROAD" drive mode was set, "NORMAL" mode will be set, but the user-set ride height will remain until the speed threshold is reached.
- **Off Road 1:** raises the vehicle by approx. 1 in (25 mm).

This is the height suitable for most off road driving conditions until the other off road option is needed. This ride height can set only in "OFF ROAD" drive mode. Select this height while the vehicle speed is below 50 MPH (80 km/h). When in the "Off Road 1" height, if the vehicle speed remains between 50 MPH (80 km/h) and 56 MPH (90 km/h) for over 30 seconds or if vehicle speed exceeds 56 MPH (90 km/h), the vehicle will be automatically lowered to "NORMAL" height. For further details, refer to "Off-road Drive" in this section.

- **Off Road 2:** raises the vehicle by approx. 1.5 in (40 mm). This height is intended for off-road use only where maximum ground clearance is required. This ride height can be set only in "OFF ROAD" drive mode. Select this height while the vehicle speed is below 18 MPH (30 km/h). When in the "Off Road 2" height, if the vehicle speed remains between 18 MPH (30 km/h) and 25 MPH (40 km/h) for over 30 seconds or if vehicle speed exceeds 25 MPH (40 km/h), the vehicle will be automatically lowered to "Off Road 1" height. For further details, refer to "Off-road drive" in this section.
- **Aero 1:** lowers the vehicle by approx. 0.8 in (20 mm). This height provides improved aerodynamics by lowering the

vehicle. This ride height is available in "NORMAL", "SPORT", "⚙️ (Suspension)" or "I.C.E." drive mode. System automatically lowers the vehicle when speed remains between 74 MPH (120 km/h) and 80 MPH (130 km/h) for over 15 seconds or if the vehicle speed exceeds 80 MPH (130 km/h). The system will return to "NORMAL" height when the vehicle speed remains between 62 MPH (100 km/h) and 56 MPH (90 km/h) for over 15 seconds or if the vehicle speed falls below 56 MPH (90 km/h). The vehicle will enter "Aero 1" height, regardless of vehicle speed if the "SPORT" mode is set.

- **Aero 2:** lowers the vehicle by approx. 1.4 in (35 mm). It is the height ensuring excellent aerodynamics for top performance by further lowering the vehicle. This ride height is available in "NORMAL", "SPORT", "⚙️ (Suspension)" or "I.C.E." drive mode. This is the default ride height when "CORSA" drive mode (TROFEO version only) is set. System automatically lowers the vehicle when speed exceeds 105 MPH (170 km/h) or when it remains between 105 MPH (170 km/h) and 115 MPH (185 km/h) for over 15 seconds. The system will return to



## Starting and Driving

Aero 1 height when the vehicle speed remains between 96 MPH (155 km/h) and 87 MPH (140 km/h) for over 15 seconds or if the vehicle speed falls below 87 MPH (140 km/h).

- **Easy/Entry:** lowers the vehicle by approx. 1.8 in (45 mm).

This mode lowers the vehicle for easier passenger entry and exit as well as lowering the rear of the vehicle for easier loading and unloading of cargo from the trunk. This ride height can be set only in “NORMAL”, “SPORT”, “ (Suspension)” or “I.C.E.” After selecting this height, once the vehicle speed goes below 15 MPH (24 km/h), the vehicle height will begin to lower. To exit “Entry/Exit” mode, move selector to another position or drive the vehicle over 15 MPH (24 km/h). Automatic lowering of the vehicle into “Entry/Exit” mode can be enabled through the MIA (refer to “Functions of Settings Menu on MIA” in section “Dashboard Instruments and Controls”). If this function is enabled, the vehicle will only lower if the gearshift lever is in P (Park), the engine is running, doors and liftgate are closed and the Pneumatic Suspension System should be either in “NORMAL” or “Aero”. The Vehicle will not automatically lower if the pneumatic suspension system is in “Off

Road 2” or “Off Road 1” mode. The lowering will be suppressed when the ignition is switched off and a door is opened to prevent setting the alarm off.

### Lowering Vehicle Height for Inactivity

Lowering of vehicle ground clearance after a long period of inactivity should be considered normal since it is due to a drop of pressure in the pneumatic suspension system.

Approximately, after one week of inactivity, vehicle ground clearance will lower by 0.4 in (10 mm). To set off the drop of pressure due to inactivity, it is necessary to start the engine and allow some time until system reaches operating pressure and lifts the vehicle to set ride height. A message on instrument cluster display will warn driver when set ride height is reached.

Driving vehicle before the set riding height is reached is not safe and could damage suspension components.

#### NOTE:

After a long period of vehicle inactivity, drive only when vehicle reaches set ride height to prevent any problems of the pneumatic suspension system.





## Launch Control Mode (TROFEO version only)

"Launch Control" mode is a performance start procedure.

By activating this procedure you get the best possible acceleration from standstill of the car.

This mode allows you to ground the torque necessary to prevent the wheels from slipping during acceleration performance.

To make a performance start in "Launch Control" mode, the following conditions must be met:

- Water and transmission temperature in proper range.
- No engine, AWD and on board systems faults.
- The vehicle mileage must be higher than 440 mi (700 km).
- "CORSA" drive mode on.
- Shift lever in "D" or "M +/-" position.
- The vehicle must be stationary on a level road surface.
- The driver door closed and the safety belt fastened

### Launch Control Sequence

#### NOTE:

- All the above mentioned conditions must be verified in order to activate

"Launch Control" performance start procedure.

- During "Launch Control" ACC, FCW and ADA (if equipped) are temporarily disabled.
- Each step displayed on the instrument cluster has a time out approximately of 5 seconds.
- The "Launch Control" maneuver requires the use of both feet, with the left foot on the brake and the right foot on the accelerator simultaneously.
- With brake pedal pressed and steering wheel straight, pull "-" left paddle. The instrument cluster shows the "Launch Control" engaged page.



- To confirm the procedure, pull again the "-" paddle. To abort the procedure, pull "+" right paddle.
- To confirm the "Launch Control" sequence, press full the brake pedal

as indicated in the message on the instrument cluster.



- With brake pedal pressed full with left foot, fully press the accelerator pedal (with right foot) as indicated in the message on the instrument cluster.



- Release brake pedal. The launch of the vehicle starts with ESC that manages the maximum performance and engine torque calibrated to maximize performance. Maximum performance can be achieved if the driver ensures



## Starting and Driving

engine rpm is above 2300 rpm before releasing the brake pedal.



During the acceleration phase the “Launch Control” symbol appears at the top right of the TFT display.



## Off-Road Drive

This vehicle is equipped with a specific Off Road driving mode which allows to drive through various terrain conditions (rock, mud, sand), also uphill and downhill, eventually in condition of lateral inclination. To set the "OFF ROAD" drive mode, please see the chapters “Drive Mode” and “Setting Ride Height” in this section.

In order to enhance this specific performance, the "OFF ROAD" drive mode modifies the setting of:

- Ride height;
- Engine, transmission calibration;
- Suspensions.

When “OFF ROAD” is selected, ride height is set to “Off Road 1” (vehicle is higher by approx. 1 in / 25 mm).

It is possible to select ride height “Off Road 2” (vehicle is raised by approx. 1.5 in / 40 mm) using the ride height selector.

“OFF ROAD” drive mode is limited up to a max speed of 56 MPH (90 km/h). In case the vehicle speed should exceed this limit, the drive mode will be de-selected automatically and the drive mode will return to “NORMAL”.

“Off Road 2” ride height is limited instead up to a max speed of 25 MPH (40 km/h). In case the vehicle speed should exceed this limit, ride height

will be put automatically to “Off Road 1” while driving mode will remain “OFF ROAD”.

An advantage of the higher ground clearance is a better view of the road, allowing you to anticipate problems. A higher clearance and the longer travel of the suspension might allow the vehicle to overcome some obstacles.

A higher ground clearance means a higher center of gravity. If at all possible, avoid sharp turns or abrupt maneuvers.

**Failure to operate this vehicle correctly may result in loss of control or vehicle rollover.**

Although the pneumatic suspension system contributes to limiting these risks by setting precautionary speed thresholds, the driver must always pay utmost attention and drive carefully.



### WARNING!

**“Off Road 2” ride height must always be selected in case of water fording. Please remember water fording limits: max depth of the water must be lower than 19 in (50 cm) and crossing speed lower than 5 MPH (8 km/h).**

In “OFF ROAD” drive mode, also engine, transmission settings are changed in order to provide the most suitable level of torque and selected gear to improve



traction on low-adherence condition and uphill climbing.



### **WARNING!**

**In case of downhill, the use of the Hill Descent Control (HDC) is recommended, especially for relevant slope and in case of low-adherence conditions.**

Also suspensions (Skyhook Continuous Damping Control) are set to a specific calibration in “OFF ROAD” drive mode, in order to obtain the right damping force provided by the shock absorbers, combined with the increased ride heights “Off Road 1” and “Off Road 2”.

### **Driving Through Water**

Set maximum ride height “Off Road 2” before driving through water. Although your vehicle is capable of driving through water, a number precautions must be considered before entering the water.

#### **NOTE:**

Your vehicle is capable of water fording to a maximum of 19 in (50 cm) of water. To maintain optimal performance of your vehicle’s heating and ventilation system it is recommended to switch the system into recirculation mode during water fording.



### **CAUTION!**

When driving through water, do not exceed 5 MPH (8 km/h). Always check water depth before entering, as a precaution. Check all fluids afterwards: driving through water may cause damage to engine and driveline that may not be covered by the new vehicle limited warranty.

Driving through water more than a few inches/centimeters deep will require extra caution to ensure safety and prevent damage to your vehicle. If you must drive through water, try to determine the depth and the bottom condition (and location of any obstacles) prior to entering. Proceed with caution and maintain a steady controlled speed lower than 5 MPH (8 km/h) while in water to minimize wave effects that might cause serious damage to all components, especially the engine.



### **WARNING!**

**Avoid driving through flowing or standing water. Doing so can be highly dangerous and can be very difficult to determine the depth of the water you are driving through. If driving through water cannot be avoided,**

**and after driving through it, apply the brakes lightly to ensure the brakes are operating correctly.**

### **Flowing Water**

If the water is swift flowing and rising (as in storm run-off), avoid crossing until the water level recedes and/or the flow rate is reduced. If you must cross flowing water avoid depths in excess of 9 in (25 cm).

### **Standing Water**

Do not drive in standing water deeper than 19 in (50 cm), and reduce speed appropriately to minimize wave effects.

### **Maintenance**

After driving through water, have your vehicle fluids and lubricants inspected at an **Authorized Maserati Dealer** to assure the fluids have not been contaminated.

### **Driving in Snow and Wet Grass**

In heavy snow, when pulling a load, or for additional control at slower speeds, set “I.C.E.” drive mode with transmission in M +/- (Manual) and shift the transmission to a low gear. See “Drive Mode” in this section for further details. Do not shift to a lower gear than necessary to maintain forward motion. Over-revving the engine can spin the wheels and traction will be lost.



## Starting and Driving

Avoid abrupt downshifts on icy or slippery roads, because engine braking may cause skidding and loss of control. Follow these instructions even when driving through a path section covered with wet grass.

### Driving in Mud and Sand

In general, when driving in mud and sand, if your wheels spin, always reduce the throttle in order to slow the tires and regain traction.

- When driving in mud, avoid using low gear that could cause wheel spin. Follow the tire and vehicle manufacturer's advice on tire pressure.
- When driving in sand, adopt lowest gear possible.

### Hill Climbing

Before climbing a hill, determine the conditions at the crest and/or on the other side and shift the transmission to a lower gear.

The vehicle is equipped with Hill Start Assist (HSA) that helps the driver to manage the brake intervention in acceleration when driving uphill (  : chapter "Brake and Stability Control Systems" in section "Safety").



### **WARNING!**

**If you lose forward motion, or cannot make it to the top of a hill or grade, never attempt to turn around. Always back carefully straight down a hill in R (Reverse) gear. Never back down a hill in N (Neutral) using only the brake.**

Remember, never drive diagonally across a hill; always drive straight up or down.

### Traction Downhill

When descending mountains or hills, use Hill Descent Control (HDC) to avoid repeated heavy braking (for further details, refer to "Hill Descent Control - HDC" in section "Driver Assistance Systems").

When descending mountains or hills, repeated braking can cause brake fade with loss of braking power. Avoid repeated heavy braking and downshift the transmission whenever possible in order to cool down the brakes.

### Warnings and Tips for Off-road Driving

When driving off-road, using the "OFF ROAD" drive mode which is specific for this use.

Before driving, always make sure that the vehicle reached the ride height set through the selector.

When driving, always:

- limit driving speed as much as possible to tackle bends, bumpy sections and slopes;
- increase visual control in front and on the sides of the vehicle to quickly spot any obstacles in your path (potholes, branches, etc.);

Always consider these tips further to your experience gained in off-road driving.

### After Driving Off-road

Off-road operation puts more stress on your vehicle than does most on-road driving. After going off-road, it is always a good idea to check for damage. That way you can get any problems taken care of right away and have your vehicle ready when you need it.

- Completely inspect the underbody of your vehicle. Check tires, body structure, steering, suspension, and exhaust system for damage.
- Inspect the radiator for mud and debris that might decrease sinking effect and clean as required.
- Check for accumulations of plants or brush in underbody. These things could be a fire hazard if they get in contact with the exhaust system.
- After extended operation in mud, sand, water, or similar dirty conditions, have all parts that got in contact with mud,



sand and water inspected and cleaned as soon as possible.



### WARNING!

**Abrasive material in any part of the brakes may cause excessive wear or unpredictable braking operation. Do not drive if braking system is not in good conditions: get your brakes checked and cleaned as necessary by an Authorized Maserati Dealer.**

- If you experience unusual vibration after driving in mud, slush or similar conditions, check the wheels and suspension linkages for impacted material. Impacted material can cause wheel imbalance and affect suspension response. Removing it will correct the situation.

## Parking Brake

The vehicle is equipped with an electric automatic parking brake, also called EPB (Electric Parking Brake).

The braking action is ensured by a power actuator directly working on the brake pad inside each caliper of the rear brake system.

It can be automatically engaged when the engine is turned off and disengaged with engine running, driver seatbelt latched and driver door closed, while pressing the brake pedal and operating the shift lever.

Furthermore, EPB can be automatically engaged above a slope threshold with transmission in park to avoid damage to the vehicle. EPB can be disengaged before turning off the vehicle.

When the parking brake is applied, the warning light **BRAKE** (United States market) or  (Canadian market) lights up on the tachometer display and the related message is displayed on the instrument cluster for 5 seconds (see “Warning and Indicators Lights” in section “Dashboard Instruments and Controls”).



United States Market

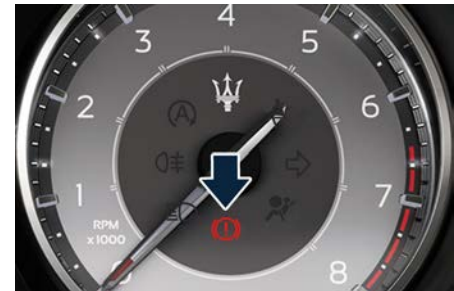

Canadian Market

During engagement and disengagement procedures, the warning light **BRAKE** (United States market) or  (Canadian market) flashes until the parking brake has reached its maximum activation force and is respectively fully released.

In the above-mentioned conditions, the automatic engagement function can be deactivated/activated by selecting the



## Starting and Driving

menu item “Vehicle settings” on the main menu (refer to paragraph “Deactivating Automatic Operation” in this chapter).

### Manual Engagement/ Disengagement

The parking brake can also be manually engaged or disengaged when the engine is running or the ignition device is in the **RUN** position, by pressing the brake pedal and raising the lever located behind the shift lever.

When the parking brake is applied, the warning light **BRAKE** (United States market) or  (Canadian market) lights up on the tachometer and the related message will be displayed for 5 seconds on the instrument cluster.

If you attempt to engage/disengage the parking brake without having pressed the brake pedal, a message will be displayed, warning you to press the brake pedal.

If the engine was turned off when the automatic engagement device was deactivated (see “Deactivating Automatic Operation” in this chapter) it is possible to shift the parking brake simply by pulling the lever upward within 3 minutes after turning off.



**CAUTION!**  
The main function of the EPB is to allow safe parking of the vehicle, therefore it must only be applied when the vehicle is already stationary. If the EPB is used while the vehicle is moving and decelerating until a speed lower of 3 MPH (5 km/h) and, in particular, until complete stop (typically in a sudden brake), it is necessary to have the EPB system checked by an **Authorized Maserati Dealer**.



- Always hold the brake pedal pressed during engagement or disengagement of the parking brake.
- The EPB command activation while running generates a deceleration of the vehicle with strong deceleration

(Dynamic Braking). It is therefore recommended to use this function only in case of emergency. When the handbrake is activated, the vehicle stability will not be affected when ESC is engaged.

- It is advisable to keep the "Auto Apply" function always active (On) so that the vehicle is properly secured with electric parking brake.

### Deactivating Automatic Operation

The automatic engagement function can be deactivated/reactivated by selecting the menu item “Vehicle settings” through the switch on the right side of the steering wheel (refer to “TFT Display Setting and Menu Overview” in section “Dashboard Instruments and Controls”). Press and release the multifunction switch toward the arrow  to select “Electric Park Brake”.



Press and release the switch once again toward the arrow  $\triangleright$  to visualize the options connected to this function.

- Auto Apply On (recommended setting);
- Auto Apply Off.



### WARNING!

It is advisable to keep the "Auto Apply" function always active (On) so that the vehicle is properly secured with electric parking brake.



Scroll with the switch toward the arrow  $\wedge$  or  $\vee$  through the programmable options.

Press and release the multifunction switch toward the arrow  $\triangleright$  to set the selected option. A check mark will remain next to the selected item until a new selection is made.



"Setting Saved" Selection notification appears as a popup for 2 seconds then the display will show again the modified function.



In order to disable the automatic operation follow the same procedures and select the other option.



### CAUTION!

- Under certain conditions when the battery voltage is low, the electric automatic parking brake system may temporarily be deactivated for safety reasons. Therefore, typically upon starting the engine, when the battery voltage drops, a message may temporarily be displayed, indicating that automatic operation is temporarily disabled.
- In case of repetitive requests to reset the EPB through the messages shown on the TFT display, please contact an **Authorized Maserati Dealer**.

### Failure Indication

In the event of electric parking brake system failure, the warning light  $\textcircled{P}$  on the display will light up and the related message will show as long as the failure is present.

In addition, the warning light **BRAKE** will flash for 10 seconds.



## **WARNING!**

In the event of an EPB failure, take your vehicle to the nearest Authorized Maserati Dealer as soon as possible.



### 5 Initialize the EPB System after Re-connecting the Vehicle Battery

After the detachment and the subsequent connection of the battery, on the instrument cluster display the warning light (P) will be illuminated. To initialize the EPB system, lift, release and lift again the lever located behind the shift lever.

After having initialized the EPB system, the error messages regarding the unavailability of the radar functions shown in the pictures will be displayed on the instrument cluster. In the next key cycle, the messages will no longer be present.



components. In these conditions the parking brake must not be used since the push of the power actuator might not be sufficient to ensure vehicle braking, especially on a slope.

Drive normally without braking to allow the brakes to cool down a few minutes before stopping. In this way, the automatic or manual activation of the parking brake will ensure vehicle braking.

### Emergency Disengagement

In case of brake lock with complete electrical system failure, it is necessary to force the electric actuator on the rear calipers (see “Emergency Release of the Parking Brake” chapter in section “In an Emergency”).

### EPB Operation with Overheated Brakes

Driving on mountain roads with steep slopes or a sports use of the vehicle could overheat the brake system



## Parking

Before leaving the vehicle, **make sure that the parking brake is fully applied** and place the transmission lever in the P (Park) position by pressing the “P” button.



### WARNING!

- **Always check that the vehicle is locked before leaving it.**
- **Never leave children unattended in the vehicle.**
- **Do not park the vehicle on paper, grass, dry leaves or other flammable materials.**
- **Do not leave the engine running while the vehicle is unattended.**



### WARNING!

**Never use the P (Park) position as a substitute for the parking brake. Always apply the parking brake firmly when parked, including when parked on an incline, to guard against vehicle movement and possible injury or damage.**

When parking on hill roads, it is important to turn the front wheels toward the curb on a downhill grade and away from the curb on an uphill grade.

Apply the parking brake before placing the shift lever in P (Park), otherwise the load on the transmission locking mechanism may make it difficult to move the shift lever out of P (Park).

In certain conditions, it is however advisable to disengage the parking brake manually and slightly apply the service brake for starting off. This is advisable when there are obstacles very close to the vehicle in the direction in which you intend to move.



## “Drive Away Inhibit” strategy

In order to avoid a dangerous condition resulting from leaving the vehicle “not braked” with running engine and without driver on board, “Drive Away Inhibit” strategy alerts the driver with messages on the instrument cluster display and sounding chimes, then puts the transmission in P (Park).

The table shows the vehicle condition and the action that the system runs to exit the dangerous condition.

Vehicle condition		Action of the driver		
<ul style="list-style-type: none"> <li>• Engine running and speed lower than 1.8 MPH (3 km/h).</li> <li>• Transmission in any position other P (Park).</li> <li>• Driver safety belt unlocked.</li> <li>• Driver door opened.</li> <li>• Brake pedal pressed.</li> </ul>	▶	<p>The driver releases the brake pedal to get out of the vehicle.</p>	▶	<p>The system puts the transmission in P (Park) position.</p>
<p><b>Warnings</b></p> <ul style="list-style-type: none"> <li>• Slow continuous chime.</li> <li>• The condition of the vehicle not in P (Park) position will be signaled by a message on the display.</li> </ul>		<p><b>Warnings</b></p> <ul style="list-style-type: none"> <li>• Fast chime.</li> <li>• A message which invites to engage the parking brake to prevent vehicle movement will be displayed on the display.</li> </ul>		



## Using the Brakes



### CAUTION!

To obtain a good performance by brake pads and discs, avoid sudden braking during the first 190 mi (300 km).

The pad wear limit is indicated by the illumination of the warning light **BRAKE** on vehicles of United States market or of the specific warning light  on vehicles of Canadian market and by a message on the instrument cluster.

In this event, please contact an **Authorized Maserati Dealer**.



United States market



Canadian market



### WARNING!

**Riding the brakes can lead to brake failure and possibly an accident. Driving with your foot resting or riding on the brake pedal can result in abnormally high brake temperatures, excessive lining wear, and possible brake damage. In an emergency full braking capacity may be impaired.**

### Brake Pads and Brake Discs

Wear on the brake pads and brake discs depends to a great extent on the driving style and the conditions of use and therefore cannot be expressed in actual miles driven on the road.

The brake system is designed for optimal braking effect at all speeds and temperatures.

Certain speeds, braking forces and ambient conditions (e.g. temperature,

humidity and long outdoor stopping periods) can therefore cause the brakes to "squeal". This is normal and will cease after a few brakings.

### New Brake Pads and/or Brake Discs

New brake pads have to be "bed in", and therefore only attain optimal friction to the brake disc when the vehicle has covered several hundreds of miles.

During this break-in period, the slightly reduced braking ability must be compensated for by pressing the brake pedal harder. This applies whenever the brake pads and/or brake discs are replaced.

### Brake Overheating

Driving on mountain roads with steep slopes or a sports use of the vehicle could overheat the brake system components. In these conditions, the parking brake must not be used since the push of the power actuator might not be sufficient to ensure vehicle braking, especially on a slope.

Drive normally without braking to allow the brakes to cool down a few minutes before stopping. The automatic or manual activation of the parking brake will ensure vehicle braking.

Brake overheating could also cause "squeals" and "vibrations".



### Use of the Engine

#### Breaking-In

Today's most modern production methods are designed to provide extremely precise construction and assembly of components. However, moving parts do undergo a settling process, basically in the first hours of vehicle operation.

Do not drive keeping at a constant high speed rate for a prolonged time. While cruising, brief full-throttle acceleration within the limits of local traffic laws contributes to a good break-in. Wide-open throttle acceleration in low gear can be detrimental and should be avoided.

The engine oil installed in the engine at the factory is a high-quality energy conserving type lubricant. Oil changes should be consistent with anticipated climate conditions under which vehicle operations will occur. For the recommended viscosity and quality grades, see "Refilling Table" in section "Maintenance and Care".

A new engine may consume some oil during its first few thousand miles/kilometers of operation. This should be considered as a normal part of the break-in and not interpreted as an indication of malfunction.

#### Specific Requirements

Avoid exceeding 5000 rpm for the first 620 mi trip (1000 km).

After starting the vehicle, do not exceed 4000 rpm until the engine has warmed up sufficiently (coolant temperature: 149-158°F /65-70°).

#### Trailer Towing

During the first 620 mi (1000 km) of a new vehicle it is advisable not to tow a trailer. This allows to limit the load on the engine and on the other parts of the vehicle.

#### While Driving

Never travel with the tachometer indicator approaching the peak rpm, not even downhill. When the tachometer indicator is approaching the peak rpm (red colored zone), take precautions to avoid exceeding that limit.



Ensure proper operation of different devices checking their respective control telltales.



#### CAUTION!

Under normal conditions, all red warning lights on the instrument cluster display should be off. When they come on, they indicate a malfunction. Refer to "Warning and Indicator Lights" in section "Dashboard Instruments and Controls".



#### WARNING!

Continuing to drive when a red warning light is on could cause serious damage to the vehicle and affect its performance.

#### On-Board Diagnostics (OBD)

Your vehicle is equipped with a sophisticated on-board diagnostic system. This system monitors the performance of the emissions, engine, and automatic transmission control systems. When these systems are operating properly, your vehicle will provide excellent performance and fuel economy, as well as engine emissions well within current local regulations of various countries.





If any of these systems require service, the system will turn on the  Malfunction Indicator Light (MIL).

It will also store diagnostic codes and other information, which your **Authorized Maserati Dealer** will use to service your vehicle. Although the vehicle will still be driveable and not need towing, contact an **Authorized Maserati Dealer** for service as soon as possible.



### CAUTION!

- Prolonged driving with the  Malfunction Indicator Light (MIL) on could cause further damage to the emissions control system. It could also affect fuel economy and drivability. The vehicle must be serviced before any emissions tests can be performed.
- If the  Malfunction Indicator Light (MIL) is flashing while the engine is

running, severe catalytic converter damage and power loss could occur.

Immediate service is required at an **Authorized Maserati Dealer**.

- After the problem has been solved, the **Authorized Maserati Dealer** personnel will perform specific tests for a complete check of the system and, if necessary, road tests.



### Spare Parts

Use of genuine Maserati parts for normal or scheduled maintenance and repairs is highly recommended to ensure excellent performance.

Damage or failures caused by non-genuine spare parts used for maintenance and repairs will not be covered by the manufacturer's warranty.

## Refueling

### Fuel Filler Neck Access

To access the fuel filler neck, the filler door must be unlocked. From outside the vehicle, this can only be done by pressing the unlock  or the lock  button on the key fob, in the same way as if opening or closing the doors. If any of the door lock controls is pressed from inside the vehicle, the filler door will still remain open to allow refueling.

- Press the indicated area on the filler door, which is located on the rear left side of the vehicle: the filler door will open completely.



### NOTE:

In order to guarantee an easy fuel filler door opening, it has to be pressed in the lower right side; if pressed in any other position, it could remain locked.



### Refill the Tank

The fuel filler neck is provided with external cap.

- Rotate counterclockwise and remove the fuel filler cap. The cap hermetic seal may result in a slight pressure increase inside the tank. Any hissing noise while the cap is being opened is therefore completely normal. The cap is linked to the filler neck with a strap, to prevent it from being lost while refueling.



- When refueling, place the cap in the proper seat on the filler door hinge.

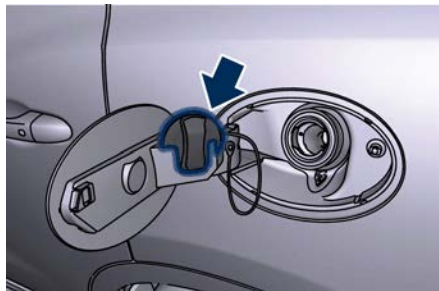

- Insert the fuel nozzle fully into the filler.



- WARNING!**
- To avoid the risk of fire, do not approach the filler with open flames or cigarettes!
  - To avoid the risk of inhaling noxious fumes, do not breathe close to the fuel filler door, when opened.
  - Never have any smoking materials lit in or near the vehicle when the fuel filler door is open or the tank is being filled.
  - Never add fuel when the engine is running. This violates most fire-prevention regulations and may cause the Malfunction Indicator Light (MIL)  to turn on (see “Warning and Indicator Lights” in section “Dashboard Instruments and Controls”).
  - Fill the vehicle with fuel. Fuel tank capacity is indicated in the “Refillings

Table” in section “Maintenance and Care”. When the fuel nozzle “clicks” or shuts off, the fuel tank is basically full: it is possible to further ensure refueling by enabling the fuel nozzle additional fuel supply until two clicks. After the two additional clicks, the amount of fuel allowed by the system is very low, we recommend therefore not to persist further.

- Wait approximately 10 seconds before removing the fuel nozzle in order to ensure completed supply of residual fuel and restrict the risk of fouling the fuel filler door area.
- Remove the fuel nozzle.
- Insert the cap on the fuel filler neck.
- Tighten the cap, turning it clockwise until it stops.
- Close the fuel filler door.



**CAUTION!**  
To avoid fuel spillage and overfilling, do not “top off” the fuel tank after filling.

### Fuel Filler Cap Open Warning Light



After refueling the car performs a check of the fuel filler cap and the amber warning light on the TFT display comes on if it is not correctly closed, after approximately 10 minutes also depending on driving conditions.



If the problem is in the fuel system, the Malfunction Indicator Light  also comes on.

If the fuel filler cap is locked and the issue remains in the system, at the next engine start only the Malfunction Indicator Light  comes on. In this case, contact an **Authorized Maserati Dealer**.

### Emergency Fuel Filler Door Release

If you are unable to unlock the fuel filler door using the key fob, use the fuel filler door emergency release located in the trunk.

- Open the power liftgate (see “Power Liftgate Operation” in section “Before Starting”).
- Lift the access cover on the left side of the trunk.

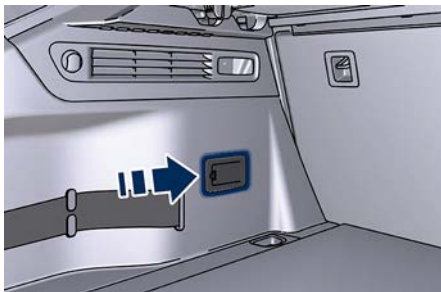

- Pull the release cable moderately to avoid its possible break. It's not

possible to feel or hear the unlocking of the fuel filler door actuator.

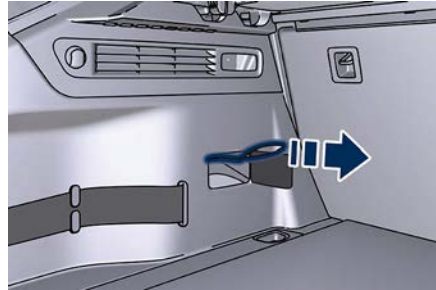

- Then open normally the fuel filler door.

## Driving Conditions

### Before the Trip

Check the following at regular intervals and always before long trips:

- tire pressure and condition;
- levels of fluids and lubricants;
- conditions of the windshield wiper blades;
- clean the glass on the external lights and all other glass surfaces;
- proper operation of the indicator lights and of the external lights.



### CAUTION!

It is recommended to perform these checks at least every 600 mi (1000 km) and always following the maintenance schedule reported in section “Maintenance and Care”.

Before you drive:

- adjust seat position, steering wheel, adjustable pedals (if equipped with) and rearview mirrors in order to have the best driving position;
- ensure that nothing (mat covers, etc.) is obstructing the pedals movement;
- carefully arrange and secure any objects in the trunk, to prevent them from moving forward in case of sudden stops;



## Starting and Driving

- avoid heavy meals before a trip. A light snack helps keep your reflexes sharp. In particular, avoid drinking alcohol.



### **WARNING!**

**Passengers must only travel seated in the vehicle seats, with the seat belts fastened. Always check that the driver and all passengers have the seat belts correctly fastened.**

### **Safe Driving**

Although the vehicle is equipped with active and passive safety devices, the driver's conduct is always a decisive factor for road safety.

Some simple rules for traveling safely in different conditions are listed below. Some of them will probably already sound familiar but, in any case, it would be useful to read them carefully.

#### **Driving at Night**

The main guidelines to follow when driving at night are set out below.

- Drive carefully. Night conditions demand more focus and attention.
- Reduce your speed, especially on roads with no streetlights.
- Stop at early signs of drowsiness. Continuing to drive would be a risk for yourself and for others. Have a rest before continuing your trip.

- Keep the vehicle at a greater distance from vehicles in front of you than you would during the day: it is difficult to assess the speed of other vehicles when you only see the lights.
- Use the high beams only outside of densely-populated areas and when you are sure that they will not disturb other drivers.
- When another vehicle is approaching, switch from high beams (if on) to low beams.
- Keep lights and headlights clean.
- Outside of densely-populated areas, beware of animals crossing the road.

#### **Driving in the Rain**

Rain and wet roads are dangerous. On a wet road all maneuvers are more difficult since wheel grip on the road is significantly reduced. This means that braking distances increase considerably and road grip decreases.

- Reduce your speed and keep a greater safety distance from the vehicles in front of you. High speed may result in a loss of vehicle control.
- When driving on wet or slushy roads, it is possible for a wedge of water to build up between the tire and road surface. This is known as aquaplaning and may cause partial or complete loss of vehicle control and stopping ability.

To reduce this possibility: slow down if the road has standing water or puddles.

- Heavy rain substantially reduces visibility. In these circumstances, even during the day, turn on the low beams, to be more visible to other drivers.
- Set the air conditioning and heating system controls on the defogging function, in order to avoid any visibility problem.
- Periodically check the conditions of the windshield wiper blades.
- In low grip conditions use "I.C.E." driving mode (see chapters "Drive Mode" and "Off-road Drive" in this section).
- Avoid driving with ESC OFF as this could possibly cause a loss of control of the vehicle.

#### **Driving in Fog**

If the fog is dense, avoid traveling if possible.

When driving in mist, blanket fog or when there is the possibility of banks of fog, please consider some advice listed below.

- Keep a moderate speed.
- Even in daytime, turn on the low beams and front and rear fog lights. Do not use the high beams.
- Remember that fog creates dampness on the asphalt and thus any type of



- maneuver is more difficult and braking distances are extended.
- Keep a safe distance from the vehicle in front of you.
  - Avoid sudden changes in speed as much as possible.
  - Whenever possible, avoid overtaking.
  - If you are forced to stop the vehicle (breakdowns, impossibility of proceeding due to poor visibility, etc.), first of all, try to stop off of the travel lane. Then turn on the hazard warning flashers and, if possible, the low beams.



### **WARNING!**

**Be aware that rear fog lights can bother the drivers following your vehicle: when visibility is back to normal, turn off these lights.**

### **Driving in the Mountains**

Mountain roads usually have many narrow turns and curves, tunnels and steep uphill or downhill slopes: please consider some advices listed below.

- Drive at a moderate speed, avoid “cutting” corners.
- When driving inside a tunnel in daylight turn on the low beams in advance; avoid high beams and be aware of the rapid brightness change. Avoid abrupt maneuvers that could be dangerous for the following vehicle.

- Never coast downhill with the engine off or in neutral.
- Remember that passing other vehicles when driving uphill is slower and thus requires more free distance on the road. If you are being overtaken on a hill, slow down and allow the other vehicle to pass.

### **Driving on Snow or Ice**

Please consider some general advice for driving in these conditions, listed below.

- Maintain a very moderate speed.
- Fit snow chains or specific tires if the road is covered with snow,  : chapter “Tires Information” in section “Safety”.
- We recommend you to activate the “I.C.E.” mode (see chapters “Drive Mode” and “Off-Road Drive” in this section).
- During the winter season, even apparently dry roads can have icy sections. Be careful when crossing bridges, viaducts and roads that have little exposure to the sun and are bordered by trees and rocks. They may be icy.
- Keep an ample safe distance from the vehicles in front of you.



### **WARNING!**

**Rapid acceleration on slippery surfaces is dangerous. Accelerate slowly and carefully whenever there is likely to be poor traction (ice, snow, wet mud, loose sand, etc.).**



### Trailer Towing

In this section you will find safety tips and information on limits to the type of towing you can reasonably do with your vehicle.

#### NOTE:

- On the TROFEO version you can not install the trailer tongue.
- Using original Maserati equipment offers an advantage, compared to aftermarket one, in terms of driving safety and utilizing the vehicle potential under all conditions, especially considering that ESC and AWD systems feature specific settings for trailer towing. Further to this, if vehicle use conditions so allow, the original trailer tongue allows use of the driver assist systems present on-board.
- To maintain the new vehicle limited warranty coverage, follow the requirements and recommendations in this chapter.

### Trailer Tongue Weight

Maximum load of tow vehicle is reduced by the trailer tongue weight and the load on the same due to the trailer. Trailer tongue weight increases vehicle weight. Do not exceed the maximum GVWR of the tow vehicle, the one for each axle (GAWR) and the mass that the vehicle is rated to tow (GTW) specified on the

nameplate located on the rear of the drivers door opening.



#### WARNING!

**It is important that you do not exceed the maximum allowed overall GVWR and GTW. A dangerous driving condition can result if either rating is exceeded. If you use aftermarket Kit for towing, the maximum trailer load must not exceed 6000 lb (2700 kg).**

### Arranging Load on Trailer

Arrange load at the bottom and as close as possible to trailer wheel axle.

In this way the trailer center of gravity will be lower, thereby increasing the driving safety of the vehicle-trailer assembly.

Always load a trailer with 60% of the weight in the front of the trailer.

Loads bearing more on wheel axle, or heavier in the rear of the trailer, can cause the trailer to sway severely side-to-side which could cause loss of control of vehicle and trailer.



#### WARNING!

**Failure to load trailers heavier in front is the cause of many trailer accidents. Never exceed the maximum tongue weight stamped on your trailer hitch.**

### Tire Pressure Adjustment

Proper tire inflation pressures of your vehicle and trailer are essential to the safe and satisfactory operation of your vehicle while driving and in maneuvers.

Check for signs of tire wear or visible tire damage on trailer and vehicle before towing a trailer.

For more information on vehicle tires,  : chapter "Tires Information" in section "Safety".

When a trailer must be towed, inflate vehicle tires to full load recommended pressure (FLC),  : chapter "Tire Inflation Pressure" in section "Technical Specifications".

For pressure of trailer tires, follow the instructions given by the trailer manufacturer.

After adjusting vehicle tire pressure and connecting and disconnecting the trailer, initialize the Tire Pressure Monitoring System (TPMS),  : chapter "Tire Pressure Monitoring System (TPMS)" in section "Safety".



## Field of Vision of External Rearview Mirrors

Law provisions require the field of vision of external rearview mirrors to include the rear trailer corners.

If vehicle external rearview mirrors cannot cover the required field of vision, it is possible to install additional rearview mirrors sticking further out at the sides.

The **Authorized Maserati Dealer** can provide you with information about towing a trailer and about the approved components available in the "Genuine Accessories" range.

## Trailer Lights

Law provisions require trailers to be equipped with an electrical lighting system that must include the following lights:

- Turn signals;
- Position lights;
- Stop lights;
- Rear fog lights;
- Reverse lights;
- License plate lights;
- Side marker lights (for trailer width over 6.8 ft/2.1 m).

The power input of the trailer lights must not exceed the values in the following list.

- Position lights, side marker lights and license plate lights: 6 x 5W per side.

- Rear fog lights: 2 x 21W
- Turn signals: 2 x 21W
- Stop lights: 4 x 21W
- Reverse lights: 2 x 21W

Minimum detectable current of Trailer Tow Module (TTM): 100mA.

## Trailer Wiring Harness

Vehicle trailer tongue includes a 4-pin sealed connector powered at 12VDC for connection of the corresponding trailer wiring connector.

In addition to the electrical branches, the vehicle electrical system can only be connected to the supply cable for an electric brake and to the cable for an internal light for the trailer, not exceeding 15W.



### CAUTION!

Do not cut or splice wiring into the vehicle wiring harness. Do not change cable connections on connectors. The table below indicates the function and section of wire corresponding to every connector pin as shown in the figure.

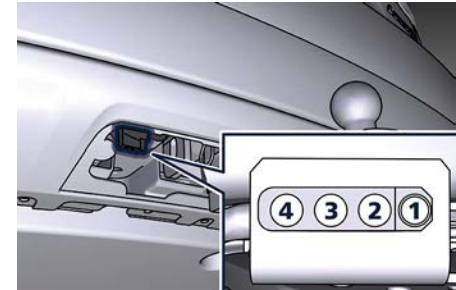

Pin N.	Function	Wire section (mm <sup>2</sup> )
1	Lights ground (Lights GND)	1.5
2	Position light, side marker lights and license plate light	1
3	Left turn signal and stop light	1
4	Right turn signal and stop light	1

If the hooking and/or the electrical connection between vehicle and trailer is faulty, the warning light and the relevant message are displayed on instrument cluster display (see example in the figure).



## Starting and Driving



In these cases please contact an **Authorized Maserati Dealer** and avoid using the vehicle with a trailer.

### Removing the Access Cover

Before fitting the trailer tongue, the access cover on the bottom part of the rear bumper must be removed.

The cover is engaged in the bumper.

- Release cover inner side from bumper, using the tip of a tool or screwdriver at the points indicated by the arrows.

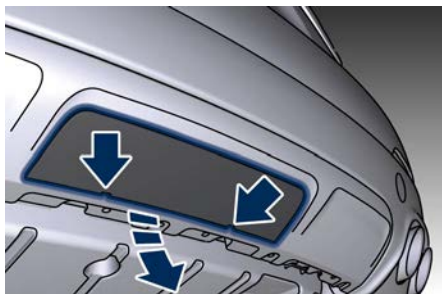

- Slide cover downward to disengage the two projecting elements indicated in the figure from bumper.

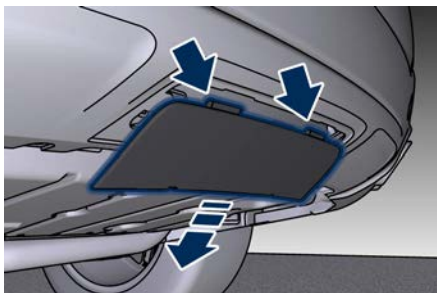

- Store cover in the luggage compartment.

### Install the Trailer Tongue

- Pull out the trailer tongue which is housed in a bag positioned on the right side of the trunk.
- Push the trailer tongue in the seat on the cross member of the car up to match the hole **A** on the trailer tongue with the one on the cross member support.

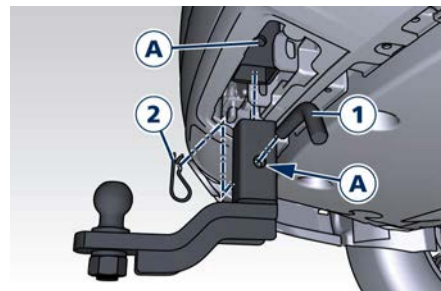

- Insert the pin **1** into the hole **A** and push it until it stops.
- Install the split pin **2** at the opposite end of the pin **1**.

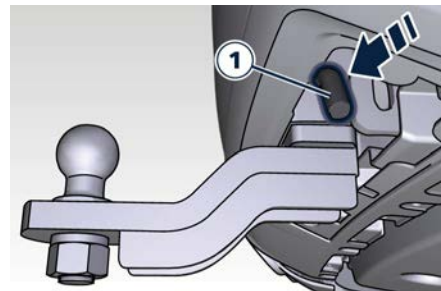



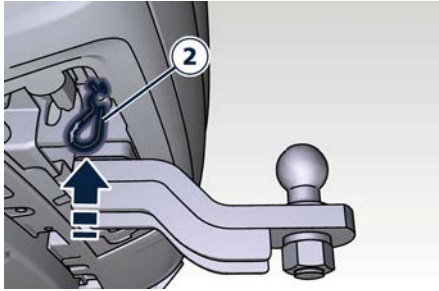

### Connect the Electrical System of the Trailer

- For connection, remove the protective cover from the car connector which is found on the left-hand side of trailer tongue seat.



- Engage the trailer male connector into the car female connector.
- Push trailer connector fully home and engage the safety lock, if any.

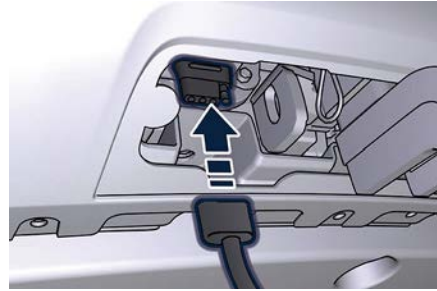

### Remove the Trailer Tongue

When trailer tongue is no longer necessary, disconnect electrical connections and remove it from its seat as described below.

- Remove the split pin **2**.
- Grip the trailer tongue firmly and pull out the pin **1**.
- Remove the trailer tongue from its seat.
- Clean the trailer tongue and remove all residues, especially on the ends.
- Install the ball protection.
- Insert the pin **1** in the trailer tongue hole and install the split pin **2**.
- Set trailer tongue in its seat inside the trunk.
- Refit the protective cover on the car connector.
- Refit the access cover making sure to engage the two projecting elements indicated by the arrow fully home into the bumper.

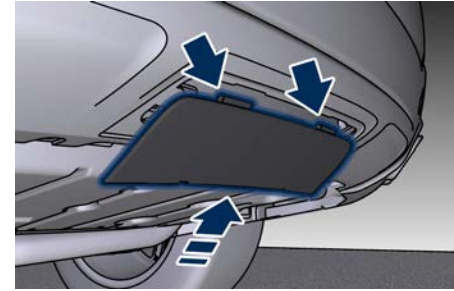

- Push cover lower end toward bumper until the two retainers click in place.

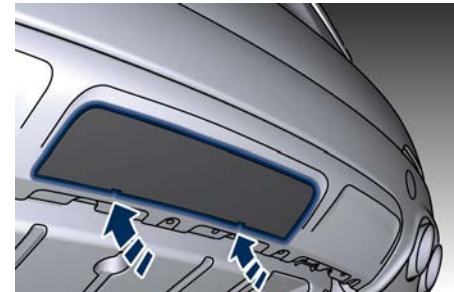

### Towing Tips

- Before setting out on a trip, check operation of trailer rear lights and stop lights to ensure you do not jeopardize other road users' safety.
- Make certain that the load is secured in the trailer and will not shift during travel. When trailering cargo that is not fully secured, dynamic load shifts can



## Starting and Driving

occur that may be difficult for the driver to control.

- When hauling cargo or towing a trailer, do not overload your vehicle or trailer. Overloading can cause a loss of control, damage to brakes, driveline, steering, suspension or tires.
- Safety metal wire must always be used between your vehicle and trailer. Always connect the wire to the hook retainers of the trailer and vehicle hitch. Cross the wire under the trailer tongue and allow enough slack for turning corners.
- Comply with local applicable speed limits.
- Towing any trailer will increase your stopping distance. When towing, you should allow for additional space between your vehicle and the vehicle in front of you. Failure to do so could result in an accident.
- For towing use "Normal" ride height.
- Do not exceed maximum specified pressure for vehicle and trailer tires.
- Vehicles with trailers should not be parked on a steep grade. When parking, put the tow vehicle transmission in P (Park) and apply the parking brake on the tow vehicle. Always, block or "chock" the trailer wheels.
- Do not use electronic Cruise Control (CC and/or ACC) when driving on slopes or when carrying heavy loads.
- The D (Drive) gear must be selected when towing. The transmission controls include a drive strategy to avoid frequent shifting when towing. However, if frequent shifting does occur while in D (Drive), if provided, you can use the paddle shift switches to manually select a lower gear.
- Using a lower gear while operating the vehicle under heavy loading conditions, will improve performance and extend transmission life by reducing excessive shifting and heat buildup. This action will also provide better engine braking.



## 6 - Driver Assistance Systems

General Notes .....	210
Park Assist .....	210
Rear Parking Camera .....	216
Surround View Camera System (OPT) .....	217
Hill Descent Control (HDC) .....	220
Cruise Control - CC .....	222
Adaptive Cruise Control - ACC (OPT, with FCW only) .....	225
Forward Collision Warning - FCW .....	235
Lane Keeping Assist - LKA (OPT, with ACC only) .....	239
Blind Spot Assist - BSA (BSA) .....	242
Active Blind Spot Assist - ABSA (OPT, with ACC only) .....	247
Active Driving Assist - ADA (OPT, with ACC only) .....	250
Traffic Sign Assist - TSA (OPT) .....	255



### General Notes

This section lists all the parking assistance systems and all the Advanced Driver Assistance Systems, synthetically called ADAS, available for this car.

Some ADAS are standard, others are optional and may vary depending on the equipment of the car and the target market.

Some of these systems activate or deactivate automatically, others can be activated or deactivated and set using the buttons on the steering wheel L/H side or via the "Controls" and "Settings" menu on the "Vehicle" page or the "Apps" page of MIA display. For further information see "Functions of Controls Menu on MIA" and "Functions of Settings Menu on MIA" in section "Dashboard Instruments and Controls".

### Park Assist

The Park Assist (also called "ParkSense") system provides visual and audible indications of the distance between the rear and/or front bumper and a detected obstacle when backing up or moving forward, e.g. during a parking maneuver. Besides the use of the sensors available on the bumpers and of the rear parking camera, the vehicle may be equipped with surround view cameras (OPI) to assist the driver during maneuvers on dead-ends/roads and on intersections. For more details on this option, see chapter "Surround View Camera System" in this section. Refer to "Park Assist System Usage Precautions" in this chapter for limitations of this system and recommendations. Park Assist system will retain the last system state (enabled or disabled) from the last ignition cycle when the ignition device is changed to the **RUN** position.

Park Assist system can be active only when the shift lever is in R (Reverse) or D (Drive).

If Park Assist is enabled at one of these shift lever positions, the system will remain active until the vehicle speed is increased to approximately 7.5 MPH (12 km/h) or above. The system will become active again if the vehicle

speed is decreased to speeds less than approximately 6.2 MPH (10 km/h).

### Park Assist Sensors

The four Park Assist sensors, located in the rear bumper, monitor the area behind the vehicle that is within the sensors' field of view. The sensors can detect obstacles up to approximately 78 in (200 cm) from the rear bumper in the horizontal direction, depending on the location, type and orientation of the obstacle.

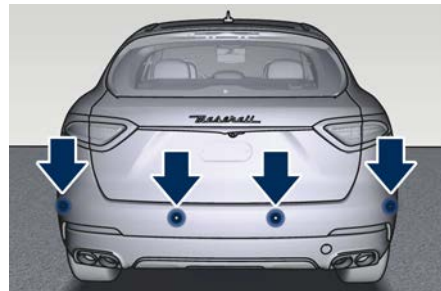

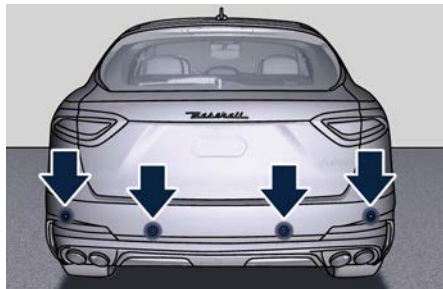
**MODENA S and TROFEO Versions**

The six Park Assist sensors, located in the front bumper, monitor the area in front of the vehicle that is within the sensors' field of view.

The sensors can detect obstacles up to a distance of approximately 50 in (120 cm) from the front bumper in the horizontal direction, depending on the location, type and orientation of the obstacle.

**MODENA S and TROFEO Versions**

### Park Assist Warning Messages Display

The Park Assist Warning screen will only be displayed if “Sound + Display” is selected from the MIA system.

Refer to “Functions of Settings Menu on MIA” in section “Dashboard Instruments and Controls” for further information.

The Park Assist warning screen is located on the instrument cluster display.

It provides visual warnings to indicate the distance between the rear bumper and/or front bumper and the detected obstacle.

The warning display will turn on indicating the system status (ready or off) when the vehicle is in R (Reverse) or in D (Drive) and an obstacle has been detected.

The detection area in front of the vehicle is divided into two parts with four arcs while the two detection areas behind the car into five arcs.

The system will indicate a detected obstacle by displaying arcs with fixed or flashing light and a characteristic sound according to the obstacle distance. The color indicates the distance and the arc indicates the position of the detected obstacle. The green color of the outer arc indicates the maximum distance, the amber color of the middle arcs indicates the medium distance, while the red color of the nearest arc indicates the minimum distance.





## Driver Assistance Systems



As the vehicle moves closer to the object, the instrument cluster will display the arc moving towards the vehicle and the sound tone will change from single to slow, to fast and to continuous.

The vehicle is close to the obstacle when the instrument cluster displays one flashing red arc only, combined with a continuous sound.



The following charts show the warning alert visualization when the system is detecting an obstacle.

<b>Front Sensors - Warning Alerts</b>					
Front distance	More than 50 in (120 cm)	50-40 in (120-101 cm)	40-24 in (100-61 cm)	23.6-12.2 in (60-31 cm)	Less than 12 in (30 cm)
Audible Alert	None	None	Slow (5 Hz)	Fast (8 Hz)	Continuous
Arc in left and right areas	None	4th	3rd	2nd	1st (inner most)
Light type	None	Solid	Solid	Flash	Flash
Arc color	—	Green	Amber	Amber	Red
Radio sound	Active	Active	Mute	Mute	Mute

<b>Rear Sensors - Warning Alerts</b>						
Rear distance	More than 78 in (200 cm)	78-59.4 in (200-151 cm)	60-40 in (150-101 cm)	40-24 in (100-61 cm)	23.6-12.2 in (60-31 cm)	Less than 12 in (30 cm)
Audible Alert	None	None	Slow (2 Hz)	Slow (5 Hz)	Fast (8 Hz)	Continuous
Arc in left and right areas	None	4th	4th	3rd	2nd	1st (inner most)
Light type	None	Solid	Solid	Solid	Flash	Flash
Arc color	—	Green	Amber	Amber	Amber	Red
Radio sound	Active	Active	Mute	Mute	Mute	Mute



### NOTE:

- Maserati reserves the right to change specifications without prior notification.
- Park Assist will turn off the front park assist audible alert (chime) after approximately 4 seconds when an obstacle has been detected, the vehicle is stationary, and brake pedal is applied.

### Enabling and Disabling Park Assist

By accessing the submenu “Safety & Driving Assistant” from MIA system, the “Park Assist” can be disabled (option “Off”). The available options regarding the warning alerts are: “Sound” or “Sound + Display”. Refer to “Functions of Settings Menu on MIA” in section “Dashboard Instruments and Controls” for further information. The front sensors can be enabled or disabled at any time by pressing the button on the front dome console.



After pressing the button the instrument cluster will display the state of front parking sensors for approximately five seconds. The button LED will be on when the front sensors are disabled. The button LED will be off when the front sensors are enabled. If the button is pressed and the system requires service, the LED will blink momentarily, and then the LED will be on.

When the shift lever is moved to R (Reverse) or to D (Drive) at a speed of 7 MPH (11 km/h) or below and the system is disabled, the instrument cluster will display the “PARK ASSIST Off” message for 5 seconds until the shift lever remains in R (Reverse) or when the shift lever is moved in D (Drive).

### Service the Park Assist System

In case of malfunction of the Park Assist system, the instrument cluster will actuate a single sound, once per ignition

cycle. The instrument cluster will display a message when any of the rear or front sensor(s) are blocked by snow, mud, or ice and the vehicle is shifted into R (Reverse) or D (Drive).

The instrument cluster will display a message when any of the rear or front sensors are damaged and require service.

When the shift lever is moved to R (Reverse) or D (Drive) and the system has detected a faulted condition, the instrument cluster will display the corresponding message for the time lapse the vehicle is in R (Reverse) or D (Drive) at speeds less than 7 MPH (11 km/h). Under this condition Park Assist will not operate. See “Warning and Indicator Lights” in section “Dashboard Instruments and Controls” for further information.

If the instrument cluster displays a message prompting you to clean the sensors, make sure the outer surface and the underside of the rear bumper and/or front bumper is clean and clear of snow, ice, mud, dirt or other obstruction and then cycle the ignition device. If the message continues to appear contact the **Authorized Maserati Dealer**.





If a failure message is displayed on the instrument cluster, contact the **Authorized Maserati Dealer**.

### Cleaning the Park Assist Sensors

When cleaning the sensors, take special care not to scratch or damage them; therefore, do not use dry, rough or hard cloths.

The sensors must be washed with clean water, possibly adding car shampoo. Should you need to repaint the bumper or in case of paint touch-ups in the sensor area, please contact exclusively the **Authorized Maserati Dealer**. Incorrect paint application could affect the parking sensors operation.

### Park Assist System Usage Precautions

#### NOTE:

- Jackhammers, large trucks, and other vibrations could affect the performance of Park Assist.
- Objects such as bicycle carriers, trailer hitches, etc., must not be placed within 12 in (30 cm) from the rear bumper while driving the vehicle. Failure to do so can result in the system misinterpreting a close object as a sensor problem, causing the service Park Assist message to be displayed in the instrument cluster.

#### **WARNING!**

- **Park Assist is only a parking aid and it is unable to recognize every obstacle, including small obstacles. Parking curbs might only be temporarily detected or not detected at all. Obstacles located above or below the sensors will not be detected when they are in close proximity.**
- **The vehicle must be driven slowly when using Park Assist in order to be able to stop in time when an obstacle is detected. When backing up, it is recommended that the driver looks**

**over his/her shoulder when using Park Assist.**

#### **WARNING!**

**Drivers must be careful when backing up even when using the Park Assist system. Always check carefully behind your vehicle, look behind you, and be sure to check for pedestrians, animals, other vehicles, obstructions, and blind spots before backing up. You are responsible for safety and must continue to pay attention to your surroundings. Failure to do so can result in serious injury or death.**

### Park Assist Volume

The volume of the acoustic signal emitted by the front and rear parking sensors is set to the medium level. Three different levels of volume can be selected via the submenu "Safety & Driving Assistant" of the "Settings" page on MIA.

Low level is useful in certain conditions when the parking sensor acoustic signal keeps coming on although there is no actual collision hazard. This may typically occur when driving in a queue or when the vehicle is overtaken by motorcycles or other vehicles on one or both sides in a queue of traffic. When you set the volume, only the



parking sensor acoustic signal will be affected. The radio or any other devices connected to the vehicle sound system will not be affected.

Refer to chapter “Functions of Settings Menu on MIA” in section “Dashboard Instruments and Controls” for further information.

### Operation with a Trailer

The operation of the rear sensors is automatically deactivated when the trailer's electric plug is inserted in the vehicle's tow hook socket, while the front sensors stay active and can provide acoustic and visual warnings. The rear sensors are automatically reactivated when the trailer's cable plug is removed.

## Rear Parking Camera

Your vehicle is equipped with a rear parking camera that allows you to see an image on the MIA screen of the rear surroundings of your vehicle whenever the shift lever is put into R (Reverse). When “Parkview Backup Camera Delay” mode is enabled, the rear view image shall be displayed for up to 10 seconds after shifting out of R (Reverse). When “Rearview Camera Delay” mode is enabled, the rear view image shall be displayed for up to 10 seconds after shifting out of R (Reverse).

To assist the driver during maneuvers on dead-ends/roads and on intersections, the vehicle may be equipped with an optional surround view camera system. In this case, the rear parking camera is integrated into the surround view camera system. In both configurations (rear parking camera only or surround view camera system), you can monitor the rear view. For more details on this option, see chapter “Surround View Camera System” in this section.

The image will be displayed along with a caution note to “Check Entire Surroundings” across the top of the screen. After five seconds this note will disappear.

The rear parking camera is located on the rear of the vehicle above the rear license plate.

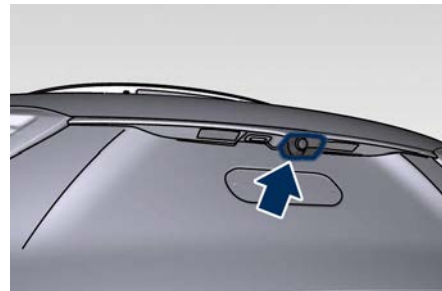

When the shift lever is shifted out of R (Reverse), the rear camera mode is exited and the navigation or audio screen appears again.

When displayed, dynamic grid lines (if the function is set to MIA through the “Settings” menu of the “Vehicle” page) will illustrate the width of the vehicle to assist with parking or aligning to a hitch/receiver. The dynamic grid lines will show separate zones in different color that will help indicate the distance to the rear of the vehicle.

The following table shows the approximate distances for each zone and color:



Zone	Distance to the rear of the vehicle
Red	11 - 12 in (28 - 30 cm)
Yellow	12 - 78 in (30 cm - 2 m)
Green	78 - 157 in (2 - 4 m) or greater

**WARNING!**

Drivers must be careful when reversing even when using the rear view camera. Always check carefully behind your vehicle, and be sure to check for pedestrians, animals, other vehicles, obstructions, or blind spots before reversing. You are responsible for the safety of your surroundings and must continue to be careful while reversing. Failure to do so can result in serious injury or death.

**CAUTION!**

- To avoid vehicle damage, the rear camera should only be used as a parking aid, as the rear camera is unable to view every obstacle or object in your drive path.
- To avoid vehicle damage, the vehicle must be driven slowly when using the rear camera to be able to stop in time when an obstacle is seen. It is recommended that the driver looks frequently over his/her shoulder when using the rear camera.

**NOTE:**

If snow, ice, mud, or any other substance builds up on the camera lens, clean the lens, rinse with water, and dry with a soft cloth. Do not cover the lens.

## Surround View Camera System (QPT)

### System components

The system uses four cameras to monitor the area around the vehicle, placed on the front grid, under the side rearview mirrors and on the liftgate, between the number plate lights.

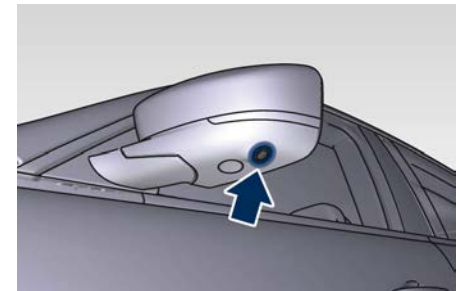
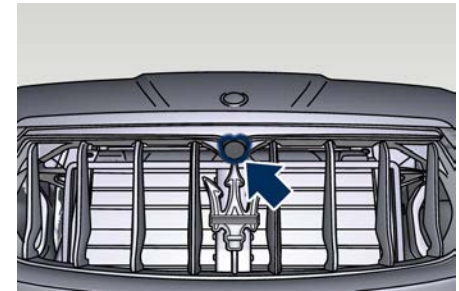



# Driver Assistance Systems

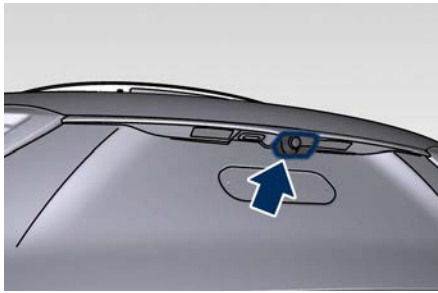





When the shift lever is shifted to R (Reverse) position, the top view and the rear view of the surrounding area will be automatically displayed on MIA display. Image will be displayed with active guidelines while in that gear as long as vehicle speed remains lower than 8 MPH (12 km/h).

When vehicle is shifted into a different gear, the image will remain displayed for 10 seconds, or vehicle is shifted in P (Park), or until vehicle speed exceeds 8 MPH (12 km/h), at which point it will immediately cancel and return to the last-viewed screen.

Instead, when the shift lever is shifted to P (Park), N (Neutral) or D (Drive) position, it is possible to activate/ deactivate the system by pressing "Surround View Camera" soft-key in "Controls" menu of the "Vehicle" page.



Once the "Surround View Camera" screen is displayed, it is possible to choose which images to display according to 4 possible settings.

-  Rear view and top view
-  Rear cross path view
-  Front cross path view
-  Front view and top view

In any shift lever condition, when "Surround View Camera" screen is displayed, a pop-up message will appear in the upper part for 5 seconds to advise the driver to check the surrounding area before any manoeuvre. With transmission in P (Park), N (Neutral) or D (Drive), the upper right corner of the screen will show the "X" key: touch it to

go back to the previous screen of MIA display, before entering in "Controls". The deactivation of the rear visualization via "X" soft-key is not possible when the transmission is in R (Reverse) position. Choose the most suitable setting for the situation and the maneuver you are performing or going to perform, by touching the relevant button present under the images: the edges of the pressed button will highlight. The button will highlight and the type of setting will appear on each image.

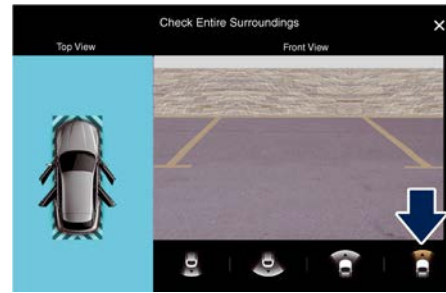

In the top view, the vehicle is represented as it is during the maneuver (see example in the figure), therefore any open doors will be visible in the image. To display also the dynamic lines of the trajectory you are setting, it is necessary to set this function by accessing the "Settings" menu on "Vehicle" page of MIA, at "Safety & Driving Assistant" item, by using the dynamic gridlines activation



menu. Once this menu is displayed, it is also possible to set the function that delays the exit from this screen in special situations when the transmission lever is in D (Drive), N (Neutral) and P (Park) position by using the surround view camera delay menu.

For further information, see “Functions of Settings Menu on MIA” in section “Dashboard Instruments and Controls”.

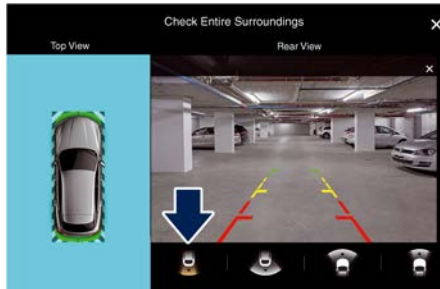

### WARNING!

Failure to follow the precautions below might result in serious injury or even death.

- Drivers must be careful during maneuvers also when using the camera system with surround view.
- Always check carefully the areas around your vehicle, before proceeding forward or backward.

- Be sure to always check for any pedestrians, animals, other vehicles, obstructions, or blind spots.
- The driver must use the utmost caution while using the system to avoid damage to property or personal injury.
- The camera system with surround view is designed for use during the day or under good lighting conditions. Do not use and rely on the system under poor lighting conditions.
- Distance lines and directional lines must be used only as a reference and only when vehicle is on a flat ground. The distance shown on MIA display must be interpreted as a reference and might be different from the distance actually present between the vehicle and any displayed objects.
- Any obstacles present above the cameras cannot be detected.



### CAUTION!

- To avoid vehicle damage, the camera system with surround view should only be used as a parking aid, as the cameras are unable to view every obstacle or object in your drive path.
- To avoid vehicle damage, the vehicle must be driven slowly when using the camera system with surround view,

to be able to stop in time when an obstacle is seen. It is recommended that the driver looks frequently over his/her shoulder when using this system.

### NOTE:

If snow, ice, mud, or any other substance builds up on the camera lens, clean the lens, rinse with water, and dry with a soft cloth. Do not cover the lens.



## Hill Descent Control (HDC)

HDC maintains vehicle speed while descending hills during various driving situations, by actively controlling the brakes.

HDC is part of the ESC system and has three possible states:

- Off: function is not enabled and will not activate.
- Enabled: function is enabled and ready but activation conditions are not met, or driver is actively overriding with brake or throttle application.
- Active: function is enabled and actively controlling vehicle speed.

### Displayed Information

Apart from the pop-up messages at the center of the TFT display, HDC status is represented by icons at the top left of the TFT display, in the dedicated area. See "TFT Display Areas" in section "Dashboard Instrument and Controls".

### Enabling and Activating the HDC

HDC is enabled by pressing the HDC switch on LH side of steering wheel.



Standard Configuration



Optional Configuration

### NOTE:

The figures only show the Standard Configuration.

The following conditions must also be met to enable HDC:

- Maximum activation speed: 18 MPH (30 km/h).
- Parking brake is released.
- Driver door is closed.

HDC enabling is indicated by the white light with below 3 dashes on TFT display coming steady on. The light remains white while the driver operates the pedal unit to change the speed, or when driving on a flat stretch of road between two descents, or when the descent is over.

Failed enabling is indicated by a message on display.

Once enabled, when driving the system automatically activates HDC.

When the vehicle is within a defined threshold of slope (12%), the light turns green and the current speed appears below it until the default speed value set to 5 MPH (8 km/h).

When the vehicle exceeds a defined threshold of slope (12%), the light turns green and the current speed appears below it until the default speed value set to 1.8-2.5 MPH (3-4 km/h).

Therefore, the vehicle speed is increased or decreased until it reaches the default value.



## Setting

The set speed for HDC is selectable by the driver, and can be adjusted by using the pedal unit or the multifunction control on steering wheel, which is the same used to set the Cruise Control (see “Cruise Control - CC” or “Adaptive Cruise Control - ACC” in this section).

- If the driver brakes, the speed goes below the default value: when s/he releases the brake pedal, the speed goes back to 3 MPH (4 km/h).
- If the driver accelerates without exceeding the maximum limit value of 18 MPH (30 km/h), when s/he releases the accelerator pedal HDC will set to the speed reached by vehicle in that moment. The set value appears under the green light on the TFT display.

Or:

- Push down (SET -) multifunction switch to decrease the speed up to 1.8 MPH (3

km/h) : pressing the brake pedal up to default speed of 5 MPH (8 km/h). The set value appears under the green light on the TFT display.



- Push up (RES +) multifunction switch to increase speed until the required value is displayed below the green light on TFT display.



## HDC Cancelled

If the driver press down (CANC) multifunction switch or presses the

brake pedal, the light turns white to indicate that HDC function is temporarily cancelled.



## Driver Override

If the driver pushes the accelerator and the vehicle speed exceeds the set speed, the green light will stay on and a pop-up message on display will warn driver.





- HDC will be deactivated but remain available when driver pushes the



## Driver Assistance Systems

accelerator steadily, without exceeding 18 MPH (30 km/h). A pop-up message and the  green light will stay on.

- When the vehicle speed exceeds 18 MPH (30 km/h) but is lower than 31 MPH (50 km/h) this function turns to stand-by mode, the  light with below the set speed turns white. In this case, to reset the function it is necessary to push up (RES +) multifunction switch.
- While, if speed exceeds 31 MPH (50 km/h), or when driving beyond 18 MPH (30 km/h) for over 70 seconds, system will immediately disable the function and the  light will turn off.

### Brake Overheating with HDC

The icon on instrument cluster display and the LED on steering wheel button will flash when HDC deactivates due to overheated brakes. The flashing will stop and HDC will activate again once the brakes have cooled sufficiently.



#### **WARNING!**

- **Hill Descent Control (HDC) is only intended to assist the driver in controlling vehicle speed when descending hills. The driver must remain attentive to the driving**

**conditions and is responsible for maintaining a safe vehicle speed.**

- **Prolonged use of the system might overheat the brakes. In case of brake overheating, the HDC, if active, will be progressively deactivated after warning the driver (switch-off of LED on button); function can be reactivated only after brake temperature will have decreased sufficiently. Distance that can be traveled depends on brake temperature, load and vehicle speed.**
- **The performance of a vehicle equipped with HDC must never be exploited in a reckless or dangerous manner that could jeopardize the driver's safety or the safety of others.**

## Cruise Control - CC

The electronic Cruise Control (CC) enables the driver to maintain the desired vehicle speed without pressing the accelerator pedal, reducing driving fatigue on highways, especially long trips, as the set speed is automatically maintained. A firm press on the accelerator pedal or the braking pedal will temporarily deactivate the cruise control function.

#### **NOTE:**

The device can only be switched on at speeds exceeding 18 MPH (30 km/h) and it switches off automatically when the brake pedal or the accelerator pedal is pressed.



#### **WARNING!**

**The Cruise Control function must only be activated when traffic and the route permit a constant speed to be maintained safely for a sufficiently long distance.**

### Controls

The Cruise Control controls are located on the left hand side of the steering wheel.

Control configuration depends on which driver assist systems are installed to the vehicle.





In the standard configuration there is a specific button to enable and disable the CC.

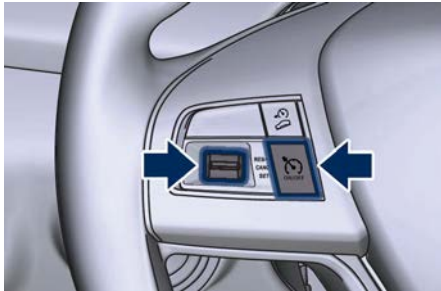

Standard Configuration

In the optional configuration, there is no specific button to enable and disable the CC, since driver uses the ACC control buttons.



Optional Configuration

Control buttons have the following functions:

### Standard Configuration



ON/OFF button to engage/disengage CC system.

### Optional Configuration



Press ACC time gap button and hold it down for 2 seconds to enable the CC system.



Press ACC button to disable the CC system.

### Shared by All Configurations

RES+  
CANC  
SET-

Multifunction switch:

- Press up (indication RES +): increase speed, set current speed or resume previously set speed when system is in “cancelled” status;
- Pushed (indication CANC): deletes the set speed;
- Press down (indication SET -): set speed/decrease speed.

### NOTE:

- The figures only show the Standard Configuration.
- In order to ensure proper operation, the CC system has been designed to shut down if multiple systems are operated at the same time (example: ACC and FCW). When conditions so allow,



the CC system can be reactivated by pushing the CC “ON/OFF” button or the ACC time gap button (in the Optional Configuration) and resetting the desired vehicle set speed.

### Displayed Information

Apart from the pop-up messages at the centre of the display, CC system status is represented by icons at the top left of the TFT display, in the dedicated area. See “TFT Display Areas” in section “Dashboard Instrument and Controls”.

Displayed information depends on system status: ready, set, temporarily cancelled or override.

### Activation

To turn the system on, push the  ON/OFF button or the ACC time gap button for 2 seconds (in the Optional Configuration). The  white light with below 3 dashes on the TFT display will illuminate.



To turn the system off, push the ON/OFF button a second time or the ACC button (in the Optional Configuration). The white light will turn off.

### NOTE:

The CC system must be turned off when not in use.



**WARNING!**  
Never leave the Cruise Control system on when not in use. You could accidentally set the system or cause it to go faster than you want. Always leave the system off when you are not using it.

### Speed Range of Use

Speed	MPH (km/h)
Minimum	20 (30)
Engaged/activated	20 (30)

Speed	MPH (km/h)
Maximum	130 (210)

### Setting Desired Speed

Turn on the CC function. When the vehicle has reached the desired speed (in the example: 60 MPH), push downward the multifunction switch (SET -) and release.

The green light below the desired speed will illuminate on the TFT display.



Release the accelerator and the vehicle will operate at the selected speed.

### NOTE:

The vehicle should be traveling at a steady speed and on level ground before pushing the switch downward.

Pressing the "ON/OFF" button or the ACC time gap button for 2 seconds (in the Optional Configuration) or moving

the ignition device in **OFF** position erases the set speed memory.

### Changing Speed Setting

Pushing the multifunction switch upward (RES +) or downward (SET -) once, or by holding it down, will enable to increase or decrease the set speed by one unit (1 MPH or 1 km/h).

If the car is equipped with ADAS Systems, the single press of the multifunction switch will increase or decrease the set speed of 1 MPH or 1 km/h; a continuous pressure of the same will increase or decrease the set speed of 5 MPH or 10 km/h.

Release the switch when the desired speed is reached, and the new set speed will be visualized below the green light. Each subsequent tap of the multifunction switch will increase or decrease the speed by 1 MPH or 1 km/h.

### Temporary Deactivation

A soft tap on the brake pedal, pressing the multifunction switch (CANC), or normal brake pressure while slowing the vehicle will temporarily deactivate the CC without erasing the set speed memory. The white light will appear on the display.



### Driver Override

If the driver presses the accelerator pedal while the CC is on, such as to overtake another vehicle, and exceeds the set speed limit, the system will temporarily deactivate the CC. During the event, the speed indication below the  green light will be blinking.



When the accelerator pedal is released, the vehicle will return to the set speed and the  green light with below the

set speed with steady light will be displayed.

### Resume Speed

To resume a previously set speed, push upward the multifunction switch (RES +) and release. The  green light with below the set speed will illuminate on the TFT display. Resume can be used at any speed above 18 MPH (30 km/h).

### Using Cruise Control on Hills

The transmission may be downshifted on hills to maintain the vehicle set speed. The CC system maintains set speed up and down hills. A slight speed change on moderate hills is normal. On steep slopes it is recommended to drive without CC.



**WARNING!**  
Cruise Control (CC) can be dangerous where the system cannot maintain a constant speed. Do not use CC in heavy traffic or on winding, icy, snow-covered or slippery roads.

## Adaptive Cruise Control - ACC (with FCW only)

The Adaptive Cruise Control (ACC) is part of ADAS equipments and can only be present on cars equipped with Front Collision Warning (FCW).

### NOTE:

LKA and ABSA and all the other ADAS systems are described in the relevant chapters of this section.

### Warning and Cautions

The ACC further increases the drive comfort ensured by the Cruise Control (CC). ACC can work in any type of road: however, its use it is not recommended in urban scenario.

Always consider that ACC is not a safety system and is not designed to prevent accidents.

The ACC allows driver to keep CC active in limited or moderate traffic conditions with no need to constantly restore the CC.

The ACC uses a radar sensor, located on the front grille behind the trident, and the forward-facing camera behind the internal rear-view mirror to detect the presence of a vehicle ahead at a close distance and moving in the same direction.



This vehicle, in this chapter, will be indicated as "target vehicle" or "vehicle ahead".

### NOTE:

- If the sensor detects no vehicle ahead, the ACC system will maintain set steady speed.
- At the time instant the ACC sensors detect a target vehicle, the system keeps the time gap selected by the driver. In the same way, the ACC adapts the vehicle speed according to both time gap and set speed selected by the driver.



### WARNING!

- The Adaptive Cruise Control (ACC) is designed to increase vehicle driving comfort. It must not be considered as a means of replacing the required attention of the driver. The driver is always required to drive carefully. The driver is always required to pay utmost attention to driving conditions (road, traffic, weather) and style (speed, distance from sensed vehicle ahead, brake use). Driver has the full responsibility of the vehicle therefore his attention is crucial to keeping vehicle control, in particular when approaching curves and situations with heavy traffic. Failure to follow these warnings can result in a collision and death or serious personal injury
- In some driving scenarios, the ACC could have detection problems. In such cases, the ACC could kick in late or unexpectedly. The driver must be careful since his/her intervention could be necessary.
- It is always the driver's responsibility to obey speed limits and to keep minimum legal distance to the preceding vehicle.

- ACC system can decelerate only with limited braking, it cannot execute emergency braking.

The ACC system:

- Does not activate/react in the presence of pedestrians, bicycles, incoming traffic from opposite direction and steady objects such as a vehicle stuck in a traffic jam.
- Is meant for the use on highways and well-built roads, not for city traffic or mountain roads.
- May not have enough time to react and/or decelerate sufficiently on vehicles when lane is changed too quickly or the relative speed is too high. In such cases the driver has to react appropriately and without any acoustic/visual warning.
- Cannot consider road, traffic and weather conditions and might prove limited when visibility is poor.
- Does not always fully recognize complex driving conditions and this could cause an incorrect assessment of the required safety distance.

It is recommended to disable the ACC system in the following instances:

- When driving in the fog, heavy rain, heavy snow, slush, heavy traffic and similar complex situations such as highway construction zones.

- When entering a junction lane or a slip road to leave the highway; when driving on narrow, icy, snowy, slippery roads, or on uphill and downhill roads.
- The system is designed and calibrated for car with no trailer.
- When circumstances do not allow to drive safely at constant speed.

### Displayed information

ACC condition, as well as the LKA and ADA status, is displayed on instrument cluster after selecting “Driver Assist” menu (see paragraph “TFT Display: Menu and Submenu Content” in section “Dashboard Instruments and Controls”). Displayed information depends on system status: ready, set, temporarily canceled or override.

Apart from the image at the center of the display, ADAS systems status is represented by icons at the top left and right of the TFT display. These icons remain displayed even when exiting the “Driver Assist” screen.

The vehicle(s) and horizontal bars represent the ACC status as ready (white) or with sensed vehicle ahead (green); the white, gray or yellow lines represent the LKA and ADA systems. The ACC screen can be displayed any time driver changes system status or settings. After 5 seconds of ACC

inactivity, the display goes back to last screen.

### System Controls and Activation Conditions

The buttons on the LH side of the steering wheel control the ACC operations and the other functions/driver assist systems installed to this vehicle.

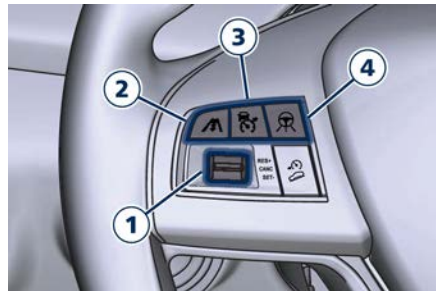

1. Multifunction control shared by all driver assist functions/systems:
  - Press up (indication “RES +”): increase speed, set current speed or resume previously set speed when system is in “canceled” status.
  - Pushed (indication “CANC”): cancel the function if it was in “set” status, going in a ready condition but remembering the previous set speed.
  - Press down (indication “SET -”): set speed/decrease speed.

2. Two functions button with ACC activated:
  - ACC time gap: pressed and released; set the distance to sensed vehicle ahead as horizontal bars (setting cycle starts to 3 bars).
  - CC On: pressed for 2 seconds activates the CC system.
  - Press it to switch from CC to ACC.
3. ACC ON/OFF button. If enabled, pressing this button will disable CC.
4. ADA ON/OFF button **with ACC set only**. See “Active Driving Assist - ADA” in this section for further details.

#### NOTE:

**Any change made to tire dimensions affects performance of Adaptive Cruise Control and Front Collision Warning, if equipped.**

The ACC is not activated in the following conditions:

- When braking.
- When parking brake is activated.
- When automatic transmission is in P (Park), R (Reverse) or N (Neutral).
- When vehicle speed is out of preset speed range.
- When brakes are overheated.
- When driver door is open.
- When the driver’s seat belt is unbuckled.



# Driver Assistance Systems

- When the road is particularly steep (both uphill and downhill) at low speed.
- When ride height is "Off Road 1" or "Off Road 2", or drive mode is "OFF ROAD".
- When drive mode (ESC OFF) is selected.
- When the door is opened at low speed.
- When there has been an ESC event in the last 5 seconds, or is still active.
- When there is an object too close in front of the vehicle.

It is possible that more than one system is active at the same time such as ACC and ABSA just to mention some. While activation of ACC and CC at the same time is impossible.

## Speed Range of Use

Speed	MPH (km/h)
Minimum	0
Engaged/activated	20 (30)
Maximum	130 (210)

## Activation/Deactivation

### NOTE:

Pictures show status of ACC and LKA systems.

Press and release ON/OFF button to activate the ACC and enter the "Driver Assist" page. The display will show in the top left corner the white symbol

with below 3 dashes will illuminate indicating that system is ready to be set. In the main area the symbology of the other ADAS system set will be displayed. When exiting the "Drive Assist" page, only the ADAS symbology will remain on the top left corner.



If a vehicle is detected as being too close, the display will show a message for 5 seconds and trigger a signal to warn the driver that current conditions do not allow enabling of the ACC. At any rate, system will remain in the ready status.



Push the ON/OFF button a second time and release to turn the system off. A pop-up message is displayed for 2 seconds to indicate that ACC was disabled.



**WARNING!**

Leaving the Adaptive Cruise Control (ACC) system on when not in use is dangerous. You could accidentally activate the system or cause it to go faster than you want. Always leave the system off when you are not using it.

**Setting the Speed**

When the vehicle reaches the required speed, press down and release the multifunction control (SET -). The display will show set speed corresponding to vehicle current one.

Speed value will be indicated below the  green symbol and above the distance bars, in the center of the display.



Remove foot from accelerator pedal and vehicle will continue at set speed.

**Driver Override**

If driver accelerates beyond the set speed or faster than the car would do with ACC engaged, the set speed below the  green light will blink and the time gap bars will vanish to indicate that in this condition the system cannot control the distance between vehicle and sensed vehicle ahead. Vehicle speed will be determined only by the accelerator pedal position.

**Changing Speed Setting**

Once speed is set, driver can increase or decrease it by respectively pressing multifunction control up (RES +) or down (SET -). Speed can be increased or decreased in two ways:

- Pressing control once, set speed will increase or decrease by one unit corresponding to 1 MPH (1 km/h).
- Hold the control to increase or decrease set speed by 5 MPH (10 km/h) at a time.

**NOTE:**

- When pressing the multifunction control up (RES +) or down (SET -), the new set speed will be the current speed of the vehicle.
- When using (SET -) control to decelerate, if the engine braking power does not slow down the vehicle sufficiently to reach the set speed, the

brake system will automatically slow down the vehicle.

- The ACC system applies the brake target to a full stop when following a target vehicle. If an ACC host vehicle follows a target vehicle to a standstill, after a two second delay, the system will not be able to resume driving the car autonomously. At this point it is necessary for the driver to manually reengage the system by either using the multifunction control (press SET- or RES+) or by pressing the accelerator pedal (see “ACC Operation Before and During Stop” in this chapter).
- The ACC system maintains set speed when driving up hill and down hill. However, a slight speed change on moderate hills is normal. In addition, downshifting may occur while climbing uphill or descending downhill. This is normal operation and necessary to maintain set speed. When driving uphill and downhill, the ACC system will cancel if the braking temperature exceeds normal range.

**Temporary Deactivation**

A soft tap on the brake pedal, pushing the multifunction control (CANC), or normal brake pressure while slowing the vehicle will temporarily deactivate the ACC without erasing the set speed



## Driver Assistance Systems

memory. The  white light will appear on the TFT display with below the set speed.

### Conditions for Disabling and Deactivation

Besides the cases specified in the previous paragraph, the following conditions will disable the system:

- Anti-Lock Brake (ABS) kicks in.
- Transmission lever is not in D (Drive).
- “CORSA” drive mode (TROFEO version only) is set.
- Ride height is set to “Off Road 1” or “Off Road 2”.
- The Electronic Stability Control and the Traction Control System (ESC/TCS) activate.
- Vehicle parking brake is operated.
- The driver safety belt is unbuckled at low speed.
- The driver door is ajar at low speed.
- The driver disabled the ESC using the  (ESC OFF) button on central console.
- The road is too steep both uphill and downhill at low speed.

The system is deactivated and set speed is deleted from system memory, if the ACC ON/OFF button is pressed or if ignition device is turned to **OFF** .

### Resuming Speed

If a speed setting is stored in system memory, press the multifunction control (RES +) up and take foot off the accelerator pedal. The last set speed will be displayed.



**WARNING!**  
The resume function should be used only when road and traffic conditions allow it. Resuming a too high or too low speed for current traffic and road conditions could cause a harsh vehicle acceleration or deceleration which could increase the risk of collisions and death or serious injury.

### Setting the Time Gap

The specified time gap has four different settings, identified by 4 horizontal bars that represent 4 different time gaps:

- Maximum (longest) time: 4 bars.
- Long time: 3 bars (default time).
- Medium time: 2 bars.
- Short time: 1 bar.

Based on both time gap, selected by the driver, and the actual vehicle speed, ACC calculates the distance to keep from the vehicle ahead.

If another information covering ADAS visualization in the main area (textual pop-ups, NAVI information, phone call, etc...) are displayed, the ACC time gap

symbol shall be displayed in the top left corner for the time the ADAS in the main area is covered (see detail in picture). If system does not detect the presence of any vehicles ahead, only the bars referred to set time gap will be displayed.

When system detects the presence of a vehicle ahead, it is displayed in front of the bars (see example in the figure).



To increase or decrease the number of bars, corresponding to the gap from vehicle ahead, press and release the distance setting button.





Each press and release of the button changes the time gap starting from 3 bars (default time) and moving in a sequential way towards the minimum distance: 3→2→1→4→3→2→1→4 and so on.

If there is no vehicle ahead, the vehicle will maintain the set speed. If a slower moving vehicle is detected in the same lane, the system displays the target vehicle icon before the bars. From that moment, the system adjusts the vehicle speed automatically to maintain the time gap setting, regardless of the set speed. The vehicle will then maintain the set distance until:

- The vehicle ahead accelerates to a speed above the set speed.
- The vehicle ahead moves out of the lane or view of the sensor.
- The time gap setting is changed.
- The driver disables the system.

The maximum braking applied by ACC is limited; however, the driver can always apply the brakes manually, if necessary. Any time the ACC system automatically operates the brakes, the brake lights will turn on as if the driver was braking.

A Proximity Warning on display will alert the driver if ACC predicts that its maximum braking level is not sufficient to maintain the set time gap. If this occurs, a visual alert will flash on the display and a chime will sound while ACC continues to apply its maximum braking capacity.



#### NOTE:

The displayed warning is a warning for the driver to take action and does not necessarily mean that the Forward Collision Warning system is applying the brakes autonomously.

## Overtake Aid

When driving with ACC engaged and following a target vehicle, the system will provide an additional acceleration to assist in passing vehicles in front.

This additional acceleration is triggered when the driver utilizes the left turn signal to start overtaking. In locations with left hand drive traffic, overtake aid is active only when passing on the left hand side of the target vehicle.

When a vehicle goes from a location with left hand drive traffic to a location with right hand drive traffic, the ACC system will automatically detect traffic direction. In this condition, overtake aid is active only when passing on the right side of the target vehicle. This additional acceleration is triggered when the driver utilizes the right turn signal to start overtaking. In this condition the ACC system will no longer provide overtake aid on the left side until it determines that the vehicle has moved back to a location with left hand drive.

## System Operation Before and During Stop

If an ACC host vehicle follows a target vehicle to a standstill, after two seconds the system will not be able to resume. In this condition, TFT displays an instruction message pop up for 5



seconds and the driver has to press the accelerator pedal or resume the ACC speed by acting on the multifunction control (RES + or SET -).

While ACC with Stop is holding your vehicle at a standstill, if the driver unbuckles the seatbelt or opens the door, the ESC system will activate the EPB. During standstill, ACC system monitors the occupant detection signals: if the driver's seatbelt becomes unbuckled, the ACC system shall be canceled when the EPB is applied.



### **WARNING!**

- **When the Adaptive Cruise Control (ACC) system is resumed, the driver must ensure that there are no pedestrians, vehicles or objects in the path of the vehicle. Failure to follow these warnings can result in a collision and death or serious personal injury.**
- **During the automatic stopping behind a vehicle in some rare cases it may happen that the system does not recognize the rearmost point of the vehicle ahead but a target under the vehicle ahead (e.g. the back axle of a truck with a high loading edge or a bumper of a vehicle although overhanging load is hanging over the vehicle's rear). In these cases**

**the system cannot guarantee the appropriate stopping distance leading to collision in the worst case. For this reason the driver has to be attentive and ready to brake during automatic stops.**

## **Display Warnings and Maintenance of ACC and FCW Systems**

### **Wipe Front Radar Sensor Warning**

This warning will display and also a chime will indicate when conditions temporarily limit system performance due to sensor poor or failed signal reception. This most often occurs at times of poor visibility, such as in snow or heavy rain. The ACC and FCW systems may also become temporarily blinded due to obstructions, such as mud, dirt or ice on the radar sensor. In these cases, the system will be disabled. This message can sometimes be displayed while driving in highly reflective areas (i.e. tunnels with reflective tiles, or ice and snow). The ACC and FCW systems will recover operation after the vehicle has left these areas. Under rare conditions, when the radar is not tracking any vehicles or objects in its path this warning may temporarily occur.

If weather conditions are not a factor, the driver should examine the sensor. It may require cleaning or removal of an obstruction. The sensor is located in the center of the front grille, behind the Maserati trident.

To keep the ACC System operating properly, it is important to note the following maintenance items:

- Always keep the sensor clean. Carefully wipe the sensor lens with a soft cloth. Be cautious not to damage it.
- Do not remove any screws from the sensor. Doing so could cause an ACC system malfunction or failure and require a sensor realignment.
- If the sensor or front end of the vehicle is damaged due to a collision, see your authorized dealer for service.
- Do not attach or install any accessories near the sensor, including transparent material or aftermarket grilles. Doing so could cause an ACC system failure or malfunction. When the condition that deactivated the system is no longer present, the system will return to the "Adaptive Cruise Control Off" state and will resume function by simply reactivating it.

### **NOTE:**

**If the radar sensor wipe warning message occurs frequently (e.g. more**



than once on every trip) without any snow, rain, mud, or other obstruction, have the radar sensor realigned at an **Authorized Maserati Dealer**.

### Clean Front Windshield Warning

The warning will display and a signal will indicate when conditions temporarily limit system performance due to failed signal reception. This most often occurs at times of poor visibility, such as in snow or heavy rain and fog. The ACC and FCW systems may also become temporarily blinded due to obstructions, such as mud, dirt, or ice on windshield and fog on the inside of glass or when driving in bad weather. In these cases, the system will have degraded performance.

The ACC and FCW systems will recover operation after the vehicle has left these areas. Under rare conditions, when the camera is not tracking any vehicles or objects in its path this warning may temporarily occur.

If weather conditions are not a factor, the driver should examine the windshield and the camera. They may require cleaning or removal of an obstruction. When the condition that created limited functionality is no longer present, the ACC and FCW systems will return to full functionality.

### NOTE:

If the windshield wiper warning message occurs frequently (e.g. more than once on every trip) without any snow, rain, mud, or other obstruction, have the windshield and forward-facing camera inspected at an **Authorized Maserati Dealer**.

### Service ACC/FCW Warning

If the ACC and FCW systems turn off, and the system displays a service warning, there may be an internal system fault or a temporary malfunction that limits functionality.

Although the vehicle is still driveable under normal conditions, ACC and FCW will be temporarily unavailable. If this occurs, try activating ACC and FCW again later, following an ignition cycle.

If the problem persists, contact an **Authorized Maserati Dealer**.



## Precautions while Driving with ACC

### Towing a Trailer



**WARNING!**  
Towing a trailer when using Adaptive Cruise Control (ACC) can lead to serious system failures which can cause severe accidents.

### Offset Driving

ACC may not detect a vehicle in the same lane that is offset from your direct line of travel, or a vehicle merging in from a side lane. There may not be sufficient distance to the vehicle ahead. The offset vehicle may move in and out of the line of travel, which can cause your vehicle to brake or accelerate unexpectedly.

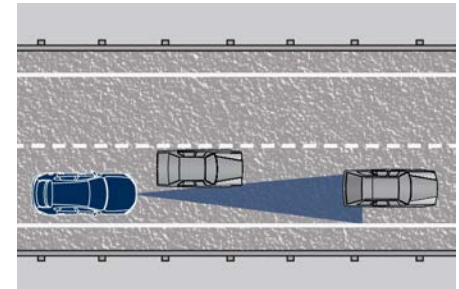

### Turns and Bends

When driving on a curve with ACC engaged, the system may decrease



## Driver Assistance Systems

the vehicle speed and acceleration for stability reasons, with no target vehicle detected. Once the vehicle is out of the curve the system will resume your original Set Speed. This is a part of normal ACC system functionality. Moreover, the radar sensor might detect a vehicle on a nearby lane or no longer detect the target vehicle.

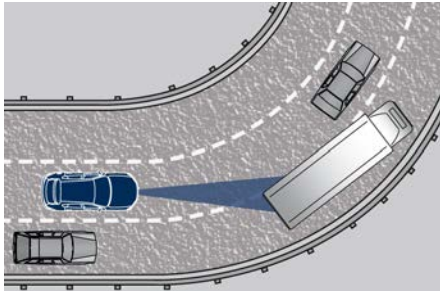

### Using ACC on Hills

When driving on steep hills, ACC may not detect a vehicle in your lane when the vehicle reaches the crest. Depending on the speed, vehicle load, traffic conditions, and the steepness of the hills, ACC performance may be limited.

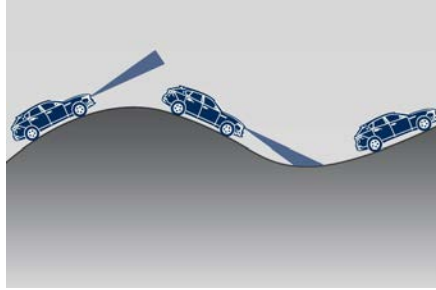

### Lane Changing

ACC may not detect a vehicle until it is completely in the lane in which you are traveling.

In the illustration shown, ACC has not yet detected the vehicle changing lane and it may not detect the vehicle until it is too late for the driver to take action. ACC may not detect a vehicle until it is completely in the lane. There may not be sufficient distance to the lane changing vehicle.

Always be attentive and ready to apply the brakes if necessary.

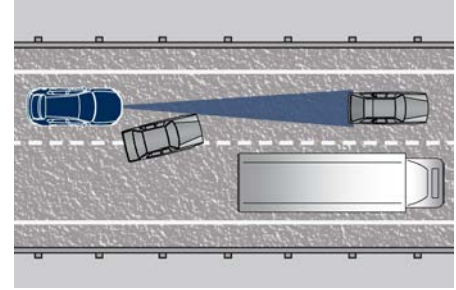

### Narrow Vehicles

Some narrow vehicles (like motorcycles) traveling near the outer edges of the lane or edging into the lane are not detected until they have moved fully into the lane. There may not be sufficient distance to the vehicle ahead.

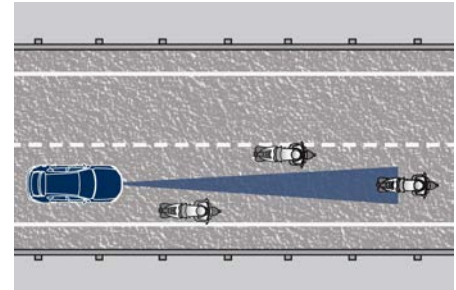

### Stationary Objects and Vehicles

ACC does not react to stationary objects and stationary vehicles. For example, ACC will not react in situations where the vehicle you are following exits your

lane and the vehicle ahead is stopped in your lane.

Always be attentive and ready to apply the brakes if necessary.

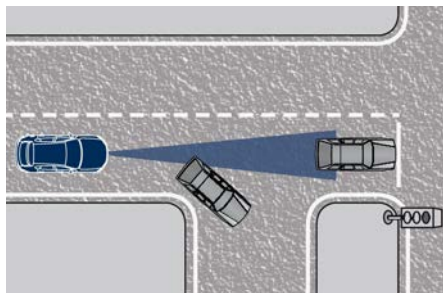

### Radar Device - Regulatory Information

The “Regulatory Information” for all the radio frequency and radar devices can be consulted by accessing the “Services” section on the website [www.maserati.com](http://www.maserati.com).

## Forward Collision Warning - FCW

The Forward Collision Warning (FCW) system with braking action uses the same parts already described for Adaptive Cruise Control (ACC) for sensing vehicle ahead (hereinafter “target vehicle”) as well as part of the warnings/messages on system condition and activation status.

Full performance can be reached only when both the sensing parts have detected a vehicle or, if the car is equipped with Pedestrian Emergency Braking (PEB) system, also a pedestrian.

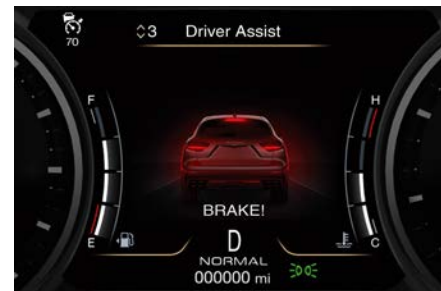

The difference between full and reduced performance is not visible for the driver.

### Pedestrian Emergency Braking (PEB) System (if equipped)

PEB is a sub-system of FCW and it provides the driver with audible warnings, visual warnings on the instrument cluster display, and may apply automatic braking when it detect a potential frontal collision with a pedestrian.

#### NOTE:

The PEB function is only active up to 37 MPH (60 km/h).



## WARNING!

**Pedestrian Emergency Braking (PEB) is not intended to avoid a collision on its own, nor can PEB detect every type of potential collision with pedestrian. The driver has the responsibility to avoid a collision by controlling the vehicle via braking and steering. Failure to follow this warning could lead to serious injury or death.**

### PEB System Limitations

PEB may be impaired or may not function in the following situations:

- If there is poor visibility, e.g. due to insufficient illumination of the road, if there are highly variable shade conditions or in rain, snow or fog.
- If there is glare, e.g. from oncoming traffic, direct sunlight or reflections from other vehicles.
- If the windshield in the area of the camera is dirty, or if the camera is fogged up, damaged or covered.
- During air suspension transitions.

### System Operation

The FCW provides audible and visual warnings when a potential collision is detected. Brake jerk and limited braking may also be applied depending on the specific scenario.

### NOTE:

FCW system is not intended for towing: this could lead the system to malfunctions and/or to late reaction.

FCW monitors the information from the forward looking radar sensor as well as the Electronic Brake Controller (EBC), to calculate the probability of a forward collision. When the system determines that a forward collision is probable, the driver will be provided with audible and visual warnings and may provide a warning brake jerk. If the driver does not take action based upon these progressive warnings, then the system will provide a limited level of active braking to help slow down the vehicle and mitigate the potential forward collision. If the driver reacts to the warnings by braking and the system determines that the driver intends to avoid the collision by braking but has not applied sufficient brake force, the system will compensate and provide additional brake force as required.

When the system determines a collision with the vehicle in front of you is no longer probable, the warning messages will be deactivated.

### NOTE:

- **Bad weather conditions, like strong rain, snow, etc., can lead to reduced**

system performance. Under these conditions relevant objects will not be detected or detected late by the system.

- FCW is designed to react in specific situations in typical traffic scenarios with objects in the same lane driving in the same direction, but under certain conditions it can also react on stationary objects in the same lane. It is not designed to react to oncoming traffic or crossing traffic.
- The FCW alerts may be triggered on objects other than vehicles such as guard rails or sign posts based on the course prediction. This can occur but it is not a part of normal FCW activation and functionality.
- It is unsafe to test the FCW system. To prevent such misuse of the system, after four Active Braking events within an ignition cycle, the Active Braking portion of FCW will be deactivated until the next ignition cycle. The limit of four events applies to the brake jerk too.
- The FCW system is intended for on-road use only. If the vehicle is taken off-road, the FCW system should be deactivated to prevent unnecessary warnings. If the vehicle ride height is set to "Off Road 1" or "Off Road 2",



the FCW system will be automatically deactivated.

- FCW will automatically deactivate when  (ESC OFF) button is pressed (LED light up) and when HDC is active.



### WARNING!

- **Forward Collision Warning (FCW) is not intended to avoid a collision on its own, nor can FCW detect every type of potential collision. The driver has the responsibility to avoid a collision by controlling the vehicle via braking and steering. Failure to follow this warning could lead to serious injury or death. The driver is always in charge to safely drive and to avoid critical situations not relying on the support of the system. Driver has to keep in mind that the system and therefore its intervention is always subject to the prevailing physical limits.**
- **FCW is not intended either to warn or to apply any brake aid/brake intervention in case of collisions with pedestrians (if not equipped with Pedestrian Emergency Braking - PEB sub-system), bicycles and smaller vehicles in general.**

## Speed Range of Use

Speed	MPH (km/h)
Minimum	0
Engaged/activated	1.24 (2)
Maximum	155 (250)

When the speed is outside the specified limits, the system automatically disables without turning on the corresponding warning light on the instrument cluster.

## System Status

The driver can adjust FCW sensitivity or enable/disable the brake jerk with the other emergency brakings by touching "Forward Collision Warning" soft-key on the "Apps" page or in the "Settings" list of the "Vehicle" page.

Setting options are described in the following paragraph.

When FCW status for some reason changes to off, the corresponding amber warning light on instrument cluster will light on.



This warning light informs the driver that FCW is disabled. This warning light will light even when the activation of another driver assistance function or drive mode (example:  (ESC OFF)) disables the FCW.

### NOTE:

The FCW system setting chosen by the User is kept in memory at each ignition cycle.

## System Setting

FCW warning can be set in "Active Braking" (default mode), "Warning" or "Warning & Active Braking". The default status of FCW Sensitivity is the "Med (Medium)" setting. When also the active braking function ("Forward Collision Warning Active Braking") setting is on, the system warns you of a possible collision with the vehicle in front of you when you are farther away and it applies limited braking.



## Driver Assistance Systems

This gives you the most reaction time to help avoid a possible collision.

Changing the sensitivity status to the “Near” setting, allows the system to warn you of a possible collision with the vehicle in front of you when you are much closer. This setting provides less reaction time than the “Warning & Active Braking” sensitivity setting, which allows for a more dynamic driving experience. “Med” is the intermediate status between the two described above.

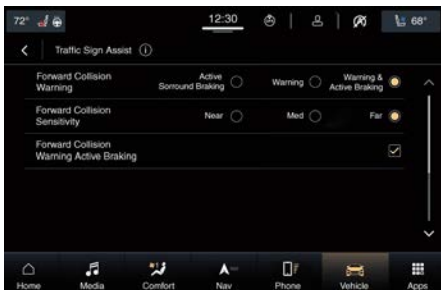

### NOTE:

- The default values shall appear at every new ignition cycle: Sensitivity = "Med" and "Active Braking" = on.
- FCW may not react to irrelevant objects such as objects not in the path of the car, stationary objects that are far away, oncoming traffic, on cross

traffic vehicles, or leading vehicles with the same or higher rate of speed.

- The active braking (autonomous braking/braking aid) will not be provided in case of potential collision with static object such as guard rails, walls, etc..).
- FCW will be disabled like ACC (refer to chapter “Adaptive Cruise Control - ACC” in this section.

Changing the active braking status to “Off” prevents the system from providing limited autonomous braking or additional brake support if the driver is not braking adequately in the event of a potential frontal collision. In this state the system disables the brake jerk.

### Limited Operation and Service Warning

The messages indicating on display the limited functionality or service at an **Authorized Maserati Dealer** required are the same as for the ACC system.

For further details, refer to “Adaptive Cruise Control – ACC” in this section.

### NOTE:

- The adjustment of the sensor could be affected by strong shocks or light collisions. This could affect the system by reducing the systems performance or could increase the false positive

rate. The adjustment of the radar system has to be proved or a new adjustment has to be performed by an **Authorized Maserati Dealer** .

- The radar system requires specific function to detect objects. The detection could be disturbed/reduced by environmental influences, for example by electrical field or the object itself. Object with small radar reflection properties could not be detected or detected late.
- When in “CORSA” mode (TROFEO version only), the FCW function is deactivated.

### Radar Device - Regulatory Information

The “Regulatory Information” for all the radio frequency and radar devices can be consulted by accessing the “Services” section on the website [www.maserati.com](http://www.maserati.com).





## Lane Keeping Assist - LKA (, with ACC only)

This system was designed especially for highway or freeway driving, to reduce the risk that the vehicle, under particular circumstances, accidentally departs from the lane in use. When this happens, graphic instructions on instrument cluster display together with steering torque application and steering wheel vibration (depending on the distance to the line and the setting that the driver has chosen from the "Settings" menu on MIA as described in "Customized Settings" of this chapter) warn the driver that the vehicle is going out of the lane initiates a steering manoeuvre to try to prevent the lane exit.

To detect lane lines, the system uses the forward-facing camera behind of the rear-view mirror, which is the same one used also by the lighting system to manage the automatic high beams. The logic core is in the front radar. LKA system remembers the condition it was in before turning off the vehicle. Refer to "Functions of Controls Menu on MIA" in section "Dashboard Instruments and Controls" for further information.

### NOTE:

In case of wet road or raining conditions the function could be disabled by the system in order to minimize the risks.

### Speed Range of Use

Speed	MPH (km/h)
Minimum	37 (60)
Engaged/activated	37 (60)
Maximum	112 (180)

### Customized Settings

LKA is configurable by the driver in order to maximize its efficiency based on the driver driving style and the expectation of the system, reducing at the same time the possible invasiveness.

Entering "Settings" menu of the "Vehicle" page on MIA display the driver can see the current setting beside the "Lane Keeping Assist" soft-key.

Touching "Lane Keeping Assist" soft-key to enter the setting page.

Driver warnings are "Visual & Haptic" (default mode).

System response can be set to "Early", "Medium" (default mode) or "Late".

System reaction force can be set to "Low", "Medium" (default mode) or "High".

### Meanings of Settings

"Visual & Haptic": the system will apply steering torque when lane departure is detected showing at the same time the proper cluster indication, adding to this steering vibration when the departure is very imminent.

When "Visual & Haptic" is selected and of course LKA is enabled then two following menu will be used by the system.

- "LKA Sensitivity": it tunes the distance to the lane boundary where the system will start to apply steering torque.
- "LKA Strength": it tunes the steering torque and speed value increasing or decreasing it to have a stronger or weaker trajectory correction/ deviation.



### WARNING!

**In rare cases, Lane Keeping Assist (LKA) may make an inappropriate steering torque application. LKA may be interrupted at any time by counter steering. Lack of driver attention may lead to serious injury or death.**

### System Availability

The ADAS systems help the driver while driving. These systems can be set and monitored simultaneously on the display, after opening "Driver Assist" menu (see paragraph "TFT Display:



## Driver Assistance Systems

Menu and Submenu Content” in section “Dashboard Instruments and Controls”). When you are not in the "Driver Assist" page, the system status is indicated by a telltale at the top left of the TFT display. LKA is designed for an attentive driver; therefore the system is available only when his/her hands are on the steering wheel or with hands off only for a very limited amount of time. When the system is enabled it will trigger cluster warning in case at least one hand is not detected on the steering wheel.

The torque application as well as the vibration are suppressed/inhibited in case of: high driver torque in the steering wheel, high lateral acceleration, trailer connected to the proper control module, hands not on the steering wheel detected for more than a certain time. High dynamic driving behaviors, driving on the lane boundary or driving off course will prevent the function from working. FCW braking and stability system interventions (ESC, ABS) will also prevent the system from operating. Changing lane results in system inhibition for a certain time. In addition, the driver must respect some road characteristics such as minimum-maximum width, lanes clearly defined by two lane boundaries and only in limited

cases for a limited time, the presence of at least one lane boundary.

The LKA system is active both in the case of both lines visible and available for the system, and in case of the only line available on the road.

Each LKA intervention is notified to the driver with the relative graphics which is shown for the entire duration of the system intervention and for a minimum time of 1 second.

Multiple interventions are allowed both in terms of visual and acoustic signals and in terms of steering torque. If more than three consecutive interventions are required within a period of 180 seconds, starting from the second intervention the acoustic signal will last 10 seconds longer the previous one. Starting from the third acoustic signal the system will emit a continuous sound and a message on TFT display will indicate to keep the center line.

### NOTE:

- In case of wet road or raining conditions the function could be disabled by the system in order to minimize any risks.
- The system is developed to work only on the lines painted on the road surfaces, but it may happen that shadows, traces of old lines, road

edges, etc. are also interpreted as such.

Being this function used to prevent unintentional lane change/lane drift, it will be temporary suppressed/inhibited by a turn indicator activation, therefore, graphic warning, steering torque application and vibration will be terminated. In these conditions the graphics turn gray.

### Function Description and Operating Mode

The function intent is to prevent the lane departure by warning the driver through indication on the cluster and if set applying steering torque and vibration. The graphic which intent is to represent at the glance the system knowledge of the lane in front of the car, the system suppression status and warning. For this a simple color code has been adopted for each line (of the two presented):

- Both gray lines means system is enabled, not able to operate (suppression condition present or lane detection system not able to estimate properly the lane);
- Left/right gray line: the lane detection system is not able to detect that specific lane boundary;



- Yellow line: there is a steering torque intervention in progress that tries to prevent a departure on that side, in this situation the warning should increase the driver attention requiring him to properly handle the situation;
- Yellow flashing line: the graphic is shown whenever the system detects a very imminent lane departure, at this can be added torque and steering vibration if configured by the customer.

The white lines (one or both) indicates that the corresponding lane boundary is detected and the system is capable to intervene on it.

Whenever the system is enabled there will be graphic on the dedicated screen of the "Driver Assist" page. This graphic will be available in the form of symbols (see detail in figure) in the top left corner of the cluster screen.

An example of this screen, with only LKA system activated and with LKA and ACC systems activated, can be found in the following figures:

In the first, only LKA system is activated, steering torque in progress to correct the trajectory towards the lane center.

In the second LKA and ACC systems are activated, car is crossing the lane boundary, steering torque and vibration if configured are in progress when this graphic is shown.



The icons that represent the status of the ADAS systems remain displayed even when you exit the "Driver Assist" screen.

### System Limitations

Because of physical limits, in order to properly operate, the system needs good visibility (it might not work or not properly operate in case of heavy rain, snow, wet roads, fog, direct sun on the camera, etc.).

### NOTE:

The sensors are not able to detect the presence of the hands on the steering wheel areas covered in wood, plastic bezels or carbon inserts (where present).

Sharp turns, slopes and change in slopes, poor lane boundaries, as well as construction areas and all the scenario described in this paragraph may challenge the system, therefore be always ready to prevent any unexpected behavior of the car.

Damaged front bumper, windshield replaced without proper technical intervention may also lead to system malfunction or system unavailability. Other conditions such as fault, but not explicitly indicated here may also prevent/interrupt the system intervention.



**WARNING!**  
If the driver fails to adapt his/her driving style, Lane Keeping Assist (LKA) can neither reduce the risk of an accident nor override the laws of physics. It cannot take into account road, weather or traffic conditions. Active LKA is only an aid. Driver is always responsible for the distance to the vehicle in front, for



## Driver Assistance Systems

vehicle speed, for braking in good time and for staying in lane.

### System in Faulty

When the LKA cannot properly operate due to a fault of its components or because the windshield in front of the forward facing camera is dirty, the amber light and/or the corresponding message will be displayed.



If message suggestion does not allow fixing the fault, do not use the system and have the vehicle inspected at the **Authorized Maserati Dealer**.

### Radar Device - Regulatory Information

The "Regulatory Information" for all the radio frequency and radar devices can be consulted by accessing the "Services" section on the website [www.maserati.com](http://www.maserati.com).

## Blind Spot Assist - BSA (👉)

### System Operation

The Blind Spot Assist (BSA) system uses two radar-based sensors, located inside the rear bumper fascia, to detect highway licensable vehicles (cars, buses, motorbikes, etc.) that enter the blind spot zones from the rear/front/side of the vehicle in the adjacent lanes.

The example shown in the figure highlights the blind spots on either side of the vehicle when overtaking traffic is approaching from behind.

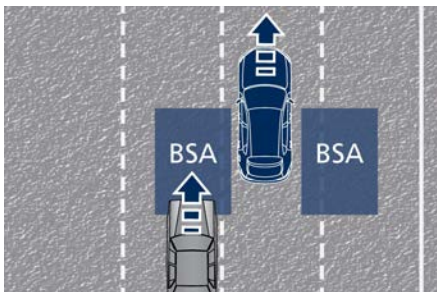

When the vehicle is started, the BSA warning light will momentarily illuminate in both outside rear view mirrors to let the driver know that the system is operational and on. The BSA system sensors operate when the vehicle is in any forward gear and enters standby mode when the transmission is in (P) Park.



The BSA detection zone shown in figure covers approximately one lane on both sides of the vehicle (approximately 11 ft or 3.3 m). The blind spot area extends from immediately behind the exterior rear-view mirrors up to about 23 ft (7 m) behind the rear bumper.

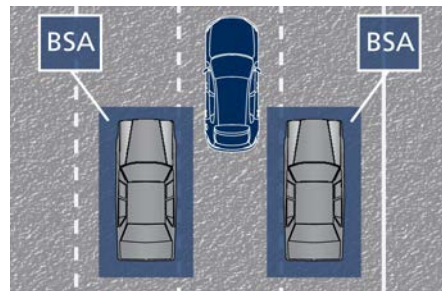

The BSA system monitors the detection zones on both sides of the vehicle to detect the presence of vehicles and begins to warn the driver by flashing the warning light in the rear view when the

vehicle speed reaches approximately 6 km/h (4 mph) or higher.



### WARNING!

- The Blind Spot Assist (BSA) system does NOT alert the driver about rapidly approaching vehicles that are outside the detection zones.
- The BSA might alert the driver too late especially in case of rapidly approaching vehicles.
- The driver must always pay utmost attention and drive carefully.



### WARNING!

Risk of accident despite Blind Spot Assist (BSA). BSA does not detect/react to the following:

- Overtaking vehicles close on the side, placing them in the blind spot area. As a result, BSA may neither give warnings nor intervene in such situations.
- Always pay attention to the traffic situation and maintain a safe distance at the side of the vehicle.

### NOTE:

If your vehicle has experienced any damage in the area where the sensor is located, even if the fascia is not damaged, the sensor may have become

misaligned. Take your vehicle at an **Authorized Maserati Dealer** to verify sensor alignment. Having a sensor that is misaligned will result in the BSA not operating to specification.

The area on the rear bumper fascia where the radar sensors are located must remain free of snow, ice, and dirt/road contamination so that the BSA system can function properly. Do not cover or block the area of the rear bumper fascia where the radar sensors are located with foreign objects (bumper stickers, spoilers, bicycle racks, etc.). The BSA system notifies the driver of vehicles or objects in the detection zones by illuminating the BSA warning light located in the outside mirrors in addition to sounding an audible (chime) alert and reducing the radio volume (if the radio is on). Refer to “BSA and RCP Setting” in this chapter for further information.

The BSA system monitors the detection zone from three different entry points (side, rear, overtaking traffic) while driving to see if an alert is necessary. The BSA system will issue an alert whenever a vehicle enters any one detection zone as outlined below.

### Speed Range of Use

Speed	MPH (km/h)
Minimum	6 (10)
Engaged/activated	6 (10)
Maximum	–

### Entering from the Side

Vehicles that move into your adjacent lanes from either side of the vehicle.

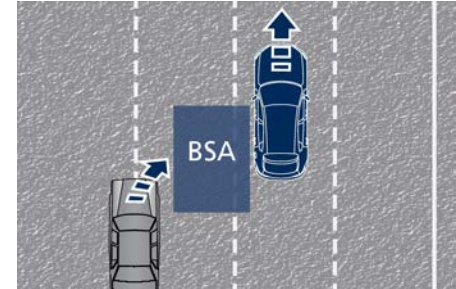

### Entering from the Rear

The alert will turn on when the vehicles that come up from behind your vehicle on either side and enter the rear detection zone with a relative speed of more than 27 MPH (43 km/h).



# Driver Assistance Systems

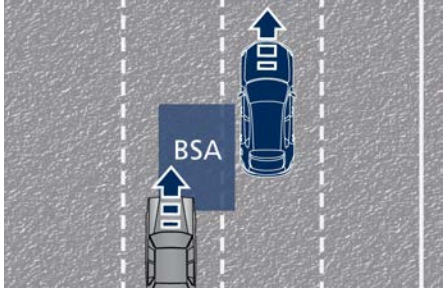

### Overtaking Traffic

The figures show the vehicle approaching (A) and passing (O) another vehicle in the overtaking lane.

If you pass another vehicle slowly, the vehicle remains in the blind spot for approximately 2 seconds, the BSA warning light in the outside mirror will illuminate after 1.5 seconds.

If the difference in speed between the two vehicles is greater, the warning light will not illuminate.

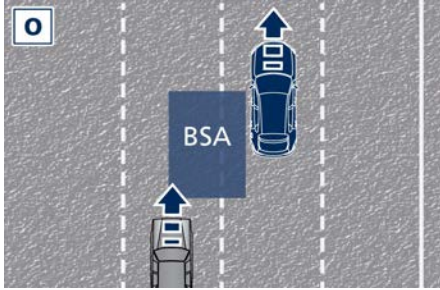
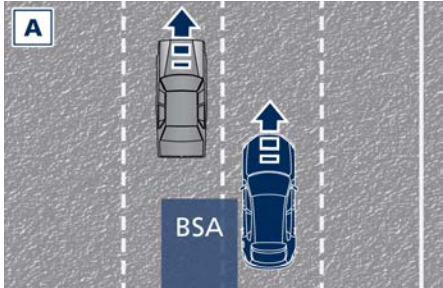

### Other Cases

The BSA system is not designed to issue an alert on stationary objects such as guardrails, posts, walls, foliage heaps, berms, etc. However, occasionally the system may alert on such objects. This is normal operation and your vehicle does not require service.

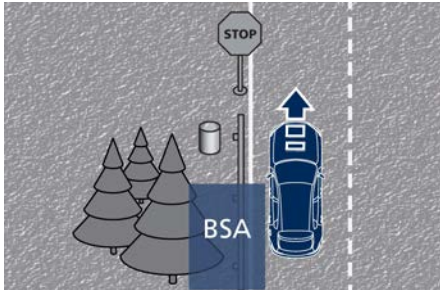

The BSA system will not alert you of objects that are traveling in the opposite direction of the vehicle in adjacent lanes.

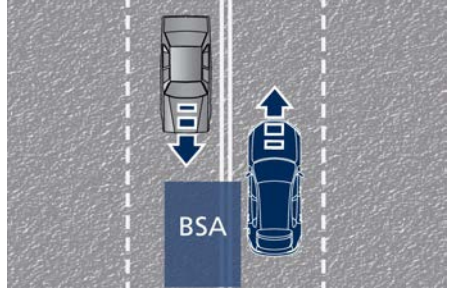

### WARNING!

- The Blind Spot Assist (BSA) system is only an aid to help detect vehicles in the blind spot zones.
- The BSA system is not designed to detect pedestrians, cyclists, or animals.
- Even if your vehicle is equipped with the BSA system, always check your vehicle's outside and rearview mirrors for any vehicles approaching from behind or overtaking.
- Use your turn signal before changing lanes.

### System Monitoring on TFT Display

Whenever the BSA system is enabled by the user, a specific indicator is displayed in the left upper corner of the TFT display (area 24). This indicator can



take on different colors depending on the system status:



stand by status (white icon);



active status (green icon).

## RCP - Rear Cross Path

The Rear Cross Path (RCP) function is intended to aid the drivers when gear in reverse of parking spaces where their vision of oncoming vehicles may be blocked.

The RCP system monitors the rear detection zones on both sides of the vehicle. Using sensors located on either side of the rear bumper, it detects vehicles or objects that are moving toward the side of the vehicle with a minimum speed of approximately 1 to 2 MPH (1 km/h to 3 km/h) to a maximum of approximately 10 MPH (16 km/h), such as in parking lot situations.

### NOTE:

In a parking lot situation, oncoming vehicles can be obscured by vehicles parked on either side. If the sensors are blocked by other structures or vehicles, the system will not be able to alert the driver.

Proceed slowly and cautiously out of the parking space until the rear end of the vehicle is moderately exposed.

The RCP system will then have a clear view of the cross traffic. If an oncoming vehicle is detected, the RCP system will alert the driver using both the visual and audible alarms. If the radio is on, it will also reduce the radio volume.

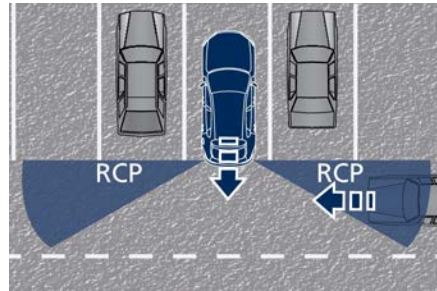

### WARNING!

**Rear Cross Path (RCP) is not a Back Up Aid system. More specifically, it is intended to be used to help a driver detect an oncoming vehicle in a parking lot situation. Drivers must be careful when backing up, even when using RCP. Always check carefully behind your vehicle, look behind you, and be sure to check for pedestrians, animals, other vehicles, obstructions, and blind spots before backing up. Failure to do so can result in serious injury or death.**

## BSA and RCP Setting

Setting modes can be selected from the MIA system.

Touch “Settings” soft-key on “Vehicle” page and then select “Blind Spot Assist” soft-key to enter the setting page.

Refer to chapter “Functions of Controls Menu on MIA” in section “Dashboard Instruments and Controls” for further information.

### BSA in Visual Mode

When operating in “Visual” mode, the BSA system will provide a visual alert in the appropriate side view mirror when it detects a vehicle or an object in the detection areas monitored by its sensors: depending on the status of the relative turn indicator, the warning light can be fixed or flashing.

However, when the system is operating in RCP mode, it will respond with both visual and audible alerts when an oncoming vehicle or an object approaching the rear end side of the vehicle is detected.

Whenever an audible alert is requested, the radio is muted (if the radio is on).

### BSA in Visual and Acoustic Mode

When operating in “Visual & Acoustic” mode, the BSA system will provide a visual alert in the appropriate side view



## Driver Assistance Systems

mirror based on a detected vehicle or object.

If the turn signal is then activated, and it corresponds to an alert present on that side of the vehicle, an audible chime will also be sounded: in the same moment the warning light will start flashing.

Whenever a turn signal and detected vehicle or object are present on the same side at the same time, both the visual and audio alerts will be issued. In addition to the audible alert, the radio volume will be reduced (if the radio is on).

### NOTE:

If the hazard flashers are on, the BSA system will issue the appropriate visual alert only.

When the system is in RCP mode, the system shall respond with both visual and audible alerts when a detected vehicle or object is present. Whenever an audible alert is requested, the radio (if on) is also muted.

Right/left turn/hazard signal status is ignored; the RCP status always requests the chime when needed.

### Blind Spot Assist Off

When this function is turned off from the MIA, there will be no visual or audible alerts from either the BSA or RCP subsystems.

### NOTE:

The BSA system will store the current operating mode when the vehicle is shut off. Each time the vehicle is started, the previously-stored mode will be recalled and used.

### System Temporarily Unavailable

The blind spot system will become temporarily unavailable and the instrument cluster display will show the message “Blind Spot Alert Temporarily Unavailable” when the vehicle enters a radio quiet zone (example the areas around radio telescopes).

The warning light on the outside rear-view mirrors will be lit up and stay lit until the vehicle exits the zone.

### System is Faulty

The BSA system cannot properly operate due to a fault of its components, or because the area on the rear bumper fascia where the radar sensors are located is dirty. In these cases the amber warning light and the related message will be displayed on the instrument cluster.



In these cases avoid using the system and have the vehicle inspected at an **Authorized Maserati Dealer**.

## Radar Device - Regulatory Information

The “Regulatory Information” for all the radio frequency and radar devices can be consulted by accessing the “Services” section on the website [www.maserati.com](http://www.maserati.com).





## Active Blind Spot Assist - ABSA (☰, with ACC only)

ABSA system represents an addition to the BSA previously described (see chapter "Blind Spot Assist - BSA" of this section).

ABSA adds to the BSA the possibility in certain circumstances to avoid and or mitigate side collisions with vehicles proceeding in the adjacent lanes by changing the car trajectory in order to try to keep it inside the detected/ estimated lane. A steering wheel vibration is used as further feedback to warn the driver that the lane change is not safe.

The main logic core is the front radar, whereas the sense inputs are the radars on the rear bumper fascia used for sensing the presence of vehicle in the blind spot areas and the forward facing camera placed behind the internal rear-view mirror that instead is used for lane detection and estimation.

ABSA is designed to avoid and/or mitigate a collision. Torque and vibration application is however available in the 37 - 112 MPH (60 - 180 km/h) speed interval. All the speed thresholds related to the BSA remain still valid, since ABSA as mentioned is BSA extension.

ABSA is intended as a "hands-on" function meaning that the driver is

required to stay engaged in the driving all the time with his/her hands on the steering wheel, in case hands are not on the steering wheel for a certain time there cannot be any steering torque application vibration included (see "System Monitoring on TFT Display" in this chapter).

### System Availability

ABSA is designed for an attentive driver therefore the system is available only when his/her hands are on the steering wheel or with hands off for a very limited amount of time. When the system is enabled, it will trigger cluster warning in case at least one hand is not detected on the steering wheel.

The torque application as well as the vibration are suppressed/inhibited in case of: high driver torque in the steering wheel, high lateral acceleration, trailer connected to the proper control module, hands not on the steering wheel detected for more than a certain time. Highly dynamic behaviours, driving on the lane boundary, off course will prevent the function from working. FCW braking and stability system interventions (ESC, ABS) will also prevent the system from operating. Changing lane results in system inhibition for a certain time.

In addition the road must respect some characteristics such as minimum-maximum width, lane clearly defined by two lane boundaries and only in limited case for a limited time at least one. Each steering of the ABSA system is always notified to the driver with acoustic and visual feedback and each signaling has the same duration as the steering intervention, with a minimum of 1 seconds.

Multiple steering interventions are only allowed if both line lines are available for the system.

Multiple interventions are allowed both in terms of visual and acoustic signals and in terms of steering torque.

If more then three consecutive interventions are required within a period of 180 seconds, starting from the second intervention the acoustic signal will last 10 seconds longer the previous one.

Starting from the third acoustic signal the system will emit a continuous sound and a message on TFT display will indicate to keep the center line.

If there is only one line on the road, when it is correctly detected by the ABSA system, only one trajectory correction with relative acoustic signal will be possible. Until two lines are displayed again, there will be no trajectory



## Driver Assistance Systems

correction but only acoustic and visual signals.

Furthermore in case of a single and very wide lane line, if the system intervenes by steering in the opposite direction to the line, this could force the car to remain slightly misaligned from the center of the lane, towards the only available line. This behavior serves to prevent the intervention that has just taken place the car off the road from the side where the lane is not available.

### NOTE:

- In case of wet road or raining conditions the function could be disabled by the system in order to minimize risks.
- The system is developed to work only on the lines painted on the road surfaces, but it may happen that shadows, traces of old lines, road edges, etc. are also interpreted as such.

### Speed Range of Use

Speed	MPH (km/h)
Minimum	37 (60)
Engaged/activated	37 (60)
Maximum	112 (180)

### System Limitation

Because of physical limits the system to properly operate needs good visibility (it might not work or not properly operate in case of heavy rain, snow, wet roads, fog, direct sun on the camera, dirty windshield, low illumination etc.) Sharp turns, slopes and change in slopes, poor lane boundaries, as well as construction areas and all the scenarios described in this paragraph may challenge the system, therefore be always ready to prevent any unexpected behavior of the car.

Damaged front bumper, windshield replaced without proper technical intervention may also lead to system malfunction or system unavailability. Other conditions such as faults, but not explicitly indicated here may also prevent/interrupt the system intervention.

### System Setting

ABSA is configurable by the customer in order to maximize its efficiency based on the driver driving style and his/her expectation of the system, reducing at the same time the possible invasiveness. Setting modes can be selected from the MIA system (see "Functions of Controls Menu on MIA" in section "Dashboard

Instruments and Controls" for further information).

Touch "Settings" soft-key on "Vehicle" page and select "Active Blind Spot Assist" function to enter the setting page.

Driver warnings can be only "Visual", "Visual & Acoustic" (default mode) or "Visual & Haptic". When "haptic" feedback is selected, every time a steering force is applied there will always also an acoustic signal to the driver.

System sensitivity can be set to "Early", "Medium" (default mode) or "Late". System strength can be set to "Low", "Medium" (default mode) or "High".

### NOTE:

The ABSA system will store the current operating mode when the vehicle is shut off. Each time the vehicle is started, the previously-stored mode will be recalled and used.

### Meanings of Settings

When "Visual & Haptic" is selected and ABSA is enabled, then two following menus will be used by the system.

- ABSA "Sensitivity": it tunes the distance to the lane boundary where the system will start to apply steering torque.
- ABSA "Strength": it tunes the steering torque value to have a stronger or weaker trajectory correction/deviation.

### System in "Visual & Haptic" Mode

When the system is on and configured "Visual & Haptic" then the ABSA is enabled and to the conventional visual warnings is added the steering torque and vibration.

When operating in this mode, the system will provide a visual alert in the appropriate outside rear-view mirror when it detects a vehicle or an object in the detection areas monitored by its sensors. In case of turn indicator activation on the appropriate side, the system will react with a torque on the steering wheel to try to prevent the lane change and therefore to avoid/mitigate the collision. The torque on the steering is applied when the car is very close to the lane boundary as a further feedback to warn the driver of the unsafe maneuver.

#### NOTE:

The steering torque is not supplied if the system is not able to estimate a lane and if the turn indicator from the appropriate side is not inserted.



#### WARNING!

- Risk of accident despite steering torque application of Active Blind Spot Assist (ABSA).
- A course-correcting steering torque application cannot always prevent a collision.
- The driver is always required to steer, brake or accelerate themselves, especially if ABSA warns or makes a course correcting steer intervention.
- Always maintain a safe distance at the sides.
- Steering torque application may be interrupted at any time by counter steering by the driver.

### System Monitoring on TFT Display

Whenever the ABSA system is enabled by the user, an specific indicator is displayed in the left upper corner of the TFT display (area 24). This indicator can take on different colors depending on the system status:



stand by status (white icon);

active status (green icon);

intervention (amber icon).

### In Case of Intervention

ABAS shall apply a torque on the steering wheel when a vehicle is detected in blind spot. If driver's hands are off the steering wheel, a graphic pop-up shall appear on TFT display to invite you to keep your hands on the steering wheel. In this case, a single audible chime is repeated until he/she will take the control of the vehicle again.



### RCP - Rear Cross Path Operation

RCP operation is the same as described in chapter "Blind Spot Assist - BSA". The visual or audible alerts from RCP subsystem will also be present when ABSA is turned off from MIA "Settings" menu of the "Vehicle" page. When ABSA is turned on with any setting, RCP subsystem shall respond with both visual and audible alerts when a detected vehicle or object is present.



## Driver Assistance Systems

Whenever an audible alert is requested, the radio (if on) is also muted.

Right/left turn/hazard signal status is ignored; the RCP status always requests the chime.

### System Temporarily Unavailable

The blind spot system will become temporarily unavailable and the instrument cluster display will show the message “Blind Spot Alert Temporarily Unavailable” when the vehicle enters a radio quiet zone (example the areas around radio telescopes).

The warning light on the outside rear-view mirrors will be lit up and stay lit until the vehicle exits the zone.

### System in Faulty

The ABSA system cannot properly operate either due to a fault of its components, or because the area on windshield where the forward-facing camera is located or on the rear bumper fascia where the radar sensors are located is dirty. In these cases the amber warning light and the related message will be displayed on the instrument cluster.



In these cases do not use the system and have the vehicle inspected at an **Authorized Maserati Dealer**.

### Radar Device - Regulatory Information

The “Regulatory Information” for all the radio frequency and radar devices can be consulted by accessing the “Services” section on the website [www.maserati.com](http://www.maserati.com).

## Active Driving Assist - ADA (DPT, with ACC only)

The Active Driving Assist (ADA) is not an autonomy system (in reference to NHTSA standards) and is designed to aid the driver in the steering, acceleration, and braking functions of the vehicle.

ADA can work in any type of road. However, its use it is not recommended in urban scenarios.

ADA centers the vehicle by controlling the EPS system based off of lane line information from the forward-facing camera and data from the front radar sensor.

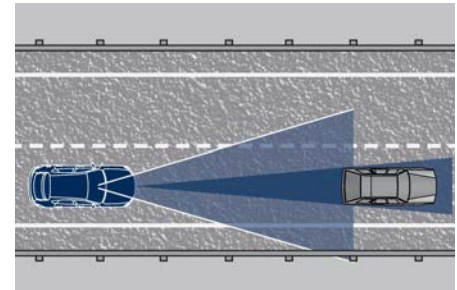

ADA combines ACC and LKA to manage the steering and speed of the vehicle under specific conditions. The conditions to engage ADA are listed in the next paragraph. If a lane line cross is imminent, the steering wheel will



vibrate and a graphic will display on the instrument cluster.



### WARNING!

- In case the vehicle approaches a curve that is too tight in relation to the current speed the system will disengage, therefore the driver must be prepared to take over control of the vehicle immediately at any time. To avoid this situation it is important that the vehicle speed is not set higher than the current speed limit of the road.
- Active Driving Assist (ADA) is a hands-on function! You must keep your hands on the steering wheel at all times. The ADA system will disengage and ACC will cancel if your hands are removed from the steering wheels for a set amount of time.
- ADA is intended for use only on highways or limited access freeways, etc. with a fully attentive driver. When using ADA, hold the steering wheel and be aware of surrounding traffic and road conditions. Always be prepared to immediately take over control of the vehicle from the ADA system. Failure to follow these instructions could result in serious injury or death.

- The following list does not fully represent all situations in which ADA may not function as intended. Do NOT solely rely on the ADA system to control the vehicle. It is the driver's responsibility to stay alert and safely control the vehicle at all times.
- If the windshield is replaced, you must have the forward-facing camera remounted and aligned by an Authorized Maserati Dealer.

Many factors can impact the performance of ADA causing the system to be unable to function as intended. These include (but are not limited to):

These include (but are not limited to):

- Narrow, winding or curvy roads.
- Poor visibility (due to heavy rain, snow, fog, etc.).
- Bright light (oncoming headlights or direct sunlight) or shadows.
- Damage or obstruction caused by mud, ice, snow, etc.
- A damaged or misaligned bumper.
- Interference from other equipment that generates electromagnetic waves.
- Wet roads, roads covered or partially covered by snow.
- Construction zones.

### System Operation

With ACC set (see “Adaptive Cruise Control – ACC” in this section), ADA system activates by simply pressing the  button on the steering wheel.

Once the conditions are met, ADA will engage.

### NOTE:

The Active Driving Assist (ADA) system may take up to 5 seconds to engage once all conditions are met.

The conditions for ADA to engage are as follows:

- ADA must be turned on or enabled.

### NOTE:

In case of wet road or raining conditions the function could be disabled by the system in order to minimize the risks.

- The vehicle must be on the highway or limited access freeway, or on the extra urban roads and enter an urban center.
- ACC must be engaged.
- Left and right visible lane lines.
- Vehicle speed must be between 0 to 90 MPH (0 and 145 km/h).
- No faults in the forward facing camera, radar, EPS, or MIA.
- Lane width between 3 to 4.6 yd (2.8 and 4.2 m).
- Turn signal not activated.
- No faults related to this system.

### Speed Range of Use

Speed	MPH (km/h)
Minimum	0
Engaged/activated (with ACC engaged)	0



Speed	MPH (km/h)
Engaged/activated (with ACC not engaged)	20 (30)
Maximum	90 (145)

- If set above the maximum speed, ADA will not function after the vehicle speed will reach the maximum speed.
- If set below the maximum speed and the ACC target speed is increased, ADA will function up to the maximum speed and then the system will turn off automatically.
- When the ACC target speed is reduce and speed is lower than the maximum speed, the system will start automatically.
- If the ACC target speed is set under the maximum speed, ADA is active and vehicle speed increases above the maximum speed due to slope, ADA will continue to function.

## Monitoring on TFT Display

ADA and the other ADAS systems conditions can be monitored on TFT display by accessing the “Driver Assist” page with the buttons on the steering wheel (see “TFT Display Setting and Menu Overview” in section “Dashboard Instruments and Controls”).

The symbol in gray indicates that the ADA system is active, but not engaged

and is shown at the center of the TFT display when the “Driver Assist” page is displayed.

The ACC and ADA information are shown with a telltale on the left top corner of the TFT display when other information (textual pop ups, NAVI information, phone call, etc...) cover the ADA's ones (see detail in picture). In telltale ADA uses steering wheel icon and corner lines to indicated its status. When exiting the "Driver Assist" page, on TFT display top left corner, the symbol will appear in the multiple light of active ADAS systems.



In addition to these symbols, on the TFT top and bottom edge a colored glow may appear (further referred to as "attention level color"). Attention level color together with the outline of the symbol represent a further indication of the system status.



When exiting the “Driver Assist” page, the attention level color will always be displayed until the system is disabled by pressing the button on the steering wheel.

The ADA system uses sensors in the steering wheel outer crown to detect if the driver’s hands are on the steering wheel. If the driver’s hands are not detected on the steering wheel, the instrument cluster will display a series of warnings to alert the driver to return their hands to the steering wheel. There will also be audible chimes. After a set amount of time, ADA will cancel if the driver’s hands are not returned to the steering wheel.

When the system does not sense the hands on the steering wheel for a few seconds (3 – 5 seconds) or more (up to 10 seconds), it tries to draw the attention of the driver by showing, even when the display is not in the "Driver Assist"

page, the symbol with the figure of the hands in the center of the display. According to such time frames, the system will change the attention level color, silence the audio in the vehicle (if it is active) and emit audible chimes to notify the driver to take the control of the vehicle again. This is the only way to reengage the system.

## Hands Detection on Steering Wheel

The sensors in the steering wheel outer crown are able to detect the presence of the hands on the steering wheel.

In order to be able to use the ADA system, place your hands around the steering wheel outer crown.

### NOTE:

The sensors are not able to detect the presence of the hands on the steering wheel areas covered in wood, plastic bezels or carbon inserts (where present).

ADA is deactivated if the steering wheel is no longer being touched.

## System Statuses

The active status of the ADA system is indicated by the green attention level color which is maintained even if the driver releases his/her grip from the steering wheel up to 3 seconds.

The graphic information changes as soon as (max 1 second) the driver releases the steering wheel:

- glow color: green;
- lines: green;
- car: centered;
- steering wheel: yellow small in the center (see picture).



The yellow attention level color appears when the driver removes his/her hands from the steering wheel for 3 to 5 seconds and the symbol with the figure of the hands will occupy the whole central area of the TFT display.



The red attention level color appears when the driver releases his/her grip from the steering wheel for 5 and up to 10 seconds: in this case a single audible chime is repeated until he/she will take the control of the vehicle again.

The red attention level color and the chime remains even when the steering wheel is released for more than 10 seconds.



When the system disengage the ADA, a sequences of 3 audible chimes will be



## Driver Assistance Systems

emitted and a message invites him/her to grip the steering wheel again. Then the  symbol on TFT display will become gray.



If the driver keeps his/her hands away from the steering wheel (for more than 8 to 10 seconds), also the ACC system is deactivated ( white ACC symbol on the display) and will have to be reset. The aid of LKA system will be disabled as well. In these cases the display will not show the attention level color anymore and the vehicle will be controlled by the driver only.

### System Disengage

To disengage ADA you can do any of the following actions:

- Press the  ADA enable button on the steering wheel.
- Begin steering manually.
- Press brake pedal.
- Turn off ACC.

- Unbuckle the driver's seat belt.
- Press ACC time gap button for two seconds to enable CC system.
- Shift out of the (D) Drive gear.
- Enter an Autonomous Emergency Braking (AEB) event (See chapter "Forward Collision Warning - FCW" in this section).
- Turn signal activated.

### System Cancellation

The ADA system will cancel (without driver intervention) if either of the following actions occur:

- Curve that is too tight.
- When removing the hands from the steering wheel.
- Lane line markers aren't detected by the forward facing camera.
- The lane intersection or roundabout (traffic circle).
- Any ADAS system faults.
- ACC cancellation.
- Vehicle speed exceeds the maximum limit.
- Lateral accelerations exceeds the limits.

#### NOTE:

When ADA cancels, the  symbol will turn red then grey.

### System Limitations

ADA is unable to guide the vehicle when the following conditions occur.

- Lane markings are not clear or visibility is poor (i.e. heavy rain, snow, fog, etc.).
- Obstructed, covered or damaged forward-facing camera or sensor.
- When driving on hills or sharp curves.
- When approaching toll booths.
- When the highway entrance or exit is wider than 20 ft (6 meters).
- Bright light (ex. direct sunlight or glare) facing the forward camera.



#### WARNING!

**Many unforeseen conditions can occur that can affect the performance of Active Driving Assist (ADA). Always keep this in mind and drive attentively. It is the drivers responsibility to keep control of the vehicle at all times.**

### System in Faulty

The ADA system cannot properly operate due to a fault of its components, or because the components themselves or their detection area is obstructed.

In these cases the amber warning light and the related message will be displayed on the instrument cluster.

In this condition avoid using the system and have the vehicle inspected at the **Authorized Maserati Dealer**.



## Radar Device - Regulatory Information

The “Regulatory Information” for all the radio frequency and radar devices can be consulted by accessing the “Services” section on the website [www.maserati.com](http://www.maserati.com).

## Traffic Sign Assist - TSA

TSA detects traffic signs through the use of a forward-facing digital camera mounted on windshield, behind the rear-view mirror. TSA assists the driver by displaying on the instrument cluster detected speed limits and traffic signs with a restriction indicated by an additional sign (e.g. in snow conditions). TSA also uses the data of the navigation system, in order to provide information to the driver in all cases in which the camera is not able to detect the traffic signs that are present on the road where the car is traveling.

Some examples of these are: due to low visibility, light reflection, damaged traffic signs, traffic signs in wrong position like rotated or fallen poles.

### NOTE:

- Overtaking restriction signs are not displayed by the TSA system.
- TSA provides a visual warning to the driver when he/she unintentionally reaches the maximum speed limit allowed or when it exceeds the set “Sensitivity” value.
- The performance of TSA depends on the update degree of navigation system’s maps.

## Customized Settings

TSA is configurable by the customer regarding the display mode on the instrument cluster and the warning sensitivity.

Entering “Vehicle” page on MIA display and select the “Traffic Sign Assist” soft-key of the “Settings” menu to enter the setting page.

The check mark on the “Warning Mode” box indicates that the warning function is active.

The display of the traffic signs can be blinking or static.

The system can be set to display the traffic signs when the speed of the vehicle is equal to the speed limit allowed, or when it is higher than 5 or 10 MPH (5 or 10 km/h).

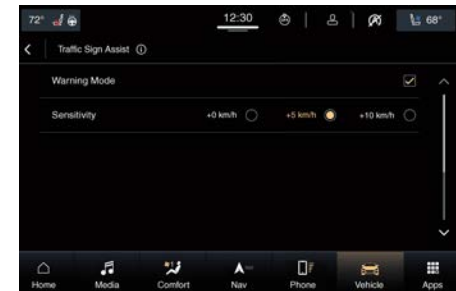



## Signs Monitoring on Instrument Cluster

If TSA function is set and a sign or a speed limit is detected, the related icons are displayed in the upper area of the instrument cluster beside of the main menu number and scroll arrows.

The display area is divided in two different sectors:

- 1 Conditioned speed limit area.
- 2 Unconditioned speed limit area.



### NOTE:

Overtaking restriction signs are not displayed by the TSA system.

If “Blinking On” warning mode is set, when the visual warning is provided only the unconditioned speed limit (in sector 2) will start blinking when the vehicle speed exceeds to the detected unconditioned speed limit (“+0 MPH” or “+0 km/h” option) or when it exceeds the set sensitivity value (“+5 MPH” -

“+5 km/h” or “+10 MPH” - “+10 km/h” options). If the vehicle speed stays above the unconditioned speed limit for several seconds the unconditioned speed limit sign will stop blinking because the manoeuver is evaluated as intentional. If the TSA is not able to determine any kind of valid speed limit neither from camera nor from digital maps the following image will be shown in sector 2.



Since TSA also uses the data provided by the navigation system, it can update the sector 2 of the display in the following situations without detecting traffic signs:

- When the vehicle changes road.
- Highway enter/exit.
- Urban area stored in the digital map enter/exit.

## System Limitations

TSA may be impaired or may not function in the following situations:

- If there is poor visibility, e.g. due to insufficient illumination of the road, if there are highly variable shade conditions or in rain, snow or fog.
- If there is glare, e.g. from oncoming traffic, direct sunlight or reflections from other vehicles.
- If the windshield in the area of the camera is dirty, or if the camera is fogged up, damaged or covered.
- If the traffic signs are hard to detect, e.g. due to dirt or snow, or because they are covered or because of insufficient lighting.
- If the information in the navigation system’s digital map is incorrect or out-of-date.
- If the signs are ambiguous, e.g. traffic signs on construction sites or in adjacent lanes.
- When passing buses or trucks with a speed sticker.



## 7 - In an Emergency

Tool Kit .....	258
Hazard Warning Flashers .....	259
In the Event of an Accident .....	260
SOS and Assist Call (OPT) .....	261
In case of a Punctured Tire .....	263
If a Fuse Blows .....	267
In Case of External Lights Fault Signal .....	273
Emergency Release of the Parking Brake .....	274
Transmission Manual Release of P (Park) Position .....	275
Auxiliary Jump-Start Procedure .....	275
Towing a Disabled Vehicle .....	278



## In an Emergency

### Tool Kit

The tools are located in the trunk inside a preformed container.

To access the tools, lift the rear part of the trunk cargo floor, by acting on the handle.



It is possible to maintain the cargo floor in the lifted position when trunk cover is not hooked to liftgate (figure 1), is hooked to liftgate (figure 2) or is removed (figure 3).

The straps for fastening the cargo floor can be found at the ends and along the band fastened by means of Velcro inserts on the floor back side.

Once cargo floor is lifted, release the strap and fasten it at the positions shown in the figures below.

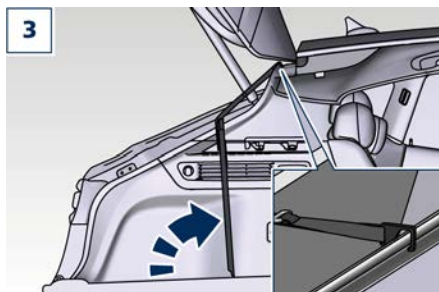
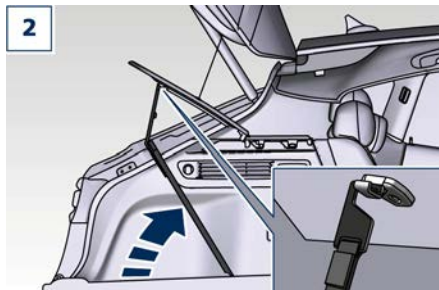
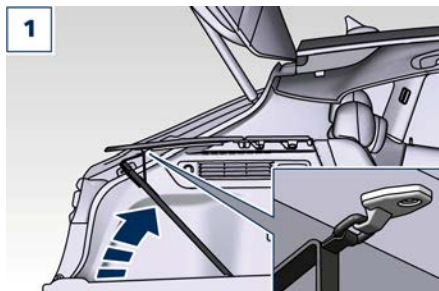

Remove the storage box.

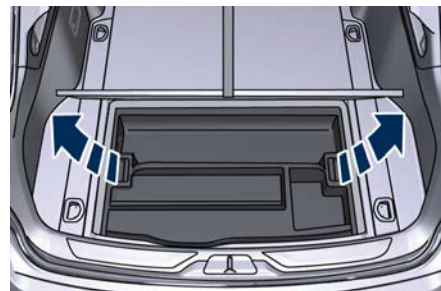

The tools inserted in the trunk container are the following:

Ref.	Description
1	Double torx + cross-head screwdriver
2	Emergency tow hook
3	Electric compressor complete with pressure gage for inflating the compact spare wheel (if equipped)
4	Extended wrench with rubber-coated handle for unscrewing/tightening the wheel nuts
5	Adapter for wheel extended spanner
6	Jack set



Ref.	Description
7	Trailer tongue (OPT, not available for TROFEO version). If equipped, is housed in a bag positioned on the right side of the trunk.

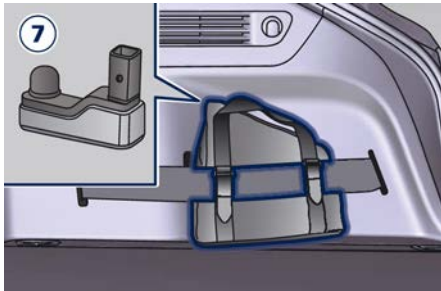
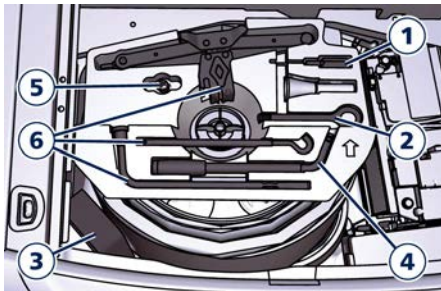

Once these operations are completed, stretch band and fasten it at the back of cargo floor, making sure to match the Velcro inserts. Lower the cargo floor.



## Hazard Warning Flashers

The hazard warning flashers switch is located in the center of the central console, behind the multimedia navigation controls.



Press the switch to turn on the hazard warning flashers to warn oncoming traffic of an emergency. When these lights illuminate, the turn signals, the related indicator lights on the instrument cluster and the button start flashing. Press the switch a second time to turn off the hazard warning flashers.

This is an emergency warning system and it should not be used when the vehicle is in motion. Use it when your vehicle is disabled and it is creating a safety hazard for other motorists. When you must leave the vehicle to seek assistance, the hazard warning flashers will continue to operate even though the ignition is placed in the **OFF** position.



### CAUTION!

- When the hazard warning flashers are activated, the turn signals control is disabled.
- The extended use of the hazard warning flashers may wear down your battery.

## In the Event of an Accident

It is important always to keep calm.

- If not directly involved, stop at a safe distance of at least ten yards (meters) away from the accident area.
- If on a highway, stop without obstructing the emergency lane and be especially careful if you need to exit the vehicle.
- Turn off the engine and switch on the hazard warning flashers.
- At night, illuminate the accident area with the headlights.
- Always act with caution to avoid the risk of being crashed into by other drivers.
- Indicate that an accident has occurred by placing the emergency triangle (if equipped) in a well visible position and at the prescribed distance.
- Call the emergency services, providing as much information as possible. On the highway, use the special call boxes.
- Remove the ignition key (if present) from the vehicles involved.
- If fuel or other chemical products can be smelled, do not smoke and ask people around you to put their cigarettes out.
- To extinguish fires, even small ones, use a fire extinguisher, blankets, sand or earth. Never use water.

- In multiple accidents occurred on highways, particularly where visibility is poor, there is a high risk of being involved in other collisions. Leave the vehicle immediately and move away from the area.

## In case of Injured Persons

- Never leave the injured person alone. Persons not directly involved in the accident are also required to give assistance.
- Do not crowd around injured persons.
- Reassure the injured person that help is on the way.



## SOS and Assist Call (OPT)

The car can be equipped with on-board assistance functions designed to provide support in the event of an accident and/or emergency (SOS Call) or vehicle malfunction (Assist Call).

### NOTE:

For SOS and Assist Call functions, location (GPS) must always be active: any deactivation would make these services unavailable.

### SOS Call

The SOS Call is sent to a private response center (this service is not equivalent to the e-call service envisaged by the applicable legislation for new type-approved vehicles). The call is powered by its own rechargeable battery to ensure operation even when the vehicle battery is low or disconnected.

When the call system battery goes low, the instrument cluster display will show a message and send a notification via mobile App.

### NOTE:

Failure to replace the call system battery or to ignore system warnings may impair or completely exclude the operation of the services.

### In an Emergency

Regardless of the state of charge, the call system battery must be replaced every 5 years at the **Service Network**. The SOS Call is only to be used when there is a concern for the health of individuals. In this case, the operator of the emergency center verifies the status of the vehicle's safety systems and defines with the driver the type of emergency support needed (ambulance, fire brigade, etc..). The SOS Call is automatically forwarded in the event of an accident with air bag deployment providing that the ignition device is in **RUN** position and air bags are working (malfunction warning light  off).

The SOS Call can be activated manually by the user in 3 different ways:

- via the button on the dome console;
- via "SOS call" soft-key on the "Apps" page of the MIA screen;
- using the MIA smartphone application (applicable only in European countries).

#### Via the Button on the Dome Console

Press and hold for a few seconds the SOS Call button on the dome console; the green LED on the button will blink and then become a fixed light indicating that a call has been placed.



The manual SOS Call is possible when the ignition device is in the **RUN** or **ACC** position and in **OFF** position until its backlight stays on, which is a convenient way to get in contact with an operator to request help. When the connection between the vehicle and a safety operator is made, your vehicle will automatically transmit location and vehicle information to the service operator.

### NOTE:

- In case the SOS Call button is accidentally pushed, there is a 10 second delay before the call is placed. The system will verbally alert you that a call is about to be made. To cancel the call connection, press the button on the dome console again.
- The SOS Call function may not be available in the first minute after starting the car.



## In an Emergency

The SOS Call has priority over other audio sources, which will be muted. If you have a phone connected via Bluetooth®, it will be disconnected and reconnected again at the end of the call. Voice prompts will guide you during the SOS Call.

If a connection is made between a service operator and your vehicle, you understand and agree that operators may, like any other SOS Call, record conversations and sounds in and near your vehicle upon connection.

Only a safety operator can remotely end the SOS Call and, if necessary, call back the vehicle eCall system. After the call, you can still call the emergency service operator to indicate additional information by pressing the button again. In an Emergency, the connection and the call to the operator of the SOS center will immediately be activated and the following screen will be displayed on the MIA App.

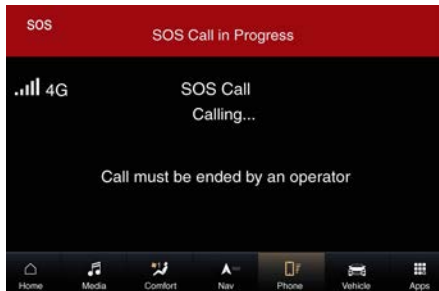

During the SOS Call, if the user opens another page and exits the screen, the SOS Call status bar will be shown on all the other screens too, displaying "SOS Call in Progress" in writing and the call time, if available.

For further information, see the “Maserati Intelligent Assistant (MIA)” guide.

### SOS Call Not Available Messages

The SOS Call is not available in the following cases:

- during a system update process;

- system error (generic fault, sim fault, antenna, USB connection, etc..);
- the subscription to the service is not active or has expired. In these cases, the SOS Call can be temporarily unavailable.

### NOTE:

**If a customer has not subscribed to Maserati Connected Services, the SOS Call will not be available. For more details, see the official Maserati website.**

### Assist Call

The Assist Call service is available only where the user has an active assistance coverage.

Assist Call requires the ignition device to be in **RUN** or **ACC** position with a properly functioning electrical system. Owners have the ability to activate to types of Assist Call:

#### • Roadside Assistance Call

Road Assistance provides 24 hours / 7 days of assistance in case of vehicle-related problems (towing, flat tire, etc..) and dispatches roadside assistance to the vehicle's location. Enter the “Assist Call” menu of the "Apps" and touch the “Road Assistance” soft-key.



**NOTE:**

When the user selects the "Road Assistance" soft-key, the vehicle location will be sent through to the call center.

**• Customer Service Call**

Customer Service provides assistance and support on general inquiries. Enter the "Assist Call" menu of the "Apps" and touch the "Customer Service" soft-key.

**NOTE:**

- When the user selects the "Customer Service" soft-key, the vehicle location will be sent through to them.
- If a customer has not subscribed to Maserati Connected Services, the Assist Call will not be available. For more details, see the official Maserati website.

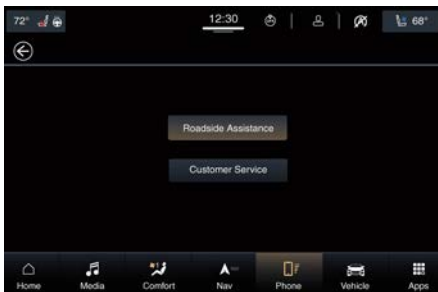
**In an Emergency****NOTE:**

- Roadside Assistance Call or Customer Service Call may not be available in the first minute after starting the car.
- In case the Roadside Assistance Call or Customer Service Call soft-key are inadvertently touched on the MIA screen, the call can be interrupted by touching the end call soft-key.
- If there is an active SOS Call, neither a Roadside Assistance or Customer Service Call can be triggered. For further information, see the "Maserati Intelligent Assistant (MIA)" guide.

**Assist Call Not Available Messages**

The Assist calls are not available in the following cases:

- the subscription to the service is not active or has expired;
- there are problems connecting to the network. In these cases, the user will be warned that the call cannot be made on the TFT display.

**In case of a Punctured Tire**

The vehicle is equipped with a compact spare wheel.

**Using the Compact Spare Wheel**

The automatic leveling of pneumatic suspensions might create problems when it is necessary to lift the vehicle to replace the wheel featuring punctured tire with the emergency wheel supplied or with another wheel.

**CAUTION!**

Before mounting the compact spare wheel it is necessary to disable the suspension system by scrolling the user settings on MIA and selecting "Wheel Replacement Mode" in "Suspensions" submenu. The tick next to selected item will indicate that this mode is active and pneumatic suspension system is disabled (for further details, refer to "Functions of Settings Menu on MIA" chapter in section "Dashboard Instruments and Controls"). After servicing, restore original conditions and eliminate the tick next to selected mode: in this way the pneumatic suspension system will go back to normal operation.

**(Continued)**



## In an Emergency

### NOTE:

The compact spare wheel is supplied in aluminum or steel: the pictures show the one in aluminum.

The compact spare wheel is stored in the trunk and is supplied deflated in order to limit the amount of space occupied. An electric compressor is also provided for inflating. In the event of a tire puncture, proceed as follows.

- Stop the vehicle in a place that does not constitute a danger to traffic and where the wheel can be changed safely. The vehicle must be level and on firm ground.
- Select the P (Park) mode and then engage manually the electric parking brake and move the ignition device to **OFF** position.
- If necessary, turn the hazard warning flashers on and place the warning triangle (if equipped) at the required distance.



### WARNING!

- **The jack should be used on level firm ground wherever possible.**
- **It is recommended that the wheels of the vehicle be chocked, and that no**

**person should remain in a vehicle that is being jacked.**

- **If the vehicle has been stopped on a slope or an uneven surface, place chocks or other suitable items in front of or behind the wheels to stop the vehicle from moving.**
- **Never start or run the engine with the vehicle on a jack.**
- Lift the ground coverage of the trunk (see chapter "Tool Kit" in this section).
- Take the tools (indicated in picture) for changing the wheel from the container.

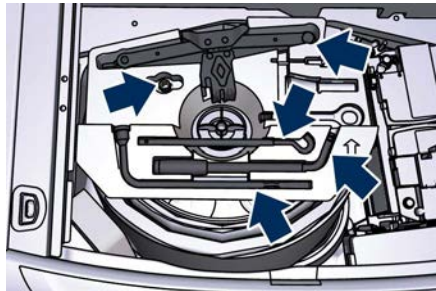

- Unscrew and pull out the spare wheel locking knob.
- Take the tool box container, the compressor and the compact spare wheel out of the trunk.

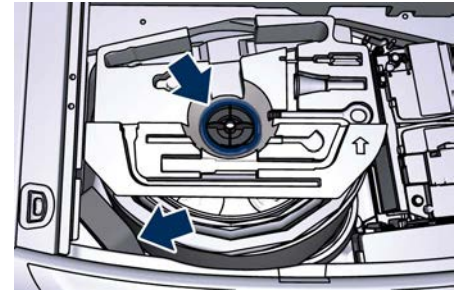

- Fit the adapter on the wrench. Extend the wrench as shown, then loosen by approximately one turn, the five bolts on the wheel to be changed. In case a wheel security stud bolt is installed, it can only be removed by using the specific fitting wrench insert provided with the "Wheel Security Stud Bolt Kit", available in the "Genuine Accessories" range. In this case, the insert must be installed on the kit wrench.

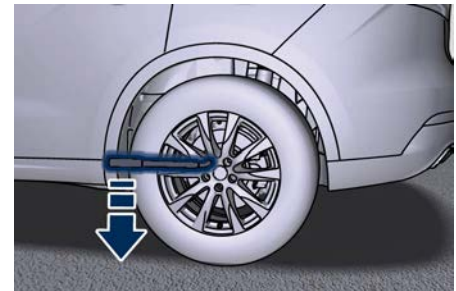

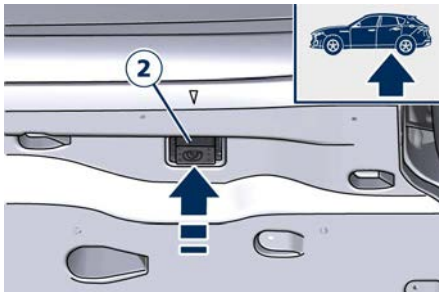
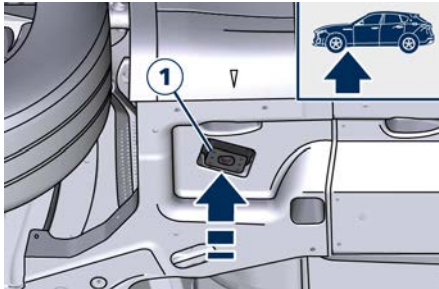

- Place the jack near the wheel to be changed as illustrated. Make sure that the head of the jack is correctly inserted in one of the slots **1** or **2** under the longitudinal member.

**WARNING!**

- Never position yourself under a jacked vehicle.**
- A jack in the wrong position could cause the vehicle to fall. Severe risk to the operator's safety and damage to the vehicle could occur.**
- Never use the jack to carry out maintenance or repairs under the vehicle.**
- Insert the extension levers in the jack.
- Turn clockwise the extension lever of the jack until the wheel is raised a few inches off the ground.



- Completely unscrew the five bolts and remove the wheel.
- Make sure that the contact surfaces between spare wheel and hub are clean and free of impurities.
- Fit the compact spare wheel with the valve stem side out and secure it with

- the five bolts previously removed, without tightening them.
- Remove from the compressor case the inflation hose and the cable with a plug for the power outlet.
- Unscrew the valve cap of the compact spare wheel and screw the fitting of the inflation hose onto the valve.
- Insert the plug inside one of the available power outlets fitted in the trunk or passenger compartment.
- Set the ignition device on **ACC** or **RUN** position.
- Turn the compressor on by pressing the switch.
- When the pressure indicated by the gauge reaches the recommended level of 350 kPa - 51 psi - 3.5 bar (  : chapter "Tire Inflation Pressure" in section "Technical Specifications"), stop the compressor by pressing switch again and screw the cap on the compact spare wheel valve.





### WARNING!

- In order to obtain a more accurate reading, the compressor should be switched off when checking the tire pressure of the compact spare wheel on the pressure gauge.
- Do not run the compressor for more than 20 minutes: there is a risk it could overheat. Also, prolonged power absorption may discharge the battery, subsequently preventing the engine from starting.
- The compressor has been designed exclusively to inflate compact spare wheels; do not use it to inflate air mattresses, dinghies etc.
- Turn counterclockwise the extension lever of the jack to lower the vehicle and remove the jack.
- Fully tighten the bolts, alternately tightening diametrically opposite.



### WARNING!

- **FOR ALUMINIUM SPARE WHEEL** Observe the tightening torque for the bolts securing the compact spare wheel ( $72 \pm 7$  lbf-ft/  $98 \pm 10$  Nm).
- **FOR STEEL SPARE WHEEL** Observe the tightening torque for the bolts

securing the compact spare wheel ( $63 \pm 7$  lbf-ft/  $86 \pm 10$  Nm).

- Bolts must be tightened only after vehicle is back to ground, so as to prevent it from falling down due to the force exerted for bolt tightening. Failure to comply with this recommendation can cause operator injuries.



### WARNING!

- The compact spare wheel is narrower than standard wheels and must only be used to travel the distance required to reach a service station, where the punctured tire can be repaired or replaced.
- Do not exceed a maximum speed of 50 MPH (80 km/h) when using the compact spare wheel; when this limit is exceeded, the stability, road

holding and braking of the vehicle will be compromised. Avoid accelerating to full speed, heavy braking and fast cornering.

- The compact spare wheel must be inflated to the recommended tire pressure (  : chapter "Tire Inflation Pressure" in section "Technical Specifications").
- For safety reasons, it is absolutely forbidden to drive with more than one compact spare wheel fitted on the vehicle.
- Snow chains cannot be fitted on the compact spare wheel.
- The spare wheel can travel a maximum of 1,800 mi (3,000 km).

### To Refit the Standard Wheel with Repaired or Replaced Tire

- Following the procedure and the caution described above, raise the vehicle and remove the compact spare wheel reusing the supplied wrench with adapter, suitably extended.
- Fit the standard wheel with repaired or replaced tire.
- Tighten the original bolts on the wheel.
- Lower the vehicle and remove the jack.
- Fully tighten the bolts, alternately tightening diametrically opposite.

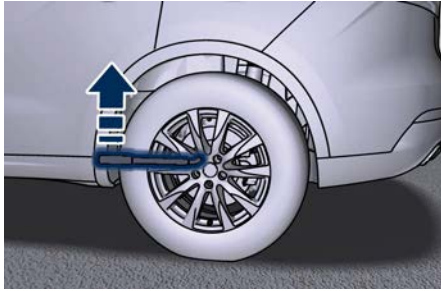
**WARNING!**

Observe the tightening torque for the bolts securing the wheels ( $72 \pm 7$  lbf-ft /  $98 \pm 10$  Nm).

Once finished:

- completely deflate the compact spare wheel by pressing on the valve with the overhang of the valve cap;
- wrap the power cable and the inflation hose inside the compressor case and place it in the trunk seat;
- place the compact spare wheel and tool container in the trunk;
- fix everything in place with the locking knob;

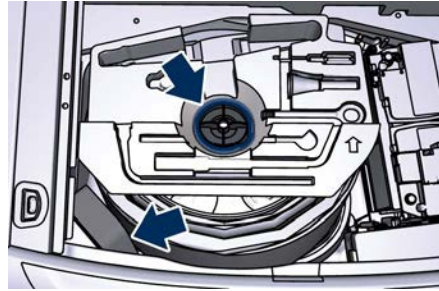

- place the extension levers, the jack, the spanner and the adapter in the container inside the compact spare wheel;

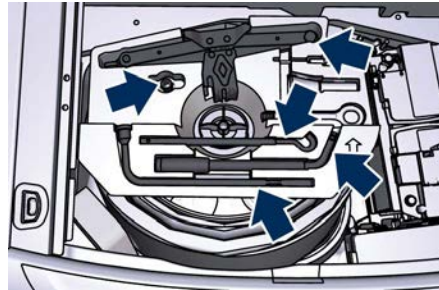

- reposition the other tools and the accessories storage box;
- lower the ground coverage at the bottom of the trunk.

## If a Fuse Blows

### Used Fuses Characteristics

When an electrical device is not functioning, check that the corresponding fuse is in proper working order (intact).

**A** Fuse intact

**B** Fuse blown



The vehicle mainly uses mini- and maxi-fuses with blade engagement. Besides these there are other types of fuses provided with holes for attaching to the cable connection terminals.

For the replacement of these fuses contact an **Authorized Maserati Dealer**. Replace the faulty fuse with a new one featuring the same rating, by using appropriate forceps added in the integrated power module and inside the cover of the rear power distribution center.



## In an Emergency

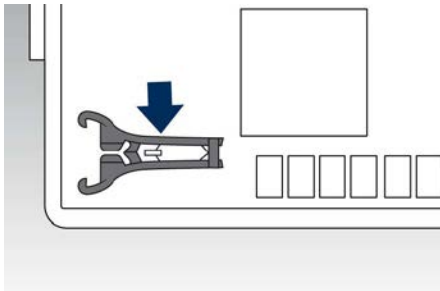

The color identifies the value of the fuses in amperes which is also reported on them.

The table shows the match between color and amperage of mini and maxi fuses.

Type	
Mini Fuse	Maxi Fuse
Beige - 5	Yellow - 20
Brown - 7,5	Green - 30
Red - 10	Orange - 40
Blue - 15	Red - 50
Yellow - 20	Blue - 60
White - 25	
Green - 30	



### CAUTION!

- Never replace a blown fuse with anything other than a new and suitable fuse (same rating).
- After replacing a fuse, if the fault recurs, contact an **Authorized Maserati Dealer**.

### Position of Fuses

The fuses are located in three parts of the vehicle, namely:

- inside the integrated power module, on the right hand side of the engine compartment;

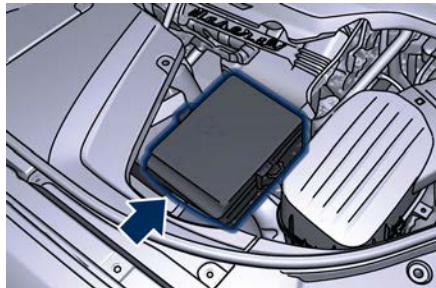

- inside the rear power distribution center, behind the battery, on the right hand side of the trunk compartment;

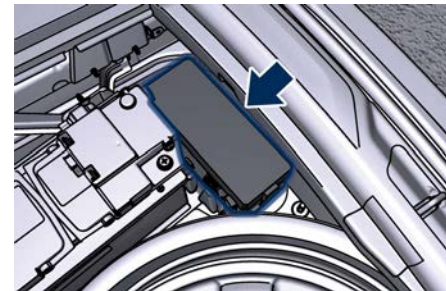

- on the fuse and relay box located in a covered area, under the dashboard left side.

### Integrated Power Module

- To access the module it is necessary to lift the hood (see "Hood Operation" in section "Before Starting").
- To access the fuses remove the module cover unhooking the lateral locks as shown in the picture. To recognize the reference number of the fuses in the table below, see the diagram inside the cover just removed.

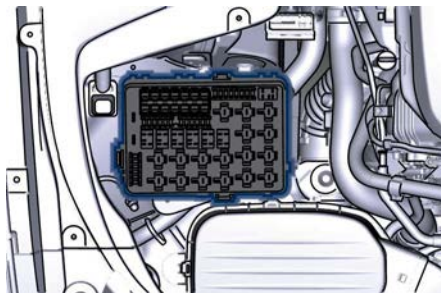
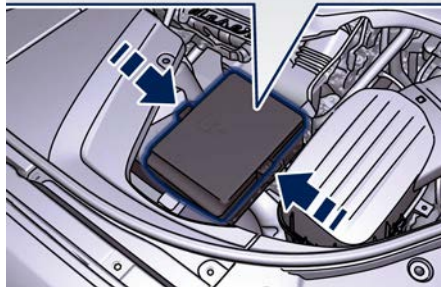
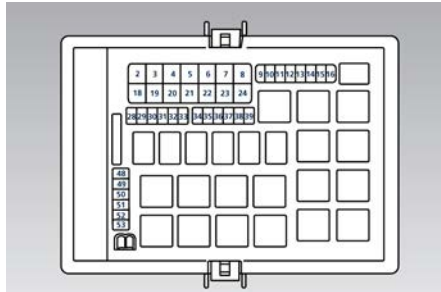

The table points out the position as featured in the cover, the type and function of the fuses included in the integrated power module.



**CAUTION!**

- After replacement, refit the protective cover of the module.
- If you need to wash the engine compartment, do not direct the water for too long directly on the module.

Ref.	Type	Function
2	Maxi – 50A	Secondary air pump relay input (3.8 V8 engines only)
3	–	–
4	Maxi – 30A	Starter motor relay input
5	Maxi – 40A	ABS-ESP pump feed
6	Maxi – 30A	AWD module relay input
7	–	–
8	Maxi – 40A	ABS-ESP valve feed
9	–	–
10	–	–

Ref.	Type	Function
11	Mini – 20A	Horn relay input
12	Mini – 10A	AC compressor feed relay input
13	–	–
14	Mini – 7,5A	Alarm siren
15	Mini – 5A	Washer heated nozzles relay input
16	Mini – 10A	Enable cooling fan relay input and enable cooling oil pump relay input
18	–	–
19	Maxi – 30A	Headlamp washer relay input
20	Maxi – 30A	Wiper motor relay output
21	Maxi – 20A	LH low beam relay input (with Bi-Xenon headlight)
22	Maxi – 20A	RH low beam relay input (with Bi-Xenon headlight)



Ref.	Type	Function
23	–	–
24	–	–
28	Mini – 7,5A	Drive Assist System Module (DASM)
29	Mini – 10A	PCM module - Starter solenoid relay coil - Voltage Body & Dashboard, PTC relay coil
30	Mini – 5A	ORC- Air bag module
31	Mini – 5A	ABS-ESP module
32	Mini – 5A	AWD module, EPS and AQS
33	Mini – 10A	HDLP Headlights - AFLS
34	Mini – 15A	Primary load to engine harness LH side
35	Mini – 15A	Primary load to engine harness RH side
36	Mini – 30A	PCM module primary load

Ref.	Type	Function
37	Mini – 15A	Engine secondary load
38	Mini – 15A	Lambda sensor
39	Mini – 7,5A	Flow meters, tank lackage, canister, exhaust by-pass valve relay coil and air shutter
48	–	–
49	Mini – 10A	Pedal brake switch - TCM module
50	Mini – 15A	+30 PCM module
51	Mini – 30A	Fuel pump relay input
52	Mini – 5A	Starter solenoid signal for PCM and voltage stabilizer
53	Mini – 10A	AWD module

### Rear Power Distribution Center

- To access the center it is necessary to lift the ground coverage of the trunk compartment (see chapter “Tool Kit” in this section) and remove the storage box.

- To access the fuses, release the cover latch shown in picture.

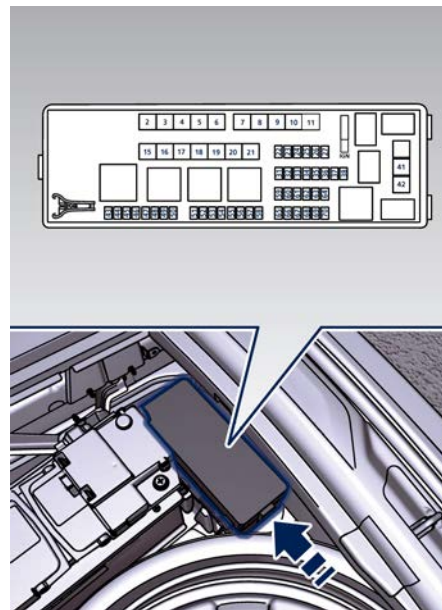

- Press the release latch and lift the lid from this side.
- Push the lid toward the right side to release the indicated latches on the unit. To recognize the reference number of the fuses in the table below, see the diagram inside the cover just removed.



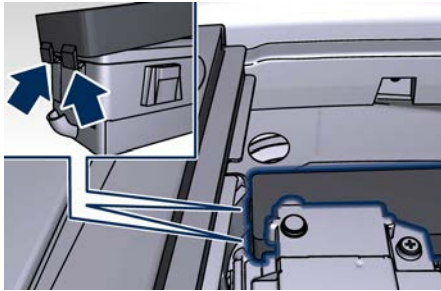

The table points out the position as featured in the cover, the type and function of the fuses on the rear area distribution control unit.

Ref.	Type	Function
2	Maxi – 40A	BCM module
3	Maxi – 40A	BCM module
4	Maxi – 30A	BCM module
5	Maxi – 30A	BCM module
6	Maxi – 20A	Trailer harness (not for TROFEO version)
7	Maxi – 30A	Driver door module
8	Maxi – 30A	Passenger door module
9	Maxi – 40A	Start&Stop: voltage stabilizer, dashboard

Ref.	Type	Function
10	Maxi – 40A	Start&Stop: voltage stabilizer, body
11	Maxi – 40A	“High Premium” stereo amplifier unit
	Maxi – 20A	“Premium” stereo amplifier unit (1)
15	Maxi – 40A	HVAC front blower relay coil
16	Maxi – 40A	Rear window defrost relay coil (HVAC module)
17	Maxi – 30A	Rear LH door module
18	Maxi – 30A	Rear RH door module
19	Maxi – 25A	Power liftgate module
20	Maxi – 20A	“Premium” stereo amplifier unit (2)
21	Maxi – 40A	ELDOR coil (3.8 V8 engines only)

Ref.	Type	Function
22	Mini – 7,5A	Rear HVAC module
23	Mini – 10A	Fuel door relay and RF Hub module
24	Mini – 10A	ITM module, ceiling light unit (front and rear), rain/lights sensor
25	Mini – 25A	Sunroof module
26	–	–
27	Mini – 7,5A	Front HVAC module
31	Mini – 30A	LH front seat movement
32	Mini – 15A	Trailer module LH side (not for TROFEO version)
33	Mini – 15A	Trailer module RH side (not for TROFEO version)
34	Mini – 20A	Soft Door Close latch
35	Mini – 20A	Rear doors sunshade



Ref.	Type	Function
36	Mini – 10A	Transmission lever, Navtrak, USB (Y2), USB charger, ASBM control suspension and Hands Free access module
37	Mini – 25A	ASCM module
38	Mini – 30A	RH front seat movement
41	Maxi – 40A	ASCM motor supply
42	–	–
43	Mini – 20A	Seat passenger heater module
44	–	–
45	–	–
46	Mini – 5A	Rear camera
47	Mini – 5A	Navtrak
48	Mini – 5A	Surround view
49	Mini – 10A	Internal temperature sensor, internal mirror and HALF
50	–	–

Ref.	Type	Function
51	Mini – 25A	Rear seat and steering wheel heater module
52	Mini – 20A	Boot power outlet
53	–	–
54	Mini – 7,5A	Blind Spot module
55	–	–
56	Mini – 10A	Blower front HVAC coil relay
57	Mini – 10A	Blower rear HVAC coil relay
58	Mini – 10A	Trailer harness (not for TROFEO version)
59	Mini – 10A	USB charger, transmission lever, ASBM, rear tunnel stack switch
60	–	–
61	Mini – 15A	Rear window wiper relay
62	Mini – 7,5A	Front HVAC module
63	Mini – 20A	Blower rear HVAC

Ref.	Type	Function
64	Mini – 7,5A	Rear HVAC module
65	Mini – 10A	Intelligent battery sensor
67	Mini – 10A	Sunroof
68	Mini – 20A	Power outlet on central console rear side
69	Mini – 25A	Rear console power outlet and cigar lighter
70	Mini – 10A	Front HVAC module, Parking Aid Module (PAM), ASCM Front HVAC module, Parking Aid Module (PAM), ASCM and ELDOR coil (3.8 V8 engines only)

## Fuse Box under the Dashboard

This box is located in an internal area under the dashboard left side.

Considering the complexity of this operation, we recommend having



the fuses replaced by an **Authorized Maserati Dealer**.

The table points out the position as featured in the figure, the type and function of the fuses in the box under the dashboard.

Ref.	Type	Function
1	Mini – 7,5A	Cluster module, USB charger, CSS, SGW and DSRC (Japan version only)
2	Mini – 15A	Cluster module, clock
3	Mini – 10A	DSRC and DTV system (Japan version only)
4	Mini – 5A	E-call
5	Mini – 7,5A	Security Gateway, Radio display
6	Mini – 15A	Radio
7	Mini – 10A	Column software module, CSS
8	Mini – 10A	Start & Stop switch, diagnostic outlet

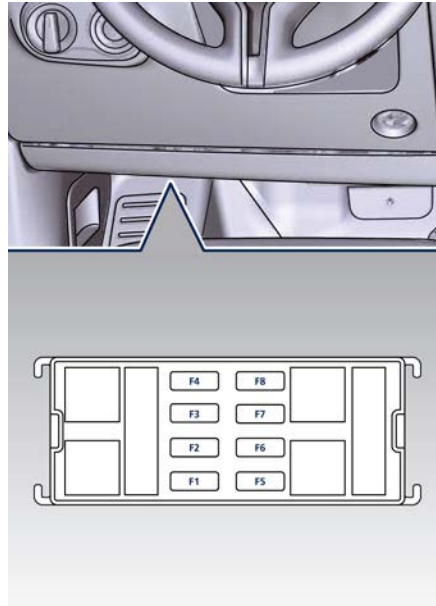

## In Case of External Lights Fault Signal

The signal failure of an external light (turn signal, low beam and high beam, license plate light, reverse light and brake light) is communicated to the instrument cluster that displays on the TFT screen in a graphical form and with a text message which light is faulty (see example in the figure).



## Replacement of LED Lights



**CAUTION!**

Except for Bi-Xenon headlamp bulbs, the front and rear light clusters are equipped with LEDs.

It is not possible to replace a single LED of the cluster, we recommend that you contact the **Authorized Maserati Dealer** for the replacement of the entire cluster.



### WARNING!

The vehicle can be equipped with the **Bi-Xenon bulbs**: these bulbs are a type of high voltage discharge tube. High voltage can remain in the circuit even with the headlamp switch and the ignition device off. Because of this, you should not attempt to replace a **Bi-Xenon bulb yourself, but take the vehicle to an Authorized Maserati Dealer for service.**

Most of the bulbs are LED powered and cannot be replaced individually.

Contact an **Authorized Maserati Dealer** to locate the correct parts and replace them.

## Emergency Release of the Parking Brake

---

In the event the electric parking brake locks due to a system failure (see “Parking Brake” in section “Starting and Driving”), it is not possible to move the vehicle, since the power actuator that operates on the brake pad inside each rear caliper will lock the rear wheels. After verifying that the battery is sufficiently charged (otherwise use an external power source connected to the vehicle electric system to operate the EPB control lever and try to unlock the parking brake), for moving the vehicle it is necessary to address the electric actuator or caliper to undo the locked brake calipers. Contact the **Authorized Maserati Dealer** to carry out this operation.



### CAUTION!

If the parking brake has been activated in manual or automatic mode and it is not possible to release it by operating on the lever of the central console, do not move the vehicle since rear brake calipers might be damaged. For more information on vehicle towing see

"Towing a Disabled Vehicle" chapter in this section.



## Transmission Manual Release of P (Park) Position

The manual disengagement of the shift from P (Park) has the purpose to allow towing the vehicle if not normally possible using the shift lever (such as inability to start the engine).

This procedure is exclusively intended for emergency situations, only!



### WARNING!

**Always secure your vehicle by fully applying the parking brake, before activating the manual park release. Activating the manual park release could allow your vehicle to roll away if it is not secured by the parking brake. Activating the manual park release on an unsecured vehicle could lead to serious injury or death for those in or around the vehicle.**

The cover that allows the emergency manual park release is located on the left part of the driver's foot well.

- Lift the mat on the driver side to access the cover.
- Slip the cover from its seat.

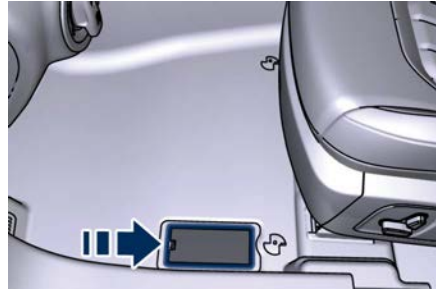

- Take strap out of its seat.
- With the tip of a screwdriver press the clip shown in the picture box and lift the strap up to release the transmission from the P (Park) position. The new position will allow vehicle moving and towing.
- Release the parking brake only when the vehicle is securely connected to a tow vehicle.

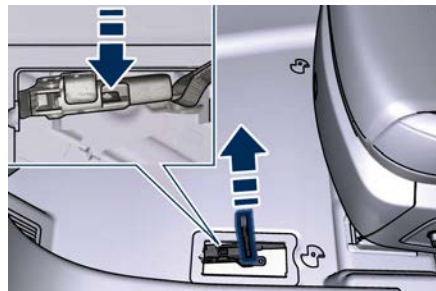

## Auxiliary Jump-Start Procedure

If your vehicle has a discharged battery it can be jump-started using a set of jumper cables and a battery of another vehicle or by using a portable battery booster. It is necessary to have proper jumper cables in order to connect the booster battery to the remote posts of the discharged battery. Booster cables have positive and negative terminal clamps and are identified by the sheath color (red = positive, black = negative).

### NOTE:

**An Authorized Maserati Dealer can provide you with information about the "Maserati Jumper Cables Kit", available in the "Genuine Accessories" range.**

Jump-starting can be dangerous if done improperly so please follow the procedures in this section carefully.

### NOTE:

**When using a portable battery booster pack, follow the battery manufacturer's operating instructions and precautions.**



## CAUTION!

- To jump start a vehicle do not use a portable battery, a booster pack or any other booster source with a system voltage greater than 14 Volts or damage to the battery, starter motor, alternator or electrical system of the vehicle with the discharged battery may occur.
- Do not use a battery charger for emergency starting under any circumstances. You could damage the electronic systems, particularly the control units managing the ignition and fuel supply functions.
- If the battery is completely discharged when the windows are fully raised, open the door with the utmost care; do not close the door again until it is possible to lower the window.



## WARNING!

- Always perform jump-starting operations with appropriate tools and environmental conditions, taking all necessary precautions.
- Do not attempt jump-starting if the discharged battery is frozen.
- To avoid the risk of explosion or fire, do not approach the battery with

open flames or cigarettes that could generate sparks.

### NOTE:

If you need to disconnect the battery from the vehicle electrical system, see “Battery Status and Maintenance” in section “Maintenance and Care”.

### Battery Remote Posts Position

For easier operation, remote battery posts for jump-starting are located in the engine compartment while the battery is stored in the trunk.

After lifting the hood (see “Hood Operation” in section “Before Starting”) the positive remote post (+) and the negative remote post (–) are shown in the picture and are easily recognizable by the icons labeled on the integrated power module.

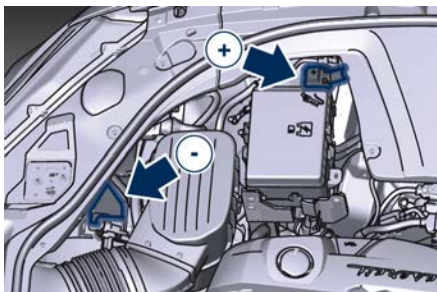

3.8 V8 Engines

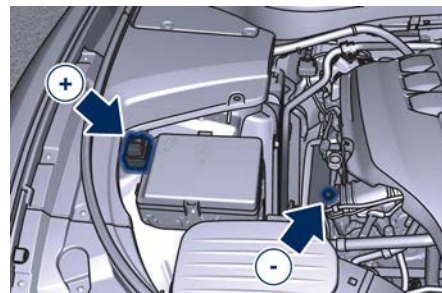

3.0 V6 Engines

### Jump-Start Procedure



## WARNING!

- Stay clear of the radiator cooling fan whenever the engine hood is raised. It can start anytime the ignition device is on. You could be injured by the moving fan blades.
- Remove any metal jewelry such as watch bands or bracelets that might make an inadvertent electrical contact. You could be seriously injured.
- Do not allow the vehicles involved in the jumpstarting operation to touch each other as this could establish a ground connection and cause personal injury.
- Turn off the heater, radio, and all unnecessary electrical accessories.



- Set the parking brake, shift the automatic transmission into P (Park) and set the ignition device to **OFF**.
- If using another vehicle to jumpstart the battery, park the vehicle within the jumper cables reach and set the parking brake and make sure the ignition is off.
- Connect one terminal clamp of the positive jumper cable to the positive (+) remote post of the vehicle with the discharged battery after lifting the protection cap of the cable indicated on the external side of the integrated power module.
- Connect the opposite terminal clamp of the positive (+) jumper cable to the positive (+) post of the booster battery.
- Connect one terminal clamp of the negative jumper cable to the negative (-) post of the booster battery.
- Connect the opposite terminal clamp of the negative (-) jumper cable to the remote negative (-) post of the vehicle with the discharged battery as rendered.

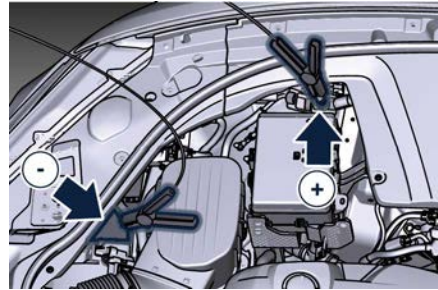

3.8 V8 Engines

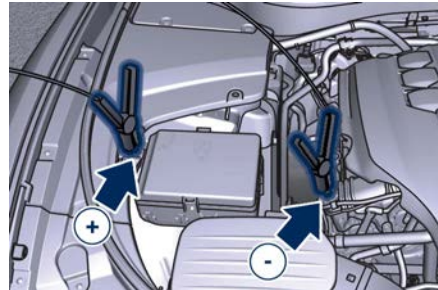

3.0 V6 Engines

- Start the engine in the vehicle that has the booster battery, let the engine idle a few minutes, and then start the engine in the vehicle with the discharged battery. If using a portable battery booster, wait a few seconds after connecting the cables, before starting the booster vehicle.

Once the engine is started, remove the jumper cables in the reverse sequence.

- Disconnect the terminal clamp of the negative (-) jumper cable from the remote negative (-) post of the vehicle with the discharged battery.
- Disconnect the opposite terminal clamp of the negative jumper cable from the negative (-) post of the booster battery.
- Disconnect the terminal clamp of the positive (+) jumper cable from the positive (+) post of the booster battery.
- Disconnect the opposite terminal clamp of the positive jumper cable from the remote positive (+) post of the discharged vehicle.

**NOTE:**

If frequent jump-starting is required to start your vehicle you should have the battery and charging system inspected at an **Authorized Maserati Dealer**.



## In an Emergency

### Towing a Disabled Vehicle

Proper towing or lifting equipment is required to prevent damage to your vehicle.



#### CAUTION!

Any improper maneuver and use of unsuitable equipment for recovering vehicle in an emergency from off road location could seriously damage the vehicle. Contact an **Authorized Maserati Dealer**.

### Manual Release of Transmission with Low Battery

In order to push or tow the vehicle if unable to shift the transmission out of P (Park) (such as a discharged battery), a manual park release is available. In this case it is necessary to manually release the shift lever and release the parking brake if inserted (see "Emergency Release of the Parking Brake" in this section).

Follow the steps as indicated in "Transmission Manual Release of P (Park) Position" in this section to manually disengage the transmission.

### Vehicle Towing Conditions

Maserati only allows vehicle towing with all four wheels off the ground.



#### CAUTION!

Single axle towing or use of a tow dolly is not allowed since it will severely damage vehicle components.

### Use the Tow Hook Included in the Tool Kit



#### CAUTION!

The tow hook should only be used for towing the car on flat roads. Do not use the tow hook to remove the car that is stuck on off road stretches.

The tow hook is also used to tow the vehicle on the platform of a tow truck. Before carrying out this operation, if the battery of the vehicle still works, set "Transport Mode" on MIA in "Suspensions" submenu (see "Functions of Settings Menu on MIA" chapter in section "Dashboard Instruments and Controls"). With this mode activated, the ride height will be lowered to the minimum value and the pneumatic suspension system will be disabled to help vehicle loading on the tow truck. The tow hook is contained in the tool kit (see "Tool Kit" chapter in this section) and must be screwed in the seat located on the front and rear bumper.

- To access the front tow hook seat on the front bumper, remove the cover on the right side of the bumper lower grid.

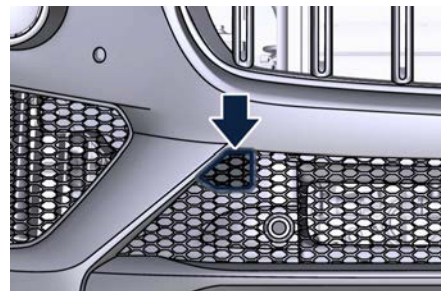
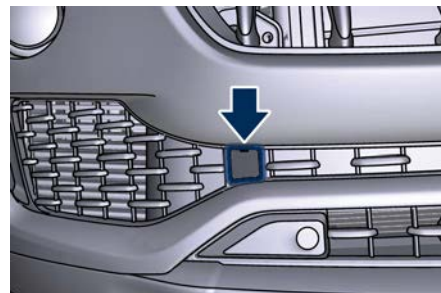

MODENA S and TROFEO Versions

- To access the rear tow hook seat, remove the external cap on the right side of the rear bumper (not present on TROFEO version).



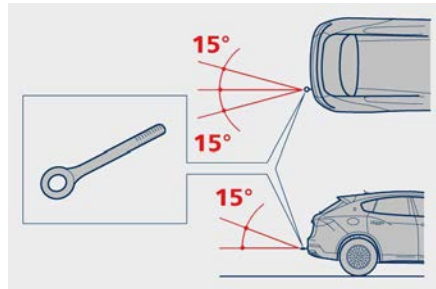
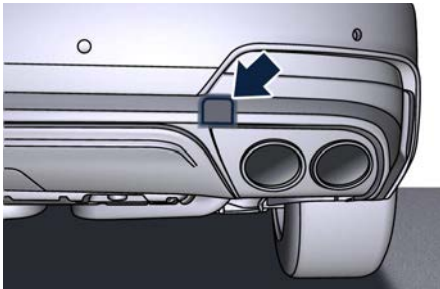
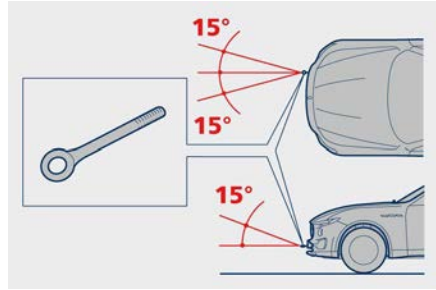
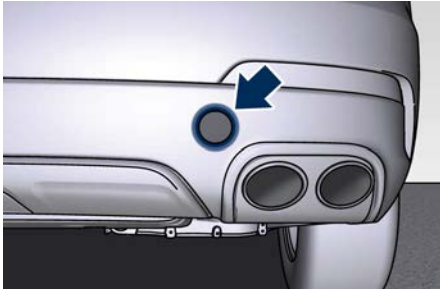

#### MODENA S Version

- Carefully clean the threaded seat before screwing the hook.
- Screw the tow hook into its seat for at least 11 turns.

#### NOTE:

Maximum work angle of towing cable:  
15°.





## 8 - Maintenance and Care

Scheduled Maintenance Service .....	282
Scheduled Service Plan .....	283
Maintenance Service Components .....	289
Maintenance Procedures .....	292
Battery Status and Maintenance .....	300
A/C System Maintenance .....	304
Wheels Maintenance .....	305
Bodywork Maintenance and Care .....	307
Interior Maintenance and Care .....	310
Vehicle Stored for Long Periods .....	311
Restarting the Vehicle after a Long Inactivity .....	312



## Scheduled Maintenance Service

Correct maintenance is clearly the best way to guarantee vehicle performance and safety functions, ensure respect for the environment and low operating costs.

**NOTE:**

Also remember that the observance of the maintenance procedures is essential for keeping your vehicle operating properly. Not adhering to the “Scheduled Service Plan” can impact your vehicle’s warranty.

### Interval Running Coupons

Maserati has therefore provided for a series of checks and maintenance operations involving the 1<sup>st</sup> service and subsequent when the vehicle reaches mileage/years reported on the “Scheduled Service Plan” in this section. After the last service, maintenance must be restarted with the operations scheduled for the 1<sup>st</sup>, 2<sup>nd</sup> and 3<sup>rd</sup> service.



**CAUTION!**

The Scheduled Maintenance services are prescribed by the Manufacturer. Failure to have the services carried out can affect your warranty.

The Scheduled Maintenance service is provided by an **Authorized Maserati Dealer**. In the event that, when a service is performed, further replacements or repairs are found to be necessary in addition to the scheduled operations, these can be carried out only with the specific consent of the Customer.



**CAUTION!**

You are advised to notify the **Authorized Maserati Dealer** of any minor operating problem, without waiting for the next scheduled service.

**NOTE:**

- Change your engine oil more often if you drive your vehicle off-road for an extended period of time or short trips without reaching operating temperatures. Even the use of the vehicle with extremely hot or cold ambient temperatures and with trailer tow may make more frequent engine oil changes necessary.

- Under no circumstances should oil change intervals exceed mileage/years reported on the “Scheduled Service Plan” in this section.



**CAUTION!**

Failure to perform the required maintenance items may result in damage to the vehicle.

## Scheduled Maintenance (Service) Indicator

The service indicator system will remind you the deadline for the maintenance program.

The indicator light  on the instrument cluster flashes for approx. 5 seconds displaying the message backed by a beeping sound, indicating that the next scheduled maintenance is due or has already overdue.





When the scheduled maintenance has overdue, the indicator light  and message will be displayed on the instrument cluster.



The service indicator and message will illuminate approximately from 620 mi (1000 km) or 30 days to the next scheduled maintenance.

Have your vehicle serviced as soon as possible.

**NOTE:**

The service indicator will not monitor the time elapsed from the last scheduled maintenance.

To check the mi/km and the days that remain at the inspiration of the next scheduled maintenance, consult the “Maintenance” submenu of “Vehicle Info” main menu (see paragraph “TFT Display: Menu and Submenu Content” in section “Dashboard Instruments and Controls” for more details).

An **Authorized Maserati Dealer** will reset the service indicator message after completing the scheduled maintenance operations.

## Scheduled Service Plan

The Scheduled Maintenance services listed in this manual must be done within the times or mileages specified to protect your vehicle warranty and ensure the best vehicle performance and reliability.

More frequent maintenance may be needed for vehicles in operating conditions, such as dusty areas, extremely hot or cold ambient temperatures and very short trip driving. Inspection and service should also be done anytime a malfunction is suspected.

Maserati recommends that these maintenance intervals be performed at an **Authorized Maserati Dealer**. The technicians at your dealership know your vehicle best, and have access to factory-approved information, genuine Maserati parts, and specially designed electronic and mechanical tools that can help prevent future costly repairs.



**Main Operations/Service Coupons**

	Interval running coupons: every 12428 mi (20000 km) or 1 year (whichever occurs first)					
Service coupons	1°	2°	3°	4°	5°	6°
<b>Main operations</b>	<b>Available Pre-Paid Maintenance Program</b>					
Vehicle road test						
Check with Maserati Diagnosis						
Engine oil and filter	R	R	R	R	R	R
Engine coolant level						
	Replace every 10 years or 150,000 mi (240,000 km)					
Engine check for leaks						
Cooling system connections and lines (check for leaks)						
Air filter				R		
Belt for alternator, water pump and air conditioning compressor (3.8 V8 engines)				R		
	Replace every time the part is removed					
Belt for alternator (1) and belt for water pump and air conditioning compressor (3.0 V6 engines)				R		
	Replace every time the part is removed					
Spark plugs			R			R
Intercooler check for leaks						
Brake fluid						
	Replace every 2 years					
Brake system (lines, calipers, connections) - Instrument cluster warning light efficiency - Parking brake operation						
Tire wear, tire and spare tire pressure check						



	Interval running coupons: every 12428 mi (20000 km) or 1 year (whichever occurs first)					
Service coupons	1°	2°	3°	4°	5°	6°
<b>Main operations</b>	<b>Available Pre-Paid Maintenance Program</b>					
Joints, rods for front and rear suspensions, front and rear under-chassis	I	I	I	I	I	I
Correct operation and reliability of the seats and seat belts	I	I	I	I	I	I
Pollen filter		R		R		R
Windshield fluid level - Windshield washer and headlight cleaner	I	I	I	I	I	I
Headlight leveling	I	I	I	I	I	I
E-Call module (E): battery change	<b>(2)</b>					
Controls and adjustment systems in general, hinges, doors, engine compartment lid and luggage compartment	I		I		I	
Condition of the leather interiors	I		I		I	
<p>I = Inspect and carry out any other necessary operation                      R = Replace  <b>(1)</b> In case of heavy-duty use of the vehicle, highlighted by the presence of mud and dust in the engine compartment, proceed to the preventive replacement of the alternator belt.  <b>(2)</b> The battery must be replaced every 5 years.</p>						



## Maintenance and Care

### Periodic Maintenance

Every 600 mi (1000 km) or before long journeys

Check:

- engine coolant;
- brake fluid;
- windshield washer fluid level;
- tire inflation pressure and condition;
- operation of lighting system (headlights, turn signals, hazard warning flashers, etc.);
- operation of windshield washer/wiper system and wear of windshield wiper blades.

Every 1900 mi (3000 km)

Check and top up, if required, the engine oil level.

### Heavy-Duty Vehicle Use

If the car is mainly used under one of the following conditions:

- towing a trailer;
- off-road;
- short, repeated journeys (less than 4–5 mi/7–8 km) at sub-zero outside temperatures;
- engine often idling or driving long distances at low speeds or long periods of idleness;

you should perform the following inspections more frequently than recommended on the “Scheduled Service Plan”:

- check front disc brake pad conditions and wear;
- check cleanliness of hood and trunk locks, cleanliness and lubrication of linkage;
- visually inspect conditions of: engine, transmission, pipes and hoses (exhaust - fuel system - brakes) and rubber elements (boots - sleeves - bushes - etc.);
- check battery charge;
- visually inspect condition of the accessory drive belts;
- check and, if necessary, change engine oil and replace oil filter;
- check and, if necessary, replace pollen filter of the A/C system;
- check and, if necessary, replace air cleaner filter.



#### CAUTION!

All maintenance operations for the vehicle must be carried out by an **Authorized Maserati Dealer**. For routine and minor maintenance operations which you can carry out yourself, make sure that you have the necessary experience and always use suitable equipment, original **Maserati** spare parts and the prescribed fluids. Shall this not be the case, do not carry any operation

on your own and contact an **Authorized Maserati Dealer**.

### On-Board Diagnostics (OBD)

Your vehicle is equipped with a sophisticated on-board diagnostic system called OBD II. This system monitors the performance of the emissions, engine, and automatic transmission control systems. When these systems are operating properly, your vehicle will provide excellent performance and fuel economy, as well as engine emissions suited to current government regulations.

If any of these systems require service, the OBD II system will turn on the Malfunction Indicator Light  on the instrument cluster display (refer to “Warning and Indicator Lights” in section “Dashboard Instruments and Controls”). The system stores as well diagnostic codes and other information to assist your service technician by performing repairs.

Although the vehicle will be driveable and will not need towing, contact an **Authorized Maserati Dealer** for service as soon as possible.





### CAUTION!



- Prolonged driving with the MIL  on could cause further damage to the emissions control system. It could also affect fuel economy and driveability. The vehicle must be serviced before any emissions tests can be performed.
- If the MIL  is flashing while the engine is running, severe catalytic converter damage and power loss could occur. Immediate service at an **Authorized Maserati Dealer** is required.

## Emissions Inspection and Maintenance Programs

In some localities, it may be a legal requirement to pass an inspection of your vehicle's emissions control system. Failure to pass could prevent vehicle registration. For states that require an Inspection and Maintenance (I/M), this check verifies the "Malfunction Indicator Light " is functioning and is not on when the engine is running, and that the OBD II system is ready for testing. Normally, the OBD II system will be ready. The OBD II system may not be ready if your vehicle was recently serviced, recently had a dead battery or a battery replacement. If the OBD II system should be determined not ready



for the I/M test, your vehicle may fail the test.

To check if your vehicle's OBD II system is ready, you must do the following:

1. Press the ignition device to the **RUN** position, but do not crank or start the engine.
2. As soon as you press the ignition device to turn the engine On, you will see the MIL remain illuminated for 15 seconds, this is a normal bulb check.
3. Approximately 15 seconds later, one of two things will happen:
  - The MIL  will remain illuminated and a message error will appear on your instrument cluster. This means that your vehicle's OBD II system is not ready and you should not proceed to the I/M station.
  - The MIL  will turn Off. This means that your vehicle's OBD II system is ready and you can proceed to the I/M station.

If your OBD II system is not ready, you should see an **Authorized Maserati Dealer** or repair facility. If your vehicle was recently serviced or had a battery failure or replacement, you may need to do nothing more than drive your vehicle as you normally would in order for your OBD II system to update. A recheck with

the above test routine may then indicate that the system is now ready.

Regardless of whether your vehicle's OBD II system is ready or not, if the MIL  is illuminated during normal vehicle operation you should have your vehicle serviced before going to the I/M station. The I/M station can fail your vehicle because the MIL  is on with the engine running.

## Spare Parts

Use of genuine Maserati parts for normal or scheduled maintenance and repairs is highly recommended to ensure excellent performance.

Damage or failures caused by non-genuine spare parts used for maintenance and repairs will not be covered by the manufacturer's warranty.

## Dealer Service

An **Authorized Maserati Dealer** has the qualified service personnel, special tools, and equipment to perform all service operations in an expert manner. Service Manuals are available which include detailed service information for your vehicle. Refer to these Service Manuals before attempting any procedure yourself.

Intentional tampering with emissions control systems may void your warranty and could result in civil penalties.



## Maintenance and Care



### **WARNING!**

**You could be injured working on or around a motor vehicle. Take your vehicle to an Authorized Maserati Dealer.**



## Maintenance Service Components

The following images show the position of the components involved in the maintenance service.

### 3.8 V8 Engine - TROFEO Version

1. Engine oil dipstick.
2. Engine oil filler neck.
3. Air cleaner filters.
4. Engine coolant expansion reservoir cap.
5. Coolant reservoir cap for transmission cooling system.
6. Windshield/headlight washer fluid reservoir cap.
7. Brake fluid reservoir access cover.
8. A/C pollen filter access cover.
9. Integrated power module (fuses).

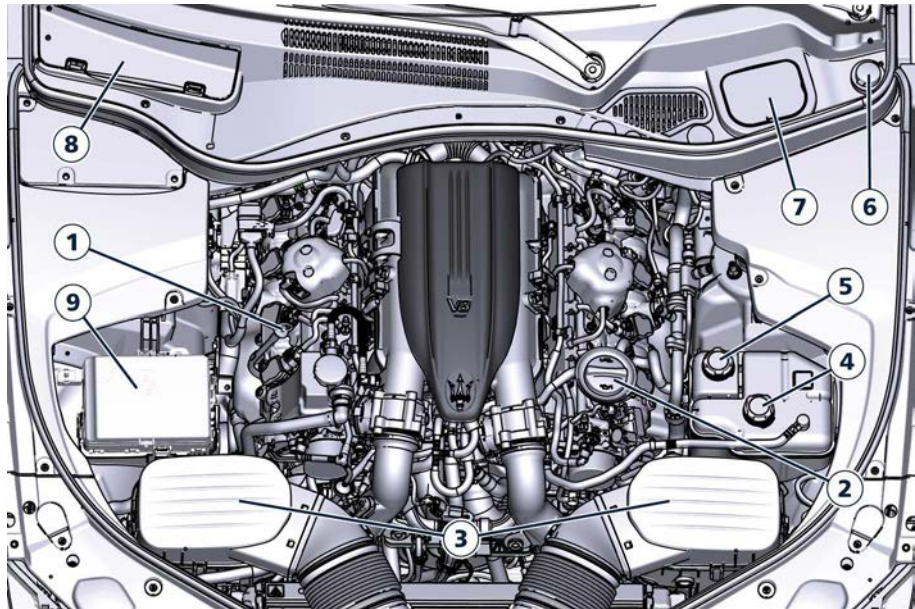

3.8 V8 Engine - TROFEO Version



## Maintenance and Care

### 3.8 V8 Engine - MODENA S Version

1. Inspection cover to access the engine oil level dipstick
2. Engine oil filler neck.
3. Air cleaner filters.
4. Engine coolant expansion reservoir cap.
5. Coolant reservoir cap for transmission cooling system.
6. Windshield/headlight washer fluid reservoir cap.
7. Brake fluid reservoir access cover.
8. A/C pollen filter access cover.
9. Integrated power module (fuses).

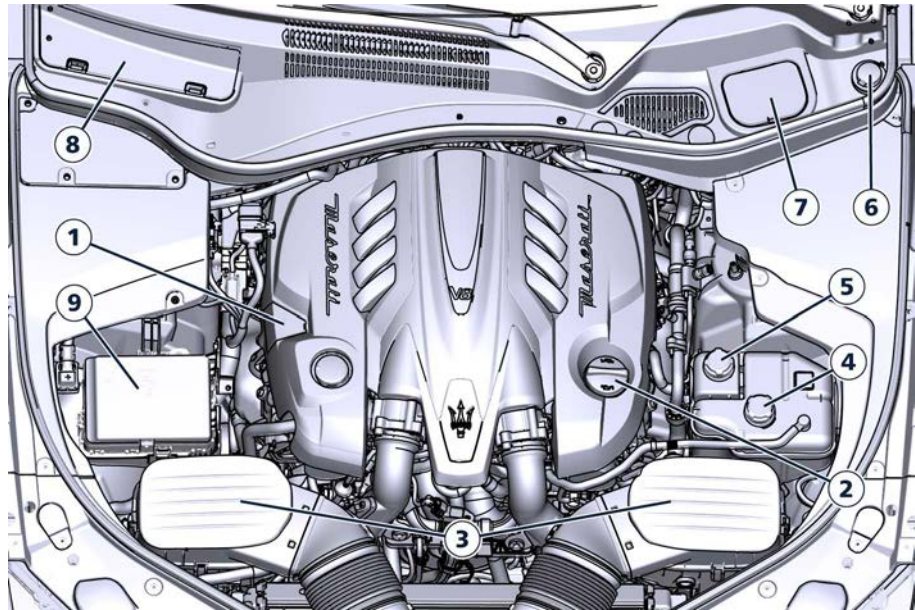

3.8 V8 Engine -MODENA S Version



### 3.0 V6 Engines

1. Engine oil dipstick.
2. Engine oil filler neck.
3. Air cleaner filters.
4. Engine coolant expansion reservoir cap.
5. Coolant reservoir cap for transmission cooling system.
6. Windshield/headlight washer fluid reservoir cap.
7. Brake fluid reservoir access cover.
8. A/C pollen filter access cover.
9. Integrated power module (fuses).

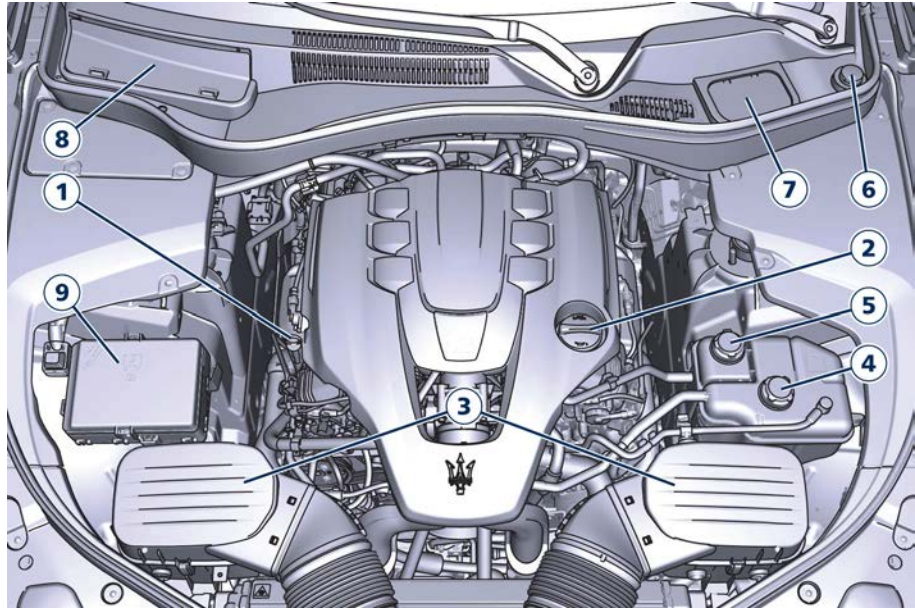

3.0 V6 Engines



### Maintenance Procedures

The following pages contain the “required” maintenance standards determined by Maserati engineers.

Besides those maintenance items specified in the “Scheduled Service Plan”, there are other components which may require service or replacement in the future.

To perform most of the services, it is necessary to open the hood (see “Hood Operation” in section “Before Starting”).



#### CAUTION!

- Failure to properly maintain your vehicle or perform repairs and service when necessary could result in more costly repairs, damage to other components or negatively impact vehicle performance. Immediately have potential malfunctions examined by an **Authorized Maserati Dealer** or a qualified repair center.
- Your vehicle has been equipped with improved fluids that protect the performance and durability of your vehicle and also allow extended maintenance intervals. Do not use chemical flushes for washing as the chemicals can damage your engine, transmission, power steering or air

conditioning. Such damages are not covered by the New Vehicle Limited Warranty. If a flush is needed because of component malfunction, use only the specified fluid for the flushing procedure.

### Level Checks



#### ENVIRONMENTAL!

- The engine oils and fluids used contain substances that are dangerous to the environment. For replacement you are advised to contact the **Authorized Maserati Dealer**, where all the necessary equipment is available to dispose of the used oil and fluids in compliance with the regulations in force and in an environment-friendly manner.
- All equipment used for fluids replacement (gloves, cloths, containers, etc) must be disposed of in compliance with the regulations in force.

#### Engine Coolant Level Check

Your vehicle has been equipped with an improved engine coolant (antifreeze) that offers high protection against corrosion, freezing and allows extended maintenance intervals. To prevent reducing extended maintenance periods, it is important to use original engine

coolant (antifreeze) when adding coolant throughout the life of your vehicle.

When adding engine coolant (antifreeze) use pure water only, such as distilled or deionized water when mixing the water/engine coolant (antifreeze) solution. The use of impure water will reduce the amount of corrosion protection in the engine cooling system.

- Mix a minimum solution of 50% engine coolant (antifreeze) and distilled water. Use higher concentrations (do not exceed 70%) if temperatures below -35°F (-37°C) are forecast.

Please note that it is the owner's responsibility to maintain the proper level of protection against freezing according to the temperatures occurring in the circulation area of the vehicle.

The coolant reservoir provides a quick visual method to determine that the coolant level is adequate. As long as the engine operating temperature is satisfactory, the coolant reservoir only needs to be checked once a month.

With the engine off and cold, the level of the coolant in the reservoir on the left side of the engine compartment should be between the ranges indicated on the reservoir and inside the filler neck.

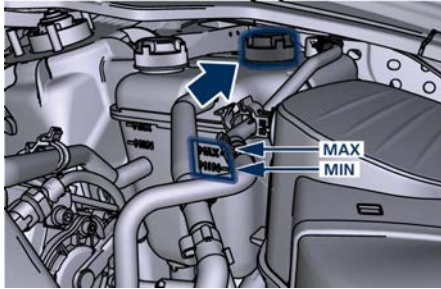

- When additional engine coolant (antifreeze) is needed to maintain the proper level, it should be added to the coolant reservoir after removing the cap. Do not overfill.
- Once the desired level is reached, reassemble and firmly close cap of the reservoir.
- If frequent engine coolant (antifreeze) additions are required, or if the level in the coolant recovery reservoir does not drop when the engine cools, the

cooling system should be tested by an **Authorized Maserati Dealer**.

- Keep the front of the radiator and the condenser clean.

### **WARNING!**

- **Never add engine coolant (antifreeze) when the engine is hot. Do not loosen or remove the cap of the engine coolant reservoir to cool a hot engine. Heat causes pressure to build up in the cooling system. To prevent scalding or injury, do not remove the pressure cap while the system is hot or under pressure.**
- **When adding coolant do not use a pressure cap other than the one specified for your vehicle. Personal injury or engine damage may result.**

### **Brake Fluid Level Check**

Check the fluid level immediately if the brake system warning light **BRAKE** and the related message turn on indicating a low level of brake fluid.

- Remove the brake fluid reservoir access cover.

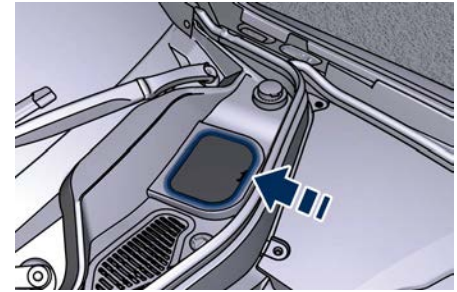

- Clean the top of the master cylinder reservoir before removing the cap.
- Add fluid to bring the level up to the “MAX” mark on the side of the master cylinder reservoir. Use only manufacturer's recommended brake fluid (see “Refilling Table” in this section).
- Once the correct level is reached, firmly close the cap.

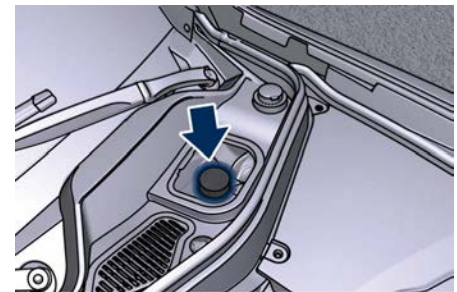

Normal brake pad wear could cause the fluid level to fall. However, low fluid



## Maintenance and Care

level may be caused by a leak too, and requires accurate checkup of the braking system.

 **CAUTION!**

The symbol  on the tank cap identifies the synthetic type of brake fluid, distinguishing it from the mineral type. Using mineral fluids damages the special rubber linings of the brake system irreparably.

 **CAUTION!**

- To avoid contamination from foreign materials or moisture, use only new brake fluid or fluid that has been in a tightly closed container. Keep the master cylinder reservoir cap secured at all times.
- Overfilling the brake fluid reservoir can result in spilling brake fluid. Brake fluid can also damage painted and vinyl surfaces, make sure it does not spill over these surfaces.
- Do not allow petroleum based fluid to contaminate the brake fluid. Brake seal components could be damaged.

### Adding Windshield/Headlight Washer Fluid

The reservoir on the left side of the engine compartment contains the fluid

to wash the windshield, the window liftgate and headlights (if equipped). During scheduled services or when the message of low level of the washer fluid appears together with the related telltale  add more fluid as soon as possible.

Depending on the system installed in the vehicle, the fluid reservoir may contain nearly 5.3 Quarts (5 liters) of windshield/headlight washer fluid or nearly 3.7 Quarts (3.5 liters) of washer fluid.

- Remove the reservoir cap in the engine compartment and lift the filler neck.

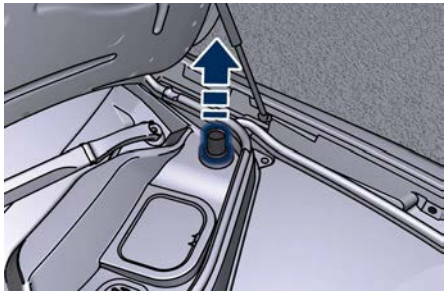
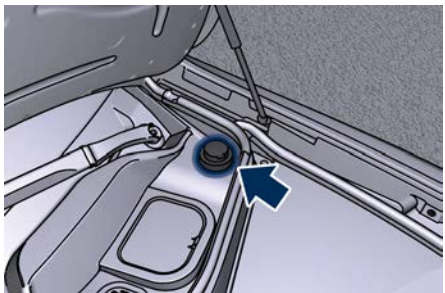

- Fill the reservoir with windshield washer solvent (refer to “Refilling Table” in this section) and operate the system for a few seconds to flush out the residual water.
- When refilling the washer fluid reservoir, apply some washer fluid to a cloth or towel and wipe the wiper blades clean. This will help blade performance.

To prevent freeze-up of your windshield/headlight washer system in cold weather, select a solution or mixture that meets or exceeds the temperature range of your climate. This rating information can be found on most washer fluid containers.



**WARNING!**

- **Commercially available windshield washer solvents are flammable. They could ignite and burn you. Care must be exercised when filling or when working around the windshield/headlight washer system.**
- **Do not drive with the windshield/headlight washer reservoir empty: the action of the washer is essential for improving visibility when driving.**

**Engine Oil Level Check**

To assure proper lubrication of your vehicle's engine, the engine oil must be maintained at the correct level.

If the  warning light illuminates and the related message of low oil level displays, or during scheduled services (see "Scheduled Maintenance Service" in this section) it is necessary to check the engine oil level.

The best time to check the engine oil level is about five minutes after a fully warmed up engine is shut off or before starting the engine after it has sat overnight. In both cases the vehicle should be parked on level ground to improve the accuracy of the oil level readings.

**CAUTION!**

- Do not top up with oil with different characteristics than the engine one (refer to "Refilling Table" in this section).
- Overfilling or underfilling the oil pan will cause aeration or loss of oil pressure. This could damage your engine.
- Do not add any supplemental materials to the engine oil. Engine oil is an engineered product, and its performance may be impaired by supplemental additives.
- Remove the inspection cover on the right engine bank (3.8 V8 - MODENA S Version only).

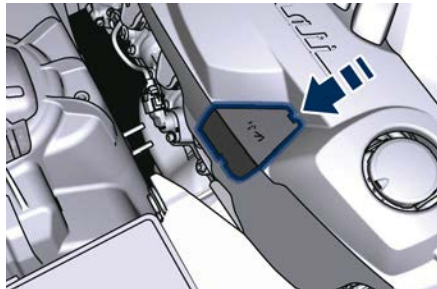
**3.8 V8 Engine - MODENA S Version**

- Remove the dipstick and clean it with a dry and clean cloth.

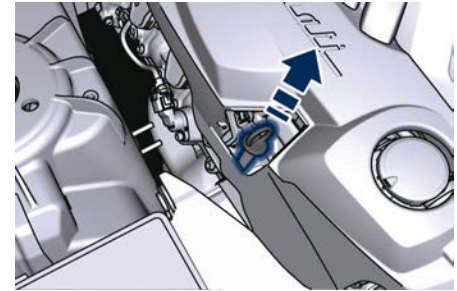
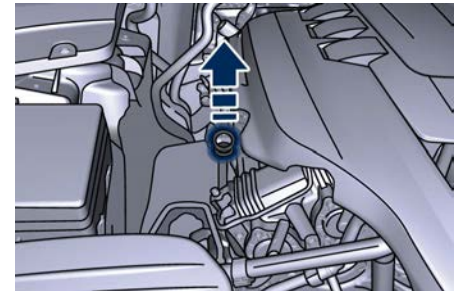
**3.8 V8 Engine - MODENA S Version****3.0 V6 Engines**

- Re-insert the dipstick completely and remove: the oil level should maintain between the "MIN" and "MAX" reference ranges (SAFE range).

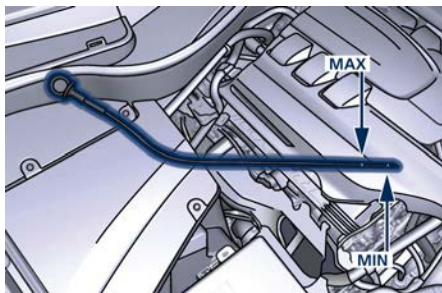

- If a refilling is necessary: unscrew the filler neck cap.



3.8 V8 Engine - MODENA S Version

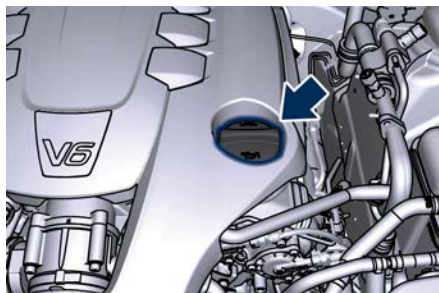

3.0 V6 Engines

- Adding 1.6 Quarter /1.4 liters (3.8 V8 Engines) or 1 Quart /1 liter (3.0 V6 Engines) of oil when the level is at the bottom of the SAFE range will result in the level being at the top of the SAFE range.
- Return the cap and dipstick to their position and wait for a few minutes to allow the oil to reach the oil pan.
- Check the level again.

### Engine Oil Filter Replacement

The engine oil filter should be replaced with a new filter at every oil change. Contact the **Authorized Maserati Dealer** to perform this service.

### Automatic Transmission Oil Check

Contact the **Authorized Maserati Dealer** for the oil level check.

### Fluid Level Check for Coolant Transmission System

The coolant contained in the bottle of this system is the same as the one used for the cooling system of the engine. For the preparation of the mixture of water and antifreeze and for the control of the level, proceed as shown in the “Engine Coolant Level Check” of this chapter.

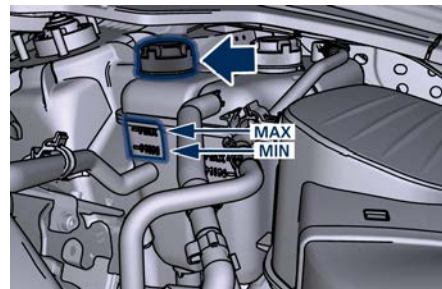

### Engine Air Filters Replacement

Contact an **Authorized Maserati Dealer** to have the air filters replaced.

### A/C Air Filter Replacement

This filter performs mechanic/ electrostatic air filtering, provided that windows and doors are closed. The filter is located under the hood in the external A/C system air inlet, on the passenger side of the vehicle, next to the windshield wipers.



To replace the filter during the scheduled maintenance services or after the vehicle has been heavily used on dusty roads, proceed as follows:

- Remove the access door in the cowl screen by pressing the retaining clips indicated.

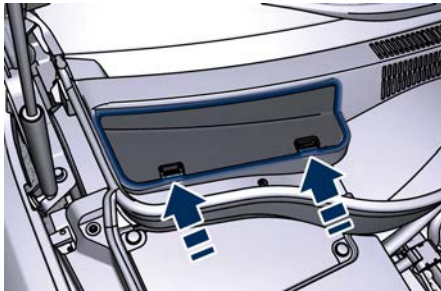

- Unsnap both ends and lift the filter retaining cover.

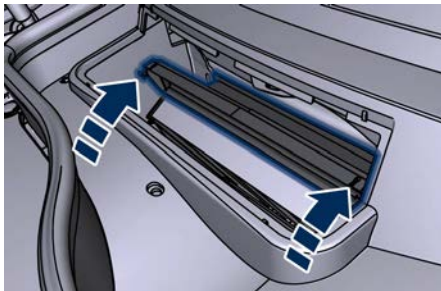

- Remove the used filter slipping it off from within the air intake.

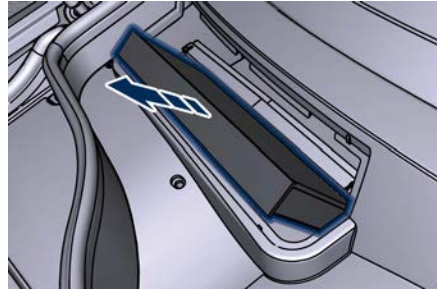

- Install the new filter with arrows pointing in the direction of airflow, which is toward the rear of the vehicle (text and arrows on the filter will indicate this).

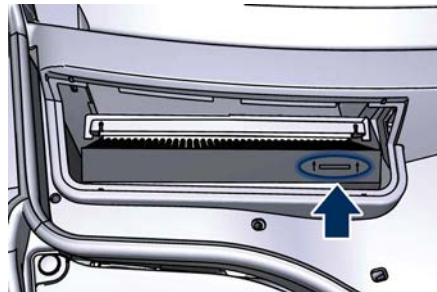

- Close the filter retaining cover and reinstall the access door.



### CAUTION!

Failure to replace the filter may considerably reduce the air conditioning and heating system efficiency.

## Wiper Maintenance and Blades Replacement

### Windshield Wiper Arms Lifting

When the windshield wiper arms are in rest position it is not possible to check or replace the blades as they remain under the engine hood.

To service the blades it is necessary to move the wiper arms in “Service” position (see chapter “Wipers and Washers Controls” in section “Dashboard Instruments and Controls”). In this way it is possible to lift the arms for cleaning or replacing the wiper blades.



### WARNING!

It is dangerous to operate or service the wiper blades with the windshield wipers in an active position (any position different from “OFF”) and with the ignition device in the RUN position. The rain sensors may suddenly activate the wipers. Always use the “Service”



### position for any intervention on the windshield wiper blades.

#### Windshield Wiper Maintenance

Life expectancy of wiper blades varies depending on the geographical area's weather conditions where the car is used and frequency of use. Poor performance of blades may be present with chattering, marks on the glass, water lines or wet spots. If any of these conditions are present, clean the wiper blades or replace if necessary.

Clean the rubber edges of the wiper blades and the windshield/rear window glasses periodically with a sponge or soft cloth and a mild nonabrasive cleaner. This will remove accumulations of salt or road film. Operation of the wipers on dry glass for long periods may cause deterioration of the wiper blades. Always use washer fluid when using the wipers to remove salt or dirt from a dry windshield.

Avoid using the wiper blades to remove frost or ice from the windshield. Keep the blade rubber out of contact with petroleum products such as engine oil, gasoline, etc.

#### Spray nozzles

If the jet does not work, first check that there is fluid in the tank (see paragraph

"Level checks" in this section) then check that the nozzles are not clogged.

#### Windshield Wiper Blades Replacement

- Move the wiper arms into "Service" position, (see chapter "Windshield Wipers and Washers Controls" in section "Dashboard Instruments and Controls") and lift them.
- Press the indicated button, slip off the blade support from the arm and replace it.



- Return the blade to its original position on the windshield.
- Turn the multifunction lever to one of the automatic settings (see chapter "Windshield Wipers and Washers Controls" in section "Dashboard Instruments and Controls") and move the ignition device to the **RUN** position: the wiper arms will return to the resting position.

#### NOTE:

Due to the difficulty of this operation, we recommend that you contact an **Authorized Maserati Dealer** for replacement of the blades.

#### Rear Window Blade Replacement

- To replace the rear window wiper blade on the liftgate, lift the wiper arm with blade up to the stop position.



- Turn the blade to the position indicated in the figure.
- Hold the arm steady and pull the blade, by holding it from the central support, until it is removed.

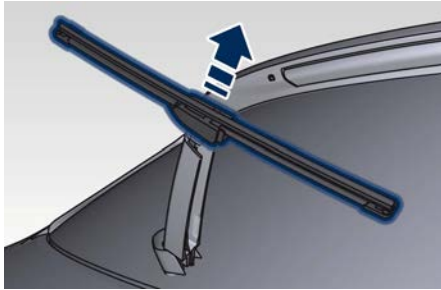

- Replace the blade.
- Insert the pivot, present inside the blade central support, in the fork-shaped end of the arm until hearing the click indicating that it is engaged.

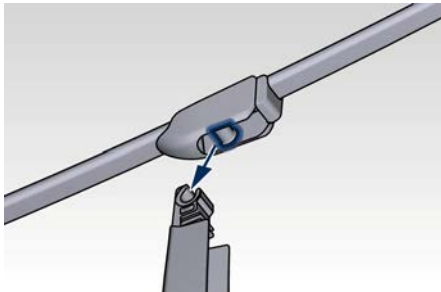

Stretch the arm and put the blade back in contact with the liftgate window.

### Front Fog Lights Adjustment

The height position of the fog light beam can be adjusted manually by turning the toothed gear to the base of the fog light assembly.



### CAUTION!

Performing this operation without the necessary equipment and attention may damage the vehicle. It is advisable to contact an **Authorized Maserati Dealer** to perform this operation.

- To make the adjustment it is necessary to remove the frame of the fog lamp, making force in the points indicated in picture corresponding to the four appendices with the retaining tooth at the end.



- Insert the end of a cross-head screwdriver into the bumper hole in the lower part of the fog lamp housing.
- Turn the screwdriver handle clockwise to lower the beam (**DOWN**), counterclockwise to lift it (**UP**).

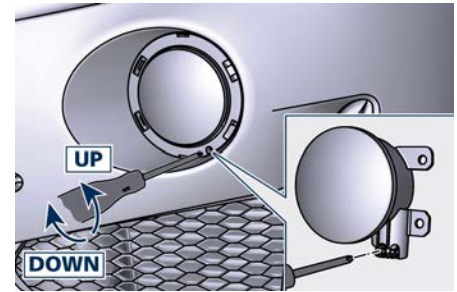

- Once the adjustment is finished, remount the fog lamp frame, centering it in the seat with the longer upper and lower appendices.

## Battery Status and Maintenance

This vehicle is equipped with a sealed type maintenance-free battery. You will never have to add water, nor is periodic maintenance required.



### WARNING!

- **Battery fluid is a corrosive acid solution and can burn or damage the eyes. Do not allow battery fluid to contact your eyes, skin, or clothing. If acid splashes in eyes or on skin, flush the area immediately with large amounts of water.**
- **Battery gas is flammable and explosive. Keep flame or sparks away from the battery. Do not use a booster battery or any other booster source with an output greater than 12 Volts. Do not allow cable clamps to touch each other.**
- **Battery posts, terminals, and related accessories contain lead and lead compounds. Wash hands after handling the battery.**
- **The battery in this vehicle has a vent hose that should not be disconnected and should only be replaced with a component of the same type (vented).**

### NOTE:

Remote battery terminals for starting are located in the engine compartment for jump-starting to be used with an auxiliary battery or a battery from another vehicle (see “Auxiliary Jump-Start Procedure” chapter in section “In an Emergency”).

### Battery State of Charge

To avoid problems with ignition and/or the electrical system in general when you are driving, the battery charge status is constantly maintained and guaranteed by the vehicle's recharge circuit; the main component of which is the alternator. This circuit is only able to supply voltage to the battery when the vehicle is traveling.

The warning light  on the instrument cluster, will indicate any malfunctions in the recharge circuit or an insufficient battery charge status (example in figure).



The vehicle contains advanced electronic systems, such as, for example, the alarm system and various electronic control modules, which consume power even when the ignition device is in the **OFF** position and the vehicle is not being used.

Therefore, it is fundamental that the battery is properly charged to ensure that the engine starts properly and that all the electrical/electronic systems in the vehicle work efficiently.

### To Disconnect the Battery

The battery is located on the inner right side of the trunk compartment.

To access the battery it is necessary to lift the ground coverage of the trunk compartment (see chapter “Tool Kit” in section “In an Emergency”) and remove the storage box.

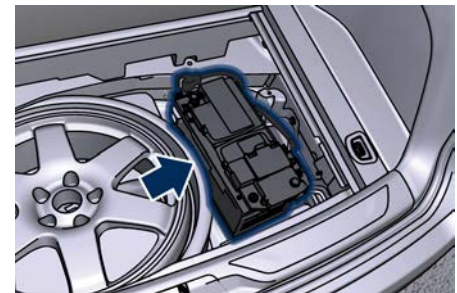

**CAUTION!**

- Before disconnecting the battery, open the trunk and lower the windows a few centimeters, to avoid damaging the seal and the glass when opening and closing the door. When the battery is connected, the lowering of the window is performed automatically when the door is opened and closed. The trunk lid must remain open and the windows lowered until the charged battery is reconnected.
- Never disconnect the battery from the electrical system when the engine is running.
- To temporarily disconnect the vehicle electrical system from the battery, simply remove the cable end with quick coupling from the negative post (-) of the battery.
- If the battery needs to be removed from its compartment, you must first detach the terminal clamp to the negative post (-) and then the other terminal clamp to the positive post (+), after removing the protective cover. Battery posts are marked positive (+) and negative (-) and are identified on the battery case.

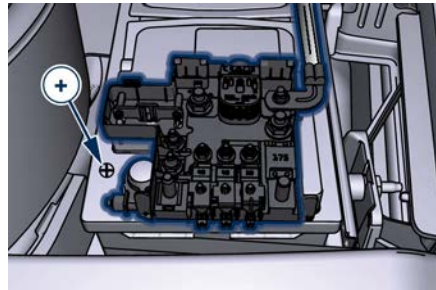
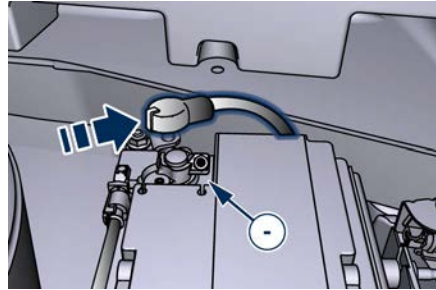
**To Reconnect the Battery****CAUTION!**

- It is essential when replacing the cables on the battery that the positive cable is attached to the positive post (+) and the negative cable is attached to the negative post (-).
- Cable clamps should be tight on the terminal posts and free of corrosion.

After the battery has been disconnected and re-connected and before starting the engine it is necessary to proceed as follows:

- Unlock and lock the doors using one more time the Key fob.
- Close manually the liftgate unlock it lid with the key fob and then lock it manually on more time. If the vehicle is equipped with power liftgate, manually perform the complete closure. Then move the lid automatically, using the buttons on the outer edge of the left trunk, performing a complete cycle of opening and closing. If the limit of the power liftgate opening has been set, it is necessary to reset it (see “Power Liftgate Operation” in section “Before Starting”).
- Initialize the climate control system by activating the system and pressing the “AUTO” control as described in chapter “Air Conditioning Controls” in section “Dashboard Instruments and Controls”.
- Turn on the MIA and set the date and time (see “TFT Display Setting and Menu Overview” in section “Dashboard Instruments and Controls”).
- Lift, release and lift again the lever on the central console to initialize the electric parking brake. Following this operation, at the next key cycle, the  warning light on the instrument cluster will turn off and the error



## Maintenance and Care

messages regarding the unavailability of the radar functions will also no longer be present.

- For correct activation of the approach lights on the external mirrors, press at least once the tilt button on the driver's door panel so that the door mode recognizes the mirrors position.
- If the car is equipped with power sunshades on rear door windows, carry out the teach mode cycle described on chapter "Power Sunshades on Rear Door Windows" in section "Before Starting".
- Start the engine and re-calibrate the EPS by steering fully to the left and then to the right; the EPS failure warning light and message should disappear on the TFT display.



### CAUTION!

- Every time the battery is reconnected, wait at least 30 seconds with the ignition device turned to **RUN** before starting the engine, in order to allow the electronic system that manages the motor-driven throttles to run a self-learning cycle. At the same time, you can run the date and time set up procedure for the MIA.
- Every time the battery is reconnected the warning light **BRAKE** (on vehicles

of United States market) or **(!)** (on vehicles of Canadian market) and **(P)!** flash for about 10 seconds and then go off.

### Useful Advice to Extend Battery Life

When parking the vehicle, make sure that the doors, hood, liftgate and flaps are properly closed. All interior lights should be off.

When the engine is turned off, do not keep the connected devices switched on for a long time (such as radio, hazard warning flashers, fan, etc.).



### CAUTION!

If the battery charge remains below 50% for a long period of time, it will be damaged due to sulfation; its performance and starting power will be reduced and it will be more subject to freezing.

We recommend you to have the battery charge condition checked, preferably at the beginning of the cold season, to prevent the electrolyte from freezing. This check should be carried out more frequently if the vehicle is used mainly for short trips or if it is equipped with power-absorbing devices that remain permanently on even when the ignition

device is off. This applies above all if these devices have been retrofitted ("Aftermarket" services). If the vehicle is not used for long periods of time, please see "Vehicle Stored for Long Periods" in this section.

### Battery Recharge



### WARNING!

The process of charging or recharging the battery produces hydrogen, a flammable gas that can explode and cause serious injuries. When charging or recharging the battery, follow the recommended precautions at all times.

- Before using a charger device always check that this tool is suitable for the installed battery, with constant voltage (lower than 14.0 V) and low amperage (maximum limit 15 A).
- Recharge the battery in a well-ventilated environment.
- Never charge or recharge a frozen battery.
- Ensure that any sparks or open flames are kept well away from the battery while it is charging.
- Before using a charger to charge or maintain the battery charge status, carefully follow the instructions provided to ensure the charger is





### connected to the battery safely and correctly.

It is possible to recharge the battery without disconnecting the cables of the vehicle electrical system.

- To access the battery lift the ground coverage of the trunk compartment (see chapter “Tool Kit” section “In an Emergency”) and remove the storage box.
- Remove the protection cover and connect the terminal clamp of the charger positive cable (typically in red) to the positive post (+) of the battery.
- Connect the terminal clamp of the charger negative cable (typically in black) to the nut located by the negative post (–) on the battery, indicated in the picture.

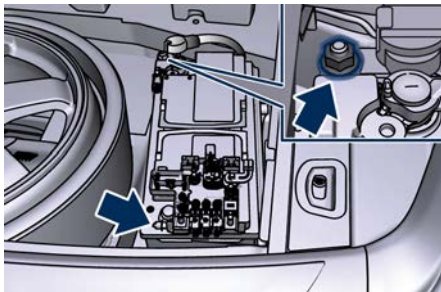

The vehicle is equipped with an IBS (Intelligent Battery Sensor) sensor able to measure charging and discharging

currents and to calculate the state of charge and state of health of the battery. This sensor is located at the negative post (–) of the battery.

For a successful charge/recharge operation, the charging current must flow through the IBS sensor as shown in the picture.

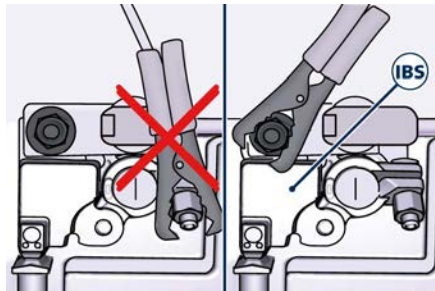

- Turn the charger on and follow the instructions on its user manual to completely recharge the battery.
- When the battery is recharged, turn off the battery charger before disconnecting it from the battery.
- Disconnect first the terminal clamp of the charger black cable from the battery and then the terminal clamp of the red cable.
- Reassemble the protection cover on the battery positive post and the other parts removed for this operation.

## Maintaining Battery Charge

If you perform short daily trips (approximately 10 miles/16 km), which correspond to an annual total of 4000 miles/6000 km, or when the vehicle is not going to be used for one week or more, Maserati recommends connecting the vehicle to a battery charger, to save you the trouble of having to recharge the battery. The battery charger will keep the battery charged properly and at the correct voltage levels required by the systems and devices in the vehicle. Before using and/or connecting the battery charger, carefully follow the instructions provided.

If you do not use a battery charger to prevent the battery from going dead when you are not going to use the vehicle for long periods of time, you need to check and recharge the battery at least once every three weeks. Make this check if you perform short daily trips (approximately 10 miles/16 km) which correspond to an annual total of 4000 miles/6000 km.

Please note that allowing the battery to go dead repeatedly can cause premature wear on the internal cells and greatly reduce their life, leading to problems with the ignition system and other electrical/electronic systems.



## Maintenance and Care

The **Authorized Maserati Dealer** is available to advise you on how to recharge your battery correctly and give you useful information on battery care and maintenance.

### NOTE:

The **Authorized Maserati Dealer** can provide you with any information about the Maserati approved “Battery Charger and Conditioner”, available in the “Genuine Accessories” range.



### WARNING!

The process of charging or recharging the battery produces hydrogen, a dangerous gas that can explode and cause serious injuries. When charging or recharging the battery, follow the recommended precautions at all times:

- always charge or recharge the battery in a well-ventilated environment;
- never charge or recharge a battery that has frozen;
- ensure that any sparks or open flames are nowhere near the battery while it is charging;
- before using a charger to charge or maintain the battery charge status, carefully follow the instructions provided to ensure the charger is

connected to the battery safely and correctly.

## A/C System Maintenance

For the best performance, the air conditioning system should be checked and serviced by an **Authorized Maserati Dealer** at the beginning of the warm season.

This service should include cleaning of the condenser, check of the drive belt tension and a performance test.

During the winter, the air conditioning system should be operated at least once a month for about 10 minutes.



### CAUTION!

Do not use chemical flushes in your air conditioning system as the chemicals can damage your air conditioning components. Such damage is not covered by the New Vehicle Limited Warranty.



### WARNING!

- Use only refrigerants and compressor lubricants approved by the manufacturer for your air conditioning system. Some unapproved refrigerants are flammable and can explode, causing injuries. Other unapproved refrigerants or lubricants can cause



the system to fail, requiring costly repairs.

- **The air conditioning system contains refrigerant under high pressure. To avoid risk of personal injury or damage to the system, adding refrigerant or any repair requiring lines to be disconnected should be done by an Authorized Maserati Dealer.**

Periodically remove any leaves and insects that may build up and obstruct the inlet of external air in the air conditioning system through the grille present underneath the rear part of the hood.

To access the grille, lift the hood as described in “Hood Operation” in section “Before Starting”.

## Wheels Maintenance

### Tires Maintenance



#### CAUTION!

To obtain the best performances and the longest mileage from the tires, take the following precautions during the first 310 mi (500 km):

- do not drive at the vehicle's maximum speed;
- drive at low speed on curves;
- avoid sudden steering;
- avoid sudden braking;
- avoid sudden acceleration;
- do not drive at high speeds for too long.

The tires inflation pressure must correspond to the prescribed values (  : chapter “Tire Inflation Pressure” in section “Technical Specifications”) and should be checked only when the tires have cooled down.

In fact, the pressure increases as the tire temperature progressively increases. Never reduce the pressure if tires are hot (  : chapter “Tires Information” chapter in section “Safety”).

Insufficient tire inflating pressure can cause tire overheating and possible internal damage.



#### CAUTION!

After inspecting or adjusting the tire pressure, always reinstall the valve stem cap. This will prevent moisture and dirt from entering the valve stem, which could damage it.

Impacts with curbs, holes, and obstacles in the road, and prolonged trips on rough roads or off-road trails can cause tire damage which may not be visible to the naked eye.

Check your tires regularly for any signs of damage (e.g. scratches, cuts, cracks, bulges, etc.). If sharp objects penetrate the tires, they can cause structural damage which is only visible when the tire is removed.

In any case, any possible damage must be inspected by an experienced technician, as it may seriously reduce the tire life.

Remember that tires deteriorate with time, even if used little or not at all.

Cracks in the tire tread and sides, alongside possible bulging, are a sign of deterioration.



### WARNING!

- Check the inflating pressure of the tires when cold, at least every two weeks and before long trips.
- Have old tires inspected by an experienced technician, to make sure they can still be used safely. If the same tire has been on your vehicle for 4 or 5 years, have it inspected anyway by an experienced technician. Tires should be replaced after 6 years, regardless of the condition or remaining tread.
- Never fit tires of uncertain origin.
- “Directional” tires have an arrow on their side showing the rolling direction. To keep the best performance when replacing a tire, make sure that the rolling direction corresponds to the one shown by the arrow.
- During the tire life, the rolling direction used for the first fitting should always be observed, also in case of “nondirectional” tires.
- Check the depth of the tire tread at regular intervals. The minimum allowed value is 0.06 in (1.6 mm) or 0.6 in (4 mm) for winter, all-season and snow tires, at that point the wear indicators on the tire will be visible (  : chapter “Tires Information”

in section “Safety”). The thinner is the tread, the greater is the risk of skidding.

- Drive carefully on wet roads to decrease the risk of aquaplaning.

### Winter Tires

These tires are specially designed for driving on snow and ice and are fitted to replace the ones supplied with the vehicle.

The specific functions of the winter tires lead to lower performance under normal environmental conditions or on long highway trips, compared to the standard tires.

Therefore, their use should be limited to the situations and performance for which they have been type-approved.

The **Authorized Maserati Dealer** can provide all necessary information about fitting winter tires on the vehicle.

### NOTE:

- We recommend fitting winter tires on the vehicle at temperatures below 45 °F (7 °C) since the driving performance of summer tires is reduced at low temperatures. Summer tires may be permanently damaged at extremely low temperatures.

- Comply with all state and local laws governing snow tire and tread depth requirements.

### Wheel Rims Maintenance

All wheel trims should be cleaned regularly with a mild soap and water.

To remove heavy soil and/or excessive brake dust, use a nonabrasive, non-acidic cleaner.

Do not use scouring pads, steel wool, a bristle brush, or metal polishes.

Do not use oven cleaner that may affect and damage the brake calipers.

Avoid automatic car washes that use acidic solutions or harsh brushes that may damage the wheel rim protective finish.



## Bodywork Maintenance and Care

### Protection from Atmospheric Agents

The main causes of corrosion are:

- atmospheric pollution;
- salinity and humidity in the atmosphere (marine areas or a damp climate);
- seasonal environmental conditions;
- salt scattered on the roadbed to melt ice and snow.

The abrasive action of wind-carried atmospheric dust and sand, mud and stones should not be underestimated.

On this vehicle, Maserati has adopted the best technological solutions to protect the bodywork from corrosion.

The main measures are:

- paint products and systems that give the vehicle particular resistance to corrosion and abrasion;
- use of galvanized (or pre-treated) metal sheets which are highly resistant to corrosion in the most exposed parts;
- spraying of the underbody, engine compartment, insides of wheel housings, and other structures with wax products having high protective power;
- spraying of plastic materials, with a protective function, in the most exposed points: underneath the doors,

inside part of the mud guards, edges, etc.;

- use of ventilated box sections, coated with protective wax products, to avoid condensation and trapped water which could encourage the formation of internal rust.

### Useful Advice to Keep the Bodywork in Good Condition Paint

The paintwork does not only have an aesthetic function but also protects the underlying metal sheets. In the event of abrasions or deep scratches, we recommend to have the necessary touch-ups made immediately, to avoid any rust formation. Touch-ups do not feature particular difficulties, even on metallic and matte finishes.

For all paint touch-ups, use only original products indicated on the plate applied on the lower left side of the hood.



Normal paint maintenance consists in washing, the frequency of which depends on the conditions of use and of the environment. For example, if driving the vehicle in areas where there is high atmospheric pollution or the roads are spread with anti-freeze salt, it is advisable to wash the vehicle more frequently.



**ENVIRONMENTAL!**  
Detergents pollute water. Therefore the vehicle should be washed in areas equipped for the collection and purification of the fluids used for washing.

#### NOTE:

The use of alcohol-based products for cleaning the metal surfaces in the engine compartment and/or the trunk may deteriorate the protective paint. It is recommended to use water-based products.

#### Car Wash

For correct washing:

- wet the bodywork with a low pressure water jet;
- pass a sponge with a light detergent solution over the bodywork, frequently rinsing the sponge;
- rinse well with water and dry with an air jet or chamois leather.



## Maintenance and Care

When drying, take particular care with the parts that are less visible, such as the door, liftgate and lid bays, headlight edges, in which water can be trapped more easily.

You are recommended not to take the vehicle immediately into an enclosed environment, but leave it in the open air so as to allow the water to evaporate. Do not wash the vehicle after it has been left in the sun or when the hood is hot: the paint gloss could be affected.

External plastic parts must be cleaned with the same procedure followed for the normal washing of the bodywork. Avoid, as far as possible, parking the vehicle under trees; the resinous substances that very often drop from the trees give the paint a dull appearance and increase the possibility of originating corrosive processes.

It is important that the drain holes in the lower sides of the doors, rocker panels, and trunk bottom be kept clear and open.



### CAUTION!

- Bird droppings must be washed off immediately and thoroughly, since their acidity is particularly corrosive.
- To provide better protection for the paint, polish the vehicle at intervals with a suitable product leaving a protective film on the paint.
- If the vehicle is washed using high-pressure water jets or cleaners, it is important that the nozzle of the jet be kept at a distance of at least 16 in (40 cm) from the bodywork to avoid damaging it.

### Washing Vehicles with Matte Finish Paint

- It is recommended to hand wash vehicles with matte-finish paint.
- Before washing, first remove from the bodywork dust and other particles that could damage the paint. Preferably use an air pressure jet.
- When grease spots and fingerprints are present, it is recommended using a special cleaner for matte finish paint. Apply the product using a microfiber cloth. To avoid damaging the paint surface, do not use too much pressure.
- Wet the bodywork with plenty of water and clean it using a soft sponge and a neutral wax-free shampoo, starting

from the top and working down. Dry the bodywork using an air pressure jet.

- Rinse all the parts of the vehicle thoroughly with plenty of water. Keep the sponge or the washing mitt in use always wet and clean.
- At last, using a different sponge or washing mitt, clean the wheels, the door sill plates and the other parts that are less visible.



### CAUTION!

- It is recommended not to wash the vehicle in direct sunlight. The little drops of water, acting as small focal lenses, could damage the paint.
- Always and only wash the vehicle by hand. Avoid using abrasive sponges or mitts that could damage the matte finish paint.
- Never polish and never use polishing agents on the vehicle with matte finish paint or on parts of it.
- Hard water (over 30 °f) could leave limestone residues.

### Glass Surfaces

All glass surfaces should be cleaned on a regular basis with any commercial household-type glass cleaner.

Never use an abrasive type cleaner. Use caution when cleaning the inside rear window on the liftgate equipped



with electric defrosters. Do not use scrapers or other sharp instrument that may scratch the elements. When cleaning the rearview mirror, spray cleaner on the towel or rag that you are using. Do not spray cleaner directly on the mirror.

Labels can be peeled off after soaking with warm water.

When cleaning is performed, keep all metal objects at a safe distance from the window.

### Cleaning Headlights

Your vehicle has plastic headlights that are lighter and less susceptible to stone breakage than glass headlights.

Plastic is not as scratch-resistant as glass and therefore different lens cleaning procedures must be followed.

To minimize the possibility of scratching the lenses and reducing light output, avoid wiping with a dry cloth. To remove road dirt, wash with a mild soap solution followed by rinsing.

Do not use abrasive cleaning components, solvents, steel wool or other aggressive material to clean the lenses.

### Condensation and Fogging on the Light Clusters

With cold or humid climates, after a driving rain or after cleaning the

car, the surface of the front and rear light clusters could fog and/or form condensate drops on the inside. This is a natural phenomenon due to the temperature and humidity differences between the lens internal and external surface, which nevertheless does not indicate a fault and does not compromise the regular operation of the lights. The fogging/condensate disappears when switching on the lights, starting from the center of the diffuser and gradually going to the edges.

### Moldings and Aluminum Trims

- For cleaning moldings and aluminum trims, avoid the use of acidic or alkaline cleaning agents that can destroy the protecting surface treatment.
- After washing aluminum trim with warm water, apply the cleaning agent with a clean tissue or a soft sponge on the surface. Do not use any other equipment such as brushes, steel wool, abrasives or any other equipment for cleaning.
- After cleaning, please rinse the aluminum trim with a lot of clear water.
- While cleaning in the car, please make sure that the moldings and aluminum trims only get in contact with soft brushes or textiles.

### Engine Compartment

At the end of each winter season, carefully wash the engine compartment, remembering to avoid directing the jet of water for too long on the electric parts. To perform this operation, you must contact an **Authorized Maserati Dealer**.

### Pre-Short Drop Function

When in a car wash, if the driver keeps the key fob in his/her pocket, or in any place outside the vehicle within 3.3 ft (1 m) distance, the front windows will perform a pre-short drop. This is a shorter drop compared to the normal short drop performed by the “Passive Entry” function when you grab the door handle to enter the vehicle.

In order to prevent water from entering the vehicle between the upper edge of the glass window and the door outline on the bodywork, while the car is being washed, it is advisable to disable the “Passive Entry” from the MIA system, for further information refer to chapter “Functions of Settings Menu on MIA” in section “Dashboard Instruments and controls”. When deactivating the “Passive Entry”, also the “Pre-Short Drop” function will be disabled.



### Interior Maintenance and Care

---

Interior trim should be cleaned starting with a damp cloth. Do not use harsh cleaners.

The leather upholstery can be best preserved by regular cleaning with a damp soft cloth. Small particles of dirt can act as an abrasive and damage the leather upholstery and should be removed promptly with a damp cloth. Stubborn soils stains can be removed easily with a soft cloth and appropriate products. Avoid soaking the leather upholstery with any liquid.

Please do not use polishes, oils, cleaning fluids, solvents, detergents, or ammonia-based cleaners to clean your leather upholstery.

Application of a leather conditioner is not required to maintain the original condition.

Check at regular intervals that there is no water trapped under the mats (due to drips off shoes, umbrellas etc.) which may cause the metal parts to oxidize.



#### CAUTION!

Do not use alcohol, petrol or solvents to clean the instrument cluster's transparent dome, the MIA display, the analog clock and the leather upholstery. We recommended the use of "Car Care" products approved by Maserati for the maintenance and care of the interior.

#### Leather Upholstery Treatment

Have the leather upholstery only treated, as provided in the Scheduled Service Plan, by an **Authorized Maserati Dealer** which has the required specific products.

#### Parts in Premium Quality Wood

Remove any dirt with a damp cloth.

#### NOTE:

The **Authorized Maserati Dealer** can provide you with any information about the Maserati approved "Car Care" products, available in the "Genuine Accessories" range.

#### Maserati Intelligent Assistant Touch Screen

- Do NOT attach any object to the touch screen, doing so can result in damage to the touch screen.
- Do not touch the screen with any hard or sharp objects (pen, USB stick,

jewelry, etc.) which could scratch the touch screen surface.

- Do not spray any liquid or caustic chemicals directly on the screen! Use a clean and dry micro fiber lens cleaning cloth in order to clean the touch screen. If necessary, use a lint-free cloth dampened with a cleaning solution, such as isopropyl alcohol, or an isopropyl alcohol and water solution ratio of 50:50. Be sure to follow the solvent manufacturer's precautions and directions.
- Prevent any liquid from entering the system: this could damage it beyond repair.

#### NOTE:

The **Authorized Maserati Dealer** can provide you with any information about the Maserati approved "Microfiber Cloth", available in the "Genuine Accessories" range.

#### Car Cleaning and Sanitizing

According to what is prescribed by the health authorities in each country, after using the car it is necessary to clean all surfaces that may have been touched by other people (example: steering wheel, transmission lever, air vents, seat belts, keys, handles, etc.).

To carry out this operation safely and correctly, trying to avoid possible





damage to the internal surfaces of the car, here are some useful tips:

- perform the operation if possible outdoors or in any case in a sufficiently ventilated area;
- wear all personal safety devices: gloves, mask and goggles using new or sanitized devices;
- clean the surfaces with a microfiber cloth moistened with an alcoholic sanitizing solution, avoiding to apply or spray said solution directly on the surface. The use of hydrogen peroxide, bleach and disinfectant is not recommended as they can develop too aggressive action on leather and plastic;
- check the air conditioning filter and sanitize the vents that circulate the air in the passenger compartment;
- vacuum the dust from the upholstery and the mats, or wash them with the appropriate detergent products.

A good habit to take, is to always have clean hands, both before and after driving, as it will help to keep the steering wheel and other surfaces more frequently touched inside cleaner car.

## Vehicle Stored for Long Periods

If the vehicle is going to be stored for long periods of time, follow the below precautions:

- Wash and dry the vehicle thoroughly.
- Store the vehicle on a level surface in a covered, dry and, if possible, ventilated area.
- Select P (Park) and turn off the engine.
- Disconnect the battery or connect a battery charger (refer to paragraph “Maintaining Battery Charge” of chapter “Battery Status and Maintenance” in this section).
- Check the battery charge status. During parking, this check must be carried out every three weeks. Recharge the battery if the open circuit voltage is lower than 12.2 V.
- Check that the parking brake is NOT engaged.
- Do not empty the engine cooling system.
- Clean and protect the painted parts applying protective wax.
- Clean and protect polished metal parts with special products available on the market.
- Cover the vehicle with a long cloth in breathable fabric (available from an **Authorized Maserati Dealer**). Do not use thick plastic sheets, which do

not allow the humidity on the vehicle surface to evaporate.

- Inflate the tires up to a pressure which must be 14.5 psi (1 bar) higher than the normally prescribed one, and check it at regular intervals.

### NOTE:

**The Authorized Maserati Dealer can provide you with any information about the available “Indoor and Outdoor Car Covers”, available in the “Genuine Accessories” range.**



### WARNING!

**The tire pressure must be brought back to the prescribed value before using the vehicle again (  : chapter “Tire Inflation Pressure” in section “Technical Specifications”).**



### Restarting the Vehicle after a Long Inactivity

---

Before restarting the vehicle after a long period of inactivity, we recommend that you carry out the following operations.

- Check the tires for pressure and for any damages, cuts or cracks. If this is the case, have them replaced.
- Do not dry-rub the external surface of the vehicle: use a damp cloth.
- Visually inspect if there are any fluid leaks (oil, brake and clutch fluid, engine coolant etc.).
- Have the engine oil and filter replaced.
- Check the fluid levels in the brake system, as well as the engine coolant level.
- Check the air filters and have them replaced if necessary.
- Reconnect the battery after checking the charge status (refer to “Battery Status and Maintenance” in this section) and perform the initializing procedure if applicable.
- With the transmission in N (Neutral), let the engine idle for several minutes.

In this way, the pneumatic suspension system will be able to reach the operating pressure and lift the car to the Entry/Exit height (for further details, see “Drive Modes” in section “Starting and Driving”).



#### **WARNING!**

**The engine idle must be performed outdoors. Exhaust gases contain carbon monoxide which is strongly toxic and potentially lethal.**



## Index

<b>A</b> bbreviations . . . . .	8	Conditions for Disabling and Deactivation . . . . .	230	Fixed Air Vents . . . . .	57
Active Blind Spot Assist - ABSA . . .	247	Display Warnings and Maintenance of ACC and FCW Systems . . . . .	232	Air Conditioning System Maintenance . . . . .	304
Radar Device - Regulatory Information . . . . .	250	Displayed information . . . . .	227	All-Wheel Drive . . . . .	170
RCP - Rear Cross Path Operation . . . . .	249	Driver Override . . . . .	229	Analog Clock . . . . .	137
Speed Range of Use . . . . .	248	Overtake Aid . . . . .	231	Audio System . . . . .	41
System Availability . . . . .	247	Precautions while Driving with ACC . . . . .	233	Basic System . . . . .	41
System in Faulty . . . . .	250	Radar Device - Regulatory Information . . . . .	235	High Premium System . . . . .	42
System Limitation . . . . .	248	Resuming Speed . . . . .	230	Premium System . . . . .	42
System Monitoring on TFT Display . . . . .	249	Setting the Speed . . . . .	229	Automatic Start&Stop System . . .	158
System Setting . . . . .	248	Setting the Time Gap . . . . .	230	Automatic Restarting of the Engine . . . . .	159
System Temporarily Unavailable . . . . .	250	Speed Range of Use . . . . .	228	Occupants Safety Function . . .	159
Active Driving Assist - ADA . . . . .	250	System Controls and Activation Conditions . . . . .	227	Start&Stop Deactivated . . . . .	158
Active Driving Assist - ADA Hands Detection on Steering		System Operation Before and During Stop . . . . .	231	Start&Stop Function Disabling . . . . .	160
Wheel . . . . .	253	Temporary Deactivation . . . . .	229	Start&Stop Not Active . . . . .	158
Monitoring on TFT Display . . . .	252	Warning and Cautions . . . . .	225	Start&Stop System Failure . . . .	160
Radar Device - Regulatory Information . . . . .	255	Adjustable Pedals . . . . .	23	Automatic Transmission . . . . .	161
Speed Range of Use . . . . .	251	Air Conditioning Controls . . . . .	141	Automatic Transmission Lever . . . . .	161
System Cancellation . . . . .	254	A/C Filter . . . . .	151	Automatic Transmission Range . . . . .	164
System Disengage . . . . .	254	Automatic Temperature Control (ATC) . . . . .	147	Service Shift Lever . . . . .	164
System in Faulty . . . . .	254	Dual Zone Climate Control Functions . . . . .	146	Transmission Malfunction and Overheating Conditions . . . . .	168
System Limitations . . . . .	254	Dual Zone Climate Controls . . . .	142	Auxiliary Jump-Start Procedure . . .	275
System Operation . . . . .	251	Four-Zone Climate Controls . . . .	148	Battery Remote Posts Position . . . . .	276
System Statuses . . . . .	253	Operating Tips . . . . .	150	Jump-Start Procedure . . . . .	276
Adaptive Cruise Control - ACC . . . .	225	Air Conditioning Distribution . . . . .	55	<b>B</b> attery Status and Maintenance . .	300
Activation/Deactivation . . . . .	228	Adjustable Air Vents . . . . .	57	Battery Recharge . . . . .	302
Changing Speed Setting . . . . .	229			Battery State of Charge . . . . .	300



# Index

Maintaining Battery Charge . . . . .	303	Vehicle Load Carrying Capacity . . . . .	43	Bi-Xenon Headlight (without AFS) . . . . .	28
To Disconnect the Battery . . . . .	300	Cargo Lights . . . . .	34	External Lights Equipment . . . . .	26
To Reconnect the Battery . . . . .	301	Consulting the Manual . . . . .	7	High Beam with “Glare Free” Function (not allowed on the US market) . . . . .	30
Useful Advice to Extend Battery Life . . . . .	302	Controls on Steering Wheel . . . . .	123	SmartBeam™ System . . . . .	27
Blind Spot Assist - BSA . . . . .	242	Audio System Controls . . . . .	126	External Lights Cluster . . . . .	26
System Monitoring on TFT Display . . . . .	244	Phone and Voice Controls . . . . .	124		
Blind Spot Assist – BSA		Cruise Control - CC . . . . .	222	<b>F</b> Forward Collision Warning - FCW . . . . .	235
BSA and RCP Setting . . . . .	245	Activation . . . . .	223	Forward Collision Warning – FCW Limited Operation and Service Warning . . . . .	238
Radar Device - Regulatory Information . . . . .	246	Changing Speed Setting . . . . .	224	Pedestrian Emergency Braking (PEB) System . . . . .	235
RCP - Rear Cross Path . . . . .	245	Controls . . . . .	222	Radar Device - Regulatory Information . . . . .	238
System Operation . . . . .	242	Displayed Information . . . . .	223	Speed Range of Use . . . . .	237
Bodywork Maintenance and Care . . . . .	307	Driver Override . . . . .	225	System Operation . . . . .	236
Pre-Short Drop Function . . . . .	309	Resume Speed . . . . .	225	System Setting . . . . .	237
Protection from Atmospheric Agents . . . . .	307	Setting Desired Speed . . . . .	224	System Status . . . . .	237
Useful Advice to Keep the Bodywork in Good Condition . . . . .	307	Speed Range of Use . . . . .	224	Front Power Seats . . . . .	14
		Temporary Deactivation . . . . .	224	Front Power Seat Controls . . . . .	14
		Using Cruise Control on Hills . . . . .	225	Front Seats . . . . .	
				Front Heated Seats . . . . .	15
<b>C</b> Cargo Area . . . . .	43	<b>D</b> Drive Mode . . . . .	171	Front Ventilated Seats  . . . . .	16
Accessories Compartment . . . . .	46	Controls Preview . . . . .	171	Front to Back Roof Rails . . . . .	50
Cargo Area Extension . . . . .	47	Setting the Drive Mode . . . . .	172	Functions of Controls Menu on MIA . . . . .	112
Installing the Cargo Net (OPT) for Cargo Area . . . . .	47	Driving Conditions . . . . .	201	Functions of Settings Menu on MIA . . . . .	113
Loading with Rear Seatbacks Folded Down . . . . .	45	Before the Trip . . . . .	201	Audio . . . . .	121
Luggage Fasteners and Retainers . . . . .	44	Safe Driving . . . . .	202	Camera . . . . .	118
Ski and Snowboard Bag Compartment . . . . .	45			Clock & Date . . . . .	116
Trunk Compartment Cover . . . . .	46	<b>E</b> Emergency Release of the Parking Brake . . . . .	274		
		Example to modify the “Speed Warning” status . . . . .	97		
		External Lighting . . . . .	26		
		Adaptive “Full-LED” Headlight . . . . .	28		
		Automatic High Beam . . . . .	29		



Display . . . . .	114	Using HomeLink® . . . . .	54	Maserati Intelligent Assistant	
Doors & Locks . . . . .	119	Hood Operation . . . . .	83	Touch Screen . . . . .	310
Geolocation . . . . .	122	Closing . . . . .	84	Parts in Premium Quality	
Key Off Options . . . . .	120	Opening . . . . .	83	Wood . . . . .	310
Lights . . . . .	118	<b>If a Fuse Blows . . . . .</b>	267	Internal Equipment . . . . .	35
Mirrors & Wipers . . . . .	118	Fuse Box under the		AUX, USB and SD Memory Card	
Navigation . . . . .	118	Dashboard . . . . .	272	Ports . . . . .	37
Notification . . . . .	122	Integrated Power Module . . . . .	268	Cupholders . . . . .	36
Phone/Bluetooth . . . . .	117	Position of Fuses . . . . .	268	Electric Power Outlets . . . . .	35
Restore Settings . . . . .	122	Rear Power Distribution		Handholds and Cloth Hooks . . . . .	40
Safety & Driving Assistant . . . . .	115	Center . . . . .	270	iPad Holder (Genuine	
Seat & Comfort . . . . .	120	Used Fuses Characteristics . . . . .	267	Accessories) . . . . .	40
SiriusXM Setup . . . . .	122	Illuminated Entry/Exit . . . . .	62	iPod® Connection . . . . .	38
Software Updates . . . . .	122	Use of Light Switch for Vehicle		Mesh Pockets . . . . .	40
Suspension . . . . .	120	Lighting . . . . .	64	Smoking Kit . . . . .	39
System Information . . . . .	122	Vehicle Lighting with		Sun Visors . . . . .	39
Voice . . . . .	117	Open/Closed Doors . . . . .	64	Wi-Fi Hotspot  . . . . .	41
<b>G</b> love Box Compartment . . . . .	137	In case of a Punctured Tire . . . . .	263	<b>Keys . . . . .</b>	60
Privacy Lock Functions . . . . .	138	Using the Compact Spare		Key fob . . . . .	61
<b>H</b> azard Warning Flashers . . . . .	259	Wheel . . . . .	263	Keyless Ignition Device . . . . .	60
Hill Descent Control (HDC) . . . . .	220	In Case of External Lights Fault		Shift Ignition Device to OFF	
HomeLink® . . . . .	51	Signal . . . . .	273	Alert . . . . .	61
Before You Start Programming		In the Event of an Accident . . . . .	260		
HomeLink® . . . . .	52	In case of Injured Persons . . . . .	260	<b>L</b> ane Keeping Assist - LKA . . . . .	239
Radio Frequency Device -		Instrument Cluster Overview . . . . .	86	Customized Settings . . . . .	239
Regulatory Information . . . . .	54	Integrated External Rearview Mirror		Function Description and	
Security . . . . .	54	Lights . . . . .	27	Operating Mode . . . . .	240
System with Devices Provided		Interior Lighting . . . . .	32	Radar Device - Regulatory	
with Rolling Codes . . . . .	52	Dome Lights . . . . .	32	Information . . . . .	242
System with Devices Without		Interior Maintenance and Care . . . . .	310	Speed Range of Use . . . . .	239
Rolling Code . . . . .	53	Car Cleaning and Sanitizing . . . . .	310	System Availability . . . . .	239
Troubleshooting Tips . . . . .	54	Leather Upholstery		System in Faulty . . . . .	242
		Treatment . . . . .	310	System Limitations . . . . .	241



# Index

Launch Control Mode (TROFEO version only) . . . . .	187	Memory Position Recall . . . . .	18	Park Assist Warning Messages Display . . . . .	211
Lights Controls . . . . .	127	Memory Profiles Setting . . . . .	17	Service the Park Assist System . . . . .	214
Light Switch . . . . .	127	Pairing Remote Keyless Entry Transmitter to Seats Memory . . . . .	18	Parking . . . . .	195
Multifunction Lever . . . . .	132			Drive Away Inhibit strategy . . . . .	196
<b>M</b> ain Controls Overview . . . . .	12	<b>N</b> ormal Starting of the Engine . . . . .	154	Parking Brake . . . . .	191
On Central Console . . . . .	12	“Panic Stop” Strategy . . . . .	155	Deactivating Automatic Operation . . . . .	192
On Dashboard . . . . .	12	Engine Start Failure . . . . .	155	EPB Operation with Overheated Brakes . . . . .	194
On Front Dome Console . . . . .	13	Engine Turn-Off . . . . .	155	Failure Indication . . . . .	193
On Front Doors . . . . .	13			Manual Engagement/Disengagement . . . . .	192
On Rear Doors . . . . .	13	<b>O</b> ff-Road Drive . . . . .	188	Passive Entry System . . . . .	68
Maintenance Procedures . . . . .	292	After Driving Off-road . . . . .	190	Manual Door Lock from Outside . . . . .	70
A/C Air Filter Replacement . . . . .	296	Driving in Mud and Sand . . . . .	190	Preventing Inadvertent Locking of the Key fob Inside the Vehicle . . . . .	69
Engine Air Filters Replacement . . . . .	296	Driving in Snow and Wet Grass . . . . .	189	Radio Frequency RKE Transmitter - Regulatory Information . . . . .	71
Level Checks . . . . .	292	Driving Through Water . . . . .	189	Release the Liftgate and Enter the Trunk . . . . .	70
Wiper Maintenance and Blades Replacement . . . . .	297	Hill Climbing . . . . .	190	Unlock Door from the Driver Side . . . . .	68
Maintenance Service Components . . . . .	289	Traction Downhill . . . . .	190	Unlock Door from the Passenger Side . . . . .	68
Manual Headlights . . . . .	131	Warnings and Tips for Off-road Driving . . . . .	190	Power Liftgate Operation . . . . .	79
Maserati Intelligent Assistant Operation . . . . .	109	On-board Documentation Kits . . . . .	6	Power Liftgate Emergency Release . . . . .	83
Customizing the Main Status and Category Bar . . . . .	112	Owner’s Information Online . . . . .	7	Power Sunroof with Sunshade . . . . .	76
Main Category Bar on MIA Display . . . . .	111			Ignition Off Operation . . . . .	78
Main Status Bar on MIA Display . . . . .	110	<b>P</b> ark Assist . . . . .	210	Initialization Procedure . . . . .	78
Manual Controls and Devices . . . . .	109	Cleaning the Park Assist Sensors . . . . .	215		
Memorize the Driver’s Seat Position . . . . .	17	Enabling and Disabling Park Assist . . . . .	214		
Easy Entry/Exit Driver Seat . . . . .	18	Operation with a Trailer . . . . .	216		
		Park Assist Sensors . . . . .	210		
		Park Assist System Usage Precautions . . . . .	215		
		Park Assist Volume . . . . .	215		



Opening the Power Sunroof with Key fob and Ignition Off . . . . .	78	Fuel Filler Cap Open Warning Light . . . . .	200	Emissions Inspection and Maintenance Programs . . . . .	287
Pinch Protect Function . . . . .	77	Fuel Filler Neck Access . . . . .	199	Heavy-Duty Vehicle Use . . . . .	286
Slide Opening Sunroof . . . . .	77	Refill the Tank . . . . .	200	Main Operations/Service Coupons . . . . .	284
Sunroof Maintenance . . . . .	78	Remote Start System . . . . .	156	On-Board Diagnostics (OBD) . . . . .	286
Sunshade . . . . .	77	Driver's Seat Comfort with Remote Start . . . . .	157	Periodic Maintenance . . . . .	286
Venting Sunroof . . . . .	77	Engine Remote Start Abort Message on Instrument Cluster . . . . .	156	Spare Parts . . . . .	287
Wind Buffeting . . . . .	78	How to use Remote Start . . . . .	156	Setting Ride Height . . . . .	183
Power Sunshades on Rear Door Windows . . . . .	73	Radio Frequency RKE Transmitter - Regulatory Information . . . . .	157	SOS and Assist Call . . . . .	261
Operations . . . . .	74	To enter Remote Start Mode . . . . .	156	Steering Wheel Adjustment . . . . .	21
Power Windows . . . . .	71	To exit Remote Start Mode and Drive the Vehicle . . . . .	157	Heated Steering Wheel . . . . .	21
Auto-Down Function . . . . .	72	To exit Remote Start Mode without Driving the Vehicle . . . . .	157	Power Adjustment . . . . .	21
Auto-Up Function with Anti-Pinch Protection . . . . .	72	Requiring and Setting Additional Key fobs . . . . .	66	Surround View Camera System . . . . .	217
Open the Windows with Key fob and Ignition Off . . . . .	73	Key fob Battery Replacement . . . . .	66	System components . . . . .	217
Rear Window and Sunshade Lockout Button . . . . .	73	Radio Frequency RKE Transmitter - Regulatory Information . . . . .	67	<b>T</b> FT Display Areas . . . . .	87
Reset Auto-Up/Down . . . . .	72	Restarting the Vehicle after a Long Inactivity . . . . .	312	TFT Display Pop up Messages . . . . .	88
Wind Buffeting . . . . .	73	<b>S</b> cheduled Maintenance Service . . . . .	282	TFT Display Setting and Menu Overview . . . . .	89
<b>R</b> ear Parking Camera . . . . .	216	Interval Running Coupons . . . . .	282	TFT Display: Menu and Submenu Content . . . . .	93
Rear Seats . . . . .	19	Scheduled Maintenance (Service) Indicator . . . . .	282	Tool Kit . . . . .	258
Rear Armrest . . . . .	20	Scheduled Service Plan . . . . .	283	Towing a Disabled Vehicle . . . . .	278
Rear Seat Folding Seatback . . . . .	19	Dealer Service . . . . .	287	Manual Release of Transmission with Low Battery . . . . .	278
Rear Side Heated Seats . . . . .	20			Use the Tow Hook Included in the Tool Kit . . . . .	278
Rearview Mirrors . . . . .	23			Vehicle Towing Conditions . . . . .	278
External Mirrors . . . . .	23			Traffic Sign Assist - TSA . . . . .	255
Internal Rearview Mirror . . . . .	25			Traffic Sign Assist - TSA Customized Settings . . . . .	255
Refueling . . . . .	199			Signs Monitoring on Instrument Cluster . . . . .	256
Emergency Fuel Filler Door Release . . . . .	201				



# Index

System Limitations . . . . .	256	<b>V</b> ehicle Stored for Long Periods . . . . .	311
Trailer Towing . . . . .	204	<b>W</b> arning and Indicator Lights . . . .	98
Arranging Load on Trailer . . . . .	204	Warning and Indicator Light on Tachometer . . . . .	100
Connect the Electrical System of the Trailer . . . . .	207	Warning and Indicator Lights on Speedometer . . . . .	98
Field of Vision of External Rearview Mirrors . . . . .	205	Warning and Indicator Lights on TFT Display . . . . .	102
Install the Trailer Tongue . . . . .	206	<b>W</b> heels Maintenance . . . . .	305
Remove the Trailer Tongue . . . . .	207	Tires Maintenance . . . . .	305
Removing the Access Cover . . . . .	206	Wheel Rims Maintenance . . . . .	306
Tire Pressure Adjustment . . . . .	204	<b>W</b> ipers and Washers Control Headlights On with Windshield	
Towing Tips . . . . .	207	Wipers . . . . .	135
Trailer Lights . . . . .	205	Rain Sensing Windshield	
Trailer Tongue Weight . . . . .	204	Wipers . . . . .	134
<b>T</b> ransmission Manual Release of P (Park) Position . . . . .	275	Rear Window Wiper/Washer . . .	136
<b>U</b> nlock the Vehicle with Key fob . . .	65	Windshield Washers and Headlight Washers . . . . .	136
Unlatch the Liftgate . . . . .	66	Windshield Wipers . . . . .	134
Unlock the Doors, Fuel Filler Door and Liftgate . . . . .	65	Wiper Blade Maintenance . . . .	135
<b>U</b> pdating . . . . .	6	<b>W</b> ipers and Washers Controls . . .	134
<b>U</b> se of the Engine . . . . .	198		
Breaking-In . . . . .	198		
On-Board Diagnostics (OBD) . . .	198		
Spare Parts . . . . .	199		
While Driving . . . . .	198		
<b>U</b> sing the Brakes . . . . .	197		
Brake Overheating . . . . .	197		
Brake Pads and Brake Discs . . .	197		
New Brake Pads and/or Brake Discs . . . . .	197		





Maserati S.p.A. & Maserati North America, Inc. reserve the right to make changes and/or modifications to the content and all technical information and specifications without prior notification.

Therefore, the user is not entitled to any claims based on the contents (texts, data, illustrations, explanations and regulations) in this manual, which are based on the data known at the time of going to print.

© 2022. Maserati S.p.A. All rights reserved.

Publication no. 910043934 - 1st Edition - 06/2022

This document may not be reproduced, printed or translated, even partially, without the written consent of MASERATI S.p.A.



\*910043934\*



WWW.MASERATI.COM

MASERATI SPA · VIALE CIRO MENOTTI, 322 · I-41121 MODENA