

Pictorial index

Search by illustration

1

For safety and security

Make sure to read through them

2

Instrument cluster

How to read the gauges and meters, the variety of warning lights and indicators, etc.

3

Operation of each component

Opening and closing the doors and windows, adjustment before driving, etc.

4

Driving

Operations and advice which are necessary for driving

5

Interior features

Usage of the interior features, etc.

6

Maintenance and care

Caring for your vehicle and maintenance procedures

7

When trouble arises

What to do in case of malfunction or emergency

8

Vehicle specifications

Vehicle specifications, customizable features, etc.

9

For owners

Reporting safety defects for U.S. owners

Index

Search by symptom

Search alphabetically

For your information.....	6
Reading this manual.....	12
How to search.....	13
Pictorial index.....	14

1 For safety and security

1-1. For safe use	
Before driving.....	24
For safe driving.....	26
Seat belts.....	28
SRS airbags.....	34
Front passenger occupant classification system.....	48
Safety information for children.....	53
Child restraint systems.....	54
Installing child restraints.....	58
Exhaust gas precautions.....	68
1-2. Emergency assistance	
Safety Connect.....	69
1-3. Hybrid system	
Hybrid system features.....	75
Hybrid system precautions.....	79
1-4. Theft deterrent system	
Immobilizer system.....	86
Alarm.....	88

2 Instrument cluster

2. Instrument cluster	
Warning lights and indicators.....	92
Gauges and meters.....	98
Multi-information display.....	102
Head-up display.....	121
Energy monitor/ consumption screen.....	128

3 Operation of each component

3-1. Key information	
Keys.....	134
3-2. Opening, closing and locking the doors	
Doors.....	138
Trunk.....	144
Smart key system.....	148
3-3. Adjusting the seats	
Front seats.....	155
Rear seats.....	157
Driving position memory.....	159
Head restraints.....	164
3-4. Adjusting the steering wheel and mirrors	
Steering wheel.....	166
Inside rear view mirror.....	168
Outside rear view mirrors.....	170
3-5. Opening and closing the windows	
Power windows.....	173
Moon roof.....	177

4 Driving

4-1. Before driving

Driving the vehicle	182
Cargo and luggage.....	190
Vehicle load limits	193
Trailer towing.....	194
Dinghy towing.....	195

4-2. Driving procedures

Power (ignition) switch	196
EV drive mode.....	202
Hybrid transmission.....	205
Turn signal lever.....	211
Parking brake	212
Brake Hold	216

4-3. Operating the lights and wipers

Headlight switch	218
Automatic High Beam	222
Windshield wipers and washer	226

4-4. Refueling

Opening the fuel tank cap	230
---------------------------------	-----

4-5. Using the driving support systems

Toyota Safety Sense P.....	235
PCS (Pre-Collision System).....	242
LDA (Lane Departure Alert with steering control)	252
Dynamic radar cruise control with full-speed range	263
BSM (Blind Spot Monitor).....	276
• BSM function	280
• RCTA function.....	283
Rear Camera Detection function	288
Intuitive parking assist	292
Intelligent Clearance Sonar (ICS)	300
Driving mode select switches.....	321
Driving assist systems	323

4-6. Driving tips

Hybrid vehicle driving tips.....	330
Winter driving tips	333

5 Interior features

- 5-1. Using the air conditioning system and defogger**
 Automatic air conditioning system..... 338
 Heated steering wheel/ seat heaters/ seat ventilators..... 349
- 5-2. Using the interior lights**
 Interior lights list 352
 • Interior light 353
 • Personal lights 353
 • Ambient lights 354
- 5-3. Using the storage features**
 List of storage features..... 355
 • Glove box..... 356
 • Console box..... 356
 • Bottle holders..... 357
 • Cup holders 358
 • Auxiliary boxes..... 359
 • Open tray 360
 Trunk features 361
- 5-4. Other interior features**
 Other interior features 362
 • Sun visors 362
 • Vanity mirrors..... 362
 • Power outlet..... 363
 • USB charging ports..... 364
 • Wireless charger 366
 • Armrest 375
 • Assist grips 375
 • Coat hooks..... 376
 Garage door opener..... 377

6 Maintenance and care

- 6-1. Maintenance and care**
 Cleaning and protecting the vehicle exterior 386
 Cleaning and protecting the vehicle interior 389
- 6-2. Maintenance**
 Maintenance requirements 392
 General maintenance 394
 Emission inspection and maintenance (I/M) programs 398
- 6-3. Do-it-yourself maintenance**
 Do-it-yourself service precautions..... 399
 Hood..... 401
 Positioning a floor jack..... 402
 Engine compartment 403
 12-volt battery..... 411
 Tires..... 415
 Tire inflation pressure 427
 Wheels..... 430
 Air conditioning filter 432
 Cleaning the hybrid battery (traction battery) air intake vent and filter..... 434
 Electronic key battery 439
 Checking and replacing fuses..... 442
 Light bulbs 445

7 When trouble arises

7-1. Essential information

Emergency flashers	448
If your vehicle has to be stopped in an emergency	449
If the vehicle is trapped in rising water	450

7-2. Steps to take in an emergency

If your vehicle needs to be towed	451
If you think something is wrong	454
If a warning light turns on or a warning buzzer sounds	455
If a warning message is displayed	465
If you have a flat tire	471
If the hybrid system will not start	482
If the electronic key does not operate properly	484
If the 12-volt battery is discharged	487
If your vehicle overheats	494
If the vehicle becomes stuck	498

8 Vehicle specifications

8-1. Specifications

Maintenance data (fuel, oil level, etc.)	502
Fuel information	510
Tire information	513

8-2. Customization

Customizable features	526
-----------------------------	-----

8-3. Items to initialize

Items to initialize	535
---------------------------	-----

9 For owners

Reporting safety defects for U.S. owners	538
---	-----

Index

What to do if... (Troubleshooting)	540
Alphabetical index	544

For information regarding the equipment listed below, refer to “NAVIGATION AND MULTIMEDIA SYSTEM OWNER’S MANUAL”.

- Navigation system
- Audio/visual system
- Toyota parking assist monitor
- Panoramic view monitor
- Connected Services

For your information

Main Owner's Manual

Please note that this manual applies to all models and explains all equipment, including options. Therefore, you may find some explanations for equipment not installed on your vehicle.

All specifications provided in this manual are current at the time of printing. However, because of the Toyota policy of continual product improvement, we reserve the right to make changes at any time without notice.

Depending on specifications, the vehicle shown in the illustrations may differ from your vehicle in terms of equipment.

Noise from under vehicle after turning off the hybrid system

Approximately five hours after the hybrid system is turned off, you may hear sound coming from under the vehicle for several minutes. This is the sound of a fuel evaporation leakage check and, it does not indicate a malfunction.

Accessories, spare parts and modification of your Toyota

A wide variety of non-genuine spare parts and accessories for Toyota vehicles are currently available in the market. You should know that Toyota does not warrant these products and is not responsible for their performance, repair, or replacement, or for any damage they may cause to, or adverse effect they may have on, your Toyota vehicle.

This vehicle should not be modified with non-genuine Toyota products. Modification with non-genuine Toyota products could affect its performance, safety or durability, and may even violate governmental regulations. In addition, damage or performance problems resulting from the modification may not be covered under warranty.

Installation of a mobile two-way radio system

The installation of a mobile two-way radio system in your vehicle could affect electronic systems such as:

- Multiport fuel injection system/sequential multiport fuel injection system
- Toyota Safety Sense P
- Anti-lock brake system
- SRS airbag system
- Seat belt pretensioner system

Be sure to check with your Toyota dealer for precautionary measures or special instructions regarding installation of a mobile two-way radio system.

High voltage parts and cables on the hybrid vehicles emit approximately the same amount of electromagnetic waves as the conventional gasoline powered vehicles or home electronic appliances despite of their electromagnetic shielding.

Unwanted noise may occur in the reception of the mobile two-way radio.

Vehicle data recording

The vehicle is equipped with sophisticated computers that will record certain data, such as:

- Engine speed/Electric motor speed (traction motor speed)
- Accelerator status
- Brake status
- Vehicle speed
- Operation status of the driving assist systems
- Images from the cameras

Your vehicle is equipped with cameras. Contact your Toyota dealer for the location of recording cameras

The recorded data varies according to the vehicle grade level and options with which it is equipped.

These computers do not record conversations or sounds, and only record images outside of the vehicle in certain situations.

● Data Transmission

Your vehicle may transmit the data recorded in these computers to Toyota without notification to you.

● Data usage

Toyota may use the data recorded in this computer to diagnose malfunctions, conduct research and development, and improve quality.

Toyota will not disclose the recorded data to a third party except:

- With the consent of the vehicle owner or with the consent of the lessee if the vehicle is leased
- In response to an official request by the police, a court of law or a government agency
- For use by Toyota in a lawsuit
- For research purposes where the data is not tied to a specific vehicle or vehicle owner

● Recorded image information can be erased by your Toyota dealer.

The image recording function can be disabled. However, if the function is disabled, data from when the system operates will not be available.

● To learn more about the vehicle data collected, used and shared by Toyota, please visit www.toyota.com/privacyvts/.

Usage of data collected through Safety Connect (U.S. mainland only)

If your Toyota has Safety Connect and if you have subscribed to those services, please refer to the Safety Connect Telematics Subscription Service Agreement for information on data collected and its usage.

- To learn more about the vehicle data collected, used and shared by Toyota, please visit www.toyota.com/privacyvts/.

Event data recorder

This vehicle is equipped with an event data recorder (EDR). The main purpose of an EDR is to record, in certain crash or near crash-like situations, such as an air bag deployment or hitting a road obstacle, data that will assist in understanding how a vehicle's systems performed. The EDR is designed to record data related to vehicle dynamics and safety systems for a short period of time, typically 30 seconds or less.

The EDR in this vehicle is designed to record such data as:

- How various systems in your vehicle were operating;
- Whether or not the driver and passenger safety belts were buckled/fastened;
- How far (if at all) the driver was depressing the accelerator and/or brake pedal; and,
- How fast the vehicle was traveling.

These data can help provide a better understanding of the circumstances in which crashes and injuries occur.

NOTE: EDR data are recorded by your vehicle only if a non-trivial crash situation occurs; no data are recorded by the EDR under normal driving conditions and no personal data (e.g., name, gender, age, and crash location) are recorded. However, other parties, such as law enforcement, could combine the EDR data with the type of personally identifying data routinely acquired during a crash investigation.

To read data recorded by an EDR, special equipment is required, and access to the vehicle or the EDR is needed. In addition to the vehicle manufacturer, other parties, such as law enforcement, that have the special equipment, can read the information if they have access to the vehicle or the EDR.

● Disclosure of the EDR data

Toyota will not disclose the data recorded in an EDR to a third party except when:

- An agreement from the vehicle's owner (or the lessee for a leased vehicle) is obtained
- In response to an official request by the police, a court of law or a government agency
- For use by Toyota in a lawsuit

However, if necessary, Toyota may:

- Use the data for research on vehicle safety performance
- Disclose the data to a third party for research purposes without disclosing information about the specific vehicle or vehicle owner

Scrapping of your Toyota

The SRS airbag and seat belt pretensioner devices in your Toyota contain explosive chemicals. If the vehicle is scrapped with the airbags and seat belt pretensioners left as they are, this may cause an accident such as fire. Be sure to have the systems of the SRS airbag and seat belt pretensioner removed and disposed of by a qualified service shop or by your Toyota dealer before you scrap your vehicle.

Perchlorate Material

Special handling may apply, See www.dtsc.ca.gov/hazardouswaste/perchlorate. Your vehicle has components that may contain perchlorate. These components may include airbag, seat belt pretensioners, and wireless remote control batteries.

WARNING

■ General precautions while driving

Driving under the influence: Never drive your vehicle when under the influence of alcohol or drugs that have impaired your ability to operate your vehicle. Alcohol and certain drugs delay reaction time, impair judgment and reduce coordination, which could lead to an accident that could result in death or serious injury.

Defensive driving: Always drive defensively. Anticipate mistakes that other drivers or pedestrians might make and be ready to avoid accidents.

Driver distraction: Always give your full attention to driving. Anything that distracts the driver, such as adjusting controls, talking on a cellular phone or reading can result in a collision with resulting death or serious injury to you, your occupants or others.

■ General precaution regarding children's safety

Never leave children unattended in the vehicle, and never allow children to have or use the key.

Children may be able to start the vehicle or shift the vehicle into neutral. There is also a danger that children may injure themselves by playing with the windows, the moon roof, or other features of the vehicle. In addition, heat build-up or extremely cold temperatures inside the vehicle can be fatal to children.

Reading this manual



WARNING:

Explains something that, if not obeyed, could cause death or serious injury to people.



NOTICE:

Explains something that, if not obeyed, could cause damage to or a malfunction in the vehicle or its equipment.



Indicates operating or working procedures. Follow the steps in numerical order.



Indicates the action (pushing, turning, etc.) used to operate switches and other devices.



Indicates the outcome of an operation (e.g. a lid opens).

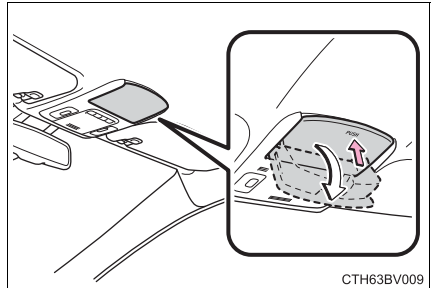

Indicates the component or position being explained.



Means “Do not”, “Do not do this”, or “Do not let this happen”.

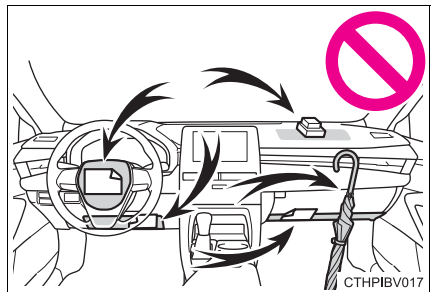

How to search

■ Searching by name

- Alphabetical indexP. 544

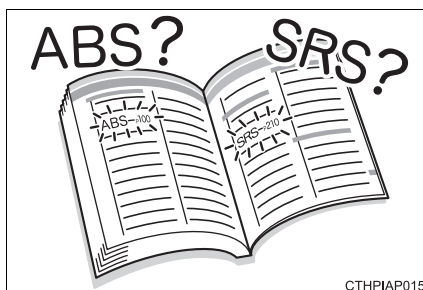

■ Searching by installation position

- Pictorial indexP. 14



■ Searching by symptom or sound

- What to do if...
(Troubleshooting)P. 540

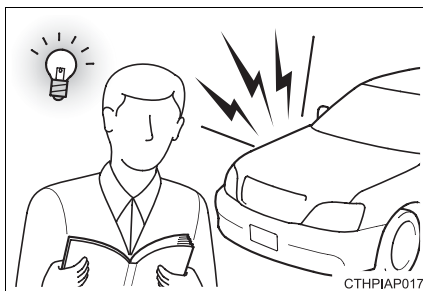

■ Searching by title

- Table of contentsP. 2

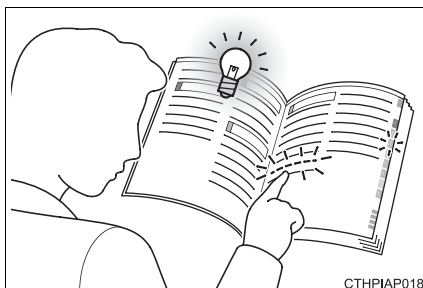

Pictorial index

Exterior

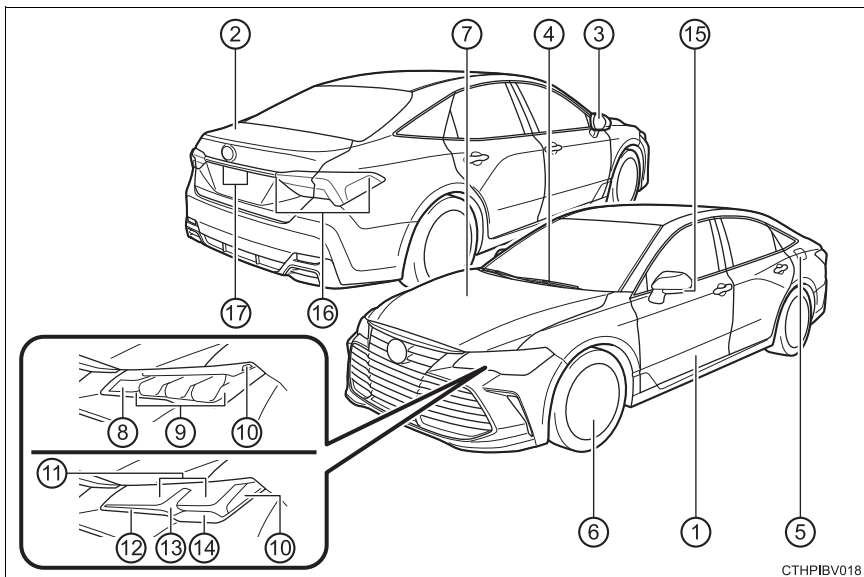

CTHPIBV018

- | | | |
|---|---|---------------|
| ① | Doors | P. 138 |
| | Locking/unlocking | P. 138 |
| | Opening/closing the side windows | P. 173 |
| | Locking/unlocking by using the mechanical key | P. 484 |
| ② | Trunk | P. 144 |
| | Opening from inside | P. 144 |
| | Opening from outside | P. 144 |
| ③ | Outside rear view mirrors | P. 170 |
| | Adjusting the mirror angle | P. 170 |
| | Folding the mirrors | P. 170 |
| | Driving position memory* | P. 159 |
| | Defogging the mirrors* | P. 343 |

- ④ **Windshield wipers** **P. 226**
 Precautions for winter season P. 333
- ⑤ **Fuel filler door** **P. 230**
 Refueling method P. 230
 Fuel type/fuel tank capacity P. 504
- ⑥ **Tires** **P. 415**
 Tire size/inflation pressure P. 508
 Winter tires/tire chains P. 333
 Checking/rotation/tire pressure warning system P. 415
 Coping with flat tires P. 471
- ⑦ **Hood** **P. 401**
 Opening P. 401
 Engine oil P. 505
 Coping with overheat P. 494

Light bulbs of the exterior lights for driving

(Replacing method: P. 445, Watts: P. 509)

- ⑧ **Front turn signal lights/parking lights** **P. 211, 218**
- ⑨ **Headlights/daytime running lights** **P. 218**
- ⑩ **Front side marker lights** **P. 218**
- ⑪ **Headlights** **P. 218**
- ⑫ **Front turn signal lights** **P. 211**
- ⑬ **Daytime running lights/parking lights** **P. 218**
- ⑭ **Front turn signal lights/cornering light** **P. 211, 218**
- ⑮ **Side turn signal lights** **P. 211**
- ⑯ **Rear turn signal lights/ rear side marker lights/
 tail lights/stoplights** **P. 211, 218**
 Back-up lights
 Shifting the shift lever to R. P. 205
- ⑰ **License plate lights** **P. 218**

■ Instrument panel

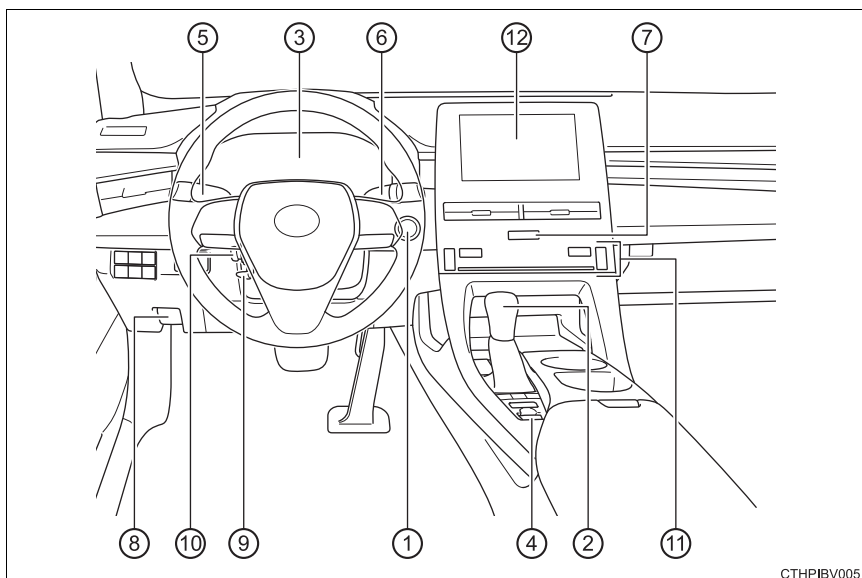

CTHPIBV005

- | | |
|--|---------------|
| ① Power switch | P. 196 |
| Starting the hybrid system/changing the modes | P. 196 |
| Emergency stop of the hybrid system | P. 449 |
| When the hybrid system will not start | P. 482 |
| ② Shift lever | P. 205 |
| Changing the shift position | P. 205 |
| Precautions for towing | P. 451 |
| When the shift lever does not move | P. 209 |
| ③ Meters | P. 98 |
| Reading the meters/adjusting the instrument panel lights | P. 98 |
| Warning lights/indicator lights | P. 92 |
| When a warning light comes on | P. 455 |
| Multi-information display | P. 102 |
| Display | P. 102 |
| When the warning messages are displayed | P. 465 |

- ④ **Parking brake switch** P. 212
 - Applying/releasing P. 212, 213
 - Precautions for winter season P. 334
 - Warning light/warning buzzer/
warning message P. 215, 455
- ⑤ **Turn signal lever** P. 211
 - Headlight switch** P. 218
 - Headlights/side marker lights/parking lights/tail lights/
license plate lights/daytime running lights P. 218
- ⑥ **Windshield wiper and washer switch** P. 226
 - Usage P. 226
 - Adding washer fluid P. 410
- ⑦ **Emergency flasher switch** P. 448
- ⑧ **Hood lock release lever** P. 401
- ⑨ **Tilt and telescopic steering lock release lever*1** P. 166
- ⑩ **Tilt and telescopic steering control switch*1** P. 166
 - Adjustment P. 166
 - Driving position memory P. 159
- ⑪ **Air conditioning system** P. 338
 - Usage P. 338
 - Rear window defogger P. 343
- ⑫ **Audio Plus*1, 2**
Premium Audio*1, 2

*1: If equipped

*2: Refer to "NAVIGATION AND MULTIMEDIA SYSTEM OWNER'S MANUAL".

Switches

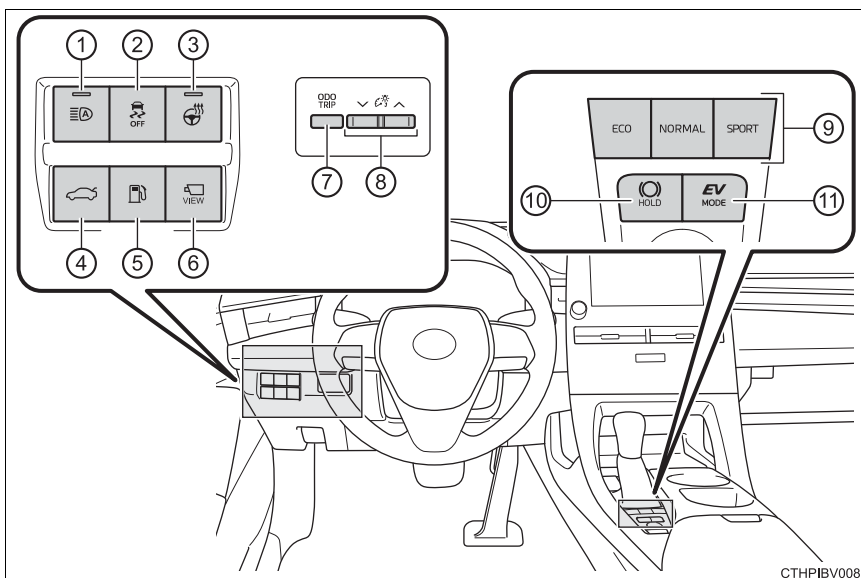

CTHPIBV008

- | | | |
|---|--|---------------|
| ① | Automatic High Beam switch | P. 222 |
| ② | VSC OFF switch | P. 324 |
| ③ | Heated steering wheel*¹ | P. 350 |
| ④ | Trunk opener switch | P. 144 |
| ⑤ | Fuel filler door opener switch | P. 233 |
| ⑥ | Camera switch*^{1, 2} | |
| ⑦ | “ODO/TRIP” switch | P. 104 |
| ⑧ | Instrument panel light control switch | P. 99 |
| ⑨ | Driving mode select switches | P. 321 |
| ⑩ | Brake hold switch | P. 216 |
| ⑪ | EV drive mode switch | P. 202 |

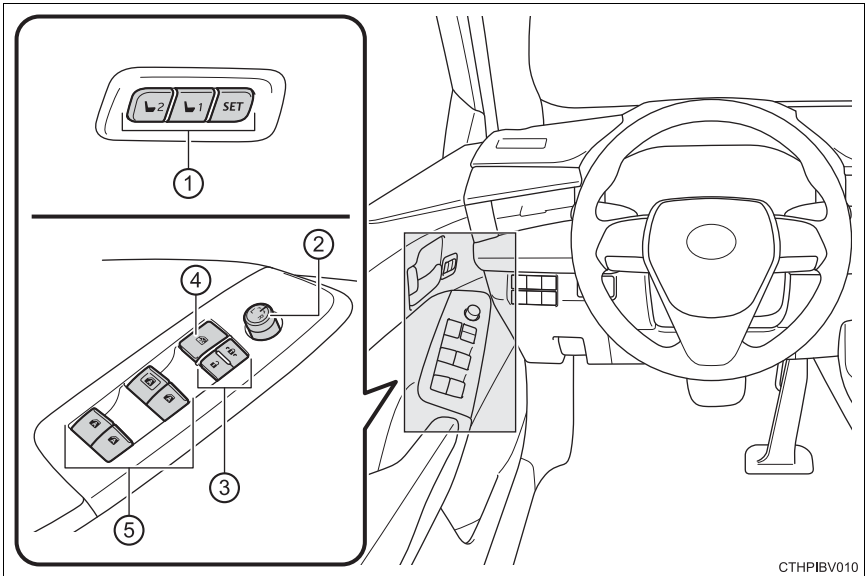

CTHP1BV010

- ① **Driving position memory switches*1** **P. 159**
 Driving position memory*1 P. 159
- ② **Outside rear view mirror switch** **P. 170**
- ③ **Door lock switches** **P. 140**
- ④ **Window lock switch** **P. 173**
- ⑤ **Power window switches** **P. 173**

*1: If equipped

*2: Refer to "NAVIGATION AND MULTIMEDIA SYSTEM OWNER'S MANUAL".

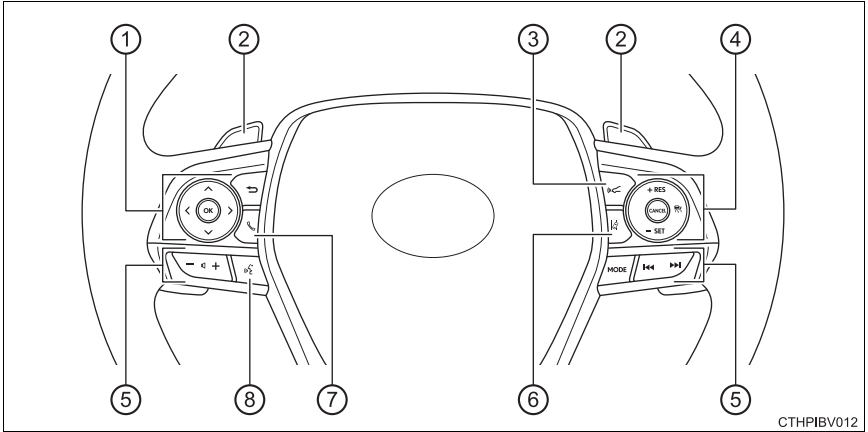

CTHPIBV012

- ① **Meter control switches** P. 103
- ② **Paddle shift switches*1** P. 205
- ③ **Vehicle-to-vehicle distance switch**..... P. 269
- ④ **Cruise control switches**
Dynamic radar cruise control with full-speed range..... P. 263
- ⑤ **Audio remote control switches*2**
- ⑥ **LDA (Lane Departure Alert with steering control)
switch** P. 252
- ⑦ **Phone switch*2**
- ⑧ **Talk switch*2**

*1: If equipped

*2: Refer to "NAVIGATION AND MULTIMEDIA SYSTEM OWNER'S MANUAL".

Interior

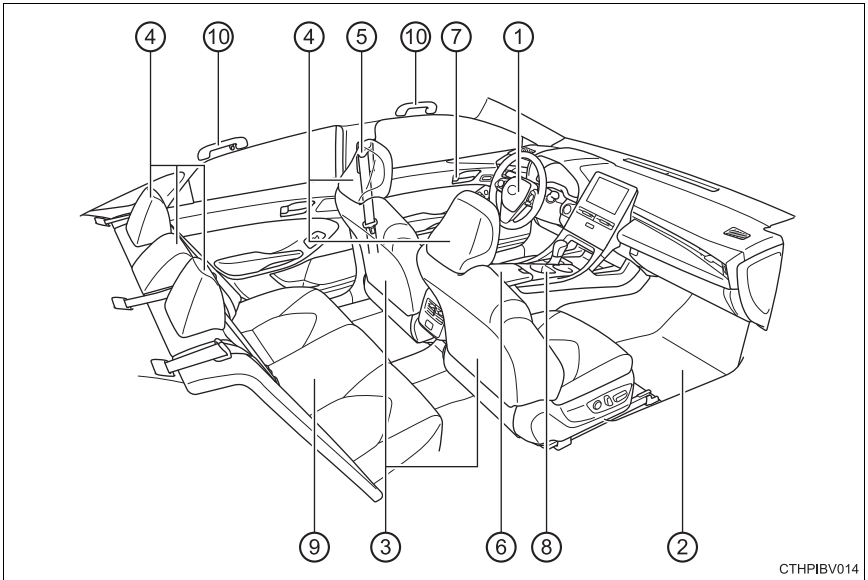

CTHPIBV014

①	SRS airbags	P. 34
②	Floor mats	P. 24
③	Front seats	P. 155
	Driving position memory*	P. 159
④	Head restraints	P. 164
⑤	Seat belts	P. 28
⑥	Console box	P. 356
⑦	Inside lock buttons	P. 140
⑧	Cup holders	P. 358
⑨	Rear seats	P. 157
⑩	Assist grips	P. 375

*: If equipped

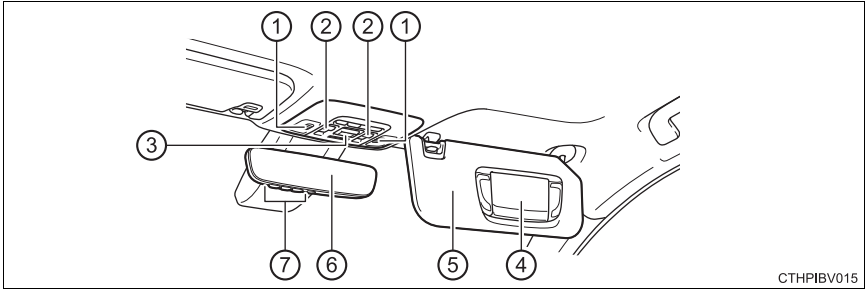

- ① Interior lights/personal lights^{*1} P. 352
- ② Moon roof switches^{*2} P. 177
- ③ “SOS” button^{*2} P. 69
- ④ Vanity mirrors P. 362
- ⑤ Sun visors P. 362
- ⑥ Inside rear view mirror P. 168
- ⑦ Garage door opener switches^{*2} P. 377

^{*1}: The illustration shows the front, but they are also equipped in the rear.

^{*2}: If equipped

For safety and security

1

1-1. For safe use	
Before driving	24
For safe driving	26
Seat belts	28
SRS airbags.....	34
Front passenger occupant classification system	48
Safety information for children	53
Child restraint systems.....	54
Installing child restraints.....	58
Exhaust gas precautions.....	68
1-2. Emergency assistance	
Safety Connect	69
1-3. Hybrid system	
Hybrid system features	75
Hybrid system precautions	79
1-4. Theft deterrent system	
Immobilizer system	86
Alarm.....	88

Before driving

Floor mat

Use only floor mats designed specifically for vehicles of the same model and model year as your vehicle. Fix them securely in place onto the carpet.

- 1 Insert the retaining hooks (clips) into the floor mat eyelets.

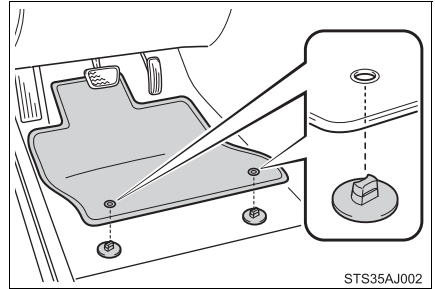

- 2 Turn the upper knob of each retaining hook (clip) to secure the floor mats in place.

*: Always align the \triangle marks.

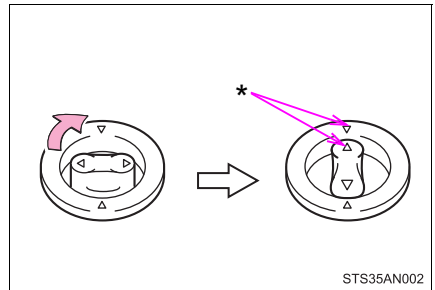

The shape of the retaining hooks (clips) may differ from that shown in the illustration.

⚠ WARNING

Observe the following precautions.

Failure to do so may cause the driver's floor mat to slip, possibly interfering with the pedals while driving. An unexpectedly high speed may result or it may become difficult to stop the vehicle. This could lead to an accident, resulting in death or serious injury.

■ When installing the driver's floor mat

- Do not use floor mats designed for other models or different model year vehicles, even if they are Toyota Genuine floor mats.
- Only use floor mats designed for the driver's seat.
- Always install the floor mat securely using the retaining hooks (clips) provided.
- Do not use two or more floor mats on top of each other.
- Do not place the floor mat bottom-side up or upside-down.

■ Before driving

- Check that the floor mat is securely fixed in the correct place with all the provided retaining hooks (clips). Be especially careful to perform this check after cleaning the floor.
- With the hybrid system stopped and the shift lever in P, fully depress each pedal to the floor to make sure it does not interfere with the floor mat.

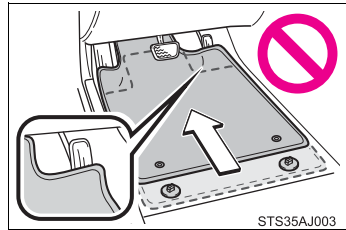

For safe driving

For safe driving, adjust the seat and mirror to an appropriate position before driving.

Correct driving posture

- ① Adjust the angle of the seat-back so that you are sitting straight up and so that you do not have to lean forward to steer. (→P. 155)
- ② Adjust the seat so that you can depress the pedals fully and so that your arms bend slightly at the elbow when gripping the steering wheel. (→P. 155)

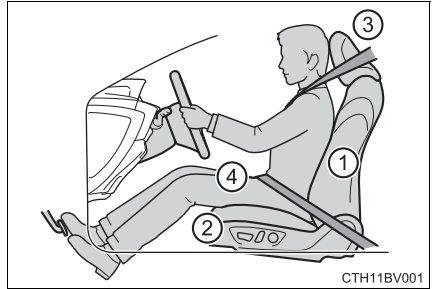

- ③ Lock the head restraint in place with the center of the head restraint closest to the top of your ears. (→P. 164)
- ④ Wear the seat belt correctly. (→P. 28)

Correct use of the seat belts

Make sure that all occupants are wearing their seat belts before driving the vehicle. (→P. 28)

Use a child restraint system appropriate for the child until the child becomes large enough to properly wear the vehicle's seat belt. (→P. 54)

Adjusting the mirrors

Make sure that you can see backward clearly by adjusting the inside and outside rear view mirrors properly. (→P. 168, 170)

 **WARNING**

Observe the following precautions.

Failure to do so may result in death or serious injury.

- Do not adjust the position of the driver's seat while driving.
Doing so could cause the driver to lose control of the vehicle.
- Do not place a cushion between the driver or passenger and the seatback.
A cushion may prevent correct posture from being achieved, and reduce the effectiveness of the seat belt and head restraint.
- Do not place anything under the front seats.
Objects placed under the front seats may become jammed in the seat tracks and stop the seat from locking in place. This may lead to an accident and the adjustment mechanism may also be damaged.
- Always observe the legal speed limit when driving on public roads.
- When driving over long distances, take regular breaks before you start to feel tired.
Also, if you feel tired or sleepy while driving, do not force yourself to continue driving and take a break immediately.

Seat belts

Make sure that all occupants are wearing their seat belts before driving the vehicle.

Correct use of the seat belts

- Extend the shoulder belt so that it comes fully over the shoulder, but does not come into contact with the neck or slide off the shoulder.
- Position the lap belt as low as possible over the hips.
- Adjust the position of the seat-back. Sit up straight and well back in the seat.
- Do not twist the seat belt.

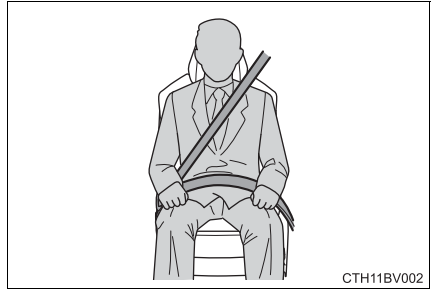

Fastening and releasing the seat belt

- ① To fasten the seat belt, push the plate into the buckle until a click sound is heard.
- ② To release the seat belt, press the release button.

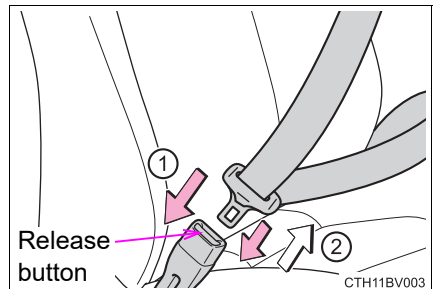

Adjusting the seat belt shoulder anchor height (front seats)

- ① Push the seat belt shoulder anchor down while pressing the release button.
- ② Push the seat belt shoulder anchor up.

Move the height adjuster up and down as needed until you hear a click.

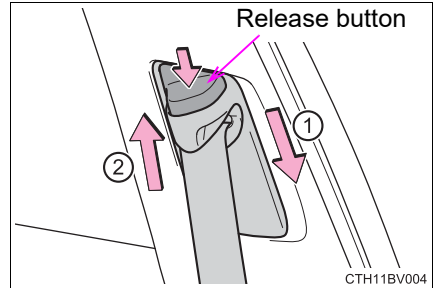

Seat belt pretensioners (front and outboard rear seats)

The pretensioners help the seat belts to quickly restrain the occupants by retracting the seat belts when the vehicle is subjected to certain types of severe frontal or side collision or a vehicle rollover.

The pretensioners do not activate in the event of a minor frontal impact, a minor side impact or a rear impact.

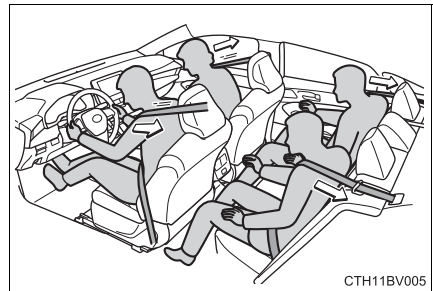

■ Emergency locking retractor (ELR)

The retractor will lock the belt during a sudden stop or on impact. It may also lock if you lean forward too quickly. A slow, easy motion will allow the belt to extend so that you can move around fully.

■ Automatic locking retractor (ALR)

When a passenger's shoulder belt is completely extended and then retracted even slightly, the belt is locked in that position and cannot be extended. This feature is used to hold the child restraint system (CRS) firmly. To free the belt again, fully retract the belt and then pull the belt out once more. (→P. 58)

■ Child seat belt usage

The seat belts of your vehicle were principally designed for persons of adult size.

- Use a child restraint system appropriate for the child, until the child becomes large enough to properly wear the vehicle's seat belt. (→P. 54)
- When the child becomes large enough to properly wear the vehicle's seat belt, follow the instructions regarding seat belt usage. (→P. 28)

■ Replacing the belt after the pretensioner has been activated

If the vehicle is involved in multiple collisions, the pretensioner will activate for the first collision, but will not activate for the second or subsequent collisions.

■ Seat belt extender

If your seat belts cannot be fastened securely because they are not long enough, a personalized seat belt extender is available from your Toyota dealer free of charge.

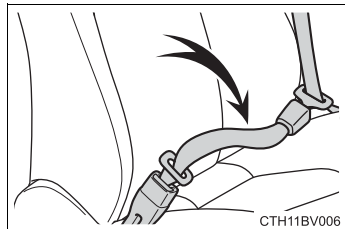

■ Rear seat belt

Use the seat belt after passing it through the guide if the seat belt comes free from the guide.

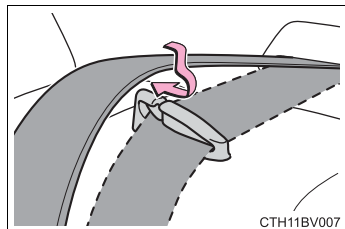

⚠ WARNING

Observe the following precautions to reduce the risk of injury in the event of sudden braking, sudden swerving or an accident.
Failure to do so may cause death or serious injury.

■ Wearing a seat belt

- Ensure that all passengers wear a seat belt.
- Always wear a seat belt properly.
- Each seat belt should be used by one person only. Do not use a seat belt for more than one person at once, including children.
- Toyota recommends that children be seated in the rear seat and always use a seat belt and/or an appropriate child restraint system.
- To achieve a proper seating position, do not recline the seat more than necessary. The seat belt is most effective when the occupants are sitting up straight and well back in the seats.
- Do not wear the shoulder belt under your arm.
- Always wear your seat belt low and snug across your hips.

■ Pregnant women

Obtain medical advice and wear the seat belt in the proper way. (→P. 28)

Women who are pregnant should position the lap belt as low as possible over the hips in the same manner as other occupants, extending the shoulder belt completely over the shoulder and avoiding belt contact with the rounding of the abdominal area.

If the seat belt is not worn properly, not only the pregnant woman, but also the fetus could suffer death or serious injury as a result of sudden braking or a collision.

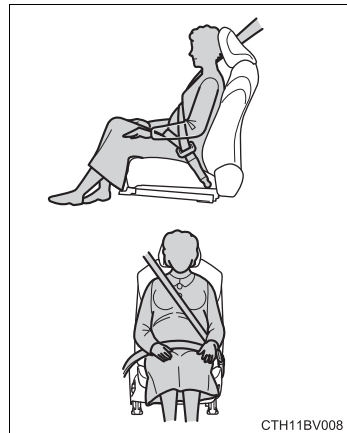

CTH11BV008

■ People suffering illness

Obtain medical advice and wear the seat belt in the proper way. (→P. 28)

**WARNING****■ When children are in the vehicle**

Do not allow children to play with the seat belt. If the seat belt becomes twisted around a child's neck, it may lead to choking or other serious injuries that could result in death.

If this occurs and the buckle cannot be unfastened, scissors should be used to cut the belt.

■ Seat belt pretensioners

- Do not place anything, such as a cushion, on the front passenger's seat. Doing so will disperse the passenger's weight, which prevents the sensor from detecting the passenger's weight properly. As a result, the seat belt pretensioner for the front passenger's seat may not activate in the event of a collision.

- If the pretensioner has activated, the SRS warning light will come on. In that case, the seat belt cannot be used again and must be replaced at your Toyota dealer.

■ Adjustable shoulder anchor

Always make sure the shoulder belt is positioned across the center of your shoulder. The belt should be kept away from your neck, but not falling off your shoulder. Failure to do so could reduce the amount of protection in an accident and cause death or serious injuries in the event of a sudden stop, sudden swerve or accident. (→P. 29)

■ Seat belt damage and wear

- Do not damage the seat belts by allowing the belt, plate, or buckle to be jammed in the door.

- Inspect the seat belt system periodically. Check for cuts, fraying, and loose parts. Do not use a damaged seat belt until it is replaced. Damaged seat belts cannot protect an occupant from death or serious injury.

- Ensure that the belt and plate are locked and the belt is not twisted. If the seat belt does not function correctly, immediately contact your Toyota dealer.

- Replace the seat assembly, including the belts, if your vehicle has been involved in a serious accident, even if there is no obvious damage.

- Do not attempt to install, remove, modify, disassemble or dispose of the seat belts. Have any necessary repairs carried out by your Toyota dealer. Inappropriate handling may lead to incorrect operation.

- Always make sure the shoulder belt passes through the guide when using the seat belt. Failure to properly position the belt may reduce the amount of protection in an accident and could lead to death or serious injury in a collision or sudden stop.

- Always make sure that the seat belt is not twisted, does not get caught in the guide or the seatback and is arranged in the proper position.

**WARNING****■ Using a seat belt extender**

- Do not wear the seat belt extender if you can fasten the seat belt without the extender.
- Do not use the seat belt extender when installing a child restraint system because the belt will not securely hold the child restraint system, increasing the risk of death or serious injury in the event of an accident.
- The personalized extender may not be safe on another vehicle, when used by another person, or at a different seating position other than the one originally intended.

**NOTICE****■ When using a seat belt extender**

When releasing the seat belt, press on the buckle release button on the extender, not on the seat belt.

This helps prevent damage to the vehicle interior and the extender itself.

SRS airbags

The SRS airbags inflate when the vehicle is subjected to certain types of severe impacts that may cause significant injury to the occupants. They work together with the seat belts to help reduce the risk of death or serious injury.

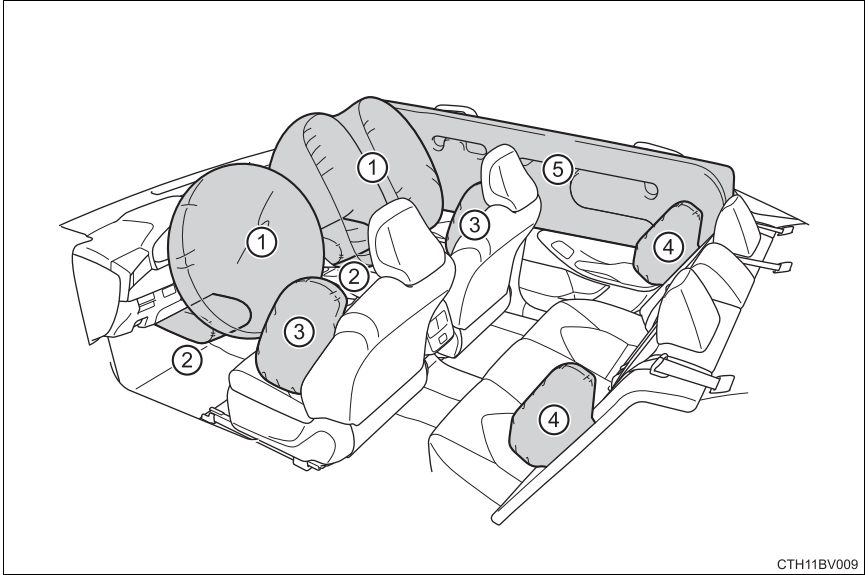

◆ SRS front airbags

- ① SRS driver airbag/front passenger airbag
Can help protect the head and chest of the driver and front passenger from impact with interior components
- ② SRS knee airbags
Can help provide driver and front passenger protection

◆ SRS side and curtain shield airbags

- ③ SRS front side airbags
 - Can help protect the torso of the front seat occupants
- ④ SRS rear side airbags
 - Can help protect the torso of occupants in the rear outer seats
- ⑤ SRS curtain shield airbags
 - Can help protect primarily the head of occupants in the outer seats
 - Can help prevent the occupants from being thrown from the vehicle in the event of vehicle rollover

SRS airbag system components

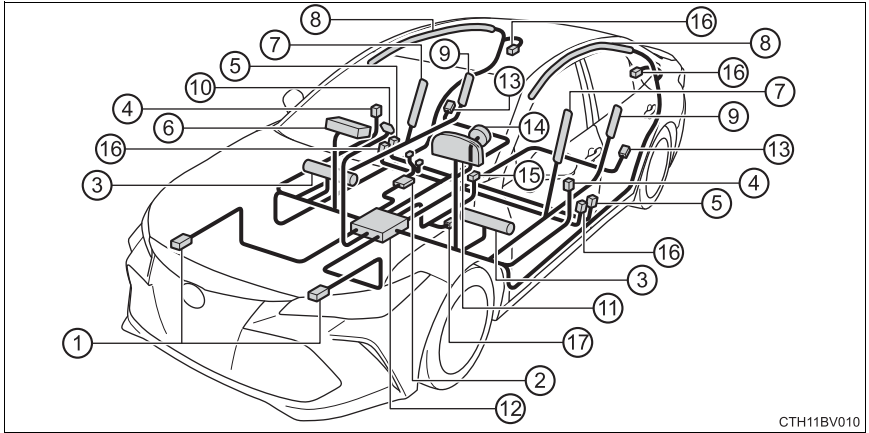

CTH11BV010

- | | |
|--|---|
| ① Front impact sensors | ⑩ "AIR BAG ON" and "AIR BAG OFF" indicator lights |
| ② Front passenger occupant classification system (ECU and sensors) | ⑪ SRS warning light |
| ③ Knee airbags | ⑫ Airbag sensor assembly |
| ④ Side impact sensors (front doors) | ⑬ Side impact sensors (rear) |
| ⑤ Side impact sensors (front) | ⑭ Driver airbag |
| ⑥ Front passenger airbag | ⑮ Driver's seat belt buckle switch |
| ⑦ Front side airbags | ⑯ Seat belt pretensioners and force limiters |
| ⑧ Curtain shield airbags | ⑰ Driver's seat position sensor |
| ⑨ Rear side airbags | |

Your vehicle is equipped with ADVANCED AIRBAGS designed based on the US motor vehicle safety standards (FMVSS208). The airbag sensor assembly (ECU) controls airbag deployment based on information obtained from the sensors etc. shown in the system components diagram above. This information includes crash severity and occupant information. As the airbags deploy, a chemical reaction in the inflators quickly fills the airbags with non-toxic gas to help restrain the motion of the occupants.

 **WARNING****■ SRS airbag precautions**

Observe the following precautions regarding the SRS airbags. Failure to do so may cause death or serious injury.

- The driver and all passengers in the vehicle must wear their seat belts properly.

The SRS airbags are supplemental devices to be used with the seat belts.

- The SRS driver airbag deploys with considerable force, and can cause death or serious injury especially if the driver is very close to the airbag. The National Highway Traffic Safety Administration (NHTSA) advises:

Since the risk zone for the driver's airbag is the first 2 - 3 in. (50 - 75 mm) of inflation, placing yourself 10 in. (250 mm) from your driver airbag provides you with a clear margin of safety. This distance is measured from the center of the steering wheel to your breastbone. If you sit less than 10 in. (250 mm) away now, you can change your driving position in several ways:

- Move your seat to the rear as far as you can while still reaching the pedals comfortably.
- Slightly recline the back of the seat.
Although vehicle designs vary, many drivers can achieve the 10 in. (250 mm) distance, even with the driver seat all the way forward, simply by reclining the back of the seat somewhat. If reclining the back of your seat makes it hard to see the road, raise yourself by using a firm, non-slippery cushion, or raise the seat if your vehicle has that feature.
- If your steering wheel is adjustable, tilt it downward. This points the airbag toward your chest instead of your head and neck.

The seat should be adjusted as recommended by NHTSA above, while still maintaining control of the foot pedals, steering wheel, and your view of the instrument panel controls.

⚠ WARNING**■ SRS airbag precautions**

- If the seat belt extender has been connected to the driver's seat belt buckle but the seat belt extender has not also been fastened to the latch plate of the driver's seat belt, the SRS front airbags for the driver will judge that the driver is wearing the seat belt even though the seat belt has not been connected. In this case, the SRS front airbags for the driver may not activate correctly in a collision, resulting in death or serious injury in the event of a collision. Be sure to wear the seat belt with the seat belt extender.
- The SRS front passenger airbag also deploys with considerable force, and can cause death or serious injury especially if the front passenger is very close to the airbag. The front passenger seat should be as far from the airbag as possible with the seatback adjusted, so the front passenger sits upright.
- Improperly seated and/or restrained infants and children can be killed or seriously injured by a deploying airbag. An infant or child who is too small to use a seat belt should be properly secured using a child restraint system. Toyota strongly recommends that all infants and children be placed in the rear seats of the vehicle and properly restrained. The rear seats are safer for infants and children than the front passenger seat. (→P. 54)

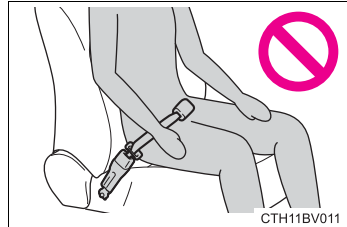

! WARNING

■ SRS airbag precautions

- Do not sit on the edge of the seat or lean against the dashboard.

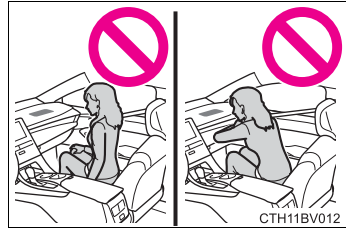

- Do not allow a child to stand in front of the SRS front passenger airbag unit or sit on the knees of a front passenger.
- Do not allow the front seat occupants to hold items on their knees.

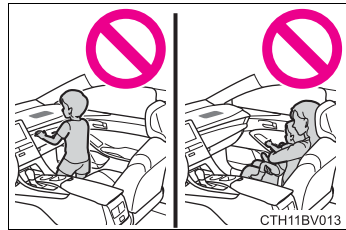

- Do not lean against the door, the roof side rail or the front, side and rear pillars.

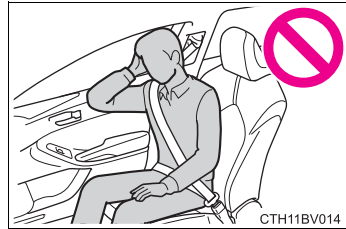

- Do not allow anyone to kneel on the passenger seats toward the door or put their head or hands outside the vehicle.

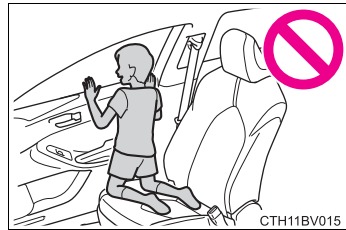

⚠ WARNING**■ SRS airbag precautions**

- Do not attach anything to or lean anything against areas such as the dashboard, steering wheel pad and lower portion of the instrument panel. These items can become projectiles when the SRS driver, front passenger and knee airbags deploy.

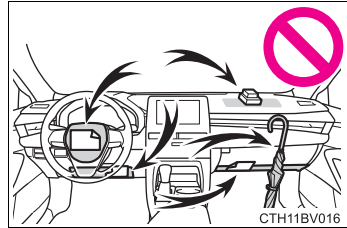

- Do not attach anything to areas such as a door, windshield, the windows, front or rear pillar, roof side rail and assist grip.

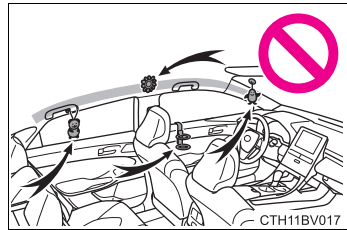

- Do not hang coat hangers or other hard objects on the coat hooks. All of these items could become projectiles and may cause death or serious injury, should the SRS curtain shield airbags deploy.

 **WARNING****■ SRS airbag precautions**

- If a vinyl cover is put on the area where the SRS knee airbag will deploy, be sure to remove it.
- Do not use seat accessories which cover the parts where the SRS side airbags inflate as they may interfere with inflation of the SRS airbags. Such accessories may prevent the side airbags from activating correctly, disable the system or cause the side airbags to inflate accidentally, resulting in death or serious injury.
- Do not strike or apply significant levels of force to the area of the SRS airbag components or the front doors.
Doing so can cause the SRS airbags to malfunction.
- Do not touch any of the component parts immediately after the SRS airbags have deployed (inflated) as they may be hot.
- If breathing becomes difficult after the SRS airbags have deployed, open a door or window to allow fresh air in, or leave the vehicle if it is safe to do so. Wash off any residue as soon as possible to prevent skin irritation.
- If the areas where the SRS airbags are stored, such as the steering wheel pad and front and rear pillar garnishes, are damaged or cracked, have them replaced by your Toyota dealer.
- Do not place anything, such as a cushion, on the front passenger's seat. Doing so will disperse the passenger's weight, which prevents the sensor from detecting the passenger's weight properly. As a result, the SRS front airbags for the front passenger may not deploy in the event of a collision.

**WARNING****■ Modification and disposal of SRS airbag system components**

Do not dispose of your vehicle or perform any of the following modifications without consulting your Toyota dealer. The SRS airbags may malfunction or deploy (inflate) accidentally, causing death or serious injury.

- Installation, removal, disassembly and repair of the SRS airbags
- Repairs, modifications, removal or replacement of the steering wheel, instrument panel, dashboard, seats or seat upholstery, front, side and rear pillars, roof side rails, front door panels, front door trims or front door speakers
- Modifications to the front door panel (such as making a hole in it)
- Repairs or modifications of the front fender, front bumper, or side of the occupant compartment
- Installation of a grille guard (bull bars, kangaroo bar, etc.), snow plows, winches, or roof luggage carrier
- Modifications to the vehicle's suspension system
- Installation of electronic devices such as mobile two-way radios and CD players
- Modifications to your vehicle for a person with a physical disability

■ If the SRS airbags deploy (inflate)

- Slight abrasions, burns, bruising etc., may be sustained from SRS airbags, due to the extremely high speed deployment (inflation) by hot gases.
- A loud noise and white powder will be emitted.
- Parts of the airbag module (steering wheel hub, airbag cover and inflator) as well as the front seats, parts of the front and rear pillars, and roof side rails, may be hot for several minutes. The airbag itself may also be hot.
- The windshield may crack.
- The interior lights will turn on automatically. (→P. 352)
- The emergency flashers will turn on automatically. (→P. 448)
- For Safety Connect subscribers, if any of the following situations occur, the system is designed to send an emergency call to the response center, notifying them of the vehicle's location (without needing to push the "SOS" button) and an agent will attempt to speak with the occupants to ascertain the level of emergency and assistance required. If the occupants are unable to communicate, the agent automatically treats the call as an emergency and helps to dispatch the necessary emergency services. (→P. 69)
 - An SRS airbag is deployed.
 - A seat belt pretensioner is activated.
 - The vehicle is involved in a severe rear-end collision.

■ SRS airbag deployment conditions (SRS front airbags)

- The SRS front airbags will deploy in the event of an impact that exceeds the set threshold level (the level of force corresponding to an approximately 12 - 18 mph [20 - 30 km/h] frontal collision with a fixed wall that does not move or deform).

However, this threshold velocity will be considerably higher in the following situations:

- If the vehicle strikes an object, such as a parked vehicle or sign pole, which can move or deform on impact
- If the vehicle is involved in an underride collision, such as a collision in which the front of the vehicle "underrides", or goes under, the bed of a truck
- Depending on the type of collision, it is possible that only the seat belt pretensioners will activate.
- The SRS front airbags for the front passenger will not activate if there is no passenger sitting in the front passenger seat. However, the SRS front airbags for the front passenger may deploy if luggage is put in the seat, even if the seat is unoccupied.

■ SRS airbag deployment conditions (SRS side and curtain shield airbags)

- The SRS side and curtain shield airbags will deploy in the event of an impact that exceeds the set threshold level (the level of force corresponding to the impact force produced by an approximately 3300 lb. [1500 kg] vehicle colliding with the vehicle cabin from a direction perpendicular to the vehicle orientation at an approximate speed of 12 - 18 mph [20 - 30 km/h]).
- Both SRS curtain shield airbags may deploy in the event of a severe side collision.
- Both SRS curtain shield airbags will deploy in the event of vehicle rollover.
- Both SRS curtain shield airbags may also deploy in the event of a severe frontal collision.

■ Conditions under which the SRS airbags may deploy (inflate), other than a collision

The SRS front airbags and SRS curtain shield airbags may also deploy if a serious impact occurs to the underside of your vehicle. Some examples are shown in the illustration.

- Hitting a curb, edge of pavement or hard surface
- Falling into or jumping over a deep hole
- Landing hard or falling

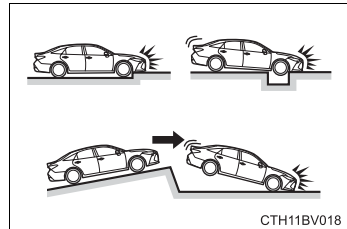

The SRS curtain shield airbags may also deploy under the situations shown in the illustration.

- The angle of vehicle tip-up is marginal.
- The vehicle skids and hits a curb stone.

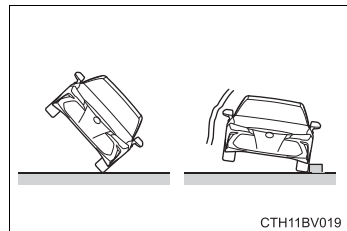

■ Types of collisions that may not deploy the SRS airbags (SRS front airbags)

The SRS front airbags do not generally inflate if the vehicle is involved in a side or rear collision, if it rolls over, or if it is involved in a low-speed frontal collision. But, whenever a collision of any type causes sufficient forward deceleration of the vehicle, deployment of the SRS front airbags may occur.

- Collision from the side
- Collision from the rear
- Vehicle rollover

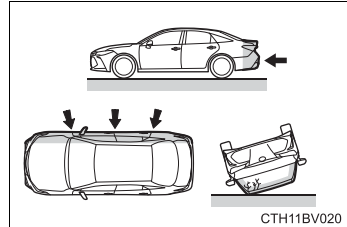

■ Types of collisions that may not deploy the SRS airbags (SRS side and curtain shield airbags)

The SRS side and curtain shield airbags may not activate if the vehicle is subjected to a collision from the side at certain angles, or a collision to the side of the vehicle body other than the passenger compartment.

- Collision from the side to the vehicle body other than the passenger compartment
- Collision from the side at an angle

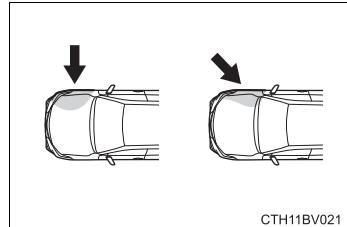

The SRS side airbags do not generally inflate if the vehicle is involved in a frontal or rear collision, if it rolls over, or if it is involved in a low-speed side collision.

- Collision from the front
- Collision from the rear
- Vehicle rollover

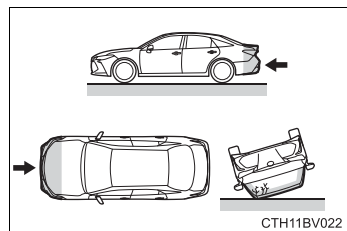

The SRS curtain shield airbags do not generally inflate if the vehicle is involved in a rear collision, if it pitches end over end, or if it is involved in a low-speed side or low-speed frontal collision.

- Collision from the rear
- Pitching end over end

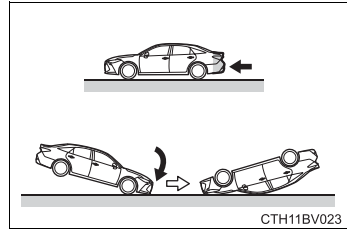

■ When to contact your Toyota dealer

In the following cases, the vehicle will require inspection and/or repair. Contact your Toyota dealer as soon as possible.

- Any of the SRS airbags have been inflated.
- The front of the vehicle is damaged or deformed, or was involved in an accident that was not severe enough to cause the SRS front airbags to inflate.

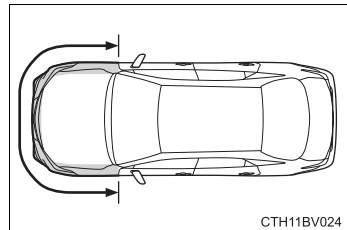

- A portion of a door or its surrounding area is damaged, deformed or has had a hole made in it, or the vehicle was involved in an accident that was not severe enough to cause the SRS side and curtain shield airbags to inflate.

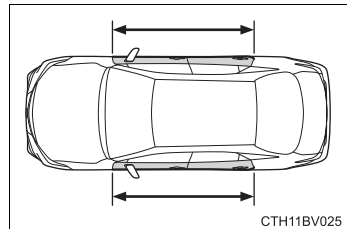

- The pad section of the steering wheel, dashboard near the front passenger airbag or lower portion of the instrument panel is scratched, cracked, or otherwise damaged.

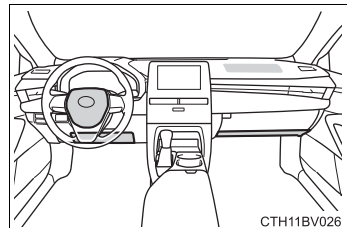

- The surface of the seats with the SRS side airbag is scratched, cracked, or otherwise damaged.

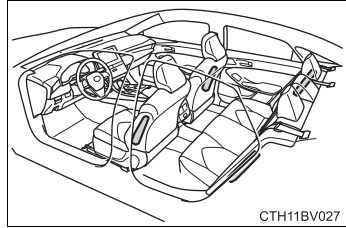

- The portion of the front pillars, rear pillars or roof side rail garnishes (padding) containing the SRS curtain shield airbags inside is scratched, cracked, or otherwise damaged.

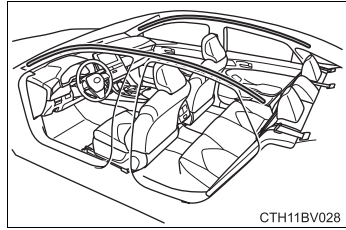

Front passenger occupant classification system

Your vehicle is equipped with a front passenger occupant classification system. This system detects the conditions of the front passenger seat and activates or deactivates the front passenger airbag and front passenger knee airbag.

- ① Driver's and front passenger's seat belt reminder light
- ② SRS warning light
- ③ "AIR BAG OFF" indicator light
- ④ "AIR BAG ON" indicator light



Condition and operation in the front passenger occupant classification system

■ Adult*1

Indicator/ warning light	“AIR BAG ON” and “AIR BAG OFF” indicator lights	“AIR BAG ON”
	SRS warning light	Off
	Driver’s and front passenger’s seat belt reminder light	Off*2 or flashing*3
Devices	Front passenger airbag	Activated
	Front passenger knee airbag	

■ Child*4

Indicator/ warning light	“AIR BAG ON” and “AIR BAG OFF” indicator lights	“AIR BAG OFF” or “AIR BAG ON”*4
	SRS warning light	Off
	Driver’s and front passenger’s seat belt reminder light	Off*2 or flashing*3
Devices	Front passenger airbag	Deactivated or activated*4
	Front passenger knee airbag	

■ Child restraint system with infant*5

Indicator/ warning light	“AIR BAG ON” and “AIR BAG OFF” indicator lights	“AIR BAG OFF”*6
	SRS warning light	Off
	Driver’s and front passenger’s seat belt reminder light	Off*2 or flashing*3
Devices	Front passenger airbag	Deactivated
	Front passenger knee airbag	

■ Unoccupied

Indicator/ warning light	“AIR BAG ON” and “AIR BAG OFF” indicator lights	“AIR BAG OFF”
	SRS warning light	Off
	Driver’s and front passenger’s seat belt reminder light	
Devices	Front passenger airbag	Deactivated
	Front passenger knee airbag	

■ There is a malfunction in the system

Indicator/ warning light	“AIR BAG ON” and “AIR BAG OFF” indicator lights	“AIR BAG OFF”
	SRS warning light	On
	Driver’s and front passenger’s seat belt reminder light	
Devices	Front passenger airbag	Deactivated
	Front passenger knee airbag	

*1: The system judges a person of adult size as an adult. When a smaller adult sits in the front passenger seat, the system may not recognize him/her as an adult depending on his/her physique and posture.

*2: In the event the front passenger is wearing a seat belt.

*3: In the event the front passenger does not wear a seat belt.

*4: For some children, child in seat, child in booster seat or child in convertible seat, the system may not recognize him/her as a child. Factors which may affect this can be the physique or posture.

*5: Never install a rear-facing child restraint system on the front passenger seat. A forward-facing child restraint system should only be installed on the front passenger seat when it is unavoidable. (→P. 54)

*6: In case the indicator light is not illuminated, consult this manual on how to install the child restraint system properly. (→P. 58)

**WARNING****■ Front passenger occupant classification system precautions**

Observe the following precautions regarding the front passenger occupant classification system.

Failure to do so may cause death or serious injury.

- Wear the seat belt properly.
- Make sure the front passenger's seat belt plate has not been left inserted into the buckle before someone sits in the front passenger seat.
- Make sure the "AIR BAG OFF" indicator light is not illuminated when using the seat belt extender for the front passenger seat. If the "AIR BAG OFF" indicator light is illuminated, disconnect the extender tongue from the seat belt buckle, and reconnect the seat belt. Reconnect the seat belt extender after making sure the "AIR BAG ON" indicator light is illuminated. If you use the seat belt extender while the "AIR BAG OFF" indicator light is illuminated, the SRS airbags for the front passenger will not activate, which could cause death or serious injury in the event of a collision.
- Do not apply a heavy load to the front passenger seat or equipment (e.g. seatback pocket).
- Do not put weight on the front passenger seat by putting your hands or feet on the front passenger seat seatback from the rear passenger seat.
- Do not let a rear passenger lift the front passenger seat with their feet or press on the seatback with their legs.
- Do not put objects under the front passenger seat.

**WARNING****■ Front passenger occupant classification system precautions**

- Do not recline the front passenger seatback so far that it touches a rear seat. This may cause the “AIR BAG OFF” indicator light to be illuminated, which indicates that the SRS airbags for the front passenger will not activate in the event of a severe accident. If the seatback touches the rear seat, return the seatback to a position where it does not touch the rear seat. Keep the front passenger seatback as upright as possible when the vehicle is moving. Reclining the seatback excessively may lessen the effectiveness of the seat belt system.
- If an adult sits in the front passenger seat, the “AIR BAG ON” indicator light is illuminated. If the “AIR BAG OFF” indicator is illuminated, ask the passenger to sit up straight, well back in the seat, feet on the floor, and with the seat belt worn correctly. If the “AIR BAG OFF” indicator still remains illuminated, either ask the passenger to move to the rear seat, or if that is not possible, move the front passenger seat fully rearward.
- When it is unavoidable to install a forward-facing child restraint system on the front passenger seat, install the child restraint system on the front passenger seat in the proper order. (→P. 58)
- Do not modify or remove the front seats.
- Do not kick the front passenger seat or subject it to severe impact. Otherwise, the SRS warning light may come on to indicate a malfunction of the front passenger occupant classification system. In this case, contact your Toyota dealer immediately.
- Child restraint systems installed on the rear seat should not contact the front seatbacks.
- Do not use a seat accessory, such as a cushion and seat cover, that covers the seat cushion surface.
- Do not modify or replace the upholstery of the front seat.
- Do not place anything between the console box and front passenger seat. Otherwise, the system may not detect the front passenger properly, leading to improper operation of the airbags.
- Adjust the front passenger seat so that the head restraint does not touch the ceiling. If the head restraint is left in contact with the ceiling, the system may not detect the front passenger properly, leading to improper operation of the airbags.

Safety information for children

Observe the following precautions when children are in the vehicle.

Use a child restraint system appropriate for the child, until the child becomes large enough to properly wear the vehicle's seat belt.

- It is recommended that children sit in the rear seats to avoid accidental contact with the shift lever, wiper switch etc.
- Use the rear door child-protector lock or the window lock switch to avoid children opening the door while driving or operating the power window accidentally.
- Do not let small children operate equipment which may catch or pinch body parts, such as the power window, hood, trunk, seats etc.



WARNING

Never leave children unattended in the vehicle, and never allow children to have or use the key.

Children may be able to start the vehicle or shift the vehicle into neutral. There is also a danger that children may injure themselves by playing with the windows, the moon roof or other features of the vehicle. In addition, heat build-up or extremely cold temperatures inside the vehicle can be fatal to children.

Child restraint systems

A child restraint system for a small child or baby must itself be properly restrained on the seat with the LATCH anchors or the lap portion of the lap/shoulder belt.

The laws of all 50 states of the U.S.A. and Canada now require the use of child restraint systems.

Points to remember

Studies have shown that installing a child restraint on a rear seat is much safer than installing one on the front passenger seat.

- Choose a child restraint system that suits your vehicle and is appropriate to the age and size of the child.
- For installation details, follow the instructions provided with the child restraint system.

General installation instructions are provided in this manual.

(→P. 58)

Types of child restraints

Child restraint systems are classified into the following 3 types according to the age and size of the child:

- ▶ Rear facing — Infant seat/convertible seat
- ▶ Forward facing — Convertible seat

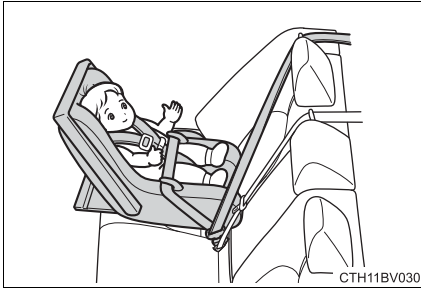

- ▶ Booster seat



■ Selecting an appropriate child restraint system

- Use a child restraint system appropriate for the child until the child becomes large enough to properly wear the vehicle's seat belt.
- If the child is too large for a child restraint system, sit the child on a rear seat and use the vehicle's seat belt. (→P. 28)

**WARNING****■ Child restraint precautions**

- For effective protection in automobile accidents and sudden stops, a child must be properly restrained, using a seat belt or child restraint system depending on the age and size of the child. Holding a child in your arms is not a substitute for a child restraint system. In an accident, the child can be crushed against the windshield, or between you and the vehicle's interior.
- Toyota strongly urges the use of a proper child restraint system that conforms to the size of the child, installed on the rear seat. According to accident statistics, the child is safer when properly restrained in the rear seat than in the front seat.
- Never install a rear-facing child restraint system on the front passenger seat even if the "AIR BAG OFF" indicator light is illuminated. In the event of an accident, the force of the rapid inflation of the front passenger airbag can cause death or serious injury to the child if the rear-facing child restraint system is installed on the front passenger seat.
- A forward-facing child restraint system may be installed on the front passenger seat only when it is unavoidable. A child restraint system that requires a top tether strap should not be used in the front passenger seat since there is no top tether strap anchor for the front passenger seat. Adjust the seatback as upright as possible and always move the seat as far back as possible even if the "AIR BAG OFF" indicator light is illuminated, because the front passenger airbag could inflate with considerable speed and force. Otherwise, the child may be killed or seriously injured.
- Do not use the seat belt extender when installing a child restraint system on the front or rear passenger seat. If installing a child restraint system with the seat belt extender connected to the seat belt, the seat belt will not securely hold the child restraint system, which could cause death or serious injury to the child or other passengers in the event of a sudden stop, sudden swerve or accident.
- Do not allow the child to lean his/her head or any part of his/her body against the door or the area of the seat, front and rear pillars or roof side rails from which the SRS side airbags or SRS curtain shield airbags deploy even if the child is seated in the child restraint system. It is dangerous if the SRS side airbags and curtain shield airbags inflate, and the impact could cause death or serious injury to the child.
- Make sure you have complied with all installation instructions provided by the child restraint manufacturer and that the system is properly secured. If it is not secured properly, it may cause death or serious injury to the child in the event of a sudden stop, sudden swerve or an accident.

**WARNING****■ When children are in the vehicle**

Do not allow children to play with the seat belt. If the seat belt becomes twisted around a child's neck, it may lead to choking or other serious injuries that could result in death.

If this occurs and the buckle cannot be unfastened, scissors should be used to cut the belt.

■ When the child restraint system is not in use

- Keep the child restraint system properly secured on the seat even if it is not in use. Do not store the child restraint system unsecured in the passenger compartment.
- If it is necessary to detach the child restraint system, remove it from the vehicle or store it securely in the trunk. This will prevent it from injuring passengers in the event of a sudden stop, sudden swerve or accident.

Installing child restraints

Follow the child restraint system manufacturer's instructions. Firmly secure child restraints to the seats using the LATCH anchors or a seat belt. Attach the top tether strap when installing a child restraint.

The lap/shoulder belt can be used if your child restraint system is not compatible with the LATCH (Lower Anchors and Tethers for Children) system.

Child restraint LATCH anchors

LATCH anchors are provided for the outboard rear seats. (Marks displaying the location of the anchors are attached to the seats.)

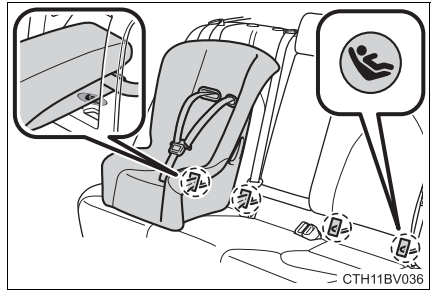

Seat belts equipped with a child restraint locking mechanism (ALR/ELR belts except driver's seat belt) (→P. 30)



Anchor brackets (for top tether strap)

An anchor bracket is provided for each rear seat.

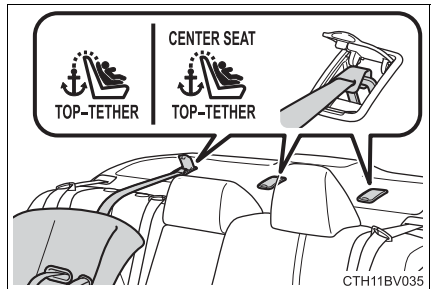

Installation with LATCH system

■ When installing in the rear outboard seats

Install the child restraint system in accordance to the operation manual enclosed with the child restraint system.

- 1 If the head restraint interferes with the child restraint system installation and the head restraint can be removed, remove the head restraint. (→P. 164)

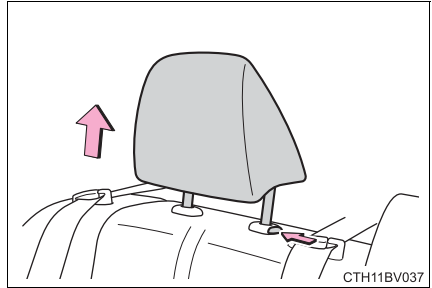

- 2 Remove the cover.

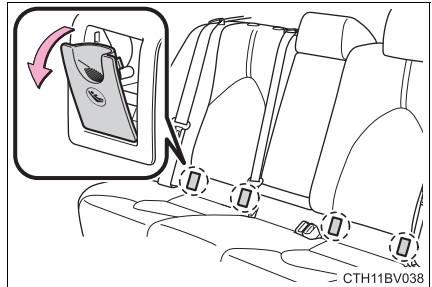

▶ With flexible lower attachments

- 3 Latch the hooks of the lower straps onto the LATCH anchors.

For owners in Canada:
The symbol on a child restraint system indicates the presence of a lower connector system.

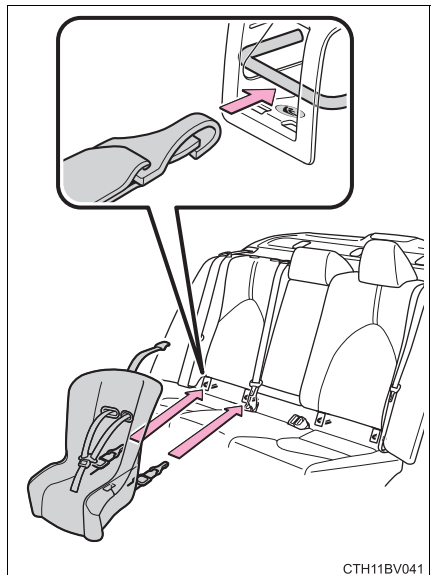

► With rigid lower attachments

- 3 Latch the buckles onto the LATCH anchors.

For owners in Canada:
The symbol on a child restraint system indicates the presence of a lower connector system.

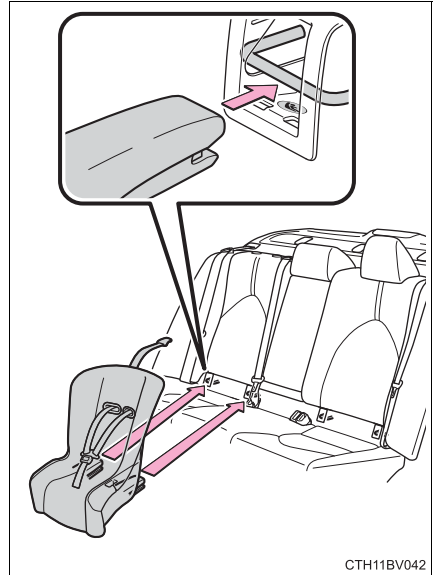

CTH11BV042

- 4 If the child restraint has a top tether strap, follow the child restraint manufacturer's operation manual regarding the installation, using the top tether strap to latch onto the top tether strap anchor. (→P. 65)
- 5 After installing the child restraint system, rock it back and forth to ensure that it is installed securely. (→P. 67)

■ **When installing in the rear center seat**

There are no LATCH anchors behind the rear center seat. However, the inboard LATCH anchors of the outboard seats, which are 16.9 in. (430 mm) apart, can be used if the child restraint system manufacturer's instructions permit use of those anchors with the anchor spacing stated.

Child restraint systems with rigid lower attachments cannot be installed in the center seat. This type of child restraint system can only be installed in the outboard seat.

Installing child restraints using a seat belt (child restraint lock function belt)

■ Rear-facing — Infant seat/convertible seat

- 1 Place the child restraint system on the rear seat facing the rear of the vehicle.

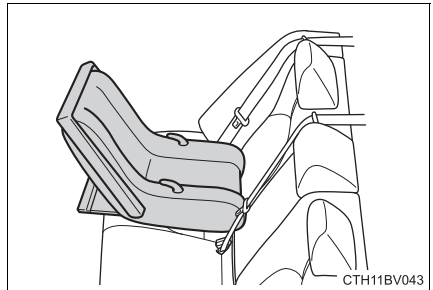

- 2 Run the seat belt through the child restraint system and insert the plate into the buckle. Make sure that the belt is not twisted.

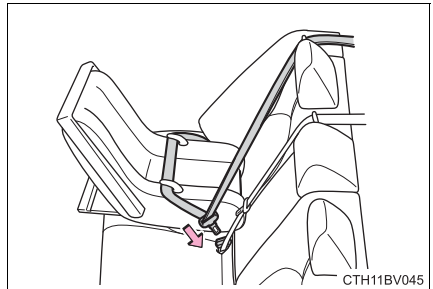

- 3 Fully extend the shoulder belt and allow it to retract to put it in lock mode. In lock mode, the belt cannot be extended.

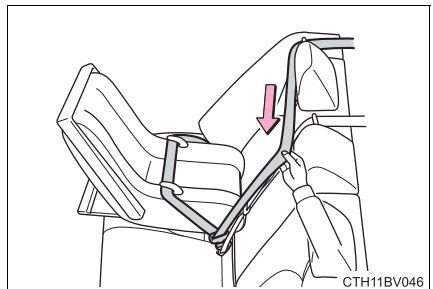

- 4 While pushing the child restraint system down into the rear seat, allow the shoulder belt to retract until the child restraint system is securely in place.

After the shoulder belt has retracted to a point where there is no slack in the belt, pull the belt to check that it cannot be extended.

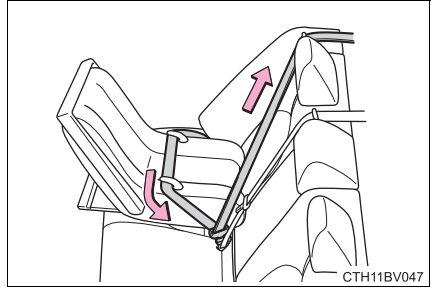

■ Forward-facing — Convertible seat

- 1 If the head restraint interferes with the child restraint system installation and the head restraint can be removed, remove the head restraint. (→P. 164)

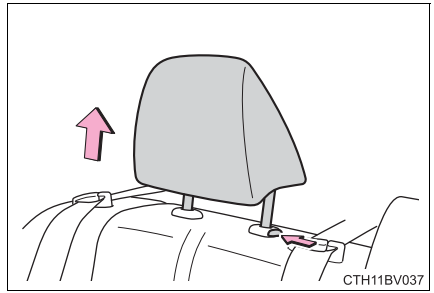

- 2 Place the child restraint system on the seat facing the front of the vehicle.

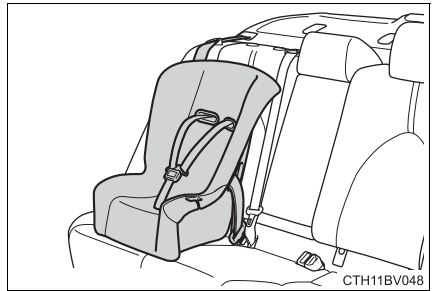

- 3 Run the seat belt through the child restraint system and insert the plate into the buckle. Make sure that the belt is not twisted.

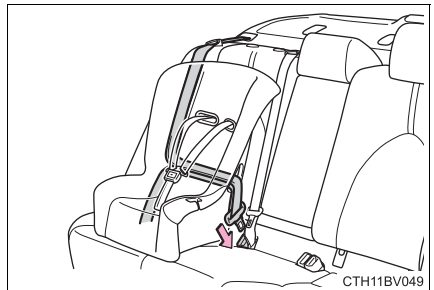

- 4 Fully extend the shoulder belt and allow it to retract to put it in lock mode. In lock mode, the belt cannot be extended.

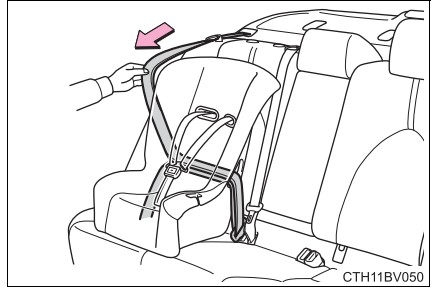

- 5 While pushing the child restraint system into the rear seat, allow the shoulder belt to retract until the child restraint system is securely in place.

After the shoulder belt has retracted to a point where there is no slack in the belt, pull the belt to check that it cannot be extended.

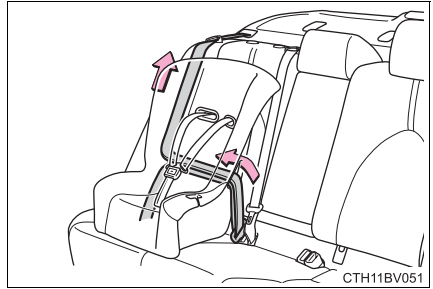

- 6 If the child restraint has a top tether strap, the top tether strap should be latched onto the top tether strap anchor. (→P. 65)

■ Booster seat

- 1 Place the child restraint system on the seat facing the front of the vehicle.

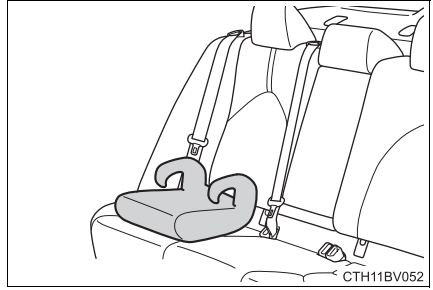

- 2 Sit the child in the child restraint system. Fit the seat belt to the child restraint system according to the manufacturer's instructions and insert the plate into the buckle. Make sure that the belt is not twisted.



Check that the shoulder belt is correctly positioned over the child's shoulder and that the lap belt is as low as possible.
(→P. 28)

Removing a child restraint installed with a seat belt

Push the buckle release button and fully retract the seat belt.

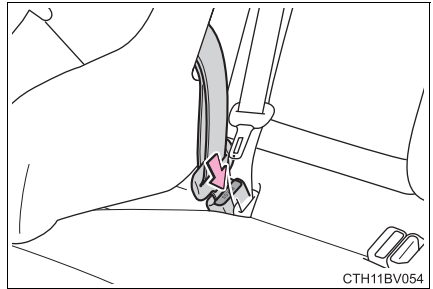

Child restraint systems with a top tether strap

Install the child restraint system in accordance to the operation manual enclosed with the child restraint system.

- 1 Adjust the head restraint to the upmost position.

If the head restraint interferes with the child restraint system installation and the head restraint can be removed, remove the head restraint. (→P. 164)

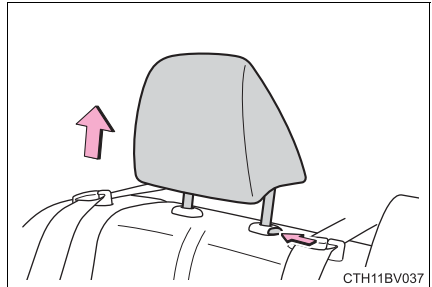

- 2 Secure the child restraint system using the seat belt or LATCH anchors.



- 3 Open the anchor bracket cover, latch the hook onto the anchor bracket and tighten the top tether strap.

Make sure the top tether strap is securely latched.

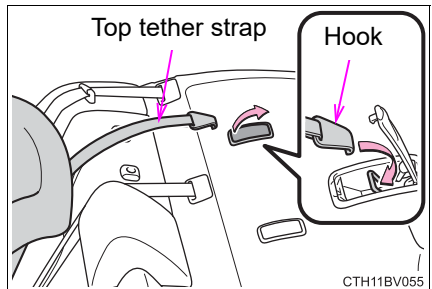

■ Laws and regulations pertaining to anchorages

The LATCH system conforms to FMVSS225 or CMVSS210.2.

Child restraint systems conforming to FMVSS213 or CMVSS213 specifications can be used.

This vehicle is designed to conform to the SAE J1819.

⚠ WARNING

■ When installing a booster seat

To prevent the belt from going into ALR lock mode, do not fully extend the shoulder belt. ALR mode causes the belt to tighten only. This could cause injury or discomfort to the child. (→P. 30)

■ When installing a child restraint system

Follow the directions given in the child restraint system installation manual and fix the child restraint system securely in place.

If the child restraint system is not correctly fixed in place, the child or other passengers may be seriously injured or even killed in the event of sudden braking, sudden swerving or an accident.

- If the driver's seat interferes with the child restraint system and prevents it from being attached correctly, attach the child restraint system to the right-hand rear seat.
- Adjust the front passenger seat so that it does not interfere with the child restraint system.
- Only put a forward-facing child restraint system on the front seat when unavoidable. When installing a forward-facing child restraint system on the front passenger seat, move the seat as far back as possible even if the "AIR BAG OFF" indicator light is illuminated. Failure to do so may result in death or serious injury if the airbags deploy (inflate).

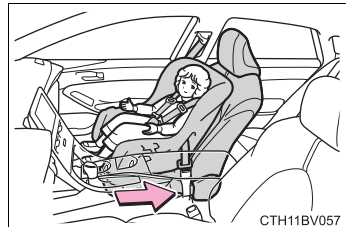
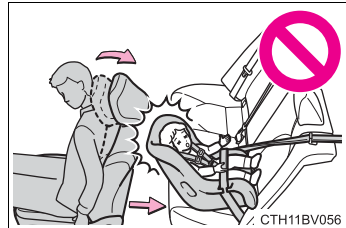

**WARNING****■ When installing a child restraint system**

- When a booster seat is installed, always ensure that the shoulder belt is positioned across the center of the child's shoulder. The belt should be kept away from the child's neck, but not so that it could fall off the child's shoulder. Failing to do so may result in death or serious injury in the event of sudden braking, sudden swerving or an accident.
- Ensure that the belt and plate are securely locked and the seat belt is not twisted.
- Shake the child restraint system left and right, and forward and backward to ensure that it has been securely installed.
- After securing a child restraint system, never adjust the seat.
- Follow all installation instructions provided by the child restraint system manufacturer.
- When securing some types of child restraint systems in rear seats, it may not be possible to properly use the seat belts in positions next to the child restraint without interfering with it or affecting seat belt effectiveness. Be sure your seat belt fits snugly across your shoulder and low on your hips. If it does not, or if it interferes with the child restraint, move to a different position. Failure to do so may result in death or serious injury.

■ Do not use a seat belt extender

If a seat belt extender is used when installing a child restraint system, the seat belt will not securely hold the child restraint system, which could cause death or serious injury to the child or other passengers in the event of a sudden braking, sudden swerving or an accident.

■ To correctly attach a child restraint system to the anchors

When using the LATCH anchors, be sure that there are no foreign objects around the anchors and that the seat belt is not caught behind the child restraint. Make sure the child restraint system is securely attached, or it may cause death or serious injury to the child or other passengers in the event of sudden braking, sudden swerve or an accident.

Exhaust gas precautions

Harmful substance to the human body is included in exhaust gases if inhaled.



WARNING

Exhaust gases include harmful carbon monoxide (CO), which is colorless and odorless. Observe the following precautions.

Failure to do so may cause exhaust gases enter the vehicle and may lead to an accident caused by light-headedness, or may lead to death or a serious health hazard.

■ Important points while driving

- Keep the trunk lid closed.
- If you smell exhaust gases in the vehicle even when the trunk lid is closed, open the windows and have the vehicle inspected at your Toyota dealer as soon as possible.

■ When parking

- If the vehicle is in a poorly ventilated area or a closed area, such as a garage, stop the hybrid system.
- Do not leave the vehicle with the hybrid system on for a long time. If such a situation cannot be avoided, park the vehicle in an open space and ensure that exhaust fumes do not enter the vehicle interior.
- Do not leave the hybrid system running in an area with snow build-up, or where it is snowing. If snowbanks build up around the vehicle while the hybrid system is running, exhaust gases may collect and enter the vehicle.

■ Exhaust pipe

The exhaust system needs to be checked periodically. If there is a hole or crack caused by corrosion, damage to a joint or abnormal exhaust noise, be sure to have the vehicle inspected and repaired by your Toyota dealer.

Safety Connect

Safety Connect is a subscription-based telematics service that uses Global Positioning System (GPS) data and embedded cellular technology to provide safety and security features to subscribers. Safety Connect is supported by Toyota's designated response center, which operates 24 hours per day, 7 days per week.

Safety Connect service is available by subscription on select, telematics hardware-equipped vehicles.

By using the Safety Connect service, you are agreeing to be bound by the Telematics Subscription Service Agreement and its Terms and Conditions, as in effect and amended from time to time, a current copy of which is available at Toyota.com in the United States, Toyotapr.com in Puerto Rico and Toyota.ca in Canada. All use of the Safety Connect service is subject to such then-applicable Terms and Conditions.

■ System components

- ① Microphone
- ② LED light indicators
- ③ "SOS" button

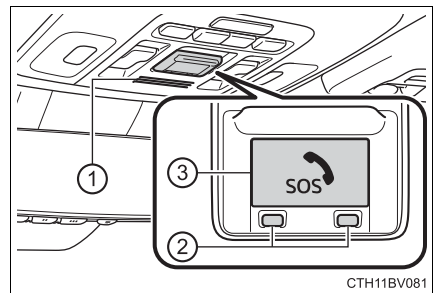

■ Services

Subscribers have the following Safety Connect services available:

- Automatic Collision Notification*

Helps drivers receive necessary response from emergency service providers. (→P. 72)

*: U.S. Patent No. 7,508,298 B2

- Stolen Vehicle Location

Helps drivers in the event of vehicle theft. (→P. 72)

- Emergency Assistance Button (“SOS”)

Connects drivers to response-center support. (→P. 72)

- Enhanced Roadside Assistance

Provides drivers various on-road assistance. (→P. 72)

■ Subscription

After you have signed the Telematics Subscription Service Agreement and are enrolled, you can begin receiving services.

A variety of subscription terms are available for purchase. Contact your Toyota dealer, call the following appropriate Customer Experience Center or push the “SOS” button in your vehicle for further subscription details.

- The United States
1-800-331-4331
- Canada
1-888-869-6828
- Puerto Rico
1-877-855-8377

■ Safety Connect Services Information

- Phone calls using the vehicle's Bluetooth® technology will not be possible when Safety Connect is active and in use.
- Safety Connect is available beginning Fall 2009 on select Toyota models (in the contiguous United States only). Contact with the Safety Connect response center is dependent upon the telematics device being in operative condition, cellular connection availability, and GPS satellite signal reception, which can limit the ability to reach the response center or receive emergency service support. Enrollment and Telematics Subscription Service Agreement are required. A variety of subscription terms are available; charges vary by subscription term selected and location.
- Automatic Collision Notification, Emergency Assistance and Stolen Vehicle Location are available in the United States, including Hawaii and Alaska, Puerto Rico and Canada, and Enhanced Roadside Assistance are available in the United States, Puerto Rico and Canada.
- Automatic Collision Notification, Emergency Assistance, Stolen Vehicle and Enhanced Road Assistance are not available in the U.S. Virgin Islands. For vehicles first sold in the U.S. Virgin Islands, no Safety Connect services will function in or outside the U.S. Virgin Islands.
- Safety Connect services are not subject to section 255 of the Telecommunications Act and the device is not TTY compatible.

■ Languages

The Safety Connect response center will offer support in multiple languages. The Safety Connect system will offer voice prompts in English, Spanish, and French. Please indicate your language of choice when enrolling.

■ When contacting the response center

You may be unable to contact the response center if the network is busy.

Safety Connect LED light Indicators

When the power switch is turned to ON mode, the red indicator light comes on for 2 seconds then turns off. Afterward, the green indicator light comes on, indicating that the service is active.

The following indicator light patterns indicate specific system usage conditions:

- Green indicator light on = Active service
- Green indicator light flashing = Safety Connect call in process
- Red indicator light (except at vehicle start-up) = System malfunction (contact your Toyota dealer)
- No indicator light (off) = Safety Connect service not active

Safety Connect services

■ Automatic Collision Notification

In case of either airbag deployment or severe rear-end collision, the system is designed to automatically call the response center. The responding agent receives the vehicle's location and attempts to speak with the vehicle occupants to assess the level of emergency. If the occupants are unable to communicate, the agent automatically treats the call as an emergency, contacts the nearest emergency services provider to describe the situation, and requests that assistance be sent to the location.

■ Stolen Vehicle Location

If your vehicle is stolen, Safety Connect can work with local authorities to assist them in locating and recovering the vehicle. After filing a police report, call the Customer Experience Center at 1-800-331-4331 in the United States, 1-877-855-8377 in Puerto Rico or 1-888-869-6828 in Canada, and follow the prompts for Safety Connect to initiate this service.

In addition to assisting law enforcement with recovery of a stolen vehicle, Safety-Connect-equipped vehicle location data may, under certain circumstances, be shared with third parties to locate your vehicle. Further information is available at Toyota.com in the United States, Toyotapr.com in Puerto Rico and Toyota.ca in Canada.

■ Emergency Assistance Button (“SOS”)

In the event of an emergency on the road, push the “SOS” button to reach the Safety Connect response center. The answering agent will determine your vehicle's location, assess the emergency, and dispatch the necessary assistance required.

If you accidentally press the “SOS” button, tell the response-center agent that you are not experiencing an emergency.

■ Enhanced Roadside Assistance

Enhanced Roadside Assistance adds GPS data to the already included warranty-based Toyota roadside service.

Subscribers can press the “SOS” button to reach a Safety Connect response-center agent, who can help with a wide range of needs, such as: towing, flat tire, fuel delivery, etc. For a description of the Enhanced Roadside Assistance services and their limitations, please see the Safety Connect Terms and Conditions, which are available at Toyota.com in the United States, Toyotapr.com in Puerto Rico and Toyota.ca in Canada.

Safety information for Safety Connect

Important! Read this information before using Safety Connect.

■ Exposure to radio frequency signals

The Safety Connect system installed in your vehicle is a low-power radio transmitter and receiver. It receives and also sends out radio frequency (RF) signals.

In August 1996, the Federal Communications Commission (FCC) adopted RF exposure guidelines with safety levels for mobile wireless phones. Those guidelines are consistent with the safety standards previously set by the following U.S. and international standards bodies.

- ANSI (American National Standards Institute) C95.1 [1992]
- NCRP (National Council on Radiation Protection and Measurement) Report 86 [1986]
- ICNIRP (International Commission on Non-Ionizing Radiation Protection) [1996]

Those standards were based on comprehensive and periodic evaluations of the relevant scientific literature. Over 120 scientists, engineers, and physicians from universities, and government health agencies and industries reviewed the available body of research to develop the ANSI Standard (C95.1).

The design of Safety Connect complies with the FCC guidelines in addition to those standards.

■ Certification for Safety Connect

FCC ID: LHJ-TVN

IC: 2807E-TVN

FCC/IC WARNING:

Changes or modifications not expressly approved by the manufacture could void the user's authority to operate the equipment.

This device complies with Part 15 of the FCC Rules and Industry Canada license-exempt RSS standards. Operation is subject to the following two conditions:

- (1) this device may not cause harmful interference, and
- (2) this device must accept any interference, including interference that may cause undesired operation of the device.

This equipment complies with IC RSS-102 radiation exposure limits set forth for uncontrolled environment.

The antennas used for this transmitter must be installed to provide a separation distance of least 20cm from all persons.

FCC/IC AVERTISSEMENT:

L'utilisateur est averti que les changements ou modifications non expressément approuvés par le fabricant pourraient annuler l'autorité de l'utilisateur à utiliser l'équipement.

Ce appareil est compatible avec la Partie 15 du règlement FCC et de la Licence de l'industrie canadienne et des normes exemptes de RSS. Opération soumise aux deux conditions suivantes :

- (1) ce appareil ne doit pas causer des interférences nuisibles, et
- (2) cet appareil doit accepté toutes les interférences, y compris les interférences qui peuvent entraîner un fonctionnement indésirable de l'appareil.

Cet appareil est compatible aux limites d'exposition aux radiation IC RSS-102 définies pour un environnement non contrôlé.

Les antennes utilisées pour cet émetteur doivent être installées à une distance d'au moins 20 cm de toutes les personnes.

Hybrid system features

Your vehicle is a hybrid vehicle. It has characteristics different from conventional vehicles. Be sure you are closely familiar with the characteristics of your vehicle, and operate it with care.

The hybrid system combines the use of a gasoline engine and an electric motor (traction motor) according to driving conditions, improving fuel efficiency and reducing exhaust emissions.

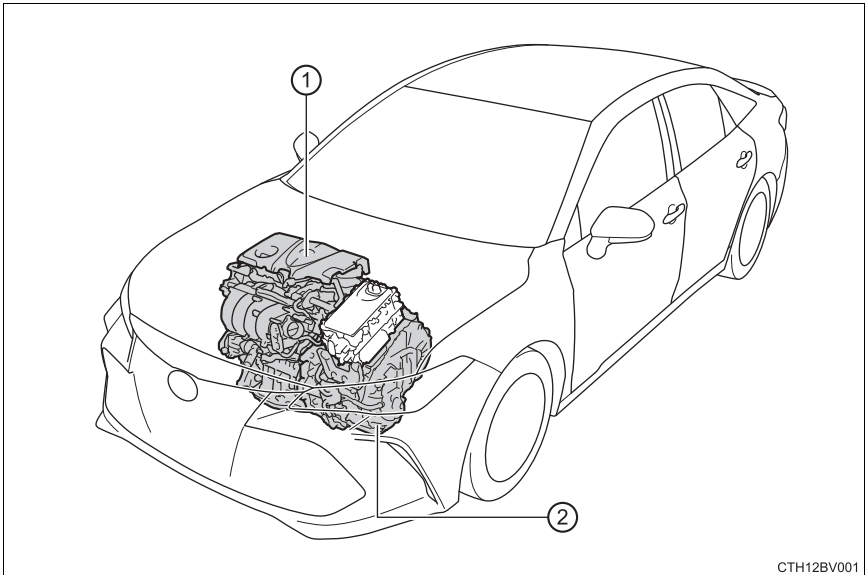

The illustration is an example for explanation and may differ from the actual item.

- ① Gasoline engine
- ② Electric motor (traction motor)

◆ When stopped/during start off

The gasoline engine stops*, when the vehicle is stopped. During start off, the electric motor (traction motor) drives the vehicle. At slow speeds or when traveling down a gentle slope, the engine is stopped* and the electric motor (traction motor) is used.

When the shift lever is in N, the hybrid battery (traction battery) is not being charged.

*: When the hybrid battery (traction battery) requires charging or the engine is warming up, etc., the gasoline engine will not automatically stop. (→P. 77)

◆ During normal driving

The gasoline engine is predominantly used. The electric motor (traction motor) charges the hybrid battery (traction battery) as necessary.

◆ When accelerating sharply

When the accelerator pedal is depressed heavily, the power of the hybrid battery (traction battery) is added to that of the gasoline engine via the electric motor (traction motor).

◆ When braking (regenerative braking)

The wheels operate the electric motor (traction motor) as a power generator, and the hybrid battery (traction battery) is charged.

Acoustic Vehicle Alerting System

When driving with the gasoline engine stopped, a sound, which changes in accordance with the driving speed, will be played in order to warn people nearby of the vehicle's approach. The sound will stop when the vehicle speed exceeds approximately 22 mph (35 km/h).

■ Regenerative braking

In the following situations, kinetic energy is converted to electric energy and deceleration force can be obtained in conjunction with the recharging of the hybrid battery (traction battery).

- The accelerator pedal is released while driving with the shift lever in D or S.
- The brake pedal is depressed while driving with the shift lever in D or S.

■ EV indicator

The EV indicator comes on when the vehicle is driven using only the electric motor (traction motor) or the gasoline engine is stopped.

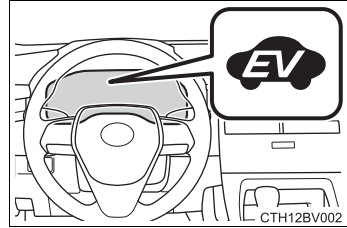

■ Conditions in which the gasoline engine may not stop

The gasoline engine starts and stops automatically. However, it may not stop automatically in the following conditions:

- During gasoline engine warm-up
- During hybrid battery (traction battery) charging
- When the temperature of the hybrid battery (traction battery) is high or low
- When the heater is switched on

■ Charging the hybrid battery (traction battery)

As the gasoline engine charges the hybrid battery (traction battery), the battery does not need to be charged from an outside source. However, if the vehicle is left parked for a long time the hybrid battery (traction battery) will slowly discharge. For this reason, be sure to drive the vehicle at least once every few months for at least 30 minutes or 10 miles (16 km). If the hybrid battery (traction battery) becomes fully discharged and you are unable to start the hybrid system, contact your Toyota dealer.

■ Charging the 12-volt battery

→P. 490

■ After the 12-volt battery has discharged or when the terminal has been removed and installed during exchange, etc.

The gasoline engine may not stop even if the vehicle is being driven by the hybrid battery (traction battery). If this continues for a few days, contact your Toyota dealer.

■ Sounds and vibrations specific to a hybrid vehicle

There may be no engine sound or vibration even though the vehicle is able to move with the "READY" indicator is illuminated. For safety, apply the parking brake and make sure to shift the shift lever to P when parked.

The following sounds or vibrations may occur when the hybrid system is operating and are not a malfunction:

- Motor sounds may be heard from the engine compartment.
- Sounds may be heard from the hybrid battery (traction battery) under the rear seats when the hybrid system starts or stops.
- Relay operating sounds such as a snap or soft clank will be emitted from the hybrid battery (traction battery), under the rear seats, when the hybrid system is started or stopped.
- Sounds from the hybrid system may be heard when the trunk lid is open.
- Sounds may be heard from the transmission when the gasoline engine starts or stops, when driving at low speeds, or during idling.
- Engine sounds may be heard when accelerating sharply.
- Sounds may be heard due to regenerative braking when the brake pedal is depressed or as the accelerator pedal is released.
- Vibration may be felt when the gasoline engine starts or stops.
- Cooling fan sounds may be heard from the air intake vent. (→P. 80)

■ Acoustic Vehicle Alerting System

In the following cases, the acoustic vehicle alerting system may be difficult for surrounding people to hear.

- In very noisy areas
- In the wind or the rain

■ Maintenance, repair, recycling, and disposal

Contact your Toyota dealer regarding maintenance, repair, recycling and disposal. Do not dispose of the vehicle yourself.

■ Customization

Some functions can be customized. (→P. 526)

Hybrid system precautions

Take care when handling the hybrid system, as it is a high voltage system (about 650 V at maximum) as well as contains parts that become extremely hot when the hybrid system is operating. Obey the warning labels attached to the vehicle.

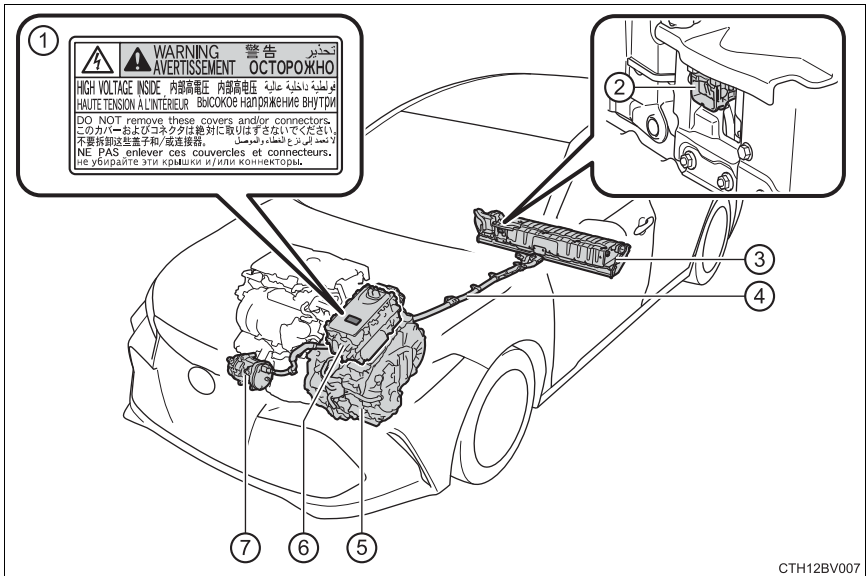

The illustration is an example for explanation and may differ from the actual item.

- | | |
|-------------------------------------|-----------------------------------|
| ① Warning label | ⑤ Electric motor (traction motor) |
| ② Service plug | ⑥ Power control unit |
| ③ Hybrid battery (traction battery) | ⑦ Air conditioning compressor |
| ④ High voltage cables (orange) | |

Hybrid battery (traction battery) air intake vent

There is an air intake vent under the right side of the rear seat for the purpose of cooling the hybrid battery (traction battery). If the vent becomes blocked, charging/discharging of the hybrid battery (traction battery) may become limited.

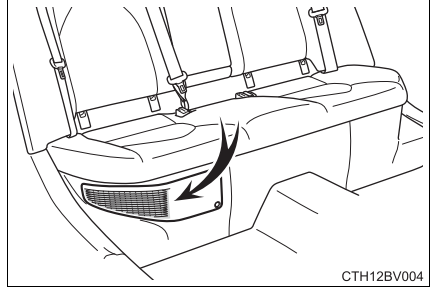

Emergency shut off system

When a certain level of impact is detected by the impact sensor, the emergency shut off system blocks the high voltage current and stops the fuel pump to minimize the risk of electrocution and fuel leakage. If the emergency shut off system activates, your vehicle will not restart. To restart the hybrid system, contact your Toyota dealer.

Hybrid warning message

A message is automatically displayed when a malfunction occurs in the hybrid system or an improper operation is attempted.

If a warning message is shown on the multi-information display, read the message and follow the instructions. (→P. 465)

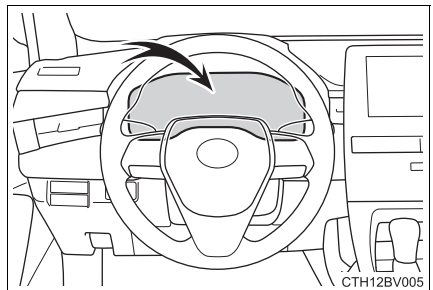

■ If a warning light comes on, a warning message is displayed, or the 12-volt battery is disconnected

The hybrid system may not start. In this case, try to start the system again. If the “READY” indicator does not come on, contact your Toyota dealer.

■ Running out of fuel

When the vehicle has run out of fuel and the hybrid system cannot be started, refuel the vehicle with at least enough gasoline to make the low fuel level warning light (→P. 458) go off. If there is only a small amount of fuel, the hybrid system may not be able to start. (The standard amount of fuel is about 2.3 gal. [8.8 L, 1.9 Imp. gal.] when the vehicle is on a level surface. This value may vary when the vehicle is on a slope. Add extra fuel when the vehicle is inclined.)

■ Electromagnetic waves

- High voltage parts and cables on hybrid vehicles incorporate electromagnetic shielding, and therefore emit approximately the same amount of electromagnetic waves as conventional gasoline powered vehicles or home electronic appliances.
- Your vehicle may cause sound interference in some third party-produced radio parts.

■ Hybrid battery (traction battery)

The hybrid battery (traction battery) has a limited service life. The lifespan of the hybrid battery (traction battery) can change in accordance with driving style and driving conditions.

■ Starting the hybrid system in an extremely cold environment

When the hybrid battery (traction battery) is extremely cold (below approximately -22°F [-30°C]) under the influence of the outside temperature, it may not be possible to start the hybrid system. In this case, try to start the hybrid system again after the temperature of the hybrid battery (traction battery) increases due to the outside temperature increase etc.

⚠ WARNING**■ High voltage precautions**

This vehicle has high voltage DC and AC systems as well as a 12-volt system. DC and AC high voltage is very dangerous and can cause severe burns and electric shock that may result in death or serious injury.

- Never touch, disassemble, remove or replace the high voltage parts, cables or their connectors.
- The hybrid system will become hot after starting as the system uses high voltage. Be careful of both the high voltage and the high temperature, and always obey the warning labels attached to the vehicle.
- Do not touch the service plug located under the right side of the rear seat. The service plug is used only when the vehicle is serviced and is subject to high voltage.

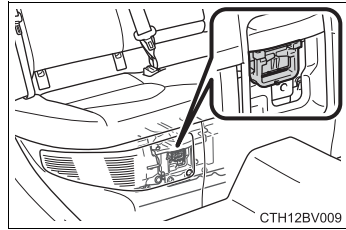

 **WARNING****■ Road accident cautions**

Observe the following precautions to reduce the risk of death or serious injury:

- Pull your vehicle off the road, apply the parking brake, shift the shift lever to P, and turn the hybrid system off.
- Do not touch the high voltage parts, cables and connectors.
- If electric wires are exposed inside or outside your vehicle, an electric shock may occur. Never touch exposed electric wires.
- If a fire occurs in the hybrid vehicle, leave the vehicle as soon as possible. Never use a fire extinguisher that is not meant for electric fires. Using even a small amount of water may be dangerous.
- If your vehicle needs to be towed, do so with front wheels raised. If the wheels connected to the electric motor (traction motor) are on the ground when towing, the motor may continue to generate electricity. This may cause a fire. (→P. 451)
- Carefully inspect the ground under the vehicle. If you find that liquid has leaked onto the ground, the fuel system may have been damaged. Leave the vehicle as soon as possible.
- If electrolyte is leaking from the hybrid battery (traction battery), do not approach the vehicle.

Even in the unlikely event that the hybrid battery (traction battery) is damaged, the internal construction of the battery will prevent a large amount of electrolyte from leaking out. However, any electrolyte that does leak out will give off a vapor. This vapor is an irritant to skin and eyes and could cause acute poisoning if inhaled.

- Do not touch the hybrid battery (traction battery) if liquid is leaking from or adhering to it. If electrolyte (carbonic-based organic electrolyte) from the hybrid battery (traction battery) comes into contact with the eyes or skin, it could cause blindness or skin wounds. In the unlikely event that it comes into contact with the eyes or skin, wash it off immediately with a large amount of water, and seek immediate medical attention.
- Do not bring burning or high-temperature items close to the electrolyte. The electrolyte may ignite and cause a fire.

**WARNING****■ Hybrid battery (traction battery)**

- Your vehicle contains a sealed lithium-ion battery.
- Never resell, hand over or modify the hybrid battery. To prevent accidents, hybrid batteries that have been removed from a disposed vehicle are collected through Toyota dealer. Do not dispose of the battery yourself.

Unless the battery is properly collected, the following may occur, resulting in death or serious injury:

- The hybrid battery may be illegally disposed of or dumped, and it is hazardous to the environment or someone may touch a high voltage part, resulting in an electric shock.
- The hybrid battery is intended to be used exclusively with your hybrid vehicle. If the hybrid battery is used outside of your vehicle or modified in any way, accidents such as electric shock, heat generation, smoke generation, an explosion and electrolyte leakage may occur.

When reselling or handing over your vehicle, the possibility of an accident is extremely high because the person receiving the vehicle may not be aware of these dangers.

- If your vehicle is disposed of without the hybrid battery having been removed, there is a danger of serious electric shock if high voltage parts, cables and their connectors are touched. In the event that your vehicle must be disposed of, the hybrid battery must be disposed of by your Toyota dealer or a qualified service shop. If the hybrid battery is not disposed of properly, it may cause electric shock that can result in death or serious injury.

**NOTICE****Hybrid battery (traction battery) air intake vent**

- Make sure not to block the air intake vent with anything, such as a seat cover, plastic cover, or luggage. The hybrid battery (traction battery) may overheat and be damaged.
- When dust etc. has accumulated in the air intake vent, clean it with a vacuum cleaner to prevent the vent from clogging.
- Do not get water or foreign materials in the air intake vent as this may cause a short circuit and damage the hybrid battery (traction battery).
- Do not carry large amounts of water such as water cooler bottles in the vehicle. If water spills onto the hybrid battery (traction battery), the battery may be damaged. Have the vehicle inspected by your Toyota dealer.
- There is a filter installed to the air intake vent. When the filter remains noticeably dirty even after cleaning the air intake vent, filter cleaning or replacement is recommended. When cleaning the filter, refer to P. 434.

Immobilizer system

The vehicle's keys have built-in transponder chips that prevent the hybrid system from starting if a key has not been previously registered in the vehicle's on-board computer.

Never leave the keys inside the vehicle when you leave the vehicle.

This system is designed to help prevent vehicle theft but does not guarantee absolute security against all vehicle thefts.

The indicator light flashes after the power switch has been turned off to indicate that the system is operating.

The indicator light stops flashing after the power switch has been turned to ACCESSORY or ON mode to indicate that the system has been canceled.

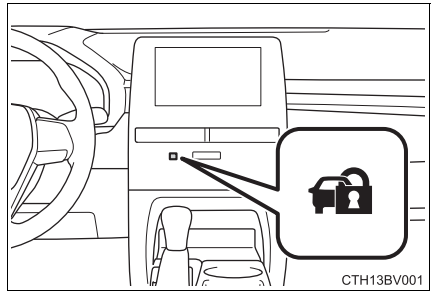

■ System maintenance

The vehicle has a maintenance-free type immobilizer system.

■ Conditions that may cause the system to malfunction

- If the grip portion of the key is in contact with a metallic object
- If the key is in close proximity to or touching a key to the security system (key with a built-in transponder chip) of another vehicle

■ Certifications for the immobilizer system

- ▶ For vehicles sold in the U.S.A.

FCC ID : NI4TMIMB-3

This device complies with part 15 of the FCC Rules. Operation is subject to the following two conditions: (1) This device may not cause harmful interference, and (2) this device must accept any interference received, including interference that may cause undesired operation.

Changes or modifications not expressly approved by the party responsible for compliance could void the user's authority to operate the equipment.

- ▶ For vehicles sold in Canada

This device complies with Industry Canada's licence-exempt RSSs. Operation is subject to the following two conditions: (1) This device may not cause interference; and (2) This device must accept any interference, including interference that may cause undesired operation of the device.

Le présent appareil est conforme aux CNR d'Industrie Canada applicables aux appareils radio exempts de licence. L'exploitation est autorisée aux deux conditions suivantes : (1) l'appareil ne doit pas produire de brouillage; (2) l'utilisateur de l'appareil doit accepter tout brouillage radioélectrique subi, même si le brouillage est susceptible d'en compromettre le fonctionnement.

WARNING

■ Certifications for the engine immobilizer system

Changes or modifications not expressly approved by the party responsible for compliance could void the user's authority to operate the equipment.

NOTICE

■ To ensure the system operates correctly

Do not modify or remove the system. If modified or removed, the proper operation of the system cannot be guaranteed.

Alarm

The alarm

The alarm uses light and sound to give an alert when an intrusion is detected.

The alarm is triggered in the following situations when the alarm is set:

- A locked door is unlocked or opened in any way other than using the entry function, wireless remote control or mechanical key. (The doors will lock again automatically.)
- The trunk is opened in any way other than using the entry function or wireless remote control.
- The hood is opened.

Setting the alarm system

Close the doors, trunk and hood, and lock all the doors. The system will be set automatically after 30 seconds.

The indicator light changes from being on to flashing when the system is set.

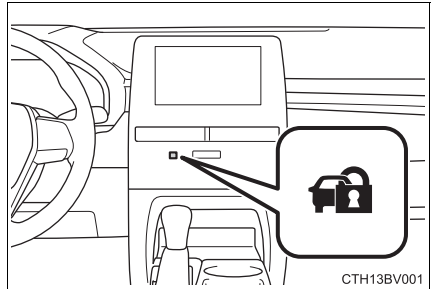

Deactivating or stopping the alarm

Do one of the following to deactivate or stop the alarm:

- Unlock the doors.
- Open the trunk using the entry function or wireless remote control.
- Turn the power switch to ACCESSORY or ON mode, or start the hybrid system. (The alarm will be deactivated or stopped after a few seconds.)

■ System maintenance

The vehicle has a maintenance-free type alarm system.

■ Items to check before locking the vehicle

To prevent unexpected triggering of the alarm and vehicle theft, make sure of the following:

- Nobody is in the vehicle.
- The windows and moon roof (if equipped) are closed before the alarm is set.
- No valuables or other personal items are left in the vehicle.

■ Triggering of the alarm

The alarm may be triggered in the following situations:
(Stopping the alarm deactivates the alarm system.)

- The trunk is opened using the mechanical key.

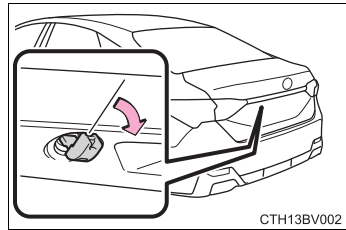

- A person inside the vehicle opens a door or the trunk or hood, or unlocks the vehicle.

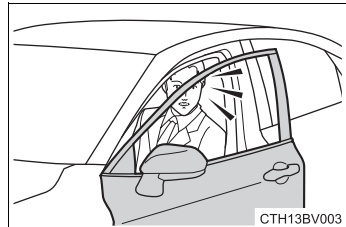

- The 12-volt battery is recharged or replaced when the vehicle is locked. (→P. 490)

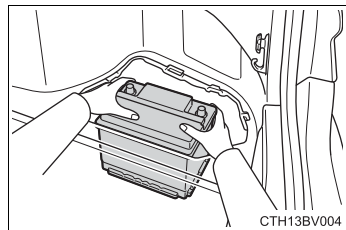

■ Alarm-operated door lock

In the following cases, depending on the situation, the door may automatically lock to prevent improper entry into the vehicle:

- When a person remaining in the vehicle unlocks the door and the alarm is activated.
- While the alarm is activated, a person remaining in the vehicle unlocks the door.
- When recharging or replacing the 12-volt battery

**NOTICE****■ To ensure the system operates correctly**

Do not modify or remove the system. If modified or removed, the proper operation of the system cannot be guaranteed.

Instrument cluster

2

2. Instrument cluster

Warning lights and indicators	92
Gauges and meters	98
Multi-information display.....	102
Head-up display	121
Energy monitor/ consumption screen.....	128

Warning lights and indicators





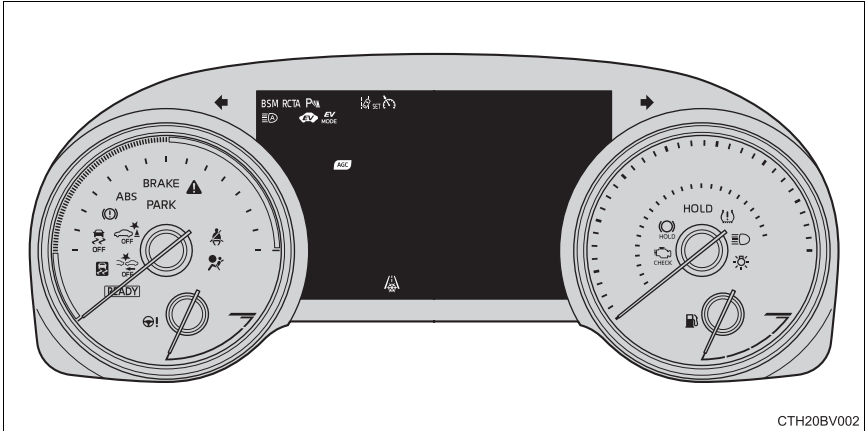













The warning lights and indicators on the instrument cluster, center panel and outside rear view mirrors inform the driver of the status of the vehicle's various systems.

For the purpose of explanation, the following illustrations display all warning lights and indicators illuminated.





Warning lights

Warning lights inform the driver of malfunctions in any of the vehicle's systems.

*1  (Red)	Brake system warning light (→P. 455)		Parking brake indicator (→P. 456)
*1  (Yellow)	Brake system warning light (→P. 455)	*1, 3 	Brake hold operated indicator (→P. 457)
*2 	High coolant temperature warning light (→P. 455)	*1  (Red/yellow)	Electric power steering system warning light (→P. 457)
*2 	Charging system warning light (→P. 455)	*1, 4  OFF	PCS warning light (→P. 457)
*2 	Low engine oil pressure warning light (→P. 455)	*1, 3  OFF (if equipped)	ICS OFF indicator (→P. 457)
*1  CHECK	Malfunction indicator lamp (→P. 456)	*2 	LDA indicator (→P. 457)
*1 	SRS warning light (→P. 456)	*1 	Slip indicator (→P. 458)
*1 	ABS warning light (→P. 456)		Low fuel level warning light (→P. 458)
*2 	Brake Override System/Drive-Start Control/Intelligent Clearance Sonar (if equipped) warning light (→P. 456)		Driver's and front passenger's seat belt reminder light (→P. 458)

*5  Rear passengers' seat
belt reminder lights
(→P. 458)

*1  Tire pressure warning
light (→P. 458)

*1  Master warning light
(→P. 458)

- *1: These lights turn on when the power switch is turned to ON mode to indicate that a system check is being performed. They will turn off after the hybrid system is on, or after a few seconds. There may be a malfunction in a system if a light does not come on, or turn off. Have the vehicle inspected by your Toyota dealer.
- *2: This light illuminates on the multi-information display.
- *3: This light flashes to indicate a malfunction.
- *4: This light flashes or illuminates to indicate a malfunction.
- *5: This light illuminates on the center panel.

Indicators

The indicators inform the driver of the operating state of the vehicle's various systems.



Turn signal indicator
(→P. 211)



Headlight indicator
(→P. 218)



Headlight high beam indicator (→P. 218)



^{*2} Automatic High Beam indicator (→P. 222)



^{*2} AGC (Auto Glide Control) indicator (→P. 322)



Parking brake indicator
(→P. 212)



^{*1} Brake hold operated indicator (→P. 216)



^{*1} Brake hold standby indicator (→P. 216)



^{*2} Cruise control indicator
(→P. 263)



^{*2} Dynamic radar cruise control indicator
(→P. 263)



^{*2} Cruise control "SET" indicator
(→P. 263)



^{*1, 3} PCS warning light
(→P. 245)



^{*1, 3} ICS OFF indicator
(→P. 303)
(if equipped)



^{*2} LDA indicator (→P. 252)
(White)



^{*2} LDA indicator (→P. 252)
(Green)















^{*2, 4} LDA indicator (→P. 252)
(Amber)



^{*1, 4} Slip indicator (→P. 324)



^{*1, 3} VSC OFF indicator
(→P. 325)

*2 	*2 "BSM" indicator (→P. 276)	*2 	*2 "SPORT" indicator (→P. 321)
*2 	*2 "RCTA" indicator (→P. 276)	*2 	*2 "ECO MODE" indicator (→P. 321)
*5, 6 	BSM (Blind Spot Monitor) outside rear view mirror indicators (→P. 276)	*2 	*2 EV drive mode indicator (→P. 202)
*1, 7 	*1, 7 "AIR BAG ON/OFF" indicator (→P. 48)	*2 	EV indicator (→P. 77)
*7 	*7 Security indicator (→P. 86, 88)	*2 	"READY" indicator (→P. 196)
*2  (if equipped)	*2 Intuitive parking assist indicator (→P. 292)	*2, 8 	*2, 8 Low outside temperature indicator (→P. 98)
*2 	*2 Smart key system indicator (→P. 196)		

- *1: These lights turn on when the power switch is turned to ON mode to indicate that a system check is being performed. They will turn off after the hybrid system is on, or after a few seconds. There may be a malfunction in a system if a light does not come on, or turn off. Have the vehicle inspected by your Toyota dealer.
- *2: This light illuminates on the multi-information display.
- *3: This light turns on when the system is off.
- *4: This light flashes to indicate that the system is operating.
- *5: These indicators will illuminate in the following situations to indicate that the system initial check is being performed:
 - When the BSM function or RCTA function is enabled and the power switch is turned to ON mode.
 - When the power switch is ON mode and the BSM function is enabled.
 - When the power switch is ON mode and the RCTA function is enabled. (At this time, a buzzer will also sound).
The indicators will turn off after a few seconds. If the indicators do not illuminate or turn off, or if a buzzer does not sound when the RCTA function is enabled, the system may be malfunctioning. Have the vehicle inspected by your Toyota dealer.
- *6: This light illuminates on the outside rear view mirrors.
- *7: This light illuminates on the center panel.
- *8: When the outside temperature is approximately 37°F (3°C) or lower, this indicator will flash for approximately 10 seconds, then stay on.



WARNING

■ If a safety system warning light does not come on

Should a safety system light such as the ABS and SRS warning lights not come on when you start the hybrid system, this could mean that these systems are not available to help protect you in an accident, which could result in death or serious injury. Have the vehicle inspected by your Toyota dealer immediately if this occurs.

Gauges and meters

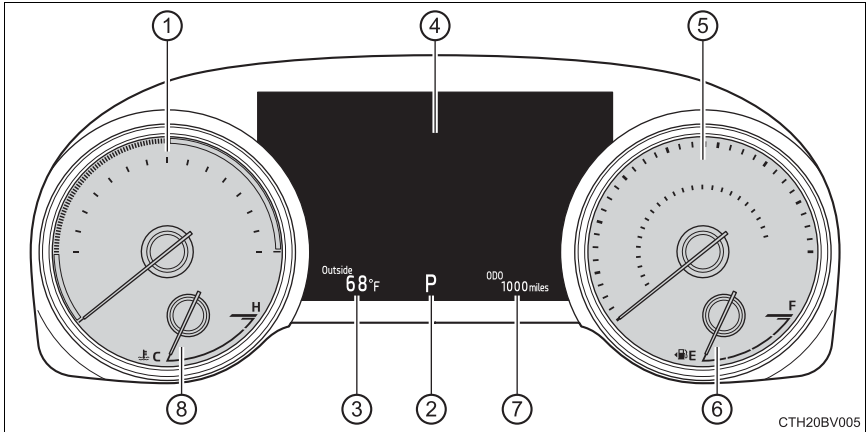

The units used on the meters may differ depending on the target region.

① Hybrid System Indicator

Displays hybrid system output or regeneration level (→P. 100)

② Shift position (→P. 205)

③ Outside temperature

Displays the outside temperature within the range of -40°F (-40°C) to 122°F (50°C). Low outside temperature indicator comes on when the ambient temperature is 37°F (3°C) or lower.

④ Multi-information display

Presents the driver with a variety of vehicle data (→P. 102)

Displays warning messages in case of a malfunction (→P. 465)

⑤ Speedometer

⑥ Fuel gauge

⑦ Odometer and trip meter (→P. 117)

⑧ Engine coolant temperature gauge

Displays the engine coolant temperature

Instrument panel light control

The brightness of the instrument panel lights can be adjusted.

The brightness of some of the interior lights will be changed when the brightness of the instrument panel lights is adjusted. (→P. 352)

① Darker

② Brighter

- The brightness of the instrument panel lights can be adjusted individually for day mode and night mode*.
- If the brightness is adjusted when the surroundings are bright and the tail lights are on (day mode brightness adjustment), the brightness level of night mode will be adjusted at the same time.

*: Day mode and night mode: →P. 100

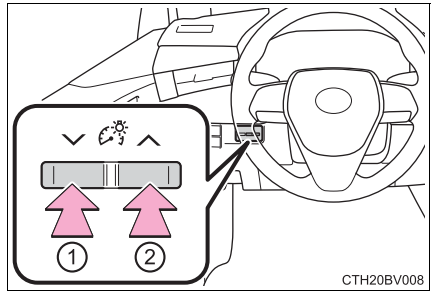

■ The meters and display illuminate when

The power switch is in ON mode.

■ Brightness of the meters (day mode and night mode)

- The brightness of the meters is changed between day mode and night mode.
 - Day mode: When the tail lights are off or when the tail lights are on but the surrounding area is bright
 - Night mode: When the tail lights are on and the surrounding area is dark
- When in night mode, the brightness will be reduced slightly unless the meters are set to the maximum brightness level.

■ Hybrid System Indicator

① Charge area

Shows regenerative charging.

② Hybrid Eco area

Shows that gasoline engine power is not being used very often.

The gasoline engine will automatically stop and restart under various conditions.

③ Eco area

Shows that the vehicle is being driven in an Eco-friendly manner.

④ Power area

Shows that an Eco-friendly driving range is being exceeded (during full power driving etc.)

- By keeping the indicator needle within Eco area, more Eco-friendly driving can be achieved.
- Charge area indicates “regeneration”^{*} status. Regenerated energy will be used to charge the battery.

^{*}: When used in this manual, “regeneration” refers to the conversion of energy created by the movement of the vehicle into electrical energy.

The Hybrid System Indicator will not operate in the following situations:

- The “READY” indicator is not illuminated.
- The shift lever is in any position other than D.

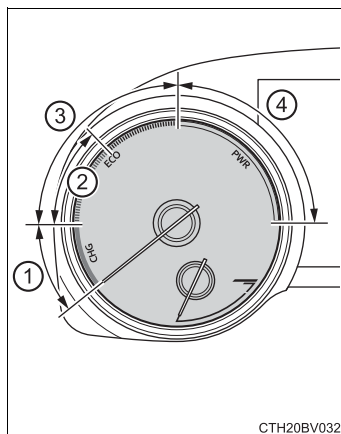

■ Engine speed

On hybrid vehicles, engine speed is precisely controlled in order to help improve fuel efficiency and reduce exhaust emissions etc.

There are times when the engine speed that is displayed may differ even when vehicle operation and driving conditions are the same.

■ Outside temperature display

In the following situations, the correct outside temperature may not be displayed, or the display may take longer than normal to change:

- When stopped, or driving at low speeds (less than 16 mph [25 km/h])
- When the outside temperature has changed suddenly (at the entrance/exit of a garage, tunnel, etc.)
- When “- -” or “E” is displayed, the system may be malfunctioning.
Take your vehicle to your Toyota dealer.



NOTICE

■ To prevent damage to the engine and its components

The engine may be overheating if the engine coolant temperature gauge is in the red zone (H). In this case, immediately stop the vehicle in a safe place, and check the engine after it has cooled completely. (→P. 494)



Multi-information display

Summary of functions

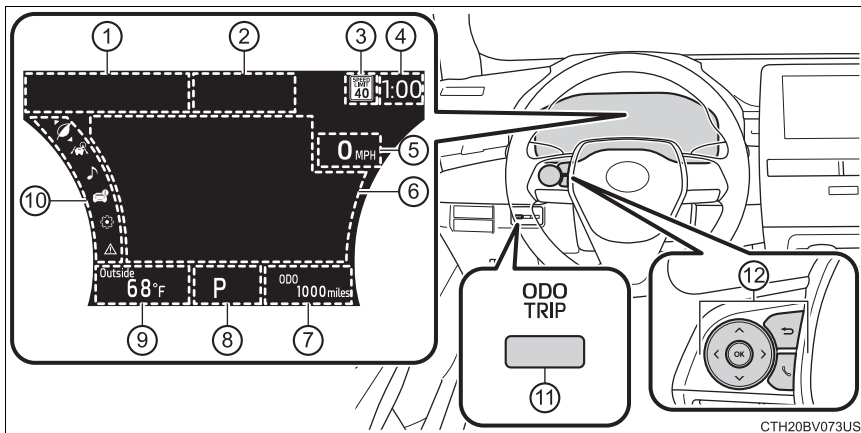
The multi-information display presents the driver with a variety of driving-related data, such as the current outside temperature. The multi-information display can also be used to change the display settings and other settings.



CTH20BV073US

- ① Indicators (→P. 92)
- ② Driving assist system status display area
 - Displays the operational status of the following systems:
 - Dynamic radar cruise control with full-speed range (→P. 263)
 - LDA (Lane Departure Alert with steering control) (→P. 252)
- ③ Speed limit display (vehicles with a navigation system) (U.S.A. only)
- ④ Clock
 - For clock settings, refer to “NAVIGATION AND MULTIMEDIA SYSTEM OWNER’S MANUAL”.
- ⑤ Speedometer
 - The speedometer display can be enabled/disabled in  on the multi-information display. (→P. 111)
 - When  is selected, the speedometer may be displayed in the content display area.

⑥ Content display area

A variety of information can be displayed by selecting a menu icon. Additionally, warning or suggestion/advice pop-up displays will be displayed in some situations.

- Menu icon content (→P. 104)
- Suggestion function (→P. 118)
- Warning message (→P. 465)

⑦ Odometer/trip meter (→P. 117)

⑧ Shift position (→P. 205)

⑨ Outside temperature (→P. 98)

⑩ Menu icons (→P. 104)

⑪ “ODO/TRIP” switch (→P. 104)

⑫ Meter control switches (→P. 103)

Using the multi-information display

◆ Using the content display area

The content display area is operated using the meter control switches.

- ① Scroll screens*, change the displayed content* and move the cursor
- ② Press: Enter/Set
Press and hold: Reset/Display the next screen
- ③ Return to the previous screen

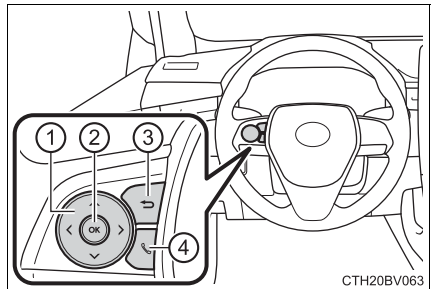

Pressing and holding the switch will display the first screen of the selected menu icon.

④ Call sending/receiving display

Linked with the hands-free system, sending or receiving call is displayed. For details regarding the hands-free system, refer to the “NAVIGATION AND MULTIMEDIA SYSTEM OWNER’S MANUAL”.

*: When the screen can be scrolled or different content can be displayed, a mark, such as an arrow, will be displayed to suggest which switch to operate.

◆ Using the odometer/trip meter

Items in this area are operated using the “ODO/TRIP” switch.

Press: Change displayed item

Each time the switch is pressed, the displayed item will be changed.

Press and hold: Reset

Display the desired trip meter and press and hold the switch to reset the trip meter.

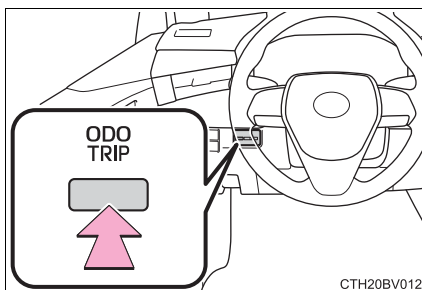

CTH20BV012

Menu icons

Select a menu icon to display its content.



Driving information (→P. 106)

Select to display the following:

- Speedometer/driving range
- Fuel consumption
- Eco guide



Driving assist system information

Select to perform the following:

Display the operational status of the following systems:

- Dynamic radar cruise control with full-speed range (→P. 263)
- LDA (Lane Departure Alert with steering control) (→P. 252)

Display the following navigation system-linked information (if equipped):

- Route guidance
- Compass display (heading-up display)



Audio system-linked display

Select to enable selection of an audio source or track on the multi-information display using the meter control switches.



Vehicle information

Select to perform the following:

Display the following information:

- Energy monitor (→P. 128)
- Tire inflation pressure (→P. 416)

Enable/Disable the following systems:

- Parking assist (Intuitive parking assist) (if equipped) (→P. 292)
- BSM (Blind Spot Monitor) function (→P. 276)
- RCTA (Rear Cross Traffic Alert) function (→P. 276)

These functions can also be enabled/disabled on .

Display the following information:

- Tachometer



Settings display (→P. 111)

Select to change the meter display settings and other settings.



Warning message display (→P. 465)

Select to display warning messages and measures to be taken if a malfunction is detected.

Driving information

■ Speedometer/driving range

- Speedometer
- Driving range

Displays the driving range with remaining fuel.

When only a small amount of fuel is added to the tank, the display may not be updated.

When refueling, turn the power switch off. If the vehicle is refueled without turning the power switch off, the display may not be updated.

This distance is computed based on your average fuel consumption. As a result, the actual distance that can be driven may differ from that displayed.

■ Fuel consumption

① Current fuel consumption

Displays the instantaneous current fuel consumption.

② Average fuel economy (after start)

Displays the average fuel consumption since hybrid system start.*1

③ Driving range

Displays the driving range with remaining fuel.*2, 3

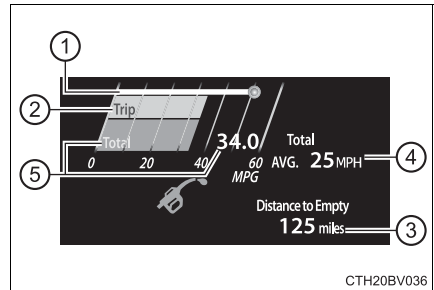

④ Gadget*4

The following items can be displayed by changing the settings for gadget content and fuel economy type on . (→P. 111)

Displayable item		Content
Gadget content	Fuel economy type	
Average vehicle speed	Trip (after start)	Displays the average vehicle speed since hybrid system start.
	Total (after reset)	Displays the average vehicle speed since the display was reset.*5
Distance	Trip (after start)	Displays the distance driven since vehicle start.
	Total (after reset)	Displays the distance driven since the display was reset.*5
Elapsed time	Trip (after start)	Displays the elapsed time since hybrid system start.
	Total (after reset)	Displays the elapsed time since the display was reset.*5

⑤ Average fuel economy

Displayed item (listed below) can be changed on the fuel economy type screen of . (→P. 111)

● Total (after reset)

Displays the average fuel consumption since the display was reset.*1, 5

● Tank (after refuel)

Displays the average fuel consumption since the vehicle was refueled.*1, 2

- *1: Use the displayed fuel consumption as a reference only.
- *2: When only a small amount of fuel is added to the tank, the display may not be updated.
When refueling, turn the power switch off. If the vehicle is refueled without turning the power switch off, the display may not be updated.
- *3: This distance is computed based on your average fuel consumption. As a result, the actual distance that can be driven may differ from that displayed.
- *4: The default setting is no display.
- *5: This display can be reset by pressing and holding  while it is displayed.

■ Eco guide

The Eco guide displays a guide for eco-friendly acceleration and scores which represent an evaluation of how the vehicle has been driven ecologically in different states.

- ① ECO Accelerator Guidance
- ② Eco score

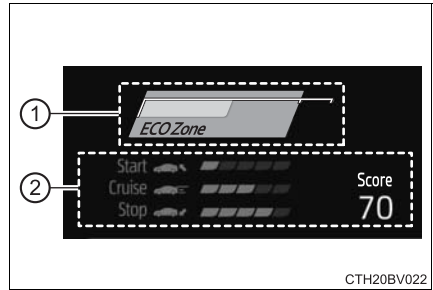

CTH20BV022

● ECO Accelerator Guidance

- ① Eco area

Indicates that the vehicle is being driven in an Eco-friendly manner.

- ② Power area

Indicates that the Eco-friendly driving range is being exceeded (during full power driving, etc.)

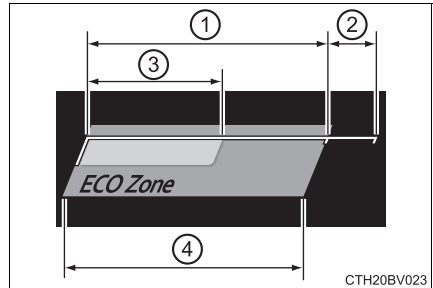

CTH20BV023

- ③ Eco driving ratio based on acceleration
- ④ Zone of Eco acceleration

Suggests a range in which Eco-friendly acceleration can be performed.

The zone of Eco acceleration changes according to situations, such as starting off or cruising.

Eco-friendly acceleration can be achieved by keeping the Eco driving ratio based on acceleration bar within the zone of Eco acceleration. (→P. 183)

● Eco score

The following 3 Eco driving methods are evaluated in 5 levels: Smooth start-off acceleration, driving without sudden acceleration, and smooth stopping. When the vehicle is stopped, an Eco score out of 100 points will be displayed.

- ① Eco start status
- ② Eco cruise status
- ③ Eco stop status
- ④ Score result

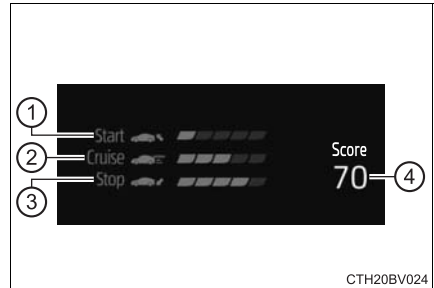

How to read the bar display:





Not yet evaluated	Low	High

- After the hybrid system is started, the Eco score will not be displayed until the vehicle speed exceeds approximately 12 mph (20 km/h).
- The Eco score will be reset each time the hybrid system is started.
- When the hybrid system is stopped, the total score of the current trip will be displayed.

Settings display ()

◆ Changing settings

Use the meter control switches on the steering wheel to change settings.





- 1 Press  or  to select .
- 2 Operate the switches to select a desired item.
- 3 Press or press and hold .

The available settings will differ depending on if  is pressed or pressed and held. Follow the instructions on the display.

◆ Setting items

■ LDA (Lane Departure Alert with steering control) (→P. 252)

Press and hold  to change the settings of the following items:



Item	Settings	Details
Steering assist	On	Select to enable/disable steering wheel assistance.
	Off	
Alert sensitivity	 (High)	Select to set the warning sensitivity.
	 (Normal)	
Sway warning	On	Select to enable/disable the vehicle sway warning.
	Off	
Sway sensitivity	 (High)	Select to set the vehicle sway warning sensitivity.
	 (Normal)	
	 (Low)	

■ PCS (Pre-Collision System) (→P. 242)

Press  to enable/disable the pre-collision system.

Item	Settings	Details
PCS	On	Select to enable/disable the pre-collision system.
	Off	

Press and hold  to change the settings of the following item:







Item	Settings	Details
Warning sensitivity (Warning timing)	 (Far)	Select to change the warning timing.
	 (Middle)	
	 (Near)	

■ BSM (Blind Spot Monitor) (→P. 276)

Press  to enable/disable the Blind Spot Monitor function.

Item	Settings	Details
BSM	On	Select to enable/disable the Blind Spot Monitor function.
	Off	

Press and hold  to change the settings of the following item:



Item	Settings	Details
Outside rear view mirror indicator brightness	 (Bright)	Select to change the brightness of the outside rear view mirror indicators.
	 (Dim)	
Sensitivity	 (Early)	Select to change the alert sensitivity for an approaching vehicle.
	 (Intermediate)	
	 (Late)	
	 (Only when vehicle detected in blind spot)	

RCTA (Rear Cross Traffic Alert) (→P. 276)

Press  to enable/disable the Rear Cross Traffic Alert function.

Item	Settings	Details
RCTA	On	Select to enable/disable the Rear Cross Traffic Alert function.
	Off	

Press and hold  to change the settings of the following item:

Item	Settings	Details
RCTA buzzer volume	 (Low)	Select to change the volume of the RCTA buzzer.
	 (Medium)	
	 (Loud)	

ICS (Intelligent Clearance Sonar) (if equipped) (→P. 300)

Press  to enable/disable the Intelligent Clearance Sonar.



Item	Settings	Details
ICS	On	Select to enable/disable the Intelligent Clearance Sonar system.
	Off	

Parking assist (Intuitive parking assist) (if equipped) (→P. 292)

Press  to enable/disable the Intuitive parking assist.

Item	Settings	Details
Intuitive parking assist	On	Select to enable/disable the intuitive parking assist.
	Off	

Press and hold  to change the settings of the following item:

Item	Settings	Details
Volume	 (Low)	Select to change the volume of the intuitive parking assist buzzer.
	 (Medium)	
	 (Loud)	

■ HUD (Head-up display) (if equipped) (→P. 121)

Press  to enable/disable the head-up display.



Item	Settings	Details
HUD	On	Select to enable/disable the head-up display.
	Off	

Press and hold  to change the settings of the following items:

Item	Settings	Details
HUD Brightness/Position		Select to adjust the brightness/position of the head-up display. <ul style="list-style-type: none"> • Press the < / > switch to adjust the display brightness. • Press the ^ / v switch to adjust the display position.
HUD Driving support	Tachometer settings	Select to change the display between the following: <ul style="list-style-type: none"> • Hybrid System Indicator • Tachometer • No content
	Navigation system	Select to enable/disable head-up display content.
	Driving Assist	
	Compass	
Rotation		Select to adjust the angle of the head-up display. <p>Press the < / > switch to adjust the display angle.</p>





■ Vehicle settings

Press and hold  to change the settings of the following items:

Item	Settings	Details
TPWS (Tire pressure warning system) (→P. 416)		
Set pressure (tire pressure warning system initialization)		<p>Select to initialize the tire pressure warning system. To perform initialization, press and hold the  switch.</p> <p>Before performing initialization, make sure to adjust the inflation pressure of each tire to the specified level. (→P. 417)</p>
Change wheel (register tire pressure warning system sensor ID codes)		<p>Select to register the ID codes of the tire pressure sensors to the tire pressure warning system. To register the ID codes, press and hold the  switch.</p> <p>(→P. 419)</p>
Scheduled maintenance display		
Maintenance data reset		<p>Select to reset the message indicating maintenance is required, after the required maintenance is performed. (→P. 393)</p>

■ Meter settings

Press and hold  to change the settings of the following items:

Item	Settings	Details
Language		Select to change the language displayed.
Units		Select to change the units of measure displayed.
 (EV indicator)	On	Select to enable/disable the EV indicator. (→P. 77)
	Off	
Speedometer	On	Select to enable/disable the speedometer display.
	Off	
Gadget content	Off	No display
	Average vehicle speed	Select to turn the display of a gadget.
	Distance	
	Elapsed time	
Fuel economy type	Trip (after start)*1	Select to change the average fuel consumption display and an item to be displayed as gadget.
	Total (after reset)	
	Tank (after refuel)*2	
Multi-information display off		Select to turn the multi-information display off. To turn the multi-information display on again, press any direction switch ( /  /  / ).
Pop-up display	Intersection guidance (if equipped)	Select to enable/disable the pop-up display.
	Incoming calls	
	Brightness adjustment	
Default setting		Select to reset the meter display settings to the default setting.

*1: Selecting this item will only change the gadget.

*2: Selecting this item will turn the display of the gadget off.

Odometer/trip meter

■ Odometer

Displays the total distance the vehicle has been driven.

■ Trip meter A/trip meter B

Displays the distance the vehicle has been driven since the meter was last reset. Trip meters A and B can be used to record and display different distances independently.

To reset, display the desired trip meter and press and hold the “ODO/TRIP” switch.

Suggestion function

Displays suggestions to the driver in the following situations. To select a response to a displayed suggestion, use the meter control switches.

The suggestion function can be turned on/off.
(Customizable features: →P. 526)

■ Suggestion to turn off the headlights

If the headlights are left on for a certain amount of time after the power switch has been turned off, if the headlight switch is in the “AUTO” position, a suggestion message will be displayed asking if you wish to turn the headlights off. To turn the headlights off, select “Yes”.

If a front door is opened after the power switch is turned off, this suggestion message will not be displayed.

■ The Eco guide will not operate when

The Eco guide will not operate in the following situations:

- The Hybrid System Indicator is not operating.
- The vehicle is being driven using the dynamic radar cruise control with full-speed range.

■ Suspension of the settings display

- Some settings cannot be changed while driving. When changing settings, park the vehicle in a safe place.
- If a warning message is displayed, operation of the settings display will be suspended.

■ Tire pressure

- It may take a few minutes to display the tire inflation pressure after the power switch is turned to ON mode. It may also take a few minutes to display the tire inflation pressure after inflation pressure has been adjusted.
- “---” may be displayed if the tire position information cannot be determined due to unfavorable radio wave conditions.
- Tire inflation pressure changes with temperature. The displayed values may also be different from the values measured using a tire pressure gauge.

■ Liquid crystal display

Small spots or light spots may appear on the display. This phenomenon is characteristic of liquid crystal displays, and there is no problem continuing to use the display.

■ Customization

Some functions can be customized. (→P. 111, 526)

**WARNING****■ Caution for use while driving**

- When operating the multi-information display while driving, pay extra attention to the safety of the area around the vehicle.
- Do not look continuously at the multi-information display while driving as you may fail to see pedestrians, objects on the road, etc. ahead of the vehicle.

■ The information display at low temperatures

Allow the interior of the vehicle to warm up before using the liquid crystal information display. At extremely low temperatures, the information display monitor may respond slowly, and display changes may be delayed.

For example, there is a lag between the driver's shifting and the new gear number appearing on the display. This lag could cause the driver to down-shift again, causing rapid and excessive engine braking and possibly an accident resulting in death or injury.

■ Cautions during setting up the display

As the hybrid system needs to be running during setting up the display, ensure that the vehicle is parked in a place with adequate ventilation. In a closed area such as a garage, exhaust gases including harmful carbon monoxide (CO) may collect and enter the vehicle. This may lead to death or a serious health hazard.

**NOTICE****■ While setting up the display**

To prevent 12-volt battery discharge, ensure that the hybrid system is operating while setting up the display features.

Head-up display*

Summary of functions

The head-up display is linked to the meters and navigation system and projects a variety of information in front of the driver, such as the current vehicle speed.

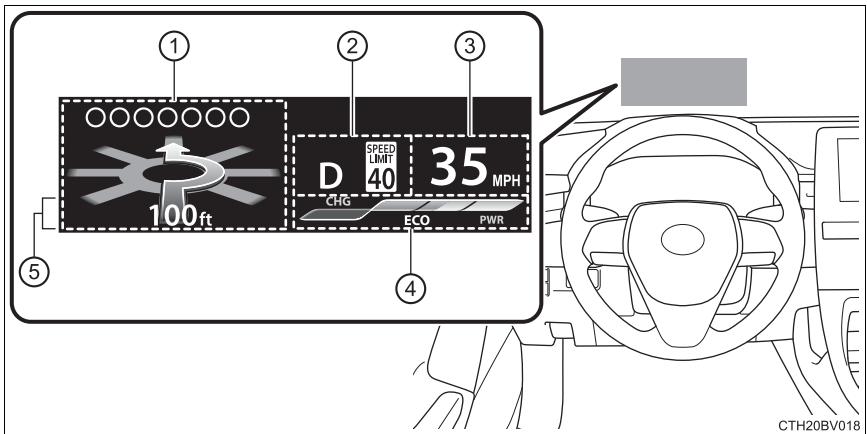

- ① Driving assist system status/navigation system-linked display area (→P. 123)

The following pop-up displays will be displayed in certain situations:

- Pre-collision warning (pre-collision system)
- Alert from the Intelligent Clearance Sonar system (if equipped)

- ② Shift position/speed limit display area

- Shift position (→P. 205)
- Speed limit (vehicles with a navigation system) (U.S.A. only)

- ③ Vehicle speed display



- ④ Hybrid System Indicator/Tachometer (→P. 124)

- ⑤ Information display area (→P. 125)

The following pop-up displays will be displayed in certain situations:

- Warning/message
- Hands-free system status
- Audio system operation status

Using the head-up display

Select  on the multi-information display (→P. 111) and then .

◆ Enabling/disabling the head-up display

Press  to enable/disable the head-up display.

◆ Changing the head-up display settings

Press and hold  to change the following settings:

■ Display brightness/position

Select to adjust the brightness and position of the head-up display.

■ Display content

Select to enable/disable the following items:

- Route guidance to destination
- Driving assist system status
- Compass

Select to change the display between the following:

- Hybrid system Indicator
- Tachometer
- No content

■ Display angle

Select to adjust the angle of the head-up display.

Driving assist system status/navigation system-linked display area

◆ Driving assist system status display

Displays the operational status of the following systems:

- Dynamic radar cruise control with full-speed range (→P. 263)
- LDA (Lane Departure Alert with steering control) (→P. 252)
- Intuitive parking assist (if equipped) (→P. 292)

◆ Navigation system-linked display area

Displays the following items, which are linked to the navigation system:

■ Street name

When the navigation system is performing route guidance, the name of the next street will be displayed on the top of the display area.

■ Route guidance to destination

Displayed when the navigation system is performing route guidance. When approaching an intersection, an arrow will be displayed to indicate the suggested direction of travel.

■ Compass

Displays the direction of travel.

Hybrid System Indicator/Tachometer

■ Hybrid System Indicator

- ① Charge area
- ② Hybrid Eco area
- ③ Eco area
- ④ Power area

Displayed content is the same as that displayed on the meter (Hybrid System Indicator). For details, refer to P. 100.

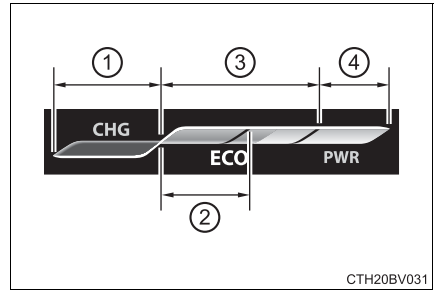

■ Tachometer

Displays the engine speed in revolutions per minute.

Information display area

Displays the following items in the appropriate situation:

■ Warning/Message

- Alert from the LDA (Lane Departure Alert with steering control)
- Dynamic radar cruise control with full-speed range

-  message

Displayed when a suggestion/advice pop-up display is displayed on the multi-information display. (→P. 118)

-  message

Displayed when a warning message is displayed on the multi-information display. (→P. 465)

- Outside temperature

Displayed in the following situations:

- When the power switch is turned to ON mode
- When the low outside temperature indicator is flashing

Displayed content is the same as that displayed on the multi-information display. For details, refer to the explanation of the outside temperature display on the multi-information display. (→P. 98)

■ Hands-free system status

Displayed when the hands-free system is operated.

■ Audio system operation status

Displayed when the audio system is operated.

■ Head-up display

The head-up display may seem dark or hard to see when viewed through sunglasses, especially polarized sunglasses.

Adjust the brightness of the head-up display or remove your sunglasses.

■ Display brightness

The brightness of the head-up display can be adjusted on  of the multi-information display. Also, it is automatically adjusted according to the ambient brightness.

■ Enabling/disabling of the head-up display

If the head-up display is disabled, it will remain disabled when the power switch is turned off then back to ON mode.

■ Street name display

Only street names which are included in the map data will be displayed.



WARNING

■ Before using the head-up display

- Check that the position and brightness of the head-up display image does not interfere with safe driving. Incorrect adjustment of the image's position or brightness may obstruct the driver's view and lead to an accident, resulting in death or serious injury.
- Do not continuously look at the head-up display while driving as you may fail to see pedestrians, objects on the road, etc. ahead of the vehicle.

■ Caution for changing settings of the head-up display

As the hybrid system needs to be running while changing the settings of the head-up display, ensure that the vehicle is parked in a place with adequate ventilation. In a closed area such as a garage, exhaust gases including harmful carbon monoxide (CO) may collect and enter the vehicle. This may lead to death or a serious health hazard.

 NOTICE**■ To prevent damage to components**

- Do not place any drinks near the head-up display projector. If the projector gets wet, electrical malfunctions may result.
- Do not place anything on or put stickers onto the head-up display projector. Doing so could interrupt head-up display indications.
- Do not touch the inside of the head-up display projector or thrust sharp edges or the like into the projector. Doing so could cause mechanical malfunctions.

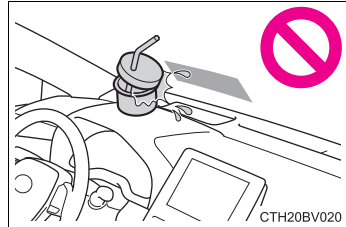
**■ When changing the settings of the head-up display**

To prevent 12-volt battery discharge, ensure that the hybrid system is operating while the changing the settings of the head-up display.

Energy monitor/consumption screen

You can view the status of your hybrid system on the multi-information display, the audio system screen.

- 1 Audio system screen
- 2 Multi-information display

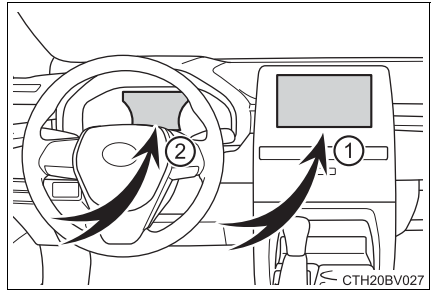

Energy monitor

- 1 Press the "MENU" button.
- 2 Select "Info" on the "Menu" screen.
- 3 Select "ECO" on the "Information" screen.

If the "Trip Information" or "History" screen is displayed, select "Energy".

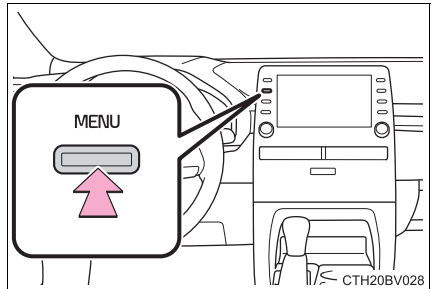





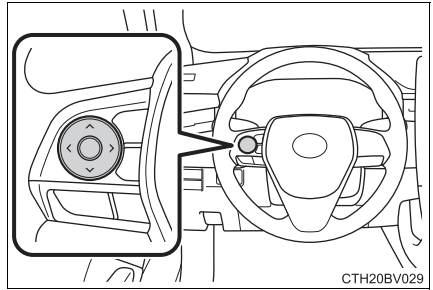

■ **Multi-information display**

Press the meter control switches on the steering wheel several times to select the energy monitor display.

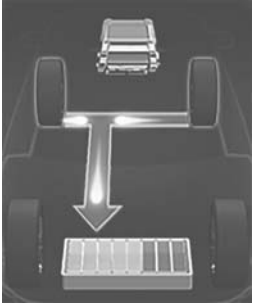

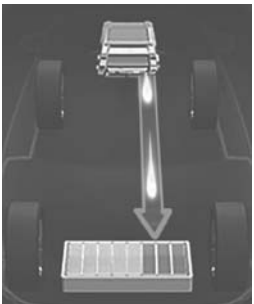
CTH20BV029

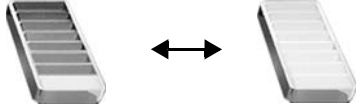
	Audio system screen	Multi-information display
When the vehicle is powered by the electric motor (traction motor)	<p>CTA20BT036</p>	
When the vehicle is powered by the gasoline engine	<p>CTA20BT037</p>	
When the vehicle is powered by both the gasoline engine and the electric motor (traction motor)	<p>CTA20BT038</p>	

	Audio system screen	Multi-information display
When the vehicle is charging the hybrid battery (traction battery)	 <p>CTA20BT039</p>	
	 <p>CTA20BT040</p>	
When there is no energy flow	 <p>CTA20BT041</p>	
Hybrid battery (traction battery) status	 <p>Low Full</p>	 <p>Low Full</p>

Fuel consumption screen

■ Trip information

- 1 Press the “MENU” button. (→P. 128)
- 2 Select “Info” on the “Menu” screen.
- 3 Select “ECO” on the “Information” screen.

If “Energy Monitor” or “History” screen is displayed, select “Trip Information”.

- 1 Resetting the consumption data
- 2 Displays the average vehicle speed since the hybrid system was started
- 3 Displays the elapsed time since the hybrid system was started

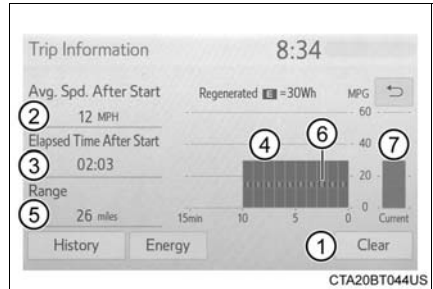

- 4 Fuel consumption in the past 15 minutes
- 5 Cruising range
- 6 Regenerated energy in the past 15 minutes

One symbol indicates 30 Wh. Up to 5 symbols are shown.

The image is example only, and may vary slightly from actual conditions.

- 7 Current fuel consumption

■ History

- 1 Press the “MENU” button. (→P. 128)
- 2 Select “Info” on the “Menu” screen.
- 3 Select “ECO” on the “Information” screen.

If “Energy Monitor” or “Trip Information” screen is displayed, select “History”.

- 1 Resetting the past record data
- 2 Best past fuel consumption
- 3 Current fuel economy
- 4 Previous fuel consumption record

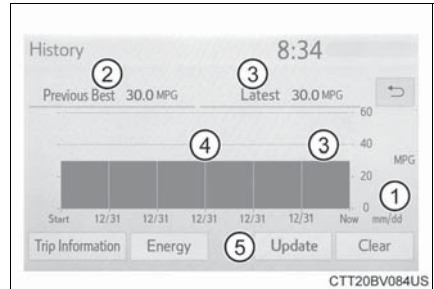

► Audio Plus

Displays the daily average fuel consumption. (Instead of the date, “Trip 1” through “Trip 5” will be displayed.)

► Premium Audio

Displays the daily average fuel consumption.

- 5 Updating the average fuel consumption data

Displays a maximum of five past record of the average fuel consumption.

The image is example only, and may vary slightly from actual conditions.

■ Resetting the consumption data

Selecting “Clear” on the “Trip Information” screen will reset the fuel consumption and the regenerated energy for the past 15 minutes. Selecting “Clear” on the “History” screen will reset the past records and best past fuel consumption. Selecting “Yes” on the following screen will confirm resetting of all the data.

Operation of each component

3

- 3-1. Key information**
 - Keys 134
- 3-2. Opening, closing and locking the doors**
 - Doors 138
 - Trunk 144
 - Smart key system 148
- 3-3. Adjusting the seats**
 - Front seats 155
 - Rear seats 157
 - Driving position
memory 159
 - Head restraints 164
- 3-4. Adjusting the steering wheel and mirrors**
 - Steering wheel 166
 - Inside rear view mirror 168
 - Outside rear view
mirrors 170
- 3-5. Opening and closing the windows**
 - Power windows 173
 - Moon roof 177

Keys

The keys

The following keys are provided with the vehicle.

- ① Electronic keys
 - Operating the smart key system (→P. 148)
 - Operating the wireless remote control function (→P. 134)
- ② Mechanical keys
- ③ Key number plate

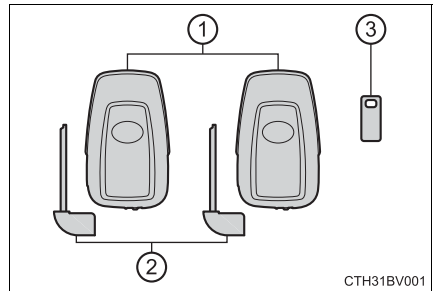

Wireless remote control

- ① Locks all the doors (→P. 138)
- ② Unlocks all the doors (→P. 138)
- ③ Opens the windows*² and moon roof*^{1, 2} (→P. 138)
- ④ Opens the trunk (→P. 145)
- ⑤ Sounds the alarm (→P. 135)

*1: If equipped

*2: This setting must be customized at your Toyota dealer.

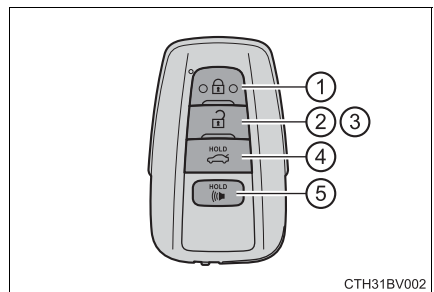

Using the mechanical key

To take out the mechanical key, slide the release lever and take the key out.

The mechanical key can only be inserted in one direction, as the key only has grooves on one side. If the key cannot be inserted in a lock cylinder, turn it over and re-attempt to insert it.

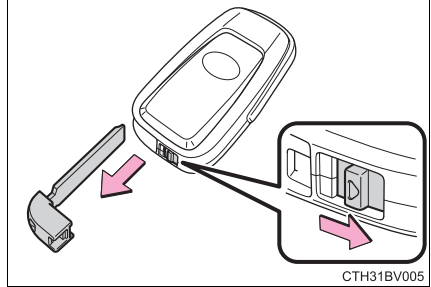

After using the mechanical key, store it in the electronic key. Carry the mechanical key together with the electronic key. If the electronic key battery is depleted or the entry function does not operate properly, you will need the mechanical key. (→P. 484)

■ Panic mode

When  is pressed for longer than about one second, an alarm will sound intermittently and the vehicle lights will flash to deter any person from trying to break into or damage your vehicle.

To stop the alarm, press any button on the electronic key.



■ If you lose your mechanical keys

New genuine mechanical keys can be made by your Toyota dealer using the other mechanical key and the key number stamped on your key number plate. Keep the plate in a safe place such as your wallet, not in the vehicle.

■ When riding in an aircraft

When bringing an electronic key onto an aircraft, make sure you do not press any button on the electronic key while inside the aircraft cabin. If you are carrying an electronic key in your bag etc., ensure that the buttons are not likely to be pressed accidentally. Pressing a button may cause the electronic key to emit radio waves that could interfere with the operation of the aircraft.

■ Conditions affecting operation

→P. 151

■ Electronic key battery depletion

- The standard battery life is 1 to 2 years.
- If the battery becomes low, an alarm will sound in the cabin when the hybrid system stops.
- As the electronic key always receives radio waves, the battery will become depleted even if the electronic key is not used. The following symptoms indicate that the electronic key battery may be depleted. Replace the battery when necessary. (→P. 439)
 - The smart key system or the wireless remote control does not operate.
 - The detection area becomes smaller.
 - The LED indicator on the key surface does not turn on.
- To reduce key battery depletion when the electronic key is to not be used for long periods of time, set the electronic key to the battery-saving mode. (→P. 150)
- To avoid serious deterioration, do not leave the electronic key within 3 ft. (1 m) of the following electrical appliances that produce a magnetic field:
 - TVs
 - Personal computers
 - Cellular phones, cordless phones and battery chargers
 - Recharging cellular phones or cordless phones
 - Table lamps
 - Induction cookers

■ Replacing the battery

→P. 439

■ Confirmation of the registered key number

The number of keys already registered to the vehicle can be confirmed. Ask your Toyota dealer for details.

■ If a wrong key is used

The key cylinder rotates freely to isolate inside mechanism.

■ Certification for the wireless remote control

→P. 154

 NOTICE**■ To prevent key damage**

- Do not drop the keys, subject them to strong shocks or bend them.
- Do not expose the keys to high temperatures for long periods of time.
- Do not get the keys wet or wash them in an ultrasonic washer etc.
- Do not attach metallic or magnetic materials to the keys or place the keys close to such materials.
- Do not disassemble the keys.
- Do not attach a sticker or anything else to the surface of the electronic key.
- Do not place the keys near objects that produce magnetic fields, such as TVs, audio systems and induction cookers, or medical electrical equipment, such as low-frequency therapy equipment.

■ Carrying the electronic key on your person

Carry the electronic key 3.9 in. (10 cm) or more away from electric appliances that are turned on. Radio waves emitted from electric appliances within 3.9 in. (10 cm) of the electronic key may interfere with the key, causing the key to not function properly.

■ In case of a smart key system malfunction or other key-related problems

Take your vehicle with all the electronic keys provided with your vehicle to your Toyota dealer.

■ When an electronic key is lost

If the electronic key remains lost, the risk of vehicle theft increases significantly. Visit your Toyota dealer immediately with all remaining electronic keys that were provided with your vehicle.

Doors

Unlocking and locking the doors from the outside

◆ Smart key system

Carry the electronic key to enable this function.

- ① Grip the driver's door handle to unlock the door. Holding the driver's door handle for approximately 2 seconds unlocks all the doors. Grip the front passenger's door handle to unlock all the doors.*

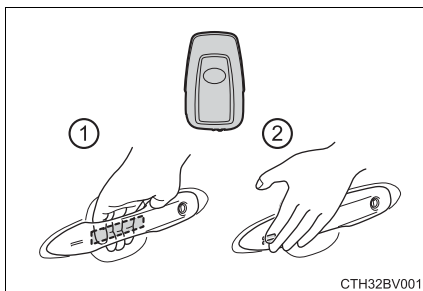

CTH32BV001

Make sure to touch the sensor on the back of the handle.

The doors cannot be unlocked for 3 seconds after the doors are locked.

*: The door unlock settings can be changed. (→P. 142)

- ② Touch the lock sensor (the indentation on the side of the door handle) to lock the doors.

Check that the door is securely locked.

◆ Wireless remote control

- ① Locks all the doors

Check that the door is securely locked.

- ② Unlocks all the doors

Pressing the button unlocks the driver's door. Pressing the button again within 3 seconds unlocks the other doors.

Press and hold to open the windows*2 and moon roof.*1, 2 (→P. 173, 178)

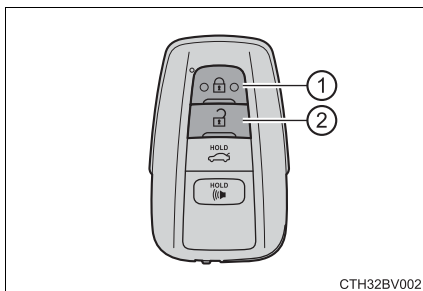

CTH32BV002

*1: If equipped

*2: This setting must be customized at your Toyota dealer.

■ Operation signals

Doors:

A buzzer sounds and the emergency flashers flash to indicate that the doors have been locked/unlocked. (Locked: Once; Unlocked: Twice)

Windows and moon roof:

A buzzer sounds to indicate that the windows and moon roof are opening.

■ Security feature

If a door is not opened within approximately 60 seconds after the vehicle is unlocked, the security feature automatically locks the vehicle again.

■ When the door cannot be locked by the lock sensor on the surface of the door handle

When the door cannot be locked even if the lock sensor on the surface of the door handle is touched by a finger, touch the lock sensor with the palm.

When gloves are being worn, remove the gloves.

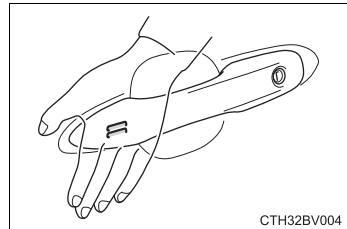

■ Door lock buzzer

If an attempt to lock the doors is made when a door is not fully closed, a buzzer sounds continuously. Fully close the door to stop the buzzer, and lock the vehicle once more.

■ Setting the alarm

Locking the doors will set the alarm system. (→P. 88)

■ If the smart key system or the wireless remote control does not operate properly

Use the mechanical key to lock and unlock the doors. (→P. 484)

Replace the key battery with a new one if it is depleted. (→P. 439)

Unlocking and locking the doors from the inside

◆ Door lock switches

- ① Locks all the doors
- ② Unlocks all the doors

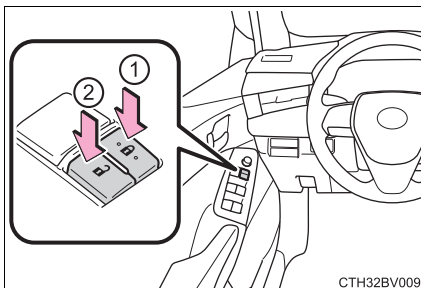

CTH32BV009

◆ Inside lock buttons

- ① Locks the door
- ② Unlocks the door

The front doors can be opened by pulling the inside handle even if the lock buttons are in the lock position.

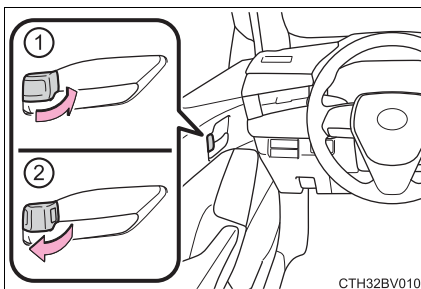

CTH32BV010

Locking the front doors from the outside without a key

- 1 Move the inside lock button to the lock position.
- 2 Close the door.

The door cannot be locked if the power switch is in ACCESSORY or ON mode, or the electronic key is left inside the vehicle.

The key may not be detected correctly and the door may be locked.

Rear door child-protector lock

The door cannot be opened from inside the vehicle when the lock is set.

- ① Unlock
- ② Lock

These locks can be set to prevent children from opening the rear doors. Push down on each rear door switch to lock both rear doors.

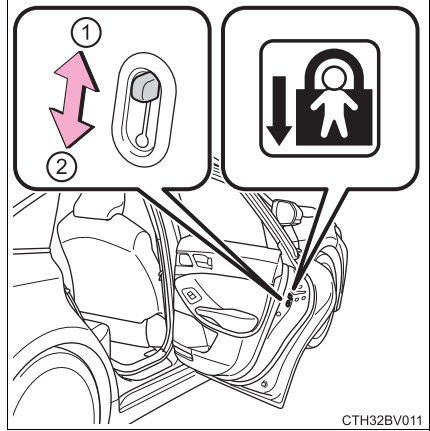

CTH32BV011

Automatic door locking and unlocking systems





The following functions can be set or cancelled:

For instructions on customizing, refer to P. 528.



Function	Operation
Speed linked door locking function	All doors are automatically locked when vehicle speed is approximately 12 mph (20 km/h) or higher.
Shift position linked door locking function	All doors are automatically locked when shifting the shift lever out of P.
Shift position linked door unlocking function	All doors are automatically unlocked when shifting the shift lever to P.
Driver's door linked door unlocking function	All doors are automatically unlocked when driver's door is opened.

■ Switching the door unlock function

It is possible to set which doors the entry function unlocks using the wireless remote control.

- 1 Turn the power switch off.
- 2 When the indicator light on the key surface is not on, press and hold  or  for approximately 5 seconds while pressing and holding , .

The setting changes each time an operation is performed, as shown below. (When changing the setting continuously, release the buttons, wait for at least 5 seconds, and repeat step 2.)

Multi-information display	Unlocking function	Beep
	Holding the driver's door handle unlocks only the driver's door.	Exterior: Beeps 3 times Interior: Pings once
	Holding the front passenger's door handle unlocks all the doors.	
	Holding either front door handle unlocks all the doors.	Exterior: Beeps twice Interior: Pings once

To prevent unintended triggering of the alarm, unlock the doors using the wireless remote control and open and close a door once after the settings have been changed. (If a door is not opened within 60 seconds after  is pressed, the doors will be locked again and the alarm will automatically be set.)

In case that the alarm is triggered, immediately stop the alarm. (→P. 88)

■ Impact detection door lock release system

In the event that the vehicle is subject to a strong impact, all the doors are unlocked. Depending on the force of the impact or the type of accident, however, the system may not operate.

■ Open door warning buzzer

If the vehicle reaches a speed of 3 mph (5 km/h), the master warning light flashes and a buzzer sounds to indicate that the door(s) are not yet fully closed.

The open door(s) is displayed on the multi-information display.

■ Using the mechanical key

The doors can also be locked and unlocked with the mechanical key. (→P. 484)

■ Conditions affecting the operation of the smart key system or wireless remote control

→P. 151

■ Customization

Some functions can be customized. (→P. 526)

**WARNING****■ To prevent an accident**

Observe the following precautions while driving the vehicle.

Failure to do so may result in a door opening and an occupant falling out, resulting in death or serious injury.

● Ensure that all doors are properly closed.

● Do not pull the inside handle of the doors while driving.

Be especially careful for the front doors, as the doors may be opened even if the inside lock buttons are in locked position.

● Set the rear door child-protector locks when children are seated in the rear seats.

■ When opening or closing a door

Check the surroundings of the vehicle such as whether the vehicle is on an incline, whether there is enough space for a door to open and whether a strong wind is blowing.

When opening or closing the door, hold the door handle tightly to prepare for any unpredictable movement.

Trunk

The trunk can be opened using the trunk opener switch, entry function or wireless remote control.

Opening the trunk from inside the vehicle

Press the trunk opener switch.

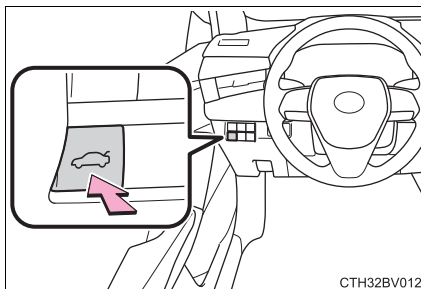

Opening the trunk from outside the vehicle

◆ Smart key system

While carrying the electronic key, press the button on the trunk lid.

When all the doors are unlocked using one of the following methods, the trunk can be opened without the electronic key:

- Entry function
- Wireless remote control
- Door lock switches
- Automatic door unlocking system
- Mechanical key

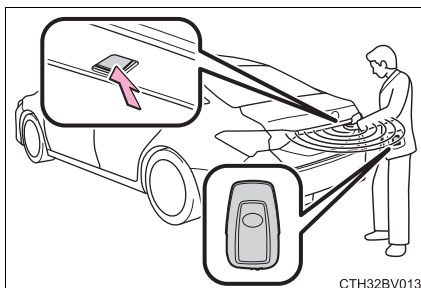

◆ Wireless remote control

Press and hold the switch.
A buzzer sounds.

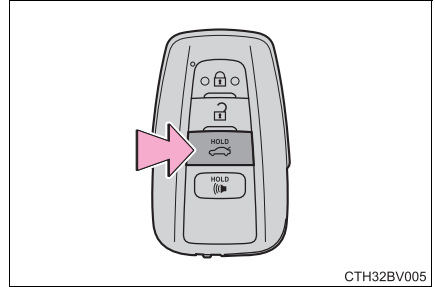

■ Trunk light

The trunk light turns on when the trunk is opened.

■ Function to prevent the trunk being locked with the electronic key inside

- When all doors are locked, closing the trunk lid with the electronic key left inside the trunk will sound an alarm.

In this case, the trunk lid can be opened by pressing the trunk release button on the trunk lid.

- If the spare electronic key is put in the trunk with all the doors locked, the key confinement prevention function is activated so the trunk can be opened. In order to prevent theft, take all electronic keys with you when leaving the vehicle.

- If the electronic key is put in the trunk with all the doors locked, the key may not be detected depending on the location of the key and the surrounding radio wave conditions. In this case, the key confinement prevention function cannot be activated, causing the doors to lock when the trunk is closed. Make sure to check where the key is before closing the trunk.

- The key confinement prevention function cannot be activated if any one of the doors is unlocked. In this case, open the trunk using the trunk opener.

■ Open trunk warning buzzer

If the vehicle reaches a speed of 3 mph (5 km/h), the master warning light flashes and a buzzer sounds to indicate that the trunk is not yet fully closed.

■ Internal trunk release lever

The trunk lid can be opened by pulling up the glow-in-the-dark lever located on the inside of the trunk lid.

The lever will continue to glow for some time after the trunk lid is closed.

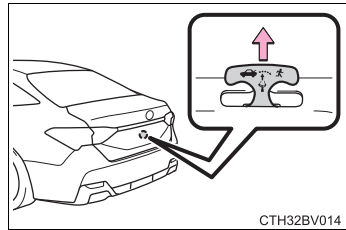

CTH32BV014

■ Using the mechanical key

The trunk can be also opened using the mechanical key. (→P. 485)

■ If the smart key system or the wireless remote control does not operate properly

Use the mechanical key to unlock the trunk. (→P. 485)

Replace the key battery with a new one if it is depleted. (→P. 439)

■ Customization

Some functions can be customized. (→P. 526)



WARNING

Observe the following precautions.

Failure to do so may result in death or serious injury.

■ Before driving

- Make sure that the trunk lid is fully closed. If the trunk lid is not fully closed, it may open unexpectedly while driving and hit near-by objects or luggage in the trunk may be thrown out, causing an accident.
- Do not allow children to play in the trunk.
If a child is accidentally locked in the trunk, they could suffer from heat exhaustion, suffocation or other injuries.
- Do not allow a child to open or close the trunk lid.
Doing so may cause the trunk lid to open unexpectedly, or cause the child's hands, head, or neck to be caught by the closing trunk lid.

■ Important points while driving

Never let anyone sit in the trunk. In the event of sudden braking or a collision, they are susceptible to death or serious injury.

⚠ WARNING

■ Using the trunk

Observe the following precautions.

Failure to do so may cause parts of the body to be caught, resulting in serious injury.

- Remove any heavy loads, such as snow and ice, from the trunk lid before opening it. Failure to do so may cause the trunk lid to suddenly shut again after it is opened.
- When opening or closing the trunk lid, thoroughly check to make sure the surrounding area is safe.
- If anyone is in the vicinity, make sure they are safe and let them know that the trunk is about to open or close.
- Use caution when opening or closing the trunk lid in windy weather as it may move abruptly in strong wind.
- On an incline it is more difficult to open or close the trunk lid than on a level surface, so beware of the trunk lid unexpectedly opening or closing by itself. Make sure that the trunk lid is fully open and secure before using the trunk.
- When opening the trunk lid, take care so that it does not hit anyone in the face or any other part of the body.

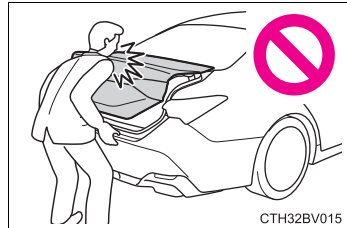

- When closing the trunk lid, take extra care to prevent your fingers etc. from being caught.
- When closing the trunk lid, make sure to press it lightly on its outer surface.

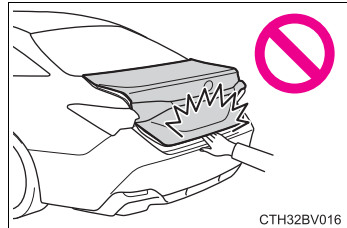

- Do not attach any accessories other than genuine Toyota parts to the trunk lid. Such additional weight on the trunk lid may cause the lid to suddenly shut again after it is opened.

Smart key system

The following operations can be performed simply by carrying the electronic key on your person, for example in your pocket. The driver should always carry the electronic key.

- Locks and unlocks the doors (→P. 138)
- Opens the trunk (→P. 144)
- Starts the hybrid system (→P. 196)

■ Antenna location

- ① Antennas outside the cabin
- ② Antennas inside the cabin
- ③ Antenna inside the trunk
- ④ Antenna outside the trunk

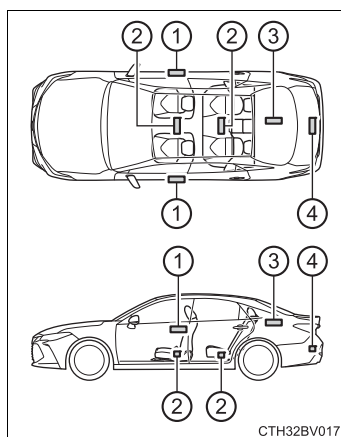

■ Effective range (areas within which the electronic key is detected)

- When locking or unlocking the doors

The system can be operated when the electronic key is within about 2.3 ft. (0.7 m) of either of the front outside door handles. (Only the doors detecting the key can be operated.)

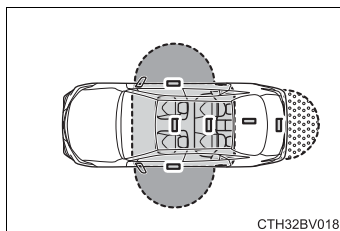

- When starting the hybrid system or changing power switch modes

The system can be operated when the electronic key is inside the vehicle.

- When opening the trunk

The system can be operated when the electronic key is within about 2.3 ft. (0.7 m) of the trunk release button.

■ Alarms and warning indicators

A combination of exterior and interior alarms as well as warning messages shown on the multi-information display are used to prevent theft of the vehicle and accidents resulting from erroneous operation. Take appropriate measures in response to any warning message on the multi-information display. (→P. 465)

When only an alarm sounds, circumstances and correction procedures are as follows.

Alarm	Situation	Correction procedure
Exterior alarm sounds once for 5 seconds	An attempt was made to lock the vehicle while a door was open.	Close all of the doors and lock the doors again.
	The trunk was closed while the electronic key was still inside the trunk and all the doors were locked.	Retrieve the electronic key from the trunk and close the trunk lid.
Interior alarm pings repeatedly	The power switch was turned to ACCESSORY mode while the driver's door was open (The driver's door was opened when the power switch was in ACCESSORY mode).	Turn the power switch off and close the driver's door.
	The power switch was turned off while the driver's door was open.	Close the driver's door.



■ Battery-saving function

The battery-saving function will be activated in order to prevent the electronic key battery and the 12-volt battery from being discharged while the vehicle is not in operation for a long time.

- In the following situations, the smart key system may take some time to unlock the doors.
 - The electronic key has been left in an area of approximately 6 ft. (2 m) of the outside of the vehicle for 10 minutes or longer.
 - The smart key system has not been used for 5 days or longer.
- If the smart key system has not been used for 14 days or longer, the doors cannot be unlocked at any doors except the driver's door. In this case, take hold of the driver's door handle, or use the wireless remote control or the mechanical key, to unlock the doors.

■ Electronic Key Battery-Saving Function

When battery-saving mode is set, battery depletion is minimized by stopping the electronic key from receiving radio waves.

Press  twice while pressing and holding . Confirm that the electronic key indicator flashes 4 times.

While the battery-saving mode is set, the smart key system cannot be used. To cancel the function, press any of the electronic key buttons.

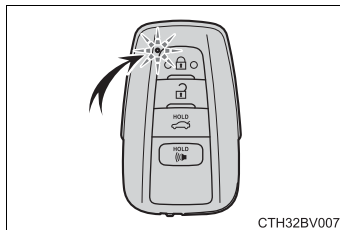

CTH32BV007

■ Conditions affecting operation

The smart key system, wireless remote control and immobilizer system use weak radio waves. In the following situations, the communication between the electronic key and the vehicle may be affected, preventing the smart key system, wireless remote control and immobilizer system from operating properly. (Ways of coping: →P. 484)

- When the electronic key battery is depleted
- Near a TV tower, electric power plant, gas station, radio station, large display, airport or other facility that generates strong radio waves or electrical noise
- When the electronic key is in contact with, or is covered by the following metallic objects
 - Cards to which aluminum foil is attached
 - Cigarette boxes that have aluminum foil inside
 - Metallic wallets or bags
 - Coins
 - Hand warmers made of metal
 - Media such as CDs and DVDs
- When other wireless keys (that emit radio waves) are being used nearby
- When carrying the electronic key together with the following devices that emit radio waves
 - Portable radio, cellular phone, cordless phone or other wireless communication devices
 - Another vehicle's electronic key, another electronic key of your vehicle, or a wireless key that emits radio waves
 - Personal computers or personal digital assistants (PDAs)
 - Digital audio players
 - Portable game systems
- If window tint with a metallic content or metallic objects are attached to the rear window
- When the electronic key is placed near a battery charger or electronic devices
- When the vehicle is parked in a pay parking spot where radio waves are emitted.

■ Note for the entry function

- Even when the electronic key is within the effective range (detection areas), the system may not operate properly in the following cases:
 - The electronic key is too close to the window or outside door handle, near the ground, or in a high place when the doors are locked or unlocked.
 - The electronic key is near the ground or in a high place, or too close to the rear bumper center when the trunk is opened.
 - The electronic key is on the instrument panel, rear package tray or floor, or in the door pockets or glove box when the hybrid system is started or power switch modes are changed.
- Do not leave the electronic key on top of the instrument panel or near the door pockets when exiting the vehicle. Depending on the radio wave reception conditions, it may be detected by the antenna outside the cabin and the door will become lockable from the outside, possibly trapping the electronic key inside the vehicle.
- As long as the electronic key is within the effective range, the doors may be locked or unlocked by anyone. However, only the doors detecting the electronic key can be used to unlock the vehicle.
- Even if the electronic key is not inside the vehicle, it may be possible to start the hybrid system if the electronic key is near the window.
- The doors may unlock or lock if a large amount of water splashes on the door handle, such as in the rain or in a car wash, when the electronic key is within the effective range. (The doors will automatically be locked after approximately 60 seconds if the doors are not opened and closed.)
- If the wireless remote control is used to lock the doors when the electronic key is near the vehicle, there is a possibility that the door may not be unlocked by the entry function. (Use the wireless remote control to unlock the doors.)
- Touching the door lock sensor while wearing gloves may delay or prevent lock operation. Remove the gloves and touch the lock sensor again.
- When the lock operation is performed using the lock sensor, recognition signals will be shown up to two consecutive times. After this, no recognition signals will be given.*
- If the door handle becomes wet while the electronic key is within the effective range, the door may lock and unlock repeatedly. In this case, follow the following correction procedures to wash the vehicle:
 - Place the electronic key in a location 6 ft. (2 m) or more away from the vehicle. (Take care to ensure that the key is not stolen.)
 - Set the electronic key to battery-saving mode to disable the smart key system. (→P. 150)
- If the electronic key is inside the vehicle and a door handle becomes wet during a car wash, a message may be shown on the multi-information display and a buzzer will sound outside the vehicle. To turn off the alarm, lock all the doors.

- The lock sensor may not work properly if it comes into contact with ice, snow, mud, etc. Clean the lock sensor and attempt to operate it again.
- A sudden approach to the effective range of door handle may prevent the doors from being unlocked. In this case, return the door handle to the original position and check that the doors unlock before pulling the door handle again.
- If there is another electronic key in the detection area, it may take slightly longer to unlock the doors after the door handle is gripped.
- Fingernails may scrape against the door during operation of the door handle. Be careful not to injure fingernails or damage the surface of the door.

*: This setting can be customized at your Toyota dealer.

■ When the vehicle is not driven for extended periods

- To prevent theft of the vehicle, do not leave the electronic key within 6 ft. (2 m) of the vehicle.
- The smart key system can be deactivated in advance. (→P. 526)
- Setting the electronic key to battery-saving mode helps to reduce key battery depletion. (→P. 150)

■ To operate the system properly

Make sure to carry the electronic key when operating the system. Do not get the electronic key too close to the vehicle when operating the system from the outside of the vehicle.

Depending on the position and holding condition of the electronic key, the key may not be detected correctly and the system may not operate properly. (The alarm may go off accidentally, or the door lock prevention function may not operate.)

■ If the smart key system does not operate properly

- Locking and unlocking the doors and opening the trunk:
Use the mechanical key. (→P. 484)
- Starting the hybrid system: →P. 485

■ Customization

Some functions can be customized. (→P. 526)

■ If the smart key system has been deactivated in a customized setting

- Locking and unlocking the doors and opening the trunk:
Use the wireless remote control or mechanical key. (→P. 138, 145, 484)
- Starting the hybrid system and changing power switch modes: →P. 485
- Stopping the hybrid system: →P. 196

■ Certification for the smart key system

FCC ID: HYQ23ABL
FCC ID: HYQ14FBC

NOTE:

This device complies with part 15 of the FCC Rules. Operation is subject to the following two conditions: (1) This device may not cause harmful interference, and (2) this device must accept any interference received, including interference that may cause undesired operation.

FCC WARNING:

Changes or modifications not expressly approved by the party responsible for compliance could void the user's authority to operate the equipment.

**WARNING****■ Caution regarding interference with electronic devices**

- People with implantable cardiac pacemakers, cardiac resynchronization therapy-pacemakers or implantable cardioverter defibrillators should keep away from the smart key system antennas. (→P. 148)

The radio waves may affect the operation of such devices. If necessary, the entry function can be disabled. Ask your Toyota dealer for details, such as the frequency of radio waves and timing of the emitted radio waves. Then, consult your doctor to see if you should disable the entry function.

- Users of any electrical medical device other than implantable cardiac pacemakers, cardiac resynchronization therapy-pacemakers or implantable cardioverter defibrillators should consult the manufacturer of the device for information about its operation under the influence of radio waves.

Radio waves could have unexpected effects on the operation of such medical devices.

Ask your Toyota dealer for details for disabling the entry function.

Front seats

Adjustment procedure

- ① Seat position adjustment switch
- ② Seatback angle adjustment switch
- ③ Seat cushion (front) angle adjustment switch
- ④ Vertical height adjustment switch
- ⑤ Lumbar support firmness adjustment switch (if equipped)
- ⑥ Lumbar support height adjustment switch (if equipped)

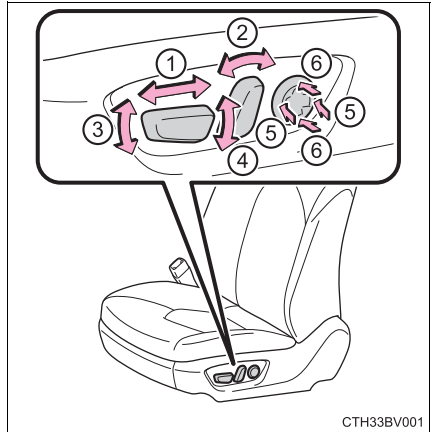

■ Power easy access system (vehicles with driving position memory)

The driver's seat and steering wheel move in accordance with power switch mode and the driver's seat belt condition. (→P. 159)

**WARNING****■ When adjusting the seat position**

- Take care when adjusting the seat position to ensure that other passengers are not injured by the moving seat.
- Do not put your hands under the seat or near the moving parts to avoid injury.
Fingers or hands may become jammed in the seat mechanism.
- Make sure to leave enough space around the feet so they do not get stuck.

■ Seat adjustment

- Be careful that the seat does not hit passengers or luggage.
- To reduce the risk of sliding under the lap belt during a collision, do not recline the seat more than necessary.
If the seat is too reclined, the lap belt may slide past the hips and apply restraint forces directly to the abdomen, or your neck may contact the shoulder belt, increasing the risk of death or serious injury in the event of an accident.
Adjustments should not be made while driving as the seat may unexpectedly move and cause the driver to lose control of the vehicle.

**NOTICE****■ When adjusting a front seat**

When adjusting a front seat, make sure that the head restraint does not contact the headliner. Otherwise, the head restraint and headliner may be damaged.

Rear seats

The seatbacks of the rear seats can be folded down.

Folding down the rear seatbacks

Pull the seatback lever in the trunk for the seatback you wish to fold down and then fold the seatback down.

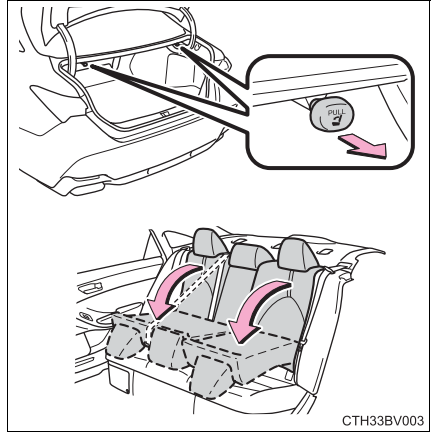

**WARNING****■ When folding the seatbacks down**

Observe the following precautions. Failure to do so may result in death or serious injury.

- Do not fold the seatbacks down while driving.
- Stop the vehicle on level ground, set the parking brake and shift the shift lever to P.
- Do not allow anyone to sit on a folded seatback or in the trunk while driving.
- Do not allow children to enter the trunk.

■ When returning the seat to its original position

- Ensure that the seat belt does not get caught between or behind the seats.
- If the seat belt has been released from its guide, pass the seat belt through its guide. (→P. 30)

■ Seat adjustment

Be careful not to get hands or feet pinched between the rear console box and the rear seat when folding down the rear seatback.

■ After returning the seatback to the upright position

Observe the following precautions. Failure to do so may result in death or serious injury.

- Make sure the seatback is securely locked by pressing it forward and rearward on the top.
- Check that the seat belts are not twisted or caught in the seatback.
- Make sure that the seat belt is passed through its guide.

**NOTICE****■ When the right seatback is folded down**

Make sure the luggage loaded in the enlarged trunk will not damage the webbing of the rear center seat belt.

Driving position memory*

This feature automatically adjusts the driver's seat, steering wheel and outside rear view mirrors to make entering and exiting the vehicle easier or to suit your preferences.

Power easy access system

The seat and steering wheel are automatically adjusted to allow the driver to enter and exit the vehicle easily.

When all of the following have been performed, the driver's seat and steering wheel are automatically adjusted to a position that allows driver to enter and exit the vehicle easily.

- The shift lever has been shifted to P.
- The power switch has been turned off.
- The driver's seat belt has been unfastened.

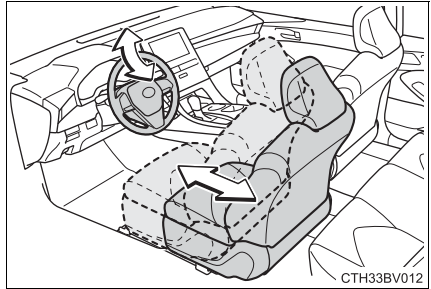

When any of the following has been performed, the driver's seat and steering wheel automatically return to their original positions.

- The power switch has been turned to ACCESSORY mode or ON mode.
- The driver's seat belt has been fastened.

■ Operation of the power easy access system

When exiting the vehicle, the power easy access system may not operate if the seat is already close to the rearmost position, etc.

■ Customization

Some functions can be customized. (→P. 526)

Driving position memory

Your preferred driving position (the position of the driver's seat, steering wheel and outside rear view mirrors) can be recorded and recalled by pressing a button.

Two different driving positions can be recorded into memory.

■ Recording procedure

- 1 Check that the shift lever is in P.
- 2 Turn the power switch to ON mode.
- 3 Adjust the driver's seat, steering wheel, and outside rear view mirrors to the desired positions.
- 4 While pressing the "SET" button, or within 3 seconds after the "SET" button is pressed, press button "1" or "2" until the buzzer sounds.

If the selected button has already been preset, the previously recorded position will be overwritten.

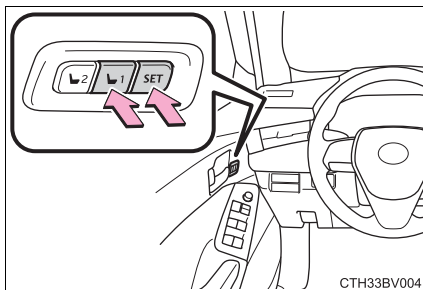

■ Recall procedure

- 1 Check that the shift lever is in P.
- 2 Turn the power switch to ON mode.
- 3 Press one of the buttons for the driving position you want to recall until the buzzer sounds.

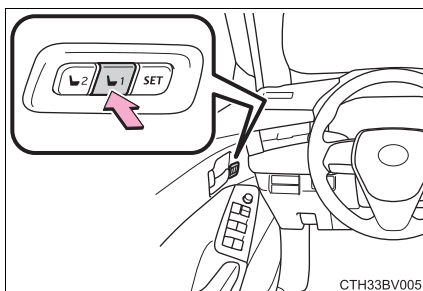

■ To stop the position recall operation part-way through

Perform any of the following operations:

- Press the "SET" button.
- Press button "1" or "2".
- Operate any of the seat adjustment switches (only cancels seat position recall).
- Operate the tilt and telescopic steering control switch (only cancels steering wheel position recall).

■ Seat positions that can be memorized (→P. 155)

The adjusted positions other than the position adjusted by lumbar support switch can be recorded.

■ Operating the driving position memory after turning the power switch off

Recorded seat positions can be activated up to 180 seconds after the driver's door is opened and another 60 seconds after it is closed again.

■ In order to correctly use the driving position memory function

If a seat position is already in the furthest possible position and the seat is operated in the same direction, the recorded position may be slightly different when it is recalled.

Memory recall function

Each electronic key can be registered to recall your preferred driving position.

■ Registering procedure

Record your driving position to button 1 or 2 before performing the following:

Carry only the key you want to register, and then close the driver's door.

If 2 or more keys are in the vehicle, the driving position cannot be recorded properly.

- 1 Check that the shift lever is in P.
- 2 Turn the power switch to ON mode.
- 3 Recall the driving position that you want to record.
- 4 While pressing the recalled button, press and hold the door lock switch (either lock or unlock) until the buzzer sounds.

If the button could not be registered, the buzzer sounds continuously for approximately 3 seconds.

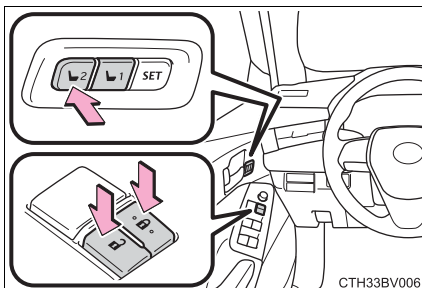

CTH333BV006

■ Recall procedure

- 1 Make sure that the doors are locked before recalling the driving position. Carry the electronic key that has been registered to the driving position, and then unlock and open the driver's door using the smart key system or wireless remote control.

The driving position will move to the recorded position (not including the steering wheel).

If the driving position is in a position that has already been recorded, the seat and outside rear view mirrors will not move.

- 2 Turn the power switch to ACCESSORY mode or ON mode.

The seat and steering wheel will move to the recorded position.

■ Cancellation procedure

Carry only the key you want to cancel and then close the driver's door.

If 2 or more keys are in the vehicle, the driving position cannot be canceled properly.

- 1 Turn the power switch to ON mode.
- 2 While pressing the "SET" button, press and hold the door lock switch (either lock or unlock) until the buzzer sounds twice.

If it button could not be canceled, the buzzer sounds continuously for approximately 3 seconds.

■ Recalling the driving position using the memory recall function

- Different driving positions can be registered for each electronic key. Therefore, the driving position that is recalled may be different depending on the key being carried.
- If a door other than the driver's door is unlocked with the smart key system, the driving position cannot be recalled. In this case, press the driving position button which has been set.

■ Customization

Some functions can be customized. (→P. 526)

WARNING

■ Seat adjustment caution

Take care during seat adjustment so that the seat does not strike the rear passenger or squeeze your body against the steering wheel.

Head restraints

Head restraints are provided for all seats.

► Front seats and rear outboard seats

① Up

Pull the head restraint up.

② Down

Push the head restraint down while pressing the lock release button.

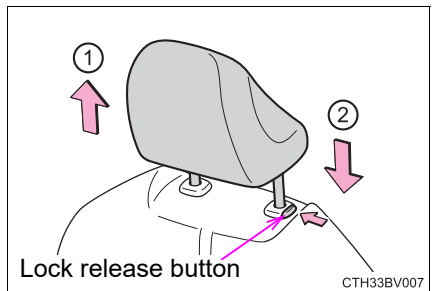

► Rear center seat

Head restraints cannot be adjusted or removed.

■ Removing the head restraints

Pull the head restraint up while pressing the lock release button.

If the head restraint touches the ceiling, making the removal difficult, change the seat back angle or, if possible, the seat height. (→P. 155, 157)

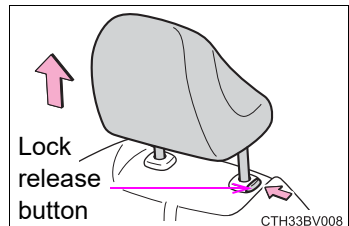

■ Installing the head restraints

▶ Front seats

Align the head restraint with the installation holes and push it down to the lock position.

Press and hold the lock release button when lowering the head restraint.

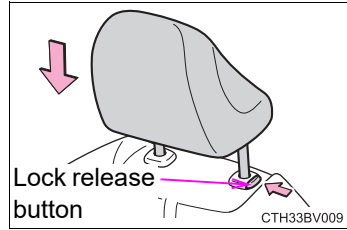

▶ Rear outboard seats

Align the head restraint with the installation holes and push it down to the lowest lock position while pressing the lock release button.

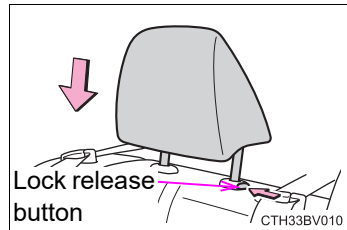

■ Adjusting the height of the head restraints

Make sure that the head restraints are adjusted so that the center of the head restraint is closest to the top of your ears.

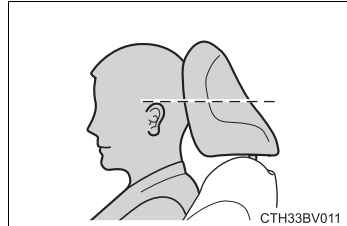

⚠ WARNING

■ Head restraint precautions

Observe the following precautions regarding the head restraints. Failure to do so may result in death or serious injury.

- Use the head restraints designed for each respective seat.
- Adjust the head restraints to the correct position at all times.
- After adjusting the head restraints, push down on them and make sure they are locked in position.
- Do not drive with the head restraints removed.
(However, if a head restraint interferes with installation of a child restraint system, the head restraint can be removed to accommodate the child restraint system: →P. 54)

Steering wheel

Adjustment procedure

► Manual type

- 1 Hold the steering wheel and push the lever down.

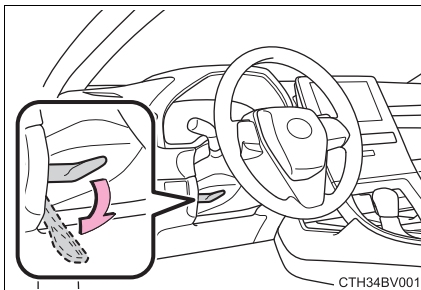

- 2 Adjust to the ideal position by moving the steering wheel horizontally and vertically. After adjustment, pull the lever up to secure the steering wheel.

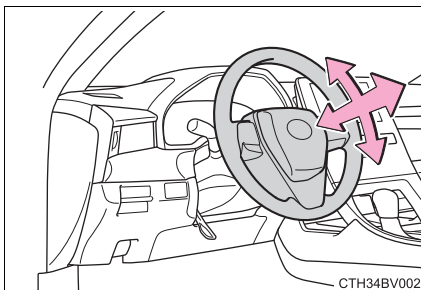

► Power type

Operating the switch moves the steering wheel in the following directions:

- 1 Up
- 2 Down
- 3 Toward the driver
- 4 Away from the driver

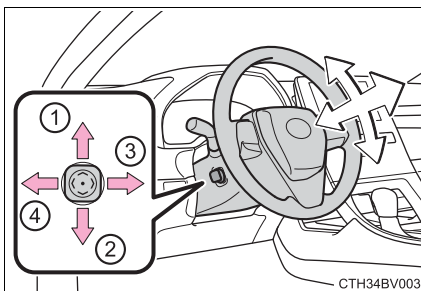

Horn

To sound the horn, press on or close to the  mark.

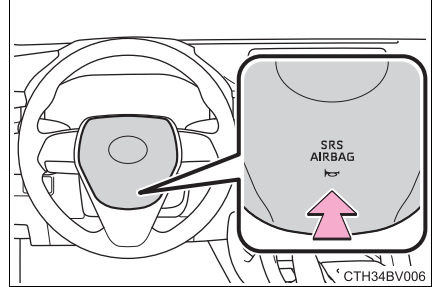

■ The steering wheel can be adjusted when (power type)

The power switch is in ACCESSORY or ON mode.

■ Automatic adjustment of the steering position (vehicles with driving position memory)

A desired steering position can be entered to memory and recalled automatically by the driving position memory system. (→P. 159)

■ Power easy access system (vehicles with driving position memory)

The steering wheel and driver's seat move in accordance with power switch mode and the driver's seat belt condition. (→P. 159)

WARNING

■ Caution while driving

Do not adjust the steering wheel while driving.

Doing so may cause the driver to mishandle the vehicle and cause an accident, resulting in death or serious injury.

■ After adjusting the steering wheel (manual type)

Make sure that the steering wheel is securely locked.

Otherwise, the steering wheel may move suddenly, possibly causing an accident, and resulting in death or serious injury. Also, the horn may not sound if the steering wheel is not securely locked.

Inside rear view mirror

The rear view mirror's position can be adjusted to enable sufficient confirmation of the rear view.

Adjusting the height of rear view mirror

The height of the rear view mirror can be adjusted to suit your driving posture.

Adjust the height of the rear view mirror by moving it up and down.

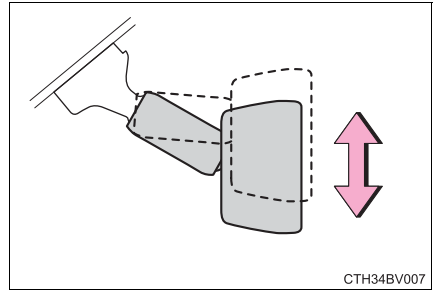

Anti-glare function

Responding to the level of brightness of the headlights of vehicles behind, the reflected light is automatically reduced.

- ▶ Vehicles with garage door opener
- ▶ Vehicles without garage door opener

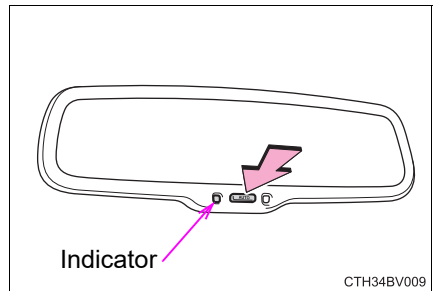
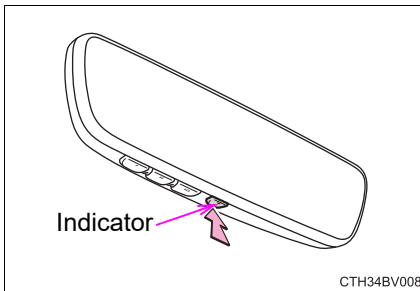

Changing automatic anti-glare function mode

On/off

When the automatic anti-glare function is in ON mode, the indicator illuminates.

The function will set to ON mode each time the power switch is turned to ON mode.

Pressing the button turns the function to OFF mode. (The indicator also turns off.)

■ To prevent sensor error

- ▶ Vehicles without garage door opener

To ensure that the sensors operate properly, do not touch or cover them.

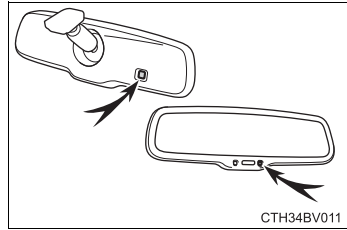

- ▶ Vehicles with garage door opener

To ensure that the sensors operate properly, do not touch or cover them.

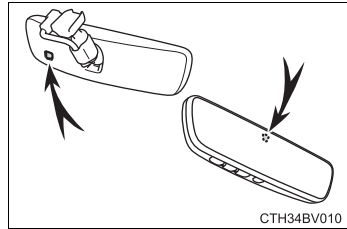
**⚠ WARNING**

Do not adjust the position of the mirror while driving. Doing so may lead to mishandling of the vehicle and cause an accident, resulting in death or serious injury.

Outside rear view mirrors

Adjustment procedure

1 To select a mirror to adjust, turn the switch.

- ① Left
- ② Right

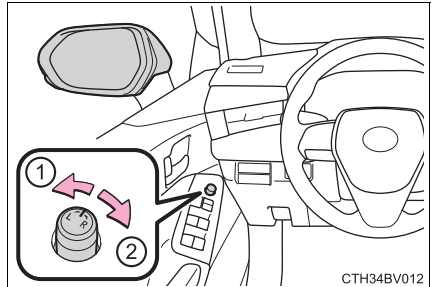

2 To adjust the mirror, operate the switch.

- ① Up
- ② Right
- ③ Down
- ④ Left

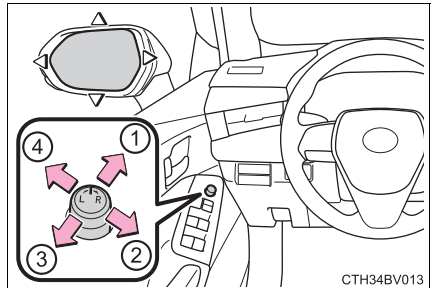

Folding the mirrors

Push the mirror back in the direction of the vehicle's rear.

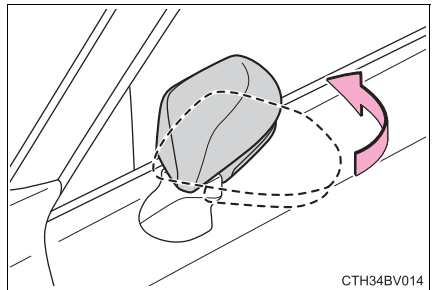

Linked mirror function when reversing (vehicles with driving position memory)

When the mirror select switch is in the “L” or “R” position, the outside rear view mirrors will automatically angle downwards when the vehicle is reversing in order to give a better view of the ground.

To disable this function, select neither “L” nor “R” of the mirror select switch.

■ Adjusting the mirror angle when the vehicle is reversing

With the shift lever in R, adjust the mirror angle at a desired position.

The adjusted angle will be memorized and the mirror will automatically tilt to the memorized angle whenever the shift lever is shifted to R from next time.

The memorized downward tilt position of the mirror is linked to the normal position (angle adjusted with the shift lever in other than R). Therefore, if the normal position is changed after adjustment, the tilt position will also change.

When the normal position is changed, readjust the angle in reversing.

■ Mirror angle can be adjusted when

The power switch is in ACCESSORY or ON mode.

■ When the mirrors are fogged up

The outside rear view mirrors can be cleared using the mirror defoggers. Turn on the rear window defogger to turn on the outside rear view mirror defoggers. (→P. 343)

■ Automatic adjustment of the mirror angle (vehicles with driving position memory)

A desired mirror face angle can be entered to memory and recalled automatically by the driving position memory. (→P. 159)

■ Auto anti-glare function (driver's side only) (if equipped)

When the anti-glare inside rear view mirror is set to automatic mode, the outside rear view mirrors will activate in conjunction with the anti-glare inside rear view mirror to reduce reflected light. (→P. 168)

■ Customization

Some functions can be customized. (→P. 526)

**WARNING****■ Important points while driving**

Observe the following precautions while driving.

Failure to do so may result in loss of control of the vehicle and cause an accident, resulting in death or serious injury.

- Do not adjust the mirrors while driving.
- Do not drive with the mirrors folded.
- Both the driver and passenger side mirrors must be extended and properly adjusted before driving.

■ When a mirror is moving

To avoid personal injury and mirror malfunction, be careful not to get your hand caught by the moving mirror.

■ When the mirror defoggers are operating

Do not touch the rear view mirror surfaces, as they can become very hot and burn you.

Power windows

Opening and closing procedures

The power windows can be opened and closed using the switches. Operating the switch moves the windows as follows:

- ① Closing
- ② One-touch closing*
- ③ Opening
- ④ One-touch opening*

*: To stop the window partway, operate the switch in the opposite direction.

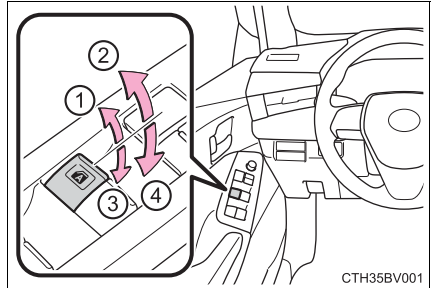

Window lock switch

Press the switch to lock the passenger window switches.

Use this switch to prevent children from accidentally opening or closing a passenger window.

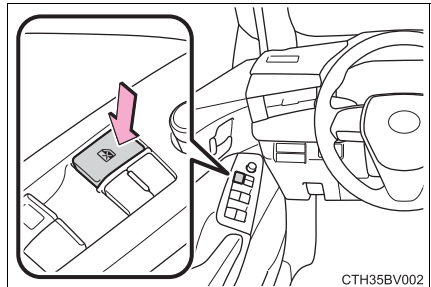

■ The power windows can be operated when

The power switch is in ON mode.

■ Operating the power windows after turning the hybrid system off

The power windows can be operated for approximately 45 seconds even after the power switch is turned to ACCESSORY mode or turned off. They cannot, however, be operated once either front door is opened.

■ Jam protection function

If an object becomes jammed between the window and the window frame while the window is closing, window movement is stopped and the window is opened slightly.

■ Catch protection function

If an object becomes caught between the door and window while the window is opening, window movement is stopped.

■ When the window cannot be opened or closed

When the jam protection function or catch protection function operates unusually and the door window cannot be opened or closed, perform the following operations with the power window switch of that door.

- Stop the vehicle. With the power switch in ON mode, within 4 seconds of the jam protection function or catch protection function activating, continuously operate the power window switch in the one-touch closing direction or one-touch opening direction so that the door window can be opened and closed.
- If the door window cannot be opened and closed even when performing the above operations, perform the following procedure for function initialization.

- 1 Turn the power switch to ON mode.
- 2 Pull and hold the power window switch in the one-touch closing direction and completely close the door window.
- 3 Release the power window switch for a moment, resume pulling the switch in the one-touch closing direction, and hold it there for approximately 6 seconds or more.
- 4 Press and hold the power window switch in the one-touch opening direction. After the door window is completely opened, continue holding the switch for an additional 1 second or more.
- 5 Release the power window switch for a moment, resume pushing the switch in the one-touch opening direction, and hold it there for approximately 4 seconds or more.
- 6 Pull and hold the power window switch in the one-touch closing direction again. After the door window is completely closed, continue holding the switch for a further 1 second or more.

If you release the switch while the window is moving, start again from the beginning.

If the window reverses and cannot be fully closed or opened, have the vehicle inspected by your Toyota dealer.

■ Door lock linked window operation

- The power windows can be opened and closed using the mechanical key.* (→P. 484)
- The power windows can be opened using the wireless remote control.* (→P. 138)

*: These settings must be customized at your Toyota dealer.

■ Alarm

The alarm may be triggered if the alarm is set and a power window is closed using the door lock linked power window operation function. (→P. 88)

■ Power windows open warning buzzer

A buzzer sounds and a message is shown on the multi-information display in the instrument cluster when the power switch is turned off and the driver's door is opened with the power windows open.

■ Customization

Some functions can be customized. (→P. 526)

⚠ WARNING

Observe the following precautions.
Failing to do so may result in death or serious injury.

■ Opening and closing the windows

- The driver is responsible for all the power window operations, including the operation for the passengers. In order to prevent accidental operation, especially by a child, do not let a child operate the power windows. It is possible for children and other passengers to have body parts caught in the power window. Also, when riding with a child, it is recommended to use the window lock switch. (→P. 173)
- Check to make sure that all passengers do not have any part of their body in a position where it could be caught when a window is being operated.

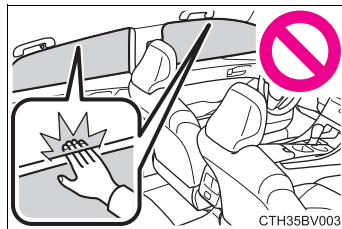

- When using the wireless remote control or mechanical key and operating the power windows, operate the power window after checking to make sure that there is no possibility of any passenger having any of their body parts caught in the window. Also do not let a child operate window by the wireless remote control or mechanical key. It is possible for children and other passengers to get caught in the power window.
- When exiting the vehicle, turn the power switch off, carry the key and exit the vehicle along with the child. There may be accidental operation, due to mischief, etc., that may possibly lead to an accident.

■ Jam protection function

- Never use any part of your body to intentionally activate the jam protection function.
- The jam protection function may not work if something gets jammed just before the window is fully closed. Be careful not to get any part of your body jammed in the window.

■ Catch protection function

- Never use any part of your body or clothing to intentionally activate the catch protection function.
- The catch protection function may not work if something gets caught just before the window is fully opened. Be careful not to get any part of your body or clothing caught in the window.

Moon roof*

Use the overhead switches to open and close the moon roof and tilt it up and down.

Opening and closing

① Opens the moon roof*

The moon roof stops slightly before the fully open position to reduce wind noise.

Press the switch again to fully open the moon roof.

② Closes the moon roof*

*: Lightly press either side of the moon roof switch to stop the moon roof partway.

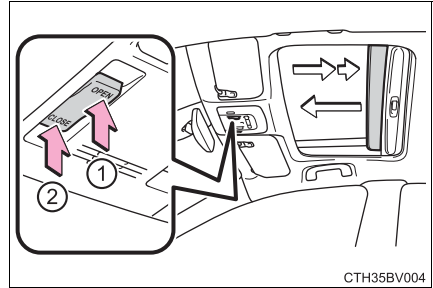

CTH35BV004

Tilting up and down

① Tilts the moon roof up*

② Tilts the moon roof down*

*: Lightly press either side of the moon roof switch to stop the moon roof partway.

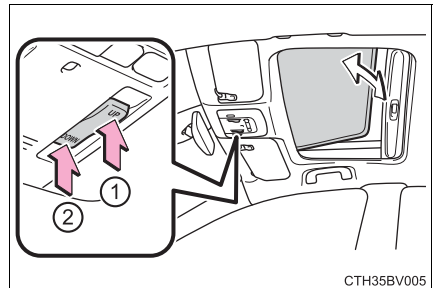

CTH35BV005

■ The moon roof can be operated when

The power switch is in ON mode.

■ Operating the moon roof after turning the hybrid system off

The moon roof can be operated for approximately 45 seconds after the power switch is turned to ACCESSORY mode or turned off. It cannot, however, be operated once either front door is opened.

■ Jam protection function

If an object is detected between the moon roof and the frame while the moon roof is closing or tilting down, travel is stopped and the moon roof opens slightly.

■ Sunshade

The sunshade can be opened and closed manually. However, the sunshade will open automatically when the moon roof is opened.

■ Door lock linked moon roof operation

- The moon roof can be opened and closed using the mechanical key.*
(→P. 484)
- The moon roof can be opened using the wireless remote control.*
(→P. 138)

*: These settings must be customized at your Toyota dealer.

■ When the moon roof does not close normally

Perform the following procedure:

- If the moon roof closes but then re-opens slightly

- 1 Stop the vehicle.
- 2 Press and hold the “CLOSE” switch.*1
The moon roof will close, reopen and pause for approximately 10 seconds.*2 Then it will close again, tilt up and pause for approximately 1 second. Finally, it will tilt down, open and close.
- 3 Check to make sure that the moon roof is completely closed and then release the switch.

- If the moon roof tilts down but then tilts back up

- 1 Stop the vehicle.
- 2 Press and hold the “UP” switch*1 until the moon roof moves into the tilt up position and stops.
- 3 Release the “UP” switch once and then press and hold the “UP” switch again.*1
The moon roof will pause for approximately 10 seconds in the tilt up position.*2 Then it will adjust slightly and pause for approximately 1 second. Finally, it will tilt down, open and close.
- 4 Check to make sure that the moon roof is completely closed and then release the switch.

*1: If the switch is released at the incorrect time, the procedure will have to be performed again from the beginning.

*2: If the switch is released after the above mentioned 10 second pause, automatic operation will be disabled. In that case, press and hold the “CLOSE” or “UP” switch, and the moon roof will tilt up and pause for approximately 1 second. Then it will tilt down, open and close. Check to make sure that the moon roof is completely closed and then release the switch.

If the moon roof does not fully close even after performing the above procedure correctly, have the vehicle inspected by your Toyota dealer.

■ Alarm

The alarm may be triggered if the alarm is set and the moon roof is closed using the door lock linked moon roof operation function. (→P. 88)

■ Moon roof open warning buzzer

A buzzer sounds and a message is shown on the multi-information display in the instrument cluster when the power switch is turned off and the driver's door is opened with the moon roof open.

■ Customization

Some functions can be customized. (→P. 526)

⚠ WARNING

Observe the following precautions.

Failing to do so may cause death or serious injury.

■ Opening the moon roof

- Do not allow any passengers to put their hands or heads outside the vehicle while it is moving.
- Do not sit on top of the moon roof.

■ Opening and closing the moon roof

- The driver is responsible for moon roof opening and closing operations. In order to prevent accidental operation, especially by a child, do not let a child operate the moon roof. It is possible for children and other passengers to have body parts caught in the moon roof.

- Check to make sure that all passengers do not have any part of their body in a position where it could be caught when the moon roof is being operated.

- When using the wireless remote control or mechanical key and operating the moon roof, operate the moon roof after checking to make sure that there is no possibility of any passenger having any of their body parts caught in the moon roof. Also, do not let a child operate moon roof by the wireless remote control or mechanical key. It is possible for children and other passengers to get caught in the moon roof.

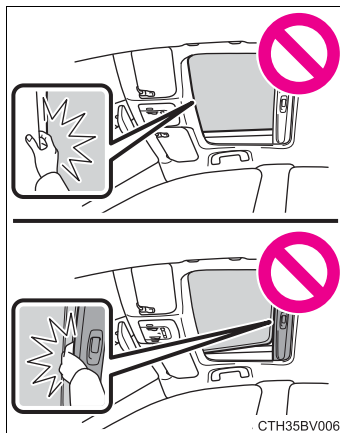

- When exiting the vehicle, turn the power switch off, carry the key and exit the vehicle along with the child. There may be accidental operation, due to mischief, etc., that may possibly lead to an accident.

■ Jam protection function

- Never use any part of your body to intentionally activate the jam protection function.
- The jam protection function may not work if something gets caught just before the moon roof is fully closed. Also, the jam protection function is not designed to operate while the switch is being pressed. Take care so that your fingers, etc. do not get caught.

Driving

4

- 4-1. Before driving**
 - Driving the vehicle..... 182
 - Cargo and luggage 190
 - Vehicle load limits 193
 - Trailer towing..... 194
 - Dinghy towing 195
- 4-2. Driving procedures**
 - Power (ignition) switch 196
 - EV drive mode 202
 - Hybrid transmission..... 205
 - Turn signal lever..... 211
 - Parking brake 212
 - Brake Hold 216
- 4-3. Operating the lights and wipers**
 - Headlight switch..... 218
 - Automatic High Beam 222
 - Windshield wipers and washer 226
- 4-4. Refueling**
 - Opening the fuel tank cap 230
- 4-5. Using the driving support systems**
 - Toyota Safety Sense P 235
 - PCS (Pre-Collision System) 242
 - LDA (Lane Departure Alert with steering control)..... 252
 - Dynamic radar cruise control with full-speed range..... 263
 - BSM (Blind Spot Monitor) 276
 - BSM function 280
 - RCTA function 283
 - Rear Camera Detection function 288
 - Intuitive parking assist..... 292
 - Intelligent Clearance Sonar (ICS)..... 300
 - Driving mode select switches 321
 - Driving assist systems 323
- 4-6. Driving tips**
 - Hybrid vehicle driving tips 330
 - Winter driving tips 333

Driving the vehicle

The following procedures should be observed to ensure safe driving:

Starting the hybrid system

→P. 196

Driving

- 1 With the brake pedal depressed, shift the shift lever to D. (→P. 205)
- 2 Release the parking brake. (→P. 212)
- 3 Gradually release the brake pedal and gently depress the accelerator pedal to accelerate the vehicle.

Stopping

- 1 With the shift lever in D, depress the brake pedal.
- 2 If necessary, set the parking brake.
If the vehicle is to be stopped for an extended period of time, shift the shift lever to P. (→P. 205)

Parking the vehicle

- 1 With the shift lever in D, depress the brake pedal.
- 2 Set the parking brake (→P. 212), and shift the shift lever to P (→P. 205).
- 3 Press the power switch to stop the hybrid system.
- 4 Lock the door, making sure that you have the key on your person.
If parking on a hill, block the wheels as needed.

Starting off on a steep uphill

- 1 Make sure that the parking brake is set and shift the shift lever to D.
- 2 Gently depress the accelerator pedal.
- 3 Release the parking brake.

■ When starting off on an uphill

The hill-start assist control will activate. (→P. 323)

■ For fuel-efficient driving

Keep in mind that hybrid vehicles are similar to conventional vehicles, and it is necessary to refrain from activities such as sudden acceleration. (→P. 330)

■ Coasting (Auto Glide Control)

When Eco drive mode is selected, under certain conditions, Auto Glide Control will operate automatically and allow the vehicle coast, enhancing fuel economy. (→P. 322)

■ Driving in the rain

- Drive carefully when it is raining, because visibility will be reduced, the windows may become fogged-up, and the road will be slippery.
- Drive carefully when it starts to rain, because the road surface will be especially slippery.
- Refrain from high speeds when driving on an expressway in the rain, because there may be a layer of water between the tires and the road surface, preventing the steering and brakes from operating properly.

■ Restraining hybrid system output (Brake Override System)

- When the accelerator and brake pedals are depressed at the same time, the hybrid system output may be restrained.
- A warning message is displayed on the multi-information display while the system is operating.

■ ECO Accelerator Guidance (→P. 109)

Eco-friendly driving may be achieved more easily by staying within the zone of Eco acceleration. Also, by staying within the zone of Eco acceleration, it will be easier to obtain a good Eco score.

- When starting off:

Gradually depress the accelerator pedal to stay within the zone of Eco acceleration and accelerate to the desired speed. By refraining from excessive acceleration, a good eco start score will be obtained.

- When driving:

After accelerating to the desired speed, release the accelerator pedal and drive at a stable speed while staying within the zone of Eco acceleration. By staying within the zone of Eco acceleration, a good eco cruise score will be obtained.

- When stopping:

By starting to release the accelerator pedal early before decelerating, a good eco stop score will be obtained.

■ Restraining sudden start (Drive-Start Control)

- When the following unusual operation is performed, the hybrid system output may be restrained.
 - When the shift lever is shifted from R to D, D to R, N to R, P to D^{*}, or P to R^{*} (D includes S) with the accelerator pedal depressed, a warning message appears on the multi-information display.
 - When the accelerator pedal is depressed too much while the vehicle is in reverse.
- *: Depending on the situation, the shift position may not be changed.
- While Drive-Start Control is being activated, your vehicle may have trouble escaping from the mud or fresh snow. In such case, deactivate TRAC (→P. 324) to cancel Drive-Start Control so that the vehicle may become able to escape from the mud or fresh snow.

■ Breaking in your new Toyota

To extend the life of the vehicle, observing the following precautions is recommended:

- For the first 186 miles (300 km):
Avoid sudden stops.
- For the first 621 miles (1000 km):
 - Do not drive at extremely high speeds.
 - Avoid sudden acceleration.
 - Do not drive continuously in low gears.
 - Do not drive at a constant speed for extended periods.

■ Operating your vehicle in a foreign country

Comply with the relevant vehicle registration laws and confirm the availability of the correct fuel. (→P. 504)

■ Eco-friendly driving

→P. 100, 124

**WARNING**

Observe the following precautions.

Failure to do so may result in death or serious injury.

■ When starting the vehicle

Always keep your foot on the brake pedal while stopped with the “READY” indicator is illuminated. This prevents the vehicle from creeping.

■ When driving the vehicle

- Do not drive if you are unfamiliar with the location of the brake and accelerator pedals to avoid depressing the wrong pedal.
 - Accidentally depressing the accelerator pedal instead of the brake pedal will result in sudden acceleration that may lead to an accident.
 - When backing up, you may twist your body around, leading to a difficulty in operating the pedals. Make sure to operate the pedals properly.
 - Make sure to keep a correct driving posture even when moving the vehicle only slightly. This allows you to depress the brake and accelerator pedals properly.
 - Depress the brake pedal using your right foot. Depressing the brake pedal using your left foot may delay response in an emergency, resulting in an accident.
- The driver should pay extra attention to pedestrians when the vehicle is powered only by the electric motor (traction motor). As there is no engine noise, the pedestrians may misjudge the vehicle’s movement.
- Do not drive the vehicle over or stop the vehicle near flammable materials. The exhaust system and exhaust gases can be extremely hot. These hot parts may cause a fire if there is any flammable material nearby.
- During normal driving, do not turn off the hybrid system. Turning the hybrid system off while driving will not cause loss of steering or braking control, however, power assist to the steering will be lost. This will make it more difficult to steer smoothly, so you should pull over and stop the vehicle as soon as it is safe to do so.
In the event of an emergency, such as if it becomes impossible to stop the vehicle in the normal way: →P. 449
- Use engine braking (downshift) to maintain a safe speed when driving down a steep hill.
Using the brakes continuously may cause the brakes to overheat and lose effectiveness. (→P. 206)
- Do not adjust the display, the positions of the steering wheel, the seat, or the inside or outside rear view mirrors while driving.
Doing so may result in a loss of vehicle control.
- Always check that all passengers’ arms, heads or other parts of their body are not outside the vehicle.

**WARNING**

Observe the following precautions.

Failure to do so may result in death or serious injury.

■ When driving the vehicle

- Do not drive in excess of the speed limit. Even if the legal speed limit permits it, do not drive over 85 mph (140 km/h) unless your vehicle has high-speed capability tires. Driving over 85 mph (140 km/h) may result in tire failure, loss of control and possible injury. Be sure to consult a tire dealer to determine whether the tires on your vehicle are high-speed capability tires or not before driving at such speeds.

■ When driving on slippery road surfaces

- Sudden braking, acceleration and steering may cause tire slippage and reduce your ability to control the vehicle.
- Sudden acceleration, engine braking due to shifting, or changes in engine speed could cause the vehicle to skid.
- After driving through a puddle, lightly depress the brake pedal to make sure that the brakes are functioning properly. Wet brake pads may prevent the brakes from functioning properly. If the brakes on only one side are wet and not functioning properly, steering control may be affected.

■ When shifting the shift lever

- Do not let the vehicle roll backward while the shift lever is in a driving position, or roll forward while the shift lever is in R.
Doing so may result in an accident or damage to the vehicle.
- Do not shift the shift lever to P while the vehicle is moving.
Doing so can damage the transmission and may result in a loss of vehicle control.
- Do not shift the shift lever to R while the vehicle is moving forward.
Doing so can damage the transmission and may result in a loss of vehicle control.
- Do not shift the shift lever to a driving position while the vehicle is moving backward.
Doing so can damage the transmission and may result in a loss of vehicle control.
- Shifting the shift lever to N while the vehicle is moving will disengage the hybrid system. Engine braking is not available when N is selected.
- Be careful not to shift the shift lever with the accelerator pedal depressed. Shifting the shift lever to any position other than P or N may lead to unexpected rapid acceleration of the vehicle that may cause an accident and result in death or serious injury.

**WARNING**

Observe the following precautions.

Failure to do so may result in death or serious injury.

■ If you hear a squealing or scraping noise (brake pad wear limit indicators)

Have the brake pads checked and replaced by your Toyota dealer as soon as possible.

Rotor damage may result if the pads are not replaced when needed.

It is dangerous to drive the vehicle when the wear limits of the brake pads and/or those of the brake discs are exceeded.

■ When the vehicle is stopped

- Do not depress the accelerator pedal unnecessarily.

If the shift lever is in any position other than P or N, the vehicle may accelerate suddenly and unexpectedly, causing an accident.

- In order to prevent accidents due to the vehicle rolling away, always keep depressing the brake pedal while stopped with the "READY" indicator is illuminated, and apply the parking brake as necessary.

- If the vehicle is stopped on an incline, in order to prevent accidents caused by the vehicle rolling forward or backward, always depress the brake pedal and securely apply the parking brake as needed.

- Avoid revving or racing the engine.

Running the engine at high speed while the vehicle is stopped may cause the exhaust system to overheat, which could result in a fire if combustible material is nearby.

■ When the vehicle is parked

- Do not leave glasses, cigarette lighters, spray cans, or soft drink cans in the vehicle when it is in the sun.

Doing so may result in the following:

- Gas may leak from a cigarette lighter or spray can, and may lead to a fire.
- The temperature inside the vehicle may cause the plastic lenses and plastic material of glasses to deform or crack.
- Soft drink cans may fracture, causing the contents to spray over the interior of the vehicle, and may also cause a short circuit in the vehicle's electrical components.
- Do not leave cigarette lighters in the vehicle. If a cigarette lighter is in a place such as the glove box or on the floor, it may be lit accidentally when luggage is loaded or the seat is adjusted, causing a fire.
- Do not attach adhesive discs to the windshield or windows. Do not place containers such as air fresheners on the instrument panel or dashboard. Adhesive discs or containers may act as lenses, causing a fire in the vehicle.

 **WARNING**

Observe the following precautions.

Failure to do so may result in death or serious injury.

■ **When the vehicle is parked**

- Do not leave a door or window open if the curved glass is coated with a metallized film such as a silver-colored one. Reflected sunlight may cause the glass to act as a lens, causing a fire.
- Always apply the parking brake, shift the shift lever to P, stop the hybrid system and lock the vehicle.
Do not leave the vehicle unattended while the “READY” indicator is illuminated.
If the vehicle is parked with the shift lever in P but the parking brake is not set, the vehicle may start to move, possibly leading to an accident.
- Do not touch the exhaust pipes while the “READY” indicator is illuminated or immediately after turning the hybrid system off.
Doing so may cause burns.

■ **When taking a nap in the vehicle**

Always turn the hybrid system off. Otherwise, if you accidentally move the shift lever or depress the accelerator pedal, this could cause an accident or fire due to hybrid system overheating. Additionally, if the vehicle is parked in a poorly ventilated area, exhaust gases may collect and enter the vehicle, leading to death or a serious health hazard.

■ **When braking**

- When the brakes are wet, drive more cautiously.
Braking distance increases when the brakes are wet, and this may cause one side of the vehicle to brake differently than the other side. Also, the parking brake may not securely hold the vehicle.
- If the electronically controlled brake system does not operate, do not follow other vehicles closely and avoid hills or sharp turns that require braking.
In this case, braking is still possible, but the brake pedal should be depressed more firmly than usual. Also, the braking distance will increase. Have your brakes fixed immediately.
- The brake system consists of 2 or more individual hydraulic systems; if one of the systems fails, the other(s) will still operate. In this case, the brake pedal should be depressed more firmly than usual and the braking distance will increase. Have your brakes fixed immediately.

**NOTICE****When driving the vehicle**

- Do not depress the accelerator and brake pedals at the same time during driving, as this may restrain the hybrid system output.
- Do not use the accelerator pedal or depress the accelerator and brake pedals at the same time to hold the vehicle on a hill.

When parking the vehicle

Always set the parking brake and shift the shift lever to P. Failure to do so may cause the vehicle to move or the vehicle may accelerate suddenly if the accelerator pedal is accidentally depressed.

Avoiding damage to vehicle parts

- Do not turn the steering wheel fully in either direction and hold it there for an extended period of time.
Doing so may damage the power steering motor.
- When driving over bumps in the road, drive as slowly as possible to avoid damaging the wheels, underside of the vehicle, etc.

If you get a flat tire while driving

A flat or damaged tire may cause the following situations. Hold the steering wheel firmly and gradually depress the brake pedal to slow down the vehicle.

- It may be difficult to control your vehicle.
- The vehicle will make abnormal sounds or vibrations.
- The vehicle will lean abnormally.

Information on what to do in case of a flat tire (→P. 471)

When encountering flooded roads

Do not drive on a road that has flooded after heavy rain etc. Doing so may cause the following serious damage to the vehicle:

- Engine stalling
- Short in electrical components
- Engine damage caused by water immersion

In the event that you drive on a flooded road and the vehicle is flooded, be sure to have your Toyota dealer check the following:

- Brake function
- Changes in quantity and quality of oil and fluid used for the engine, hybrid transmission, etc.
- Lubricant condition for the bearings and suspension joints (where possible), and the function of all joints, bearings, etc.

Cargo and luggage

Take notice of the following information about storage precautions, cargo capacity and load:

Capacity and distribution

Cargo capacity depends on the total weight of the occupants.

(Cargo capacity) = (Total load capacity) — (Total weight of occupants)

Steps for Determining Correct Load Limit —

- (1) Locate the statement “The combined weight of occupants and cargo should never exceed XXX kg or XXX lbs.” on your vehicle’s placard.
- (2) Determine the combined weight of the driver and passengers that will be riding in your vehicle.
- (3) Subtract the combined weight of the driver and passengers from XXX kg or XXX lbs.
- (4) The resulting figure equals the available amount of cargo and luggage load capacity.
For example, if the “XXX” amount equals 1400 lbs. and there will be five 150 lb passengers in your vehicle, the amount of available cargo and luggage load capacity is 650 lbs. (1400 – 750 (5 × 150) = 650 lbs.)
- (5) Determine the combined weight of luggage and cargo being loaded on the vehicle. That weight may not safely exceed the available cargo and luggage load capacity calculated in Step 4.
- (6) If your vehicle will be towing a trailer, load from your trailer will be transferred to your vehicle. Consult this manual to determine how this reduces the available cargo and luggage load capacity of your vehicle.

(→P. 193)

Toyota does not recommend towing a trailer with your vehicle. Your vehicle is not designed for trailer towing.

Calculation formula for your vehicle

- ① Cargo capacity
- ② Total load capacity (vehicle capacity weight) (→P. 502)

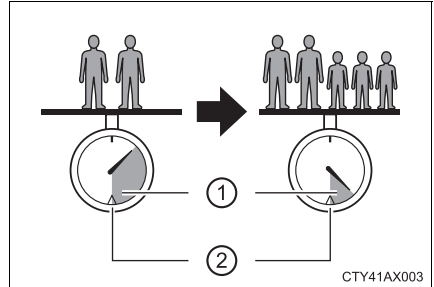

When 2 people with the combined weight of A lb. (kg) are riding in your vehicle, which has a total load capacity (vehicle capacity weight) of B lb. (kg), the available amount of cargo and luggage load capacity will be C lb. (kg) as follows:

$$B^{*2} \text{ lb. (kg)} - A^{*1} \text{ lb. (kg)} = C^{*3} \text{ lb. (kg)}$$

*1: A =Weight of people

*2: B =Total load capacity

*3: C =Available cargo and luggage load

In this condition, if 3 more passengers with the combined weight of D lb. (kg) get on, the available cargo and luggage load will be reduced E lb. (kg) as follows:

$$C \text{ lb. (kg)} - D^{*4} \text{ lb. (kg)} = E^{*5} \text{ lb. (kg)}$$

*4: D =Additional weight of people

*5: E =Available cargo and luggage load

As shown in the example above, if the number of occupants increases, the cargo and luggage load will be reduced by an amount that equals the increased weight due to the additional occupants. In other words, if an increase in the number of occupants causes an excess of the total load capacity (combined weight of occupants plus cargo and luggage load), you must reduce the cargo and luggage on your vehicle.

**WARNING****■ Things that must not be carried in the trunk**

The following things may cause a fire if loaded in the trunk:

- Receptacles containing gasoline
- Aerosol cans

■ Storage precautions

Observe the following precautions.

Failure to do so may prevent the pedals from being depressed properly, may block the driver's vision, or may result in items hitting the driver or passengers, possibly causing an accident.

- Stow cargo and luggage in the trunk whenever possible.
- To prevent cargo and luggage from sliding forward during braking, do not stack anything in the enlarged trunk. Keep cargo and luggage low, as close to the floor as possible.
- Do not place cargo or luggage in or on the following locations.
 - At the feet of the driver
 - On the front passenger or rear seats (when stacking items)
 - On the package tray
 - On the instrument panel
 - On the dashboard
 - Tray that has no lid
- Secure all items in the occupant compartment.
- When you fold down the rear seats, long items should not be placed directly behind the front seats.
- Never allow anyone to ride in the enlarged trunk. It is not designed for passengers. They should ride in their seats with their seat belts properly fastened.

■ Capacity and distribution

- Do not exceed the maximum axle weight rating or the total vehicle weight rating.
- Even if the total load of occupant's weight and the cargo load is less than the total load capacity, do not apply the load unevenly. Improper loading may cause deterioration of steering or braking control which may cause death or serious injury.

Vehicle load limits

Vehicle load limits include total load capacity, seating capacity, towing capacity and cargo capacity.

◆ **Total load capacity (vehicle capacity weight): (→P. 502)**

Total load capacity means the combined weight of occupants, cargo and luggage.

◆ **Seating capacity: (→P. 502)**

Seating capacity means the maximum number of occupants whose estimated average weight is 150 lb. (68 kg) per person.

◆ **Towing capacity**

Toyota does not recommend towing a trailer with your vehicle.

◆ **Cargo capacity**

Cargo capacity may increase or decrease depending on the weight and the number of occupants.

■ **Total load capacity and seating capacity**

These details are also described on the tire and loading information label. (→P. 427)

WARNING

■ **Overloading the vehicle**

Do not overload the vehicle.

It may not only cause damage to the tires, but also degrade steering and braking ability, resulting in an accident.

Trailer towing

Toyota does not recommend towing a trailer with your vehicle. Toyota also does not recommend the installation of a tow hitch or the use of a tow hitch carrier for a wheelchair, scooter, bicycle, etc. Your vehicle is not designed for trailer towing or for the use of tow hitch mounted carriers.

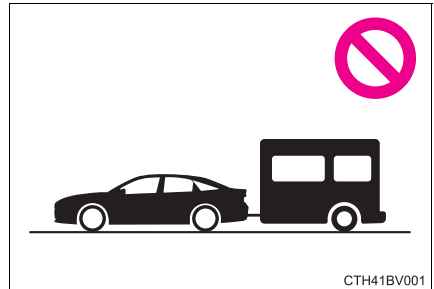

Dinghy towing

Your vehicle is not designed to be dinghy towed (with 4 wheels on the ground) behind a motor home.

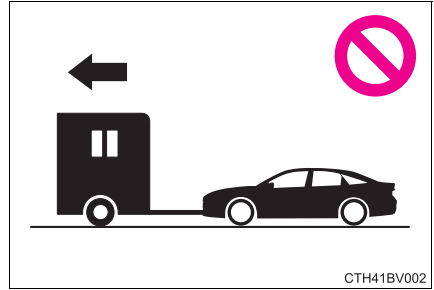

NOTICE

■ To avoid serious damage to your vehicle

Do not tow your vehicle with four wheels on the ground.

Power (ignition) switch

Performing the following operations when carrying the electronic key on your person starts the hybrid system or changes power switch modes.

Starting the hybrid system

- 1 Check that the parking brake is set.
- 2 Check that the shift lever is in P.
- 3 Firmly depress the brake pedal.



and a message will be displayed on the multi-information display. If it is not displayed, the hybrid system cannot be started.

- 4 Press the power switch shortly and firmly.

When operating the power switch, one short, firm press is enough. It is not necessary to press and hold the switch.

If the “READY” indicator turns on, the hybrid system will operate normally.

Continue depressing the brake pedal until the “READY” indicator is illuminated.

The hybrid system can be started from any power switch mode.

- 5 Check that the “READY” indicator is illuminated.

The vehicle will not move when the “READY” indicator is off.

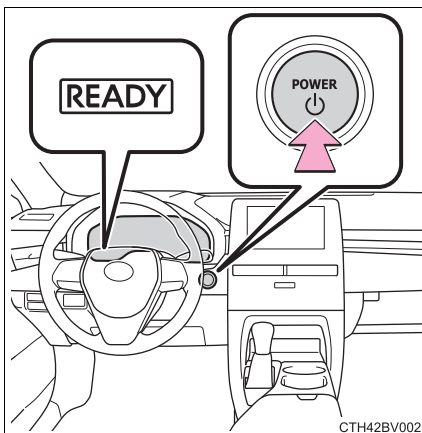

Stopping the hybrid system

- 1 Stop the vehicle completely.
- 2 Set the parking brake (→P. 212), and shift the shift lever to P.
- 3 Press the power switch.
- 4 Release the brake pedal and check that “ACCESSORY” or “IGNITION ON” is not shown on the meter.

Changing power switch modes

Modes can be changed by pressing the power switch with brake pedal released. (The mode changes each time the switch is pressed.)

① Off*

The emergency flashers can be used.

② ACCESSORY mode

Some electrical components such as the audio system can be used.

A message indicating how to start the hybrid system will be displayed on the multi-information display.

③ ON mode

All electrical components can be used.

A message indicating how to start the hybrid system will be displayed on the multi-information display.

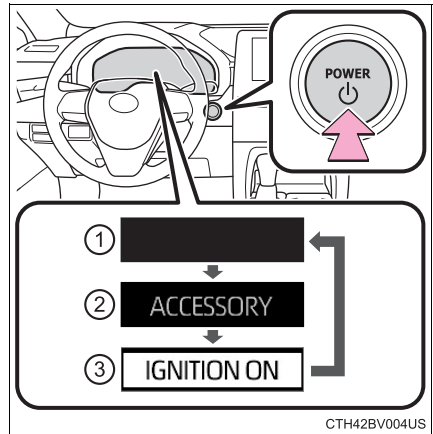

*: If the shift lever is in a position other than P when turning off the hybrid system, the power switch will be turned to ACCESSORY mode, not to off.

When stopping the hybrid system with the shift lever in a position other than P

If the hybrid system is stopped with the shift lever in a position other than P, a message indicating to shift the shift lever to P will be displayed on the multi-information display. At this time, the power switch will not be turned off but instead be turned to ACCESSORY mode. Perform the following procedure to turn the switch off:

- ① Check that the parking brake is set.
- ② Shift the shift lever to P.
- ③ Check that "Turn Power Off" is displayed on the multi-information display and then press the power switch once.
- ④ Check that "Turn Power Off" on the multi-information display is turned off.

■ Auto power off function

If the vehicle is left in ACCESSORY mode for more than 20 minutes or ON mode (with the hybrid system not operating) for more than an hour with the shift lever in P, the power switch will automatically turn off. However, this function cannot entirely prevent 12-volt battery discharge. Do not leave the vehicle with the power switch in ACCESSORY or ON mode for long periods of time when the hybrid system is not operating.

■ Automatic hybrid system shut off feature

- The vehicle is equipped with a feature that automatically shuts off the hybrid system when the shift lever is in P with the hybrid system operating for an extended period.
- The hybrid system will automatically shut off after approximately 1 hour if it has been left running while the shift lever is in P.
- The timer for the automatic hybrid system shut off feature will reset if the brake pedal is depressed or if the shift lever is in a position other than P.
- After the vehicle is parked, if the door is locked with the door lock switch (→P. 140) from the inside or the mechanical key (→P. 484) from the outside, the automatic hybrid system shut off feature will be disabled. The timer for the automatic hybrid system shut off feature will be re-enabled if the driver's door is opened.

■ Sounds and vibrations specific to a hybrid vehicle

→P. 78

■ Electronic key battery depletion

→P. 136

■ When the ambient temperature is low, such as during winter driving conditions

- When starting the hybrid system, the flashing time of the "READY" indicator may be long. Leave the vehicle as it is until the "READY" indicator is steady on, as steady means the vehicle is able to move.
- When the hybrid battery (traction battery) is extremely cold (below approximately -22°F [-30°C]) under the influence of the outside temperature, it may not be possible to start the hybrid system. In this case, try to start the hybrid system again after the temperature of the hybrid battery increases due to the outside temperature increase etc.

■ Conditions affecting operation

→P. 151

■ Notes for the entry function

→P. 152

■ If the hybrid system does not start

- The immobilizer system may not have been deactivated. (→P. 86)
Contact your Toyota dealer.
- Check that the shift lever is securely set in P. The hybrid system may not start if the shift lever is displaced out of P.

- If a message related to start-up is shown on the multi-information display, read the message and follow the instructions.

■ Steering lock

After turning the power switch off and opening and closing the doors, the steering wheel will be locked due to the steering lock function. Operating the power switch again automatically cancels the steering lock.

■ When the steering lock cannot be released

A message informing the driver that the steering wheel is locked will be displayed on the multi-information display.

Check that the shift lever is set in P. Press the power switch while turning the steering wheel left and right.

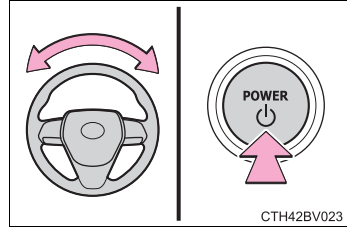

■ Steering lock motor overheating prevention

To prevent the steering lock motor from overheating, the motor may be suspended if the hybrid system is turned on and off repeatedly in a short period of time. In this case, refrain from operating the hybrid system. After about 10 seconds, the steering lock motor will resume functioning.

■ When a message requesting the smart key system be inspected is displayed on the multi-information display

The system may be malfunctioning. Have the vehicle inspected by your Toyota dealer immediately.

■ If the “READY” indicator does not come on

In the event that the “READY” indicator does not come on even after performing the proper procedures for starting the vehicle, contact your Toyota dealer immediately.

■ If the hybrid system is malfunctioning

→P. 80

■ If the electronic key battery is depleted

→P. 439

■ Operation of the power switch

- If the switch is not pressed shortly and firmly, the power switch mode may not change or the hybrid system may not start.
 - If attempting to restart the hybrid system immediately after turning the power switch off, the hybrid system may not start in some cases. After turning the power switch off, wait a few seconds before restarting the hybrid system.
- ### ■ If the smart key system has been deactivated in a customized setting
- P. 484

**WARNING****■ When starting the hybrid system**

Always start the hybrid system while sitting in the driver's seat. Do not depress the accelerator pedal while starting the hybrid system under any circumstances.

Doing so may cause an accident resulting in death or serious injury.

■ Caution while driving

If hybrid system failure occurs while the vehicle is moving, do not lock or open the doors until the vehicle reaches a safe and complete stop. Activation of the steering lock in this circumstance may lead to an accident, resulting in death or serious injury.

■ Stopping the hybrid system in an emergency

● If you want to stop the hybrid system in an emergency while driving the vehicle, press and hold the power switch for more than 2 seconds, or press it briefly 3 times or more in succession. (→P. 449)

However, do not touch the power switch while driving except in an emergency. Turning the hybrid system off while driving will not cause loss of steering or braking control, however, power assist to the steering will be lost. This will make it more difficult to steer smoothly, so you should pull over and stop the vehicle as soon as it is safe to do so.

● If the power switch is operated while the vehicle is running, a warning message will be shown on the multi-information display and a buzzer sounds.

● When restarting the hybrid system after an emergency shutdown while driving, press the power switch. When restarting the hybrid system after stopping the vehicle, change the shift position to P and then press the power switch.

■ When parking

Exhaust gases include harmful carbon monoxide (CO), which is colorless and odorless. Observe the following precautions.

Failure to do so may cause exhaust gases to enter the vehicle and may lead to an accident caused by light-headedness, or may lead to death or a serious health hazard.

● If the vehicle is in a poorly ventilated area or a closed area, such as a garage, stop the hybrid system.

● Do not leave the vehicle with the hybrid system operating for a long time. If such a situation cannot be avoided, park the vehicle in an open space and ensure that exhaust fumes do not enter the vehicle interior.

● Do not leave the hybrid system operating in an area with snow build-up, or where it is snowing. If snowbanks build up around the vehicle while the hybrid system is operating, exhaust gases may collect and enter the vehicle.

**NOTICE****■ To prevent 12-volt battery discharge**

- Do not leave the power switch in ACCESSORY or ON mode for long periods of time without the hybrid system on.
- If “ACCESSORY” or “IGNITION ON” is displayed on the multi-information display, the power switch is not off. Exit the vehicle after turning the power switch off.
- Do not stop the hybrid system when the shift lever is in a position other than P. If the hybrid system is stopped in another shift lever position, the power switch will not be turned off but instead be turned to ACCESSORY mode. If the vehicle is left in ACCESSORY mode, 12-volt battery discharge may occur.

■ When starting the hybrid system

- Do not depress the accelerator pedal unnecessarily.
- If the hybrid system becomes difficult to start, have your vehicle checked by your Toyota dealer immediately.

■ Symptoms indicating a malfunction with the power switch

If the power switch seems to be operating somewhat differently than usual, such as the switch sticking slightly, there may be a malfunction. Contact your Toyota dealer immediately.

EV drive mode

In EV drive mode, electric power is supplied by the hybrid battery (traction battery), and only the electric motor (traction motor) is used to drive the vehicle.

This mode allows you to drive in residential areas early in the morning and late at night, or in indoor parking lots etc. without concern for noises and gas emissions.

However, when the Acoustic Vehicle Alerting System is active, the vehicle may produce sound.

Turns EV drive mode on/off

When EV drive mode is turned on, the EV drive mode indicator will come on. Pressing the switch when in EV drive mode will return the vehicle to normal driving (using the gasoline engine and electric motor [traction motor]).

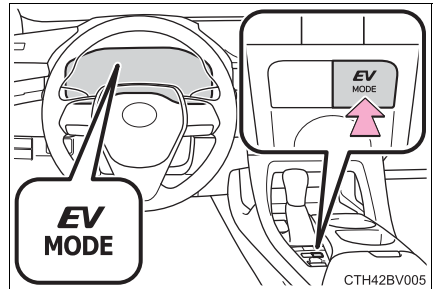

■ Situations in which EV drive mode cannot be turned on

It may not be possible to turn EV drive mode on in the following situations. If it cannot be turned on, a buzzer will sound and a message will be shown on the multi-information display.

- The temperature of the hybrid system is high.
The vehicle has been left in the sun, driven on a hill, driven at high speeds, etc.
- The temperature of the hybrid system is low.
The vehicle has been left in temperatures lower than about 32°F (0°C) for a long period of time etc.
- The gasoline engine is warming up.
- The hybrid battery (traction battery) is low.
The remaining battery level indicated in the energy monitor display is low. (→P. 128)
- Vehicle speed is high.
- The accelerator pedal is depressed firmly or the vehicle is on a hill etc.
- The windshield defogger is in use.

■ Switching to EV drive mode when the gasoline engine is cold

If the hybrid system is started while the gasoline engine is cold, the gasoline engine will start automatically after a short period of time in order to warm up. In this case, you will become unable to switch to EV drive mode.

After the hybrid system has started and the “READY” indicator has illuminated, press the EV drive mode switch before the gasoline engine starts to switch to EV drive mode.

■ Automatic cancelation of EV drive mode

When driving in EV drive mode, the gasoline engine may automatically restart in the following situations. When EV drive mode is canceled, a buzzer will sound and the EV drive mode indicator will flash and go off.

- The hybrid battery (traction battery) becomes low.

The remaining battery level indicated in the energy monitor on the multi-information display is low. (→P. 128)

- Vehicle speed is high.

- The accelerator pedal is depressed firmly or the vehicle is on a hill etc.

■ Possible driving distance when driving in EV drive mode

EV drive mode's possible driving distance ranges from a few hundred meters to approximately 0.9 miles (1 km). However, depending on vehicle conditions, there are situations when EV drive mode cannot be used.

(The distance that is possible depends on the hybrid battery [traction battery] level and driving conditions.)

■ Fuel economy

The hybrid system is designed to achieve the best possible fuel economy during normal driving (using the gasoline engine and electric motor [traction motor]). Driving in EV drive mode more than necessary may lower fuel economy.

■ If “EV Mode Unavailable” is shown on the multi-information display

The EV drive mode is not available. The reason the EV drive mode is not available (the vehicle is idling, battery charge is low, vehicle speed is higher than the EV drive mode operating speed range or accelerator pedal is depressed too much) may be displayed. Use the EV drive mode when it becomes available.

■ If “EV Mode Deactivated” is shown on the multi-information display

The EV drive mode has been automatically canceled. The reason the EV drive mode is not available (the battery charge is low, vehicle speed is higher than the EV drive mode operating speed range or accelerator pedal is depressed too much) may be displayed. Drive the vehicle for a while before attempting to turn on the EV drive mode again.

**WARNING****■ Caution while driving**

When driving in EV drive mode no engine noise is made. As such, pedestrians, people riding bicycles or other people and vehicles in the surrounding area may not be aware of the vehicle starting off or approaching them. Therefore, take extra care while driving even if the acoustic vehicle alerting system is active.

Hybrid transmission

Shifting the shift lever

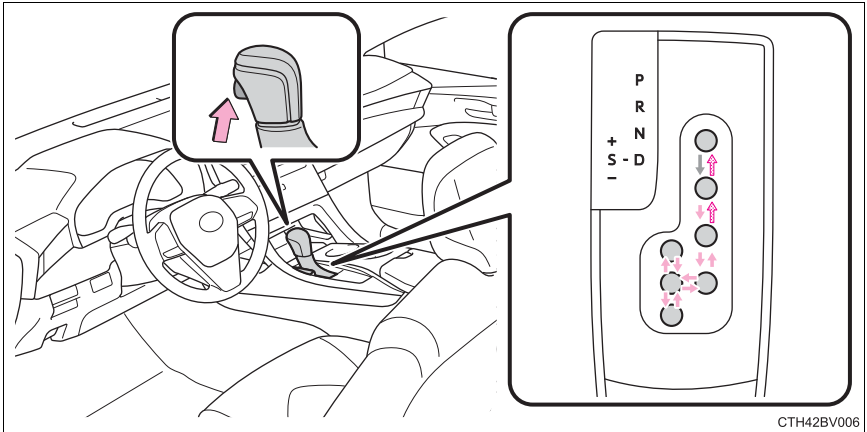

CTH42BV006

- ← While the power switch is in ON mode and the brake pedal depressed*, shift the shift lever while pushing the shift release button on the shift knob.
- ↔ Shift the shift lever while pushing the shift release button on the shift knob.
- ← Shift the shift lever normally.

When shifting the shift lever between P and D, make sure that the vehicle is completely stopped and the brake pedal is depressed.

- *: For the vehicle be able to be shifted from P, the brake pedal must be depressed before the shift release button is pushed. If the shift release button is pushed first, the shift lock will not be released.

Shift position purpose

Shift position	Objective or function
P	Parking the vehicle/starting the hybrid system
R	Reversing
N	Neutral
D	Normal driving ^{*1}
S	S mode driving ^{*2} (→P. 207)

*1: To improve fuel efficiency and reduce noise, shift the shift lever to D for normal driving.

*2: By selecting shift ranges using S mode, you can control accelerating force and engine braking force.

Selecting the driving mode

→P. 321

Changing shift ranges in S mode

When the shift lever is in the S position, the shift lever or paddle shift switches (if equipped) can be operated as follows:

▶ Shift lever

▶ Paddle shift switches (if equipped)

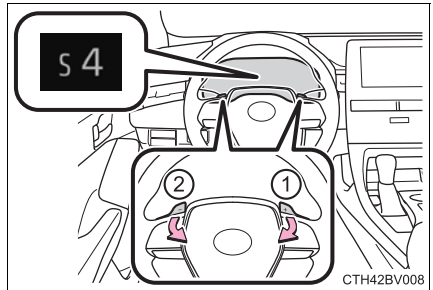
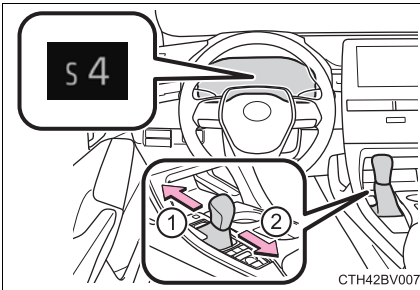

- ① Upshifting
- ② Downshifting

The initial shift range in S mode is set automatically to S5 or S4 according to vehicle speed.

■ Shift ranges and their functions

- You can choose from 6 levels of accelerating force and engine braking force.
- A lower shift range will provide greater accelerating force and engine braking force than a higher shift range, and the engine revolutions will also increase.
- If you accelerate while in ranges 1 to 4, the shift range may automatically increase in accordance with the vehicle speed.

Selecting shift ranges in the D position (vehicles with paddle shift switches)

To drive using temporary shift range selection, operate the “-” paddle shift switch. The shift range can then be selected by operating the “-” and “+” paddle shift switches. Changing the shift range allows restriction of the highest gear, preventing upshifting and enabling the level of engine braking force to be selected.

- ① Upshifting
- ② Downshifting

The selected shift range, from D1 to D6 will be displayed on the multi-information display.

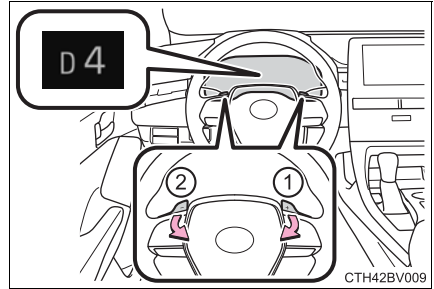

■ When the “-” paddle shift switch is operated with the shift lever in the D position (vehicles with paddle shift switches)

The shift range is downshifted to a range that enables engine braking force that is suitable to driving conditions.

■ Automatic deactivation of shift range selection in the D position

Shift range selection in the D position will be deactivated in the following situations:

- The “+” paddle shift switch is held down for a period of time
- When the vehicle comes to a stop
- If the accelerator pedal is depressed for more than a certain period of time
- When the shift lever is shifted to a position other than D

■ S mode

- When the shift range is S4 or lower, holding the shift lever toward “+” sets the shift range to S6.
- To prevent the engine from over-revving, upshifting may automatically occur.

■ Downshift restriction warning buzzer (S mode or paddle shifting)

To help ensure safety and driving performance, downshifting operation may sometimes be restricted. In some circumstances, downshifting may not be possible even when the shift lever or paddle shift switches (if equipped) are operated. (A buzzer will sound twice.)

■ When driving with dynamic radar cruise control with full-speed range activated

Even when performing the following actions with the intent of enabling engine braking, engine braking will not activate because radar cruise control with full-speed range will not be canceled.

- While driving in D or S mode, downshifting to 5 or 4.
- When switching the driving mode to sport mode while driving in the D position. (→P. 321)

■ Restraining sudden start (Drive-start Control)

→P. 184

■ Shift lock system

The shift lock system is a system to prevent accidental operation of the shift lever in starting.

The shift lever can be shifted from P only when the power switch is in the ON mode, the brake pedal is depressed and the shift release button is pushed.

■ If the shift lever cannot be shifted from P

First, check whether the brake pedal is being depressed.

If the shift lever cannot be shifted even though the brake pedal is depressed and the shift release button is pushed, there may be a problem with the shift lock system. Have the vehicle inspected by your Toyota dealer immediately.

The following steps may be used as an emergency measure to ensure that the shift lever can be shifted.

Releasing the shift lock:

- 1 Set the parking brake.
- 2 Turn the power switch off.
- 3 Depress the brake pedal.
- 4 Pry the cover up with a flathead screwdriver or equivalent tool.

To prevent damage to the cover, cover the tip of the screwdriver with a rag.

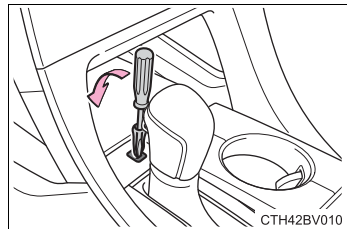

- 5 Press and hold the shift lock override button and then push the button on the shift knob.

The shift lever can be shifted while both buttons are pressed.

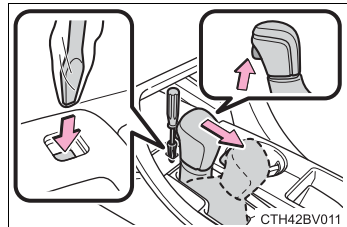

■ **If the S indicator does not come on or the D indicator is displayed even after shifting the shift lever to S**

This may indicate a malfunction in the automatic transmission system. Have the vehicle inspected by your Toyota dealer immediately.

(In this situation, the transmission will operate in the same manner as when the shift lever is in D.)



WARNING

■ **When driving on slippery road surfaces**

Do not accelerate or shift gears suddenly.

Sudden changes in engine braking may cause the vehicle to spin or skid, resulting in an accident.

■ **To prevent an accident when releasing the shift lock**

Before pressing the shift lock override button, make sure to set the parking brake and depress the brake pedal.

If the accelerator pedal is accidentally depressed instead of the brake pedal when the shift lock override button is pressed and the shift lever is shifted out of P, the vehicle may suddenly start, possibly leading to an accident resulting in death or serious injury.



NOTICE

■ **Hybrid battery (traction battery) charge precaution**

If the shift lever is in N, the hybrid battery (traction battery) will not be charged even when the engine is running. Therefore, if the vehicle is left with the shift lever in N for a long period of time, the hybrid battery (traction battery) will discharge, and this may result in the vehicle not being able to start.

Turn signal lever

Operating instructions

- ① Right turn
- ② Lane change to the right (move the lever partway and release it)

The right hand signals will flash 3 times.

- ③ Lane change to the left (move the lever partway and release it)

The left hand signals will flash 3 times.

- ④ Left turn

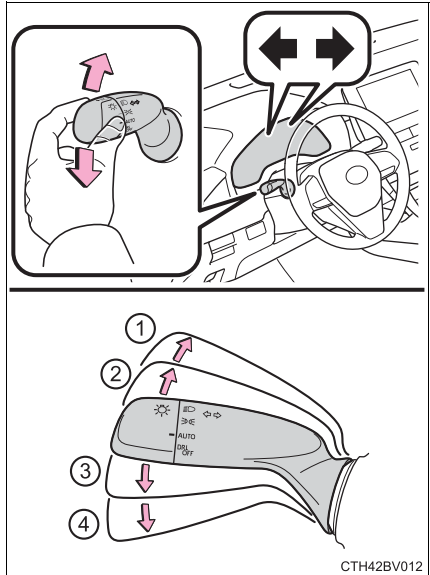

■ Turn signals can be operated when

The power switch is in ON mode.

■ If the indicator flashes faster than usual

Check that a light bulb in the front or rear turn signal lights has not burned out.

■ If the turn signals stop flashing before a lane change has been performed

Operate the lever again.

■ To discontinue flashing of the turn signals during a lane change

Operate the lever in the opposite direction.

Parking brake

A mode can be selected from the following modes.

Automatic mode

The parking brake is set or released automatically according to the shift lever operation.

Even when in automatic mode, the parking brake can be set and released manually. (→P. 213)

- ① Turns automatic mode on (while the vehicle is stopped, pull and hold the parking brake switch until a message is shown on the multi-information display)

- When the shift lever is moved out of P, the parking brake will be released, and the parking brake indicator light and parking brake light turn off.
- When the shift lever is moved into P, the parking brake will be set, and the parking brake indicator light and parking brake light turn on.

Operate the shift lever with the brake pedal depressed.

- ② Turns automatic mode off (while the vehicle is stopped, press and hold the parking brake switch until a message is shown on the multi-information display)

Operate the parking brake switch while depressing the brake pedal.

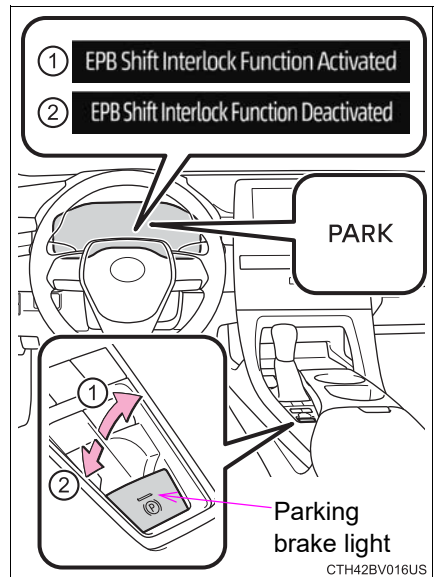

Manual mode

The parking brake can be set and released manually.

① Sets the parking brake

The parking brake indicator light and parking brake light will turn on.

Pull and hold the parking brake switch if an emergency occurs and it is necessary to operate the parking brake while driving.

② Releases the parking brake

Operate the parking brake switch while depressing the brake pedal. Make sure that the parking brake indicator light or parking brake light turn off.

If the parking brake indicator light and parking brake light flashes, operate the switch again.

(→P. 456)

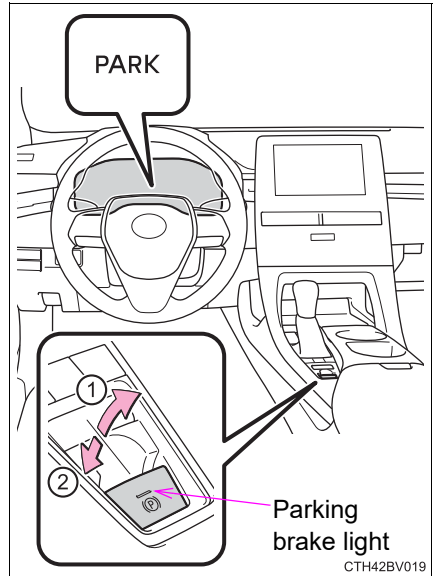

■ Parking the vehicle

→P. 182

■ Parking brake operation

- When the power switch is not in ON mode, the parking brake cannot be released using the parking brake switch.
- When the power switch is not in ON mode, automatic mode (automatic brake setting and releasing) is not available.

■ Automatic release function

The parking brake is automatically released when slowly depress the accelerator pedal.

The parking brake will be released automatically under the following conditions:

- The driver's door is closed.
- The driver's seat belt is fastened.
- Shift the shift lever is in a forward or reverse position.
- The malfunction indicator lamp or brake system warning light is not illuminated.

If the automatic release function does not operate, manually release the parking brake.

■ If “Parking Brake Temporarily Unavailable” is displayed on the multi-information display

If the parking brake is operated repeatedly over a short period of time, the system may restrict operation to prevent overheating. If this happens, refrain from operating the parking brake. Normal operation will return after about 1 minute.

■ If “Parking Brake Unavailable” is displayed on the multi-information display

Operate the parking brake switch. If the message does not disappear after operating the switch several times, the system may be malfunctioning. Have the vehicle inspected by your Toyota dealer immediately.

■ Parking brake operation sound

When the parking brake operates, a motor sound (whirring sound) may be heard. This does not indicate a malfunction.

■ Parking brake indicator light and parking brake light

- Depending on the power switch mode, the parking brake indicator light and parking brake light will turn on and stay on as described below:
 - ON mode: Comes on until the parking brake is released.
 - Not in ON mode: Stays on for approximately 15 seconds.
- When the power switch is turned off with the parking brake set, the parking brake indicator light and parking brake light will stay on for about 15 seconds. This does not indicate a malfunction.

■ Parking brake engaged warning buzzer

A buzzer will sound if the vehicle is driven with the parking brake engaged. "Release Parking Brake" is displayed on the multi-information display.

■ Warning messages and buzzers

Warning messages and buzzers are used to indicate a system malfunction or to inform the driver of the need for caution. If a warning message is shown on the multi-information display, read the message and follow the instructions.

■ If the brake system warning light comes on

→P. 455

■ Usage in winter time

→P. 333

WARNING

■ When parking the vehicle

Do not leave a child in the vehicle alone. The parking brake may be released unintentionally and there is the danger of the vehicle moving that may lead to an accident resulting in death or serious injury.

■ Parking brake switch

Do not set any objects near the parking brake switch. Objects may interfere with the switch and may lead the parking brake to unexpectedly operate.

NOTICE

■ When parking the vehicle

Before you leave the vehicle, shift the shift lever to P, set the parking brake and make sure that the vehicle does not move.

■ When the system malfunctions

Stop the vehicle in a safe place and check the warning messages.

■ When the parking brake cannot be released due to a malfunction

Driving the vehicle with the parking brake set will lead to brake components overheating, which may affect braking performance and increase brake wear. Contact your Toyota dealer immediately if this occurs.

Brake Hold

The brake hold system keeps the brake applied when the shift lever is in D, S or N with the system on and the brake pedal has been depressed to stop the vehicle. The system releases the brake when the accelerator pedal is depressed with the shift lever in D or S to allow smooth start off.

Turns the brake hold system on

The brake hold standby indicator (green) comes on. While the system is holding the brake, the brake hold operated indicator (yellow) comes on.

*1: Brake hold standby indicator

*2: Brake hold operated indicator

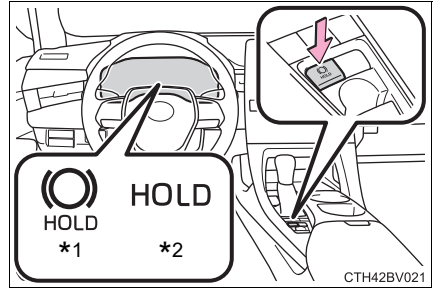

■ Brake hold system operating conditions

The brake hold system cannot be turned on in the following conditions:

- The driver's door is not closed.
- The driver is not wearing the seat belt.

If any of the conditions above are detected when the brake hold system is enabled, the system will turn off and the brake hold standby indicator light will go off. In addition, if any of the conditions are detected while the system is holding the brake, a warning buzzer will sound and a message will be shown on the multi-information display. The parking brake will then be set automatically.

■ Brake hold function

- If the brake pedal is left released for a period of about 3 minutes after the system has started holding the brake, the parking brake will be set automatically. In this case, a warning buzzer sounds and a message is shown on the multi-information display.
- To turn the system off while the system is holding the brake, firmly depress the brake pedal and press the button again.
- The brake hold function may not hold the vehicle when the vehicle is on a steep incline. In this situation, it may be necessary for the driver to apply the brakes. A warning buzzer will sound and the multi-information display will inform the driver of this situation. If a warning message is shown on the multi-information display, read the message and follow the instructions.

■ When the parking brake is set automatically while the system is holding the brakes

Perform any of the following operations to release the parking brake.

- Depress the accelerator pedal. (The parking brake will not be released automatically if the seat belt is not fastened.)
- Operate the parking brake switch with the brake pedal depressed.

Make sure that the parking brake indicator light goes off. (→P. 212)

■ When an inspection at your Toyota dealer is necessary

When the brake hold standby indicator (green) does not illuminate even when the brake hold switch is pressed with the brake hold system operating conditions met, the system may be malfunctioning. Have the vehicle inspected at your Toyota dealer.

■ Warning messages and buzzers

Warning messages and buzzers are used to indicate a system malfunction or to inform the driver of the need for caution. If a warning message is shown on the multi-information display, read the message and follow the instructions.

■ If the brake hold operated indicator flashes

→P. 457

WARNING

■ When the vehicle is on a steep incline

When using the brake hold system on a steep incline, exercise caution. The brake hold function may not hold the vehicle in such a situation.

■ When stopped on a slippery road

The system cannot stop the vehicle when the gripping ability of the tires has been exceeded. Do not use the system when stopped on a slippery road.

NOTICE

■ When parking the vehicle



The brake hold system is not designed for use when parking the vehicle for a long period of time. Turning the power switch off while the system is holding the brake may release the brake, which would cause the vehicle to move. When operating the power switch, depress the brake pedal, shift the shift lever to P and set the parking brake.

Headlight switch

The headlights can be operated manually or automatically.

Operating instructions

Operating the  switch turns on the lights as follows:

- ① **AUTO** The headlights, daytime running lights (→P. 219) and all the lights listed below turn on and off automatically. (When the power switch is in ON mode)
- ②  The side marker, parking, tail, license plate, instrument panel lights, and daytime running lights (→P. 219) turn on.
- ③  The headlights and all the lights listed above (except daytime running lights) turn on.
- ④  The daytime running lights turn off. (→P. 219)

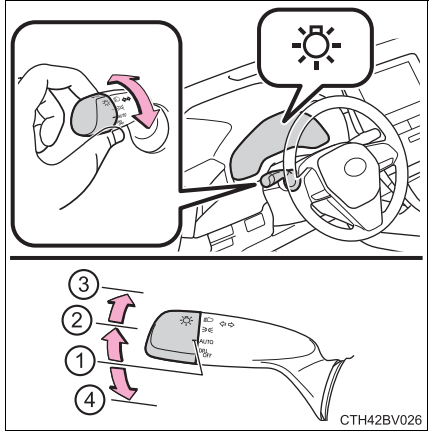

Turning on the high beam headlights

- ① With the headlights on, push the lever away from you to turn on the high beams.
Pull the lever toward you to the center position to turn the high beams off.
- ② Pull the lever toward you and release it to flash the high beams once.

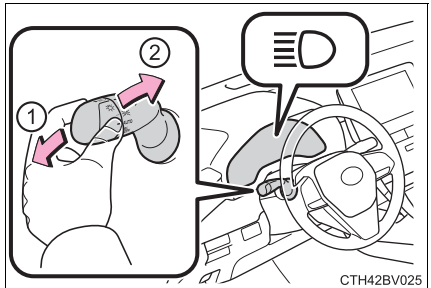

You can flash the high beams with the headlights on or off.

Cornering lights (if equipped)

- When the steering wheel or turn signal lever is operated while the headlights are on (low beam), a cornering light will turn on and light up the direction of movement of the vehicle. The cornering lights are designed to ensure excellent visibility when making a turn at an intersection.

However, when vehicle speed is approximately 93 mph (150 km/h) or higher, the cornering lights will not turn on.

- When the shift position is in R while the headlights are on (low beam), both cornering lights will turn on. This is designed to enhance visibility when parking.

Daytime running light system

- Type A:

The daytime running lights illuminate using the same lights as the low beam headlights and illuminate dimmer than the low beam headlights.

Type B:

The daytime running lights illuminate using the same lights as the parking lights and illuminate brighter than the parking lights.

- To make your vehicle more visible to other drivers during daytime driving, the daytime running lights turn on automatically when all of the following conditions are met. (The daytime running lights are not designed for use at night.)
 - The hybrid system is starting
 - The parking brake is released
 - The headlight switch is in the  or AUTO * position

*: When the surroundings are bright

The daytime running lights remain on after they illuminate, even if the parking brake is set again.

- Daytime running lights can be turned off by operating the switch.
- Compared to turning on the headlights, the daytime running light system offers greater durability and consumes less electricity, so it can help improve fuel economy.

Cornering lights (if equipped)

When the cornering lights are on for more than 30 minutes, they will turn off automatically.

■ Headlight control sensor

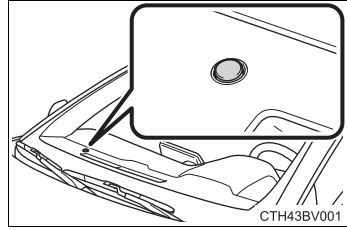

The sensor may not function properly if an object is placed on the sensor, or anything that blocks the sensor is affixed to the windshield.

Doing so interferes with the sensor detecting the level of ambient light and may cause the automatic headlight system to malfunction.



■ Automatic light off system

- When the headlights are on: The headlights and tail lights turn off 30 seconds after the power switch is turned to ACCESSORY mode or turned off and a door is opened and closed. (The lights turn off immediately if  on the key is pressed twice after all the doors are closed.)
- When only the tail lights are on: The tail lights turn off automatically if the power switch is turned to ACCESSORY mode or turned off and the driver's door is opened.

To turn the lights on again, turn the power switch to ON mode, or turn the light switch off once and then back to  or .

If any of the doors or trunk lid is kept open, the lights automatically turn off after 20 minutes.

■ Light reminder buzzer (except when the light switch is in AUTO)

A buzzer sounds when the power switch is turned off or turned to ACCESSORY mode and the driver's door is opened while the lights are turned on.

■ Windshield wiper linked headlight illumination

When driving during daytime with the headlight switch turned to **AUTO** , if the windshield wipers are used, the headlights will turn on automatically after several seconds to help enhance the visibility of your vehicle.

■ 12-volt battery-saving function

In the following conditions, the remaining lights will go off automatically after 20 minutes in order to prevent the 12-volt battery from being discharged:

- The headlights and/or tail lights are on.
- The power switch is in ACCESSORY mode or turned off.

This function will be canceled in any of the following situations:

- When the power switch is turned to ON mode.
- When the light switch is operated.
- When a door or the trunk is opened or closed.

■ Welcome lighting

If the headlight switch is turned to **AUTO** and the surrounding area is dark, unlocking the doors using the smart key system or wireless remote control will turn the parking lights and tail lights on automatically.

■ Customization

Some functions can be customized. (→P. 526)



NOTICE

■ To prevent 12-volt battery discharge

Do not leave the lights on longer than necessary when the hybrid system is off.

Automatic High Beam

The Automatic High Beam uses a camera sensor located behind the upper portion of the windshield to assess the brightness of the lights of vehicles ahead, streetlights, etc., and automatically turns the high beams on or off as necessary.

WARNING

■ Limitations of the Automatic High Beam

Do not overly rely on the Automatic High Beam. Always drive safely, taking care to observe your surroundings and turning the high beams on or off manually if necessary.

■ To prevent incorrect operation of the Automatic High Beam system

Do not overload the vehicle.

Activating the Automatic High Beam

- 1 Push the lever away from you with the headlight switch in the  or **AUTO** position.

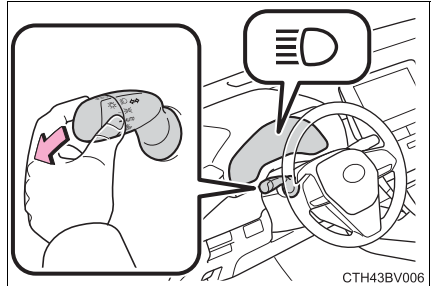

- 2 Press the Automatic High Beam switch.

The Automatic High Beam indicator will come on when the system is operating.

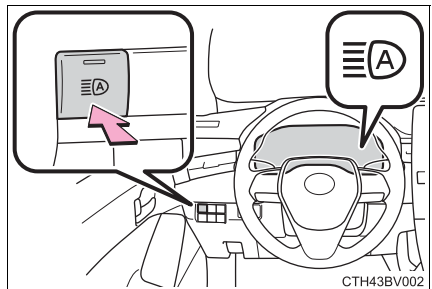

Turning the high beams on/off manually

■ Switching to the low beams

Pull the lever to its original position.

The Automatic High Beam indicator will turn off.

Push the lever away from you to activate the Automatic High Beam system again.

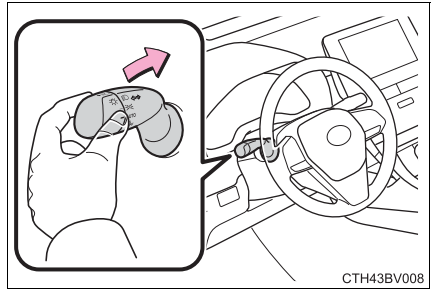

■ Switching to the high beams

Press the Automatic High Beam switch.

The Automatic High Beam indicator will turn off and the high beam indicator will turn on.

Press the switch to activate the Automatic High Beam system again.

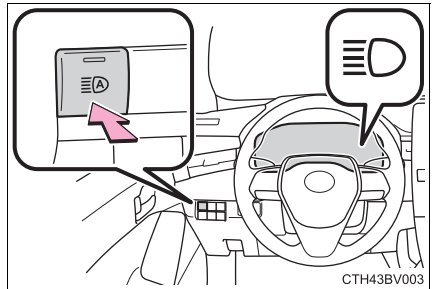

■ Conditions to turn the high beams on/off automatically

- When all of the following conditions are met, the high beams will be turned on automatically (after approximately 1 second):
 - The vehicle speed is approximately 21 mph (34 km/h) or more.
 - The area ahead of the vehicle is dark.
 - There are no vehicles ahead with headlights or tail lights turned on.
 - There are few streetlights on the road ahead.
- If any of the following conditions is met, the high beams will turn off automatically:
 - The vehicle speed is below approximately 17 mph (27 km/h).
 - The area ahead of the vehicle is not dark.
 - Vehicles ahead have their headlights or tail lights turned on.
 - There are many streetlights on the road ahead.

■ Camera sensor detection information

- The high beams may not be automatically turned off in the following situations:
 - When a vehicle suddenly appears from around a curve
 - When the vehicle is cut in front of by another vehicle
 - When vehicles ahead cannot be detected due to repeated curves, road dividers or roadside trees
 - When vehicles ahead appear in a faraway lane on a wide road
 - When the lights of vehicles ahead are not on
- The high beams may be turned off if a vehicle ahead that is using fog lights without its headlights turned on is detected.
- House lights, street lights, traffic signals, and illuminated billboards or signs and other reflective objects may cause the high beams to change to the low beams, or the low beams to remain on.
- The following factors may affect the amount of time taken for the high beams to turn on or off:
 - The brightness of the headlights, fog lights, and tail lights of vehicles ahead
 - The movement and direction of vehicles ahead
 - When a vehicle ahead only has operational lights on one side
 - When a vehicle ahead is a two-wheeled vehicle
 - The condition of the road (gradient, curve, condition of the road surface, etc.)
 - The number of passengers and amount of luggage in the vehicle
- The high beams may turn on or off unexpectedly.
- Bicycles or similar vehicles may not be detected.

- In the following situations the system may not be able to correctly detect the surrounding brightness level. This may cause the low beams to remain on or the high beams to flash or dazzle pedestrians or vehicles ahead. In such a case, it is necessary to manually switch between the high and low beams.
 - When driving in inclement weather (heavy rain, snow, fog, sandstorms, etc.)
 - When the windshield is obscured by fog, mist, ice, dirt, etc.
 - When the windshield is cracked or damaged
 - When the camera sensor is deformed or dirty
 - When the temperature of the camera sensor is extremely high
 - When the surrounding brightness level is equal to that of headlights, tail lights or fog lights
 - When headlights or tail lights of vehicles ahead are turned off, dirty, changing color, or not aimed properly
 - When the vehicle is hit by water, snow, dust, etc. from a preceding vehicle
 - When driving through an area of intermittently changing brightness and darkness
 - When frequently and repeatedly driving ascending/descending roads, or roads with rough, bumpy or uneven surfaces (such as stone-paved roads, gravel roads, etc.)
 - When frequently and repeatedly taking curves or driving on a winding road
 - When there is a highly reflective object ahead of the vehicle, such as a sign or mirror
 - When the back of a preceding vehicle is highly reflective, such as a container on a truck
 - When the vehicle's headlights are damaged or dirty, or are not aimed properly
 - When the vehicle is listing or titling due to a flat tire, a trailer being towed, etc.
 - When the headlights are changed between the high beams and low beams repeatedly in an abnormal manner
 - When the driver believes that the high beams may be flashing or dazzling pedestrians or other drivers

■ Temporarily lowering sensor sensitivity

The sensitivity of the sensor can be temporarily lowered.

- 1 Turn the power switch off while the following conditions are met.
 - The headlight switch is in **AUTO**.
 - The headlight switch lever is in high beam position.
- 2 Turn the power switch to the ON mode.
- 3 Within 5 seconds after 2, repeat pulling the headlight switch lever to the original position then pushing it to the high beam position quickly 9 times, then leave the lever in high beam position.

Automatic High Beam (headlights) may turn on even when the vehicle is stopped.

Windshield wipers and washer

Operating the wiper lever

Operating the  lever operates the wipers or washer as follows: When intermittent windshield wiper operation is selected, the wiper interval can be also adjusted.

- ① **INT** Intermittent windshield wiper operation
The intermittent windshield wiper operates more frequently as vehicle speed becomes higher.
- ② **LO** Low speed windshield wiper operation
- ③ **HI** High speed windshield wiper operation
- ④ **MIST** Temporary operation

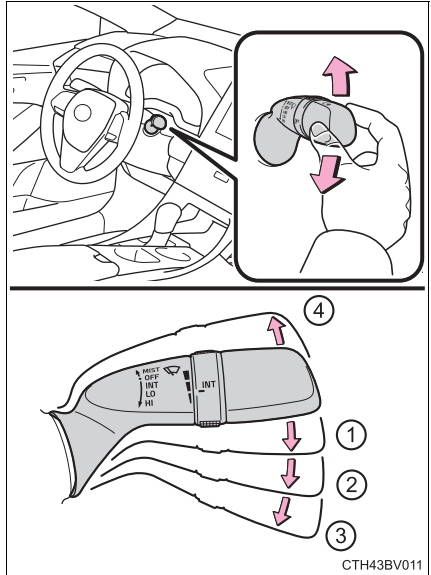

Wiper intervals can be adjusted when intermittent operation is selected.

- ⑤ Increases the intermittent windshield wiper frequency
- ⑥ Decreases the intermittent windshield wiper frequency

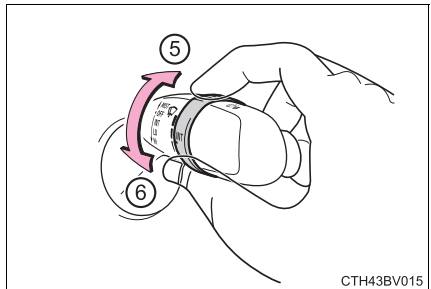

⑦ Washer/wiper dual operation

Pulling the lever operates the wipers and washer.

Wipers will automatically operate a couple of times after the washer squirts.

(After operating several times, the wipers operate once more time after a short delay to prevent dripping. However, the dripping prevention does not operate while the vehicle is moving.)

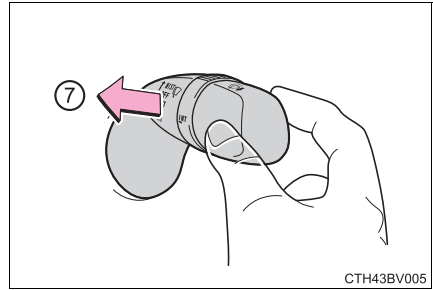

■ The windshield wiper and washer can be operated when

The power switch is in ON mode.

■ If no windshield washer fluid sprays

Check that the washer nozzles are not blocked if there is washer fluid in the windshield washer fluid reservoir.

■ When stopping the hybrid system in an emergency while driving

If the windshield wipers are operating when the hybrid system is stopped, the windshield wipers will operate in high speed operation. After the vehicle is stopped, operation will return to normal when the power switch is turned to ON mode, or operation will stop when the driver's door is opened.

WARNING

■ Caution regarding the use of washer fluid

When it is cold, do not use the washer fluid until the windshield becomes warm. The fluid may freeze on the windshield and cause low visibility. This may lead to an accident, resulting in death or serious injury.

NOTICE

■ When the windshield is dry

Do not use the wipers, as they may damage the windshield.

■ When the washer fluid tank is empty

Damage to the washer fluid pump may be caused if the lever is pulled toward you and held continually.

■ When a nozzle becomes blocked

In this case, contact your Toyota dealer.

Do not try to clear it with a pin or other object. The nozzle will be damaged.

Changing the windshield wiper rest position/Lifting the windshield wipers

When the windshield wipers are not being used, they retract to below the hood. To enable the windshield wipers to be lifted when parking in cold conditions or when replacing a windshield wiper insert, change the rest position of the windshield wipers to the service position using the wiper lever.

■ Raising the wipers to the service position

Within approximately 45 seconds of turning the power switch off, move the wiper lever to the **MIST** position and hold it for approximately 2 seconds or more.

The wipers will move to the service position.

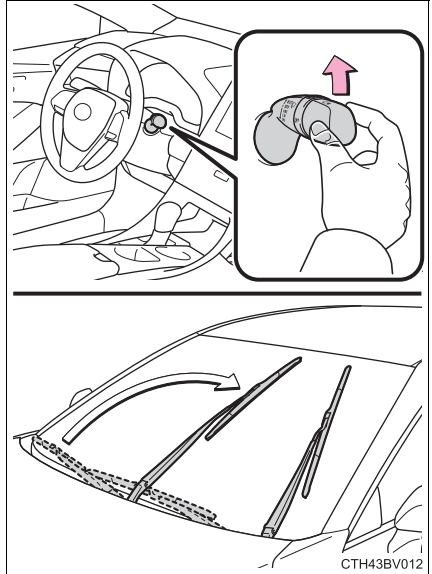

■ Lifting the windshield wipers

While holding the hook portion of the wiper arm, lift the windshield wiper from the windshield.

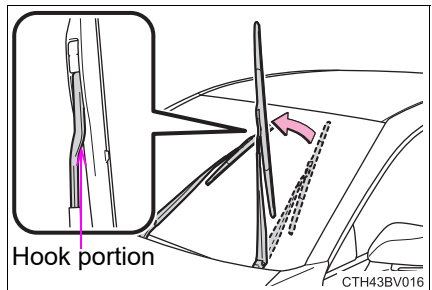

■ Lowering the windshield wipers to the retracted position

With the windshield wipers placed on the windshield, turn the power switch to ON mode and then move the wiper lever to an operating position. When the wiper switch is turned off, the windshield wipers will stop at the retracted position.

**NOTICE****■ When lifting the windshield wipers**

- Do not lift the windshield wipers when they are in the retracted position below the hood. Otherwise, they may contact the hood, possibly resulting in damage to a windshield wiper and/or the hood.
- Do not operate the wiper lever when the windshield wipers are lifted. Otherwise, the windshield wipers may contact the hood, possibly resulting in damage to the windshield wipers and/or hood.

Opening the fuel tank cap

The fuel tank of your vehicle has a special structure, which requires a reduction in fuel tank pressure before refueling. After the opener switch has been pressed, it will take several seconds until the vehicle is ready for refueling.

Before refueling the vehicle

- Close all the doors and windows, and turn the power switch off.
- Confirm the type of fuel. (→P. 510)

■ Fuel types

→P. 504, 510

■ Fuel tank opening for unleaded gasoline

To help prevent incorrect fueling, your vehicle has a fuel tank opening that only accommodates the special nozzle on unleaded fuel pumps.

■ If the malfunction indicator lamp illuminates

The malfunction indicator lamp may illuminate erroneously if refueling is performed repeatedly when the fuel tank is nearly full.

**WARNING****■ When refueling the vehicle**

Observe the following precautions while refueling the vehicle. Failure to do so may result in death or serious injury.

- After exiting the vehicle and before opening the fuel door, touch an unpainted metal surface to discharge any static electricity. It is important to discharge static electricity before refueling because sparks resulting from static electricity can cause fuel vapors to ignite while refueling.
- Always hold the grips on the fuel tank cap and turn it slowly to remove it. A whooshing sound may be heard when the fuel tank cap is loosened. Wait until the sound cannot be heard before fully removing the cap. In hot weather, pressurized fuel may spray out the filler neck and cause injury.
- Do not allow anyone that has not discharged static electricity from their body to come close to an open fuel tank.
- Do not inhale vaporized fuel.
Fuel contains substances that are harmful if inhaled.
- Do not smoke while refueling the vehicle.
Doing so may cause the fuel to ignite and cause a fire.
- Do not return to the vehicle or touch any person or object that is statically charged.
This may cause static electricity to build up, resulting in a possible ignition hazard.

■ When refueling

Observe the following precautions to prevent fuel overflowing from the fuel tank:

- Securely insert the fuel nozzle into the fuel filler neck.
- Stop filling the tank after the fuel nozzle automatically clicks off.
- Do not top off the fuel tank.

 NOTICE**Refueling**

- Finish refueling within 30 minutes. If more than 30 minutes passes, the internal valve closes. In this condition, fuel may overflow during the refueling process.

Press the fuel filler door opener switch again.

- Do not spill fuel during refueling.

Doing so may damage the vehicle, such as causing the emission control system to operate abnormally or damaging fuel system components or the vehicle's painted surface.

- When refueling your vehicle, make sure that the fuel filler door lock is not pushed by the fuel nozzle boot, etc., as this may cause a valve to close, possibly resulting in a fuel spill.

If the fuel filler door lock has been pushed, operate the fuel filler door opener switch in the vehicle before continuing to refuel.

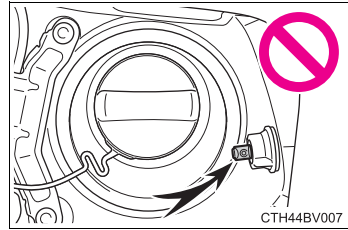

Opening the fuel tank cap

- 1 Press the opener to open the fuel filler door.
The fuel filler door will open within about 10 seconds of the switch being pressed.
Before refueling is possible, a message will be shown on the multi-information display in the instrument cluster to indicate the progress of the fuel filler door opener.
- 2 Turn the fuel tank cap slowly to remove it and hang it on the back of the fuel filler door.

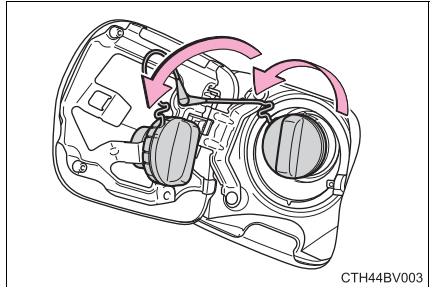
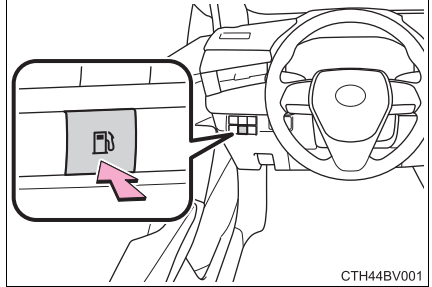

Closing the fuel tank cap

After refueling, turn the fuel tank cap until you hear a click. Once the cap is released, it will turn slightly in the opposite direction.

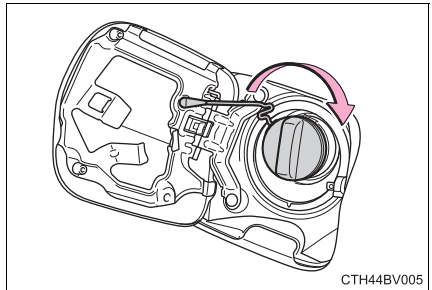

■ If the fuel filler door cannot be opened

- Remove the cover inside the trunk and pull the lever.
- Using the lever to open the fuel filler door may not allow for an adequate reduction in fuel tank pressure before refueling. To prevent fuel from spilling out, turn the cap slowly when removing it.

During refueling, fuel may spill out from the filler opening due to air being discharged from inside the fuel tank. Therefore, fill the fuel tank carefully and slowly.

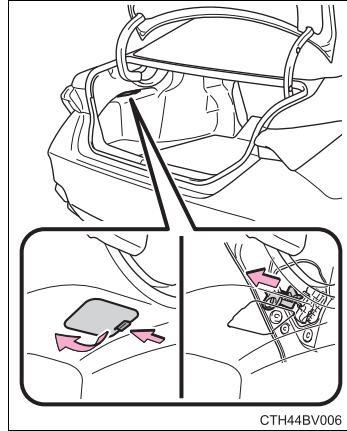
**WARNING****■ When replacing the fuel tank cap**

Do not use anything but a genuine Toyota fuel tank cap designed for your vehicle. Doing so may cause a fire or other incident which may result in death or serious injury.

Toyota Safety Sense P

The Toyota Safety Sense P consists of the following drive assist systems and contributes to a safe and comfortable driving experience:

Driving assist system

◆ PCS (Pre-Collision System)

→P. 242

◆ LDA (Lane Departure Alert with steering control)

→P. 252

◆ AHB (Automatic High Beam)

→P. 222

◆ Dynamic radar cruise control with full-speed range

→P. 263



WARNING

■ Toyota Safety Sense P

The Toyota Safety Sense P is designed to operate under the assumption that the driver will drive safely, and is designed to help reduce the impact to the occupants and the vehicle in the case of a collision or assist the driver in normal driving conditions.

As there is a limit to the degree of recognition accuracy and control performance that this system can provide, do not overly rely on this system. The driver is always responsible for paying attention to the vehicle's surroundings and driving safely.

Sensors

Two types of sensors, located behind the front grille and windshield, detect information necessary to operate the drive assist systems.

- ① Radar sensor
- ② Front camera

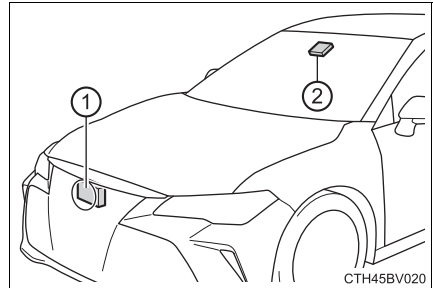

⚠ WARNING

■ To avoid malfunction of the radar sensor

Observe the following precautions.

Otherwise, the radar sensor may not operate properly, possibly leading to an accident resulting in death or serious injury.

- Keep the radar sensor and the radar sensor cover clean at all times.

- ① Radar sensor
- ② Radar sensor cover

If the front of the radar sensor or the front or back of the radar sensor cover is dirty or covered with water droplets, snow, etc., clean it.

Clean the radar sensor and radar sensor cover with a soft cloth to avoid damaging them.

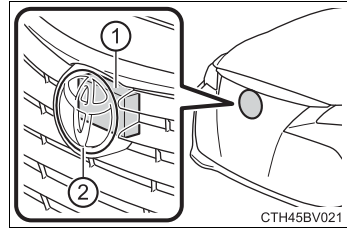

- Do not attach accessories, stickers (including transparent stickers) or other items to the radar sensor, radar sensor cover or surrounding area.
- Do not subject the radar sensor or its surrounding area to a strong impact. If the radar sensor, front grille, or front bumper has been subjected to a strong impact, have the vehicle inspected by your Toyota dealer.
- Do not disassemble the radar sensor.
- Do not modify or paint the radar sensor or radar sensor cover.
- In the following cases, the radar sensor must be recalibrated. Contact your Toyota dealer for details.
 - When the radar sensor or front grille are removed and installed, or replaced
 - When the front bumper is replaced

WARNING

■ To avoid malfunction of the front camera

Observe the following precautions.

Otherwise, the front camera may not operate properly, possibly leading to an accident resulting in death or serious injury.

- Keep the windshield clean at all times.
 - If the windshield is dirty or covered with an oily film, water droplets, snow, etc., clean the windshield.
 - If a glass coating agent is applied to the windshield, it will still be necessary to use the windshield wipers to remove water droplets, etc. from the area of the windshield in front of the front camera.
 - If the inner side of the windshield where the front camera is installed is dirty, contact your Toyota dealer.

- Do not attach objects, such as stickers, transparent stickers, etc., to the outer side of the windshield in front of the front camera (shaded area in the illustration).

A: From the top of the windshield to approximately 0.4 in. (1 cm) below the bottom of the front camera

B: Approximately 7.9 in. (20 cm) (Approximately 4.0 in. [10 cm] to the right and left from the center of the front camera)

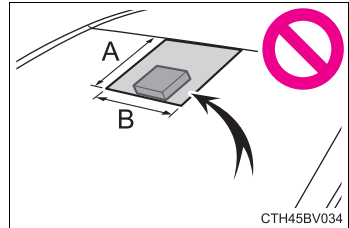

- If the part of the windshield in front of the front camera is fogged up or covered with condensation, or ice, use the windshield defogger to remove the fog, condensation, or ice. (→P. 343)
- If water droplets cannot be properly removed from the area of the windshield in front of the front camera by the windshield wipers, replace the wiper insert or wiper blade.
- Do not attach window tint to the windshield.
- Replace the windshield if it is damaged or cracked. After replacing the windshield, the front camera must be recalibrated. Contact your Toyota dealer for details.
- Do not allow liquids to contact the front camera.
- Do not allow bright lights to shine into the front camera.
- Do not dirty or damage the front camera. When cleaning the inside of the windshield, do not allow glass cleaner to contact the lens of the front camera. Also, do not touch the lens. If the lens is dirty or damaged, contact your Toyota dealer.

 **WARNING**

- Do not subject the front camera to a strong impact.
- Do not change the installation position or direction of the front camera or remove it.
- Do not disassemble the front camera.
- Do not modify any components of the vehicle around the front camera (inside rear view mirror, etc.) or ceiling.
- Do not attach any accessories to the hood, front grille or front bumper that may obstruct the front camera. Contact your Toyota dealer for details.
- If a surfboard or other long object is to be mounted on the roof, make sure that it will not obstruct the front camera.
- Do not modify the headlights or other lights.

■ Certification

FCC ID: HYQDNMWR008

NOTE:

This device complies with part 15 of the FCC Rules. Operation is subject to the following two conditions: (1) This device may not cause harmful interference, and (2) this device must accept any interference received, including interference that may cause undesired operation.

FCC WARNING:

Changes or modifications not expressly approved by the party responsible for compliance could void the user's authority to operate the equipment.

Radiofrequency radiation exposure Information:

This equipment complies with FCC radiation exposure limits set forth for an uncontrolled environment. This equipment should be installed and operated with minimum distance of 20 cm between the radiator (antenna) and your body. This transmitter must not be co-located or operating in conjunction with any other antenna or transmitter.

■ If a warning message is displayed on the multi-information display

A system may be temporarily unavailable or there may be a malfunction in the system.

- In the following situations, perform the actions specified in the table. When the normal operating conditions are detected, the message will disappear and the system will become operational.

If the message does not disappear, contact your Toyota dealer.

Situation	Actions
When the area around a sensor is covered with dirt, moisture (fogged up, covered with condensation, ice, etc.), or other foreign matter	To clean the part of the windshield in front of the front camera, use the windshield wipers or the windshield defogger of the air conditioning system (→P. 343).
When the temperature around the front camera is outside of the operational range, such as when the vehicle is in the sun or in an extremely cold environment	<p>If the front camera is hot, such as after the vehicle had been parked in the sun, use the air conditioning system to decrease the temperature around the front camera.</p> <p>If a sunshade was used when the vehicle was parked, depending on its type, the sunlight reflected from the surface of the sunshade may cause the temperature of the front camera to become excessively high.</p>
	If the front camera is cold, such after the vehicle is parked in an extremely cold environment, use the air conditioning system to increase the temperature around the front camera.
The area in front of the front camera is obstructed, such as when the hood is open or a sticker is attached to the part of the windshield in front of the front camera.	Close the hood, remove the sticker, etc. to clear the obstruction.

- In the following situations, if the situation has changed (or the vehicle has been driven for some time) and the normal operating conditions are detected, the message will disappear and the system will become operational.

If the message does not disappear, contact your Toyota dealer.

- When the temperature around the radar sensor is outside of the operational range, such as when the vehicle is in the sun or in an extremely cold environment
- When the front camera cannot detect objects in front of the vehicle, such as when driving in the dark, snow, or fog, or when bright lights are shining into the front camera

PCS (Pre-Collision System)

The pre-collision system uses a radar sensor and front camera to detect vehicles and pedestrians in front of your vehicle. When the system determines that the possibility of a frontal collision with a vehicle or pedestrian is high, a warning operates to urge the driver to take evasive action and the potential brake pressure is increased to help the driver avoid the collision. If the system determines that the possibility of a frontal collision with a vehicle or pedestrian is extremely high, the brakes are automatically applied to help avoid the collision or help reduce the impact of the collision.

The pre-collision system can be disabled/enabled and the warning timing can be changed. (→P. 245)

◆ Pre-collision warning

When the system determines that the possibility of a frontal collision is high, a buzzer will sound and a warning message will be displayed on the multi-information display to urge the driver to take evasive action.

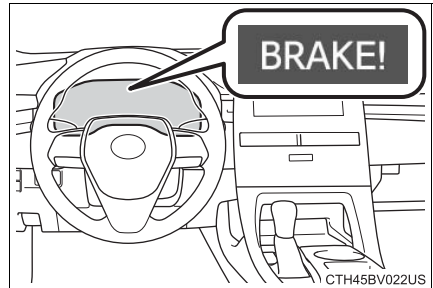

◆ Pre-collision brake assist

When the system determines that the possibility of a frontal collision is high, the system applies greater braking force in relation to how strongly the brake pedal is depressed.

◆ Pre-collision braking

When the system determines that the possibility of a frontal collision is high, the system warns the driver. If the system determines that the possibility of a frontal collision is extremely high, the brakes are automatically applied to help avoid the collision or reduce the collision speed.

**WARNING****■ Limitations of the pre-collision system**

- The driver is solely responsible for safe driving. Always drive safely, taking care to observe your surroundings.

Do not use the pre-collision system instead of normal braking operations under any circumstances. This system will not prevent collisions or lessen collision damage or injury in every situation. Do not overly rely on this system. Failure to do so may lead to an accident, resulting in death or serious injury.

- Although this system is designed to help avoid a collision or help reduce the impact of the collision, its effectiveness may change according to various conditions, therefore the system may not always be able to achieve the same level of performance.

Read the following conditions carefully. Do not overly rely on this system and always drive carefully.

- Conditions under which the system may operate even if there is no possibility of a collision: →P. 247
- Conditions under which the system may not operate properly: →P. 249
- Do not attempt to test the operation of the pre-collision system yourself. Depending on the objects used for testing (dummies, cardboard objects imitating detectable objects, etc.), the system may not operate properly, possibly leading to an accident.

■ Pre-collision braking

- When the pre-collision braking function is operating, a large amount of braking force will be applied.
- If the vehicle is stopped by the operation of the pre-collision braking function, the pre-collision braking function operation will be canceled after approximately 2 seconds. Depress the brake pedal as necessary.
- The pre-collision braking function may not operate if certain operations are performed by the driver. If the accelerator pedal is being depressed strongly or the steering wheel is being turned, the system may determine that the driver is taking evasive action and possibly prevent the pre-collision braking function from operating.
- In some situations, while the pre-collision braking function is operating, operation of the function may be canceled if the accelerator pedal is depressed strongly or the steering wheel is turned and the system determines that the driver is taking evasive action.
- If the brake pedal is being depressed, the system may determine that the driver is taking evasive action and possibly delay the operation timing of the pre-collision braking function.

**WARNING****■ When to disable the pre-collision system**

In the following situations, disable the system, as it may not operate properly, possibly leading to an accident resulting in death or serious injury:

- When the vehicle is being towed
- When your vehicle is towing another vehicle
- When transporting the vehicle via truck, boat, train or similar means of transportation
- When the vehicle is raised on a lift with the hybrid system on and the tires are allowed to rotate freely
- When inspecting the vehicle using a drum tester such as a chassis dynamometer or speedometer tester, or when using an on vehicle wheel balancer
- When a strong impact is applied to the front bumper or front grille, due to an accident or other reasons
- If the vehicle cannot be driven in a stable manner, such as when the vehicle has been in an accident or is malfunctioning
- When the vehicle is driven in a sporty manner or off-road
- When the tires are not properly inflated
- When the tires are very worn
- When tires of a size other than specified are installed
- When tire chains are installed
- When a compact spare tire or an emergency tire puncture repair kit is used
- If equipment (snow plow, etc.) that may obstruct the radar sensor or front camera is temporarily installed to the vehicle

Changing settings of the pre-collision system

■ Enabling/disabling the pre-collision system

The pre-collision system can be enabled/disabled on  (→P. 111) of the multi-information display.

The system is automatically enabled each time the power switch is turned to ON mode.

If the system is disabled, the PCS warning light will turn on and a message will be displayed on the multi-information display.

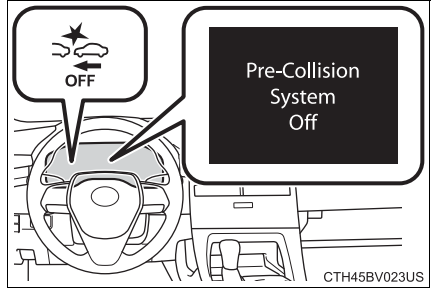

■ Changing the pre-collision warning timing

The pre-collision warning timing can be changed on  (→P. 111) of the multi-information display.

The operation timing setting is retained when the power switch is turned off.

① Far

The warning will begin to operate earlier than with the default timing.

② Middle

This is the default setting.

③ Near

The warning will begin to operate later than with the default timing.

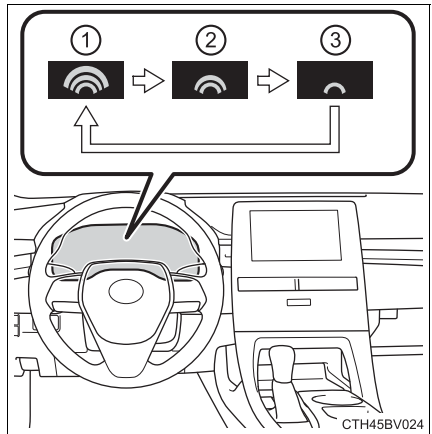

■ Operational conditions

The pre-collision system is enabled and the system determines that the possibility of a frontal collision with a vehicle or pedestrian is high.

Each function is operational at the following speeds:

- Pre-collision warning:

- Vehicle speed is between approximately 7 and 110 mph (10 and 180 km/h). (For detecting a pedestrian, vehicle speed is between approximately 7 and 50 mph [10 and 80 km/h].)
- The relative speed between your vehicle and the vehicle or pedestrian ahead is approximately 7 mph (10 km/h) or more.

- Pre-collision brake assist:

- Vehicle speed is between approximately 20 and 110 mph (30 and 180 km/h). (For detecting a pedestrian, vehicle speed is between approximately 20 and 50 mph [30 and 80 km/h].)
- The relative speed between your vehicle and the vehicle or pedestrian ahead is approximately 20 mph (30 km/h) or more.

- Pre-collision braking:

- Vehicle speed is between approximately 7 and 110 mph (10 and 180 km/h). (For detecting a pedestrian, vehicle speed is between approximately 7 and 50 mph [10 and 80 km/h].)
- The relative speed between your vehicle and the vehicle or pedestrian ahead is approximately 7 mph (10 km/h) or more.

The system may not operate in the following situations:

- If a 12-volt battery terminal has been disconnected and reconnected and then the vehicle has not been driven for a certain amount of time
- If the shift lever is in R
- If VSC is disabled (only the pre-collision warning function will be operational)

■ Pedestrian detection function

The pre-collision system detects pedestrians based on the size, profile, and motion of a detected object. However, a pedestrian may not be detected depending on the surrounding brightness and the motion, posture, and angle of the detected object, preventing the system from operating properly. (→P. 251)

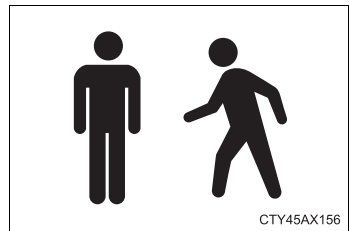

■ Cancellation of the pre-collision braking

If either of the following occur while the pre-collision braking function is operating, it will be canceled:

- The accelerator pedal is depressed strongly.
- The steering wheel is turned sharply or abruptly.

■ Conditions under which the system may operate even if there is no possibility of a collision

- In some situations such as the following, the system may determine that there is a possibility of a frontal collision and operate.
 - When passing a vehicle or pedestrian
 - When changing lanes while overtaking a preceding vehicle
 - When overtaking a preceding vehicle that is changing lanes

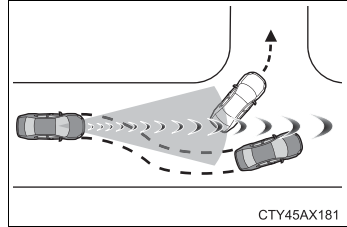

- When passing a vehicle in an oncoming lane that is stopped to make a right/left turn

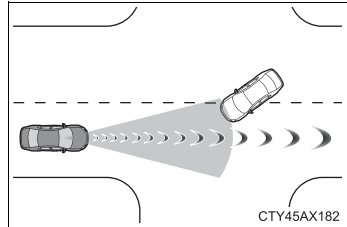

- When driving on a road where relative location to vehicle ahead in an adjacent lane may change, such as on a winding road

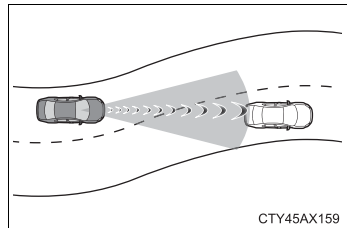

- When rapidly closing on a vehicle ahead
- If the front of the vehicle is raised or lowered, such as when the road surface is uneven or undulating
- When approaching objects on the roadside, such as guardrails, utility poles, trees, or walls
- When there is a vehicle, pedestrian, or object by the roadside at the entrance of a curve

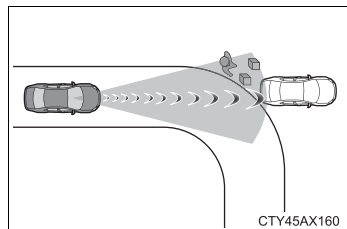

- When driving on a narrow path surrounded by a structure, such as in a tunnel or on an iron bridge

- When there is a metal object (manhole cover, steel plate, etc.), steps, or a protrusion on the road surface or roadside
- When a crossing pedestrian approaches very close to the vehicle

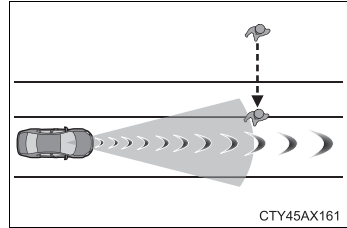

- When passing through a place with a low structure above the road (low ceiling, traffic sign, etc.)

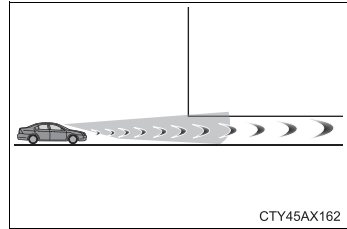

- When passing under an object (billboard, etc.) at the top of an uphill road

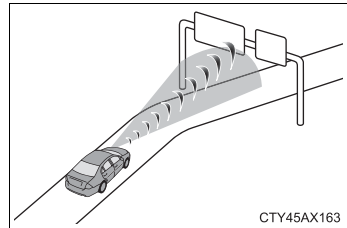

- When rapidly closing on an electric toll gate barrier, parking area barrier, or other barrier that opens and closes
- When using an automatic car wash
- When driving through or under objects that may contact the vehicle, such as thick grass, tree branches, or a banner

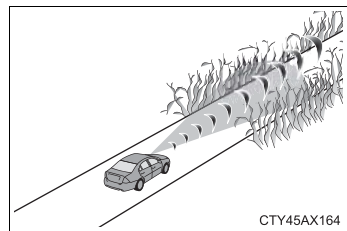

- When the vehicle is hit by water, snow, dust, etc. from a vehicle ahead
- When driving through steam or smoke
- When there are patterns or paint on the road or a wall that may be mistaken for a vehicle or pedestrian
- When driving near an object that reflects radio waves, such as a large truck or guardrail
- When driving near a TV tower, broadcasting station, electric power plant, or other location where strong radio waves or electrical noise may be present

■ Situations in which the system may not operate properly

● In some situations such as the following, a vehicle may not be detected by the radar sensor and front camera, preventing the system from operating properly:

- If an oncoming vehicle is approaching your vehicle
- If a vehicle ahead is a motorcycle or bicycle
- When approaching the side or front of a vehicle
- If a preceding vehicle has a small rear end, such as an unloaded truck
- If a preceding vehicle has a low rear end, such as a low bed trailer

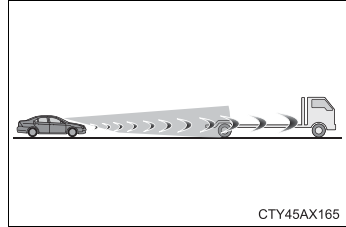

- If a vehicle ahead is carrying a load which protrudes past its rear bumper
- If a vehicle ahead has extremely high ground clearance

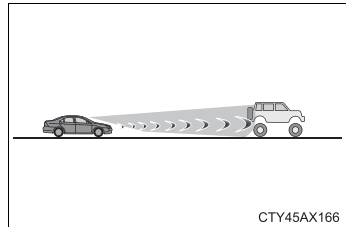

- If a vehicle ahead is irregularly shaped, such as a tractor or side car
- If the sun or other light is shining directly on a vehicle ahead
- If a vehicle cuts in front of your vehicle or emerges from beside a vehicle
- If a vehicle ahead makes an abrupt maneuver (such as sudden swerving, acceleration or deceleration)
- When suddenly cutting behind a preceding vehicle
- When a vehicle ahead is not directly in front of your vehicle

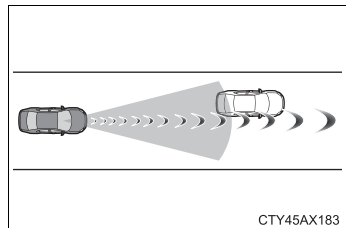

- When driving in inclement weather such as heavy rain, fog, snow or a sandstorm
- When the vehicle is hit by water, snow, dust, etc. from a vehicle ahead
- When driving through steam or smoke
- When driving in a place where the surrounding brightness changes suddenly, such as at the entrance or exit of a tunnel

- When a very bright light, such as the sun or the headlights of oncoming traffic, shines directly into the front camera
- When the surrounding area is dim, such as at dawn or dusk, or while at night or in a tunnel
- After the hybrid system has started the vehicle has not been driven for a certain amount of time
- While making a left/right turn and for a few seconds after making a left/right turn
- While driving on a curve and for a few seconds after driving on a curve
- If your vehicle is skidding
- If the front of the vehicle is raised or lowered

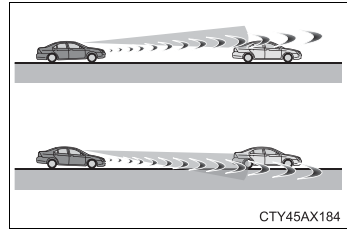

- If the wheels are misaligned
- If a wiper blade is blocking the front camera
- The vehicle is wobbling.
- The vehicle is being driven at extremely high speeds.
- When driving on a hill
- If the radar sensor or front camera is misaligned
- In some situations such as the following, sufficient braking force may not be obtained, preventing the system from performing properly:
 - If the braking functions cannot operate to their full extent, such as when the brake parts are extremely cold, extremely hot, or wet
 - If the vehicle is not properly maintained (brakes or tires are excessively worn, improper tire inflation pressure, etc.)
 - When the vehicle is being driven on a gravel road or other slippery surface

- Some pedestrians such as the following may not be detected by the radar sensor and front camera, preventing the system from operating properly:
 - Pedestrians shorter than approximately 3.2 ft. (1 m) or taller than approximately 6.5 ft. (2 m)
 - Pedestrians wearing oversized clothing (a rain coat, long skirt, etc.), making their silhouette obscure
 - Pedestrians who are carrying large baggage, holding an umbrella, etc., hiding part of their body
 - Pedestrians who are bending forward or squatting
 - Pedestrians who are pushing a stroller, wheelchair, bicycle or other vehicle
 - Groups of pedestrians which are close together
 - Pedestrians who are wearing white and look extremely bright
 - Pedestrians in the dark, such as at night or while in a tunnel
 - Pedestrians whose clothing appears to be nearly the same color or brightness as their surroundings
 - Pedestrians near walls, fences, guardrails, or large objects
 - Pedestrians who are on a metal object (manhole cover, steel plate, etc.) on the road
 - Pedestrians who are walking fast
 - Pedestrians who are changing speed abruptly
 - Pedestrians running out from behind a vehicle or a large object
 - Pedestrians who are extremely close to the side of the vehicle (outside rear view mirror, etc.)

■ If VSC is disabled

- If VSC is disabled (→P. 324), the pre-collision brake assist and pre-collision braking functions are also disabled.
- The PCS warning light will turn on and “VSC Turned Off Pre-Collision Brake System Unavailable” will be displayed on the multi-information display.

LDA (Lane Departure Alert with steering control)

Summary of functions

When driving on highways and freeways with white (yellow) lines, this function alerts the driver when the vehicle might depart from its lane and provides assistance by operating the steering wheel to keep the vehicle in its lane.

The LDA system recognizes visible white (yellow) lines with the camera sensor on the upper portion of the windshield.

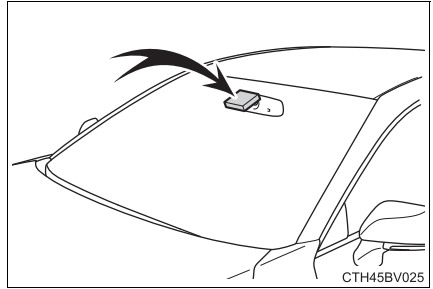

Functions included in LDA system

◆ Lane departure alert function

When the system determines that the vehicle might depart from its lane, a warning is displayed on the multi-information display and the warning buzzer sounds to alert the driver.

When the warning buzzer sounds, check the surrounding road situation and carefully operate the steering wheel to move the vehicle back to the center of the lane.

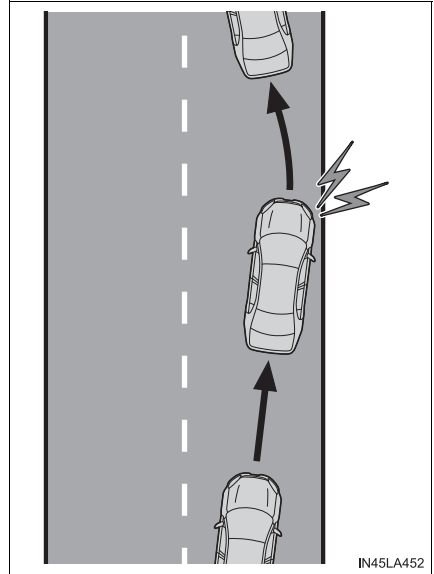

◆ Steering control function

When the system determines that the vehicle might depart from its lane, the system provides assistance as necessary by operating the steering wheel in small amounts for a short period of time to keep the vehicle in its lane.

If the system detects that the steering wheel has not been operated for a fixed amount of time or the steering wheel is not being firmly gripped, a warning is displayed on the multi-information display and the function is temporarily canceled.

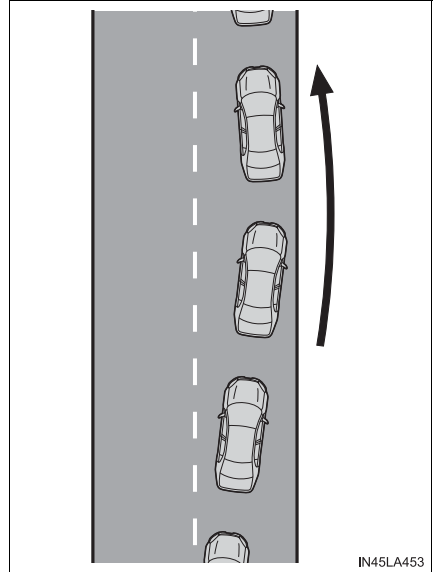

◆ Vehicle sway warning function

When the vehicle is swaying or appears as if it may depart from its lane multiple times, the warning buzzer sounds and a message is displayed on the multi-information display to alert the driver.

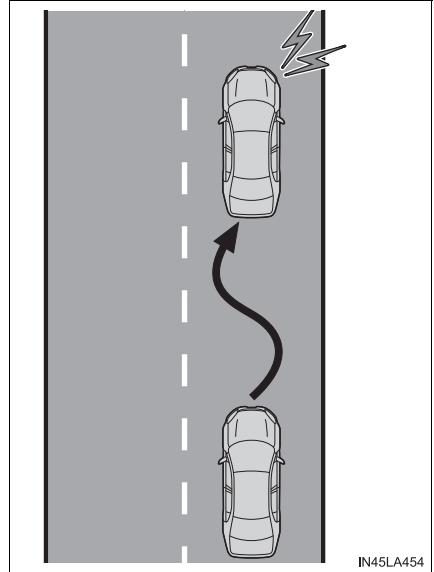

⚠ WARNING

■ Before using LDA system

Do not rely solely upon the LDA system. The LDA system does not automatically drive the vehicle or reduce the amount of attention that must be paid to the area in front of the vehicle. The driver must always assume full responsibility for driving safely by paying careful attention to the surrounding conditions and operating the steering wheel to correct the path of the vehicle. Also, the driver must take adequate breaks when fatigued, such as from driving for a long period of time.

Failure to perform appropriate driving operations and pay careful attention may lead to an accident, resulting in death or serious injury.

■ To avoid operating LDA system by mistake

When not using the LDA system, use the LDA switch to turn the system off.

**WARNING****■ Situations unsuitable for LDA system**

Do not use the LDA system in the following situations.

The system may not operate properly and lead to an accident, resulting in death or serious injury.

- A spare tire, tire chains, etc. are equipped.
- When the tires have been excessively worn, or when the tire inflation pressure is low.
- Tires which differ by structure, manufacturer, brand or tread pattern are used.
- Objects or patterns that could be mistaken for white (yellow) lines are present on the side of the road (guardrails, curbs, reflective poles, etc.).
- Vehicle is driven on a snow-covered road.
- White (yellow) lines are difficult to see due to rain, snow, fog, dust, etc.
- Asphalt repair marks, white (yellow) line marks, etc. are present due to road repair.
- Vehicle is driven in a temporary lane or restricted lane due to construction work.
- Vehicle is driven on a road surface which is slippery due to rainy weather, fallen snow, freezing, etc.
- Vehicle is driven in traffic lanes other than on highways and freeways.
- Vehicle is driven in a construction zone.

■ Preventing LDA system malfunctions and operations performed by mistake

- Do not modify the headlights or place stickers, etc. on the surface of the lights.
- Do not modify the suspension etc. If the suspension etc. needs to be replaced, contact your Toyota dealer.
- Do not install or place anything on the hood or grille. Also, do not install a grille guard (bull bars, kangaroo bar, etc.).
- If your windshield needs repairs, contact your Toyota dealer.

Turning LDA system on

Press the LDA switch to turn the LDA system on.

The LDA indicator illuminates and a message is displayed on the multi-information display.

Press the LDA switch again to turn the LDA system off.

When the LDA system is turned on or off, operation of the LDA system continues in the same condition the next time the hybrid system is started.

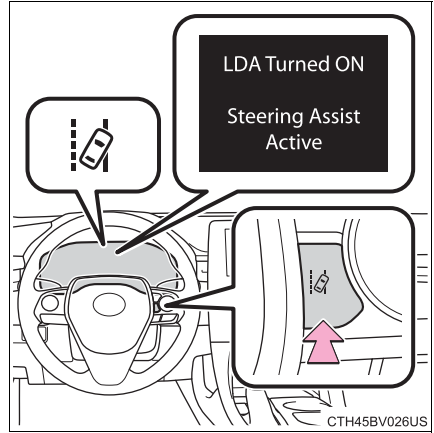

Indications on multi-information display

The illustration used is intended as an example, and may differ from the image that is actually displayed on the multi-information display.

① LDA indicator

The illumination condition of the indicator informs the driver of the system operation status.

Illuminated in white:
LDA system is operating.

Illuminated in green:
Steering wheel assistance of the steering control function is operating.

Flashing in amber:
Lane departure alert function is operating.

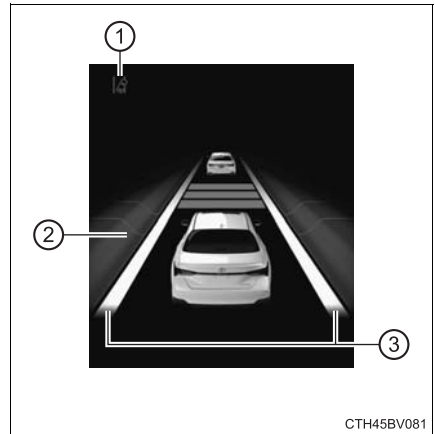

CTH45BV081

② Operation display of steering wheel operation support

Indicates that steering wheel assistance of the steering control function is operating.

③ Lane departure alert function display

Displayed when the multi-information display is switched to the driving assist system information screen.

▶ Inside of displayed white lines is white

▶ Inside of displayed white lines is black

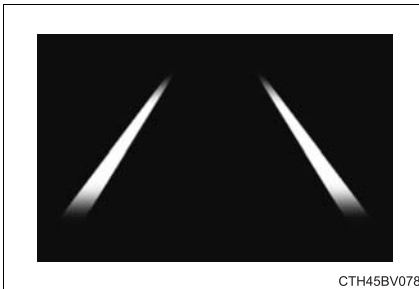

CTH45BV078

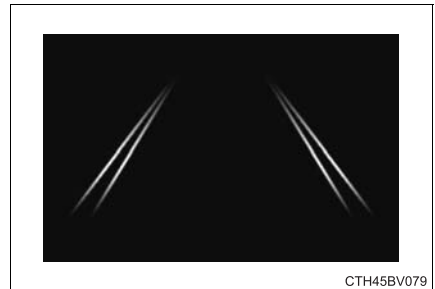

CTH45BV079

Indicates that the system is recognizing white (yellow) lines. When the vehicle departs from its lane, the white line displayed on the side the vehicle departs from flashes yellow.

Indicates that the system is not able to recognize white (yellow) lines or is temporarily canceled.

■ Operation conditions of each function

● Lane departure alert function

This function operates when all of the following conditions are met.

- LDA is turned on.
- Vehicle speed is approximately 32 mph (50 km/h) or more.
- System recognizes white (yellow) lines.
- Width of traffic lane is approximately 9.8 ft. (3 m) or more.
- Turn signal lever is not operated.
- Vehicle is driven on a straight road or around a gentle curve with a radius of more than approximately 492 ft. (150 m).
- No system malfunctions are detected. (→P. 262)

● Steering control function

This function operates when all of the following conditions are met in addition to the operation conditions for the lane departure alert function.

- Setting for “Steering Assist” in  of the multi-information display is set to “On”. (→P. 111)
- Vehicle is not accelerated or decelerated by a certain amount or more.
- Steering wheel is not operated with a steering force level suitable for changing lanes.
- ABS, VSC, TRAC and PCS are not operating.
- TRAC or VSC is not turned off.
- Hands off steering wheel warning is not displayed. (→P. 260)

● Vehicle sway warning function

This function operates when all of the following conditions are met.

- Setting for “Sway Warning” in  of the multi-information display is set to “On”. (→P. 111)
- Vehicle speed is approximately 32 mph (50 km/h) or more.
- Width of traffic lane is approximately 9.8 ft. (3 m) or more.
- No system malfunctions are detected. (→P. 262)

■ Temporary cancellation of functions

When the operation conditions are no longer met, a function may be temporarily canceled. However, when the operation conditions are met again, operation of the function is automatically restored. (→P. 259)

■ Steering control function

Depending on the vehicle speed, lane departure situation, road conditions, etc., the driver may not feel the function is operating or the function may not operate at all.

■ Lane departure alert function

The warning buzzer may be difficult to hear due to external noise, audio playback, etc.

■ Hands off steering wheel warning

When the system determines that the driver has removed their hands from the steering wheel while the steering control function is operating, a warning message urging the driver to hold the steering wheel and the symbol shown in the illustration are displayed on the multi-information display.



If the driver continues to keep their hands off of the steering wheel, a warning message and the symbol shown in the illustration are displayed on the multi-information display, and the function is temporarily canceled.

This warning also operates in the same way when the driver continuously operates the steering wheel only a small amount. Always keep your hands on the steering wheel when using this system, regardless of warnings.

Depending on the vehicle and road conditions, the warning may not operate.

■ Vehicle sway warning function

When the system determines that the vehicle is swaying while the vehicle sway warning function is operating, a buzzer sounds and a warning message urging the driver to rest and the symbol shown in the illustration are simultaneously displayed on the multi-information display.



Depending on the vehicle and road conditions, the warning may not operate.

■ White (yellow) lines are only on one side of road

The LDA system will not operate for the side on which white (yellow) lines could not be recognized.

■ Conditions in which functions may not operate properly

In the following situations, the camera sensor may not detect white (yellow) lines and various functions may not operate normally.

- There are shadows on the road that run parallel with, or cover, the white (yellow) lines.
- The vehicle is driven in an area without white (yellow) lines, such as in front of a tollgate or checkpoint, or at an intersection, etc.
- The white (yellow) lines are cracked, “Botts’ dots”, “Raised pavement marker” or stones are present.
- The white (yellow) lines cannot be seen or are difficult to see due to sand, etc.
- The vehicle is driven on a road surface that is wet due to rain, puddles, etc.
- The traffic lines are yellow (which may be more difficult to recognize than lines that are white).
- The white (yellow) lines cross over a curb, etc.
- The vehicle is driven on a bright surface, such as concrete.
- The vehicle is driven on a surface that is bright due to reflected light, etc.
- The vehicle is driven in an area where the brightness changes suddenly, such as at the entrances and exits of tunnels, etc.
- Light from the headlights of an oncoming vehicle, the sun, etc. enters the camera.
- The vehicle is driven where the road diverges, merges, etc.
- The vehicle is driven on a slope.
- The vehicle is driven on a road which tilts left or right, or a winding road.
- The vehicle is driven on an unpaved or rough road.
- The vehicle is driven around a sharp curve.
- The traffic lane is excessively narrow or wide.
- The vehicle is extremely tilted due to carrying heavy luggage or having improper tire pressure.
- The distance to the preceding vehicle is extremely short.
- The vehicle is moving up and down a large amount due to road conditions during driving (poor roads or road seams).
- The headlight lenses are dirty and emit a faint amount of light at night, or the beam axis has deviated.
- The vehicle is struck by a crosswind.
- The vehicle has just changed lanes or crossed an intersection.
- Snow tires, etc. are equipped.

■ Warning message

If the following warning message is displayed on the multi-information display and the LDA indicator illuminates in amber, follow the appropriate troubleshooting procedure.

Warning message	Details/Actions
"LDA Malfunction Visit Your Dealer"	The system may not be operating properly. → Have the vehicle inspected at your Toyota dealer.
"Front Camera Unavailable"	The operation conditions of the camera sensor (temperature, etc.) are not met. → When the operation conditions of the camera sensor (temperature, etc.) are met, the LDA system will become available. Turn the LDA system off, wait for a little while, and then turn the LDA system back on.
"LDA Unavailable"	The LDA system is temporarily canceled due to a malfunction in a sensor other than the camera sensor. → Turn the LDA system off and follow the appropriate troubleshooting procedures for the warning message. Afterward, drive the vehicle for a short time, and then turn the LDA system back on.
"LDA Unavailable Below Approx. 32MPH"	The LDA system cannot be used as the vehicle speed is less than approximately 32 mph (50 km/h). → Drive the vehicle at approximately 32 mph (50 km/h) or more.

If a different warning message is displayed, follow the instructions displayed on the screen. (→P. 469)

■ Customization

Some functions can be customized. (→P. 111)

Dynamic radar cruise control with full-speed range

Summary of functions

In vehicle-to-vehicle distance control mode, the vehicle automatically accelerates, decelerates and stops to match the speed changes of the preceding vehicle even if the accelerator pedal is not depressed. In constant speed control mode, the vehicle runs at a fixed speed.

Use the dynamic radar cruise control with full-speed range on free-ways and highways.

- Vehicle-to-vehicle distance control mode (→P. 266)
- Constant speed control mode (→P. 272)

■ Meter display

- ① Display
- ② Set speed
- ③ Indicators

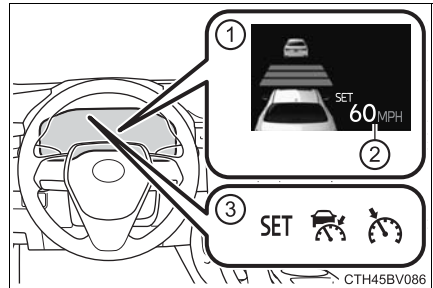

■ Operation switches

- ① Vehicle-to-vehicle distance switch
- ② “+ RES” switch
- ③ Cruise control main switch
- ④ Cancel switch
- ⑤ “- SET” switch

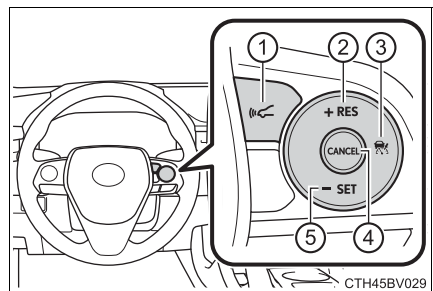

**WARNING****■ Before using dynamic radar cruise control with full-speed range**

- Driving safely is the sole responsibility of the driver. Do not rely solely on the system, and drive safely by always paying careful attention to your surroundings.
- The dynamic radar cruise control with full-speed range provides driving assistance to reduce the driver's burden. However, there are limitations to the assistance provided.
Read the following conditions carefully. Do not overly rely on this system and always drive carefully.
 - When the sensor may not be correctly detecting the vehicle ahead:
→P. 274
 - Conditions under which the vehicle-to-vehicle distance control mode may not function correctly: →P. 275
- Set the speed appropriately depending on the speed limit, traffic flow, road conditions, weather conditions, etc. The driver is responsible for checking the set speed.
- Even when the system is functioning normally, the condition of the preceding vehicle as detected by the system may differ from the condition observed by the driver. Therefore, the driver must always remain alert, assess the danger of each situation and drive safely. Relying on this system or assuming the system ensures safety while driving can lead to an accident, resulting in death or serious injury.
- Switch the dynamic radar cruise control with full-speed range off using the cruise control main switch when not in use.

■ Cautions regarding the driving assist systems

Observe the following precautions, as there are limitations to the assistance provided by the system.

Failure to do so may cause an accident resulting in death or serious injury.

- **Assisting the driver to measure following distance**
The dynamic radar cruise control with full-speed range is only intended to help the driver in determining the following distance between the driver's own vehicle and a designated vehicle traveling ahead. It is not a mechanism that allows careless or inattentive driving, and it is not a system that can assist the driver in low-visibility conditions. It is still necessary for driver to pay close attention to the vehicle's surroundings.
- **Assisting the driver to judge proper following distance**
The dynamic radar cruise control with full-speed range determines whether the following distance between the driver's own vehicle and a designated vehicle traveling ahead is within a set range. It is not capable of making any other type of judgement. Therefore, it is absolutely necessary for the driver to remain vigilant and to determine whether or not there is a possibility of danger in any given situation.

**WARNING**

- Assisting the driver to operate the vehicle

The dynamic radar cruise control with full-speed range has limited capability to prevent or avoid a collision with a vehicle traveling ahead. Therefore, if there is ever any danger, the driver must take immediate and direct control of the vehicle and act appropriately in order to ensure the safety of all involved.

■ **Situations unsuitable for dynamic radar cruise control with full-speed range**

Do not use dynamic radar cruise control with full-speed range in any of the following situations.

Doing so may result in inappropriate speed control and could cause an accident resulting in death or serious injury.

- Roads where there are pedestrians, cyclists, etc.
- In heavy traffic
- On roads with sharp bends
- On winding roads
- On slippery roads, such as those covered with rain, ice or snow
- On steep downhill, or where there are sudden changes between sharp up and down gradients
Vehicle speed may exceed the set speed when driving down a steep hill.
- At entrances to freeways and highways
- When weather conditions are bad enough that they may prevent the sensors from detecting correctly (fog, snow, sandstorm, heavy rain, etc.)
- When there is rain, snow, etc. on the front surface of the radar sensor or camera sensor
- In traffic conditions that require frequent repeated acceleration and deceleration
- When an approach warning buzzer is heard often

Driving in vehicle-to-vehicle distance control mode

This mode employs a radar sensor to detect the presence of vehicles up to approximately 328 ft. (100 m) ahead, determines the current vehicle-to-vehicle following distance, and operates to maintain a suitable following distance from the vehicle ahead.

Note that vehicle-to-vehicle distance will close in when traveling on down-hill slopes.

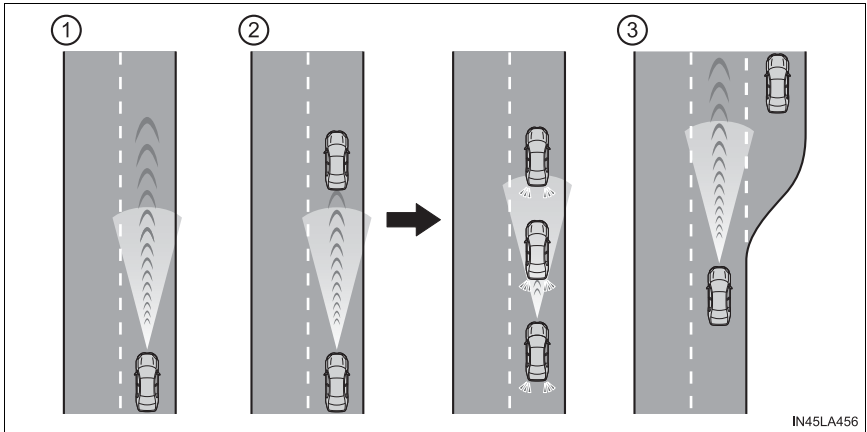

① Example of constant speed cruising

When there are no vehicles ahead

The vehicle travels at the speed set by the driver. The desired vehicle-to-vehicle distance can also be set by operating the vehicle-to-vehicle distance switch.

② Example of deceleration cruising and follow-up cruising

When a preceding vehicle driving slower than the set speed appears

When a vehicle is detected running ahead of you, the system automatically decelerates your vehicle. When a greater reduction in vehicle speed is necessary, the system applies the brakes (the stop lights will come on at this time). The system will respond to changes in the speed of the vehicle ahead in order to maintain the vehicle-to-vehicle distance set by the driver. Approach warning warns you when the system cannot decelerate sufficiently to prevent your vehicle from closing in on the vehicle ahead.

When the vehicle ahead of you stops, your vehicle will also stop (vehicle is stopped by system control). After the vehicle ahead starts off, pressing the "+ RES" switch or depressing the accelerator pedal will resume follow-up cruising.

③ Example of acceleration

When there are no longer any preceding vehicles driving slower than the set speed

The system accelerates until the set speed is reached. The system then returns to constant speed cruising.

Setting the vehicle speed (vehicle-to-vehicle distance control mode)

- 1 Press the cruise control main switch to activate the cruise control.

Dynamic radar cruise control indicator will come on and a message will be displayed on the multi-information display.

Press the switch again to deactivate the cruise control.

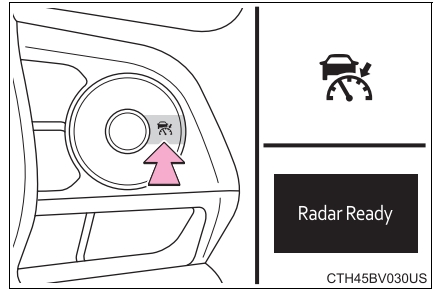

If the cruise control main switch is pressed and held for 1.5 seconds or more, the system turns on in constant speed control mode. (→P. 272)

- 2 Accelerate or decelerate, with accelerator pedal operation, to the desired vehicle speed (at or above approximately 30 mph [50 km/h]) and press the “- SET” switch to set the speed.

Cruise control “SET” indicator will come on.

The vehicle speed at the moment the switch is released becomes the set speed.

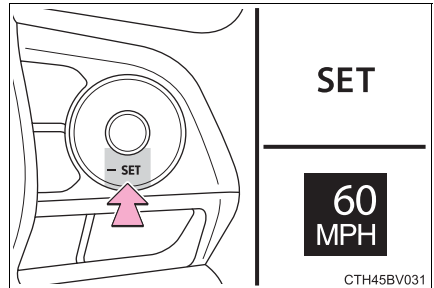

If the switch is operated while the vehicle speed is below approximately 30 mph (50 km/h) and a preceding vehicle is present, the set speed will be adjusted to approximately 30 mph (50 km/h).

Adjusting the set speed

To change the set speed, operate the “+ RES” or “- SET” switch until the desired set speed is displayed.

① Increases the speed

(Except when the vehicle has been stopped by system control in vehicle-to-vehicle distance control mode)

② Decreases the speed

Fine adjustment: Press the switch.

Large adjustment: Press and hold the switch to change the speed, and release when the desired speed is reached.

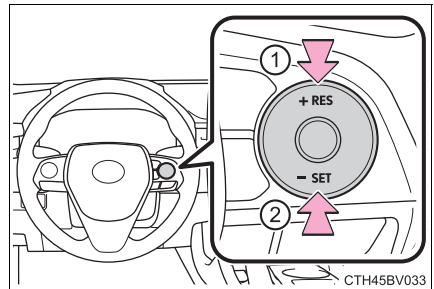

In the vehicle-to-vehicle distance control mode, the set speed will be increased or decreased as follows:

► For U.S. mainland and Hawaii

Fine adjustment: By 1 mph (1.6 km/h)^{*1} or 1 km/h (0.6 mph)^{*2} each time the switch is pressed

Large adjustment: Increases or decreases in 1 mph (1.6 km/h)^{*1} or 1 km/h (0.6 mph)^{*2} increments for as long as the switch is held

► For Puerto Rico

Fine adjustment: By 1 mph (1.6 km/h)^{*1} or 1 km/h (0.6mph)^{*2} each time the switch is pressed

Large adjustment: Increases or decreases in 5 mph (8 km/h)^{*1} or 5 km/h (3.1 mph)^{*2} increments for as long as the switch is held

In the constant speed control mode (→P. 272), the set speed will be increased or decreased as follows:

Fine adjustment: By 1 mph (1.6 km/h)^{*1} or 1 km/h (0.6 mph)^{*2} each time the switch is pressed

Large adjustment: The speed will continue to change while the switch is held.

*1: When the set speed is shown in “MPH”

*2: When the set speed is shown in “km/h”

Changing the vehicle-to-vehicle distance (vehicle-to-vehicle distance control mode)

Pressing the switch changes the vehicle-to-vehicle distance as follows:

- ① Long
- ② Medium
- ③ Short

The vehicle-to-vehicle distance is set automatically to long mode when the power switch is turned to ON mode.

If a vehicle is running ahead of you, the preceding vehicle mark will also be displayed.

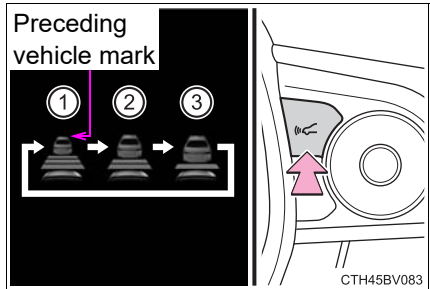

Vehicle-to-vehicle distance settings (vehicle-to-vehicle distance control mode)

Select a distance from the table below. Note that the distances shown correspond to a vehicle speed of 50 mph (80 km/h). Vehicle-to-vehicle distance increases/decreases in accordance with vehicle speed. When the vehicle is stopped by system control, the vehicle stops at a certain vehicle-to-vehicle distance depending on the situation.

Distance options	Vehicle-to-vehicle distance
Long	Approximately 160 ft. (50 m)
Medium	Approximately 130 ft. (40 m)
Short	Approximately 100 ft. (30 m)

Resuming follow-up cruising when the vehicle has been stopped by system control (vehicle-to-vehicle distance control mode)

After the vehicle ahead of you starts off, press the “+ RES” switch.

Your vehicle will also resume follow-up cruising if the accelerator pedal is depressed after the vehicle ahead of you starts off.

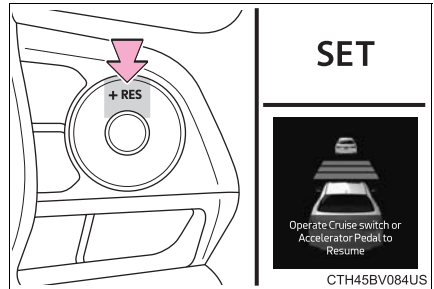

Canceling and resuming the speed control

- ① Pressing the cancel switch cancels the speed control.

The speed control is also canceled when the brake pedal is depressed.

(When the vehicle has been stopped by system control, depressing the brake pedal does not cancel the setting.)

- ② Pressing the “+ RES” switch resumes the cruise control and returns vehicle speed to the set speed.

However, when a vehicle ahead is not detected, cruise control does not resume when the vehicle speed is approximately 25 mph (40 km/h) or less.

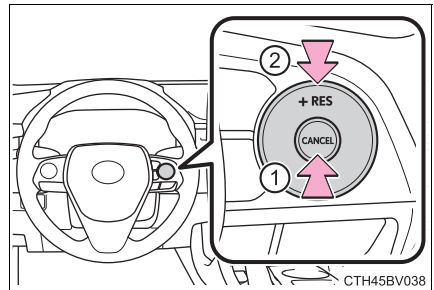

Approach warning (vehicle-to-vehicle distance control mode)

When your vehicle is too close to a vehicle ahead, and sufficient automatic deceleration via the cruise control is not possible, the display will flash and the buzzer will sound to alert the driver. An example of this would be if another driver cuts in front of you while you are following a vehicle. Depress the brake pedal to ensure an appropriate vehicle-to-vehicle distance.

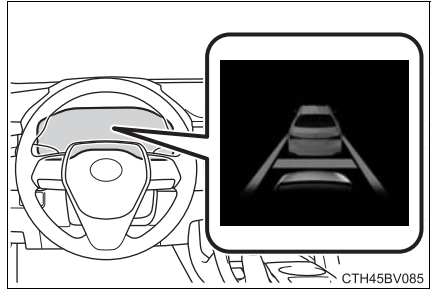
**■ Warnings may not occur when**

In the following instances, warnings may not occur even when the vehicle-to-vehicle distance is small.

- When the speed of the preceding vehicle matches or exceeds your vehicle speed
- When the preceding vehicle is traveling at an extremely slow speed
- Immediately after the cruise control speed was set
- When depressing the accelerator pedal

Selecting constant speed control mode

When constant speed control mode is selected, your vehicle will maintain a set speed without controlling the vehicle-to-vehicle distance. Select this mode only when vehicle-to-vehicle distance control mode does not function correctly due to a dirty radar sensor, etc.

- 1 With the cruise control off, press and hold the cruise control main switch for 1.5 seconds or more.

Immediately after the switch is pressed, the radar cruise control indicator will come on. Afterwards, it switches to the cruise control indicator.

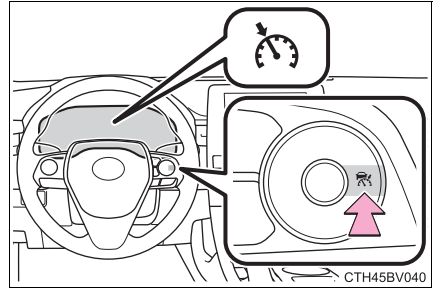

Switching to constant speed control mode is only possible when operating the switch with the cruise control off.

- 2 Accelerate or decelerate, with accelerator pedal operation, to the desired vehicle speed (at or above approximately 25 mph [40 km/h]) and press the “- SET” switch to set the speed.

Cruise control “SET” indicator will come on.

The vehicle speed at the moment the switch is released becomes the set speed.

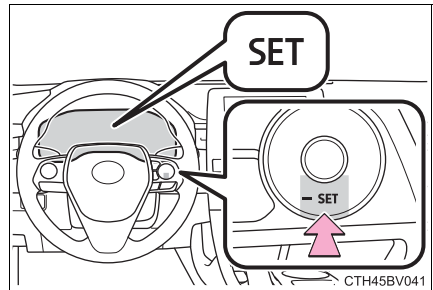

Adjusting the speed setting: →P. 268

Canceling and resuming the speed setting: →P. 270

■ Dynamic radar cruise control with full-speed range can be set when

- The shift lever is in D or range 4 or higher of S has been selected.
- Range 4 or higher of D has been selected by using the paddle shift switch. (vehicles with paddle shift switches)
- Vehicle speed is at or above approximately 30 mph (50 km/h). However, when a preceding vehicle is detected, the dynamic radar cruise control with full-speed range can be set even if the vehicle speed is below approximately 30 mph (50 km/h).

■ Accelerating after setting the vehicle speed

The vehicle can accelerate by operating the accelerator pedal. After accelerating, the set speed resumes. However, during vehicle-to-vehicle distance control mode, the vehicle speed may decrease below the set speed in order to maintain the distance to the preceding vehicle.

■ When the vehicle stops while follow-up cruising

- Pressing the “+ RES” switch while the vehicle ahead stops will resume follow-up cruising if the vehicle ahead starts off within approximately 3 seconds after the switch is pressed.
- If the vehicle ahead starts off within 3 seconds after your vehicle stops, follow-up cruising will be resumed.

■ Automatic cancelation of vehicle-to-vehicle distance control mode

Vehicle-to-vehicle distance control mode is automatically canceled in the following situations.

- Actual vehicle speed falls at or below approximately 25 mph (40 km/h) when there are no vehicles ahead.
- The preceding vehicle leaves the lane when your vehicle is following at a vehicle speed at or below approximately 25 mph (40 km/h). Otherwise, the sensor can not properly detect the vehicle. (“Radar Cruise Control Unavailable” is displayed on the multi-information display)
- VSC is activated.
- TRAC is activated for a period of time.
- When the VSC or TRAC system is turned off.
- The sensor cannot detect correctly because it is covered in some way.
- Pre-collision braking is activated.
- The parking brake is operated.
- The vehicle is stopped by system control on a steep incline.
- The following are detected when the vehicle has been stopped by system control:
 - The driver is not wearing a seat belt.
 - The driver’s door is opened.
 - The vehicle has been stopped for about 3 minutes

If vehicle-to-vehicle distance control mode is automatically canceled for any other reason, there may be a malfunction in the system. Contact your Toyota dealer.

■ Automatic cancelation of constant speed control mode

Constant speed control mode is automatically canceled in the following situations:

- Actual vehicle speed is more than approximately 10 mph (16 km/h) below the set vehicle speed.
- Actual vehicle speed falls below approximately 25 mph (40 km/h).
- VSC is activated.
- TRAC is activated for a period of time.
- When the VSC or TRAC system is turned off.
- Pre-collision braking is activated.

If constant speed control mode is automatically canceled for any other reason, there may be a malfunction in the system. Contact your Toyota dealer.

■ Brake system operation sound

If the brakes are applied automatically while the vehicle is in vehicle-to-vehicle distance control mode, a brake system operation sound may be heard. This does not indicate a malfunction.

■ Warning messages and buzzers for dynamic radar cruise control with full-speed range

Warning messages and buzzers are used to indicate a system malfunction or to inform the driver of the need for caution while driving. If a warning message is shown on the multi-information display, read the message and follow the instructions.

■ When the sensor may not be correctly detecting the vehicle ahead

In the case of the following and depending on the conditions, operate the brake pedal when deceleration of the system is insufficient or operate the accelerator pedal when acceleration is required.

As the sensor may not be able to correctly detect these types of vehicles, the approach warning (→P. 271) may not be activated.

- Vehicles that cut in suddenly
- Vehicles traveling at low speeds
- Vehicles that are not moving in the same lane
- Vehicles with small rear ends (trailers with no load on board, etc.)

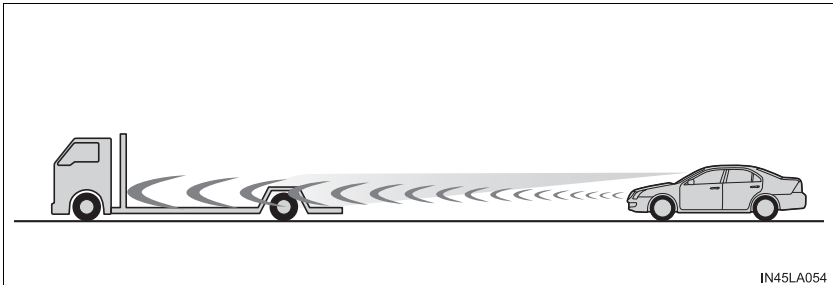

- Motorcycles traveling in the same lane
- When water or snow thrown up by the surrounding vehicles hinders the detecting of the sensor
- When your vehicle is pointing upwards (caused by a heavy load in the luggage compartment, etc.)

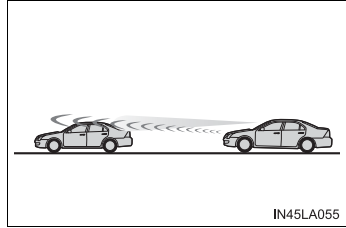

- Preceding vehicle has an extremely high ground clearance

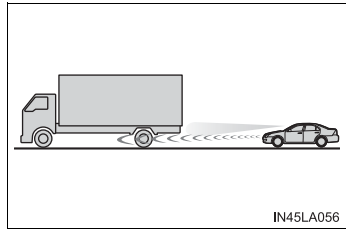

■ Conditions under which the vehicle-to-vehicle distance control mode may not function correctly

In the case of the following conditions, operate the brake pedal (or accelerator pedal, depending on the situation) as necessary.

As the sensor may not be able to correctly detect vehicles ahead, the system may not operate properly.

- When the road curves or when the lanes are narrow

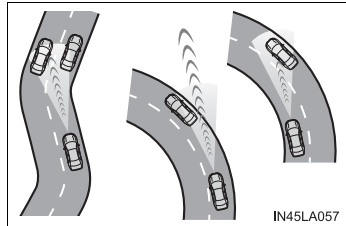

- When steering wheel operation or your position in the lane is unstable

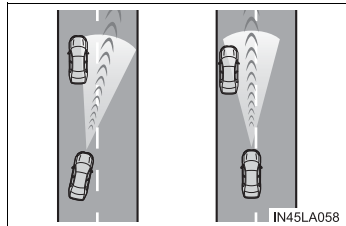

- When the vehicle ahead of you decelerates suddenly
- When driving on a road surrounded by a structure, such as in a tunnel or on a bridge
- While the vehicle speed is decreasing to the set speed after the vehicle accelerates by depressing the accelerator pedal

BSM (Blind Spot Monitor)

Summary of the Blind Spot Monitor

The Blind Spot Monitor is a system that has 2 functions;

- The BSM (Blind Spot Monitor) function
 - Assists the driver in making a decision when changing lanes
- The RCTA (Rear Cross Traffic Alert) function
 - Assists the driver when backing up

These functions use same sensors.

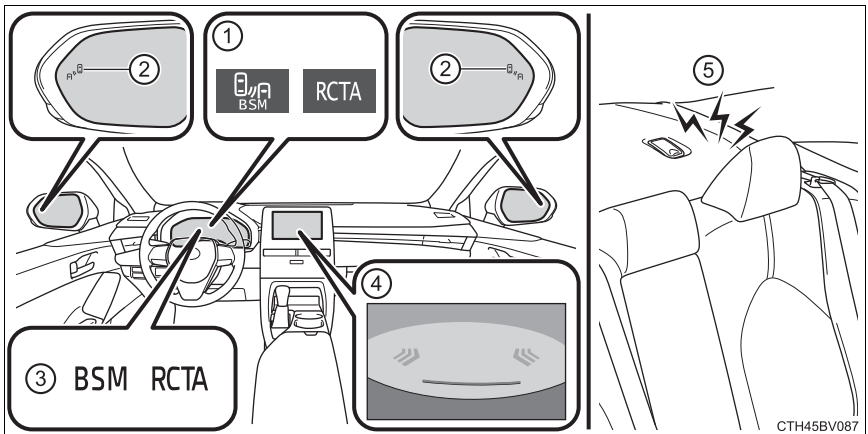

① Multi-information display

Turning the BSM function/RCTA function on/off. (→P. 277)

② Outside rear view mirror indicators

BSM function:

When a vehicle is detected in the blind spot, the outside rear view mirror indicator comes on while the turn signal lever is not operated and the outside rear view mirror indicator flashes while the turn signal lever is operated.

RCTA function:

When a vehicle approaching from the right or left rear of the vehicle is detected, the outside rear view mirror indicators flash.

③ “BSM” indicator/“RCTA” indicator

When the BSM function/RCTA function is turned on, the indicator illuminates.









④ Audio system screen (RCTA function only)

If a vehicle approaching from the right or left at the rear of the vehicle is detected, the RCTA icon (→P. 284) for the detected side will be displayed.

⑤ RCTA buzzer (RCTA function only)

When a vehicle approaching from the right or left rear of the vehicle is detected, a buzzer sounds from behind the rear seat.

Turning the BSM function/RCTA function on/off

- 1 Press  /  of the meter control switches, select .
- 2 Press  /  of the meter control switched, select  or .
- 3 Press  of the meter control switch.

Each time  is pressed, the function changes on/off.

■ The outside rear view mirror indicators visibility

When under strong sunlight, the outside rear view mirror indicator may be difficult to see.

■ RCTA buzzer hearing

RCTA function may be difficult to hear over loud noises such as high audio volume.

■ When “Blind Spot Monitor Unavailable” or “Rear Cross Traffic Alert Unavailable” are shown on the multi-information display

Ice, snow, mud, etc., may be attached to the rear bumper around the sensors. (→P. 279)

The system should return to normal operation after removing the ice, snow, mud, etc., from the rear bumper. Additionally, the sensors may not operate normally when driving in extremely hot or cold environments.

■ When there is a malfunction in the Blind Spot Monitor

If a system malfunction is detected due to any of the following reasons, a warning message will be displayed:

- There is a malfunction with the sensors
- The sensors have become dirty
- The outside temperature is extremely high or low
- The sensor voltage has become abnormal

■ Certification for the Blind Spot Monitor

FCC ID: HYQDNSRR003

FCC ID: HYQDNSRR004

NOTE:

This device complies with part 15 of the FCC Rules. Operation is subject to the following two conditions: (1) This device may not cause harmful interference, and (2) this device must accept any interference received, including interference that may cause undesired operation.

FCC WARNING:

Changes or modifications not expressly approved by the party responsible for compliance could void the user's authority to operate the equipment.

⚠ WARNING

■ Handling the radar sensor

One Blind Spot Monitor sensor is installed inside the left and right side of the vehicle rear bumper respectively. Observe the following to ensure the Blind Spot Monitor can function correctly.

- Keep the sensor and its surrounding area on the bumper clean at all times.

If a sensor or its surrounding area on the rear bumper is dirty or covered with snow, the Blind Spot Monitor may not operate and a warning message (→P. 277) will be displayed.

In this situation, clear off the dirt or snow and drive the vehicle with the operation conditions of the BSM function (→P. 281) satisfied for approximately 60 minutes.

If the warning message does not disappear, have the vehicle inspected by your Toyota dealer.

- Do not subject a sensor or its surrounding area on the rear bumper to a strong impact.

If a sensor is moved even slightly off position, the system may malfunction and vehicles may not be detected correctly.

In the following situations, have your vehicle inspected by your Toyota dealer.

- A sensor or its surrounding area is subject to a strong impact.
- If the surrounding area of a sensor is scratched or dented, or part of them has become disconnected.
- Do not disassemble the sensor.
- Do not attach accessories or stickers to the sensor or surrounding area on the bumper.
- Do not modify the sensor or surrounding area on the bumper.
- Do not paint the rear bumper any color other than an official Toyota color.

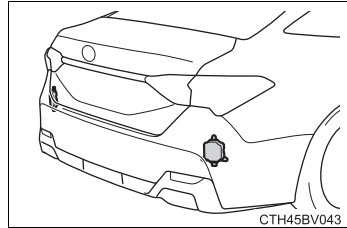

BSM function

The BSM function uses radar sensors to detect vehicles that are traveling in an adjacent lane in the area that is usually not reflected in the outside rear view mirror (the blind spot), and advises the driver of the vehicles existence via the outside rear view mirror indicator.

BSM function detection areas

The areas that vehicles can be detected in are outlined below.

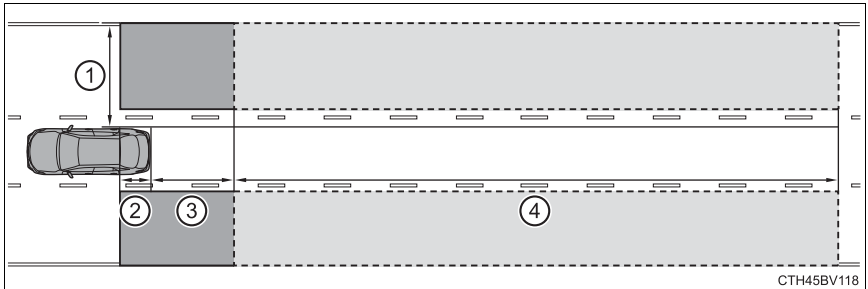

The range of the detection area is:

- ① Approximately 1.6 ft. (0.5 m) to 11.5 ft. (3.5 m) from either side of the vehicle
The area between the side of the vehicle and 1.6 ft. (0.5 m) from the side of the vehicle cannot be detected.
- ② Approximately 3.3 ft. (1 m) forward of the rear bumper
- ③ Approximately 9.8 ft. (3 m) from the rear bumper
- ④ Approximately 9.8 ft. (3 m) to 197 ft. (60 m) from the rear bumper

The greater the difference in speed between your vehicle and the detected vehicle is, the farther away the vehicle will be detected, causing the outside rear view mirror indicator to illuminate or flash.

**WARNING****■ Cautions regarding the use of the system**

The driver is solely responsible for safe driving. Always drive safely, taking care to observe your surroundings.

The BSM function is a supplementary function which alerts the driver that a vehicle is present in the blind spot. Do not overly rely on the BSM function. The function cannot judge if it is safe to change lanes, therefore over reliance could cause an accident resulting in death or serious injury.

According to conditions, the system may not function correctly. Therefore the driver's own visual confirmation of safety is necessary.

■ The BSM function is operational when

- The BSM function is turned on
- Vehicle speed is greater than approximately 10 mph (16 km/h).

■ The BSM function will detect a vehicle when

- A vehicle in an adjacent lane overtakes your vehicle.
- You overtake a vehicle in adjacent lane slowly.
- Another vehicle enters the detection area when it changes lanes.

■ Conditions under which the BSM function will not detect a vehicle

The BSM function is not designed to detect the following types of vehicles and/or objects:

- Small motorcycles, bicycles, pedestrians, etc.*
- Vehicles traveling in the opposite direction
- Guardrails, walls, signs, parked vehicles and similar stationary objects*
- Following vehicles that are in the same lane*
- Vehicles driving 2 lanes across from your vehicle*
- Vehicles which are being overtaken rapidly by your vehicle

*: Depending on the conditions, detection of a vehicle and/or object may occur.

■ Conditions under which the BSM function may not function correctly

- The BSM function may not detect vehicles correctly in the following conditions:
 - When the sensor is misaligned due to a strong impact to the sensor or its surrounding area
 - During bad weather such as heavy rain, fog, snow, etc.
 - When mud, snow, ice, a sticker, etc., is covering the sensor or surrounding area on the rear bumper
 - When driving on a road surface that is wet due to rain, standing water, snow, etc.
 - When there is a significant difference in speed between your vehicle and the vehicle that enters the detection area
 - When a vehicle is in the detection area from a stop and remains in the detection area as your vehicle accelerates
 - When driving up or down consecutive steep inclines, such as hills, a dip in the road, etc.
 - When driving on roads with sharp bends, consecutive curves, or uneven surfaces
 - When multiple vehicles approach with only a small gap between each vehicle
 - When vehicle lanes are wide, and the vehicle in the next lane is too far away from your vehicle
 - When the vehicle that enters the detection area is traveling at about the same speed as your vehicle
 - When there is a significant difference in height between your vehicle and the vehicle that enters the detection area
 - Immediately after the BSM function is turned on

- Instances of the BSM function unnecessarily detecting a vehicle and/or object may increase under the following conditions:
 - When the sensor is misaligned due to a strong impact to the sensor or its surrounding area
 - When there is only a short distance between your vehicle and a guardrail, wall, etc.
 - When there is only a short distance between your vehicle and a following vehicle
 - When vehicle lanes are narrow and a vehicle driving 2 lanes across from your vehicle enters the detection area
 - When driving on roads with sharp bends, consecutive curves, or uneven surfaces
 - When items such as a bicycle carrier are installed on the rear of the vehicle

RCTA function

The RCTA functions when your vehicle is in reverse. It can detect other vehicles approaching from the right or left rear of the vehicle. It uses radar sensors to alert the driver of the other vehicle's existence through flashing the outside rear view mirror indicators and sounding a buzzer.

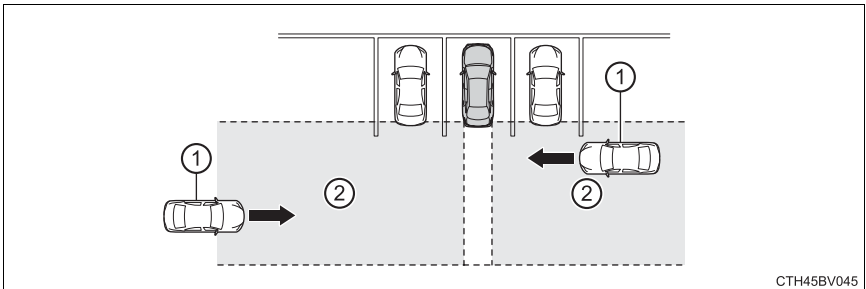



① Approaching vehicles

② Detection areas

■ RCTA icon display

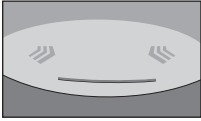
When a vehicle approaching from the right or left at the rear of the vehicle is detected, the following will be displayed on the audio system screen.

Toyota parking assist monitor	Panoramic view monitor	Content
		<p>A vehicle is approaching from the left or right at the rear of the vehicle</p>

: The RCTA function is malfunctioning (→P. 277)

WARNING

■ Cautions regarding the use of the system

The driver is solely responsible for safe driving. Always drive safely, taking care to observe your surroundings.

The RCTA function is only an assist and is not a replacement for careful driving. Driver must be careful when backing up, even when using RCTA function. The driver's own visual confirmation of behind you and your vehicle is necessary and be sure there are no pedestrians, other vehicles, etc., before backing up. Failure to do so could cause death or serious injury.

According to conditions, the system may not function correctly. Therefore the driver's own visual confirmation of safety is necessary.

RCTA function detection areas

The areas that vehicles can be detected in are outlined below.

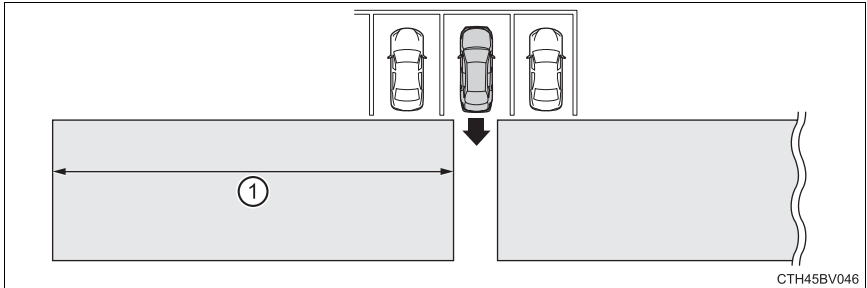

To give the driver a more consistent time to react, the buzzer can alert for faster vehicles from farther away.

Example:

Approaching vehicle	Speed	① Approximate alert distance
Fast	18 mph (28 km/h)	65 ft. (20 m)
Slow	5 mph (8 km/h)	18 ft. (5.5 m)

■ The RCTA function is operational when

- The RCTA function is turned on.
- The shift lever is in R.
- Vehicle speed is less than approximately 5 mph (8 km/h).
- Approaching vehicle speed is between approximately 5 mph (8 km/h) and 18 mph (28 km/h).

■ Conditions under which the RCTA function will not detect a vehicle

The RCTA function is not designed to detect the following types of vehicles and/or objects:

- Small motorcycles, bicycles, pedestrians, etc.*
- Vehicles approaching from directly behind
- Vehicles that the sensors cannot detect due to obstructions

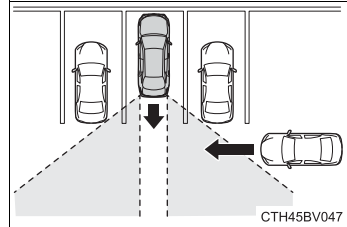

- Guardrails, walls, signs, parked vehicles and similar stationary objects*
- Vehicles moving away from your vehicle
- Vehicles approaching from the parking spaces next to your vehicle*
- Vehicles backing up in the parking space next to your vehicle*

*: Depending on the conditions, detection of a vehicle and/or object may occur.

■ Conditions under which the RCTA function may not function correctly

- The RCTA function may not detect vehicles correctly in the following conditions:
 - When the sensor is misaligned due to a strong impact to the sensor or its surrounding area
 - When mud, snow, ice, a sticker, etc., is covering the sensor or surrounding area on the rear bumper
 - During bad weather such as heavy rain, fog, snow, etc.
 - When multiple vehicles approach continuously
 - Shallow angle parking
 - When a vehicle is approaching at high speed
 - When parking on a steep incline, such as hills, a dip in the road, etc.
 - Immediately after the RCTA function is turned on
 - Immediately after the hybrid system is started with the RCTA function on.
- Vehicles that the sensors cannot detect due to obstructions

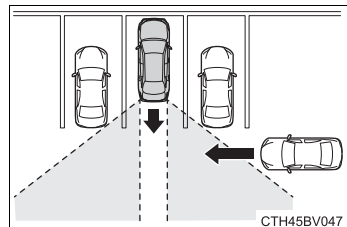

- When items such as a bicycle carrier are installed on the rear of the vehicle

- Instances of the RCTA function unnecessarily detecting a vehicle and/or object may increase in the following situations:
 - When a vehicle passes by the side of your vehicle
 - When the parking space faces a street and vehicles are being driven on the street

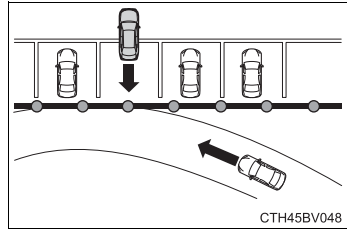

- When the distance between your vehicle and metal objects, such as a guardrail, wall, sign, or parked vehicle, which may reflect electrical waves toward the rear of the vehicle, is short
 - When there are spinning objects near your vehicle such as the fan of an air conditioning unit
- **Customization**
Some functions can be customized.
(→P. 111, 527)

Rear Camera Detection function (vehicles with panoramic view monitor)*

When the vehicle is backing up, the rear camera detection function can detect pedestrians in the detection area behind the vehicle. If a pedestrian is detected, a buzzer will sound and an icon on the audio system screen will be displayed to inform the driver of the pedestrian.

Display

- ① Pedestrian detection icon
Displayed automatically when a pedestrian is detected.
- ② Mute switch
Select to mute the buzzer. The buzzer will be re-enabled when the shift lever is shifted to a position other than R.

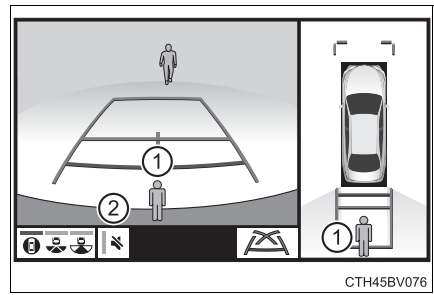

*: If equipped

When a pedestrian is detected

If the rear camera detection function detects a pedestrian in the detection area, the buzzer and icon will operate as shown in the following table:

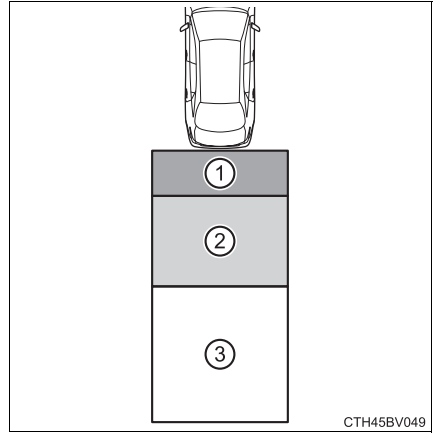

Area	Buzzer	Icon
①	Sounds repeatedly	Blinks 3 times and then stays on
②	When the vehicle is stationary: Sounds 3 times When the vehicle is backing up: Sounds repeatedly	
③	When it is determined that a pedestrian will enter area ① within a few seconds: Sounds repeatedly	When it is determined that a pedestrian will enter area ① within a few seconds: Blinks 3 times and then stays on

■ The rear camera detection function is operational when

The rear camera detection function is operational when the following conditions are met:

- The power switch is in the ON mode.
- The shift lever is in R.

■ Setting the buzzer volume

The buzzer volume of this function changes with the RCTA buzzer volume. (→P. 111, 527)

■ If the rear camera detection function is malfunctioning

If a malfunction of the rear camera detection function is detected, one of the following messages will be displayed on the audio system screen. Have the vehicle inspected by your Toyota dealer.

- “RCD malfunction.”
- “Visit your dealer.”
- “RCD unavailable.”

■ If “Clean dirt from lens” is displayed on the audio system screen

A rear camera lens may be dirty or covered with snow or ice. In such cases, if it is removed from the rear camera lens, the system should return to normal. (It may be necessary to drive the vehicle for some time before the system returns to normal.)

■ If “RCD unavailable” is displayed on the audio system screen

- If this message is displayed after the 12-volt battery has been disconnected and reconnected, fully turn the steering wheel to the left and then the right on level ground.
- If this message is displayed only when the R shift position is selected, the rear camera lens may be dirty. Clean the rear camera lens.

■ Situations in which the system may not operate properly

- Some pedestrians, such as the following, may not be detected by the rear camera detection function, preventing the function from operating properly:
 - Pedestrians who are squatting
 - Pedestrians who are lying down
 - Pedestrians who are running
 - Pedestrians who suddenly enter the detection area
 - Pedestrians riding a bicycle, skateboard, or other light vehicle
 - Pedestrians wearing unusual clothing, such as a costume
 - Pedestrians whose body is partially hidden by a cart or other object
 - Pedestrians which are obscured by darkness, such as at night
- In some situations, such as the following, pedestrians may not be detected by the rear camera detection function, preventing the function from operating properly:
 - When backing up in inclement weather (rain, snow, fog, etc.)
 - When the rear camera is obscured (dirt, snow, ice, etc. are attached) or scratched
 - When a very bright light, such as the sun, or the headlights of another vehicle, shines directly into the rear camera
 - When backing up in a place where the surrounding brightness changes suddenly, such as at the entrance or exit of a garage or underground parking lot

- In some situations, such as the following, the rear camera detection function may operate even though there are no pedestrians in the detection area.
 - When a three dimensional object, such as a pole, traffic cone, fence, or parked vehicle, is detected
 - When a moving object, such as a car or motorcycle is detected
 - When backing up toward moving objects such as flags or puddles, or airborne matter, such as smoke, steam, rain, or snow
 - When there is a pattern on the road, due to the road being made of cobblestone or gravel or having tram rails, traces of repair, white lines, pedestrian crossings or fallen leaves on the surface
 - When backing up on a metal cover (grating), such as those used for drainage ditches
 - When backing up toward the roadside or a bump in the road
 - When an object is reflected in a puddle or on a wet road surface
 - When there are shadows on the road
 - When backing up over a bump in the road
 - If the vehicle is significantly tilted, such as when carrying a heavy load
 - When backing up toward an incline/decline
 - If the suspension has been modified or tires of a size other than specified are installed
 - If the rear of the vehicle is raised or lowered due to the carried load
 - If an electronic component, such as a backlit license plate or rear fog light, is installed near the rear camera
 - If a bumper protector, such as an additional trim strip, is installed to the rear bumper
 - If the orientation of the rear camera has been changed due to a collision or other impact, or removal and installation
 - If a towing eyelet is installed to the rear of the vehicle
 - When the rear camera is obscured (dirt, snow, ice, etc. are attached) or scratched
 - When water is flowing over the rear camera lens
 - If there is a flashing light in the detection area, such as the emergency flashers of another vehicle
- **Situations in which the rear camera detection function may be difficult to notice**
 - If buzzer may be difficult to hear if the surrounding area is noisy, the volume of the audio system volume is high, the air conditioning system is being used, etc.
 - If the temperature in the cabin is extremely high or low, the audio system screen may not operate correctly.

Intuitive parking assist*



The distance from your vehicle to nearby objects when parallel parking or maneuvering into a garage is measured by the sensors and communicated via the displays and a buzzer. Always check the surrounding area when using this system.

Types of sensors

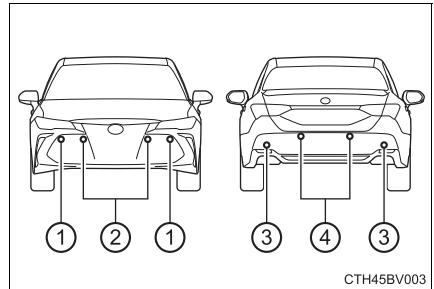
- ① Front corner sensors
- ② Front center sensors
- ③ Rear corner sensors
- ④ Rear center sensors



Turning the intuitive parking assist on/off

- 1 Press \wedge / \vee of the meter control switches, select .
- 2 Press \langle / \rangle of the meter control switches, select .
- 3 Press  of the meter control switch.

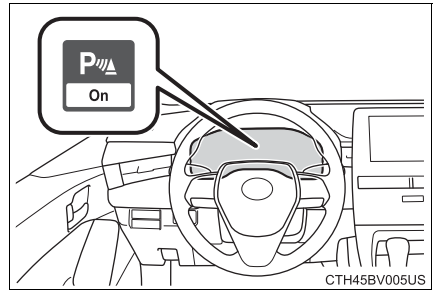

Each time  is pressed, the function changes on/off.

When on, the indicator light comes on to inform the driver that the system is operational.

*: If equipped

Display

When the sensors detect an object, the following displays inform the driver of the position and distance to the object.

■ Multi-information display

- ① Front corner sensor operation
- ② Front center sensor operation
- ③ Rear corner sensor operation
- ④ Rear center sensor operation
- ⑤ Select to mute the buzzer sounds.

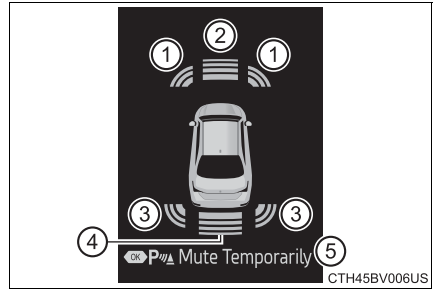

■ Audio system screen

- ① Intuitive parking assist
- When the vehicle is moving backward.
- A simplified image is displayed on the upper part of the screen when an object is detected.

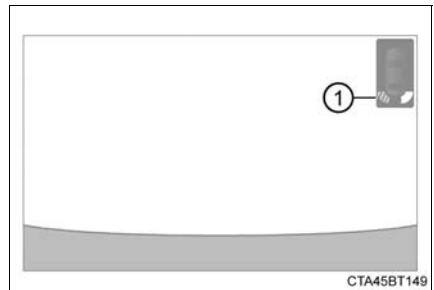

■ Muting the buzzer sound

- To mute the buzzer sound

The buzzer can be temporarily muted by pressing  of the meter control switches while an object detection display is shown on the multi-information display.
- To cancel the mute









Mute will be automatically cancelled in the following situations.

 - When the shift position is changed
 - When the vehicle speed has reached or exceeded approximately 6 mph (10 km/h) with the shift lever in D
 - When the intuitive parking assist is turned off once and turned on again
 - When the power switch is turned off once and turned to ON mode again
 - When a sensor is malfunctioning

Sensor detection display, object distance

Distance display

Sensors that detect an object will illuminate continuously or blink.

Multi-information display*	Insert display	Approximate distance to object		
		Front and rear center sensor	Front and rear corner sensor	
 (continuous)	 (blinking slowly)	Far  Near	Front center sensor: 3.3 ft. (100 cm) to 2.4 ft. (73 cm) Rear center sensor: 4.9 ft. (150 cm) to 2.5 ft. (75 cm)	—
 (continuous)	 (blinking)		Front center sensor: 2.4 ft. (73 cm) to 1.5 ft. (45 cm) Rear center sensor: 2.5 ft. (75 cm) to 1.5 ft. (45 cm)	2.6 ft. (80 cm) to 1.5 ft. (45 cm)
 (continuous)	 (blinking rapidly)		1.5 ft. (45 cm) to 1.1 ft. (35 cm)	1.5 ft. (45 cm) to 1.1 ft. (35 cm)
 (blinking)	 (continuous)		Less than 1.1 ft. (35 cm)	Less than 1.1 ft. (35 cm)

*: The images may differ from those shown in the illustrations. (→P. 293)

■ Buzzer operation and distance to an object

A buzzer sounds when the sensors are operating.

- The buzzer sounds faster as the vehicle approaches an object. When the vehicle comes within the following distance of the object, the buzzer sounds continuously: Approximately 1.2 ft. (35 cm).
- When 2 or more objects are detected simultaneously, the buzzer system responds to the nearest object. If one or both come within the above distances, the beep will repeat a long tone, followed by fast beeps.

Detection range of the sensors

- ① Approximately 3.3 ft. (100 cm)
- ② Approximately 4.9 ft. (150 cm)
- ③ Approximately 2.6 ft. (80 cm)

The diagram shows the detection range of the sensors. Note that the sensors cannot detect objects that are extremely close to the vehicle.

The range of the sensors may change depending on the shape of the object, etc.

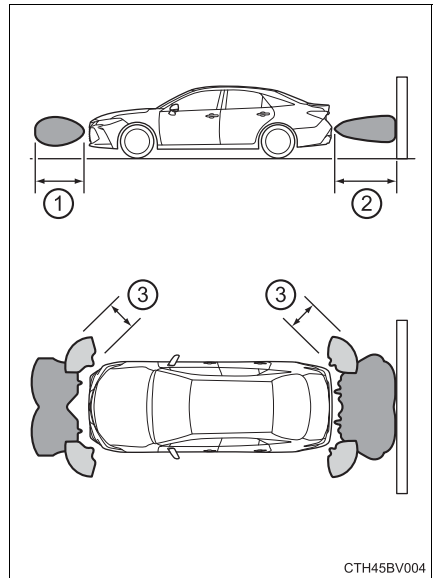

CTH45BV004

■ The intuitive parking assist can be operated when

- Front corner sensors:
 - The power switch is in ON mode.
 - The shift lever is in other than P.
 - The vehicle speed is less than about 6 mph (10 km/h).
- Front center sensors:
 - The power switch is in ON mode.
 - The shift lever is in other than P or R.
 - The vehicle speed is less than about 6 mph (10 km/h).
- Rear corner and rear center sensors:
 - The power switch is in ON mode.
 - The shift lever is in R.
 - The vehicle speed is less than about 6 mph (10 km/h).

■ Intuitive parking assist display

When an object is detected while the Toyota parking assist monitor or panoramic view monitor is in use, the warning indicator will appear in the upper part of the screen even if the display setting has been set to off.

■ Sensor detection information

- The sensor's detection areas are limited to the areas around the vehicle's bumper.
- Depending on the shape of the object and other factors, the detection distance may shorten, or detection may be impossible.
- Objects may not be detected if they are too close to the sensor.
- There will be a short delay between object detection and display. Even at slow speeds, there is a possibility that the object will come within the sensor's detection areas before the display is shown and the buzzer sounds.
- Thin posts or objects lower than the sensor may not be detected when approached, even if they have been detected once.
- It might be difficult to hear beeps due to the volume of audio system or air flow noise of the air conditioning system.

■ If a battery terminal has been disconnected and reconnected

The system needs to be initialized.

To initialize the system, drive the vehicle straight ahead for 5 seconds or more at a speed of approximately 22 mph (35 km/h) or more.

■ If "Parking Assist Unavailable Please Clean Parking Assist Sensor" is displayed on the multi-information display

A sensor may be dirty or covered with snow or ice. In such cases, if it is removed from the sensor, the system should return to normal.

Also, due to the sensor being frozen at low temperatures, a malfunction display may appear or an object may not be detected. If the sensor thaws out, the system should return to normal.

■ If “Parking Assist Unavailable” is displayed on the multi-information display

- Water may be continuously flowing over the sensor surface, such as in a heavy rain. When the system determines that it is normal, the system will return to normal.
- Initialization may not have been performed after a battery terminal was disconnected and reconnected. Initialize the system. If this message continues to be displayed even after initialization, have the vehicle inspected by your Toyota dealer.

■ Customization

Some functions can be customized. (→P. 111, 527)

**WARNING****■ When using the intuitive parking assist**

Observe the following precautions.

Failing to do so may result in the vehicle being unable to be driven safely and possibly cause an accident.

- Do not use the sensor at speeds in excess of 6 mph (10 km/h).
- The sensors' detection areas and reaction times are limited. When moving forward or reversing, check the areas surrounding the vehicle (especially the sides of the vehicle) for safety, and drive slowly, using the brake to control the vehicle's speed.
- Do not install accessories within the sensors' detection areas.

 **WARNING****■ Sensors**

Certain vehicle conditions and the surrounding environment may affect the ability of a sensor to correctly detect an object. Particular instances where this may occur are listed below.

- There is dirt, snow or ice on the sensor. (Wiping the sensors will resolve this problem.)
- The sensor is frozen. (Thawing the area will resolve this problem.)
In especially cold weather, if a sensor is frozen the screen may show an abnormal display, or objects may not be detected.
- The sensor is covered in any way.
- The vehicle is leaning considerably to one side.
- On an extremely bumpy road, on an incline, on gravel, or on grass.
- The vicinity of the vehicle is noisy due to vehicle horns, motorcycle engines, air brakes of large vehicles, or other loud noises producing ultrasonic waves.
- There is another vehicle equipped with parking assist sensors in the vicinity.
- The sensor is coated with a sheet of spray or heavy rain.
- The sensor is drenched with water on a flooded road.
- The vehicle is equipped with a fender pole or wireless antenna.
- Towing eyelets are installed.
- The bumper or sensor receives a strong impact.
- The vehicle is approaching a tall or curved curb.
- The detection range is reduced due to an object such as a sign.
- In harsh sunlight or intense cold weather.
- The area directly under the bumpers is not detected.
- If objects draw too close to the sensor.
- A non-genuine Toyota suspension (lowered suspension, etc.) is installed.
- A backlit license plate is installed.

In addition to the examples above, there are instances in which, because of their shape, signs and other objects may be judged by a sensor to be closer than they are.

**WARNING****■ Objects which may not be properly detected**

The shape of the object may prevent a sensor from detecting it. Pay particular attention to the following objects:

- Wires, fences, ropes, etc.
- Cotton, snow and other materials that absorb sound waves
- Sharply-angled objects
- Low objects
- Tall objects with upper sections projecting outwards in the direction of your vehicle
- People may not be detected if they are wearing certain types of clothing.
- Moving objects such as people or animals

**NOTICE****■ When using intuitive parking assist**

In the following situations, the system may not function correctly due to a sensor malfunction, etc. Have the vehicle checked by your Toyota dealer.

- The intuitive parking assist operation display flashes, and a buzzer sounds when no objects are detected.
- If the area around a sensor collides with something, or is subjected to strong impact.
- If the bumper collides with something.
- If the display shows continuously without beeping, except when the buzzer volume is muted.
- If a display error occurs, first check the sensor.
If the error occurs even if there is no ice, snow or mud on the sensor, it is likely that the sensor is malfunctioning.

■ Notes when washing the vehicle

Do not apply intensive bursts of water or steam to the sensor area.

Doing so may result in the sensor malfunctioning.

Intelligent Clearance Sonar (ICS)*

If a collision with an object may occur due to the vehicle suddenly moving forward due to an accidental accelerator pedal operation, the vehicle moving the unintended direction due to the wrong shift position being selected, or while parking or traveling at low speeds, the sensors detect objects, such as a wall, in the traveling direction of the vehicle, and the system operates to lessen an impact with an object and reduce the resulting damage.

Examples of system operation

The system will operate in situations such as the following if an object is detected in the traveling direction of the vehicle.

- ◆ When traveling at a low speed and the brake pedal is not depressed, or is depressed late

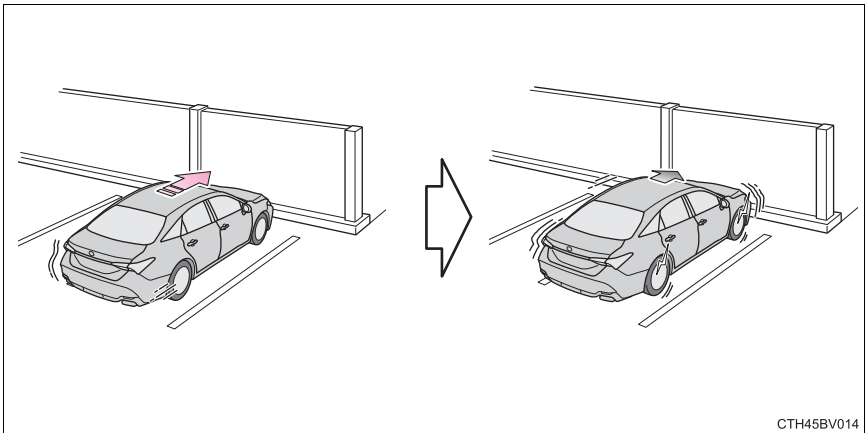

*: If equipped

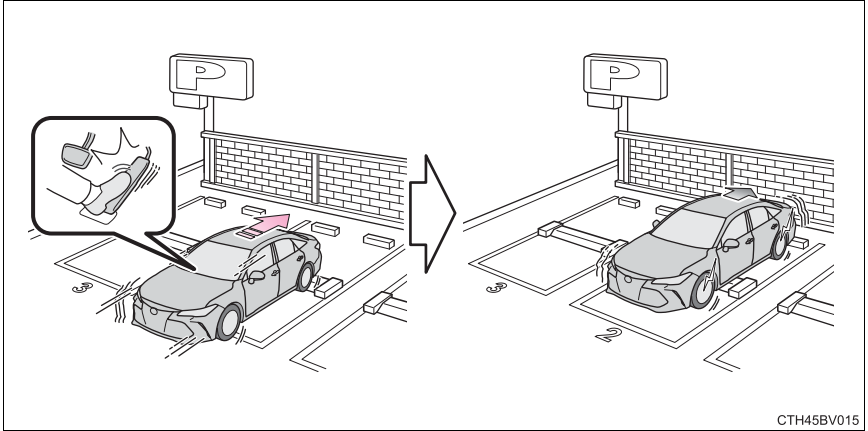
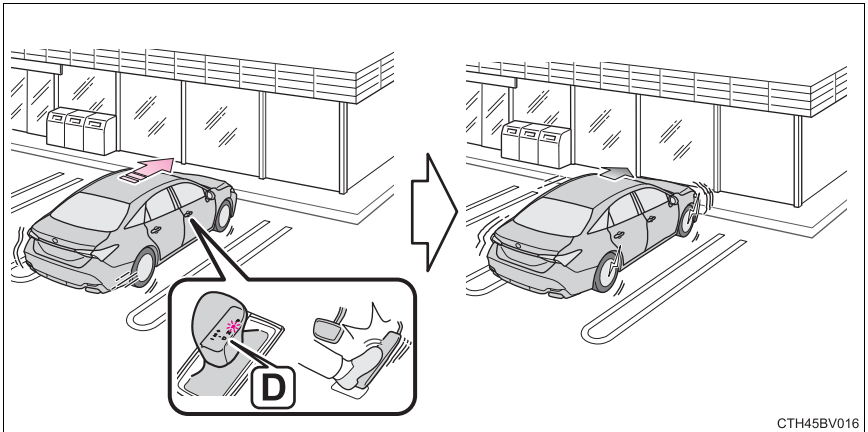
◆ When the accelerator pedal is depressed excessively**◆ When the vehicle moves in the unintended direction due to the wrong shift position being selected**

Rear Cross Traffic Auto Brake function

If a radar sensor detects a vehicle approaching from the right or left at the rear of the vehicle and a collision may occur, this function will perform brake control to reduce the likelihood of an impact with the approaching vehicle.

■ Examples of system operation

The system will operate in situations such as the following if an object is detected in the traveling direction of the vehicle.

- ◆ **When reversing, a vehicle is approaching and the brake pedal is not depressed, or is depressed late**

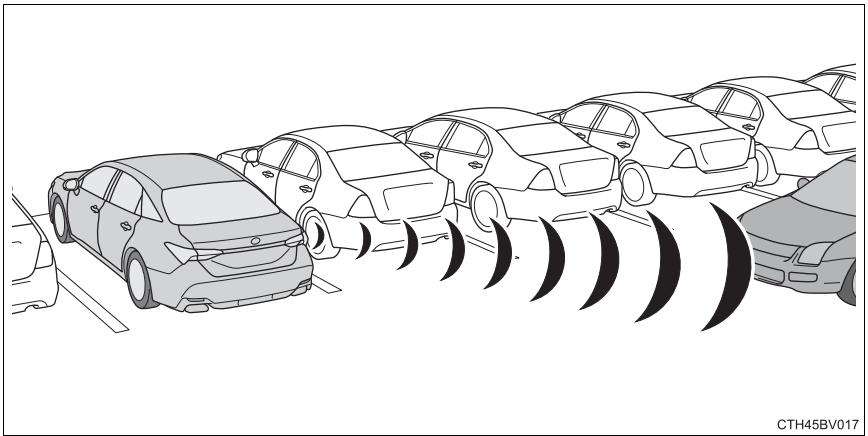



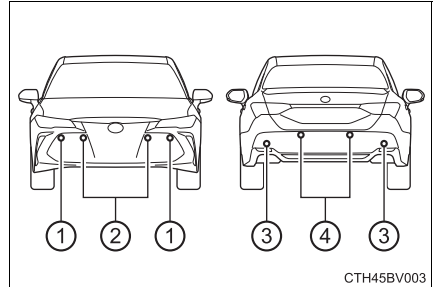

Types of sensors

- ① Front corner sensors
- ② Front center sensors
- ③ Rear corner sensors
- ④ Rear center sensors



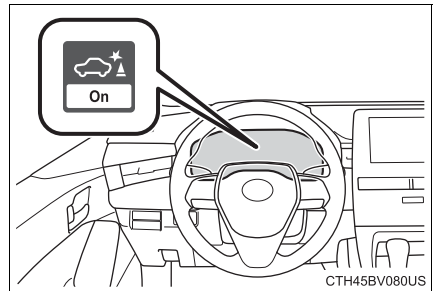

Turning the Intelligent Clearance Sonar system on/off

- 1 Press \wedge / \vee of the meter control switches, select .
- 2 Press \langle / \rangle of the meter control switches, select .
- 3 Press  of the meter control switch.
- 4 Select the "Yes" and push .



When the Intelligent Clearance Sonar is disabled, the ICS OFF indicator illuminates.

To re-enable the system when it was disabled, select  on the multi-information display, select  and then "On". If disabled using this method, the system will not be re-enabled by turning the power switch off and then to ON mode.

Displays and buzzers for hybrid system output restriction control and brake control

If the hybrid system output restriction control or brake control operates, a buzzer will sound and a message will be displayed on the multi-information display to alert the driver.

Depending on the situation, hybrid system output restriction control will operate to either limit acceleration or restrict output as much as possible.

Control	Situation	Multi-information display	ICS OFF Indicator	Buzzer
Hybrid system output restriction control is operating (acceleration restriction)	Acceleration greater than a certain amount is not possible.	“Object Detected Acceleration Reduced”	Not illuminated	—
Hybrid system output restriction control is operating (output restricted as much as possible)	Stronger-than-normal brake operation is necessary.	“Brake!”		Short beep
Brake control is operating	Emergency braking is necessary.			
Vehicle stopped by system operation	The vehicle has been stopped by brake control operation.	If the accelerator pedal is depressed: “Switch to Brake” If the accelerator pedal is not depressed: “Brake”	Illuminated	

Intelligent Clearance Sonar function

If the Intelligent Clearance Sonar function detects that a collision with an object is possible, the hybrid system output will be restricted to restrain any increase in the vehicle speed. (Hybrid system output restriction control: See A below.)

Additionally, if the accelerator pedal continues to be depressed, the brakes will be applied automatically to reduce the vehicle speed. (Brake control: See B below.)

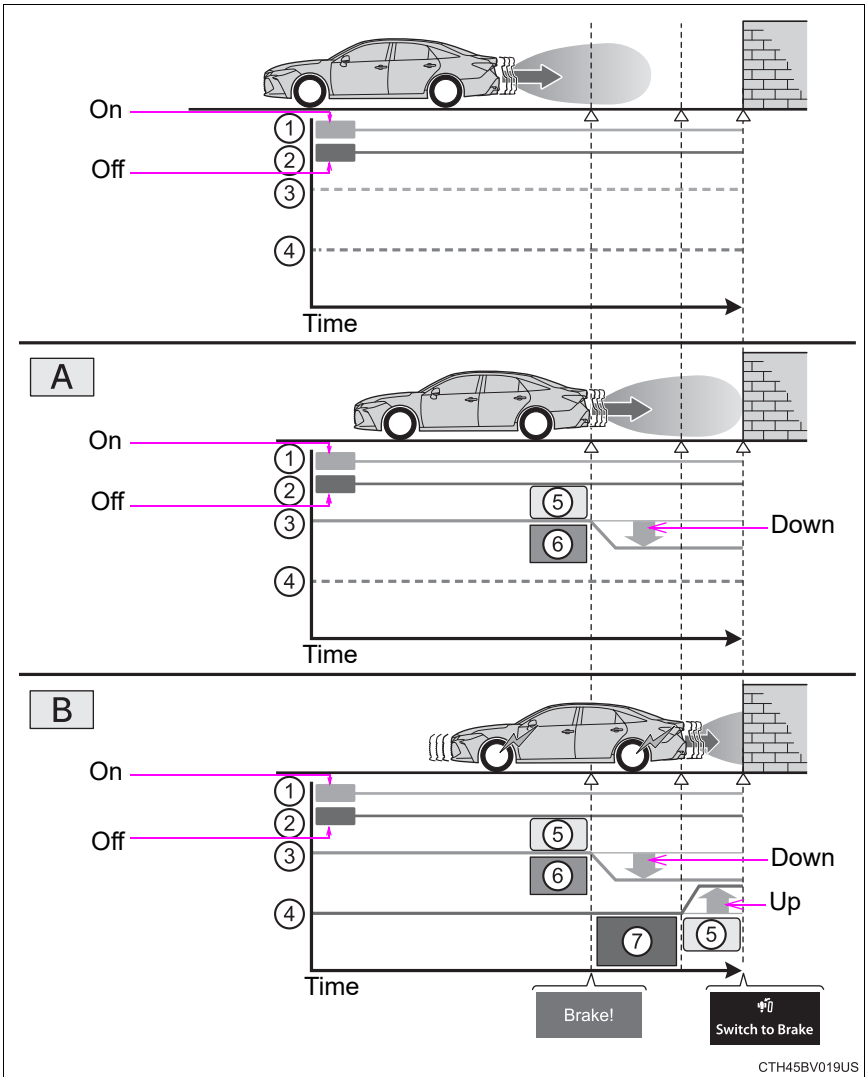

CTH45BV019US

- ① Accelerator pedal
- ② Brake pedal
- ③ Hybrid system output
- ④ Braking force

- ⑤ Start of control
- ⑥ High possibility of a collision
- ⑦ Extremely high possibility of a collision

■ The Intelligent Clearance Sonar function will operate when

The function will operate when the ICS OFF indicator is not illuminated or flashing (→P. 303, 311) and all of the following conditions are met:

- Hybrid system output restriction control
 - The Intelligent Clearance Sonar system is enabled.
 - The vehicle speed is 10 mph (15 km/h) or less.
 - There is an object in the traveling direction of the vehicle and 6 to 13 ft. (2 to 4 m) away.
 - The system determines that a stronger-than-normal brake operation is necessary to avoid a collision.
- Brake control
 - Hybrid system output restriction control is operating.
 - The system determines that an emergency brake operation is necessary to avoid a collision.

■ The Intelligent Clearance Sonar function will stop operating when

The function will stop operating if any of the following conditions are met:

- Hybrid system output restriction control
 - The Intelligent Clearance Sonar system is disabled.
 - The collision becomes avoidable with normal brake operation.
 - The object is no longer 6 to 13 ft. (2 to 4 m) away in the traveling direction of the vehicle.
- Brake control
 - The Intelligent Clearance Sonar system is disabled.
 - Approximately 2 seconds elapse after the vehicle is stopped by brake control.
 - The brake pedal is depressed after the vehicle is stopped by brake control.
 - The object is no longer 6 to 13 ft. (2 to 4 m) away in the traveling direction of the vehicle.

■ Detection range of the Intelligent Clearance Sonar function

The detection range of the Intelligent Clearance Sonar function differs from the detection range of the intuitive parking assist. (→P. 295)

Therefore, even if the intuitive parking assist detects an object and provides a warning, the Intelligent Clearance Sonar function may not start operating.

■ If the Intelligent Clearance Sonar function has operated

If the vehicle is stopped due to operation of the Intelligent Clearance Sonar function, the Intelligent Clearance Sonar system will be disabled and the ICS OFF indicator will illuminate.

■ Re-enabling the Intelligent Clearance Sonar system

To re-enable the Intelligent Clearance Sonar system when it is disabled due to operation of the Intelligent Clearance Sonar function, either enable the system again (→P. 303), or turn the power switch off and then back to ON mode.

Additionally, if the object becomes no longer in the traveling direction of the vehicle or if the traveling direction of the vehicle changes (such as changing from moving forward to backing up, or from backing up to moving forward), the system will be re-enabled automatically.

■ Objects that the Intelligent Clearance Sonar function may not detect

The sensors may not be able to detect certain objects, such as the following.

- Cotton cloth, snow, and other materials that are poor reflectors of ultrasonic waves.

(People may also not be detected depending on the type of clothing they are wearing.)

- Objects which are not perpendicular to the ground, are not perpendicular to the traveling direction of the vehicle, are uneven or are waving.
- Low objects
- Thin objects such as wires, fences, ropes and signposts
- Objects that are extremely close to the bumper

■ Situations in which the Intelligent Clearance Sonar may not operate properly

When the shift lever is in N.

■ Intuitive parking assist buzzer

Regardless of whether the intuitive parking assist system is enabled or not (→P. 292), if the Intelligent Clearance Sonar system is enabled (→P. 303), the front or rear sensors detect an object and brake control is performed, the intuitive parking assist buzzer will sound to notify the driver of the approximate distance to the object.

■ Situations in which the Intelligent Clearance Sonar function may operate even if there is no possibility of a collision

In some situations such as the following, the Intelligent Clearance Sonar function may operate even though there is no possibility of a collision.

● Vehicle surroundings

- When driving on a narrow road

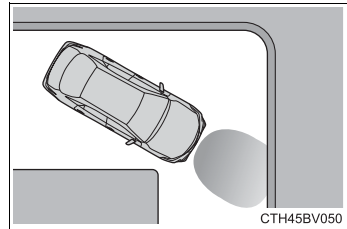

- When driving on a gravel road or in an area with tall grass

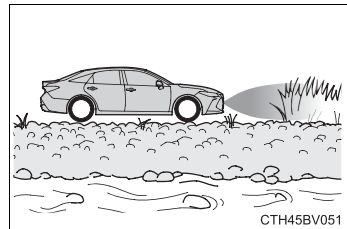

- When driving toward a banner, flag, low-hanging branch or boom barrier (such as those used at railroad crossings, toll gates and parking lots).
- When driving on a narrow path surrounded by a structure, such as in a tunnel or on an iron bridge
- When parallel parking
- When there is a rut or hole in the surface of the road
- When driving on a metal cover (grating), such as those used for drainage ditches
- When driving on a steep slope
- If a sensor is hit by a large amount of water, such as when driving on a flooded road

● Weather

- If a sensor is covered with ice, snow, dirt, etc. (when cleared, the system will return to normal)
- If heavy rain or water strikes a sensor
- When driving in inclement weather such as fog, snow or a sandstorm

● Other ultrasonic waves sources

- When vehicle horns, vehicle detectors, motorcycle engines, air brakes of large vehicles, the clearance sonar of other vehicles or other devices which produce ultrasonic waves are near the vehicle
- If a sticker or an electronic component, such as a backlit license plate (especially fluorescent type), fog lights, a fender pole or wireless antenna is installed near a sensor

- Changes in the vehicle posture

- If the vehicle is significantly tilted
- If the front of the vehicle is raised or lowered due to the carried load
- If the orientation of a sensor has been changed due to a collision or other impact

- **If the Intelligent Clearance Sonar function operates unnecessarily such as at a railroad crossing**

Even in the event that the Intelligent Clearance Sonar function operates unnecessarily, such as at a railroad crossing, brake control will be canceled after approximately 2 seconds, allowing you to proceed forward and leave the area. Brake control can also be canceled by depressing the brake pedal. Depressing the accelerator pedal again will allow you to proceed forward and leave the area.

- **Situations in which the Intelligent Clearance Sonar Brake function may not operate properly**

In some situations such as the following, this function may not operate properly.

- Weather

- When a sensor or the area around a sensor is extremely hot or cold

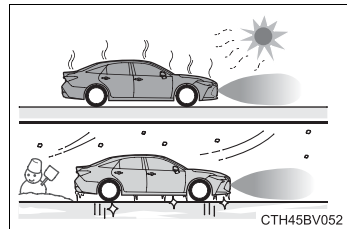

- When strong winds are blowing

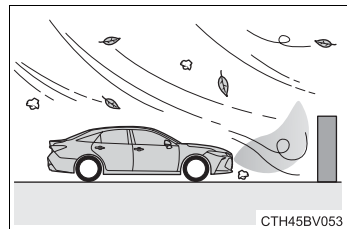

- If a sensor is covered with ice, snow, dirt, etc. (when cleared, the system will return to normal)
- If heavy rain or water strikes a sensor
- When driving in inclement weather such as fog, snow or a sandstorm

- Vehicle surroundings

- When an object that cannot be detected is between the vehicle and a detected object
- If an object such as a vehicle, motorcycle, bicycle or pedestrian cuts in front of the vehicle or runs out from the side of the vehicle.

- Other ultrasonic waves sources
 - When vehicle horns, vehicle detectors, motorcycle engines, air brakes of large vehicles, the clearance sonar of other vehicles or other devices which produce ultrasonic waves are near the vehicle
 - If a sticker or an electronic component, such as a backlit license plate (especially fluorescent type), fog lights, a fender pole or wireless antenna is installed near a sensor
- Changes in the vehicle posture
 - If the vehicle is significantly tilted
 - If the front of the vehicle is raised or lowered due to the carried load
 - If the orientation of a sensor has been changed due to a collision or other impact

■ **If a 12-volt battery terminal has been disconnected and reconnected**

The system needs to be initialized.

To initialize the system, drive the vehicle straight ahead for 5 seconds or more at a speed of approximately 22 mph (35 km/h) or more.

■ **If “ICS Unavailable” is displayed on the multi-information display and the ICS OFF indicator is flashing**

Initialization may not have been performed after a 12-volt battery terminal was disconnected and reconnected. Initialize the system. (→P. 311)

If this message continues to be displayed even after initialization, have the vehicle inspected by your Toyota dealer.

■ **If “ICS Unavailable” and “Parking Assist Unavailable Clean Parking Assist Sensor” are displayed on the multi-information display and the ICS OFF indicator is flashing**

- A sensor may be covered with ice, snow, dirt, etc. In this case, remove the ice, snow, dirt, etc., from the sensor to return the system to normal. If this message is shown even after removing dirt from the sensor, or shown when the sensor was not dirty to begin with, have the vehicle inspected at your Toyota dealer.
- A sensor may be frozen. Once the ice melts, the system will return to normal.
- Water may be continuously flowing over the sensor surface, such as in a heavy rain. When the system determines that it is normal, the system will return to normal.

 **WARNING****■ Limitations of the Intelligent Clearance Sonar system**

Do not overly rely on the system, as doing so may lead to an accident.

- The driver is solely responsible for safe driving. Always drive carefully, taking care to observe your surroundings. The Intelligent Clearance Sonar system is designed to provide support to lessen the severity of collisions. However, it may not operate in some situations.
- The Intelligent Clearance Sonar system is not designed to stop the vehicle completely. Additionally, even if the system has stopped the vehicle, it is necessary to depress the brake pedal immediately as brake control will be canceled after approximately 2 seconds.

■ To ensure the Intelligent Clearance Sonar system can operate properly

Observe the following precautions regarding the sensors (→P. 303). Failure to do so may cause a sensor to not operate properly, and may cause an accident.

- Do not modify, disassemble or paint the sensors.
- Do not replace a sensor with a part other than a genuine part.
- Do not subject a sensor or its surrounding area to a strong impact.
- Do not damage the sensors, and always keep them clean.

Observe the following precautions regarding the radar sensors (→P. 279). Failure to do so may cause a radar sensor to not operate properly, and may cause an accident.

- Do not modify, disassemble or paint the sensors.
- Do not replace a radar sensor with a part other than a genuine part.
- Do not subject a radar sensor or its surrounding area to a strong impact.
- Do not damage the radar sensors, and always keep the radar sensors and their surrounding area on the bumper clean.

■ Handling the suspension

Do not modify the suspension, as changes to the height or inclination of the vehicle may prevent the sensors from detecting objects correctly or cause the system to not operate or operate unnecessarily.

**NOTICE****■ To prevent the system from malfunctioning**

- If the area around a sensor is subjected to an impact, the system may not operate properly due to the sensor being misaligned. Have the vehicle inspected by your Toyota dealer.
- When using a high pressure washer to wash the vehicle, do not spray the sensors directly, as doing so may cause a sensor to malfunction.
- When using steam to clean the vehicle, do not direct steam too close to the sensors as doing so may cause a sensor to malfunction.

■ To prevent a radar sensor from malfunctioning

- If the area around a radar sensor is subjected to an impact, the system may not operate properly due to a sensor malfunction. Have the vehicle inspected by your Toyota dealer.
- Observe the radar sensor handling precautions. (→P. 279)

■ To prevent unnecessary operation of the Intelligent Clearance Sonar system

In the following situations, disable the Intelligent Clearance Sonar system as the system may operate even though there is no possibility of a collision.

- When inspecting the vehicle using a chassis roller, chassis dynamo or free roller
- When loading the vehicle onto a boat, truck or other transport vessel
- If the suspension has been modified or tires of a size other than specified are installed
- If the front of the vehicle is raised or lowered due to the carried load
- When equipment that may obstruct a sensor is installed, such as a towing eyelet, bumper protector (an additional trim strip, etc.), bicycle carrier, or snow plow
- When using an automatic car wash

Rear Cross Traffic Auto Brake function

If the Rear Cross Traffic Auto Brake function detects that a collision with an approaching vehicle is possible, the hybrid system output will be restricted to restrain any increase in vehicle speed. (Hybrid system output restriction control: See A below.)

Additionally, if the accelerator pedal continues to be depressed, the brakes will be applied automatically to reduce the vehicle speed. (Brake control: See B below.)

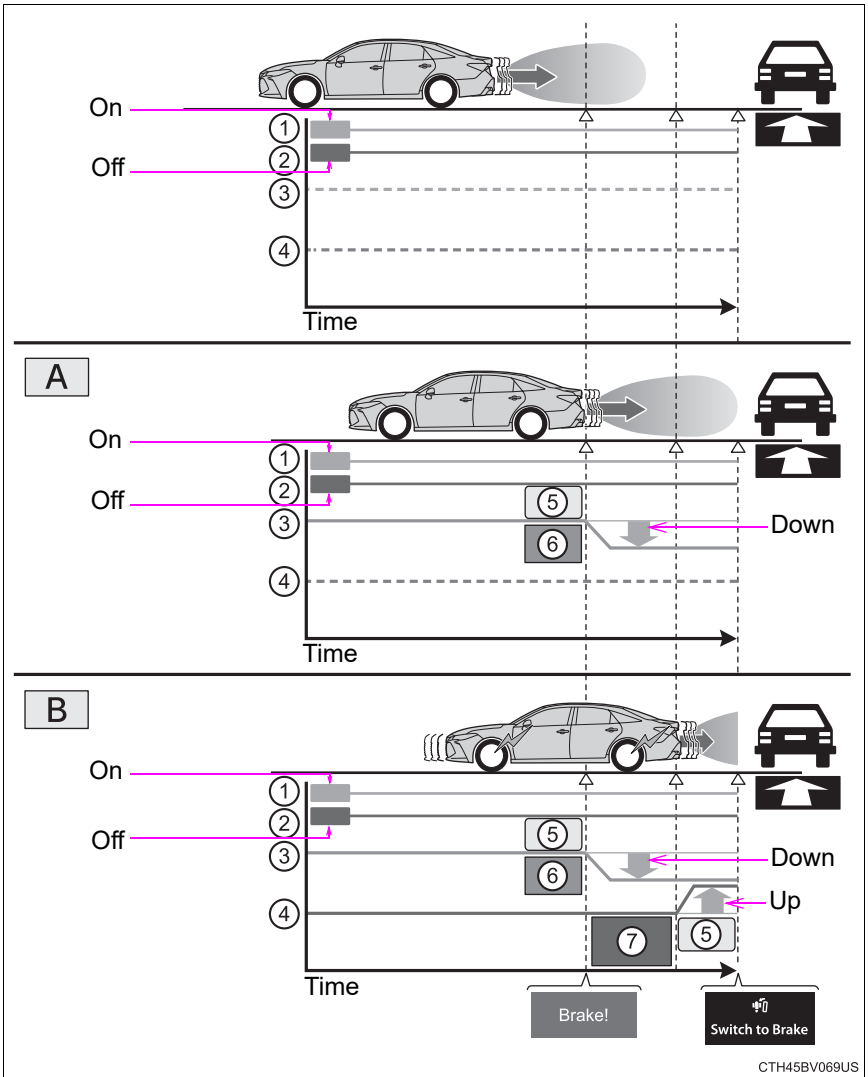

CTH45BV069US

- ① Accelerator pedal
- ② Brake pedal
- ③ Hybrid system output
- ④ Braking force
- ⑤ Start of control
- ⑥ High possibility of a collision
- ⑦ Extremely high possibility of a collision

■ The Rear Cross Traffic Auto Brake function will operate when

The function will operate when the ICS OFF indicator is not illuminated or flashing (→P. 303, 311) and all of the following conditions are met:

● Hybrid system output restriction control

- The Intelligent Clearance Sonar with Rear Cross Traffic Auto Brake is enabled.
- The vehicle speed is 10 mph (15 km/h) or less.
- Vehicles which are approaching from the right or left at the rear of the vehicle at a traveling speed of less than approximately 5 mph (8 km/h)
- The shift lever is in R.
- The system determines that a stronger than normal brake operation is necessary to avoid a collision with an approaching vehicle.

● Brake control

- Hybrid system output restriction control is operating.
- The system determines that an emergency brake operation is necessary to avoid a collision with an approaching vehicle.

■ The Rear Cross Traffic Auto Brake function will stop operating when

The function will stop operating if any of the following conditions are met:

● Hybrid system output restriction control

- The Intelligent Clearance Sonar with Rear Cross Traffic Auto Brake is disabled.
- The collision becomes avoidable with normal brake operation.
- A vehicle is no longer approaching from the right or left at the rear of the vehicle.

● Brake control

- The Intelligent Clearance Sonar with Rear Cross Traffic Auto Brake is disabled.
- Approximately 2 seconds elapse after the vehicle is stopped by brake control.
- The brake pedal is depressed after the vehicle is stopped by brake control.
- A vehicle is no longer approaching from the right or left at the rear of the vehicle.

■ Detection area of the Rear Cross Traffic Auto Brake function

The detection area of the Rear Cross Traffic Auto Brake function differs from the detection area of the RCTA function (→P. 285).

Therefore, even if the RCTA function detects a vehicle and provides an alert, the Rear Cross Traffic Auto Brake function may not start operating.

■ If the Rear Cross Traffic Auto Brake function has operated

If the vehicle is stopped due to operation of the Rear Cross Traffic Auto Brake function, the Rear Cross Traffic Auto Brake function will be disabled and the ICS OFF indicator will illuminate.

■ Re-enabling the Rear Cross Traffic Auto Brake function

To re-enable the Rear Cross Traffic Auto Brake function when it is disabled while it is operating, either enable the Intelligent Clearance Sonar system again (→P. 303), or turn the power switch off and then back to ON mode. When the function is disabled, the ICS OFF indicator will illuminate. (→P. 95)

If there is no longer a vehicle approaching from the right or left at the rear of the vehicle when backing up, or if the traveling direction of the vehicle changes (such as changing from backing up to moving forward), the system will be re-enabled automatically. When the function is re-enabled, the ICS OFF indicator will turn off.

■ Conditions under which the Rear Cross Traffic Auto Brake function will not detect a vehicle

The Rear Cross Traffic Auto Brake function is not designed to detect the following types of vehicles and/or objects.

- Vehicles approaching from directly behind
- Vehicles backing up in a parking space next to your vehicle
- Vehicles that the sensors cannot detect due to obstructions
- Vehicles which suddenly accelerate or decelerate near your vehicle

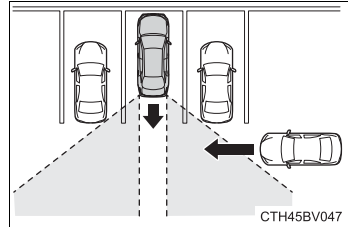

- Guardrails, walls, signs, parked vehicles and similar stationary objects*
- Small motorcycles, bicycles, pedestrians, etc.*
- Vehicles moving away from your vehicle
- Vehicles approaching from the parking spaces next to your vehicle*

*: Depending on the conditions, detection of a vehicle and/or object may occur.

■ RCTA function buzzer

Regardless of whether the RCTA function is enabled or not (→P. 277), if the Rear Cross Traffic Auto Brake function is enabled and brake control is performed, a buzzer will sound to notify the driver.

■ Situations in which the system may operate even though there is no possibility of a collision

In some situations such as the following, the Rear Cross Traffic Auto Brake function may operate even though there is no possibility of a collision.

- When the parking space faces a street and vehicles are being driven on the street

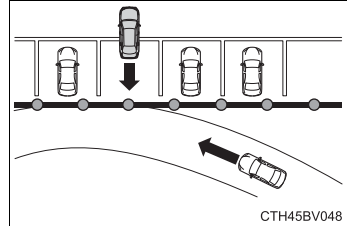

- When a detected vehicle turns while approaching the vehicle

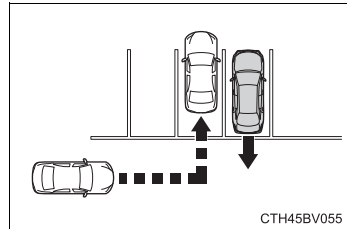

- When a vehicle passes by the side of your vehicle

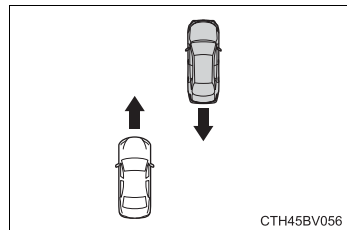

- When the distance between your vehicle and metal objects, such as a guardrail, wall, sign, or parked vehicle, which may reflect electrical waves toward the rear of the vehicle, is short

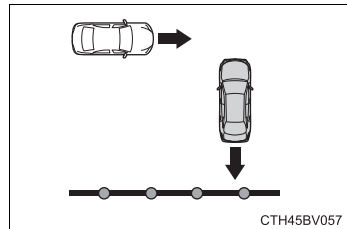

- When there are spinning objects near your vehicle such as the fan of an air conditioning unit
- When water is splashed or sprayed toward the rear bumper, such as from a sprinkler

■ Situations in which the Rear Cross Traffic Auto Brake function may not operate properly

In some situations such as the following, this function may not operate properly.

- Objects and vehicles which the radar sensors are not designed to detect
 - Stationary objects
 - Vehicles which are moving away from your vehicle
 - Pedestrians, motorcycles, bicycles, etc.*
 - Objects which are extremely close to a radar sensor
 - Vehicles which are approaching from the right or left at the rear of the vehicle at a traveling speed of less than approximately 5 mph (8 km/h)
 - Vehicles which are approaching from the right or left at the rear of the vehicle at a traveling speed of more than approximately 15 mph (24 km/h)

*: Depending on conditions, detection of a vehicle and/or object may occur.

- Situations in which the radar sensors may not be able to detect an object
 - When a sensor or the area around a sensor is extremely hot or cold
 - If the rear bumper is covered with ice, snow, dirt, etc.
 - If heavy rain or water strikes the vehicle
 - When the detection area of a radar sensor is obstructed by an adjacent vehicle
 - If the vehicle is significantly tilted
 - When equipment that may obstruct a sensor is installed, such as a towing eyelet, bumper protector (an additional trim strip, etc.), bicycle carrier, or snow plow
 - If the suspension has been modified or tires of a size other than specified are installed
 - If the front of the vehicle is raised or lowered due to the carried load
 - If a sticker or an electronic component, such as a backlit license plate (especially fluorescent type), fog lights, a fender pole or wireless antenna is installed near a radar sensor
 - If the orientation of a radar sensor has been changed due to a collision or other impact or removal and installation
 - When multiple vehicles are approaching with only a small gap between each vehicle
 - When a vehicle is approaching at high speed
- Situations in which the radar sensor may not detect a vehicle
 - When a vehicle approaches from the right or left at the rear of the vehicle while you are turning while backing up
 - When turning while backing up

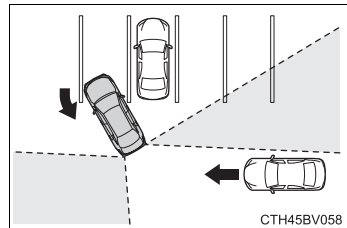

- When backing out of a shallow angle parking spot

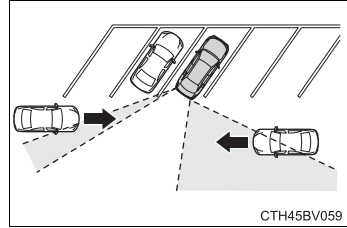

- Vehicles that the sensors cannot detect due to obstructions

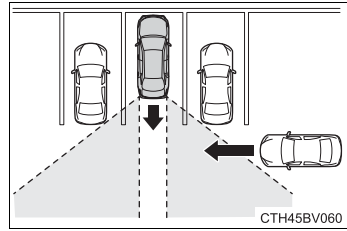

- When backing up on a slope with a sharp change in grade

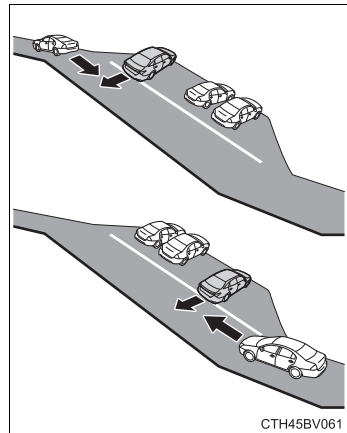

- When a vehicle turns into the detection area

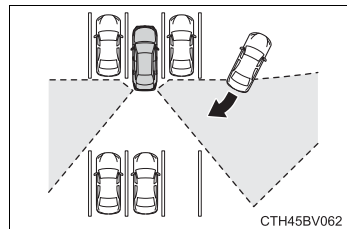

■ Handling the radar sensors

→P. 279

Driving mode select switches

The driving modes can be selected to suit driving condition.

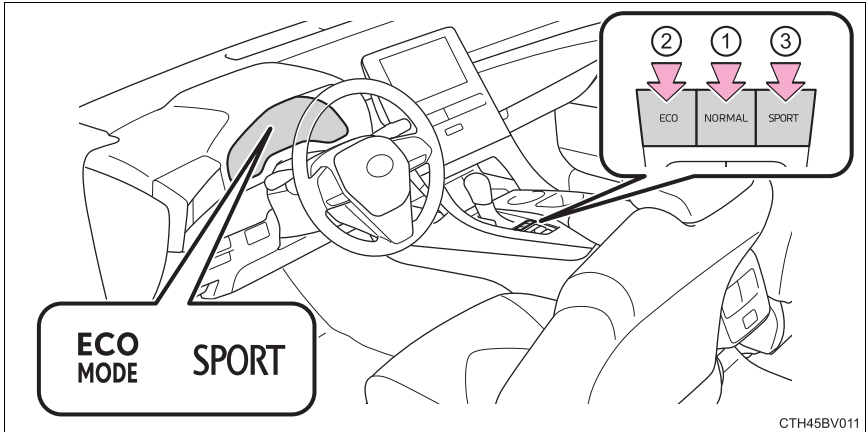

① Normal mode

Use for normal driving.

While in Eco drive mode or Sport mode, press the “NORMAL” switch to change the driving mode to normal mode.

② Eco drive mode

Use Eco drive mode to help achieve low fuel consumption during trips that involve frequent accelerating.

When the “ECO” switch is pressed, the “ECO MODE” indicator comes on in the multi-information display.

③ Sport mode

Use sport mode when increased acceleration response and precise handling is desired, for example, when driving on mountain roads.

When the “SPORT” switch is pressed, the “SPORT” indicator comes on in the multi-information display.

■ Operation of the air conditioning system in Eco drive mode

Eco drive mode controls the heating/cooling operations and fan speed of the air conditioning system to enhance fuel efficiency (→P. 338). To improve air conditioning performance, adjust the fan speed or turn off Eco drive mode.

■ Auto Glide Control

● While driving in Eco drive mode with D selected, releasing the accelerator pedal will activate Auto Glide Control under certain conditions. (Auto Glide Control may activate before the accelerator pedal is fully released.)

When Auto Glide Control operates, the electric motor (traction motor) will be controlled, reducing the deceleration force and allowing the vehicle to coast, enhancing fuel economy.

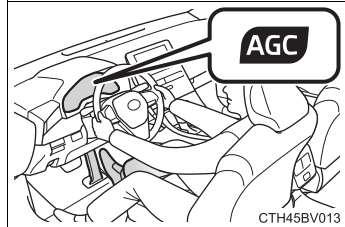

When Auto Glide Control operates, the AGC indicator light will illuminate.

● Auto Glide Control may not operate in the following situations:

- When the brake pedal is depressed
- When a shift position other than D is selected
- When the vehicle speed is approximately 10 mph (15 km/h) or lower
- When the vehicle is accelerating on a downward slope
- When the PCS (Pre-Collision System) is operating
- When the dynamic radar cruise control with full-speed range is operating
- When the Intelligent Clearance Sonar system is operating
- When the TRAC or VSC system is operating
- When the TRAC or VSC system is disabled by pressing the VSC OFF switch

■ Sport mode automatic deactivation

Sport mode is automatically deactivated if the power switch is turned off after driving in sport mode.

Driving assist systems

To keep driving safety and performance, the following systems operate automatically in response to various driving situations. Be aware, however, that these systems are supplementary and should not be relied upon too heavily when operating the vehicle.

◆ **ECB (Electronically Controlled Brake System)**

The electronically controlled system generates braking force corresponding to the brake operation

◆ **ABS (Anti-lock Brake System)**

Helps to prevent wheel lock when the brakes are applied suddenly, or if the brakes are applied while driving on a slippery road surface

◆ **Brake assist**

Generates an increased level of braking force after the brake pedal is depressed when the system detects a panic stop situation

◆ **VSC (Vehicle Stability Control)**

Helps the driver to control skidding when swerving suddenly or turning on slippery road surfaces.

◆ **Enhanced VSC (Enhanced Vehicle Stability Control)**

Provides cooperative control of the ABS, TRAC, VSC and EPS. Helps to maintain directional stability when swerving on slippery road surfaces by controlling steering performance.

◆ **TRAC (Traction Control)**

Helps to maintain drive power and prevent the drive wheels from spinning when starting the vehicle or accelerating on slippery roads

◆ **Hill-start assist control**

Helps to reduce the backward movement of the vehicle when starting on an uphill

◆ EPS (Electric Power Steering)

Employs an electric motor to reduce the amount of effort needed to turn the steering wheel

◆ The Secondary Collision Brake

When the SRS airbag sensor detects a collision and the system operates, the brakes and stop lights are automatically controlled to reduce the vehicle speed and help reduce the possibility of further damage due to a secondary collision.

When the TRAC/VSC/ABS systems are operating

The slip indicator light will flash while the TRAC/VSC/ABS systems are operating.

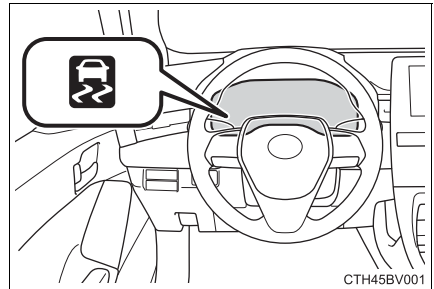

CTH45BV001

Disabling the TRAC system

If the vehicle gets stuck in mud, dirt or snow, the TRAC system may reduce power from the hybrid system to the wheels. Pressing  to turn the system off may make it easier for you to rock the vehicle in order to free it.

To turn the TRAC system off, quickly press and release .

The "Traction Control Turned Off" will be shown on the multi-information display.

Press  again to turn the system back on.

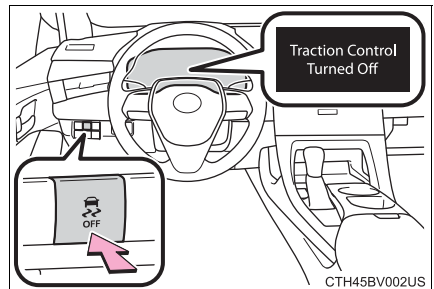

CTH45BV002US

■ Turning off both TRAC and VSC systems

To turn the TRAC and VSC systems off, press and hold  for more than 3 seconds while the vehicle is stopped.

The VSC OFF indicator light will come on and the “Traction Control Turned Off” will be shown on the multi-information display*.

Press  again to turn the system back on.

*: Pre-collision brake assist and pre-collision braking will also be disabled. The PCS warning light will come on and the message will be shown on the multi-information display. (→P. 251)

■ When the message is displayed on the multi-information display showing that TRAC has been disabled even if has not been pressed

TRAC is temporary deactivated. If the information continues to show, contact your Toyota dealer.

■ Operating conditions of hill-start assist control

When the following four conditions are met, the hill-start assist control will operate:

- The shift lever is in a position other than P or N (when starting off forward/backward on an upward incline)
- The vehicle is stopped
- The accelerator pedal is not depressed
- The parking brake is not engaged

■ Automatic system cancelation of hill-start assist control

The hill-start assist control will turn off in any of the following situations:

- The shift lever is shifted to P or N
- The accelerator pedal is depressed
- The parking brake is engaged
- 2 seconds at maximum elapsed after the brake pedal is released

■ Sounds and vibrations caused by the ABS, brake assist, VSC, TRAC, and hill-start assist control systems

- A sound may be heard from the engine compartment when the brake pedal is depressed repeatedly, when the hybrid system is started or just after the vehicle begins to move. This sound does not indicate that a malfunction has occurred in any of these systems.
- Any of the following conditions may occur when the above systems are operating. None of these indicates that a malfunction has occurred.
 - Vibrations may be felt through the vehicle body and steering.
 - A motor sound may be heard also after the vehicle comes to a stop.

■ ECB brake operation

Braking power may be stronger than normal for a short time after the hybrid system is started.

■ ECB operating sound

ECB operating sound may be heard in the following cases, but it does not indicate that a malfunction has occurred.

- Operating sound heard from the engine compartment when the brake pedal is operated.
- Motor sound of the brake system heard from the front part of the vehicle when the driver's door is opened.
- Operating sound heard from the engine compartment when one or two minutes passed after the stop of the hybrid system.

■ EPS operation sound

When the steering wheel is operated, a motor sound (whirring sound) may be heard. This does not indicate a malfunction.

■ Automatic reactivation of TRAC and VSC systems

After turning the TRAC and VSC systems off, the systems will be automatically re-enabled in the following situations:

- When the power switch is turned off
- If only the TRAC system is turned off, the TRAC will turn on when vehicle speed increases
If both the TRAC and VSC systems are turned off, automatic re-enabling will not occur when vehicle speed increases

■ Secondary Collision Brake operating conditions

The system operates when the SRS airbag sensor detects a collision while the vehicle is in motion.

However, the system does not operate in any of the following situations.

- The vehicle speed is below 6 mph (10 km/h)
- Components are damaged

■ Secondary Collision Brake automatic cancellation

The system is automatically canceled in any of the following situations.

- The vehicle speed drops below approximately 6 mph (10 km/h)
- A certain amount of time elapses during operation
- The accelerator pedal is depressed a large amount

■ Reduced effectiveness of the EPS system

The effectiveness of the EPS system is reduced to prevent the system from overheating when there is frequent steering input over an extended period of time. The steering wheel may feel heavy as a result. Should this occur, refrain from excessive steering input or stop the vehicle and turn the hybrid system off. The EPS system should return to normal within 10 minutes.

**WARNING****■ The ABS does not operate effectively when**

- The limits of tire gripping performance have been exceeded (such as excessively worn tires on a snow covered road).
- The vehicle hydroplanes while driving at high speed on wet or slick roads.

■ Stopping distance when the ABS is operating may exceed that of normal conditions

The ABS is not designed to shorten the vehicle's stopping distance. Always maintain a safe distance from the vehicle in front of you, especially in the following situations:

- When driving on dirt, gravel or snow-covered roads
- When driving with tire chains
- When driving over bumps in the road
- When driving over roads with potholes or uneven surfaces

■ TRAC/VSC may not operate effectively when

Directional control and power may not be achievable while driving on slippery road surfaces, even if the TRAC/VSC system is operating.

Drive the vehicle carefully in conditions where stability and power may be lost.

■ Hill- start assist control does not operate effectively when

- Do not overly rely on hill-start assist control. Hill-start assist control may not operate effectively on steep inclines and roads covered with ice.
- Unlike the parking brake, hill-start assist control is not intended to hold the vehicle stationary for an extended period of time. Do not attempt to use hill-start assist control to hold the vehicle on an incline, as doing so may lead to an accident.

■ When the TRAC/ABS/VSC is activated

The slip indicator light flashes. Always drive carefully. Reckless driving may cause an accident. Exercise particular care when the indicator light flashes.

■ When the TRAC/VSC systems are turned off

Be especially careful and drive at a speed appropriate to the road conditions. As these are the systems to help ensure vehicle stability and driving force, do not turn the TRAC/VSC systems off unless necessary.

 **WARNING****■ Replacing tires**

Make sure that all tires are of the specified size, brand, tread pattern and total load capacity. In addition, make sure that the tires are inflated to the recommended tire inflation pressure level.

The ABS, TRAC and VSC systems will not function correctly if different tires are installed on the vehicle.

Contact your Toyota dealer for further information when replacing tires or wheels.

■ Handling of tires and the suspension

Using tires with any kind of problem or modifying the suspension will affect the driving assist systems, and may cause a system to malfunction.

■ Secondary Collision Brake

Do not rely solely upon the Secondary Collision Brake. This system is designed to help reduce the possibility of further damage due to a secondary collision, however, that effect changes according to various conditions. Overly relying on the system may result in death or serious injury.

Hybrid vehicle driving tips

For economical and ecological driving, pay attention to the following points:

◆ Using Eco drive mode

When using Eco drive mode, the torque corresponding to the accelerator pedal depression amount can be generated more smoothly than it is in normal conditions. In addition, the operation of the air conditioning system (heating/cooling) will be minimized, improving the fuel economy. (→P. 321)

◆ Use of Hybrid System Indicator

The Eco-friendly driving is possible by keeping the needle of Hybrid System Indicator within Eco area. (→P. 100)

◆ Shift lever operation

Shift the shift lever to D when stopped at a traffic light, or driving in heavy traffic etc. Shift the shift lever to P when parking. When using the N, there is no positive effect on fuel consumption. In the N, the gasoline engine operates but electricity cannot be generated. Also, when using the air conditioning system, etc., the hybrid battery (traction battery) power is consumed.

◆ Accelerator pedal/brake pedal operation

- Drive your vehicle smoothly. Avoid abrupt acceleration and deceleration. Gradual acceleration and deceleration will make more effective use of the electric motor (traction motor) without having to use gasoline engine power.
- Avoid repeated acceleration. Repeated acceleration consumes hybrid battery (traction battery) power, resulting in poor fuel consumption. Battery power can be restored by driving with the accelerator pedal slightly released.

◆ **When braking**

Make sure to operate the brakes gently and in a timely manner. A greater amount of electrical energy can be regenerated when slowing down.

◆ **Delays**

Repeated acceleration and deceleration, as well as long waits at traffic lights, will lead to bad fuel economy. Check traffic reports before leaving and avoid delays as much as possible. When driving in a traffic jam, gently release the brake pedal to allow the vehicle to move forward slightly while avoiding overuse of the accelerator pedal. Doing so can help control excessive gasoline consumption.

◆ **Highway driving**

Control and maintain the vehicle at a constant speed. Before stopping at a toll booth or similar, allow plenty of time to release the accelerator and gently apply the brakes. A greater amount of electrical energy can be regenerated when slowing down.

◆ **Air conditioning**

Use the air conditioning only when necessary. Doing so can help reduce excessive gasoline consumption.

In summer: When the ambient temperature is high, use the recirculated air mode. Doing so will help to reduce the burden on the air conditioning system and reduce fuel consumption as well.

In winter: Because the gasoline engine will not automatically cut out until it and the interior of the vehicle are warm, it will consume fuel. Also, fuel consumption can be improved by avoiding overuse of the heater.

◆ **Checking tire inflation pressure**

Make sure to check the tire inflation pressure frequently. Improper tire inflation pressure can cause poor fuel economy.

Also, as snow tires can cause large amounts of friction, their use on dry roads can lead to poor fuel economy. Use tires that are appropriate for the season.

◆ Luggage

Carrying heavy luggage will lead to poor fuel economy. Avoid carrying unnecessary luggage. Installing a large roof rack will also cause poor fuel economy.

◆ Warming up before driving

Since the gasoline engine starts up and cuts out automatically when cold, warming up the engine is unnecessary. Moreover, frequently driving short distances will cause the engine to repeatedly warm up, which can lead to excess fuel consumption.

Winter driving tips

Carry out the necessary preparations and inspections before driving the vehicle in winter. Always drive the vehicle in a manner appropriate to the prevailing weather conditions.

Preparation for winter

- Use fluids that are appropriate to the prevailing outside temperatures.
 - Engine oil
 - Engine/power control unit coolant
 - Washer fluid
- Have a service technician inspect the condition of the 12-volt battery.
- Have the vehicle fitted with four snow tires or purchase a set of tire chains for the front tires.*

Ensure that all tires are the specified size and brand, and that chains match the size of the tires.

*: Tire chains cannot be mounted on vehicles with 18 and 19-inch tires.

Before driving the vehicle

Perform the following according to the driving conditions:

- Do not try to forcibly open a window or move a wiper that is frozen. Pour warm water over the frozen area to melt the ice. Wipe away the water immediately to prevent it from freezing.
- To ensure proper operation of the climate control system fan, remove any snow that has accumulated on the air inlet vents in front of the windshield.
- Check for and remove any excess ice or snow that may have accumulated on the exterior lights, vehicle's roof, chassis, around the tires or on the brakes.
- Remove any snow or mud from the bottom of your shoes before getting in the vehicle.

When driving the vehicle

Accelerate the vehicle slowly, keep a safe distance between you and the vehicle ahead, and drive at a reduced speed suitable to road conditions.

When parking the vehicle

- Park the vehicle and move the shift lever to P without setting the parking brake. The parking brake may freeze up, preventing it from being released. If the vehicle is parked without setting the parking brake, make sure to block the wheels.

Failure to do so may be dangerous because it may cause the vehicle to move unexpectedly, possibly leading to an accident.

- If the vehicle is parked without setting the parking brake, confirm that the shift lever cannot be moved out of P*.

*: The shift lever will be locked if it is attempted to be shifted from P to any other position without depressing the brake pedal. If the shift lever can be shifted from P, there may be a problem with the shift lock system. Have the vehicle inspected by your Toyota dealer immediately.

Selecting tire chains

- ▶ Vehicles with 17-inch tires

Use the correct tire chain size when mounting the snow chains.

Chain size is regulated for each tire size.

Side chain:

① 0.12 in. (3 mm) in diameter

② 0.39 in. (10 mm) in width

③ 1.18 in. (30 mm) in length

Cross chain:

④ 0.16 in. (4 mm) in diameter

⑤ 0.55 in. (14 mm) in width

⑥ 0.98 in. (25 mm) in length

- ▶ Vehicles with 18 and 19-inch tires

Tire chains cannot be mounted.

Snow tires should be used instead.

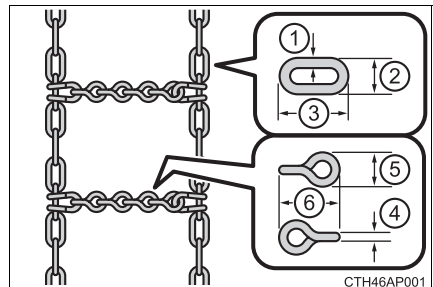

Regulations on the use of tire chains

Regulations regarding the use of tire chains vary depending on location and type of road. Always check local regulations before installing chains.

■ Tire chain installation

Observe the following precautions when installing and removing chains:

- Install and remove tire chains in a safe location.
- Install tire chains on the front tires. Do not install tire chains on the rear tires.
- Install tire chains on front tires as tightly as possible. Retighten chains after driving 1/4 — 1/2 mile (0.5 — 1.0 km).
- Install tire chains following the instructions provided with the tire chains.



WARNING

■ Driving with snow tires

Observe the following precautions to reduce the risk of accidents. Failure to do so may result in a loss of vehicle control and cause death or serious injury.

- Use tires of the specified size.
- Maintain the recommended level of air pressure.
- Do not drive in excess of 75 mph (120 km/h), regardless of the type of snow tires being used.
- Use snow tires on all, not just some wheels.

■ Driving with tire chains (vehicles with 17-inch tires)

Observe the following precautions to reduce the risk of accidents. Failure to do so may result in the vehicle being unable to be driven safely, and may cause death or serious injury.

- Do not drive in excess of the speed limit specified for the tire chains being used, or 30 mph (50 km/h), whichever is lower.
- Avoid driving on bumpy road surfaces or over potholes.
- Avoid sudden acceleration, abrupt steering, sudden braking and shifting operations that cause sudden engine braking.
- Slow down sufficiently before entering a curve to ensure that vehicle control is maintained.
- Do not use LDA (Lane Departure Alert with steering control) system.

**NOTICE****■ Repairing or replacing snow tires**

Request repairs or replacement of snow tires from Toyota dealers or legitimate tire retailers.

This is because the removal and attachment of snow tires affects the operation of the tire pressure warning valves and transmitters.

■ Fitting tire chains (vehicles with 17-inch tires)

The tire pressure warning valves and transmitters may not function correctly when tire chains are fitted.

Interior features

5

5-1. Using the air conditioning system and defogger

Automatic air conditioning system.....	338
Heated steering wheel/ seat heaters/ seat ventilators.....	349

5-2. Using the interior lights

Interior lights list	352
• Interior light	353
• Personal lights	353
• Ambient lights	354

5-3. Using the storage features

List of storage features	355
• Glove box.....	356
• Console box.....	356
• Bottle holders.....	357
• Cup holders	358
• Auxiliary boxes.....	359
• Open tray	360
Trunk features	361

5-4. Other interior features

Other interior features	362
• Sun visors	362
• Vanity mirrors.....	362
• Power outlet.....	363
• USB charging ports.....	364
• Wireless charger.....	366
• Armrest	375
• Assist grips	375
• Coat hooks.....	376
Garage door opener.....	377

Automatic air conditioning system



Air outlets and fan speed are automatically adjusted according to the temperature setting.

Press the “MENU” button on the Audio Plus or Premium Audio, then select “Climate” to display the air conditioning control screen.

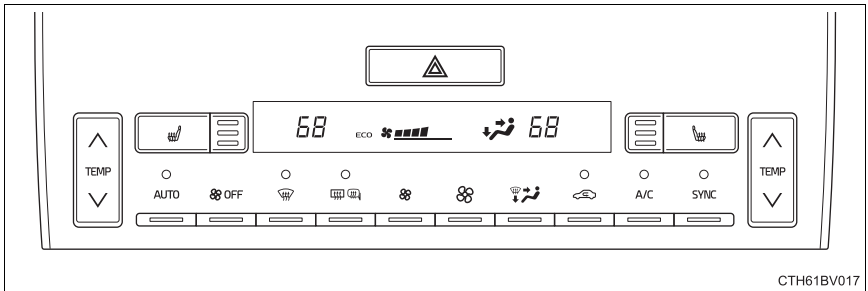
Control panel





■ Adjusting the temperature setting

To adjust the temperature setting, press “” on  (driver’s

side) to increase the temperature and press “” on

(driver’s side) to decrease the temperature.

If  is not pressed, the system will blow ambient temperature air or heated air.

The air conditioning system switches between individual and synchronized modes each time  is pressed or SYNC is selected on the air conditioning control screen.

Synchronized mode (indicator on):



The driver’s side  can be used to adjust the temperature for the driver’s and front passenger’s side. To enter individual mode, operate

the front passenger’s side  .

Individual mode (indicator off):

The temperature for the driver's and front passenger's side can be adjusted separately.

■ Fan speed setting

To adjust the fan speed, press  to increase the fan speed and  to decrease the fan speed.

Press  to turn the fan off.

■ Change the airflow mode

To change the airflow mode, press .

The air outlets used are switched each time the button is pressed.

- ① Air flows to the upper body.
- ② Air flows to the upper body and feet.
- ③ Air flows to the feet.
- ④ Air flows to the feet and the windshield defogger operates.

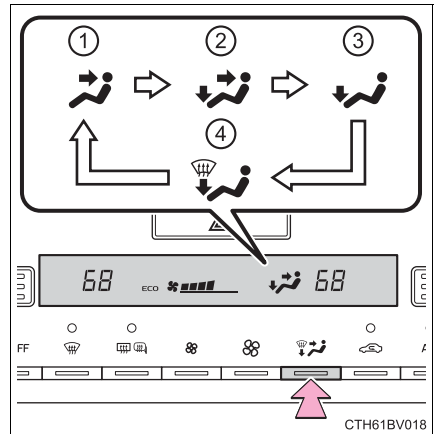

■ Other functions

- Switching between outside air and recirculated air modes (→P. 343)
- Defogging the windshield (→P. 343)
- Defogging the rear window and outside rear view mirrors (→P. 343)

Control screen

- ① Adjust the driver's side temperature setting
- ② Adjust the fan speed setting
- ③ Select the air flow mode*
- ④ Adjust the front passenger's side temperature setting
- ⑤ Display the option control screen (→P. 341)
- ⑥ Turn automatic mode on/off
- ⑦ Turn the fan off
- ⑧ Turn cooling and dehumidification function on/off

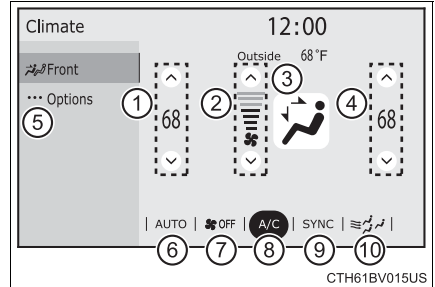

- If the A/C indicator is turned off, the system will blow ambient temperature air or heated air.
- ⑨ Change the temperature setting between individual/synchronized mode. (→P. 338)
 - ⑩ Enable/Disable S-FLOW mode (→P. 341)

*:  — Air flows to the upper body

 — Air flows to the upper body and feet

 — Air flows to the feet

 — Air flows to the feet and the windshield defogger operates

■ Option control screen

Select ●●● on the air conditioning control screen to display the option control screen. The functions can be switched on and off.

When the function is on, the indicator illuminates on the screen.

- ① Select to change the temperature setting between individual/synchronized mode (→P. 338)
- ② Select to set cooling and dehumidification function on/off
- ③ Select the S-FLOW mode (→P. 341)

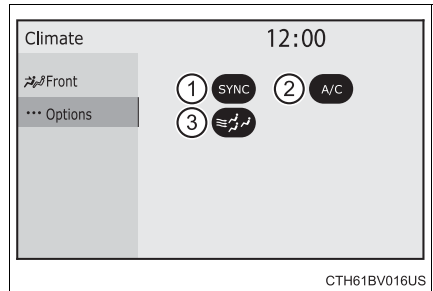



Air conditioning controls

■ Using the automatic mode

- ① Press  or select AUTO on the air conditioning control screen.

The dehumidification function begins to operate. Air outlets and fan speed are automatically adjusted according to the temperature setting.

- ② Adjust the temperature setting.

- ③ To stop the operation, press  or select  OFF on the air conditioning control screen.

■ Automatic mode indicator

If the fan speed setting or air flow modes are operated, the automatic mode indicator goes off. However, automatic mode for functions other than that operated is maintained.

■ S-FLOW mode

When the air conditioning system is operating in S-FLOW mode, air conditioner efficiency will be enhanced by concentrating the airflow on occupied seats only.

- The following S-FLOW modes are available:

- ▶ Automatic S-FLOW mode

When this mode is selected, if the rear seats are determined to be unoccupied, the air conditioning system will operate in S-FLOW mode.

When a rear passenger is detected, S-FLOW mode will be automatically disabled.

The  indicator on the air conditioning control screen will illuminate when the air conditioning system is operating in S-FLOW mode.

To enter manual S-FLOW mode, select  on the air conditioning control screen.

- ▶ Manual S-FLOW mode

When  is selected, S-FLOW mode will be manually enabled/disabled.

The  indicator on the air conditioning control screen will illuminate when the air conditioning system is operating in S-FLOW mode.

- Operation of the air conditioning system when S-FLOW mode is enabled:

When the air conditioning system is operating in S-FLOW mode, the airflow will be concentrated on the front seats, reducing the airflow and air conditioning effect on the rear seats.

Additionally, if the front passenger seat is determined to be unoccupied, the airflow will be concentrated on the driver's seat only. (Depending on the set temperature or ambient temperature, the air conditioning system may not operate in S-FLOW mode as described above.)

When certain conditions are met and priority is given to the driver's seat only, the temperature indicator for the front passenger side will turn off.

How the system judges if a seat is occupied in S-FLOW mode:

→P. 345

Other functions

■ Switching between outside air and recirculated air modes

Press  .

The mode switches between outside air mode (indicator off) and recirculated air mode (indicator on) each time  is pressed.

■ Defogging the windshield

Defoggers are used to defog the windshield and front side windows.

Press  .

The dehumidification function operates and fan speed increases. Set the outside/recirculated air mode button to the outside air mode if the recirculated air mode is used. (It may switch automatically.) To defog the windshield and the side windows early, turn the air flow and temperature up.

To return to the previous mode, press  again when the windshield is defogged.

■ Defogging the rear window and outside rear view mirrors

Defoggers are used to defog the rear window, and to remove rain-drops, dew and frost from the outside rear view mirrors.

Press  .

The defoggers will automatically turn off after a period of time.

Air outlets

■ Location of air outlets

The air outlets and air volume change according to the selected airflow mode.

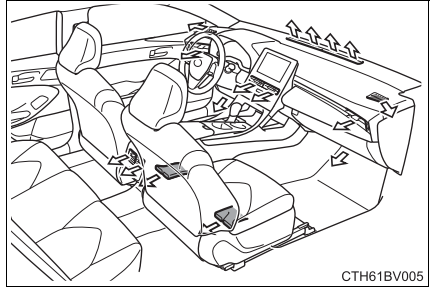

CTH61BV005

■ Adjusting the position of and opening and closing the air outlets

► Front

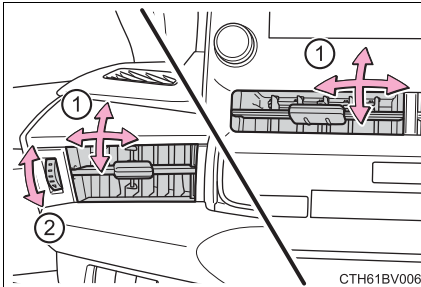

CTH61BV006

► Rear

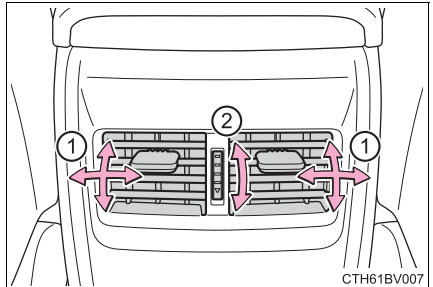

CTH61BV007

- ① Direct air flow to the left or right, up or down.
- ② Turn the knob to open or close the vent.

■ Using automatic mode

Fan speed is adjusted automatically according to the temperature setting and the ambient conditions.

Therefore, the fan may stop for a while until warm or cool air is ready to flow immediately after  is pressed or AUTO is selected.

■ How the system judges if a seat is occupied in S-FLOW mode

The system judges if a passenger is in the vehicle as follows:

• Front passenger seat:

The front passenger seat is judged to be occupied when the system detects an object on the front passenger seat, fastening of the front passenger seat belt, changing of the set temperature for the front passenger seat, or the opening and closing of the front passenger door. (However, when only opening and closing of the front passenger door is detected, the system will judge that the passenger seat is unoccupied after the vehicle speed reaches approximately 12 mph (20 km/h) or more.)

• Rear seats (automatic S-FLOW mode only):



The rear seats are judged to be occupied when the system detects the opening and closing of a rear door.

If a seat is judged to be occupied, the system will retain that judgement for 60 minutes after the power switch is turned off.

■ Changing from automatic S-FLOW mode to manual S-FLOW mode

When the system is operating in automatic S-FLOW mode, if a rear door is opened and then closed, S-FLOW mode will be disabled. To enable S-FLOW mode, select  on the air conditioning control screen. (In this case, the system will operate in manual S-FLOW mode.)

■ Changing from manual S-FLOW mode to automatic S-FLOW mode

1 Select  on the air conditioning control screen to disable S-FLOW mode (check that  indicator is not illuminated).

2 Turn the power switch off.

3 Wait for 60 minutes or more and change the power switch to ON mode.

■ Fogging up of the windows

● The windows will easily fog up when the humidity in the vehicle is high.

Turning  or A/C on will dehumidify the air from the outlets and defog the windshield effectively.

● If you turn  or A/C off, the windows may fog up more easily.

● The windows may fog up if the recirculated air mode is used.

■ When driving on dusty roads

Close all windows. If dust thrown up by the vehicle is still drawn into the vehicle after closing the windows, it is recommended that the air intake mode be set to outside air mode and the fan speed to any setting except off.

■ Outside/recirculated air mode

- Setting to the recirculated air mode temporarily is recommended in preventing dirty air from entering the vehicle interior and helping to cool the vehicle when the outside air temperature is high.
- Outside/recirculated air mode may automatically switch depending on the temperature setting or the inside temperature.

■ When the outside temperature exceeds 75°F (24°C) and the air conditioning system is on

- In order to reduce the air conditioning power consumption, the air conditioning system may switch to recirculated air mode automatically. This may also reduce fuel consumption.
- Recirculated air mode is selected as a default mode when the power switch is turned to ON mode.

- It is possible to switch to outside air mode at any time by pressing  .

■ When the outside temperature is low

The dehumidification function may not operate even when  is pressed or A/C is selected.

■ Operation of the air conditioning system in Eco drive mode

- In the Eco drive mode, “ECO” is displayed on the air conditioning screen and the air conditioning system is controlled as follows to prioritize fuel efficiency:
 - Engine speed and compressor operation controlled to restrict heating/cooling capacity
 - Fan speed restricted when automatic mode is selected
- To improve air conditioning performance, perform the following operations:
 - Adjust the fan speed
 - Turn off Eco drive mode

■ Ventilation and air conditioning odors

- To let fresh air in, set the air conditioning system to the outside air mode.
- During use, various odors from inside and outside the vehicle may enter into and accumulate in the air conditioning system. This may then cause odor to be emitted from the vents.
- To reduce potential odors from occurring:
 - It is recommended that the air conditioning system be set to outside air mode prior to turning the vehicle off.
 - The start timing of the blower may be delayed for a short period of time immediately after the air conditioning system is started in automatic mode.

■ Air conditioning filter

→P. 432

■ Air conditioning system refrigerant

- A label regarding the refrigerant of the air conditioning system is attached to the hood at the location shown in the following illustration.

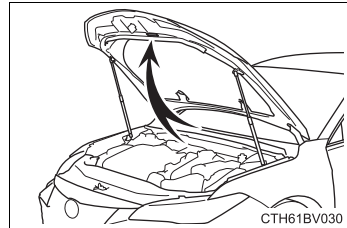

- The meaning of each symbol on the label are as follows:

	Caution
	Air conditioning system
	Air conditioning system lubricant type
	Requires registered technician to service air conditioning system
	Flammable refrigerant

■ Customization

Some functions can be customized. (→P. 533)

 **WARNING**

■ **To prevent the windshield from fogging up**

- Do not use  during cool air operation in extremely humid weather. The difference between the temperature of the outside air and that of the windshield can cause the outer surface of the windshield to fog up, blocking your vision.
- Do not place anything on the instrument panel which may cover the air outlets. Otherwise, air flow may be obstructed, preventing the windshield defoggers from defogging.

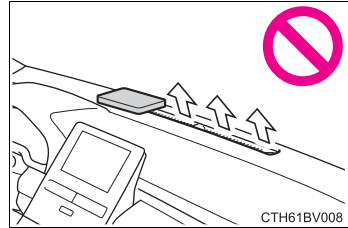

■ **To prevent burns**

Do not touch the rear view mirror surfaces when the outside rear view mirror defoggers are on.

 **NOTICE**

■ **To prevent 12-volt battery discharge**

Do not leave the air conditioning system on longer than necessary when the hybrid system is stopped.

■ **When repairing/replacing parts of the air conditioning system**

Have repair/replacement performed by your Toyota dealer.

When a part of the air conditioning system, such as the evaporator, is to be replaced, it must be replaced with a new one.

Heated steering wheel*/seat heaters/seat ventilators*

Heated steering wheel and seat heaters heat the side grips of the steering wheel and seats, respectively. Seat ventilators maintain good ventilation by pulling air through the seat upholstery.

WARNING

- Care should be taken to prevent injury if anyone in the following categories comes in contact with the steering wheel and seats when the heater is on:
 - Babies, small children, the elderly, the sick and the physically challenged
 - Persons with sensitive skin
 - Persons who are fatigued
 - Persons who have taken alcohol or drugs that induce sleep (sleeping drugs, cold remedies, etc.)
- Observe the following precautions to prevent minor burns or overheating:
 - Do not cover the seat with a blanket or cushion when using the seat heater.
 - Do not use seat heater more than necessary.

NOTICE

- Do not put heavy objects that have an uneven surface on the seat and do not stick sharp objects (needles, nails, etc.) into the seat.
- To prevent 12-volt battery discharge, do not use the functions when the hybrid system is off.

Heated steering wheel

Turns the heated steering wheel on/off

The indicator light comes on when the heated steering wheel is operating.

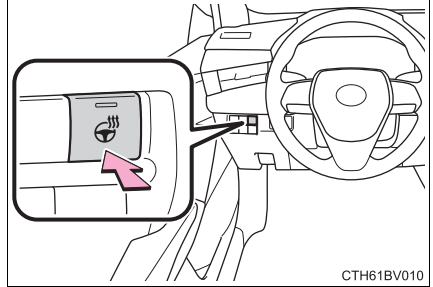

CTH61BV010

The heated steering wheel can be used when the power switch is in ON mode.

Seat heaters

■ Front

▶ Without seat ventilators

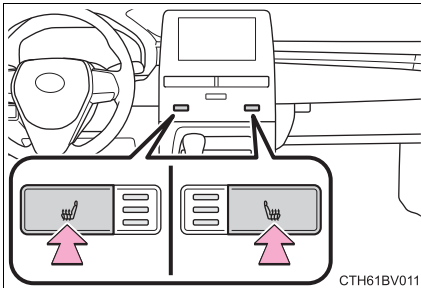

CTH61BV011

▶ With seat ventilators

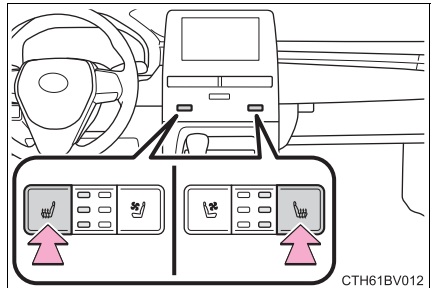

CTH61BV012

Each time the switch is pressed, the operation condition changes as follows.

Hi (3 segments lit) → Mid (2 segments lit) → Lo (1 segment lit) → Off

The level indicator lights up during operation.

■ Rear (if equipped)

Turns the heated rear seat on/off

The indicator light will illuminate when the rear seat heater is operating.

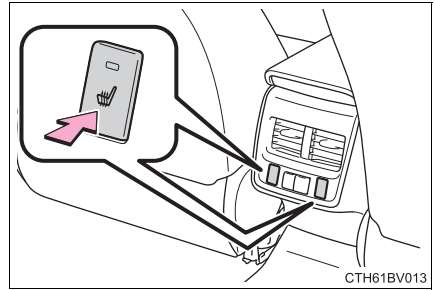

The seat heaters can be used when the power switch is in ON mode.

Seat ventilators

Each time the switch is pressed, the operation condition changes as follows.

Hi (3 segments lit) → Mid (2 segments lit) → Lo (1 segment lit) → Off

The level indicator lights up during operation.

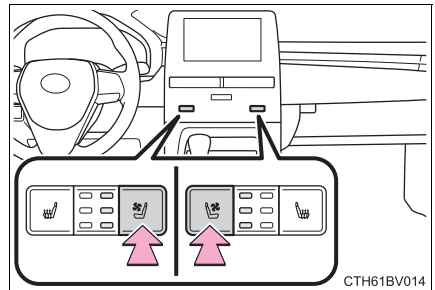

■ The seat ventilators can be used when

The power switch is in ON mode.

■ Air conditioning system-linked control mode

When a seat ventilator is set to Hi, the fan speed of the seat ventilator may increase according to the fan speed of the air conditioning system

Interior lights list

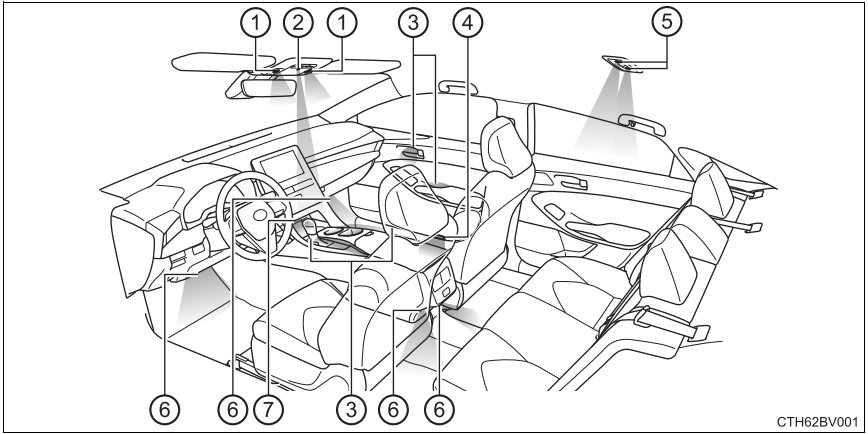

- ① Front interior/personal lights (→P. 353)
- ② Shift lever light
- ③ Ambient lights (if equipped) (→P. 354)
- ④ Door courtesy lights
- ⑤ Rear personal lights (→P. 353)
- ⑥ Footwell lights
- ⑦ Front center console light

Interior light

The rear personal lights turn on/off together with the interior light.

- ① Turns the lights on/off linked to door positions
- ② Turns the lights on/off

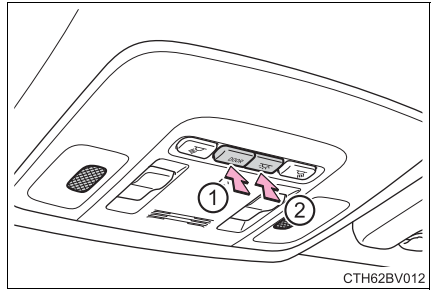

Personal lights

■ Front

Turns the lights on/off

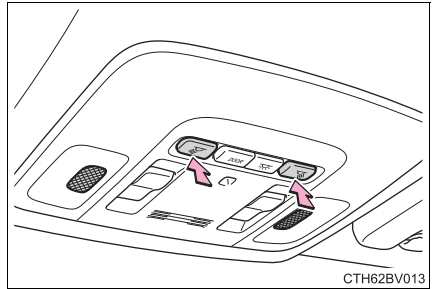

■ Rear

Turns the lights on/off

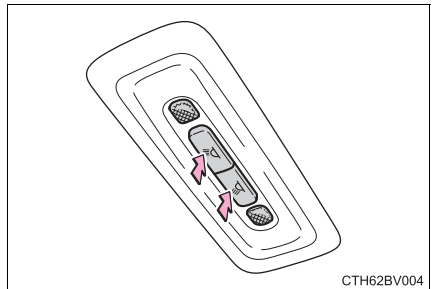

Ambient lights (if equipped)

Each time the “MOOD” switch is pressed, the brightness level changes.

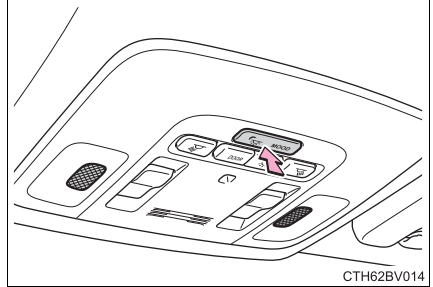

- **Illuminated entry system:**

The lights automatically turn on/off according to the power switch mode, the presence of the electronic key, whether the doors are locked/unlocked, and whether the doors are open/closed.

- If the interior lights remain on when the power switch is turned off, the lights will go off automatically after 20 minutes.
- If any of the SRS airbags deploy (inflate) or in the event of a strong rear impact, the interior lights will turn on automatically. The interior lights will turn off automatically after approximately 20 minutes. The interior lights can be turned off manually. However, in order to help prevent further collisions, it is recommended that they be left on until safety can be ensured.
(The interior lights may not turn on automatically depending on the force of the impact and conditions of the collision.)
- Some functions can be customized. (→P. 533)

List of storage features

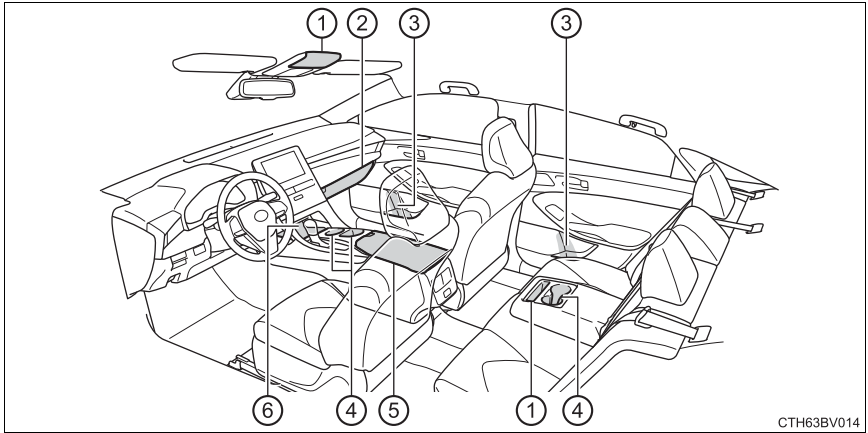

- | | | | |
|-------------------------------|-----------|---------------------------|----------------|
| ① Auxiliary boxes | (→P. 359) | ④ Cup holders | (→P. 358) |
| ② Glove box | (→P. 356) | ⑤ Console box | (→P. 356) |
| ③ Bottle holders/door pockets | (→P. 357) | ⑥ Auxiliary box/open tray | (→P. 359, 360) |

⚠ WARNING

- Do not leave glasses, lighters or spray cans in the storage spaces, as this may cause the following when cabin temperature becomes high:
 - Glasses may be deformed by heat or cracked if they come into contact with other stored items.
 - Lighters or spray cans may explode. If they come into contact with other stored items, the lighter may catch fire or the spray can may release gas, causing a fire hazard.
- When driving or when the storage compartments are not in use, keep the lids closed.
In the event of sudden braking or sudden swerving, an accident may occur due to an occupant being struck by an open lid or the items stored inside.

Glove box

Push the button to open the glove box.

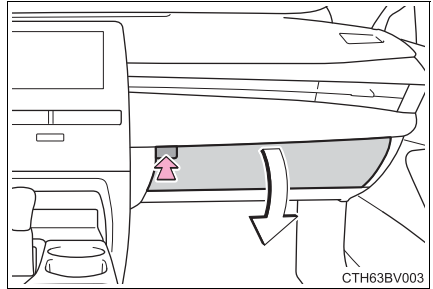

The glove box light turns on when the power switch is in ACCESSORY or ON mode.

Console box

Push the knob.

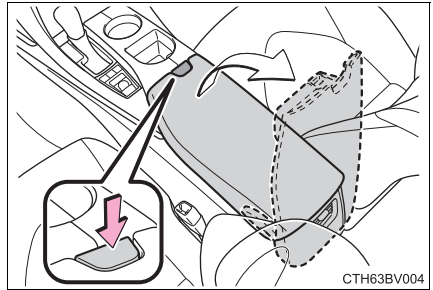

Console box tray

The tray can be removed.

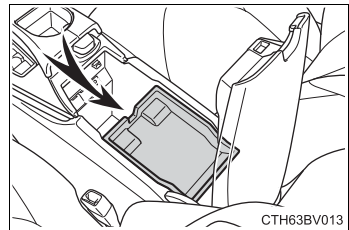

Console box light

The console box light turns on when the power switch is in ACCESSORY or ON mode.

Bottle holders

▶ Front

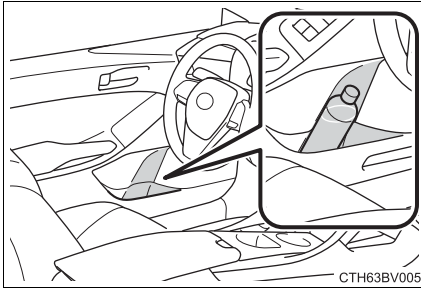

▶ Rear

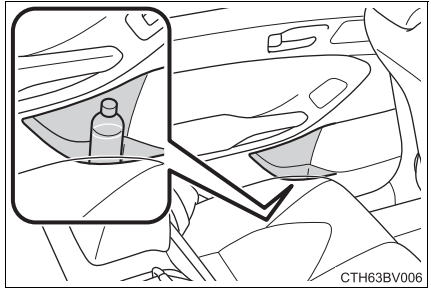

- When storing a bottle, close the cap.
- The bottle may not be stored depending on its size or shape.

⚠ WARNING

Do not place anything other than a bottle in the bottle holders. Other items may be thrown out of the holders in the event of an accident or sudden braking and cause injury.

⚠ NOTICE

Put the cap on before stowing a bottle. Do not place open bottles in the bottle holders, or glass or paper cups containing liquid. The contents may spill and glass cups may break.

Cup holders

▶ Front

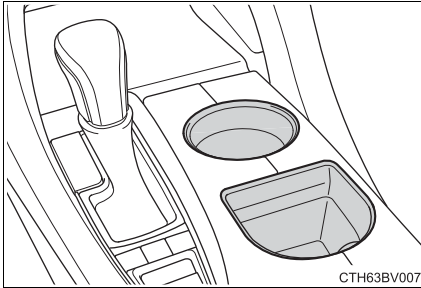

▶ Rear

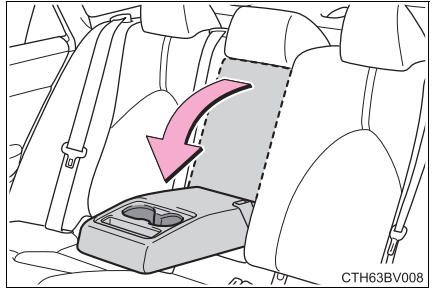

Pull the armrest down.

**WARNING**

- Do not place any objects that fit loosely or are very tall in the cup holders, otherwise they may fall out while driving, possibly leading to an accident.
- To prevent burns, cover hot drinks when placed in the cup holders.

Auxiliary boxes

▶ Type A (if equipped)

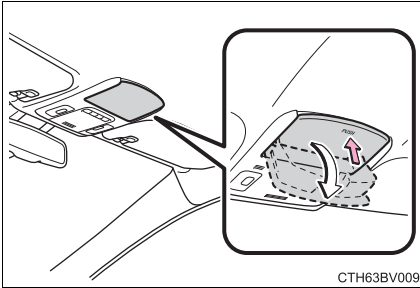

CTH63BV009

Push the lid.

▶ Type B

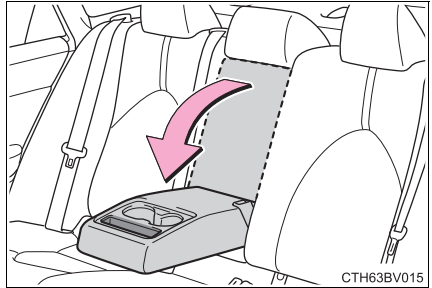

CTH63BV015

Pull the armrest down.

▶ Type C

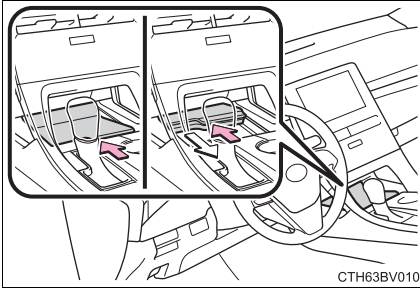

CTH63BV010

Opening:

Push the tray forward until it locks.

Closing:

Push the tray forward to release the lock and the tray will automatically close.

■ When small items are placed on top of the tray (type C)

The tray can be opened while small items are placed on it.

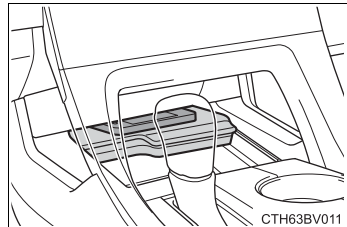

CTH63BV011

■ When using wireless charger (if equipped)

→P. 366

⚠ WARNING**■ Items unsuitable for storing (type A)**

Do not store items heavier than 0.4 lb. (0.2 kg).

Doing so may cause the auxiliary box to open and the items inside may fall out, resulting in an accident.

⚠ NOTICE**■ When opening or closing the tray (type C)**

- To prevent damaging small items, when opening the tray while small items are placed on it, make sure the items will not get caught.
- To prevent damaging the tray, do not pull the tray to close it. Doing so may damage the tray.
- When on a steep downward incline, the tray may be slow to close automatically. In this case, the tray can be pulled closed after pushing it to release the lock.

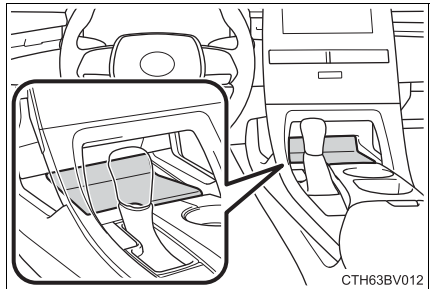
Open tray**⚠ WARNING**

Do not store items in the tray that can easily shift or roll out.

Failure to do so may cause items to be thrown out of the tray in the event of sudden braking or steering. In these cases, the items may interfere with pedal operation or cause driver distraction, resulting in an accident.

Trunk features

Grocery bag hooks

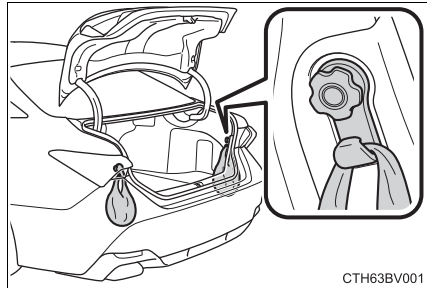

 NOTICE

To prevent damage to the hooks, do not apply too much load to the hooks.

Cargo net

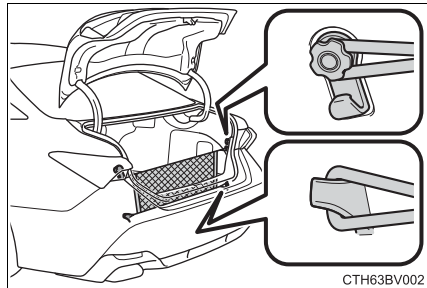

Other interior features

Sun visors

- ① To set the visor in the forward position, flip it down.
- ② To set the visor in the side position, flip down, unhook, and swing it to the side.
- ③ To use the side extender, place the visor in the side position, then slide it backward.

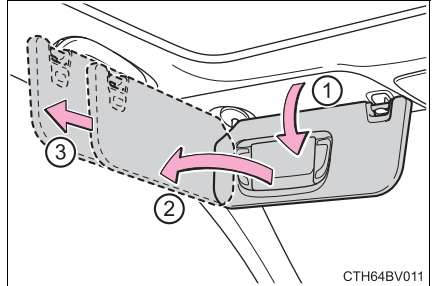

Vanity mirrors

Open the cover to use.

The light turns on when the cover is opened.

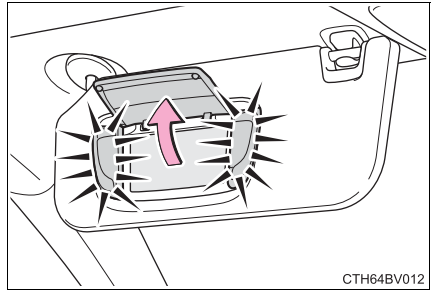

If the vanity lights remain on for 20 minutes while the hybrid system is off, the lights will turn off automatically.

Power outlet

Please use as a power supply for electronic goods that use less than 12 VDC/10 A (power consumption of 120 W).

Open the lid.

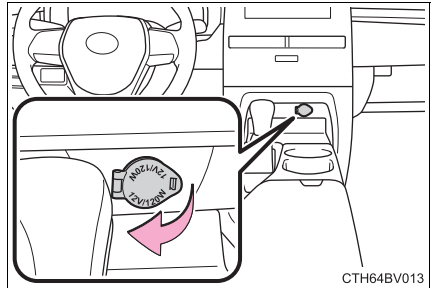

■ The power outlet can be used when

The power switch is in ACCESSORY or ON mode.

■ When stopping the hybrid system

Disconnect electrical devices with charging functions, such as mobile battery packs.

If such devices are left connected, the hybrid system may not stop normally.



NOTICE

- To avoid damaging the power outlet, close the power outlet lid when it is not in use.
Foreign objects or liquids that enter the power outlet may cause a short circuit.
- To prevent 12-volt battery discharge, do not use the power outlet longer than necessary when the hybrid system is off.

USB charging ports

The USB charging ports are used to supply 2.5 A (USB Type-A port) or 3.0 A (USB Type-C port) of electricity at 5 V to external devices (power consumption of 12.5 W [USB Type-A port] or 15 W [USB Type-C port]).

The USB charging ports are for charging only. They are not designed for data transfer or other purposes.

Depending on the external device, it may not charge properly. Refer to the manual included with the device before using a USB charging port.

■ Using the USB charging ports

► Front

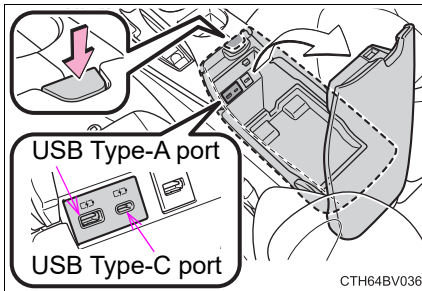

Open the console box lid.

► Rear

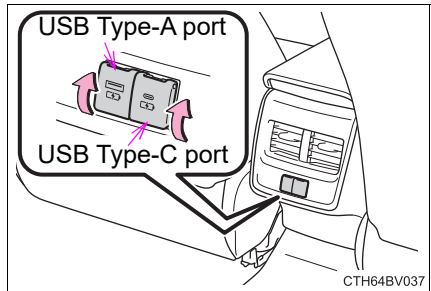

Open the lid.

■ The USB charging ports can be used when

The power switch is in ACCESSORY or ON mode.

■ Situations in which the USB charging ports may not operate correctly

- If a device which consumes more than 2.5 A at 5 V (12.5 W) (USB Type-A port) or 3.0 A at 5 V (15 W) (USB Type-C port) is connected
- If a device designed to communicate with a personal computer, such as a USB memory device, is connected
- If the connected external device is turned off (depending on device)
- If the temperature inside the vehicle is high, such as after the vehicle has been parked in the sun

■ About connected external devices

Depending on the connected external device, charging may occasionally be suspended and then start again. This is not a malfunction.

■ Cable pass through

- The cutouts on the console box rim allow power cables to be passed through when the console box lid is closed.

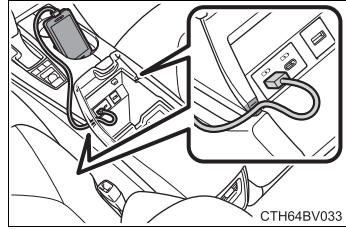

- An electronic device on the console box tray can be recharged by running power cables through the clearance of the tray and connecting it to the USB charging ports underneath the tray.

To prevent damage to the charging port of an electronic device when it is placed on the tray while it is being charged, place the connector side of the device on the raised portions near the cutout.

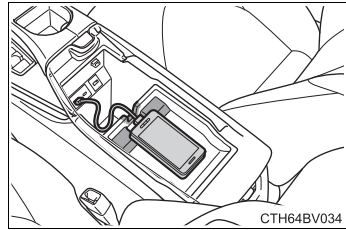

NOTICE

■ To prevent damage to the USB charging ports

- Do not insert foreign objects into the ports.
- Do not spill water or other liquids into the ports.
- Rear USB charging ports: When the USB charging ports are not in use, close the lids. If a foreign object or liquid enters a port may cause a short circuit.
- Do not apply excessive force to or impact the USB charging ports.
- Do not disassemble or modify the USB charging ports.

■ To prevent damage to external devices

- Do not leave external devices in the vehicle. The temperature inside the vehicle may become high, resulting in damage to an external device.
- Do not push down on or apply unnecessary force to an external device or the cable of an external device while it is connected.

■ To prevent 12-volt battery discharge

Do not use the USB charging ports for a long period of time with the hybrid system stopped.

Wireless charger (if equipped)

A portable device, such as a smartphone or mobile battery, can be charged by just placing it on the charging area, provided the device is compatible with the Qi wireless charging standard created by the Wireless Power Consortium.

The wireless charger cannot be used with a portable device that is larger than the charging area. Additionally, depending on the portable device, the wireless charger may not operate properly. Refer to the operation manual of the portable device.

■ The “Qi” symbol

The “Qi” symbol is a trademark of the Wireless Power Consortium.



■ Name for all parts

- ① Power supply switch
- ② Operation indicator light
- ③ Charge area

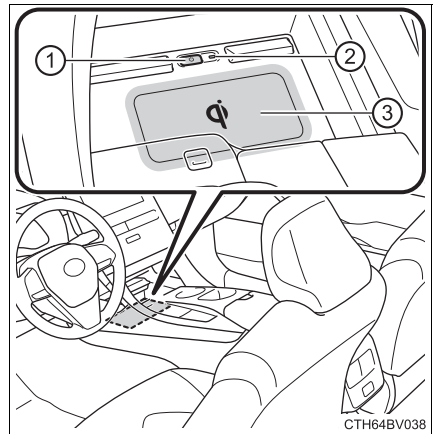

■ Using the wireless charger

- 1 Push the open tray forward until it locks. (→P. 359)
- 2 Press the power supply switch of the wireless charger.

Pressing the switch again turns the wireless charger off.

When turned on, the operation indicator light (green) comes on.

When the power switch is turned off, the on/off state of the wireless charger will be memorized.

- 3 Place a portable device on the charging area with its charging surface facing down.

While charging, the operation indicator light (orange) will be illuminated.

If charging does not begin, move the portable device as close to the center of the charging area as possible.

When charging is complete, the operation indicator light (green) will illuminate.

● Recharging function

- If a certain amount of time has elapsed since charging completed and the portable device has not been moved, the wireless charger will restart charging.
- If the portable device is moved within the charging area, charging will stop temporarily then restart.

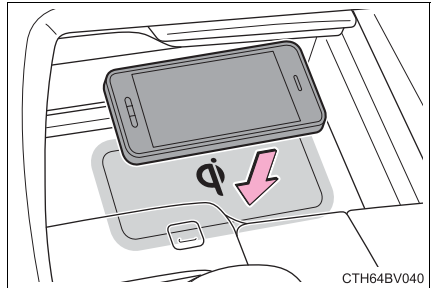
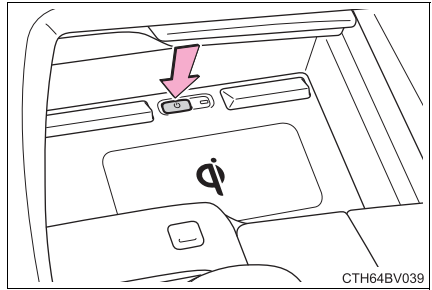

■ Operation indicator light status

Operation indicator light	State
Off	The Wireless charger is off
Green (illuminated)	Standby (charging is possible)
	Charging is complete*
Orange (illuminated)	A portable device has been placed on the charging area (identifying the portable device)
	Charging in progress

*: Depending on the portable device, the operation indicator light may stay illuminated (orange) after charging has completed.

● If the operation indicator light blinks

If an error is detected, the operation indicator light will blink (orange). Take the appropriate measures according to the table below.

Operation indicator light	Suspected causes	Measure
Blinks (orange) at a one second interval continuously	Vehicle to charger communication failure.	Contact your Toyota dealer.
Blinks (orange) 3 times repeatedly	A foreign object exists between the portable device and charging area.	Remove the foreign object.
	Portable device is not positioned properly on the charging area.	Move the portable device toward the center of the charging area.
Blinks (orange) 4 times repeatedly	The temperature of the wireless charger is excessively high.	Stop charging immediately and continue charging after a while.

■ The wireless charger can be operated when

The power switch is in ACCESSORY or ON mode.

■ Portable devices that can be charged

- Portable devices compatible with the Qi wireless charging standard can be charged by the wireless charger. However, compatibility with all devices which meet the Qi wireless charging standard is not guaranteed.
- The wireless charger is designed to supply low power electricity (5 W or less) to a cellular phone, smartphone, or other portable device.

■ If a cover or accessory is attached to the portable device

Do not charge a portable device if a cover or accessory which is not Qi compatible is attached. Depending on the type of cover and/or accessory attached, it may not be possible to charge the portable device. If the portable device is placed on the charging area and does not charge, remove the cover and/or accessories.

■ If interference is heard in AM radio broadcasts while charging

Turn off the wireless charger and check if the noise is reduced. If noise is reduced, press and hold the power supply switch of the wireless charger for 2 seconds. The frequency of the wireless charger is changed and noise may be reduced. When the frequency is changed, the operation indicator light will blink (orange) 2 times.

■ Charging precautions

- If the electronic key cannot be detected in the cabin, charging cannot be performed. When a door is opened and closed, charging may be temporarily suspended.
- While charging, the wireless charger and the portable device will become warm. This is not a malfunction.
If a portable device becomes warm while charging and charging stops due to the protection function of the portable device, wait until the portable device cools down and charge it again.

■ Sound generated during operation

When the power supply switch is turned on or while a portable device is being identified, operation sounds may be heard. This is not a malfunction.

■ Cleaning the wireless charger

→P. 390

■ Certification for the wireless charger**FCC Provided Information:**

This equipment has been tested and found to comply with Part 18 of the FCC Rules. These limits are designed to provide reasonable protection against harmful interference in a residential installation. Any changes or modifications not expressly approved by the party responsible for compliance could void the user's authority to operate this equipment.

This device complies with Part 18 of the FCC Rules. Operation is subject to the following two conditions:

(1) This device may not cause harmful interference, and (2) this device must accept any interference received, including interference that may cause undesired operation.

Declaration of Conformity

Trade Name:	Panasonic
Model Numbers:	AT1701 contains CA-QS03J1AJ
Responsible Party:	Panasonic Corporation of North America Two Riverfront Plaza, Newark, NJ 07102-5490
Support Contact:	http://shop.panasonic.com/support/

Panasonic

PRODUCT SAFETY AND COMPLIANCE DEPARTMENT, PANASONIC CORPORATION OF NORTH AMERICA, TWO RIVERFRONT PLAZA, 8TH FLOOR, NEWARK, NJ 07102-6469

FCC Declaration of Conformity Summary

Product Name	In-Vehicle Wireless Charger	
Model Number	AT1701	
Brand Name	Panasonic	
Size and Mass	<ul style="list-style-type: none"> • 245mm (w), 136mm (l) and 48mm (h) and mass is 515grams 	
Purpose Updated DoC	Added similarity variant model / AT1701 contains CA-QS03J1AJ	
Compliance Information	<ul style="list-style-type: none"> • 47 CFR, FCC Part 18, Subpart C for ISM Equipment • FCC's KDB 680106 D01 RF Exposure Wireless Charging Apps v02 • Industry Canada RSS-216, Issue 1, dated August 2014 • For Wireless Power Transfer Devices (Wireless Chargers) 	
Responsible Applicant	<p>Panasonic Corporation Automotive & Industrial Systems Company Automotive Infotainment Systems Business Division 4261, Ikonohe-cho, Tsuzuki-ku, Yokohama-shi, 224-8520, Japan</p>	
Responsible Factories	<ul style="list-style-type: none"> • Panasonic Corporation, Automotive & Industrial Systems Company Automotive Infotainment / Systems Business Division Global Manufacturing Innovation Center, Matsumoto Factory 5652 Sasaga, Matsumoto city, Nagano 399-8730, Japan • Panasonic Automotive Systems Czech, s.r.o. U Panasonicu 266, 530 06 Pardubice-Stare Cvice, Czech Republic • Panasonic Automotive Systems Asia Pacific (Thailand) Co., Ltd. 101 Moo 2 Teparak Road, T.Bangsaothong Ging A, Bangsaothong Samutprakarn 10540 Thailand • Panasonic Automotive Systems Dalian Co., Ltd. No.300, HongGang Road, GanJingZi District, Dalian, Liaoning Province, 116033 China 	
Responsible Sales Company	<p>Panasonic Consumer Electronics Company Division of Panasonic Corporation of North America Two Riverfront Plaza, Newark, NJ 07102-5490 General Contact: http://shop.panasonic.com/support</p>	
Special Conditions For Compliance	<p>In-Vehicle Wireless Charger will be installed and used exclusively within transportation vehicle and as such, it is exempt from the following requirements: (1) Part 15 digital device technical rules in accordance with §15.103(a); and (2) §15.105(b) full text information to user to appear in User Manual in accordance with §18.213.</p>	
EMI Test Report	TCB	UL Japan
	Test Report	10120384-R2
	Model Tested	AT1701 contains CA-QS03J1AJ
	Date Issued	12/14/2015
	Methodology	FCC-OET MP-4



PRODUCT SAFETY AND COMPLIANCE DEPARTMENT, PANASONIC CORPORATION OF NORTH AMERICA, TWO RIVERFRONT PLAZA, 8TH FLOOR, NEWARK, NJ 07102-6469

Panasonic

PRODUCT SAFETY AND COMPLIANCE DEPARTMENT, PANASONIC CORPORATION OF NORTH AMERICA, TWO RIVERFRONT PLAZA, 8TH FLOOR, NEWARK, NJ 07102-6499

FCC Declaration of Conformity

Summary

RF Exposure Evaluation	TCB	UL Japan
	MPE Test Report	10197157S-E-R1
	Model Tested	AT1701 contains CA-QS0311AJ
	Date Issued	12/14/2015
	Methodology	KDB 680106 D01 RF Exposure Wireless Charging Apps v02
Importation	The subject In-Vehicle Wireless Charger can be imported on behalf of Panasonic affiliated sales companies by PNA's Logistics Import Customs, or their authorized brokers, by electronically filing FCC Form 740 while declaring Box 2 with no reference to any FCC ID.	

This DoC is granted for the subject In-Vehicle Wireless Charger on the basis of the manufacturer's attested compliance with the above described conditions and in accordance with FCC Part 18 and FCC's KDB 0680106 D01 RF Exposure Wireless Charging Apps v02.

Certificate Number: DoC 2014-008C
Applicant Ref No.: PAS-16-P001

Richard Mullin
Issued by: Richard Mullin
Issue Date: January 14, 2016

PRODUCT SAFETY AND COMPLIANCE DEPARTMENT, PANASONIC CORPORATION OF NORTH AMERICA, TWO RIVERFRONT PLAZA, 8TH FLOOR, NEWARK, NJ 07102-6499

**WARNING****■ Caution while driving**

When charging a portable device while driving, for safety reasons, the driver should not operate the portable device.

■ Caution regarding interference with electronic devices

People with implantable cardiac pacemakers, cardiac resynchronization therapy pacemakers or implantable cardioverter defibrillators, as well as any other electrical medical device, should consult their physician about the usage of the wireless charger.

Operations of the wireless charger may have an affect on medical devices.

■ To prevent damage or burns

Observe the following precautions.

Failure to do so may result in the possibility of fire, equipment failure or damage, or burns due to heat.

- Do not put any metallic objects between the charging area and the portable device while charging.
- Do not attach metallic objects, such as aluminum stickers, to the charging area.
- Do not cover the wireless charger with a cloth or other object while charging.
- Do not attempt to charge portable devices which are not compatible with the Qi wireless charging standard.
- Do not disassemble, modify or remove the wireless charger.
- Do not apply force or impact to the wireless charger.

**NOTICE****■ Conditions in which the wireless charger may not operate correctly**

In the following situations, the wireless charger may not operate correctly:

- When a portable device is fully charged
- When there is a foreign object between the charging area and portable device
- When a portable device becomes hot while charging
- When a portable device is placed on the wireless area with its charging surface facing up
- When a portable device is not centered on the charging area
- When the vehicle is near a TV tower, electric power plant, gas station, radio station, large display, airport or other facility that generates strong radio waves or electrical noise
- When the portable device is in contact with, or is covered by any of the following metallic objects:
 - Cards to which aluminum foil is attached
 - Cigarette boxes that have aluminum foil inside
 - Metallic wallets or bags
 - Coins
 - Metal hand warmers
 - Media such as CDs and DVDs
- When wireless keys (that emit radio waves) other than those of your vehicle are being used nearby.

If in situations other than above the wireless charger does not operate properly or the operation indicator light is blinking, the wireless charger may be malfunctioning. Contact your Toyota dealer.

■ To prevent failure or damage to data

- Do not bring magnetic cards, such as a credit card, or magnetic recording media, close to the wireless charger while charging. Otherwise, data may be erased due to the influence of magnetism. Additionally, do not bring precision instruments such as wrist watches, close to the wireless charger, as such objects may malfunction.
- Do not leave portable devices in the cabin. The temperature inside the cabin may become high when parked in the sun, and cause damage to the device.

■ To prevent 12-volt battery discharge

Do not use the wireless charger for a long period of time with the hybrid system stopped.

Armrest

Fold down the armrest for use.

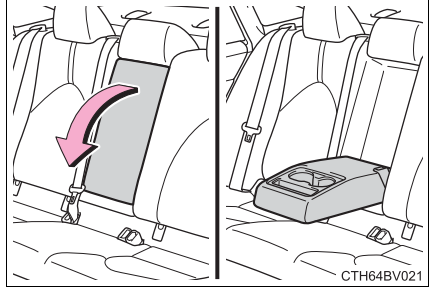

NOTICE

To prevent damage to the armrest, do not apply too much load on the armrest.

Assist grips

An assist grip installed on the ceiling can be used to support your body while sitting on the seat.

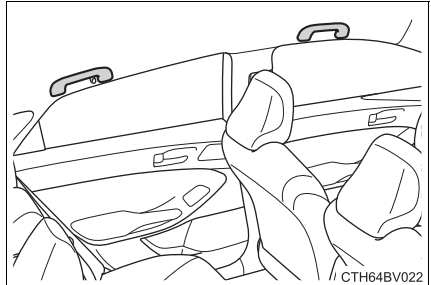

WARNING

Do not use the assist grip when getting in or out of the vehicle or rising from your seat.

NOTICE

To prevent damage to the assist grip, do not put a heavy load on the assist grip.

Coat hooks

Coat hooks are provided on the rear assist grips.

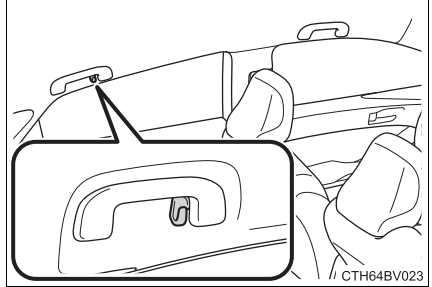

WARNING

Do not hang coat hangers or other hard or sharp objects on the hook. If the SRS curtain shield airbags deploy, these items may become projectiles, causing death or serious injury.

Garage door opener*

The garage door opener can be programmed to operate garage doors, gates, entry doors, door locks, home lighting systems, security systems, and other devices.

HomeLink®

The HomeLink® wireless control system in your vehicle has 3 buttons which can be programmed to operate 3 different devices. Refer to the programming methods on the following pages to determine the method which is appropriate for the device.

- ① HomeLink® indicator light
- ② Garage door operation indicators
- ③ HomeLink® icon
Illuminates while HomeLink® is operating.
- ④ Buttons

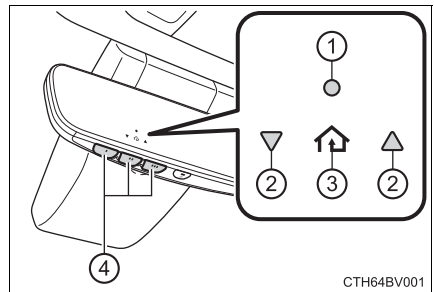

■ Before programming the HomeLink®

- During programming, it is possible that garage doors, gates, or other devices may operate. For this reason, make sure that people and objects are clear of the garage door or other devices to prevent injury or other potential harm.
- It is recommended that a new battery be placed in the remote control transmitter for more accurate programming.
- Garage door opener motors manufactured after 1995 may be equipped with rolling code protection. If this is the case, you may need a stepladder or other sturdy, safe device to reach the “Learn” or “Smart” button on the garage door opener motor.

*: If equipped

■ Programming the HomeLink®

Steps **1** through **3** must be performed within 60 seconds, otherwise the indicator light will stop flashing and programming will not be able to be completed.

- 1** Press and release the HomeLink® button you want to program and check that the HomeLink® indicator light flashes orange.
- 2** Point the remote control transmitter for the device at the rear view mirror, 1 to 3 in. (25 to 75 mm) from the HomeLink® buttons.

Keep the HomeLink® indicator light in view while programming.

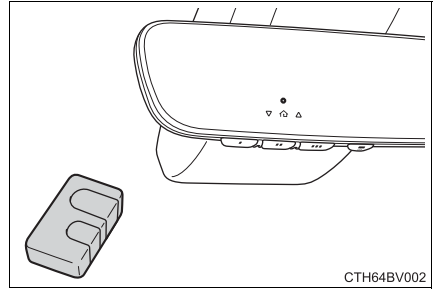

- 3** Program a device.

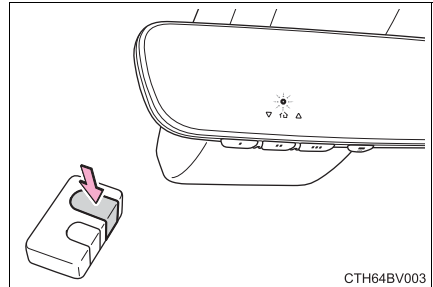

- ▶ Programming a device other than an entry gate (for U.S.A. owners)

Press and hold the remote control transmitter button until the HomeLink® indicator light changes from slowly flashing orange to rapidly flashing green (rolling code) or continuously lit green (fixed code), then release the button.

- ▶ Programming an entry gate (for U.S.A. owners)/Programming a device in the Canadian market

Press and release the remote control transmitter button at 2 second intervals, repeatedly, until the HomeLink® indicator light changes from slowly flashing orange to rapidly flashing green (rolling code) or continuously lit green (fixed code).

- 4 Test the HomeLink[®] operation by pressing the newly programmed button and observing the indicator light:
 - Indicator light illuminates: Programming of a fixed code device has completed. The garage door or other device should operate when a HomeLink[®] button is pressed and released.
 - Indicator light flashes rapidly: The garage door opener motor or other device is equipped with a rolling code. To complete programming, firmly press and hold the HomeLink[®] button for 2 seconds then release it.
 - If the garage door or other device does not operate, proceed to “Programming a rolling code system”.
- 5 Repeat the steps above to program another device for any of the remaining HomeLink[®] buttons.

■ Programming a rolling code system

2 or more people may be necessary to complete rolling code programming.

- 1 Locate the “Learn” or “Smart” button on the garage door opener motor in the garage.

This button can usually be found where the hanging antenna wire is attached to the unit. The name and color of the button may vary by manufacturer. Refer to the Owner’s manual supplied with the garage door opener motor for details.

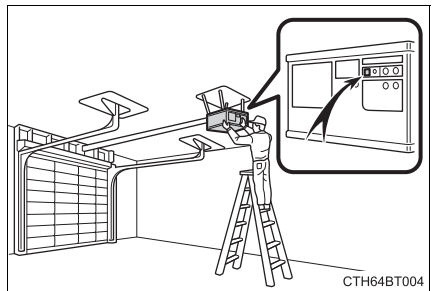

- 2 Press and release the “Learn” or “Smart” button. Perform 3 within 30 seconds after performing 2.

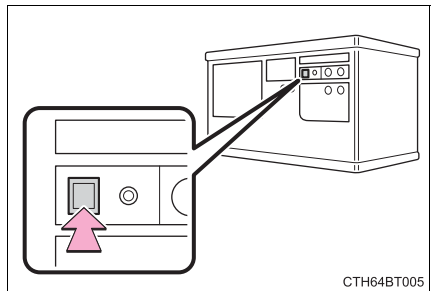

- 3 Press and hold the desired HomeLink[®] button (inside the vehicle) for 2 seconds and release it. Repeat this sequence (press/hold/release) up to 3 times to complete programming.

If the garage door opener motor operates when the HomeLink[®] button is pressed, the garage door opener motor recognizes the HomeLink[®] signal.

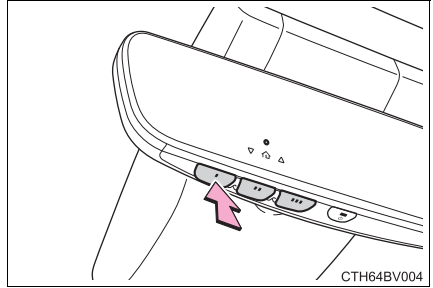

■ Enabling 2-way communication with a garage door (only available for compatible devices)

When enabled, 2-way communication allows you to check the status of the opening and closing of a garage door through indicators in your vehicle.

2-way communication is only available if the garage door opener motor used is a compatible device. (To check device compatibility, refer to www.HomeLink.com.)

- 1 Within 5 seconds after programming the garage door opener has been completed, if the garage door opener motor is trained to HomeLink[®], both garage door operation indicators will flash rapidly green and the light on the garage door opener motor will blink twice, indicating that 2-way communication is enabled.

If the indicators do not flash, perform 2 and 3 within the first 10 presses of the HomeLink[®] button after programming has been completed.

- 2 Press a programmed HomeLink[®] button to operate a garage door.
- 3 Within 1 minute of pressing the HomeLink[®] button, after the garage door operation has stopped, press the “Learn” or “Smart” button on the garage door opener motor. Within 5 seconds of the establishment of 2-way communication with the garage door opener, both garage door operation indicators in the vehicle will flash rapidly green and the light on the garage door opener motor will blink twice, indicating that 2-way communication is enabled.

■ Reprogramming a single HomeLink® button

When the following procedure is performed, buttons which already have devices registered to them can be overwritten:

- 1 With one hand, press and hold the desired HomeLink® button.
- 2 When the HomeLink® indicator starts flashing orange, continue to hold the HomeLink® button and perform “Programming the HomeLink®” 1 (it takes 20 seconds for the HomeLink® indicator to start flashing).

Operating the HomeLink®

Press the appropriate HomeLink® button. The HomeLink® indicator light should turn on.

Garage door operation indicators

The status of the opening and closing of a garage door is shown by the indicators.

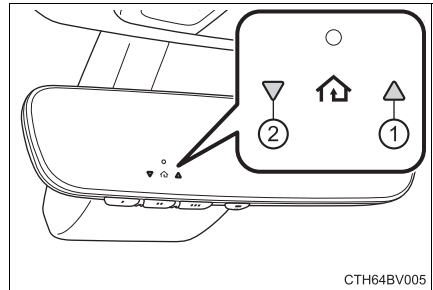

- 1 Opening
- 2 Closing

This function is only available if the garage door opener motor used is a compatible device. (To check device compatibility, refer to www.HomeLink.com.)



Color	Status
Orange (flashing)	Currently opening/closing
Green	Opening/closing has completed
Red (flashing)	Feedback signals cannot be received

The indicators can operate within approximately 820 ft. (250 m) of the garage door. However, if there are obstructions between the garage door and the vehicle, such as houses and trees, feedback signals from the garage door may not be received. To recall the previous door operation status, press and release either HomeLink®

buttons  and  or  and  simultaneously.

The last recorded status will be displayed for 3 seconds.

Erasing the entire HomeLink® memory (all three codes)

Press and hold the 2 outside buttons for 10 seconds until the HomeLink® indicator light changes from continuously lit orange to rapidly flashing green.

If you sell your vehicle, be sure to erase the programs stored in the HomeLink® memory.

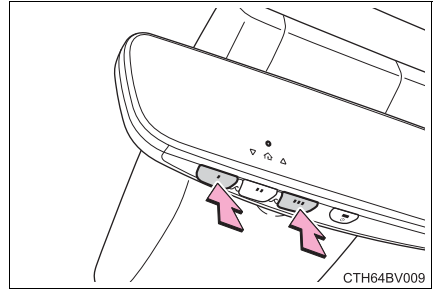

Codes stored in the HomeLink® memory

- The registered codes are not erased even if the 12-volt battery cable is disconnected.
- If learning failed when registering a different code to a HomeLink® button that already has a code registered to it, the already registered code will not be erased.

Before programming

- Install a new battery in the transmitter.
- The battery side of the transmitter must be pointed away from the HomeLink®.

Certification for the garage door opener

This device complies with FCC rules part 15 and Innovation, Science, and Economic Development Canada RSS-210. Operation is subject to the following two conditions: (1) This device may not cause harmful interference, and (2) This device must accept any interference that may be received including interference that may cause undesired operation. **WARNING:** The transmitter has been tested and complies with FCC and ISCED rules. Changes or modifications not expressly approved by the party responsible for compliance could void the user's authority to operate the device.

This equipment complies with FCC and ISCED radiation exposure limits set forth for an uncontrolled environment. End Users must follow the specific operating instructions for satisfying RF exposure compliance. This transmitter must be at least 20 cm from the user and must not be co-located or operating in conjunction with any other antenna or transmitter.

When support is necessary

Visit on the web at www.homelink.com/toyota or call 1-800-355-3515.

**WARNING****■ When programming a garage door or other remote control device**

The garage door or other device may operate, so ensure people and objects are out of danger to prevent potential harm.

■ Conforming to federal safety standards

Do not use the HomeLink[®] compatible transceiver with any garage door opener or device that lacks safety stop and reverse features as required by federal safety standards. This includes any garage door that cannot detect an interfering object. A door or device without these features increases the risk of death or serious injury.

■ When operating or programming HomeLink[®]

Never allow a child to operate or play with the HomeLink[®] buttons.

Maintenance and care

6

6-1. Maintenance and care

- Cleaning and protecting
the vehicle exterior..... 386
- Cleaning and protecting
the vehicle interior..... 389

6-2. Maintenance

- Maintenance
requirements 392
- General maintenance..... 394
- Emission inspection and
maintenance (I/M)
programs..... 398

6-3. Do-it-yourself maintenance

- Do-it-yourself service
precautions 399
- Hood 401
- Positioning a floor jack..... 402
- Engine compartment..... 403
- 12-volt battery 411
- Tires 415
- Tire inflation pressure 427
- Wheels 430
- Air conditioning filter..... 432
- Cleaning the hybrid
battery (traction battery)
air intake vent and
filter 434
- Electronic key battery..... 439
- Checking and replacing
fuses 442
- Light bulbs..... 445

Cleaning and protecting the vehicle exterior

Perform the following to protect the vehicle and maintain it in prime condition:

- Working from top to bottom, liberally apply water to the vehicle body, wheel wells and underside of the vehicle to remove any dirt and dust.
- Wash the vehicle body using a sponge or soft cloth, such as a chamois.
- For hard-to-remove marks, use car wash soap and rinse thoroughly with water.
- Wipe away any water.
- Wax the vehicle when the waterproof coating deteriorates.

If water does not bead on a clean surface, apply wax when the vehicle body is cool.

■ Automatic car washes

- Fold the mirrors before washing the vehicle. Start washing from the front of the vehicle. Make sure to extend the mirrors before driving.
- Brushes used in automatic car washes may scratch the vehicle surface, parts (wheel, etc.) and harm your vehicle's paint.
- Vehicles with a rear spoiler: In certain automatic car washes, the rear spoiler may interfere with machine operation. This may prevent the vehicle from being cleaned properly or result in damage to the rear spoiler.

■ High pressure car washes

As water may enter the cabin, do not bring the nozzle tip near the gaps around the doors or perimeter of the windows, or spray these areas continuously.

■ When using a car wash

If the door handle becomes wet while the electronic key is within the effective range, the door may lock and unlock repeatedly. In that case, follow the following correction procedures to wash the vehicle:

- Place the key in a position 6 ft. (2 m) or more separate from the vehicle while the vehicle is being washed. (Take care to ensure that the key is not stolen.)
- Set the electronic key to battery-saving mode to disable the smart key system. (→P. 150)

■ Wheels and wheel ornaments

- Remove any dirt immediately by using a neutral detergent.
- Wash detergent off with water immediately after use.
- To protect the paint from damage, make sure to observe the following precautions.
 - Do not use acidic, alkaline or abrasive detergent
 - Do not use hard brushes
 - Do not use detergent on the wheels when they are hot, such as after driving or parking in hot weather

■ Bumpers

Do not scrub with abrasive cleaners.

■ Plated portions

If dirt cannot be removed, clean the parts as follows:

- Use a soft cloth dampened with an approximately 5% solution of neutral detergent and water to clean the dirt off.
- Wipe the surface with a dry, soft cloth to remove any remaining moisture.
- To remove oily deposits, use alcohol wet wipes or a similar product.

WARNING

■ When washing the vehicle

Do not apply water to the inside of the engine compartment. Doing so may cause the electrical components, etc. to catch fire.

■ Precautions regarding the exhaust pipes

Exhaust gasses cause the exhaust pipes to become quite hot.

When washing the vehicle, be careful not to touch the pipes until it has cooled sufficiently, as touching a hot exhaust pipes can cause burns.

■ Precaution regarding the rear bumper with Blind Spot Monitor

If the paint of the rear bumper is chipped or scratched, the system may malfunction. If this occurs, avoid using the system and consult your Toyota dealer.

**NOTICE****■ To prevent paint deterioration and corrosion on the body and components (aluminum wheels, etc.)**

- Wash the vehicle immediately in the following cases:
 - After driving near the sea coast
 - After driving on salted roads
 - If coal tar or tree sap is present on the paint surface
 - If dead insects, insect droppings or bird droppings are present on the paint surface
 - After driving in an area contaminated with soot, oily smoke, mine dust, iron powder or chemical substances
 - If the vehicle becomes heavily soiled with dust or mud
 - If liquids such as benzene and gasoline are spilled on the paint surface
- If the paint is chipped or scratched, have it repaired immediately.
- To prevent the wheels from corroding, remove any dirt and store in a place with low humidity when storing the wheels.

■ Cleaning the exterior lights

- Wash carefully. Do not use organic substances or scrub with a hard brush. This may damage the surfaces of the lights.
- Do not apply wax to the surfaces of the lights. Wax may cause damage to the lenses.

■ When using a high pressure car wash

- Do not bring the nozzle tip close to boots (rubber or resin manufactured cover), connectors or the following parts. The parts may be damaged if they come into contact with high-pressure water.
 - Traction related parts
 - Steering parts
 - Suspension parts
 - Brake parts
- Do not wash the underside of the vehicle using a high-pressure car washer.
- Keep the cleaning nozzle at least 11.9 in. (30 cm) away from the vehicle body. Otherwise resin section, such as moldings and bumpers, may be deformed and damaged. Also, do not continuously hold the nozzle in the same place.
- Do not spray the lower part of the windshield continuously. If water enters the air conditioning system intake located near the lower part of the windshield, the air conditioning system may not operate correctly.
- Do not wash the underside of the vehicle using a high pressure car washer.

Cleaning and protecting the vehicle interior

The following procedures will help protect your vehicle's interior and keep it in top condition:

Protecting the vehicle interior

- Remove dirt and dust using a vacuum cleaner. Wipe dirty surfaces with a cloth dampened with lukewarm water.
- If dirt cannot be removed, wipe it off with a soft cloth dampened with neutral detergent diluted to approximately 1%.
Wring out any excess water from the cloth and thoroughly wipe off remaining traces of detergent and water.

Cleaning the areas with satin-finish metal accents

- Remove dirt using a soft cloth or synthetic chamois dampened in a baking soda (sodium bicarbonate) solution.
Use a solution of approximately 9% baking soda dissolved in water.
- Wipe the surface with a dry, soft cloth to remove any remaining moisture.

Cleaning the leather areas

- Remove dirt and dust using a vacuum cleaner.
- Wipe off any excess dirt and dust with a soft cloth dampened with diluted detergent.
Use a diluted water solution of approximately 5% neutral wool detergent.
- Wring out any excess water from the cloth and thoroughly wipe off all remaining traces of detergent.
- Wipe the surface with a dry, soft cloth to remove any remaining moisture. Allow the leather to dry in a shaded and ventilated area.

Cleaning the synthetic leather areas

- Remove dirt and dust using a vacuum cleaner.
- Wipe it off with a soft cloth dampened with neutral detergent diluted to approximately 1%.
- Wring out any excess water from the cloth and thoroughly wipe off remaining traces of detergent and water.

■ Caring for leather areas

Toyota recommends cleaning the interior of the vehicle at least twice a year to maintain the quality of the vehicle's interior.

■ Shampooing the carpets

There are several commercial foaming-type cleaners available. Use a sponge or brush to apply the foam. Rub in overlapping circles. Do not use water. Wipe dirty surfaces and let them dry. Excellent results are obtained by keeping the carpet as dry as possible.

■ Seat belts

Clean with mild soap and lukewarm water using a cloth or sponge. Also check the belts periodically for excessive wear, fraying or cuts.

**WARNING****■ Water in the vehicle**

- Do not splash or spill liquid in the vehicle, such as on the floor, in the hybrid battery (traction battery) air vent, and in the trunk. Doing so may cause the hybrid battery, electrical components, etc. to malfunction or catch fire.
- Do not get any of the SRS components or wiring in the vehicle interior wet. (→P. 36)
An electrical malfunction may cause the airbags to deploy or not function properly, resulting in death or serious injury.
- Vehicles with wireless charger:
Do not let the wireless charger (→P. 366) get wet. Failure to do so may cause the charger to become hot and cause burns or could cause electric shock resulting in death or serious injury.

■ Cleaning the interior (especially instrument panel)

Do not use polish wax or polish cleaner. The instrument panel may reflect off the windshield, obstructing the driver's view and leading to an accident, resulting in death or serious injury.

 NOTICE**■ Cleaning detergents**

- Do not use the following types of detergent, as they may discolor the vehicle interior or cause streaks or damage to painted surfaces:
 - Areas other than the seats and steering wheel: Organic substances such as benzene or gasoline, alkaline or acidic solutions, dye, and bleach
 - Seats: Alkaline or acidic solutions, such as thinner, benzene, and alcohol
 - Steering wheel: Organic substances, such as thinner, and cleaner that contains alcohol
- Do not use polish wax or polish cleaner. The instrument panel's or other interior part's painted surface may be damaged.

■ Preventing damage to leather surfaces

Observe the following precautions to avoid damage to and deterioration of leather surfaces:

- Remove any dust or dirt from leather surfaces immediately.
- Do not expose the vehicle to direct sunlight for extended periods of time. Park the vehicle in the shade, especially during summer.
- Do not place items made of vinyl, plastic, or containing wax on the upholstery, as they may stick to the leather surface if the vehicle interior heats up significantly.

■ Water on the floor

Do not wash the vehicle floor with water.

Vehicle systems such as the audio system may be damaged if water comes into contact with electrical components such as the audio system above or under the floor of the vehicle. Water may also cause the body to rust.

■ When cleaning the inside of the windshield

Do not allow glass cleaner to contact the lens. Also, do not touch the lens. (→P. 236)

■ Cleaning the inside of the rear window

- Do not use glass cleaner to clean the rear window, as this may cause damage to the rear window defogger heater wires or antenna. Use a cloth dampened with lukewarm water to gently wipe the window clean. Wipe the window in strokes running parallel to the heater wires or antenna.
- Be careful not to scratch or damage the heater wires or antenna.

Maintenance requirements

To ensure safe and economical driving, day-to-day care and regular maintenance are essential. It is the owner's responsibility to perform regular checks. Toyota recommends the following maintenance:

General maintenance

General maintenance should be performed on a daily basis. This can be done by yourself or by a Toyota dealer.

Scheduled maintenance

Scheduled maintenance should be performed at specified intervals according to the maintenance schedule.

For details about maintenance items and schedules, refer to the "Scheduled Maintenance Guide" or "Owner's Manual Supplement".

Do-it-yourself maintenance

You can perform some maintenance procedures by yourself. Please be aware that do-it-yourself maintenance may affect warranty coverage.

The use of Toyota Repair Manuals is recommended.

For details about warranty coverage, refer to the separate "Owner's Warranty Information Booklet" or "Owner's Manual Supplement".





■ Repair and replacement

It is recommended that genuine Toyota parts be used for repairs to ensure performance of each system. If non-Toyota parts are used in replacement or if a repair shop other than a Toyota dealer performs repairs, confirm the warranty coverage.

■ Resetting the message indicating maintenance is required

After the required maintenance is performed according to the maintenance schedule, please reset the message.

To reset the message, perform the following procedure:

- 1 Select  on the multi-information display using the meter control switches on the steering wheel. (→P. 111)
- 2 Select  and then press and hold  .
- 3 Select “Scheduled Maintenance” and then press  .
- 4 Select “Yes” and then press  .
- 5 A message will be displayed on the multi-information display when the reset procedure has been completed.

■ Allow inspection and repairs to be performed by a Toyota dealer

- Toyota technicians are well-trained specialists and are kept up to date with the latest service information. They are well informed about the operations of all systems on your vehicle.
- Keep a copy of the repair order. It proves that the maintenance that has been performed is under warranty coverage. If any problem should arise while your vehicle is under warranty, your Toyota dealer will promptly take care of it.

WARNING

■ If your vehicle is not properly maintained

Improper maintenance could result in serious damage to the vehicle and possible death or serious injury.

■ Important health and safety information

- Engine exhaust, some of its constituents, and a wide variety of automobile components contain or emit chemicals known to the State of California to cause cancer and birth defects and other reproductive harm. Work in a well ventilated area.
- Oils, fuels and fluids contained in vehicles as well as waste produced by component wear contain or emit chemicals known to the State of California to cause cancer and birth defects or other reproductive harm. Avoid exposure and wash any affected area immediately.
- 12-volt battery posts, terminals and related accessories contain lead and lead compounds which are known to cause brain damage. Wash your hands after handling. (→P. 411)

General maintenance

Listed below are the general maintenance items that should be performed at the intervals specified in the “Owner’s Warranty Information Booklet” or “Owner’s Manual Supplement/Scheduled Maintenance Guide”. It is recommended that any problem you notice should be brought to the attention of your Toyota dealer or qualified service shop for advice.

Engine compartment

Items	Check points
Brake fluid	Is the brake fluid at the correct level? (→P. 409)
Coolant	Is the coolant at the correct level? (→P. 407)
Engine oil	Is the engine oil at the correct level? (→P. 404)
Exhaust system	There should not be any fumes or strange sounds.
Radiator/condenser	The radiator and condenser should be free from foreign objects. (→P. 408)
Washer fluid	Is there sufficient washer fluid? (→P. 410)

Trunk

Items	Check points
12-volt battery	Check the connections. (→P. 411)

Vehicle interior

Items	Check points
Accelerator pedal	<ul style="list-style-type: none"> The accelerator pedal should move smoothly (without uneven pedal effort or catching).
Hybrid transmission "Park" mechanism	<ul style="list-style-type: none"> When parked on a slope and the shift lever is in P, is the vehicle securely stopped?
Brake pedal	<ul style="list-style-type: none"> Does the brake pedal move smoothly? Does the brake pedal have appropriate clearance from the floor? (→P. 507) Does the brake pedal have the correct amount of free play? (→P. 507)
Brakes	<ul style="list-style-type: none"> The vehicle should not pull to one side when the brakes are applied. The brakes should work effectively. The brake pedal should not feel spongy. The brake pedal should not get too close to the floor when the brakes are applied.
Head restraints (adjustable type)	<ul style="list-style-type: none"> Do the head restraints move smoothly and lock securely?
Indicators/buzzers	<ul style="list-style-type: none"> Do the indicators and buzzers function properly?
Lights	<ul style="list-style-type: none"> Do all the lights come on?
Parking brake	<ul style="list-style-type: none"> Does the parking brake operate normally? When parked on a slope and the parking brake is on, is the vehicle securely stopped?

Items	Check points
Seat belts	<ul style="list-style-type: none"> • Do the seat belts operate smoothly? • The seat belts should not be damaged.
Seats	<ul style="list-style-type: none"> • Do the seat controls operate properly?
Steering wheel	<ul style="list-style-type: none"> • Does the steering wheel rotate smoothly? • Does the steering wheel have the correct amount of free play? • There should not be any strange sounds coming from the steering wheel.

Vehicle exterior

Items	Check points
Doors/trunk	<ul style="list-style-type: none"> • Do the doors/trunk operate smoothly?
Engine hood	<ul style="list-style-type: none"> • Does the engine hood lock system work properly?
Fluid leaks	<ul style="list-style-type: none"> • There should not be any signs of fluid leakage after the vehicle has been parked.
Tires	<ul style="list-style-type: none"> • Is the tire inflation pressure correct? • The tires should not be damaged or excessively worn. • Have the tires been rotated according to the maintenance schedule? • The wheel nuts should not be loose.
Windshield wipers	<ul style="list-style-type: none"> • The wiper blades should not show any signs of cracking, splitting, wear, contamination or deformation. • The wiper blades should clear the windshield without streaking or skipping.

**WARNING****■ If the hybrid system is operating**

Turn the hybrid system off and ensure that there is adequate ventilation before performing maintenance checks.

Emission inspection and maintenance (I/M) programs

Some states have vehicle emission inspection programs which include OBD (On Board Diagnostics) checks. The OBD system monitors the operation of the emission control system.

If the malfunction indicator lamp comes on

The OBD system determines that a problem exists somewhere in the emission control system. Your vehicle may not pass the I/M test and may need to be repaired. Contact your Toyota dealer to service the vehicle.

Your vehicle may not pass the I/M test in the following situations:

- When the 12-volt battery is disconnected or discharged
Readiness codes that are set during ordinary driving are erased. Also, depending on your driving habits, the readiness codes may not be completely set.
- When the fuel tank cap is loose
The malfunction indicator lamp comes on indicating a temporary malfunction and your vehicle may not pass the I/M test.

When the malfunction indicator lamp still remains on after several driving trips

The error code in the OBD system will not be cleared unless the vehicle is driven 40 or more times.

If your vehicle does not pass the I/M test

Contact your Toyota dealer to prepare the vehicle for re-testing.

Do-it-yourself service precautions

If you perform maintenance by yourself, be sure to follow the correct procedure as given in these sections.

Items	Parts and tools
12-volt battery condition (→P. 411)	<ul style="list-style-type: none"> • Grease • Conventional wrench (for terminal clamp bolts)
Brake fluid level (→P. 409)	<ul style="list-style-type: none"> • SAE J1703 or FMVSS No.116 DOT 3 • SAE J1704 or FMVSS No.116 DOT 4 • Rag or paper towel • Funnel (used only for adding brake fluid)
Engine/power control unit coolant level (→P. 407)	<ul style="list-style-type: none"> • “Toyota Super Long Life Coolant” or a similar high quality ethylene glycol-based non-silicate, non-amine, non-nitrite and non-borate coolant with long-life hybrid organic acid technology • “Toyota Super Long Life Coolant” is pre-mixed with 50% coolant and 50% deionized water. • Funnel (used only for adding coolant)
Engine oil level (→P. 404)	<ul style="list-style-type: none"> • “Toyota Genuine Motor Oil” or equivalent • Rag or paper towel • Funnel (used only for adding engine oil)
Fuses (→P. 442)	<ul style="list-style-type: none"> • Fuse with same amperage rating as original
Hybrid battery (traction battery) air intake vent (→P. 434)	<ul style="list-style-type: none"> • Vacuum cleaner, etc. • Phillips screwdriver
Radiator/condenser (→P. 408)	—

Items	Parts and tools
Tire inflation pressure (→P. 427)	<ul style="list-style-type: none"> • Tire pressure gauge • Compressed air source
Washer fluid (→P. 410)	<ul style="list-style-type: none"> • Water or washer fluid containing antifreeze (for winter use) • Funnel (used only for adding water or washer fluid)

**WARNING**

The engine compartment contains many mechanisms and fluids that may move suddenly, become hot, or become electrically energized. To avoid death or serious injury, observe the following precautions.

■ **When working on the engine compartment**

- Make sure that the “ACCESSORY” or “IGNITION ON” on the multi-information display and the “READY” indicator are both off.
- Keep hands, clothing and tools away from the moving fan and engine drive belt.
- Be careful not to touch the engine, power control unit, radiator, exhaust manifold, etc. right after driving as they may be hot. Oil and other fluids may also be hot.
- Do not leave anything that may burn easily, such as paper and rags, in the engine compartment.
- Do not smoke, cause sparks or expose an open flame to fuel. Fuel fumes are flammable.

■ **When working near the electric cooling fan or radiator grille**

Be sure the power switch is off.

With the power switch in ON mode, the electric cooling fan may automatically start to run if the air conditioning is on and/or the coolant temperature is high. (→P. 408)

■ **Safety glasses**

Wear safety glasses to prevent flying or falling material, fluid spray, etc. from getting in your eyes.

**NOTICE**

■ **If you remove the air cleaner filter**

Driving with the air cleaner filter removed may cause excessive engine wear due to dirt in the air.

Hood

Release the lock from the inside of the vehicle to open the hood.

- 1 Pull the hood lock release lever.
The hood will pop up slightly.

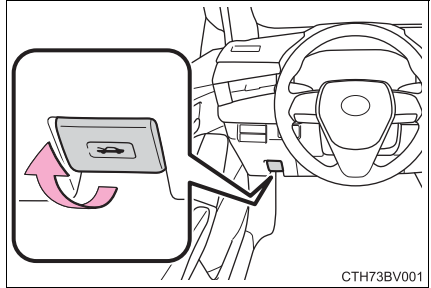

- 2 Pull up the auxiliary catch lever and lift the hood.

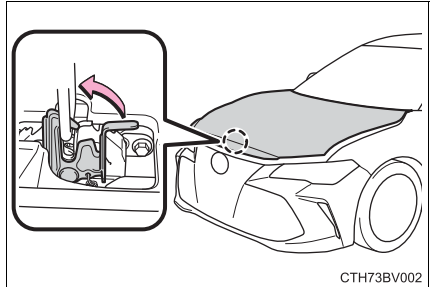

■ Open hood warning buzzer

If the vehicle reaches a speed of 3 mph (5 km/h), the master warning light flashes and a buzzer sounds to indicate that the hood is not fully closed.

⚠ WARNING

■ Pre-driving check

Check that the hood is fully closed and locked.
If the hood is not locked properly, it may open while the vehicle is in motion and cause an accident, which may result in death or serious injury.

Positioning a floor jack

When using a floor jack, follow the instructions in the manual provided with the jack and perform the operation safely.

When raising your vehicle with a floor jack, position the jack correctly. Improper placement may damage your vehicle or cause injury.

◆ Front

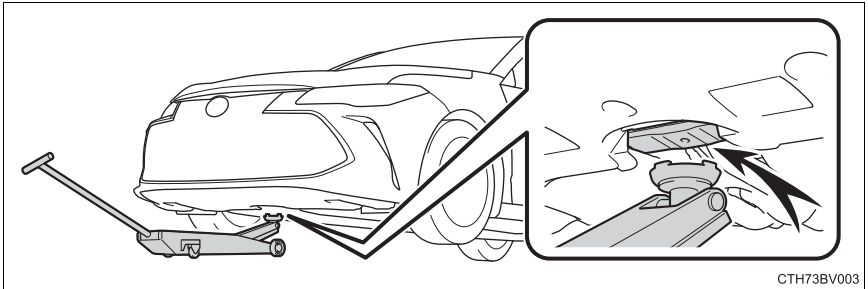

◆ Rear

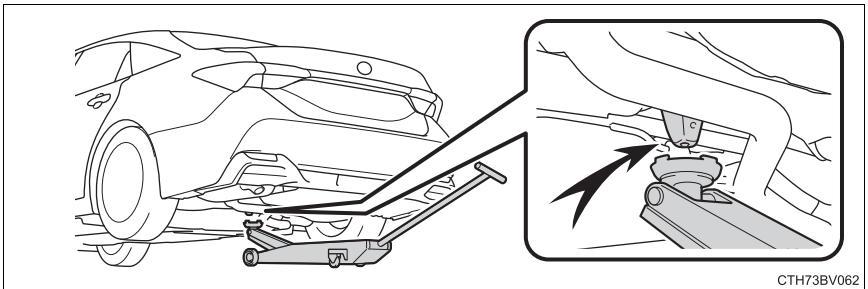

Engine compartment

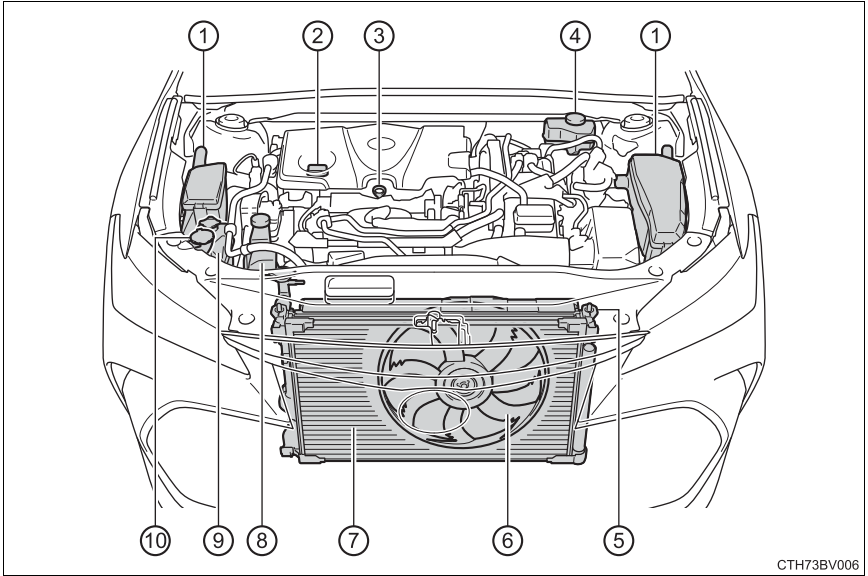

- | | |
|---------------------------------------|--|
| ① Fuse boxes (→P. 442) | ⑥ Electric cooling fan |
| ② Engine oil filler cap (→P. 405) | ⑦ Condenser (→P. 408) |
| ③ Engine oil level dipstick (→P. 404) | ⑧ Power control unit coolant reservoir (→P. 407) |
| ④ Brake fluid reservoir (→P. 409) | ⑨ Engine coolant reservoir (→P. 407) |
| ⑤ Radiator (→P. 408) | ⑩ Washer fluid tank (→P. 410) |

Engine oil

With the engine at operating temperature and turned off, check the oil level on the dipstick.

■ Checking the engine oil

- 1 Park the vehicle on level ground. After warming up the engine and turning it off the hybrid system, wait more than 5 minutes for the oil to drain back into the bottom of the engine.
- 2 Holding a rag under the end, pull the dipstick out.

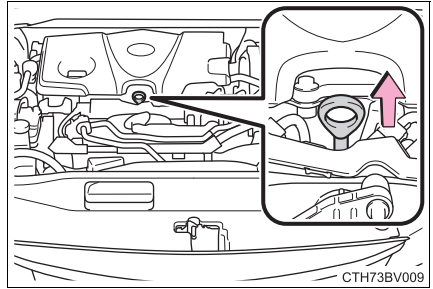

- 3 Wipe the dipstick clean.
- 4 Reinsert the dipstick fully.
- 5 Holding a rag under the end, pull the dipstick out and check the oil level.

- ① Low
- ② Normal
- ③ Excessive

The shape of the dipstick may differ depending on the type of vehicle or engine.

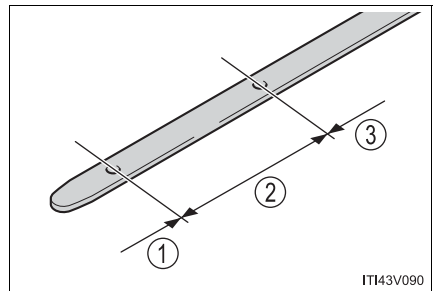

- 6 Wipe the dipstick and reinsert it fully.

■ Adding engine oil

If the oil level is below or near the low level mark, add engine oil of the same type as that already in the engine.

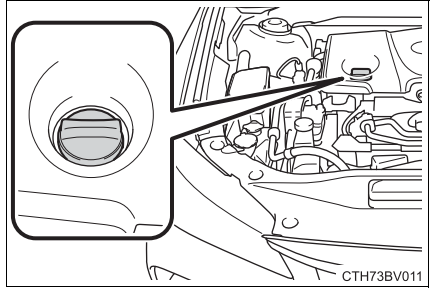

Make sure to check the oil type and prepare the items needed before adding oil.

Engine oil selection	→P. 505
Oil quantity (Low → Full)	1.6 qt. (1.5 L, 1.3 Imp. qt.)
Items	Clean funnel

- 1 Remove the oil filler cap by turning it counterclockwise.
- 2 Add engine oil slowly, checking the dipstick.
- 3 Install the oil filler cap by turning it clockwise.

■ Engine oil consumption

A certain amount of engine oil will be consumed while driving. In the following situations, oil consumption may increase, and engine oil may need to be refilled in between oil maintenance intervals.

- When the engine is new, for example directly after purchasing the vehicle or after replacing the engine
- If low quality oil or oil of an inappropriate viscosity is used
- When driving at high engine speeds or with a heavy load, or when driving while accelerating or decelerating frequently
- When leaving the engine idling for a long time, or when driving frequently through heavy traffic

**WARNING****■ Used engine oil**

- Used engine oil contains potentially harmful contaminants which may cause skin disorders such as inflammation and skin cancer, so care should be taken to avoid prolonged and repeated contact. To remove used engine oil from your skin, wash thoroughly with soap and water.
- Dispose of used oil and filters only in a safe and acceptable manner. Do not dispose of used oil and filters in household trash, in sewers or onto the ground.
Call your Toyota dealer, service station or auto parts store for information concerning recycling or disposal.
- Do not leave used engine oil within the reach of children.

**NOTICE****■ To prevent serious engine damage**

Check the oil level on a regular basis.

■ When replacing the engine oil

- Be careful not to spill engine oil on the vehicle components.
- Avoid overfilling, or the engine could be damaged.
- Check the oil level on the dipstick every time you refill the vehicle.
- Be sure the engine oil filler cap is properly tightened.

■ If oil is spilled on the engine cover

To prevent the engine cover from being damaged, remove any engine oil from the engine cover as soon as possible using a neutral detergent. Do not use an organic solvent such as brake cleaner.

Coolant

▶ Engine coolant reservoir

The coolant level is satisfactory if it is between the “F” and “L” lines on the reservoir when the hybrid system is cold.

- ① Reservoir cap
- ② “F” line
- ③ “L” line

If the level is on or below the “L” line, add coolant up to the “F” line. (→P. 494)

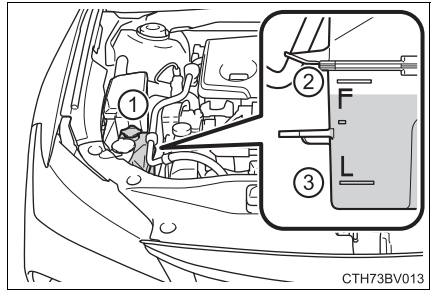

▶ Power control unit coolant reservoir

The coolant level is satisfactory if it is between the “FULL” and “LOW” lines on the reservoir when the hybrid system is cold.

- ① Reservoir cap
- ② “FULL” line
- ③ “LOW” line

If the level is on or below the “LOW” line, add coolant up to the “FULL” line. (→P. 494)

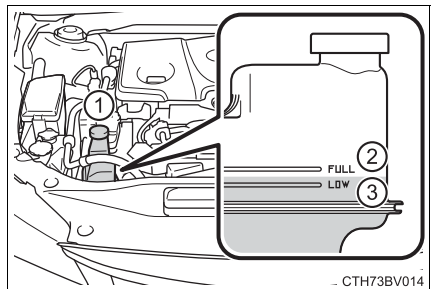

■ Coolant selection

Only use “Toyota Super Long Life Coolant” or a similar high quality ethylene glycol based non-silicate, non-amine, non-nitrite, and non-borate coolant with long-life hybrid organic acid technology.

“Toyota Super Long Life Coolant” is a mixture of 50% coolant and 50% deionized water. (Minimum temperature: -31°F [-35°C])

■ If the coolant level drops within a short time of replenishing

Visually check the radiators, hoses, engine/power control unit coolant reservoir caps, drain cock and water pump.

If you cannot find a leak, have your Toyota dealer test the cap and check for leaks in the cooling system.

**WARNING****■ When the hybrid system is hot**

Do not remove the engine/power control unit coolant reservoir caps or the radiator cap.

The cooling system may be under pressure and may spray hot coolant if the cap is removed, causing serious injuries, such as burns.

**NOTICE****■ When adding coolant**

Coolant is neither plain water nor straight antifreeze. The correct mixture of water and antifreeze must be used to provide proper lubrication, corrosion protection and cooling. Be sure to read the antifreeze or coolant label.

■ If you spill coolant

Be sure to wash it off with water to prevent it from damaging parts or paint.

Radiator and condenser

Check the radiator and condenser and clear away any foreign objects.

If either of the above parts is extremely dirty or you are not sure of their condition, have your vehicle inspected by your Toyota dealer.

**WARNING****■ When the hybrid system is hot**

Do not touch the radiator or condenser as they may be hot and cause serious injuries, such as burns.

Brake fluid

■ Checking fluid level

The brake fluid level should be between the “MAX” and “MIN” lines on the tank.

- ① “MAX”
- ② “MIN”

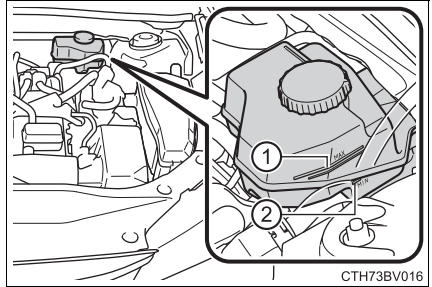

CTH73BV016

■ Adding fluid

Make sure to check the fluid type and prepare the necessary item.

Fluid type	SAE J1703 or FMVSS No.116 DOT 3 brake fluid SAE J1704 or FMVSS No.116 DOT 4 brake fluid
Item	Clean funnel

■ Brake fluid can absorb moisture from the air

Excess moisture in the brake fluid can cause a dangerous loss of braking efficiency. Use only newly opened brake fluid.

WARNING

■ When filling the reservoir

Take care as brake fluid can harm your hands and eyes and damage painted surfaces.

If fluid gets on your hands or in your eyes, flush the affected area with clean water immediately.

If you still experience discomfort, see a doctor.

NOTICE

■ If the fluid level is low or high

It is normal for the brake fluid level to go down slightly as the brake pads wear out or when the fluid level in the accumulator is high.

If the reservoir needs frequent refilling, there may be a serious problem.

Washer fluid

Add washer fluid in the following situations:

- A washer does not work.
- “Windshield Washer Fluid Low” is displayed on the multi-information display.

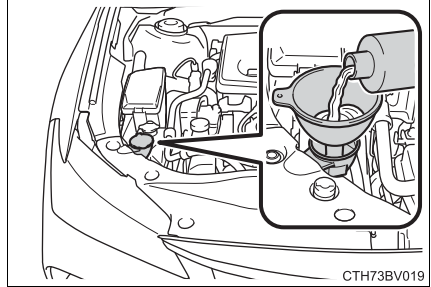

WARNING

■ When adding washer fluid

Do not add washer fluid when the hybrid system is hot or operating as washer fluid contains alcohol and may catch fire if spilled on the engine, etc.

NOTICE

■ Do not use any fluid other than washer fluid

Do not use soapy water or engine antifreeze instead of washer fluid. Doing so may cause streaking on the vehicle's painted surfaces, as well as damaging the pump leading to problems of the washer fluid not spraying.

■ Diluting washer fluid

Dilute washer fluid with water as necessary. Refer to the freezing temperatures listed on the label of the washer fluid bottle.

12-volt battery

Location

The 12-volt battery is located on the right-hand side of the trunk.

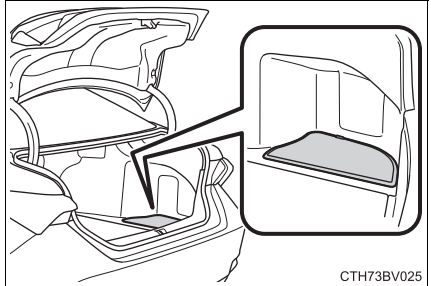

Removing the 12-volt battery cover

Remove the 12-volt battery cover.

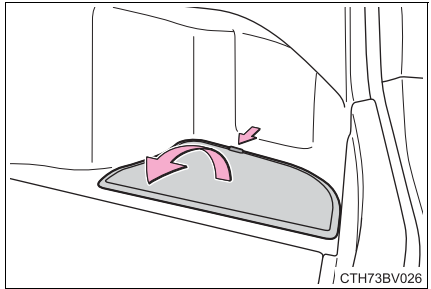

Exterior

Make sure that the 12-volt battery terminals are not corroded and that there are no loose connections, cracks, or loose clamps.

- ① Terminals
- ② Hold-down clamp

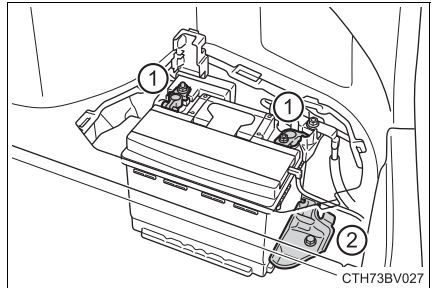

■ Before recharging

When recharging, the 12-volt battery produces hydrogen gas which is flammable and explosive. Therefore, observe the following precautions before recharging:

- If recharging with the 12-volt battery installed on the vehicle, be sure to disconnect the ground cable.
- Make sure the power switch on the charger is off when connecting and disconnecting the charger cables to the 12-volt battery.

■ After recharging/reconnecting the 12-volt battery

- Unlocking the doors using the smart key system may not be possible immediately after reconnecting the 12-volt battery. If this happens, use the wireless remote control or the mechanical key to lock/unlock the doors.
- Start the hybrid system with the power switch in ACCESSORY mode. The hybrid system may not start with the power switch turned off. However, the hybrid system will operate normally from the second attempt.
- The power switch mode is recorded by the vehicle. If the 12-volt battery is reconnected, the vehicle will return the power switch mode to the status it was in before the 12-volt battery was disconnected. Make sure to turn off the power before disconnecting the 12-volt battery. Take extra care when connecting the 12-volt battery if the power switch mode prior to discharge is unknown.

If the system will not start even after multiple attempts, contact your Toyota dealer.

 **WARNING****■ Chemicals in the 12-volt battery**

The 12-volt battery contains poisonous and corrosive sulfuric acid and may produce hydrogen gas which is flammable and explosive. To reduce the risk of death or serious injury, take the following precautions while working on or near the 12-volt battery:

- Do not cause sparks by touching the 12-volt battery terminals with tools.
- Do not smoke or light a match near the 12-volt battery.
- Avoid contact with eyes, skin and clothes.
- Never inhale or swallow electrolyte.
- Wear protective safety glasses when working near the 12-volt battery.
- Keep children away from the 12-volt battery.

■ Where to safely charge the 12-volt battery

Always charge the 12-volt battery in an open area. Do not charge the 12-volt battery in a garage or closed room where there is insufficient ventilation.

■ How to recharge the 12-volt battery

Only perform a slow charge (5 A or less). The 12-volt battery may explode if charged at a quicker rate.

■ Emergency measures regarding electrolyte

- If electrolyte gets in your eyes
Flush your eyes with clean water for at least 15 minutes and get immediate medical attention. If possible, continue to apply water with a sponge or cloth while traveling to the nearest medical facility.
- If electrolyte gets on your skin
Wash the affected area thoroughly. If you feel pain or burning, get medical attention immediately.
- If electrolyte gets on your clothes
It can soak through clothing on to your skin. Immediately take off the clothing and follow the procedure above if necessary.
- If you accidentally swallow electrolyte
Drink a large quantity of water or milk. Get emergency medical attention immediately.

■ When disconnecting the 12-volt battery

Do not disconnect the negative (-) terminal on the body side. The disconnected negative (-) terminal may touch the positive (+) terminal, which may cause a short and result in death or serious injury.

■ When replacing the 12-volt battery

Use a 12-volt battery designed for this vehicle. Failure to do so may cause gas (hydrogen) to enter the passenger compartment, causing a fire or explosion.

For replacement of the 12-volt battery, contact your Toyota dealer.

**NOTICE****■ When recharging the 12-volt battery**

Never recharge the 12-volt battery while the hybrid system is operating. Also, be sure all accessories are turned off.

Tires

Replace or rotate tires in accordance with maintenance schedules and treadwear.

Checking tires

Check if the treadwear indicators are showing on the tires. Also check the tires for uneven wear, such as excessive wear on one side of the tread.

Check the spare tire condition and pressure if not rotated.

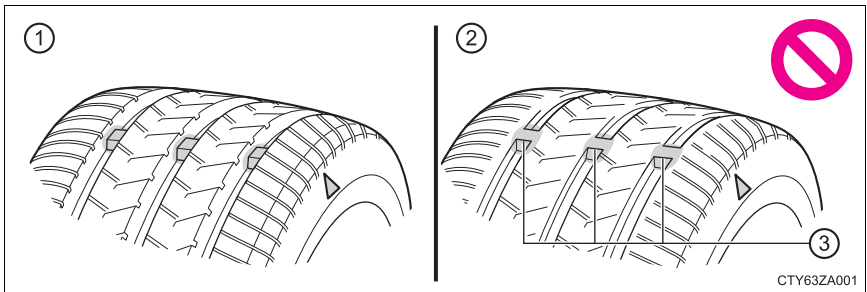

- ① New tread
- ② Worn tread
- ③ Treadwear indicator

The location of treadwear indicators is shown by a “TWI” or “Δ” mark, etc., molded into the sidewall of each tire.

Replace the tires if the treadwear indicators are showing on a tire.

Tire rotation

Rotate the tires in the order shown.

To equalize tire wear and extend tire life, Toyota recommends that tire rotation is carried out at the same interval as tire inspection.

Do not fail to initialize the tire pressure warning system after tire rotation.

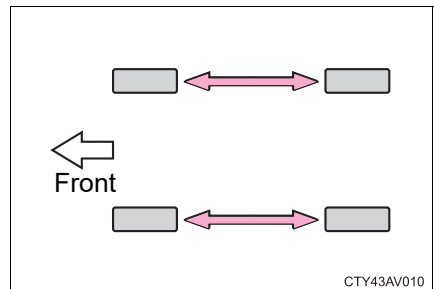

Tire pressure warning system

Your vehicle is equipped with a tire pressure warning system that uses tire pressure warning valve and transmitters to detect low tire inflation pressure before serious problems arise.

- The tire pressure detected by the tire pressure warning system can be displayed on the multi-information display.

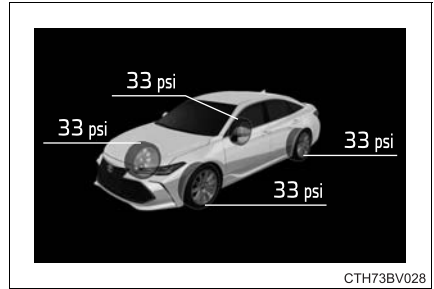

- If the tire pressure drops below a predetermined level, the driver is warned by a screen display and a warning light. (→P. 458)

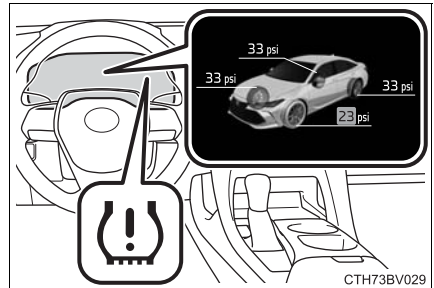

◆ Installing tire pressure warning valves and transmitters

When replacing the tires or wheels, the tire pressure warning valve and transmitters must be installed to the wheels which will be installed to the vehicle.

When new tire pressure warning valve and transmitters are installed, new ID codes must be registered in the tire pressure warning computer and the tire pressure warning system must be initialized. (→P. 419)

◆ Initializing the tire pressure warning system

■ The tire pressure warning system must be initialized in the following circumstances:

- When the tire inflation pressure is changed such as when changing traveling speed or load weight.
- When the tire inflation pressure is changed such as when the tire size is changed.
- When rotating the tires.
- After performing the transmitter ID code registration procedure. (→P. 419)

When the tire pressure warning system is initialized, the current tire inflation pressure is set as the benchmark pressure.

■ How to initialize the tire pressure warning system

- 1 Park the vehicle in a safe place and turn the power switch off.



The initialization procedure cannot be started while the vehicle is moving.

- 2 Adjust the tire inflation pressure to the specified cold tire inflation pressure level. (→P. 508)

Make sure to adjust the tire pressure to the specified cold tire inflation pressure level. The tire pressure warning system will operate based on this pressure level.

- 3 Start the hybrid system. (→P. 196)

- 4 Select  on the multi-information display using the meter control switches on the steering wheel. (→P. 111)

- 5 Select  and then press and hold .

- 6 Select "TPWS" and then press .

- 7 Select “Set Pressure” then press and hold  until the tire pressure warning light blinks 3 times.

Then a message will be displayed on the multi-information display.

“---” will be displayed on the multi-information display for the inflation pressure of each tire while initialization is being performed.

- 8 Drive straight (with occasional left and right turns) at approximately 25 mph (40 km/h) or more for approximately 10 to 30 minutes.

Initialization is complete when the position of each tire is determined and the inflation pressure of each tire is displayed on the multi-information display.

Initialization may take longer than approximately 1 hour in certain situations, such as when the vehicle is stopped for a long time at traffic lights, etc. (→P. 423)

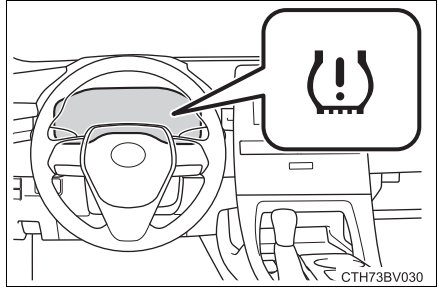





◆ Registering ID codes

Every tire pressure warning valve and transmitter has a unique ID code. When replacing a tire pressure warning valve and transmitter, it is necessary to register the ID codes.

The ID codes can be registered on  of the multi-information display.

■ How to register the ID codes

- 1 Select  on the multi-information display using the meter control switches on the steering wheel. (→P. 111)
- 2 Select  and then press and hold  .
- 3 Select “TPWS” and then press  .
- 4 Select “Change Wheel” then press and hold  until the tire pressure warning light blinks slowly 3 times.

Then a message will be displayed on the multi-information display.

When registration is being performed, the tire pressure warning light will blink for approximately 1 minute then illuminate and “---” will be displayed for the inflation pressure of each tire on the multi-information display.

- 5 Drive straight (with occasional left and right turns) at approximately 25 mph (40 km/h) or more for approximately 10 to 30 minutes.

Registration is complete when the tire pressure warning light turns off and the inflation pressure of each tire is displayed on the multi-information display.

Registration may take longer than approximately 1 hour in certain situations, such as when the vehicle is stopped for a long time at traffic lights, etc. (→P. 424)

After registering the ID codes, make sure to initialize the tire pressure warning system. (→P. 417)

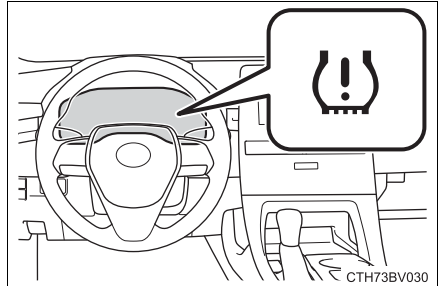

■ When to replace your vehicle's tires

Tires should be replaced if:

- The treadwear indicators are showing on a tire.
- You have tire damage such as cuts, splits, cracks deep enough to expose the fabric, and bulges indicating internal damage
- A tire goes flat repeatedly or cannot be properly repaired due to the size or location of a cut or other damage

If you are not sure, consult with your Toyota dealer.

■ Replacing tires and wheels

If the ID codes of the tire pressure warning valve and transmitters are not registered, the tire pressure warning system will not work properly. In this case, after driving for about 20 minutes, the tire pressure warning light will blink for approximately 1 minute and then illuminate to indicate a system malfunction.

■ Tire life

Any tire over 6 years old must be checked by a qualified technician even if it has seldom or never been used or damage is not obvious.

■ Routine tire inflation pressure checks

The tire pressure warning system does not replace routine tire inflation pressure checks. Make sure to check tire inflation pressure as part of your routine of daily vehicle checks.

■ Low profile tires (vehicles with 18 or 19-inch wheels)

Generally, low profile tires will wear more rapidly and tire grip performance will be reduced on snowy and/or icy roads when compared to standard tires. Be sure to use snow tires on snowy and/or icy roads and drive carefully at a speed appropriate for road and weather conditions.

■ Maximum load of tire

Check that the maximum load of the replacement tire is greater than 1/2 of the Gross Axle Weight Ratings (GAWR) of either the front axle or the rear axle, whichever is greater.

For the GAWR, see the Certification Label. For the maximum load of the tire, see the load limit at maximum cold tire inflation pressure mentioned on the sidewall of the tire. (→P. 513)

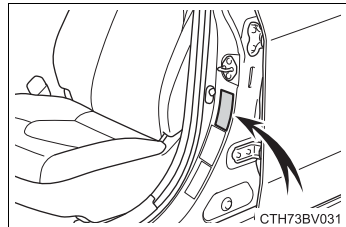

CTH73BV031

■ Tire types

● Summer tires

Summer tires are high-speed performance tires best suited to highway driving under dry conditions. Since summer tires do not have the same traction performance as snow tires, summer tires are inadequate for driving on snow-covered or icy roads. For driving on snow-covered roads or icy roads, the use of snow tires is recommended. When installing snow tires, be sure to replace all four tires.

● All season tires

All season tires are designed to provide better traction in snow and to be adequate for driving in most winter conditions as well as for use year-round. All season tires, however, do not have adequate traction performance compared with snow tires in heavy or loose snow. Also, all season tires fall short in acceleration and handling performance compared with summer tires in highway driving.

● Snow tires

For driving on snow-covered roads or icy roads, we recommend using snow tires. If you need snow tires, select tires of the same size, construction and load capacity as the originally installed tires. Since your vehicle has radial tires as original equipment, make sure your snow tires also have radial construction. Do not install studded tires without first checking local regulations for possible restrictions. Snow tires should be installed on all wheels. (→P. 333)

■ If the tread on snow tires wears down below 0.16 in. (4 mm)

The effectiveness of the tires as snow tires is lost.

■ Situations in which the tire pressure warning system may not operate properly

- In the following situations, the tire pressure warning system may not operate properly.
 - If non-genuine Toyota wheels are used.
 - If a tire has been replaced with a tire that is not an OE (Original Equipment) tire.
 - If a tire has been replaced with a tire that is not of the specified size.
 - If tire chains, etc. are installed.
 - If a window tint that affects radio wave signals is installed.
 - If there is a lot of snow or ice on the vehicle, particularly around the wheels or wheel housings.
 - If the tire inflation pressure is much higher than the specified level.
 - If wheels not equipped with tire pressure warning valve and transmitter are used.
 - If the ID codes of the tire pressure warning valve and transmitters are not registered in the tire pressure warning computer.
- Performance may be affected in the following situations.
 - When driving near a TV tower, electric power plant, gas station, radio station, large display, airport or other facility that generates strong radio waves or electrical noise
 - When carrying a portable radio, cellular phone, cordless phone or other wireless communication deviceIf tire position information is not correctly displayed due to the radio wave conditions, the display may be corrected by changing the location of the vehicle as the radio wave conditions may change.
- When the vehicle is stopped, the time taken for the warning to start or turn off may be longer.
- When the inflation pressure of a tire drops rapidly, for example when a tire has burst, the warning may not operate.

■ Initialization procedure

- Make sure to perform the initialization procedure after adjusting the tire inflation pressure.

Also, make sure the tires are cold before performing the initialization procedure or adjusting the tire inflation pressure.
- If the power switch is turned off during initialization, it is not necessary to restart the initialization procedure from the beginning as it will begin automatically when the power switch is turned back to ON mode.
- If initialization has accidentally been started when it is not necessary, adjust the tire inflation pressure to the specified level when the tires are cold and then perform the initialization procedure again.
- While the position of each tire is being determined and the inflation pressures are not being displayed on the multi-information display, if the inflation pressure of a tire drops, the tire pressure warning light will come on.

■ Warning performance of the tire pressure warning system

The warning of the tire pressure warning system will change in accordance with the conditions under which it was initialized. For this reason, the system may give a warning even if the tire pressure does not reach a low enough level, or if the pressure is higher than the pressure that was adjusted to when the system was initialized.

■ If the tire pressure warning system is not initialized properly

● In the following situations, initialization may take longer than usual to be completed or may not be possible. (Usually, the vehicle will need to be driven for approximately 10 to 30 minutes to complete initialization.)

If initialization is not complete after driving approximately 30 minutes, continue driving for a while.

- If the vehicle is driven on an unpaved road, it may take longer to complete initialization.
- If the vehicle is backed up while performing initialization, data collected during initialization will be cleared and it will take longer than normal to complete.
- If the vehicle is driven in heavy traffic or another situation where other vehicles are driven close by, it may take time for the system to recognize the tire pressure warning valve and transmitters of your vehicle over those of other vehicles.

If initialization is not complete after driving for approximately 1 hour, park the vehicle in a safe place for approximately 20 minutes and then drive the vehicle again.

● In the following situations, initialization will not be started or was not completed properly and the system will not operate properly. Perform the initialization procedure again.

- If, when attempting to start initialization, the tire pressure warning light does not blink 3 times.
- If, when the vehicle has been driven for about 20 minutes after performing initialization, the tire pressure warning light blinks for approximately 1 minute and then illuminates.

● If initialization cannot be completed after performing the above procedure, contact your Toyota dealer.

■ When registering ID codes

● Before performing ID code registration, make sure that no wheels with tire pressure warning valve and transmitters installed are near the vehicle.

● Make sure to initialize the tire pressure warning system after registering the ID codes. If the system is initialized before registering the ID codes, the initialized values will be invalid.

● As the tires will be warm when registration is completed, make sure to allow the tires to cool before performing initialization.

■ Canceling ID code registration

- To cancel ID code registration after it has been started, turn the power switch off before driving the vehicle.
If the vehicle is driven after ID code registration is started, to cancel registration, perform the ID code registration start procedure again and turn the power switch off before driving.
- If ID code registration has been canceled, the tire pressure warning light will blink for approximately 1 minute when the power switch is turned to ON mode and then illuminate. The tire pressure warning system will be operational when the tire pressure warning light turns off.
- If the warning light does not turn off even after several minutes have elapsed, ID code registration may not have been cancelled correctly. To cancel registration, perform the ID code registration start procedure again and then turn the power switch off before driving.

■ If ID codes are not registered properly

- In the following situations, ID code registration may take longer than usual to be completed or may not be possible. (Usually, the vehicle will need to be driven for approximately 10 to 30 minutes to complete ID code registration.)

If ID code registration is not complete after driving for approximately 30 minutes, continue driving for a while.

- If the vehicle is driven on an unpaved road, it may take longer than normal to complete registration.
- If the vehicle is backed up while performing registration, data collected during registration will be cleared, and it will take longer than normal to complete.
- If the vehicle is driven in heavy traffic or another situation where other vehicles are driven close by, it may take time for the system to recognize the tire pressure warning valve and transmitters of your vehicle over those of other vehicles.
- If a wheel with a tire pressure warning valve and transmitter installed is inside or near the vehicle, registration of the ID codes for the installed wheels may not be possible.

If ID registration is not complete after driving for approximately 1 hour, park the vehicle in a safe place for approximately 20 minutes and then perform the ID code registration procedure again.

- In the following situations, ID code registration will not be started or was not completed properly and the system will not operate properly. Perform the ID code registration procedure again.
 - If, when attempting to start ID code registration, the tire pressure warning light does not blink slowly 3 times.
 - If, when the vehicle has been driven for about 20 minutes after performing ID code registration, the tire pressure warning light blinks for approximately 1 minute and then illuminates.
- If ID code registration cannot be completed after performing the above procedure, contact your Toyota dealer.

■ Tire pressure warning system certification

FCC ID: PAXPMVE000

NOTE

This device complies with part 15 of the FCC Rules. Operation is subject to the following two conditions:
 (1) This device may not cause harmful interference, and (2) this device must accept any interference received, including interference that may cause undesired operation.

FCC WARNING

Changes or modifications not expressly approved by the party responsible for compliance could void the user's authority to operate the equipment.



WARNING

■ When inspecting or replacing tires

Observe the following precautions to prevent accidents. Failure to do so may cause damage to parts of the drive train as well as dangerous handling characteristics, which may lead to an accident resulting in death or serious injury.

- Do not mix tires of different makes, models or tread patterns.
Also, do not mix tires of remarkably different treadwear.
- Do not use tire sizes other than those recommended by Toyota.
- Do not mix differently constructed tires (radial, bias-belted or bias-ply tires).
- Do not mix summer, all season and snow tires.
- Do not use tires that have been used on another vehicle.
Do not use tires if you do not know how they were used previously.

■ When initializing the tire pressure warning system

Do not initialize the tire pressure warning system without first adjusting the tire inflation pressure to the specified level. Otherwise, the tire pressure warning light may not come on even if the tire inflation pressure is low, or it may come on when the tire inflation pressure is actually normal.

**NOTICE****■ Repairing or replacing tires, wheels, tire pressure warning valve and transmitters and tire valve caps**

- When removing or fitting the wheels, tires or the tire pressure warning valve and transmitters, contact your Toyota dealer as the tire pressure warning valve and transmitters may be damaged if not handled correctly.
- Make sure to install the tire valve caps. If the tire valve caps are not installed, water may enter the valves of the tire pressure warning valve and transmitters and the valves may become stuck.
- When replacing tire valve caps, do not use tire valve caps other than those specified. The cap may become stuck.

■ To avoid damage to the tire pressure warning valve and transmitters

When a tire is repaired with liquid sealants, the tire pressure warning valve and transmitter may not operate properly. If a liquid sealant is used, contact your Toyota dealer or other qualified service shop as soon as possible. Make sure to replace the tire pressure warning valve and transmitter when replacing the tire. (→P. 417)

■ Driving on rough roads

Take particular care when driving on roads with loose surfaces or potholes.

These conditions may cause losses in tire inflation pressure, reducing the cushioning ability of the tires. In addition, driving on rough roads may cause damage to the tires themselves, as well as the vehicle's wheels and body.

■ Low profile tires (vehicles with 18 or 19-inch wheels)

Low profile tires may cause greater damage than usual to the tire wheel when sustaining impact from the road surface. Therefore, pay attention to the following:

- Be sure to use proper tire inflation pressure. If tires are under-inflated, they may be damaged more severely.
- Avoid potholes, uneven pavement, curbs and other road hazards. Failure to do so may lead to severe tire and wheel damage.

■ If tire inflation pressure of each tire becomes low while driving

Do not continue driving, or your tires and/or wheels may be ruined.

Tire inflation pressure

Tire inflation pressure

The recommended cold tire inflation pressure and tire size are displayed on the tire and loading information label. (→P. 508)

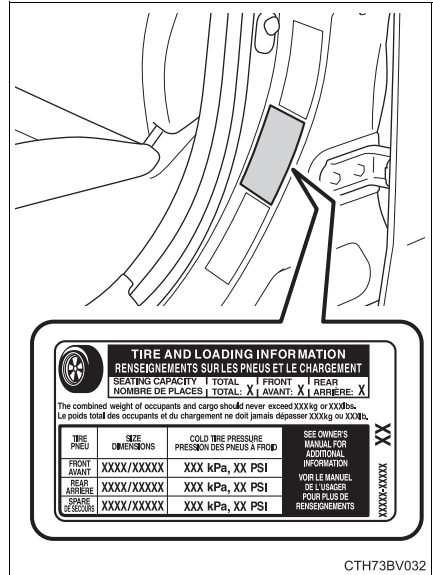

Inspection and adjustment procedure

- ① Tire valve
- ② Tire pressure gauge

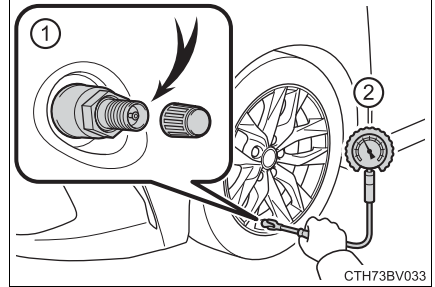

- 1 Remove the tire valve cap.
- 2 Press the tip of the tire pressure gauge onto the tire valve.
- 3 Read the pressure using the gauge gradations.
- 4 If the tire inflation pressure is not at the recommended level, adjust the pressure.
If you add too much air, press the center of the valve to deflate.
- 5 After completing the tire inflation pressure measurement and adjustment, apply soapy water to the valve and check for leakage.
- 6 Put the tire valve cap back on.

■ Tire inflation pressure check interval

You should check tire inflation pressure every two weeks, or at least once a month.

Do not forget to check the spare.

■ Effects of incorrect tire inflation pressure

Driving with incorrect tire inflation pressure may result in the following:

- Reduced fuel economy
- Reduced driving comfort and poor handling
- Reduced tire life due to wear
- Reduced safety
- Damage to the drivetrain

If a tire needs frequent inflating, have it checked by your Toyota dealer.

■ Instructions for checking tire inflation pressure

When checking tire inflation pressure, observe the following:

- Check only when the tires are cold.
If your vehicle has been parked for at least 3 hours or has not been driven for more than 1 mile or 1.5 km, you will get an accurate cold tire inflation pressure reading.
- Always use a tire pressure gauge.
It is difficult to judge if a tire is properly inflated based only on its appearance.
- It is normal for the tire inflation pressure to be higher after driving as heat is generated in the tire. Do not reduce tire inflation pressure after driving.
- Never exceed the vehicle capacity weight.
Passengers and luggage weight should be placed so that the vehicle is balanced.



WARNING

■ Proper inflation is critical to save tire performance

Keep your tires properly inflated.

If the tires are not properly inflated, the following conditions may occur which could lead to an accident resulting in death or serious injury:

- Excessive wear
- Uneven wear
- Poor handling
- Possibility of blowouts resulting from overheated tires
- Air leaking from between tire and wheel
- Wheel deformation and/or tire damage
- Greater possibility of tire damage while driving (due to road hazards, expansion joints, sharp edges in the road, etc.)



NOTICE

■ When inspecting and adjusting tire inflation pressure

Be sure to put the tire valve caps back on.

If a valve cap is not installed, dirt or moisture may get into the valve and cause an air leak, resulting in decreased tire inflation pressure.

Wheels

If a wheel is bent, cracked or heavily corroded, it should be replaced. Otherwise, the tire may separate from the wheel or cause a loss of handling control.

Wheel selection

When replacing wheels, care should be taken to ensure that they are equivalent to those removed in load capacity, diameter, rim width and inset*.

Replacement wheels are available at your Toyota dealer.

*: Conventionally referred to as "offset".

Toyota does not recommend using the following:

- Wheels of different sizes or types
- Used wheels
- Bent wheels that have been straightened

Aluminum wheel precautions

- Use only Toyota wheel nuts and wrenches designed for use with your aluminum wheels.
- When rotating, repairing or changing your tires, check that the wheel nuts are still tight after driving 1000 miles (1600 km).
- Be careful not to damage the aluminum wheels when using tire chains.
- Use only Toyota genuine balance weights or equivalent and a plastic or rubber hammer when balancing your wheels.

■ When replacing wheels

The wheels of your vehicle are equipped with tire pressure warning valve and transmitters that allow the tire pressure warning system to provide advance warning in the event of a loss in tire inflation pressure. Whenever wheels are replaced, tire pressure warning valve and transmitters must be installed. (→P. 417)

**WARNING****■ When replacing wheels**

- Do not use wheels that are a different size from those recommended in the Owner's Manual, as this may result in a loss of handling control.
- Never use an inner tube in a leaking wheel which is designed for a tubeless tire. Doing so may result in an accident, causing death or serious injury.

■ When installing the wheel nuts

- Be sure to install the wheel nuts with the tapered ends facing inward.(→P. 478) Installing the nuts with the tapered ends facing outward can cause the wheel to break and eventually cause the wheel to come off while driving, which could lead to an accident resulting in death or serious injury.
- Never use oil or grease on the wheel bolts or wheel nuts.
Oil and grease may cause the wheel nuts to be excessively tightened, leading to bolt or disc wheel damage. In addition, the oil or grease can cause the wheel nuts to loosen and the wheel may fall off, causing an accident and resulting in death or serious injury. Remove any oil or grease from the wheel bolts or wheel nuts.

**NOTICE****■ Replacing tire pressure warning valve and transmitters**

- Because tire repair or replacement may affect the tire pressure warning valve and transmitters, make sure to have tires serviced by your Toyota dealer or other qualified service shop. In addition, make sure to purchase your tire pressure warning valve and transmitters at your Toyota dealer.
- Ensure that only genuine Toyota wheels are used on your vehicle.
Tire pressure warning valve and transmitters may not work properly with non-genuine wheels.

Air conditioning filter

The air conditioning filter must be changed regularly to maintain air conditioning efficiency.

Removal method

- 1 Turn the power switch off.
- 2 Open the glove box and remove the glove box cover inside the glove box.

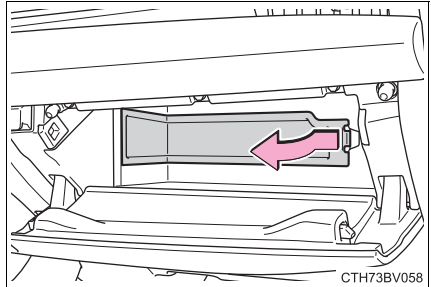

- 3 Remove the filter cover.
 - ① Unlock the filter cover.
 - ② Move the filter cover in the direction of the arrow, and then pull it out of the claws.

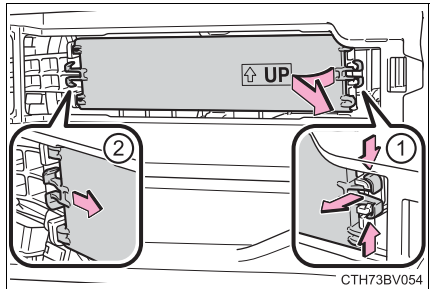

- 4 Remove the filter case.

There may be foreign objects on top of the air conditioning filter.

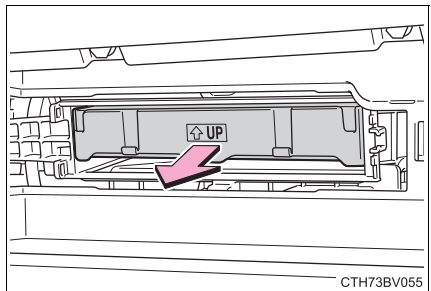

- 5 Remove the air conditioning filter from the filter case and replace it with a new one.

The “↑UP” marks shown on the filter and the filter case should be pointing up.

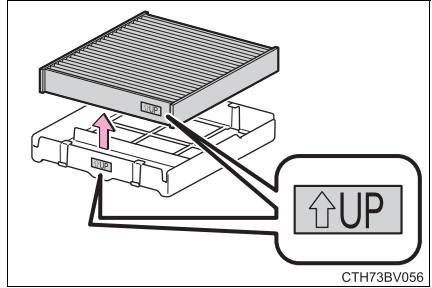

■ Checking interval

Inspect and replace the air conditioning filter according to the maintenance schedule. In dusty areas or areas with heavy traffic flow, early replacement may be required. (For scheduled maintenance information, please refer to the “Schedule maintenance guide” or “Owner’s Manual Supplement”).

■ If air flow from the vents decreases dramatically

The filter may be clogged. Check the filter and replace if necessary.

■ Air conditioning filter with deodorizing function

When fragrances are placed in your vehicle, the deodorizing effect may become significantly weakened in a short period.

When an air conditioning odor comes out continuously, replace the air conditioning filter.

⚠ NOTICE

■ When using the air conditioning system

Make sure that a filter is always installed.

Using the air conditioning system without a filter may cause damage to the system.

■ To prevent damage to the filter cover

When moving the filter cover in the direction of arrow to release the fitting, pay attention not to apply excessive force to the claws. Otherwise, the claws may be damaged.

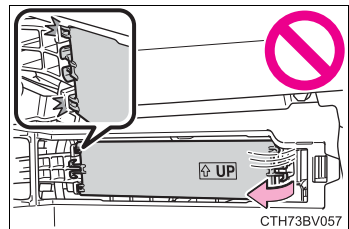

Cleaning the hybrid battery (traction battery) air intake vent and filter

To prevent the fuel economy from being affected, visually inspect the hybrid battery (traction battery) air intake vent periodically for dust and clogs. If it is dusty or clogged or if “Maintenance Required for Traction Battery Cooling Parts See Owner’s Manual” is displayed on the multi-information display, clean the air intake vent using the following procedures:

Cleaning the air intake vent

Remove the dust from the air intake vent with a vacuum cleaner, etc.

Make sure to only use a vacuum to suck out dust and clogs. Attempting to blow out dust and clogs using an airgun, etc. may push it into the air intake vent. (→P. 438)

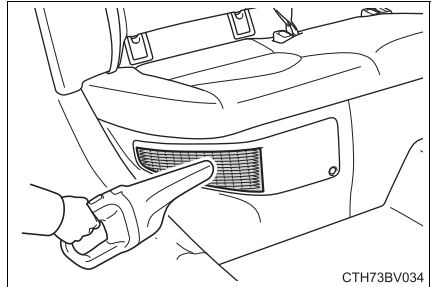

If dust and clogs cannot be completely removed

If dust and clogs cannot be completely removed with the air intake vent cover installed, remove the cover and clean the filter.

- 1 Turn the power switch off.
- 2 Using a Phillips screwdriver, remove the clip.

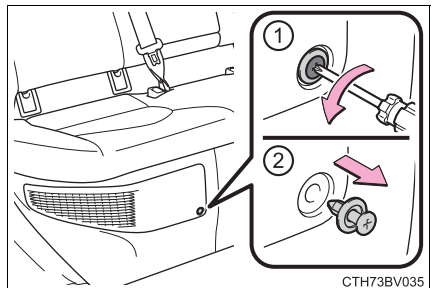

- 3** Remove the air intake vent cover.

- ① Pull the cover as shown in the illustration to disengage the 7 claws, starting from the claw in the upper right corner.
- ② Pull the cover toward the front of the vehicle to remove it.

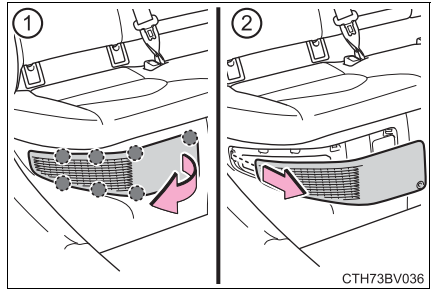

- 4** Remove the air intake vent filter.

- ① Disengage the 3 claws as shown in the illustration.
- ② Remove the filter from the cover.

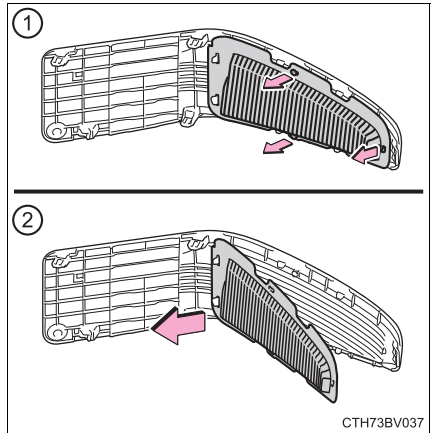

- 5** Remove the dust and clogs from the filter using a vacuum cleaner, etc.

Make sure to also remove the dust and clogs from the inside of the air intake vent cover.

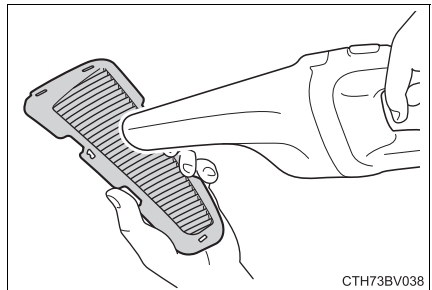

6 Reinstall the filter to the cover.

- ① Engage the filter to the 2 claws as shown in the illustration.
- ② Engage the 3 claws to install the filter.

Make sure that the filter is not crooked or deformed when installing it.

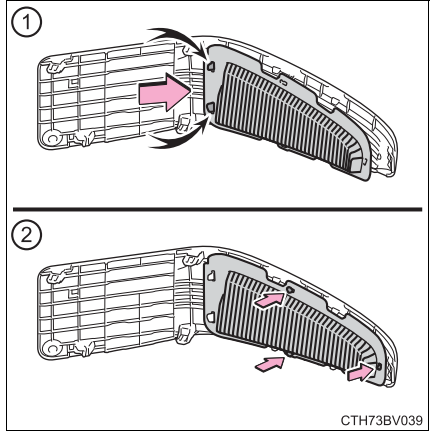
**7** Install the air intake vent cover.

- ① Insert the tab of the cover as shown in the illustration.
- ② Push the cover to engage the 7 claws.

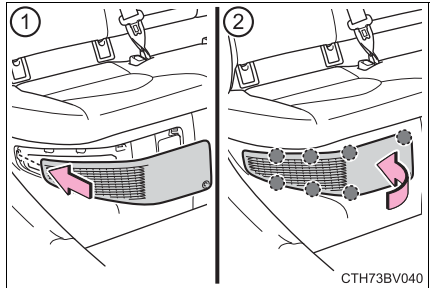
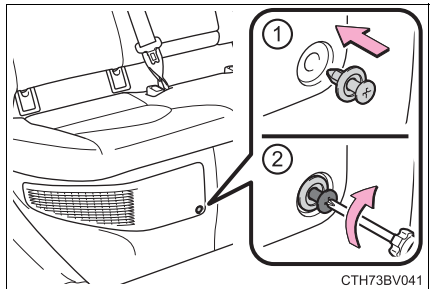
**8** Using a Phillips screwdriver, install the clip.

■ Scheduled maintenance of the air intake vent is necessary when

In some situations such as when the vehicle is used frequently or in heavy traffic or dusty areas, the air intake vent may need to be cleaned more regularly. For details, refer to “Schedule maintenance guide” or “Owner’s Manual Supplement”.

■ Cleaning the air intake vent

- Dust in the air intake vent may interfere with the cooling of the hybrid battery (traction battery). If charging/discharging of the hybrid battery (traction battery) becomes limited, the distance that the vehicle can be driven using the electric motor (traction motor) may be reduced and the fuel economy may be reduced.
- Improper handling of the air intake vent cover and filter may result in damage to them. If you have any concerns about cleaning the filter, contact your Toyota dealer.

■ If “Maintenance Required for Traction Battery Cooling Parts See Owner’s Manual” is displayed on the multi-information display

- If this warning message is displayed on the multi-information display, remove the air intake vent cover and clean the filter. (→P. 434)
- After cleaning the air intake vent, start the hybrid system and check that the warning message is no longer displayed.
It may take approximately 20 minutes after the hybrid system is started until the warning message disappears. If the warning message does not disappear, have the vehicle inspected by your Toyota dealer.

WARNING

■ When cleaning the air intake vent

- Do not use water or other liquids to clean the air intake vent. If water is applied to the hybrid battery (traction battery) or other components, a malfunction or fire may occur.
- Before cleaning the air intake vent, make sure to turn the power switch off to stop the hybrid system.

■ When removing the air intake vent cover

Do not touch the service plug located near the air intake vent. (→P. 82)

 NOTICE

■ When cleaning the air intake vent

When cleaning the air intake vent, make sure to only use a vacuum to suck out dust and clogs. If a compressed air blow gun, etc. is used to blow out dust and clogs, the dust or clogs may be pushed into the air intake vent, which may affect the performance of the hybrid battery (traction battery) and cause a malfunction.

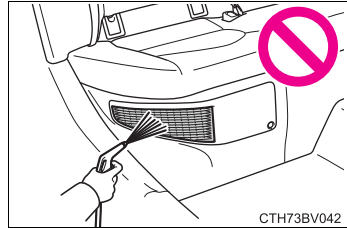

CTH73BV042

■ To prevent damage to the vehicle

- Do not allow water or foreign matter to enter the air intake vent when the cover is removed.
- Carefully handle the removed filter so that it will not be damaged. If the filter is damaged, have it replaced with a new filter by your Toyota dealer.
- Make sure to reinstall the filter and cover to their original positions after cleaning.
- Do not install anything to the air intake vent other than the exclusive filter for this vehicle or use the vehicle without the filter installed.

■ If “Maintenance Required for Traction Battery Cooling Parts See Owner’s Manual” is displayed on the multi-information display

If the vehicle is continuously driven with the warning message (indicating that charging/discharging of the hybrid battery (traction battery) may become limited) displayed, the hybrid battery (traction battery) may malfunction. If a warning message is displayed, clean the air intake vent immediately.

Electronic key battery

Replace the battery with a new one if it is depleted.

You will need the following items:

- Flathead screwdriver
- Small flathead screwdriver
- Lithium battery CR2032

Replacing the battery

- 1 Release the lock and remove the mechanical key.

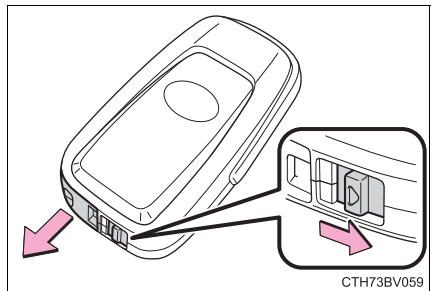

- 2 Remove the key cover.

To prevent damage to the key, cover the tip of the flathead screwdriver with a rag.

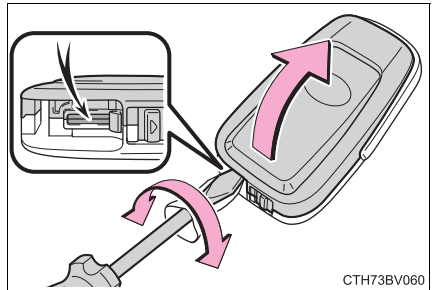

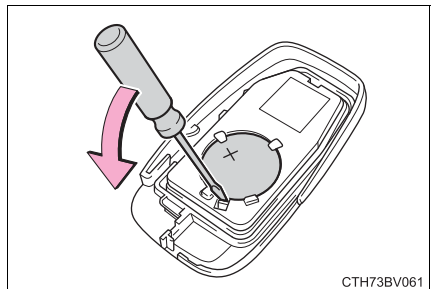

- 3 Remove the depleted battery using a small flathead screwdriver.

When removing the cover, the electronic key module may stick to the cover and the battery may not be visible. In this case, remove the electronic key module in order to remove the battery.



Insert a new battery with the “+” terminal facing up.

- 4 When installing the key cover and mechanical key, install by conducting 2 and 1 with the directions reversed.
- 5 Operate the  or  switch and check that the doors can be locked/unlocked.

■ When replacing the key battery

Be careful not to lose the battery or any other small parts.

■ Use a CR2032 lithium battery

- Batteries can be purchased at your Toyota dealer, local electrical appliance shops or camera stores.
- Replace only with the same or equivalent type recommended by the manufacturer.
- Dispose of used batteries according to local laws.

■ If the key battery is depleted

The following symptoms may occur:

- The smart key system and wireless remote control will not function properly.
- The operational range will be reduced.



WARNING

■ Battery precautions

Observe the following precautions.

Failure to do so may result in death or serious injury.

- Do not swallow the battery. Doing so may cause chemical burns.
- A coin battery or button battery is used in the electronic key. If a battery is swallowed, it may cause severe chemical burns in as little as 2 hours and may result in death or serious injury.
- Keep away new and removed batteries from children.
- If the cover cannot be firmly closed, stop using the electronic key and stow the key in the place where children cannot reach, and then contact your Toyota dealer.
- If you accidentally swallow a battery or put a battery into a part of your body, get emergency medical attention immediately.

■ To prevent battery explosion or leakage of flammable liquid or gas

- Replace the battery with a new battery of the same type. If a wrong type of battery is used, it may explode.
- Do not expose batteries to extremely low pressure due to high altitude or extremely high temperatures.
- Do not burn, break or cut a battery.

**NOTICE****■ For normal operation after replacing the battery**

Observe the following precautions to prevent accidents:

- Always work with dry hands.
Moisture may cause the battery to rust.
- Do not touch or move any other component inside the remote control.
- Do not bend either of the battery terminals.

Checking and replacing fuses

If any of the electrical components do not operate, a fuse may have blown. If this happens, check and replace the fuses as necessary.

- 1 Turn the power switch off.
- 2 Open the fuse box cover.

► Engine compartment (type A)

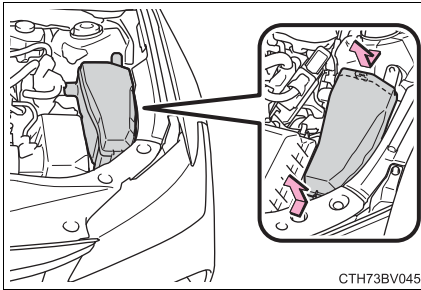

Push the tabs in and lift the lid off.

► Engine compartment (type B)

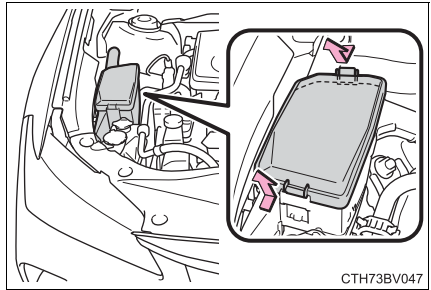

Push the tabs in and lift the lid off.

► Under the driver's side instrument panel

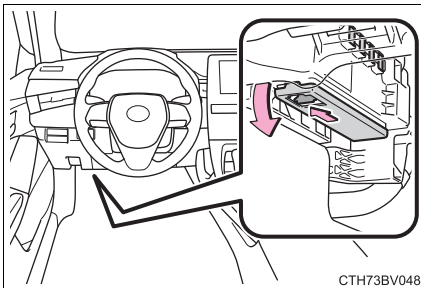

Remove the lid.

Make sure to push the claw when removing/installing the lid.

- 3** Remove the fuse with the pull-out tool.
Only type A fuses can be removed using the pullout tool.

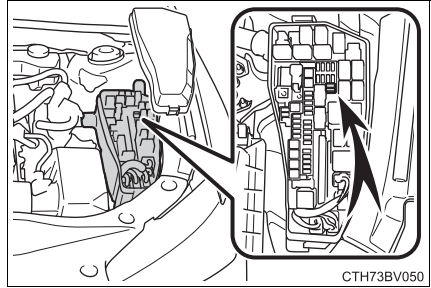

- 4** Check if the fuse is blown.

► Type A

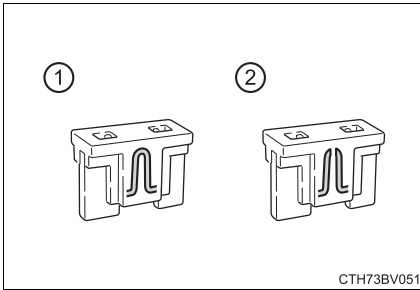

► Type B

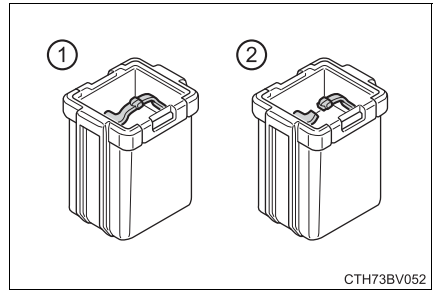

► Type C

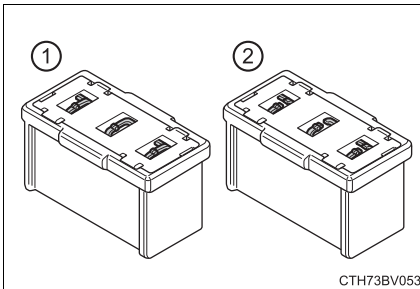

- ① Normal fuse
② Blown fuse

Replace the blown fuse with a new fuse of an appropriate amperage rating. The amperage rating can be found on the fuse box lid.

■ After a fuse is replaced

- If the lights do not turn on even after the fuse has been replaced, a bulb may need replacement. (→P. 445)
- If the replaced fuse blows again, have the vehicle inspected by your Toyota dealer.

■ If there is an overload in a circuit

The fuses are designed to blow, protecting the wiring harness from damage.

**WARNING****■ To prevent system breakdowns and vehicle fire**

Observe the following precautions.

Failure to do so may cause damage to the vehicle, and possibly a fire or injury.

- Never use a fuse of a higher amperage rating than that indicated, or use any other object in place of a fuse.
- Always use a genuine Toyota fuse or equivalent.
Never replace a fuse with a wire, even as a temporary fix.
- Do not modify the fuses or fuse boxes.

**NOTICE****■ Before replacing fuses**

Have the cause of electrical overload determined and repaired by your Toyota dealer as soon as possible.

Light bulbs

If any lights burn out, have it replaced by your Toyota dealer.

■ LED lights

The lights consist of a number of LEDs. If any of the LEDs burn out, take your vehicle to your Toyota dealer to have the light replaced.

■ Condensation build-up on the inside of the lens

Temporary condensation build-up on the inside of the headlight lens does not indicate a malfunction.

Contact your Toyota dealer for more information in the following situations:

- Large drops of water have built up on the inside of the lens.
- Water has built up inside the headlight.

When trouble arises

7

7-1. Essential information

Emergency flashers	448
If your vehicle has to be stopped in an emergency	449
If the vehicle is trapped in rising water.....	450

7-2. Steps to take in an emergency

If your vehicle needs to be towed	451
If you think something is wrong	454
If a warning light turns on or a warning buzzer sounds	455
If a warning message is displayed	465
If you have a flat tire.....	471
If the hybrid system will not start.....	482
If the electronic key does not operate properly	484
If the 12-volt battery is discharged.....	487
If your vehicle overheats	494
If the vehicle becomes stuck	498

Emergency flashers

The emergency flashers are used to warn other drivers when the vehicle has to be stopped on the road due to a breakdown, etc.

Press the switch.

All the turn signal lights will flash.
To turn them off, press the switch once again.

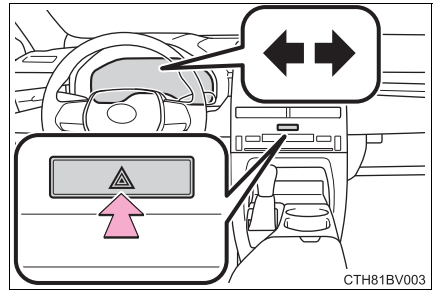

■ Emergency flashers

- If the emergency flashers are used for a long time while the hybrid system is not operating (while the “READY” indicator is not illuminated), the 12-volt battery may discharge.
- If any of the SRS airbags deploy (inflate) or in the event of a strong rear impact, the emergency flashers will turn on automatically. The emergency flashers will turn off automatically after operating for approximately 20 minutes. To manually turn the emergency flashers off, press the switch twice.
(The emergency flashers may not turn on automatically depending on the force of the impact and conditions of the collision.)

If your vehicle has to be stopped in an emergency

Only in an emergency, such as if it becomes impossible to stop the vehicle in the normal way, stop the vehicle using the following procedure:

- 1 Steadily step on the brake pedal with both feet and firmly depress it.
Do not pump the brake pedal repeatedly as this will increase the effort required to slow the vehicle.
- 2 Shift the shift lever to N.
 - ▶ If the shift lever is shifted to N
- 3 After slowing down, stop the vehicle in a safe place by the road.
- 4 Stop the hybrid system.
 - ▶ If the shift lever cannot be shifted to N
- 3 Keep depressing the brake pedal with both feet to reduce vehicle speed as much as possible.
- 4 To stop the hybrid system, press and hold the power switch for 2 consecutive seconds or more, or press it briefly 3 times or more in succession.

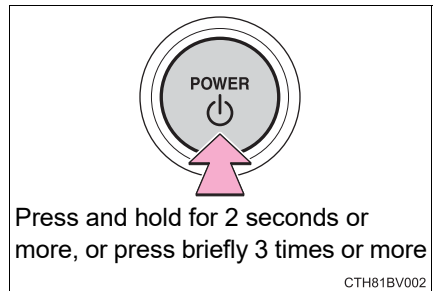

- 5 Stop the vehicle in a safe place by the road.

WARNING

■ If the hybrid system has to be turned off while driving

Power assist for the steering wheel will be lost, making the steering wheel heavier to turn. Decelerate as much as possible before turning off the hybrid system.

If the vehicle is trapped in rising water

In the event the vehicle is submerged in water, remain calm and perform the following.

- Remove the seat belt first.
- If the door can be opened, open the door and exit the vehicle.
- If the door can not be opened, open the window using the power window switch and exit the vehicle through the window.
- If the window can not be opened using the power window switch, remain calm, wait until the water level inside the vehicle rises to the point that the water pressure inside of the vehicle equals the water pressure outside of the vehicle, and then open the door and exit the vehicle.



WARNING

■ Using an emergency hammer* for emergency escape

The rear side windows and rear window of this vehicle can be shattered by an emergency hammer* used for emergency escape, however, since the windshield and front side windows are laminated glass they can not be shattered by an emergency hammer*.

*: Contact your Toyota dealer or aftermarket accessory manufacturer for further information about an emergency hammer.

■ Escaping the vehicle from the window

There are cases where escaping the vehicle from the window is not possible due to seating position, passenger body type, etc.

When using an emergency hammer, consider your seat location and the size of the window opening to ensure that the opening is accessible and large enough to escape.

If your vehicle needs to be towed

If towing is necessary, we recommend having your vehicle towed by your Toyota dealer or a commercial towing service, using a wheel-lift type truck or flatbed truck.

Use a safety chain system for all towing, and abide by all state/provincial and local laws.

WARNING

Observe the following precautions.
Failure to do so may result in death or serious injury.

■ When towing the vehicle

Be sure to transport the vehicle with the front wheels raised or with all four wheels raised off the ground. If the vehicle is towed with the front wheels contacting the ground, the drivetrain and related parts may be damaged or electricity generated by the operation of the motor may cause a fire to occur depending on the nature of the damage or malfunction.

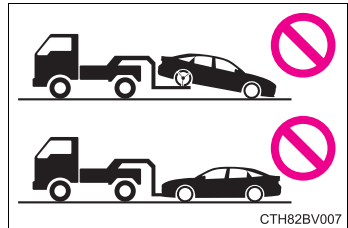

■ While towing

- When towing using cables or chains, avoid sudden starts, etc. which place excessive stress on the towing eyelets, cables or chains. The towing eyelets, cables or chains may become damaged, broken debris may hit people, and cause serious damage.
- Do not turn the power switch off.
There is a possibility that the steering wheel is locked and cannot be operated.

 NOTICE

■ To prevent damage to the vehicle when towing using a wheel-lift type truck

- Do not tow the vehicle from the rear when the power switch is off. The steering lock mechanism is not strong enough to hold the front wheels straight.
- When raising the vehicle, ensure adequate ground clearance for towing at the opposite end of the raised vehicle. Without adequate clearance, the vehicle could be damaged while being towed.

■ To prevent damage to the vehicle when towing with a sling-type truck

Do not tow with a sling-type truck, either from the front or rear.

■ To prevent damage to the vehicle during emergency towing

Do not secure cables or chains to the suspension components.

Situations when it is necessary to contact dealers before towing

The following may indicate a problem with your transmission. Contact your Toyota dealer or commercial towing service before towing.

- The hybrid system warning message is shown on the multi-information display and the vehicle does not move.
- The vehicle makes an abnormal sound.

Towing with a wheel-lift type truck

▶ From the front

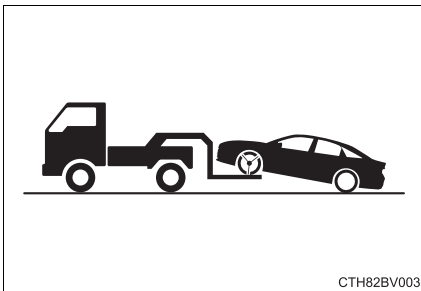

Release the parking brake.
Turn automatic mode off.
(→P. 212)

▶ From the rear

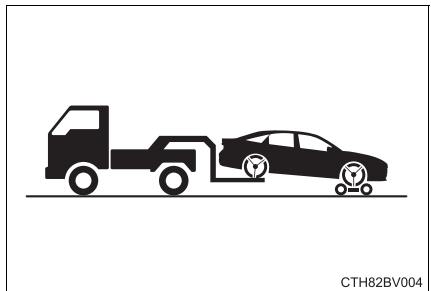

Use a towing dolly under the front wheels.

 NOTICE**■ Towing with a sling-type truck**

Do not tow with a sling-type truck to prevent body damage.

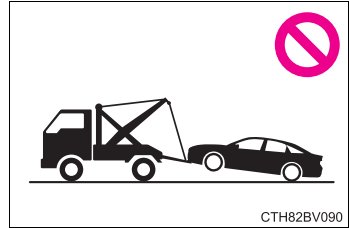
**Using a flatbed truck**

When using a flat-bed truck to transport the vehicle, use tire strapping belts. Refer to the owner's manual of the flat-bed truck for the tire strapping method.

In order to suppress vehicle movement during transportation, set the parking brake and turn the power switch off.

If you think something is wrong

If you notice any of the following symptoms, your vehicle probably needs adjustment or repair. Contact your Toyota dealer as soon as possible.

Visible symptoms

- Fluid leaks under the vehicle.
(Water dripping from the air conditioning after use is normal.)
- Flat-looking tires or uneven tire wear
- Engine coolant temperature gauge needle continually points higher than normal

Audible symptoms

- Changes in exhaust sound
- Excessive tire squeal when cornering
- Strange noises related to the suspension system
- Pinging or other noises related to the hybrid system





Operational symptoms





- Engine missing, stumbling or running roughly
- Appreciable loss of power
- Vehicle pulls heavily to one side when braking
- Vehicle pulls heavily to one side when driving on a level road
- Loss of brake effectiveness, spongy feeling, pedal almost touches the floor





If a warning light turns on or a warning buzzer sounds







Calmly perform the following actions if any of the warning lights comes on or flashes. If a light comes on or flashes, but then goes off, this does not necessarily indicate a malfunction in the system. However, if this continues to occur, have the vehicle inspected by your Toyota dealer.

Warning light and warning buzzer list

Warning light	Warning light/Details/Actions
 <p>BRAKE (Red)</p>	<p>Brake system warning light (warning buzzer) Indicates that:</p> <ul style="list-style-type: none"> • The brake fluid level is low; or • The brake system is malfunctioning <p>→ Immediately stop the vehicle in a safe place and contact your Toyota dealer. Continuing to drive the vehicle may be dangerous.</p>
 <p>(Yellow)</p>	<p>Brake system warning light (warning buzzer) Indicates a malfunction in:</p> <ul style="list-style-type: none"> • The regenerative braking system; • The electronically controlled brake system; or • The electric parking brake <p>→ Have the vehicle inspected by your Toyota dealer immediately.</p>
	<p>High coolant temperature warning light (warning buzzer)*1 Indicates that the engine coolant temperature is too high → Immediately stop the vehicle in a safe place. Handling method (→P. 494)</p>
	<p>Charging system warning light*1 Indicates a malfunction in the vehicle's charging system → Immediately stop the vehicle in a safe place and contact your Toyota dealer.</p>
	<p>Low engine oil pressure warning light (warning buzzer)*1 Indicates that the engine oil pressure is too low → Immediately stop the vehicle in a safe place and contact your Toyota dealer.</p>

Warning light	Warning light/Details/Actions
	<p>Malfunction indicator lamp (warning buzzer) Indicates a malfunction in:</p> <ul style="list-style-type: none"> • The hybrid system; • The electronic engine control system; or • The electronic throttle control system; or • The electronic hybrid transmission control system <p>→ Have the vehicle inspected by your Toyota dealer immediately.</p>
	<p>SRS warning light (warning buzzer) Indicates a malfunction in:</p> <ul style="list-style-type: none"> • The SRS airbag system; • The front passenger occupant classification system; or • The seat belt pretensioner system <p>→ Have the vehicle inspected by your Toyota dealer immediately.</p>
	<p>ABS warning light (warning buzzer) Indicates a malfunction in:</p> <ul style="list-style-type: none"> • The ABS; or • The brake assist system <p>→ Have the vehicle inspected by your Toyota dealer immediately.</p>
	<p>Brake Override System/Drive-Start Control/Intelligent Clearance Sonar warning light (warning buzzer)*1 When a buzzer sounds:</p> <ul style="list-style-type: none"> • Brake Override System is malfunctioning; • Drive-Start Control is operating; • Drive-Start Control is malfunctioning; or • The Intelligent Clearance Sonar (if equipped) is operating (→P. 300) <p>→ Follow the instructions displayed on the multi-information display.</p> <p>When a buzzer does not sound: Brake Override System is operating</p> <p>→ Release the accelerator pedal and depress the brake pedal.</p>
	<p>Parking brake indicator (warning buzzer)*2 It is possible that the parking brake is not fully engaged or released</p> <p>→ Operate the parking brake once again.</p> <p>This light comes on when the parking brake is not released. If the light turns off after the parking brake is fully released, the system is operating normally.</p>

Warning light	Warning light/Details/Actions
 <p>HOLD (Flashes)</p>	<p>Brake hold operated indicator Indicates a malfunction in the brake hold system → Have the vehicle inspected by your Toyota dealer immediately.</p>
 <p>(Red/yellow)</p>	<p>Electric power steering system warning light (warning buzzer) Indicates a malfunction in the EPS (Electric Power Steering) system → Have the vehicle inspected by your Toyota dealer immediately.</p>
 <p>(Amber)</p>	<p>LDA indicator Indicates a malfunction in the LDA → When “LDA Unavailable” is displayed on the multi-information display, turn the LDA system off, drive the vehicle for a short time, and then turn the LDA system back on. (→P. 257) When a message other than above is displayed, follow the instructions displayed in the message.</p>
 <p>(Flashes or illuminates)</p>	<p>PCS warning light When a buzzer sounds simultaneously: Indicates a malfunction has occurred in the PCS (Pre-Collision System). → Have the vehicle inspected by your Toyota dealer immediately.</p> <p>When a buzzer does not sound: The PCS (Pre-Collision System) has become temporarily unavailable, corrective action may be necessary. → Follow the instructions displayed on the multi-information display. (→P. 240, 465)</p> <p>If the PCS (Pre-Collision System) or VSC (Vehicle Stability Control) system is disabled, the PCS warning light will illuminate. → P. 251</p>
 <p>(If equipped) (Flashes)</p>	<p>ICS OFF indicator When a buzzer sounds: Indicates a malfunction in the Intelligent Clearance Sonar system → Have the vehicle inspected by your Toyota dealer immediately.</p> <p>When a buzzer does not sound: Indicates that the system is temporarily unavailable, possibly due to a sensor being dirty or covered with ice, etc. → Clear the dirt, etc.</p>

Warning light	Warning light/Details/Actions
	<p>Slip indicator Indicates a malfunction in:</p> <ul style="list-style-type: none"> • The VSC (Vehicle Stability Control) system; • The TRAC (Traction Control) system • The ABS; or • The hill-start assist control system <p>The light will flash when the ABS, VSC or TRAC system is operating. → Have the vehicle inspected by your Toyota dealer immediately.</p>
	<p>Low fuel level warning light Indicates that remaining fuel is approximately 1.8 gal. (6.7 L, 1.5 Imp. gal.) or less → Refuel the vehicle.</p>
	<p>Driver's and front passenger's seat belt reminder light (warning buzzer)*3 Warns the driver and/or front passenger to fasten their seat belts → Fasten the seat belt. If the front passenger's seat is occupied, the front passenger's seat belt also needs to be fastened to make the warning light (warning buzzer) turn off.</p>
	<p>Rear passengers' seat belt reminder lights (warning buzzer)*4 Warns the rear passengers to fasten their seat belts. → Fasten the seat belt.</p>
	<p>Master warning light (warning buzzer) A buzzer sounds and the warning light comes on and flashes to indicate that the master warning system has detected a malfunction. → P. 465</p>
	<p>Tire pressure warning light Indicates the following:</p> <ul style="list-style-type: none"> • Low tire pressure due to flat tire; • Low tire pressure due to natural causes; or • The tire pressure warning system is malfunctioning <p>→ Immediately stop the vehicle in a safe place. Handling method (→P. 461)</p>

*1: This light illuminates on the multi-information display.

*2: Parking brake engaged warning buzzer:

A buzzer will sound if the vehicle is driven at a speed of approximately 3 mph (5 km/h) or more.

*3: Driver's and front passenger's seat belt warning buzzer:

The driver's seat belt warning buzzer sounds to alert the driver that his or her seat belt is not fastened. Once the power switch is turned to ON mode, the buzzer sounds. If the seat belt is still unfastened, the buzzer sounds intermittently for a certain period of time after the vehicle reaches a certain speed.

The front passenger's seat belt warning buzzer sounds to alert the front passenger that his or her seat belt is not fastened. If the seat belt is unfastened, the buzzer sounds intermittently for a certain period of time after the vehicle reaches a certain speed.

*4: Rear passenger's seat belt buzzer:

The rear passengers' seat belt warning buzzer sounds to alert the rear passenger that his or her seat belt is not fastened. If the seat belt is unfastened, the buzzer sounds intermittently for a certain period of time, after the seat belt is fastened and unfastened and the vehicle reaches a certain speed.

■ SRS warning light

This warning light system monitors the airbag sensor assembly, front impact sensors, side impact sensors (front door), side impact sensors (front), side impact sensors (rear), driver's seat position sensor, driver's seat belt buckle switch, front passenger occupant classification system (ECU and sensors), "AIR BAG ON" indicator light, "AIR BAG OFF" indicator light, seat belt pretensioners, airbags, interconnecting wiring and power sources. (→P. 36)

■ Front passenger detection sensor, seat belt reminder and warning buzzer

- If luggage is placed on the front passenger seat, the front passenger detection sensor may cause the warning light to flash and the warning buzzer to sound even if a passenger is not sitting in the seat.
- If a cushion is placed on the seat, the sensor may not detect a passenger, and the warning light may not operate properly.

■ If the malfunction indicator lamp comes on while driving

First check the following:

- Is the fuel tank empty?
If it is, fill the fuel tank immediately.
- Is the fuel tank cap loose?
If it is, tighten it securely.

The light will go off after several driving trips.

If the light does not go off even after several trips, contact your Toyota dealer as soon as possible.

■ Electric power steering system warning light (warning buzzer)

When the 12-volt battery charge becomes insufficient or the voltage temporarily drops, the electric power steering system warning light may come on and the warning buzzer may sound.

■ When the tire pressure warning light comes on

Inspect the tires to check if a tire is punctured.

If a tire is punctured: →P. 471

If none of the tires are punctured:

Turn the power switch off then turn it to ON mode. Check if the tire pressure warning light comes on or blinks.

▶ If the tire pressure warning light comes on

- 1 After the temperature of the tires has lowered sufficiently, check the inflation pressure of each tire and adjust them to the specified level.
- 2 If the warning light does not turn off even after several minutes have elapsed, check that the inflation pressure of each tire is at the specified level and perform initialization. (→P. 417)

If the warning light does not turn off several minutes after the initialization has been performed, have the vehicle inspected by your Toyota dealer immediately.

▶ If the tire pressure warning light blinks for 1 minute then stays on

There may be a malfunction in the tire pressure warning system. Have the vehicle inspected by your Toyota dealer immediately.

■ The tire pressure warning light may come on due to natural causes

The tire pressure warning light may come on due to natural causes such as natural air leaks and tire inflation pressure changes caused by temperature. In this case, adjusting the tire inflation pressure will turn off the warning light (after a few minutes).

■ When a tire is replaced with a spare tire

The compact spare tire is not equipped with a tire pressure warning valve and transmitter. If a tire goes flat, the tire pressure warning light will not turn off even though the flat tire has been replaced with the spare tire. Replace the spare tire with the repaired tire and adjust the tire inflation pressure. The tire pressure warning light will go off after a few minutes.

■ Conditions that the tire pressure warning system may not function properly

→P. 422

■ Warning buzzer

In some cases, the buzzer may not be heard because of noisy place or an audio sound.

**WARNING****■ If both the ABS and the brake system warning lights remain on**

Stop your vehicle in a safe place immediately and contact your Toyota dealer. The vehicle will become extremely unstable during braking, and the ABS system may fail, which could cause an accident resulting in death or serious injury.

■ When the electric power steering system warning light comes on

When the light comes on yellow, the assist to the power steering is restricted. When the light comes on red, the assist to the power steering is lost and handling operations of the steering wheel become extremely heavy.

If the steering wheel becomes heavier than usual when operating, hold firmly and operate using more force than usual.

■ If the tire pressure warning light comes on

Be sure to observe the following precautions. Failure to do so could cause a loss of vehicle control and result in death or serious injury.

- Stop your vehicle in a safe place as soon as possible. Adjust the tire inflation pressure immediately.
- If the tire pressure warning light comes on even after tire inflation pressure adjustment, it is probable that you have a flat tire. Check the tires. If a tire is flat, change it with the spare tire and have the flat tire repaired by the nearest Toyota dealer.
- Avoid abrupt maneuvering and braking. If the vehicle tires deteriorate, you could lose control of the steering wheel or the brakes.

■ If a blowout or sudden air leakage should occur

The tire pressure warning system may not activate immediately.

 **WARNING****■ Maintenance of the tires**

Each tire, including the spare (if provided), should be checked monthly when cold and inflated to the inflation pressure recommended by the vehicle manufacturer on the vehicle placard or tire inflation pressure label (tire and load information label). (If your vehicle has tires of a different size than the size indicated on the vehicle placard or tire inflation pressure label [tire and load information label], you should determine the proper tire inflation pressure for those tires.)

As an added safety feature, your vehicle has been equipped with a tire pressure monitoring system (TPMS-tire pressure warning system) that illuminates a low tire pressure telltale (tire pressure warning light) when one or more of your tires is significantly under-inflated. Accordingly, when the low tire pressure telltale (tire pressure warning light) illuminates, you should stop and check your tires as soon as possible, and inflate them to the proper pressure. Driving on a significantly under-inflated tire causes the tire to overheat and can lead to tire failure. Under-inflation also reduces fuel efficiency and tire tread life, and may affect the vehicle's handling and stopping ability.

Please note that the TPMS (tire pressure warning system) is not a substitute for proper tire maintenance, and it is the driver's responsibility to maintain correct tire pressure, even if under-inflation has not reached the level to trigger illumination of the TPMS low tire pressure telltale (tire pressure warning light).

Your vehicle has also been equipped with a TPMS (tire pressure warning system) malfunction indicator to indicate when the system is not operating properly. The TPMS (tire pressure warning system) malfunction indicator is combined with the low tire pressure telltale (tire pressure warning light). When the system detects a malfunction, the telltale will flash for approximately one minute and then remain continuously illuminated. This sequence will continue upon subsequent vehicle start-ups as long as the malfunction exists. When the malfunction indicator is illuminated, the system may not be able to detect or signal low tire pressure as intended.

TPMS (tire pressure warning system) malfunctions may occur for a variety of reasons, including the installation of replacement or alternate tires or wheels on the vehicle that prevent the TPMS (tire pressure warning system) from functioning properly. Always check the TPMS (tire pressure warning system) malfunction telltale after replacing one or more tires or wheels on your vehicle to ensure that the replacement or alternate tires and wheels allow the TPMS (tire pressure warning system) to continue to function properly.

**NOTICE****■ To ensure the tire pressure warning system operates properly**

Do not install tires with different specifications or makers, as the tire pressure warning system may not operate properly.

If a warning message is displayed

The multi-information display shows warnings of system malfunctions, incorrectly performed operations, and messages that indicate a need for maintenance. When a message is shown, perform the correction procedure appropriate to the message.

① Master warning light

The master warning light also comes on or flashes in order to indicate that a message is currently being displayed on the multi-information display.

② Multi-information display

③ Handling method

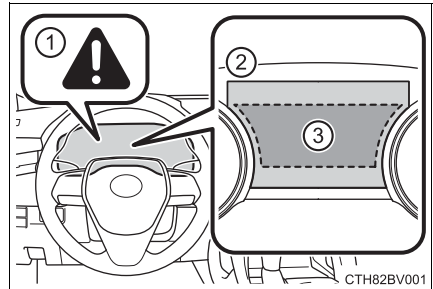

Follow the instructions of the message on the multi-information display.

If any of the warning messages are shown again after the appropriate actions have been performed, contact your Toyota dealer.

Messages and warnings

The warning lights and warning buzzers operate as follows depending on the content of the message. If a message indicates the need for inspection by a dealer, have the vehicle inspected by your Toyota dealer immediately.

	System warning light	Warning buzzer*	Warning
Comes on	—	Sounds	Indicates an important situation, such as when a system related to driving is malfunctioning or that danger may result if the correction procedure is not performed
—	Comes on or flashes	Sounds	Indicates an important situation, such as when the systems shown on the multi-information display may be malfunctioning
Flashes	—	Sounds	Indicates a situation, such as when damage to the vehicle or danger may result
Comes on	—	Does not sound	Indicates a condition, such as malfunction of electrical components, their condition, or indicates the need for maintenance
Flashes	—	Does not sound	Indicates a situation, such as when an operation has been performed incorrectly, or indicates how to perform an operation correctly

The operation of the warning lights and warning buzzers may differ from those stated. In this case, perform the correction procedure according to the displayed message.

*: A buzzer sounds the first time a message is shown on the multi-information display.

■ Warning messages

The warning messages explained below may differ from the actual messages according to operation conditions and vehicle specifications.

■ System warning lights

The master warning light does not come on or flash in the following cases. Instead, a separate system warning light will come on along with a message shown on the multi-information display.

● Malfunction in the ABS

The ABS warning light comes on. (→P. 456)

● Malfunction in the brake system

The brake system warning light (yellow) comes on. (→P. 455)

● Malfunction in the tire pressure warning system

The tire pressure warning light comes on. (→P. 458)

● Remaining fuel level is low

The low fuel level warning light comes on. (→P. 458)

■ If a message instructing to refer to the Owner's Manual is displayed

● If the following messages are shown, there may be a malfunction.

Immediately stop the vehicle in a safe place and contact your Toyota dealer. Continuing to drive the vehicle may be dangerous.

- “Low Braking Power Stop in a Safe Place See Owner's Manual”
- “Oil Pressure Low Stop in a Safe Place See Owner's Manual”
- “Charging System Malfunction Stop in a Safe Place See Owner's Manual”

● If the following message is shown, there may be a malfunction.

Immediately have the vehicle inspected by your Toyota dealer.

- “Hybrid System Malfunction”
 - “Check Engine”
 - “Hybrid Battery System Malfunction”
 - “Accelerator System Malfunction”
 - “Smart Key System Malfunction”
- If “Engine Coolant Temp High Stop in a Safe Place See Owner's Manual” is displayed, follow the instructions accordingly. (→P. 494)
- If “Maintenance Required for Traction Battery Cooling Parts See Owner's Manual” is displayed, follow the instructions accordingly. (→P. 434)

■ If “Hybrid System Overheated Output Power Reduced” is shown

This message may be displayed when driving under severe operating conditions. (For example, when driving up a long steep hill.)

Handling method: →P. 494

■ If “Maintenance Required for Traction Battery Cooling Parts See Owner’s Manual” is shown

The filter may be clogged, the air intake vent may be blocked or there may be a gap in the duct.

- If the air intake vent or filter is dirty, refer to P. 434 for cleaning the air intake vent and filter.

- If the message is being displayed and the air intake vent and filter are not dirty, have the vehicle inspected at your Toyota dealer.

■ If “Traction Battery Needs to be Protected Refrain From the Use of N Position” is shown

This message may be displayed when the shift lever is in N.

As the hybrid battery (traction battery) cannot be charged when the shift lever is in N, shift the shift lever to P when the vehicle is stopped.

■ If “Traction Battery Needs to be Protected Shift into P to Restart” is shown

This message is displayed when the hybrid battery (traction battery) charge has become extremely low because the shift lever has been left in N for a certain amount of time.

When operating the vehicle, shift to P and restart the hybrid system.

■ If “Shift to P Before Exiting Vehicle” is shown

Message is displayed when the driver’s door is opened without turning the power switch off with the shift lever in any position other than P.

Shift the shift lever to P.

■ If “Shift Is in N Release Accelerator Before Shifting” is shown

Message is displayed when the accelerator pedal has been depressed and the shift lever is in N. Release the accelerator pedal and shift the shift lever to D or R.

■ If “Press Brake When Vehicle Is Stopped Hybrid System May Overheat” is shown

Message is displayed when the accelerator pedal is depressed to maintain the vehicle position when stopped on an upward slope, etc.

If this continues, the hybrid system may overheat.

Release the accelerator pedal and depress the brake pedal.

■ If “Auto Power Off to Conserve Battery” is displayed

Power was turned off due to the automatic power off function.

Next time when starting the hybrid system, operate the hybrid system for approximately 5 minutes to recharge the 12-volt battery.

■ If “A New Key has been Registered Contact Your Dealer for Details” is displayed

This message will be displayed each time the driver's door is opened when the doors are unlocked from the outside for approximately one week after a new electronic key has been registered.

If this message is displayed but you have not had a new electronic key registered, ask your Toyota dealer to check if an unknown electronic key (other than those in your possession) has been registered.

■ When “Headlight System Malfunction Visit Your Dealer” is displayed

The following systems may be malfunctioning. Have the vehicle inspected by your Toyota dealer immediately.

- The LED headlight system
- Automatic High Beam

■ If a message that indicates the malfunction of front camera is displayed

The following systems may be suspended until the problem shown in the message is resolved.

- PCS (Pre-Collision System)
- LDA (Lane Departure Alert with steering control)
- Dynamic radar cruise control with full-speed range
- Automatic High Beam

■ If “Maintenance Required Soon” is displayed

Indicates that all maintenance according to the driven distance on the maintenance schedule* should be performed soon.

Comes on approximately 4500 miles (7200 km) after the message has been reset.

If necessary, perform maintenance. Please reset the message after the maintenance is performed. (→P. 393)

*: Refer to the separate “Scheduled Maintenance Guide” or “Owner’s Manual Supplement” for the maintenance interval applicable to your vehicle.

■ If “Maintenance Required Visit Your Dealer” is displayed

Indicates that all maintenance is required to correspond to the driven distance on the maintenance schedule*.

Comes on approximately 5000 miles (8000 km) after the message has been reset.

(The indicator will not work properly unless the message has been reset.)

Perform the necessary maintenance. Please reset the message after the maintenance is performed. (→P. 393)

*: Refer to the separate “Scheduled Maintenance Guide” or “Owner’s Manual Supplement” for the maintenance interval applicable to your vehicle.

■ If “Engine Oil Level Low Add or Replace” is displayed

The engine oil level may be low. Check the level of the engine oil, and add engine oil if necessary. This message may be displayed if the vehicle is stopped on a slope. Move the vehicle to a level surface and check if the message disappears.

■ Warning buzzer

→P. 461

**NOTICE****■ If “High Power Consumption Power to Climate Temporarily Limited” is frequently shown**

There is a possible malfunction relating to the charging system or the 12-volt battery may be deteriorating. Have the vehicle inspected by your Toyota dealer.

■ If “Maintenance Required For Traction Battery At Your Dealer” is shown

The hybrid battery (traction battery) is scheduled to be inspected or replaced. Have the vehicle inspected by your Toyota dealer immediately.

● Continuing to drive the vehicle without having the hybrid battery (traction battery) inspected will cause the hybrid system not to start.

● If the hybrid system does not start, contact your Toyota dealer immediately.

If you have a flat tire

Your vehicle is equipped with a spare tire. The flat tire can be replaced with the spare tire.

For details about tires: →P. 415

⚠ WARNING

■ If you have a flat tire

Do not continue driving with a flat tire.

Driving even a short distance with a flat tire can damage the tire and the wheel beyond repair, which could result in an accident.

Before jacking up the vehicle

- Stop the vehicle in a safe place on a hard, flat surface.
- Set the parking brake.
- Shift the shift lever to P.
- Stop the hybrid system.
- Turn on the emergency flashers. (→P. 448)

Location of the spare tire, jack and tools

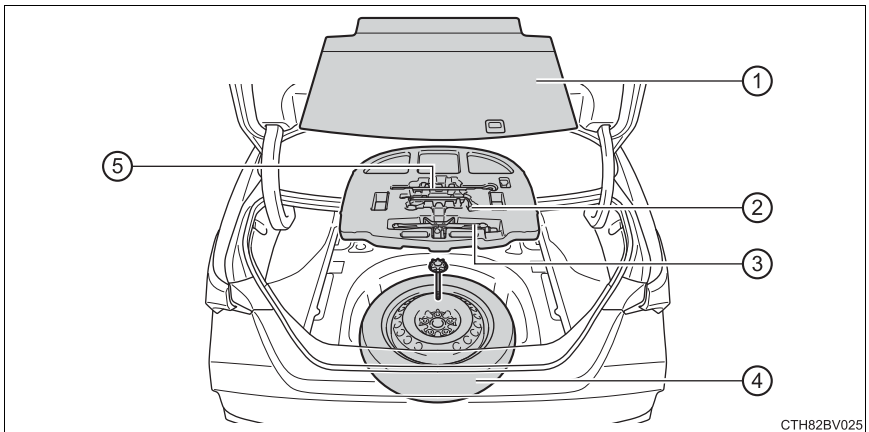

- | | |
|-----------------------|---------------|
| ① Luggage floor cover | ④ Spare tire |
| ② Wheel nut wrench | ⑤ Jack handle |
| ③ Jack | |

WARNING

■ Using the tire jack

Observe the following precautions.

Improper use of the tire jack may cause the vehicle to suddenly fall off the jack, leading to death or serious injury.

- Do not use the tire jack for any purpose other than replacing tires or installing and removing tire chains.
- Only use the tire jack that comes with this vehicle for replacing a flat tire.
Do not use it on other vehicles, and do not use other tire jacks for replacing tires on this vehicle.
- Put the jack properly in its jack point.
- Do not put any part of your body under the vehicle while it is supported by the jack.
- Do not start the hybrid system or drive the vehicle while the vehicle is supported by the jack.
- Do not raise the vehicle while someone is inside.
- When raising the vehicle, do not put an object on or under the jack.
- Do not raise the vehicle to a height greater than that required to replace the tire.
- Use a jack stand if it is necessary to get under the vehicle.
- When lowering the vehicle, make sure that there is no-one near the vehicle. If there are people nearby, warn them vocally before lowering.

NOTICE

■ To prevent damage to the vehicle when using a jack

When jacking up the rear of the vehicle, make sure not to position the jack under the bracket shown in the illustration near the rear jack point, as the vehicle body may be damaged.

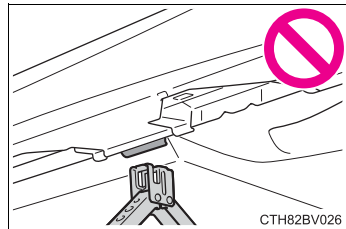

CTH82BV026

Taking out the jack

- 1 Lift up the hook of the luggage floor cover on the trunk floor.

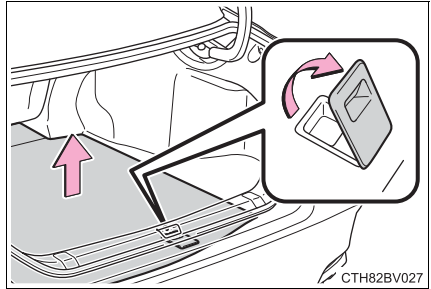

- 2 Secure the luggage floor cover using the hook provided.

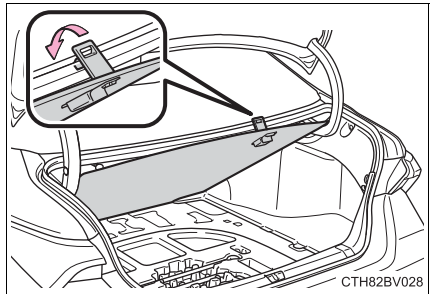

- 3 Remove the jack.

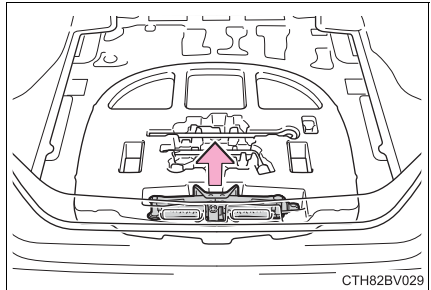

Taking out the spare tire

- 1 Lift up the hook of the luggage floor cover on the trunk floor.

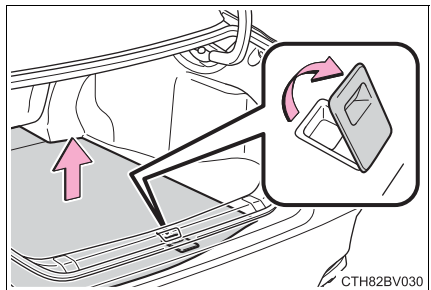

- 2 Secure the luggage floor cover using the hook provided.

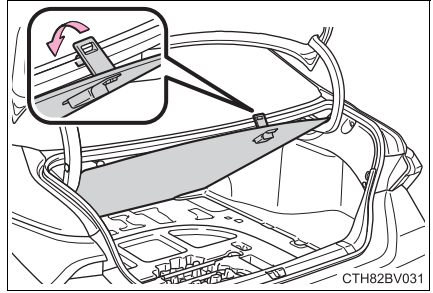

- 3 Remove the tool tray.

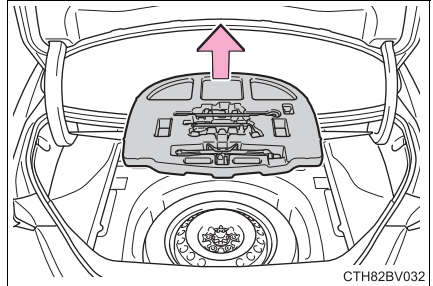

- 4 Loosen the center fastener that secures the spare tire.

When taking out or stowing the spare tire, make sure to firmly hold opposite end of the tire.

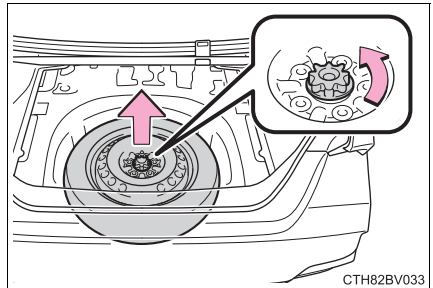

! WARNING

■ When storing the spare tire

Be careful not to catch fingers or other body parts between the spare tire and the body of the vehicle.

Replacing a flat tire

- 1 Chock the tires.

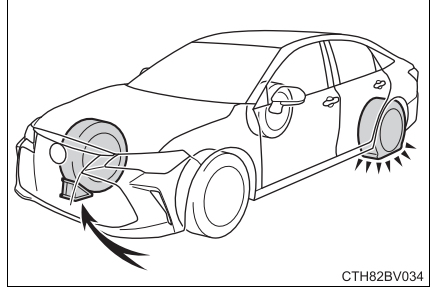

CTH82BV034

Flat tire		Wheel chock positions
Front	Left-hand side	Behind the rear right-hand side tire
	Right-hand side	Behind the rear left-hand side tire
Rear	Left-hand side	In front of the front right-hand side tire
	Right-hand side	In front of the front left-hand side tire

- 2 Slightly loosen the wheel nuts (one turn).

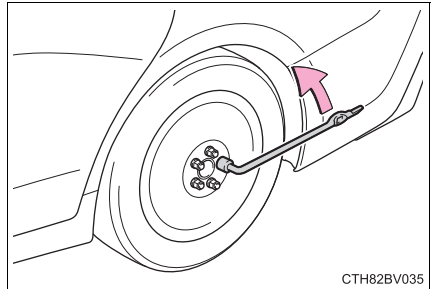

CTH82BV035

- 3 Turn the tire jack portion "A" by hand until the notch of the jack is in contact with the jack point.

To prevent damage to the vehicle when using the jack, position the jack in the correct location. (→P. 472)

The jack point guides are located under the rocker panel. They indicate the jack point positions.

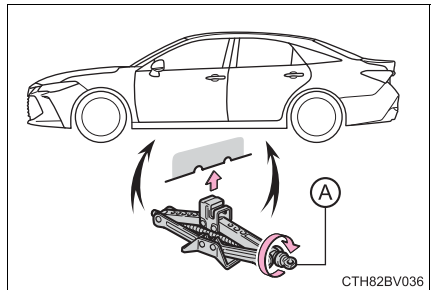

CTH82BV036

- 4 Assemble the jack handle.

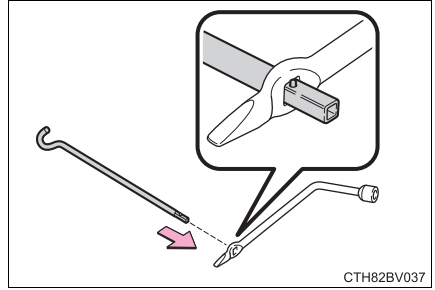

- 5 Raise the vehicle until the tire is slightly raised off the ground.

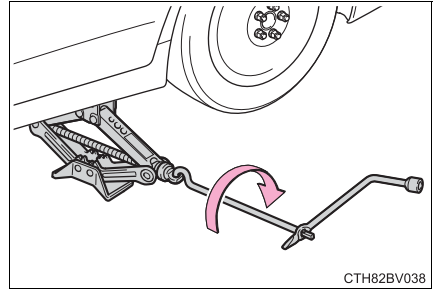

- 6 Remove all the wheel nuts and the tire.

When resting the tire on the ground, place the tire so that the wheel design faces up to avoid scratching the wheel surface.

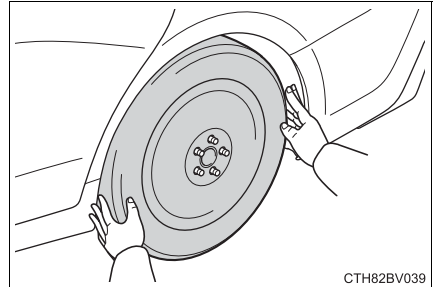

**WARNING****■ Replacing a flat tire**

- Do not touch the disc wheels or the area around the brakes immediately after the vehicle has been driven. After the vehicle has been driven the disc wheels and the area around the brakes will be extremely hot. Touching these areas with hands, feet or other body parts while changing a tire, etc. may result in burns.
- Failure to follow these precautions could cause the wheel nuts to loosen and the tire to fall off, resulting in death or serious injury.
 - Have the wheel nuts tightened with a torque wrench to 76 ft•lbf (103 N•m, 10.5 kgf•m) as soon as possible after changing wheels.
 - Do not attach a heavily damaged wheel ornament, as it may fly off the wheel while the vehicle is moving.
 - When installing a tire, only use wheel nuts that have been specifically designed for that wheel.
 - If there are any cracks or deformations in the bolt screws, nut threads or bolt holes of the wheel, have the vehicle inspected by your Toyota dealer.
 - When installing the wheel nuts, be sure to install them with the tapered ends facing inward.

Installing the spare tire

- 1 Remove any dirt or foreign matter from the wheel contact surface.

If foreign matter is on the wheel contact surface, the wheel nuts may loosen while the vehicle is in motion, causing the tire to come off.

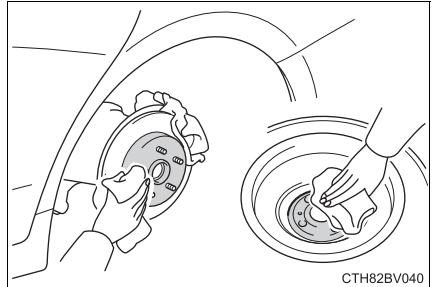

CTH82BV040

- 2 Install the tire and loosely tighten each wheel nut by hand by approximately the same amount.

Tighten the wheel nuts until the tapered portion comes into loose contact with the disc wheel seat.

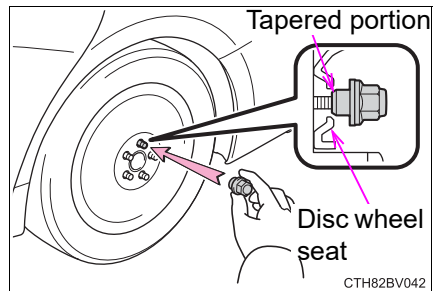

CTH82BV042

- 3 Lower the vehicle.

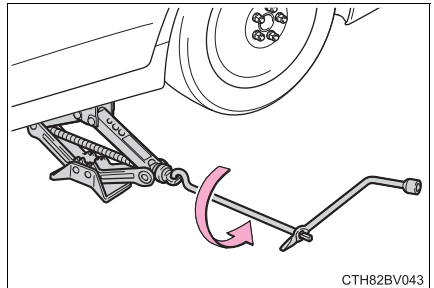

CTH82BV043

- 4 Firmly tighten each wheel nut two or three times in the order shown in the illustration.

Tightening torque:
76 ft•lbf (103 N•m, 10.5 kgf•m)

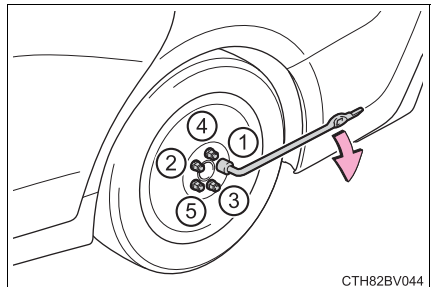

CTH82BV044

- 5 Stow the flat tire, tire jack and all tools.

■ The compact spare tire

- The compact spare tire is identified by the label “TEMPORARY USE ONLY” on the tire sidewall.
Use the compact spare tire temporarily, and only in an emergency.
- Make sure to check the tire inflation pressure of the compact spare tire.
(→P. 508)

■ When using the compact spare tire

As the compact spare tire is not equipped with a tire pressure warning valve and transmitter, low inflation pressure of the spare tire will not be indicated by the tire pressure warning system. Also, if you replace the compact spare tire after the tire pressure warning light comes on, the light remains on.

■ When the compact spare tire is equipped

When driving with the compact spare tire installed, the vehicle height will be different than when driving with standard tires.

■ If you have a flat front tire on a road covered with snow or ice

Install the compact spare tire on one of the rear wheels of the vehicle. Perform the following steps and fit tire chains to the front tires:

- 1 Replace a rear tire with the compact spare tire.
- 2 Replace the flat front tire with the tire removed from the rear of the vehicle.
- 3 Fit tire chains to the front tires.

**WARNING**

■ When using the compact spare tire

- Remember that the compact spare tire provided is specifically designed for use with your vehicle. Do not use your compact spare tire on another vehicle.
- Do not use more than one compact spare tires simultaneously.
- Replace the compact spare tire with a standard tire as soon as possible.
- Avoid sudden acceleration, abrupt steering, sudden braking and shifting operations that cause sudden engine braking.

■ When the compact spare tire is attached

The vehicle speed may not be correctly detected, and the following systems may not operate correctly:

- | | |
|--|--------------------------------------|
| • ABS & Brake assist | • Tire pressure warning system |
| • VSC | • BSM (Blind Spot Monitor) |
| • TRAC | • Intuitive parking assist* |
| • EPS | • Intelligent Clearance Sonar (ICS)* |
| • Automatic High Beam | • Rear view monitor system* |
| • Dynamic radar cruise control with full-speed range | • Toyota parking assist monitor |
| • LDA (Lane Departure Alert with steering control) | • Panoramic view monitor* |
| • PCS (Pre-Collision System) | • Navigation system* |

*: If equipped

■ Speed limit when using the compact spare tire

Do not drive at speeds in excess of 50 mph (80 km/h) when a compact spare tire is installed on the vehicle.

The compact spare tire is not designed for driving at high speeds. Failure to observe this precaution may lead to an accident causing death or serious injury.

■ After using the tools and jack

Before driving, make sure all the tools and jack are securely in place in their storage location to reduce the possibility of personal injury during a collision or sudden braking.

 NOTICE**■ Be careful when driving over bumps with the compact spare tire installed on the vehicle.**

The vehicle becomes lower when driving with the compact spare tire compared to when driving with standard tires. Be careful when driving over uneven road surfaces.

■ Driving with tire chains and the compact spare tire

Do not fit tire chains to the compact spare tire.

Tire chains may damage the vehicle body and adversely affect driving performance.

■ When replacing the tires

When removing or fitting the wheels, tires or the tire pressure warning valve and transmitter, contact your Toyota dealer as the tire pressure warning valve and transmitter may be damaged if not handled correctly.

■ To avoid damage to the tire pressure warning valve and transmitters

When a tire is repaired with liquid sealants, the tire pressure warning valve and transmitter may not operate properly. If a liquid sealant is used, contact your Toyota dealer or other qualified service shop as soon as possible. Make sure to replace the tire pressure warning valve and transmitter when replacing the tire. (→P. 417)

If the hybrid system will not start

Reasons for the hybrid system not starting vary depending on the situation. Check the following and perform the appropriate procedure:

The hybrid system will not start even though the correct starting procedure is being followed. (→P. 196)

One of the following may be the cause of the problem:

- The electronic key may not be functioning properly. (→P. 485)
- There may not be sufficient fuel in the vehicle's tank.
Refuel the vehicle.
- There may be a malfunction in the immobilizer system.
(→P. 86)
- There may be a malfunction in the steering lock system.
- The hybrid system may be malfunctioning due to an electrical problem such as electronic key battery depletion or a blown fuse. However, depending on the type of malfunction, an interim measure is available to start the hybrid system. (→P. 483)
- The temperature of the hybrid battery (traction battery) may be extremely low (below approximately -22°F [-30°C]). (→P. 81, 198)

The interior lights and headlights are dim, or the horn does not sound or sounds at a low volume.

One of the following may be the cause of the problem:

- The 12-volt battery may be discharged. (→P. 487)
- The 12-volt battery terminal connections may be loose or corroded.
(→P. 411)

The interior lights and headlights do not turn on, or the horn does not sound.

One of the following may be the cause of the problem:

- The 12-volt battery may be discharged. (→P. 487)
- One or both of the 12-volt battery terminals may be disconnected. (→P. 411)

Contact your Toyota dealer if the problem cannot be repaired, or if repair procedures are unknown.

Emergency start function

When the hybrid system does not start, the following steps can be used as an interim measure to start the hybrid system if the power switch is functioning normally.

Do not use this starting procedure except in case of emergency.

- 1 Set the parking brake.
- 2 Shift the shift lever to P.
- 3 Turn the power switch to ACCESSORY mode.
- 4 Press and hold the power switch for about 15 seconds while depressing the brake pedal firmly.

Even if the hybrid system can be started using the above steps, the system may be malfunctioning. Have the vehicle inspected by your Toyota dealer.

If the electronic key does not operate properly

If communication between the electronic key and vehicle is interrupted (→P. 151) or the electronic key cannot be used because the battery is depleted, the smart key system and wireless remote control cannot be used. In such cases, the doors and trunk can be opened and the hybrid system can be started by following the procedure below.

Locking and unlocking the doors, unlocking the trunk and key linked functions

■ Doors

Using the mechanical key (→P. 135) in order to perform the following operations (driver's door only):

- ① Locks all doors
- ② Closes the windows and the moon roof*¹ (turn and hold)*²
- ③ Unlocks the door

Turning the key rearward unlocks the driver's door. Turning the key once again unlocks the other doors.

- ④ Opens the windows and the moon roof*¹ (turn and hold)*²

*1: If equipped

*2: This setting must be customized at your Toyota dealer.

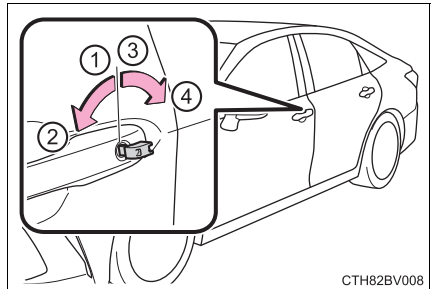

■ Trunk

Turn the mechanical key clockwise to open.

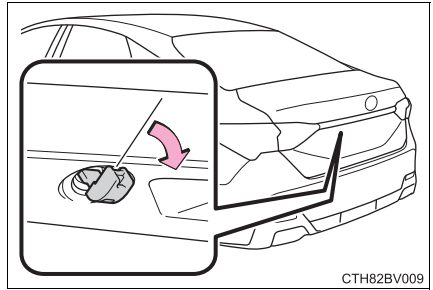

Starting the hybrid system

1 Ensure that the shift lever is in P and firmly depress the brake pedal.

2 Touch the Toyota emblem side of the electronic key to the power switch.

When the electronic key is detected, a buzzer sounds and the power switch will turn to ON mode.

When the smart key system is deactivated in customization setting, the power switch will turn to ACCESSORY mode.

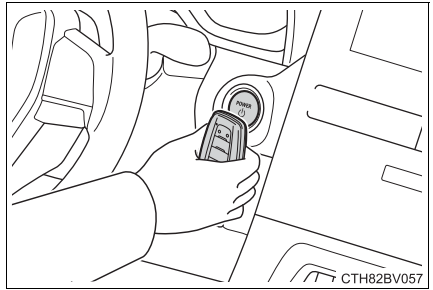

3 Firmly depress the brake pedal and check that  is displayed on the multi-information display.

4 Press the power switch shortly and firmly.

In the event that the power switch still cannot be started, contact your Toyota dealer.

■ Stopping the hybrid system

Shift the shift lever to P and press the power switch as you normally do when stopping the hybrid system.

■ Replacing the key battery

As the above procedure is a temporary measure, it is recommended that the electronic key battery be replaced immediately when the battery is depleted. (→P. 439)

■ Changing power switch modes

Release the brake pedal and press the power switch in step **3** above.

The hybrid system does not start and modes will be changed each time the switch is pressed. (→P. 197)

■ When the electronic key does not work properly

- Make sure that the smart key system has not been deactivated in the customization setting. If it is off, turn the function on. (Customizable features: →P. 526)
- Check if battery-saving mode is set. If it is set, cancel the function. (→P. 150)

**WARNING****■ When using the mechanical key and operating the power windows or moon roof**

Operate the power window or moon roof after checking to make sure that there is no possibility of any passenger having any of their body parts caught in the window or moon roof. Also, do not allow children to operate the mechanical key. It is possible for children and other passengers to get caught in the power window or moon roof.

If the 12-volt battery is discharged

The following procedures may be used to start the hybrid system if the vehicle's 12-volt battery is discharged.

You can also call your Toyota dealer or a qualified repair shop.

If you have a set of jumper (or booster) cables and a second vehicle with a 12-volt battery, you can jump start your vehicle by following the steps below.

- 1 Confirm that the electronic key is being carried.

When connecting the jumper (or booster) cables, depending on the situation, the alarm may activate and doors locked. (→P. 90)

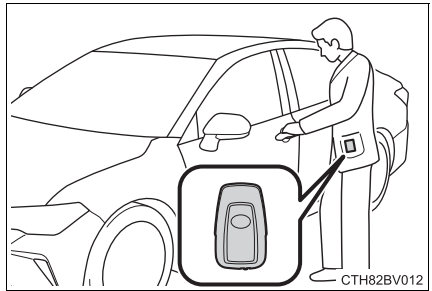

- 2 Open the hood and remove the fuse box cover.

Push the tabs in and lift the lid off.

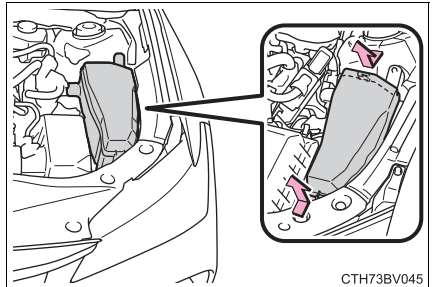

- 3 Open the exclusive jump starting terminal cover.

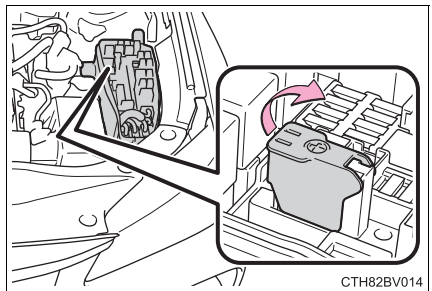

- 4 Connect the jumper cables according to the following procedure:

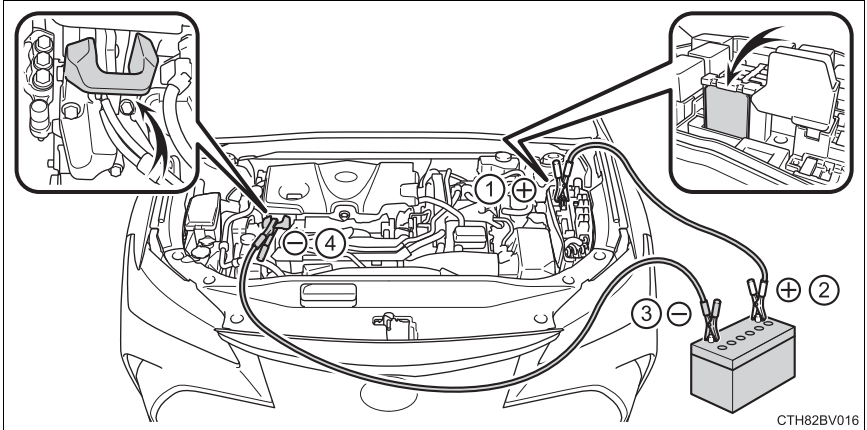

CTH82BV016

- ① Connect a positive jumper cable clamp to the exclusive jump starting terminal on your vehicle.
- ② Connect the clamp on the other end of the positive cable to the positive (+) battery terminal on the second vehicle.
- ③ Connect a negative cable clamp to the negative (-) battery terminal on the second vehicle.
- ④ Connect the clamp at the other end of the negative cable to a solid, stationary, unpainted metallic point away from the exclusive jump starting terminal and any moving parts, as shown in the illustration.

- 5 Start the engine of the second vehicle. Increase the engine speed slightly and maintain at that level for approximately 5 minutes to recharge the 12-volt battery of your vehicle.
- 6 Open and close any of the doors of your vehicle with the power switch off.
- 7 Maintain the engine speed of the second vehicle and turn the power switch to ON mode, then start the vehicle's engine.
- 8 Make sure the "READY" indicator comes on. If the indicator does not come on, contact your Toyota dealer.
- 9 Once the hybrid system has started, remove the jumper cables in the exact reverse order from which they were connected.
- 10 Close the exclusive jump starting terminal cover, and reinstall the fuse box cover to its original position.

Once the hybrid system starts, have the vehicle inspected at your Toyota dealer as soon as possible.

■ Starting the hybrid system when the 12-volt battery is discharged

The hybrid system cannot be started by push-starting.

■ To prevent 12-volt battery discharge

- Turn off the headlights and the audio system while the hybrid system is off.
- Turn off any unnecessary electrical components when the vehicle is running at a low speed for an extended period, such as in heavy traffic.

■ When the 12-volt battery is removed or discharged

- Information stored in the ECU is cleared. When the 12-volt battery is depleted, have the vehicle inspected at your Toyota dealer.
- Some systems may require initialization. (→P. 535)

■ When removing the 12-volt battery terminals

When the 12-volt battery terminals are removed, the information stored in the ECU is cleared. Before removing the 12-volt battery terminals, contact your Toyota dealer.

■ Charging the 12-volt battery

The electricity stored in the 12-volt battery will discharge gradually even when the vehicle is not in use, due to natural discharge and the draining effects of certain electrical appliances. If the vehicle is left for a long time, the 12-volt battery may discharge, and the hybrid system may be unable to start. (The 12-volt battery recharges automatically while the hybrid system is operating.)

■ When recharging or replacing the 12-volt battery

- In some cases, it may not be possible to unlock the doors using the smart key system when the 12-volt battery is discharged. Use the wireless remote control or the mechanical key to lock or unlock the doors.
- The hybrid system may not start on the first attempt after the 12-volt battery has recharged but will start normally after the second attempt. This is not a malfunction.
- The power switch mode is memorized by the vehicle. When the 12-volt battery is reconnected, the system will return to the mode it was in before the 12-volt battery was discharged. Before disconnecting the 12-volt battery, turn the power switch off.

If you are unsure what mode the power switch was in before the 12-volt battery discharged, be especially careful when reconnecting the 12-volt battery.

■ When replacing the 12-volt battery

- Use a Central Degassing type 12-volt battery (European Regulations).
- Use a 12-volt battery that the case size is same as the previous one (LN2), 20 hour rate capacity (20HR) is equivalent (64Ah) or greater, and performance rating (CCA) is equivalent (356A) or greater.
 - If the sizes differ, the 12-volt battery cannot be properly secured.
 - If the 20 hour rate capacity is low, even if the time period where the vehicle is not used is a short time, the 12-volt battery may discharge and the hybrid system may not be able to start.
- Use a 12-volt battery with a handle. If a 12-volt battery without a handle is used, removal is more difficult.
- After replacing, firmly attach the following items to the exhaust hole of the 12-volt battery.
 - Use the exhaust hose that was attached to the 12-volt battery before replacing and confirm that it is firmly connected to the hole section of the vehicle.
 - Use the exhaust hole plug included with the 12-volt battery replaced or the one installed on the battery prior to the replacement. (Depending on the 12-volt battery to be replaced, the exhaust hole may be plugged.)

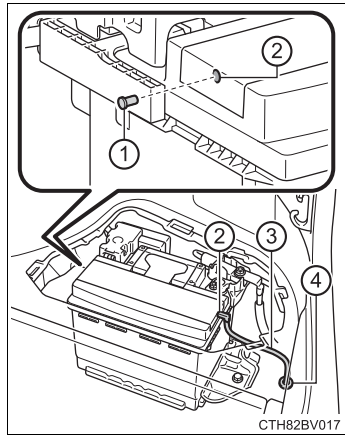

- ① Exhaust hole plug
- ② Exhaust hole
- ③ Exhaust hose
- ④ Hole section of the vehicle

For details, consult your Toyota dealer.

**WARNING****■ When removing the 12-volt battery terminals**

Always remove the negative (-) terminal first. If the positive (+) terminal contacts any metal in the surrounding area when the positive (+) terminal is removed, a spark may occur, leading to a fire in addition to electrical shocks and death or serious injury.

■ Avoiding 12-volt battery fires or explosions

Observe the following precautions to prevent accidentally igniting the flammable gas that may be emitted from the 12-volt battery:

- Make sure each jumper cable is connected to the correct terminal and that it is not unintentionally in contact with any other than the intended terminal.
- Do not allow the other end of the jumper cable connected to the “+” terminal to come into contact with any other parts or metal surfaces in the area, such as brackets or unpainted metal.
- Do not allow the + and - clamps of the jumper cables to come into contact with each other.
- Do not smoke, use matches, cigarette lighters or allow open flame near the 12-volt battery.

■ 12-volt battery precautions

The 12-volt battery contains poisonous and corrosive acidic electrolyte, while related parts contain lead and lead compounds. Observe the following precautions when handling the 12-volt battery:

- When working with the 12-volt battery, always wear safety glasses and take care not to allow any battery fluids (acid) to come into contact with skin, clothing or the vehicle body.
- Do not lean over the 12-volt battery.
- In the event that battery fluid comes into contact with the skin or eyes, immediately wash the affected area with water and seek medical attention. Place a wet sponge or cloth over the affected area until medical attention can be received.
- Always wash your hands after handling the 12-volt battery support, terminals, and other 12-volt battery-related parts.
- Do not allow children near the 12-volt battery.

■ After recharging the 12-volt battery

Have the 12-volt battery inspected at your Toyota dealer as soon as possible.

If the 12-volt battery is deteriorating, continued use may cause the 12-volt battery to emit a malodorous gas, which may be detrimental to the health of passengers.

**WARNING****■ When replacing the 12-volt battery**

After replacing, securely attach the exhaust hose and exhaust hole plug to the exhaust hole of the replaced 12-volt battery. If not properly installed, gases (hydrogen) may leak into the vehicle interior, and there is the possible danger of the gas igniting and exploding.

**NOTICE****■ When handling jumper cables**

When connecting the jumper cables, ensure that they do not become entangled in the cooling fan or engine drive belt.

■ To prevent damaging the vehicle

The exclusive jump starting terminal is to be used when charging the 12-volt battery from another vehicle in an emergency. It cannot be used to jump start another vehicle.

If your vehicle overheats

The following may indicate that your vehicle is overheating.

- The needle of the engine coolant temperature gauge (→P. 98) enters the red zone or a loss of hybrid system power is experienced. (For example, the vehicle speed does not increase.)
- “Engine Coolant Temp High Stop in a Safe Place See Owner’s Manual” or “Hybrid System Overheated Output Power Reduced” is shown on the multi-information display
- Steam comes out from under the hood.

Correction procedures

- **If the needle of the engine coolant temperature gauge enters the red zone or “Engine Coolant Temp High Stop in a Safe Place See Owner’s Manual” is shown on the multi-information display**

- 1 Stop the vehicle in a safe place and turn off the air conditioning system, and then stop the hybrid system.
- 2 If you see steam:
Carefully lift the hood after the steam subsides.

If you do not see steam:
Carefully lift the hood.
- 3 After the hybrid system has cooled down sufficiently, inspect the hoses and radiator core (radiator) for any leaks.

- ① Radiator
- ② Cooling fan

If a large amount of coolant leaks, immediately contact your Toyota dealer.

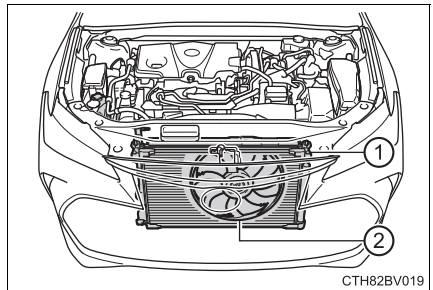

CTH82BV019

- 4 The coolant level is satisfactory if it is between the “F” and “L” lines on the reservoir.

- ① Reservoir
- ② “F” line
- ③ “L” line
- ④ Radiator cap

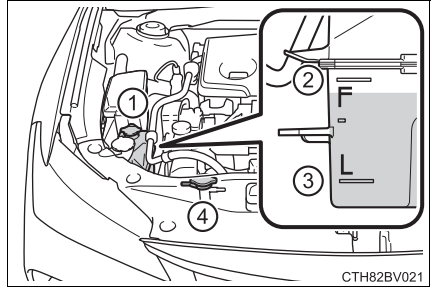

- 5 Add coolant if necessary.

Water can be used in an emergency if coolant is unavailable.

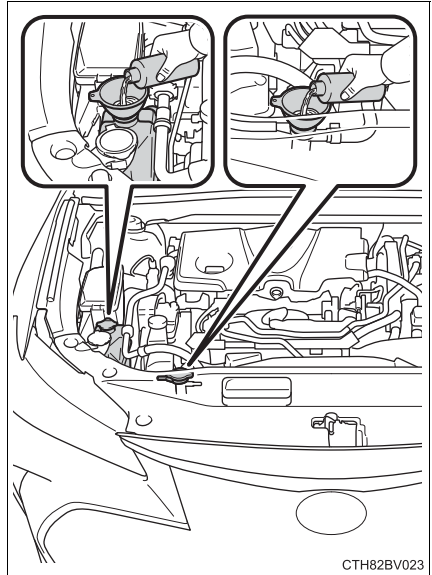

- 6 Start the hybrid system and turn the air conditioning system on to check that the radiator cooling fan operates and to check for coolant leaks from the radiator or hoses.

The fan operates when the air conditioning system is turned on immediately after a cold start. Confirm that the fan is operating by checking the fan sound and air flow. If it is difficult to check these, turn the air conditioning system on and off repeatedly. (The fan may not operate in freezing temperatures.)

- 7 If the fan is not operating:

Stop the hybrid system immediately and contact your Toyota dealer.

If the fan is operating:

Have the vehicle inspected at the nearest Toyota dealer.

■ If “Hybrid System Overheated Output Power Reduced” is shown on the multi-information display

- 1 Stop the vehicle in a safe place.
- 2 Stop the hybrid system and carefully lift the hood.
- 3 After the hybrid system has cooled down, inspect the hoses and radiator core (radiator) for any leaks.

- ① Radiator
- ② Cooling fan

If a large amount of coolant leaks, immediately contact your Toyota dealer.

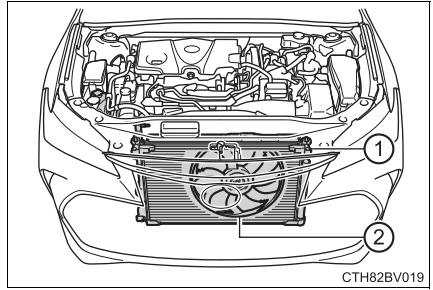

- 4 The coolant level is satisfactory if it is between the “FULL” and “LOW” lines on the reservoir.

- ① Reservoir
- ② “FULL”
- ③ “LOW”

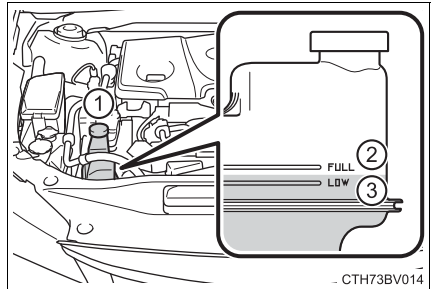

- 5 Add coolant if necessary.

Water can be used in an emergency if coolant is unavailable.

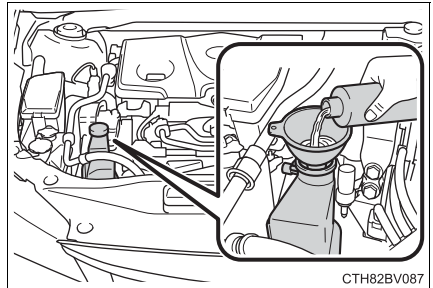

- 6 After stopping the hybrid system and waiting for 5 minutes or more, start the hybrid system again and check for the multi-information display.

If the message does not disappear:

Stop the hybrid system and contact your Toyota dealer.

If the message is not displayed:

The hybrid system temperature has dropped and the vehicle may be driven normally.

However, if the message appears again frequently, contact your Toyota dealer.



WARNING

■ To prevent an accident or injury when inspecting under the hood of your vehicle

Observe the following precautions.

Failure to do so may result in serious injury such as burns.

- If steam is seen coming from under the hood, do not open the hood until the steam has subsided. The engine compartment may be very hot.
- After the hybrid system has been turned off, check that the “READY” indicator is off. When the hybrid system is operating, the gasoline engine may automatically start, or the cooling fan may suddenly operate even if the gasoline engine stops. Do not touch or approach rotating parts such as the fan, which may lead to fingers or clothing (especially a tie, a scarf or a muffler) getting caught, resulting in serious injury.
- Do not loosen the radiator cap and the coolant reservoir cap while the hybrid system and radiator are hot.
High temperature steam or coolant could spray out.



NOTICE

■ When adding engine/power control unit coolant

Wait until the hybrid system has cooled down before adding engine/power control unit coolant.

When adding coolant, do so slowly. Adding cool coolant to a hot hybrid system too quickly can cause damage to the hybrid system.

■ To prevent damage to the cooling system

Observe the following precautions:

- Avoid contaminating the coolant with foreign matter (such as sand or dust etc.).
- Do not use any coolant additives.

If the vehicle becomes stuck

Carry out the following procedures if the tires spin or the vehicle becomes stuck in mud, dirt or snow:

- 1 Stop the hybrid system. Set the parking brake and shift the shift lever to P.
- 2 Remove the mud, snow or sand from around the front wheels.
- 3 Place wood, stones or some other material under the front wheels to help provide traction.
- 4 Restart the hybrid system.
- 5 Shift the shift lever to D or R and release the parking brake. Then, while exercising caution, depress the accelerator pedal.

■ When it is difficult to free the vehicle

Press  to turn off TRAC.

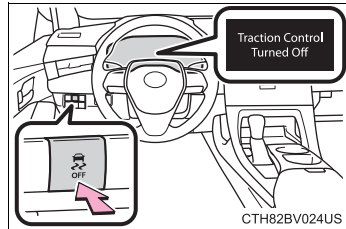

WARNING

■ When attempting to free a stuck vehicle

If you choose to push the vehicle back and forth to free it, make sure the surrounding area is clear to avoid striking other vehicles, objects or people. The vehicle may also lunge forward or lunge back suddenly as it becomes free. Use extreme caution.

■ When shifting the shift lever

Be careful not to shift the shift lever with the accelerator pedal depressed. This may lead to unexpected rapid acceleration of the vehicle that may cause an accident resulting in death or serious injury.

**NOTICE****■ To avoid damaging the transmission and other components**

- Avoid spinning the front wheels and depressing the accelerator pedal more than necessary.
- If the vehicle remains stuck even after these procedures are performed, the vehicle may require towing to be freed.

Vehicle specifications

8

8-1. Specifications

Maintenance data (fuel, oil level, etc.).....	502
Fuel information	510
Tire information	513

8-2. Customization

Customizable features	526
-----------------------------	-----

8-3. Items to initialize

Items to initialize	535
---------------------------	-----

Maintenance data (fuel, oil level, etc.)

Dimensions and weights

Overall length		195.9 in. (4975 mm)
Overall width		72.8 in. (1850 mm)
Overall height ^{*1}		56.5 in. (1435 mm)
Wheelbase		113.0 in. (2870 mm)
Tread	Front	62.6 in. (1590 mm) ^{*2} 63.0 in. (1600 mm) ^{*3}
	Rear	63.2 in. (1605 mm) ^{*2} 63.6 in. (1615 mm) ^{*3}
Vehicle capacity weight (occupants + luggage)		940 lb. (425 kg)

*1: Unladen vehicles

*2: Vehicles with 235/45R18 tires and 235/40R19 tires

*3: Vehicles with 215/55R17 tires

Seating capacity

Seating capacity	5 occupants (Front 2, Rear 3)
------------------	-------------------------------

Vehicle identification

■ Vehicle identification number

The vehicle identification number (VIN) is the legal identifier for your vehicle. This is the primary identification number for your Toyota. It is used in registering the ownership of your vehicle.

This number is stamped on the top left of the instrument panel.

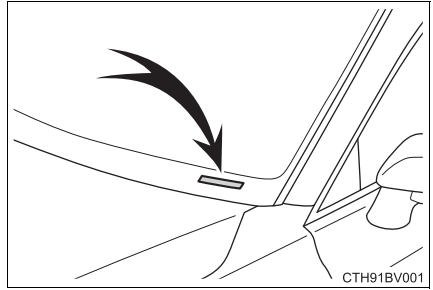

This number is also on the Certification Label.

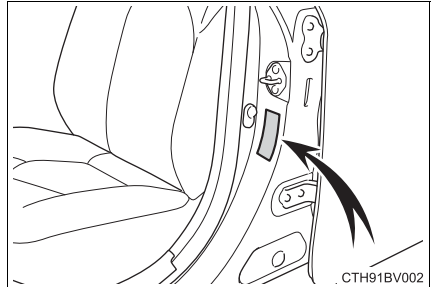

■ Engine number

The engine number is stamped on the engine block as shown.

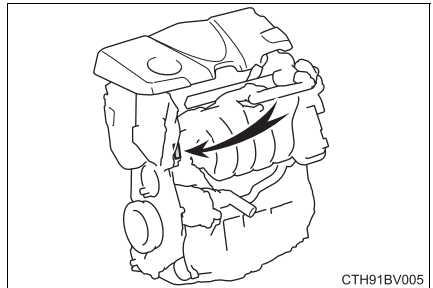

Engine

Model	A25A-FXS
Type	4-cylinder in line, 4-cycle, gasoline
Bore and stroke	3.44 × 4.07 in. (87.5 × 103.4 mm)
Displacement	151.8 cu. in. (2487 cm ³)
Valve clearance	Automatic adjustment

Fuel

Fuel type	Unleaded gasoline only
Octane rating	87 (Research Octane Number 91) or higher
Fuel tank capacity (Reference)	13 gal. (49.3 L, 10.8 Imp. gal.)

Electric motor (Traction motor)

Type	Permanent magnet synchronous motor
Maximum output	88 kW
Maximum torque	149 ft•lbf (202 N•m, 20.6 kgf•m)

Hybrid battery (Traction battery)

Type	Lithium-ion battery
Voltage	3.7 V/cell
Capacity	4.0 Ah
Quantity	70 cells
Nominal voltage	259 V

Lubrication system

Oil capacity (Drain and refill — reference*)	
With filter	4.8 qt. (4.5 L, 4.0 Imp. qt.)
Without filter	4.4 qt. (4.2 L, 3.7 Imp. qt.)

*: The engine oil capacity is a reference quantity to be used when changing the engine oil. Warm up the engine and turn off the hybrid system, wait more than 5 minutes, and check the oil level on the dipstick.

■ Engine oil selection

“Toyota Genuine Motor Oil” is used in your Toyota vehicle. Use Toyota approved “Toyota Genuine Motor Oil” or equivalent to satisfy the following grade and viscosity.

Oil grade: API SN/RC multigrade engine oil

Recommended viscosity: SAE 0W-16

SAE 0W-16 is the best choice for good fuel economy and good starting in cold weather.

If SAE 0W-16 is not available, SAE 0W-20 oil may be used. However, it must be replaced with SAE 0W-16 at the next oil change.

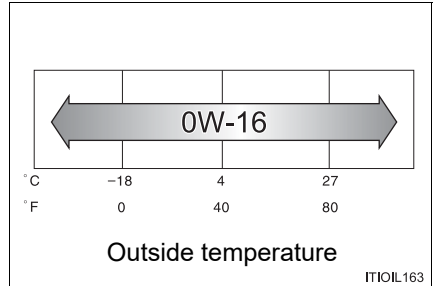

Oil viscosity (0W-16 is explained here as an example):

- The 0W in 0W-16 indicates the characteristic of the oil which allows cold startability. Oils with a lower value before the W allow for easier starting of the engine in cold weather.
- The 16 in 0W-16 indicates the viscosity characteristic of the oil when the oil is at high temperature. An oil with a higher viscosity (one with a higher value) may be better suited if the vehicle is operated at high speeds, or under extreme load conditions.

How to read oil container label:

API registered mark is added to some oil containers to help you select the oil you should use.



CTH81BV005

Cooling system

Capacity (Reference)	<ul style="list-style-type: none"> ▶ Gasoline engine 6.4 qt. (6.1 L, 5.4 Imp. qt.) ▶ Power control unit 1.9 qt. (1.8 L, 1.6 Imp. qt.)
Coolant type	<p>Use either of the following:</p> <ul style="list-style-type: none"> • “Toyota Super Long Life Coolant” • Similar high-quality ethylene glycol-based non-silicate, non-amine, non-nitrite, and non-borate coolant with long-life hybrid organic acid technology <p>Do not use plain water alone.</p>

Ignition system

Spark plug	
Make	DENSO FC16HR-Q8
Gap	0.031 in. (0.8 mm)



NOTICE

■ Iridium-tipped spark plugs

Use only iridium-tipped spark plugs. Do not adjust spark plug gap.

Electrical system

12-volt battery Open voltage at 68°F (20°C):	12.0 V or higher If the voltage is lower than the standard value, charge the battery. (When checking the voltage, after turning the power switch off, wait for 30 seconds with the high beam headlights illuminated, then turn the high beam headlights off and check the voltage.)
Charging rates	5 A max.

Hybrid transmission

Fluid capacity*	4.1 qt. (3.9 L, 3.4 Imp. qt.)
Fluid type	Toyota Genuine ATF WS

*: The fluid capacity is a reference quantity.
If replacement is necessary, contact your Toyota dealer.

NOTICE

■ Hybrid transmission fluid type

Using transmission fluid other than the above type may cause abnormal noise or vibration, or ultimately damage the transmission of your vehicle.

Brakes

Pedal clearance*	3.3 in. (85 mm)
Pedal free play	0.04 — 0.24 in. (1 — 6 mm)
Brake pad wear limit	0.04 in. (1.0 mm)
Fluid type	SAE J1703 or FMVSS No.116 DOT 3 SAE J1704 or FMVSS No.116 DOT 4

*: Minimum pedal clearance when depressed with a force of 67 lbf (300 N, 31 kgf) while the hybrid system is operating.

Steering

Free play	Less than 1.2 in. (30 mm)
-----------	---------------------------

Tires and wheels

► 17-inch tires

Tire size	215/55R17 94V, T155/70D17 110M
Tire inflation pressure (Recommended cold tire inflation pressure)	<p>Driving under normal conditions</p> <p>Front: 35 psi (240 kPa, 2.4 kgf/cm² or bar)</p> <p>Rear: 35 psi (240 kPa, 2.4 kgf/cm² or bar)</p> <p>Spare: 60 psi (420 kPa, 4.2 kgf/cm² or bar)</p> <p>Driving at high speeds (above 100 mph [160 km/h]) (in countries where such speeds are permitted by law)</p> <p>Add 5 psi (30 kPa, 0.3 kgf/cm² or bar) to the front tires and rear tires. Never exceed the maximum cold tire inflation pressure indicated on the tire sidewall.</p>
Wheel size	17 × 7 1/2 J, 17 × 4 T (compact spare)
Wheel nut torque	76 ft•lbf (103 N•m, 10.5 kgf•m)

► 18-inch tires

Tire size	235/45R18 94V, T155/70D17 110M
Tire inflation pressure (Recommended cold tire inflation pressure)	<p>Driving under normal conditions</p> <p>Front: 35 psi (240 kPa, 2.4 kgf/cm² or bar)</p> <p>Rear: 35 psi (240 kPa, 2.4 kgf/cm² or bar)</p> <p>Spare: 60 psi (420 kPa, 4.2 kgf/cm² or bar)</p> <p>Driving at high speeds (above 100 mph [160 km/h]) (in countries where such speeds are permitted by law)</p> <p>Add 5 psi (30 kPa, 0.3 kgf/cm² or bar) to the front tires and rear tires. Never exceed the maximum cold tire inflation pressure indicated on the tire sidewall.</p>
Wheel size	18 × 8 J, 17 × 4 T (compact spare)
Wheel nut torque	76 ft•lbf (103 N•m, 10.5 kgf•m)

► 19-inch tires

Tire size	235/40R19 92V, T155/70D17 110M
Tire inflation pressure (Recommended cold tire inflation pressure)	<p>Driving under normal conditions</p> <p>Front: 35 psi (240 kPa, 2.4 kgf/cm² or bar)</p> <p>Rear: 35 psi (240 kPa, 2.4 kgf/cm² or bar)</p> <p>Spare: 60 psi (420 kPa, 4.2 kgf/cm² or bar)</p> <p>Driving at high speeds (above 100 mph [160 km/h]) (in countries where such speeds are permitted by law)</p> <p>Add 5 psi (30 kPa, 0.3 kgf/cm² or bar) to the front tires and rear tires. Never exceed the maximum cold tire inflation pressure indicated on the tire sidewall.</p>
Wheel size	19 × 8 J, 17 × 4 T (compact spare)
Wheel nut torque	76 ft•lbf (103 N•m, 10.5 kgf•m)

Light bulbs*

	Light bulbs	Bulb No.	W	Type
Interior	Door courtesy lights	168	5	A
	Vanity lights	7065	1.4	B
	Trunk light	—	5	A

A: Wedge base bulbs

B: Double end bulbs

*: Light bulbs not listed in this table are LED bulbs.

Fuel information

You must only use unleaded gasoline.

Select octane rating 87 (Research Octane Number 91) or higher. Use of unleaded gasoline with an octane rating lower than 87 may result in engine knocking. Persistent knocking can lead to engine damage.

At minimum, the gasoline you use should meet the specifications of ASTM D4814 in the U.S.A..

■ Gasoline quality

In very few cases, driveability problems may be caused by the brand of gasoline you are using. If driveability problems persist, try changing the brand of gasoline. If this does not correct the problem, consult your Toyota dealer.

■ Recommendation of the use of gasoline containing detergent additives

- Toyota recommends the use of gasoline that contains detergent additives to avoid the build-up of engine deposits.
- All gasoline sold in the U.S.A. contains minimum detergent additives to clean and/or keep clean intake systems, per EPA's lowest additives concentration program.
- Toyota strongly recommends the use of Top Tier Detergent Gasoline. For more information on Top Tier Detergent Gasoline and a list of marketers, please go to the official website www.toptiergas.com.

■ Recommendation of the use of low emissions gasoline

Gasolines containing oxygenates such as ethers and ethanol, as well as reformulated gasolines, are available in some cities. These fuels are typically acceptable for use, providing they meet other fuel requirements.

Toyota recommends these fuels, since the formulations allow for reduced vehicle emissions.

■ Non-recommendation of the use of blended gasoline

- Use only gasoline containing up to 15% ethanol.

DO NOT use any flex-fuel or gasoline that could contain more than 15% ethanol, including from any pump labeled E30, E50, E85 (which are only some examples of fuel containing more than 15% ethanol).

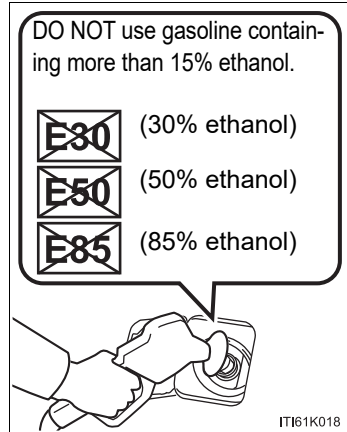

- If you use gasohol in your vehicle, be sure that it has an octane rating no lower than 87.
- Toyota does not recommend the use of gasoline containing methanol.

■ Non-recommendation of the use of gasoline containing MMT

Some gasoline contains an octane enhancing additive called MMT (Methylcyclopentadienyl Manganese Tricarbonyl).

Toyota does not recommend the use of gasoline that contains MMT. If fuel containing MMT is used, your emission control system may be adversely affected.

The malfunction indicator lamp on the instrument cluster may come on. If this happens, contact your Toyota dealer for service.

■ If your engine knocks

- Consult your Toyota dealer.
- You may occasionally notice light knocking for a short time while accelerating or driving uphill. This is normal and there is no need for concern.

**NOTICE****■ Notice on fuel quality**

- Do not use improper fuels. If improper fuels are used, the engine will be damaged.
- Do not use leaded gasoline.
Leaded gasoline can cause damage to your vehicle's three-way catalytic converters causing the emission control system to malfunction.
- Do not use gasohol other than the type previously stated.
Other gasohol may cause fuel system damage or vehicle performance problems.
- Using unleaded gasoline with an octane number or rating lower than the level previously stated will cause persistent heavy knocking.
At worst, this will lead to engine damage.

■ Fuel-related poor driveability

If poor driveability (poor hot starting, vaporization, engine knocking, etc.) is encountered after using a different type of fuel, discontinue the use of that type of fuel.

■ When refueling with gasohol

Take care not to spill gasohol. It can damage your vehicle's paint.

Tire information

Typical tire symbols

► Full-size tire

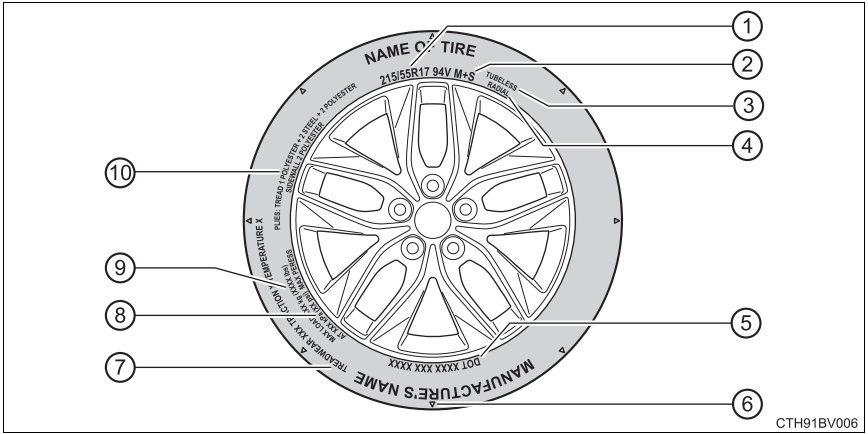

► Compact spare tire

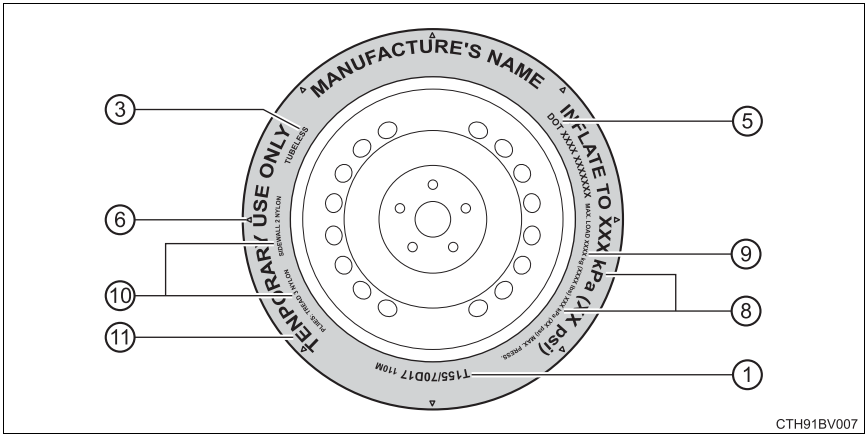

- ① Tire size (→P. 516)
- ② Summer tires or all season tires (→P. 421)

An all season tire has “M+S” on the sidewall. A tire not marked “M+S” is a summer tire.
- ③ TUBELESS or TUBE TYPE

A tubeless tire does not have a tube and air is directly put into the tire. A tube type tire has a tube inside the tire and the tube maintains the air pressure.
- ④ Radial tires or bias-ply tires

A radial tire has “RADIAL” on the sidewall. A tire not marked “RADIAL” is a bias-ply tire.
- ⑤ DOT and Tire Identification Number (TIN) (→P. 515)
- ⑥ Location of treadwear indicators (→P. 415)
- ⑦ Uniform tire quality grading

For details, see “Uniform Tire Quality Grading” that follows.
- ⑧ Maximum cold tire inflation pressure (→P. 508)

This means the pressure to which a tire may be inflated.
- ⑨ Load limit at maximum cold tire inflation pressure (→P. 420)
- ⑩ Tire ply composition and materials

Plies are layers of rubber-coated parallel cords. Cords are the strands which form the plies in a tire.
- ⑪ “TEMPORARY USE ONLY”

A compact spare tire is identified by the phrase “TEMPORARY USE ONLY” molded on its sidewall. This tire is designed for temporary emergency use only.

Typical DOT and Tire Identification Number (TIN)

► Type A

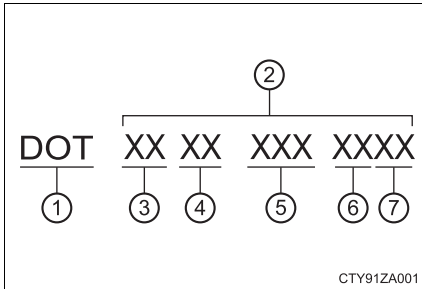

► Type B

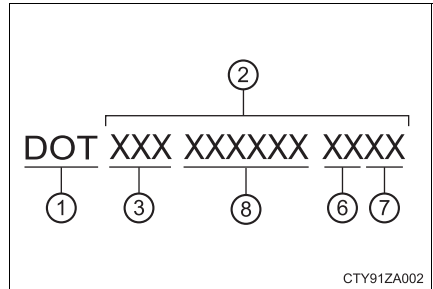

- ① DOT symbol*
- ② Tire Identification Number (TIN)
- ③ Tire manufacturer's identification mark
- ④ Tire size code
- ⑤ Manufacturer's optional tire type code (3 or 4 letters)
- ⑥ Manufacturing week
- ⑦ Manufacturing year
- ⑧ Manufacturer's code

*: The DOT symbol certifies that the tire conforms to applicable Federal Motor Vehicle Safety Standards.

Tire size

■ Typical tire size information

The illustration indicates typical tire size.

- ① Tire use
(P = Passenger car [sometimes omitted],
T = Temporary use)
- ② Section width (millimeters)
- ③ Aspect ratio
(tire height to section width)
- ④ Tire construction code (R = Radial, D = Diagonal)
- ⑤ Wheel diameter (inches)
- ⑥ Load index (2 digits or 3 digits)
- ⑦ Speed symbol (alphabet with one letter)

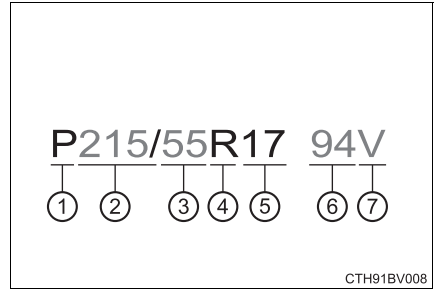

■ Tire dimensions

- ① Section width
- ② Tire height
- ③ Wheel diameter

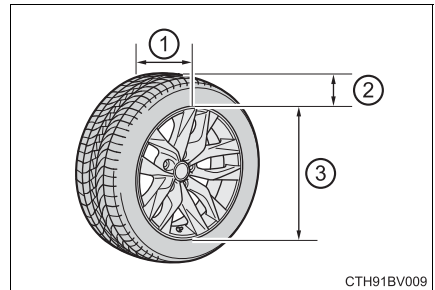

Tire section names

- ① Bead
- ② Sidewall
- ③ Shoulder
- ④ Tread
- ⑤ Belt
- ⑥ Inner liner
- ⑦ Reinforcing rubber
- ⑧ Carcass
- ⑨ Rim lines
- ⑩ Bead wires
- ⑪ Chafer

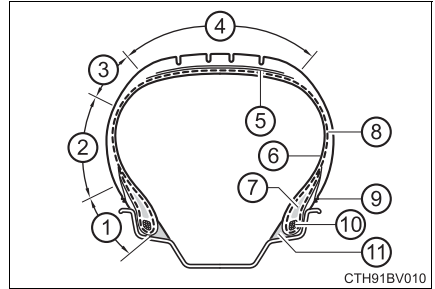

Uniform Tire Quality Grading

This information has been prepared in accordance with regulations issued by the National Highway Traffic Safety Administration of the U.S. Department of Transportation.

It provides the purchasers and/or prospective purchasers of Toyota vehicles with information on uniform tire quality grading.

Your Toyota dealer will help answer any questions you may have as you read this information.

■ DOT quality grades

All passenger vehicle tires must conform to Federal Safety Requirements in addition to these grades. Quality grades can be found where applicable on the tire sidewall between tread shoulder and maximum section width.

For example: Treadwear 200 Traction AA Temperature A

■ Treadwear

The treadwear grade is a comparative rating based on the wear rate of the tire when tested under controlled conditions on a specified government test course.

For example, a tire graded 150 would wear one and a half (1 - 1/2) times as well on the government course as a tire graded 100.

The relative performance of tires depends upon the actual conditions of their use. Performance may differ significantly from the norm due to variations in driving habits, service practices and differences in road characteristics and climate.

■ Traction AA, A, B, C

The traction grades, from highest to lowest, are AA, A, B and C, and they represent the tire's ability to stop on wet pavement as measured under controlled conditions on specified government test surfaces of asphalt and concrete.

A tire marked C may have poor traction performance.

Warning: The traction grade assigned to this tire is based on braking (straight ahead) traction tests and does not include cornering (turning) traction.

■ Temperature A, B, C

The temperature grades are A (the highest), B, and C, representing the tire's resistance to the generation of heat and its ability to dissipate heat when tested under controlled conditions on a specified indoor laboratory test wheel.

Sustained high temperature can cause the material of the tire to degenerate and reduce tire life, and excessive temperature can lead to sudden tire failure.

Grade C corresponds to a level of performance which all passenger car tires must meet under the Federal Motor Vehicle Safety Standard No. 109.

Grades B and A represent higher levels of performance on the laboratory test wheel than the minimum required by law.

Warning: The temperature grades of a tire assume that it is properly inflated and not overloaded.

Excessive speed, underinflation, or excessive loading, either separately or in combination, can cause heat buildup and possible tire failure.

Glossary of tire terminology

Tire related term	Meaning
Cold tire inflation pressure	Tire pressure when the vehicle has been parked for three hours or more, or has not been driven more than 1 mile or 1.5 km under that condition
Maximum inflation pressure	The maximum cold inflated pressure to which a tire may be inflated, shown on the sidewall of the tire
Recommended inflation pressure	Cold tire inflation pressure recommended by a manufacturer
Accessory weight	The combined weight (in excess of those standard items which may be replaced) of hybrid transmission, power steering, power brakes, power windows, power seats, radio and heater, to the extent that these items are available as factory-installed equipment (whether installed or not)
Curb weight	The weight of a motor vehicle with standard equipment, including the maximum capacity of fuel, oil and coolant, and if so equipped, air conditioning and additional weight optional engine
Maximum loaded vehicle weight	The sum of: (a) Curb weight (b) Accessory weight (c) Vehicle capacity weight (d) Production options weight
Normal occupant weight	150 lb. (68 kg) times the number of occupants specified in the second column of Table 1* that follows
Occupant distribution	Distribution of occupants in a vehicle as specified in the third column of Table 1* below

Tire related term	Meaning
Production weight options	The combined weight of installed regular production options weighing over 5 lb. (2.3 kg) in excess of the standard items which they replace, not previously considered in curb weight or accessory weight, including heavy duty brakes, ride levelers, roof rack, heavy duty 12-volt battery, and special trim
Rim	A metal support for a tire or a tire and tube assembly upon which the tire beads are seated
Rim diameter (Wheel diameter)	Nominal diameter of the bead seat
Rim size designation	Rim diameter and width
Rim type designation	The industry manufacturer's designation for a rim by style or code
Rim width	Nominal distance between rim flanges
Vehicle weight capacity (Total load capacity)	The rated cargo and luggage load plus 150 lb. (68 kg) times the vehicle's designated seating capacity
Vehicle maximum load on the tire	The load on an individual tire that is determined by distributing to each axle its share of the maximum loaded vehicle weight, and dividing by two
Vehicle normal load on the tire	The load on an individual tire that is determined by distributing to each axle its share of curb weight, accessory weight, and normal occupant weight (distributed in accordance with Table 1* below), and dividing by two
Weather side	The surface area of the rim not covered by the inflated tire
Bead	The part of the tire that is made of steel wires, wrapped or reinforced by ply cords and that is shaped to fit the rim
Bead separation	A breakdown of the bond between components in the bead

Tire related term	Meaning
Bias ply tire	A pneumatic tire in which the ply cords that extend to the beads are laid at alternate angles substantially less than 90 degrees to the centerline of the tread
Carcass	The tire structure, except tread and sidewall rubber which, when inflated, bears the load
Chunking	The breaking away of pieces of the tread or sidewall
Cord	The strands forming the plies in the tire
Cord separation	The parting of cords from adjacent rubber compounds
Cracking	Any parting within the tread, sidewall, or innerliner of the tire extending to cord material
CT	A pneumatic tire with an inverted flange tire and rim system in which the rim is designed with rim flanges pointed radially inward and the tire is designed to fit on the underside of the rim in a manner that encloses the rim flanges inside the air cavity of the tire
Extra load tire	A tire designed to operate at higher loads and at higher inflation pressures than the corresponding standard tire
Groove	The space between two adjacent tread ribs
Innerliner	The layer(s) forming the inside surface of a tubeless tire that contains the inflating medium within the tire
Innerliner separation	The parting of the innerliner from cord material in the carcass
Intended sidewall outboard	(a)The sidewall that contains a whitewall, bears white lettering, or bears manufacturer, brand, and/or model name molding that is higher or deeper than the same molding on the other sidewall of the tire, or (b)The outward facing sidewall of an asymmetrical tire that has a particular side that must always face outward when mounted on a vehicle

Tire related term	Meaning
Light truck (LT) tire	A tire designated by its manufacturer as primarily intended for use on lightweight trucks or multipurpose passenger vehicles
Load rating	The maximum load that a tire is rated to carry for a given inflation pressure
Maximum load rating	The load rating for a tire at the maximum permissible inflation pressure for that tire
Maximum permissible inflation pressure	The maximum cold inflation pressure to which a tire may be inflated
Measuring rim	The rim on which a tire is fitted for physical dimension requirements
Open splice	Any parting at any junction of tread, sidewall, or innerliner that extends to cord material
Outer diameter	The overall diameter of an inflated new tire
Overall width	The linear distance between the exteriors of the sidewalls of an inflated tire, including elevations due to labeling, decorations, or protective bands or ribs
Passenger car tire	A tire intended for use on passenger cars, multipurpose passenger vehicles, and trucks, that have a gross vehicle weight rating (GVWR) of 10,000 lb. or less.
Ply	A layer of rubber-coated parallel cords
Ply separation	A parting of rubber compound between adjacent plies
Pneumatic tire	A mechanical device made of rubber, chemicals, fabric and steel or other materials, that, when mounted on an automotive wheel, provides the traction and contains the gas or fluid that sustains the load
Radial ply tire	A pneumatic tire in which the ply cords that extend to the beads are laid at substantially 90 degrees to the centerline of the tread
Reinforced tire	A tire designed to operate at higher loads and at higher inflation pressures than the corresponding standard tire

Tire related term	Meaning
Section width	The linear distance between the exteriors of the sidewalls of an inflated tire, excluding elevations due to labeling, decoration, or protective bands
Sidewall	That portion of a tire between the tread and bead
Sidewall separation	The parting of the rubber compound from the cord material in the sidewall
Snow tire	A tire that attains a traction index equal to or greater than 110, compared to the ASTM E-1136 Standard Reference Test Tire, when using the snow traction test as described in ASTM F-1805-00, Standard Test Method for Single Wheel Driving Traction in a Straight Line on Snow-and Ice-Covered Surfaces, and which is marked with an Alpine Symbol () on at least one sidewall
Test rim	The rim on which a tire is fitted for testing, and may be any rim listed as appropriate for use with that tire
Tread	That portion of a tire that comes into contact with the road
Tread rib	A tread section running circumferentially around a tire
Tread separation	Pulling away of the tread from the tire carcass
Treadwear indicators (TWI)	The projections within the principal grooves designed to give a visual indication of the degrees of wear of the tread
Wheel-holding fixture	The fixture used to hold the wheel and tire assembly securely during testing

*: Table 1 — Occupant loading and distribution for vehicle normal load for various designated seating capacities

Designated seating capacity, Number of occupants	Vehicle normal load, Number of occupants	Occupant distribution in a normally loaded vehicle
2 through 4	2	2 in front
5 through 10	3	2 in front, 1 in second seat
11 through 15	5	2 in front, 1 in second seat, 1 in third seat, 1 in fourth seat
16 through 20	7	2 in front, 2 in second seat, 2 in third seat, 1 in fourth seat

Customizable features

Your vehicle includes a variety of electronic features that can be personalized to suit your preferences. The settings of these features can be changed using the multi-information display, on the audio system screen, or at your Toyota dealer.

Customizing vehicle features

When customizing vehicle features, ensure that the vehicle is parked in a safe place with the shift lever in P and the parking brake set.

■ Changing on the audio system screen

- 1 Press the “MENU” button.
- 2 Select “Setup” on the “Menu” screen.
- 3 Select “General” or “Vehicle” on the “Setup” screen.

Various setting can be changed. Refer to the list of settings that can be changed for details.

■ Changing using the multi-information display

→P. 111

Customizable features

Some function settings are changed simultaneously with other functions being customized. Contact your Toyota dealer for further details.

- ① Settings that can be changed on the audio system screen
- ② Settings that can be changed by your Toyota dealer

Definition of symbols: O = Available, — = Not available

■ Gauges, meters and multi-information display (→P. 98, 102)

Function	Default setting	Customized setting	①	②
Language	English	French	○	—
		Spanish		
Units*	miles (MPG US)	miles (MPG Imperial)	○	—
		km (L/100 km)		
		km (km/L)		
Convenience services (Suggestion function)	On	On (when the vehicle is stopped)	○	○
		Off		

*: The default setting varies according to country.

■ Door lock (→P. 138, 144, 484)

Function	Default setting	Customized setting	①	②
Unlocking using a mechanical key	Driver's door unlocked in one step, all doors unlocked in two steps	All doors unlocked in one step	—	○
Automatic door lock	Shift position linked door locking operation	Off	○	○
		Speed linked door locking operation		
Automatic door unlock	Shift position linked door unlocking operation	Off	○	○
		Driver's door linked door unlocking operation		
Locking/unlocking of the trunk when all doors are locked/unlocked	On	Off	—	○

■ **Smart key system and wireless remote control**
 (→P. 138, 144, 148)

Function	Default setting	Customized setting	①	②
Operating signal (Buzzers)	5	Off to 7	○	○
Operation signal (Emergency flashers)	On	Off	○	○
Time elapsed before automatic door lock function is activated if door is not opened after being unlocked	60 seconds	Off	○	○
		30 seconds		
		120 seconds		
Open door warning buzzer	On	Off	—	○

■ **Smart key system (→P. 138, 144, 148)**

Function	Default setting	Customized setting	①	②
Smart key system	On	Off	—	○
Time elapsed before unlocking all the door when gripping and holding the driver's door handle	2 seconds	Off	—	○
Number of consecutive door lock operations	2 times	As many as desired	—	○

■ Wireless remote control (→P. 134, 138, 144)

Function	Default setting	Customized setting	①	②
Wireless remote control	On	Off	—	○
Unlocking operation	Driver's door unlocked in one step, all doors unlocked in two steps	All doors unlocked in one step	○	○
Trunk unlocking operation	Press and hold (short)	One short press	—	○
		Push twice		
		Press and hold (long)		
		Off		
Panic function	On	Off	—	○
Reservation lock	On	Off	○	○

■ Power windows and moon roof* (→P. 173, 177)

Function	Default setting	Customized setting	①	②
Mechanical key linked operation	Off	On	—	○
Wireless remote control linked operation	Off	On (open only)	—	○
Wireless remote control linked operation signal (buzzer)	On	Off	—	○

*: If equipped

■ Moon roof* (→P. 177)

Function	Default setting	Customized setting	①	②
Linked operation of components when mechanical key is used (open only)	Slide only	Tilt only	—	○
Linked operation of components when wireless remote control is used	Slide only	Tilt only	—	○

*: If equipped

■ Driving position memory* (→P. 159)

Function	Default setting	Customized setting	①	②
Selecting doors linked to the memory recall function	Driver's door	All doors	—	○
Driver's seat movement when exiting the vehicle	Standard	Off	○	○
		Partial		
Steering wheel movement	Tilt only	Telescopic only	○	○
		Tilt & telescopic		
		Off		

*: If equipped

■ Automatic light control system (→P. 218)

Function	Default setting	Customized setting	①	②
Light sensor sensitivity	Standard	-2 to 2	○	○
Time elapsed before headlights automatically turn off after doors are closed	30 seconds	Off	○	○
		60 seconds		
		90 seconds		

■ Lights (→P. 218)

Function	Default setting	Customized setting	①	②
Daytime running light system	On	Off	○	○
Welcome lighting	On	Off	—	○
Windshield wiper linked headlight illumination	On	Off	—	○

■ Intuitive parking assist* (→P. 292)

Function	Default setting	Customized setting	①	②
Detection distance of the front center sensor	Far	Near	—	○
Detection distance of the rear center sensor	Far	Near	—	○

*: If equipped

■ BSM (Blind Spot Monitor) (→P. 276)

Function	Default setting	Customized setting	①	②
Outside rear view mirror indicator brightness	Bright	Dim	—	○
Alert sensitivity for presence of approaching vehicle	Intermediate	Early	—	○
		Late		
		Only when vehicle detected in blind spot		

■ RCTA (Rear Cross Traffic Alert) (→P. 276)

Function	Default setting	Customized setting	①	②
Buzzer volume	2	1 to 3	—	○

■ Automatic air conditioning system (→P. 338)

Function	Default setting	Customized setting	①	②
A/C auto switch operation	Auto	Manual	○	○

■ Illumination (→P. 352)

Function	Default setting	Customized setting	①	②
Time elapsed before lights turn off	15 seconds	Off	○	○
		7.5 seconds		
		30 seconds		
Operation after the power switch turned off	On	Off	—	○
Operation when the doors are unlocked	On	Off	—	○
Operation when you approach the vehicle with the electronic key on your person	On	Off	—	○
Ambient lights*	On	Off	—	○

*: If equipped

**WARNING****■ During customization**

As the hybrid system needs to be operating during customization, ensure that the vehicle is parked in a place with adequate ventilation. In a closed area such as a garage, exhaust gases including harmful carbon monoxide (CO) may collect and enter the vehicle. This may lead to death or a serious health hazard.

**NOTICE****■ During customization**

To prevent 12-volt battery discharge, ensure that the hybrid system is operating while customizing features.

Items to initialize

The following items must be initialized for normal system operation after such cases as the 12-volt battery being reconnected, or maintenance being performed on the vehicle:

Item	When to initialize	Reference
Message indicating maintenance is required	<ul style="list-style-type: none"> • After the maintenance is performed 	P. 393
Tire pressure warning system	<ul style="list-style-type: none"> • When the tire inflation pressure is changed such as when changing traveling speed or load weight • When the tire inflation pressure is changed such as when the tire size is changed • When rotating the tires • After performing the transmitter ID code registration procedure 	P. 417
Intelligent Clearance Sonar (ICS) (If equipped)	<ul style="list-style-type: none"> • After reconnecting or changing the 12-volt battery 	P. 311

For owners

9

Reporting safety defects for
U.S. owners 538

Reporting safety defects for U.S. owners

If you believe that your vehicle has a defect which could cause a crash or could cause injury or death, you should immediately inform the National Highway Traffic Safety Administration (NHTSA) in addition to notifying Toyota Motor Sales, U.S.A., Inc. (Toll-free: 1-800-331-4331).

If NHTSA receives similar complaints, it may open an investigation, and if it finds that a safety defect exists in a group of vehicles, it may order a recall and remedy campaign. However, NHTSA cannot become involved in individual problems between you, your dealer, or Toyota Motor Sales, U.S.A., Inc.

To contact NHTSA, you may call the Vehicle Safety Hotline toll-free at 1-888-327-4236 (TTY: 1-800-424-9153); go to <http://www.safercar.gov>; or write to: Administrator, NHTSA, 1200 New Jersey Ave. SE., Washington, DC 20590. You can also obtain other information about motor vehicle safety from <http://www.safercar.gov>.

Index

What to do if... (Troubleshooting)	540
Alphabetical index	544

For information regarding the equipment listed below, refer to “NAVIGATION AND MULTIMEDIA SYSTEM OWNER’S MANUAL”.

- Navigation system
- Audio/visual system
- Toyota parking assist monitor
- Panoramic view monitor
- Connected Services

What to do if... (Troubleshooting)

If you have a problem, check the following before contacting your Toyota dealer.

The doors cannot be locked, unlocked, opened or closed



You lose your keys

- If you lose your mechanical keys, new genuine mechanical keys can be made by your Toyota dealer. (→P. 135)
- If you lose your electronic keys, the risk of vehicle theft increases significantly. Contact your Toyota dealer immediately. (→P. 137)



The doors cannot be locked or unlocked

- Is the key battery weak or depleted? (→P. 439)
- Is the power switch in ON mode?
When locking the doors, turn the power switch off. (→P. 197)
- Is the electronic key left inside the vehicle?
When locking the doors, make sure that you have the electronic key on your person.
- The function may not operate properly due to the condition of the radio wave. (→P. 151)



The rear door cannot be opened

- Is the child-protector lock set?
The rear door cannot be opened from inside the vehicle when the lock is set. Open the rear door from outside and then unlock the child-protector lock. (→P. 141)



The trunk lid is closed with the electronic key left inside

- The function to prevent the electronic key from being left inside the trunk will operate and you can open the trunk as usual. Take the key out from the trunk. (→P. 145)

If you think something is wrong



The hybrid system does not start

- Did you press the power switch while firmly depressing the brake pedal? (→P. 196)
- Is the shift lever in P? (→P. 198)
- Is the electronic key anywhere detectable inside the vehicle? (→P. 148)
- Is the steering wheel unlocked? (→P. 199)
- Is the electronic key battery weak or depleted?
In this case, the hybrid system can be started in a temporary way. (→P. 485)
- Is the 12-volt battery discharged? (→P. 487)



The shift lever cannot be shifted from P even if you depress the brake pedal

- Is the power switch in ON mode?
If you cannot release the shift lever by depressing the brake pedal with the power switch in ON mode. (→P. 209)



The steering wheel cannot be turned after the hybrid system is stopped

- It is locked automatically to prevent theft of the vehicle. (→P. 199)



The windows do not open or close by operating the power window switches

- Is the window lock switch pressed?
The power window except for the one at the driver's seat cannot be operated if the window lock switch is pressed. (→P. 173)



The power switch is turned off automatically

- The auto power off function will be operated if the vehicle is left in ACCESSORY or ON mode (the hybrid system is not operating) for a period of time. (→P. 198)



A warning buzzer sounds during driving

- The seat belt reminder light is flashing
Are the driver and the passenger wearing the seat belts? (→P. 458)
- The parking brake indicator is on
Is the parking brake released? (→P. 212)

Depending on the situation, other types of warning buzzer may also sound. (→P. 455, 465)



An alarm is activated and the horn sounds

- Did anyone inside the vehicle open a door during setting the alarm?
The sensor detects it and the alarm sounds. (→P. 88)
Do one of the following to stop the alarm:
 - Unlock the doors.
 - Open the trunk using the entry function or wireless remote control.
 - Turn the power switch to ACCESSORY or ON mode, or start the hybrid system.



A warning buzzer sounds when leaving the vehicle

- Is the message displayed on the multi-information display?
Check the message on the multi-information display. (→P. 465)



A warning light turns on or a warning message is displayed

- When a warning light turns on or a warning message is displayed, refer to P. 455, 465.

When a problem has occurred



If you have a flat tire

- Stop the vehicle in a safe place and replace the flat tire with the spare tire. (→P. 471)



The vehicle becomes stuck

- Try the procedure for when the vehicle becomes stuck in mud, dirt, or snow. (→P. 498)

Alphabetical index

A

A/C	338
Air conditioning filter	432
Automatic air conditioning system	338
ABS	
(Anti-lock Brake System)	323
Warning light	456
Acoustic Vehicle Alerting System	76
AGC (Auto glide control)	322
Air conditioning filter	432
Air conditioning system	338
Air conditioning filter	432
Automatic air conditioning system	338
S-FLOW mode	341
Airbags	34
Airbag operating conditions	43
Airbag precautions for your child	37
Correct driving posture	26
Curtain shield airbag operating conditions	44
Curtain shield airbag precautions	40
Front passenger occupant classification system	48
General airbag precautions	37
Locations of airbags	34
Modification and disposal of airbags	42
Side airbag operating conditions	44
Side airbag precautions	37
Side and curtain shield airbags operating conditions	44
Side and curtain shield airbags precautions	37
SRS airbags	34
SRS warning light	456

Alarm	88
Ambient lights	354
Anchor brackets	58
Antennas	
(smart key system)	148
Anti-lock Brake System (ABS)	323
Warning light	456
Approach warning	271
Armrest	375
Assist grips	375
Audio Plus*	
Audio/visual system*	
Auto glide control (AGC)	322
Automatic air conditioning system	338
Air conditioning filter	432
Automatic High Beam	222
Automatic light control system	218
Auxiliary boxes	359

B

Back-up lights	
Replacing light bulb	445
Battery (12-volt battery)	411
Battery checking	411
If the battery is discharged....	487
Preparing and checking	
before winter.....	333
Replacing.....	491
Battery (traction battery).....	79
Blind Spot Monitor (BSM)	276
Blind Spot Monitor	
function.....	280
Rear Cross Traffic Alert	
function.....	283
Bottle holders	357
Brake	
Brake Hold	216
Fluid	507
Parking brake.....	212
Warning light.....	455
Brake assist	323
Brake Hold.....	216
Warning light.....	457
Brake override system	183
Break-in tips	184
Brightness control	
Ambient lights	354
Instrument panel light	
control.....	99
BSM (Blind Spot Monitor)	276
Blind Spot Monitor	
function.....	280
Rear Cross Traffic Alert	
function.....	283

C

Care	
Exterior	386
Interior	389
Seat belts.....	390
Wheels and wheel	
ornaments	387
Cargo capacity.....	193
Cargo net.....	361
Chains	334
Child restraint system.....	54
Booster seats, definition	55
Booster seats, installation.....	64
Convertible seats, definition ...	55
Convertible seats,	
installation	62
Front passenger occupant	
classification system	48
Infant seats, definition.....	55
Infant seats, installation.....	61
Installing CRS	
with LATCH anchors	59
Installing CRS	
with seat belts	61
Installing CRS	
with top tether strap.....	65

*: Refer to the “NAVIGATION AND MULTIMEDIA SYSTEM OWNER’S MANUAL”.

Child safety	53
12-volt battery	
precautions	413, 492
Airbag precautions	37
Battery precautions	413, 492
Child restraint system	54
How your child should wear	
the seat belt	30
Installing child restraints	58
Moon roof precautions	180
Power window lock switch	173
Power window precautions ...	176
Rear door child-protectors	141
Removed electronic key	
battery precautions	440
Seat belt extender	
precautions	33
Seat belt precautions	32
Seat heater precautions	349
Trunk precautions	146
Child-protectors	141
Cleaning	386, 389
Exterior	386
Interior	389
Seat belts	390
Wheels and wheel	
ornaments	387
Coat hooks	376
Condenser	408
Connected Services*	
Console box	356
Consumption	
screen	106, 128
Coolant	
Capacity	506
Checking	407
Preparing and checking	
before winter	333
Cooling system	407
Hybrid system	
overheating	494
Cornering lights	219

Cruise control

Dynamic radar cruise control	
with full-speed range	263
Cup holders	358
Curtain shield airbags	35
Customizable features	526

D

Daytime running light

system	219
--------------	-----

Defogger

Outside rear view mirrors	343
Rear window	343
Windshield	343

Dimensions

502

Dinghy towing

195

Display

Dynamic radar cruise control	
with full-speed range	263
LDA (Lane Departure Alert	
with steering control)	258
Multi-information display	102
Warning messages	465

Do-it-yourself maintenance

399

Door courtesy lights

Location	352
Wattage	509

Door lock

Doors	138
Smart key system	138
Wireless remote control	138

Doors

Automatic door locking	
and unlocking systems	141
Door lock	140
Outside rear view mirrors	170
Rear door child-protector	141
Side doors	138
Side windows	173

Drive-Start Control

184

Driver's seat belt

reminder light	458
----------------------	-----

Driver's seat position	
memory	159
Driving	
Break-in tips	184
Correct posture	26
Driving mode select	
switches.....	321
Hybrid vehicle driving tips	330
Procedures	182
Winter drive tips	333
Driving information	106
Driving position memory	159
Memory recall function.....	162
Power easy access	
system	159
Dynamic radar cruise control	
with full-speed range	263

E

ECO Accelerator Guidance	109
Eco drive mode	321
Eco guide	109
Eco score	109
EDR	
(Event data recorder)	10
Electric motor	
(traction motor)	79
Electric Power Steering	
(EPS)	324
Warning light.....	457
Electronic key	134
Battery-saving function	150
If the electronic key does	
not operate properly	484
Replacing the battery.....	439
Emergency flashers	448

Emergency, in case of

If a warning buzzer	
sounds.....	455
If a warning light turns on	455
If a warning message is	
displayed	465
If the 12-volt battery is	
discharged.....	487
If the electronic key does not	
operate properly	484
If the hybrid system	
will not start	482
If the vehicle is trapped in	
rising water	450
If you have a flat tire	471
If you lose your keys.....	135, 137
If you think something is	
wrong	454
If your vehicle becomes	
stuck.....	498
If your vehicle has to be	
stopped in an emergency...	449
If your vehicle needs to be	
towed.....	451
If your vehicle overheats.....	494

*: Refer to the "NAVIGATION AND MULTIMEDIA SYSTEM OWNER'S MANUAL".

Engine

ACCESSORY mode	197
Compartment	403
Engine switch	196
Hood	401
How to start the hybrid system	196
Identification number	503
If your vehicle has to be stopped in an emergency	449
Ignition switch (power switch)	196
Overheating	494
Power switch	196
Engine coolant	
Capacity	506
Checking	407
Preparing and checking before winter	333
Engine coolant temperature gauge	98
Engine oil	
Capacity	505
Checking	404
Preparing and checking before winter	333
Engine switch	196
Enhanced VSC	323
EPS	
(Electric Power Steering)	324
Warning light	457
EV drive mode	202
Event data recorder (EDR)	10
Exclusive jump starting terminal	487

F

Flat tire	471
Floor mats	24
Fluid	
Brake	507
Hybrid transmission	507
Washer	410
Front interior light	353
Front passenger occupant classification system	48
Front passenger's seat belt reminder light	458
Front personal lights	353
Front seat heaters	349
Front seats	155
Adjustment	155
Cleaning	389
Correct driving posture	26
Driving position memory	159
Head restraints	164
Power easy access system	159
Seat heaters	349
Seat ventilators	349
Front side marker lights	
Light switch	218
Replacing light bulbs	445
Front turn signal lights	
Replacing light bulbs	445
Turn signal lever	211
Fuel	
Capacity	504
Fuel gauge	98
Information	510
Refueling	230
Type	504, 510
Warning light	458
Fuel consumption	106, 131
Fuel filler door	230
If the fuel filler door cannot be opened	234
Refueling	230
Fuses	442

G

Garage door opener	377
Gauges	98
Glove box	356
Grocery bag hooks	361

H

Head restraints	164
Head-up display	121
Headlights	218
Automatic High Beam	222
Light switch	218
Replacing light bulbs.....	445
Windshield wiper linked headlight illumination.....	220
Heated steering wheel	349
Heaters	
Automatic air conditioning system.....	338
Outside rear view mirrors.....	343
Seat heaters	349
High mounted stoplight	
Replacing.....	445
High voltage components	79
Hill-start assist control	323
Hood	401
Hooks	
Coat hooks.....	376
Grocery bag hooks	361
Retaining hooks (floor mat).....	24
Horn	167
HUD (Head-up display)	121
Hybrid battery	
(traction battery).....	79
Hybrid battery	
(traction battery) air intake vent	80, 434

Hybrid system..... **75**

Acoustic Vehicle Alerting System	76
Emergency shut off system	80
Energy monitor/ consumption screen	128
EV drive mode	202
High voltage components	79
Hybrid System Indicator	100
Hybrid system precautions	79
Hybrid vehicle driving tips.....	330
If the hybrid system will not start	482
Overheating	494
Power (ignition) switch.....	196
Starting the hybrid system	196
Hybrid System Indicator	100
Hybrid transmission	205
If the shift lever cannot be shifted from P	209
Paddle shift switches	208
S mode	207

I

- I/M test** 398
- ICS (Intelligent Clearance Sonar)**..... 300
 - Warning light..... 457
 - Warning messages 311
- Identification**
 - Engine..... 503
 - Vehicle 503
- Ignition switch (power switch)** 196
- Illuminated entry system** 354
- Immobilizer system** 86
- Indicators** 95
- Initialization**
 - Intelligent Clearance Sonar..... 311
 - Items to initialize 535
 - Tire pressure warning system 416
- Inside rear view mirror**..... 168
- Instrument panel light control**..... 99
- Intelligent Clearance Sonar (ICS)**..... 300
 - Warning light..... 457
 - Warning messages 311
- Interior lights**..... 352
 - Switch 353
- Intuitive parking assist**..... 292

J

- Jack**
 - Positioning the jack..... 402
 - Vehicle-equipped jack..... 471
- Jack handle**..... 471
- Jam protection function**
 - Moon roof..... 178
 - Power window..... 173

K

- Keyless entry**
 - Smart key system 138, 144
 - Wireless remote control 138, 145
- Keys**..... 134
 - Battery-saving function 150
 - Electronic key 134
 - Engine switch 196
 - If the electronic key does not operate properly 484
 - If you lose your keys..... 135, 137
 - Key number plate 134
 - Keyless entry..... 134
 - Mechanical key..... 135
 - Power switch 196
 - Replacing the battery..... 439
 - Warning buzzer 149
 - Wireless remote control..... 134
- Knee airbags**..... 34

L

- Lane Departure Alert with steering control (LDA)** 252
- Language (multi-information display)**..... 116
- LATCH anchors** 59
- LDA (Lane Departure Alert with steering control)** 252
- Lever**
 - Auxiliary catch lever..... 401
 - Hood lock release lever 401
 - Internal trunk release lever... 146
 - Shift lever..... 205
 - Tilt and telescopic steering lock release lever 166
 - Turn signal lever 211
 - Wiper lever 226
- License plate lights**
 - Light switch..... 218
 - Replacing light bulbs 445

Light bulbs

Replacing..... 445

Lights

Automatic High Beam..... 222

Cornering lights..... 219

Daytime running light
system..... 219

Door courtesy lights..... 352

Headlight switch..... 218

Illuminated entry system..... 354

Interior lights..... 353

Interior lights list..... 352

Personal lights..... 353

Replacing light bulbs..... 445

Trunk light..... 145

Turn signal lever..... 211

Vanity lights..... 362

Wattage..... 509

Welcome lighting..... 221

Load capacity..... 193

Lock steering column..... 199

M**Maintenance**

Do-it-yourself maintenance... 399

General maintenance..... 394

Maintenance data..... 502

Maintenance
requirements..... 392

Resetting the message
indicating maintenance
is required..... 393

Malfunction indicator lamp..... 456

Master warning light..... 458

Memory recall function..... 162

Meter

Head-up display..... 121

Indicators..... 95

Instrument panel light
control..... 99

Meters..... 98

Multi-information display..... 102

Settings..... 111

Warning lights..... 93

Warning messages..... 465

Mirrors

Inside rear view mirror..... 168

Outside rear view mirror
defoggers..... 343

Outside rear view mirrors..... 170

Vanity mirrors..... 362

Moon roof..... 177

Door lock linked moon roof
operation..... 178

Jam protection function..... 178

Operation..... 177

Multi-information display..... 102

Driving information..... 106

Dynamic radar cruise control
with full-speed range..... 263

Language..... 116

LDA (Lane Departure Alert
with steering control)..... 258

Outside temperature..... 98

PCS (Pre-Collision
System)..... 245

Settings..... 111

Suggestion function..... 118

Warning messages..... 465

N

- Navigation system***
- Noise from under vehicle..... 6**

O

- Odometer..... 98**
- Oil**
 - Engine oil 505
- Opener**
 - Fuel filler door 233
 - Hood 401
 - Trunk..... 144
- Outside rear view mirrors 170**
 - Adjusting and folding 170
 - Blind spot monitor (BSM)..... 276
 - Linked mirror function
 - when reversing 171
 - Mirror position memory 159
 - Outside rear view mirror
 - defoggers 343
- Outside temperature display..... 98**
- Overheating, Hybrid system..... 494**

P

- Paddle shift switches..... 208**
- Panic mode 135**
- Panoramic view monitor***
- Parking brake..... 212**
 - Parking brake engaged
 - warning buzzer/
 - message..... 215
 - Warning light..... 456
- Parking lights..... 218**
 - Light switch..... 218
 - Replacing light bulbs 445
- PCS (Pre-Collision System) 242**
 - Warning light..... 457
- Personal lights..... 353**
- Power control unit..... 79**
- Power control unit coolant..... 407**
 - Capacity..... 506
 - Checking..... 407
 - Preparing and checking
 - before winter 333
- Power outlet..... 363**
- Power steering (Electric power steering system) 324**
 - Warning light..... 457
- Power switch 196**
- Power windows 173**
 - Door lock linked window
 - operation 175
 - Jam protection function 173
 - Operation 173
 - Window lock switch 173
- Pre-Collision System (PCS) 242**
 - Warning light..... 457
- Premium Audio***

R

Radar cruise control	
(dynamic radar cruise control with full-speed range)	263
Radiator	408
Rear Camera Detection	
Function	288
Rear Cross Traffic Alert	283
Rear Cross Traffic	
Auto Brake	302
Rear passengers' seat belt reminder light	458
Rear personal lights	353
Rear seat	
Folding down	157
Rear seat heaters	349
Rear side marker lights	
Light switch	218
Replacing light bulbs	445
Rear turn signal lights	
Replacing light bulbs	445
Turn signal lever	211

Rear view mirror

Inside rear view mirror	168
Outside rear view mirrors	170
Rear window defogger	343
Refueling	230
Capacity	504
Fuel types	504, 510
If the fuel filler door cannot be opened	234
Opening the fuel tank cap	233
Replacing	
Electronic key battery	439
Fuses	442
Light bulbs	445
Tires	471
Reporting safety defects for U.S. owners	538
Resetting the message indicating maintenance is required	393
Road accident cautions	83

*: Refer to the "NAVIGATION AND MULTIMEDIA SYSTEM OWNER'S MANUAL".

S

Safety Connect	69
Seat belt reminder light	458
Seat belts	28
Adjusting the seat belt	29
Automatic Locking	
Retractor.....	30
Child restraint system	
installation	58
Cleaning and maintaining	
the seat belt.....	390
Emergency Locking	
Retractor.....	30
How to wear your seat belt	28
How your child should wear	
the seat belt.....	30
Pregnant women, proper	
seat belt use	31
Reminder light and buzzer....	458
Seat belt extender.....	30
Seat belt pretensioners.....	29
SRS warning light	456
Seat heaters	349
Seat ventilators	349
Seating capacity	193

Seats	155, 157
Adjustment.....	155, 157
Adjustment	
precautions.....	156, 158
Child seats/child restraint	
system installation.....	58
Cleaning	389
Driving position memory	159
Folding down the rear	
seatbacks	157
Front seat heaters	349
Head restraints	164
Power easy access	
system.....	159
Properly sitting in the seat	26
Rear seat heaters	349
Seat ventilators.....	349
Secondary Collision Brake	324
Sensor	
Automatic headlight	
system.....	220
Automatic High Beam	
system.....	222
Camera sensor	236
Inside rear view mirror	169
Intuitive parking assist	292
LDA (Lane Departure Alert	
with steering control).....	252
Radar sensor	236

- Service reminder**
- indicators 92
- Service plug** 79
- Shift lever** 205
- Hybrid transmission 205
- If the shift lever cannot
be shifted from P 209
- S mode 207
- Shift lock system** 209
- Side airbags** 35
- Side marker lights** 218
- Light switch 218
- Replacing light bulbs 445
- Side mirrors** 170
- Adjusting and folding 170
- BSM (Blind Spot Monitor) 276
- Heaters 343
- Side turn signal lights**
- Replacing light bulbs 445
- Turn signal lever 211
- Smart key system** 148
- Antenna location 148
- Entry functions 138, 144
- Starting the hybrid system 196
- Snow tires** 335
- Spare tire** 471
- Inflation pressure 508
- Storage location 471
- Spark plug** 506
- Specifications** 502
- Speedometer** 98
- Sport mode** 321
- Steering lock**
- Column lock release 199
- Steering wheel** 166
- Adjustment 166
- Heated steering wheel 349
- Meter control switches 103
- Power easy access
system 159
- Stoplights**
- Replacing light bulbs 445
- Storage feature** 355
- Storage precautions** 355
- Stuck**
- If the vehicle becomes
stuck 498
- Sun visors** 362
- Sunshade**
- Roof 178

Switches

- Automatic High Beam
 - switch 222
- Brake hold switch..... 216
- Cruise control switch..... 263
- Door lock switches..... 140
- Driving mode select
 - switches..... 321
- Driving position memory
 - switches..... 159
- Emergency flasher switch..... 448
- EV drive mode switch 202
- Fuel door opener switch 233
- Garage door opener
 - switches..... 377
- Heated steering wheel 349
- Ignition switch 196
- LDA (Lane Departure Alert
 - with steering control)
 - switch 257
- Light switch 218
- Meter control switches 103
- “MOOD” switch 354
- Moon roof switches..... 177
- “ODO/TRIP” switch..... 104
- Outside rear view mirror
 - switches 170
- Paddle shift switches 208
- Parking brake switch 212
- Power door lock switch..... 140
- Power switch 196
- Power window switches..... 173
- Rear window and outside
 - rear view mirror
 - defoggers switch 343
- Seat heater switches 349
- Seat ventilators switches 349
- “SOS” button..... 69
- Tilt and telescopic steering
 - lock release switch 166
- Trunk opener switch 144
- Vehicle-to-vehicle
 - distance switch..... 263
- VSC OFF switch 324
- Window lock switch 173
- Windshield wiper and
 - washer switch..... 226
- Wireless charger switch..... 366

T

Tachometer	98
Tail lights	
Light switch	218
Replacing light bulbs	445
Theft deterrent system	
Alarm	88
Immobilizer system	86
Tire inflation pressure	427
Maintenance data	508
Warning light	458
Tire information	513
Glossary	520
Size	516
Tire identification number	515
Uniform Tire Quality Grading	518
Tire pressure warning system	
Initializing	417
Installing tire pressure warning valve and transmitters	417
Registering ID codes	419
Warning light	458

Tires	415
Chains	334
Checking	415
Glossary	520
If you have a flat tire	471
Inflation pressure	508
Replacing	471
Rotating tires	415
Size	508
Snow tires	335
Spare tire	471
Tire pressure warning system	416
Uniform Tire Quality Grading	518
Warning light	458
Tools	471
Top tether strap	65
Total load capacity	193
Towing	
Dinghy towing	195
Emergency towing	451
Trailer towing	194
Toyota parking assist monitor*	
Toyota Safety Sense P	235
Automatic High Beam	222
Dynamic radar cruise control with full-speed range	263
LDA (Lane Departure Alert with steering control)	252
PCS (Pre-Collision System)	242

*: Refer to the “NAVIGATION AND MULTIMEDIA SYSTEM OWNER’S MANUAL”.

TRAC (Traction Control)	323
Traction battery	
(hybrid battery).....	79
Traction Control (TRAC)	323
Traction motor	
(electric motor).....	75
Trailer towing	194
Transmission	
Driving mode select	
switches.....	321
Hybrid transmission	205
If the shift lever cannot be	
shifted from P	209
Paddle shift switches	208
S mode	207
Trip meters	98
Trunk.....	144
Cargo net.....	361
Grocery bag hooks	361
Internal trunk release lever ...	146
Smart key system	144
Trunk light.....	145
Trunk opener	144
Wireless remote control	145
Trunk light	
Trunk light.....	145
Wattage	509
Turn signal lights	
Replacing light bulbs.....	445
Turn signal lever	211

U

USB charging port.....	364
-------------------------------	------------

V

Vanity lights	362
Wattage	509
Vanity mirrors	362
Vanity lights	362
Vehicle data recording.....	8
Vehicle identification	
number.....	503
Vehicle Stability Control	
(VSC)	323
VSC	
(Vehicle Stability Control)	323

W

Warning buzzers	
Approach warning.....	271
Brake system.....	455
Downshifting	208
Electric power steering	
system.....	457
Intuitive parking assist	295
Lane departure alert	
function.....	253
Light reminder.....	220
Open door.....	142
Open hood.....	401
Open moon roof.....	179
Open trunk.....	145
Parking brake	456
Pre-collision warning	242
Seat belt reminder	458
Vehicle sway warning	255

- Warning lights..... 93**
- ABS..... 456
 - Brake hold operated
 - indicator..... 457
 - Brake Override System..... 456
 - Brake system..... 455
 - Charging system..... 455
 - Drive-Start Control..... 456
 - Driver's seat belt
 - reminder..... 458
 - Electric power steering..... 457
 - Front passenger's
 - seat belt reminder..... 458
 - High coolant temperature..... 455
 - ICS OFF indicator..... 457
 - LDA indicator..... 457
 - Low engine oil pressure..... 455
 - Low fuel level..... 458
 - Malfunction indicator lamp..... 456
 - Master warning light..... 458
 - Parking brake indicator..... 456
 - PCS warning light..... 457
 - Rear passengers'
 - seat belt reminder light..... 458
 - Seat belt reminder light..... 458
 - Slip indicator..... 458
 - SRS..... 456
 - Tire pressure..... 458
- Warning messages..... 465**
- Washer 226**
- Checking..... 410
 - Preparing and checking
 - before winter..... 333
 - Switch..... 226
- Washing and waxing..... 386**
- Weight 502**
- Cargo capacity..... 193
 - Load limits..... 193
 - Vehicle capacity weight..... 502
- Wheels..... 430**
- Replacing..... 430
 - Size..... 508
- Window glasses 173**
- Window lock switch 173**
- Windows..... 173**
- Power windows..... 173
 - Rear window defogger..... 343
 - Washer..... 226
- Windshield wipers..... 226**
- Winter driving tips..... 333**
- Wireless charger 366**
- Wireless remote control 134**
- Battery-Saving Function..... 150
 - Locking/Unlocking..... 138, 145
 - Panic mode..... 135
 - Replacing the battery..... 439

GAS STATION INFORMATION

Auxiliary catch lever

P. 401

Trunk opener

P. 144

Fuel filler door

P. 230

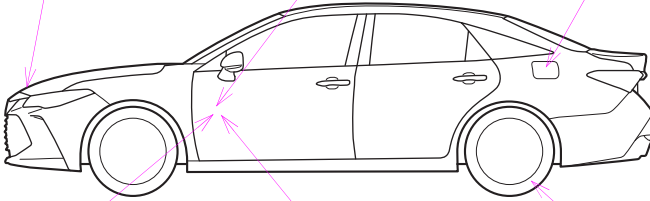

CTHPIBV001

Hood lock release
lever

P. 401

Fuel filler
door opener

P. 230

Tire inflation
pressure

P. 508

Fuel tank capacity
(Reference)

13 gal. (49.3 L, 10.8 Imp. gal.)

Fuel type

P. 504, 510

Cold tire inflation
pressure

P. 508

Engine oil capacity
(Drain and refill —
reference)

P. 505

Engine oil type

"Toyota Genuine Motor Oil" or equivalent
P. 505